



**Calhoun: The NPS Institutional Archive**  
**DSpace Repository**

---

Theses and Dissertations

1. Thesis and Dissertation Collection, all items

---

2008-09

## C4I architecture supporting conduct of defensive and offensive joint ASW

Clendening, Michael; New, James; Cuevas, Alejandro;  
Ngo, Van; Dhindsa, Amritpal; Patel, Amrish; Hopkins,  
Dennis; Saijid, Baasit; Letourneau, Matthew; Traganza, William...  
Monterey, California

---

<http://hdl.handle.net/10945/6987>

*Downloaded from NPS Archive: Calhoun*



Calhoun is a project of the Dudley Knox Library at NPS, furthering the precepts and goals of open government and government transparency. All information contained herein has been approved for release by the NPS Public Affairs Officer.

**Dudley Knox Library / Naval Postgraduate School**  
**411 Dyer Road / 1 University Circle**  
**Monterey, California USA 93943**

<http://www.nps.edu/library>



# NAVAL POSTGRADUATE SCHOOL

MONTEREY, CALIFORNIA

## **C4I Architecture Supporting Conduct of Defensive and Offensive Joint ASW**

By

Michael Clendening  
Alejandro Cuevas  
Amritpal Dhindsa  
Dennis Hopkins  
Matthew Letourneau  
Justin Loy

James New  
Van Ngo  
Amrish Patel  
Baasit Saijid  
William Traganza

September 2008

**Approved for public release; distribution is unlimited**

Prepared for: Chairman of the Systems Engineering Department in partial fulfillment of  
the requirements for the degree of Master of Science in Systems Engineering

THIS PAGE INTENTIONALLY LEFT BLANK

**NAVAL POSTGRADUATE SCHOOL  
Monterey, California 93943-5000**

Daniel T. Oliver  
President

Leonard A. Ferrari  
Executive Vice President and  
Provost

This report was prepared for the Chairman of the Systems Engineering Department in partial fulfillment of the requirements for the degree of Master of Science in Systems Engineering.

Reproduction of all or part of this report is authorized.

This report was prepared by the Master of Science in Systems Engineering (MSSE) Cohort 311-071 from the (Command(s)): SPAWAR Systems Center San Diego and Charleston, Naval Surface Warfare Center Corona Division, Naval Sea Systems Command, PEO C4I, JTRS JPEO, East Coast Electronic Warfare Systems, PEO CS&CSS, and CERDEC

\_\_\_\_\_  
Michael Clendening

\_\_\_\_\_  
Alejandro Cuevas

\_\_\_\_\_  
Amritpal Dhindsa

\_\_\_\_\_  
Dennis Hopkins

\_\_\_\_\_  
Matthew Letourneau

\_\_\_\_\_  
Justin Loy

\_\_\_\_\_  
James New

\_\_\_\_\_  
Van Ngo

\_\_\_\_\_  
Amrish Patel

\_\_\_\_\_  
Baasit Saijid

\_\_\_\_\_  
William Traganza

Reviewed by:

\_\_\_\_\_  
Gregory A. Miller  
Project Advisor

\_\_\_\_\_  
John M. Green  
Project Advisor

Released by:

\_\_\_\_\_  
David H. Olwell, Ph.D.  
Department of Systems Engineering  
Second Reader

\_\_\_\_\_  
Karl A. van Bibber, Ph. D.  
Vice President and  
Dean of Research



THIS PAGE INTENTIONALLY LEFT BLANK

<b>REPORT DOCUMENTATION PAGE</b>			<i>Form Approved OMB No. 0704-0188</i>
Public reporting burden for this collection of information is estimated to average 1 hour per response, including the time for reviewing instruction, searching existing data sources, gathering and maintaining the data needed, and completing and reviewing the collection of information. Send comments regarding this burden estimate or any other aspect of this collection of information, including suggestions for reducing this burden, to Washington headquarters Services, Directorate for Information Operations and Reports, 1215 Jefferson Davis Highway, Suite 1204, Arlington, VA 22202-4302, and to the Office of Management and Budget, Paperwork Reduction Project (0704-0188) Washington DC 20503.			
<b>1. AGENCY USE ONLY (Leave blank)</b>	<b>2. REPORT DATE</b> September 2008	<b>3. REPORT TYPE AND DATES COVERED</b> Capstone Project Technical Report	
<b>4. TITLE AND SUBTITLE:</b> C4I Architecture Supporting Conduct of Defensive and Offensive Joint ASW		<b>5. FUNDING NUMBERS</b>	
<b>6. AUTHOR(S)</b>		<b>8. PERFORMING ORGANIZATION REPORT NUMBER</b>	
<b>7. PERFORMING ORGANIZATION NAME(S) AND ADDRESS(ES)</b> Naval Postgraduate School Monterey, CA 93943-5000		<b>10. SPONSORING/MONITORING AGENCY REPORT NUMBER</b> NPS-SE-09-001	
<b>9. SPONSORING /MONITORING AGENCY NAME(S) AND ADDRESS(ES)</b> N/A		<b>11. SUPPLEMENTARY NOTES</b> The views expressed in this report are those of the author and do not reflect the official policy or position of the Department of Defense or the U.S. Government.	
<b>12a. DISTRIBUTION / AVAILABILITY STATEMENT</b> Approved for public release; distribution is unlimited.		<b>12b. DISTRIBUTION CODE</b>	
<b>13. ABSTRACT (maximum 200 words)</b> The Anti-Submarine Warfare (ASW) community requires a fully operational Command, Control, Communications, Computers, and Intelligence (C4I) architecture to significantly reduce time from sensor detection to defensive weapons release. The United States Navy has established programs of record leveraging space, terrestrial, and maritime communications capabilities extending to fiscal year 2015. An ordered systems engineering process was performed to derive requirements and identify Joint ASW C4I Architecture strengths and weaknesses. This architecture is dependent upon the ASW community's ability to leverage current and planned technologies impacting C4I areas including common operational tactical picture delivery, data transmission rate, time latency, and data fusion processes. Performance forecasts for identified alternatives were modeled and simulated based on a synthesized operational scenario using the EXTEND simulation tool, and life cycle cost estimates were produced for each alternative. Based on those outcomes, one of the several alternatives is recommended for implementation. In addition, it was discovered that programmed C4I capabilities lack an integrated fielding plan and do not properly align in FY2020. Furthermore, the ASW community must make process changes to enable cross-program manager collaboration supported by a single system architect to ensure robust architectures are fielded by 2020.			
<b>14. SUBJECT TERMS</b> Command, Control, Communications, Computers, and Intelligence (C4I), Joint, ASW, Architecture			<b>15. NUMBER OF PAGES</b> 306
			<b>16. PRICE CODE</b>
<b>17. SECURITY CLASSIFICATION OF REPORT</b> Unclassified	<b>18. SECURITY CLASSIFICATION OF THIS PAGE</b> Unclassified	<b>19. SECURITY CLASSIFICATION OF ABSTRACT</b> Unclassified	<b>20. LIMITATION OF ABSTRACT</b> UU

THIS PAGE INTENTIONALLY LEFT BLANK

## **ABSTRACT**

The Anti-Submarine Warfare (ASW) community requires a fully operational Command, Control, Communications, Computers, and Intelligence (C4I) architecture to significantly reduce time from sensor detection to defensive weapons release. The United States Navy has established programs of record leveraging space, terrestrial, and maritime communications capabilities extending to fiscal year 2015. An ordered systems engineering process was performed to derive requirements and identify Joint ASW C4I Architecture strengths and weaknesses. This architecture is dependent upon the ASW community's ability to leverage current and planned technologies impacting C4I areas including common operational tactical picture delivery, data transmission rate, time latency, and data fusion processes. Performance forecasts for identified alternatives were modeled and simulated based on a synthesized operational scenario using the EXTEND simulation tool, and life cycle cost estimates were produced for each alternative. Based on those outcomes, one of the several alternatives is recommended for implementation. In addition, it was discovered that programmed C4I capabilities lack an integrated fielding plan and do not properly align in FY2020. Furthermore, the ASW community must make process changes to enable cross-program manager collaboration supported by a single system architect to ensure robust architectures are fielded by 2020.

THIS PAGE INTENTIONALLY LEFT BLANK

## TABLE OF CONTENTS

<b>I.</b>	<b>INTRODUCTION.....</b>	<b>1</b>
<b>A.</b>	<b>PROBLEM STATEMENT .....</b>	<b>1</b>
<b>B.</b>	<b>BACKGROUND .....</b>	<b>4</b>
<b>C.</b>	<b>PROJECT DESCRIPTION AND DELIVERABLE PRODUCTS .....</b>	<b>5</b>
<b>D.</b>	<b>SYSTEMS ENGINEERING APPROACH .....</b>	<b>7</b>
<b>1.</b>	<b>Overview .....</b>	<b>7</b>
<b>2.</b>	<b>Tailored Systems Engineering Development Process Phases .....</b>	<b>8</b>
<b>a.</b>	<b>Needs Analysis.....</b>	<b>8</b>
<b>b.</b>	<b>Value System Design.....</b>	<b>9</b>
<b>c.</b>	<b>Alternatives Generation .....</b>	<b>9</b>
<b>d.</b>	<b>Model Alternatives.....</b>	<b>9</b>
<b>e.</b>	<b>Alternative Scoring .....</b>	<b>9</b>
<b>f.</b>	<b>Best Alternative.....</b>	<b>10</b>
<b>II.</b>	<b>NEEDS ANALYSIS .....</b>	<b>11</b>
<b>A.</b>	<b>STAKEHOLDER ANALYSIS .....</b>	<b>12</b>
<b>1.</b>	<b>Resource Sponsors .....</b>	<b>14</b>
<b>2.</b>	<b>Acquisition Community.....</b>	<b>18</b>
<b>3.</b>	<b>User Community .....</b>	<b>24</b>
<b>B.</b>	<b>THREAT ANALYSIS .....</b>	<b>28</b>
<b>C.</b>	<b>FUNCTIONAL ANALYSIS .....</b>	<b>35</b>
<b>1.</b>	<b>Requirements.....</b>	<b>36</b>
<b>2.</b>	<b>Constraints.....</b>	<b>36</b>
<b>a.</b>	<b>Natural Constraints .....</b>	<b>37</b>
<b>b.</b>	<b>Physical Constraints .....</b>	<b>39</b>
<b>c.</b>	<b>Doctrinal Constraints .....</b>	<b>40</b>
<b>d.</b>	<b>Operational Constraints.....</b>	<b>41</b>
<b>e.</b>	<b>Man-Made Constraints .....</b>	<b>42</b>
<b>3.</b>	<b>Interfaces .....</b>	<b>43</b>
<b>4.</b>	<b>Functional Hierarchy.....</b>	<b>44</b>
<b>5.</b>	<b>IDEF0 .....</b>	<b>47</b>
<b>6.</b>	<b>Functional Flow Block Diagram.....</b>	<b>52</b>
<b>D.</b>	<b>FUTURES ANALYSIS.....</b>	<b>54</b>
<b>1.</b>	<b>Purpose.....</b>	<b>54</b>
<b>2.</b>	<b>Process.....</b>	<b>54</b>
<b>3.</b>	<b>Results .....</b>	<b>56</b>
<b>E.</b>	<b>EFFECTIVE NEED.....</b>	<b>57</b>
<b>III.</b>	<b>VALUE SYSTEM DESIGN.....</b>	<b>59</b>
<b>A.</b>	<b>VALUE HIERARCHY.....</b>	<b>60</b>
<b>B.</b>	<b>EVALUATION MEASURES .....</b>	<b>62</b>
<b>IV.</b>	<b>ALTERNATIVES GENERATION.....</b>	<b>65</b>
<b>A.</b>	<b>GENERATION PROCESS.....</b>	<b>65</b>
<b>1.</b>	<b>Conduct Research .....</b>	<b>67</b>
<b>a.</b>	<b>Program of Record Planned Changes.....</b>	<b>68</b>
<b>b.</b>	<b>Network Topologies .....</b>	<b>80</b>

	c.	Communicating with Submarines .....	84
	2.	Construct Joint ASW C4I Architecture Baseline .....	86
	3.	Conduct Functional Gap Analysis.....	100
	4.	Consolidate Value Hierarchy and Stakeholder Analysis .....	108
	5.	Brainstorm Alternative Solutions.....	108
B.		ALTERNATIVE SOLUTIONS .....	109
	1.	Alternative 0 .....	112
	2.	Alternative 1 .....	119
	3.	Alternative 2 .....	122
	4.	Alternative 3 .....	126
V.		MODEL ALTERNATIVES .....	137
	A.	MODELING AND SIMULATION PROCESS .....	137
	B.	SCENARIO AND VIGNETTES OVERVIEW .....	138
	C.	MODELING AND SIMULATION APPROACH .....	141
	1.	Tool Selection .....	141
	2.	Evaluation Measures for Modeling and Simulation .....	142
	3.	Assumptions .....	142
	4.	Generic Model Description .....	143
	a.	Detect.....	143
	b.	Control .....	145
	c.	Engagement .....	149
	5.	Modeling Alternatives .....	150
	D.	MODELING AND SIMULATION RESULTS.....	151
	1.	Throughput Results .....	151
	2.	Latency Results .....	153
	3.	Data Fusion Results .....	155
	E.	MODELING AND SIMULATION SUMMARY.....	157
VI.		LIFE CYCLE COSTS .....	159
	A.	LIFE CYCLE COST OVERVIEW.....	159
	B.	COST ESTIMATION APPROACH.....	159
	1.	Scope.....	159
	2.	Assumptions .....	159
	3.	Cost Breakdown Structure.....	160
	C.	COST DATA COLLECTION .....	163
VII.		ANALYSIS OF ALTERNATIVES .....	167
	A.	METHODOLOGY .....	167
	B.	VALUE MODELING TECHNIQUE .....	168
	C.	UTILITY CURVES .....	169
	1.	Development of Utility Curves.....	169
	2.	Fuse ASW Data Utility Curve.....	171
	3.	Interconnect Communication Nodes Utility Curve .....	172
	4.	Transmit ASW Information Utility Curve.....	173
	D.	RAW DATA VALUES .....	174
	E.	EVALUTION MEASURE WEIGHTING.....	175
	F.	DECISION MATRIX.....	177

G.	UTILITY SCORE VERSUS LIFE CYCLE COST.....	177
VIII.	FINAL RECOMMENDATIONS AND CONCLUSIONS .....	181
A.	CONCLUSION .....	181
B.	AREAS FOR FURTHER CONSIDERATION.....	185
APPENDIX A.	PROJECT PLAN .....	189
APPENDIX B.	NET-CENTRIC SYSTEM REQUIREMENTS.....	203
APPENDIX C.	VALUE HIERARCHY STAKHOLDER SURVEY .....	207
APPENDIX D.	EVALUATION MEASURES.....	211
APPENDIX E.	DEFINITIONS AND IDEF0 DIAGRAMS .....	221
APPENDIX F.	COMPLETE FUNCTIONAL FLOW BLOCK DIAGRAM.....	235
APPENDIX G.	JOINT ASW C4I ARCHITECTURE BASELINE NODE CONFIGURATIONS .....	237
APPENDIX H.	DETAILED SCENARIO.....	241
APPENDIX I.	MODELING AND SIMULATION RESULTS.....	265
	LIST OF REFERENCES.....	271
	INITIAL DISTRIBUTION LIST .....	279



## LIST OF FIGURES

Figure 1. Tenets and Principles of Network Centric Warfare .....	1
Figure 2. Operational View 1 (OV-1).....	6
Figure 3. Tailored Systems Engineering Development Process.....	8
Figure 4. ASW Users and Stakeholders.....	13
Figure 5. Pre-Full Operational Capability .....	29
Figure 6. Submarine Disruptive Activities .....	31
Figure 7. Vulnerabilities of the Threat.....	33
Figure 8. Functional Analysis Process.....	35
Figure 9. Constraints on the Joint ASW C4I Architecture .....	37
Figure 10. Functional Hierarchy .....	45
Figure 11. A-1 (External Systems) IDEF0 Diagram .....	49
Figure 12. IDEF A0 Diagram .....	50
Figure 13. Enhanced Functional Flow Block Diagram .....	53
Figure 14. Futures Process for ASW C4I Net-Centric Operations.....	55
Figure 15. 2020 Net-Centric Operational Environment .....	56
Figure 16. Value System Design Process .....	60
Figure 17. Value Hierarchy.....	61
Figure 18. Alternatives Generation Process.....	65
Figure 19. Notional Star Network Topology Based on Line-Of-Sight and Beyond Line-Of-Sight Communication Systems .....	82
Figure 20. Notional Partial Mesh Network Topology Based on Line-Of-Sight Communication Systems .....	83
Figure 21. Notional Tiered Network Topology Based on Line-Of-Sight Communication Systems .....	84
Figure 22. Aircraft Carrier Strike Group based FY2020 Joint ASW C4I Architecture Baseline.....	87
Figure 23. Joint ASW C4I Architecture Baseline Aircraft Carrier Node Configuration.....	88
Figure 24. Joint ASW C4I Architecture Baseline Cruiser and Destroyer Node Configuration .....	90
Figure 25. Joint ASW C4I Architecture Baseline Submarine Node Configuration .....	91
Figure 26. 2008 Communication Interconnectivity between Nodes .....	93
Figure 27. 2020 Communication Interconnectivity between Nodes .....	94
Figure 28. Military Satellite Communication Systems of Systems Schedule .....	95
Figure 29. Tactical Radio Roadmap .....	96
Figure 30. Graphical Representation of the Systems Expected to Perform the Interconnect Communication Nodes Function for Alternatives 0, 1, and 2 ..	112
Figure 31. Internal System Connectivity for a Typical Node for Alternative 0 and 1 .....	115
Figure 32. Data Processing Flow Diagram for Alternatives 0 and 1 .....	117
Figure 33. Internal Node System Connectivity with NECC absorbed into the CANES System for Alternative 2 .....	123
Figure 34. Data Processing Flow Diagram for Alternative 2 .....	124
Figure 35. Graphical Representation of the Interconnection of Communication of Nodes for Alternative 3 .....	127

Figure 36. Internal Node System Connectivity with the Addition of HALO Network Wireless Access Points Included for Alternative 2.....	129
Figure 37. Internal Node Configuration of High Altitude Aircraft and Graphical representation of Ground, Sea and Air Node Configurations.....	131
Figure 38. Militarized Version of the HALO Aircraft Network Concept .....	132
Figure 39. Data Process Flow Chart for Alternative 3.....	133
Figure 40. Modeling and Simulation Process.....	137
Figure 41. Top-Level Diagram of Model .....	143
Figure 42. Detect Section of the Model .....	144
Figure 43. Control Section of the Model .....	145
Figure 44. Information Operations Module of the Model .....	146
Figure 45. Data Fusion Model .....	147
Figure 46. Provide COTP Module.....	148
Figure 47. Identify, Store, Share and Share ASW Data and Information Module .....	149
Figure 48. Engage Section of the Model .....	150
Figure 49. Throughput Measurement Block Diagram.....	152
Figure 50. Throughput Measurement for Alternative 0.....	153
Figure 51. Latency Measurement Block Diagram.....	154
Figure 52. Latency Time Histogram of Alternative 3.....	155
Figure 53. Data Fusion Measurement Block Diagram .....	156
Figure 54. Fusion Time Histogram for Alternative 1 .....	157
Figure 55. Cost Breakdown Structure.....	161
Figure 56. SSF3 Utility Curve .....	170
Figure 57. SSF9 Utility Curve .....	171
Figure 58. Fuse ASW Data Utility Curve.....	172
Figure 59. Interconnect Communication Nodes Utility Curve.....	172
Figure 60. Transmit ASW Information Utility Curve (Latency).....	173
Figure 61. Transmit ASW Information Utility Curve (Throughput).....	174
Figure 62. Utility vs. LCCE Plot (All Alternatives) .....	178
Figure 63. Utility vs. LCCE Plot (Alt 0, 1, and 2).....	179
Figure 64. Organization Chart .....	192
Figure 65. Tailored Systems Engineering Development Process.....	197
Figure 66. ASW C4I Project Management Plan and Milestones.....	200
Figure 67. Value System A1 - Objectives and Evaluation Measures .....	211
Figure 68. Value System A2 - Objectives and Evaluation Measures .....	213
Figure 69. Value System A3 - Objectives and Evaluation Measures .....	215
Figure 70. Value System A4 - Objectives and Evaluation Measures .....	216
Figure 71. Value System A5 - Objectives and Evaluation Measures .....	217
Figure 72. Value System A0 - Objectives and Evaluation Measures .....	219
Figure 73. IDEF0 A1 Diagram .....	231
Figure 74. IDEF0 A2 Diagram .....	232
Figure 75. IDEF0 A3 Diagram .....	233
Figure 76. IDEF0 A4 Diagram .....	233
Figure 77. IDEF0 A5 Diagram .....	234
Figure 78. Functional Flow Block Diagram .....	235
Figure 79. T-AGOS Class C4I Baseline .....	237

Figure 80. P-3C Orion Communications Baseline Flow Diagram .....	238
Figure 81. E-2C Hawk Eye Communications Baseline Flow Diagram.....	238
Figure 82. RC-135V/W Rivet Joint Communications Baseline Flow Diagram.....	239
Figure 83. EP-3E Aries II Communications Baseline Flow Diagram.....	239
Figure 84. F/A-18E/F Super Hornet Communications Baseline Flow .....	240
Figure 85. E-8C JSTARS Communications Baseline Flow Diagram .....	240
Figure 86. Economic Exclusion Zone & Shallow Water Areas .....	243
Figure 87. Bathymetric Chart of Bay of Bengal .....	244
Figure 88. Principle Green Force Ports.....	245
Figure 89. Data Quadrant Identifiers .....	259
Figure 90. Blue Force Detection Event Log (Day 1 - 2) .....	261
Figure 91. Blue Force Detection Event Log (Day 3 - 7) .....	262
Figure 92. Blue Force Detection Event Log (Day 20 - 25) .....	263
Figure 93. Blue Force Detection Event Log (Day 26 - 30) .....	264
Figure 94. The Histogram for Data Fusion of Alternative 0.....	266
Figure 95. The Histogram for Data Fusion of Alternative 2.....	266
Figure 96. The Histogram for Data Fusion of Alternative 3.....	267
Figure 97. The Histogram for Latency of Alternative 0 .....	267
Figure 98. The Histogram for Latency of Alternative 1 .....	268
Figure 99. The Histogram for Latency of Alternative 2 .....	268
Figure 100. The Histogram for Throughput of Alternative 1 .....	269
Figure 101. The Histogram for Throughput of Alternative 2 .....	269
Figure 102. The Histogram for Throughput of Alternative 3 .....	270

## LIST OF TABLES

Table 1. Top Ranked Functions .....	64
Table 2. Fleet Top 10 C4I Requirements – 2007 .....	67
Table 3. C4I Masterplan Identified Planned Upgrades Beyond FY12 .....	80
Table 4. FY2020 Joint ASW C4I Physical Architecture .....	100
Table 5. Programs of Record Functional Capability Relationships.....	106
Table 6. Alternative Solutions and Functional Gaps .....	111
Table 7. FY2020 Joint ASW C4I Architecture Baseline “Interconnect Communication Nodes” Function Data Rates and Relay Delay Times for Alternative 0.....	114
Table 8. FY2020 Joint ASW C4I Architecture Baseline Estimated Data Processing Times expected for Alternative 0.....	119
Table 9. FY2020 Joint ASW C4I Architecture Baseline “Interconnect Communication Nodes” Function Data Rates and Relay Delay Times for Alternative 1.....	120
Table 10. FY2020 Joint ASW C4I Architecture Baseline Estimated Data Processing Times for Alternative 1 .....	121
Table 11. FY2020 Joint ASW C4I Architecture Baseline “Interconnect Communication Nodes” Function Data Rates and Relay Delay Times for Alternative 2.....	122
Table 12. FY2020 Joint ASW C4I Architecture Baseline Estimated Data Processing Times for Alternative 2.....	125
Table 13. FY2020 Joint ASW C4I Architecture Baseline “Interconnecting Communication Nodes” Data Rates and Relay Delay Times for Alternative 3.....	134
Table 14. FY2020 Joint ASW C4I Architecture Baseline Estimated Data Processing Times for Alternative 3 .....	135
Table 15. Scenario Order of Battle .....	140
Table 16. Average Throughput Comparison of all Alternatives.....	152
Table 17. Latency Time Averages for all Alternatives.....	154
Table 18. Fusion Time Averages for all Alternatives.....	156
Table 19. Modeling and Simulations Results .....	157
Table 20. Life Cycle Cost Summary.....	165
Table 21. Raw Data Matrix.....	174
Table 22. Swing Weight Assessment Table .....	175
Table 23. Swing Weight Assessment Table with Rankings, Ratings, and Weights.....	176
Table 24. Decision Matrix .....	177
Table 25. List of Milestones and Deliverables .....	199
Table 26. Modeling and Simulation Results.....	265

THIS PAGE INTENTIONALLY LEFT BLANK

## EXECUTIVE SUMMARY

This capstone project design team directed its efforts at providing the ASW community well researched alternatives for obtaining and maintaining a robust Joint ASW Command, Control, Communications, Computers, and Intelligence (C4I) Architecture enabling reduction of communication exchange time from sensor awareness to weapons on target in fiscal year (FY) 2020 and beyond. A tailored systems engineering development process was used to accomplish this task. It consisted of needs analysis, value system design, alternatives generation, modeling of alternatives, alternative scoring, and determination of the best alternative.

Needs analysis included consideration of needs, desires, and wants of the stakeholders, an overview of an adversarial submarine threat, the functional Joint ASW C4I Architecture, future C4I contributing systems, and identification of an effective need statement. Stakeholders agreed upon the following effective need statement: Key ASW stakeholders require a new standardized joint ASW-specific C4I architecture for the 2020 target time frame. The proposed Joint ASW C4I Architecture needs to use open standards, common waveforms, and a common data schema. It needs to be consistent with DoD policy and processes and be vertically integrated with other DoD C4I systems.

Value system design consisted of value hierarchy and evaluation measures. This step was crucial to accurately refining system requirements based on the effective need. It permitted insight into conflicting stakeholder preferences, allowed documentation of stakeholders' objectives, and aided in evaluating and ranking design alternatives. The top ranked functions identified in this process were Provide ASW Common Operational Tactical Picture, Fuse ASW Data, Interconnect Communication Nodes, and Enable Smart Pull and Push of ASW Information. Alternatives were generated after researching current programs of record, network topologies, and techniques and technologies to communicate with submarines. A FY2020 Joint ASW C4I Architecture Baseline was analyzed to discern functional gaps in existing and planned C4I supporting system designs which led to the four feasible alternatives.

The next step, alternatives generation, required significant research regarding programs of record planned changes, network topologies, and techniques to communicate with submarines. The four feasible alternative solutions consisted of Alternative 0 (Baseline Architecture); Alternative 1 (Baseline Architecture plus Joint Tactical Radio System (JTRS) Increment 4, Net-Enabled Command Capability (NECC), and Consolidated Afloat Network Enterprise Services (CANES) improvements); Alternative 2 (Baseline Architecture plus JTRS Increment 5, CANES improvements, and Joint Track

Manager); and Alternative 3 (Baseline Architecture plus modulated x-ray source communications system, autonomous Command, Control, Communications, Computers, Intelligence, Surveillance, and Reconnaissance (C4ISR) Unmanned Undersea Vehicles (UUVs), military High Altitude Aircraft (HAA), use of High Altitude Long Operation (HALO), Helios, and HAA for tropospheric or space-based distribution and fusion of common operational and tactical picture (COTP)).

Each of the four alternatives were simulated in EXTEND. To simplify the simulation a static model of the FY2020 Joint ASW C4I Architecture Baseline was created using operational scenario-based communication transmissions. The evaluation measures obtained using multiple simulation runs were throughput, latency, and data fusion time. The results of the simulation were used in alternative performance scoring where Alternative 2 had the greatest throughput and Alternative 3 had the lowest latency value and lowest data fusion processing time.

Life cycle cost estimates were developed for each alternative. The life cycle cost analysis considered all future costs associated with the Joint ASW C4I Architecture alternatives. It involved costs of all technical and management activities, research and development, production, operations and support, and disposal, throughout its lifetime and provided the basis for comparing alternatives. The cost model was developed using Microsoft Excel and calculated the cost of each task, life cycle phase, and year. Several cost estimation methods were used, including examining actual data from similar projects.

The analysis of alternatives (AoA) provided the consolidation of alternative performance scoring and a methodology for determining the best alternative recommendation. Classic multi-attribute utility theory (MAUT) was used with adequate stakeholder feedback to complete the analysis of alternatives. Using cost as an independent variable, the AoA compared the alternatives' ability to satisfy performance requirements to their life cycle cost to produce a cost-effectiveness comparison.

Based on this comparison, it was clear that Alternative 3 could be discarded since it has a lower utility than Alternative 2 and costs more than seven times as much. Though the Baseline Architecture is consistent for all alternatives it is imperative that the ASW Community avoid high research and development costs for x-ray communications, autonomous C4ISR unmanned undersea vehicles (UUV), High Altitude Long Operation (HALO), Helios, and military High Altitude Airship (HAA) support platforms. It is advised that these future C4ISR opportunities be leveraged from a distance using results from other DoD agencies to gain insight into their utility.

In the end, Alternative 2 was recommended for further development. Alternative 2 provides significant improvements in utility for a small cost. Further investigation and validation of Alternative 2 is recommended in a real world event. Further, it is recommended that the ASW community continue to support and fund all C4I related programs contributing to the FY2020 Baseline Architecture ensuring robust communications are fielded and sustained for all ASW platforms.

During alternatives generation, it was discovered that there were many existing programs of record that collectively had capabilities that could fulfill the requirements and functionality identified for the Joint ASW C4I Architecture. So the focus was shifted to identifying a system of systems ASW C4I architecture to integrate and field the capabilities by fiscal year 2020. This required significant additional research regarding the selected program of record change plans because there was no top-down plan for integrating the individual systems into a Joint ASW C4I Architecture for a fiscal year 2020 fielding.

It is recommended that a full-time funded organization be stood up that manages from the system of systems level. This organization would enable program managers for the individual program of record systems that solve a piece of the C4I architecture to collaborate with other program managers of the individual programs of record that solve another piece. This will ensure proper integration. Further, this organization would provide the top-down program management and technical analysis required to effectively develop and implement a robust Joint ASW C4I Architecture.



THIS PAGE INTENTIONALLY LEFT BLANK

## LIST OF SYMBOLS, ACRONYMS, AND ABBREVIATIONS

<u>Acronym</u>	<u>Term</u>
A2RF	Acoustic to Radio Frequency
ADNS	Automated Digital Network System
AdvHDR	Advanced High Data Rate
AEHF	Advanced Extremely High Frequency
ALE	Automatic Link Establishment
ANCC	Automated Network Control Center
AoA	Analysis of Alternatives
ASD-NII	Assistant Secretary of Defense, National Information Infrastructure
ASN-RD&A	Assistant Secretary of Navy Research, Development, and Acquisition
ASW	Anti-Submarine Warfare
ASWC	Anti-Submarine Warfare Commander
ATC	Automated Technical Control
ATM	Asynchronous Transfer Mode
ATO	Authority to Operate
BCA	Broadcast Control Authority
BFEM	Battle Force Email
C3I	Command, Control, Communications, and Intelligence
C4I	Command, Control, Communications, Computers, and Intelligence
C4ISR	Command, Control, Communications, Computers, Intelligence, Surveillance, and Reconnaissance
CANES	Consolidated Afloat Network and Enterprise Services
CBSP	Commercial Broadband Satellite Program
CDC	Combat Direction Center
CDLMS	Common Data Link Management System
CEC	Cooperative Engagement Capability
CENTRIXS	Combined Enterprise Regional Information Exchange, System
CFFC	Commander, Fleet Forces Command
CG	Guided Missile Cruiser
CJCSI	Chairman Joint Chiefs of Staff Instruction
COI	Community of Interest
COMPACFLT	Commander, United States Pacific Fleet
COMPOSE	Common Personal Computer Operating System Environment
CONOPS	Concept of Operations
COP	Common Operational Picture
COTP	Common Operational and Tactical Picture
CSD	Communications at Speed and Depth

CSRR	Common Submarine Radio Room
CT	Cipher Text
CTF	Commander, Task Force
CTP	Common Tactical Picture
CUS	Commander Undersea Surveillance
CVN	Carrier Vessel Nuclear
CWSP	Commercial Wideband Satellite Program
DDG	Guided Missile Destroyer
DIACAP	Department of Defense Information Assurance Certification and Accreditation Process
DISA	Defense Information Systems Agency
DISN	Defense Information System Network
DMR	Digital Modular Radio
DoD	Department of Defense
DoDAF	Department of Defense Architecture Framework
DON CIO	Department of the Navy Chief Information Officer
DOTMLPF	Doctrine, Organization, Training, Materiel, Leadership and Education, Personnel, and Facilities
DSCS	Defense Satellite Communications System
DSN	Defense Switched Network
DWTS	Digital Wideband Transmission System
ECC	Elliptic Curve Cryptography
ECU	End Crypto Unit
EEZ	Economic Exclusion Zone
EHF	Extremely High Frequency
ELINT	Electronic Intelligence
EPLRS-DR	Enhanced Position Location Reporting System – Data Radio
EPS	Enhanced Polar System
ERAST	Environmental Research Aircraft and Sensor Technology
FAA	Federal Aviation Administration
FASWC	Fleet Anti-Submarine Warfare Command
FFRDC	Federally Funded Research and Development Center
FLAG	Fiber-Optic Link Around the Globe
FOC	Full Operational Capability
FY	Fiscal Year
GCCS-M	Global Command and Control System - Maritime
GIG	Global Information Grid
GNO	Global Network Operations
GNOSC	Global Network Operations and Security Centers
HAA	High Altitude Aircraft
HAIPE	High Assurance Internet Protocol Encryptor

HALO	High Altitude Long Operation
HDR	High Data Rate
HF	High Frequency
HFRG	High Frequency Radio Group
HSGR	High Speed Global Ring
IA	Information Assurance
IDEF0	Integration Definition for Function Modeling
INMARSAT	International Marine and Maritime Satellite
ISDS	Information Screening and Delivery Sub-System
ISNS	Integrated Shipboard Network System
ISR	Intelligence, Surveillance, and Reconnaissance
ITIL	Information Technology Infrastructure Library
ITSM	Information Technology Service Management
IUSS	Integrated Undersea Surveillance Systems
IWS	Integrated Warfare Systems
JCSS	Joint Communications Simulation System
JFC	Joint Functional Concept
JIC	Joint Integrating Concept
JSTARS	Joint Surveillance and Target Attack Radar System
JTEN	Joint Tactical Edge Networks
J-TENG	Joint Tactical Edge Network and Gateways
JTF	Joint Task Force
JTM	Joint Track Manager
JTRS	Joint Tactical Radio System
KIP	Key Interface Profiles
KMI	Key Management Infrastructure
LAMPS	Light Airborne Multipurpose System
LCC	Life Cycle Cost
LCCE	Life Cycle Cost Estimation
LDT	Logistics Delay Time
LFA	Low Frequency Active
LHA	Landing Helicopter Assault
LHD	Landing Helicopter Dock
LMW	Littoral and Mine Warfare
LOS	Line-of-Sight
LPD	Landing Platform Dock
LSD	Landing Ship Dock
M&S	Modeling and Simulation
MAUT	Multi-Attribute Utility Theory
MCAP	Medium Data Rate Channel Access Protocol
MDA	Maritime Domain Awareness

MDR	Medium Data Rate
METOC	Meteorological and Oceanographic
MGEN	Multi-Generator
MIDS	Multifunctional Information Distribution System
MILSTAR	Military Strategic and Tactical Relay
MLT	Manufacturing Lead Time
MOS	Multifunctional Information Distribution System on Ship
MPLS	Multi-Protocol Label Switching
MSS	Maritime Surveillance Systems
MSSE	Master of Science in Systems Engineering
MUOS	Mobile User Objective System
MXS	Modulated X-ray Source
NASA	National Aeronautics and Space Administration
NAVAIR	Naval Air Systems Command
NAVSEA	Naval Sea Systems Command
NCA	National Command Authority
NCE	Net-Centric Environment
NCES	Net-Centric Enterprise Services
NCOE	Net-Centric Operational Environment
NCOW	Net-Centric Operations and Warfare
NECC	Net-Enabled Command Capability
NESI	Net-Centric Enterprise Solutions for Interoperability
NESP	Navy Extremely High Frequency Satellite Program
NETWARCOM	Naval Network Warfare Command
NETWARS	Network Warfare Simulation
NGEN	Next Generation Enterprise Networks
NMAWC	Naval Mine and Anti-Submarine Warfare Command
NMOC	Naval Meteorology and Oceanography Command
NMS	Network Management System
NMT	Navy Multi-Band Terminal
NR	Network Rationalization
NRL	Naval Research Laboratory
NSWC	Naval Surface Warfare Center
NTM	National Technical Means
NUWC	Naval Undersea Warfare Center
O&S	Operations and Support
OLC	Optical Laser Communications
OPNAV	Chief of Naval Operations
OPNET	Optimized Network Engineering Tool
OSD	Office of the Secretary of Defense
OTNK	Over the Net Keying

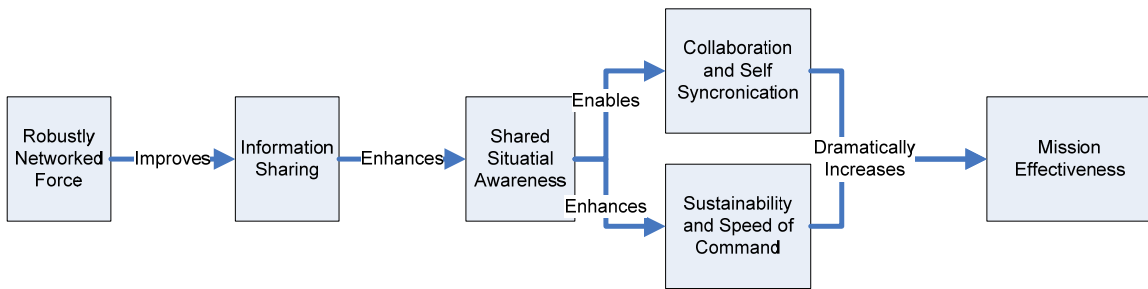
OV	Operational View
P&I	Production and Installation
PA&E	Program Analysis and Evaluation
PACOM	Pacific Command
PEO	Program Executive Office
PEO-A	Program Executive Office for Air ASW, Assault and Special Mission Programs
PEO-SUB	Program Executive Office, Submarines
PKI	Public Key Infrastructure
PMA	Program Manager Air
PMS	Program Manager Ships
PMW	Program Manager Warfare
POM	Program Objective Memorandum
PoP	Period of Performance
PROTEAN	PROTocol Engineering Advanced Networking
QoS	Quality of Service
R&D	Research and Development
RF	Radio Frequency
RM	Reference Model
RNOSC	Regional Network Operations and Security Center
RSA	Ron Rivest, Adi Shamir, and Leonard Adleman
SAFE	South Africa - Far East
SATCOM	Satellite Communications
SCC	Sea Combat Commander
SE	Systems Engineering
SEDP	Systems Engineering Design Process
SH	Sea-Hawk
SHA	Secure Hash Algorithm
SIGINT	Signals Intelligence
SINCGARS	Single Channel Ground and Airborne Radio System
SIPRNet	Secret Internet Protocol Router Network
SLOC	Sea Lines of Communication
SMAN	Super-Metropolitan Area Network
SNR	Subnet Relay
SOA	Service-Oriented Architecture
SONAR	Sound Navigation and Ranging
SPAWAR	Space and Naval Warfare
SSC	Space and Naval Warfare Systems Center
SSDS	Ship Self Defense System
SSF	Standard Scoring Function
SSTD	Surface Ship Torpedo Defense

STEP	Standardized Tactical Entry Point
SUBOPAATHWAN	Submarine Operating Authority Wide Area Network
SURTASS	Surveillance Towed Array Sensor System
SV	System View
SVDS	Shipboard Video Display System
TACLAN	Tactical Local Area Network
TASWC	Theater ASW Commander
TC	Transformational Communications
TCA	Transformational Communications Architecture
TDL	Tactical Data Link
TDM	Time Division Multiplexing
TECB	Tethered Expendable Communications Buoy
TG	Task Group
TGBE	Transformational Satellite Communications Global Information Grid Border Element
TPO	Teleport Program Office
TRANSEC	Transmission Security
TSAT	Transformational Satellite Communications System
TSC-M	Tactical Support Center - Maritime
TSw	Tactical Switching
TWJN	Tactical Wireless Joint Network
UAV	Unmanned Aerial Vehicle
UFO	Ultra-High Frequency Follow-On
UHF	Ultra High Frequency
USCG	United States Coast Guard
USPACOM	United States Pacific Command
USW-DSS	Undersea Warfare-Decision Support System
USWC	Undersea Warfare Commander
UUV	Unmanned Undersea Vehicles
VAMOSOC	Visibility and Management of Operating and Support Costs
VoIP	Voice Over Internet Protocol
VRF	Virtual Routing and Forwarding
WAN	Wide Area Network
WeCAN	Web-Centric Anti-Submarine Warfare Net
WGS	Wideband Gapfiller System
WNW	Wideband Network Waveforms

# I. INTRODUCTION

## A. PROBLEM STATEMENT

The United States Navy's conduct of anti-submarine warfare (ASW) today uses platform-centric ASW Command, Control, Communications, Computers, and Intelligence (C4I) systems that are not used in a networked fashion. Many were developed to support blue-water ASW operations and were designed in large part with communication architectures where data sharing may have been point-to-point and hierarchical rather than many-to-many and edge-oriented. They lack robust routing and networking capabilities, provide low to medium data throughput, and present logistics challenges. More specifically, the Navy has not employed the tenets and principles of network-centric warfare for ASW C4I systems which are displayed in Figure 1 [Miller, G., 2006]:



**Figure 1. Tenets and Principles of Network Centric Warfare**

This is the logic path for the tenets and principles of network centric warfare. It shows how each capability is dependent on the previous capability and, in a sense, provided the priority from left to right.

The threat today from quiet diesel-electric and air-independent propulsion submarines operating in a littoral environment requires the ability to connect sensors and platforms in order to exchange data and share information. Without information sharing there can be a depletion of sensor or weapon resources when needed most due to high false alarm rates, ineffective wide area search plans, and battle group asset dispersion [Clarkson, 2008]. Sharing of information requires ASW to be conducted as a team. Commander Perry D. Yaw, United States Navy, discussed the importance of teamwork in conducting ASW [Yaw, 2006]:

ASW will remain a challenging mission area. It is, and will remain, a team sport for the Navy. Increased complexity of the operating environment, an increasingly



capable threat, and limited depth on the Navy's bench require more inter-service cooperation to field an effective team. This will require the Navy to share the [mission] of ASW and recruit new players. The other services have the players the Navy needs to round out the team.

To support network-centricity, improved connectivity within and between different kinds of platforms is required. This allows machine-to-machine transfer of data without human intervention and provides a reduction in workload and susceptibility to error and an increase in speed of command. Joint, interagency, allied, and coalition forces need to share data from space, air, surface, and subsurface platforms conducting ASW operations. Today, these platforms may have evolved C4I systems optimized for their environment, but they lack the capability to share information and coordinate operations effectively.

Shared information improves the quality of information through data fusion, information management, and human-systems integration. This provides more accurate, precise, and timely data required to detect, track, and engage the enemy and to reduce the time in the kill chain. Today, the fielded capabilities in data fusion, information management, human-systems integration, and networking are either technically immature or nonexistent.

To increase ASW effectiveness, commanders require a Common Operational and Tactical Picture (COTP) to view the shared and fused information and to allow collaboration not only within the Navy, but also with joint, interagency, allied, and coalition forces. The operational picture consists of data with longer life spans. The tactical picture is generally envisioned to consist of data with shorter life spans serving operators and weapons that operate in term of seconds or microseconds [Mittu and Segaria, 2000]. Tactical operators and their commanders want an accurate tactical picture, reliable and effective decision aids, and a faster detect-to-engage sequence. A COTP provides Strike Force and Theater Commanders realistic options for force allocation, threat prioritization, and engagement. This is particularly important when considering the necessity of joint, interagency, allied, and coalition force allocation involving air, surface, and subsurface platforms in ASW operations. Further, a COTP reduces one-on-one engagements, reduces the probability of blue-on-blue engagements, and increases the kill rate. This is done while shrinking the no-attack zones to engage red submarines which might not be possible without a COTP [Hutter, 2008].

There have been a number of comments from stakeholders regarding the use of COTP instead of separating it into a Common Operational Picture (COP) and Common

Tactical Picture (CTP). The Chairman Joint Chiefs of Staff Instruction (CJCSI) 3151.01A [2003] defines the COP:

A distributed data processing and exchange environment for developing a dynamic database of objects, allowing each user to filter and contribute to the database, according to the user's area of responsibility and command role. The common operational picture provides the integrated capability to receive, correlate and display a common tactical picture, including planning applications and theater-generated overlays and projections.

Clearly, the CTP is considered a subset of the COP. The COP can also show many other forms of information that include readiness, intelligence, reconnaissance, and environmental information. The overarching goal of the COP is to facilitate collaborative planning and assist all echelons to achieve situational awareness [CJCSI 3151.01A, 2003]. The Chairman Joint Chiefs of Staff Instruction 3151.01A [2003] defines the CTP:

An accurate and complete display of relevant tactical data, supporting a joint task force that integrates tactical information from the multi-tactical data link network, composite tracking network, intelligence network, and ground digital network. The common tactical picture enables command and control, situational awareness, and combat identification, as well as supporting the tactical elements of all joint mission areas.

From a purely naval perspective, FORCEnet utilizes the term COTP when defining it as one of three critical areas required to support the 19 specific capabilities that FORCEnet is built on [National Research Council of the National Academies, 2005]. It was believed that the end state product should be a single application that is tailorable to the user's need, whether that is strategic, operational, tactical, or logistical. This is in conformance with the CJCSI 3151.01A vision for the COP and the FORCEnet vision for the COTP. The team chose to utilize the term COTP for consistency with the FORCEnet vernacular.

ASW net-centric C4I architectures operate with systems and concepts that predominately use either acoustics data gathered from the ocean or radio frequencies data gathered from the atmosphere. Unlike radio frequencies, acoustics are significantly affected by the medium in which they travel. In general, the ocean medium is not as homogenous as the atmosphere. Ocean environment and meteorological conditions at the sensor affect its performance. This complexity has impeded the progress in sensor processing automation when compared to atmospheric sensor processing. In some applications, transmission of larger amounts of data associated with ASW sensors is required when compared to radio frequency (RF) sensors. This data is transferred from the sensor to C4I processing. Human intervention is needed to interpret the data which

causes higher latency and a higher level of false alarm contacts. This drives differences in threat danger zones, targeting timelines, and asset allocations. C4I systems that rely on a single acoustic sensing system can have a large target area of uncertainty that can cause low probability of kill. This is because existing weapons have relatively short ranges. With a stand alone acoustic sensor system, sensor operators never really know if the area is clear, they only have a probability-based metric. However, when data from multiple acoustic and radio frequency sensors can be fused, greater accuracy and speed of command can be achieved.

What stakeholders want today is a system of systems that can be updated quickly and affordably as new capabilities are required. To date, there has been funding for research and development; however, it has produced little in acquisition and implementation. With large misconceptions and lack of understanding, the vision of the real problem is not clear and future progress is hindered. There are some realities about the maturity of capabilities being proposed today. A service-oriented architecture (SOA) is needed, but significant effort and associated data models are still required to fully define it. The ASW C4I challenge is also the result of a number of ASW systems being designed without a standard architecture such as the one designed to accommodate Aegis, Ballistic Missile Defense, and Theater Air Defense. This project assumed that the funding will be available, the architectures are open, and decisions were made based on best technical solution to get to a standard Joint ASW C4I Architecture.

## **B. BACKGROUND**

With the fall of the Soviet Union and the end of the Cold War in 1989, the threat to the United States military from submarines had waned. The states of the former Soviet Union did not have the resources to deploy submarines after its disintegration which had posed a credible threat to the United States. Until recently, the United States has had no other competitors that were capable of deploying submarines that could threaten the United States' interests. The disappearance of the submarine threat resulted in the Navy's reallocation of resources assigned to anti-submarine warfare to other more immediate threats. An outfall of the diversion of the resources from ASW is that the infrastructure that was in place to detect, track, and engage submarines has deteriorated. However, with the growth of terror groups and rogue nations, the emergence of credible economic and political competitors, and advances in technology, the submarine is again viewed by the United States as a clear and present threat. Over ten years ago, the Chief of Naval Operations testified before Congress that the "ASW holiday" has ended. He stated that submarines and mines are among the most serious threats to the Navy [Morgan, 2008]. Still today, in the Pacific Ocean alone there are over 250 submarines, and only 30% of those belong to allied nations [Benedict, 2005; Yaw, 2006]. In addition,

China and India have or will soon have the ability to launch nuclear missiles capable of delivering a nuclear warhead from submarines [Adams, 2008].

### **C. PROJECT DESCRIPTION AND DELIVERABLE PRODUCTS**

This project's goal was to create a standard Joint ASW C4I Architecture that enhances the Combatant Commander's ability to execute a mission in support of campaign objectives. C4I supports all aspects of the kill chain from detection through engagement to battle damage assessment. A standard architecture based on the Net-Centric Operational Environment (NCOE) Joint Integrating Concept (JIC) is provided. The goal of the architecture was to allow for the employment of joint networking capabilities at the tactical and operational level for existing and future tactical and theater systems to communicate effectively [NCOE JIC, 2005]. More specifically, it aligns with the Information Joint Enabling Construct appendix of the NCOE JIC to implement and enable joint network-centric ASW operations for the 2020 timeframe.

The operational view, Figure 2, provides a high-level description of the Joint ASW C4I Architecture. It describes the mission, main operational nodes, and interesting or unique aspects of operations. Furthermore, because the Navy has decided that legitimate targets include enemy submarines in port, at submarine bases, and any other locations that support the enemy submarine they can target these with non-traditional Navy ASW assets. Besides the joint approach, interagency, coalition, and allied partners were also included. However, the cross-domain user focus was on the joint approach.



**Figure 2. Operational View 1 (OV-1)**

This is the OV-1 for the Joint ASW C4I Architecture. It is a High-level graphical description of operational concept. It shows ASW operations using joint forces for traditional and non-traditional targets.

It is also important to state that developing or redesigning any sensors or weapons was not considered. The C4I architecture was looked at in a true platform-independent, network-centric fashion. It provides the connection between the sensors and the effectors that includes kinetic and non-kinetic weapon systems.

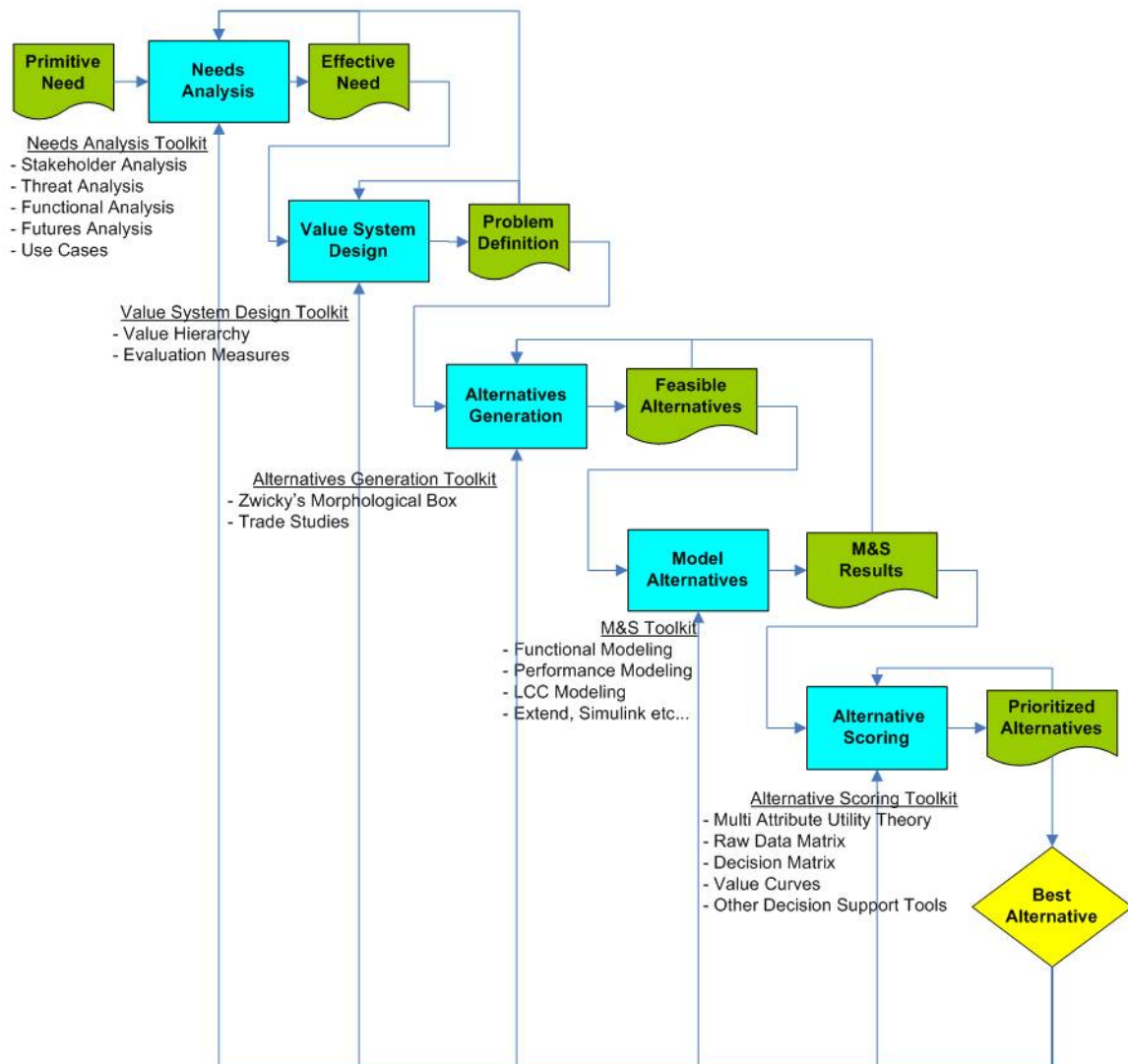
The integrated Joint ASW C4I Architecture was tightly coupled to functional requirements by performing a thorough requirements analysis. This had not been done before in a net-centric context. The Joint ASW C4I Architecture formed the basis for a gap analysis which in turn allowed this capstone design team to map existing program's planned capabilities to what is really needed. It provides a tool that describes interactions and functionality enabling war-fighter capabilities. The Joint ASW C4I Architecture should be used by all existing programs in managing their interfaces moving forward and provides the test community with a means to map system effectiveness to joint mission operational effectiveness.

## **D. SYSTEMS ENGINEERING APPROACH**

### **1. Overview**

A number of systems engineering processes were examined in evaluating an approach to the project. The “Vee” approach, Hatley Pirbhai, the “Spiral” approach, and the Systems Engineering Design Process (SEDP) as taught at the Naval Postgraduate School were all evaluated on suitability and applicability to the task [Blanchard and Fabrycky, 2006: 30, 34]. Through a multi-step process, rigorous systems engineering methods were applied to refine requirements and to develop a set of feasible alternatives, evaluate those alternatives against each other, and then select a preferred alternative to be presented to the stakeholders for final approval. The multi-step process had to be flexible and iterative in nature to allow for feedback throughout the process with the intent to positively influence the outcome.

All the examined systems engineering processes were found to be suitable for the task. However, a tailored SEDP was selected as the preferred process due to the variety of tools available to complete each step and the team’s overall familiarity with that particular process. Figure 3 shows the tailored SEDP. There are five tier two processes: needs analysis, value system design, alternatives generation, model alternatives, and alternative scoring. Each tier two process has a summary input and output deliverable. Each deliverable was created using its respective toolkit. The toolkit boxes do not include every potential option available to help complete its associated tier two process but is representative of what was available. Figure 3 also shows the iterative nature of the overall process. Each output was reviewed by the stakeholders. Once each output deliverable was approved, it became the input for the next tier two process. If neither the stakeholders nor the team were satisfied with a tier two output, the systems engineering effort was backed up to an appropriate tier two process and restarted. All output deliverables were compared to the input deliverable to check for consistency and traceability. The final step was a recommended Joint ASW C4I Architecture alternative that was provided to the ASW Community of Interest.



**Figure 3. Tailored Systems Engineering Development Process**

The process has five steps: needs analysis, value system design, alternatives generation, model alternatives, and alternative scoring. Each step has a summary input and output deliverable. Each deliverable was created using its respective toolkit.

## 2. Tailored Systems Engineering Development Process Phases

### a. Needs Analysis

The first tier two process performed was needs analysis. The primitive stakeholder need was taken as an input and turned it into an effective need as an output through the use of numerous tools. A stakeholder analysis, threat analysis, functional analysis, and futures analysis were performed. The effective need statement was assessed by the stakeholders and the team.

***b. Value System Design***

Upon stakeholder approval of the effective need, that deliverable served as input to the next step, which was value system design. The value system design began with identification of the major functions the system must perform. The functions were decomposed into sub-functions down to the lowest logical level. The lowest level sub-functions had objectives assigned. Evaluation measures were then identified to determine satisfactory performance of those objectives. The output of the value system design was the problem definition statement.

***c. Alternatives Generation***

The Joint ASW C4I Architecture value hierarchy survey was forwarded to the ASW stakeholders to rank order the functional hierarchy. This information helped to identify specific functional gaps needing materiel or non-materiel solutions for ASW warfighters to accomplish their mission areas. Results of the functional gap analysis led to the creation of a fiscal year (FY) 2020 Joint ASW C4I Architecture Baseline which proved to be in very close agreement with those of the ASW stakeholders. A comprehensive list of DoD programs of record combined with numerous strategic guidance documents and design studies contributed to a comprehensive list of programs and proposals in the alternatives generation process that could be traced back to ASW functional gaps. These programs and proposals included specific hardware and software applications and other non-materiel solutions which will close today's functional gaps over the coming decade leading into FY2020 and the Joint ASW C4I Architecture Baseline. Brainstorming provided additional ideas for improving interconnectivity of nodes, data fusion, smart push and pull of ASW data, and development of a common operational and tactical picture. Evaluation measures and operational factors contributed to the differentiation of final alternative solutions during feasibility studies and risk analysis which led to the recommended alternative solution set.

***d. Model Alternatives***

Using the approved feasible alternatives as an input, the Model Alternatives step began. From research as well as hands-on experience, EXTEND was chosen as the primary modeling tool. Based on the developed scenario, IDEF0, and functional flow block diagram, performance models for each alternative were built. Simulation was performed to generate data related to evaluation measures developed in the value system. Modeling and simulation results were the output of the model alternatives step, which was used as the input to the Alternative Scoring step.

***e. Alternative Scoring***

Using the results from the Modeling and Simulation (M&S) step as an input, the alternative scoring step began. The relevant M&S results and offline analysis



results were inserted in a raw data matrix. From there, multi-attribute utility theory was used to turn raw scores into utility scores. Each alternative had a life cycle cost estimate developed to assist in objective decision making. The utility of each alternative had to take cost into consideration as the alternative with the most utility could also be cost prohibitive, thus it would not be the best alternative.

*f. Best Alternative*

Each alternative provided a level of utility with some associated life cycle cost. A utility versus life cycle cost comparison was utilized to ascertain if any alternatives could be clearly discarded. Remaining alternatives were assessed to see if one clearly stood out as a recommendation for the best alternative. The comparison of viable alternative utility scores versus their life cycle cost estimate, along with any potential recommendation for the best alternative was forwarded to the stakeholders for consideration. The stakeholders may accept the recommendation, pick another alternative or discard them all in favor of a new set of alternatives. Curriculum constraints prevent this capstone design team from going beyond delivery of a set of alternatives with a recommendation. However, the next step in the process would be to either implement the chosen alternative or go through the alternatives generation process again.

## II. NEEDS ANALYSIS

The needs analysis was completed to provide justification for proceeding further in the design process and served as the cornerstone on which subsequent design and decision processes were built. It was also completed in order to transform the problem from a primitive need to an effective need.

Before performing needs analysis it was imperative to determine if others had previously worked on analyzing Joint ASW C4I Architecture and what issues or accomplishments may have been identified in their work. Several government sponsored initiatives, discussed throughout this report, were discovered which served as starting points for this capstone project. The United States Navy's ASW Concept of Operations and the Maritime Domain Awareness documents and briefings offered insight into operational considerations that needed to be understood with regard to C4I operational needs. Several stakeholders introduced this capstone project design team to the ASW community of interest integrated product team which set the table for a quick look at the issues impacting the ASW community's C4I capabilities and C4I relative functional gaps. The Net-Centric Operational Environment Joint Integrating Concept and ASW needs statement were utilized to frame the Joint ASW C4I Architecture and with specifying functional areas relative to the ASW needs statement. Pertinent approved C4I programs of record found in the PEO-C4I Masterplan, Version 1 and the PEO-C4I "Communications at Speed and Depth and Optical Laser Communications Status" briefing were invaluable to the search for solutions contributing to the FY2020 Joint ASW C4I Architecture Baseline. Many additional references are cited throughout this study that enhanced understanding of the ASW C4I problem set.

One area of the effective needs statement requiring resolution is data schema. In the pursuit of a common data schema and data model, the DoD has explored many developments in the instantiation of data-oriented structures. The schema can be defined by what data is allowed to be included for a specific data element, a data file, a data set or table. Analysis of data schema was not completed because the ASW COI was already developing the ASW data schema.

The needs analysis was conducted as a five part process. First, a stakeholder analysis was performed by developing a primitive needs statement and identifying those organizations that stood to gain from the success of the Joint ASW C4I Architecture being developed. Once the stakeholders were identified they were presented with the primitive need statement and asked question to identify their requirements for that need. Then, research was conducted, specific net-centric documents were analyzed, and the

system boundary was established. Later, the stakeholders were engaged in the threat, functional, and future analyses.

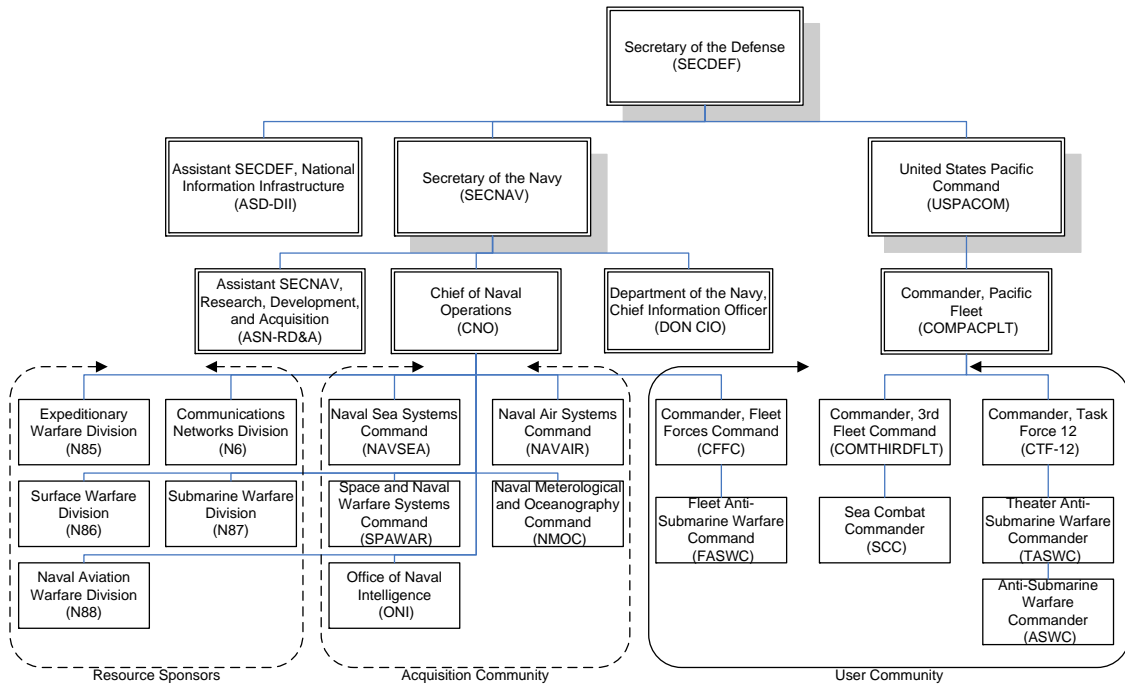
Second, the threat analysis identified the strengths of the enemy submarine and five areas of vulnerability impacting this enemy capability and the Joint ASW C4I Architecture. They consist of physical infrastructure (material); in construction or maintenance (material); during maneuver (energy); energy signatures produced (signals); and sensor related (signals and data). United States Navy ASW communications equipment and network architecture are no less vulnerable to enemy attack than those of the enemy submarine. Third, the functional analysis translated the stakeholder and the NCOE JIC requirements into detailed design criteria, helped identify the resources necessary in the cost analysis section for system operation and support, and created draft functional models. Fourth, the futures analysis was used to make educated predictions with respect to the future operational environment. The future environment addressed extends to the year 2020. This analysis was conducted to identify and discover critical requirements that shape and define future development of the system, provide flexibility and robustness in the face of a changing environment, and extend system life. Finally, an analysis was conducted on the draft functional models using input from the stakeholder, threat, and futures analysis until the revised functional models were completed. These analyses led to the development of an effective needs statement.

#### **A. STAKEHOLDER ANALYSIS**

The following sections review the organizations that would gain from the success of the Joint ASW C4I Architecture being developed. They can be grouped into resource sponsors, the acquisition community, and the user community. Figure 4 shows the higher echelon organizations identified. Lower tiered organizations are addressed in the individual sections. Policymakers for the above communities may include the Assistant Secretary of Defense, National Information Infrastructure (ASD-NII); the Assistant Secretary of Navy Research, Development, and Acquisition (ASN-RD&A); and the Department of the Navy Chief Information Officer (DON CIO). They were initially reviewed for consideration as stakeholders, but it was determined that they did not stand to gain directly from the success of a Joint ASW C4I Architecture. Rather, they could use the results of this report to tailor future policy.

In summary, it was learned as a whole from the stakeholders that reducing the time in the kill chain was the most important measure to achieve in a coalition and joint ASW C4I system. The next most important measure was accuracy. The contact data accuracy is initially a function of the sensor's capability. Some stakeholders wanted this to be addressed. However, that was considered outside the boundaries of a Joint ASW

C4I Architecture. Yet, timeliness of data has a direct impact on accuracy since the area of uncertainty of a target grows over time. In addition, the stakeholders identified that integration of underwater, surface, air, and space sensor systems along with fusion of contact data from these systems affects the accuracy by also reducing the area of uncertainty. So the major focus of the modeling effort was to address timing and the duration of the data fusion process.



**Figure 4. ASW Users and Stakeholders**

This organization chart provides the high level ASW organizations that stand to gain from the success of an ASW C4I architecture. Lower tiered organizations are addressed in the sections below.

In addition to integrating sensors, the stakeholders pointed out that the weapons systems need to be integrated in order to optimize the use of these limited assets. The integration of sensors and weapons in a C4I system requires interoperability, interfacing, and open source considerations.

Integration of sensors, weapons, and data fusion was taken into consideration by looking at existing programs of records, policy, and guidance that the stakeholders provided. While it is against good requirements generation practices to provide solutions, the team did not want to waste effort creating elements of a C4I architecture that have already been created or go against policy without good reason. So these were looked at as possible project or design constraints.

Cross domain communications were critical to the stakeholders. In particular, high bandwidth and satellites with robust availability and reliability were important. Further, it was pointed out by several stakeholders that communications need to include coalition partners even more so than joint partners because ASW battles are not fought without coalition partners. However, it was also pointed out that coalition participation in ASW C4I architecting has been sparse and the security policy has not been resolved. So the focus of this project is on joint participation with the idea that the coalition partners or the Joint ASW C4I Architecture could adapt. Communications was a major focus of this project and is addressed in the alternatives generation section.

The stakeholders generally felt that a common picture was required to effectively utilize the information being integrated. There was some inconsistency between them as to whether it would be a CTP or a COP. This seemed to be dependent on their background and perspectives. The team decided to use the COPT for reasons provided in the problem statement section. Again, programs of record, policy, and other guidance were reviewed when selecting functionality and alternative solutions for evaluation.

Other needs identified were training, knowledge management, human systems integration, role based access to services and data, archiving for intermittent or disadvantaged users, redundancy for network connectivity, and available space on platforms for the processing hardware. All of these needs were either addressed by the alternative solutions identified for evaluation or were considered as elements that were beyond the scope of this project, but could be studied as a follow-on project.

The users and concepts of operation used today were provided by the stakeholders and are described in the user community section of the stakeholder analysis. New users and concepts of operations may need to be developed with a new C4I architecture since it may change the way ASW can be conducted. This was beyond the scope of this paper, but would be an excellent follow-on study.

Finally, the stakeholders identified constraints and performance measures. These were addressed in the constraints section and the details of the measures in the value system section, respectively. In any of the sections that reviewed the stakeholder input, how that input was used or not used was addressed.

### **1. Resource Sponsors**

The resource sponsors come under the Office of the Chief of Naval Operations. These organizations manage the user community's prioritized needs by either funding the acquisition of capability or accepting and managing the risk of not funding the need. Their interest is maximizing the capability they can acquire across projects from their limited funds. Improving ASW C4I is of great interest to the resource sponsors because

it has the potential to provide a multiplying effect in capability gained. Rather than spending more funding on new or improved sensors or weapons capability, existing sensors and weapons will be much more effective with a new network-centric C4I architecture. This is achieved when data from existing sensors is fused, which then provides more accurate and timely target information. This accuracy and timeliness improves the effectiveness of sensors and weapons, thus providing a greater return on investment than if individual sensors and weapon were improved. The following paragraphs provide the divisions of resource sponsors from the Office of the Chief of Naval Operations that gain from the success of a developed Joint ASW C4I Architecture and whether or not they participated in this project.

The Communication Networks Division, N6, optimizes Navy network and communications investments. N6 acts as principal advisor to Chief of Naval Operations for communications and network matters and serves as the Navy's top level advocate for information management and information technology resources throughout the Navy and the joint environment [Deputy CNO Communication Networks, 2007].

The stakeholder that provided written input from Communication Networks Division, N6, was LCDR Kevin L Smith. Mr. Smith, who has some experience in this topic, felt that there must be adequate communication assets made available to support this particular warfare area such as satellites and bandwidth. Communications were made a priority as shown in the alternatives generation section. He suggests that the Joint ASW C4I Architecture is not nearly as important as a coalition compliant one and that parallel development and integration with other service and nationalities should be conducted. However, other stakeholders pointed out that coalition participation has been sparse and security policy has not been resolved. So the focus of this project is on the joint approach with the idea that the coalition partners or the architecture could adapt. An architecture that is capable of handling new and legacy systems is more realistic than doing concurrent parallel development. Mr. Smith felt that the ability to access a real time, common operational picture of the ASW effort in support of the larger campaign should be the end state. However, the team concurs that the type of picture, tactical or operational, should be configurable so the team uses COTP. The team felt that Mr. Smith's desire for the Joint ASW C4I Architecture to support processing of environmental data, predictions of sensor performance, and sharing of tactically relevant information to include sensor to weapon pairing was important and was evaluated in the modeling section at a high level. He considers the constraints to include physical space for processing hardware on platforms, lean government spending, systems command realignment to service-oriented architecture, and Consolidated Afloat Network Enterprise Services (CANES) practices. These were addressed in the constraints and alternatives

generation sections, respectively. Mr. Smith believes that the tolerances to be observed include accuracy, reliability, and integration. The team considered these and used accuracy and integration in the value system and alternatives generation sections, respectively. His suggestion on the use of gliders for intelligence collection and data retention, acoustics intelligence, and imagery as elements to be integrated was considered outside the scope of a C4I system.

The Expeditionary Warfare Division, N85, ensures that the Department of the Navy addresses the unique aspects of naval expeditionary operations in the world's littoral [The OPNAV Assessment Process, 1993]. This capstone project design team was either unable to identify or convince stakeholders from the Expeditionary Warfare Division, N85, to participate on this project. Their lack of participation may have a little effect on the Joint ASW C4I Architecture since their platform view was not obtained.

Surface Warfare Division, N86, is responsible for naval surface ship investment, current readiness, and modernization as well as future ship acquisition. Their goal is to provide a surface navy that has the capability to defeat all maritime threats to the country and defend way of life [N86 Surface Warfare Division, 2008]. This capstone project design team was either unable to identify or convince stakeholders from the Surface Warfare Division, N86, to participate on this project. Their lack of participation may have a little effect on the Joint ASW C4I Architecture since their platform view was not obtained.

Submarine Warfare Division, N87, is responsible for coordinating overall policy for submarine force planning, programming, budgeting, and is the source of submarine platform and undersea warfare expertise for developing submarine platform requirements. N87 is the principle source of expertise for anti-submarine warfare, mine warfare, submarine-based intelligence surveillance and reconnaissance, and information warfare. They are also the lead for the anti-submarine warfare Cross Functional Board. They are responsible for providing expert advocacy for submarine and undersea warfare related research and development, acoustic and non-acoustic submarine security, warfare capability development, integrated undersea surveillance systems, submarine force structure, and oversight of submarine related program execution [N86 Surface Warfare Division, 2008].

Bob Cepek, N87, who has a moderate to expert level of experience in Integrated Undersea Surveillance Systems (IUSS), provided written input. He felt that the primary reason for the standardization of an architecture is that it allows all components, both tactical and theater, to communicate effectively in a timely manner. The primary capability lacking is interoperability. The Navy is the first benefactor of a standardized

C4I architecture, but at the joint level, the timely and accurate sharing of contact level information is a primary need. The team concurred that communications and interoperability was of primary importance before anything else can happen. This was addressed in the alternatives generation section. Mr. Cepek felt that the metrics must address the timely communication of information along with other standard requirements of the Global Information Grid such as information assurance. Timeliness was the priority and was addressed in the value system and modeling sections. Information assurance is important, however, it was not addressed this in this report due to it being a lower tiered requirement that could be addressed in a follow-on project. He felt that the Joint ASW C4I Architecture would be used to exchange the full range of information needed to support ASW. This would include tactical, theater, environmental and intelligence information. He recommended consulting Undersea FORCENet Working Group recent reports and products. The team did review this information, but it was marked for official use only and determined unusable in this unclassified project. Mr. Cepek felt that the Joint ASW C4I Architecture should support data handling, tactical and theater communications, weapons system tasking, provision of environmental data, and provision of intelligence information. Further, the processing and analysis will be accomplished at the contact level probably in conjunction with or based upon data fusion. The team concurred and the major focus of the modeling effort was to address timing and fusion of contact data. He felt the limits on the Joint ASW C4I Architecture are costs. The solution set must integrate C4I components that are already assessed effective, exploit commercial off the shelf products and be based upon rigorous trade studies to control costs. This was addressed in the constraints section of this report. Mr. Cepek felt that the ASW C4I challenge is also to address the result of a number of ASW systems being designed without a standard architecture. The standard architecture is the focus of this project and does address legacy and new systems.

"KC" Stangl, N87, has 30 years in ASW and associated command and control and five years in communication technology. He felt that ASW commanders require a common tactical picture with low enough latency and high enough accuracy to effectively multiply force effects and avoid one-on-one engagements. The latency and accuracy issues imply capabilities in data fusion, knowledge management, human systems integration, and interoperability that are either technically immature or non-existent. All of these are addressed except knowledge management and human systems integration. These were an important, but could be addressed by a follow-on project and were considered out of scope for this project. Mr. Stangl believe that geospatial and temporal filtering will allow for different display configurations, and mission definitions will define data pulls and pushes, with automated services tailored to specific roles. The



team agreed with this and called the common picture a COTP to imply that it is configurable. He believes that the constraints include computational load versus available real estate and bandwidth, open source versus proprietary software, standard data interfaces to facilitate rapid technology insertion, fleet military utility assessments, and information assurance accreditation and certification. These are addressed in the constraints section. He provided several policy and programs of record to consider that are addressed in the alternatives generation section.

Naval Aviation, N88, has a process to review, validate, and prioritizes the war fighting requirements. The decisions are based on three major program issues: safety, readiness and maintainability; and mission performance. Once the proposed prioritization is complete, the Aviation Flag Board, comprised of senior members of Naval and Marine Corps aviation, meets to finalize the sponsor program proposal for input into the Navy Program Objective Memorandum [Evans, Lyman, and Ennis, 1995]. This capstone project design team was either unable to identify or convince stakeholders from the Naval Aviation, N88, to participate on this project. Their lack of participation may have a little effect on the Joint ASW C4I Architecture since their platform view was not obtained.

## **2. Acquisition Community**

The Defense Acquisition Community designs, integrates, and procures C4I equipment and processing under the sponsorship of the resource organizations above. This community includes the technology and system development community which consists of systems command field activities and federally funded research and development centers.

Program Executive Office (PEO), Littoral and Mine Warfare (LMW) is one of five PEOs affiliated with Naval Sea Systems Command (NAVSEA). The mission of the Program Executive Office for Littoral and Mine Warfare is to assure access in the littorals for the joint warfighter. In addition, PEO-LMW has two program offices that would benefit from the development of the Joint ASW C4I Architecture. This includes Program Manager Ships (PMS)-485, Maritime Surveillance Systems, and PMS-420, Littoral Combat Ship Mission Modules. The stakeholder that provided written input for the PEO-LMW acquisition community was Cecil Whitfield. He reviewed the team's questions and initial primitive needs statement, but provided only editorial comments. His lack of comment likely had little effect on the outcome of the project since the program offices under PEO-LMW that are associated with this project did provide input.

The Maritime Surveillance Systems (MSS) Program Office is involved with the development and maintenance of various Integrated Undersea Surveillance Systems

(IUSS). IUSS provides the Navy with its primary means of submarine detection of both modern diesel and nuclear submarines in littoral or broad ocean areas of interest. This includes efforts for both Fixed Surveillance Systems (FSS) and Surveillance Towed Array Sensor (SURTASS). The stakeholder that provided written input from Maritime Surveillance Systems was Doug Dickerson. He solicited and consolidated information from his C4I team. Most of his resources are expended maintaining existing C4I systems and managing their upgrade to the current Navy C4I programs of record such as Global Command and Control System– Maritime (GCCS-M) 4.x and Common Personal Computer Operating System Environment (COMPOSE) 3.x, from PMW-150 and PMW-160, respectively. However, he felt that current operational C4I systems were not designed to operate seamlessly with one another. Particularly when considering the necessity of joint operations involving air, surface, and subsurface platforms that may have evolved C4I systems optimized to their environment, but not for coordination with one another. He felt that system performance should be measured as time late as applied to detection, localization, and weapon on target. System availability such as robust satellite communications was important. All of these measures were considered in the value system section. Mr. Dickerson also believes that robust satellite communications is essential. The existing and planned systems that he provided were addressed in the alternatives generation section. Mr. Dickerson stated that core services include web, instant messaging, persistent chat, domain name service, secure mail, global address list, common operational picture, voice over internet protocol (IP), user authentication, and simple mail transfer protocol. However, with the exception of the common operational picture, that level of detail was considered out of scope for this project. He provided major program of record systems that the Joint ASW C4I Architecture needs to comply with. These were reviewed in the constraints and alternatives generation sections. He felt that a new architecture, such as this project, could be an improvement of current Undersea Warfare-Decision Support System (USW-DSS) conceptual thinking.

PMS-420, the Littoral Combat Ship Mission Module Program Office, packages a variety of technologies, many of which are produced by other program offices and delivered as elements of a particular mission module for the Littoral Combat Ship. The ASW module includes acoustic sensors such as a multifunction towed array and a remote towed active source, along with other detection systems and weapons designed for use aboard the MH-60 helicopter and unmanned surface vessels like the Spartan [Defense Industry Daily, 2006]. The stakeholder that provided written input from PMS-420 was Rich Volkert. He felt that the Joint ASW C4I Architecture needs long range unrelayed data transmission capability with high bandwidth capability. The end goal of net-centric warfare is transparent data sharing between users. Bandwidth and data transmission were

a significant consideration in the alternatives generation section. He provided environmental threat information that was addressed in the threat analysis section. The environmental characteristics to comply with include spectrum use constraints depending on operational site, active denial of spectrum such as jamming and anti-satellite operations, and the need to counter active source acoustic sensing. He also provided existing systems that the Joint ASW C4I Architecture needed to interface with which was addressed in the constraints and alternatives generation sections. Mr. Volkert also provided functions of the Joint ASW C4I Architecture addressed in the functional analysis section. He believes our constraints include legacy radio assets and limited links, product obsolescence, and multiple proposed relay concepts in existence but no clear acquisition path on what is real. His expectation of a Joint ASW C4I Architecture is a document laying out the minimum link needs for integrating today's capability with a defined incremental path leading to longer duration relayable high bandwidth capability. The legacy radio asset and minimum link needs are addressed in the alternatives generation section. Mr. Volkert felt that a new war fighting view should be developed for the acquisition communities to support vice the legacy approach of developing capabilities that are then fitted into the existing nets. Both a new and legacy system needed to be considered. Mr. Volkert felt that the system tolerances include latency and the need to clearly define prioritization in data messaging to ensure that you do not place mission in hazard due to maintaining a link of lower priority. Higher level of false alarm and potential minimal data availability in the ASW mission drive the need for large distributed links and data fusion. These elements are addressed in the value system and modeling sections. Mr. Volkert suggests that the Navy should be able to conduct the detect-to-engage sequence with off board vehicles and distributed systems under remote control today eventually leading to engagement capability with these systems. These vehicles were believed to be outside the scope of the Joint ASW C4I Architecture. They could interface with it, but are not part of it.

Program Executive Office, Integrated Warfare Systems (IWS) is another one of five program executive offices affiliated with NAVSEA. PEO-IWS delivers enterprise solutions for Naval warfare systems that operate within the fleet and joint force [PEO IWS, 2008]. PEO-IWS has one program office that would benefit from the development of the Joint ASW C4I Architecture. The Undersea Systems Program Office (PEO-IWS 5.0) is involved with development of enterprise solutions that integrate various undersea systems. This includes surface ship undersea warfare combat systems, ASW systems engineering, task force ASW acquisition, and ASW C2 systems. The USW-DSS program is particularly applicable to this project. James N. Thompson and Raymond J. Curts were points of contact from PEO-IWS, IWS-5.0 (Undersea Systems). They have

moderate to expert experience on ASW and C4I architectures. They felt that the Joint ASW C4I Architecture needs to be consistent with Net-Enabled Command Capability (NECC). This was reviewed in the constraints and alternatives generation sections of this report. Mr. Thompson and Mr. Curts felt that metrics include quality, accuracy, timeliness, and authenticity of ASW related data as it is transmitted to fleet commanders and other users. Timeliness and accuracy were addressed in the value system and modeling sections. However, quality and authenticity were not addressed at this phase of architecture development. Rather, those could be addressed as an area of further study. They felt that the functions the Joint ASW C4I Architecture will perform include common tactical picture and decision aids. The common picture was addressed this project, but not the decision aids. That is suggested for a follow-on project activities. They felt that the Joint ASW C4I Architecture should be captured in a data format that can be queried, analyzed, and manipulated. Ideally, the data schema and format should be compatible with all other architecture data but, since there is no accepted standard and a large number of data structures are in use, compatibility can only be accomplished with a limited subset. Mr. Thompson and Mr. Curts believed that ASW is consolidating around the Undersea Warfare-Decision Support System as the primary C2 system for the mission area. This was reviewed in the constraints and alternatives generation sections.

The Program Executive Office, C4I develops implementation guidance for program execution of Network Centric Enterprise Solutions for Interoperability (NESI) [Cox, 2005]. PEO-C4I has three program offices that stand to gain from the implementation of the Joint ASW C4I Architecture. These include Program Manager Warfare-770 (PMW-770), PMW-160, and PMW-150 - C2 Applications. Submarine Integration (PMW-770) is responsible for integration to submarines, primary fleet point of contact, installation, and delivery of the C4I capabilities to submarines [Miller, C., 2006]. PMW-160 is the Navy acquisition and technical authority for networks, information assurance, and enterprise services. They provide interoperable and secure net-centric enterprise capabilities to the Navy, joint, and coalition warfighters [Wolborsky, 2005]. PMS-150 transforms operational needs into Command and Control capabilities for Navy, Marine Corps, joint, and coalition warfighters [Spencer, 2005].

Michael Hutter, Technical Director of PMW-770 (Submarine Integration), represented all of PEO-C4I for this study. He has 21 years in submarines practicing ASW and 15 years in submarine communications requirements generation, funding, acquisition, systems development, fielding, and testing. He felt the Joint ASW C4I Architecture needed to be developed because it will reduce the time in the kill chain, reduce the incidence of blue-on-blue, and increase the kill rate or number of detection and disruption of red attacks. He does not think the joint services need an ASW C4I

architecture. He believes ASW is a uniquely Navy Mission and a not joint mission. ASW is required to ensure access to commit land forces to battle and to resupply those forces. While it is a predominately a Navy mission, this capstone project design team does not agree that it is solely a Navy mission. It needs to be a coalition and joint mission to be effective. He provided interfaces, functions, and constraints for those sections, respectively. For submarines, he states that limitations to communications at speed and depth (CSD). Mr. Hutter's view point of the situation today is that there is a temporary solution in place for CSD today until the holy grail of CSD is achieved. This can be achieved through technology such as satellite based optical laser communications (OLC) to enable full coverage of the speed and depth operating envelope for submarines. This was addressed in the alternatives generation section.

Program Executive Office, Submarines (PEO-SUB) develops, acquires, modernizes, and maintains the submarines and undersea systems. Team Submarine is an amalgamation of PEO-SUB, the Deputy Commander, Undersea Warfare (NAVSEA 07), and the Deputy Commander, Undersea Technology (NAVSEA 073). The Team Submarine concept unifies the once diverse submarine-related commands and activities into a single "submarine-centric" organization. Its goal is to eliminate traditional stove-piped structures and processes that created impediments and inefficiencies in the submarine research, development, acquisition, and maintenance communities. Team Submarine provides improved communication among the various offices that contribute to the overall success of the United States Submarine Force One program office under PEO-SUB. A program office under PEO-SUB that stands to gain from the development of the Joint ASW C4I Architecture is Program Manager Ships-425 (PMS-425), Submarine Tactical Control Systems. PMS-425 develops and acquires the combat and weapons control systems for both in-service and new construction ships [PEO Subs, 2008].

Program Executive Office for Air ASW, Assault and Special Mission Programs (PEO-A) provides expertise, assistance, resources to program teams and represent executable programs for air assault, air ASW, and air special mission to higher levels of management; provides evaluations, options, and recommendations on program planning and execution to the appropriate Milestone Decision Authority and resource sponsor [PEO (A), 2008]. PEO-A has three programs that stand to gain from the Joint ASW C4I Architecture. This includes Program Manager Air 290 (PMA-290), Maritime Patrol and Reconnaissance Aircraft; PMA-299, ASW Rotary Wing Aircraft; and Program PMS-264, Air ASW Systems. PMA-290 leads programs for replacement of aircraft with Under Secretary of Defense for Acquisition, Technology, and Logistics as Milestone Decision Authority [PMA-290, 2008]. PMA-299 leads the H-60 Seahawk program. The H-60 is a

multi-mission, ship-based naval helicopter designed to extend the sensor range of frigates for anti-submarine warfare [Naval Supply Systems Command, 2008]. PMS-264 leads the sonobuoys programs under various contracts. These include the bathythermograph, directional frequency analysis and recording, low frequency analysis and recording, directional command activated sonobuoy system, vertical line array directional frequency analysis and recording, and data link communications sonobuoys [Approved Navy Training System Plan for the Navy Consolidated Sonobuoys, 1998].

Defense Information Systems Agency (DISA) is a combat support agency responsible for planning, engineering, acquiring, fielding, and supporting global net-centric solutions to serve the needs of DoD. DISA is the lead for NECC. NECC will be the DoD's principal command and control information technology. It will enable decision superiority via advanced collaborative information sharing achieved through vertical and horizontal interoperability. NECC is the net-centric migration path for the Global Command and Control System family of systems. It will use Net-Centric Enterprise Services (NCES) core enterprise services and will be able to exchange information across multiple security domains [NECC, 2008].

There are five systems command field activities that should participate in the development and fielding of the Joint ASW C4I Architecture. Each is affiliated with a systems command. Two are warfare centers affiliated with NAVSEA: the Naval Undersea Warfare Center (NUWC) and Naval Surface Warfare Center (NSWC). NUWC is the Navy's research, development, test and evaluation, engineering, and fleet support center for submarines, autonomous underwater systems, and offensive and defensive weapons systems associated with undersea warfare [Naval Undersea Warfare, 2008]. NSWC is the Navy's main research, development, and test and evaluation activity for ship and submarine platform and machinery technology for surface ship combat systems, ordnance, mines, and strategic systems support [The Naval Sea Systems Command: A Determined Team, 2008].

The Naval Air Systems Command (NAVAIR) provides acquisition, research, development, test and evaluation, and in-service support capabilities for airborne weapons. NAVAIR is the principal provider for the Naval Aviation Enterprise and contributes to every warfare enterprise in the interest of national security [NAVAIR, 2008]. Affiliated with NAVAIR is the third systems command field activity that should participate in this architecture project; Naval Air Warfare Center – Aircraft Division. They perform research, development, testing, and evaluation for Naval aircraft systems and antisubmarine warfare systems, and perform associated software development [Naval Air Warfare Center, 2008].

Space and Naval Warfare (SPAWAR) Systems Center (SSC) San Diego and Charleston are warfare centers affiliated with Space and Naval Warfare Systems Command Headquarters. They are the fourth and fifth systems command field activities that should participate in this architecture project. SSC San Diego develops Command, Control, Communications, Computers, Intelligence, Surveillance, and Reconnaissance (C4ISR) capabilities that allow decision makers of the Navy, and increasingly of the joint services, to carry out their operational missions and protect their forces. SPAWAR HQ, SSC San Diego, and SSC Charleston are contributing significantly to the efforts of the FORCEnet [Space and Naval Warfare Systems Command, 2008]. FORCEnet is the operational construct and architectural framework for Naval Warfare which integrates warriors, sensors, networks, command and control, platforms and weapons into a networked, distributed combat force, scalable across the spectrum of conflict from seabed to space and sea to land [FORCEnet, 2008].

United States Coast Guard (USCG) Deep Water Program stands to gain from a the Joint ASW C4I Architecture in its Maritime Patrol Aircraft's command and control systems [Allen, 2007].

The Mitre Department of Defense Command, Control, Communications, and Intelligence (C3I) Federally Funded Research and Development Center (FFRDC) supports the Navy. The C3I FFRDC directs its work program toward achieving the DoD's vision of an integrated command and control capability based upon C4ISR systems that support joint United States and multinational military operations [Mitre, 2008].

This capstone project design team was unable to identify or convince stakeholders from PEO-SUB, PMS-425, DISA, NSWC, NUWC, NAVAIR, SPAWAR, SSC –SD, SSC – Charleston, USCG, and Mitre organizations to participate on this project. Their lack of participation caused more research while defining the needs. Ideally the team would have preferred to have them engaged.

### **3. User Community**

The ultimate users of the Joint ASW C4I Architecture are the cue-to-kill chain communities. This community drives the requirements for C4I architectures. They can improve their tactical and operational superiority through a joint integrated open ASW C4I architecture. This allows for the exchange of the full range of information. This includes tactical, theater, environmental, and intelligence information. This information is needed to plan and execute missions and search strategies; coordinate undersea warfare operations with multiple ASW platforms; monitor prosecution of targets; assess kills; and perform battle damage assessment. Further, the Joint ASW C4I Architecture must meet

the commanders' requirements to have current and accurate information regarding threat status. This community includes United States Joint Forces, Homeland Security such as the Coast Guard, and coalition partners who are essential to the vision of a 1,000-ship navy. The different user roles are identified by the Global ASW concept of operation recently updated by Naval Mine and Anti-Submarine Warfare Command (NMAWC). However, that document is classified and could not be used for this project. Therefore the user roles were captured through unclassified sources and may not be complete or current. The users' roles drive what the data needs are and how they will be used for ASW operations. This will drive the data sources that need to be integrated in the Joint ASW C4I Architecture. Specifically the users and their roles are included the following paragraphs.

Joint United States Forces Combatant Commanders are strategic theater commanders that have planners for air and land war that determine losses in route and enable prediction or success in air and land battle. For example, the Commander, United States Pacific Fleet (COMPACFLT) mission is to support the United States Pacific Command's (USPACOM) theater strategy, and to provide interoperable, trained, and combat-ready naval forces to USPACOM and other United States unified commanders. As such, the COMPACFLT is a "force provider" to unified commanders in various regions around the world. Although the COMPACFLT is primarily a force provider, five numbered fleets and operational commanders report directly to COMPACFLT. One of the five numbered fleet commanders is Commander, Task Force 12 (CTF-12). CTF-12 conducts anti-submarine warfare operations theater-wide [Commander, United States Pacific Fleet, 2007]. Similarly, there are CTF-69, 74, 84 supporting their numbered fleet.

So, for example, the USPACOM has COMPACFLT with the following organizations to conduct ASW. Tactical Strike Group Commanders are the operational users in assigning and prioritizing user allocation of bandwidth and the authorized available frequency spectrum. Theater Anti-Submarine Warfare Commander (TASWC) organization has experts at coordinating ASW. They are responsible for ASW planning; environmental prediction areas; correlations; and tasking orders, but often delegate that to the Anti-submarine Warfare Commander (ASWC). TASWC or ASWC develops mission plans based on available assets and resources, intelligence, and environmental predictions. ASWC afloat and ashore coordinate resource use and risk for transiting forces or forces in a sea-base. TASWC or ASWC hands out coordinated tasking through the Sea Combat Commander (SCC) to units. SCC requires the ability to communicate intentions, on-going actions, requirements, and results to peer level warfare commanders, supporting commands, and higher authority. The SCC requires the ability to rapidly send their directions to the ASW mission or unit commanders for implementation.



The units then execute the plan, provide real time status, and obtain kill. ASW mission or unit commanders are used for coordinated sensing, attacking, and to prevent blue on blue engagement. These units require the ability to rapidly receive and implement the directions of the SCC, obtain kill, respond to the actions of other assigned platforms, and provide real time status to the SCC and other platforms concerning the current state of the tactical situation. Assets may include submarine platforms, surface platforms, aircraft platforms, or Integrated Undersea Surveillance Systems (IUSS). IUSS includes the shore processing facilities, supporting commands, and national intelligence infrastructure.

Commander, Fleet Forces Command (CFFC) mission is to generate ready Navy forces for assignment and provide operational planning and support to Combatant Commanders, articulate to the Chief of Naval Operations (CNO) the integrated Fleet warfighting capabilities requirements as coordinated with all Navy Component Commanders, and develop Fleet Concepts of Operations [United States Fleet Forces, 2008]. The Fleet Anti-Submarine Warfare Command (FASWC) reports to CFFC. The command's mission includes integrating advanced ASW networks, establish doctrine and new operating concepts, fleet ASW training, and assisting naval leadership with ASW policy. Its primary focus will be on providing standardized ASW training for the entire Navy, assessing ASW capabilities and readiness throughout the fleet, and in seamlessly implementing the latest state-of-the-art technology into ASW operations [Fleet Antisubmarine Warfare Command, 2004].

Naval Network Warfare Command (NETWARCOM) is the type commander for Navy networks. Networks, as warfare enablers, are becoming increasingly important to today's warfighter. NETWARCOM will be the central operational authority responsible for coordinating all information technology, information operations, space requirements, and operations within the Navy [Slaght, 2002].

Naval Mine and Anti-Submarine Warfare Command (NMAWC) is the war fighting center and principal authority for the mine warfare and ASW mission. It focuses efforts across numerous resource sponsors, systems commands, research laboratories, training organizations, and operational commands to ensure Navy-wide competency in the mine warfare and ASW mission areas. NMAWC is the primary command through which issues related to mine warfare and ASW are coordinated with tactical development agencies and commands [Naval Mine and Anti-Submarine Warfare Command, 2007].

Naval Meteorology and Oceanography Command (NMOC) is an echelon III command under the lead of the Commander, Fleet Forces Command. NMOC is the lead in multidimensional battlespace awareness. They analyze and predict acoustic ranges for

the Navy's ASW effort. The Commander Undersea Surveillance (CUS), head of the Navy's Integrated Undersea Surveillance System (IUSS), is an echelon IV command that serves under the NMOC. CUS uses and monitors sensors in the Navy's ASW effort [Naval Meteorology and Oceanography Command Public Affairs, 2007]. Other users or providers for ASW include the Intelligence Commanders and Space Warfare Commanders.

The only stakeholder that provided written input from the user community was Greg Clarkson from Commander Undersea Surveillance. He has extensive experience with net-centric ASW having served as the Director of Operations for the Web-Centric ASW Net (WeCAN), the first joint C4I system for ASW COI. He also has 27 years experience as an IUSS Master Acoustic Analyst. He felt that the need to communicate across the joint community and coalition is critical to the Navy ASW community. Mr. Clarkson believes that the greatest thing lacking today is cross domain communication capability. Security restraints and policies preventing United States and allied IP based communications are not only frustrating it is likely to endanger engaged platforms or cause depletion of sensor and weapon resources when needed most. Joint ASW C4I Architecture is needed to enhance battle communication effectiveness, protect the fleet, and to mitigate risks of resource waste. The joint services need a Joint ASW C4I Architecture that maximizes the use of limited resources. This capstone project design team agrees with this assessment. Mr. Clarkson felt that the performance measures of a Joint ASW C4I Architecture should include timeliness of reports, false alarm rates, actual versus requested search patterns, units pulled off search for other tasking, source inventory and bearing accuracy, positional accuracy, correlation accuracy, and send and receipt speed of communications. The timing and accuracy at a high level was addressed in the value system and modeling sections. However, the other performance parameters suggested were too low level and were not addressed here. They could be the topic of a follow-on study. Many constraints, functions, interfaces were provided by Mr. Clarkson and were incorporated in those sections, respectively.

The Department of Homeland Security outlines the national priorities for achieving Maritime Domain Awareness (MDA). MDA is the effective understanding of anything associated with the global maritime domain that could impact the United States' security, safety, economy, or environment. MDA is a key component of an active, layered, maritime defense-in-depth. MDA will be achieved by improving the ability to collect, fuse, analyze, display, and disseminate actionable information and intelligence to operational commanders and decision makers. It will reorient and integrate relevant Cold War Command C4ISR legacy systems and operational concepts with current and emerging sensor capabilities and applicable procedures. These capabilities will be fused

in a common operational picture that is available to maritime operational commanders and accessible as appropriate throughout the United States government. The COP is shared by United States federal, state, and local agencies with maritime interests and responsibilities. This dynamic and scalable COP will provide the appropriate types and level of information to the various agencies in a near-real time, customizable, network-centric virtual information grid. The United States Coast Guard comes under the Department of Homeland Security. They stand to gain from a common Joint ASW C4I Architecture [National Plan to Achieve Maritime Domain Awareness, 2005].

Coalition and Multi-National Forces including Canada, Great Britain, Japan, and Australia will gain from a common Joint ASW C4I Architecture.

There were no stakeholders representing COMPACFLT, CTF-12, 69, 74, or 84, TASWC, ASWC, SCC, CFCC, FASWC, NETWARCOM, Intelligence Commanders and Space Warfare Commanders, Coalition and Multi-National Forces, or the United States Coast Guard. However, several of the stakeholders from the acquisition and resource communities had been in the user community at one time, so they were a good surrogate stakeholder for the user.

## **B. THREAT ANALYSIS**

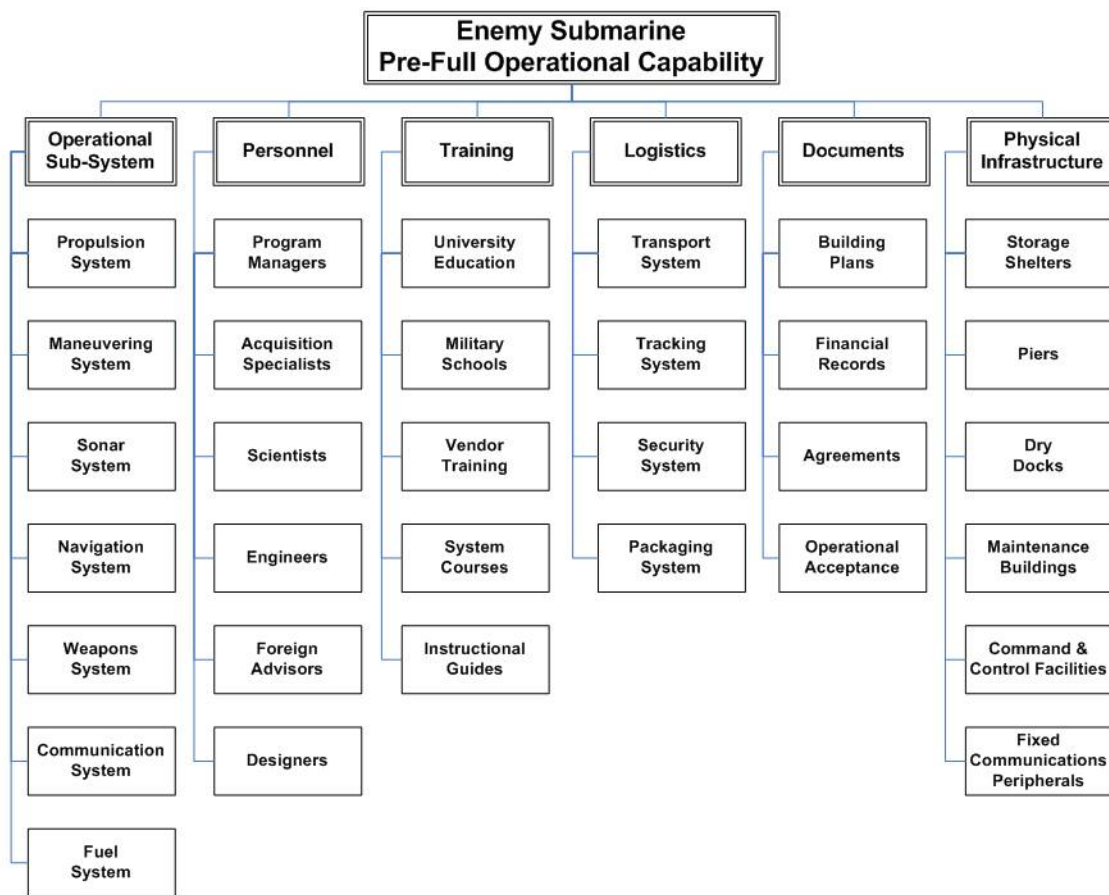
Threat is defined as “an expression of intention to inflict evil, injury, or damage; one that threatens; an indication of something impending” [Merriam-Webster, 2008]. For this report, the threat is an enemy submarine’s complete system capabilities and the threat to the C4I architecture. The threat of the enemy submarine includes elements beyond the submarine itself such as its command and control, country’s ideology, supply system, and fleet support units. Further, the threat is addressed across the life span of its operational use including its initial design stage, parts production and fabrication, and the launch of an operationally ready submarine.

In his January 2002 article “Practical Threat Analysis and Risk Management,” Mick Bauer [2002] asserts, “Threat is the combination of an asset, vulnerability and an attacker.” Though directed more specifically to computer unique situations Mr. Bauer’s following points help to further define the threat to the Joint ASW C4I Architecture and its operational environment. Specifically the following:

An asset is anything you wish to protect. In information security scenarios, an asset is usually data, a computer system or a network of computer systems. We want to protect those assets’ integrity and, in the case of data, confidentiality. Integrity is the absence of unauthorized changes. Unauthorized changes result in that computer’s or data’s integrity is compromised. We also want to protect the confidentiality of at least some of our data. This is a somewhat different problem than that of integrity, since confidentiality can be compromised completely

passively. Step one in any threat analysis, then, is identifying which assets need to be protected and which qualities of those assets need protecting. Step two is identifying known and plausible vulnerabilities in that asset and in the systems that directly interact with it [Bauer, 2002].

Our analysis of the enemy submarine and support organization assets was considered for two specific phases of the enemy submarine’s life cycle: before its subsystems are completely integrated (pre-full operational capability) and after it has become a fully operational unit capable of conducting sea-going missions (full operational capability).



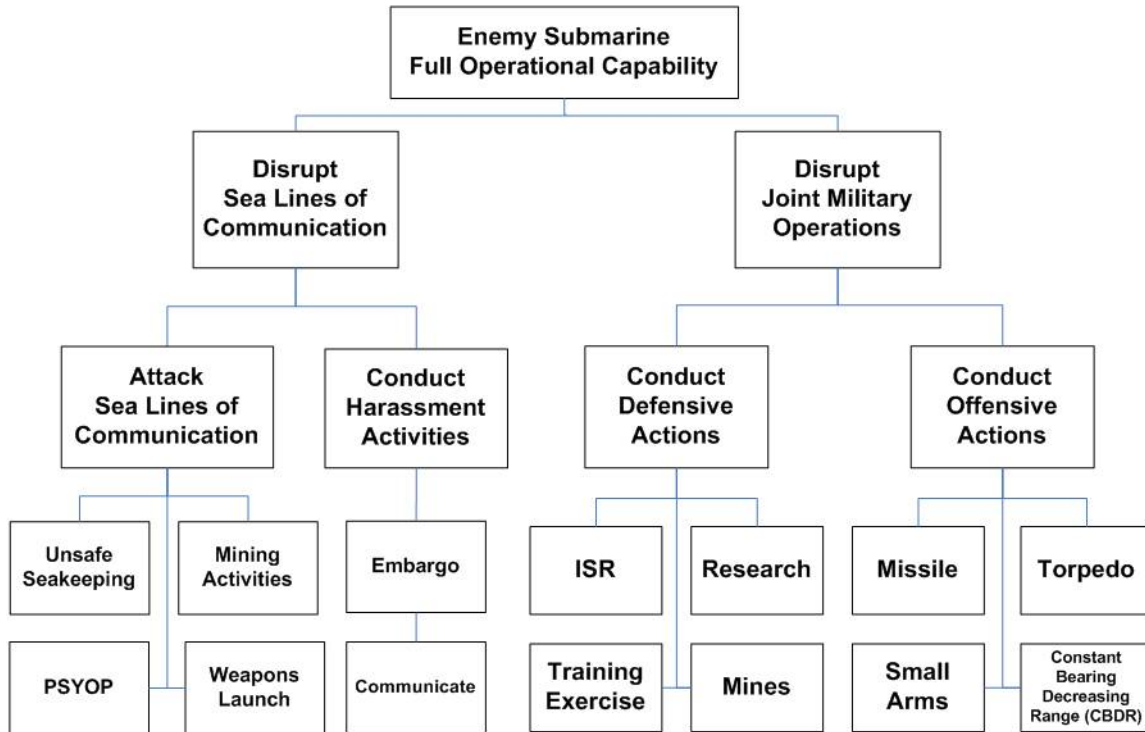
**Figure 5. Pre-Full Operational Capability**

This diagram details six areas of major importance to the enemy forces ability to produce a fully operational submarine – operational sub-systems, personnel, training, logistics, documents, and its physical infrastructure.

Figure 5 identifies six pre-fully operational capability areas and their hierarchical decompositions. The pre-full operational capability areas include: operational sub-systems, personnel, training, logistics, documents and physical infrastructure.

Operational sub-systems include all hardware systems and equipment, which, when properly integrated, form a fully operational mission capable submarine. Personnel are those individuals and teams that contribute to the designing, crafting, integrating and ultimately controlling the operational performance of the submarine at sea. Training offers the ways and means for attaining skill sets required to conduct submarine operations and most efficiently operate the subsystems being placed onto the submarine. Logistics addresses the secure movement and tracking of consumables, parts, and subsystems from construction to final delivery and storage. Documentation is required to properly construct the vessel, acknowledge financial expenditures, show program information, and exchange operational acceptance for the submarine system. The enemy's physical infrastructure includes command and control buildings, communications peripherals, storage and maintenance, as well as, dry docks and piers.

In the full operational capability phase submarines play key roles in strategic military operations and are often politically sensitive to global diplomatic relationships. Rogues of the world's naval forces, submarines quietly navigate the world's seaways above and below the ocean's surface independently or in close proximity to a fleet or battle group. A submarine is specifically built to operate and endure long periods of time under water [Offley, 2008]. To understand this undersea threat it is most important to be aware of its operational subsystems and their collective dangers posed on friendly forces and the conduct of submarine military operations. The submarine threat is capable of a myriad of sea and undersea missions. Figure 6 provides a detailed look at disruptive activities submarines could be engaged in around the world. Each activity represents an important input to overall defensive and offensive strategies of the adversary. The activities were broken down into two categories: disrupt sea lines of communication and disrupt joint military operations.



**Figure 6. Submarine Disruptive Activities**

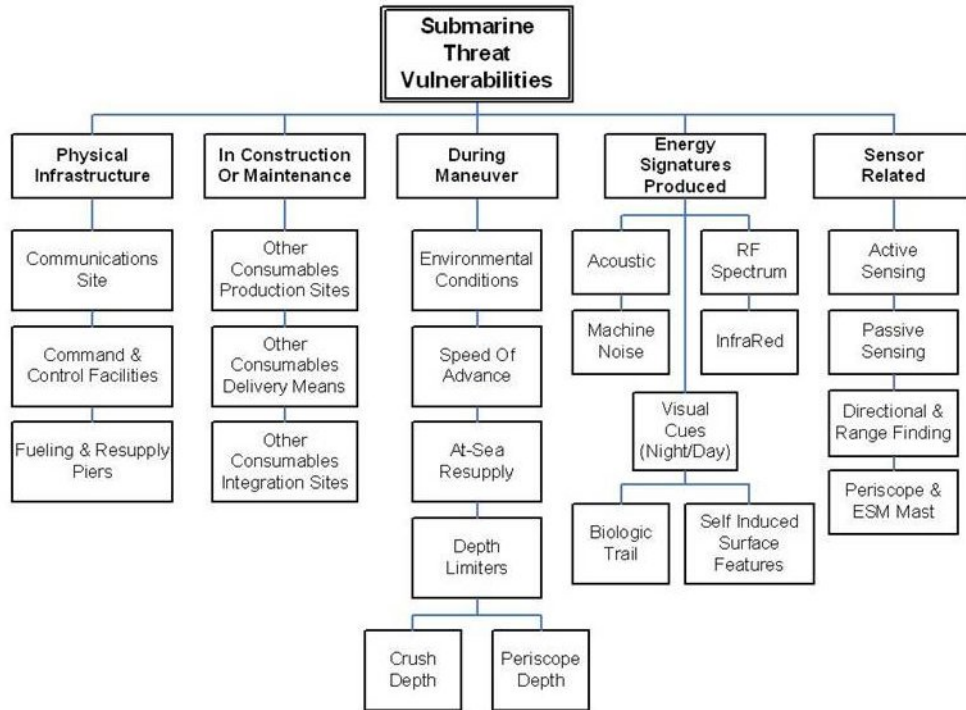
Submarines have the capacity to create disorder to sea lines of communication and joint military operations through offensive and defensive actions, harassment activities, and attack missions.

Disruptions within sea lines of communication include unsafe enemy submarine sea keeping practices forcing surface ships off course, mine laying activities, psychological operations, and weapons launch and the conduct of harassment activities such as embargo and communications. These activities could wreak havoc on commercial and military shipping alike, having severe impacts on political and economic venues of affected areas. Additionally, it is expected that the enemy will conduct defensive and offensive actions to disrupt joint military operations. Defensive actions could include research, the deployment of sea mines, conduct of training exercises, or the performance of intelligence, surveillance, and reconnaissance missions. Offensive actions would include the deployment of missiles or torpedoes, the use of small arms weapons, or simply running their submarine at perspective targets to cause dangerous navigational situations.

Submarines move freely through sea space looking to gain positional advantage over a single quarry at depth, on the sea surface, ashore and space-based targets. Operational functions of the enemy threat consist of delivering weapon, observing targets, maneuvering the boat, and communicating information. The submarine, by its

nature, performs its duties with utmost secrecy and sensitivity to its environment. It observes its environment acoustically, visually, and electromagnetically. It relies on its keen sense of situational awareness in its search for contacts while maintaining proper positioning within the x, y, and z axes of the water column to best perform its passive, observational duties. These duties may include surveillance and reconnaissance; release of weapons like mines, torpedoes, missiles; and communication of tactical or strategically significant information. Communication by enemy submarines is expected to be infrequent, if at all. The joint and coalition maritime forces must be ready to receive these signals, decrypt as necessary, or jam if in naval ASW force's best interest to protect assets. One thing is certain, expect a submarine to be operating where it presents a large number of safety risks to operational forces and commercial shipping while ensuring multiple escape routes for its own survivability.

“The identification of system elements whose required performance may exceed demonstrated limits can be grouped into four classes of critical characteristics of systems functional elements: signal, data, material, and energy” [Kossiakoff and Sweet, 2003: 209]. It is this capstone project design team's assertion that these four elements are the keys to accurately identifying not only the vulnerabilities of the enemy submarine threat, but the threat to the vulnerabilities of the Joint ASW C4I Architecture systems and subsystems as well. The enemy threat is by its own nature and operational environment vulnerable to being located, identified, and, in time of war, destroyed. Figure 7 expands on the “big four” elements offered by Kossiakoff and Sweet by breaking out five areas of vulnerability for further consideration: physical infrastructure (material); in construction or maintenance (material); during maneuver (energy); energy signatures produced (signals); and sensor related (signals and data). These vulnerabilities will be exploited in anti-submarine warfare operations. They include not only the enemy submarine, before it is actually constructed and equipped, but also once it is deployed.



**Figure 7. Vulnerabilities of the Threat**

Submarines are at risk to operational delay, attack, and destruction in five distinctly different areas including the physical infrastructure of its supporting facilities, while under construction or maintenance, during maneuvering activities, from energy signatures it produces, and sensor related activities.

The enemy force’s physical infrastructure spans beyond the submarine pier. It includes numerous communications sites, command and control facilities, and fueling and resupply piers. With regard to the submarine threat and its need to be sustained and maintained, it is recommended that exploitation be carried out on “other consumables” by locating and targeting production sites, the physical delivery vehicles, and the specific system integration sites. Destruction of transport vehicles and the parts or complete sub-system could represent the delay or cancellation of the entire submarine as a whole. Loss of a key component could be critical to fielding this initiative. While the submarine threat is underway, during maneuver, it is at risk to environmental conditions; its own speed of advance; while conducting at-sea resupply; and its own depth limiters bounding a more specific operational area of the water column. Two very similar but differing areas of vulnerability are energy signature produced and sensor related. Energy signatures produced includes acoustic, machine noise, radio frequency spectrum, infrared, and visual cues, night or day. The ability to identify these signatures and locate their origins is vital to successfully exploiting them. The enemy’s choice of sensor could actually help to expose his presence; hence, sensor related elements, such as active



and passive sensing, directional and range finding, and the use of periscope and the mast used for electronic surveillance measures mast, are of significant importance. ASW forces should seek to interact with all enemy sensors to better detect, locate and engage enemy submarines at the furthest ranges possible.

The threat will not always be under power such as when it is simply drifting with the current or loitering on the sea bottom. It may be in other vulnerable states such as if it were not making way in a navigable sea lane, being pier side, or as a surface contact. If recognized it may be an easy target. Further, it could be identified, tracked, and cataloged by its own boat noise signatures, while communicating, from its exposed surface area or environmentally-induced visual cues such as waves, thermal signatures, and bioluminescence trails.

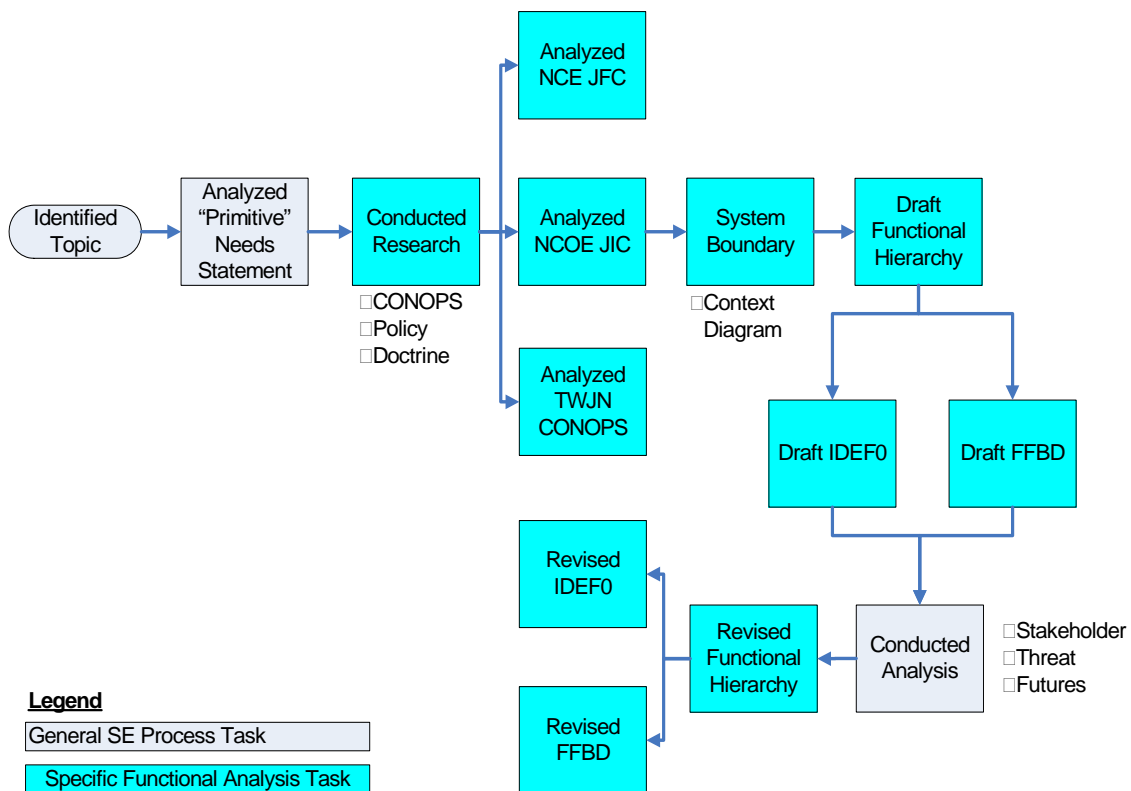
Weapons ranges need also be considered when determining the enemy submarine's intelligence, surveillance, and reconnaissance or weapons engagement positions. Over the horizon targets, land and sea, will require much larger anti-submarine search areas than those with line-of-sight (LOS) targeting solutions. The close-in targets offer additional operational shortcomings in that the prey will have limited warning and equally small reaction periods to thwart enemy actions.

ASW is a team sport - requiring a complex mosaic of diverse capabilities in a highly variable physical environment. No single ASW platform, system, or weapon will work all the time. A wide spectrum of undersea, surface, airborne, and space-based systems to ensure that we maintain what the Joint Chiefs of Staff publication Joint Vision 2010 calls "full-dimensional protection." The undersea environment, ranging from the shallows of the littoral to the vast deeps of the great ocean basins - and polar regions under ice - demand a multi-disciplinary approach, subsuming intelligence, oceanography, surveillance and cueing, multiple sensors and sensor technologies, coordinated multi-platform operations, and underwater weapons. Most importantly, it will take highly skilled and motivated people [Morgan, 2008].

Our threat can remain submerged indefinitely but is controlled by its own operational systems' limiters, such as, fuel efficiency; battery duration and life cycle; air, food, and water for crew survivability; weapons sustainability, communications; and navigational subsystems. Exploiting these operational shortcomings will help to address their operating areas, the conduct of their missions, and offer opportunity to impede their effectiveness. The submarine's operational value is limited only by its crew's ability to stay hidden in the world's seaways. The ability to communicate accurate and timely threat information will be significant when attempting to frustrate the plans of global submarine threats.

### C. FUNCTIONAL ANALYSIS

A functional analysis was completed to help translate stakeholder requirements into detailed design criteria and to help identify the resources necessary for system operation and support. The process followed for the functional analysis is displayed in Figure 8. This process was started by analyzing the primitive needs statement. After that, research was conducted on net-centric requirements, constraints, and interfaces. Specific net-centric documents were analyzed, the system boundary was established, and draft functional models were created. Finally, an analysis was completed on those draft models using input from the stakeholders, threat analysis, and futures analysis until the revised functional models were completed.



**Figure 8. Functional Analysis Process**

The Functional Analysis Process consisted of conducting research, analyzing key documents, establishing a system boundary, and creating draft functional analysis products. Completion of those products prompted another analysis which led to the completion of the revised products.

The stakeholders asked this capstone project design team to build a net-centric architecture. For this reason, research was conducted and the NCOE JIC, the Net-Centric Environment (NCE) Joint Functional Concept (JFC), and the Tactical Wireless Joint Network (TWJN) Concept of Operations (CONOPS) were identified as important net-

centric documentation. The NCOE JIC presents the concept of a net-centric operational environment and lists the capabilities that a net-centric architecture should provide [NCOE JIC, 2005]. The NCE JFC identifies the principles, capabilities, and attributes required to function in a net-centric environment [NCE JFC, 2005]. The TWJN CONOPS brings more fidelity to the NCOE JIC regarding the employment of wireless joint networking capabilities [TWJN CONOPS, 2007]. An analysis of those documents allowed for identification of the top-level functions the system must perform in support of the Joint ASW C4I Architecture.

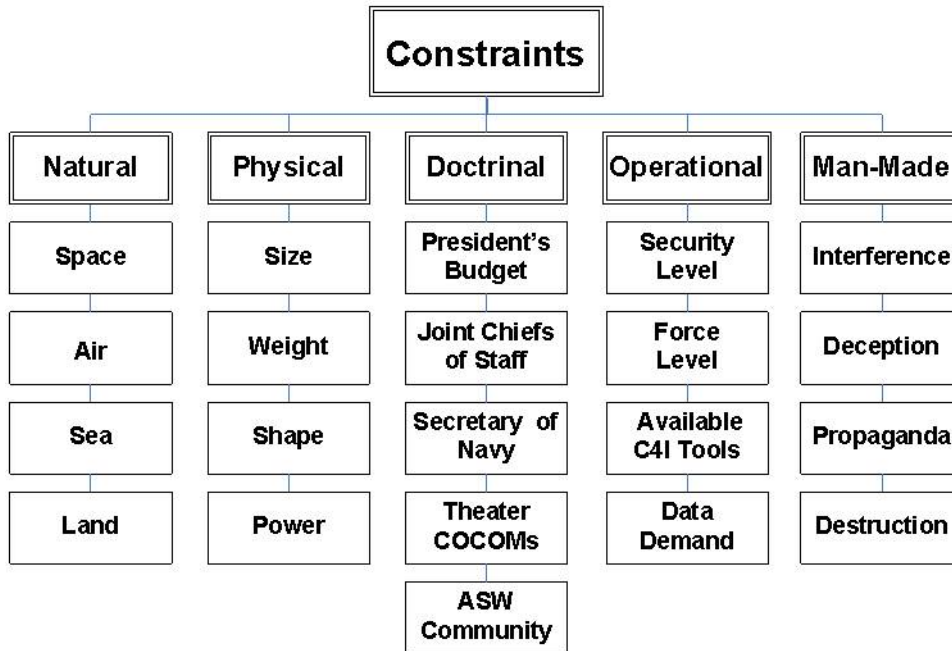
Analyzing the aforementioned documents allowed the system boundary to be identified, which established the interfaces between the Joint ASW C4I Architecture and other systems. Establishing the system boundary helped to determine what functions the system accomplishes and provided the justification for the components that are implemented in the system. Overall, the functional analysis provided the basis for developing innovative alternatives because how the Joint ASW C4I Architecture accomplishes these functions was not specified. This allowed for the design and study of systems independent of any specific technical solution.

### **1. Requirements**

In order to build a net-centric system that meets stakeholders' expectations, the capabilities and requirements that are needed for the C4I system were defined. Based on research and feedback from the stakeholders, five main capabilities that are required for a net-centric system were defined. From these capabilities, seventy-eight top level requirements were identified to be necessary in building a net-centric architecture. All of these capabilities and requirements for a net-centric system are shown in Appendix B.

### **2. Constraints**

Constraints are factors that lie outside the control of this capstone project design team but have a direct impact on the system design effort. The Joint ASW C4I Architecture will not be used within a functional void. Its functions while being contained by many factors contributing to its overall cost, scheduling, and performance. It is certain that proposed alternative solutions must stand up to the rigors of five specific constraints: requirements definition, system acquisition, test and evaluation, fielding, and ending with maximum utility to the ASW warfighter. Topical controlling factors considered in this study, depicted in Figure 9, calls for the Joint ASW C4I Architecture to be: conformal to nature; limited by its own physical system and subsystem attributes; regulated by doctrine; stressed in operational use; and impacted by man-made influences. ASW stakeholder constraints, specific to the Joint ASW C4I Architecture, are consolidated in the below sections.



**Figure 9. Constraints on the Joint ASW C4I Architecture**

Each system and subsystem applied to the Joint ASW C4I Architecture is constrained by cost, schedule, or performance characteristics and demands resulting from natural events, physical limiters, doctrinal guidelines, operational controls, and man-made C4I countermeasures.

*a. Natural Constraints*

**(1) Space**

Nature surrounds all conceivable applications of the Joint ASW C4I Architecture from space to mud. Sound and electrical impulses must travel through, over, or between four transmission mediums – space, air, sea, and land – to affect the art of communicating. The space environment can be characterized as a non-atmospheric entity devoid of weather effects but greatly affected by temperature extremes and sun-originated electromagnetic energies interfering with all radio frequency signals. This area outside of the earth’s stratospheric layer offers opportunity to place satellite communication systems at elevations and geostationary or polar transiting orbits to maximize beyond line-of-sight data relaying capabilities. This technology comes at considerable cost for research and development, operational sustainment, and system maintenance. Communicators need to consider distance and speed problems when planning satellite support to ensure the most efficient use of data rates and frequencies in order to reduce operational time latency issues. Once a safe operational haven, space has become a target-rich environment for enemy opposition to counter both commercial and military satellite-based communications tools with intrusion or destruction capabilities.

## **(2) Air**

Communication through the air environment has received the most attention relative to improving ways and means to communicate data through its atmospheric medium both above and below the tropopause. This is an area of great variability resulting from ever changing atmospheric parameters and resultant weather features. Precipitation rates, lightning, high winds, turbulence, temperature, and humidity all effect the path of radio frequency energy as it travels between known transmit and receive locations. Typically, excessive precipitation greatly reduces expected transmission ranges since water molecules absorb or diffuse electromagnetic energy. Lightning activity may cause intermittent interference with transmission activities or result in complete loss of communications at transmit or receive sites as a result of a direct lightning strike. High winds and turbulence mainly impact the operational use of communication systems and platforms which carry them ashore, at sea, or in flight. In some cases, systems may be redesigned to permit communication in worst case wind events. Understanding temperature and humidity values above the earth's surface may offer insight into the occurrence of extended or shortened radio frequency communications ranges due to the atmospheric phenomena ducting. Ducting essentially traps radio frequency energy within an invisible tunnel. Ducts can be at the earth's surface or elevated. When correctly using transmitters and receivers within the duct, extended ranges are expected. Otherwise communication ranges could be significantly less.

## **(3) Sea**

Natural constraints within the sea are derived from the sea surface and wave activity; the physical and chemical properties of the water mass; and the depth and type of seafloor. All contribute to how well sound travels through water and what ranges it may be detected. The sea surface is the upper boundary for underwater sound. It represents the operational playing field for naval surface platforms. High sea states may result in the inability of these ships to perform operational ASW detection missions. As for the water column, it is not uniform in salt content, temperature, and clarity. Its sound velocity profiles change with current, time of day, sea state, locations of land masses, biologics, fronts, and eddies. The lower boundary of the water column is the seafloor. Its bottom type is critical to sound energy absorption rates. Hard bottoms offer an excellent probability of limited loss of energy and extended range. Mud floors ensure that much of the energy is absorbed and a marked loss of energy directed at the bottom.

Radio frequency energy does not penetrate water very far; therefore, alternate communication methods at speed and depth constraints are needed.

Sound energy can be received hundreds of miles away from its originating source. Similar to that of air, sound energy can be trapped in sound channels to obtain extended ranges below the ocean's surface. This energy trapping is the result of several types of gradient features resulting from isothermal or isohaline conditions. As in the air, sensors placed within the trapping region or duct is able to maintain contact with noise producers. If outside of these ducts other operational Sound Navigation and Ranging (SONAR) detection techniques are needed to be used such as bottom bounce or direct path. Bottom features such as seamounts and deep canyons reflect or absorb sound energy, further complicating the detection problem.

Deep water offers relatively quieter listening conditions, whereas littoral shallow water areas are known to be extremely noisy, making the task of locating and identifying specific underwater targets nearly impossible. It is expected that the ASW future lies in the detection, control, and engagement of subsurface targets operating near or within these noisy, heavily traveled bodies of water.

#### **(4) Land**

For the most part, the land environment communication mirrors those already provided in the air and sea sections with several key discriminators. Radio frequency energy has the limited ability to travel through solid stone to pass imagery and voice data to underground users. Land masses interface with both the sea and air environments from ocean shorelines to the highest mountain elevations. Elevation is important to attain greater line-of-sight communication ranges, making higher land elevations important for over sea communication needs.

##### ***b. Physical Constraints***

Size, weight, and power attributes determine where the Joint ASW C4I Architecture may be used operationally. Stakeholders desire to have the most efficient communication tool kits with high data rates, high frequencies, and minimal data latencies. The Joint ASW C4I Architecture is limited by available real estate at shore sites and facilities, and cubic space obtainable on current or planned naval platforms. Today's platform commanders subscribe to the zero sum gain law of placing new systems into platform specific use regardless of reduced size and weight claims being marketed by technology vendors. It is understood that the Joint ASW C4I Architecture is only as good as improvements made for the intermittent, disadvantaged, and low bandwidth communicator.

Shaping of communication systems has permitted unique conformal antenna variations though limited to available surface areas of bulkheads, hulls, and superstructures. Typically, larger antenna systems offer higher bandwidth capabilities

with larger data rates. Cumbersome dish antennas require firm ground or large naval deck space capable of supporting its weight and power needs. Aircraft carriers and ships uniquely constructed for at sea communication are able to support medium to large communication interface tools. Aircraft and smaller combatant surface platforms make use of small to medium sized tools, with submarines having even smaller areas available for C4I tools.

Communication systems performance attributes such as data throughput, high frequency transmissions, and improved data latency may be enhanced with large antenna systems but may be of limited operational utility. The exception to this could occur through the enhancement of smaller communication systems such as burst communication techniques, on the move technologies, software-driven automations, and improved digital interface formats. Internal rack mounted communication systems such as modems, transmitters, receivers, and tactical interfaces are faced with similar size, weight, and power issues as platform commanders seek to benefit from the latest communication tool expected to offer greater interoperability and improved situational awareness.

*c. Doctrinal Constraints*

Federal doctrine, associated laws, and contractual and acquisition responsibilities all contribute to putting the most cost-effective system into the ASW operator's hands to fill the identified capability gap. Operational needs are put into motion by the ASW community through timely doctrinal driven actions to derive quantitative, qualitative, and functionally correct data sets. If the Joint ASW C4I Architecture is viewed by the Navy, and the Theater Combatant Commanders it supports, as critical to future operations it will be raised to the United States Secretary of the Navy's level for consideration, approval, and placement into the Navy's overall budget submission. Although completely sponsored by Navy leadership the proposal would require validation by the Joint Chiefs of Staff before it is submitted to Congress by the Secretary of Defense. Once submitted to Congress and approved as law, the President's budget can be enacted with the proposal receiving the necessary funds for acquisition and fielding.

A key to successfully gaining program approval is to meet the demanding Program Objective Memorandum (POM) schedule to gain the necessary operational and fiscal support within the requisite timeline. POM fiscal year 2010 has already been submitted. It will be imperative to provide inputs to the next programmed budget estimate submission in the next fiscal year.

There are different ways to field any or all of the proposed alternative solutions. Doctrine templates the requisite staffing actions needed to achieve a successful fielding of an alternate solution to address the ASW community's operational C4I capability gap. Cost, schedule, and performance level debates will be conducted at the highest levels of government to ensure the proper spending of taxpayers' money in regard to the Joint ASW C4I Architecture.

***d. Operational Constraints***

Security, force levels, availability of C4I tools, and operational demand for data were considered the most critical constraints addressed. Once operational, the Joint ASW C4I Architecture needs to respond to all security needs of the ASW force. Security includes, but not be limited to, information assurance consisting of availability, integrity, confidentiality, non-repudiation, and authentication. Depending upon the nature of operation, certain users may require limited access to special data sets and the assurance that it is not compromised in any way. Submarine operations and missions they support tend to be placed in higher classification areas. The Joint ASW C4I Architecture must conform to this requirement. The classification of blue submarine positions can range from secret to sensitive compartmented information because of unique submarine limitations that affect the classification of all track data sent from the submarine. It is recognized that current security policies prevent United States and allied forces from effectively communicating. Network security aside, many coalition and allied partners do not have the required network infrastructures in place to use information technology and satellite communication solutions. This capstone project assumes that those policies and infrastructures will be modified by 2020. Therefore, they were not treated as constraints.

The force level or number of communication nodes participating in any given operation is critical to the overall success of the Joint ASW C4I Architecture. Too many users of the Joint ASW C4I Architecture could lead to bandwidth restrictions, spectrum realignment, and use of standard data interfaces to facilitate rapid technology insertions for improved interoperability. Force level would determine the type and availability of specific C4I tools that would be driven by system command realignments to initiate compliance of all naval platforms to the CANES and the requirement to conform to the service-oriented architecture model.

A key metric of success for the Joint ASW C4I Architecture is its ability to meet the ASW communicator's demand for data during operations normal and above. The more individual users, the more capable the Joint ASW C4I Architecture must be. Timely, accurate data delivery to each and every operational user is paramount.



*e. Man-Made Constraints*

Man-made contributions must also be considered as they pertain to constraints on the Joint ASW C4I Architecture's levels of effectiveness. For every action there is a reaction. The United States blue force has been able to adjust to opposition force C4I system capabilities in the battlespace. They can expect no less from their opposition. They have well established means to interfere with radio frequency signals, conduct deception operations, produce misleading propaganda, and perform destructive acts at will.

Jamming of radio frequency signals is commonplace in today's battlespace. The Joint ASW C4I Architecture must automatically realize this counter action, react, and move its operational users seamlessly into a new signal frequency. The Joint ASW C4I Architecture utilizes low probability of intercept and low probability of detection devices where practical and necessary. The Joint ASW C4I Architecture is expected to rely heavily on web-based IP interactions, making it imperative that the architecture is secure from enemy information operations and hacking.

Given today's demand to multitask, ASW C4I consumers want even more data. Opponents will take advantage of all available communications sources and networks in an attempt to deceive and keep friendly forces from knowing their true intentions. The Joint ASW C4I Architecture must be designed to recognize deceptive activities and counter them in order to understand the enemy's real actions and activities. Current events prove every day the utility of enemy propaganda to sway the hearts and minds of loyal supporters. ASW operators must receive accurate reporting from which to make correct operational decisions. The Joint ASW C4I Architecture makes forces mindful of enemy propaganda and take steps to thwart it in a timely manner.

Lastly, the enemy's ability to destroy all or part of the Joint ASW C4I Architecture must be considered. If communication subsystems are lost, the system must be pre-planned, self-healing, and offer secondary backup solutions for continued, unbroken C4I services to ASW operators. Edge operators and their C4I systems are envisioned to be lost initially although recent events indicate opposition submarine ability to get inside operational screens to remove high value communication assets.

Our alternative solution topologies offer several workable proposals to address these scenarios. It is imperative for them to offer C4I users diverse network connectivity and survivability using redundancy and replication. It is also imperative for them to be multi-communication path capable with voice, radio, beyond line-of-sight, and line-of-sight communications. It must maintain threshold-level communications despite increasingly sophisticated enemy countermeasures consisting of electromagnetic

interference; high altitude electromagnetic pulse; anti-satellite operations such as denial of relays; and active homing systems similar to high-speed anti-radiation missile type threats.

### **3. Interfaces**

The ASW community requires a more complete, well structured C4I system for the year 2020. It is envisioned that the Joint ASW C4I Architecture will remain constrained by current atmospheric phenomena, space weather events, signal transmission physics at the air-sea interface, and at-sea motions of communications nodes afloat. As such, communications interfaces must more capably bridge these environmental and physical constraints. Space based systems offer over the horizon beyond line-of-sight communications relay tools with inherent time delays in operational data transmission and receipt. Improvements in hardware and software applications are viewed as areas that increase data throughput capacities for users operating under different frequencies and communications channels. Terrestrial and maritime communications devices and techniques need to challenge the limits of physical dimensions and atmospheric conditions to maximize speed and capacity of data transmissions for tactical line-of-sight links and more strategic beyond line-of-sight communications networks. The air-sea interface represents one of the final challenges of the ASW community to attain communications at speed and depth. Several underwater communications devices and buoys are expected to bridge the acoustic to radio frequency energy gap of the air-sea interface and represent areas of critical importance to communicating with and from submarines.

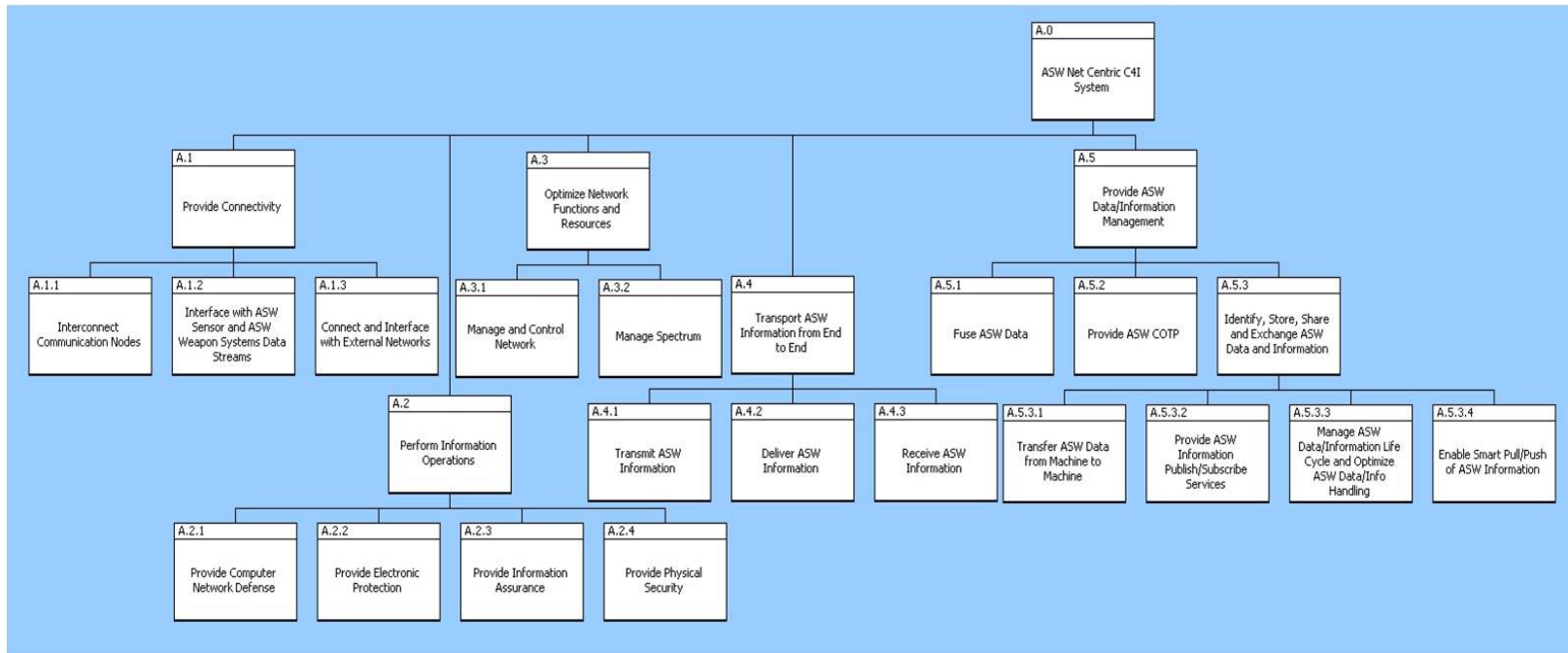
Radio frequency and acoustic energies provide means to transmit data between platforms at various frequencies, speeds and capacities. These communications provide wireless pathways networking ASW communications nodes with any and all communications devices around the world. Each communication path is capable of simultaneous two-way communications. These communication paths are used in the Joint ASW C4I Architecture to receive intelligence, surveillance, and reconnaissance sensor data which is fused and added to a common operational picture. The same communication paths are used to disseminate the common operational picture to all United States, NATO, and coalition force maritime and terrestrial nodes. At the direction of the strike force commanders, each user uses that information to track and engage submarine threats using the weapon assets and combat systems available to them on their individual platform. ASW platform specific combat systems use the submarine radio frequency system by way of internet protocol and messaging paths from broadcast control authorities ashore using the extremely high frequency, super high frequency, ultra high frequency, high frequency, low frequency, and very low frequency.

The United States Navy must take advantage of all maritime, terrestrial, and space based relay devices, receivers, transmitters, fusion devices and graphic displays to be interoperable, multi-frequency capable with all C4ISR systems in use by U.S joint forces, as well as, coalition forces in the year 2020 and beyond. All sensor transmissions must be compliant with joint communications standards permitting on time delivery and reporting of target information for the creation of up to the second common operational pictures for the ASW community and its supporting operational units. Antenna systems need to take on platform conformal, streamlined physical dimensions conscious of size, weight, and power demands while permitting maximum throughput of information as permitted by the lowest common denominator for bandwidth receipt - the operational ASW community communicator. The ASW operator utilizes data and information collected from the various platform sensors to interface with the joint C4I systems intended to fuse and disseminate tactically and strategically significant data to the warfighters, command authorities, and intelligence community.

#### **4. Functional Hierarchy**

The next step in the functional analysis was the completion of a draft functional hierarchy. With the draft functional hierarchy complete, an iterative analysis using the stakeholder analysis, threat analysis, and futures analysis was conducted until the revised functional hierarchy was completed.

In the revised functional hierarchy, the system was decomposed into five top-level functions: provide connectivity; perform information operations; optimize network functions and resources; transport ASW information from end-to-end; and provide ASW data and information management. These functions were decomposed as displayed in Figure 10.



**Figure 10. Functional Hierarchy**

This figure displays the complete functional hierarchy after analysis of key documents and stakeholder input. The top five functions are provide connectivity, perform information operations, optimize network functions and resources, transport ASW information from end to end, and provide ASW data and information management.

The definitions of the top level functions are:

**A.1 – Provide Connectivity:** This function physically connects the different elements of the system together. This includes connecting all communication nodes, interfacing with sensor and weapon systems, and connecting to external networks.

**A.2 – Perform Information Operations:** JP 3-13 defines information operations as, “The integrated employment of the core capabilities of electronic warfare, computer network operations, psychological operations, military deception, and operations security, in concert with specified supporting and related capabilities, to influence, disrupt, corrupt or usurp adversarial human and automated decision making while protecting our own” [JP 3-13, 2006: GL-9]. In the Joint ASW C4I Architecture, this function establishes aspects of information operations intended to provide a secure and protected network. This includes computer network defense, electronic protection, information assurance and physical security. This function establishes aspects of information operations intended to provide a secure and protected network.

**A.3 – Optimize Network Functions and Resources:** This high level function prioritizes network functions and resources and provides access based upon the roles and responsibilities of each individual user. This function allows commanders and warfighters to have the access and resources they need in combat situations [NCOE JIC, 2005: 44].

**A.4 – Transport ASW Information from End-to-End:** This function includes the transportation of information into, out of, and throughout this dynamically changing network [NCOE JIC, 2005: 44].

**A.5 – Provide ASW Data and Information Management:** This high level function includes the exchange, fusion, display, and storage of all data and information associated with the system.

The definition for each of the lower level functions can be found in Appendix E.

The NCOE JIC was utilized as a baseline for the functional hierarchy and modified it based on stakeholder input and because of areas of disagreement were identified. There were two main areas where this capstone project design team disagreed with the NCOE JIC. Firstly, since Joint Publication 3-13 defines electronic protection as a supporting function of Information Operations, the function Provide Electronic Protection was moved from a Tier 1 function to a Tier 2 sub-function of Perform Information Operations. Secondly, as the IDEF0 model was built it was discovered that

the Transport ASW Information from End-to-End sub-function did not fit well at the Tier 2 level creating a flow complexity that was easily overcome by elevating it to a Tier 1 function. Additionally, the NCOE JIC provided a comprehensive set of capability requirements that reside in the realm of doctrine and training under the title of knowledge management. The team focused on the system's ability to provide information management, which precluded the inclusion of many knowledge management capabilities found in the NCOE JIC into the functional hierarchy.

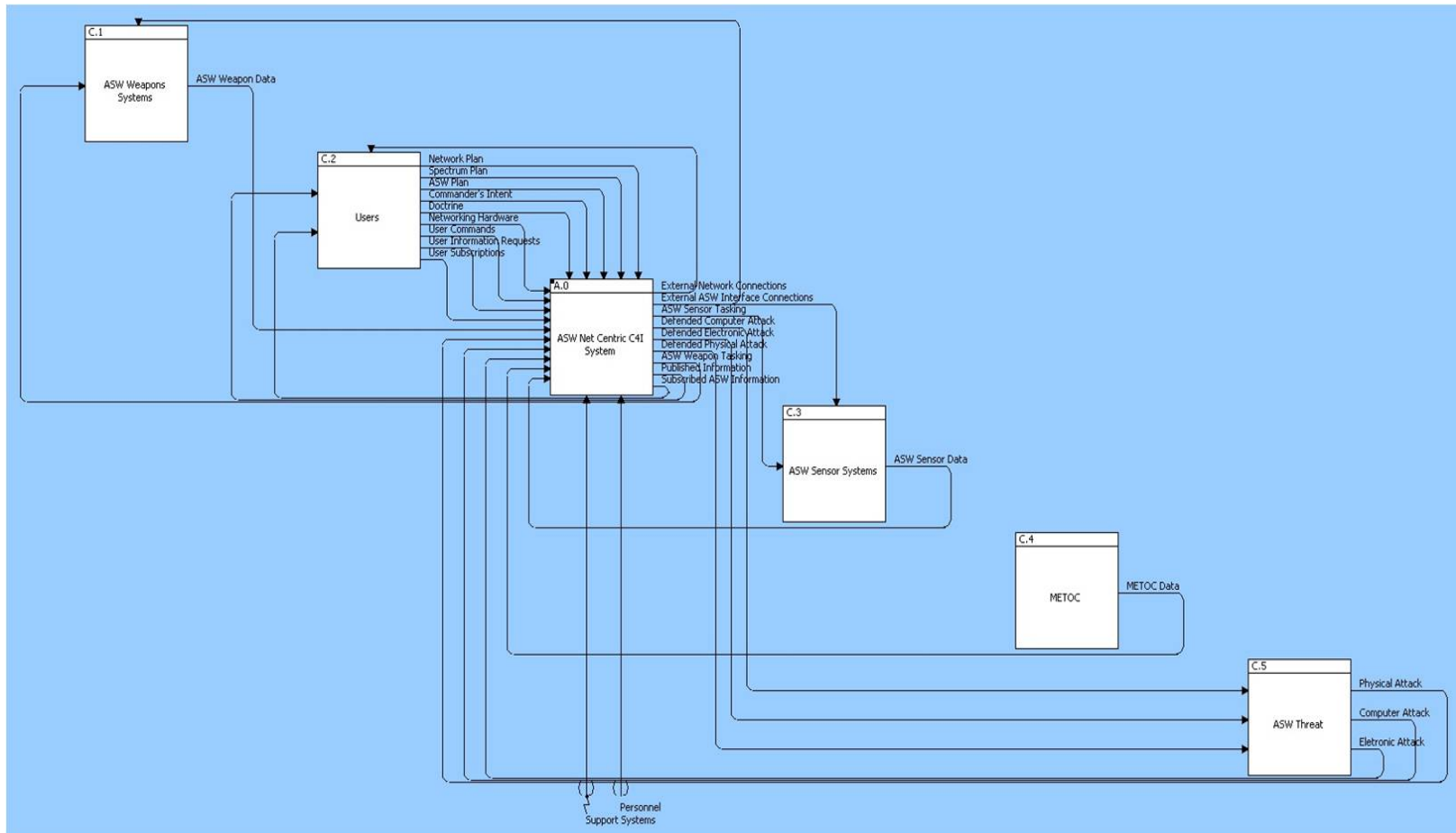
The NCOE JIC divided capabilities into three distinct areas: knowledge management, network management, and information assurance. As previously stated, knowledge management was not addressed due to the non-materiel aspects of many of the described capabilities. An inconsistency discovered was the inverse way the NCOE JIC addressed information operations. Per the Joint Publication 3-13, information assurance is a core function of information operations along with computer network defense, physical security of the system, and electronic protection. The NCOE JIC inserted these capabilities underneath information assurance. Provide Information Operations, found in the NCOE JIC, was changed to Perform Information Operations to be in alignment with the Joint Publication 3-13.

An area of divergence from the NCOE JIC was in the assumption that the network is established. The NCOE JIC assumed a network was in place. Since a network architecture was developed and not just an operational environment, the function establishing the network, provide connectivity, needed to be a top tier function. Another area of divergence with the NCOE JIC was the separation of information management functions from network management functions. The NCOE JIC combined the two capabilities underneath the overarching network management capability. It was believed that management of the network itself is a very different function than the management of information that is intended for the warfighter.

## **5. IDEF0**

Needs analysis was continued by constructing draft Integration Definition for Function Modeling (IDEF0) diagrams. The draft IDEF0 diagrams were used to identify and analyze the functions that are performed by the system. This analysis helped identify shortcomings in the draft diagrams and make the necessary revisions to the architecture. The revised IDEF0 diagrams show data flow, system control, functional flow, and transformation of inputs into outputs by the system. Additionally, the diagrams provided a reference architecture for analysis during alternatives generation. Overall, the IDEF0 products are a coordinated set of diagrams that helped facilitate understanding using both graphical and natural language.

The IDEF0 was started by building a system boundary diagram, A-1, to establish the boundary of the system in relation to external systems. The system boundary diagram shows how the ASW weapon systems, users (includes systems and platforms), ASW sensor systems, meteorological and oceanographic (METOC) systems, and the ASW threat interact with the system. After multiple iterations, inputs and outputs were made generic so that the system is adaptable to many different situations. For example, the system receives ASW weapons data from the ASW weapons systems; ASW sensor data from the ASW sensor systems; and user commands and user information requests from the users. Furthermore, the system returns ASW weapon tasking to the ASW weapons systems; ASW sensor tasking to the ASW sensor systems; and published or subscribed data back to the users. All of this is displayed in Figure 11.



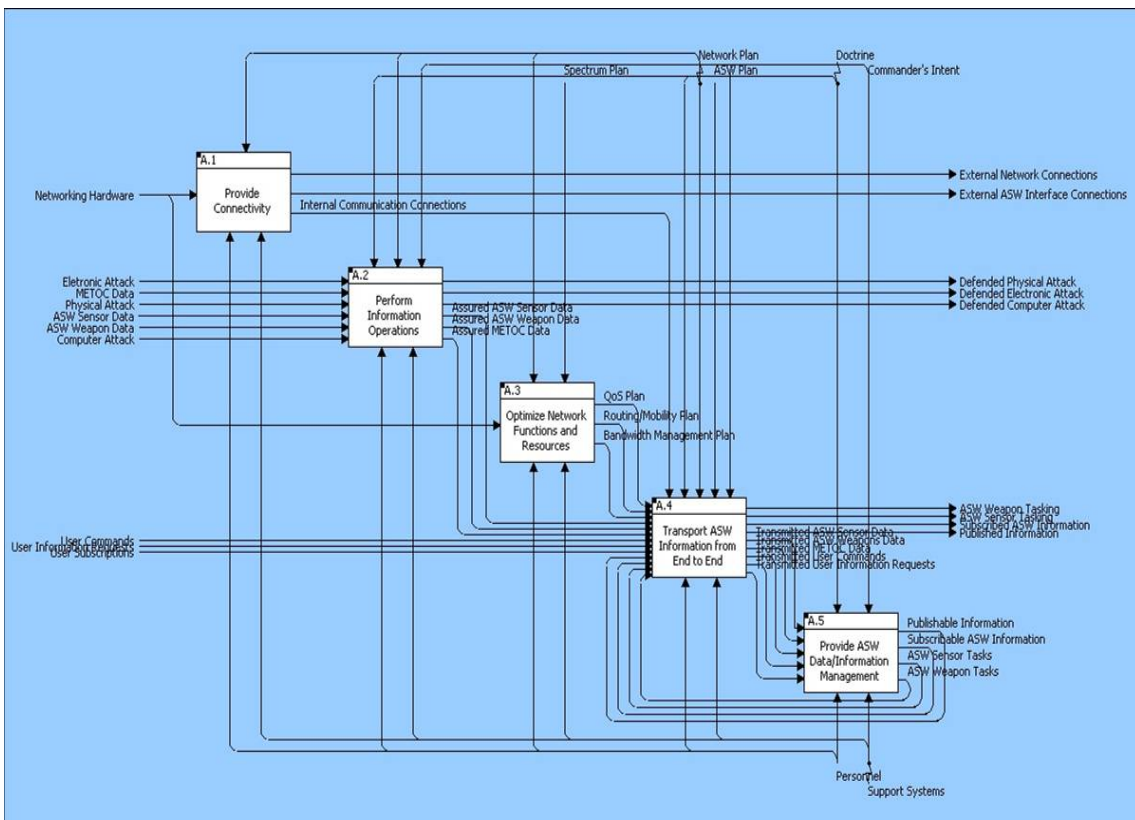
**Figure 11. A-1 (External Systems) IDEF0 Diagram**

This figure displays the A-1 diagram which displays the Joint ASW C4I Architecture relationships with the ASW weapon systems, ASW sensor systems, users, METOC, and the ASW threat.



ASW sensor data may include intelligence, reconnaissance, or surveillance data, or any other potential source that can generate data or information on a contact of interest. ASW weapons data may include action taken by the weapons or any other status of the weapon system. User commands may include requests for information or data, or operational tasking. ASW sensor tasking includes sensor queuing. Published and subscribed data may include ASW sensor data, ASW weapon data, fused data, or the COTP.

Our group continued building the IDEF0 diagrams by creating an A0 which is a top-level functions diagram. The top-level functions diagram shows the internal data flow, system control, functional flow, and transformation of inputs into outputs. The top-level functions diagram is displayed in Figure 12. The additional detailed IDEF0 diagrams can be found in Appendix E.



**Figure 12. IDEF A0 Diagram**

This figure displays the top-level functions diagram which shows the internal data flow, system control, functional flow, and transformation of inputs into outputs.

Some of the important inputs and outputs are defined as follows:

**ASW Sensor Data** - Raw or processed sensor data that is transmitted to the Joint ASW C4I Architecture by all of the ASW sensors in the network. This includes all devices that measure or detect real-world conditions, such as acoustic or electromagnetic sensors. This can also include sensor-to-sensor cueing which is transported through the architecture and sent to another sensor through ASW sensor tasking.

**ASW Sensor Tasking** - Transports the ASW sensor task to the external sensors.

**ASW Sensor Tasks** - The “Provide ASW Data and Information Management” function transmits the ASW sensor tasks to the “Transport ASW Information from End-to-End” function. Commands for the sensors that enable sensor resources to be dynamically focused on high priority sectors of the battlespace. This enables a scarce sensor resource to serve many customers, and helps ensure that the right mix of sensors are available at the right time. The operational benefit of sensor tasking is enhanced when sensors from multiple platforms simultaneously focus their energy on the same object. These are generated based on ASW sensor data or user commands. Sensor tasks can include sensor cueing, tracking, or battle damage assessment.

**ASW Weapon Data** - Weapon data that is transmitted to the Joint ASW C4I Architecture by all of the ASW weapon assets in the network. This includes weapon status and engagement status for post engagement re-evaluation.

**ASW Weapon Tasking** - Transports the ASW weapon task to the external weapons.

**ASW Weapon Tasks** - The “Provide ASW Data and Information Management” function transmits the ASW weapon tasks to “Transport ASW Information from End-to-End” function. These are generated based on user commands. Weapon tasks can include weapon control orders, weapon assignment, or weapon and target pairing.

**Subscribable ASW Information** - The “Provide ASW Data and Information Management” function transmits the subscribable ASW information to the “Transport ASW Information from End-to-End” function. The subscribable ASW information can range from sensor data to the COTP and is disseminated based on user subscriptions.

**User Commands** - An instruction given by the user that needs to be transported to the appropriate external or internal asset. User commands can include cueing the sensors, target nomination, threat evaluation, and weapon assignment.

**User Information Requests** - This is a request for specific information from the user. It can be returned to the user through published information or smart pull of information.

**User Subscriptions** - Users request to receive or obtain frequent updates on specific information.

The definition for the rest of the inputs and outputs in the IDEF0 A0 can be found in Appendix E.

## **6. Functional Flow Block Diagram**

The functional analysis was completed by constructing draft functional flow block diagrams, conducting an analysis, and building a revised functional flow block diagram. The Joint ASW C4I Architecture interacts with the three main functions of the kill chain: detect, control, and engage. However, the architecture is mainly centered on the control aspect of the kill chain. Through the application of network-centric principles, the architecture should be able to effectively shorten the kill chain through increased situational awareness, increased decision making velocity, and rapid dissemination of processed data that has been turned into actionable information.

Figure 13 displays a subset of the revised enhanced functional flow block diagram and shows how published information reaches the user in the Joint ASW C4I Architecture. The enhanced functional flow block diagram begins when the ASW Sensor Systems detect a threat and passes the ASW Sensor Data to the Perform Information Operations function. The Perform Information Operations function assures that the data is coming from a valid source and passes it to the Transport ASW Information from End-to-End function for transport through the architecture. From there, it sends the ASW Sensor Data to the Provide ASW Data and Information Management function for storage, fusion, inclusion in the COTP, and dissemination. The Provide ASW Data and Information Management function then sends the publishable information back to the Transport ASW Information from End-to-End function for additional distribution. From there, the information is published to the users, and the users send their commands back. The Transport ASW Information from End-to-End function then sends ASW Sensor Tasking to the ASW Sensor System or ASW Weapon Tasking to ASW Weapons System. Appendix F includes the complete functional flow block diagram.



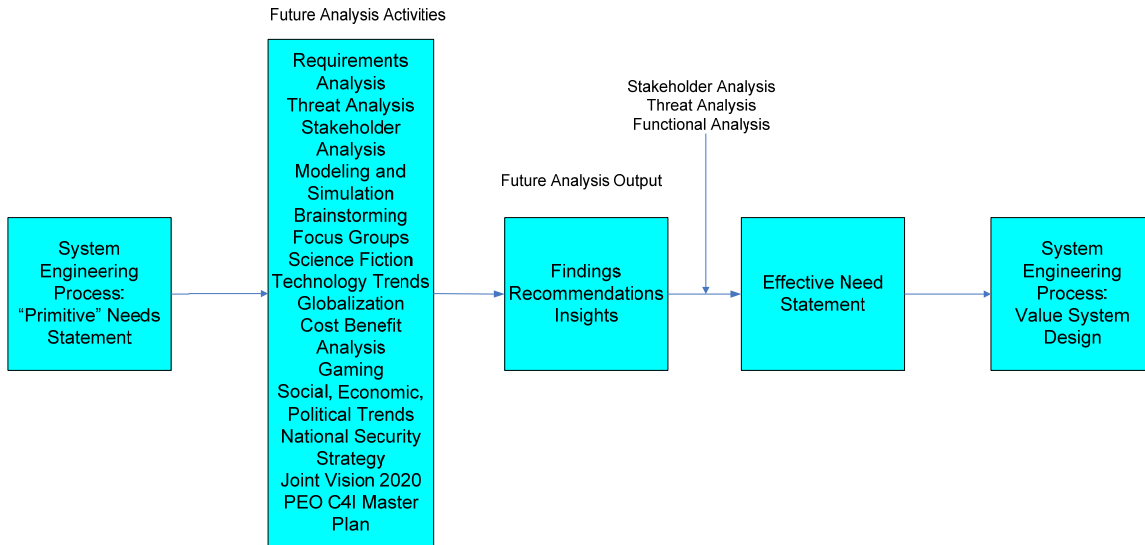
## **D. FUTURES ANALYSIS**

### **1. Purpose**

Futures Analysis is the fourth tool, in addition to Stakeholder Analysis, Threat Analysis, and Functional Analysis, that was used to complete the Needs Analysis phase of the systems engineering process. The purpose of Futures Analysis is to make educated predictions with respect to the future operational environment; in this case the future environment that was addressed extends to the year 2020. This analysis is conducted to identify and discover critical requirements that will shape and define future development of the system, provide flexibility and robustness in the face of a changing environment, and to extend system life. Extreme care should be taken with regards to future predictions, the longer the time horizon the riskier the predictions.

### **2. Process**

Figure 14 is a simplified depiction of the Futures Analysis process. A thorough Futures Analysis is a time consuming and a difficult undertaking as it depends on a large set of complex and inter-related activities [Technology Futures Analysis Methods Working Group, 2003]. This Future Analysis is a simplified process that takes as input the Primitive Need statement and performs a handful of activities, namely, review of technology trends, Joint Vision 2020 document, the Program Executive Office Command, Control, Communications, Computers and Intelligence Masterplan and information from Department of Defense and its agencies from relevant web sites. The output or the results are findings, recommendations, and insights which are combined with the results from other Needs Analysis tools to produce the Effective Needs statement.

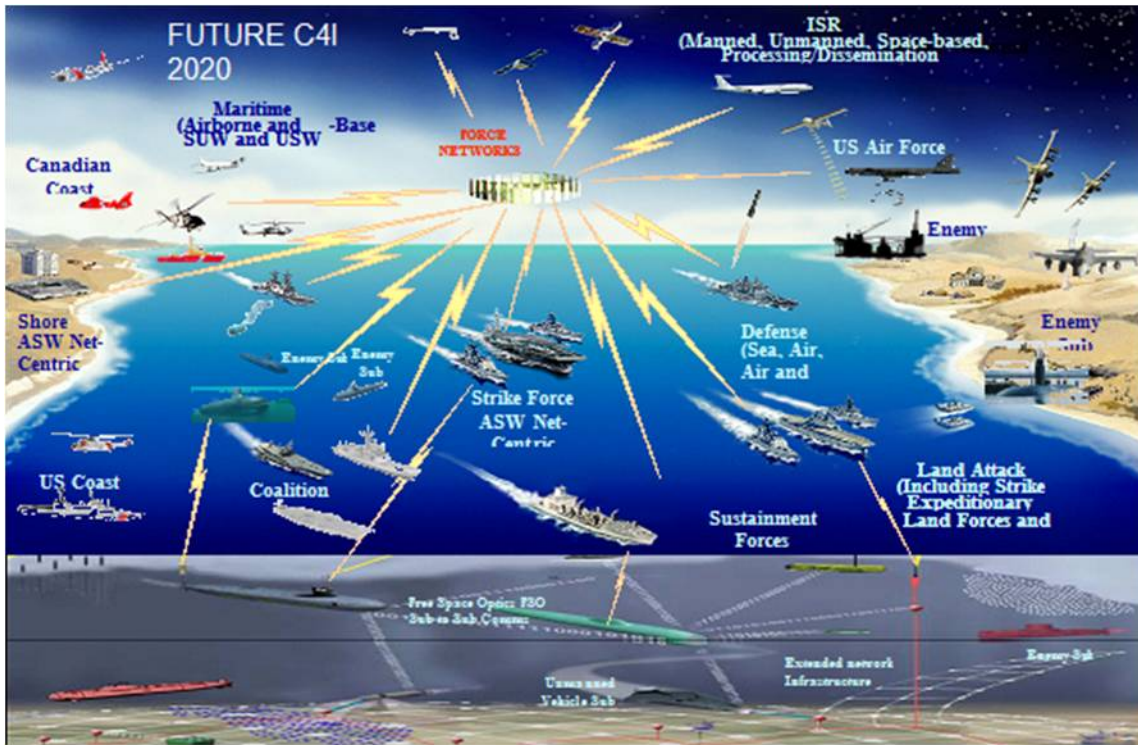


**Figure 14. Futures Process for ASW C4I Net-Centric Operations**

This figure shows the Futures Analysis step in the ASW C4I System Engineering process. The activities inside the process box are executed - serial, parallel, iterative and feedback to arrive at the output.

### 3. Results

Figure 15 is an operational view of the future C4I Environment.



**Figure 15. 2020 Net-Centric Operational Environment**

This is a representation of a net-centric operational environment. This figure depicts real-time interaction enabled by the Joint ASW C4I Architecture between the air, surface, and subsurface components.

In order to attain the Joint Vision 2020 goal of full spectrum dominance this requires a net-centric operational environment as outlined in the NCOE JIC and the JFC. The figure shows a globally connected force by land, air, surface, and subsurface. It includes manned and unmanned components out to the tactical edge. It is expected that ASW components will have enhanced communication capabilities. The Joint ASW C4I Architecture should include the capabilities to meet the needs for the warfighter to conduct distributed and power to the edge operations. The capability to enable ASW net-centric operations should also include the needs for the warfighter through a vetted process and stakeholder input. The future of planned systems and programs of record; through conducted research and analysis will include many of the capability requirements. The enhancement of legacy systems or retirement of legacy systems by replacement must be included in the scope of futures development. A major support

element of the any communications architecture must be a system that allows voice, data, information, and video to be transported. One such capability is the use of software defined radio and wideband network waveforms. The software defined radio capability enables many of those requirements for wireless security of communications, wideband waveforms, and common architecture a hardware package that is easily reconfigured simply by software to define the radio and encryption package. The capability provides bandwidth for data, voice, and video pushing power to the edge of the complete battlefield. A family of different hardware packages in air, land, sea, sub-surface, and space will support a wide range of applications in a net-centric operation environment. This net-centric operation environment will include single purpose terminals, line-of-sight communication links, beyond line-of-sight communication links, narrow band and wideband communications, transmitting voice, video, and data at high rates. Devices will have to range from handheld devices to multi-band, multi-mode, multi-channel radios supporting voice, video, and data communications on every conceivable platform [PEO C4I Masterplan, 2007].

It is also expected that technology will mature to support two-way submarine communication at speed and depth and the Joint ASW C4I Architecture must address this. Communication at speed and depth requires buoyant cable antenna technology, recoverable tethered fiber optic communications, and laser communications. These new communication buoys will support satellite communications and acoustic communications [PEO C4I Masterplan, 2007].

The Department of Defense has embarked on transforming its current stove-piped operational environment into a net-centric operational environment. A net-centric operational environment depends on the service-oriented architecture paradigm. The NCOE JIC defines service-oriented architecture with the following:

The ability of networked users to manage and make available relevant, accurate information, transform it into knowledge, and act upon it with confidence. This provides access to newly discovered or recurring information in a useable format and facilitates collaboration, distributed decision-making, adaptive organizations, and a greater unity of effort via synchronization and integration of force elements to the lowest levels [NCOE JIC, 2005].

The Joint ASW C4I Architecture, indeed the entire DoD information technology portfolio, must align, support, and adapt to the service-oriented architecture to enable a true net-centric operational environment as envisioned in the NCOE JIC.

#### **E. EFFECTIVE NEED**

The following effective needs statement was defined based on the completion of the needs analysis: Key ASW stakeholders require a new standardized joint ASW-



specific C4I architecture for the 2020 target time frame. The proposed Joint ASW C4I Architecture needs to use open standards, common waveforms, and a common data schema. It needs to be consistent with DoD policy and processes and be vertically integrated with other DoD C4I systems. It will enhance the commander's ability to execute the joint ASW mission in support of a Combatant Commander's campaign objectives [NCOE JIC, 2005]. The purpose of the architecture is to guide development and to support engineering, force composition, and acquisition decisions.

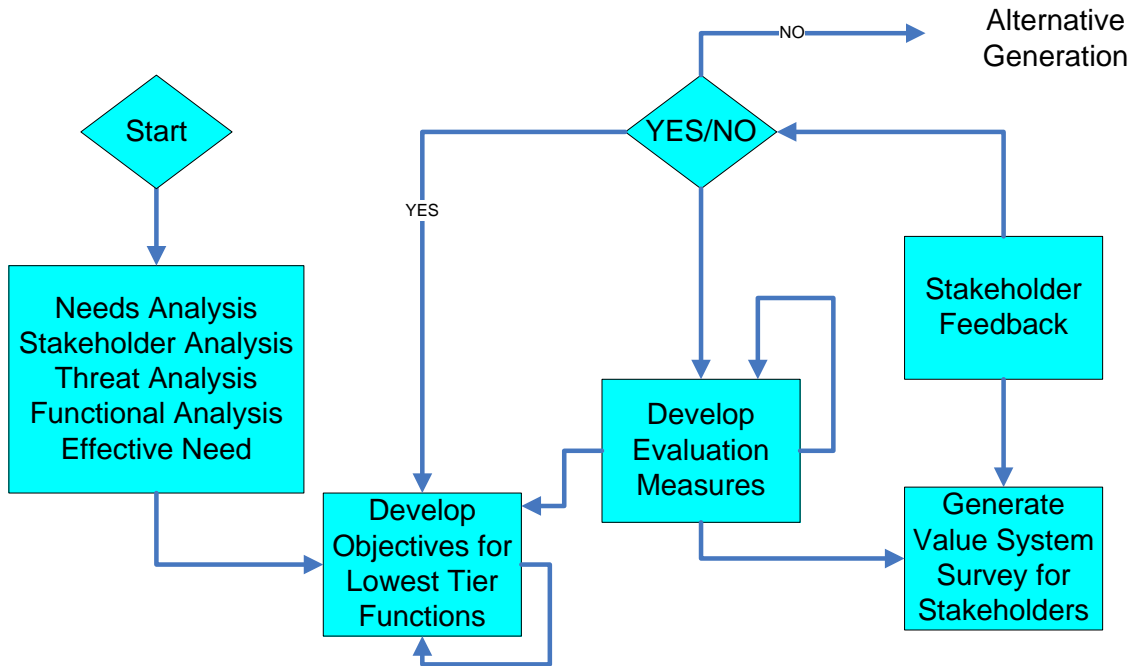
### III. VALUE SYSTEM DESIGN

The value system design is the second step in the systems engineering process. The purpose of a value system, also called value hierarchy, is to refine the system requirements based on the effective need, to uncover conflicts in stakeholder preferences, to document stakeholders' objectives, and to aid in evaluating and ranking design alternatives. The value system hierarchy also serves to improve communication among the team members and stakeholders, and it guides research and decision making.

The value system design process is graphically depicted in Figure 16. The process began with input from the needs analysis step of the systems engineering process, namely, the effective needs statement, and the results of the stakeholder analysis, threat analysis, and functional analysis. The entire process was iterative; each lowest tiered function was assigned an objective and then the objective was validated against stakeholder requirements, the NCOE JIC, and the NCE JFC documents. The evaluation measures for each objective were also derived iteratively from review of the stakeholder needs, the NCOE JIC, and the NCE JFC. The principles that guided the selection of the objectives and evaluation measures are listed below.

1. Clearly and unambiguously linked to stakeholder needs.
2. Resolve conflicting evaluation measures based on stakeholder needs and values.
3. Objectives which are independent and complete.
4. Quantifiable objectives that will distinguish alternatives; use qualitative measures otherwise; all objectives must be either quantitatively or qualitatively expressed.
5. Based on operations
6. These are the stakeholders' objectives and they make all value judgments.

The value hierarchy design process was difficult and consumed much time. A number of measures of effectiveness for each lowest tiered function were proposed and then discarded. The discussions centered on meaning and interpretation of the value, which was the "best" value to choose and how easily it could be measured and modeled. The following summarizes this capstone project design team's experience well, "developing a good set of measures of effectiveness is usually a harrowing business" [Feuchter, 2000].



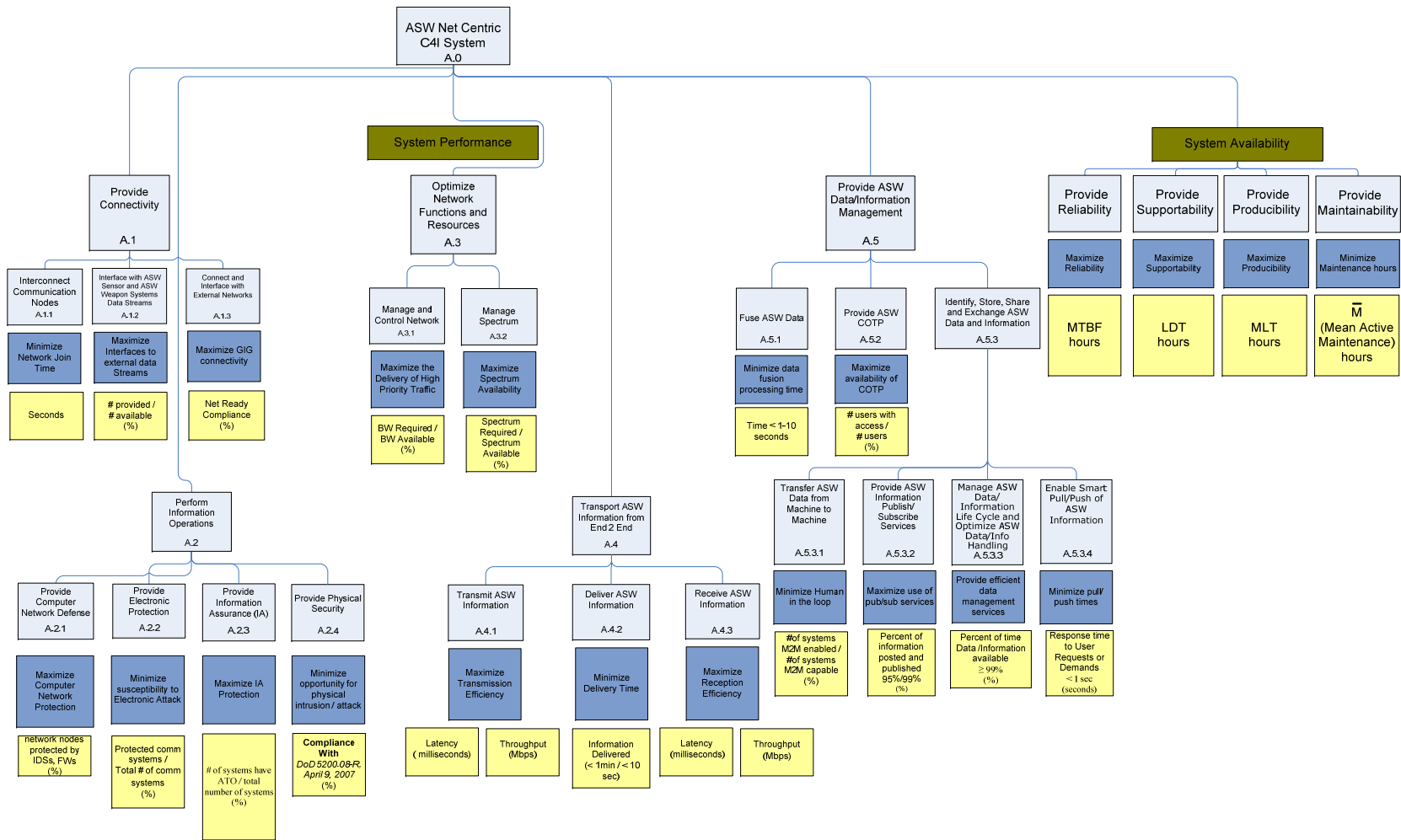
**Figure 16. Value System Design Process**

This figure represents the value system design process. Its input is a fully decomposed functional hierarchy and the output is evaluation measures for each lowest tier function.

#### A. VALUE HIERARCHY

The value hierarchy for the Joint ASW C4I Architecture is depicted in Figure 17. The value hierarchy has two distinct branches, functional (System Performance) and non-functional (System Availability). Availability is a higher level measure which depends on a number of sub-measures such as reliability, supportability, producibility, and maintainability. Generally, there are more non-functional requirements to be measured but it was decided to use availability as it is derived from reliability and maintainability measures and is a good non-functional measure for the architecture.

This value hierarchy was developed as part of the system engineering design process to aid in evaluating and ranking alternatives and then choosing the alternative that best meets the stakeholder requirements and values for the Joint ASW C4I Architecture. The first step in creating the value hierarchy was a functional and non-functional decomposition of the instantiation of NCOE JIC C4I architecture. The second step was to assign objectives to the lowest tier functions. The third step was to assign evaluation measures to each objective.



**Figure 17. Value Hierarchy**

This is the complete ASW C4I functional and non-functional hierarchy. The top level functions are in light blue, the objectives are in dark blue, and the evaluation measures are the light yellow squares.

## **B. EVALUATION MEASURES**

The evaluation measures are based on the feedback provided by the stakeholders. They are captured in “Stakeholder’s Consolidated Feedback” dated March 06, 2008 and can be found in Appendix C. In short, the stakeholders desire a net-centric operational environment. In other words, the stakeholders desire to have a timely common operational and tactical picture, low latency, high accuracy data fusion, human system integration, knowledge management, reduced human error, interoperability – joint and coalition, and actionable information whose net effect is a time reduction of the kill chain.

The iterative value system design process yielded twenty functional evaluation measures, and four non-functional evaluation measures for a total of twenty-four evaluation measures. The large number of functional evaluation measures is indicative of the complexity of the Joint ASW C4I Architecture. As stated previously, these evaluation measures were based on stakeholder feedback before using them in the evaluation of alternatives. This step was necessary in order to make effective use of the evaluation process as a large number of evaluations make the scoring process cumbersome and complex. Appendix D contains the complete description of the evaluation measures.

The survey data from stakeholders’ responses were merged together. Table 1 summarizes the top ranked functions from stakeholder feedback plus one lower ranked function, Transmit ASW Information. The top requirement was almost unanimously the Provide ASW COTP function. Besides that, three other functions had a higher priority among the stakeholders and, therefore, they were worth measuring in order to compare alternatives later in the systems engineering process. These three functions are Fuse ASW Data, Interconnect Communication Nodes, and Enable Smart Pull and Push of Information. The Transmit ASW Information evaluation measure represents the end-to-end latency and throughput between source and sink of data – two nodes engaged in a transaction. This is not the “system” latency, throughput or performance.

<b>Function</b>	<b>Evaluation Measure</b>	<b>Definition</b>	<b>Rationale</b>
<b>Provide ASW COTP (A.5.2)</b>	Percent of users with access to COTP	The unit of measure is percent. The numerator represents the number of users with access to the COTP. The denominator represents the number of users. No threshold or objective values have been determined yet.	It is a measure of situational awareness which promotes synchronization of action among strike group members in carrying out the commander's intent.
<b>Fuse ASW Data (A.5.1)</b>	Minimize data fusion processing time	The unit of measure is the time required to produce an output from the Fuse ASW Data function. No threshold or objective value has been determined yet.	The lower the latency of fused data the more accurate the COTP.
<b>Interconnect Communication Nodes (A.1.1)</b>	Time to join network	Minimize Network Join Time – Join Time is defined as the amount of time it takes for a node to advertise its presence, be authenticated and associated, and be capable of transmitting and receiving network data. Degree of connectivity is the number of connections.	The ability to share common situational awareness data depends on the degree of connectivity. Fast and redundant network connectivity promotes robustness of communications.

<p><b>Enable Smart Pull and Push of ASW Information (A.5.3.4)</b></p>	<p>User response time to critical information</p>	<p>The measure is the response time to a user request or demand. The threshold is &lt; 1 second. The threshold value is from NCOE JIC.</p>	<p>Smart push is the ability to gather information, process that information, and make decisions on who should receive it. Smart pull allows the war fighters to grab the information that is needed, regardless of where they are located.</p>
<p><b>Transmit ASW Information (A.4.1)</b></p>	<p>Total node to node latency Communication link data throughput</p>	<p>Sum of data transmission latency and path latency for each hop between two nodes Throughput was calculated as Message size divided by latency</p>	<p>Minimize network latency to improve response time Maximize throughput to improve COTP distribution, and reduce push/pull time</p>

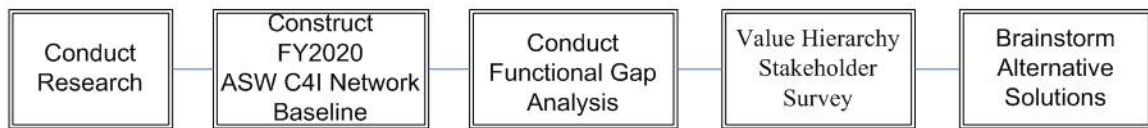
**Table 1. Top Ranked Functions**

This table summarizes the evaluation measures, their definitions, and the rationale for choosing them.

## IV. ALTERNATIVES GENERATION

### A. GENERATION PROCESS

Our alternatives generation process, illustrated in Figure 18, consisted of five separate actions: research, construction of a FY2020 Joint ASW C4I Architecture Baseline, functional gap analysis, stakeholder value hierarchy survey, and brainstorming of alternative solutions which were completed in series. The resulting alternative solutions conform to stakeholders needs, are functionally correct, and offer feasible solutions for further consideration and risk analysis.



**Figure 18. Alternatives Generation Process**

Five steps taken to obtain alternative solutions included researching activities, construction of a FY2020 Joint ASW C4I Architecture Baseline, a functional gap analysis, consolidation of the stakeholder gap analysis, and brainstorming activities relative to alternative solutions.

The purpose of this study is to address shortfalls of the United States Navy’s ASW community’s current system fielding plan for the FY2020 Joint ASW C4I Architecture Baseline. To accomplish this, research was conducted to identify technology driven system capabilities, current and planned C4I technologies, consider strengths and weaknesses of network topologies, and the basics of today’s submarine communications problem. The Joint ASW C4I Architecture was constructed setting the timeframe at FY2020 because of research and acquisition time. A functional gap analysis was conducted by comparing research findings and FY2020 Joint ASW C4I Architecture Baseline capabilities with the system performance and system availability attributes identified earlier in this report. The findings of the Functional Gap Analysis were combined with the results of the Value Hierarchy Stakeholder Survey where the stakeholders identified by priority the functions that they rated as most important. The resultant list of functional gaps was then used to brainstorm possible alternative solutions. Areas of risk have been highlighted throughout this section and summarized at the end of this section to ensure ASW community awareness of cost, schedule, and performance issues that could alter the functional capabilities identified in the FY2020 Joint ASW C4I Architecture Baseline. Doctrine, Organization, Training, Materiel, Leadership and Education, Personnel, and Facilities (DOTMLPF) solutions offered in this report must be



interoperable with established C4I relative DoD programs of record and commercially available communications network tools to most efficiently support ASW warfighter C4I requirements. Alternative solutions will be interoperable with joint service C4I network architectures in operational use beyond FY2020. It was assumed that areas of technology advancement including research and development projects currently underway or planned by DoD laboratories and agencies are being directed toward addressing the requirements of the United States Navy's Fleet Top 10 C4I Requirements offered in Table 2 and will have enabled many of the end state goals of their project work for use in the FY2020 Joint ASW C4I Architecture Baseline. This table was not included in the requirements section because it was derived during research and was not part of the stakeholders' original requirements or intentions.

<b>C4I Requirement</b>	<b>Description</b>
<b>1. Coalition and Multinational C4 Interoperability</b>	United States Navy's vision of 1,000 ship Navy is dependent upon the ability to share information and interoperate in a multinational environment.
<b>2. Reliable Satellite Communication</b>	Reliable satellite communications is a major Fleet priority.
<b>3. Data Throughput</b>	Data throughput is the ultimate measure of connectivity to forward deployed units. It is increasingly limited by applications which demand higher bandwidth during warfighter reach back activities.
<b>4. Computer Network Defense</b>	Defense of the networks is critical to their use as weapons systems. Continued focus on improved computer network defense is validated by the fleet.
<b>5. Common Operational Picture and Maritime Domain Awareness</b>	United States Navy's use of Maritime COP has expanded to include not only traditional blue water force-on-force scenarios but also the MDA mission.
<b>6. Real-Time Collaboration</b>	Real-time collaboration is critical to the warfighting commander. Tools and technologies bring instantaneous transfer to vital information and decisions that allow forces increased battle space flexibility.
<b>7. Standards Based on Information Technology Service Management Best Practices</b>	C4 environment is in critical need of standardized processes, doctrine, technology implementation, and metrics. Information technology service management based on the information technology infrastructure library framework offers a coherent, adaptable, and flexible approach to Navy C4 deployment, warfighting use, and life cycle sustainment.
<b>8. Streamlined Administrative C4 Processes</b>	Administrative processes directly affect proper management of C4I environment while fully engaged in warfighting planning and operations. Use of joint processes and documentation will reduce current administrative burden.
<b>9. C4I Training</b>	Increased deployment of complex technology and lack of training curriculum responsiveness led to ineffective C4I system maintenance.
<b>10. Warfighting Network Sustainment and Life Cycle Management</b>	Holistic approach to C4 Networked environment is absolutely vital. Separation by region by area of operations is an unrealistic means to ensure reliable and redundant global communications. Result is under equipped and under funded end-to-end network nodes adversely affecting warfighting capacity of entire netted force.

**Table 2. Fleet Top 10 C4I Requirements – 2007**

These requirements provide the operational fleet perspective on ten DOTMLPF areas of concern needing the attention of the ASW community, the United States Navy and DoD to resolve [PEO C4I Masterplan, 2007: 19-20].

### **1. Conduct Research**

Our investigation focused on ASW C4I applications and systems relating to the construction of a FY2020 Joint ASW C4I Architecture Baseline. The primary research objective was to definitively account for systems planned to be in operational use by the United States Navy and contributing to the service and joint wide C4I network architectures in FY2020. Research findings were categorized into three specific areas

impacting future C4I networking architectures and supporting applications: program of record planned changes, network topologies, and communicating with submarines.

*a. Program of Record Planned Changes*

The United States Navy is currently transitioning from legacy systems that do not seamlessly interface or distribute information to the end users. Current acquisition strategies appear directed at reducing expense by looking at all major programs and new starts and deliberating the value of new expensive ships and aircraft against the use of older ships and planes that have solid track records of performance and come with existing production line capabilities. The United States Navy's ASW community will need to embrace not only fellow United States Navy communications networks and techniques but smartly carry out business plans to identify shared funding opportunities with other United States Navy and joint service program offices working similar communications initiatives to offset system testing and development, procurement, operations, and maintenance costs.

We found that functional capabilities existed or were planned offering near and mid term solutions out through the latest program objective memorandum cycle from FY2010 to FY2015. Two key research documents proved invaluable in validating ongoing programs of record, projects, planned test and evaluation events, and design studies contributing to the identification of systems and subsystems for the FY2020 Joint ASW C4I Architecture Baseline. First, the C4I Masterplan is

designed to be the single reference document that program managers, resource sponsors, and warfighters can go to get an understanding of what transformation is required to meet modern warfare needs, what is planned and budgeted for, known shortfalls, future budgeted modifications to meet those shortfalls, baseline architectures, future architectures, and recommendations for modernization initiatives [PEO C4I Masterplan, 2007: iv].

This over arching, living document ensures all umbrella C4I related programs of record, supported by several major design studies, lead to a network centric naval force. Four specific areas needing attention from the ASW community – communications, networks, common computing environment and common services, and application services are further detailed by the Masterplan/Reference Model/ Portfolio/Entitlements/Programs of Record Matrix [PEO C4I Masterplan, 2007: 32].

Second, the Communications at Speed and Depth and Optical Laser Communications Status PEO C4I briefing recommended by the stakeholder community gave descriptive insight into the United States Navy submarine community's communications speed and depth family of systems including scheduling, and performance characteristics expected of current and planned C4I related programs and

projects [Reddish and Lovern, 2007]. The C4I Masterplan represents the United States Navy's plan to transform from stove-piped architectural systems into a C4I network-centric architecture and is a comprehensive account of the condition and plans for improvement of the United States Navy's C4I network architecture. Both documents provided specific C4I network related technological advancements that seek to close functional gaps identified by stakeholders.

The ever growing global marketplace allows unprecedented access to the latest off the shelf communications tools making it much more difficult for United States forces to stay ahead of adversaries in areas such as subsurface sensing, communication techniques, lethal and non-lethal weapons, and damage assessment assets. To counter improved adversarial technologies research suggests the ASW community fully recognize the need for a systems engineered C4I network solution using identified strengths of joint service capabilities coupled with foreign coalition forces C4I operational capabilities to identify complete best of breed communications toolsets. The following excerpt from the PEO-C4I Masterplan highlights the need and requirement for the ASW community to be fully engaged in communications programs planned to meet the DoD Net-Centric goals.

As part of the joint force all services, including the ASW community, are required to meet the interoperability requirements identified by several large ACAT I communications programs meeting DoD's Net Centric goals. It is imperative for the ASW community to gain the necessary technologies and capabilities to interoperate with these programs interconnecting into the global network these C4I programs of record provide [PEO C4I Masterplan, 2007: 20].

DoD sponsored design studies provided important information identifying the best path to meet future requirements and those focused on elimination of stove-piped legacy systems. The assumption was made that the planned program of record systems listed in the PEO-C4I Masterplan will be funded and implemented and that the current design studies listed in the PEO-C4I Masterplan will be funded by one or more program offices. Also, it was assumed that the recommendations of these current design studies will be funded and implemented. The following abbreviated design study summaries are taken from the C4 Masterplan pages 23 to 27 and provide rationale for their inclusion within the FY2020 Joint ASW C4I Architecture Baseline [PEO C4I Masterplan, 2007: 23-27]:

### **Global Information Grid Joint Tactical Edge Networks (JTEN)**

The JTEN is an Office of the Secretary of Defense initiative to improve joint connectivity in the battlespace. It proposed developing a set of joint Tactical Edge Networks as a means to address and resolve

shortfalls in the current Global Information Grid architecture, over the next several years. GIG JTEN is a joint effort that will identify needed capabilities to support multi-mission warfare requirements into and beyond the 2015 timeframe. It is focused on the tactical edge first and will build outward using a spiral engineering approach. JTEN capability benefits include: enhanced applications interoperability, improved security, more effective management of the network's limited resources, more extensive collaboration among units, smarter publish-subscribe services, a shorter technology development cycle, enhanced interoperability among the GIG components, and improved platform connectivity. Functional areas include: architecture and concept of operations, routing and network dynamics, tactical wireless connectivity, mission applications and JTEN services, network management and operations, and information assurance.

### **Joint Track Manager (JTM)**

The vision of Joint Track Manager is to provide common merged track data across the tactical, operational, and strategic domains. JTM will use all available resources to provide capabilities maximizing the accuracy and controlled management of persistent situational awareness data. Track data will be distributable to all levels of command, coalition partners, and civil agencies using profiles, filters, and security services to manage the level of detail shared. The workload and required skill sets required to manage and maintain the track data will be reduced through maximized use of automation.

### **Joint Tactical Edge Network and Gateways (J-TENG)**

The warfighting objective of Joint Tactical Edge Network and Gateways is to provide a network-centric operating environment for improved communications and collaboration between warfighters, manned and unmanned platforms, and network-enabled joint fires at the forward, or "tactical edge" of the battlespace. The bottom line is to extend Global Information Grid capabilities to the tactical edge. J-TENG capabilities will support a full range of military operations for Combatant Commander missions stated in the Unified Command Plan (deterrence, execution, planning, and force protection). Characteristics of the operating environment at the tactical edge include a modular, dispersed, on-the-move force, operating increasingly in urban environments and other

complex terrain including maritime and littoral operations. It is assumed that forces will include joint and coalition forces; and for civil support and humanitarian relief missions, will include federal, state, local, tribal agencies, and non-governmental agencies in addition to military forces.

### **Network Rationalization (NR) Initiative**

This initiative found that legacy network proliferation afloat impedes affordable, efficient C4I and tactical edge network implementation that supports advanced information technology, information assurance, network capabilities, forces duplication of acquisition, DOTMLPF operations, and sustainment costs. Two main thrusts were proposed. First, to provide an affordable, effective alternative for legacy programs and systems afloat - as currently programmed by Chief of Naval Operations (OPNAV) N6 and PEO C4I, the Consolidated Afloat Networks and Enterprise Services is recommended. Second, the United States Navy leadership needs to embrace the “Transformation by Reduced Total Ownership Costs” DoD initiative within the enterprise naval network environment.

### **Serial Circuit Transition Afloat**

This study was commissioned to determine the number of serial connections that are still in use within the fleet. As the Navy moves towards its goal of net-centricity, it is vital to seek elimination of older non net-centric technologies. The Serial Circuit Transition Afloat study is designed to identify circuit locations, resource owner, understand the mission they are designed for, and evaluate the ability of these circuits to transition to an IP connection, the plan for transition, and what resources will be required. The transition to IP serves two purposes: to continue with migration to an all IP infrastructure and to assist in the efficient use of bandwidth on and off the ship.

In addition to DoD C4I programs of record and design studies, the PEO-C4I Masterplan’s planned C4I portfolio strategies beyond the FY2012 timeframe was taken into account as identified in Table 3 for use in specifying systems and refinement of functional capability gaps of the FY2020 Joint ASW C4I Architecture Baseline.

<b>Portfolio</b>	<b>Probable Solution Sets</b>	<b>Expected Fielding FY</b>
<b><i>Wideband Satellite Communications</i></b>	<p>1. Terminal integration using United States Navy's Multiband Terminal, and launch of first Transformational Satellite. Current AN/WSC-6(V) super high frequency terminal functionality will be incorporated within Navy Multi-Band Terminal (NMT) to provide single terminal, when paired with the appropriate aperture that will provide wideband (Ka, X-Band) and protected (Q/Ka) satellite communications. NMT terminal will be upgraded to interoperate with Transformation Satellite System [PEO C4I Masterplan, 2007: 45].</p> <p>2. Advanced High Data Rate (HDR) is next-generation multi-band antenna for wideband and protected submarine communications. Potential use of phased array technology providing two-way wideband capacity for K/Ka/Q satellite communications including Extremely High Frequency (EHF) Medium Data Rate (MDR), Advanced EHF, Wideband Gapfiller System, GlobalHawk, Joint Surveillance and Target Attack Radar System (JSTARS), and emerging military and commercial satellite systems. Advanced High Data Rate (AdvHDR) upgrades coincide with NMT implementation and fielding of Automated Digital Network System (ADNS) Increment III. It will provide wideband and protected communications to submarines, and multi-homed radio frequency for IP suite communications [PEO C4I Masterplan, 2007: 45].</p>	<p><b>2016</b></p> <p><b>2016</b></p>

<b>Portfolio</b>	<b>Probable Solution Sets</b>	<b>Expected Fielding FY</b>
<b><i>Protected Satellite Communications</i></b>	<p>1. NMT protected systems deployed as replacement for Navy EHF Satellite Program (NESP) terminals and primary military satellite communications terminal for Carrier Vessel Nuclear (CVN), Landing Helicopter Dock (LHD), Landing Helicopter Assault (LHA), Guided Missile Cruiser (CG), Guided Missile Destroyer (DDG), Landing Ship Dock (LSD), Landing Platform Dock (LPD), and Submarines [PEO C4I Masterplan, 2007: 47].</p> <p>2. NMT wideband upgrade will begin in 4QFY12. Transformational Satellite Communications System (TSAT) compatible upgrade to NMT to be deployed to support the TSAT constellation, but no fielding schedule currently exists [PEO C4I Masterplan, 2007: 47].</p>	<p><b>2012</b></p> <p><b>TBD</b></p>
<b><i>Broadcast</i></b>	<p>Information Screening and Delivery Sub-System (ISDS) Medium Data Rate Channel Access Protocol (MCAP) will be upgraded for ADNS INC III for submarines, to include IP version 6 capabilities, QoS and Ciphertext Core. The Performance Enhancing Proxy, which is incorporated into the existing MCAP to efficiently utilize the 32 Kbps forward channel, will be extracted and incorporated in the ADNS INC III Plaintext segment, because it cannot operate in an encrypted environment [PEO C4I Masterplan, 2007: 51].</p>	<b>2012</b>





Portfolio	Probable Solution Sets	Expected Fielding FY
	<p>3. Transformational Communications (TC) will be the major forcing function [PEO C4I Masterplan, 2007: 83].</p> <p>4. Transformational Satellite Communications System launches. Full Operational Capability (FOC) consists of five satellite constellations in FY19. TSAT shore ground component at locations to be determined, most likely at a combination of Teleport and TSAT GIG Border Element (TGBE) sites [PEO C4I Masterplan, 2007: 83].</p> <p>5. The Regional Network Operations and Security Centers (RNOSCs) are major shore tactical communications nodes and provide an opportunity for further tactical application hosting center consolidation. If Navy migrates completely to Teleports significant cost avoidance will be realized by allowing further site consolidation and legacy systems disinvestments [PEO C4I Masterplan, 2007: 83].</p> <p>6. Submarine Operating Authority Wide Area Network (SUBOPAATHWAN) will also transition to the DISN Core, and Submarines and Broadcast Control Authorities (BCAs) will transition to ADNS INC III and a CT Core. Navy will be utilizing the IP solution fielded by the Teleport Program Office (TPO) under the Teleport Gen III Phase. All Navy communications and network services will be managed and controlled in near real-time by the RNOSCs, which will provide situational awareness and common operational picture information to Global Network Operations and Security Centers (GNOSC) and Joint Task Force (JTF) – Global Network Operations (GNO) [PEO C4I Masterplan, 2007: 83].</p> <p>7. Teleport Gen III FOC. Assume all Navy and Joint services have migrated to IP. Most services</p>	<p><b>2012</b></p> <p><b>2013</b></p> <p><b>2015</b></p>

<b>Portfolio</b>	<b>Probable Solution Sets</b>	<b>Expected Fielding FY</b>
	<p>will be High Assurance Internet Protocol Encryptor (HAIPE) encrypted and transported over the DISN Black Core. Unencrypted Unclassified services can still use the DISN Unclassified Core, as well as internet protocol video and voice services that are not HAIPE encrypted [PEO C4I Masterplan, 2007: 83].</p> <p>8. If DoD Teleports are configured with appropriate security devices and software applications (firewalls, High Assurance Internet Protocol Encryptor, Transmission Security (TRANSEC), and required routers), direct inter and intra-theater internet protocol connectivity can be achieved among Services via Virtual Routing and Forwarding (VRF) or similar technology that supports multi-exit domain connections for direct cross connect between and among the service's net-centric internet protocol systems. A proposed FY13-FY15 Navy specific multi-exit domain future architecture builds upon ADNS INC III and the Tactical Switching (TSw) Navy Shore Tactical Architecture, to allow for implementation of a Navy internet protocol network solution that will seamlessly interface with the mature DISN Core for DISN services, other Navy users, and other military services, directly at the Teleports [PEO C4I Masterplan, 2007: 84].</p>	
<i>Network Core</i>	<p>“Relevant information for this area will be provided when planned upgrades are solidified [PEO C4I Masterplan, 2007: 93].</p>	<b>TBD</b>

<b>Portfolio</b>	<b>Probable Solution Sets</b>	<b>Expected Fielding FY</b>
<i>Shore Telephony</i>	Continued migration to Voice Over Internet Protocol (VoIP) and deployment of enhanced services to concentrations of high value end users. Value added services will include unified communications, web conferencing and collaboration. A consistent upgrade plan will be necessary to maintain current Defense Switched Network (DSN) and DISN interoperability and security [PEO C4I Masterplan, 2007: 113]. Due to funding constraints, continued operation of TDM “last mile” telephone service on base via legacy infrastructure will continue to be supported well into the future [PEO C4I Masterplan, 2007: 114].	<b>2012</b>
<i>Shore Network Management</i>	<p>1. TSw Network Management System (NMS) Increment III fully deployed for Navy Enterprise Network Operations to provide near real-time and real-time networks and communications situational awareness information to Navy Component Commanders and JTF-GNO for global operations of the GIG [PEO C4I Masterplan, 2007: 119].</p> <p>2. Operational and network management interfaces with Navy afloat networks, GIG, and Joint Communities completely fielded [PEO C4I Masterplan, 2007: 119].</p>	<b>2012</b>  <b>2013</b>
<i>Afloat Network and Systems Management</i>	CANES System Management capabilities fielded in spirals throughout the increments of CANES. 2nd and 3rd increments scheduled to be fielded after FY12 [PEO C4I Masterplan, 2007: 123].	<b>2012</b>

<b>Portfolio</b>	<b>Probable Solution Sets</b>	<b>Expected Fielding FY</b>
<i>Communications Circuit Management</i>	<p>1. Navy shore communications infrastructure completely transitioned to internet protocol-based networks. United States Navy's serial switching infrastructure replaced by internet protocol routers and switches [PEO C4I Masterplan, 2007: 128].</p> <p>2. High Speed Global Ring eliminated or provides edge access to DISN Core network; and Automated Network Control Center (ANCC), Automated Technical Control (ATC) switches replaced with an internet protocol, Asynchronous Transfer Mode (ATM), Multi-Protocol Label Switching (MPLS) control plane switching, and routing capability. For all non-Navy agencies and groups including Joint and other nations' militaries which may still employ serial communications in this timeframe, technology will be left in place to accommodate requirements on an as needed basis [PEO C4I Masterplan, 2007: 128].</p>	<b>2012</b>
<i>Network Operating Systems</i>	Specific details of each component of planned configuration are currently under development. The functionality of each component was briefly described in the section above [PEO C4I Masterplan, 2007: 135].	<b>TBD</b>
<i>Computer Network Defense</i>	No planning information available [PEO C4I Masterplan, 2007: 143].	<b>TBD</b>

<b>Portfolio</b>	<b>Probable Solution Sets</b>	<b>Expected Fielding FY</b>
<p><i>Electronic Key Management System and Key Management Infrastructure</i></p>	<p>Key Management Infrastructure (KMI) Capability Increment 3 will be realized and be a major pillar of the GIG infrastructure. It will provide a unified, net-centric infrastructure to provide integrated, consolidated and automated capabilities for ordering, generating, distributing, and monitoring status of all cryptographic products. Products will include Key, crypto software and other End Crypto Unit (ECU) management data, Product distribution to User nodes, and Over the Net Keying (OTNK) [PEO C4I Masterplan, 2007: 150].</p> <p>KMI focus will be on wrapped product distribution and operations over the network for all KMI users and managers. It will also provide transparency and mobility (operate from any client) and will have a web based user interface. It will provide direct Product Distribution to Net enabled ECUs, Over the Net Keying, Role and Rule based access control, Type 1 public key infrastructure (PKI) for managers and ECUs, and a modular architecture [PEO C4I Masterplan, 2007: 150].</p>	<p><b>2012</b></p>

Portfolio	Probable Solution Sets	Expected Fielding FY
<i>Public Key Infrastructure</i>	<p>Implement Ron Rivest, Adi Shamir, and Leonard Adleman (RSA) 2048 when testing demonstrates performance is satisfactory across all domains. Following this, it will transition to Suite B algorithms (Elliptic Curve Cryptography (ECC) and Secure Hash Algorithm 256 (SHA-256)) when systems and applications ubiquitously support ECC &amp; SHA-256 [PEO C4I Masterplan, 2007: 155].</p> <p>Evolving status of afloat infrastructures and operating systems will drive the implementation of the next generation of PKI, which will include elliptic curve cryptography and stronger hashing algorithms in support of confidentiality, integrity, and non-repudiation [PEO C4I Masterplan, 2007: 155].</p>	<b>2012</b>

**Table 3. C4I Masterplan Identified Planned Upgrades Beyond FY12**

PEO C4I offers a plan of attacking the Joint ASW C4I Architecture demands for improvement in areas significantly impacting the quantity and quality of data throughput to operational war fighters [PEO C4I Masterplan, 2007: 45-155].

***b. Network Topologies***

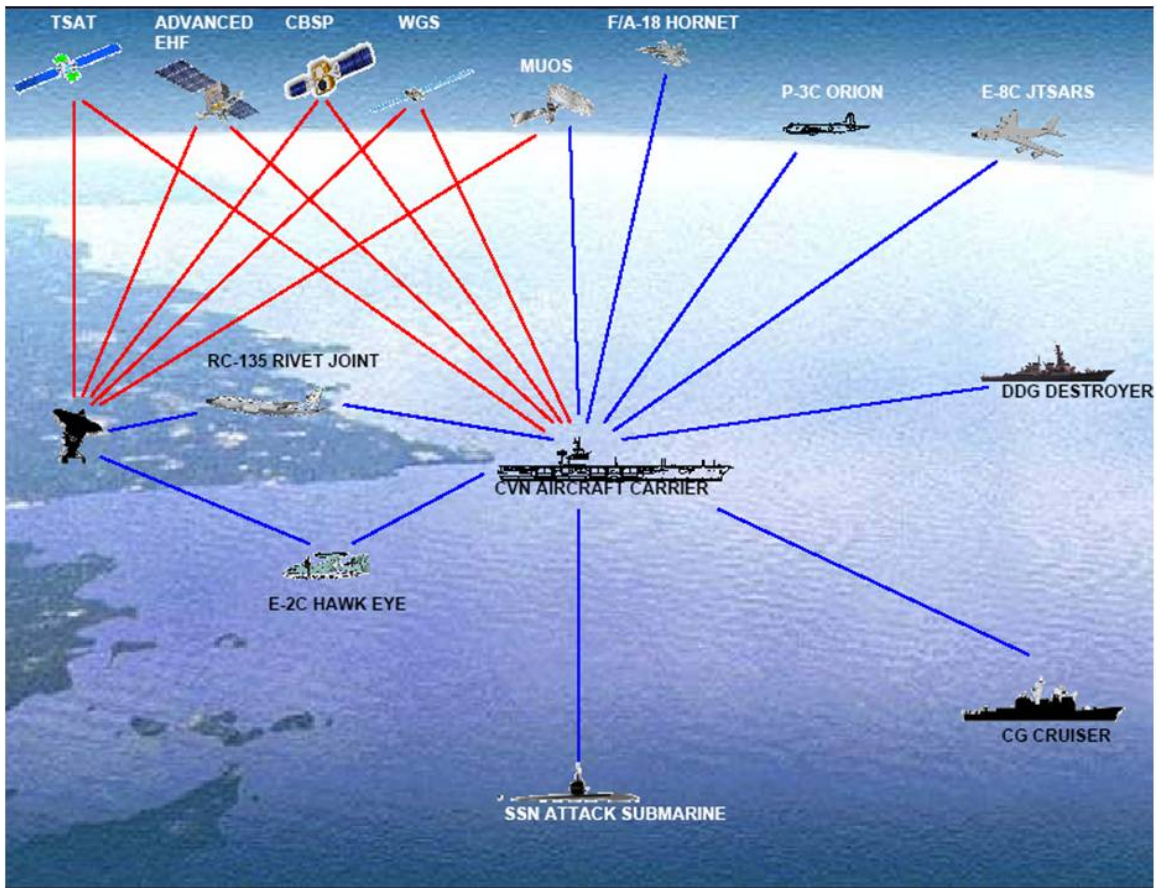
The selection of the best wide area network topology can lend powerful capabilities to the Joint ASW C4I Architecture’s maritime operations. One of the key objectives is to select a wide area network topology that will improve the throughput of time sensitive data from end user to end user between communication nodes without the loss of data. Equally important is a self-healing network topology that will permit the loss of one or more nodes while having limited or no impact on the interoperability of the remaining nodes on the network. Network topologies must ensure maximum operational availability for the overall network providing backups and workarounds to operationally control system down time for maintenance or repair. The network must remain operational through the duration of an ASW mission to be most effective for the ASW community users. Communications and network services between operational nodes must be available at all times to provide uninterrupted, tactically relevant service to the end user at each operational node. Mesh, star, partial mesh, and tiered wide area network topologies provide fleet communicators with differing levels of connectivity opportunity and, more importantly to this capstone project, the speed of receiving real time targeting

data. The FY2020 Joint ASW C4I Architecture Baseline will take advantage of manual and automatic network topology configuration controls to establish the most effective communications support for its ASW warfighters and decision makers.

Network configuration is preplanned in most operational scenarios to provide the necessary bandwidth, frequency spectrum control, and robust securities for friendly forces. “A physical topology or the pattern of the nodes on a network depicts a network in broad scope. It does not specify device types, connectivity methods or addressing schemes for the network” [Dean, 2006: 286]. The ASW forces identified in the FY2020 Joint ASW C4I Architecture Baseline will have multiple tools to communicate in several wide area network topologies including mesh, star, partial mesh, and tiered as constrained or demanded by operational influences. The current communication systems in place today and the ones planned to be in place in the year 2020 have the ability to be reconfigured on the fly to support variations in missions. United States Navy communications experts will determine how to configure the available communication systems on a mission by mission basis to provide the most efficient and robust network to support the specific mission operating environment. The alternatives that are presented later in this section will address improvements to the throughput and recommend the best wide area network topology best suited for collecting and fusing sensor data and distributing the COTP to the end users.

Star wide area network topologies, Figure 19, are characterized by a central transmit and receive site which connects directly to individual nodes around it. These nodes do not connect to each other without first going through a central interconnection point. These are viewed as excellent point-to-point command and control networks such as takeoff and landing communication to permit the interconnection point to control its flight deck without overburdening its nodes with unnecessary data. It offers superb security of information opportunity between edge performers like a submarine and specifically identified operational headquarters. If a single node is designated to function as the central hub for collecting and fusing sensor data and generating and distributing the COTP, this configuration can be considered operating in a star topology using line-of-sight and beyond line-of-sight communication systems for connectivity. Figure 19 depicts a notional star network topology for the Joint ASW C4I Architecture Baseline. The blue lines in Figure 19 represent line-of-sight communication links and the red lines represent satellite communication links. The central hub for this topology is the CVN Aircraft Carrier. The shore nodes represented by the satellite dish require either a satellite or aircraft relay to communication with the central hub. One of the drawbacks of this topology is the lack of the capability for each node to communicate directly with each other.

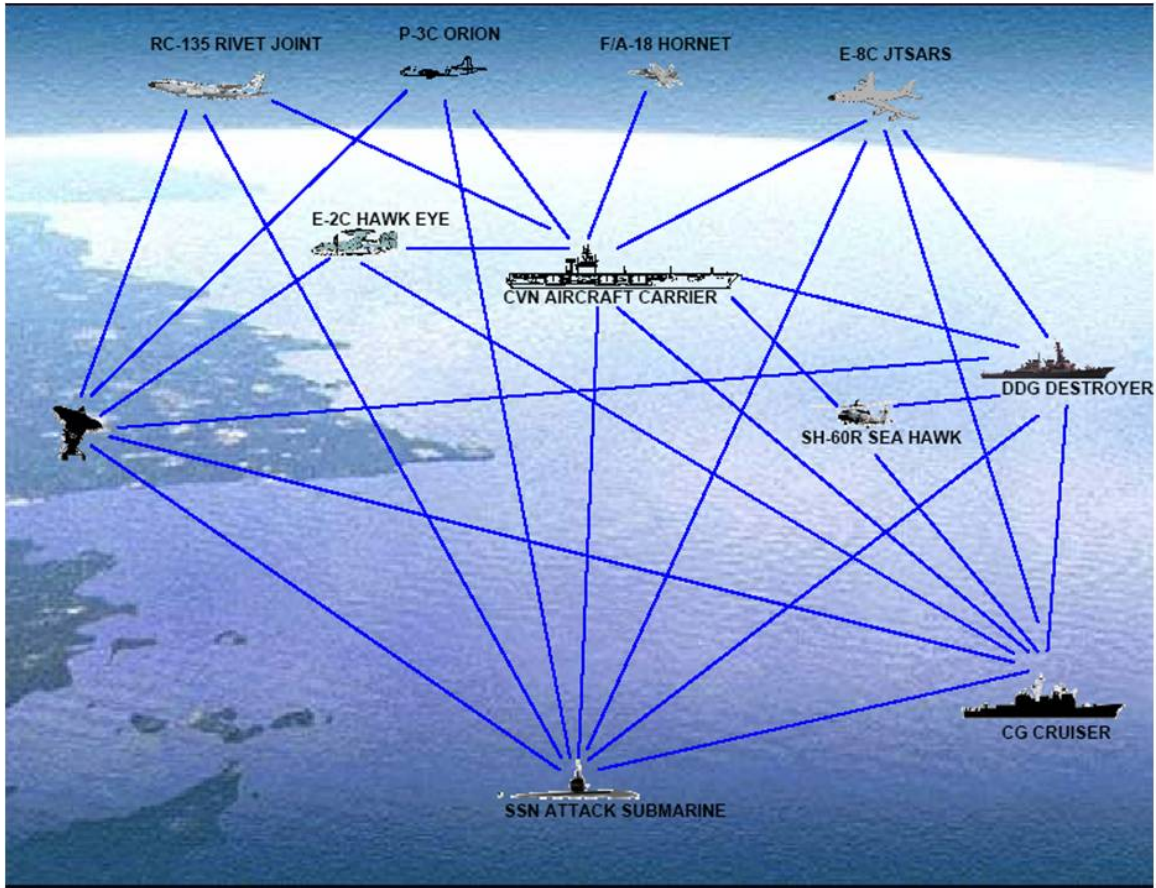




**Figure 19. Notional Star Network Topology Based on Line-Of-Sight and Beyond Line-Of-Sight Communication Systems**

This figure shows a notional star network topology. The blue lines represent line-of-sight communication links and the red lines represent satellite communication links. The central hub for this topology is the aircraft carrier. Communications between the central hub and shore nodes require a relay through either a satellite or aircraft relay.

Mesh networks allow node-to-node connectivity streamlining the receipt of time sensitive situational awareness information offering all nodes on this type of wide area network topology nearly real time access of a complete common operational picture. Efficient node based sensor information sharing is key to establishing and maintaining force wide awareness and reaction time. Shipboard, aircraft and shore based nodes have the ability to connect to each other over line-of-sight communication systems to form a mesh or partial mesh network connectivity between nodes. Figure 20 illustrates a notional partial mesh configuration that can be established between nodes using existing line-of-sight communication systems. The blue lines represent line-of-sight communication links. One of the primary drawbacks of this configuration is the requirement to implement and maintain multiple communication links for each node.

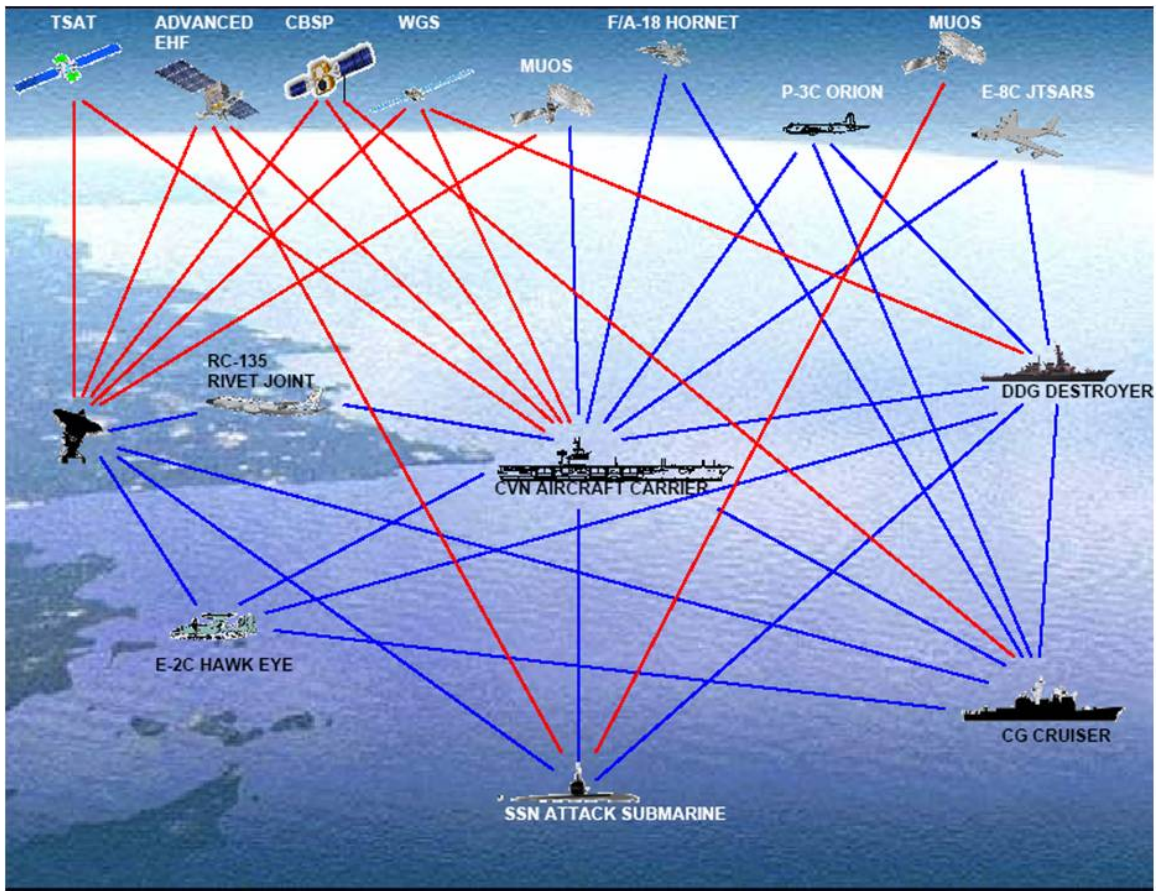


**Figure 20. Notional Partial Mesh Network Topology Based on Line-Of-Sight Communication Systems**

This figure shows a notional partial mesh configuration for the Joint ASW C4I Architecture Baseline. The blue lines represent line-of-sight communication links. Note that the submarine node is required to be on the surface or at periscope depth in order to be part of the network topology.

Tiered networks combine the above topologies to take advantage of interconnection node to interconnection node reach back beyond line-of-sight capabilities to exchange data resulting in a strategic common operational picture while each individual node is freely gathering and exchanging data with each other with or without the help of the interconnection node. Increased battlespace awareness is expected using this topology and the opportunity to control regional information flow as necessary to limit bandwidth overuse. Figure 21 illustrates a notional tiered network configuration that can be established between nodes using line-of-sight and beyond line-of-sight communication systems.





**Figure 21. Notional Tiered Network Topology Based on Line-Of-Sight Communication Systems**

This figure shows a notional tiered network configuration for the Joint ASW C4I Architecture Baseline. Blue lines represent line of sight communication paths and red lines represent satellite communication paths.

The Joint ASW C4I Architecture Baseline can be configured in any of the three previously described network topologies shown in Figure 19, Figure 20, and Figure 21 using the year 2020 planned systems outlined in the PEO-C4I Masterplan. The preferred topology is best described as a tiered wide area network topology illustrated in Figure 21 because the operators can make use of all communication links in both a star and partial mesh network topology as necessary to help maintain operational efficiencies.

**c. Communicating with Submarines**

To understand submarine communication strengths and weaknesses it was necessary to baseline today’s submarine C4I systems. Communication capabilities of the Virginia Class (SSN-774) and Los Angeles Class (SSN-688) submarines used in the FY2020 Joint ASW C4I Architecture Baseline begin with the Common Submarine Radio

Room (CSRR). The following is from the PEO-C4I Masterplan that describes the components and systems on a submarine that are used to conduct ASW functions.

The components for all CSRR class submarines are the same but the number of antenna, transceivers, terminals and network components changes by class of submarine. These differences are driven primarily by the missions of each class of submarine as designed and based on sail and rack space. Radio frequency communications consist of antennas, radio frequency distribution, transceivers, terminals and crypto. Radio frequency communications are routed to either a tactical voice switch or logger for voice, or to the Automated Digital Network System Internet Protocol router for data. There is a direct data connection to the combat system for the Tomahawk Strike Network. The Command and Monitoring system allows for the monitoring, establishment and breakdown of all the radio room circuits and components. Automated Digital Network System distributes data to the different security enclaves including unclassified, top secret, and special compartmented information via inline network encryptions and directly to the Secret Submarine Local Area Network. Each enclave provides messaging capability, tactical applications via GCCS, chat and web service. The Time and Frequency Distribution System and NAVSSI distribute timing and GPS signals to all components in the radio room and combat systems. The SUBLAN is connected to the submarine Tactical Local Area Network (TACLAN) via a High Assurance Guard. Tactical Local Area Network is a period processing LAN that can operate at security classifications from secret to SCI, depending on the submarine's mission. Tactical Local Area Network includes internet protocol services for all forward electronics systems on the submarine, including SONAR, fire control, electronic surveillance measure, navigation, RADAR, imaging and others [PEO C4I Masterplan, 2007: 246].

Our stakeholder community has shown strong interest in technologies that will improve upon current communications techniques based on the PEO C4I "Communications at Speed and Depth and Optical Laser Communications Status" briefing and additional data exchanges with individual stakeholders including March 2008 email exchange with Mr. Dave Cepek, N872A [Cepek, 2008]. Today's technology projects addressing CSD demands of the Joint ASW C4I Architecture range from moored acoustic buoys to submarine tethered near-surface antennas to expendable acoustic-radio frequency surface buoys. All seek to bridge the interconnection gap at the air-sea

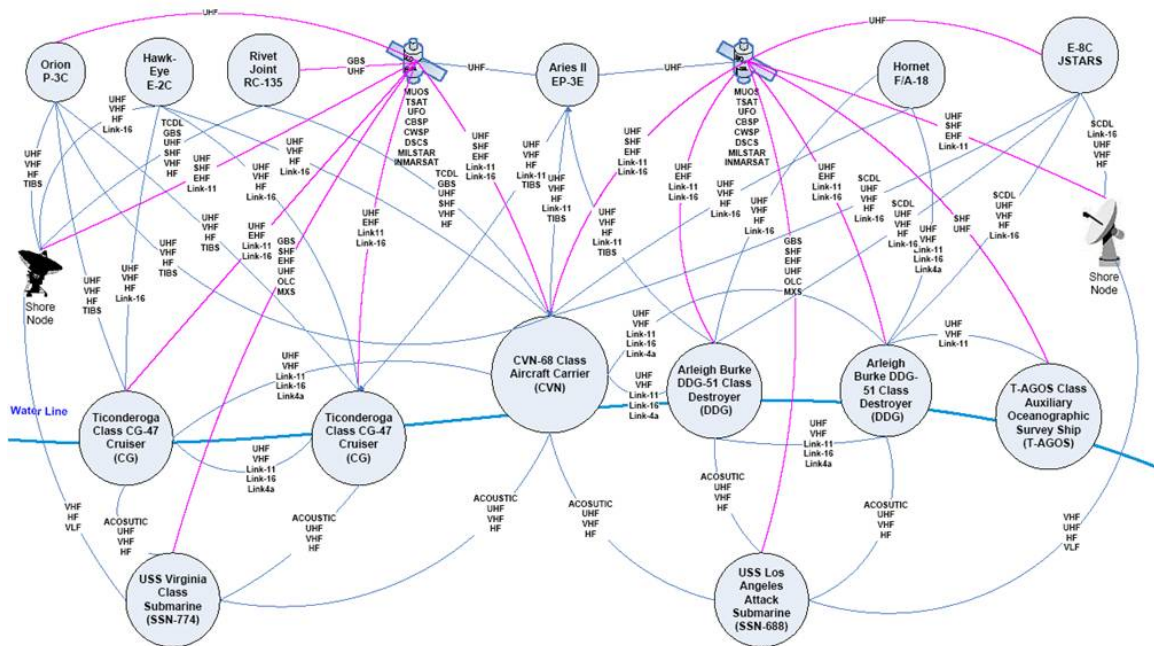
interface while allowing the submarine to remain at depth. Solving the interconnect issues is only part of the problem for two way communications. A critically important concern is the quality of the information being communicated. Today extremely high frequency wideband radio frequency communications are limited to submarines at periscope depth with raised antenna masts which are not submerged. To bridge the air-sea interface gap, future relay systems will need to account for data capacity differences and establish efficient means for transmission of time sensitive data to and from submarines. This communication includes blue force tracking which indicates a friendly boat's course, speed, and depth; exchange of time sensitive intelligence, surveillance, and reconnaissance (ISR) or target data; and all other communications needed to conduct ASW operations in deep ocean or littoral areas around the world.

## **2. Construct Joint ASW C4I Architecture Baseline**

A decision was made to use an aircraft carrier strike group to develop the baseline for the Joint ASW C4I Architecture Baseline. The aircraft carrier strike group in conjunction with the shore facilities, coalition partners, and other service components such as Air Force, Army, Marine Corp, and Coast Guard were used to develop the Joint ASW C4I Architecture Baseline. This baseline was developed in order to perform a decomposition of the functional architecture into the physical components or systems that currently perform Joint ASW C4I functions. The decomposition of the functional architecture into a physical architecture included existing and planned systems up to the FY2020 timeframe. We first identified a baseline using year 2008 systems for each node in the aircraft carrier strike group and conducted research for each system to identify which systems performed the functions identified in our ASW functional architecture. Later during the systems engineering process, it was decided to move the Joint ASW C4I Architecture Baseline to the year 2020. At this point in the systems engineering process, further research was conducted to determine the physical architecture that will meet the ASW C4I functional architecture in the year 2020. In order to determine a physical architecture for the FY2020 timeframe, it became necessary to determine the system that are planned to be funded and implemented by year 2020. Since the architecture is a C4I-based architecture, research led us to the plans of the PEO-C4I. Figure 22 depicts the top level results of the previously described analysis.

The aircraft carrier strike group baseline depicted in Figure 22 identifies communication links between the various nodes or blue force platforms within the strike group used to perform the ASW mission. Each platform is identified by specific class or generic title and represented in the drawing by circles. The satellite icons, located at the top of this diagram are representative of more than one satellite constellation. FY2020 satellite constellations are envisioned to consist of both military and commercial satellite

systems. These satellite systems consist of Mobile User Objective System (MUOS), Transformational Satellite System (TSAT), Ultra-High Frequency Follow-On (UFO), Commercial Broadband Satellite Program (CBSP), Commercial Wideband Satellite Program (CWSP), Defense Satellite Communications System (DSCS), Military Strategic and Tactical Relay (MILSTAR), International Marine and Maritime Satellite (INMARSAT), and others. Shore communications nodes are represented by ground receiving antenna icons which also represent multiple systems that range from large fixed site Standardized Tactical Entry Point (STEP) locations to man portable antenna systems.



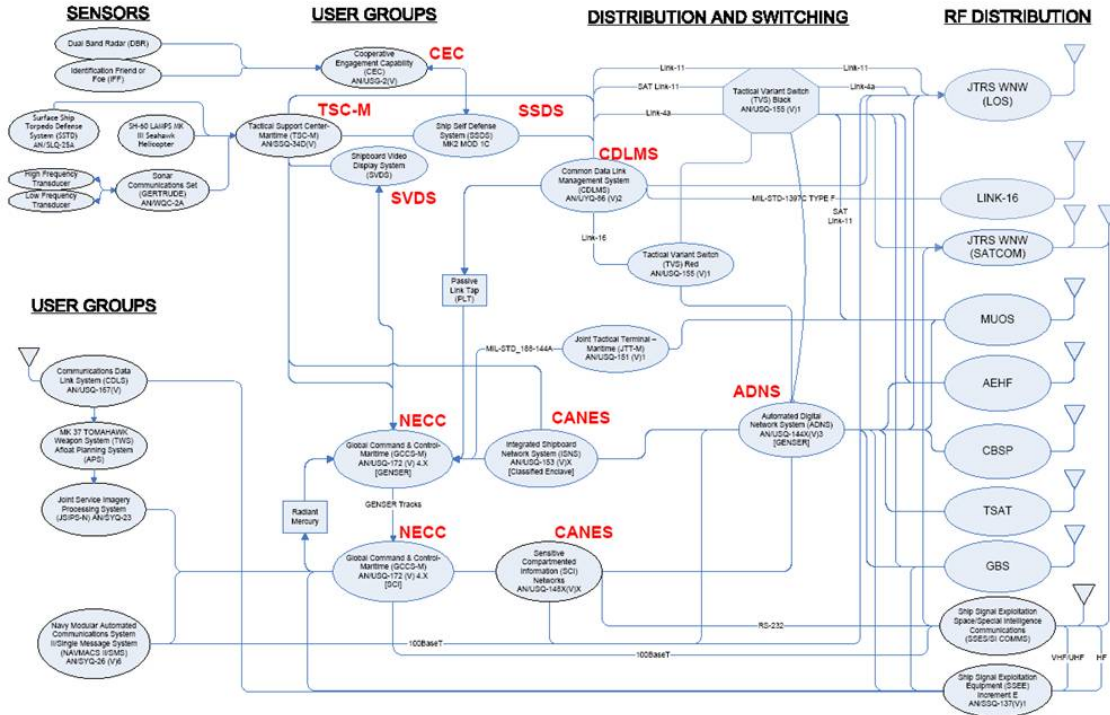
**Figure 22. Aircraft Carrier Strike Group based FY2020 Joint ASW C4I Architecture Baseline**

This C4I network architecture is representative of real world carrier strike group communications depicting tactical line-of-sight and strategic beyond line-of-sight communications paths between maritime operators and shore based support sites.

Each of the nodes in Figure 22 was further decomposed into the individual systems peculiar to each node that physically perform the functions identified in the Joint ASW C4I functional architecture. Current 2008 systems were used for the decomposition of each individual node because the systems planned for FY2020 have not yet been developed and system connectivity is not available. Therefore, the discussions and descriptions pertaining to the data flow through the systems peculiar to each node are based on 2008 systems. However, the systems that are planned to be fielded by the



FY2020 are noted next to each 2008 system for which the FY2020 system is slated to replace in the graphical descriptions. The FY2020 systems are also noted on the drawings next to the 2008 system for which it is intended to replace.



**Figure 23. Joint ASW C4I Architecture Baseline Aircraft Carrier Node Configuration**

This figure is representative of the systems that exist on an aircraft carrier that are used in the execution of anti-submarine warfare. This figure is the expansion of the CVN node in Figure 22.

The decomposition of the aircraft carrier node into the systems that make up the physical architecture required to meet the ASW C4I functional architecture are illustrated in Figure 23. The flow of data through the physical architecture of an aircraft carrier node moves from the left side of Figure 23 to the right side where the processed data is distributed to other nodes by way of the systems that provide RF distribution. The left side of Figure 23 illustrates the sensors peculiar to an aircraft carrier that are used to conduct anti-submarine warfare. The NECC system collects the ASW sensor data from the encrypted sensor data received from other nodes by way of the various RF communication links and onboard ASW sensors. The Common Data Link Management System (CDLMS) and the Automated Digital Network System receive the encrypted sensor data from the radio frequency distribution communication links and pass it

through the CANES to NECC. The NECC system then fuses the data received from multiple sensors and the NECC operators manually generate the COTP.

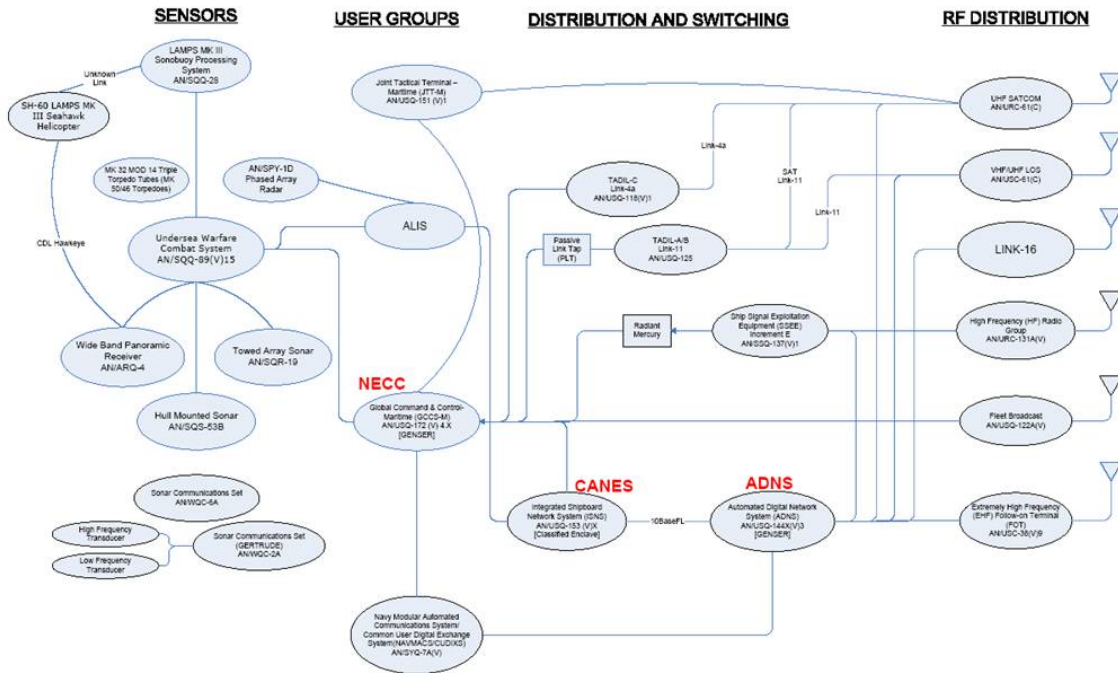
The combined ASW sensor data from the TSC-M is also provided to the Ship Self Defense System (SSDS). The picture developed by the TSC-M system is provided to the NECC system for incorporation into the COTP and the CANES and Shipboard Video Display System (SVDS) distributes the COTP to all operator workstations and command centers that require it. The COTP generated by the NECC system is distributed to individual workstations and operators in the Combat Direction Center (CDC) by way of the CANES system and SVDS. The operators in the CDC use the COTP generated by the NECC system and displayed by SVDS on large screen displays and video walls to make decisions as to which targets or tracks to engage using the SSDS system and Cooperative Engagement Capability (CEC) Systems. The aircraft carrier has the Surface Ship Torpedo Defense System (SSTD) to protect itself against enemy submarines.

Once the NECC system collects all of the sensor data from ADNS and CDLMS and the COTP has been generated, the COTP is then transmitted back through ADNS and CDLMS for the purpose of distributing the COTP to other nodes by way of the RF Distribution communication links (same once used to collect ASW sensor data external to the aircraft carrier). The COTP is then used by other nodes in a similar manner as the aircraft carrier node to conduct command and control. The COTP is used by decision makers to decide which targets to track and engage using the node specific sensor and weapon systems. If the aircraft carrier node is designated as the central hub for collecting and fusing sensor data and generating the COTP, then the COTP generated would be referred to as the Top COTP. The Top COTP can be designated to take place at any node illustrated in Figure 22. The sharing of the Top COTP is done by way of the RF Distribution communication links characteristic of each node in the baseline.

Furthermore, the entire strike group and all nodes operating within the strike group including shore locations have the capability to generate and share the COTP by way of the RF communication links. All assets within a strike force which includes United States, NATO, and coalition aircraft, ships and ground forces use the sensors available to them to locate and track friendly, unfriendly, and unknown entities or tracks. That information is then provided back to a central NECC node that collects the data, fuses the data and generates the Top COTP. External NECC nodes include ISR platforms such as unmanned aerial vehicles, electronics intelligence aircraft and ground-based assets, special operations forces, and meteorological and messaging activities. Other nodes may include higher-level combatant commands, commanders, and decision-makers. NECC fuses ISR, tactical tracks, battle damage assessment, weather, and formatted message data from multiple wired and radio communications links including satellite communications,



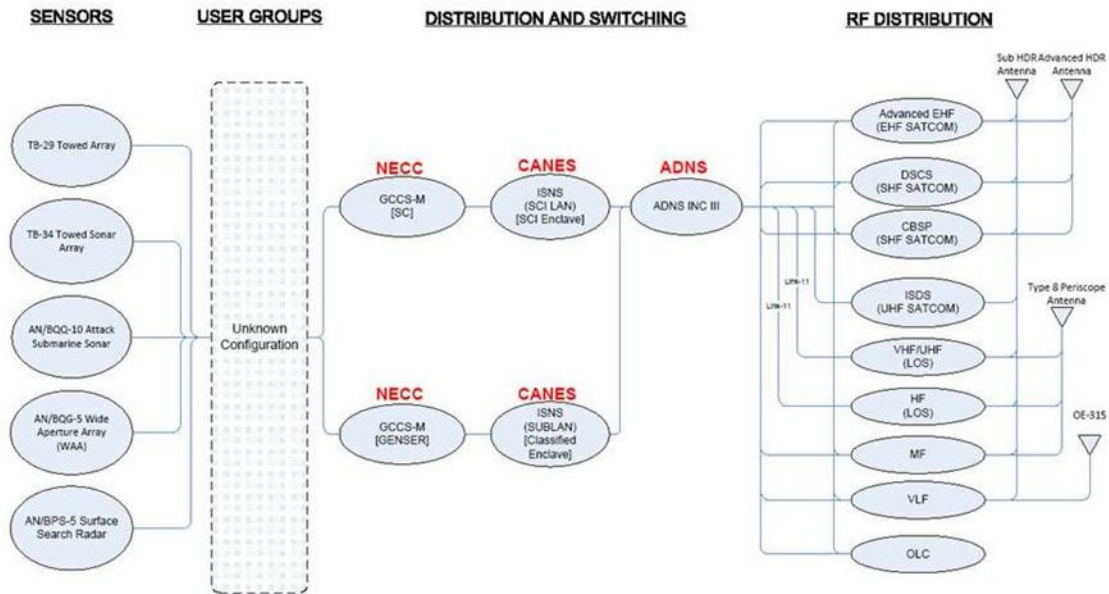
tactical data links, the Secret Internet Protocol Router Network (SIPRNet), and coalition networks to form the Top COTP. The process previously described is a continuous process.



**Figure 24. Joint ASW C4I Architecture Baseline Cruiser and Destroyer Node Configuration**

This figure is the expansion of the DDG and CG nodes in Figure 22. This figure is representative of the systems that exist on Arleigh Burke Destroyers and Aegis Cruisers that are used in the execution of anti-submarine warfare.

A similar breakout of system connectivity for the cruiser and destroyer nodes is illustrated in Figure 24. The data flow for the CG and DDG nodes are identical to the data flow described for the CVN node in Figure 23. Each of the node system connectivity drawings are arranged to show data flow from the sensors to the user groups to the distribution and switching functions to RF distribution from left to right. Common to each node are NECC, CANES, ADNS and various radio frequency distribution satellite and line-of-sight external communication systems. Each type of platform (CG, DDG, CVN, SSN and various aircraft) has its own unique set of sensors and weapon systems. The common system shared between all ships, aircraft coalition partners and shore facilities that perform the data fusing and COTP development functions is the NECC system.



**Figure 25. Joint ASW C4I Architecture Baseline Submarine Node Configuration**

This figure is the expansion of the SSN-668 and SSN-774 nodes in Figure 22. This figure is representative of the systems that exist on Los Angeles and Virginia Class Attack Submarines that are used in the execution of anti-submarine warfare.

The system connectivity diagram for the submarine node is depicted in Figure 25. Other system connectivity diagrams for other nodes depicted in Figure 22 are included in Appendix G. Some sections of the system connectivity drawings listed in Appendix G are labeled as unknown because the specific sensors, weapons, user groups and communication systems pertaining to these platforms are not available. As a means to fill the gaps in the communication baseline for the submarine node, a quote from the PEO-C4I Masterplan was used that describes in better detail, the make up of the systems on a submarine communication node.

In FY10 to FY12 the submarine radio room will increase their baseline capabilities by adding Satellite and Line-of-Sight waveforms, Joint Tactical Radio and Mobile User Objective System (MUOS) transceivers, changing from a SubHDR (OE-562) antenna to an Advanced HDR antenna, adding Communications at Speed and Depth, adding security enclaves for access to Allied information and simultaneous access to different compartmented information, and by adding capabilities to provide quality of service to applications in a service-oriented architecture. ADNS

will be upgraded to ADNS INC III and NAVMACS will be replaced by ISDS Inc 2.

The addition of the ADV HDR antenna adds significant additional bandwidth capability by introducing a larger aperture antenna into the submarine antenna mix and includes the addition of Ka-band. The upgrade of the OE-538 antenna to increment 2 capabilities will include the Mobile User Objective System waveform, an L-Band antenna for access to LOS internet protocol waveforms and the IRIDIUM waveform. The LOS internet protocol waveforms are now included in Naval Tactical Networks and may include the Wideband Networking Waveform, the Soldier Radio Waveform, and a tactical airborne waveform. The addition of CSD capabilities will allow the submarine to access satellite and LOS services while maintaining the submarine in a stealth posture below periscope depth and provide the tactical commander with the capability to change submarine tasking without waiting for the next scheduled submarine communications window.

The addition of super high frequency capability in the Follow-on Terminal or Navy Multi-band Terminal will significantly increase the internet protocol bandwidth available to a submarine that is not operating in a region covered by an extremely high frequency spotbeam. Additionally, commercial satellite communications in the super high frequency band may be available in regions covered by the XTAR satellite footprint. The addition of MUOS capability in either the JTRS AMF Increment 1 radio or in Digital Modular Radio will provide dynamic ultra high frequency internet protocol connectivity at higher data rates than the shared 32 Kbps available in the baseline.

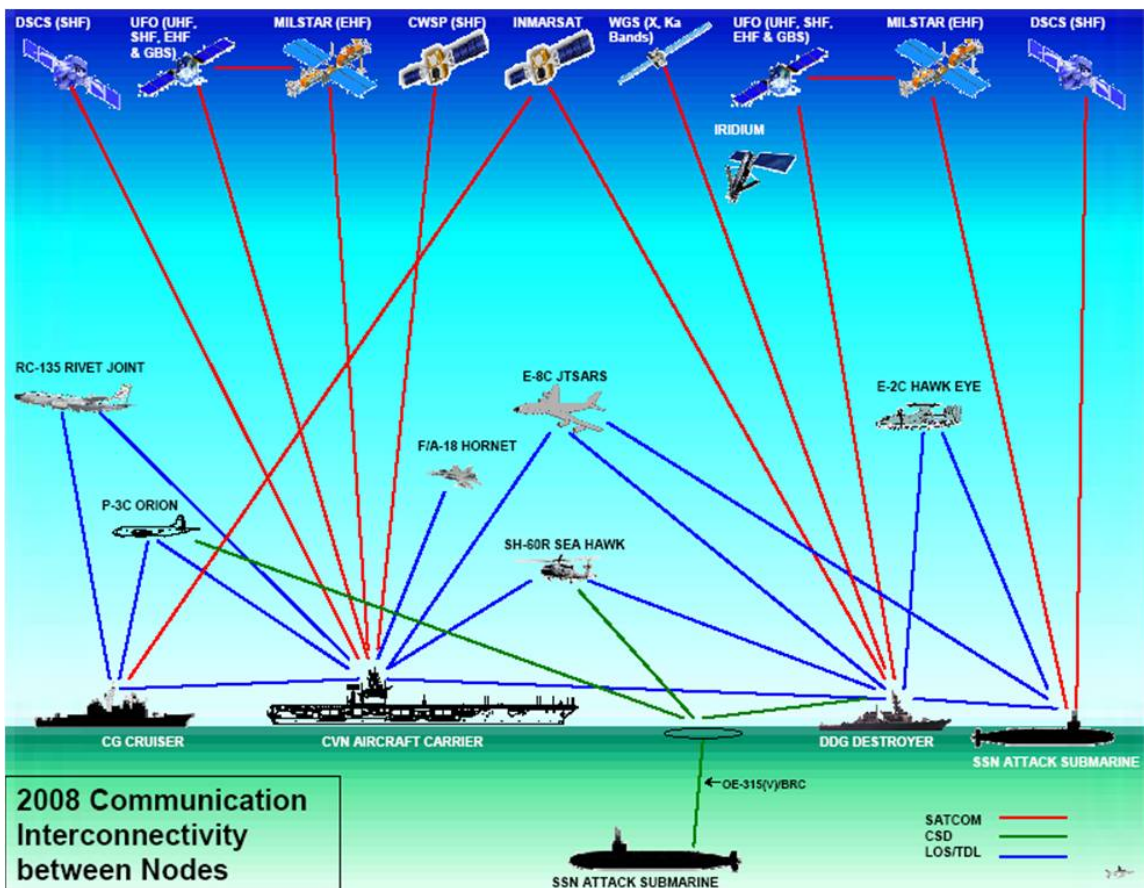
ADNS INC III brings a change from the baseline architecture with the installation of a Ciphertext Core. All enclaves will be encrypted over this Core. Capability improvements provided by ADNS INC III include Quality of Service, internet protocol version 6 capable networks, improved interoperability with ciphertext routing, and the ability to access multiple satellite communications and LOS internet protocol networks simultaneously. ADNS INC III also provides the replacement path for Crypto Modernization of the in-line network encryptors.

Additional new capability is provided by the addition of JWICS and one or more Combined Enterprise Regional Information Exchange, System (CENTRIXS) enclaves and by the inclusion of GCCS-M segments such as Joint Range Extension. The CENTRIXS enclave allows the submarine to exchange information with Allied nations, including participation in chat rooms and websites. The JWICS enclave supports passing of

intelligence in support of the Intelligence, Surveillance and Reconnaissance and Special Operating Forces missions.

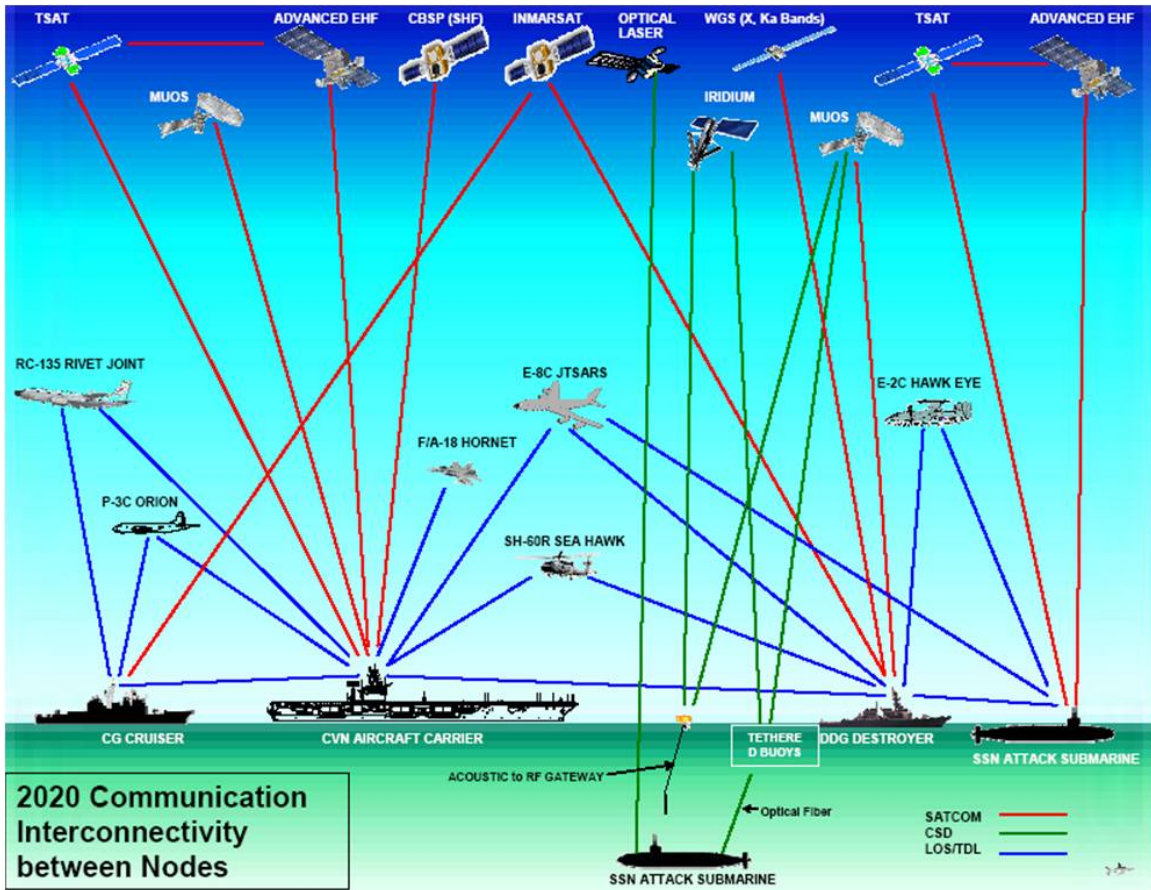
The Los Angeles Class has 1 OE-538, 1 OE 562, 1 OE-315, 1 Type18, and 1 OE-499 antennas, while an SSGN has 2 OE-538, 2 OE -562, 1 OE 315, 2 BRA-6, 1 Type 15 and 1 OE-499 antennas. The SSBN is the same as the SSGN with the exception of using 2 OE-592 antennas vice 2 OE-538 antennas. The SSGN has 2 EHF follow-on terminals while all other classes have only 1. The SSBN has 3 Submarine LF/VLR Receivers while all other classes have only one [PEO C4I Masterplan, 2007: 246].

The previous descriptions of systems for each node (Figure 23, Figure 24, and Figure 25) are the systems that make up the physical architecture of the Joint ASW C4I Architecture. These are the systems that were used to decompose the ASW functional architecture into the physical architecture required to perform the ASW functions.



**Figure 26. 2008 Communication Interconnectivity between Nodes**

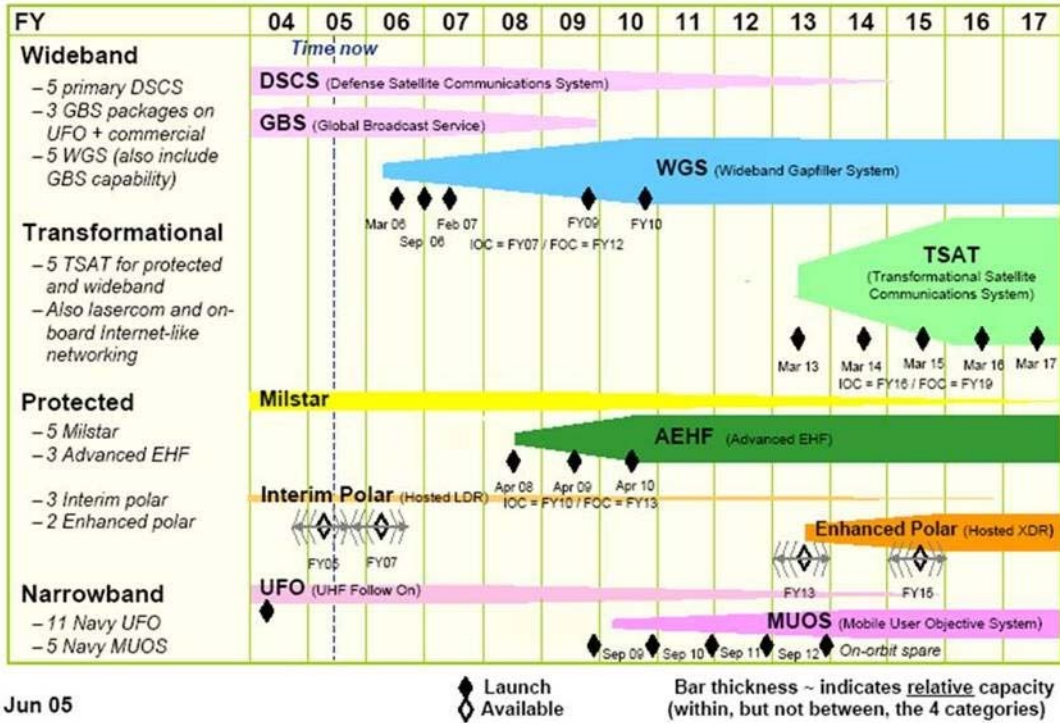
This figure shows the current (2008) communication interconnectivity between nodes for the purpose of comparing today's communication links to the communication links planned to be operational in 2020.



**Figure 27. 2020 Communication Interconnectivity between Nodes**

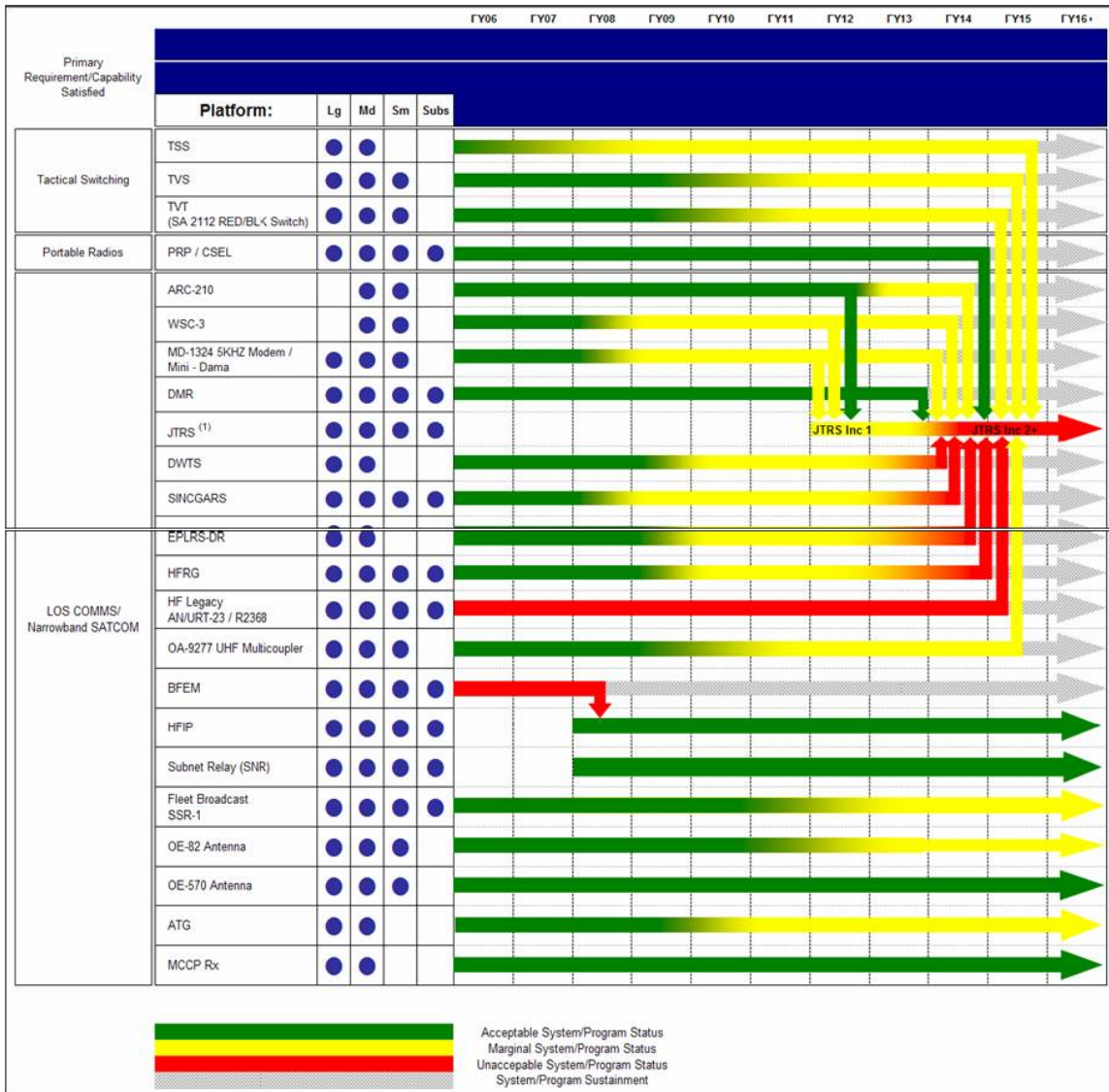
This figure shows the planned communication interconnectivity between nodes in characteristic if the FY2020 Joint ASW C4I Architecture Baseline.





**Figure 28. Military Satellite Communication Systems of Systems Schedule**

This figure shows the schedule that detail the transitional period from existing communication systems to the ones identified in the FY2020 Joint ASW C4I Architecture Baseline [Cinlemis, 2005].



**Figure 29. Tactical Radio Roadmap**

This figure shows the schedule that detail the transitional period from existing tactical radio communication systems to the JTRS identified in the FY2020 Joint ASW C4I Architecture Baseline [PEO C4I Masterplan, 2007: 30].

Figure 26 illustrates a simplified configuration of the communication systems that are currently in use today. The red lines depict satellite communications, the blue lines represent surface to surface and surface to air line-of-site communications combined with the tactical data links (TDLs) and the green lines represent the communications at speed and depth for the submarine. The 2008 configuration is shown for the purpose of illustrating the changes from the systems that perform Joint ASW C4I functions today and the systems that are planned to perform Joint ASW C4I functions in 2020. Figure 27 depicts the updated 2020 version of Figure 26 that includes the systems planned to be

fielded by year 2020. Figure 27 illustrates the line-of-sight and satellite communication systems that make up the FY2020 Joint ASW C4I Architecture Baseline. Figure 26 and Figure 27 were provided to highlight the changes planned for FY2020. Defense Satellite Communications System (DSCS) is planned to be replaced by the Wideband Global Satellite Communication (WGS) system. “The Wideband Global SATCOM, or WGS is the replacement for the current DSCS and as a significantly more capable satellite, it will provide improvements in the data throughput available to Navy users. It is expected, with the combination of the EBEM and the WGS, Navy shipboard users will see a more than doubling of the currently allocated data rates” [PEO C4I Masterplan, 2007: 44]. MILSTAR is planned to be replaced by the Advanced EHF system. “Advanced EHF satellites will provide 10 times greater total capacity and offer channel data rates four times higher than that of MILSTAR II communications satellites. The higher data rates permit transmission of tactical military communications such as real-time video, battlefield maps, and targeting data” [PEO C4I Masterplan, 2007: 47]. The CWSP system is planned to be replaced by the CBSP system. “The CBSP architecture is currently undefined but is expected to continue as an augment to military satellite communications while providing significantly more capacity to users than the current CWSP program” [PEO C4I Masterplan, 2007: 44]. There are currently no planned upgrades to INMARSAT but the CBSP system may provide some of this capability. The Enhanced Polar satellite system is intended to provide polar orbit satellites that will enhance the coverage of the Advanced EHF system.

For satellite communication systems, the addition of the optical laser communication system depicted in Figure 27 is one of the major improvements expected to improve communications with submarines at speed and depth. This system is expected to allow the submarine to be part of strike group while submerged and is one of the primary gaps in the communication links for the Joint ASW C4I Architecture. Without the implementation of this system or one similar the current communication gap to a submerged submarine will still exist in the FY2020 Joint ASW C4I Architecture.

The UFO satellite communications system shown in Figure 26 will be replaced by the Mobile User Objective System (MUOS) satellite communication system. The maximum narrowband throughput for the UFO system is 19.6 kilobits per second per channel. With the implementation of the MUOS system the throughput will go up to 64 kilobits per second per channel. The MUOS system is fully compatible with JTRS and the existing UFO terminal system. In addition submarines will be using MUOS and the existing IRIDIUM satellite system to communicate with other nodes using tethered buoys and RF to Acoustic gateways.



Transformational Satellite System (TSAT) is another addition to the ASW C4I physical architecture planned for the FY2020 timeframe. “The Transformational Satellite System (TSAT) provides orbit-to-ground laser and RF communications. The Transformational Satellite Communications System will provide DoD with high data rate Military Satellite Communications and Internet-like services as defined in the Transformational Communications Architecture. TSAT is key to global net-centric operations” [PEO C4I Masterplan, 2007: 21].

Figure 28 illustrates the transitional period from existing communication systems to the ones identified in the FY2020 Joint ASW C4I Architecture Baseline [Cinlemis, 2005]. According to this schedule, all of the system identified in the ASW C4I physical architecture are expected to be in place and operational. Any lack of funding or failure to implement affects the ASW C4I physical architecture.

For line-of-sight communications, the systems are depicted by the blue and green lines in Figure 27. The systems in use today are Multifunctional Information Distribution System (MIDS) on Ship (MOS), Battle Force Email (BFEM), High Frequency (HF) Automatic Link Establishment (ALE), Digital Wideband Transmission System (DWTS), Single Channel Ground and Airborne Radio System (SINCGARS), Enhanced Position Location Reporting System – Data Radio (EPLRS-DR), Subnet Relay (SNR), AN/URC-131(V) known as High Frequency Radio Group (HFRG), the very high frequency military radio band from 30 megahertz to 88 megahertz and the ultra high frequency communication system supporting line-of-sight communications between accomplishing units and is comprised of several different radio groups or subsystems such as AN/WSC-3, Digital Modular Radio (DMR), and AN/ARC-210. Included in the line-of-sight communication systems are Link-16, Link-11, Link-11B, and Link-4. For the 2020 timeframe, the JTRS will replace the current high frequency, very high frequency, ultra high frequency, and DWTS systems. The Joint Tactical Radio System will combine the functionality of numerous single function radios among the services into a single, joint-interoperable family of radios. Figure 29 depicts the current PEO-C4I plan to migrate from these legacy line-of-sight systems to the JTRS.

It is expected that every system listed in Table 4 will be fielded by year 2017 and will be included in the Joint ASW C4I Architecture Baseline. The JTRS with wideband network waveforms (WNW) was identified as the 2020 baseline system for line-of-sight and tactical data links and are illustrated with blue lines in Figure 26. For the wideband satellite communication systems, the transformational satellite system (TSAT), the Wideband Gapfiller System (WGS), and the Commercial Broadband Satellite Program (CBSP) were identified as part of the Joint ASW C4I Architecture Baseline. For the

protected satellite communication systems, the Advanced Extremely High Frequency (AEHF) system and the Enhanced Polar System (EPS) were selected. For narrowband ultra high frequency (UHF) satellite communications, the Mobile User Objective System satellite constellation system was selected. For the submarine communications at speed and depth shown as green lines in Figure 27 there are several communication methods that rely on the Iridium satellite constellation and the MUOS satellite constellations. Other submarine CSD include the optical laser communications system, the buoyant cable antenna with high frequency over internet protocol, the buoyant cable antenna with high frequency Special Radio Variant, the Tethered Expendable Communications Buoy (TECB) using the Iridium constellation, the Tethered Expendable Communications Buoy using the MUOS ultra high frequency constellation, the Acoustic to radio frequency Gateway (A2RF) System, and the Tethered Reconfigurable Expendable Buoy system. There are discussions ongoing to determine if the OLC system will be initially hosted by TSAT or MUOS satellites when initially executed [Reddish and Lovern, 2007]. These systems in conjunction with the JTRS, ADNS, NECC, CANES, Link-16 and USW-DSS make up the FY2020 Joint ASW C4I Architecture Baseline. Table 4 lists the systems just described in a tabular format so the reader can easily determine which systems were selected as part of the FY2020 Joint ASW C4I Architecture Baseline.

<b>Communicate between Nodes</b>	<b>Fuse Data</b>	<b>Provide COTP</b>	<b>Distribute Sensor Data and COTP</b>
MUOS	NECC	NECC	CANES
TSAT	USW-DSS	USW-DSS	ADNS
EPS		CANES	TSAT
Advanced EHF		ADNS	EPS
WGS			Advanced EHF
CBSP			WGS
JTRS WNW Inc. 3			CBSP
Link-16			JTRS WNW Inc. 3
IRIDIUM			OLC
OLC			Link-16
BCA w/HF IP			
TECB – Iridium			
TECB – UHF/MUOS			
A2RF System			
T-Rex			
BCA w/HF Special Radio Variant			

**Table 4. FY2020 Joint ASW C4I Physical Architecture**

This table maps the physical architecture for the functions identified as gaps in the ASW functional architecture in the FY2020 Joint ASW C4I Architecture Baseline.

### **3. Conduct Functional Gap Analysis**

The functional gap analysis compared the future capabilities of systems planned to be fielded under DoD program of record initiatives against the functional architecture established earlier in this report as well the current year’s list of Top 10 Fleet Requirements and comments received from stakeholders throughout this project. It was necessary to make several assumptions to establish a solid starting point which include:

- All seven programs of record identified in the C4I Masterplan are completely funded and the resulting functional capabilities would be fielded on time prior to reaching the FY2020 timeframe.
- Current year resources were properly accounted for by the United States Navy in the FY10 to 15 program objective memorandum and did not lead to reduction of the capabilities specified in the FY2020 Joint ASW C4I Architecture Baseline.
- The ASW community will ensure full procurement and operational life cycle funding of all available technologies initiated in today's science and technology communities.
- The ASW community will take advantage of all design study interfaces to best leverage opportunities to close all functional gaps identified in this study.

DoD programs of record are key to the success of the FY2020 Joint ASW C4I Architecture Baseline. Although twelve years away, programs being planned for and funded today to address ASW C4I shortfalls will be solutions counted on in FY2020. Table 5 lists the program of record systems and their expected capabilities outlined by the PEO C4I Masterplan. Summaries of the DoD programs of record identified in the C4I Masterplan are provided to detail the planned capabilities for use in the FY2020 Joint ASW C4I Architecture Baseline:

### **Global Information Grid**

The GIG enables a world-wide, end-to-end set of information capabilities, associated processes, and personnel for collecting, processing, storing, disseminating, and managing information on demand to warfighters, policymakers, and support personnel. The GIG includes all owned and leased communications and computing systems and services, software (including applications), system data, security services, and other associated services necessary to achieve information superiority for the United States military.

### **Transformational Satellite System**

TSAT is the key component to conducting global net-centric operations which provide orbit-to-ground laser and radio frequency communications. The TSAT system will provide the ASW community with high data rate military satellite communications and Internet-like services as defined in the Transformational Communications Architecture (TCA). TSAT is the GIGs space borne element extending the GIG to users

without terrestrial connections providing improved connectivity and data transfer capability, vastly improving satellite communications for the warfighter.

### **DoD Teleport**

The DoD Teleport system, implemented by the Defense Information Systems Agency, integrates, manages, and controls a variety of communications interfaces between the Defense Information System Network terrestrial and tactical satellite communications assets at a single point of presence. DoD Teleport is a telecommunications collection and distribution point, providing deployed warfighters with multi-band, multimedia, and worldwide reach-back capabilities to DISN that far exceed today's capabilities. Teleport is an extension of the Standardized Tactical Entry Point program, which currently provides reach-back for deployed warfighters via the Defense Satellite Communications System X-band satellites. This new system provides additional connectivity via multiple military and commercial satellite communications systems, and it provides a seamless interface into the DISN. The system provides inter- and intra-theater communications through a variety of satellite communications choices and increased DISN access capabilities.

### **Net-Enabled Command Capability**

NECC is DoD's principal command and control capability accessible in a net-centric environment and focused on providing the commander with data and information needed to make timely, effective, and informed decisions. NECC draws from the command and control community to evolve current and provide new C2 capabilities into a fully integrated, interoperable, collaborative Joint solution. Warfighters can rapidly adapt to changing mission needs by defining and tailoring their information environment and drawing on capabilities that enable the efficient, timely, and effective command of forces and control of engagements. It was assumed that the Global Command and Control System – Maritime program will be completely migrated into the Joint Net-Enabled Command Capability program by the FY2020 timeframe.

### **Joint Tactical Radio System**

JTRS is an important area of improvement assumed to be in place for operational use by the ASW community in the FY2020 timeframe. It will provide a common platform for wireless applications, ranging from low cost, single purpose terminals, to multi-band, multi-mode, multi-channel voice and data radios supporting narrowband and wideband waveforms. JTRS family of tactical radios supports line-of-sight and beyond line-of-sight C4I capabilities. It will be capable of transmitting voice, video and high-speed data. The program will support vehicular, airborne and portable configurations

including man portable, handheld and Small Form Factor for a variety of mission requirements.

**Net-Centric Enterprise Services**

The NCES program provides enterprise services in support of the GIG. NCES will provide DoD organizations ubiquitous access to reliable, decision-quality information through a net-based services infrastructure and applications to bridge real-time and near-real-time communities of interest. NCES will empower the edge user to pull information from any available source, with minimal latency, to support the mission. Its capabilities will allow GIG users to task, post, process, use, and store, manage and protect information resources on demand for operational users, policy makers and support personnel.

**Next Generation Enterprise Networks (NGEN)**

NGEN is assumed to be in place for use in the FY2020 Joint ASW C4I Architecture Baseline. It will focus on the integration of some or all of the components that make up the Navy’s other networks such as ONEnet and BLII, into a single enterprise network. Other architectural efforts being leveraged by NGEN are FORCEnet, CANES, Sea Warrior and Distant Support to move towards open architecture and service-oriented architecture concepts.

<b>Program of Record</b>	<b>C4I Systems &amp; Architectures</b>	<b>Functional Capability</b>
<b>Global Information Grid</b>		<ul style="list-style-type: none"> <li>• World-wide, End-to-End Information Set</li> <li>• Inclusive of all capabilities, associated processes, and personnel for collecting, processing, storing, disseminating, and managing information on demand</li> <li>• All owned and leased communications and computing systems and services, software (including applications), system data, security services, and other associated services</li> </ul>

<b>Program of Record</b>	<b>C4I Systems &amp; Architectures</b>	<b>Functional Capability</b>
<b>Transformational Satellite System</b>	Transformational Communications Architecture	<ul style="list-style-type: none"> <li>• Global net-centric operations</li> <li>• Orbit-to-ground laser and radio frequency communications</li> <li>• High data rate military satellite communications and Internet-like services</li> <li>• GIG's space borne element extending the GIG to users without terrestrial connections</li> <li>• Improved connectivity and data transfer capability</li> <li>• Improve satellite communications</li> </ul>

<b>Program of Record</b>	<b>C4I Systems &amp; Architectures</b>	<b>Functional Capability</b>
<b>DoD Teleport</b>	Defense Satellite Communications System X-band satellites	<ul style="list-style-type: none"> <li>• Single point of presence to integrate, manage, and control a variety of communications interfaces between the Defense Information System Network terrestrial and tactical satellite communications assets</li> <li>• Telecommunications collection and distribution point</li> <li>• Provides deployed warfighters with multi-band, multimedia, and worldwide reach-back capabilities to DISN that far exceed today's capabilities</li> <li>• Extension of Standardized Tactical Entry Point program</li> <li>• Additional connectivity via multiple military and commercial satellite communications systems</li> <li>• Seamless interface into the DISN</li> <li>• Inter- and intra-theater communications through a variety of satellite communications choices</li> <li>• Increased DISN access</li> </ul>



<b>Program of Record</b>	<b>C4I Systems &amp; Architectures</b>	<b>Functional Capability</b>
<b>Net-Enabled Command Capability</b>	Global Command and Control System – Maritime migrates into Joint Net-Enabled Command Capability	<ul style="list-style-type: none"> <li>• Joint Command and Control</li> </ul>
<b>Joint Tactical Radio System</b>	<ul style="list-style-type: none"> <li>• Common platform for wireless applications</li> <li>• Support vehicular, airborne and portable configurations including man portable, handheld and Small Form Factor</li> </ul>	<ul style="list-style-type: none"> <li>• Tactical multi-band, multi-mode, multi-channel</li> <li>• Narrowband waveforms</li> <li>• Wideband waveforms</li> <li>• Line-of-sight</li> <li>• Beyond line-of-sight</li> <li>• Voice, video and high-speed data.</li> </ul>
<b>Net-Centric Enterprise Services</b>		<ul style="list-style-type: none"> <li>• GIG supporting Enterprise services</li> <li>• Net-based services</li> <li>• Ubiquitous access</li> <li>• Reliability</li> <li>• Decision Quality Information</li> <li>• Empower “Edge” User</li> <li>• Task, post, process, use, and store, manage and protect information resources on demand</li> </ul>
<b>Next Generation Enterprise Networks</b>	<ul style="list-style-type: none"> <li>• ONEnet &amp; BLII</li> <li>• Components</li> <li>• FORCEnet</li> <li>• CANES</li> <li>• Sea Warrior</li> <li>• Distant Support</li> </ul>	<ul style="list-style-type: none"> <li>• Open Architecture</li> <li>• Service-Oriented Architecture</li> </ul>

**Table 5. Programs of Record Functional Capability Relationships**

This table offers quick reference to functional C4I capabilities being programmed by DoD yielding a joint service C4I networked architecture.

During the execution of the functional gap analysis it was clear that the “Interconnect Communication Nodes” function is a functional gap that most affects the submarine operating at speed and depth in the Joint ASW C4I Architecture. Today, there is a recognized lack of a direct high bandwidth two-way communications links between

the submarine and surface assets including satellite and line-of-sight communication systems while the submarine is operating at speed and depth. The FY2020 Joint ASW C4I Architecture Baseline addresses this functional gap by including the use of an optical laser communication system that is planned to be implemented by FY2020 but was not included as part of the planned systems in the PEO-C4I Masterplan. In order for the submarine to be included in the overall communication network depicted in the FY2020 Joint ASW C4I Architecture Baseline, it will have to rely on the OLC system as well as other tethered communication buoys planned for communications at speed and depth. None of these tethered buoy options offer a high bandwidth solution to communicating with the submarine at speed and depth. The OLC system is the only system found by research to provide a high bandwidth two-way communications path for a submerged submarine operating at speed and depth. Since the target of interest for the ASW community is an enemy submarine, it is advantageous to be able to have two-way high bandwidth real time communications between a stealthy submerged submarine and surface assets engaged in the ASW effort. Therefore, there is a potential for an “Interconnect Communication Nodes” functional gap without the implementation of the OLC system. If the OLC system is not funded and implemented then there will be a functional gap for high bandwidth two-way communications with any submarine operating at speed and depth. The tethered buoy options will meet the functional gap but at very low bandwidth rates which will be very difficult for real-time sharing of sensor data and the COTP. This possible functional gap was equated to Function A.1.1 - Interconnect Communication Nodes because there is a risk that the systems planned for FY2020 may not get implemented. Research indicated that maritime communications will continue to require the current levels of bandwidth, and more, and will need to maximize the use of the existing frequency spectrum.

The other functions identified from the functional analysis as possible gaps are the Fuse ASW Data, Provide ASW COTP and Distribute COTP. Today the current systems that provide these functions are ADNS, GCCS-M and ISNS. For the FY2020 Joint ASW C4I Architecture these functions will be accomplished by ADNS Inc III+, NECC and CANES. The reason that these functions were identified as possible gaps is because of the current levels of throughput and fusion (Level 1) currently being done by existing systems. It is expected that NECC will provide a higher level of data fusion by the FY2020 timeframe and that ADNS and CANES will have evolved to a level of maturity where the distribution of sensor data and the COTP will be at or near real-time. Therefore the functions of interest identified by the functional gap analysis include Function A.5.1 – Fuse ASW Data; Function A.5.2 - Provide ASW COTP; and Function A.5.3 - Identify, Store, Share and Exchange ASW Data and Information. Although the

current C4I systems in place today and the systems planned for FY2020 provide basic functionality for these functions, it was deemed necessary to include them as possible functional gaps because of the levels of throughput and fusion capabilities.

Therefore, the functional gaps identified by the functional gap analysis are

- A.1.1 - Interconnect Communication Nodes;
- A.5.2 - Fuse ASW Data;
- A.5.1 - Provide ASW Common Operational Tactical Picture and
- A.5.3 – Identify, Store, Share and Exchange ASW Data and Information.

The program of record systems listed in Table 5 were identified as future planned systems that are expected to fill the functional gaps identified by the functional gap analysis. The Joint ASW C4I Architecture Baseline depends on these systems being funded and implemented.

#### **4. Consolidate Value Hierarchy and Stakeholder Analysis**

Concurrent with the functional gap analysis, a value hierarchy stakeholder survey of the functional architecture was conducted. The intent of the value hierarchy stakeholder survey was to ascertain a relative value for each function in the value hierarchy; identify the most critical sub-functions in the value hierarchy and gain feedback on the proposed evaluation measures.

From the Value System Design section of this report, the highest ranked functions in terms of importance to the stakeholders were Function A.5.2 - Provide ASW COTP; Function A.5.1 - Fuse ASW Data; Function A.1.1 - Interconnect Communication Nodes; and Function A.5.3.4 - Enable Smart Pull and Push of ASW Information. As a result of the value hierarchy stakeholder survey, the stakeholders identified functions that they perceived as needing attention and were translated into a set of functional gaps. The combination of the functional gap analysis and the stakeholder analysis narrowed the focus of functional gaps to the A.1 Provide Connectivity and A.5 Provide ASW Data Information Management upper level functions. The results of the two analyses were used to examine, evaluate, and derive viable alternative network architectures that most aligns with stakeholder needs.

#### **5. Brainstorm Alternative Solutions**

The research into future technologies contributed to the far reaching out year capabilities desired of the alternatives. Value hierarchy contributions offered solutions contributing to stakeholder identified functional gaps. This capstone project design team sought to identify ways and means to address functional gaps of the FY2020 Joint ASW

C4I Architecture Baseline resulting from the consolidated functional analysis initiatives. DOTMLPF items needed to be identified that would close or fill the four possible functional shortfalls identified above: Function A.1.1 - Interconnect Communication Nodes; Function A.5.1 - Fuse ASW Data; Function A.5.2 - Provide ASW COTP; and Function; A.5.3.4 - Enable Smart Pull and Push of ASW Information.

Interfacing or communicating with and between sensors and ASW nodes requires a vast knowledge of existing C4I techniques, architecting network topologies to attain the highest quality C4I architectural footing, and own system specifications to get the most benefit in making the interface. Programs of record appear to have met many of the functional gaps well into the FY2020 timeframe. This capstone project design team maintained it is most difficult to attain high quality robust communications between submarines operating at speed and depth. Brainstormed solutions included on board and off board submarine systems communication relay devices that would be moored or distributed for submarine or fleet wide use to bridge the air-sea interface gap. Thoughts also were directed at powering data signals directly to the submarine using x-rays, lasers, and other signaling devices that could be used from United States Navy, coalition force, or joint force surface, air, or space platforms.

Fused data rests on the ability of the systems collecting sensor data from multiple sensors; the systems collating and assigning the sensor data to a specific target or track; and the systems used to create a track that contains multiple sensor data used to generate the COTP that can be used by Combatant Commanders to rapidly make a decision. Improvements in software applications, additional data recognition training for operational users, and hardware capabilities to more readily move and translate data formats were offered as possible solutions.

The function that enables smart pull and push of ASW information could improve the delivery of the COTP by refining data agreements and improving the speed of merging significant strategic and tactical data. It was agreed that today's programs of record are seeking to improve information exchange and operational performance to better support United States Navy and coalition decision makers and their supporting systems. Brainstorming ideas called out improvements for computer hardware systems and recognized the need for futuristic data storage and delivery techniques beyond the FY2020 Joint ASW C4I Architecture Baseline.

## **B. ALTERNATIVE SOLUTIONS**

The following alternative solutions are made up of programs of record, non-programs of record, and proposed technologies. Table 6 is a matrix of four alternatives versus the four functions derived from the functional gap analysis. The systems that are

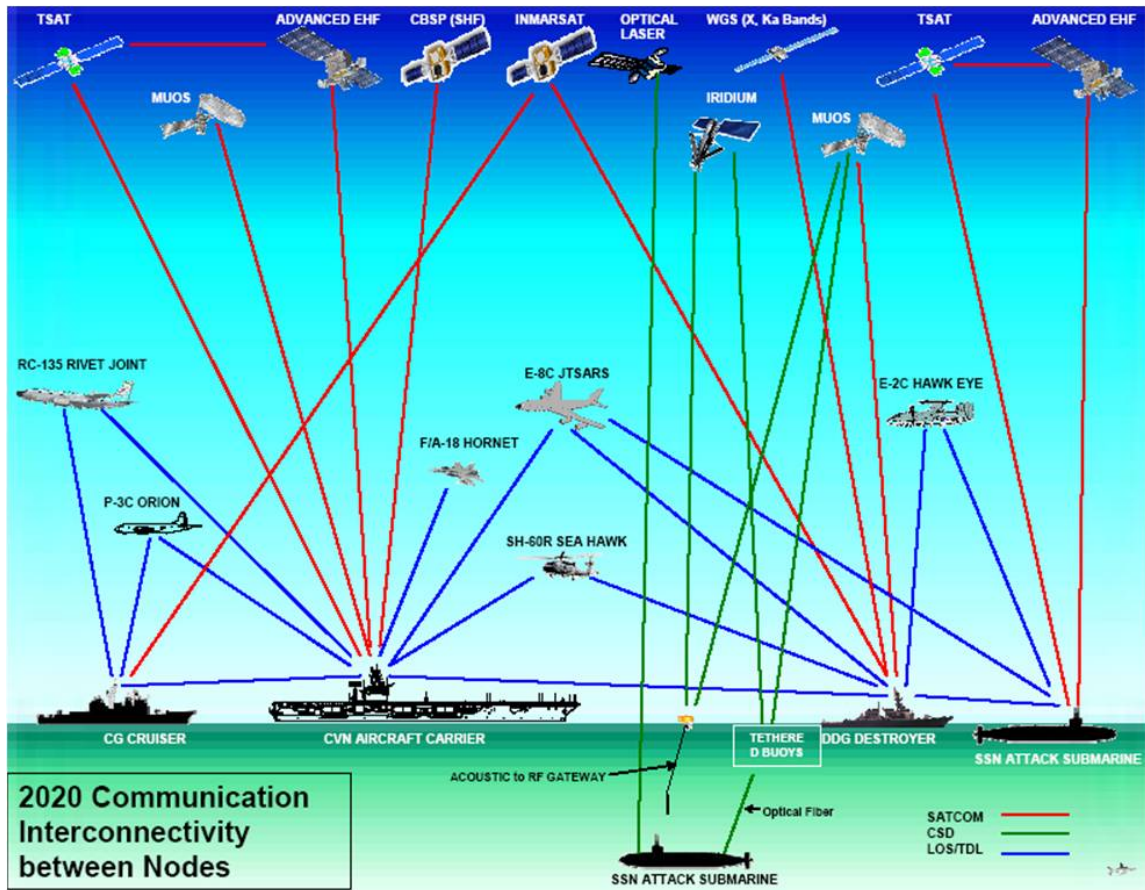
expected to perform the functions identified as functional gaps are listed in the body of the table.

<b>Functional Gap</b>	<b>A.1.1 Interconnect Communication Nodes</b>	<b>A.5.2 Provide ASW Common Operational Picture</b>	<b>A.5.1 Fuse ASW Data</b>	<b>A.5.3.4 Enable Smart Pull and Push of ASW Information</b>
<b>Alternative 0</b>	FY2020 Baseline listed in Table 4	FY2020 Baseline listed in Table 4	FY2020 Baseline listed in Table 4	FY2020 Baseline listed in Table 4
<b>Alternative 1</b>	FY2020 Baseline listed in Table 4 plus - JTRS Increment 4	FY2020 Baseline listed in Table 4 plus - NECC Improvements - CANES Improvements	FY2020 Baseline listed in Table 4 plus - NECC Improvements - CANES Improvements	FY2020 Baseline listed in Table 4
<b>Alternative 2</b>	FY2020 Baseline listed in Table 4 plus - JTRS Increment 5	FY2020 Baseline listed in Table 4 plus - CANES Improvements	FY2020 Baseline listed in Table 4 plus - CANES Improvements – - Joint Track Manager System	FY2020 Baseline listed in Table 4
<b>Alternative 3</b>	FY2020 Baseline listed in Table 4 plus - Modulated X-Ray Source Communication System - Autonomous C4ISR Unmanned Undersea Vehicles (UUV) o Military High Altitude Aircraft (HAA) o HALO o Helios o HAA	FY2020 Baseline listed in Table 4 plus - Tropospheric or Space-based distribution of the common operational picture by means of HALO, Helios, and HAA	FY2020 Baseline listed in Table 4 plus - Satellite or high altitude aircraft based fusion of the common operational picture by means of HALO, Helios, and HAA	FY2020 Baseline listed in Table 4 plus - Wireless user capable of pulling and pushing information directly to a satellite or high altitude aircraft based network by way of HALO, Helios, and HAA

**Table 6. Alternative Solutions and Functional Gaps**

This table shows the four alternatives versus the functional gaps with the systems proposed to perform each function for each alternative.

## 1. Alternative 0



**Figure 30. Graphical Representation of the Systems Expected to Perform the Interconnect Communication Nodes Function for Alternatives 0, 1, and 2**

This figure shows the systems that are planned to be implemented and operational by FY2020 expected to perform the “interconnect communication nodes” function for the FY2020 Joint ASW C4I Architecture Baseline Alternatives 0, 1, and 2.

Alternative 0 is the Baseline already discussed in some detail. It is based entirely on the planned program of record systems outlined by PEO-C4I in their PEO-C4I Masterplan version 1.0 dated 7 October 2007 and the submarine communications systems outlined by Reddish and Lovern in their “Communications at Speed and Depth and Optical Laser Communications Status” presentation [Reddish and Lovern, 2007]. All of the systems outlined by these two documents are planned to be in place by year 2020 and are included in FY2020 Joint ASW C4I Architecture Baseline. Figure 30 provides a pictorial representation of the interconnection between communication nodes function of the FY2020 Joint ASW C4I Architecture Baseline for Alternative 0. The FY2020 Joint ASW C4I Architecture Baseline Alternative 0 is expected to suffice in addressing the

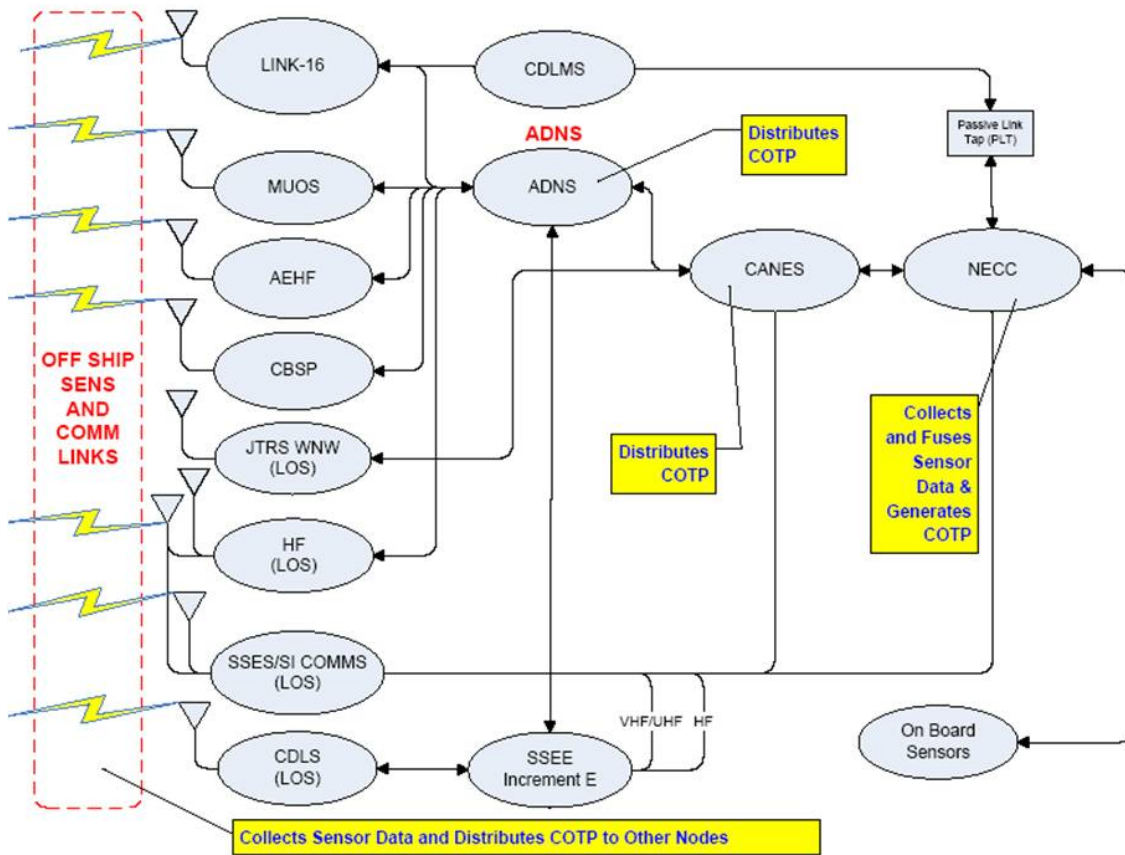
current interconnection between nodes functional gap beyond the next twelve years. Table 7 lists the communication bandwidths for each system that will be used to model the performance of the “interconnection of communication node” function depicted in Figure 30. One of the evaluation measures associated with the “interconnection of communication nodes” function that will be used to conduct an analysis of alternatives is the network join time. The network join time for each communication path is listed in Table 7. In Table 7, the value for the network join time, effective throughput and bandwidth for the JTRS WNW increment 3 was obtained from the Tactical Data Link-T Capabilities Development Document [TDL-T CDD, 2003]. The bandwidth for the Optical Laser Communications (OLC) was derived from a briefing written by Reddish and Lovern titled, “Communications at Speed and Depth (CSD) and Optical Laser Communications (OLC) Status,” [Reddish and Lovern, 2007]. The bandwidth and effective throughput for the MUOS was derived from a document provided by the Navy Communications Satellite Program Office called “Mobile User Objective System (MUOS)” [Navy Communications Satellite Program Office, 2004] and a MUOS Datasheet provided by Ericsson titled “Proud Partner in MUOS” [Ericsson, 2006]. The information for the Link-16 bandwidth and effective throughput came from the Link-16 subject matter expert Matthew Letourneau. Table 7, Table 9, Table 11, and Table 13 only have data for MUOS because it was deliberately chosen for simplicity sake to model the preferred communication paths. For line-of-sight surface to surface and surface to air, that is WNW. For surface to sub-surface that is CSD. For TDL, this is Link-16 and for SATCOM, it is MUOS. We did not want to expand the scope by looking at degraded operations or overflow operations and it has also been an assumption on our part that the Navy will be migrating from numerous stove-piped solutions to joint ubiquitous solutions. So, while other communication paths will likely exist in 2020, we wanted to focus on the preferred communications paths that are designed to provide superior performance and joint interoperability. CSD is somewhat Navy-centric but MUOS, Link-16, and WNW are clearly joint solutions.



Communication Path	System	Network Join Time (sec)	Effective Throughput	RF Bandwidth	Laser Bandwidth Transmit/Receive		Relay Delay Time (msec)
					Uplink	Downlink	
Surface to Surface (LOS)	JTRS WNW Inc. 3	5	2 Mbps/# Users	2 Mbps			45
Surface to Air (LOS)	JTRS WNW Inc. 3	5	2 Mbps/# Users	2 Mbps			45
Surface to Sub-surface (LOS)	OLC				224 Kbps @ 200 ft	1200 Kbps @ 200 ft	
SATCOM	MUOS (UHF)		64 Kbps	64 Kbps			500
TDL (LOS)	Link-16		8 Kbps	53.7 Kbps			

**Table 7. FY2020 Joint ASW C4I Architecture Baseline “Interconnect Communication Nodes” Function Data Rates and Relay Delay Times for Alternative 0**

This table shows the bandwidths and effective throughputs of the systems that are part of the FY2020 Joint ASW C4I Architecture Baseline that are expected to perform the “interconnection between communication nodes” function for Alternative 0 [TDL-T CDD, 2003; Reddish and Lovern, 2007; Navy Communications Satellite Program Office, 2004; Ericsson, 2006; Letourneau, 2008].



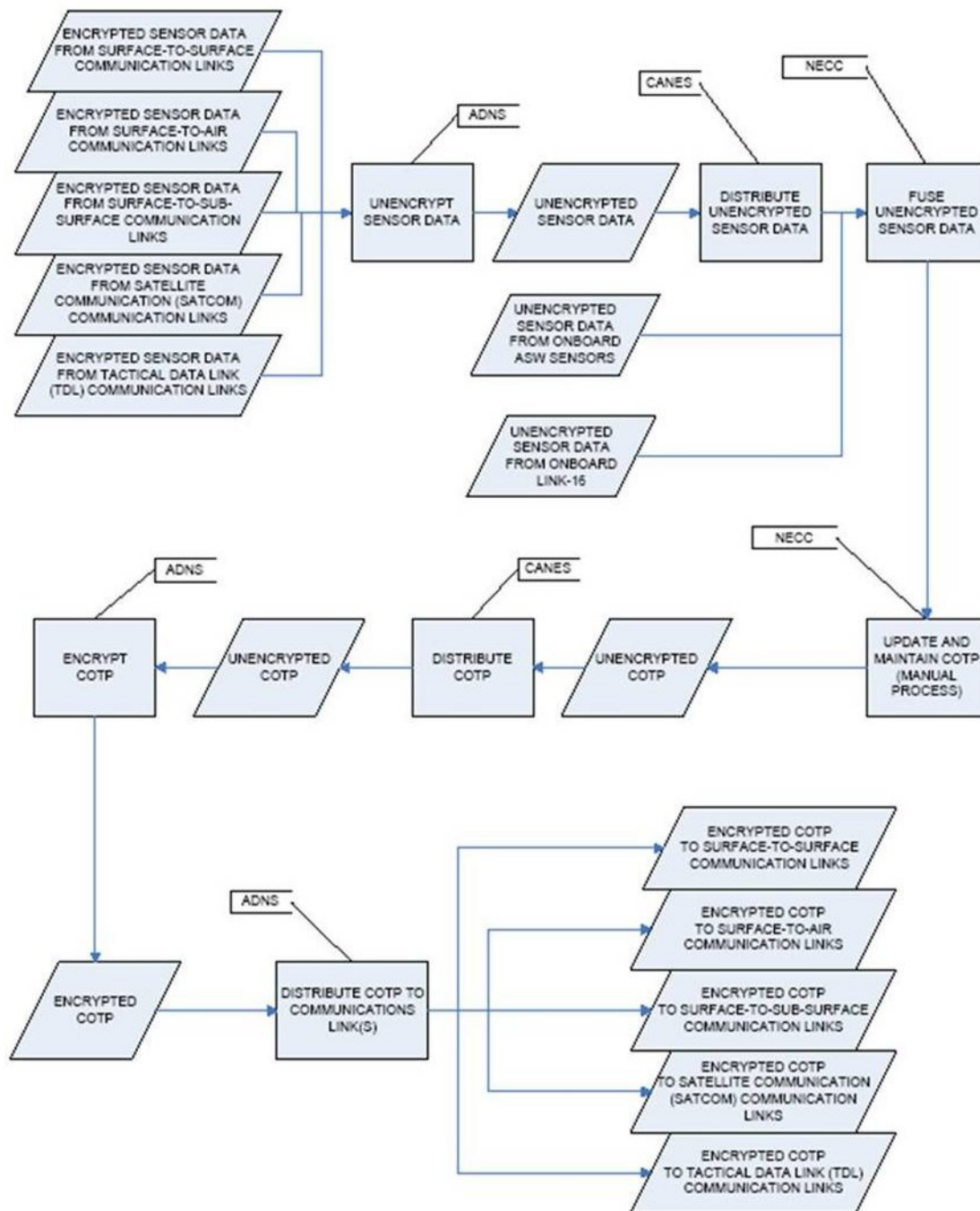
**Figure 31. Internal System Connectivity for a Typical Node for Alternative 0 and 1**

This figure shows the internal system connectivity for the systems that are part of the FY2020 Joint ASW C4I Architecture Baseline that are expected to be fielded by FY2020 and represent a typical internal configuration of a typical node for Alternative 0 and 1.

Figure 31 depicts the interconnection of systems that is typical of or common to each internal node configuration for Alternative 0. The following description describes the data flow through the systems depicted in Figure 31.

The Net-Enabled Command and Control (NECC) system collects sensor data from on board sensors as well as sensor data from other nodes by way of the satellite communication links such as MUOS, AEHF and CBSP and line-of-Sight systems such as JTRS, Link-16 and other high frequency communication systems. The encrypted sensor data coming into the node from the external communication links are collected by the Automated Digital Network System (ADNS), unencrypted and distributed to the NECC system by way of the CANES system. The NECC system then fuses the sensor data from multiple sources into track information and generates the common operational tactical picture. Once the COTP has been created, it is distributed back through the CANES

network to ADNS where it is encrypted and transmitted by way of the various communication links to the other nodes. When the data is received at each subsequent node, the data is processed in the same way as just described. Figure 32 illustrates the data flow process for the system connectivity illustrated in Figure 31.



**Figure 32. Data Processing Flow Diagram for Alternatives 0 and 1**

This figure shows the flow of sensor and COTP data through the systems represented in Figure 31. The estimated processing times are listed in Table 8.

There are process times for each of data flow processes depicted in Figure 31. Table 8 lists the data process times characteristic of a typical node for Alternative 0 and were derived by expert opinion.

For the Provide COTP function, the assumption was made that all nodes in the Joint ASW C4I Architecture Baseline will have the ability to receive the COTP by FY2020. This assumption is based the PEO-C4I Masterplan [PEO C4I Masterplan, 2007: 58] that shows Link-4, Link-11, Link-16 and Link-22 all migrating to IP based waveforms near the year 2020 timeframe. Today there are a few of the nodes in the Joint ASW C4I Architecture Baseline such as the F/A-18 Hornet that does not receive the COTP. We expect by the year 2020 that those nodes will have the capability to receive the COTP. Therefore, the associated evaluation measure “percent of users with access to the COTP” for this function is expected to be at 100 percent in FY2020.

The evaluation measure for the “Fuse ASW Data” function is “minimize data fusion processing time.” The value for this measure will be determined by modeling the fusion process.

The evaluation measure for the “Enable Smart Pull and Push of ASW Information” function is the “user response time to critical information.” The “Enable Smart Pull and Push of ASW Information” function is a sub function under the “Identify, Store, Share and Exchange ASW Data and Information” function. The value for this measure will be determined by modeling and simulation using an average throughput derived from all communication paths listed in Table 7.

<b>Data Process</b>	<b>System</b>	<b>Data Process Time</b>
<b>Interconnect Communication Nodes</b>	All	4.2 sec
<b>Unencrypted Sensor Data</b>	ADNS	100 msec [SSC Charleston Fleet Support Branch, 2008]
<b>Distribute Unencrypted Sensor Data</b>	CANES	100 msec [SSC Charleston Fleet Support Branch, 2008]
<b>Fuse Unencrypted Sensor Data</b>	NECC	200 msec [SSC Charleston Fleet Support Branch, 2008]
<b>Update and Maintain COTP</b>	NECC	Range: 20 to 120 sec [SSC Charleston Fleet Support Branch, 2008]

<b>Data Process</b>	<b>System</b>	<b>Data Process Time</b>
<b>Distribute COTP</b>	CANES	100 msec [SSC Charleston Fleet Support Branch, 2008]
<b>Encrypt COTP</b>	ADNS	100 msec [SSC Charleston Fleet Support Branch, 2008]
<b>Distribute COTP to Communication Link(s)</b>	ADNS	100 msec [SSC Charleston Fleet Support Branch, 2008]

**Table 8. FY2020 Joint ASW C4I Architecture Baseline Estimated Data Processing Times expected for Alternative 0**

This table shows a tabular representation of the data processes illustrated in Figure 32 with the approximated processing times for Alternative 0.

## **2. Alternative 1**

Alternative 1 is all of the systems listed in Alternative 0 with expected improvements to JTRS and NECC. A part of these planned modifications will be the absorption of the Undersea Warfare Decision Support System (USW-DSS) into the NECC [Ross and Rupp, 2008]. It is assumed that there will be a decrease in the processing time and an increase in the level of fusion for the NECC system due to continuing improvements to the SOA structure. We made the assumption that the NECC system’s capability to Fuse Unencrypted Sensor Data will decrease (improve) to 150 milliseconds.

Figure 30 also represents the systems planned to provide the interconnection of communication nodes functionality for Alternative 1. No planned modifications to the satellite communications (SATCOM), Surface-to-Sub-Surface, CSD, and TDL communication systems are expected to increase throughput for this alternative. Changes due to the implementation JTRS WNW version 4.0 is expected to increase throughput and increase the bandwidth for surface-to-surface and surface-to-air communications. Table 9 lists the communication bandwidths for each system that will be used to model the performance of the interconnection of communication node function depicted in Figure 30. As in Alternative 0, the evaluation measure “network join time” will be used in an analysis of alternatives. The network join time for each communication path is listed in Table 9.

Communication Path	System	Network Join Time (sec)	Effective Throughput	RF Bandwidth	Laser Bandwidth Transmit/Receive		Relay Delay Time (msec)
					Uplink	Downlink	
Surface to Surface (LOS)	JTRS WNW Inc. 4	4.5	2.2 Mbps/# Users	2.2 Mbps			45
Surface to Air (LOS)	JTRS WNW Inc. 4	4.5	2.2 Mbps/# Users	2.2 Mbps			45
Surface to Sub-surface (LOS)	OLC				224 Kbps @ 200 ft	1200 Kbps @ 200 ft	
SATCOM	MUOS (UHF)		64 Kbps	64 Kbps			500
TDL (LOS)	Link-16		8 Kbps	53.7 Kbps			

**Table 9. FY2020 Joint ASW C4I Architecture Baseline “Interconnect Communication Nodes” Function Data Rates and Relay Delay Times for Alternative 1**

This table shows the bandwidths and effective throughputs of the systems that are part of the FY2020 Joint ASW C4I Architecture Baseline that are expected to perform the “interconnection between communication nodes” function for Alternative 1 [TDL-T CDD, 2003; Reddish and Lovern, 2007; Navy Communications Satellite Program Office, 2004; Ericsson, 2006; Letourneau, 2008].

Figure 30 depicts the interconnection of systems that is typical or common for each internal node configuration for Alternative 1. The expected improvements in data processing time for Alternative 1 are shown in Table 10.

For the “Provide COTP” function for this alternative as in Alternative 0, the assumption was made that all nodes in the Joint ASW C4I Architecture Baseline will have the ability to receive the COTP by FY2020. This assumption is based on the PEO-C4I Masterplan [PEO C4I Masterplan, 2007: 58] that shows Link-4, Link-11, Link-16 and Link-22 all migrating to IP based waveforms near the year 2020 timeframe. Today there are a few of the nodes in the Joint ASW C4I Architecture Baseline such as the F/A-18 Hornet that does not receive the COTP. We expect by the year 2020 that those nodes will have the capability to receive the COTP. Therefore, the associated evaluation measure “percent of users with access to the COTP” for this function is expected to be at 100 percent by FY2020.

The evaluation measure for the “Fuse ASW Data” function is “minimize data fusion processing time.” The value for this measure will be determined by modeling the fusion process.

The evaluation measure for the “Enable Smart Pull and Push of ASW Information” function is the “user response time to critical information.” The “Enable Smart Pull and Push of ASW Information” function is a sub function under the “Identify, Store, Share and Exchange ASW Data and Information” function. The value for this measure will be determined by modeling and simulation using an average throughput derived from all communication paths listed in Table 9.

<b>Data Process</b>	<b>System</b>	<b>Data Process Time</b>
<b>Interconnect Communication Nodes</b>	All	4.2 sec
<b>Unencrypted Sensor Data</b>	ADNS	100 msec [SSC Charleston Fleet Support Branch, 2008]
<b>Distribute Unencrypted Sensor Data</b>	CANES	100 msec [SSC Charleston Fleet Support Branch, 2008]
<b>Fuse Unencrypted Sensor Data</b>	NECC	150 msec
<b>Update and Maintain COTP</b>	NECC	Range: 20 to 120 sec [SSC Charleston Fleet Support Branch, 2008]
<b>Distribute COTP</b>	CANES	100 msec [SSC Charleston Fleet Support Branch, 2008]
<b>Encrypt COTP</b>	ADNS	100 msec [SSC Charleston Fleet Support Branch, 2008]
<b>Distribute COTP to Communication Link(s)</b>	ADNS	100 msec [SSC Charleston Fleet Support Branch, 2008]

**Table 10. FY2020 Joint ASW C4I Architecture Baseline Estimated Data Processing Times for Alternative 1**

This table shows a tabular representation of the data processes illustrated in Figure 32 with the approximated processing times for Alternative 1.



### 3. Alternative 2

Alternative 2 includes all of the systems listed in Alternative 0 with expected improvements to JTRS and NECC. This alternative includes another improvement to the interconnection of communication nodes function by including JTRS WNW increment 5. Table 11 shows the expected improvements in bandwidth for the addition of the JTRS WNW increment 5 for Alternative 2. As in Alternative 1, the evaluation measure “network join time” will be used in an analysis of alternatives. The network join time for each communication path is listed in Table 11.

Communication Path	System	Network Join Time (sec)	Effective Throughput	RF Bandwidth	Laser Bandwidth Transmit/Receive		Relay Delay Time (msec)
					Uplink	Downlink	
Surface to Surface (LOS)	JTRS WNW Inc. 5	2.5	3 Mbps/# Users	3 Mbps			25
Surface to Air (LOS)	JTRS WNW Inc. 5	2.5	3 Mbps/# Users	3 Mbps			25
Surface to Sub-surface (LOS)	OLC				224 Kbps @ 200 ft	1200 Kbps @ 200 ft	
SATCOM	MUOS (UHF)		64 Kbps	64 Kbps			500
TDL (LOS)	Link-16		8 Kbps	53.7 Kbps			

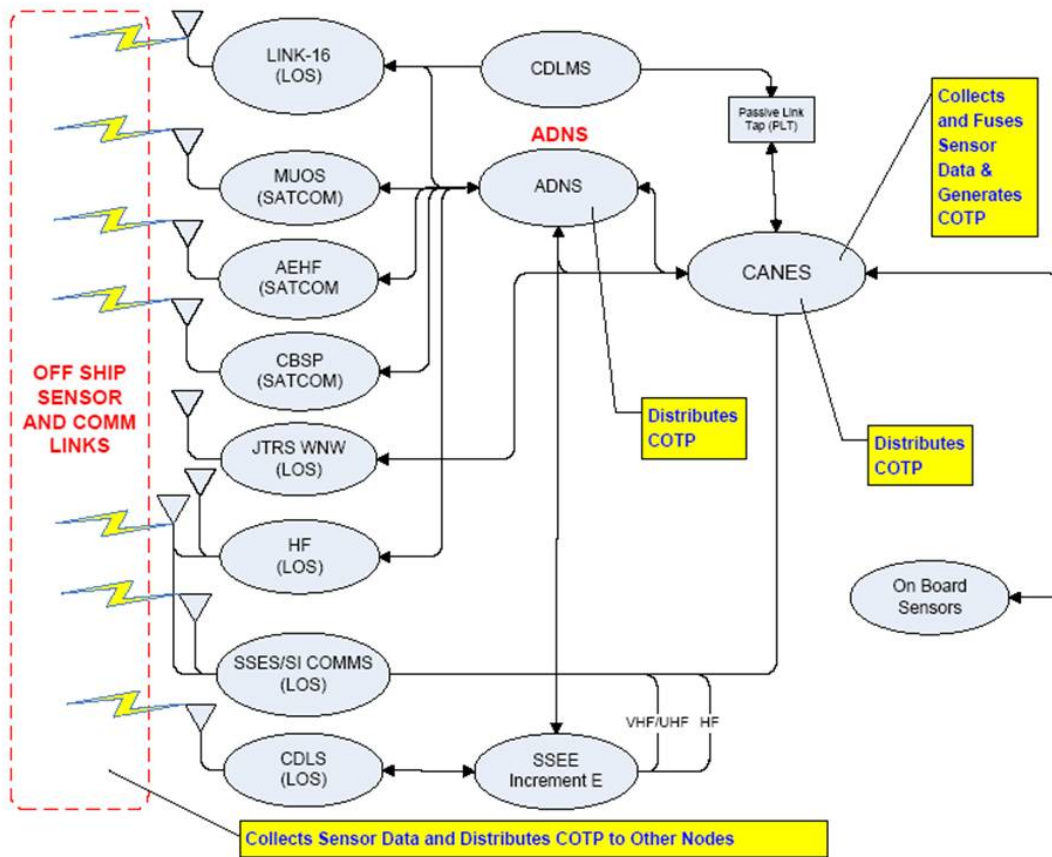
**Table 11. FY2020 Joint ASW C4I Architecture Baseline “Interconnect Communication Nodes” Function Data Rates and Relay Delay Times for Alternative 2**

This table shows the bandwidths and effective throughputs of the systems that are part of the FY2020 Joint ASW C4I Architecture Baseline that are expected to perform the “interconnect communication nodes” function for Alternative 2 [TDL-T CDD, 2003; Reddish and Lovern, 2007; Navy Communications Satellite Program Office, 2004; Ericsson, 2006; Letourneau, 2008].

For the A.5.1 function, incremental improvements in the net enabled command capability system listed in the previous alternatives are expected to provide a higher level of data fusion capability. In addition, it is expected that the NECC system will be consolidated into the CANES system as well as the consolidation of all standard services. It is also expected that the CANES system will establish the ability to create community of interest applications and integrate them into the CANES environment thereby reducing stove-piped hardware solutions into software applications within the CANES/NECC

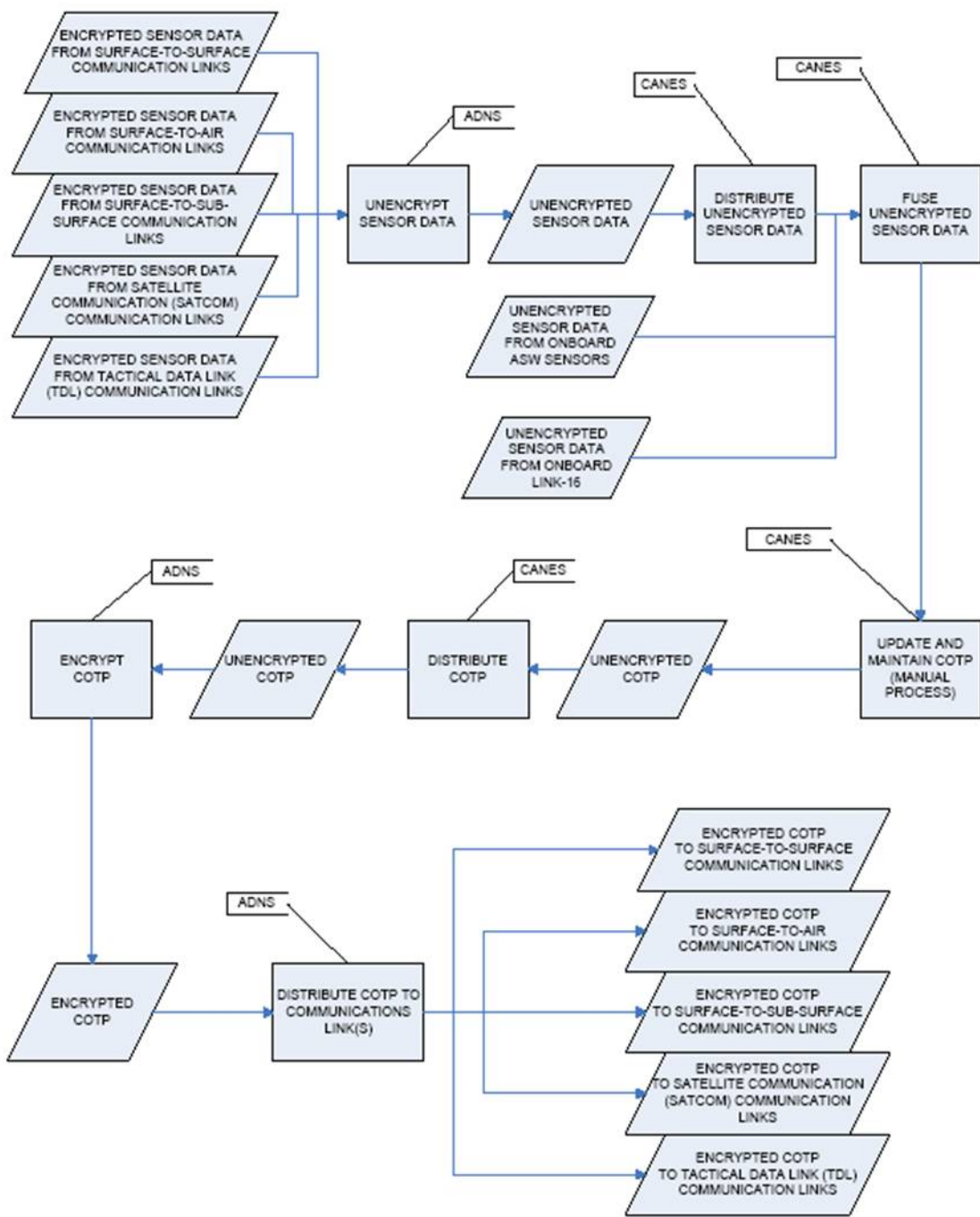
system. Research and study into providing this capability is being conducted by means of the JTM study which is expected to make recommendations for the replacement and improvement of the Net-Enabled Command Capability (NECC) system in fiscal year 2012 and carry through past the FY2020 timeframe.

Figure 33 depicts the interconnection of systems that will be typical of internal node system connectivity Alternative 2. Figure 34 depicts the process data flow for ASW sensor and COTP data. This consolidation is expected to improve the data processing rates by the amounts shown in Table 12.



**Figure 33. Internal Node System Connectivity with NECC absorbed into the CANES System for Alternative 2**

This figure shows the internal system connectivity for the systems that are part of the FY2020 Joint ASW C4I Architecture Baseline that are expected to be fielded by FY2020 and represent a typical internal configuration of a typical node for Alternative 2.



**Figure 34. Data Processing Flow Diagram for Alternative 2**

This figure shows the flow of sensor and COTP data through the systems represented in Figure 33. The estimated processing times are listed in Table 12.

<b>Data Process</b>	<b>System</b>	<b>Data Process Time</b>
<b>Interconnect Communication Nodes</b>	All	4.2 sec
<b>Unencrypted Sensor Data</b>	ADNS	100 msec [SSC Charleston Fleet Support Branch, 2008]
<b>Distribute Unencrypted Sensor Data</b>	CANES	100 msec [SSC Charleston Fleet Support Branch, 2008]
<b>Fuse Unencrypted Sensor Data</b>	CANES	100 msec
<b>Update and Maintain COTP</b>	CANES	Range: 20 to 120 sec [SSC Charleston Fleet Support Branch, 2008]
<b>Distribute COTP</b>	CANES	100 msec [SSC Charleston Fleet Support Branch, 2008]
<b>Encrypt COTP</b>	ADNS	100 msec [SSC Charleston Fleet Support Branch, 2008]
<b>Distribute COTP to Communication Link(s)</b>	ADNS	100 msec [SSC Charleston Fleet Support Branch, 2008]

**Table 12. FY2020 Joint ASW C4I Architecture Baseline Estimated Data Processing Times for Alternative 2**

This table shows a tabular representation of the data processes illustrated in Figure 34 with the approximated processing times for Alternative 2.

For the “Provide COTP” function for this alternative as in Alternative 1, the assumption was made that all nodes in the Joint ASW C4I Architecture Baseline will have the ability to receive the COTP by FY2020. This assumption is based on PEO-C4I Masterplan [PEO-C4I Masterplan, 2007: 58] that shows Link-4, Link-11, Link-16 and Link-22 all migrating to IP Based waveforms near the year 2020 timeframe. Today there are a few of the nodes in the Joint ASW C4I Architecture Baseline such as the F/A-18 Hornet that does not receive the COTP. We expect by the year 2020 that those nodes will have the capability to receive the COTP. Therefore, the associated evaluation measure “percent of users with access to the COTP” for this function is expected to be at 100 percent in FY2020.

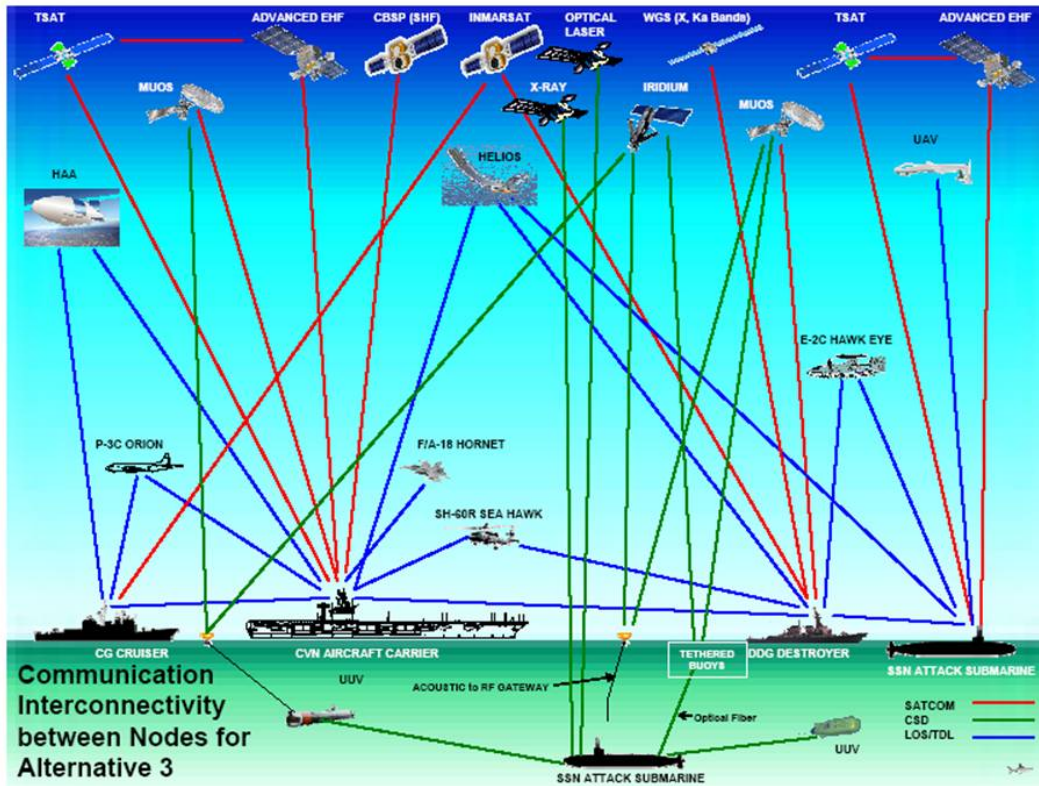
The evaluation measure for the “Fuse ASW Data” function is “minimize data fusion processing time.” The value for this measure will be determined by modeling the fusion process.

The evaluation measure for the “Enable Smart Pull and Push of ASW Information” function is the “user response time to critical information.” The “Enable

Smart Pull and Push of ASW Information” function is a sub function under the “Identify, Store, Share and Exchange ASW Data and Information” function. The value for this measure will be determined by modeling and simulation using an average throughput derived from all communication paths listed in Table 11.

#### **4. Alternative 3**

Alternative 3 represents additional unplanned systems that can be added to the systems in Alternative 0 that could be implemented by FY2020 and significantly increase the functions to “Identify, Store, Share and Exchange ASW Data and Information” and “Interconnect Communication Nodes” by increasing the bandwidth of communications to submarines while operating at speed and depth. In addition these systems can improve the survivability of communications between nodes as a result of the failure of one or more satellite systems due to a system failure or deliberate destruction. Figure 35 is a pictorial depiction of the systems expected to provide the interconnection between nodes functionality for Alternative 3. As in Alternative 2, the evaluation measure “network join time” will be used in an analysis of alternatives. The network join time for each communication path is listed in Table 13.



**Figure 35. Graphical Representation of the Interconnection of Communication of Nodes for Alternative 3**

This figure illustrates the communication interconnectivity of nodes portion of the FY2020 ASW C4I Baseline with the addition of High Altitude Aircraft collecting and fusing data and distributing the Common Operational Picture to all nodes as described in Alternative 3.

For the A.1.1 function, National Aeronautics and Space Administration (NASA) is developing a system that has the ability to communicate using x-rays. A technologist at NASA’s Goddard space center has developed the world’s first x-ray communication system using a Modulated X-ray Source (MXS) [NASA, 2008]. The inventor is integrating the system with x-ray optics in the hope of demonstrating the system’s data rate of 1 Mbps [NASA, 2008]. The goal is to transmit gigabytes of data per second using minimal power [NASA, 2008].

Communication via x-rays offers significant advantages to both civilian and military space programs. Although currently at a very low technology- readiness level, it has the potential to provide high-data rates at low power over vast distances in space. In addition, such a communication system could penetrate RF shielding on the ground and communicate with hypersonic vehicles during that short period of

time when the build-up of heat during reentry blocks traditional communications signals [NASA 2008].

Further research into determining the feasibility or capability of communicating with submarines operating at speed and depth needs to be conducted.

Communication links to submarines are expected to be improved by the use of unmanned undersea vehicles [UUV Masterplan, 2004: 1]. These vehicles can be configured to function as a radio frequency to acoustic gateways. This allows the manned submarines to remain submerged and still have the ability to communicate on the tactical level. However, the unmanned undersea vehicles currently planned will not increase the bandwidth and throughput to a submarine at speed and depth at the levels provided by OLC and the possible use of the x-ray communication system using a Modulated X-ray Source (MXS). The MXS is expected to increase the data rate of communications to 1 Mbps.

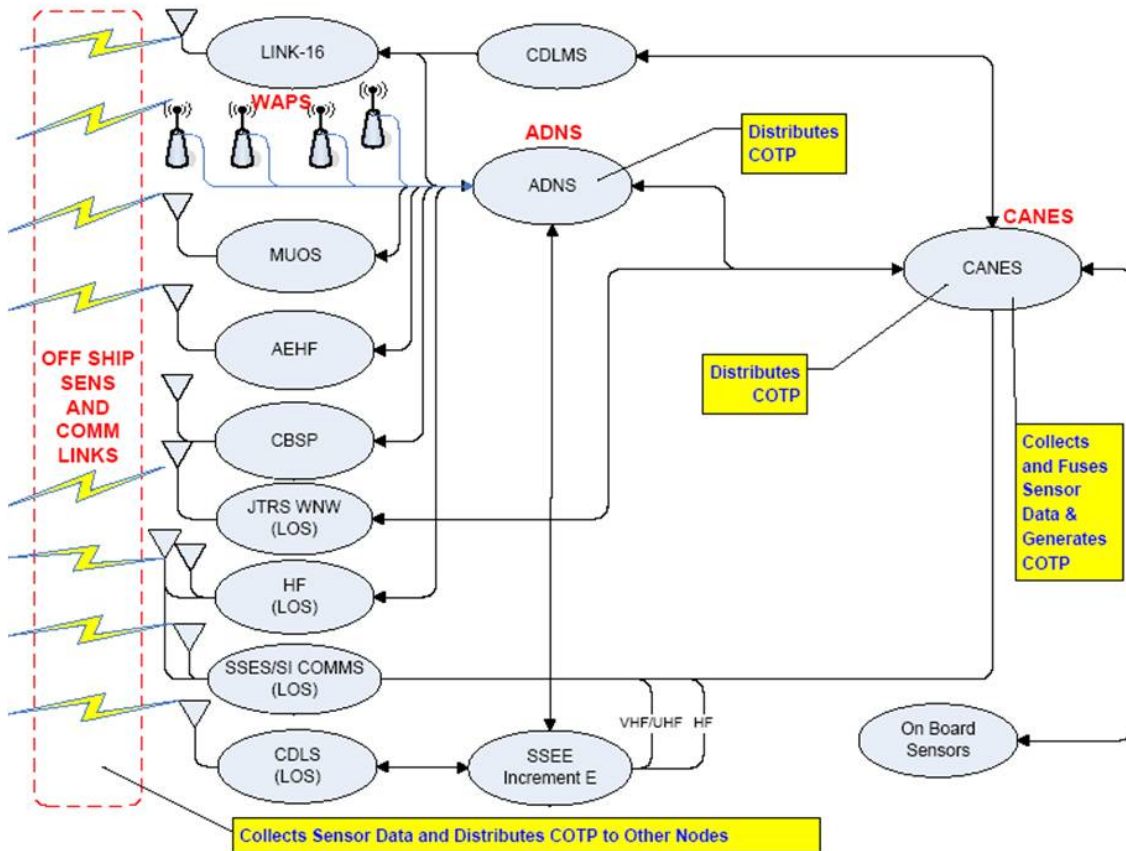
For the functions A.5.1 and A.5.2, high-altitude unmanned aircraft and dedicated satellite constellations could be used as an alternative platform to fuse and disseminate the common operational tactical picture. The following quote details the NASA's plans for these aircraft.

In restricted airspace more than 55,000 feet above air force bases and remote airstrips in the California desert, NASA this summer will be testing four remotely-piloted experimental aircraft. The planes are part of NASA's Environmental Research Aircraft and Sensor Technology (ERAST) Program, which is developing alternatives to satellites and traditional aircraft as platforms for carrying scientific instruments to high altitudes. The experimental aircraft are being called 'atmospheric satellites,' because they will be able to perform many of the functions of orbiting satellites, only at lower altitudes. Project engineers aspire to build a plane that will essentially be able to park 55,000 to 60,000 feet above a particular location on Earth and remain there for at least six months [Clark, 1999].

One example of such an aircraft is the solar-powered Helios Prototype being experimented with by NASA [Dunbar and Curry, 2008]. Another example is the High Altitude Airship being developed by Lockheed Martin [High Altitude Airship, 2008]. These aircraft could be designed and configured with the ability to collect, fuse, and disseminate data. Since China has demonstrated the capability to destroy satellites, these aircraft could serve as the next "high ground" alternatives in the event the current satellite constellations were rendered inoperable. Satellites and high altitude aircraft can be outfitted with the same systems previously listed in the system connectivity drawings for individual nodes Alternative 0, 1, and 2. The advantage of this configuration is increased survivability of an overall mission and redundancy. For an unmanned "high ground" Top



COTP node alternative, the continuous updating of the Top COTP must be automated and not conducted manually as it is in alternatives 0, 1 and 2. Figure 36 illustrates the internal node system connectivity representative of Alternative 3. Algorithms will have to be developed that can verify that the source track data is indeed coming from the sensor associated with the source. Figure 39 is a data flow chart representation of the data flow through the systems depicted in Figure 36.



**Figure 36. Internal Node System Connectivity with the Addition of HALO Network Wireless Access Points Included for Alternative 2**

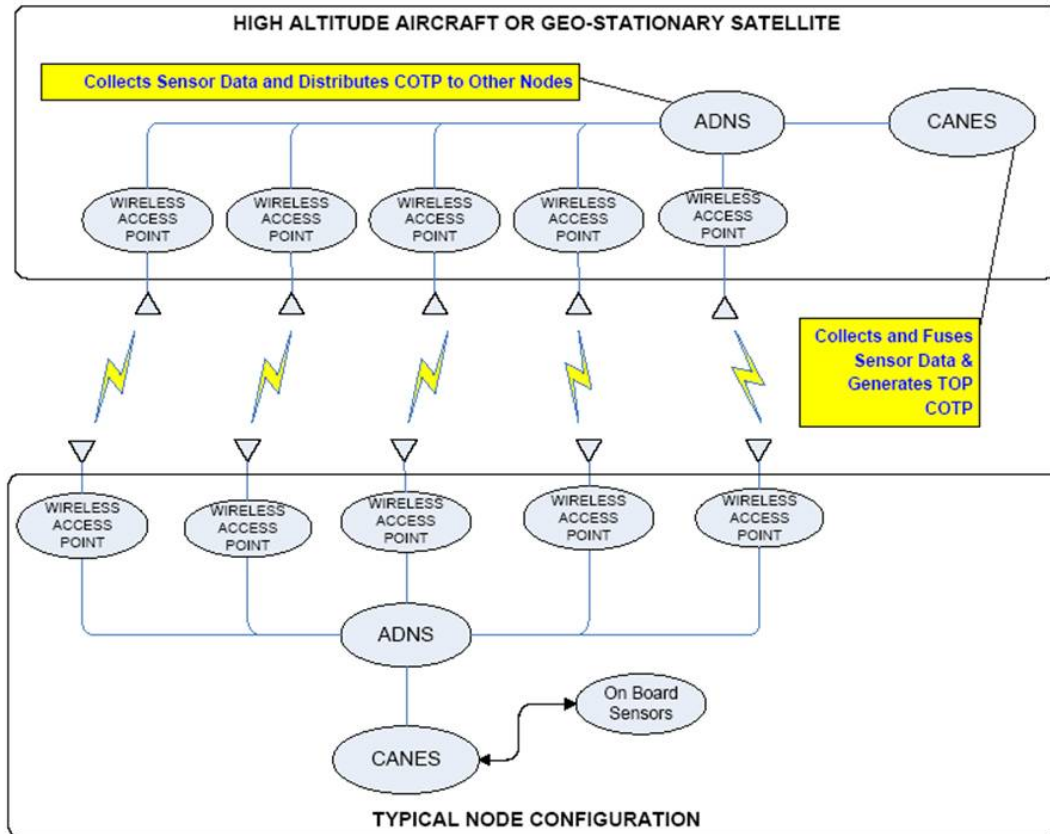
This figure shows the internal system connectivity for the systems that are part of the FY2020 Joint ASW C4I Architecture Baseline that represent the connection of systems of a typical node for Alternative 3.

For function A.5.3, the consolidated network and enterprise services system is expected to have evolved far enough to be able to provide wireless connectivity to the end users giving the end user the ability to be to connect directly to network services provided by satellite and high altitude based communication nodes. There is a corporation and its partners that are in the process of creating a wireless broadband super-



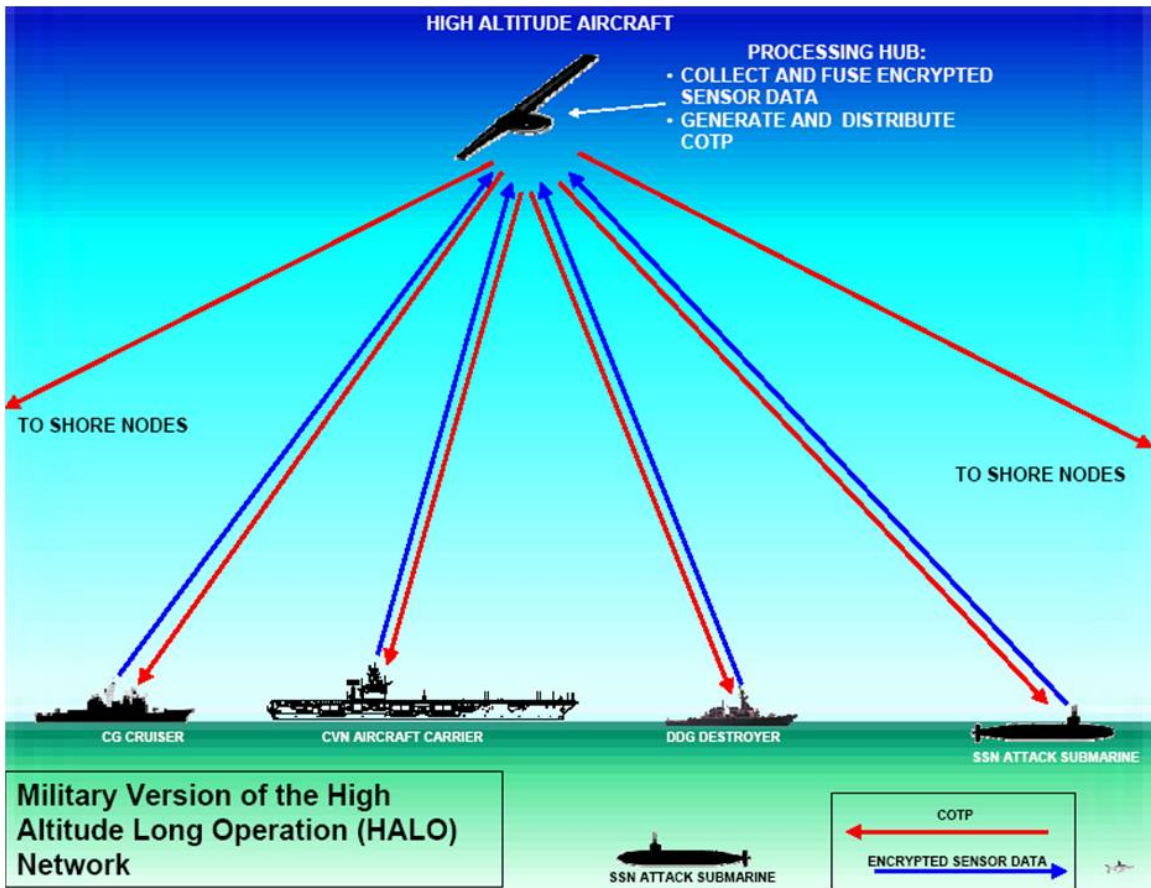
metropolitan area network (SMAN) for the purpose of interconnecting hundreds of thousands of subscribers are multi-megabit per second data rates [The Halo Network, 2000]. The plan is to offer a ubiquitous access and dedicated point-to-point connection through a Federal Aviation Administration (FAA) certified High Altitude Long Operation (HALO) aircraft as the hub of the network [The Halo Network, 2000]. The aircraft will operate above 52,000 feet and will be viewed as a very tall tower or “atmospheric satellite” [The Halo Network, 2000]. The links will be wireless, broadband, line-of-sight covering an area thousands of square miles [The Halo Network, 2000]. Giving all users the ability to connect to the network wirelessly and directly to a high altitude connection would eliminate the need for extensive shipboard or shore-based network infrastructures thereby increasing the overall throughput and speed of operations. This improves the distribution of sensor data and the COTP.

Figure 37 and Figure 38 provide graphical representations of the HALO concept that could be applied to military operations. This configuration could add a multi-megabit network that would have access to all nodes within the battlespace and would eliminate many of the relay hops required with satellite systems to receive process and distribute the COTP and raw sensor data. This will reduce the need to design and launch expensive satellite systems that are not easily recovered and maintained. Based on recent demonstrations by the Chinese to take out an in flight weather satellite, a military version of the HALO system would be a necessary alternative to existing and planned satellite systems [Smith, C; 2007]. In the event one of the satellite systems is disabled, this system could be quickly deployed and implemented. A fleet of these aircraft could be maintained to support round the clock high altitude network services support to include data fusion, COTP distribution and interconnectivity between nodes functionality.



**Figure 37. Internal Node Configuration of High Altitude Aircraft and Graphical representation of Ground, Sea and Air Node Configurations**

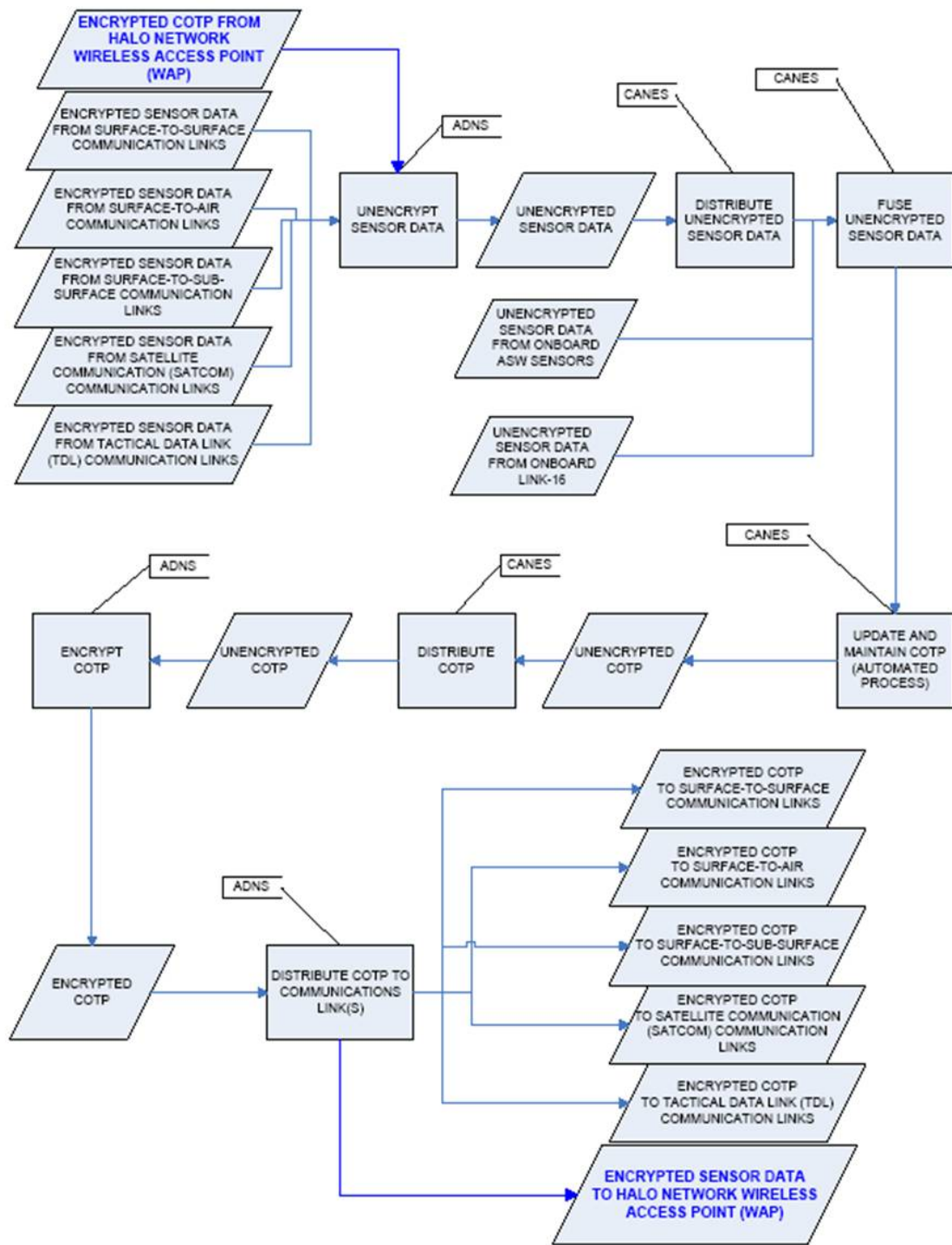
This figure shows the internal system connectivity for the addition of the HALO network to the FY2020 Joint ASW C4I Architecture Baseline and illustrates a typical node system connectivity for the HALO Network and the “High Altitude” central node system connectivity for Alternative 3.



**Figure 38. Militarized Version of the HALO Aircraft Network Concept**

This figure is a graphical representation of the communication between nodes using the HALO Network concept. The High Altitude Aircraft will function as the Central Processing Hub for collecting sensor data and distributing the Top COTP for Alternative 3.

Table 13 depicts possible improvements that can be realized with the addition of the HALO Network. This alternative will provide a network backbone hub or switch located at 52,000 feet which can cover thousands of miles of ground area. Each node will have the ability to communicate directly with the central high altitude node reducing the number of systems that data will have to travel for communications between the various nodes forming a star wide area network (WAN) topology. The improvements with this alternative are recognized as improvements with the bandwidths available for surface-to-surface surface-to-air communications due the HALO network and increased bandwidth to the surface-to-sub-surface communications due to MXS. The data processing times for collecting, distributing and fusing sensor data and generating and distributing the COTP are expected to decrease for Alternative 3. Table 14 is a tabular representation of the estimated data process times depicted in Figure 39 for Alternative 3.



**Figure 39. Data Process Flow Chart for Alternative 3**

This figure shows the flow of sensor and COTP data through the systems represented in Figure 36. The estimated processing times are listed in Table 14.

Communication Path	System	Network Join Time (msec)	Effective Throughput	RF Bandwidth	HALO Network Bandwidth Transmit/Receive		Relay Delay Time (msec)
					Uplink	Downlink	
Surface to Surface (LOS) Network	HALO				25 Mbps	25 Mbps	
Surface to Air (LOS) Network	HALO				25 Mbps	25 Mbps	
Surface to Surface (LOS)	JTRS WNW Inc. 5	2.5	3 Mbps/ # Users	3 Mbps			25
Surface to Air (LOS)	JTRS WNW Inc. 5	2.5	3 Mbps/ # Users	3 Mbps			25
Surface/Air to Sub-surface (LOS)	MXS			1 Mbps			
SATCOM	MUOS (UHF)		64 Kbps	64 Kbps			500
TDL (LOS)	Link-16		8 Kbps	53.7 Kbps			

**Table 13. FY2020 Joint ASW C4I Architecture Baseline “Interconnecting Communication Nodes” Data Rates and Relay Delay Times for Alternative 3**

This table shows the bandwidths and effective throughputs of the systems that are part of the FY2020 Joint ASW C4I Architecture Baseline that are expected to perform the “interconnection between communication nodes” function for Alternative 3 [The Halo Network, 2000; TDL-T CDD, 2003; Navy Communications Satellite Program Office, 2004; Ericsson, 2006; Letourneau, 2008].

For the Provide COTP function for this alternative as in Alternative 2, the assumption was made that all nodes in the Joint ASW C4I Architecture Baseline will have the ability to receive the COTP by FY2020. This assumption is based on the PEO-C4I Masterplan [PEO C4I Masterplan, 2007: 58] that shows Link-4, Link-11, Link-16 and Link-22 all migrating to IP Based waveforms near the year 2020 timeframe. Today there are a few of the nodes in the Joint ASW C4I Architecture Baseline such as the F/A-18 Hornet that does not receive the COTP. We expect by the year 2020 that those nodes will have the capability to receive the COTP. Therefore, the associated evaluation measure “percent of users with access to the COTP” for this function is expected to be at 100 percent by FY2020.

The evaluation measure for the “Fuse ASW Data” function is “minimize data fusion processing time.” The value for this measure will be determined by modeling and simulating the fusion process.

The evaluation measure for the “Enable Smart Pull and Push of ASW Information” function is the “user response time to critical information.” The “Enable Smart Pull and Push of ASW Information” function is a sub function under the “Identify, Store, Share and Exchange ASW Data and Information” function. The value for this measure will be determined by modeling and simulation using an average throughput derived from all communication paths listed in Table 13.

<b>Data Process</b>	<b>System</b>	<b>Data Process Time</b>
<b>Interconnect Communication Nodes</b>	All	5.8 sec
<b>Unencrypted Sensor Data</b>	ADNS	100 msec [SSC Charleston Fleet Support Branch, 2008]
<b>Distribute Unencrypted Sensor Data</b>	CANES	100 msec [SSC Charleston Fleet Support Branch, 2008]
<b>Fuse Unencrypted Sensor Data</b>	CANES	100 msec [SSC Charleston Fleet Support Branch, 2008]
<b>Update and Maintain COTP (Automatic)</b>	CANES	Range: 20 to 120 sec [SSC Charleston Fleet Support Branch, 2008]
<b>Distribute COTP</b>	CANES	100 msec [SSC Charleston Fleet Support Branch, 2008]
<b>Encrypt COTP</b>	ADNS	100 msec [SSC Charleston Fleet Support Branch, 2008]
<b>Distribute COTP to Communication Link(s)</b>	ADNS	25 msec [SSC Charleston Fleet Support Branch, 2008]

**Table 14. FY2020 Joint ASW C4I Architecture Baseline Estimated Data Processing Times for Alternative 3**

This tables shows a tabular representation of the data processes illustrated in Figure 39 with the approximated processing times for Alternative 3.

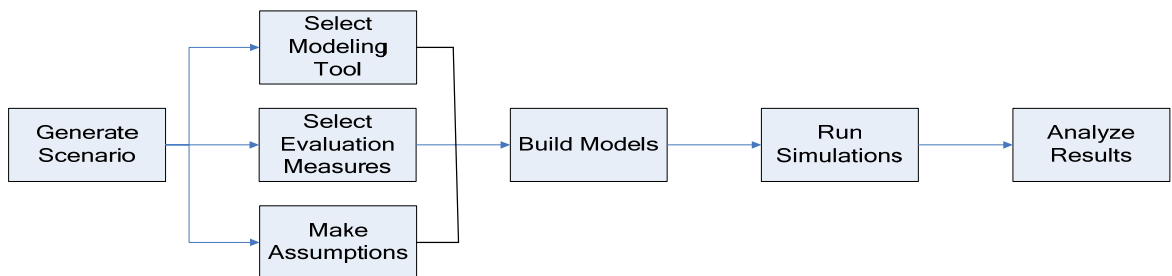
THIS PAGE INTENTIONALLY LEFT BLANK

## V. MODEL ALTERNATIVES

### A. MODELING AND SIMULATION PROCESS

Modeling and simulation was conducted in order to compare alternative solutions in an affordable, effective, and repeatable manner. A model is a simplified representation of an actual system to increase understanding. Since it is not feasible to compare alternatives in their real operating environment, models were built to simplify the alternatives into an abstraction of reality in order to mimic the behavior of each alternative and promote understanding of the real system. Ultimately, the models were built as a strategy to deal with the complexity and uncertainty of the Joint C4I ASW Architecture. Additionally, the models were built as an analytic framework to quantify how well the alternatives performed selected top-ranked functions. Simulation is the specific application of a model performed as a method to deal with the dynamic behavior of the system and its components.

The modeling and simulation process, illustrated in Figure 40, consisted of seven steps: generating scenarios, selecting the modeling tool and evaluation measures, making assumptions, building the models, running the simulations, and analyzing results. During this process, a model was created and the simulations were performed by varying the inputs in a systematic and logical manner for each alternative. Modeling and simulation provided outputs which were used in the analysis of alternatives step to provide the stakeholders with recommendations on choosing the best alternative. Further details of these seven steps are discussed in the sections below.



**Figure 40. Modeling and Simulation Process**

This figure shows seven actions in the modeling and simulation process. The final result from this process is used in the analysis of alternatives step to provide the stakeholders with good recommendations on choosing the best alternative.



## **B. SCENARIO AND VIGNETTES OVERVIEW**

The fabricated operational scenario was developed for use in modeling the Joint ASW C4I Architecture. The scenario served to bind the architecture to a finite support role and helped to focus this capstone project design team which had no prior experience with Naval operations. Mission area specific vignettes provided individual communication events occurring throughout the course of this Indian Ocean-centered scenario. They were developed using a four phased approach: initial preparation of the battlespace, extended reconnaissance and surveillance, proactive prosecution, and command controlled weapons engagement. To accomplish each of these phases, the Undersea Warfare Commander received Joint ASW C4I Architecture support to effect movement of data between manned and unmanned sensors, operational platforms, and weapons systems focused on ASW. The full 30 day scenario, maps, and vignettes, located in Appendix H, outlines the baseline Naval ASW missions, platforms, and operational communication paths required to assimilate Naval operations with all blue, green and white forces to effectively carry out tasking related to red force identification, containment, and destruction.

The scenario developed for this capstone project is a student exercise and is not based on any actual events. This specific scenario was arbitrarily chosen in order to frame the modeling and simulation effort in a realistic situation. The scenario began with sensing and identification of an underwater missile test being conducted off the coast of India in the Bay of Bengal. The President of the United States, upon being briefed on national security concerns, ordered the National Command Authority (NCA) to conduct ASW specific reconnaissance and surveillance over the area. The theater commander, United States Pacific Command (PACOM), was directed to carry out a 30 day reconnaissance and surveillance mission. PACOM assigned the mission to the 7th Fleet Commander aboard a United States CVN in the South China Sea. The 7th Fleet's blue force task group consisted of an aircraft carrier (50 embarked aircraft (four SH-60 ASW helicopters, two E-2 Hawkeye surveillance and 44 fighter and attack (F/A-18) fixed wing aircraft)); two guided missile cruisers (two embarked SH-60 ASW helicopters each); one destroyer (one embarked SH-60 ASW helicopter); one frigate (one embarked SH-60 ASW helicopter; and two attack submarines (two embarked unmanned undersea vehicles each)). Additionally, the task group was supplemented by United States Navy EP-3, P-3C, United States Air Force RC-135 V/W (Rivet Joint) and a RC-8C (JSTARS) aircraft stationed in Guam, and one Surveillance Towed Array Sensor System (SURTASS) Low Frequency Active (LFA) vessel on station in the Arabian Sea.

The blue force commander distributed all available maritime platforms and sensors at his disposal to prepare the blue force task group's over the horizon battlespace. Blue force sensor nodes identified small boat and mini-submarine activity transiting the Straits of Malacca in Malaysia, but chose not to engage. Later, these units will play a role in the scenario. Space-based and joint service air platform sensing activities confirmed India's missile testing. Commercial force shipping operations were confirmed in and around India's major sea port of Vishakhapatnam. Early in the conduct of blue force task group operations, a pair of Indian commercial "white force" ships carrying sensitive weapon materiel were presumed lost at sea by the Indian government. India requested assistance from the United States through diplomatic channels to assist with locating the ships. Blue force task group submarines and signals intelligence gathering platforms sensed an Indian submarine and aircraft carrier breaking out of port during heavy weather. After a series of intra-country coalition communications it was determined the two Indian commercial vessels had been hijacked by terrorists using high speed boats and mini-submarines. These were the same small maritime contacts made earlier and now they are recognized as the red force vessels. The blue force commander was directed to change his mission from surveillance of the Indian test firings to tracking the terrorists and recovering the stolen weapon materiel. India's green force went from being under blue force surveillance to a strong coalition partner coordinating naval operations to locate and engage terrorists and lost cargo. Complete order of battle information is provided in Table 15.

<b>Platforms</b>	<b>Blue Force</b>	<b>Green Force</b>	<b>White Force</b>	<b>Red Force</b>
<b>Surface Ships</b>	1 Aircraft Carrier (CVN) 2 Guided Missile Cruiser (CG) 2 Guided Missile Destroyer (DDG) 1 Surveillance Towed Array Sensor System (SURTASS)	1 Aircraft Carrier (CVN) 1 Guided Missile Cruiser (CG)	2 Merchant Ships	2 Small Go Fast Boats
<b>Aircraft</b>				
<b>Land Based</b>	1 Joint Surveillance & Target Attack Radar System (RC-8C (JSTARS)) 1 Rivet Joint (RC-135V/W) 1 Electronic P-3 (EP-3) 1 P-3 Orion	1 Electronic P-3 (EP-3) 1 P-3 Orion		
<b>Ship Based</b>	30 Strike Attack (F/A-18) 2 Surveillance (E2D Hawkeye) 10 ASW Helicopter (SH-60)	15 Harrier (AV-8) 6 ASW Helicopter		
<b>Submarines</b>	1 Nuclear Attack (SSN 688) 1 Nuclear Attack (SSN 774)	1 Nuclear Attack (Kilo Class) 1 Nuclear Attack (SSN 774)		2 Miniature Submarines
<b>Shore C2/C4I Sites</b>	1 Naval Operational Processing Facility (NOPF) 1 NCTS Bahrain	1 Communications Facility, Cochin 1 Communications Facility, Vishakhapat		

**Table 15. Scenario Order of Battle**

This table displays all platforms of United States Blue Force; India's Green Force; hijacked White Commercial Maritime Forces, and Adversarial Red Forces portrayed and participating in the operational scenario.

The combined blue and green maritime coalition force acted quickly to identify and locate the red force high speed craft and mini-submarines using a well coordinated and communicated engagement plan. Fixed wing and rotary wing aircraft contributed to sensing the surface and subsurface enemy targets and ensured decisive weapons engagement of the enemy along with blue and green coalition force surface and submarine platforms. The engagement culminated in the return of the weapon materials and the confiscation of terrorist vessels. White commercial forces were sunk by the enemy.

### **C. MODELING AND SIMULATION APPROACH**

The goal of this phase was to model and run simulations of a blue force ASW task group's C4I network. Modeling and simulation served as the mechanism for quantifying each alternative's performance as it relates to the key evaluation measures. "Key issues in simulation include acquisition of valid data source information about the system, a selection of key characteristics, the use of simplifying approximations and assumptions within the simulation, and reliability and validity of the simulation outcomes" [Universiteit Leiden, 2008]. Alternative solution performance characteristics served as inputs for the model. Models were run for the blue force task group's FY2020 Joint ASW C4I Architecture Baseline (Alternative 0) and three additional alternative solutions.

#### **1. Tool Selection**

To build the performance models for each of the alternatives, the modeling tools CORE, NSS-21, EXTEND, and ARENA were studied. Each of these tools has its advantages and limitations. For example, CORE can provide the capability to simulate behavior models, such as functional flow block diagrams, in order to analyze the dynamic performance and behavior of a system's functional model. It can also be used to verify system design to clarify breakpoints and aid the systems engineering process [Vitech Corporation, 2000: 1]. Unlike CORE, NSS-21 can be used to support multi-warfare mission area analysis and operational commanders in developing and analyzing operational courses of action. NSS-21 is an object-oriented Monte Carlo modeling and simulation tool and was developed to analyze operational metrics. However, it was not chosen because it provides coarse and sometimes incorrect assumptions of the underlying network. As for EXTEND and ARENA, these two tools can be used to model any system or process. Their dynamic modeling capabilities can be utilized to help organizations answer questions about how an existing or a proposed system will perform. In the end, EXTEND was chosen over ARENA because EXTEND allows the sequence of simultaneous events to be modified by adjusting graphical position while ARENA does not. This was a very important feature in this complicated architecture because its flexibility allowed for easy modification of the model based on the alternatives.

EXTEND has unique capabilities that enabled the building of performance models for the Joint ASW C4I Architecture. Additional details of the EXTEND model that was built are provided in the sections below.

## **2. Evaluation Measures for Modeling and Simulation**

The value hierarchy shown in Figure 17 has two distinct branches, functional and non-functional. The focus of the modeling and simulation was to model and measure the evaluation measures of the functional branch. There were six critical evaluation measures associated with the five top ranked functions, identified by the stakeholders as the most important and shown in Table 1. From these six evaluation measures, it was easy to quantify the performance of three of them – latency, throughput, and data fusion time – through modeling and simulation. The remaining three evaluation measures – the percentage of users with access to COTP, time to interconnect, and time to pull and push ASW information – were analyzed through research and offline evaluation, which is described in detail in the alternatives generation section.

Since the scenario for each alternative was unchanged and only the performance parameters were changed, the selected evaluation measures were captured in a systematic fashion. Once the data for latency, throughput, and data fusion processing time was collected, statistical analysis was performed and results were used in the next step of the process, analysis of alternatives.

## **3. Assumptions**

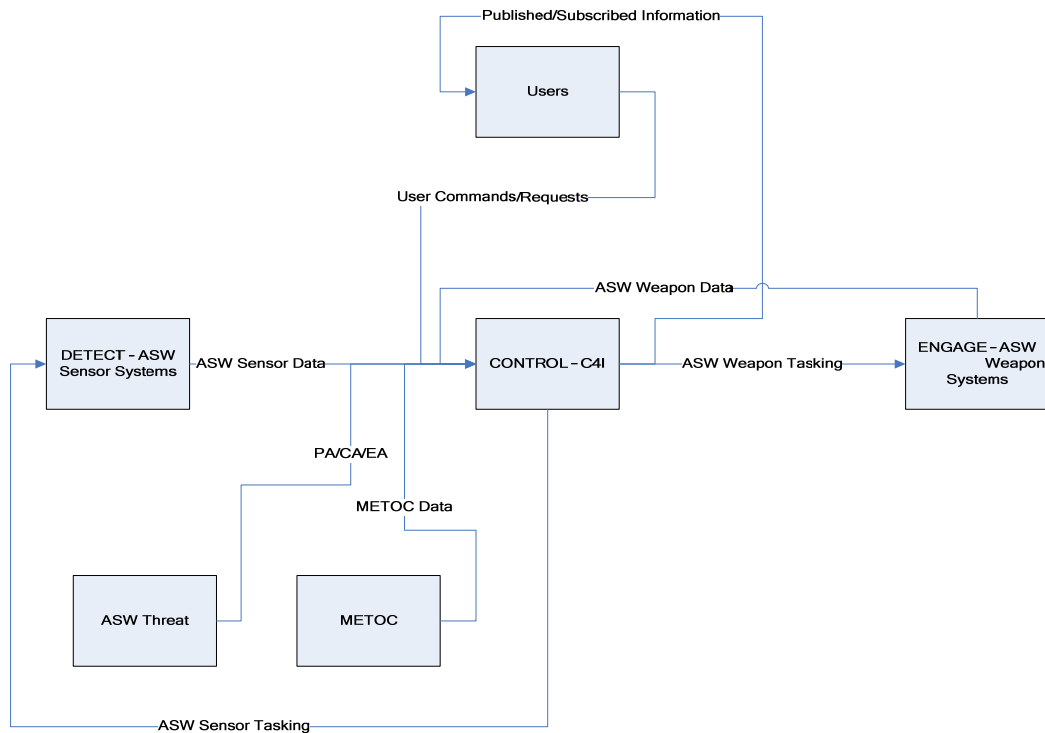
Each C4I node within the baseline system is mobile resulting in ever changing distances between nodes. Range changes were not considered in these modeling and simulation activities. Ranges were assumed to be static with no platform position changes in latitude, longitude, or elevation. The blue force ASW task force required communications flexibility using all line-of-sight and beyond line-of-sight communication tools available to each communicating platform. However, since it would be too complex to model all of the communication paths, it was decided to focus on the preferred communication paths without a degraded mode analysis. Therefore, for line-of-sight, surface-to-surface, and surface-to-air, the preferred communication path is wideband network waveforms. For surface to sub-surface, it is communications at speed and depth. For tactical data links, it is Link-16, and for satellite communications, it is MUOS.

Key modeling and simulation objectives were to determine which alternative solution most reduced latency, reduced data fusion time, and increased data throughput. Thus, time lag of data receipt and the number of required hops between transmitting and receiving locations are directly related to physical distance and geographic positioning

between blue force ASW task group communicators and the number of communications relays and nodes needing connection to achieve positive communications.

#### 4. Generic Model Description

In order to aid the decision making phase, the model was built based on a kill chain which includes three components: detect, control, and engage. The kill chain was adopted to establish a clear set of functions that the system of systems must perform. Within this model, the inputs and outputs for each of these functions were consistent with the IDEF0 and functional flow block diagram developed during needs analysis. The purpose of the model was to demonstrate and quantify how effectively the architecture performed the kill chain, from detect to engage, for each alternative. The top-level diagram of the model is shown in Figure 41. Detailed explanations on the model are provided in paragraphs below.



**Figure 41. Top-Level Diagram of Model**

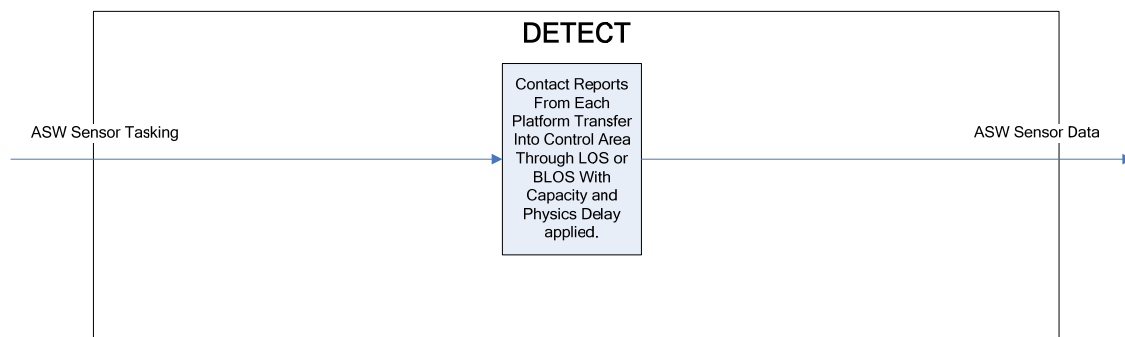
This figure shows the top-level diagram of the model, which is based on a kill chain. The inputs and outputs for each of these functions are based upon IDEF0 and functional flow block diagrams.

##### a. Detect

Detection was the first phase of the kill chain in the model. Using EXTEND, each platform was modeled separately. Within the detect phase, contact reports were generated in the model based on the scenario and fed into the simulated

system. Each of these contact reports included the detection time, identification, and location of a track as well as the data size. Then, depending on the platform’s location and communication equipment, an off-ship path of either line-of-sight or beyond line-of-sight would be selected to transfer these contact reports into the control area. As mentioned in the alternatives generation section, the scope did not include degraded or overflow operations because it was assumed that the Navy will be migrating from numerous stove-piped solutions to joint solutions. So, while other communication paths will likely exist in 2020, the focus was on preferred communications paths that are designed to provide superior performance and joint interoperability.

Depending on the selected off-ship path and its bandwidth, a capacity delay and a physics delay were applied. Capacity delay was determined by dividing the size of data input with the bandwidth. Physics delay was the latency of the communication system such as satellite communications or tactical links. The values for bandwidth and latency came from Table 7, Table 9, Table 11, and Table 13 in the alternatives generation section. Depending on the alternative, different values would be used. Also, based on this knowledge from this capstone project design team’s work on data collection, the size of data input was randomly selected between the ranges of 50-500 kilobits. Finally, the contact reports from all of the platforms were transferred into the control area where data fusion would be performed. Based on each alternative and its description in the alternatives generation section, time lag of data receipt and the number of required hops between relay locations were applied into the model. The detect section of the model is shown in Figure 42.

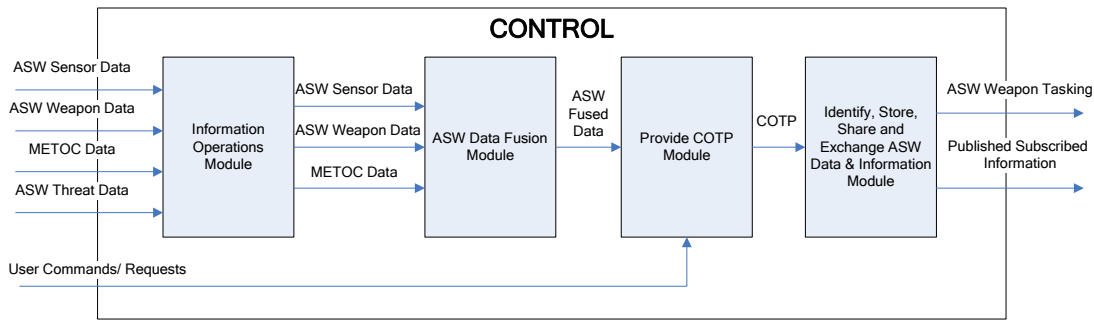


**Figure 42. Detect Section of the Model**

This figure shows the detect section of the model. The input and output for this function are based upon IDEF0 and functional flow block diagrams.

**b. Control**

As indicated previously, the Joint ASW C4I Architecture Baseline model was developed in EXTEND using the functional hierarchy, IDEF0, extended functional flow block diagrams, and information from the baseline of interconnecting links. As shown in the IDEF0 A-1 diagram in Figure 11, various types of data such as ASW sensor data, meteorological and oceanographic data, computer attack data, physical attack data, electronic attack data, weapon status data, user commands, and user requests were generated and implemented in EXTEND. Once all the different types of data were generated from various sources, it entered the control section of the kill chain. Furthermore, the control section was separated into four interconnecting modules: information operation module; fuse data module; provide COTP module; and identify, store, share, and exchange ASW data and information module. The control section of the model is shown in Figure 43.



**Figure 43. Control Section of the Model**

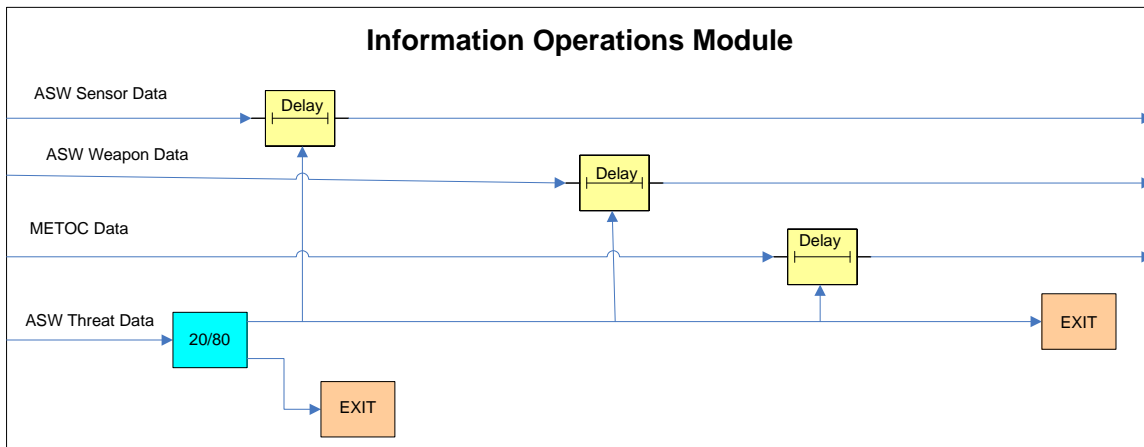
This figure shows the control section of the model. The inputs and outputs for each of these functions are based upon IDEF0 and functional flow block diagrams.

**(1) Information Operation Module**

As described by the perform information operations function, the Joint ASW C4I Architecture provides a secure and protected network. Therefore, the goal of this module was to remove all of the possible threats such as computer attack, physical attack, and electronic attack from entering the Joint ASW C4I Architecture. The assumption was made that 80% of the threats will be defeated prior to entering the Joint ASW C4I Architecture; however, 20% will enter the Joint ASW C4I Architecture. If the threat entered the Joint ASW C4I Architecture, then additional resources were used to respond to the threat, which caused additional delay in the processing of ASW sensor data, METOC data, and ASW weapon data. Once all the threats were completely defeated and removed, ASW sensor, METOC, and ASW weapon data was passed



through to the ASW data fusion module. The information operations module is shown in Figure 44.



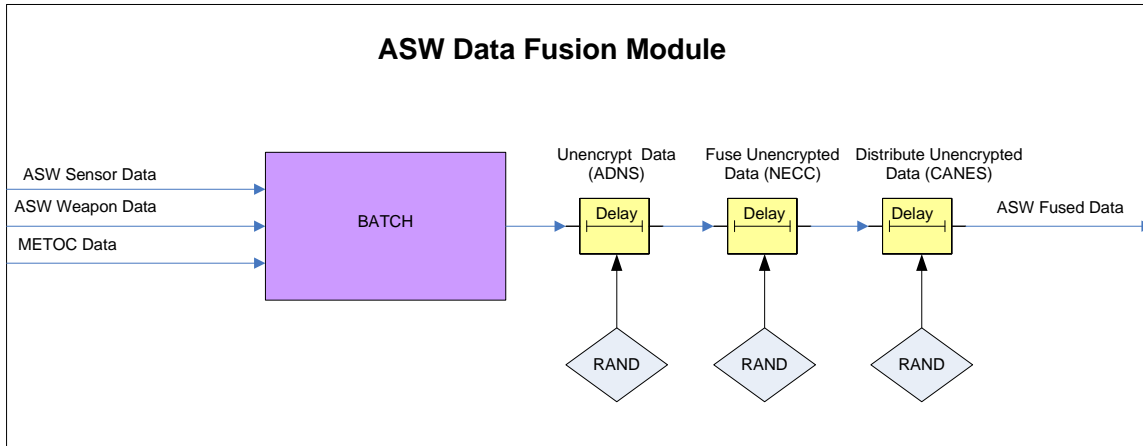
**Figure 44. Information Operations Module of the Model**

This figure shows the information operations module of the model. The inputs and outputs for each of these functions are based upon IDEF0 and functional flow block diagrams.

## (2) ASW Data Fusion Module

Since the focus of the model was to capture latency, bandwidth, and data fusion processing time rather than accuracy or quality of the fused data, the assumption was made that ASW Data Fusion functionality will be treated as a “black box.” Therefore, no algorithms, codes, or blocks were implemented to show that contact reports from sensors were fused to create a track report. However, the processing time for a particular contact report to be fused was captured. The expected performance parameters of processing time from Net-Enabled Command Capability (NECC) and Consolidated Afloat Network Enterprise Services (CANES) were utilized in the EXTEND model, and the data fusion processing time was captured for each event generated by the scenario.

ASW sensor data, ASW weapon data, and METOC data were combined into single outputs, shown in Figure 45. This single output is consistent with the IDEF0 and extended functional flow block diagrams that were constructed during the functional analysis phase. Fused data was then passed through to the provide COTP module.

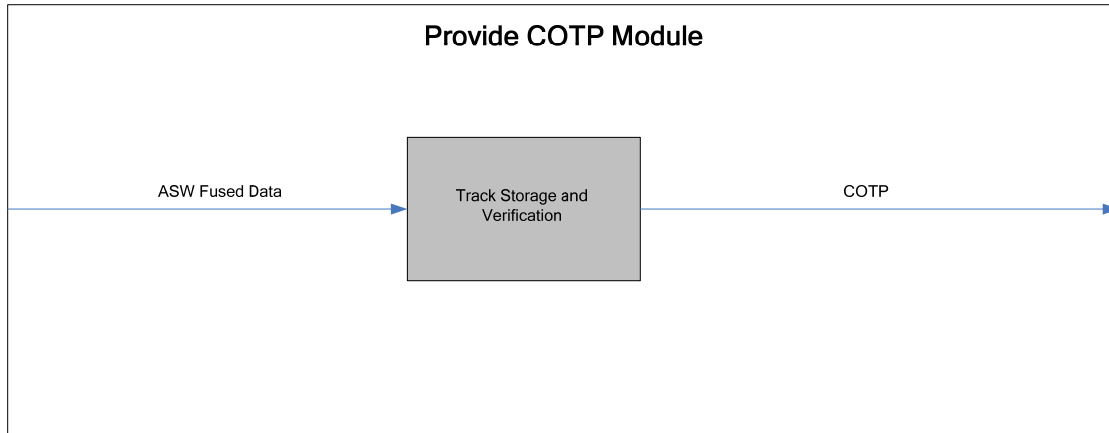


**Figure 45. Data Fusion Model**

This figure shows the ASW data fusion module of the model. The inputs and outputs for each of these functions are based upon IDEF0 and functional flow block diagrams.

### (3) Provide COTP Module

The COTP is used for situational awareness, which took its inputs from the data fusion function. Single track information, in the form of ASW fused data, received from the data fusion module was inserted into a central location which kept information for multiple tracks. The tracks being stored here were verified to see whether they were current. Those tracks that were engaged and destroyed would be deleted. If the tracks were engaged and not destroyed, the track was kept until it was destroyed. The COTP gave the user a visual representation of all tracks that provided information on both friendly tracks and hostile tracks. The provide COTP module is shown in Figure 46.



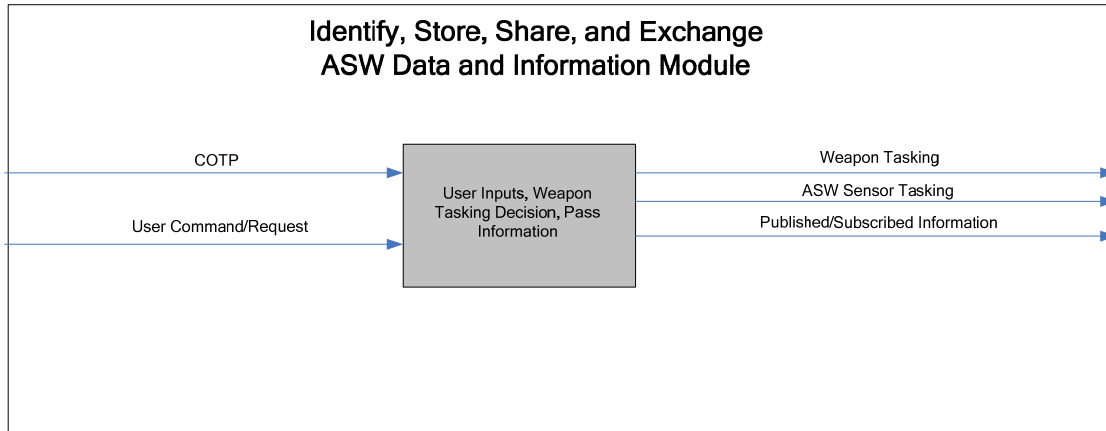
**Figure 46. Provide COTP Module**

This figure shows the provide COTP module of the model. The inputs and outputs for each of these functions are based upon IDEF0 and functional flow block diagrams.

(4) Identify, Store, Share, and Share ASW Data and Information

This function included all the actions necessary to store, publish, and exchange information and data. Data was appropriately identified, labeled, and placed into a repository which was shared by the engage portion of the model. Information on the tracks that the user was interested in utilizing for engagement was given a priority to be sent to the engaged elements. For a hostile track, based on its information, the appropriate weapon was selected for engagement. When the weapon of choice was out of its inventory, the system automatically selected the next appropriate weapon. Figure 47 represents information going in and out of the identify, store, share, and exchange ASW data and information module.

When the user had no communication with the system, automation was utilized to let the system select the weapon of its choice, again keeping the inventory status in mind. Finally, information was passed to the engage portion for engaging the track after the system compared the weapon selection criteria for a track against the weapon inventory.

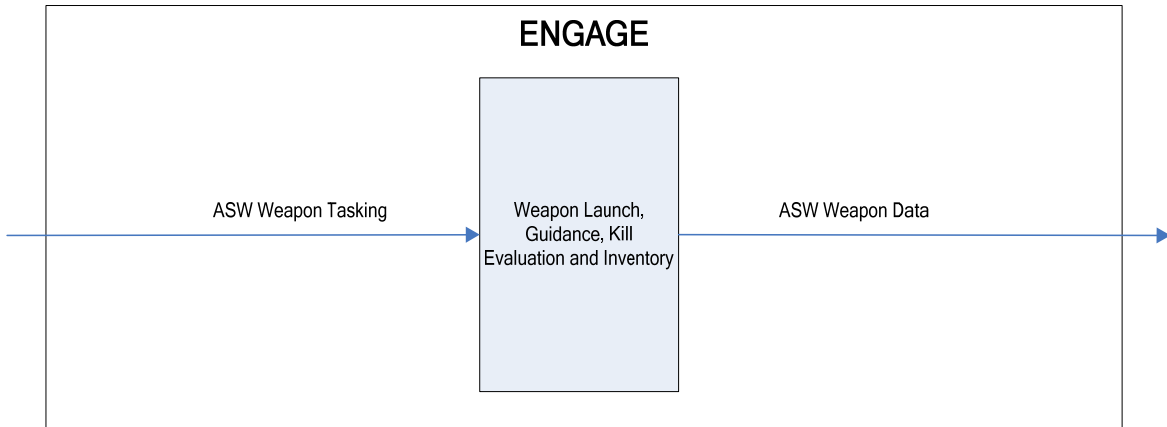


**Figure 47. Identify, Store, Share and Share ASW Data and Information Module**

This figure shows the identify, store, share, and exchange ASW data and information module of the model. The inputs and outputs for each of these functions are based upon IDEF0 and functional flow block diagrams.

***c. Engagement***

The engage portion of the model was developed in accordance with how a typical weapon engagement is executed and the kinds of outputs it will provide to the rest of the kill chain. Some of the characteristics of a weapon engagement considered were the following: receive a weapon task, launch a weapon, guide a weapon to target, provide weapon inventory, and provide a kill evaluation of the target track. To simplify the system model, it was assumed that the receive ASW information function is responsible for providing the ASW weapon tasking to the weapons. The weapon tasking was made available through the receive ASW information function in the Joint ASW C4I Architecture, which is an internal network function and is similar to retrieving a piece of mail from your mailbox. The tasking provided information regarding the weapon type and communication node. A majority of the characteristics of a weapon engagement were demonstrated; but the weapon launch, guidance, and target intercept characteristics were simplified in order to keep the model within the scope of the project. The inputs and outputs of the engagement portion can be viewed in Figure 48.



**Figure 48. Engage Section of the Model**

This figure demonstrates the input and output of the engage portion. The weapon tasks are received from the control portion. These tasks are interpreted and a weapon is engaged.

Prior to engaging a target track, the proper communication path needed to be selected to allow the weapon tasking to reach a designated platform on which the preferred weapon resided. In keeping the scope of the engagement at a minimum, the detailed launch sequence was not modeled. The overall weapon engagement, kill evaluation, and intercept were demonstrated through various probability and delay functions. The delays contained minimal times to represent a weapon launch sequence, while the probabilities represented the actuality of a weapon intercepting the target track. Depending on the probability of weapon intercept, a kill or no kill status was provided to the control architecture. Next, an evaluation of weapon inventory was modeled by decrementing the number of weapons available every time a particular weapon was selected and launched. The status for kill evaluation, weapon inventory, and target engaged were then provided to the control section for further evaluation.

## 5. Modeling Alternatives

For all four alternatives, the baseline model is used as a skeleton to start the modeling, specifically the detect and engage functions of the baseline model. Furthermore, the configuration of the users' inputs and the insertion of a scenario with multiple tracks were also common among the alternatives. The alternatives differed from each other in terms of the predicted performance of the communication systems and the additions of different sensors. Thus, based on these differences in communication, the models for each alternative were constructed. Within each model, the inputs for latency for line-of-sight, beyond line-of-sight, and common operational and tactical picture were pulled from Table 7 through Table 14 in the alternatives generation section. Furthermore, for the model to represent a realistic environment, random normal distribution generators of time for information being inserted from outside threats and

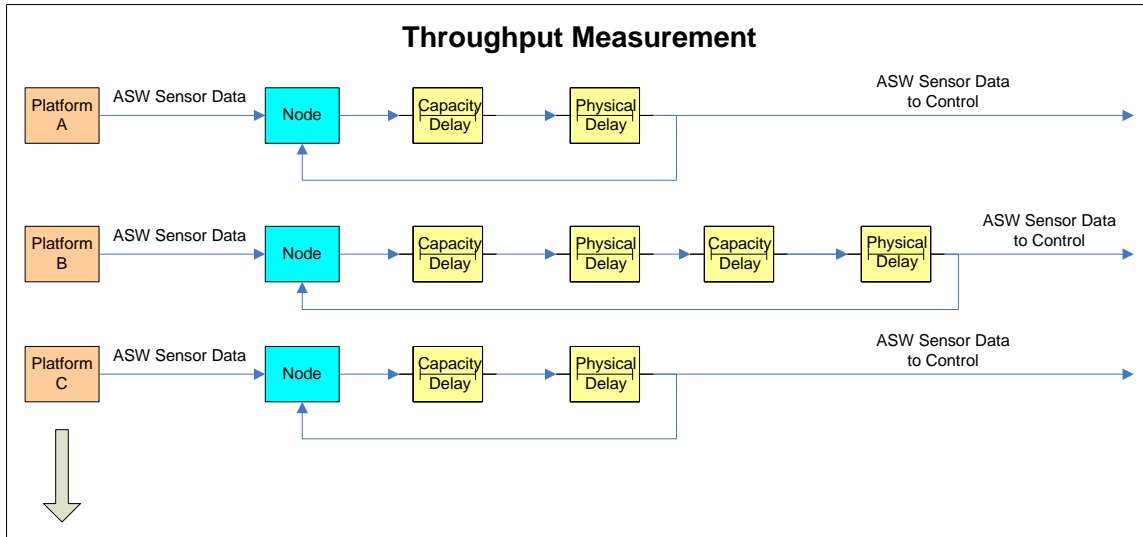
from sensors within the system were added into the control section. Tolerance levels were set for each distribution generator so that the outputs being generated for each of the runs for each alternative are not controlled.

#### **D. MODELING AND SIMULATION RESULTS**

As stated previously, the evaluation measures that were modeled were throughput, latency, and data fusion time. To effectively model these evaluation measures, each of the four alternatives was simulated ten times in the operational scenario model. During each one of these simulations, one hundred data points were collected for each of the three evaluation measures. Overall, this resulted in one thousand data points for each evaluation measure for every one of the four alternatives. The amount of data captured with the simulations allowed the mean to be calculated for each evaluation measure for each alternative. The data was also used to construct visual statistical techniques such as histograms to demonstrate the frequency distribution of the data and to aid in the determination of any skewness or outliers in the data.

##### **1. Throughput Results**

The throughput evaluation measurement represented the amount of data, in kilobits per second, that could flow through any particular platform based on the allowable bandwidth, size of the data, and time. It is important to maximize throughput because this allows more information to flow through the system and ultimately speeds up the kill chain. In the Joint ASW C4I Architecture model, the throughput measurement was taken for every platform from the operational scenario. The throughput measurement was collected at a node that was located at the output of contact tracks and after the capacity and physical delays as part of a feedback loop. This is all depicted in Figure 49. As seen in this figure, there were numerous platforms which required multiple communication jumps to reach the control portion of the kill chain. These platforms were modeled with more capacity and physical delays as shown in platform B in the figure.



**Figure 49. Throughput Measurement Block Diagram**

The figure depicts the nodes used to obtain the throughput measurements in the various alternatives.

The configuration of the model allowed for simple adjustments to the capacity and physical delays. After ten simulations were run for each alternative and data was recorded, the throughput mean for each alternative was calculated. For the throughput measurement, every alternative had approximately one thousand data points to calculate the throughput mean. The calculated mean for Alternative 0, 51.292 kilobits per second, was the lowest throughput mean when compared to all the alternatives as viewed in Table 16. The mean for Alternative 2, 58.855 kilobits per second, was the highest of all the alternatives.

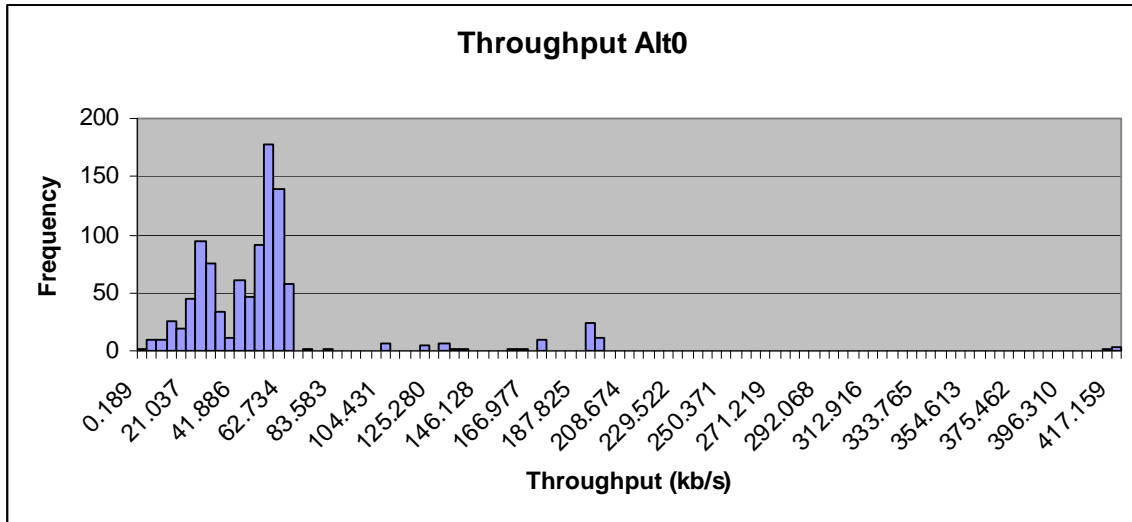
Measurement	Alt 0	Alt 1	Alt 2	Alt 3
Throughput (kbps)	51.292	53.930	58.855	58.155

**Table 16. Average Throughput Comparison of all Alternatives**

This table shows the mean of all the ten runs of all the alternatives. It can be observed from the table that Alternative 2 had the largest throughput mean.

Histograms were constructed in order to better comprehend the behavior of the data, such as the one found in Figure 50 for Alternative 0. The histogram provided a visual depiction of Alternative 0's frequency distribution of the throughput data. The figure shows that the data for Alternative 0 was positively skewed. This phenomenon was a result of numerous outliers that were generated due to certain platforms having

longer delay times and various jumps to get their sensor data to the control function. The phenomenon was consistent with the rest of the alternatives as seen in Appendix I.



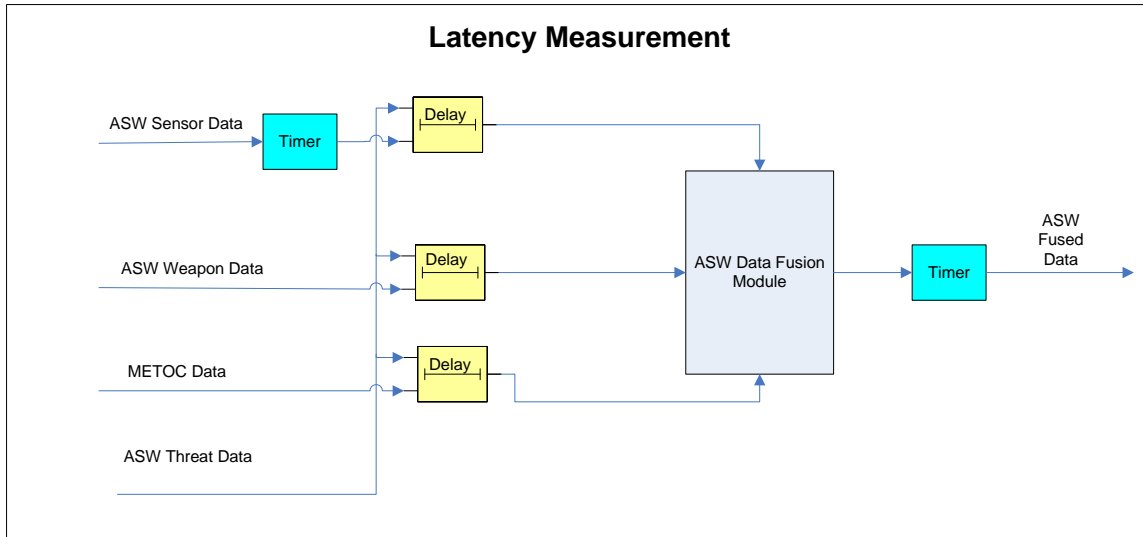
**Figure 50. Throughput Measurement for Alternative 0**

This figure shows the histogram of the throughput measurement for Alternative 0. The mean of all the data was calculated and used in the average throughput comparison between all the alternatives.

## 2. Latency Results

The latency evaluation measurement represented the internal processing time of data. It is important to minimize latency because this increases the flow of information through the system and ultimately speeds up the kill chain. In the Joint ASW C4I Architecture model, the latency measurement was taken at the control section of the system because all the data processing of the operational scenario occurred at this point. The latency measurement was obtained by allocating timers at particular locations in the model to obtain the time when a track entered the control section and when it exited the section, as displayed in Figure 51.





**Figure 51. Latency Measurement Block Diagram**

The figure depicts the timers used to obtain the latency measurements in the various alternatives.

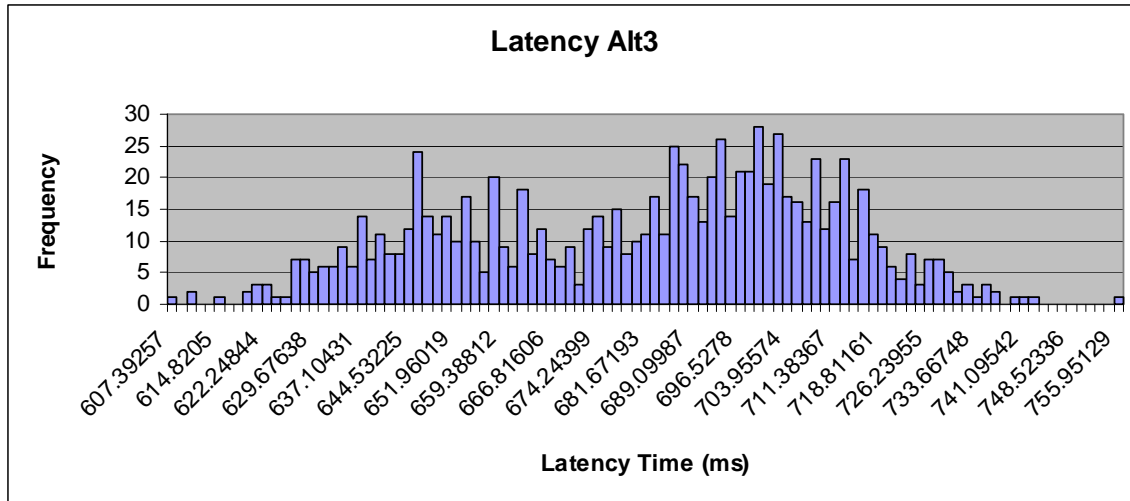
The configuration of the model allowed for a complete measurement of latency from start to finish within the Joint ASW C4I Architecture. After ten simulations were run for each alternative and data was recorded, the latency mean for each alternative was calculated. Every alternative had approximately one thousand data points to calculate the latency mean. The calculated mean for Alternative 3, 680.160 milliseconds, was the lowest latency mean when compared to all the alternatives as viewed in Table 17. The mean for Alternative 0, 1334.161 milliseconds, was the highest of all the alternatives.

Measurement	Alt 0	Alt 1	Alt 2	Alt 3
Latency (ms)	1334.161	1205.027	685.560	680.160

**Table 17. Latency Time Averages for all Alternatives**

This table demonstrates the averages of all the ten runs of all the alternatives for the latency measurement. It can be observed from the table that Alternative 0 had the largest latency mean.

Similar to the throughput measurement, histograms were constructed such as the one found in Figure 52 for Alternative 3 to better comprehend the behavior of the data. The histogram provided a visual depiction of Alternative 3's frequency distribution of the latency data. It can be observed that the data for Alternative 3 was bimodal. This phenomena was the result of two variables: the delayed sensor data received from platforms in the sensor portion and the relative distance of both timers. The phenomenon was consistent with the rest of the alternatives as seen in Appendix I.

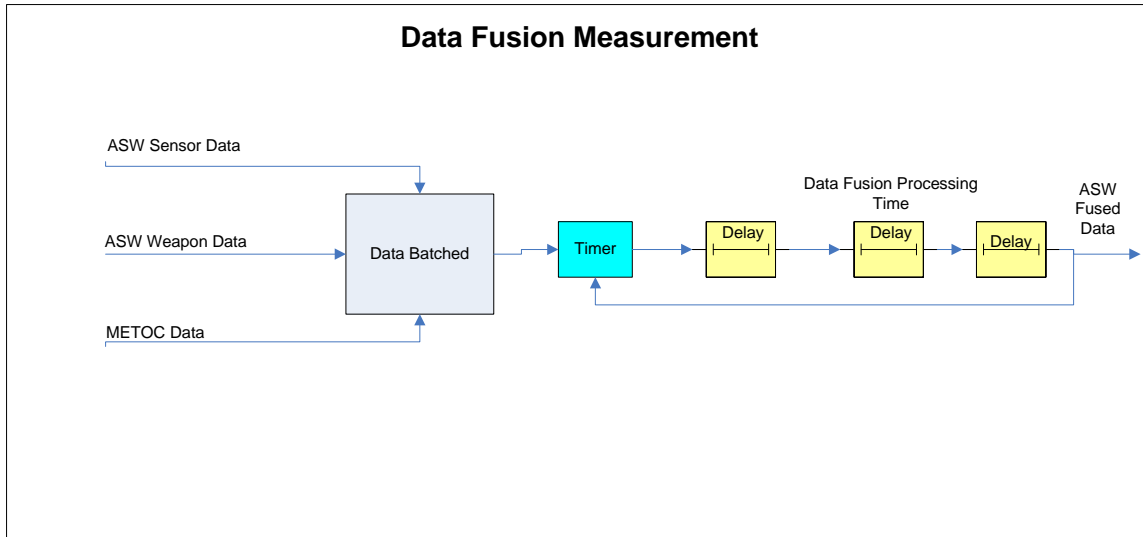


**Figure 52. Latency Time Histogram of Alternative 3**

This figure shows the histogram of the latency measurement for Alternative 3. The average of all the data was calculated and used in the average latency comparison between all the alternatives.

### 3. Data Fusion Results

The data fusion evaluation measurement represented the amount of time to fuse various sensor, weapon, and METOC data. It is important to minimize data fusion time because this increases the flow of information through the system and ultimately speeds up the kill chain. Data fusion was considered a black box within the Joint ASW C4I Architecture model, that consisted of multiple delay functions which demonstrated the data fusion processing time found in various systems. As shown in Figure 53, the measurement for data fusion processing was obtained by incorporating a timer after all the inputs from ASW sensor data, ASW weapon data, and METOC data were fused and sent to the COTP.



**Figure 53. Data Fusion Measurement Block Diagram**

The figure depicts the timer used to obtain the Data Fusion Measurements in the various alternatives.

As with the throughput and latency measurements, the data fusion processing time measurement was obtained through simulation of the Joint ASW C4I model. The model was simulated ten times for each alternative and data fusion processing time was captured. The data fusion processing time mean for each alternative was calculated. Every alternative had approximately one thousand data points to calculate the data fusion processing time mean. The calculated mean for Alternative 3, 299.720 milliseconds, was the lowest data fusion processing time mean when compared to all the alternatives as viewed in Table 18. The mean for Alternative 0, 702.395 milliseconds, was the highest of all the alternatives.

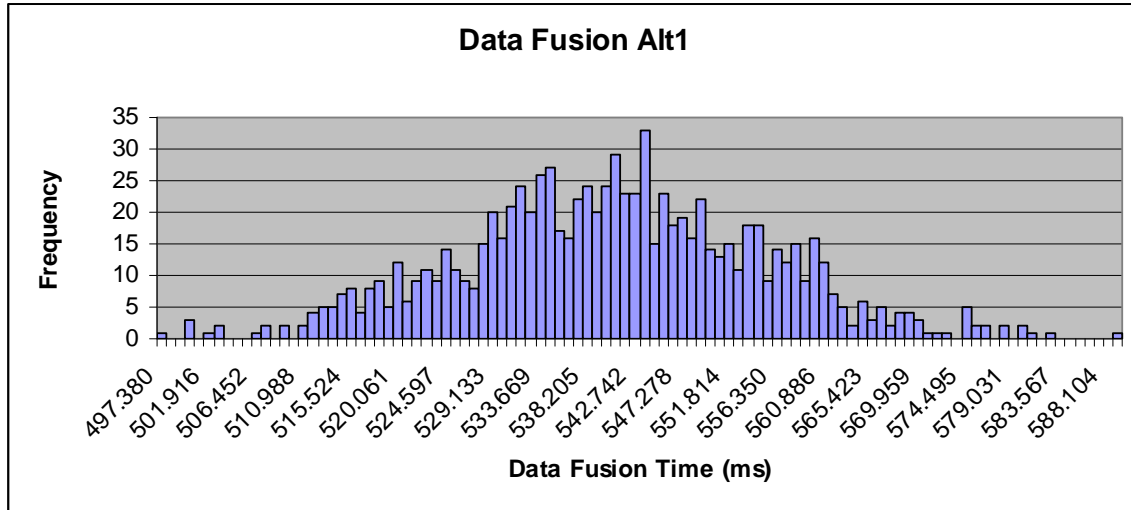
Measurement	Alt 0	Alt 1	Alt 2	Alt 3
Data Fusion Processing Time (ms)	702.395	540.139	299.823	299.720

**Table 18. Fusion Time Averages for all Alternatives**

This table demonstrates the averages of all the ten runs of all the alternatives for the data fusion time measurement. It can be observed from the table that Alternative 3 had the lowest data fusion time average.

To better comprehend the behavior of the data, histograms were constructed such as the one found in Figure 54 for Alternative 1. The histogram provided a visual depiction of Alternative 1's frequency distribution of the data fusion processing time. It can be observed that the data for Alternative 1 was unimodal in nature and had a normal

distribution. This phenomenon was consistent with the rest of the alternatives as seen in Appendix I.



**Figure 54. Fusion Time Histogram for Alternative 1**

This figure shows the histogram of the data fusion time measurement for Alternative 1. The population mean of all the data was calculated and used in the average data fusion time comparison between all the alternatives.

**E. MODELING AND SIMULATION SUMMARY**

The modeling and simulation phase of the Joint ASW C4I Architecture utilized a simple operational scenario and performance models, built in EXTEND, to quantify the performance of each alternative. This was accomplished through simulation to generate data related to evaluation measures developed in the value system. The evaluation measures identified for modeling and simulation were throughput, latency, and data fusion time. The values for throughput and latency, which were inputs into the model, came from the alternatives generation section. These values were acquired through extensive research of fielded and planned systems. Furthermore, the values for data fusion times were derived from the aforementioned data. A summary of the results that were inputs to the analysis of alternatives are displayed in Table 19.

Measurement	Alt 0	Alt 1	Alt 2	Alt 3
Throughput (kbps)	51.292	53.93	58.855	58.155
Latency (ms)	1334.161	1205.027	685.56	680.16
Data Fusion Processing Time (ms)	702.395	540.139	299.823	299.72

**Table 19. Modeling and Simulations Results**

This table demonstrates the averages of all the ten runs of all the alternatives for the throughput, latency, and data fusion measurements.

Overall, confidence is high in the modeled results because the input values were traceable through the systems engineering process and represent a close approximation of the actual performance. While the model provides insight to difficulties and expectations for networks supporting line-of-sight and long haul communications, it does not accurately describe the multitude of two way electronic signals traveling between the ASW fleet's communications suites. More explicit data inputs would improve the understanding of the Joint ASW C4I Architecture's ability to interoperate. However, this would require the use of far more robust modeling techniques but would permit the operational user to identify and quickly enter new C4I tools as they continually improve operational data transmission means. The C4I network architecture modeled here identifies problems of latency, environmental and distance constraints, and more importantly demonstrates the extreme level of difficulty for multiple frequency ASW operations on a global scale.

## **VI. LIFE CYCLE COSTS**

### **A. LIFE CYCLE COST OVERVIEW**

Life cycle cost estimation (LCCE) for the Joint ASW C4I Architecture is an important multi-faceted contributor of the systems engineering process. LCCE, when sufficiently detailed, enables high level decision makers to determine affordability, analyze alternatives, conduct cost versus performance tradeoffs, and establish program cost goals. A conscious decision was made to limit the scope of the life cycle costs for this project to research and development, production and installation, operation and support, and disposal costs. Ground truth information was sought out from program executive offices to better itemize future C4I architecture costs. The life cycle cost summary provided a solid basis for recommending the best alternative addressing the war fighter's needs.

### **B. COST ESTIMATION APPROACH**

#### **1. Scope**

LCCE was developed for each of the four alternatives described in the alternatives generation section. The cost categories addressed are research and development, production and installation, operation and support, and disposal. The LCCE is for a single United States Navy ship and only shows costs to address the functional gaps identified in the alternatives generation section, Table 6. LCCE does not include costs for the coalition or joint partners to deploy the Joint ASW C4I Architecture. A separate analysis for costs would have to be carried out for coalition partners as their functional gaps would be different depending on their specific implemented architecture.

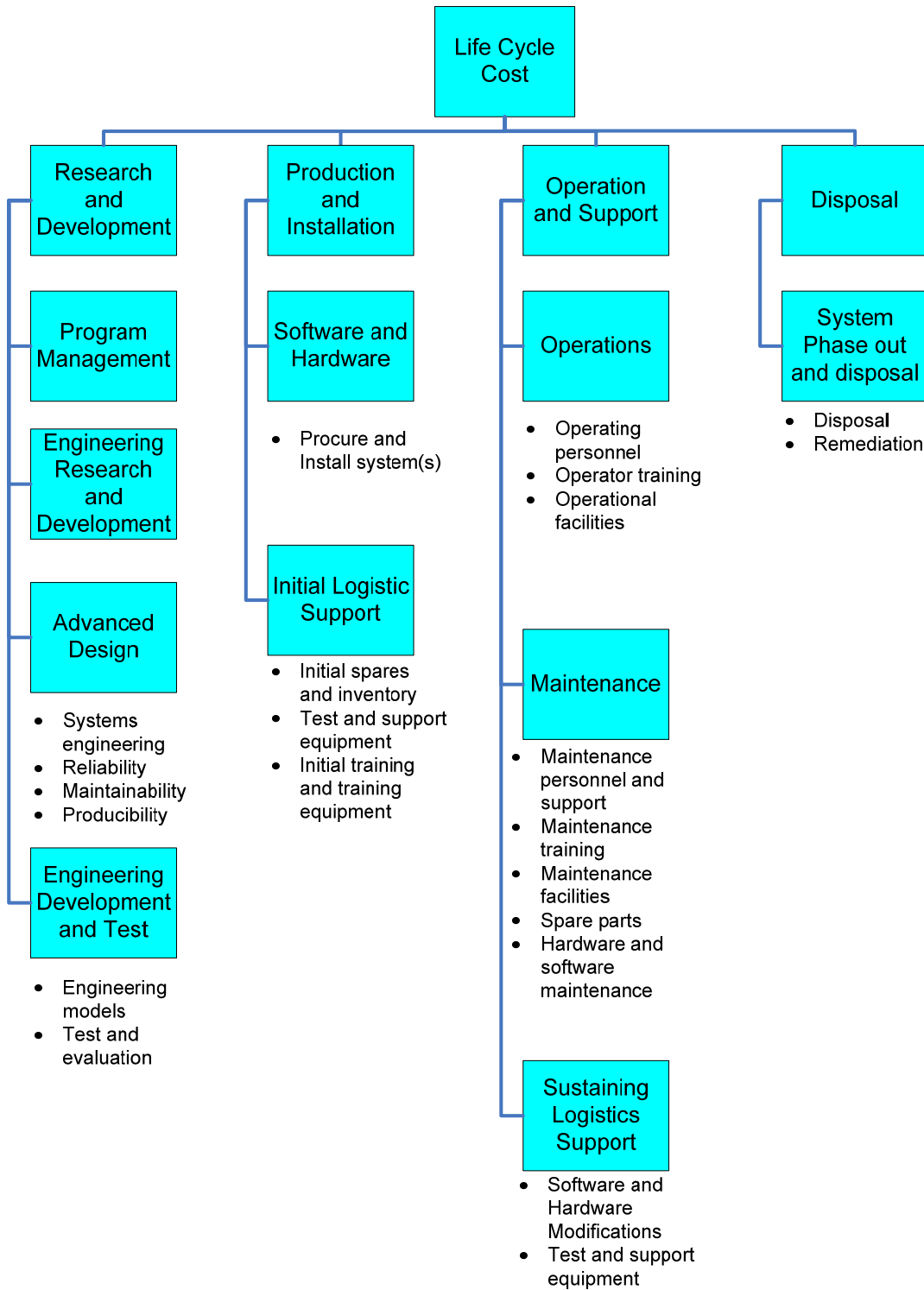
#### **2. Assumptions**

Multiple DoD infrastructure programs of record contribute to the Joint ASW C4I Architecture. The components of a joint net-centric architecture are the space segment such as SATCOM – TSAT and CBSP; terrestrial infrastructure segment such as gateways for space segments, internet gateways, and line-of-sight links such as microwave, fiber, JTRS; network management segment; and the local node segment that includes hosted service oriented architecture applications and common computing environment. A nine year life cycle is assumed based on obsolescence of technology in software, hardware, and architecture. The individual programs of record within the four segments have their own life cycles. This life cycle cost estimate, provided below, only applies to the local segment for a notional Navy ship. This is a simplification of the problem at hand to make it manageable. The life cycle cost for Alternatives 0, 1, and 2 covers the common computing infrastructure, wide band internet protocol based communications, and service

oriented architecture for the Joint ASW C4I Architecture. Alternative 3 adds HALO and HAA platforms to the joint net-centric architecture. Research and development costs are incurred whether the capability is deployed on one ship or the entire fleet. Man-day costs, percentage of time an operator works on the system, mean time to repair, logistical delay time, maintenance delay time, number of operators and maintainers, and number of repair actions per system per year are included in the overall operation and support costs. Maintenance is restricted to be replacement of defective items.

### **3. Cost Breakdown Structure**

A cost breakdown structure was developed as an aid to the life cycle cost analysis. The cost break down structure is displayed in Figure 55. The cost breakdown structure was built to cover activities and associated costs which include research and development, production and installation, operation and support, and disposal. The CBS guided the collection of data from the individual program offices.



**Figure 55. Cost Breakdown Structure**

This figure shows the cost breakdown structure used to estimate Joint ASW C4I Architecture costs. Cost data for each of the sub-elements was collected and rolled up to the top level categories: Research and Development, Production and Installation, Operation and Support and Disposal.



Research and development costs are costs related to program management; concept refinement; trade studies; prototyping – fabrication and assembly, engineering, integration, testing, and test equipment; training; and initial spares associated with prototypes and engineering development models. Research and development costs for the Joint ASW C4I architecture are recurring costs. Research and development provides new capabilities through continuous investment in each new increment and also addresses the need to reduce manpower requirements through increasing levels of automation and distance support. Research and development costs for Alternative 0, 1, and 2 is a mix of integration costs for commercial of the shelf software and hardware and development and integration of special purpose built software and hardware. Research and development costs for Alternative 3 are higher as this capability requires development and maturation of new technology.

Production and installation costs cover production and deployment costs from the initial production units through full deployment. These costs include program management, hardware and software, engineering, special equipment needed in the production and deployment, training, technical publication, and initial spares and repair parts. It also includes site construction, operation, and maintenance costs as needed. Installation of systems on a ship is an expensive effort as compared to installation of systems at a shore site. Installation for future ASW C4I will be enhanced through complete staging of modular systems at pre-configuration facilities. The modular system will be fully assembled and tested in an integration facility which duplicates the final environment down to cable lengths. This will reduce costs and greatly simplify installation and check out of a system on ship. Production and installation cost for Alternative 3 are higher due to the need for ground control stations which are required for management and control of these platforms.

Operation and support costs are all costs, direct or indirect, that pay for personnel, supplies, equipment, software and hardware maintenance, and training. The costs cover the time from initial deployment to end of systems life. Operation and support costs are the dominating costs over the life of a ship. The future ASW C4I architecture will be designed to reduce operation and support costs through “smart equipment” design, simpler modular equipments that are repairable on board ships, tracking equipment life history for condition based maintenance, and automated diagnostics for isolating problems and directing repair. Maintenance concept is limited to replacement of defective parts and or whole units. Operation and support costs for Alternative 3 are much higher than any of the other alternatives, because Alternative 3 requires ground control stations and personnel to man it. Costs may be reduced by sharing the cost of this

platform with other unmanned vehicles. Yearly operation and support costs for the alternatives are assumed to be fourteen percent of procurement cost.

Disposal costs are costs associated with removing the system from its deployed environment and its proper disposal. This includes demilitarization, disassembly, hazardous material processing and decontamination of site and equipment, transportation, and safety precautions. Disposal costs can be as simple as de-installing an automated information system or as complex and costly a task as proper disposal of nuclear waste. The wide variability of costs associated with disposal requires serious consideration up front. Disposal costs for future ASW C4I systems are expected to increase as environmental laws are tightened and global awareness of environment grows. The use of solar panels and fuel cells increases the costs of disposal for Alternative 3.

### **C. COST DATA COLLECTION**

Program Executive Offices (PEO) are the DoD's acquisition arms that provide mission capabilities to the fleet. PEO Integrated Warfare Systems (IWS) provides the combat systems, PEO Littoral and Mine Warfare (LMW) provides mission systems that support LMW, and PEO C4I is responsible for the acquisition of the communication links such as tactical data links, line-of-sight, and beyond line-of-sight communications for the Joint ASW C4I Architecture as well as ship wide common computing environment, signal exploitation system, command and control systems, meteorological systems, cryptography hardware, and crypto logical systems. The C4I cost data was collected from the PEO C4I program offices through interviews with Mr. Roland Feghali (PMW 120), Mr. R. Miguel Heard (PMW 150), Mr. Baasit Saijid (PMW 160), and Mr. Joel Cabana (PMW 170) [Feghali, 2008; Heard, 2008; Saijid, 2008; Cabana, 2008]. Cost data was requested from PEO IWS but was never received. No cost data was requested from PEO LMW. One reason was the hesitancy of each program to share what is considered sensitive cost data. The fidelity of data as well as the time span addressed varies greatly by source; sometimes the costs were ship construction Navy costs and sometimes the costs were research and development costs that were provided for only two or three cost categories over future years defense plan. Most of the data was at the level of individual program offices within the PEO. Operation and support costs were assumed to be approximately fourteen percent of procurement cost per year for commercial off the shelf products (hardware and software). This is a nominal operational and maintenance cost and is consistent with operation and support costs currently incurred in similar programs across PEO C4I and DoD.

Table 20 summarizes the preliminary life cycle cost estimate for each category. The costs are in millions of dollars and have been deflated using DoD guidelines for future years. The table shows costs of each alternative starting from relative year one of the program out to year nine. The total cost for Alternative 0 is \$95.09M, Alternative 1 is \$121.11M, Alternative 2 is \$136.92M, and Alternative 3 is \$854.60M.

		Year									Totals
		1	2	3	4	5	6	7	8	9	
		\$M	\$M	\$M	\$M	\$M	\$M	\$M	\$M	\$M	\$Million
Alt0	R&D	6.14	10.14	8.92	16.08	18.21	10.55	0.00	0.00	0.00	70.04
	P&I	0.00	0.00	7.19	0.00	0.00	0.00	10.16	0.00	0.00	17.35
	O&S	0.00	0.00	0.00	1.01	1.07	1.15	1.27	1.42	1.63	7.54
	Disposal	0.00	0.00	0.00	0.00	0.00	0.00	0.00	0.00	0.15	0.15
	Totals	6.14	10.14	16.11	17.09	19.27	11.70	11.43	1.42	1.78	95.09
Alt1	R&D	10.76	14.29	13.12	20.22	22.43	14.86	0.00	0.00	0.00	95.67
	P&I	0.00	0.00	7.30	0.00	0.00	0.00	10.32	0.00	0.00	17.62
	O&S	0.00	0.00	0.00	1.02	1.08	1.17	1.29	1.44	1.65	7.66
	Disposal	0.00	0.00	0.00	0.00	0.00	0.00	0.00	0.00	0.15	0.15
	Totals	10.76	14.29	20.42	21.24	23.51	16.03	11.60	1.44	1.81	121.11
Alt2	R&D	13.86	18.19	14.62	20.92	22.43	14.86	0.00	0.00	0.00	104.87
	P&I	0.00	0.00	9.20	0.00	0.00	0.00	13.00	0.00	0.00	22.20
	O&S	0.00	0.00	0.00	1.29	1.36	1.47	1.62	1.82	2.09	9.65
	Disposal	0.00	0.00	0.00	0.00	0.00	0.00	0.00	0.00	0.20	0.20
	Totals	13.86	18.19	23.82	22.21	23.79	16.33	14.62	1.82	2.28	136.92
Alt3	R&D	51.65	59.51	53.47	61.93	62.73	55.07	0.00	0.00	0.00	344.36
	P&I	0.00	0.00	146.20	0.00	0.00	0.00	206.59	0.00	0.00	352.79
	O&S	0.00	0.00	0.00	20.47	21.66	23.38	25.75	28.92	33.14	153.32
	Disposal	0.00	0.00	0.00	0.00	0.00	0.00	0.00	0.00	4.13	4.13
	Totals	51.65	59.51	199.67	82.40	84.39	78.45	232.34	28.92	37.27	854.60

**Table 20. Life Cycle Cost Summary**

This table is a life cycle cost summary for Alternative 0 through Alternative 3. Each row is a major cost category and the columns represent cost for that relative year. Each cost category total appears in the right most column and the total cost for each alternative is the highlighted cell.

Alternative 0 is the baseline cost for the Joint ASW C4I Architecture. Alternative 1 augments Alternative 0 with line-of-sight and beyond line-of-site wide band internet protocol based communications and Alternative 2 adds the service-oriented architecture capability to the Joint ASW C4I Architecture. The maintenance costs for Alternatives 0, 1, and 2 vary only slightly. This is due to the fact that Alternative 0 is the common network infrastructure for the whole ship and is the major portion of the operation and support costs. The introduction of additional capability in Alternative 1 and 2 does not increase the operation and maintenance cost significantly because a ship's automated data processing support staff is fixed. The operation and support cost increases for Alternative 1 and 2 are cumulative as each alternative builds on the previous one. The highest cost alternative is Alternative 3. It proposes the introduction of a HALO platform to improve line-of-sight communication capability. This capability, if implemented, would reduce the latency due to beyond line-of-sight communications (eliminate satellite hops) to every component of a strike group. This capability requires a large investment in research and development in the areas of power distribution, payload, lifting gas, solar panels, energy storage, and production systems, drive train, and airship structure and consequently had the highest cost [Colozza and Dolce, 2005:8-10; Global Security: High Altitude Airship, 2008]. Operation and support costs are assumed to be about fourteen percent per year of procurement costs for Alternative 3. This is in line with operation and support costs for Global Hawk which is another unmanned air vehicle [United States General Accounting Office, 2000]. The disposal costs are de-installation costs which are assumed to be small as compared to the overall cost of the system. The de-installation would consist of disconnecting power and signal cables, removing whole equipment racks, and recycling material and does not require careful disassembly, handling, or management of hazardous material.

## VII. ANALYSIS OF ALTERNATIVES

### A. METHODOLOGY

An Analysis of Alternatives (AoA) was conducted to compare the performance of the four feasible alternatives. The Analysis of Alternatives compares the alternatives' ability to satisfy requirements to their life cycle cost to produce a cost-effectiveness comparison. This comparison allows the stakeholders to evaluate the alternatives and make a decision.

To simplify the selection of the alternative, multi-attribute utility theory (MAUT) was used. Sage and Armstrong [2000: 414] define MAUT as, "an approach for evaluating, prioritizing, and ranking the outcomes associated with different action alternatives in complex decision situations." The details of the MAUT process used are outlined in the next section.

Choosing an alternative can often be very difficult because it is impossible to compare the values of multiple evaluation measures since they may be measured in totally different units. It is a much easier decision when the stakeholders have a single quantitative value. Thus, the team derived a scalar-valued function that produced a single quantitative value for each function and allowed the stakeholders to compare alternatives across all the evaluation measures. The scalar-valued function that was developed for the purposes of analysis is

$$v[x_1, \dots, x_n] = w_1v_1[x_1] + w_2v_2[x_2] + \dots + w_nv_n[x_n]$$

where  $x_i$  is the evaluation measure for a function,  $v_i(x_i)$  is the utility score of that evaluation measure for the specific alternatives, and  $w_i$  is the weight of the evaluation measure.

MAUT was used because it is a useful tool that takes multiple evaluation measures and an aggregation of individual preferences and simplifies them into a scalar-valued function that can aid in deciding between alternatives. While completing MAUT it was assumed that the evaluation measures used in the analysis were based on the most important factors of the overall system and each factor was independent of each other. The team understood that MAUT is based on preferences that are clearly subjective and sometimes the conclusions are open to question. Furthermore, while completing MAUT the team understood the difficulty and sensitivity in determining the weights of evaluation measures and their associated utility curves. Even with the shortcomings of MAUT, it was decided this was the best method for analysis and MAUT made it easy to quantify the alternatives and explain it to stakeholders.

## **B. VALUE MODELING TECHNIQUE**

The first step in MAUT is to define the evaluation measures that will be used to compare the performance of each of the alternatives. Five functions and their six associated evaluation measures were considered for comparing the performance of each of the alternatives. Of the five functions, four of them were the stakeholders' top ranked functions. The top ranked functions are the most important functions identified by the stakeholders from the Value System Design survey. It should be noted these are the measures associated with the exact same functions considered the most important as discussed in the Value System and Alternatives Generation sections. The other function that was used, Transmit ASW Information, was also a highly ranked function and was easily modeled during the modeling and simulation phase. The evaluation measures that were considered for comparing alternatives were percentage of users with access to the COTP, time required to fuse data, time to interconnect, time to pull and push information, transmit latency, and transmit throughput. However, the percentage of users with access to the COTP is 100% for all alternatives as noted in the Alternatives Generation section. Furthermore, the time to push and pull information is the same for all alternatives as noted in the Alternatives Generation section. Therefore, since these evaluation measures were equal for all alternatives they were eliminated from the analysis. In the end, four evaluation measures were used to compare the alternatives: time required to fuse data, time to interconnect, transmit latency, and transmit throughput.

The next step in creating the scalar-valued utility function is the development of a raw data matrix and utility curves in order to assign utility scores to the evaluation measure of each specific alternative. The raw data matrix contains the raw scores of each alternative with respect to each evaluation measure and is a quick way to compare alternatives based on their raw numbers. Utility curves were used to translate the raw data for each evaluation measure into a score from 0 to 1. For each alternative, this utility score represents what the stakeholders' satisfaction with that attribute would be. The process of creating the utility curves is discussed in the next section.

Next, weightings were developed for each evaluation measure. The weight computation method used was based on swing weights and was a combination of ordering preference and direct decision and input. The method that was followed was very similar to the approach used by Clemen and Reilly [2001: 615]. Swing weights are useful because they take into account the relative value of moving from best to worst on each scale.

Finally, a decision matrix was created that assigned values for each attribute for the four feasible alternatives. To create the decision matrix, each alternative's raw data

values were mapped onto the value curves to determine their utility scores. The weights were applied to the utility scores for each evaluation measure and the result for each alternative was summed into a single score. This single score quantified the performance of each alternative.

## **C. UTILITY CURVES**

### **1. Development of Utility Curves**

Wymorian scoring functions were used to develop the utility curves because of the parameters that were available. Wymore [1993] developed a set of twelve standard scoring functions which represent twelve fundamental shapes and vary based on the availability of the following parameters [Daniels, Werner, and Bahill, 2001: 203]:

- L: The parameter L is the lower threshold of performance and the value to the customer is undesirable (but not necessarily unacceptable) and is assigned a zero score.
- U: The parameter U is the higher threshold of performance and the value to the customer is very desirable and is assigned a one score.
- B: The parameter B is called the baseline value and can be chosen as the design goal or the status quo for this or similar systems. By definition, baseline values are always assigned a score of 0.5.
- S: The parameter S determines the behavior of the scoring function in the neighborhood of the baseline value B. Mathematically, S is the slope of the tangent to the scoring function at the baseline value B. Practically speaking, the slope represents the maximum incremental change in the customer's quantitative judgment with each incremental change in input.
- D: The parameter D represents the domain of definition of the scoring function. Values outside this range constitute impossible or unacceptable inputs.

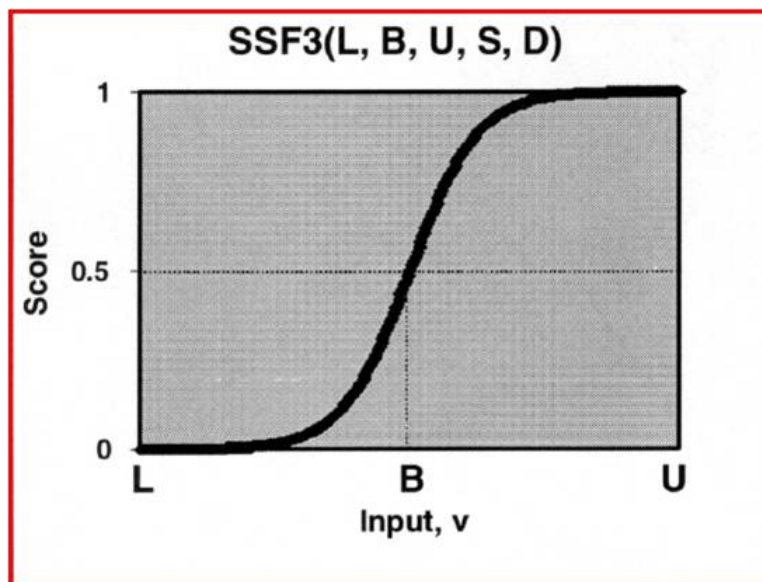
For the purposes of the Joint ASW C4I Architecture, the Wymorian scoring functions were limited to Standard Scoring Function 3 (SSF3) and SSF9 since all the values for the parameters were provided by the stakeholders. SSF3 is used if “more is better, the customer can provide both a finite upper bound and finite lower bound” [Daniels, Werner, and Bahill, 2001: 204-205]. SSF9 is used if “more is worse, and the stakeholder can provide both a finite upper bound and a finite lower bound” [Daniels, Werner, and Bahill, 2001: 205]. The values for the parameters L, U, and B were developed by sending a survey to the stakeholders to determine their preferences. The stakeholders were asked to provide the following:



- The lowest threshold performance which the value to the customer is undesirable and is assigned a zero score.
- The upper threshold performance which the value to the customer is very desirable and is assigned a score of 1.
- The baseline value which is the design goal or the status quo for this or similar systems and is assigned a score of 0.5.

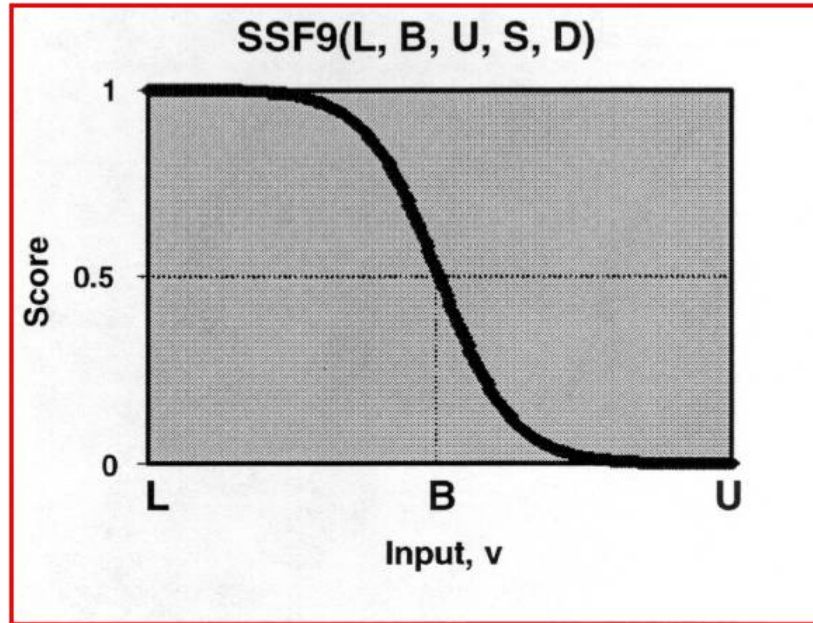
A survey was sent to the stakeholders to develop the initial parameters and utility curves for the four evaluation measures. The utility curves were then sent to the stakeholders for feedback and approval. Ultimately, the stakeholders approved of the utility curves presented below.

Example plots of SSF3 and SSF9 can be found in Figure 56 and Figure 57, respectively. To build the utility curves, Wymore’s Scoring Functions Tool built by Tom Rogers was used [Rogers, 2008].



**Figure 56. SSF3 Utility Curve**

This is an example of a standard SSF3 utility curve [Daniels, Werner, and Bahill, 2001: 204]. Five parameters were needed to create the SSF3: Lower Limit (L), Baseline (B), Upper Limit (U), Slope (S), and Domain (D). SSF3 was used for evaluation measures that are more valuable as they increase.

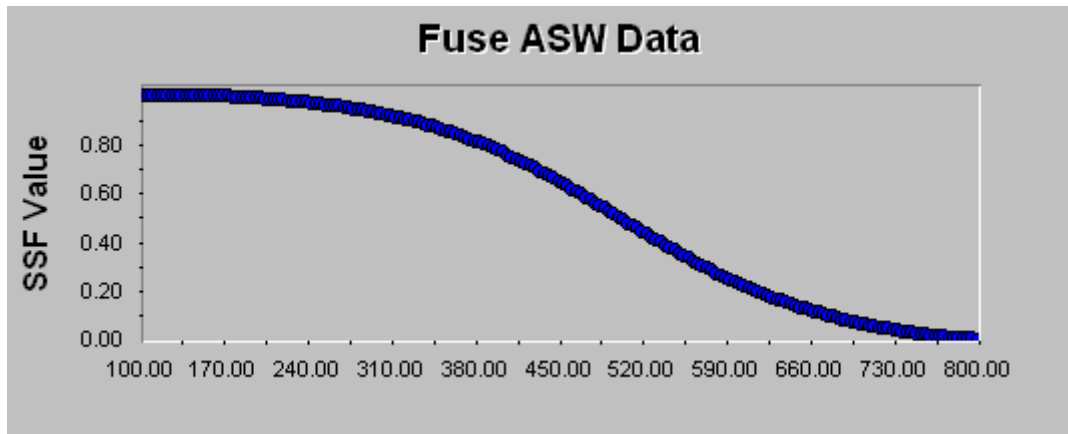


**Figure 57. SSF9 Utility Curve**

This is an example of a standard SSF9 utility curve [Daniels, Werner, and Bahill, 2001: 208]. Five parameters were needed to create the SSF9: Lower Limit (L), Baseline (B), Upper Limit (U), Slope (S), and Domain (D). SSF9 was used for evaluation measures that are more valuable as they decreased.

## **2. Fuse ASW Data Utility Curve**

The objective for the Fuse ASW Data function is to minimize data fusion processing time. The evaluation measure of this function is the time required to produce output from the Fuse ASW Data function and is measured in milliseconds. Since more is worse, the SSF9 curve was used. The utility curve for the Fuse ASW Data function is displayed in Figure 58.

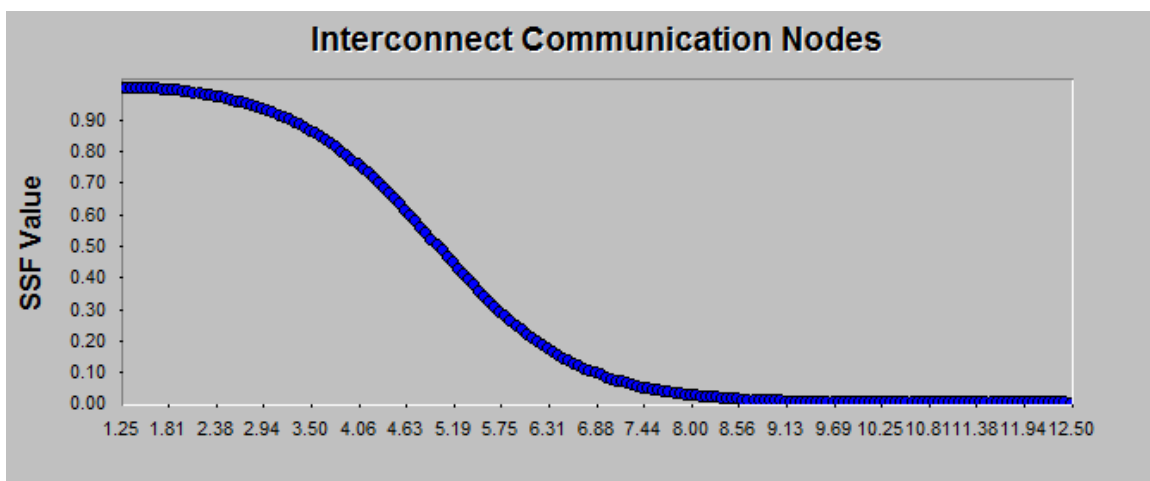


**Figure 58. Fuse ASW Data Utility Curve**

This figure shows the utility curve for the function Fuse ASW Data. The x-axis is the time required to produce output from the Fuse ASW Data function, measured in milliseconds, and the y-axis is the utility score. SSF9 parameters were  $L = 100$  ms,  $U = 800$  ms,  $B = 500$  ms,  $S = -0.003$ , and  $D = 700$  ms.

### 3. Interconnect Communication Nodes Utility Curve

The objective for the Interconnect Communication Nodes function is to minimize the network join time. The evaluation measure of this function is the time for a node to advertise its presence, be authenticated and associated, and be capable of transmitting and receiving network data and is measured in seconds. Since more is worse, the SSF9 curve was used. The utility curve for the Interconnect Communication Nodes function is displayed in Figure 59.

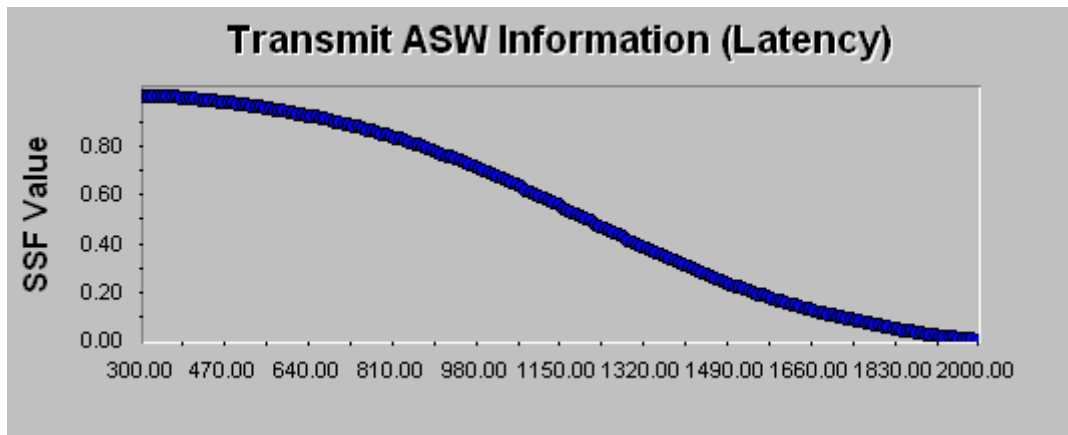


**Figure 59. Interconnect Communication Nodes Utility Curve**

This figure shows the utility curve for the function Interconnect Communication Nodes. The x-axis is time for a node to advertise its presence, be authenticated and associated, and be capable of transmitting and receiving network data measured in seconds, and the y-axis is the utility score. SSF9 parameters were  $L = 1.25$  s,  $U = 12.5$  s,  $B = 5$  s,  $S = -0.3$ , and  $D = 11.25$  s.

#### 4. Transmit ASW Information Utility Curve

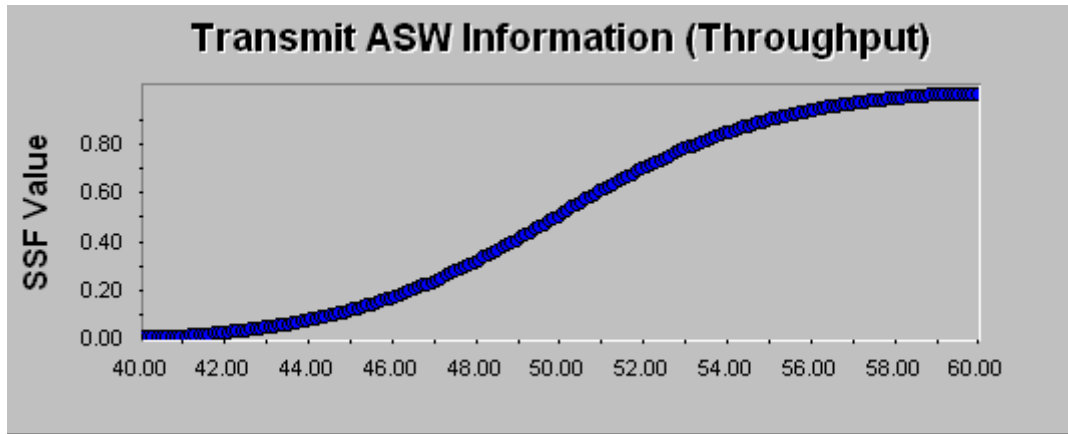
The objective for the Transmit ASW Information function is to maximize transmission efficiency. As stated previously, the Transmit ASW Information has two evaluation measures. The first evaluation measure is latency which is the time it takes to pass a track through the control portion of the kill chain in the Joint ASW C4I Architecture. Since more is worse, the SSF9 curve was used. The utility curve for the latency evaluation measure for the Transmit ASW Information function is displayed in Figure 60.



**Figure 60. Transmit ASW Information Utility Curve (Latency)**

This figure shows the utility curve for the latency evaluation measure of the function Transmit ASW Information. The x-axis is the time to transmit ASW information from one internal node to another measured in milliseconds, and the y-axis is the utility score. SSF9 parameters were  $L = 300$  ms,  $U = 2000$  ms,  $B = 1200$  ms,  $S = -0.001$ , and  $D = 950$  ms.

The second evaluation measure is throughput which was measured by modeling and simulation and it is the amount of data, in kilobits per second, that could flow through any particular platform based on the allowable bandwidth, size of the data, and time. Since more is better, the SSF3 curve was used. The utility curve for the throughput evaluation measure for the Transmit ASW Information function is displayed in Figure 61.



**Figure 61. Transmit ASW Information Utility Curve (Throughput)**

This figure shows the utility curve for the throughput evaluation measure of the function Transmit ASW Information. The x-axis is amount of kilobits that can be transmitted in one second, and the y-axis is the utility score. SSF3 parameters were  $L = 40$  Kbps,  $U = 60$  Kbps,  $B = 50$  Kbps,  $S = 0.1$ , and  $D = 20$  Kbps.

#### D. RAW DATA VALUES

This section summarizes the raw data values that were obtained from modeling and simulation and offline analysis. As stated previously, there were four evaluation measures that were used to assess the performance of the alternatives. The raw data values for the time required to fuse data, transmit latency, and transmit throughput were all obtained using modeling and simulation. The raw data values for time to interconnect were obtained through research and analysis that was completed in the Alternatives Generation section. These raw data values are displayed in

Table 21.

Function (Evaluation Measure)	Ideal Value	Alternatives			
		Alternative 0	Alternative 1	Alternative 2	Alternative 3
Fuse ASW Data (Time Required to Fuse Data)	Less is better	702.395 ms	540.139 ms	299.823 ms	299.720 ms
Interconnect Communication Nodes (Time to Interconnect)	Less is better	5 s	4.5 s	2.5 s	2.5 s
Transmit ASW Information (Transmit Latency)	Less is better	1334.161 ms	1205.027 ms	685.560 ms	680.160 ms
Transmit ASW Information (Transmit Throughput)	More is better	51.292 Kbps	53.930 Kbps	58.855 Kbps	58.155 Kbps

**Table 21. Raw Data Matrix**

This table shows the raw data matrix with raw scores for each evaluation measure and each alternative. It shows the raw scores of each alternative with respect to each evaluation measure and is a quick way to compare alternatives based on their raw numbers.

**E. EVALUTION MEASURE WEIGHTING**

The weight computation method used was based on swing weights and was a combination of ordering preference and direct decision and input. The method that was followed was very similar to the approach used by Clemen and Reilly [2001: 615]. Swing weights are useful because they take into account the relative value of moving from best to worst on each scale. Clemen and Reilly [2001: 617] explain the advantage to using swing weights:

Swing weights have a built-in advantage in that they are sensitive to the range of values that an attribute takes on. For example, suppose you are comparing two personal computers, and price is an attribute. One computer costs \$3500 and the other \$3600. When you work through the swing-weight assessment procedure, you probably will conclude that the increase in utility from swinging the price is pretty small. This would result, appropriately, in a small weight for price. But if the difference in price is \$1000 rather than \$100, the increase in utility experienced by swinging from worst to best would be much larger, resulting in a larger weight for price.

The first step in the process was to create Table 22. Each of the rows represents a hypothetical alternative with the first row representing a benchmark “worst case” scenario. Each succeeding line represents a possibility of taking just one attribute and swinging it from its worst value to its best. For example, the second row in Table 22 swung the fusion time from the worst, 702.395 milliseconds, to the best, 299.72 milliseconds.

Attribute Swung from Worst to Best	Consequence to Compare (Fusion Time, Interconnect Time, Latency, Throughput)	Rank	Rate	Weight
(Benchmark)	702.395 ms, 5 s, 1334.161 ms, 51.292 Kbps			
Fusion Time	299.72 ms, 5 s, 1334.161 ms, 51.292 Kbps			
Interconnect Time	702.395 ms, 2.5 s, 1334.161 ms, 51.292 Kbps			
Latency	702.395 ms, 5 s, 680.16 ms, 51.292 Kbps			
Throughput	702.395 ms, 5 s, 1334.161 ms, 58.855 Kbps			

**Table 22. Swing Weight Assessment Table**

This table shows the first step in the development of the swing weights. The benchmark row is the worst possible scenario of the alternatives. Each of the succeeding rows swings one of the attributes from worst to best.

With the initial table constructed, the outcomes were ranked based on interactions with stakeholders and their preferences. In this analysis there were five hypothetical architectures to compare and it was safe to assume that the benchmark architecture, the one that was worst on all evaluation measure, ranked fifth (worst) overall. The other four hypothetical architectures were compared to determine which ranked first, second, third, and fourth. Based on stakeholder feedback and interaction, fusion time was ranked first, latency ranked second, interconnect time ranked third, and throughput ranked fourth.

The next step was to fill in the “Rate” column in the table. Two of the ratings were predetermined: the benchmark received a rating of 0 and the fusion time hypothetical architecture, the top-ranked architecture, received a rating of 100. Again, based on stakeholder feedback and interaction, latency received a rating of 75. This means that improving latency from worst to best is worth 75% of the value of improving data fusion time from worst to best. Along the same lines, interconnect time received a rating of 50 and throughput received a rating of 45 since it was just a little bit less important than interconnect time.

With the rankings and rating completed, the table was completed by filling in the weights. Ultimately, the weights were normalized ratings and each rating is divided by 270, the sum of all the distributed ratings. After dividing each rating by 270, fusion time had a weight of 0.370, latency had a weight of 0.278, interconnect time had a weight of 0.185, and throughput had a weight of 0.167. The final rankings, ratings, and weights are displayed in Table 23.

Attribute Swung from Worst to Best	Consequence to Compare (Fusion Time, Interconnect Time, Latency, Throughput)	Rank	Rate	Weight
(Benchmark)	702.395 ms, 5 s, 1334.161 ms, 51.292 Kbps	5	0	0
Fusion Time	299.72 ms, 5 s, 1334.161 ms, 51.292 Kbps	1	100	0.370
Interconnect Time	702.395 ms, 2.5 s, 1334.161 ms, 51.292 Kbp	3	50	0.185
Latency	702.395 ms, 5 s, 680.16 ms, 51.292 Kbps	2	75	0.278
Throughput	702.395 ms, 5 s, 1334.161 ms, 58.855 Kbps	4	45	0.167

**Table 23. Swing Weight Assessment Table with Rankings, Ratings, and Weights**

This table shows the final table in the development of the swing weights. The rankings, ratings, and weights have been filled in.

A sensitivity analysis on the effect of the weights was performed. The conclusion was that the relative rankings and relative magnitude was pretty insensitive to the weights. Furthermore, the weight distribution has no bearing on the final ranking of the

alternatives. Overall, the results of applying these swing weights to the utility scores resulted in valid relative rankings of the alternatives.

#### F. DECISION MATRIX

The next step in the process was the development of the decision matrix. The decision matrix was completed by mapping each alternative’s raw data values onto the value curves to determine their utility scores. Next, the weightings that were calculated in the previous section for each evaluation measure were added to the matrix. Finally, these weights were multiplied by the utility scores for each evaluation measure and the result for each alternative was summed into a single score. This single score quantified the performance of each alternative. The decision matrix is displayed in Table 24.

Function (Evaluation Measure)	Weight	Alternatives			
		Alternative 0	Alternative 1	Alternative 2	Alternative 3
Fuse ASW Data (Time Required to Fuse Data)	0.370	0.06	0.36	0.93	0.93
Interconnect Communication Nodes (Time to Interconnect)	0.185	0.5	0.65	0.96	0.96
Transmit ASW Information (Transmit Latency)	0.278	0.37	0.49	0.9	0.9
Transmit ASW Information (Transmit Throughput)	0.167	0.63	0.83	0.99	0.98
Total Score (0-1)		0.32	0.53	0.94	0.94
LCCE (\$Mil)		92.70	118.69	133.37	829.00

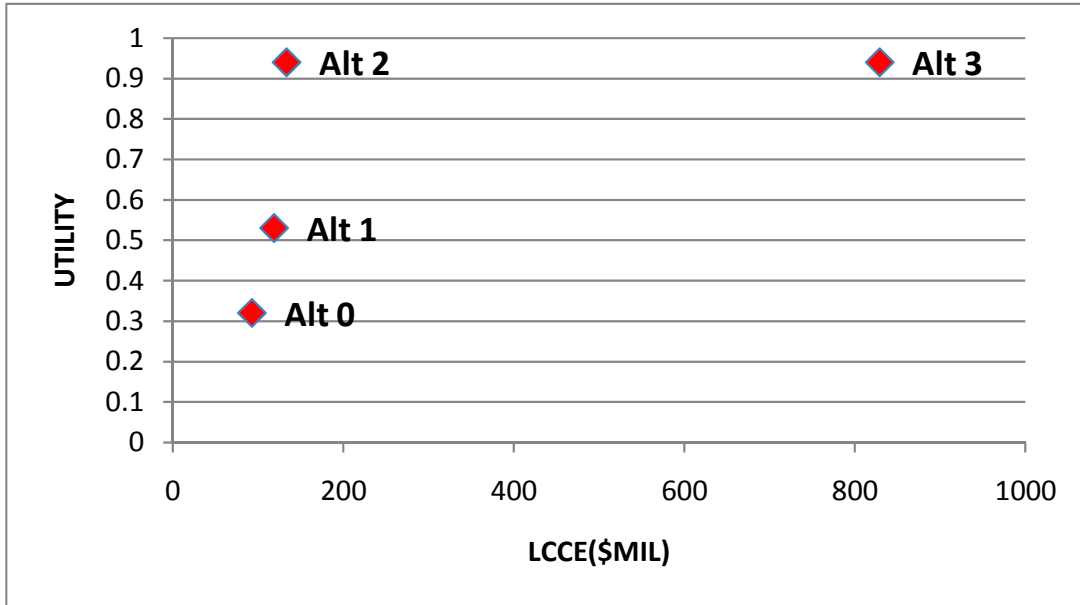
**Table 24. Decision Matrix**

This table shows the decision matrix and the estimated performance of each alternative as weighted utility scores for each evaluation measure.

#### G. UTILITY SCORE VERSUS LIFE CYCLE COST

The final step in the analysis of alternatives was to compare the utility score to the life cycle cost. This was done using a utility versus life cycle cost plot which is shown in Figure 62. This plot allows for decision makers to visually compare the alternatives in regards to performance versus cost. The utility score versus life cycle cost plot was sent to the stakeholders for a final decision.

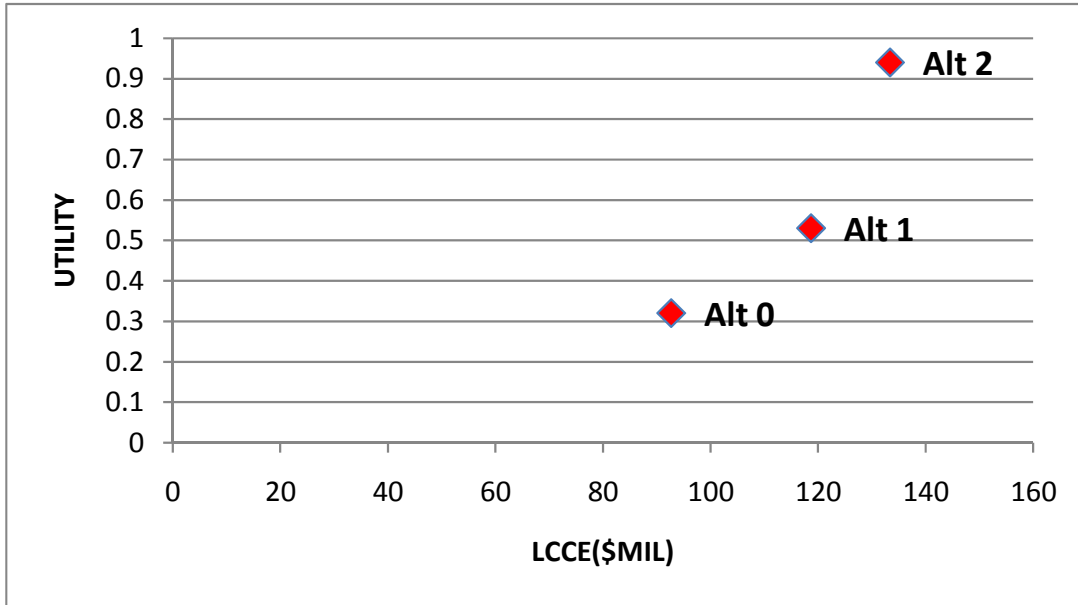




**Figure 62. Utility vs. LCCE Plot (All Alternatives)**

This figure shows the utility of each alternative while displaying the estimated cost to achieve that performance.

Based on the utility versus cost it was very clear that Alternative 3 should be discarded since it has the same utility as Alternative 2 but costs more than six times as much. That left three remaining alternatives which were plotted again using a utility versus life cycle cost plot to increase the ability to make a distinction between alternatives. This plot is shown in Figure 63.



**Figure 63. Utility vs. LCCE Plot (Alt 0, 1, and 2)**

This figure shows the utility of each alternative after the elimination of Alternative 3.

Among the three remaining alternatives, Alternative 2 had the highest LCCE at \$136.92M, Alternative 1 has the second highest cost at \$121.11M, and Alternative 0 \$95.09M. Subsequently, the alternatives were also ranked in the same order for performance. Therefore, the decision was based on whether the stakeholders want to spend more money for more performance.

THIS PAGE INTENTIONALLY LEFT BLANK

## **VIII. FINAL RECOMMENDATIONS AND CONCLUSIONS**

### **A. CONCLUSION**

This report is the result of this capstone project design team's effort to provide the ASW community well-researched alternatives for obtaining and maintaining a robust Joint ASW C4I Architecture enabling reduction of communication exchange time from sensor awareness to weapons on target in FY2020 and beyond. A tailored systems engineering process consisting of five phases: needs analysis, value system design, alternatives generation, model alternative, and alternative scoring was employed in the development of the Joint ASW C4I Architecture.

The first step in the process was needs analysis. In this step, the primitive stakeholder need was transformed into an effective need through a set of processes, stakeholder analysis, threat analysis, functional analysis, and futures analysis. The resulting effective need statement was assessed by the stakeholders and the capstone project team.

A stakeholder analysis was completed to identify relevant stakeholders, their needs, and what was most important to them. The stakeholder analysis concluded that reducing the time in the kill chain and the accuracy and integration of underwater, surface, air, and space sensor systems along with fusion of contact data from these systems were most important.

A threat analysis helped to scope and bound the problem. It highlighted the fact that the threat from enemy submarines includes elements beyond the submarine itself such as its command and control, country's ideology, supply system, and fleet support units. Further, the threat was addressed across the life span of its operational use including its initial design stage, parts production and fabrication, and the launch of an operationally ready submarine. The analysis led this capstone project design team to focus on two specific phases of the enemy submarine's life cycle: before its subsystems are completely integrated (pre-full operational capability) and after it has become a fully operational unit capable of conducting sea-going missions (full operational capability).

A functional analysis was completed to help translate stakeholder requirements into detailed design criteria and to help identify the resources necessary for system operation and support. Research was conducted and the Net-Centric Operational Environment Joint Integrating Concept, the Net-Centric Environment Joint Functional Concept, and the Tactical Wireless Joint Network Concept of Operations were identified as important net-centric documentation. Analyzing the aforementioned documents

allowed the system boundary to be identified, which established the interfaces between the Joint ASW C4I Architecture and other systems. Establishing the system boundary helped to determine what functions the system should accomplish and provided the justification for the components that are implemented in the system. Overall, the functional analysis provided the basis for developing innovative alternatives independent of any specific technical solution. A functional hierarchy was developed that decomposed the system into five top-level functions: provide connectivity; perform information operations; optimize network functions and resources; transport ASW information from end-to-end; and provide ASW data and information management. IDEF0 diagrams were developed to identify and analyze the functions that are performed by the system. The IDEF0 products were a coordinated set of diagrams that helped facilitate understanding using both graphical and natural language. Additionally, the diagrams served as a reference architecture for analysis during alternatives generation.

A futures analysis was completed to make educated predictions with respect to the future operational environment; in this case the future environment that was addressed extends to the year 2020. The most important piece of information learned from this analysis is that the Joint ASW C4I Architecture must align, support, and adapt to the service-oriented architecture to enable a true net-centric operational environment as envisioned in the Net-Centric Operational Environment Joint Integrating Concept.

Needs analysis concluded with the development of the following effective needs statement: Key ASW stakeholders require a new standardized joint ASW-specific C4I architecture for the 2020 target time frame. The proposed Joint ASW C4I Architecture needs to use open standards, common waveforms, and a common data schema. It needs to be consistent with DoD policy and processes and be vertically integrated with other DoD C4I systems. It will enhance the commander's ability to execute the joint ASW mission in support of a Combatant Commander's campaign objectives [NCOE JIC, 2005]. The purpose of the architecture is to guide development and to support engineering, force composition, and acquisition decisions.

The next step in the process was the value system design. The functions were decomposed into sub-functions down to the lowest logical level. Evaluation measures were then identified based on stakeholder feedback to determine satisfactory performance of those objectives. The iterative value system design process yielded twenty functional evaluation measures, and four non-functional evaluation measures for a total of twenty-four evaluation measures. The large number of functional evaluation measures is indicative of the complexity of the Joint ASW C4I Architecture. The evaluation measures were then ranked, by the stakeholder, to determine the most important functions

of the system. The top-ranked functions from most important to least important were: Provide ASW COTP, Fuse ASW Data, Interconnect Communication Nodes, Enable Smart Pull and Push of Information, and Transmit ASW Information.

The third step in the process was the alternatives generation. The alternatives generation process consisted of five separate actions: research, construction of a FY2020 Joint ASW C4I Architecture Baseline, functional gap analysis, stakeholder value hierarchy survey, and brainstorming of alternative solutions which were completed in series. From this process, four feasible alternative solutions were developed. The four feasible alternative solutions consisted of Alternative 0 (Baseline Architecture) which includes Joint Surveillance and Target Attack Radar System (JSTARS), satellite communication links, Surveillance and Control Data Link (SCDL), Joint Tactical Information Distribution System (JTIDS), Tactical Air Navigation (TACAN) operation, Tactical Data Information Link-J (TADIL-J), the Tactical Common Data Link (TCDL), and the Tactical Control System (TCS); Alternative 1 (Baseline Architecture plus JTRS Increment 4, NECC, and CANES improvements); Alternative 2 (Baseline Architecture plus JTRS Increment 5, CANES improvements, and Joint Track Manager); and Alternative 3 (Baseline Architecture plus modulated x-ray source communications system, autonomous C4ISR UUVs, military HAA, use of HALO, Helios, and HAA for tropospheric or space-based distribution and fusion of COTP, and wireless users capable of pulling and pushing information directly to a satellite or HAA based network by way of HALO, Helios, and HAA). The resulting alternative solutions conformed to stakeholders needs, were functionally correct and feasible.

The fourth step was the modeling and simulation of the four feasible alternatives. In this step, EXTEND was chosen as the primary modeling tool. Performance models for each alternative were built based on the developed scenario, IDEF0, and functional flow block diagram. Simulation was performed to generate data related to evaluation measures developed in the value system. The evaluation measures identified using these tools were throughput, latency, and data fusion time. Alternative 2 had the greatest throughput. Alternative 3 had the lowest latency value and lowest data fusion processing time. The results from the modeling and simulation were used in the alternative scoring step. Furthermore, the model alternative step included life cycle cost estimation. The life cycle cost estimate included research and development, production and installation, operation and support, and disposal costs. It involved the costs of all technical and management activities throughout its lifetime and provided the basis for comparing alternatives. A cost model was developed to calculate the cost of each task, life cycle phase, and year. From this cost model, it was determined that the least expensive alternative was Alternative 0 at a life cycle cost of \$95.09M over a nine year projected

lifespan. In order of increasing costs, the other alternatives were Alternative 1 at \$121.11M; Alternative 2 at \$136.92M, and Alternative 3 at \$854.60M.

The final step, alternative scoring, was conducted to compare the performance of the four feasible alternatives. The alternative scoring step compared the alternatives' ability to satisfy requirements to their life cycle cost to produce a cost-effectiveness comparison. This comparison allowed the stakeholders to evaluate the alternatives. To simplify the selection of the alternative, classic multi-attribute utility theory was used with adequate stakeholder feedback. Based on the utility versus cost developed using multi-attribute utility theory, it was very clear that Alternative 3 could be discarded since it has a lower utility than Alternative 2 and costs more than seven times as much. The remaining three alternatives were analyzed and it was determined that Alternative 2 is recommended for further development. Alternative 2 provides significant improvements in utility for a small cost. Further investigation and validation of Alternative 2 is recommended in a real world event.

Overall, this capstone project design team learned that functional C4I characteristics are not unique to the ASW community and demand appropriate levels of funding to address operational user C4I needs. Our research indicated that planned United States Navy programs of record are being positioned to solve most ASW stakeholder concerns with a joint C4I network architecture near or soon after the established baseline of FY2020. Future C4I capabilities impacting ASW forces are very much dependent upon DoD joint service and United States Navy fleet wide resourcing activities to cross-leveling of future DoD funds across all services and agencies contributing to the ASW mission. Equal resourcing of all naval warfare areas and warfighting platforms is paramount in ensuring the ASW community receives its fair share of research and development, operations and support, and procurement funding to develop and acquire mature C4I networking technologies for ASW operational forces. The ASW community must proactively seek out all available resources. ASW operational C4I standards must be solidified by FY2020. The ASW community must maintain a focused approach to best resource and acquire the necessary tools to achieve improvements in C4I attributes submarine sensing devices, data transmit-receive techniques, and enemy submarine engagement tools requiring data transmission capabilities.

Finally, we learned that the Navy has individual systems that solve a piece of the C4I architecture with no broader program office that manages from the system of systems level. To properly manage the C4I architecture, a system of systems architect is required. This would likely be from PEO-C4I, PEO-IWS, or new full-time funded acquisition

organization. This architect would have a staff to perform the system of systems modeling and simulations in much greater detail and depth than this project team did and include classified data sets. The architect would address the various follow-on projects indentified that need to be addressed at a system of systems level and, most importantly, enable cross-program manager collaboration.

## **B. AREAS FOR FURTHER CONSIDERATION**

The following areas of interest are offered to United States Navy ASW operational users and acquisition community to develop and staff requirements documents – initial capability, capability development, or capability production from which new technology can be obtained for operational use beyond the FY2020 timeframe:

1. Identify increment developments of C4I integration tools to improve interoperability of United States ASW forces with coalition forces.
2. Collaborate with all United States government agencies and departments to ensure coordination and integration of all C4I plans and acquisitions to optimize interoperability with United States Coast Guard and others concerned with maritime domain awareness issues.
3. Development or redesign of sensors and weapons should be considered with the concept of data fusion and data sharing because of the potential iterative improvements of accuracy that can be obtained.
4. Continue to monitor, support and fund, as necessary, taking the ASW community towards next generation sub-surface and surface systems interoperability initiatives using autonomous or semi-autonomous UUV, UAV, and HAA or vehicles utilizing advanced artificial intelligence, nanotechnology, and neural nets with laser and wireless networks.
5. Follow-on projects are needed to address lower tiered elements that were outside the scope of this project, but are necessary. This includes training, knowledge management, human systems integration, role based access to services and data, archiving for intermittent or disadvantaged users, redundancy for network connectivity, and available space on platforms for the processing hardware. Another excellent follow-on study would be to assess the users and concepts of operation used with a new C4I architecture since it may change the way ASW can be conducted.
6. Investigate utility of proposed Joint ASW C4I Architecture modeled against a possible scenario combating a submarine launched anti-submarine cruise missile.



7. Conduct a more detailed study of the threat to the Joint ASW C4I Architecture.
8. Conduct additional research and obtain details about possible laser communications and impacts on communication, speed, and depth assertions.
9. It was our understanding that the ASW COI was conducting an ASW data schema analysis. However, there may be a need to conduct additional research and extract detailed approaches for data schema roles and responsibilities of the ASW community to ensure its compliance with DoD certified service-oriented architectures and any promising commercial data schema solution. Future work must include in-depth study of the complete data schema structure; the system of information transport, service-oriented architecture, and data definition.
10. Utilize operationally ready systems engineering models and tools to optimize value system design and permit use of real world classified data sets as required for better decision making on the part of the ASW community. Models and tools to consider include:

- a. Network Warfare Simulation (NETWARS) - re-designated as Joint Communications Simulation System (JCSS) in 2007. It represents the Joint Chiefs of Staff standard for modeling military communication systems. It represents an integrated ability to analyze communication networks while also providing a validated simulation capability with databases and underlying models so that studies can be consistent throughout the unified combatant commands, services, and others within the command, control, communications, and computer systems community.
- b. Optimized Network Engineering Tool (OPNET) - provides a comprehensive development environment for the specification, simulation, and performance analysis of communication networks.
- c. QualNet Developer - is ultra high-fidelity network evaluation software that predicts wireless, wired and mixed-platform network and networking device performance. It supports hardware, software, and human-in-the loop testing over thousands of network nodes.
- d. Multi-Generator (MGEN) - open source software developed by Naval Research Laboratory (NRL) PROTOcol Engineering Advanced Networking (PROTEAN) Research Group. MGEN provides the ability to perform IP network performance tests and measurements.

11. Conduct research to develop operational mission sets for combined ASW unmanned vehicles and netted sensor devices.

12. Conduct sensitivity analyses on impacts to Joint ASW C4I Architecture by reduction of man-in-loop human interface time and what it might mean to increasing target identification.

The United States Navy and, more specifically, the ASW community stakeholders are turning the corner to regain undersea warfare prowess. Use of a robust Joint ASW C4I Architecture by all ASW platforms and supporting operational joint units prior to and beyond fiscal year 2020 will enable continued network enhanced ASW mission performance.

THIS PAGE INTENTIONALLY LEFT BLANK

## **APPENDIX A. PROJECT PLAN**

### **INTRODUCTION**

#### **PROJECT DESCRIPTION**

We, the members of the 311-071 cohort capstone project team, will create an Anti-Submarine Warfare (ASW) specific joint Command, Control, Communications, Computers, & Intelligence (C4I) architecture that fulfills the goal of enhancing the combatant commander's ability to execute a mission in support of his or her campaign objectives. C4I has to support cueing, turnover to tactical platforms, and prosecution up to weapons on target. The architecture will consider the offensive and defensive actions contained in the National Military Command Authority Global ASW Concept of Operations. The following subsections provide the detailed description of the problem and what our end state will look like.

##### **Problem Statement**

Existing platforms whose primary or collateral missions include ASW were designed in large part with functionally stove-piped communication architectures. These architectures often have limited or no interoperable capabilities with existing communication systems. They lack robust routing and networking capabilities, are capable of only low to medium data throughput, and present logistics challenges due to their stove-piped nature. Key ASW stakeholders require a new joint C4I architecture that uses open standards, common waveforms, and common data schema for the various data classes supported by development of the requisite Department of Defense Architecture Framework (DoDAF) products to implement and enable joint network-centric ASW operations.

##### **Vision**

Our vision is to create a C4I architecture that allows for the employment of joint networking capabilities at the tactical and operational level to fulfill the goals of the Net-Centric Operational Environment (NCOE) Joint Integrating Concept (JIC) of enhancing the commander's ability to execute the joint ASW mission in support of a combatant commander's campaign objectives [NCOE JIC, 2005].

##### **End State**

An ASW-specific open systems architecture will be developed that is aligned with the NCOE JIC and more specifically aligned with the Information Joint Enabling Construct appendix of the NCOE JIC. Some of the features of this architecture will be the ability to install and deploy a scalable, modular network that is survivable and maintainable while providing the ability to transport information from end-to-end with strong information assurance. This architecture will provide a roadmap to implement the enhancements inherent in network centric operations. Some of these enhancements include real-time access to available data on the Global Information Grid; backward compatibility with legacy tactical data links and voice; a common operational picture; and seamless interoperability. Additional enhancements include increased bandwidth;

simultaneous voice, data and video operations; a reduced logistics footprint through an enterprise set of hardware and software solutions; and the ability to rapidly check in and check out of the network without loss of data or loss of precedence.

A future end state would include the ability to communicate with submarines at speed and depth. This would include sharing data via acoustic data links from various underwater sources to onboard computers. Then, the data would be shared from the computers to digital data links via antennas to the fleet and back again to the underwater sources.

## **SUPPORTING ACTIVITIES AND BACKGROUND**

The ASW Community has recently been registered as an Office of Secretary of Defense Community of Interest (COI) for data sharing. Under the Integrated Warfare Systems-5 (IWS-5) leadership, the ASW COI has initiated a data management workgroup. This group has begun development of data standards. In addition, the group has begun development of a pilot project that is focused on air and shore classes of data and information sharing architecture. Therefore, it is a relevant subset to this capstone project. The pilot project is facilitated and led by NPS Professor Brutzman.

IWS –5 is one of the primary supporting activities for ASW. It is the Navy office responsible for all ASW software and interoperability development as well as the process developer for planning capability evolution. In particular, it is also responsible for changes to the Littoral Combat Ship Mission Module ASW Package. They have recently developed an ASW Mission Capability Architecture to establish a baseline for improvements in interoperability, performance, and evolution. It is based on traditional command relationships, system level controls, and data or information distribution. Additionally, it does not include joint extensions for the expanded composable ASW force.

Open architecture, net-centric operations, and distributed netted sensors should enhance operational interoperability among non-traditional entities, such as the United States Coast Guard (USCG). Traditionally, the USCG had an ASW role that was minimized in the post cold war period. So, the ability of new platforms, such as the USCG's new Naval Security Cutter, to participate in ASW as a member of the 1000 ship Navy has not been adequately explored. Program Executive Office (PEO)-Integrated Warfare Systems agrees that the Navy lacks a revised set of operational views and systems views for a next-generation composable ASW force based on net-centric operations and presumed data sharing.

## **THREAT AND WARFIGHTING DISCUSSION**

Admiral J. L. Johnson, former Chief of Naval Operations was quoted, "Anti-Submarine Warfare is a core enduring naval competency that will be a vital mission in the 21st Century" [Anti-Submarine Warfare, 2008]. This statement surely suggests that enemy submarines of every size and capability pose a very real threat to the United States and its coalition forces. Specifically, the threats today are quiet diesel submarines operating in littoral environments as well as submarines operating in open ocean environments. Further, there is a very real threat of communications disruption from the adversary destroying communications satellites. These environments pose communications and connectivity challenges.

Here is a quote from “Anti-Submarine Warfare: A Phoenix for the Future” which describes a fundamental truth about ASW:

ASW is a team sport - requiring a complex mosaic of diverse capabilities in a highly variable physical environment. No single ASW platform, system, or weapon will work all the time. A wide spectrum of undersea, surface, airborne, and space-based systems to ensure that we maintain what the Joint Chiefs of Staff publication Joint Vision 2010 calls full-dimensional protection. The undersea environment, ranging from the shallows of the littoral to the vast deeps of the great ocean basins - and polar regions under ice - demand a multi-disciplinary approach, subsuming intelligence, oceanography, surveillance and cueing, multiple sensors and sensor technologies, coordinated multi-platform operations, and underwater weapons [Anti-Submarine Warfare, 2008].

## **ORGANIZATION STRUCTURE**

Our team consists of 11 team members located in five different geographical locations. We divided the roles and responsibilities into two categories: systems engineering product development responsibilities and project management responsibilities as displayed in Figure 64. We reserve the right to reassign personnel between the product development and project management areas within the organization to balance the workload as the project progresses.

		Project Management Responsibilities					
SE Product Development Responsibilities		Bill Traganza PROJECT LEADER	Matt Letourneau DEPUTY LEADER/ SCHEDULER	Scott Hopkins LIBRARIAN (CM)	Matt Letourneau Alex Cuevas Amrish Patel Michael Cheff Bassit Saijid Scott Hopkins MODELLERS	Justin Loy Paul Dhindsa Jim New EDITORS	Van Ngo MEETING MINUTES
NEEDS ANALYSIS	Bill Traganza – Lead, Mike Cheff <b>STAKEHOLDER ANALYSIS</b>						
	Matt Letourneau -- Lead Justin Loy, Jim Mew <b>FUNCTIONAL ANALYSIS</b>						
	Michael Clendening, -- Lead, Bill Traganza, Alex Cuevas <b>THREAT ANALYSIS</b>						
	Scott Hopkins – Lead, Bill Traganza, Amrish Patel <b>FUTURES ANALYSIS</b>						
ALTERNATIVES GENERATION	(Team members will be identified in this phase) <b>VALUE SYSTEM DESIGN</b>						
	Total Team <b>ALTERNATIVES BRAINSTORM</b>						
	(Team members will be identified in this phase) <b>ARCHITECTURE BUILDING</b>						
	(Team members will be identified in this phase) <b>ALTERNATIVES MODELING</b>						
	(Team members will be identified in this phase) <b>ALTERNATIVES SCORING</b>						

**Figure 64. Organization Chart**

### Systems Engineering Product Development Responsibilities

The systems engineering product development responsibilities show which product area each individual team member is responsible for during the project. The product development responsibilities are divided into five general systems engineering categories: needs analysis, value system design, alternatives generation, model alternatives, and alternative scoring. These responsibilities are detailed in section 2: Systems Engineering Approach.

### Project Management Responsibilities

The project management responsibilities show which overarching area each individual team member is responsible for during the project. They are divided into six categories: leader, scheduler, librarian, modelers, editors, and meeting minutes.

### ***Leader***

The team leader's primary responsibility will be to facilitate the overall coordination of the project. This includes being the chair of total team meetings, preparing the agenda, reviewing the schedule, getting collaboration on issues, reaching decisions, assigning action items with due dates, and managing the project risks. In absence of the leader, the deputy leader will fill these responsibilities. The leader and deputy leader will be the final sign off of the project plan. Their signature represents the concurrence of the whole class.

### ***Scheduler***

The scheduler will be responsible for developing project schedules and tracking group progress versus planned due dates. The scheduler will also be responsible for posting the current schedule on Blackboard upon team leader approval. Finally, the scheduler will provide status of group performance in meeting timelines during scheduled integrated product reviews.

### ***Librarian (Configuration Manager)***

The librarian will also be the configuration manager and responsible for keeping a complete audit trail of decisions, design modifications, and documented changes. This includes gathering and cataloguing all reference material provided by the team. The configuration manager will also be responsible for version control of all project documentation including the final report and briefing packages. Version control will be accomplished using a numerical revision number in combination with the date. The revision number ensures that editorial consistency is maintained. The Blackboard group file exchange will be utilized to exchange and store versioned files. The configuration manager will be responsible for archiving and keeping a backup copy of all files posted to the Blackboard group file exchange.

The use of configuration management tools will enable us to apply industry standards to all documentation. It will also enable us to manage the quality and development of products as the system is developed for the final proposal. The process and procedures utilized in providing guidance are the American National Standards Institute/Electronic Industries Alliance-649 [1998], Military Handbook-61A (SE) [2007], and the Defense Acquisition Guidebook [2006] Chapter 4, section 4.2.3.6.

Documentation of any systems engineering project must be maintained throughout the development and operational life of a system. This ensures the integrity of the information and process, providing the stakeholder or customer a reliable product and documentation trail for audit, revision, and requirements.

### ***Modelers***

The modelers will be responsible for the development of a life cycle cost (LCC) model, a functional performance model, and an operational performance model. Within the modelers, there will be two focus groups: one will concentrate on the LCC models and the other will concentrate on both functional and operational performance models. The LCC will assess the affordability of the various alternatives. The functional performance model will be used to verify what the system and sub-system must do, as well as determining the outputs through the use of simulation. The



operational performance model will be used to assess the impact to interoperability and overall mission effectiveness through the use of simulation.

### ***Editors***

The editors will be responsible for the editorial aspects of the report, which include reviewing, rewriting, and editing the work of teammates. They will be responsible for formatting, spelling, grammar, resolving conflicts, and making the report a cohesive document. During the editorial process, it is important that the editors communicate directly with the author and the rest of the team. The editors will collect, merge, and render a final editorial decision on each submission. Editors will also be responsible for verifying the correct format of all the citations and references in the report. American Psychological Association format will be used for citations and references. However, it is the task of the author to provide the citations and the references. It is the editor's responsibility that all citations and references are incorporated adequately and consistently throughout the report.

### ***Meeting Minutes***

Since our project team consists of 12 people from six different locations, effective meetings are required. An important element of those meetings is documenting the decisions reached and the actions taken. Thus, it is important to have a dedicated individual taking meeting minutes and then sending them to the whole team upon completion of the meeting to keep everyone in the group informed of project progress. Furthermore, this person is responsible for keeping track of the status of all action items to ensure success of the project.

## **STAKEHOLDERS**

The following organizations stand to gain from the success of the C4I architecture being developed. They can be grouped into resources sponsors, the acquisition community, and the user community.

Disagreement among stakeholders will be handled in the following manner. If the disagreement is within the organization with one being the higher authority, then we will use the higher authority direction, but inform the lower authority of this decision. If the disagreement is between peer groups, then we will attempt to adjudicate. If resolution cannot be reached, the project team will decide. There is a desire to develop a useful product, but there is an overriding requirement to complete the product on time.

### **Resource Sponsors**

This group sponsors the requirements. Their interest is leveraging their resources across projects. C4I provides a tremendous financial leveraging opportunity.

- N-6 – Communication Networks
- N-86 – Ship resource sponsors.
- N-87 – Submarine resource sponsors.
- N-88 – Air Warfare

### **Acquisition Community**

This group designs, interfaces with and procures C4I equipment under the sponsorship of the resource organizations above.

- Program Executive Office, Littoral and Mine Warfare
- Program Manager Ships-485, Maritime Surveillance Systems
- Program Manager Ships-420, Littoral Combat Ship, Mission Modules
- Program Executive Office, Integrated Warfare Systems-5
- Program Executive Office, C4I

### **User Community**

This community drives the requirements for C4I architectures. They can greatly leverage their tactical and operational superiority through a joint open C4I architecture.

- Commander Undersea Surveillance
- Commander Naval Meteorology and Oceanography Command
- Navy and Mine and ASW Warfare Center
- ASW Cross Functional Team – This community plays an important role in ASW C4I requirements.
- Pacific Command
- Department of Homeland Security: Maritime Domain Awareness
- United States Coast Guard: Deep Water Program Manager
- United States Coast Guard C4I

## **RISK MANAGEMENT**

The risk to the project will be regularly reviewed by the project leader and deputy leader through solicitation from the team members. The risk analysis will be documented in an if-then format as shown in the examples below. A risk management sheet for each risk will be developed that will capture the risk description, risk management decision, impact and likelihood of occurrence rating, plans, and status of those plans. Once identified, the leader and deputy leader will assess whether to watch, mitigate, or transfer the risk. If watched or mitigated, contingency plans will be developed. If mitigated, the risk will be assigned to a teammate. Then, steps to mitigate will be developed, approved by the team, and executed. Status of the mitigation or contingency plan will be an agenda item at team meetings. The initial risks identified for this project are:

- If the problem scope is too large, then the project may not be completed in the period of performance (PoP).
- If the model development is too complex, then the project may not be completed in the PoP.
- If members of our team are not proactive and do not take ownership of their tasking or ask questions when they do not understand, then the project may not be completed in the PoP.

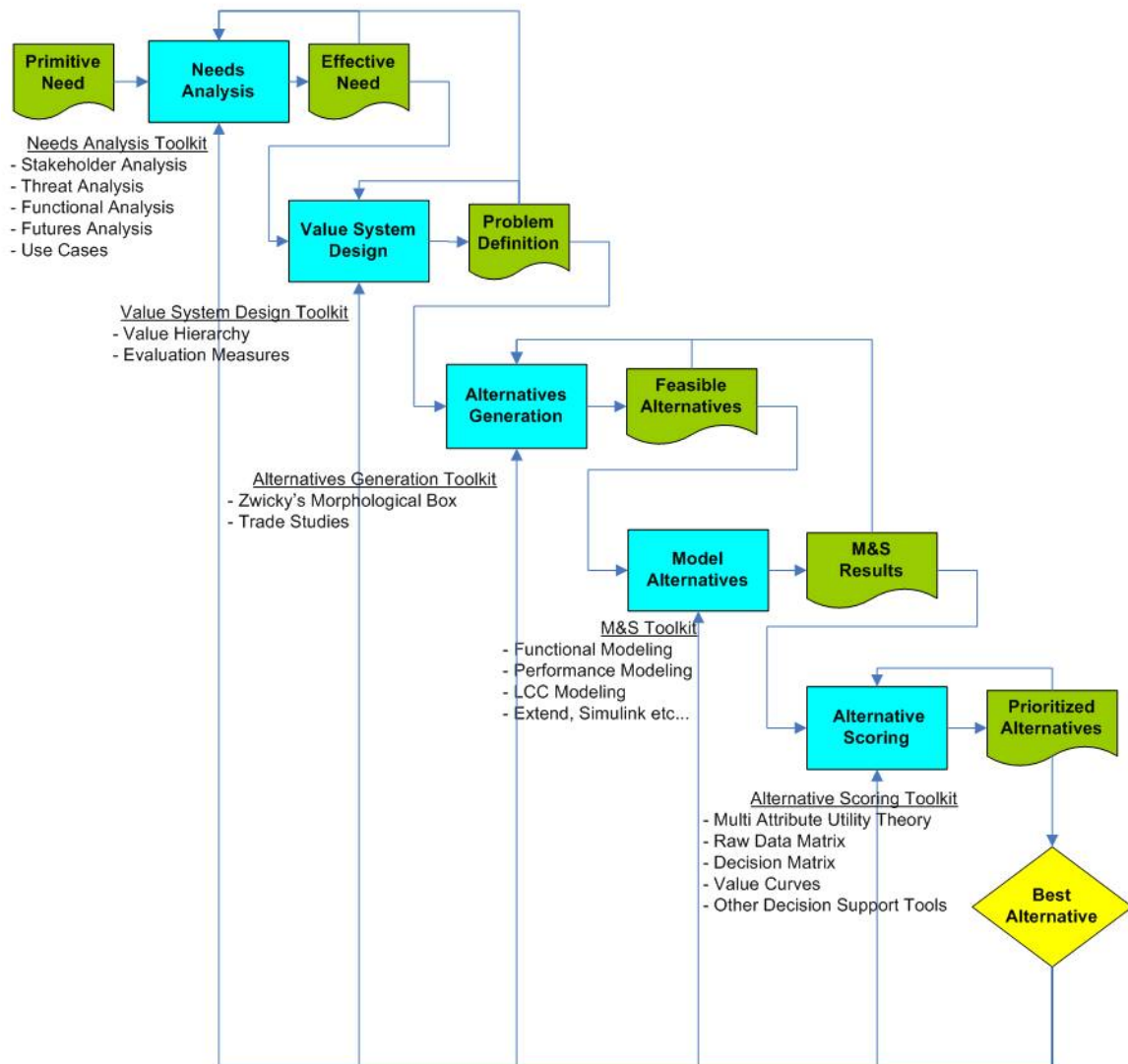
- If the stakeholders do not participate and provide feedback in the interim project reviews, then the value and accuracy of the project could be reduced.

## **SYSTEMS ENGINEERING APPROACH**

### **OVERVIEW**

We examined a number of systems engineering processes in evaluating an approach to the project. The “Vee” approach, Hatley Pirbhai, the “Spiral” approach, and the Systems Engineering Design Process (SEDP) as taught at NPS were all evaluated on suitability and applicability to the task [Blanchard and Fabrycky, 2006: 30, 34]. We need to ensure that there is a proper requirements analysis that is clearly defined and is traceable to what the stakeholders require. Through a multi-step process, we are seeking to apply rigorous systems engineering tasks to those refined requirements to develop a set of feasible alternatives, evaluate those alternatives against each other, and then select a preferred alternative to be presented to the stakeholders for final approval. The multi-step process has to be flexible and iterative in nature to allow for feedback throughout the process with the intent to positively influence the outcome. This will provide the best possible alternative within cost, performance, schedule, and other constraints (e.g., political or environmental).

All the examined systems engineering processes were found to be suitable for the task. However, a tailored SEDP was selected as the preferred process due to the variety of tools available to complete each step of the overall process and our overall familiarity with that particular process. Figure 65 shows our tailored SEDP. There are five tier two processes: needs analysis, value system design, alternatives generation, model alternatives, and alternative scoring. Each tier two process has a summary input and output deliverable. These deliverables are a roll up of lower tier tasks that are highlighted in the toolkit text boxes. It should be noted that the toolkit boxes are not all inclusive of every potential option available to help complete its associated tier two process but is representative of what we have at our disposal. We have not yet evaluated which tools we will use to complete each tier two process. Figure 65 also shows the iterative nature of the overall process. Each output is intended to be reviewed first by us and second by the stakeholders. Once approval of the output deliverable is achieved, it becomes the input for the next tier two process. If neither the stakeholders nor us are satisfied with a tier two output, the systems engineering effort backs up to an appropriate tier two process and starts again. Some output deliverables will be compared to the input deliverable to check for consistency and traceability. Our team will utilize tools such as CORE for requirements traceability. The final step is a decision by the stakeholders on the recommended alternative. Should the stakeholders not approve of the recommended alternative, then the process can move back to any subsequent point to re-engage and work to another recommended alternative.



**Figure 65. Tailored Systems Engineering Development Process**

## NEEDS ANALYSIS

The first tier two process we will perform is that of a needs analysis. We will take the primitive stakeholder need as an input and through the use of numerous tools will turn it into an effective need as an output. While we have not yet settled on which tools we will use, it is likely that a stakeholder analysis, a threat analysis, a functional analysis, and a futures analysis will be performed. Another tool available to us to assist in developing the effective need statement is the development of use cases. The effective need statement will be assessed by the stakeholders and us.

## VALUE SYSTEM DESIGN

Upon stakeholder approval of the effective need, that deliverable will serve as input to the next step, which is a value system design. The value system design will

begin with identification of the major functions the system must perform. The functions will be decomposed into sub-functions down to the lowest logical level. The lowest level sub-functions will have objectives assigned. Evaluation measures must then be identified to determine satisfactory performance of those objectives. The output of the value system design will be the problem definition statement.

## **ALTERNATIVES GENERATION**

Upon approval of the value hierarchy, it will be used as input into the alternatives generation process. This process may utilize a Zwicky's morphological box, trade studies, or a combination of these methods. All phases of the threat life cycle (e.g., industrial capability, under construction, in port, training, or at sea) will be considered when brainstorming alternative C4I architectures intended to enhance mission effectiveness. As alternatives are identified, the evaluation measures developed in the value system design will be utilized to differentiate between feasible and infeasible alternatives. Each alternative will be assessed and a list of feasible alternatives will be the output of the alternatives generation step.

## **MODEL ALTERNATIVES**

Using the approved feasible alternatives as an input, the model alternatives step will begin. We expect to perform functional modeling of the feasible alternatives. This functional modeling may be scenario-based, processing-based, control-based, data-based or a combination. It is expected that at a minimum, processing and control-based functional modeling will be performed yielding the appropriate outputs (e.g., IDEF0 & functional flow block diagram). We also expect to build performance models. The modeling tools are yet to be determined. Finally, we expect to perform life cycle cost modeling of each of the feasible alternatives. It is unlikely that an engineering life cycle cost model will be utilized due to time constraints, but analogy and parametric life cycle cost models are likely candidates. Simulation, where applicable, will be performed to generate data related to evaluation measures developed in the value system design and the output of this step will be the modeling and simulation (M&S) results.

## **ALTERNATIVE SCORING**

Using the results from the M&S step as an input, the alternative scoring step will begin. The relevant M&S results will be inserted in a raw data matrix. From there, we will apply an objective decision making tool such as multi-attribute utility theory to turn raw scores into utility scores. Those scores may be further weighted, value curves may be developed, and the final set of data will go into a decision matrix. The output of this step will be the prioritized alternatives list.

## **BEST ALTERNATIVE**

Upon approval of the prioritized alternatives list by us, we will agree upon the recommended alternative. This recommended alternative, along with the entire prioritized list will be forwarded to the stakeholders for consideration. Should the stakeholders approve our recommendation, we would wait for further tasking from the stakeholders for implementation. Due to curriculum schedule constraints, we do not believe we will get beyond the decision step. Should the stakeholders reject the

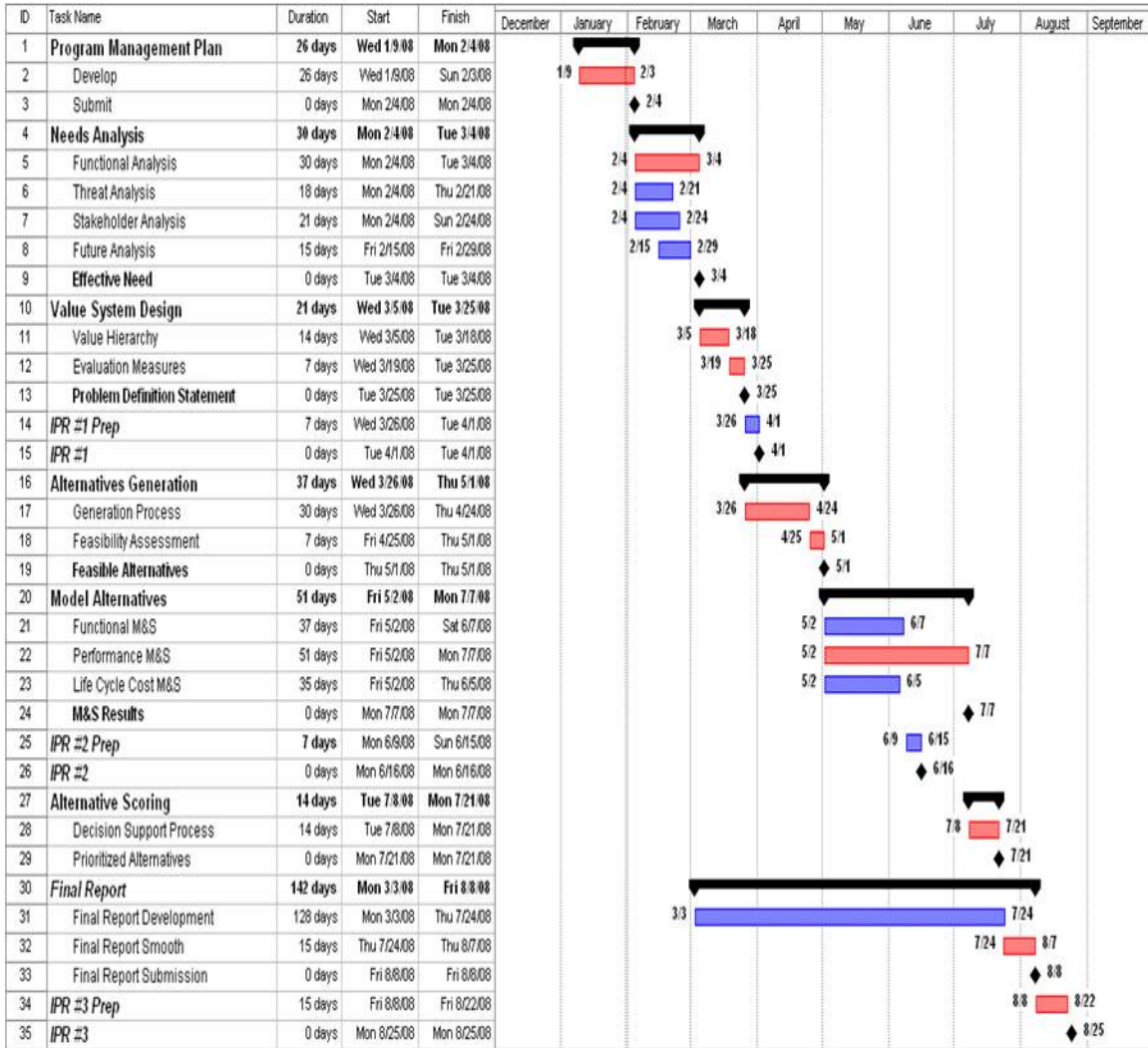
recommended alternative in favor of one of the other alternatives, the next step would also be implementation of that alternative. Should the stakeholders reject all the prioritized alternatives, then an assessment of where the systems engineering process needs to be reengaged would be performed and the process would be restarted.

## **MILESTONES AND DELIVERABLES**

<i>Milestone</i>	<i>Description</i>	<i>Deliverable</i>	<i>Date</i>
1	Project Management Plan Approval	Project Management Plan (Primitive Need)	4 February 2008
2	Integrated Product Review - #1	Problem Definition Report (Effective Need; Problem Definition Statement)	1 April 2008
3	Integrated Product Review - #2	Modeling and Simulation	16 June 2008
4	Final Report Submission	Best Alternative	8 August 2008
5	Integrated Product Review - #3	Project Presentation and Final Report	25 August 2008

**Table 25. List of Milestones and Deliverables**

# SCHEDULE



**Figure 66. ASW C4I Project Management Plan and Milestones**

## Critical Path Method

The critical path method is a “technique that aids understanding of the dependency of events in a project and the time required to complete them. Activities which, when delayed, have an impact on the total project schedule are critical and said to be on the critical path” [Defense Acquisition Guidebook, 2001]. The Gantt chart, Figure 66, represent the critical tasks and subtasks of this project. They are scheduled to occur in the following order: project management plan, needs analysis, value system design, alternatives generation, model alternatives, alternative scoring, and best alternative. However, task and process overlapping is planned to ensure schedule efficiencies.

Timely, efficient management and completion of each individual task and subtask is paramount to our overall project success. We have identified the most critical task of our project to be model alternatives due to its perceived complexity and it being the longest individual task requiring careful management of time and resources. Four

additional subtasks further refine our project's critical path: functional analysis; Value Hierarchy; Alternative Generation Process; and Performance Modeling and Simulation. All four subtasks are significant to qualifying and quantifying our findings.

Our cohort has begun researching areas for our needs analysis while final staffing and approval actions are being taken on the project management plan. Detailed analyses will provide our value system design team the data needed to establish the necessary input metrics for the alternatives generation process. In order to model alternatives it will be imperative to permit our modelers the maximum amount of time to identify, choose, and gain the requisite experience to afford well-organized modeling activities. They also need time to evaluate models for use in this project to offer the highest quality output data sets. Modeling and simulation results will set the stage for the derivation of Feasible Alternative data and presenting opportunities supportive to alternative scoring. Ultimately, these results will allow us to prioritize the alternatives to identify the best alternative in the final report recommendation to our stakeholders.



THIS PAGE INTENTIONALLY LEFT BLANK

## **APPENDIX B. NET-CENTRIC SYSTEM REQUIREMENTS**

Based on our research and feedback from the stakeholders, five main capabilities that are required for a net-centric system were defined. From these five capabilities, seventy-eight top level requirements were identified to be necessary in building a net-centric architecture. All of the capabilities and requirements for a net-centric system are listed below:

### **Ability to Provide Connectivity**

- Establish a collaborative session [NCOE JIC, 2005:A-2].
- Maintain a consistent collaborative session [NCOE JIC, 2005:A-2].
- Provide synchronization between multiple applications with simultaneous user interaction [NCOE JIC, 2005:A-3].
- Maintain traceability of collaborative process [NCOE JIC, 2005:A-3].
- Rapidly deploy and employ robust connectivity forward [NCOE JIC, 2005:A-16].
- Provide global ASW information transport services [NCOE JIC, 2005:A-16].
- Establish nodes where needed [NCOE JIC, 2005:A-16].
- Operate without geographic constraints [NCOE JIC, 2005:A-16].
- Ensure network availability [NCOE JIC, 2005:A-15].

### **Ability to Perform Information Operations**

- Prevent the injection of malicious functionality [NCOE JIC, 2005:A-23].
- Ensure that only authorized entities and valid information and services are used [NCOE JIC, 2005:A-23].
- Establish access and implement subscriber authentication [NCOE JIC, 2005:A-9].
- Maintain ASW information and knowledge connectivity in limited bandwidth environment [NCOE JIC, 2005:A-9].
- Ensure that only authorized groups and individuals can access information [NCOE JIC, 2005:A-7].
- Ensure that hostile attacks to the environment are detected, investigated, and dealt with appropriately [NCOE JIC, 2005:A-10].
- Assure information [NCOE JIC, 2005:A-10].
- Validate critical and valuable information [NCOE JIC, 2005:A-11].
- Determine and maintain an information pedigree [NCOE JIC, 2005:A-11].
- Securely label data and information consistent with information assurance guidelines [NCOE JIC, 2005:A-11].
- Authenticate identity [NCOE JIC, 2005:A-27].
- Verify identity of information and service provider or requestor [NCOE JIC, 2005:A-28].
- Protect in-transit information [NCOE JIC, 2005:A-29].

- Identify mission criticality or friendly systems and nodes [NCOE JIC, 2005:A-29].
- Track DoD information flow [NCOE JIC, 2005:A-29].
- Electronically map networks in which DoD information traverses [NCOE JIC, 2005:A-29].
- Perform continuous network defense [NCOE JIC, 2005:A-29].
- Employ tiered, defense in-depth protection across the NCOE [NCOE JIC, 2005:A-30].
- Deter, detect, and deny unauthorized intrusions to the NCOE [NCOE JIC, 2005:A-31].
- Deter, detect, and deny unauthorized insider access to the NCOE [NCOE JIC, 2005:A-31].
- Identify network intrusions and probing attempts [NCOE JIC, 2005:A-31].
- Provide cyber situational awareness and network defense [NCOE JIC, 2005:A-31].
- Investigate security events and incidents to determine cause, impacts, and response options [NCOE JIC, 2005:A-31].
- Assess operational impact of attacks [NCOE JIC, 2005:A-31].
- Characterize the current threat to network environment [NCOE JIC, 2005:A-31].
- Report on characterization of attack elements [NCOE JIC, 2005:A-32].
- Respond to network attacks and intrusions with appropriate actions [NCOE JIC, 2005:A-32].
- Share information assurance and computer network defense situation awareness information with authorized users [NCOE JIC, 2005:A-32].
- Conduct vulnerability assessments and evaluations [NCOE JIC, 2005:A-32].
- Employ security patches [NCOE JIC, 2005:A-15].
- Channel the attacker [NCOE JIC, 2005:A-15].
- Isolate compromised network nodes [NCOE JIC, 2005:A-16].
- Synchronize defense operation across DoD and with coalition partners [NCOE JIC, 2005:A-16].
- Replicate information systems and information infrastructures through modeling and simulation [NCOE JIC, 2005:A-16].
- Perform forensic analysis to establish the facts or evidence surrounding security events and incidents [NCOE JIC, 2005:A-16].
- Provide network situational awareness [NCOE JIC, 2005:A-17].
- Maintain network capabilities and ensure survivability [NCOE JIC, 2005:A-17].
- Minimize packet loss in a hostile environment [NCOE JIC, 2005:A-17].
- Maintain service under physical and information attack [NCOE JIC, 2005:D-10].
- Degrade gracefully
- Utilize dynamic rerouting

### **Ability to Optimize Network Functions and Resources**

- Ensure spectrum availability to satisfy operational requirements [NCOE JIC, 2005:A-17].

- Manage and configure systems and networks [NCOE JIC, 2005:A-17].

### **Ability to Transport ASW Information from End-to-End**

- Transmit ASW information [NCOE JIC, 2005:A-17].
- Receive ASW information [NCOE JIC, 2005:A-17].
- Automatically implement service prioritization [NCOE JIC, 2005:A-17].
- Deliver ASW information [NCOE JIC, 2005:A-17].

### **Ability to Provide ASW Data and Information Management**

- Interact effectively with collaborative tools in a cooperative environment [NCOE JIC, 2005:A-18].
- Develop a parallel process for monitoring an understanding the operational environment and synchronizing actions of assigned forces [NCOE JIC, 2005:A-4].
- Provide visualizations of non-visible phenomena by synthetic means for COI purposes and threat awareness [NCOE JIC, 2005:A-18].
- Present ASW data from multiple enterprise sources in a humanly intelligible, timely, and fused format [NCOE JIC, 2005:A-5].
- Identify selection criteria and assess alternatives to decisively control operational situations through automation in exchange, fusion, and understanding of ASW information [NCOE JIC, 2005:A-5].
- Achieve situational awareness using geospatial and time-centric displays of enterprise-wide data to relate information with similar characteristics [NCOE JIC, 2005:A-5].
- Simultaneously process inputs from multiple sources and retain focus on the task at hand [NCOE JIC, 2005:A-19].
- Limit the sharing of situational understanding to authorized individuals and to only accept situation updates from authoritative sources [NCOE JIC, 2005:A-23].
- Connect and interface with interagency and coalition [NCOE JIC, 2005:A-7].
- Share across security areas such as coalitions such as Homeland Security [NCOE JIC, 2005:A-7].
- Enable machine-to-machine info-sharing [NCOE JIC, 2005:A-7].

- Provide relevant ASW information based on users roles and responsibilities [NCOE JIC, 2005:A-7].
- Manage ASW data and information life cycle and optimize ASW data and information handing [NCOE JIC, 2005:A-7].
- Enable smart pull and push ASW information [NCOE JIC, 2005:A-8].
- Perform intelligent search [NCOE JIC, 2005:A-8].
- Determine the sensitivity of the ASW information being requested [NCOE JIC, 2005:A-24].
- Integrate and fuse ASW data [NCOE JIC, 2005:A-10].
- Maintain confidence in the authority of the information and services received and the authorization of the consumers of those information and services [NCOE JIC, 2005:A-10].
- Enable sharing of the enterprise information resources and enterprise process and applications [NCOE JIC, 2005:A-10].
- Provide accurate and relevant ASW data [NCOE JIC, 2005:A-10].

## **APPENDIX C. VALUE HIERARCHY STAKHOLDER SURVEY**

From: Naval Postgraduate School, Master's of Science Systems Engineering, Cohort 311-071

To: Anti-Submarine Warfare Community of Interest Stakeholders

Subject: STAKEHOLDER SURVEY OF VALUE HIERARCHY

Enclosure:

- (1) Anti-Submarine Warfare C4I Value Hierarchy
- (2) Value Hierarchy Glossary
- (3) Stakeholder Survey

1. This memorandum requests your participation in evaluating and completing our Value Hierarchy. The purpose of a Value Hierarchy is to reflect the critical values of the stakeholders by expanding the effective need of a system into critical functions, sub-functions and objectives. The Value Hierarchy then attempts to quantify the relative value placed on those critical functions, sub-functions and objectives by the stakeholders. The critical functions, sub-functions, objectives and evaluation measures are shown graphically in Enclosure 1. A glossary that defines each of the critical functions, sub-functions, objectives and evaluation measures is found in Enclosure 2. Enclosure 3 is the actual survey we are requesting you to fill out. The intent of the survey is to ascertain relative value, identify the most critical sub-functions and to gain feedback on the proposed evaluation measures.

2. The first goal of the survey is to compare entries at the same tier that also share the same parent in terms of relative importance to the stakeholder. We are utilizing the following numerical-based scale of 1 to 5:

- 1 – “much less” value
- 2 – “less” value
- 3 – “the same” value
- 4 – “more” value

- 5 – “much more” value

The survey is intentionally very qualitative and subjective in nature. Please ensure you provide a relative rating for each entry in a table. Each table is to be treated independently. A few notes to consider. As an example, if a tier has 4 functions that share the same parent and you rank them all a 5, that tells us that while you place a lot of value on them all, you also view them as equal to each other on a relative basis. Normalizing that input would make the score a three since they are all equal to each other. To expound on the example a little more, if you rate them all a five but the parent is ranked a one relative to its peer(s) then you would be sending a very conflicting message to us. If the sub-functions are viewed as providing ‘much more’ value, then consistency in that view should mean the parent also should likely show ‘much more’ value or ‘more’ value.

The second goal of the survey is to have you rank order the top five sub-functions. Enclosure 3 has a table listing all the sub-functions that have evaluation measures. All that is requested is that you rank order what you believe are the top 5.

The final goal is to solicit feedback on the provided evaluation measures in terms of validity of the proposed measure and inputs regarding threshold and objective values. Please take the time to look at Enclosure 1 and read through Enclosure 2 from which to formulate your comments back to us.

3. Your time and effort in completing this survey are greatly appreciated. If you have any questions, please email me at [maletour@nps.edu](mailto:maletour@nps.edu). We look forward to receiving your responses by email (preferably) or FAX no later than 23 May, 2008. Emails can be sent to me at [maletour@nps.edu](mailto:maletour@nps.edu) and you can FAX me at 760-633-3536.

Very Respectfully,

Matt LeTourneau, CDR, USN

**Scale: 1 – Much Less; 2 – Less; 3 – The Same; 4 – More; 5 – Much More**  
 (Remember to fill in each table completely and treat each table independently)

**Tier 1 – Parent is A0 (ASW Net-Centric C4I System)**

<b>Critical Element</b>	<b>Score</b>
System Performance	
System Availability	

**Tier 2 – Parent is System Performance**

<b>Critical Element</b>	<b>Score</b>
A.1 Provide Connectivity	
A.2 Perform Information Operations	
A.3 Optimize Network Functions and Resources	
A.4 Transport ASW Information from End-to-End	
A.5 Provide ASW Data and Information Management	

**Tier 2 – Parent is System Availability**

<b>Critical Element</b>	<b>Score</b>
Provide Reliability	
Provide Availability	
Provide Maintainability	

**Tier 3 – Parent is A.1 (Provide Connectivity)**

<b>Critical Element</b>	<b>Score</b>
A.1.1 Interconnect Communication Nodes	
A.1.2 Interface with ASW Sensor and ASW Weapon Systems Data Streams	
A.1.3 Connect and Interface with External Networks	

**Tier 3 – Parent is A.2 (Perform Information Operations)**

<b>Critical Element</b>	<b>Score</b>
A.2.1 Provide Computer Network Defense	
A.2.2 Provide Electronic Protection	
A.2.3 Provide Information Assurance (IA)	
A.2.4 Provide Physical Security	

**Tier 3 – Parent is A.3 (Optimize Network Functions and Resources)**

<b>Critical Element</b>	<b>Score</b>
A.3.1 Manage and Control Network	
A.3.2 Manage Spectrum	

**Tier 3 – Parent is A.4 (Transport ASW Information from End-to-End)**

<b>Critical Element</b>	<b>Score</b>



A.4.1 Transmit ASW Information	
A.4.2 Deliver ASW Information	
A.4.3 Receive ASW Information	

**Tier 3 – Parent is A.5 (Provide ASW Data and Information Management)**

Critical Element	Score
A.5.1 Fuse ASW Data	
A.5.2 Provide ASW COTP	
A.5.3 Identify, Store, Share and Exchange ASW Data and Information	

**Tier 4 – Parent is A.5.3 (Identify, Store, Share and Exchange ASW Data and Information)**

Critical Element	Score
A.5.3.1 Transfer ASW Data from Machine to Machine	
A.5.3.2 Provide ASW Information Publish and Subscribe Services	
A.5.3.3 Manage ASW Data and Information Life Cycle and Optimize ASW Data and Information Handling	
A.5.3.4 Enable Smart Pull and Push of ASW Information	

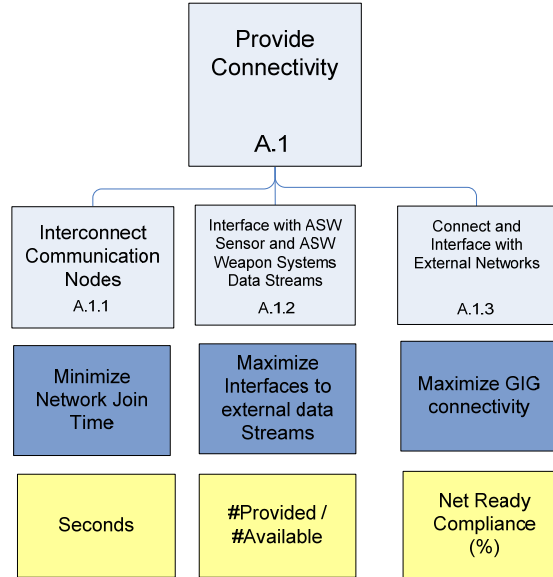
**Top Five Evaluated Sub-Functions**

(Please Rank Order Your Top Five Using 1-5)

Critical Element	Rank
A.1.1 Interconnect Communication Nodes	
A.1.2 Interface with ASW Sensor and ASW Weapon Systems Data Streams	
A.1.3 Connect and Interface with External Networks	
A.2.1 Provide Computer Network Defense	
A.2.2 Provide Electronic Protection	
A.2.3 Provide Information Assurance (IA)	
A.2.4 Provide Physical Security	
A.3.1 Manage and Control Network	
A.3.2 Manage Spectrum	
A.4.1 Transmit ASW Information	
A.4.2 Deliver ASW Information	
A.4.3 Receive ASW Information	
A.5.1 Fuse ASW Data	
A.5.2 Provide ASW COTP	
A.5.3.1 Transfer ASW Data from Machine to Machine	
A.5.3.2 Provide ASW Information Publish and Subscribe Services	
A.5.3.3 Manage ASW Data and Information Life Cycle and Optimize ASW Data and Information Handling	
A.5.3.4 Enable Smart Pull and Push of ASW Information	

## APPENDIX D. EVALUATION MEASURES

### A1 - Provide Connectivity



**Figure 67. Value System A1 - Objectives and Evaluation Measures**

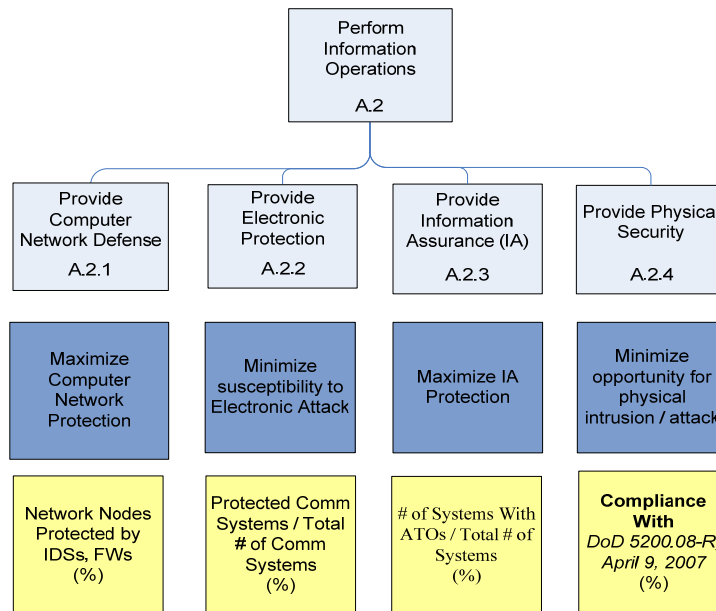
This figure represents the Provide Connectivity function and its sub-functions along with the objectives and evaluations measures.

The evaluation measure for function A.1.1, “Interconnect Communication Nodes,” is the time it takes a node to join the network, and the unit of measure is seconds. This evaluation measure was chosen because in a NCOE it is essential that a node join the network and start participating in information exchange to establish a common situational awareness. This function supports the NCOE Network Management capability. The objective is to “Minimize Network Join Time.”

The evaluation measure for function A.1.2, “Interface with ASW Sensor and ASW Weapon Systems Data Streams,” is the number of data streams provided divided by the number of streams available, and the unit of measure is percentage. This measure is an indication of the “nettedness” of the sensors and weapons and provides the operator with the ability to match weapons with sensors to maximize their effectiveness. This function supports the NCOE Knowledge Management capability. The objective for this measure is to “Maximize Interfaces to External Data Streams”.

The evaluation measure for function A.1.3, “Connect and Interface with External Networks,” is “Net Ready Compliance,” and the unit of measure is percent (%). The measure ““Net Ready Compliance” is an evaluation of net ready key performance parameters and an indicator of net-centricity. Two of the elements that make up the net ready key performance parameters are GIG Key Interface Profiles (KIP) and Net-Centric Operations and Warfare (NCOW) Reference Model (RM). An example of GIG KIP is a mission critical interface or an interface that affects multiple programs. The NCOW RM describes the set of activities comprising a net-centric environment, such as core services and enterprise management. Compliance with GIG KIPs and NCOW RM is demonstrated by analysis of systems engineering specification documents and interoperability testing. This function supports the NCOE Knowledge Management capability. The objective for this measure is “Maximize GIG Connectivity.”

## A2 - Perform Information Operations



**Figure 68. Value System A2 - Objectives and Evaluation Measures**

This figure represents the Information Operations function and its sub-functions along with the objectives and evaluations measures.

The evaluation measure for function A.2.1, “Provide Computer Network Defense,” is the fraction of network nodes protected by computer network defense appliances, such as intrusion detection systems, firewalls, and malicious software scanners. The unit of measure is percent (%). These appliances automatically and continuously scan, sanitize, and alert operators of potential network born threats. This function supports the NCOE Information Assurance capability. The objective of this measure is to “Maximize Computer Network Protection.”

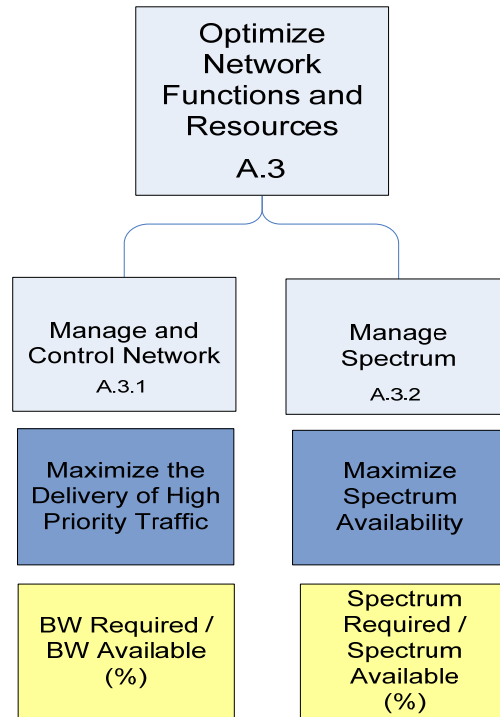
The evaluation measure for function A.2.2, “Provide Electronic Protection,” is the fraction of communication links protected from disruption, and the unit of measure is percent (%). Critical communication links need to be protected from a hostile environment, such as jammers and electromagnetic impulse. However, not all communication links are critical and need protection. Protection can also be provided through communication diversity. The percentage of protected critical links is a measure of robustness of the Joint ASW C4I Architecture. This function supports the NCOE

Information Assurance capability. The objective of this measure is to “Minimize Susceptibility to Electronic Attack.”

The evaluation measure for function A.2.3, “Provide Information Assurance,” is the fraction of systems in the Joint ASW C4I Architecture that have an authority to operate (ATO), and the unit of measure is percent (%). An authority to operate is an indicator of degree of compliance of a system with Department of Defense information assurance requirements. These requirements are stated in the DoDI 8500.1 and Department of Defense Information Systems Agency (DISA) Security Technical Implementation Guides [STIGS, 2008]. An authority to operate is the result of completing the certification and accreditation activities which are described in DoDI 5200.4, Defense Information Technology Certification and Accreditation Process [DoDI 5200.40, 1997]. The DITSCAP has been superseded by the Department of Defense Information Assurance Certification and Accreditation Process (DIACAP) DoDI 8510.01. The objective of this measure is “Maximize Information Assurance Protection.”

The evaluation measure for function A.2.4, “Provide Physical Security,” is also an authority to operate. The authority to operate is the result of a comprehensive evaluation of the technical and non-technical security requirements. Physical security falls under the non-technical security requirements, and the evaluation is carried out in accordance with DOD 5200.08-R, dated April 9, 2007. This function supports the NCOE Information Assurance Management capability. The objective of this measure is “Minimize Opportunity for Physical Intrusion and or Attack.”

### A3 - Optimize Network



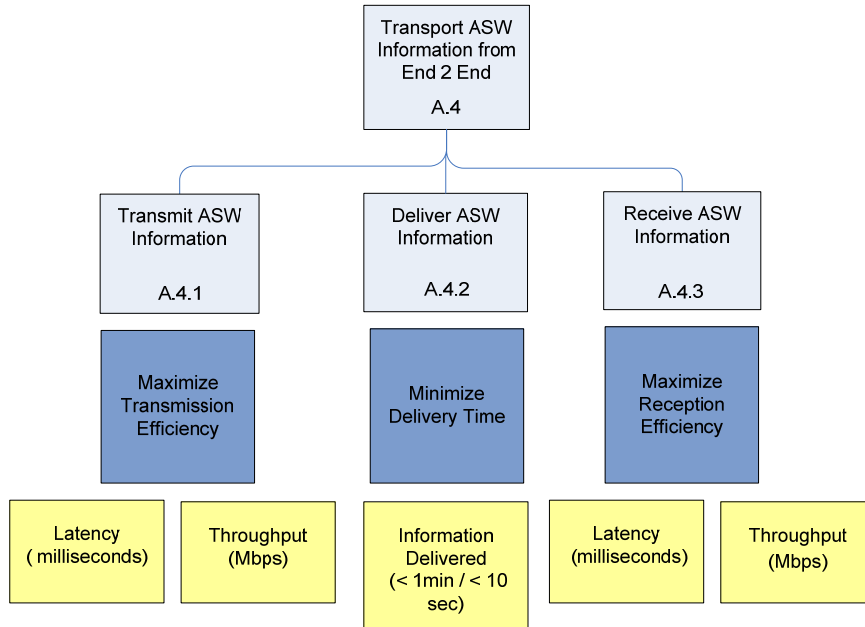
**Figure 69. Value System A3 - Objectives and Evaluation Measures**

This figure represents the Optimize Network functions and its sub-functions along with the objectives and evaluations measures.

The evaluation measure for function A.3.1, “Manage and Control Network,” is the fraction of bandwidth required divided by the bandwidth available, and the unit of measure is percent (%). Bandwidth is an indicator of quality of communication in the Joint ASW C4I Architecture. This function supports the NCOE Network Management capability. The objective of this function is to “Maximize the Delivery of High Priority Traffic.”

The evaluation measure for function A.3.2, “Manage Spectrum,” is spectrum required divided by the spectrum available, and the unit of measure is percent (%). Spectrum is allocated by higher authority. Request for spectrum can be cumbersome and time consuming and not well suited for a rapidly changing networked battlespace. Therefore it is essential to ensure that allocated spectrum will meet or exceed spectrum demands and be provided in near real-time. This function supports the NCOE Network Management capability. The objective of this function is to “Maximize Spectrum Availability.”

## A4 - Transport Information ASW Operations from End-to-End

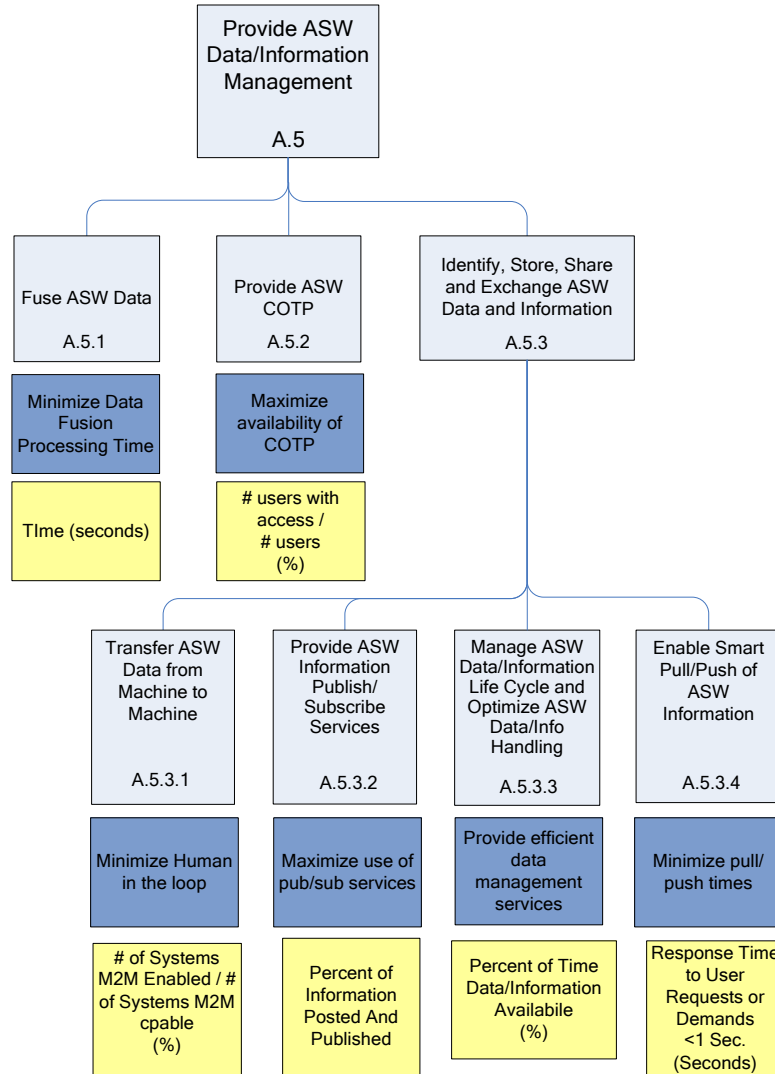


**Figure 70. Value System A4 - Objectives and Evaluation Measures**

This figure represents the Transport ASW Information End-to-End function and its sub-functions along with the objectives and evaluations measures.

The evaluation measure for function A.4.1, “Transmit ASW Information,” for function A.4.2 “Deliver ASW Information,” and for function A.4.3, “Receive ASW Information,” are latency and throughput, and the units of measure are time (milliseconds) and mega bits per second, respectively. These measures represent a standard measure of end-to-end delivery chain which characterizes the performance and quality of these functions. Latency indicates the internal processing and path delay, and the bandwidth measure represents the amount of information, in bits, that can be transmitted in one second – the “fatness of the pipe.” The objective for each of the functions, A.4.1, A.4.2, and A.4.3, is “Maximize Transport Efficiency,” “Maximize Delivery Time,” and “Maximize Reception Efficiency,” respectively.

**A5 - Provide ASW Data and Information Management**



**Figure 71. Value System A5 - Objectives and Evaluation Measures**

This figure represents the Provide ASW Data and Information Management function and its sub-functions along with the objectives and evaluations measures.

The evaluation measure for function A.5.1, “Fuse ASW Data,” is the amount of time it takes for the data fusion process to produce an output after the input is received. This function supports the NCOE Knowledge Management capability. The objective of this function is to “Minimize Data Fusion Processing Time.”

The evaluation measure for A.5.2, “Provide ASW COTP,” is the number of users with access divided by the total number of users that can access the COTP, and the unit



of measure is percent (%). The availability of COTP is a measure of the common organization situational awareness. A common situational awareness is a prerequisite for coordination and self synchronization in a net-centric operational environment. This function supports the NCOE Knowledge Management capability. The objective of this measure is to “Maximize availability of COTP.”

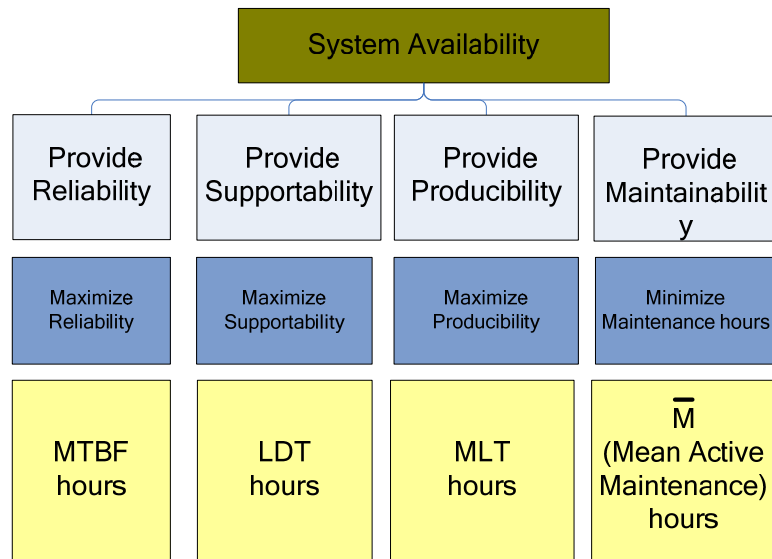
The evaluation measure for A.5.3.1, “Transfer ASW Data from Machine to Machine,” is the number of systems machine-to-machine enabled divided by the number of systems machine-to-machine capable, and the unit of measure is percent (%). This measure represents the timeliness and elimination of human error in completing an action. This function supports the NCOE Knowledge Management capability. The objective of this measure is “Minimize Human in the Loop.”

The evaluation measure for A.5.3.2, “Provide ASW Information Publish and Subscribe Services,” is the percent of information posted and published, and the unit of measure is percent (%). This evaluation measure is extracted from the NCOE JIC. Publish and subscribe services automate the process of sharing information as it is generated or updated. This function supports the NCOE Knowledge Management capability. The objective of this measure is to “Maximize Use of Publish and Subscribe Services.”

The evaluation measure for function A.5.3.3, “Manage ASW Data and Information Life Cycle and Optimize ASW Data and Information Handling,” is the availability of data and information to the network, and the unit of measure is percent (%). Management of data and information encompasses a number of functions, such as managing storage, providing catalog service, providing search services, data reconciliation, database query service, data get and put functions, purging of old data, and data backup services. This service frees the user from mundane tasks and lets them concentrate on knowledge production. This function supports the NCOE Knowledge Management capability. The objective of this measure is to “Provide efficient data management services.”

The evaluation measure for function A.5.3.4, “Enable Smart Pull and Push of ASW Information,” is the response time to user push and pull requests, and the unit of measure is time (seconds). This measure permits users to search for specific data not available through publish and subscribe services and to retrieve it. The users can also update (post) data for other users to pull from an archive or data distribution center. This function supports the NCOE Knowledge Management capability. The objective of this measure is to “Maximize Pull and Push times.”

**A0: Non - Functional Value System Requirements**



**Figure 72. Value System A0 - Objectives and Evaluation Measures**

This figure represents the non-functional branch of the decomposition and its sub-functions along with the objectives and evaluations measures.

The discussion of reliability, maintainability, and availability is extracted from Blanchard and Fabrycky chapters 12 and 13 [Blanchard and Fabrycky, 2006: 369-449]. Availability is discussed last as it is derived from reliability and maintainability measures.

The evaluation measures for “Provide Reliability,” are the mean time between failures which is the inverse of failure rate of the entity under consideration, and the unit of measure is time (hours). This measure was chosen based on the discussion in section 12.2 of Blanchard and Fabrycky [Blanchard and Fabrycky, 2006: 369-449]. The objective of this measure is to “Maximize Reliability.”

The evaluation measure for "Provide Supportability," is logistics delay time (LDT). This is the maintenance downtime that results from waiting for a spare part or test equipment to be available and waiting for transportation or use of a facility. This measure was chosen based on the discussion in section 13.2 of Blanchard and Fabrycky [Blanchard and Fabrycky, 2006: 430].

The evaluation measure for "Provide Producibility," is manufacturing lead time (MLT). This is the time needed for a product to be in the manufacturing process. This

includes time spent being processed on machines, set up requirements and time between processes. This measure was chosen based on the discussion in section 16.3 of Blanchard and Fabrycky [Blanchard and Fabrycky, 2006: 562].

The evaluation measure for “Provide Maintainability,” is the Mean Active Maintenance Time ( $\bar{M}$ ). This is the average time required to perform maintenance and includes both scheduled and unscheduled maintenance actions. The measure is a function of failure rate ( $\lambda$ ), Mean Corrective Maintenance Time ( $\bar{M}ct$ ), Mean Preventive Maintenance Time ( $\bar{M}pt$ ), and frequency of preventive maintenance per operational hour ( $fpt$ ). Mathematically it is defined as the ratio:

$$\bar{M} = \frac{(\lambda)(\bar{M}ct) + (fpt)(\bar{M}pt)}{\lambda + fpt}$$

The objective of this measure is to “Minimize Maintenance Hours.”

## APPENDIX E. DEFINITIONS AND IDEF0 DIAGRAMS

### **Input and Output Definitions**

**Assured ASW Sensor Data** – The Joint ASW C4I Architecture protects and defends ASW sensor data by ensuring its availability, integrity, authentication, confidentiality, and non-repudiation.

**Assured ASW Weapon Data** – The Joint ASW C4I Architecture protects and defends ASW weapon data by ensuring its availability, integrity, authentication, confidentiality, and non-repudiation.

**Assured METOC Data** – The Joint ASW C4I Architecture protects and defends METOC data by ensuring its availability, integrity, authentication, confidentiality, and non-repudiation.

**ASW Sensor Data** - Raw or processed sensor data that is transmitted to the Joint ASW C4I Architecture by all of the ASW sensors in the network. This includes all devices that measure or detect real-world conditions, such as acoustic or electromagnetic sensors. This can also include sensor-to-sensor cueing which is transported through the Joint ASW C4I Architecture and sent to another sensor through ASW sensor tasking.

**ASW Sensor Tasking** - Transports the ASW sensor task to the external sensors.

**ASW Sensor Tasks** - The “Provide ASW Data and Information Management” function transmits the ASW sensor tasks to the “Transport ASW Information from End-to-End” function. Commands for the sensors that enable sensor resources to be dynamically focused on high priority sectors of the battlespace. This enables a scarce sensor resource to serve many customers, and helps ensure that the right mix of sensors are available at the right time. The operational benefit of sensor tasking is enhanced when sensors from multiple platforms simultaneously focus their energy on the same object. These are generated based on ASW sensor data or user commands. Sensor tasks can include sensor cueing, tracking, or battle damage assessment.

**ASW Weapon Data** - Weapon data that is transmitted to the Joint ASW C4I Architecture by all of the ASW weapon assets in the network. This includes weapon status and engagement status for post engagement re-evaluation.

**ASW Weapon Tasking** - Transports the ASW weapon task to the external weapons.

**ASW Weapon Tasks** - The “Provide ASW Data and Information Management” function transmits the ASW weapon tasks to “Transport ASW Information from End-to-End” function. These are generated based on user commands. Weapon tasks can include weapon control orders, weapon assignment, or weapon and target pairing.

**Bandwidth Management Plan** - The plan to determine the bandwidth management strategy which will measure and control communications in the Joint ASW C4I Architecture. The bandwidth management plan will help avoid overfilling the network, which would result in network congestion and poor performance.

**Computer Attack** - Actions taken through the use of computer networks to disrupt, deny, degrade, or destroy information resident in computers and computer networks, or the computers and networks themselves [JP 1-02, 2001: 111].

**Defended Computer Attack** - An output of the “Perform Information Operations” function that results in a computer attack being thwarted, negated or minimized.

**Defended Electronic Attack** - An output of the “Perform Information Operations” function that results in an electronic attack being thwarted, negated or minimized.

**Defended Physical Attack** - An output of the “Perform Information Operations” function that results in a physical attack being thwarted, negated or minimized.

**External ASW Interface Connections** - Establishes the network with all external sensors and weapons. This is established so that the Joint ASW C4I Architecture can interface with the external sensors and weapons so that the sensors and weapons are networked.

**Electronic Attack** - Division of electronic warfare involving the use of electromagnetic energy, directed energy, or anti-radiation weapons to attack personnel, facilities, or equipment with the intent of degrading, neutralizing, or destroying enemy combat capability and is considered a form of fires [JP 1-02, 2001: 178]. The emphasis for the Joint ASW C4I Architecture is on the aspect of spectrum denial.

**External Network Connections** - Connects the network with other networks. This is established so that the Joint ASW C4I Architecture can utilize other networks for transport and retrieval of information.

**Internal Communication Connections** - Establishes the network between all internal nodes of the system. This is established so that the Joint ASW C4I Architecture can transport information from end-to-end.

**METOC Data** - A term used to convey all meteorological (weather) and oceanographic (physical oceanography) factors as provided by service components. These factors include the whole range of atmospheric and oceanographic phenomena, from the sub-bottom of the earth's oceans up to the space environment (space weather) [JP 1-02, 2001: 338].

**Networking Hardware** - The physical equipment needed to facilitate the Joint ASW C4I Architecture. It includes routers, switches, access points, network interface cards, and other related hardware. The networking hardware is having a function performed on it that transforms its state. In A.1 it goes from being a collection of individual units to a networked system. For A.3, the hardware is being transformed again with new policies for spectrum and network planning. It is not facilitating the performance of the function like people and support systems. It is the item being transformed.

**Physical Attack** - Physical attack disrupts, damages, or destroys targets through destructive power. Physical attack can also be used to create or alter adversary perceptions or drive an adversary to use certain exploitable information systems [JP 3-13, 2006: II-7].

**Publishable ASW Information** - The “Provide ASW Data and Information Management” function transmits the publishable ASW information to the “Transport ASW Information from End-to-End” function. The publishable ASW information can range from sensor data to the COTP and is disseminated based on the commander’s intent.

**Published ASW Information** - Distributes the publishable information to the external user.

**Quality of Service (QoS) Plan** - The plan that allows the network to deliver traffic with minimum delay and maximum availability.

**Routing and Mobility Plan** - The plan that determines the correct and most efficient circuit path for a message.

**Subscribable ASW Information** - The “Provide ASW Data and Information Management” function transmits the subscribable ASW information to the “Transport ASW Information from End-to-End” function. The subscribable ASW information can range from sensor data to the COTP and is disseminated based on user subscriptions.

**Subscribed ASW Information** - Distributes the subscribable information to the external user.

**Transmitted ASW Sensor Data** - Transmits the ASW sensor data through the Joint ASW C4I Architecture to the “Provide ASW Data and Information Management” function for processing.

**Transmitted ASW Weapons Data** - Transmits the ASW weapons data through the Joint ASW C4I Architecture to the “Provide ASW Data and Information Management” function for processing.

**Transmitted METOC Data** - Transmits the METOC data through the Joint ASW C4I Architecture to the “Provide ASW Data and Information Management” function for processing.

**Transmitted User Commands** - Transmits the user commands through the Joint ASW C4I Architecture to the “Provide ASW Data and Information Management” function for processing.

**Transmitted User Information Requests** - Transmits the user information requests through the Joint ASW C4I Architecture to the “Provide ASW Data and Information Management” function for processing.

**User Commands** - An instruction given by the user that needs to be transported to the appropriate external or internal asset. User commands can include cueing the sensors, target nomination, threat evaluation, and weapon assignment.

**User Information Request** - This is a request for specific information from the user. It can be returned to the user through published information or smart pull of information.

**User Subscriptions** - Users request to receive or obtain frequent updates on specific information.



## **Subfunction Definitions**

**A.1.1 – Interconnect Communication Nodes:** This function ensures connectivity amongst all participating network nodes and defines a routing scheme. The more efficient the Joint ASW C4I Architecture network's nodes work together, the more the network can utilize its collective resources [NCOE JIC, 2005:8].

**A.1.2 – Interface with ASW Sensor and ASW Weapon Systems Data Streams:** This function establishes the connection between the Joint ASW C4I Architecture, the sensors, and the weapon systems. This includes ensuring that data and information generated by weapons and sensor systems can be provided to the communication nodes for further transport, translation, or modification.

**A.1.3 – Connect and Interface with External Networks:** This function includes establishing the physical layer connection that allows the Joint ASW C4I Architecture access and use other external networks.

**A.2.1 – Provide Computer Network Defense:** JP 3-13 defines computer network defense as, “actions taken through the use of computer networks to protect, monitor, analyze, detect and respond to unauthorized activity within Department of Defense information systems and computer networks” [JP 3-13, 2006: GL-5]. In the Joint ASW C4I Architecture, this function includes monitoring the situational awareness of the network and identifying when unauthorized users attempt to gain access. It also includes providing network security measures to ensure network integrity.

**A.2.2 – Provide Electronic Protection:** JP 3-13 defines electronic protection as, “That division of electronic warfare involving passive and active means taken to protect personnel, facilities, and equipment from any effects of friendly or enemy employment of electronic warfare that degrade, neutralize, or destroy friendly combat capability” [JP 3-13, 2006: GL-7]. In the Joint ASW C4I Architecture, this function establishes protection of the use of the electromagnetic spectrum.

**A.2.3 – Provide Information Assurance:** JP 3-13 defines information assurance as, “Measures that protect and defend information and information systems by ensuring their availability, integrity, authentication, confidentiality, and nonrepudiation. This includes providing for restoration of information systems by incorporating protection, detection, and reaction capabilities” [JP 3-13, 2006: GL-9]. In the Joint ASW C4I Architecture, this function includes the protection of sensitive information by enabling confidentiality, authentication, integrity, non-repudiation, and availability. Confidentiality is the need to ensure that information is accessed, used, copied, or disclosed by users who have been authorized and have a genuine need. Authentication is a security measure designed to establish the validity of a transmission, message, or originator. Integrity means data cannot be created, changed, or deleted without proper authorization. Non-repudiation is the method by which the sender of data is provided with proof of delivery and the recipient is assured of the sender’s identity, so that neither can later deny having processed the data [Texas State Library and Archives Commission, 2008]. Availability means that the information and systems used to process the information are all available when the information is needed.

**A.2.4 – Provide Physical Security:** JP 3-13 defines physical security as, “That part of security concerned with physical measures designed to safeguard personnel; to prevent unauthorized access to equipment, installations, material, and documents; and to safeguard them against espionage, sabotage, damage, and theft” [JP 3-13, 2006: GL-9]. In the Joint ASW C4I Architecture, this function establishes the physical protection of the information and the information infrastructure.

**A.3.1 – Manage and Control Network:** This function includes managing and controlling the network to ensure that the greatest capability is provided to the warfighter. This means monitoring, tuning, repairing, and optimizing the network to meet their needs. The network must be able to maintain service through both physical and information attack. When system or equipment has been destroyed or damaged, the network should continue operations at a gradually reduced capacity in accordance with prioritization plans. It must be capable of dynamically rerouting services when nodes become incapacitated or information flow requirements change. To maintain or increase capacity, the network must be capable of obtaining additional resources as required [NCOE JIC, 2005: D-10].

**A.3.2 – Manage Spectrum:** The function includes managing a spectrum that is capable of operating regardless of the radio frequency spectral environment. Furthermore, the network must be able to dynamically allocate resources to support all operations and transitional states along the range of military operations [NCOE JIC, 2005: D-9].

**A.4.1 – Transmit ASW Information:** This function includes the ability of a communication node to send out data or information based on a user's command. This function is an internal network function and is similar to placing a piece of mail in the mailbox. This function is responsible for transmitting user information requests, user commands, METOC data, ASW Weapons Data, and ASW Sensor Data internally throughout the Joint ASW C4I Architecture.

**A.4.2 – Deliver ASW Information:** This function includes the ability of the network to actually deliver the data or information to a destination where someone else can receive it. This function is an internal network function and is similar to the mailman retrieving a piece of mail from one mailbox and delivering it to another.

**A.4.3 – Receive ASW Information:** This function includes the ability of a communication to receive data or information based on a user's command. This function is an internal network function and is similar to retrieving a piece of mail from your mailbox. This function is responsible for providing the ASW Weapon Tasking to the weapons, ASW Sensor Tasking to the sensors, and Subscribed and Published ASW Information to Users. Ultimately, it is responsible for providing information to the external systems.

**A.5.1 – Fuse ASW Data:** This function refers to the process of gathering data from multiple sources and combining that data into a single source of information. The detailed description of the data fusion process can be found in the modeling and simulation section.

**A.5.2 – Provide ASW COTP:** This function incorporates the display of information into a single identical display of relevant tactical or operational information which is shared by multiple users. At the tactical level this can include location, identification, intentions,

track history and track vector of hostile, friendly and unknown tracks of interest as well as items that may affect tactical decision making such as meteorological and oceanographic data and systems status tracks of interest. At the operational level this can include everything at the tactical level in addition to other sources of information relevant at the operational level, such as intelligence, logistics, rules of engagement, and Commander's intent.

**A.5.3 – Identify, Store, Share and Exchange ASW Data and Information:** This function includes all actions necessary to store, publish, and exchange information and data. Data must be appropriately identified and labeled (tagged), placed in a database or other data and information repository, and its presence announced to those who need it (post, publish, or advertise) [NCOE JIC, 2005: 43].

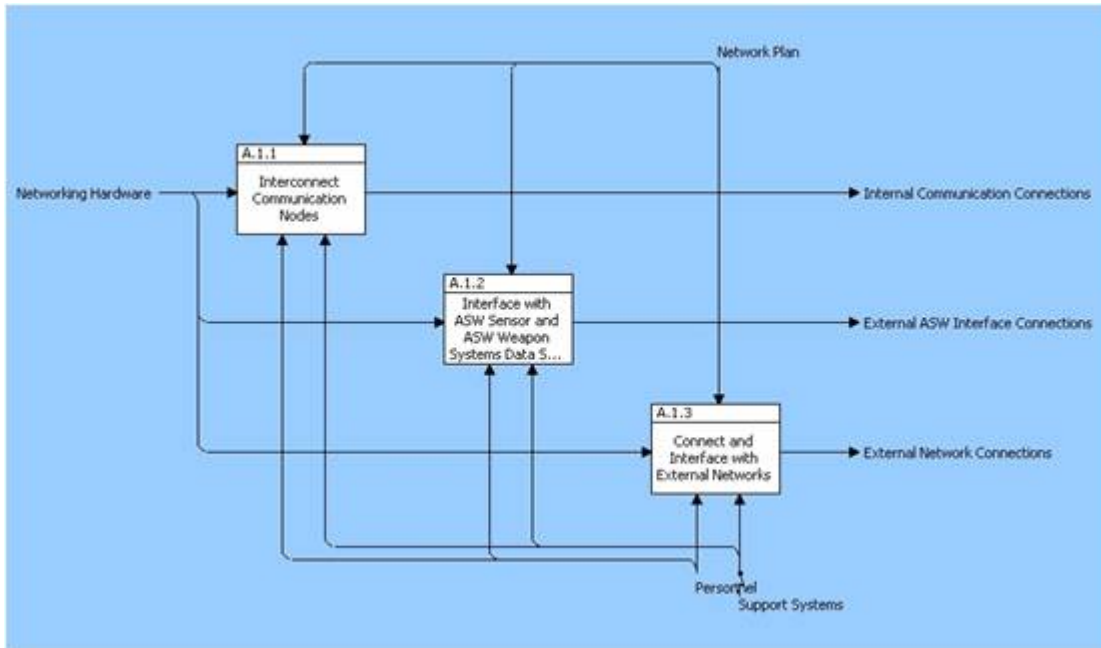
**A.5.3.1 – Transfer ASW Data from Machine to Machine:** This function includes all of the activities that occur when sending the data from one machine to another and is meant to remove the human from the loop to avoid transcription errors. An example would be target coordinates are generated at some command center, transmitted from that machine over the Joint ASW C4I Architecture's network to a receiving communication node which through its interface to a weapons system sends the coordinates straight to the weapon system without a human needing to enter them manually. The human can still approve or disapprove but the transfer of the data requires no human to act as middleware between the machine that generated the data and the machine that will utilize the data.

**A.5.3.2 – Provide ASW Information Publish and Subscribe Services:** This function allows the users to find and access relevant information and publish or subscribe the information to those who need it. Publish is exposing the information they produce for other to discover [NCOE JIC, 2005: E-13]. Subscribing allows users to select from a source of information and receive updates on a regular basis or when events occur.

**A.5.3.3 – Manage ASW Data and Information Life Cycle and Optimize ASW Data and Information Handling:** This function includes a comprehensive approach to managing the flow of data and information from receipt and initial storage to the time when it becomes obsolete and is deleted.

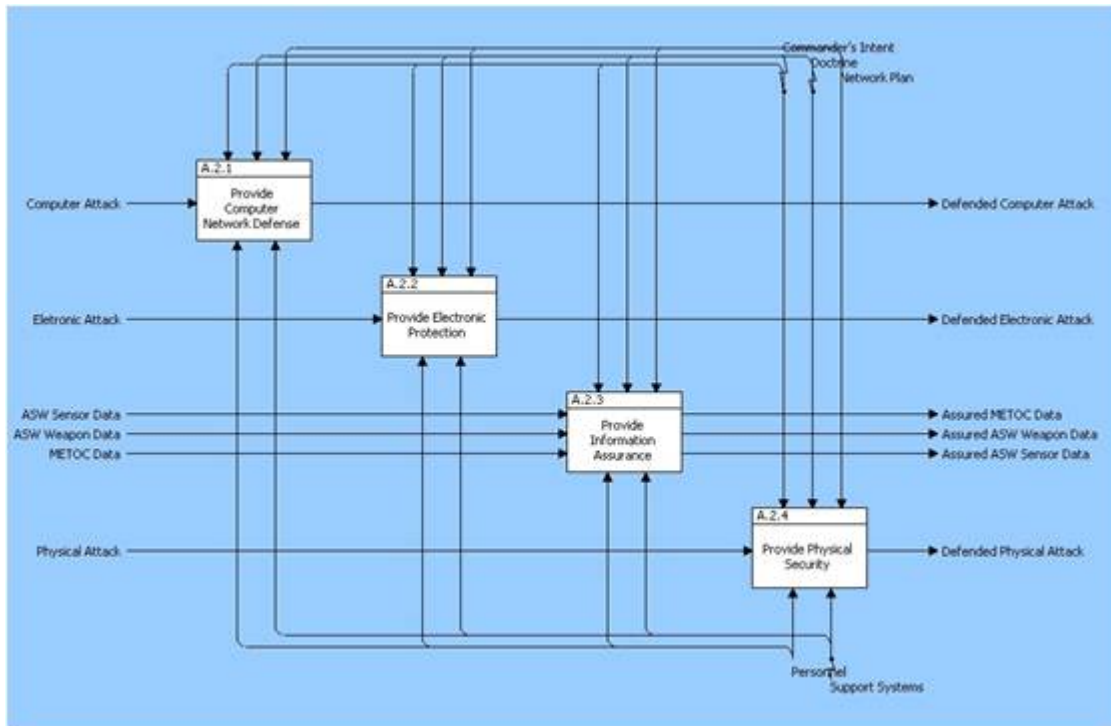
**A.5.3.4 – Enable Smart Pull and Push of ASW Information:** This function includes the ability to distribute information through either smart pull or smart push. Smart push is the ability to gather information, process that information, and make decisions on who should receive it. Smart pull allows the warfighters to grab the information that is needed, regardless of where they are located.

## IDEF0 DIAGRAMS



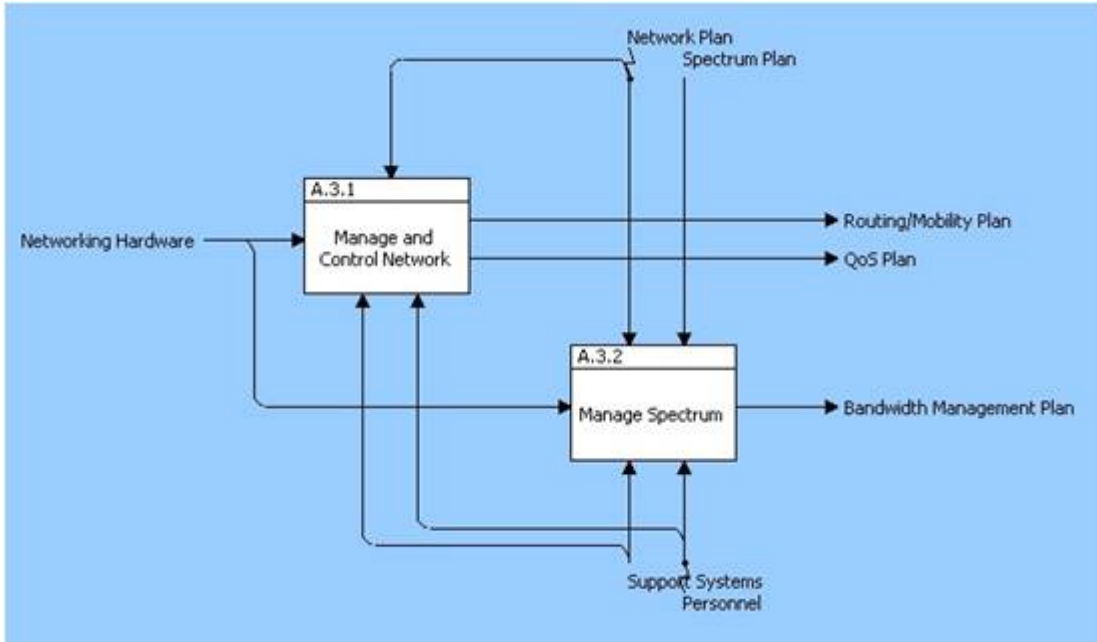
**Figure 73. IDEF0 A1 Diagram**

This figure displays the Joint ASW C4I Architecture A1 diagram which is detailed drill of the Provide Connectivity function (A.1) and it shows the transformation of inputs to outputs by the system.



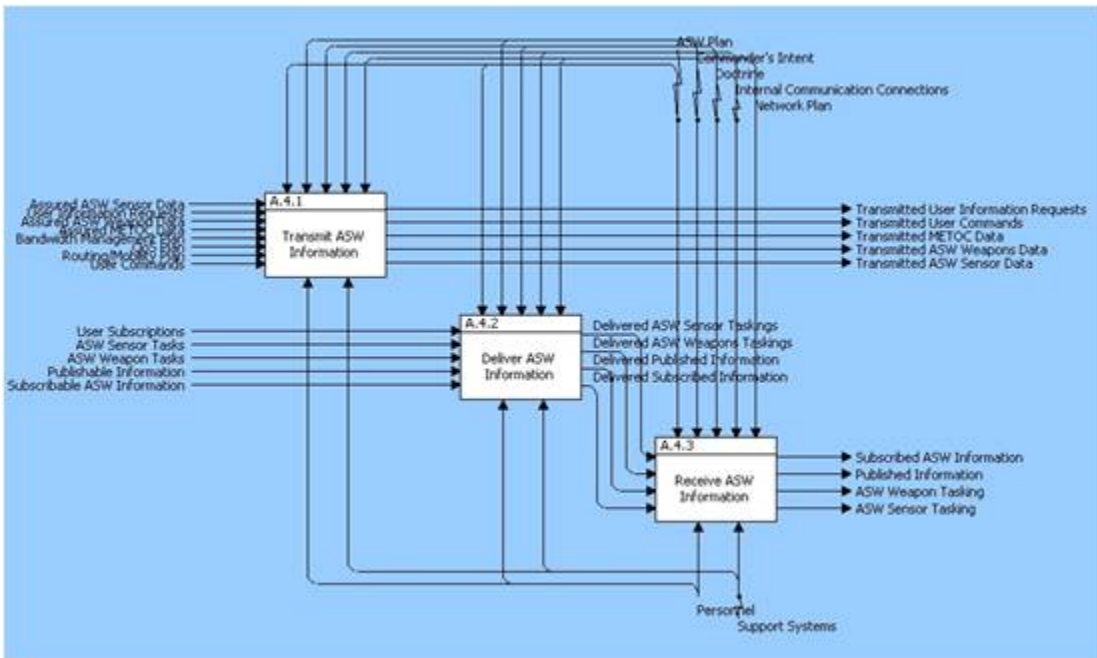
**Figure 74. IDEF0 A2 Diagram**

This figure displays the Joint ASW C4I Architecture A2 diagram which is detailed drill of the Perform Information Operations function (A.2) and it shows the transformation of inputs to outputs by the system.



**Figure 75. IDEF0 A3 Diagram**

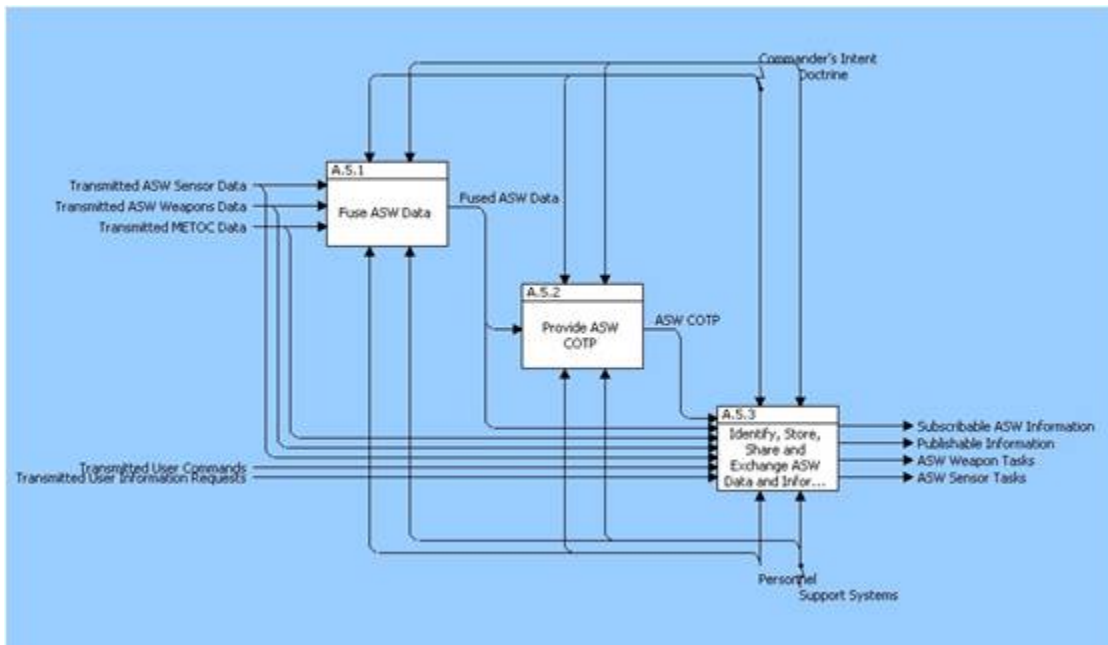
This figure displays the Joint ASW C4I Architecture A3 diagram which is detailed drill of the Optimize Network Functions and Resources function (A.3) and it shows the transformation of inputs to outputs by the system.



**Figure 76. IDEF0 A4 Diagram**

This figure displays the Joint ASW C4I Architecture A4 diagram which is detailed drill of the Transport ASW Information from End-to-End function (A.4) and it shows the transformation of inputs to outputs by the system.

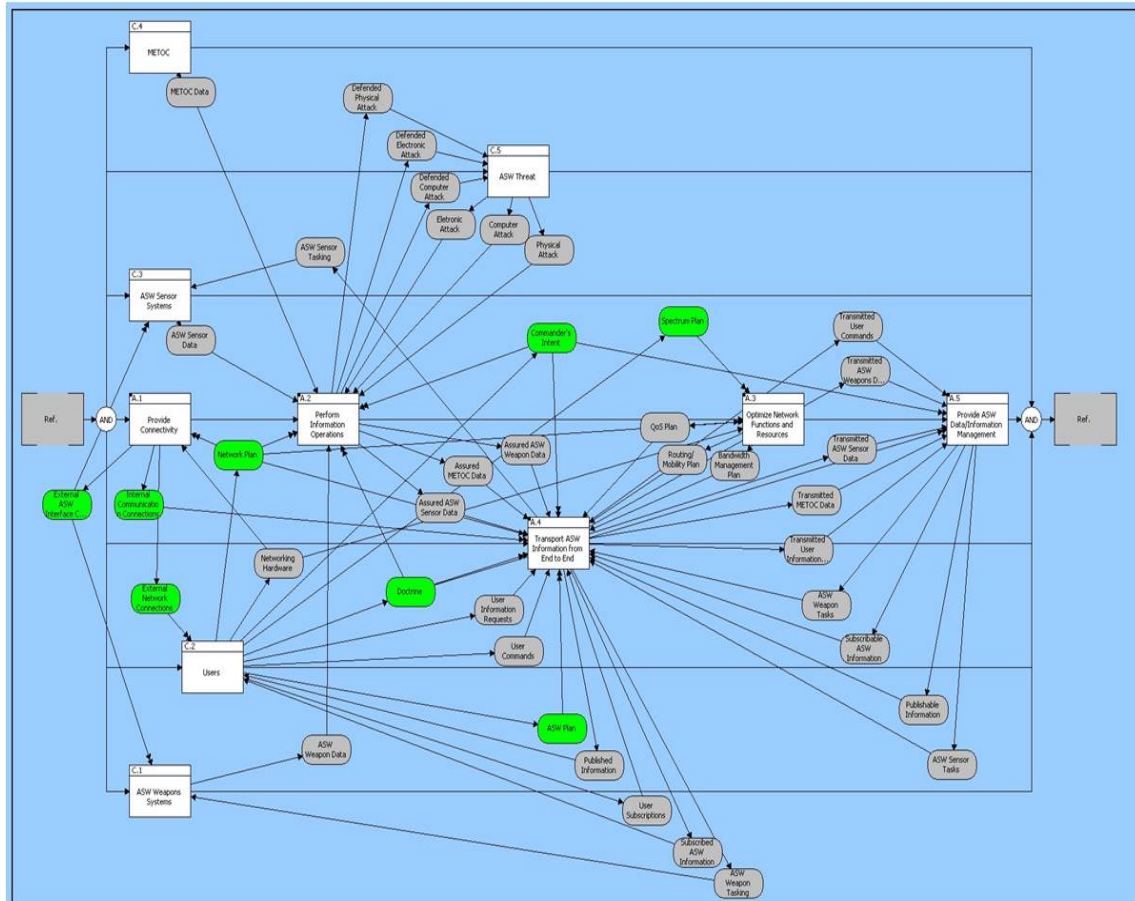




**Figure 77. IDEF0 A5 Diagram**

This figure displays the Joint ASW C4I Architecture A5 diagram which is detailed drill of the Provide ASW Data and Information Management function (A.5) and it shows the transformation of inputs to outputs by the system.

# APPENDIX F. COMPLETE FUNCTIONAL FLOW BLOCK DIAGRAM

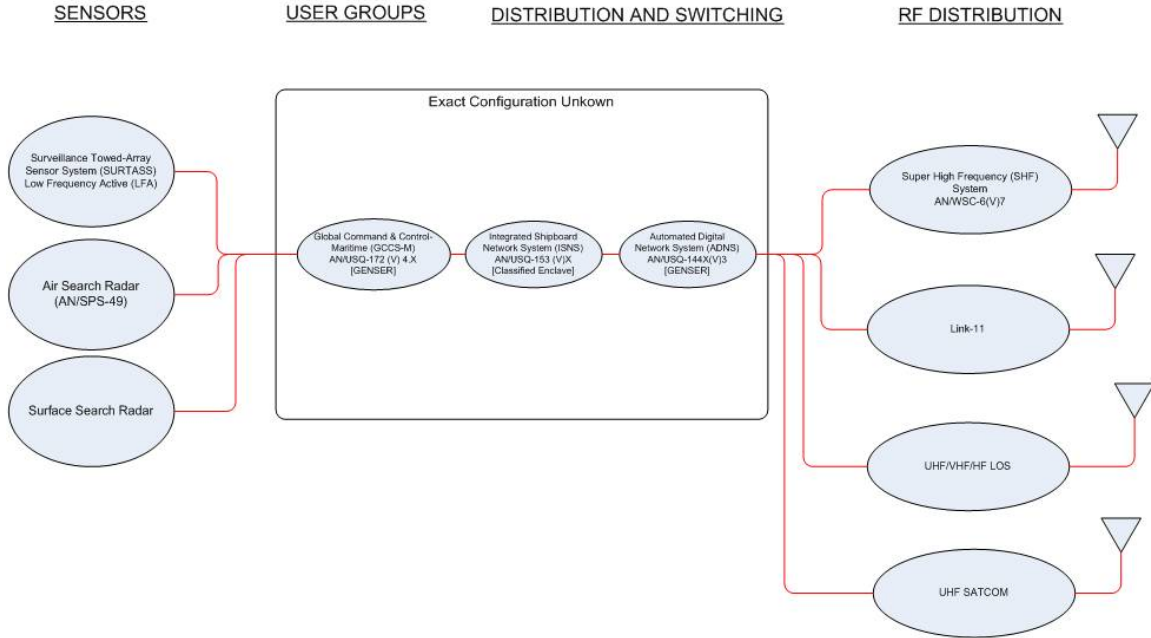


**Figure 78. Functional Flow Block Diagram**

This figure displays the Joint ASW C4I Architecture completed enhanced functional flow block diagram which shows how the system performs its functions.

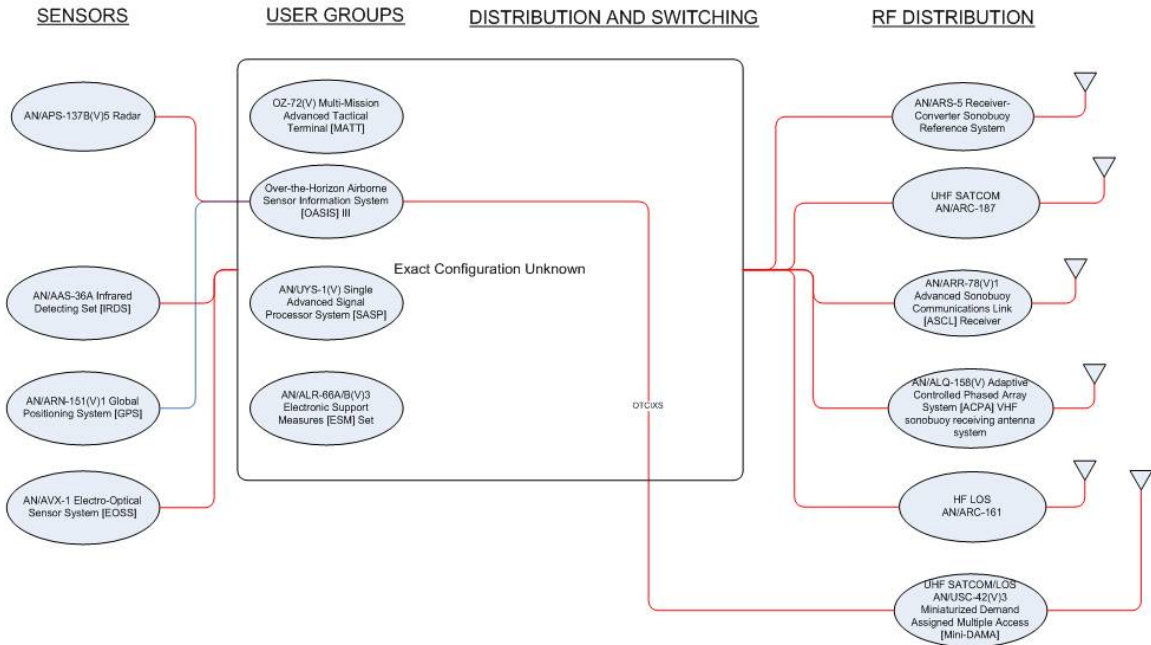
THIS PAGE INTENTIONALLY LEFT BLANK

## APPENDIX G. JOINT ASW C4I ARCHITECTURE BASELINE NODE CONFIGURATIONS



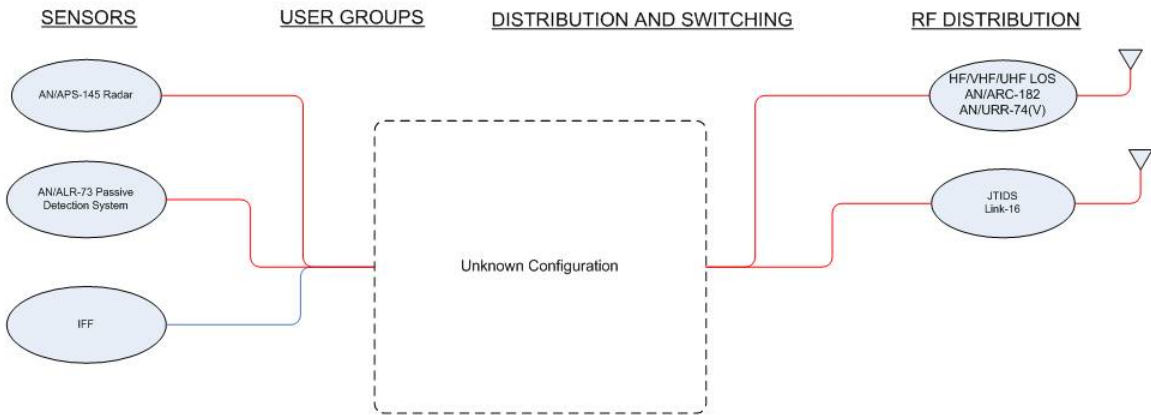
**Figure 79. T-AGOS Class C4I Baseline**

This figure is the expansion of the T-AGOS node in Figure 22 of the alternatives section of this report. This figure is representative of the systems that exist on an Ocean Surveillance Ship that are used in the execution of anti-submarine warfare.



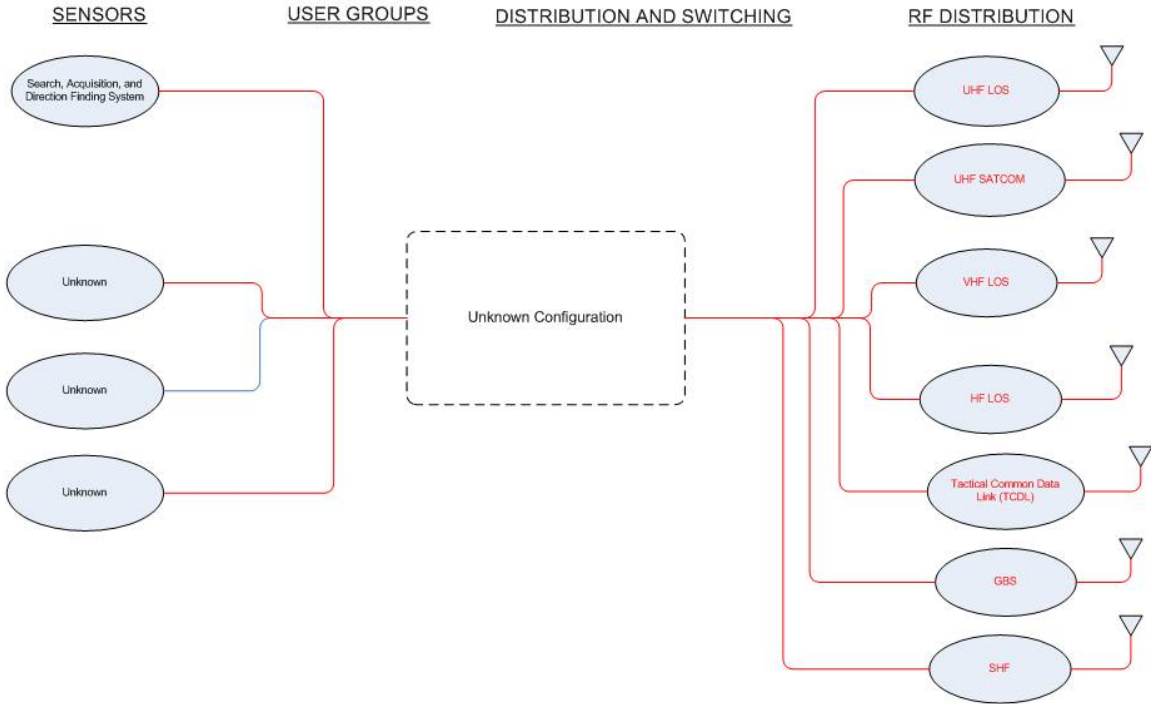
**Figure 80. P-3C Orion Communications Baseline Flow Diagram**

This figure is the expansion of the P-3C Orion node in Figure 22 of the alternatives section of this report. This figure is representative of the systems that exist on P-3C Orion aircraft that are used in the execution of anti-submarine warfare.



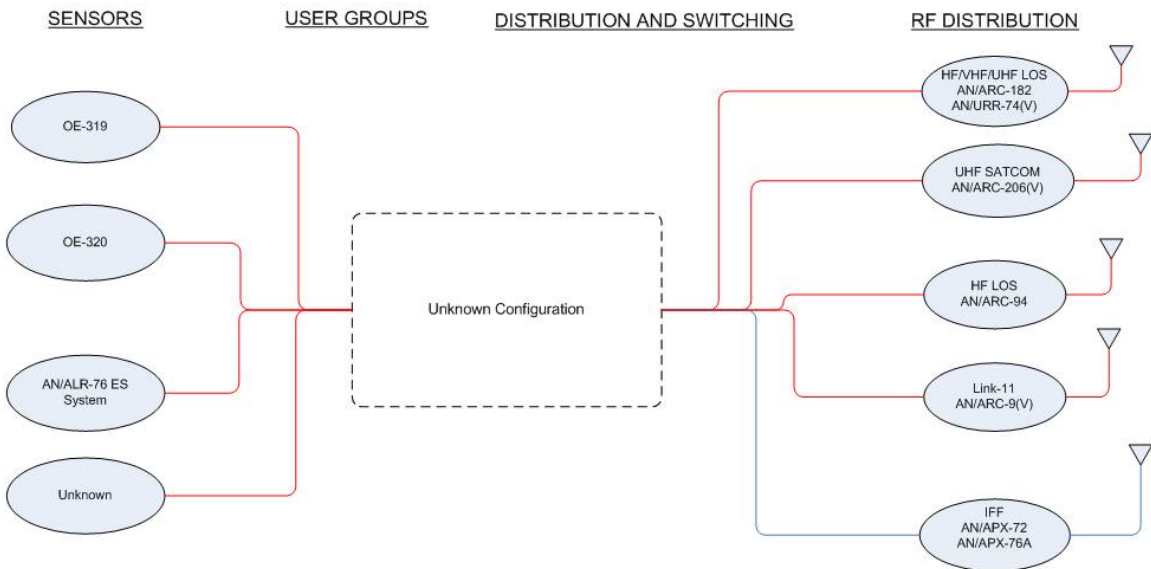
**Figure 81. E-2C Hawk Eye Communications Baseline Flow Diagram**

This figure is the expansion of the E-2C node in Figure 22 of the alternatives section of this report. This figure is representative of the systems that exist on E-2C Hawk Eye aircraft that are used to assist in the execution of anti-submarine warfare.



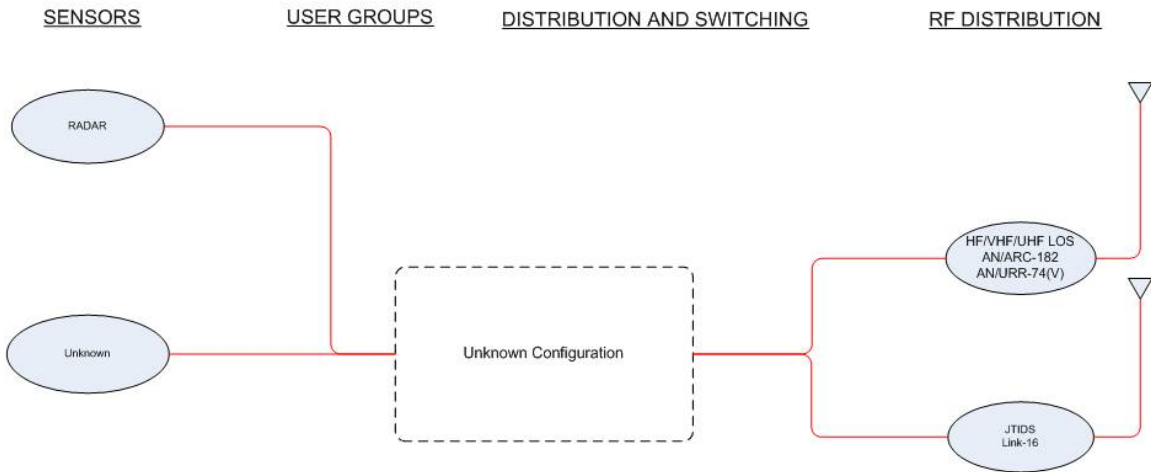
**Figure 82. RC-135V/W Rivet Joint Communications Baseline Flow Diagram**

This figure is the expansion of the RC-135V/W node in Figure 22 of the alternatives section of this report. This figure is representative of the systems that exist on RC-135 Rivet Joint aircraft that are used in the execution of anti-submarine warfare.



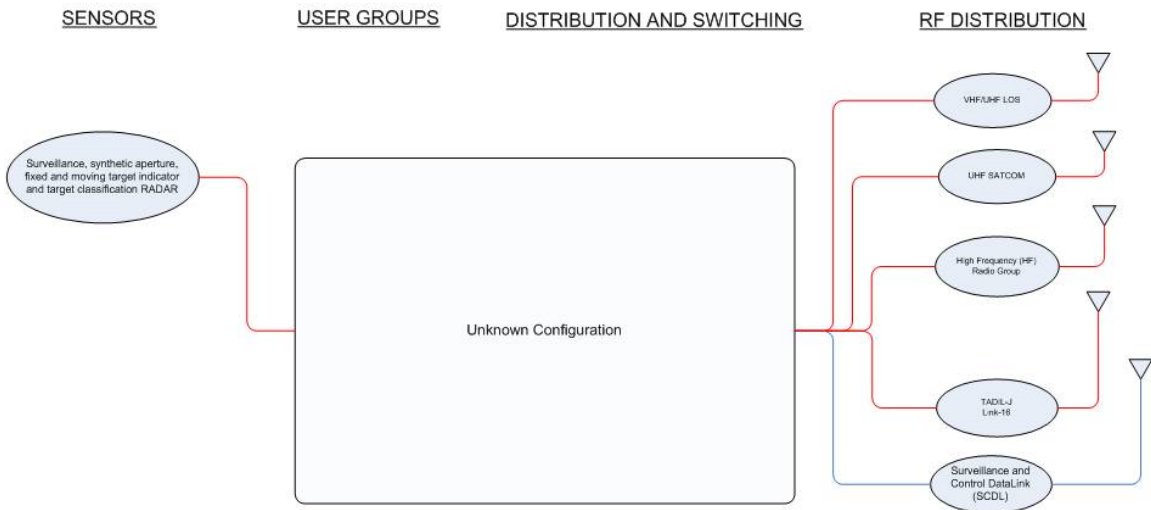
**Figure 83. EP-3E Aries II Communications Baseline Flow Diagram**

This figure is the expansion of the EP-3E node in Figure 22 of the alternatives section of this report. This figure is representative of the systems that exist on EP-3E Aries II aircraft that are used to assist in the execution of anti-submarine warfare.



**Figure 84. F/A-18E/F Super Hornet Communications Baseline Flow Diagram**

This figure is the expansion of the FA-18 node in Figure 22 of the alternatives section of this report. This figure is representative of the systems that exist on F/A-18E/F Super Hornet aircraft that are used to assist in the execution of anti-submarine warfare.



**Figure 85. E-8C JSTARS Communications Baseline Flow Diagram**

This figure is the expansion of the E-8C in Figure 22 of the alternatives section of this report. This figure is representative of the systems that exist on E-8C JSTARS aircraft that are used to assist in the execution of anti-submarine warfare.

## APPENDIX H. DETAILED SCENARIO

Our proposed Joint ASW C4I Architecture must be responsive to real world battle force interactions within and exterior to its sphere of operational submarine specific influences. This operational scenario uses a series of vignettes to develop a Pacific theater maritime environment using generalized military and non-military force denominators to drive communication-oriented events of limited durations through FY2020 available communications paths. Reaction to data is of critical importance to the Blue Force Commander and his or her combatant forces for command and control, early warning, and battle readiness. Timely data delivery will determine the effectiveness and suitability of the network architecture and is required for the fleet to perform and accomplish its assigned mission tasks. Additionally, the Joint ASW C4I Architecture includes the difficult underwater ingredient to obtain and transmit data to submarines on and below the sea surface.

The scenario outlines a finite number of key network systems identified in the Scenario Order of Battle, Table 15, using interactive C4I events located in four mission vignettes. Inputs to the Joint ASW C4I Architecture are essential for the assigned Undersea Warfare Commander include geography; known maritime operating areas; and, the expected capabilities of Red, White, and Blue Forces within the intended battlespace and timeframe.

To detect and defeat Red Force threats, Blue Force sensors and weapons will be integrated to produce battlespace dominance on, above, and below the sea. This is a challenging goal. Communications required between sensors and weapons when functioning within the littoral environment will be extremely limited due to significant noise and clutter found above and trapped below the sea surface. The most effective approach to countering these limitations is to network large numbers of distributed sensors and weapon [Navy Warfare Development Command, 2008].

### **Geography**

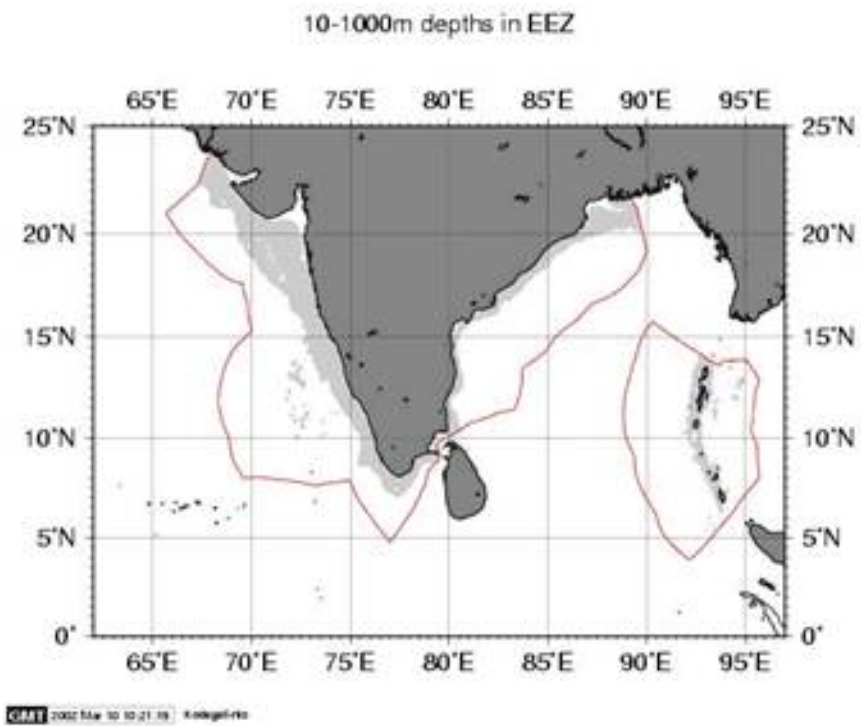
Our battle space will span the oceanic and littoral areas from the South China Sea through the Straits of Malacca, into the Bay of Bengal, as well as, the coastal reaches of eastern India. Figure 86 provides a graphic depiction of India's shallow water areas, 10 to 1000 meters in-depth, overlaid with the economic exclusion zone (EEZ) [Comprehensive Swath Bathymetric Survey of Entire Indian EEZ, 2008]. The narrow littoral regions along India's east coast allow for limited surface transits allowing them to dive much closer to the shoreline.



Littoral waters are characterized by relatively shallow water columns normally adjacent to landmasses and almost always found to be noisy both acoustically and electromagnetically. Underwater sound including ship traffic and underwater sea life is trapped in this water mass. Blue Force communication nodes may receive enemy electromagnetic jamming activity due to their proximity to enemy shore based sites and most assuredly by enemy shore based aircraft. Line-of-sight communications can be expected between all friendly force actors and with friendly relay sites ashore.

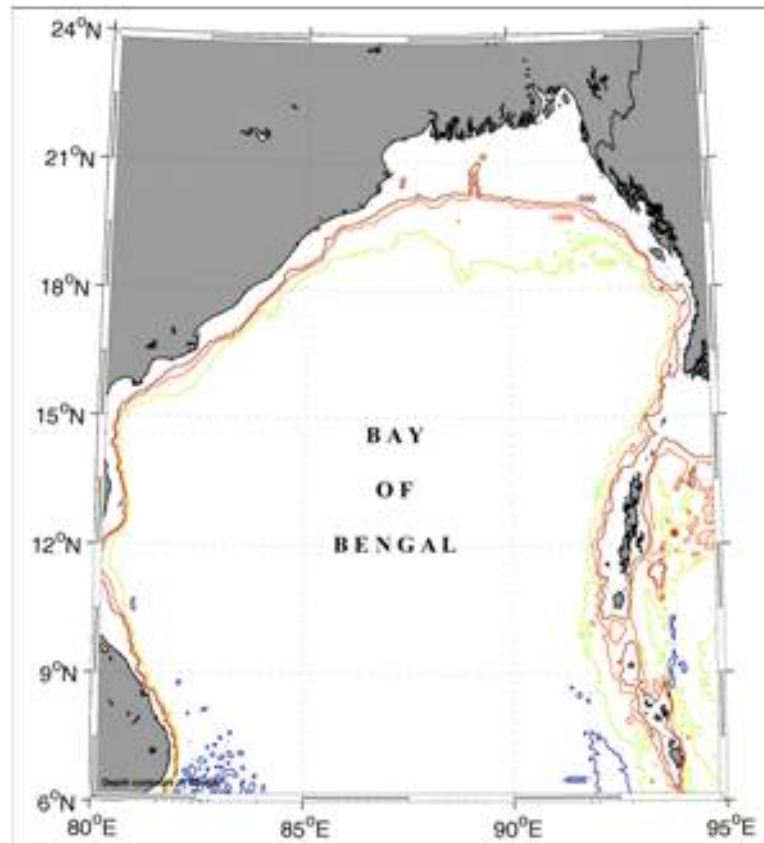
The deep water environment can be characterized as open, ocean with much less noisy conditions. It generally offers the opportunity for long range acoustic sound channeling to send or receive signals. Though the Blue Force nodes will have line-of-sight communication options with each other sheer distance requires them to have over the horizon reach-back capabilities to adequately carry out missions.

Bathymetric features and water column characteristics provide the ocean's framework for acoustic energy propagation ranges. Understanding dynamic ocean features will benefit the ASW forces in improved submarine detection, location, and weapons engagement. Figure 87 displays water depths for the Bay of Bengal that exceed 3500 meters. Major weather conditions impacting operational missions in the world's tropical regions are monsoonal rains and typhoons. Weather and oceanographic conditions need to be sensed, reported on, and modeled to provide friendly forces a tactical advantage over the adversary.



**Figure 86. Economic Exclusion Zone & Shallow Water Areas**

This chart provides a simple graphic display of shallow blue areas and the solid lined economic exclusion zones of marshalling and security interest to India [From Global Ocean Associates, 2004].



**Figure 87. Bathymetric Chart of Bay of Bengal**

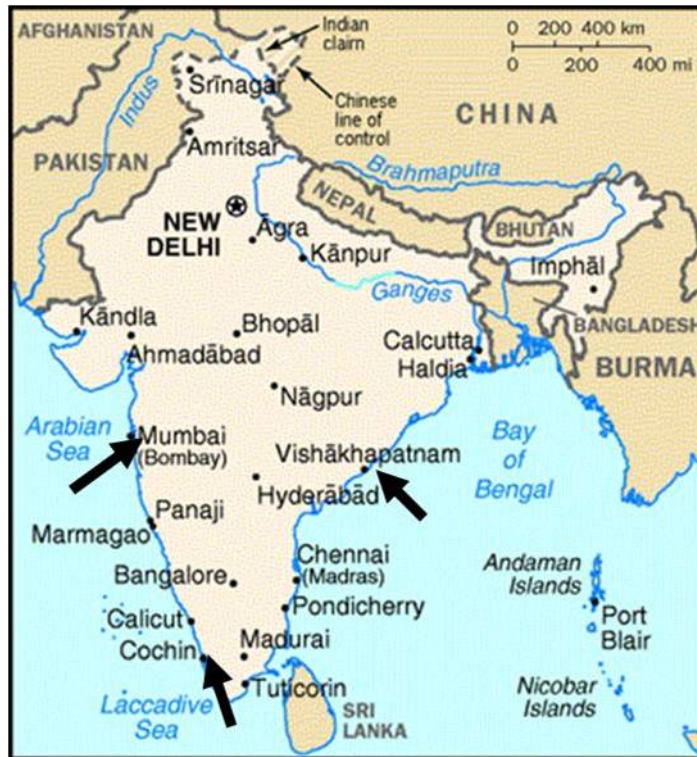
This chart provides a simple graphic display of the depths off of eastern India showing littoral shallow water to be very close to shore [From Global Ocean Associates, 2004].

### **Green Force Maritime Operating Areas**

India is centrally located to key Indian Ocean sea lines of communication (SLOC) interests between the Sea of Oman and the Straits of Malacca leading into Malaysia. Its maritime forces have immediate access to littoral and deep ocean waterways to enable its enforcement of distant, off shore SLOC and with the preservation and protection of its littoral, near shore EEZ. India's Navy is principally responsible for conducting SLOC security in support of its import and export trade well away from the mainland. Surveillance and policing of the EEZ duties fall to the Coast Guard who seek to prevent activities spanning from offshore fishery poaching to coastal intercept of non-state, terrorist advances.

### Green Force (ISR Target then Becoming Coalition Force Partner)

The Green Force Army and Air Force are using terrestrial and air-based search and command and control systems nearest the coastal India shoreline. The Air Force is estimated to have 45 fixed-wing squadrons, 20 helicopter units and numerous surface-to-air missile squadrons, with units varying from 12 to 18 aircraft. Coast Guard units are conducting surveillance and C2 operations from both sea surface and air based platforms though limited to the bounds of the EEZ, while India's Naval Force conducts similar operations from within and well beyond the EEZ in littoral and open ocean areas. The Navy's subsurface submarine platform capability rounds out the maritime options. Figure 88 highlights three major seaports - Mumbai, Cochin, and Vishakhapatnam. All are under intermittent Blue Force surveillance to monitor, control and hold the Green force maritime assets, especially its submarines, at bay.



**Figure 88. Principle Green Force Ports**

This chart offers a graphic depiction of India's major sea ports and their proximity to the Bay of Bengal and Arabian Sea [About.com, 2008].

India's naval forces are multi-national, mostly pre-owned, aging ships and aircraft originating from the United Kingdom, Russia, and the United States. Its Coast Guard

consists of 76 ships - 4 Advance Offshore Patrol Vessels; 9 Offshore Patrol Vessels; 11 Fast Patrol Vessels; 13 Inshore Patrol Vessels; 2 Seaward Defense Boats; 12 Interceptor Boats; 8 Interceptor Vadyar Crafts; 4 Interceptor Bristol Crafts; and 6 Hovercraft; 24 Fixed Wing (Dorniers) 228 Aircraft; and, 21 helicopters - 17 Chetak and 4 Advance Lightweight Helicopters) [Indian Armed Forces, 2007]. Red Force naval platforms are estimated to be over 80 vessels with 2 aircraft carriers (additional 1 in construction), 16 submarines (6 under construction), 8 destroyers, 13 frigates, 24 frigates, 20 patrol craft, 12 minesweepers and numerous amphibious and support ships. The aircraft carriers have the following aviation assets:

- Viraat (ex-Hermes) – 28 aircraft (Sea Harriers Mk51 and Mk52; H-3 Sea King Mk42; HAL Chetak; HAL Dhruv)
- Vikramaditya (ex-Admiral Gorshkov) - 16 aircraft (MiG-29K; HAL Tejas; Sea Harrier; 6 Ka-31 ‘Helix’; HAL Dhruv)
- Vikrant (Air Defense Ship class under construction) – 30 aircraft (MiG-29K; HAL Tejas; HAL Dhruv; Ka-31 ‘Helix’)

### **Green Force Communications**

India’s military forces use standard military and commercially available architectures to address C2 and C4ISR networking requirements including, but, not limited to [Corps of Signals, 2008]:

- Digital, fully automated, secure, reliable and survivable static communication system based on microwave radio, optical fiber, and satellite and millimeter wave communication equipments.
- Satellite Communications are exploiting international maritime satellites, and the Indian National Satellite.
- Computer Data Networks and Information Technology are being heavily used for data communications, weapon control and management systems.
- Electronic Warfare is a potent force multiplier playing a key role in anti-insurgency and low intensity conflict operations.
- Cellular waveforms being used include Global System for Mobile communications, Code Division Multiple Access, Wireless Local Loop, mobile trunked radio, and mobile satellite systems

- Advanced data transmission techniques such as Synchronous Digital Hierarchy and Plesiochronous Digital Hierarchy are used.

Other commercial communication attributes of interest include:

- International submarine cable systems with landing sites at Cochin, Mumbai, and Chennai;
- Fiber-Optic Link Around the Globe (FLAG) at Mumbai;
- South Africa - Far East (SAFE) site at Cochin;
- Cable network with Singapore landing at Mumbai and Chennai;
- Tata Indicom linking Singapore and Chennai.
- Satellite earth stations (e.g., 8 Intelsat (Indian Ocean) and 1 international maritime satellite (Indian Ocean region));
- 9 gateway exchanges operating from Mumbai, New Delhi, Kolkata, Chennai, Jalandhar, Kanpur, Gandhinagar, Hyderabad, and Ernakulam.

### **White Force (Commercial Merchant Ships and Airlines)**

Import and export trading relies heavily on the merchant shipping industry made up of over 450 ships (e.g., 101 bulk carrier, 202 cargo, 18 chemical tanker, 1 combination ore and oil, 9 container, 19 liquefied gas, 3 passenger, 10 passenger and cargo, 95 petroleum tankers, and, 1 roll on and roll off) [The World Factbook, 2008]. These vessels represent opportunities for submarines to come and go without detection and will need to be positively identified as non hostile surface contacts as soon as possible in the kill chain process.

Commercial airlines operating on normal international and national flight routes and schedules represent another entity having access to the battlespace and require awareness. Rapid detection, identification and deconfliction from military Red or Blue air assets are a must to avoid misidentification incidents and possible engagement with friendly aircraft.

### **Red Force (Maritime Terrorist)**

Numerous third world actors have successfully obtained high performance speed boat and miniature submarine capabilities throughout the last decade. High performance speed boat numbers and their performance have continued to grow around the world

driven by designers and boat racing enthusiasts. This global market has been known to be tapped by guerilla forces in the western Pacific who have procured many for the conduct of their pirating operations against the world's merchant marine fleet. Mini-submersibles have also become a worthy opponent for the continuing Global War on Terror. These platforms continue to turn up in drug smuggling and pirating operations around the world. Miniature submarine suppliers include North Korea, Iran, Germany, and Sweden. These miniatures have been known to operate out to ranges of 1,100 nautical miles using crews of two to eight. Top operational speeds average near 10 knots. Though expected to have high frequency communications, they are more likely to be carrying portable commercial satellite transmit and receive equipment to connect to worldwide internet protocol networks while operating on the surface at snorkel depths. Miniature submarines are extremely quiet, diesel and electric powered systems with very small surface cross sections. This capstone project design team expected them to operate solely in the littoral seas but they have been known to venture into blue water areas for pirating operations.

### **Mission Vignettes - Four Phased Approach**

ASW C4I functional system requirements are motivated by ASW unique operational scenarios involving enemy submarine activities. The mission vignettes are developed using a four phased approach – Initial Preparation of the Battlespace; Extended Reconnaissance and Surveillance; Proactive Prosecution; and, Command Controlled Weapons Engagement. To accomplish each of these phases the Undersea Warfare Commander receives the support of the Joint ASW C4I Architecture to effect movement of data between manned and unmanned sensors, operational platforms, and weapons systems focused on the ASW problem. It is understood that the Joint ASW C4I Architecture must:

- Be 99% operational for the duration of the mission vignettes.
- Process, exploit and distribute necessary data sets.
- Communicate 99.9% of all input sensor data to 99.9% of all intended system receivers.
- Communicate all signals with 99.9% accuracy to receivers and data users.

Mission Threads and Assumptions have many similarities from one mission phase to the next and will not be duplicated.

### **Mission Threads**

The Joint ASW C4I Architecture must account for mission threads falling within the conduct of the Blue Force reconnaissance and surveillance mission scenario including:

- Employ surface, subsurface, and air platforms.
- Employ unmanned underwater vehicles.
- Develop situational awareness of beyond line-of-sight battlespace.
- Conduct line-of-sight and over the horizon ship maneuvering.
- Conduct line-of-sight and beyond line-of-sight aircraft control.
- Conduct aircraft launch and recovery of fixed and rotary wing aircraft.
- Deploy in-situ sensors (such as sonobuoys or fixed bottom sensors).
- Network sensed data throughout Task Group-ASW.
- Construct common operational tactical picture.

### **Assumptions**

The following assumptions have been made in constructing this vignette:

- India remains a strong coalition partner of the United States in the Global War on Terror.
- United States reconnaissance and surveillance actions are to remain as passive and non provocative as possible.
- Current beyond line-of-sight C4I networks are available 75% of the time while operating in deep ocean areas.
- Current beyond line-of-sight C4I networks are available 95% while transiting between South China Sea and Bay of Bengal battlespace.



- Fixed underwater surveillance systems are available and communicating twice weekly analyses to Task Group-ASW for inclusion in tactical picture from ashore location.
- Line-of-sight communication ranges reduced to less than 7 nautical miles when operating in heavy seas (greater than 10 feet) and moderate to heavy precipitation rates.
- Radio frequency signal jamming is not expected from Indian military forces.
- Blue Force reconnaissance and surveillance mission is for intelligence gathering.
- Red Force weapons engagement is not anticipated.

### **Phase I - Initial Preparation of the Battlespace Vignette**

This vignette seeks to maximize the Blue Force Commander's situational awareness of the intended battlespace. The Joint ASW C4I Architecture will take advantage of all possible sources of information including historical literature; known Red Force concepts of operation; tactical strategies; and, most assuredly, will seek to meet or exceed the Commander's intent. The Undersea Warfare Commander will ensure this task is accomplished before moving into follow-on mission sets.

#### **Day 1 & 2: (Command and Control)**

Event 1: (Shore Commercial Broadcast to Surface Ships and Shore Sites using Audio and Video Data) International CNN news reports underwater ballistic missile testing observations off the coast of India. Port of Vishakhapatnam is identified as the principle research and development location.

Event 2: (Local Shore to Local Shore using classified verbal and digital message) President orders United States National Command Authority (NCA) 30 day monitoring of foreign area using National Technical Means (NTM) surveillance assets and requisite military forces.

Event 3: (Shore to Overseas Shore using verbal and digital message) NCA assigns the Pacific Command (PACOM) with carrying out and reporting on 30 day reconnaissance and surveillance mission.

Event 4: (Overseas Shore to CVN using secure audio, video, digital data) PACOM assigns ASW related mission to the 7<sup>th</sup> Fleet Commander currently aboard a United States CVN in South China Sea.

Event 5: (CVN to Overseas Shore using secure audio, video, digital data) 7<sup>th</sup> Fleet Commander requests use of his entire Blue Force Task Group for this 30 day surveillance mission along India's east coast. The Task Group (TG) consists of an aircraft carrier (50 embarked aircraft (four SH-60 ASW helicopters, two E2 Hawkeye surveillance and 44 fighter and attack (F/A-18) fixed wing aircraft); two guided missile cruisers (two embarked SH-60 ASW helicopters each); one destroyer (one embarked SH-60 ASW helicopter); one frigate (one embarked SH-60 ASW helicopter; and two attack submarines (two embarked Unmanned Undersea Vehicles (UUV) each). Additionally, the TG will be supplemented by United States Navy electronic P-3, P-3D, United States Air Force RC-135 V/W (Rivet Joint) and a RC-8C (Joint Surveillance Target Attack Radar System (JSTARS)) aircraft stationed in Guam, and one Surveillance Towed Array Sensor System (SURTASS) Low Frequency Active (LFA) vessel on station in the Arabian Sea. Air assets will begin R&S mission support to the intended Bay of Bengal battlespace three days before the TG's arrival. These aircraft will provide a maximum of 20 hours of overlapping coverage within the operating area through the duration of the mission (weather permitting).

Event 6: (CVN to Task Group using secure audio broadcast) 7<sup>th</sup> Fleet Commander orders "TG-ASW" to relinquish current operations and report readiness to conduct 30 day R&S mission within next 6 hours.

Event 7: (CVN Onboard C2 system) 7<sup>th</sup> Fleet Commander assigns ASW mission to carrier based Undersea Warfare Commander (USWC) and orders the planning, coordination, establishment of the tactical picture, and exercise tactical control of all force assets versus the Red Force ASW threat in accordance with the Rules of Engagement within 48 hours. (Note: USWC has taken into consideration the geography

of the battlespace, Red Force attributes, maritime operating areas, economic exclusion zone, communications infrastructure, and White forces such as, merchant shipping and commercial air traffic provided at the top of this section.)

Event 8: (CVN to Shore Activity using secure digital data) USWC requests additional digital maps and overhead imagery files of Indian ports by secure message traffic for delivery over next 12 hours.

TG-ASW is 54 hours from intended battlespace in Bay of Bengal. Weather is forecasted to remain cloudy to partly cloudy with occasional light rain, winds from the southeast at 10 to 20 knots. Sea heights are forecasted at 4 to 6 feet becoming 1 to 3 feet near coast. Sonar conditions are good for extended bottom bounce ranges. Deep sound channel is expected between 375 to 600 feet.

## **Phase II - Extended Reconnaissance and Surveillance Vignette**

The purpose of this vignette is to delineate the operational ASW reconnaissance and surveillance mission requirements for the Joint ASW C4I Architecture support capability. The Joint ASW C4I Architecture is needed to command and control fleet operational maneuvers from one battlespace to another; communicate line-of-sight and beyond line-of-sight situational awareness of immediate and intended battlespace; communicate all source situational awareness of a specified Red Force seaport to operational afloat Task Force and a myriad of ashore staffs; and, coordinate coalition force command and control to reposition both naval battle groups against a new enemy. Ships, submarines, aircraft, and national assets, will ensure “unblinking eye” surveillance of India’s port of Vishakhapatnam throughout the conduct of this operational scenario.

### **Day 3 - 17: (Conduct R&S; Develop, Maintain Common Operational Picture)**

Task Group-ASW is operating within Bay of Bengal battlespace.

Event 1: (Shore Commercial Broadcast to Surface Ships and Shore Sites using audio and video data) International news reports return of India Kilo class submarine after testing

mission. News channel available 24 hours a day though there appears to be a 4 hour delay in normal reporting.

Event 2: (Shore Activity to CVN using imagery analysis, graphic and alphanumeric data) NTM surveillance assets confirm news reports and confirms Red Force naval assets in port Vishakhapatnam at 5 submarines (2 in dry-dock), 1 Aircraft Carrier (believed the former Soviet ship Admiral Gorshkov), and several corvettes. Updates are received every three hours.

Event 3: (DDG, FFG, and SURTASS to CVN using alphanumeric and digital data) Surface ships communicate sensed data from 20 to 40 mile standoff ranges. All systems remain operational.

Event 4: (Aircraft to CVN using alphanumeric and digital data) (E2 communicate standoff electronic and signals intelligence (ELINT and SIGINT) range of 60 to 80 miles at an altitude of 25,000 to 37,000 feet.

Event 5: (Aircraft to CVN and Shore Activities using radar, alphanumeric and digital data) Air Force's Rivet Joint and JSTARS remain on station in southern battlespace and confirm Red Force underway activity.

Event 6: (Aircraft to CVN using audio, video and digital data) TG-ASW receives hourly report from electronic P-3 audio and video signals while flying over international waters of the Bay of Bengal from line-of-sight to 25 nautical miles standoff from India coast. Sonobuoys are deployed for use throughout 20 overlapping mission as coordinated and controlled by USWC or onboard P-3 operators as necessary to eavesdrop on possible underwater contacts. USWC notes heavy merchant ship traffic making submarine finding and tracking difficult if used as a screen.

Event 7: (Aircraft to any and all surface ships using alphanumeric and digital data) Routine flight operations continuing. Helicopters conduct line-of-sight SONAR dipping operations. USWC issues operating intentions for TG-ASW platform stations and

frequency of helicopter operational use around NATOPS routine maintenance schedules. Each ship is expected to have one helicopter available 12 hours per day.

Event 8: (Submarine to Overseas Shore Activity and CVN using secure alphanumeric and digital burst data) Blue Force submarines report all systems operational, maintaining underwater passive surveillance, deployed fixed bottom sensors nearest main shipping channel, and conducting normal beyond line-of-sight communications. They report all conditions normal and have updated latest common tactical picture. All surface and subsurface contacts and plot data have been transmitted for last 24 hours.

Weather begins to deteriorate on Day 15 with easterly gale force winds and seas in excess of 10 feet. Heavy precipitation and monsoonal conditions expected to persist next 5 days.

### **Phase III – Proactive Prosecution**

This phase offers the Joint ASW C4I Architecture the opportunity to support the detection and location of Red Force surface and subsurface contacts using signals originating from unmanned underwater sensors; air, sea, and land reporting sites. This phase has a communication twist to it with the need to establish coalition force communications with the very Red Force assets friendly forces have been maintaining tracks on.

### **Day 18 – 25: (Red Force Detection and Location)**

Poor weather continues into Day 20 though moving slowly northward with easterly gale force winds and seas in excess of 10 feet. Forecast for improved conditions with light winds and 3 to 5 foot seas. No precipitation expected over next 96 hours. USWC recommends move TG-ASW northward and reset all R&S missions at 0600, Day 21

Event 1: (Shore Commercial Broadcast to Surface Ships and Shore Sites using audio and video data) International news reports monsoonal conditions beginning to reach into Eastern India. India merchant ships reported overdue. India's President expresses concern over missing seamen.

Event 2: (Shore Activity to CVN using secure imagery analysis, alphanumeric and digital graphic data) NTM surveillance (every 3 hours) – Kilo class submarine and Aircraft carrier appear to be readying for sea.

Event 3: (CVN to TG-ASW and Aircraft Overseas Shore Sites using secure traffic) Blue Force surface and aircraft R&S operations aborted during weather event.

Event 4: (Shore Activity to CVN using secure imagery analysis, alphanumeric and digital graphic data) NTM surveillance (every 3 hours) – data received indicates Kilo class submarine and Aircraft carrier may have been moved to safer harbor due to storm force winds and heavy seas.

Event 5: (Shore Commercial Broadcast to Surface Ships and Shore Sites using audio and video data) International news reports monsoonal conditions have moved over Northeastern India and Bangladesh. India merchant ships reported taken by pirate activity in Straits of Malacca. India's President wants answers.

Event 6: (Submarine to Overseas Shore Activity and CVN using alphanumeric and digital data) Submarines report bottom sensors have identified Indian Kilo submarine and large surface contact both submarines are following from safe distance. Bottom acoustic sensor devices picked up multiple contacts over night. Indications are that a Kilo submarine moved eastward through the channel at 0100 followed by large ship at 0200. Submarines had to move south to communicate on surface and lost positive contact with Indian vessels. Seas reported rough at 6 to 8 feet.

Event 7: (Aircraft to CVN using radar, alphanumeric and digital data) Air Force Rivet Joint and JSTARS report submarine and large surface contact at mouth of Red Force harbor heading east southeast at 10 knots.

Event 8: (Aircraft to CVN using audio, video, and digital data) TG-ASW receives last P-3 reports before being weathered out, confirming underway activity of Red Force Kilo submarine and aircraft carrier.

Event 9: (CVN to TG-ASW using audio, video and digital data) Surface and aircraft R&S operations resumed on Day 21 with orders to locate Indian Kilo submarine from a distance.

Event 10: (Ships to CVN; Aircraft to CVN; and SURTASS to Overseas Shore to CVN using audio, video, graphic digital data) Surface, aircraft, and SURTASS R&S operations confirm India's aircraft carrier is underway at 30 knots and not attempting to avoid United States maritime activities. Indian aircraft reported to have made radio contact with United States forces to dialog about weather and if the United States had any reports of pirated merchant ships.

Event 11: (SURTASS to Overseas Shore Activity to CVN using secure graphic and alphanumeric data) USWC receives IUSS shore station report with Kilo track information.

Event 12: (Shore Commercial Broadcast to Surface Ships and Shore Sites using audio and video data) CNN International reported several Indian merchant ships being attacked by pirates while exiting the Straits of Malacca. These vessels were alleged to have valuable missile cargo onboard and their loss would be devastating to India and of extreme value to non-state terrorist actors.

Event 13: (Pentagon to CVN using secure audio, video, digital data) TG-ASW Commander received time critical message: "American Ambassador to India asked if US could provide necessary national and naval support to assist Indian naval forces in recovering missing cargo and merchant ships. National Command Authority has modified surveillance orders to conduct joint coordinated Indian Navy and United States Navy operations to recover ships and cargo. Coordinate on scene with Indian Commander to make best operational speed to area around Straits of Malacca; conduct joint coordinated operations with Indian Navy assets; and, recover Indian merchant ships.

Event 14: (Shore Activity to CVN using secure imagery analysis, alphanumeric and digital graphic data) All source intelligence information identified 2 mini-submarines maneuvering on surface at 0300 Pacific local time about 60 miles from last known position of Indian merchant ships.

Event 15: (Shore Activity to CVN using secure audio, video, digital data) NCA conducted secure video teleconference with TG-ASW and USWC confirmed mini-submarines and ordered Coalition naval force, led by TG-ASW, to conduct Command Controlled Weapons Engagement to avoid international embarrassment.

#### **Phase IV - Command Controlled Weapons Engagement**

United States and Indian Coalition Force successfully detects and locates two mini-submarines maneuvering near the Straits of Malacca. USWC intent is to force mini-submarines to relinquish control of their platforms and weapons material without weapons engagement. Active sonar prosecution is authorized to ensure new Red Force subsurface targets are fully aware of Blue Force presence. USWC objective is to drive Red Force targets south of Straits towards uninhabited coastline.

#### **Day 26–30: (Mini-Submarine Identification and Weapons Engagement)**

Event 1: (CVN to Coalition CVN) USWC conducts coordinated prosecution planning activities with Indian Naval Force counterparts to detect, locate and engage new Red Force mini-submarines at the earliest opportunity.

Event 2: (CVN to all Coalition and TG-ASW forces using audio and digital data) - All air, sea, and submarine forces conducting R&S duties to detect and locate new Red Force targets.

Event 3: (Ships to CVN; Aircraft to CVN; and SURTASS to Overseas Shore to CVN using audio, video, graphic digital data ) Surface, aircraft, and SURTASS R&S operations confirm detection and location of two HPSB and two mini-submarines nearing Straits of Malacca.



Event 4: (CVN Secure Broadcast to TG-ASW and Coalition Force) USWC orders surface, submarine and air weapons carrying platforms to ready for shallow water engagement of mini-submarine.

Event 5: (Aircraft to Surface Ship to CVN using audio and digital data) Forward SH-60 aircraft report visual surface contacts to TG-ASW awaiting orders.

Event 6: (CVN to United States Shore headquarters using audio, video, digital data) TG-ASW Commander live feed report to PACOM, NCA, and POTUS current status of mini-submarines.

Event 7: (CVN to SH-60 using audio, digital data) USWC orders SH-60 aircraft to communicate directly with Red Force mini-submarines of Blue Force intent to engage and sink if necessary.

Event 8: (Visual signals from enemy to aircraft) Red Force mini-submarines wave white flag, and makes voice communications that they are ready to turnover cargo and vessels to boarding crews.

Event 9: (Coordinated communications between Blue and Coalition Forces using audio, digital data) On scene Blue Force coalition assets coordinate boarding event by Indian Navy crews to ensure cargo is retrieved for Indian government.

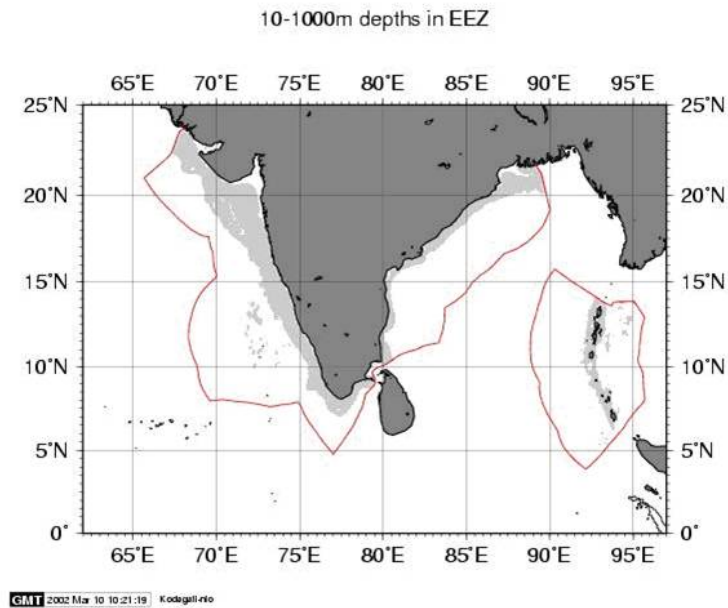
Event 10: Mission complete.

## **DETECTION EVENT LOG**

The Detection Event Log was created at the request of this capstone project's modeling and simulation team to improve their understanding of specific operational scenario sensing and communication events. Fictitious events were itemized to paint a picture of probable occurrences during the course of an at sea exercise or real world

event. This log served to baseline inputs used in the modeling of the FY2020 Joint ASW C4I Architecture.

The section provides the underpinning of this capstone project design team’s modeling and simulation initiatives by identifying specific “contact made” input parameter information derived from detection events occurring in this fictitious operational scenario. Figure 89 provides a geographical depiction of the expected operating area once the Blue Force commences its reconnaissance and surveillance missions by sea, air, and space.



**Figure 89. Data Quadrant Identifiers**

This chart depicts quadrant identifiers to offer positional awareness of individual platforms specified in the event log. With the center point at 10 degrees north by 80 degrees east the quadrant positions are as follows: Quadrant I (southwest), Quadrant II (southeast), Quadrant III (northeast), and Quadrant IV (northwest) [Comprehensive Swath Bathymetric Survey of entire Indian EEZ, 2008].

The Blue Force Detection Event Log represents the single database consolidating contact information received from each of the naval platforms. It keeps a complete record of Blue Force contacts as communicated by all available sensing modes. Excerpts of this log are provided below to baseline the data received over the course of the scenario. The log presents information by day, the position quadrant of the detection, the operational reporting node that detected the contact, the time of detection, type of sensor making the detection, data type, the target detected, and the fusion bin receiving the

information. Reporting nodes include all data sources impacting the operational environment including CNN broadcasts; specific Blue Force surface ships, submarines, and aircraft, as well as, coalition force platforms. Time of detection will be in military time (Zulu) to ensure all commanders and operational units are using the same clock. Contacts will be surface ships and submarines but include anomalies and unknowns. Type of data is primarily identified as digital although reference is made to audio, video, and voice. Targets detected are classified when identified as Merchant Ship, Red Platform (X), and others. Fusion bins have been limited to surface, sub, intelligence and all to permit more focused modeling initiatives. The details of the Blue Force Detection Event Log can be found in Figure 90 through Figure 93.

<b>Blue Force Detection Event Log</b>							
<b>Day</b>	<b>Position Quadrant</b>	<b>Reporting Node</b>	<b>Detect Time (Z)</b>	<b>Blue Force Sensor</b>	<b>Data Type</b>	<b>Target</b>	<b>Fusion Bin</b>
<b>Phase I: Initial Preparation of the Battlespace (Command &amp; Control)</b>							
1	IV	SAT	06:00:00	Camera	Image	Unk Sfc Contacts	Intel
1	IV	CNN	06:00:15	Human	Aud/Vid	India Harbor Area	Intel
1	IV	SURTASS	06:00:30	Towed Array	Digital	Unk Sub on Sfc	Surface
1	IV	NOFF	06:05:00	Relay	Digital	Unk Sub on Sfc	Surface
1	IV	PACOM	07:00:00	Human	SecVTC	Blue TF Assignment	All
1	IV	P-3D	07:20:00	ISAR	Digital	Unk Sfc Contact	Surface
1	IV	E2	07:23:20	ISAR	Digital	Unk Sfc Contact	Surface
1	IV	P-3D	07:25:00	Visual	Voice	Unk Mini-Sub	Surface
1	IV	CGN	07:25:00	Bow Sonar	Digital	Unk Sub Contact	Sub
1	IV	CGN	07:25:30	Bow Sonar	Digital	Unk Sub Contact	Sub
1	IV	P-3D	07:25:45	Sonobuoy	Digital	Mini Sub - R1	Sub
1	IV	CGN	07:26:00	Bow Sonar	Digital	Mini Sub - R1	Sub
1	IV	P-3D	07:27:30	Sonobuoy	Digital	Mini Sub - R1	Sub
1	IV	SH-60	07:29:45	Dipped Array	Digital	Mini Sub - R1	Sub
1	IV	7th Fleet	07:30:00	Human	SecVTC	TG-ASW Assigned	All
1	IV	SH-60	07:39:00	Dipped Array	Digital	Mini Sub - R1	Sub
1	IV	SH-60	07:40:00	Sonobuoy	Digital	Mini Sub - R1	Sub
1	IV	CGN	07:35:00	<i>Lost SUB Contact in Noise of Littoral.</i>			Last Posit
1	IV	SH-60	07:45:00	<i>Lost SUB Contact in Noise of Littoral.</i>			Last Posit
<i>No Further Entries This Day.</i>							
2	IV	RC-135	02:00:00	ESM	Digital	Merchant Ship	Surface
2	II	P-3D	02:05:00	ISAR	Digital	Merchant Ship	Surface
2	IV	SURTASS	02:30:00	Towed Array	Digital	Merchant Ship	Surface
2	IV	CGN	02:10:00	Bow Sonar	Digital	Merchant Ship	Surface
2	II	P-3D	02:15:00	Sonobuoy	Digital	Merchant Ship	Surface
2	II	SAT	02:30:00	Camera	Video	India Harbor Area	Intel
2	IV	FFG	02:20:00	ESM	Digital	Merchant Ship	Surface
2	II	F/A-18	02:25:00	Visual	Digital	Merchant Ship	Surface
<i>Eastbound Surface Contacts Out of Range - 03:15:00.</i>							
<i>TG-ASW Enroute Bay of Bengal Operations.</i>							
<i>No Further Entries This Day.</i>							

**Figure 90. Blue Force Detection Event Log (Day 1 - 2)**

This table provides two specific days of Phase I events detailing the Initial Preparation of the Battlespace (Command and Control) portion of the operational scenario.

<b>Blue Force Detection Event Log</b>							
<b>Day</b>	<b>Position Quadrant</b>	<b>Reporting Node</b>	<b>Detect Time (Z)</b>	<b>Blue Force Sensor</b>	<b>Data Type</b>	<b>Target</b>	<b>Fusion Bin</b>
<b>Phase II: Extended Reconnaissance and Surveillance</b> (Conduct R&S; Develop, Maintain Common Operational Picture)							
3	IV	PACOM J2	13:00:00	All Source	Digital	Human Analysis	All
3	IV	CGN	14:00:00	Bow Sonar	Digital	Merchant Ship	Surface
3	II	E2	14:05:00	ESM	Digital	Merchant Ship	Surface
3	IV	SSN	14:10:00	Bow Sonar	Digital	Merchant Ship	Surface
3	II	EP-3	14:15:00	ISAR	Digital	Merchant Ship	Surface
3	II	SAT	14:18:00	Camera	Image	Merchant Ship	Intel
3	IV	CVN	14:20:00	RADAR	Digital	Merchant Ship	Surface
3	II	SSN	14:22:00	ESM	Digital	Merchant Ship	Surface
3	II	RC-135	14:25:00	ISAR	Digital	Merchant Ship	Surface
3	IV	PACOM J2	16:00:00	All Source	Digital	Human Analysis	All
3	IV	NOFF	18:30:00	Relay	Digital	Merchant Ships	Surface
3	IV	PACOM J2	16:00:00	All Source	Digital	Human Analysis	All
3	II	SSN	19:22:00	Visual	Digital	Merchant Ship	Surface
<i>Westbound Commercial Surface Contacts Out of Range - 19:15:00.</i>							
<i>TG-ASW Conducting Bay of Bengal Operations.</i>							
<i>No Further Entries This Day.</i>							
7	II	SSN	02:22:00	ESM	Digital	Merchant Ship	Surface
7	IV	PACOM J2	04:00:00	All Source	Digital	Human Analysis	All
7	II	CGN	07:00:00	Bow Sonar	Digital	Merchant Ship	Surface
7	IV	PACOM J2	07:00:00	All Source	Digital	Human Analysis	All
7	IV	EP-3	07:05:00	ISAR	Digital	Merchant Ship	Surface
7	IV	FFG	07:10:30	ESM	Digital	Merchant Ship	Surface
7	II	P-3D	07:10:30	Sonobuoy	Digital	Merchant Ship	Surface
7	II	SAT	07:15:00	Camera	Video	India Harbor Area	Intel
7	II	CGN	07:20:00	Bow Sonar	Digital	Merchant Ship	Surface
7	II	SSN	07:22:00	Bow Sonar	Digital	Merchant Ship	Surface
7	II	EP-3	07:25:00	ISAR	Digital	Merchant Ship	Surface
7	II	CGN	07:30:00	Bow Sonar	Digital	Whale	Sub
7	II	FFG	08:00:00	ESM	Digital	Merchant Ship	Surface
7	IV	EP-3	08:05:00	ISAR	Digital	Merchant Ship	Surface
7	IV	CGN	08:10:30	ESM	Digital	Merchant Ship	Surface
7	II	SH-60	08:10:30	Sonobuoy	Digital	Unk Sub	Sub
7	II	SAT	08:15:00	Camera	Video	India Harbor Area	Intel
7	II	FFG	08:20:00	Bow Sonar	Digital	Whale	Sub
7	II	SH-60	08:25:00	Visual	Digital	Whale	Surface
7	IV	PACOM J2	10:00:00	All Source	Digital	Human Analysis	All
7	II	CGN	18:30:00	Bow Sonar	Digital	Merchant Ship	Surface
<i>Maintained East &amp; Westbound Commercial Surface Contacts Every 15 Minutes.</i>							
<i>No Further Entries This Day.</i>							

**Figure 91. Blue Force Detection Event Log (Day 3 - 7)**

This table provides two specific days of Phase II events detailing the Extended Reconnaissance and Surveillance (Conduct Reconnaissance and Surveillance; Develop and Maintain Common Operational Picture) portion of the operational scenario.



<b>Blue Force Detection Event Log</b>							
<b>Day</b>	<b>Position Quadrant</b>	<b>Reporting Node</b>	<b>Detect Time (Z)</b>	<b>Blue Force Sensor</b>	<b>Data Type</b>	<b>Target</b>	<b>Fusion Bin</b>
<b>Phase III: Proactive Prosecution (Red Force Detection &amp; Prosecution)</b>							
20	IV	PACOM J2	19:00:00	All Source	Digital	Human Analysis	All
20	II	SSN	20:26:00	Deployed	Digital	Red Sub (Kilo)	Surface
20	II	RC-8C	20:30:05	ESM	Digital	Red Sub (Kilo)	Surface
20	IV	RC-8C	20:45:00	ESM	Digital	Red CVN	Surface
20	II	SSN	20:50:00	Bow Sonar	Digital	Red CVN	Surface
20	II	EP-3	21:00:00	ISAR	Digital	Red CVN	Surface
20	IV	CGN	21:20:15	ESM	Digital	Red CVN	Surface
20	IV	PACOM J2	22:00:00	All Source	Digital	Human Analysis	All
20	II	EP-3	22:10:05	ISAR	Digital	Red Sub (Kilo) Mast	Surface
20	II	SSN	23:22:00	Bow Sonar	Digital	Red Sub (Kilo)	Sub
20	IV	CGN	23:25:28	ESM	Digital	Red CVN	Surface
20	II	P-3D	23:30:00	Sonobuoy	Digital	Red Sub (Kilo)	Sub
20	IV	CGN	23:45:00	ESM	Digital	Red CVN	Surface
20	IV	P-3D	23:50:00	Sonobuoy	Digital	Red Sub (Kilo)	Sub
20	IV	CGN	23:55:10	ESM	Digital	Red CVN	Surface
20	II	SSN	23:58:00	Bow Sonar	Digital	Red Sub (Kilo)	Sub
<i>Maintain Contact with India Kilo Class Submarine &amp; Aircraft Carrier.</i>							
<i>No Further Entries This Day.</i>							
25	IV	PACOM J2	22:00:00	All Source	Digital	Human Analysis	All
25	IV	CGN	23:55:10	ESM	Digital	Red CVN	Surface
25	II	SSN	23:58:00	Bow Sonar	Digital	Red Sub (Kilo)	Sub
<i>TG-ASW Directed to Coordinate Operations With India's OnScene Naval Commander</i>							
<i>No Further Entries This Day.</i>							

**Figure 92. Blue Force Detection Event Log (Day 20 - 25)**

This table provides two specific days of Phase III events detailing the proactive prosecution (Red Force Detection and Prosecution) portion of the operational scenario.

<b>Blue Force Detection Event Log</b>							
<b>Day</b>	<b>Position Quadrant</b>	<b>Reporting Node</b>	<b>Detect Time (Z)</b>	<b>Blue Force Sensor</b>	<b>Data Type</b>	<b>Target</b>	<b>Fusion Bin</b>
<b>Phase IV: Command Controlled Weapons Engagement (Mini-Submarine Identification and Weapons Engagement)</b>							
26	IV	TG-ASW	01:00:00	Broadcast	Digital	Coalition Comms	All
26	IV	PACOM J2	01:00:00	All Source	Digital	Human Analysis	All
26	IV	Coalition TF	01:30:00	Broadcast	Digital	Search Location	All
26	IV	RC-8C	03:45:00	ESM	Digital	Search Area Activity	Surface
26	IV	PACOM J2	04:00:00	All Source	Digital	Human Analysis	All
26	IV	F/A-18	04:10:00	RADAR	Digital	High Speed Boats	Surface
26	IV	F/A-18	04:15:00	Visual	Digital	HSBs w/Mini Subs	Surface
26	IV	P-3D	05:05:00	ISAR	Digital	HSBs w/Mini Subs	Surface
26	IV	P-3D	05:35:00	ISAR	Digital	HSBs Underway	Surface
26	IV	P-3D	05:40:00	ISAR	Digital	Mini-Subs Diving	Sub
26	IV	P-3D	05:45:00	Sonobuoy	Digital	Red Mini-Subs	Sub
26	IV	P-3D	07:00:00	Sonobuoy	Digital	Red Mini-Subs	Sub
<i>Maintain Contact with Red Mini Submarines &amp; High Speed Boats.</i>							
<i>No Further Entries This Day.</i>							
29	IV	Coalition Helo	15:05:05	Dipping Array	Digital	Mini Subs (R1 & R2)	Sub
29	IV	PACOM J2	16:00:00	All Source	Digital	Human Analysis	All
29	IV	P-3D	16:05:00	ISAR	Digital	HSBs	Surface
29	IV	SH-60	17:25:00	Dipping Array	Digital	Mini-Subs (R1 & R2)	Sub
29	IV	CGN	18:30:00	ESM	Digital	HSB Signals	Surface
29	IV	P-3D	18:35:00	ISAR	Digital	R1 & R2 on Surface	All
29	IV	PACOM J2	19:00:00	All Source	Digital	Human Analysis	All
29	IV	Coalition SSN	19:05:00	RADAR	Digital	R1 & R2 on Surface	All
29	IV	SH-60	19:15:00	Visual	Digital	R1 & R2 on Surface	All
29	IV	FFG	20:00:00	Weapon	Digital	Lock on R1	All
29	IV	Coalition SSN	20:05:00	Weapon	Digital	Lock on R2	All
29	IV	F/A-18	21:00:00	Weapon	Digital	Lock on HSB 1	All
29	IV	P-3D	21:30:00	Weapon	Digital	Lock on HSB 2	All
29	IV	SAT	21:35:00	Camera	Video	Area Overview	Intel
<i>Maintain Weapons Lock with Red Mini Submarines &amp; High Speed Boats.</i>							
<i>Coalition Task Force Commander Communicates with Red Force.</i>							
30	IV	Coalition SSN	00:24:00	Visual	Digital	Mini Sub (R1)	All
30	IV	FFG	00:30:00	Visual	Digital	Mini Sub (R2)	All
30	IV	CGN	00:32:00	Visual	Digital	HSB 1	All
30	IV	SSN	00:36:00	Visual	Digital	HSB 2	All
30	IV	SSN NSW	01:00:00	Visual	Digital	NSW Boards HSB 2	All
30	IV	SSN NSW	01:15:00	Visual	Digital	HSB 2 Safe	All
30	IV	CGN Boat	02:00:00	Visual	Digital	HSB 1 Safe	All
30	IV	Coalition SSN	03:00:10	Torpedo	Digital	Mini-Sub R1 Sunk	All
30	IV	FFG Boat	04:00:00	Visual	Digital	Crew Boards R2	All
30	IV	FFG	04:00:12	Weapon	Digital	Lock on R2	All
30	IV	FFG Boat	04:20:00	Weapon	Digital	Mini-Sub R2 Safe	All
<i>Coalition Task Force Commander Reports All Red Forces Captured or Sunk; Nuclear Material Reclaimed and Returned to India Naval Commander; Mini-Sub R2 Under Tow by Blue Force FFG. Mission Complete.</i>							
<i>No Further Entries This Day.</i>							

**Figure 93. Blue Force Detection Event Log (Day 26 - 30)**

This table provides three specific days of Phase IV events detailing the Command Controlled Weapons Engagement (Mini-Submarine Identification and Weapons Engagement) portion of the operational scenario.

## APPENDIX I. MODELING AND SIMULATION RESULTS

The tool utilized for modeling and simulation of each alternative was EXTEND, from which the results were extracted. Each alternative was simulated ten times with EXTEND to obtain sufficient data for each measurement. The data gathered for each simulation run represented numerous track reports that existed in the scenario environment. For data reduction, the data was then reduced to construct histograms that allowed for a graphical view of the ranges where the frequency of the measurements was greater, which were then used to compare against the overall average of the measurements. Figure 94 to Figure 102 show these histograms.

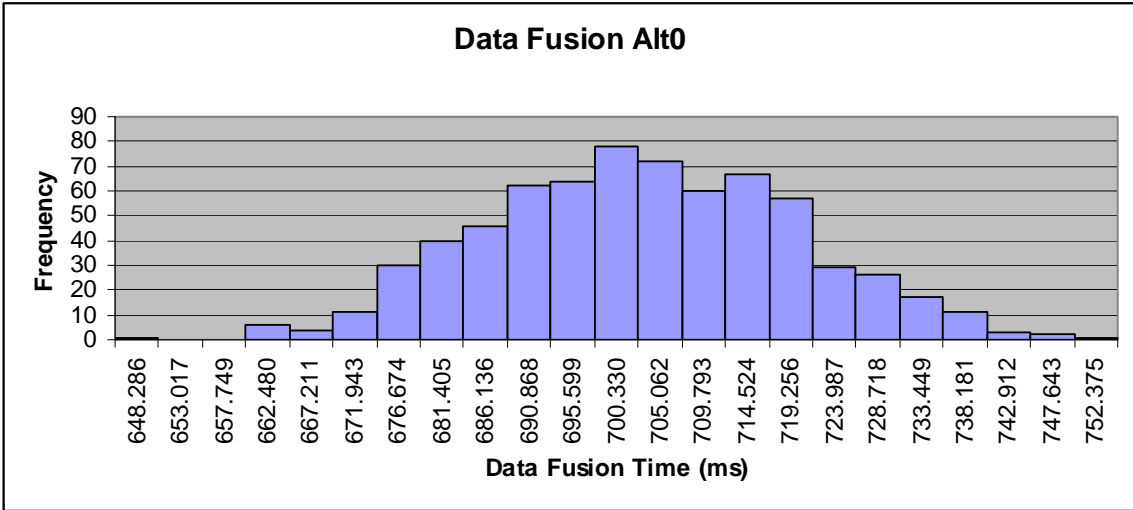
In the figures below, the measurements provided in the results represented throughput, latency, and data fusion time measurements. The data obtained from the EXTEND model was extracted similarly for all the evaluation measures. Throughput data was achieved by placing nodes at the output of contact tracks and after the capacity and physical delays. This allowed for a consistent measurement of how much data was able to travel through the nodes and at what rate. Next, the latency measurement was obtained by allocating timers at particular locations in the model which would obtain the time when a track entered the control section and when it exited the section. This configuration provided a measurement of time duration of contact tracks when as they traveled from input to output. The measurement for data fusion processing was obtained by incorporating a timer within the black box after all the inputs such as sensor, METOC, and user data were fused and sent to the COTP. Table 26 shows the overall results for each of the alternatives.

Measurement	Alt 0	Alt 1	Alt 2	Alt 3
Data Fusion Processing Time (ms)	702.395	540.139	299.823	299.720
Latency (ms)	1334.161	1205.027	685.560	680.160
Throughput (kbps)	51.292	53.930	58.855	58.155

**Table 26. Modeling and Simulation Results**

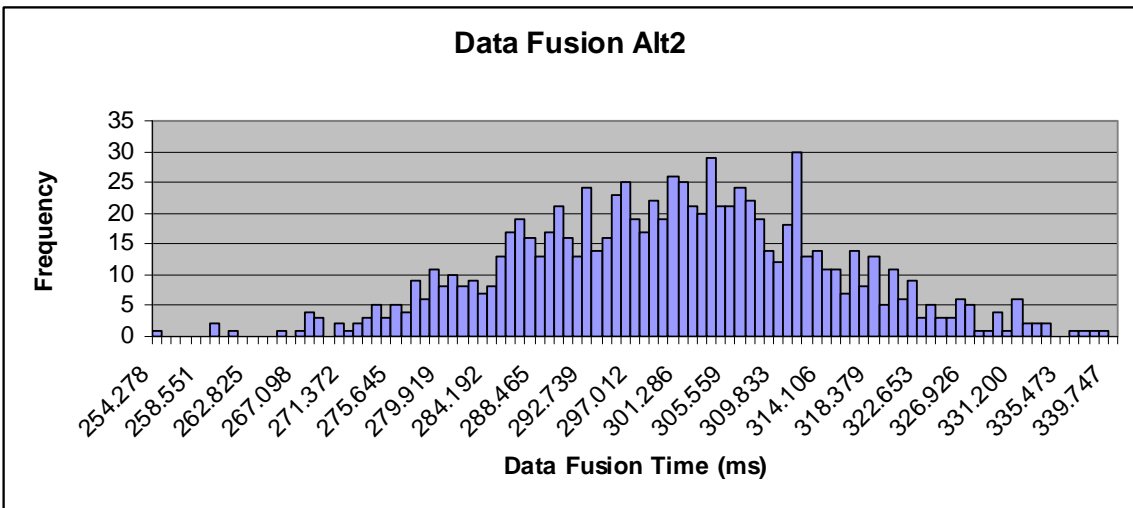
This table shows the M&S results for each alternative. It demonstrates the averages of all the ten runs for all of the alternatives. It can be observed from the table that Alternative 2 had the greatest throughput and Alternative 3 had the lowest latency value and lowest data fusion processing time.





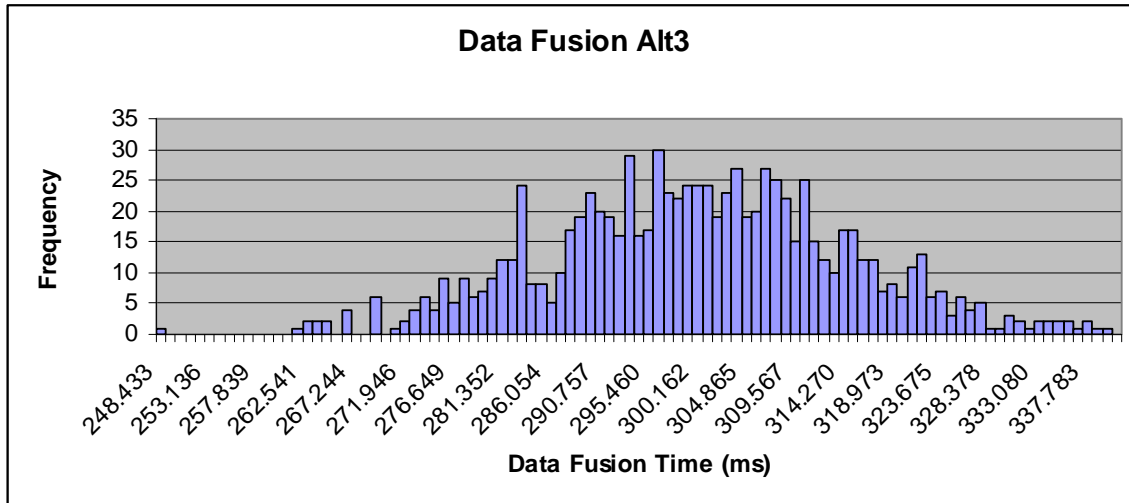
**Figure 94. The Histogram for Data Fusion of Alternative 0**

This figure shows the histogram of the fusion time measurement for Alternative 0. It is a culmination of all the data points obtained from ten consecutive simulations that modeled Alternative 1 in the scenario environment.



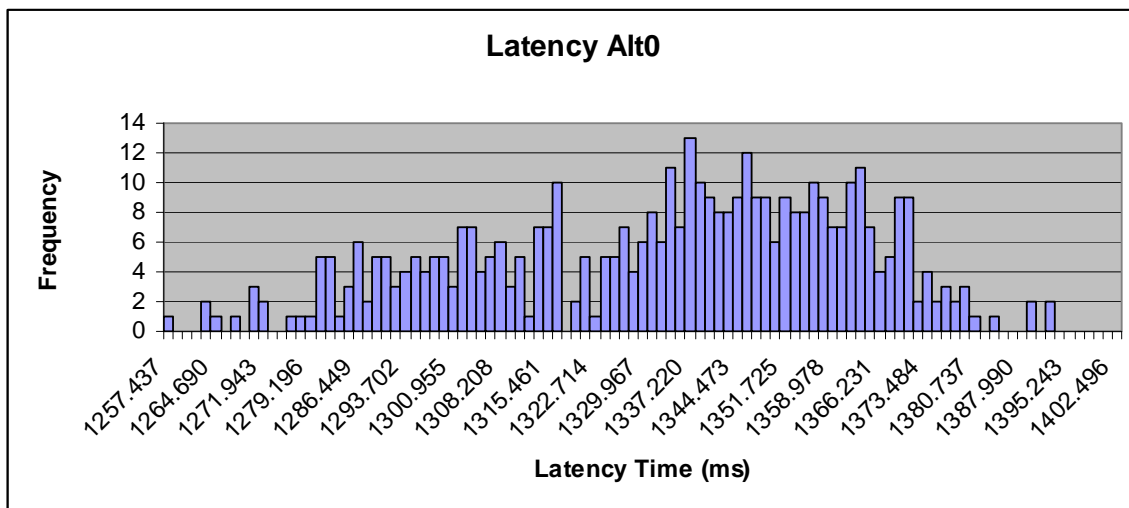
**Figure 95. The Histogram for Data Fusion of Alternative 2**

This figure shows the histogram of the fusion time measurement for Alternative 2. It is a culmination of all the data points obtained from ten consecutive simulations that modeled Alternative 2 in the scenario environment.



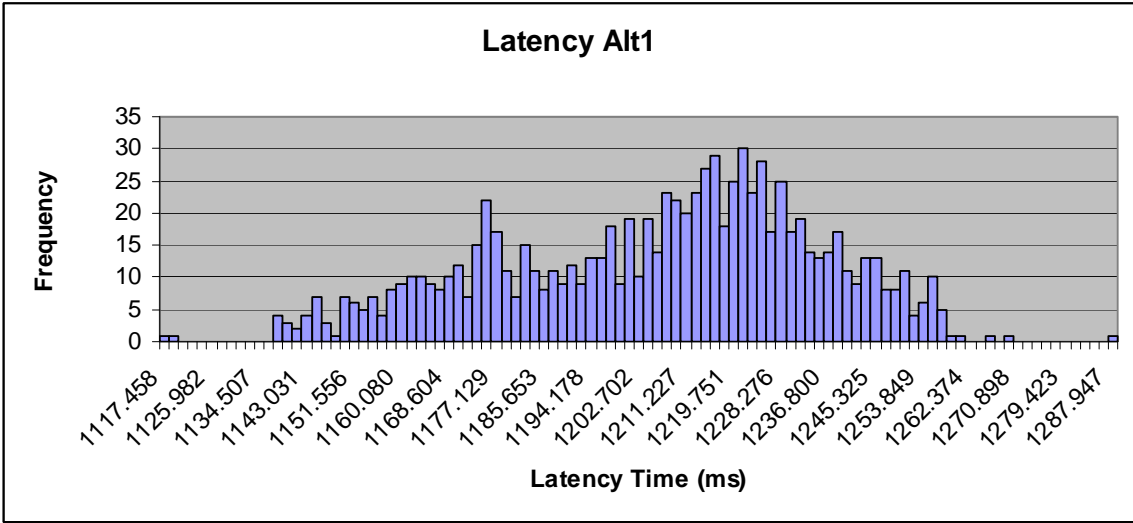
**Figure 96. The Histogram for Data Fusion of Alternative 3**

This figure shows the histogram of the fusion time measurement for Alternative 3. It is a culmination of all the data points obtained from ten consecutive simulations that modeled Alternative 3 in the scenario environment.



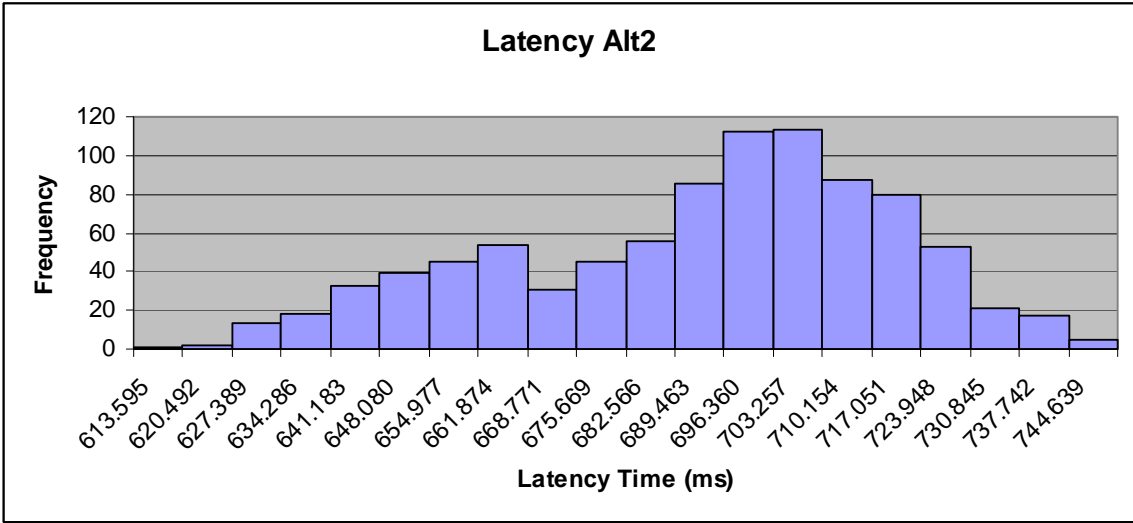
**Figure 97. The Histogram for Latency of Alternative 0**

After obtaining the raw data from EXTEND model, appropriate histogram bins were created to show the overall data distribution. This figure shows the data distribution for Latency measurement for Alternative 0. Histogram of Latency for Alternative 0 shows the bimodal nature distribution.



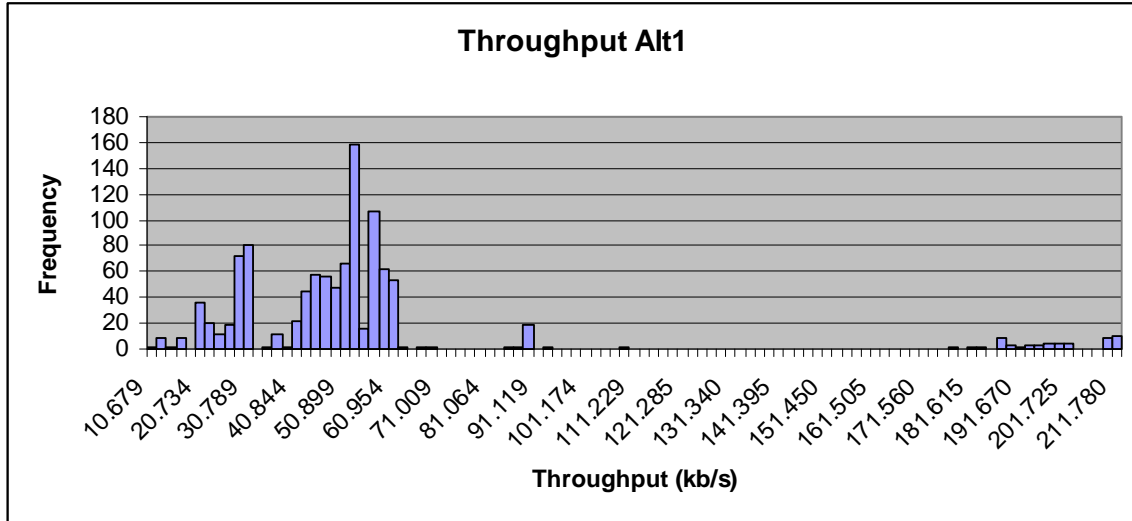
**Figure 98. The Histogram for Latency of Alternative 1**

After obtaining the raw data from EXTEND model, appropriate histogram bins were created to show the overall data distribution. This figure shows the data distribution for Latency measurement for Alternative 1. Histogram of Latency for Alternative 1 shows the normal curve distribution.



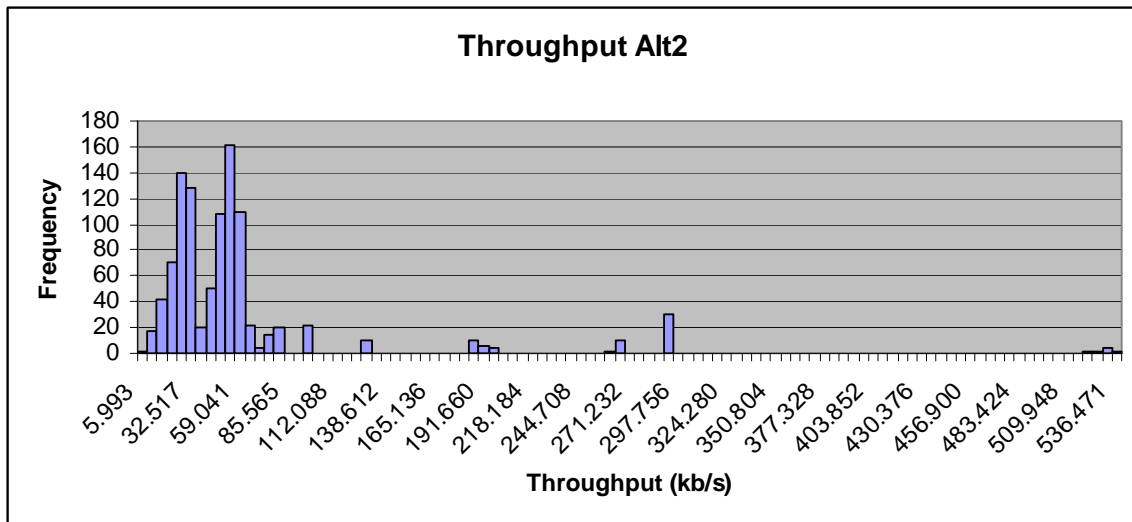
**Figure 99. The Histogram for Latency of Alternative 2**

After obtaining the raw data from EXTEND model, appropriate histogram bins were created to show the overall data distribution. This figure shows the data distribution for Latency measurement for Alternative 2. Histogram of Latency for Alternative 2 shows the normal curve distribution.



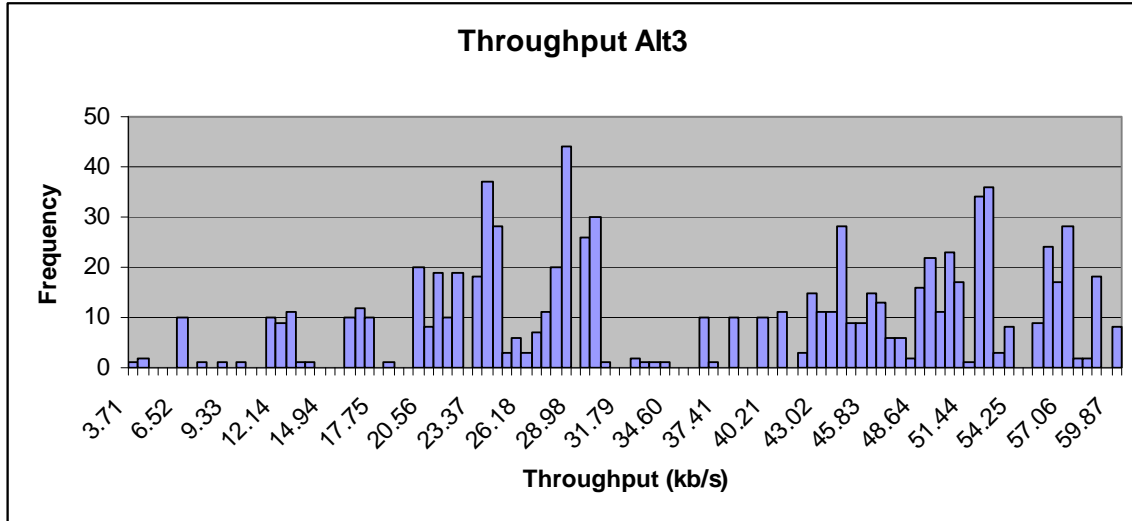
**Figure 100. The Histogram for Throughput of Alternative 1**

This figure shows the histogram of the throughput measurement for Alternative 1. It is a culmination of all the data points obtained from ten consecutive simulations that modeled Alternative 1 in the scenario environment.



**Figure 101. The Histogram for Throughput of Alternative 2**

This figure shows the histogram of the throughput measurement for Alternative 2. It is a culmination of all the data points obtained from ten consecutive simulations that modeled Alternative 2 in the scenario environment.



**Figure 102. The Histogram for Throughput of Alternative 3**

This figure shows the histogram of the throughput measurement for Alternative 3. It is a culmination of all the data points obtained from ten consecutive simulations that modeled Alternative 3 in the scenario environment.

## LIST OF REFERENCES

- About.com, "India," [<http://geography.about.com/library/cia/blcindia.htm>]. May 2008.
- Adams, J., "Global Scrutiny Follows Reports of Chinese Nuclear Base," [<http://www.csmonitor.com/2008/0513/p99s01-duts.html>]. May 2008.
- Allen, T., "Recent Setbacks to the Coast Guard Deepwater Program," [[http://www.uscg.mil/comdt/testimony/docs/14Feb2007\\_Deepwater\\_Written\\_Testimony.pdf](http://www.uscg.mil/comdt/testimony/docs/14Feb2007_Deepwater_Written_Testimony.pdf)]. February 2007.
- Angel Technologies Corporation, "The Halo Network," [<http://www.angelcorp.com/overview.htm>]. 2000.
- Bassett, D. and Emery, D., "SOSCOE-The Glue That Holds FCS Together," [<http://www.dsci-usa.com/document/Emeryarticle.pdf>]. October 2005.
- Bauer, M., "Practical Threat Analysis and Risk Management," [<http://www.linuxjournal.com/article/5567>]. January 2002.
- Benedict, J., "The Unraveling and Revitalization of United States Navy Antisubmarine Warfare," [[http://findarticles.com/p/articles/mi\\_m0JIW/is\\_2\\_58/ai\\_n14705062/](http://findarticles.com/p/articles/mi_m0JIW/is_2_58/ai_n14705062/)]. September 2005.
- Blanchard, B. and Fabrycky, W., *Systems Engineering and Analysis*, 4th ed., Prentice Hall International, 2006.
- Cabana, J., PMW 170, private conversation in August, 2008.
- Central Intelligence Agency, "The World Factbook," [<https://www.cia.gov/library/publications/the-world-factbook/geos/in.html>]. April 2008.
- Cepek B., Submarine Warfare Division, N872A Stakeholder, private conversation through email in March, 2008.
- Chairman of the Joint Chiefs of Staff, "Net-Centric Environment Joint Functional Concept (NCE JFC) Version 1.0," Joint Chiefs of Staff, Washington, D.C., April 2005.

Chairman of the Joint Chiefs of Staff, “Net-Centric Operational Environment Joint Integrating Concept (NCOE JIC),” Joint Chiefs of Staff, Washington, D.C., October 2005.

Chairman of the Joint Chiefs of Staff, Joint Publication 1-02 (JP 1-02), “Department of Defense Dictionary of Military and Associated Terms” Joint Chiefs of Staff, Washington, D.C., April 2001 (As Amended Through 04 March 2008).

Chairman of the Joint Chiefs of Staff, Joint Publication 3-13 (JP 3-13), “Information Operations (IO),” Joint Chiefs of Staff, Washington, D.C., February 2006.

Chairman of the Joint Chiefs of Staff, “Tactical Wireless Joint Network Concept of Operations (TWJN CONOPS) Version 1.0,” Joint Chiefs of Staff, Washington, D.C., April 2007.

Chairman of the Joint Chiefs of Staff Instruction (CJCSI) 3151.01A, “Global Command and Control System Common Operational Picture Reporting Requirements,” January 2003.

Chief of Naval Operations, “N86 Surface Warfare Division,” [[https://ucstcdom03.ahf.nmci.navy.mil/n8/webbas01.nsf/\(vwWebPage\)/home.htm?OpenDocument&Set=01,Scope=S\\_07](https://ucstcdom03.ahf.nmci.navy.mil/n8/webbas01.nsf/(vwWebPage)/home.htm?OpenDocument&Set=01,Scope=S_07)]. March 2008.

Cinlemis, M. “Military Satellite Communications (MILSATCOM) Systems,” Briefing presented to the National Defense Industry Association (NDIA) in August of 2005 by the Air Force Space Command.

Clark, G., “High-Altitude Aircraft Offer Satellite Alternative,” [[http://www.space.com/business/technology/business/erast\\_planes.html](http://www.space.com/business/technology/business/erast_planes.html)]. August 1999.

Clarkson G., Commander, Undersea Surveillance, Stakeholder, private conversation through email in March 2008.

Clemen, R. and Reilly, T., *Making Hard Decisions with Decision Tools*, 2nd ed., Duxbury, 2001.

Colozza, A. and Dolce, J., “High-Altitude, Long Endurance Airships for Coastal Surveillance,” [<http://gltrs.grc.nasa.gov/reports/2005/TM-2005-213427.pdf>]. February 2005.

Commander, United States Pacific Fleet, “United States Pacific Fleet Organization,” [<http://www.cpf.navy.mil/organization.shtml>]. December 2007.

Cox, A., "Program Executive Office C4I and Space: Service Oriented Architecture (SOA) Efforts and Challenges,"  
[[http://www.afei.org/brochure/5AF7/documents/Cox\\_SOA.pdf](http://www.afei.org/brochure/5AF7/documents/Cox_SOA.pdf)]. February 2005.

Daniels, B. and DiRenzo III, J., "Maritime Anti-Terrorism at the Crossroads of National Security and Homeland Defense,"  
[[http://www.nationaldefensemagazine.org/issues/2005/Feb/Maritime\\_Anti-Terrorism.htm](http://www.nationaldefensemagazine.org/issues/2005/Feb/Maritime_Anti-Terrorism.htm)]. February 2005.

Daniels, J., Werner P., and Bahill A., "Quantitative Methods for Tradeoff Analyses," *Systems Engineering*, 4(3): 190 – 212, 2001.

Dean, T., *Network+ Guide to Networks*, 4th ed., Thomson Course Technology, 2006.

Defense Industry Daily, "N-G Gets \$159M Littoral Combat Ship Mission Package Integration Contract," [<http://www.defenseindustrydaily.com/ng-gets-159m-littoral-combat-ship-mission-package-integration-contract-01723/>]. January 2006.

Defense Information Systems Agency, "Net-Centric Enterprise Services (NCES)," [<http://www.disa.mil/nces/>]. April 2008.

Defense Information Systems Agency, "Net-Enabled Command Capability (NECC)," [<http://www.disa.mil/necc/index.html>]. April 2008.

Department of Defense Instruction (DoDI) 5200.40, "DoD Information Technology Security Certification and Accreditation Process (DITSCAP)," December 1997.

Department of Homeland Security, "National Plan to Achieve Maritime Domain Awareness," [[http://www.dhs.gov/xprevprot/programs/editorial\\_0753.shtm](http://www.dhs.gov/xprevprot/programs/editorial_0753.shtm)]. October 2005.

Department of the Navy, "Approved Navy Training System Plan for the Navy Consolidated Sonobuoys," [<http://www.fas.org/man/dod-101/sys/ship/weaps/docs/ntsp-Sonobuoy.pdf>]. September 1998.

Department of the Navy, "Deputy CNO Communication Networks [N6]," [<http://www.navy.mil/navydata/organization/org-n6.asp>]. January 2007.

Department of the Navy, "FORCEnet," [<http://forcenet.navy.mil/fn-definition.htm>]. March 2008.

Department of the Navy, "The Naval Sea Systems Command: A Determined Team," [[http://www.bescorp.us/Downloads/Downloads\\_GetFile.aspx?id=26036](http://www.bescorp.us/Downloads/Downloads_GetFile.aspx?id=26036)]. March 2008.



Department of the Navy, "The OPNAV Assessment Process," [<http://www.navy.mil/navydata/policy/fromsea/ftsuoap.txt>]. May 1993.

Department of the Navy, "Program Executive Officer, Air ASW, Assault and Special Mission Programs (PEO (A))," [[http://acquisition.navy.mil/organizations/peos\\_drpms/peo\\_a](http://acquisition.navy.mil/organizations/peos_drpms/peo_a)]. March 2008.

Department of the Navy, "Program Executive Officer, Submarines (PEO Subs)," [[http://acquisition.navy.mil/organizations/peos\\_drpms/peo\\_subs](http://acquisition.navy.mil/organizations/peos_drpms/peo_subs)]. March 2008.

Department of the Navy, "Program Executive Officer, Integrated Warfare Systems (PEO IWS)," [[http://acquisition.navy.mil/organizations/peos\\_drpms/peo\\_iws](http://acquisition.navy.mil/organizations/peos_drpms/peo_iws)]. March 2008.

Dickerson D., PMS-485 Stakeholder, private conversation through email in March, 2008.

Dunbar, B. and Curry, M., "Helios Prototype: A Forerunner of 21<sup>st</sup> Century Solar-Powered Atmospheric Satellites," [<http://www.nasa.gov/centers/dryden/news/FactSheets/FS-068-DFRC.html>]. March 2008.

Ericsson, "Proud Partner in MUOS: Innovation through Continuous Development and Refinement of Technology," April 2006.

Evans, T., Lyman, K., and Ennis M., *Modernization in Lean Times: Modifications and Upgrades*, Fort BelDefense Systems Management College Press, Fort Belvoir, Virginia, July 1995.

Feghali, R., PMW 120, private conversation in August, 2008.

Feuchter, C., *Air Force Analyst's Handbook: On Understanding the Nature of Analysis*, United States Air Force Material Command, Office of Aerospace Studies, 2000.

Global Ocean Associates, "An Atlas of Oceanic Internal Solitary Waves," [[http://www.internalwaveatlas.com/Atlas2\\_PDF/IWAtlas2\\_Pg519\\_BayofBengal2.pdf](http://www.internalwaveatlas.com/Atlas2_PDF/IWAtlas2_Pg519_BayofBengal2.pdf)]. February 2004.

Global Security, "Fleet Antisubmarine Warfare Command," [<http://www.globalsecurity.org/military/agency/navy/faswc.htm>]. April 2004.

Global Security, "High Altitude Airship," [<http://www.globalsecurity.org/intell/systems/haa.htm>]. May 2008.

Heard, M., PMW 150, private conversation in August, 2008.

Hutter, M., PEO C4I Stakeholder, private conversation through email in March, 2008.

Indian Army, “Corps of Signals,” [<http://www.indianarmy.gov.in/sigs.html>]. April 2008.

Information Assurance Support Environment, “Security Technical Implementation Guides (STIGS) and Supporting Documents,” [[http://iase.disa.mil/stigs/stig/dns\\_stig\\_v4r1\\_20071017.pdf](http://iase.disa.mil/stigs/stig/dns_stig_v4r1_20071017.pdf)]. May 2008.

Kossiakoff, A. and Sweet W., *Systems Engineering Principles and Practice*, Wiley-Interscience, 2003.

Letourneau, M., JTRS Subject Matter Expert, private conversation through email in August, 2008.

Merriam-Webster, “Threat,” [<http://www.merriam-webster.com/dictionary/threat>]. August 2008.

Miller, C., “Program Executive Office Command, Control, Communications, Computers, and Intelligence (PEO C4I): Brief for SPAWAR – Industry Executive Network (SIEN),” [[http://ndia-sd.org/objects/Event-0/briefs/SPAWAR\\_Industry\\_Executive\\_Network\\_18\\_SEPT.pdf](http://ndia-sd.org/objects/Event-0/briefs/SPAWAR_Industry_Executive_Network_18_SEPT.pdf)]. September 2006.

Miller, G., Notes for Network Centric Warfare, Naval Postgraduate School, 2006 (unpublished).

Ministry of Defense, “Indian Armed Forces,” [<http://mod.nic.in/aforges/welcome.html>]. April 2007.

Ministry of Earth Sciences, “Comprehensive Swath Bathymetric Survey of Entire Indian EEZ,” [<http://www.dod.nic.in/bathy1.htm>]. April 2008.

Mitre, “Command, Control, Communications, and Intelligence (C3I),” [<http://www.mitre.org/about/ffrdcs/c3i.html>]. July 2008.

Mittu, R. and Segaria, F., “Common Operational Picture (COP) and Common Tactical Picture (CTP) Management via a Consistent Networked Information Stream (CNIS),” presented at the NTIS Conference March 2000.

Morgan, J., “Anti-Submarine Warfare: A Phoenix for the Future,” [<http://www.fas.org/man/dod-101/sys/ship/docs/anti-sub.htm>]. January 2008.

National Aeronautics and Space Administration (NASA), “Next-Generation Communications: Demonstrating the World’s First X-ray Communication System,” [[http://gsfctechnology.gsfc.nasa.gov/TechSheets/XRAY\\_Goddard\\_Final.pdf](http://gsfctechnology.gsfc.nasa.gov/TechSheets/XRAY_Goddard_Final.pdf)]. March 2008.

National Research Council of the National Academies, *Navy’s Needs in Space for Providing Future Capabilities*, The National Academies Press, 2005.

Naval Air Systems Command (NAVAIR), “Welcome to NAVAIR,” [<http://www.navair.navy.mil/>]. March 2008.

Naval Air Systems Command (NAVAIR), “Naval Air Warfare Center,” [<http://www.navair.navy.mil/nawcad/aboutus.cfm>]. May 2008.

Naval Meteorology and Oceanography Command Public Affairs, “Undersea Surveillance Aligned Under Naval Oceanography,” [[http://www.news.navy.mil/search/display.asp?story\\_id=28072](http://www.news.navy.mil/search/display.asp?story_id=28072)]. March 2007.

Naval Mine and Anti-Submarine Warfare Command, “Naval Mine and Anti-Submarine Warfare Command: Knowledge – Tactics – Integration,” [<http://www.nmawc.navy.mil/>]. November 2007.

Naval Supply Systems Command, “H-60 Seahawk Team,” [[https://www.navsup.navy.mil/navsup/ourteam/navicp/prod\\_serv/aviation/h60\\_seahawk](https://www.navsup.navy.mil/navsup/ourteam/navicp/prod_serv/aviation/h60_seahawk)]. April 2008.

Naval Undersea Warfare, “The Naval Undersea Warfare Center,” [<http://www.nuwc.navy.mil/>]. April 2008.

Navy Warfare Development Command, “Sea Shield,” April 2008.

Navy Communications Satellite Program Office, Office of Congressional and Public Affairs, Space and Naval Warfare Systems Command, “Mobile User Objective System (MUOS),” October 2004.

Offley, E., “Submarine-MSN Encarta,” [[http://encarta.msn.com/encyclopedia\\_761567260/submarine.html](http://encarta.msn.com/encyclopedia_761567260/submarine.html)]. February 2008.

PMA-290, “Maritime Patrol and Reconnaissance Aircraft,” [[http://www.navair.navy.mil/slating\\_panel/documents/PMA290\\_Apr08.ppt#1](http://www.navair.navy.mil/slating_panel/documents/PMA290_Apr08.ppt#1)]. July 2008.

Program Executive Officer, Command, Control, Communications, Computers, and Intelligence, “PEO C4I Masterplan,” Version 1.0, August 2007.

Raytheon, “Distributed Common Ground System (DCGS) Block 10.2 Upgrade Program,”  
[[http://www.raytheon.com/capabilities/products/stellent/groups/iis/documents/content/cms01\\_052741.pdf](http://www.raytheon.com/capabilities/products/stellent/groups/iis/documents/content/cms01_052741.pdf)]. February 2006.

Reddish, M. and Lovern, M., “Communications at Speed and Depth (CSD) and Optical Laser Communications (OLC) Status,” Program Executive Office, Command, Control, Communications, Computers and Intelligence (PEO C4I) PMW-770-1. 2007.

Rogers, T., “Wymorian Scoring Functions Tool,”  
[<http://www.sie.arizona.edu/sysengr/slides/SSF.zip>]. February, 2008.

Ross, J. and Rupp, R., “Global Command and Control System– Maritime (GCCS-M) Program Overview,” March 2008.

Sage, A. and Armstrong, J., *Introduction to Systems Engineering*, John Wiley and Sons, 2000.

Saijid, B., PMW 160, private conversation in August, 2008.

Slaght, K., “Network Centric Warfare from PowerPoint to Reality,” May 2002.

Smith, C., “China Shoots Down Satellite,”  
[<http://archive.newsmax.com/archives/articles/2007/1/23/120656.shtml>]. January 2007.

Smith K., CUS Stakeholder, private conversation through email in March, 2008.

Space and Naval Warfare Systems Command, “SSC San Diego – Organization Information,”  
[<http://enterprise.spawar.navy.mil/body.cfm?type=c&category=29&subcat=63>]. January 2008.

Spencer, M., “Test and Evaluation of C2 Capabilities,” [<http://www.itea-sd.org/images/ITEAPWM150Briefing15Sep05.pdf>]. September, 2005.

SSC Charleston Fleet Support Branch, Code 52670, private conversation through telephone and email in August, 2008.

Stangl K., ASW COI Stakeholder, private conversation through email in March, 2008.

- Technology Futures Analysis Methods Working Group, "Technology Futures Analysis: Toward Integration of the Field and New Methods," [<http://www.tpac.gatech.edu/papers/TFM.pdf>]. November 2003.
- Texas State Library and Archives Commission, "Computer and Network Security in Small Libraries Glossary," [<http://www.tsl.state.tx.us/ld/pubs/compsecurity/glossary.html>]. May 2008.
- Thompson J., PEO-IWS Stakeholder, private conversation through email in March, 2008.
- United States Air Force, "Capability Development Document for Tactical Data Link Transformation (TDL-T CDD)," 2003.
- United States Fleet Forces, "United States Fleet Forces Command Missions," [<http://www.cffc.navy.mil/mission.htm>]. April 2008.
- United States General Accounting Office, "Unmanned Aerial Vehicles: Progress of the Global Hawk Advanced Concept Technology Demonstration," [<http://www.gao.gov/archive/2000/ns00078.pdf>]. April 2000.
- United States Navy, "Unmanned Undersea Vehicle (UUV) Masterplan," November 2004.
- Universiteit Leiden, "Empirical Research Method Law," [[http://www.law.leidenuniv.nl/org/fisceco/economie/onderwijs/empiricalresearchmethods\\_inlaw\\_1.jsp](http://www.law.leidenuniv.nl/org/fisceco/economie/onderwijs/empiricalresearchmethods_inlaw_1.jsp)]. April 2008.
- Vitech Corporation, "COREsim User Guide," [<http://www.vitechcorp.com/support/docs/30/COREsm30.pdf>]. 2000.
- Volkert R., PMS-420 Stakeholder, private conversation through email in March, 2008.
- Wolborsky, R., "PMW 160: Networks, IA and Enterprise Services Overview for NDIA," [<http://ndia-sd.org/objects/Event-0/briefs/PMW%20160%20NDIA%20brief%20050810.ppt>]. August 2005.
- Wymore, A., *Model-Based Systems Engineering*, CRC Press, 1993.
- Yaw, P., *ASW Not Just a Navy Sport. The Need for Joint ASW*, Naval War College, Newport, Rhode Island, October 2006.

## INITIAL DISTRIBUTION LIST

1. Defense Technical Information Center  
Ft. Belvoir, Virginia
2. Dudley Knox Library  
Naval Postgraduate School  
Monterey, California
3. Gregory A. Miller  
Naval Postgraduate School  
Monterey, California
4. John M. Green  
Naval Postgraduate School  
Monterey, California
5. Rich Volkert  
SSC Pacific  
10059 Casa Nueva St  
Spring Valley, CA 91977
6. Commander, Undersea Surveillance  
Attn: Greg Clarkson (CUS N6P1)  
373 Bullpup St.  
Virginia Beach, VA 23461
7. Program Executive Officer, Integrated Warfare Systems  
Attn: C. Cannon, IWS-5SE  
1333 Isaac Hull Ave SE Stop 2301  
Washington Navy Yard, DC 20376-2301
8. John Ebken  
SSC Pacific/PEO-LMW  
722 Wakefield Ct.  
El Cajon, CA 92020
9. Michael Hutter  
PEO C4I PMW 770 TD  
4301 Pacific HWY  
San Diego, CA 92110-3127

10. Joe Conway  
PEO-LMW (PMS-485)  
1911 Lindamoor Dr.  
Annapolis, MD 21401