

THE
ELEKTRON

**ELECTRICAL
SYSTEM
SERVICE
INSTRUCTION
NO. 21**

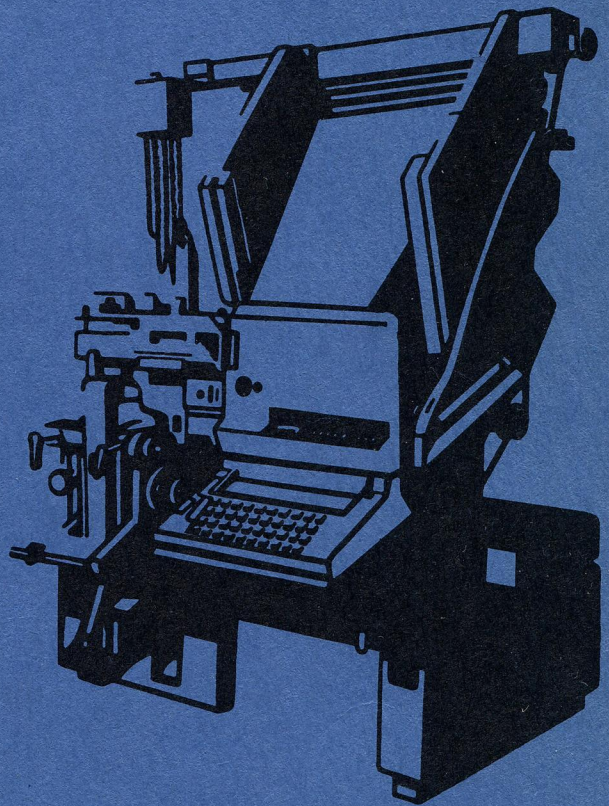

the
total
graphic arts
company

Mergenthaler

MERGENTHALER LINOTYPE COMPANY
A Division of ELTRA Corporation
Mergenthaler Drive, Plainview, N. Y. 11803

THE ELEKTRON ELECTRICAL SYSTEM

SERVICE INSTRUCTION NO. 21

LINOTYPE SERVICE DEPARTMENT

MERGENTHALER LINOTYPE COMPANY

A Division of ELTRA Corporation

Mergenthaler Drive, Plainview, N. Y. 11803

This Service Instruction covers the electrical system of the Linotype Elektron, Elektron II and the Elektron Mixer. Other Service Instructions are available which describe the adjustment and maintenance of the mechanical portions of these machines and those circuits and mechanisms peculiar to the Automated Controlled Elektron (ACE). These other Service Instructions are:

Service Instruction No. 22

*Adjustment and Maintenance of the Linotype Elektron
(Assembling and Line Delivery).*

Service Instruction No. 23

*Adjustment and Maintenance of the Linotype Elektron
(Casting, Driving, Distributing, Elevating, Fanning and Mixing).*

Service Instruction No. 24

Automated Controlled Elektron Operational Manual.

Service Instruction No. 25

Automated Controlled Elektron Maintenance Manual.

June 1968

AGENCIES

Atlanta 30313—300 Luckie Street, N. W.	Dallas 75247—1350 Motor Circle
Boston 02116—Park Square Building	Los Angeles 90015—1212 Albany Street
Chicago 60605—531 Plymouth Court	New York 10017—300 East 42 Street
San Francisco 94103—155 Twelfth Street	

IN CANADA

Canadian Linotype Company
829 Oxford Street, Toronto 18

Mergenthaler

TABLE OF CONTENTS

	<u>Page Number</u>
Introduction	a - h
Description of High Voltage Circuits	1 - 4
Description of Low Voltage Circuits	4 - 5
Low Voltage Circuits	
Assembler Belt and Assembler Chute Finger Switches	65
Assembler Finger Brake Mechanism	58 - 60
Assembly Mode Control	61 - 63
Cam Shaft Clutch and Brake, including Slow Start	17 - 24
Distributor Clutch and Brake	11 - 16
Duplex Rail Solenoid	25 - 29
Electric Hydraquadder	70 - 75
Electromatic Safety	76
Elevating and Fanning System	77 - 85
Hydraulic Justification	9 - 10
Left Hand Vise Jaw and Pot Advance Safety	6 - 8
Line Delivery, including Delivery Timer	40 - 57
Line Measuring	34 - 39
Machine Control Circuit - Wiring Diagram	106
Mixing System	86 - 92
No Cast Indicator	67 - 69
Operating Unit Stop Relay	64
Reed Rack Switch	65 - 66
Spaceband Timing and Star Wheel Pusher Solenoid	30 - 33
Complete Schematic Diagram	117 - 118
Linotronic Control Pot Wiring	100 - 101
Location of Switches and Solenoids	102 - 105
Location of Terminal Boards and Plugs	114 - 115
Microtherm Electric Pot Wiring	98 - 99
Power Central Wiring	94 - 97
Resistance of Solenoids, Relays and Resistors	111 - 113
TeleTypesetter Operating Unit Schematic Diagram	93
Wire Connections to Switches, Solenoids, Plugs and Receptacles . . .	106 - 110

INTRODUCTION

-a-

For electrical purposes, the Elektron is a Linotype machine, in which for the first time, electrical devices have been incorporated as basic parts of the machine and not as extras.

In some instances, functions which formerly were purely mechanical have been replaced by electro-mechanical devices (Distributor Clutch, Camshaft Driving Clutch, machine safeties) and also by electro-hydraulic devices (Justification and Magazine Elevating).

These former mechanical functions have been replaced by electrical functions, because performing them electrically permits simpler and faster operation.

Most of the electrical circuits are simple ones involving only switches, solenoids and relays. Such pieces of electrical equipment have been used previously on Linotypes for many years. We refer to the Micro-Switches used in the Linotype Electric Pot, the relays used in the Electric Pot, in the Electric Hydraquadder, and the solenoids used in the Electric L.H. Vise Jaw Safety of the Hydraquadder and in other places.

Only one electronic tube is used in the electrical system of the Elektron, and this is used for the same purpose as the tube used in other model Linotypes equipped with the electromatic safety system (Models 29, 30, 35 and 36).

For those who do not understand the functions of electrical components, such as switches, relays, solenoids, etc., the following brief description of the various components and how they operate may be helpful.

Micro-Switch. The word micro-switch is a trade name for a small snap action switch. A micro-switch may be regarded as a small plastic box containing two or more electrical contacts which can be opened or closed by a mechanism such as a cam, lever or push-rod.

Solenoid. A solenoid is a device which converts electrical energy to mechanical motion. This motion may be either linear or rotary.

A circuit consisting of a micro-switch, solenoid and a proper source of electrical power, will allow the solenoid to energize or actuate when the micro-switch is closed.

Solenoids are used in the Elektron to operate latches, as in the elevate and fan mechanism, to impart direct mechanical force, as in the starwheel pusher, and to operate trigger mechanisms, as in the space-band release. They are also incorporated in clutches, brakes and hydraulic valves.

Thus a micro-switch at some distant part of the machine can be used to start or stop a mechanical function at any other part, giving a flexibility impossible by purely mechanical means.

Relay. A relay is a switch or a number of switches operated by a coil and assembled as a unit. When a circuit is completed through the coil, a magnetic field is generated which operates the relay.

Normally closed switches (or contacts as they are called when incorporated in a relay) are closed whenever the relay coil is not energized, therefore they will complete a circuit. Normally open contacts are open whenever the relay coil is not energized, and therefore will not complete a circuit.

When the coil is energized, the normally closed contacts open and the normally open contacts close. They remain in that position until the coil is de-energized, at which time the contacts return to normal.

It is clear that if a relay has several sets of contacts, one micro-switch connected to its coil may be used to operate several different circuits through each set of relay contacts.

The relay may also be wired so that it uses one of its normally open set of contacts to keep its own coil energized after the switch which originally operated the relay has returned to the open position, i.e., after the cam operating a micro-switch has allowed the micro-switch to open. The circuit used to hold the relay energized (holding circuit) will usually be controlled by another micro-switch which will open and cause the relay to be de-energized some time later. Schematically, such a circuit would look like this:

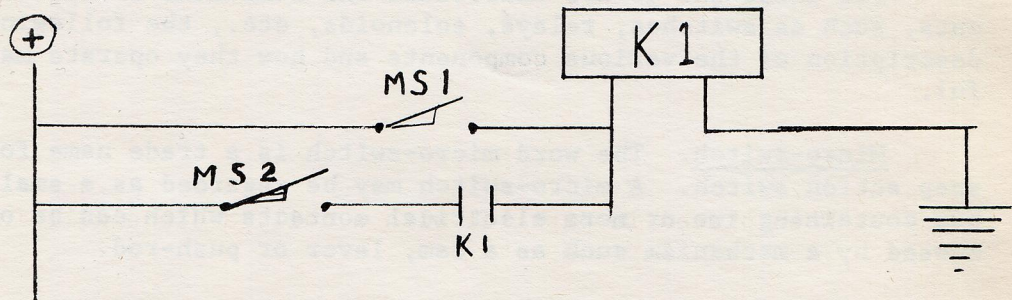

If MS 1 was closed from 20° - 40° of a camshaft rotation and MS 2 was closed from 35° - 200° of a camshaft rotation, K1 relay would be held energized from approximately 20° to 200° , despite the fact that the switch (MS 1) which originally completed the circuit had opened after 40° .

Diode (Rectifier). Diodes, sometimes erroneously referred to as rectifiers, come in various shapes or packages. Some consist of one or more plates, some are small metallic, glass or plastic cylinders, some look like small top hats.

Diodes have the ability to conduct in one direction, while blocking in another direction.

Schematically diodes are shown:



When a diode has negative connected to its cathode, and positive connected to its anode (+ → → -) it will conduct.

When a diode has its cathode connected to positive and its anode connected to negative (- → → +) it will not conduct.

Diodes can be used for three different purposes:

1. To prevent unwanted circuits.

In the example below, the diode connected in the circuit will allow only K1 relay to energize when switch S1 is closed, but will allow both K1 and K2 relays to energize when switch S2 is closed.

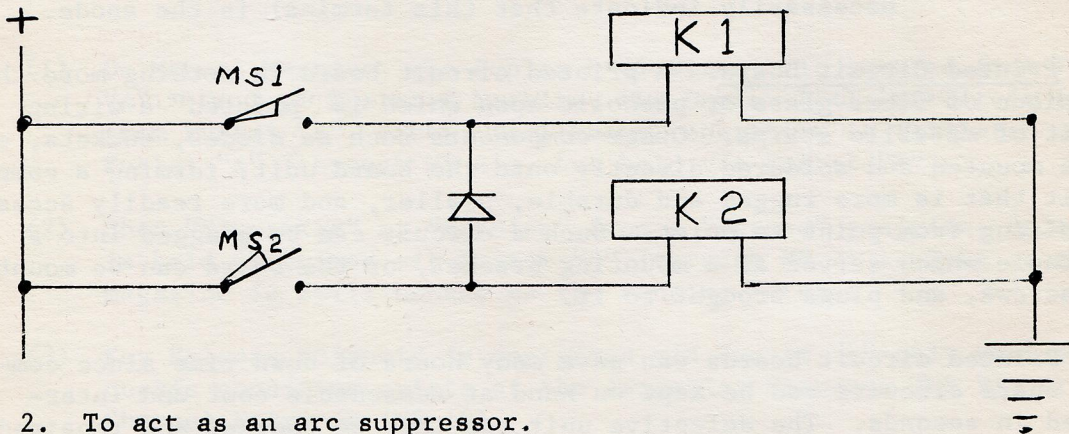

2. To act as an arc suppressor.

When placed in parallel with a coil, a diode will increase the life of switch or relay contacts.

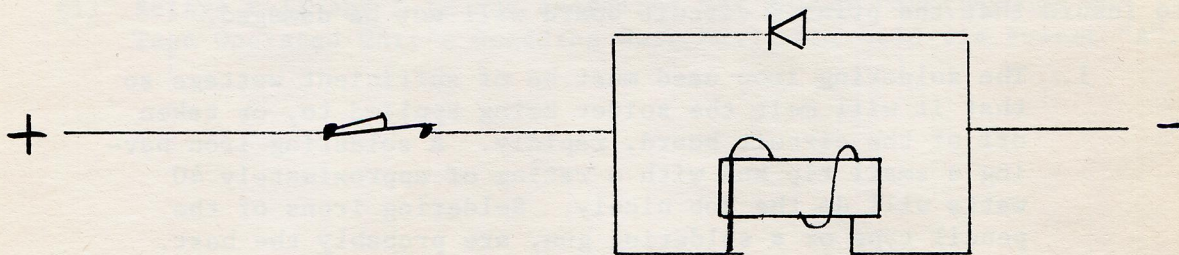

3. To rectify (convert A.C. to D.C.).

When four diodes are placed in a circuit as shown, the circuit will convert A.C. current to D.C. Such an assembly of diodes is generally referred to as a full wave bridge rectifier.

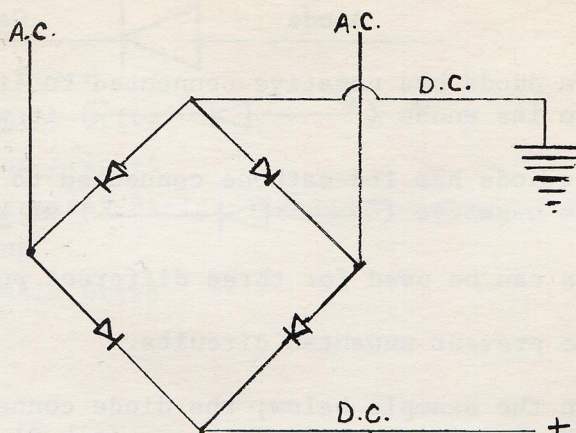

CAUTION: A plus sign stamped on a rectifier or diode does not necessarily indicate that this terminal is the anode.

Printed Circuit Board. A printed circuit board is nothing more than a flat piece of fiber-glass or phenolic upon which is "printed" a wiring circuit of metallic strips. Other components such as diodes, sockets, etc., can be mounted and soldered directly onto the board unit, forming a complete circuit that is more rugged and durable, smaller, and more readily accessible than wiring from point to point. Such a circuit can be plugged into a receptacle which serves as a mounting bracket, or the board can be mounted with screws, and plugs brought to it.

Printed circuit boards can save many hours of down time since complete spare circuits can be kept on hand at reasonable cost and interchanged in seconds. The defective unit can then be checked and repaired when time permits.

When doing any work with a printed circuit board, there are several precautions that must be observed in order for the repair to be successful and to insure that the printed circuit board will not be damaged.

1. The soldering iron used must be of sufficient wattage so that it will melt the solder being applied to, or taken off of the circuit board, rapidly. A soldering iron having a small tip and with a rating of approximately 40 watts will do the job nicely. Soldering irons of the pencil type or a soldering gun, are probably the best.
2. The soldering iron should be up to maximum temperature before the work on the board should even be attempted. Excess heat applied to the board may cause the printed circuit metal foil to peel away from the phenolic or fiber-glass material which comprises the major portion of the board. Before using the soldering iron, be sure that the tip of the iron is clean, bright and tinned with solder. This insures maximum heat conduction from the soldering iron to the work.

3. When soldering, the solder should be applied to the item being soldered, and never to the soldering iron directly.
4. The pieces of work being soldered should be clean and bright to insure a good soldered joint. If the pieces being soldered together are not tinned, it is advisable to do so before soldering them together.
5. The solder used should be of a wire type of fairly thin diameter, such as Kester #44 Resin Core, as this will be a quick melting type. Never use an acid soldering flux, as this will cause the joint to corrode over a period of time. A resin solder flux should always be used for any electrical work. There are many manufacturers who market a thin wire solder with a resin flux core.
6. When removing a component from a printed circuit board, it is better to first remove the excess solder on the joint first. This is done by heating the joint until the solder melts and then shake the board sharply. The melted solder will be shaken off. Do not try to wipe the excess solder off with a rag, as this may cause a thin film of solder to be left on the printed circuit board that can short together some of the conductors on the board.
7. When removing or adding any solid state components, such as diodes, transistors or rectifiers, to a printed circuit board, always use a heat sink to avoid damage to the component. A heat sink is a pair of pliers or a tweezer that is placed on the lead to the component, between the component and the soldering. This is done to prevent the heat from reaching the component as most solid state components are quite heat sensitive and can be ruined by heat.
8. When a component being removed has only two leads on it, it may be unsoldered one lead at a time, and the component lifted from the board one end at a time. If the component being removed has more than two leads, it is important to first remove all the excess solder. Then gently lift each of the leads while heating the joint. If the component is rigid or the leads are long, it may take more than one attempt at each lead to completely remove the component.
9. When the solder joint is completed, it should have a smooth, clean appearance. A solder joint that appears frosty, or has a grainy surface or a rough surface, indicates that the pieces were probably not cleaned sufficiently, not tinned, or were not heated enough before soldering.

10. When two pieces of unequal size are being soldered together, it is advisable to concentrate most of the heat from the soldering iron on the heavier item, otherwise the solder will probably not adhere well to the heavier piece even though the solder adheres well to the lighter piece. An example of this is connecting the lead of a switch to a printed circuit. In this case, it is wise to put most of the heat on the lead of the switch.

Wiring Plugs and Receptacles. In the wiring diagrams used in this instruction, the receptacles and plugs are identified by P-numbers, such as P-9 (which is a receptacle) and P-8 which is the plug which plugs into the P-9 receptacle.

The number of each terminal in the plugs and receptacles are stamped on the back of the part because this is where the wires are soldered to each terminal. However, for testing and checking purposes, in the wiring diagrams, the number on each terminal in either a receptacle or a plug is the number as you look at the part where it is plugged together.

A plug with prongs is identified by solid rectangles to indicate prongs; a receptacle by open rectangles, as follows:

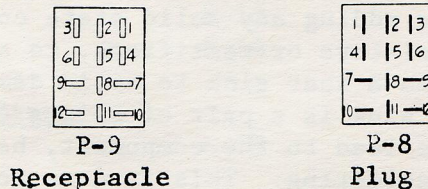

Plug and Receptacle Assembly. In wiring a plug or receptacle, the wires are brought through a clamp mounted on the rear of a plug or receptacle cover, and then are soldered to the terminals in the back of the plug or receptacle. The cover is then placed over the plug or receptacle and a pin is driven through both parts, or screws are used. The clamp is then tightened around the wires.

Therefore, to take a plug apart, the pin must be driven out or the holding screws removed, the clamp loosened and then the plug can be pulled out of the cover, exposing the wire terminals and the ends of the wires soldered to the terminals.

Schematic Symbols. In the schematic diagrams used in this instruction, standard symbols are used to represent components and their normal position (open, closed, actuated, unactuated, etc.). If these symbols are unfamiliar to the reader, the following legend should be studied before proceeding:

-8-
SCHEMATIC SYMBOL LEGEND

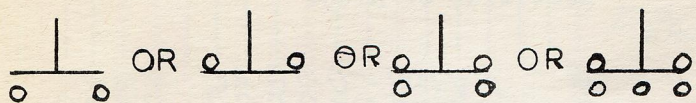

Manual Pushbutton Switch - in normal or released position

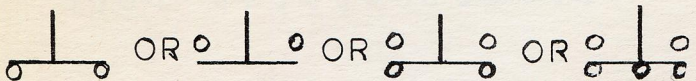

Manual Pushbutton Switch - in depressed or operated position

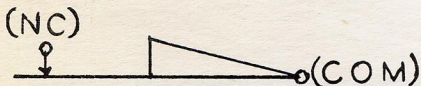

Micro-Switch, or Large Keyboard Pushbutton Switch (MS6, etc.) or Timer Switch (TS1 through TS7) - in normal or released position

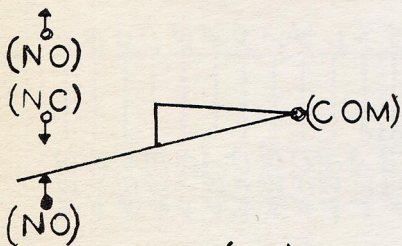

Micro-Switch, or Large Keyboard Pushbutton Switch, or Timer Switch - in actuated or held position

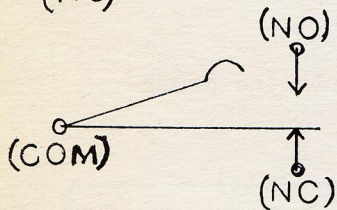

Magazine Carriage Position Sensing Switch (MS1 through MS5) - in normal or released position

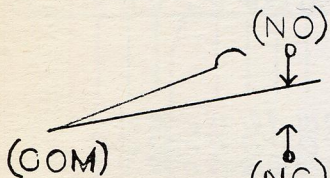

Magazine Carriage Position Sensing Switch - in actuated or held position

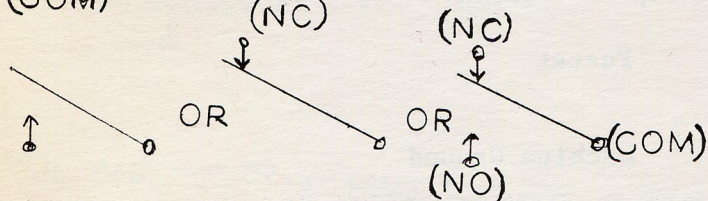

Relay Contacts or Leaf Spring Switch - in normal or released position

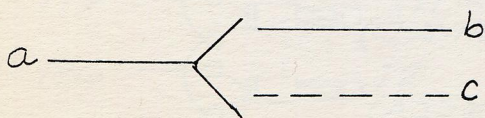

Wiring Option - Point "a" connects to Point "b" or to Point "c" (but not both at same time) per explanatory note associated with symbol

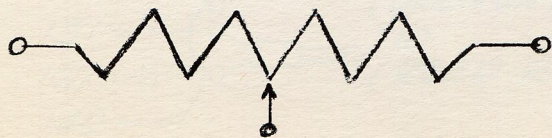

Resistor (adjustable)

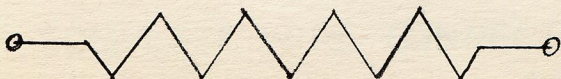

Resistor (fixed)



Rectifier or Diode

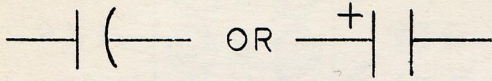

Capacitor

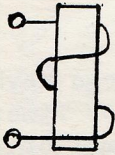

Relay Coil

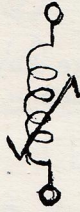

Rotary Solenoid

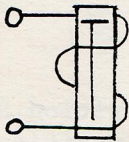

Linear Solenoid, Valve Solenoid,
Electric Clutch or Brake



Fustat



Machine Ground



Motor

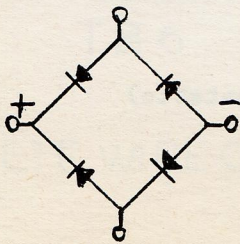

Full Wave Bridge Rectifier



Lamp

THE LINOTYPE ELEKTRON ELECTRICAL SYSTEM

The electrical circuits of the Elektron are of two basic types; power circuits and control circuits.

The power circuits are used to connect the electric pot and the motors of the Elektron to the Elektron purchaser's high voltage power lines (110 volts, 208 volts, 240 volts, 380 volts, 415 volts, etc.).

The control circuits operate on 24 volts direct current to operate the switches, relays, solenoids, electric clutches, etc., of the Elektron.

The main power switch, Thermo-Blo switch, Microtherm electric pot relay panel (or Linotronic control panel), transformer, rectifier, fuses, circuit boards, etc., are all located in one place in a Power Central in the right hand side of the base. The Elektron is prewired before it is shipped from the factory.

High Voltage Power Circuits

Power is connected to the Elektron at the junction box located at the rear right-hand corner of the base. Fig. 31 shows this junction box and how the power connections are made to the wire connectors for single phase power. Fig. 30 shows the connections for three phase power and three phase power with a neutral wire which is connected to the power central so that the electric pot, Thermo-Blo motor and the transformer can be operated by the lower single phase voltage, such as 240 volts if a 385 or 415 three phase circuit is used.

Electric Pot power (See Figs. 30 and 31) is conducted from the junction box to the Power Central by wires 247 and 248 direct to the terminals 7 and 8 of the Microtherm relay panel or to terminals 10 and 11 of the Control Panel Assembly if the Linotronic Temperature Control is used.

If the Electric Pot has a Microtherm Temperature Control, a cable with six wires (601 to 606) runs to the control box attached to the side of the Electric Pot. If the Electric Pot has a Linotronic Control, two cables run to the wire junction box on the side of the Electric Pot. One cable has four wires (601 to 604) while the other has three wires (607, 608 and 609). The wiring diagram shows how the wires are connected to the box on the side of the Electric Pot.

Caution must be exercised when working in or around the "Power Central" with power connected to the machine because full line voltage will be present across terminals 7 and 8 of the Microtherm assembly or terminals 10 and 11 of the Linotronic assembly.

Fustats are not incorporated in the wiring of the Power Central for the single phase power line to either the Microtherm Panel Assembly or the Linotronic Control Panel Assembly. The purchaser's power line connected to the Elektron's wire junction box should be disconnected by a switch, or the fuses in the purchaser's power line should be removed to shut off the power to the Power Central.

The Microtherm Panel Assembly (Fig. 32) is equipped with a circuit breaker which will throw off power to the electric pot automatically, if the pot gets too hot or if the current becomes excessive.

The Microtherm Panel Assembly in the Power Central differs from that in the Microtherm Relay Box used on other model Linotypes, in that it has been redesigned to fit in the Power Central and so that the indicating lights can be seen when the inspection cover is raised. The Linotronic Panel Assembly (Fig. 33) is essentially the same as the Panel Assembly in the Linotronic Control Box used on other model Linotypes, except that the control box has been removed. The wiring connections in the Panel Assembly and the terminal strip connections are identically the same as in the Linotronic Control used on other Linotypes.

Fig. 30 and 31 show the wiring connections of the Microtherm Relay Panel Assembly in the Power Central, as well as the connections from the Relay Panel Assembly to the Microtherm Control Box on the side of the electric pot. In addition, Fig. 32 shows the way the terminals of the electric heaters are connected to the terminal strip in the control box. For maintenance information on the Universal Electric Pot with Microtherm Temperature Controls, see the Instruction Booklet provided for this purpose.

Fig. 33 shows the wiring connections from the Linotronic Control Panel Assembly in the Power Central, to the wire junction box on the side of the electric pot. It also shows the method of connecting the terminals of the electric heaters and the wires from the crucible and mouthpiece probes to the terminal strip in the junction box.

Except for the fact that the Linotronic Control Panel Assembly is located in the Power Central in the Elektron, instead of being in a box fastened to the side of the mold gear arm as it is on other model Linotypes, the Linotronic Temperature Control is the same as used on other model Linotypes. Service Instruction No. 18-3 should be used for the description and maintenance information on this temperature control.

Main Power Switch

The power switch located in the base of the front right-hand side of the machine, performs five functions when turned on.

1. Powers the Casting side motor.
2. Powers the Magazine side motor.
3. Powers the Mohr Saw motor, if the Mohr Saw is part of the equipment.
4. Provides power to the Thermo-Blo switch which is located just to the right of the main power switch.
5. Provides low voltage power (AC and DC) via a step down transformer and rectifier for the control circuits.

Turning the main power switch to its off position disconnects all power except that to the Electric Pot. The on-and-off switch on the electric pot

panel assembly in the Power Central must be turned to the off position to shut off power to the electric pot.

Power is connected from the junction box to the power switch via a Terminal Block (terminal 1 and 2). Wires 245 and 246 from the junction box connect to these terminals and wires 201 and 202 connect from these terminals to the Power Switch.

If the power supply is three phase, the third terminal of the power switch connects to the junction box via jumper wire 203 to terminal 7 on the Microtherm Panel Assembly or terminal 10 on the Linotronic Panel Assembly. Terminals 7 or 10 are connected to the junction box by wire 247.

Turning the power switch to the on position connects the power, through Fustrons F-1 and F-2 (via wires 204 and 205 for single phase) and also through Fustron F-3 (via wire 206) in the case of three phase power, back to terminals 5 and 4 (via wires 223 and 222) for single phase and also to terminal 3 (via wire 221) in the case of three phase power. From these terminals power is supplied to the motors as follows:

- (a) Casting Side Motor via wire 214 from terminal 3 and wire 216 from terminal 5 for single phase and in addition wire 215 from terminal 4 if for three phase.
- (b) Magazine Side Motor via wire 211 from terminal 3 and wire 212 from terminal 4 for single phase and in addition wire 213 from terminal 5 if for three phase.
- (c) Mohr Saw Motor via wire 237 from terminal 3 and wire 238 from terminal 4 for single phase and in addition wire 239 from terminal 5 for three phase.
- (d) Thermo-Blo Motor via wire 226 from terminal 3 and wire 230 from terminal 5, through its off-on switch.

Transformer (Primary Leads). The primary leads of the transformer connect to terminal 3 of the terminal block by wire 207, and to terminal 4 via wires 210 and 220, except for 360-440 volt operation, when wires 207 and 226 are connected to terminal 8 of the Microtherm Relay Panel or terminal 11 of the Linotronic Control Panel.

For 110-130 volts A.C., wire 208 is connected to the junction of wire 210 and fuse "1" lead 220, and wire 209 is connected to terminal 3 of terminal block along with wire 207.

For 200-250 volts A.C., wires 208 and 209 are connected together.

Fustrons. The cartridge type fustrons used in the power circuits are rated for 15 amps. and are available under part number 41-2873-01.

Utility Receptacle for 115 (110-125) Volts. A four gang plug-in type utility receptacle is mounted on the rear of the column of the Elektron, to provide 115 volt A.C. current for a keyboard light, trouble light and also for any attachments which use 115 volt A.C. current.

This receptacle is connected by a cable to the junction box at the rear outside of the Power Central so that a 115 volt lighting line can be connected to the receptacle through a fuse socket. A regular 15 ampere fuse is used to protect this 115 volt circuit. The connections in the junction box for this 115 volt circuit are shown in the Power Central diagrams, Figs. 30 and 31.

Low Voltage Power Circuits

To obtain the 30 volts A.C. used to power the Timer motor (the "Timer" will be described under its own heading) and the 24 volt D.C. used to power the control circuits, a transformer is used. This reduces the voltage from either 110-125 volts or 200-250 volts to 30 volts A.C. This 30 volts A.C. is then changed to D.C. by a rectifier and reduced to 24 volts, so that 24 volts D.C. is made available for all the low voltage control circuits.

The Timer motor is designed to operate on 30 volts A.C., and this A.C. power is obtained from the secondary of the transformer via wires 314 and 315.

24 volts D.C. will appear across the red (+) and black (-) terminals of the rectifier when 30 volts from the secondary of the transformer are connected to the yellow terminals of the rectifier. To accomplish this, transformer secondary lead 301 is connected to one yellow rectifier terminal via wire 305, the other yellow rectifier terminal is connected via wire 306 to either transformer secondary lead 302, 303 or 304, depending on which lead is closest to producing 30 volts A.C. (See "Power Central Wiring", Figs. 30 and 31).

To determine whether lead 302, 303 or 304 is to be used with lead 301 to obtain 30 volts A.C., the leads of a voltmeter should be connected to lead 301 and to lead 302, 303 or 304. Either 302, 303 or 304 lead should be used depending on which one shows the closest to 30 volts A.C.

The black terminal of the rectifier is connected to ground via wire 307. From the red terminal of the rectifier wires 308, 309 and 310 are connected to Fustat "A", "B" and "C" respectively, to provide the 24 volt D.C. power for the control circuits.

The 24 volt D.C. control circuits are "grounded" circuits. That is, the 24 volt current travels from the red terminal of the rectifier, through either the "A", "B" or "C" Fustats, and through the switch, solenoid, etc. of a particular circuit to a connection to the machine which serves as a ground return. Since the black terminal of the rectifier is connected to the machine and therefore "grounded", the 24 volt D.C. circuit is thus completed to energize the particular circuit involved.

Fustat "A", "B" and "C" used in the 24 volt D.C. power circuits are rated at 3.5 amperes each, and are available by ordering part number 41-0649-12.

The following low voltage power circuits in the control system of the Elektron, are illustrated and described in this service instruction by using both schematic and wiring diagrams. In this way, it will be possible to trace individual wires, switches, solenoids, etc., if trouble is encountered in a particular control circuit.

1. L.H. Vise Jaw and Pot Advance Safety
2. Hydraulic Justification
3. Distributor Clutch and Brake
4. Cam Shaft Clutch and Brake
5. Duplex Rail
6. Spaceband Timing and Starwheel Pusher Solenoid
7. Line Measuring
8. Delivery Timing Clutch Solenoid
9. Delivery of the Line
10. Assembler Finger Brake Release Solenoid
11. Assembly Mode Control
12. Operating Unit
13. Assembler Belt and Assembler Chute Finger Switches
14. Reed Rack Switch
15. No Cast Indicator
16. Electric Hydraquadder
17. Magazine Elevating and Fanning
18. Electromatic Safety
19. Mixing System

In the wiring diagrams shown for various low voltage circuits, only the wires through which the 24 volt D.C. passes for the particular circuit, are shown. Other wires from other circuits may also be attached to a switch terminal, for instance, but they can generally be disregarded when a particular low voltage circuit is being traced. The complete wiring for all the low voltage circuits can be found by referring to the Machine Control Circuit wiring diagram (Fig. 40) and the Elevating, Fanning and Mixing wiring diagram (Fig. 41).

Low voltage power is not always obtained direct from the three Fustats "A", "B" and "C". Power is obtained from other points for some circuits, such as a switch terminal or the terminal of a plug, or receptacle, etc.

For instance, power to energize the L18 pot pump solenoid is taken from the normally closed terminal of the No Cast Indicator Clearing Switch MS 38, as shown in the schematic diagram for the L.H. Vise Jaw and Pot Advance Safety. At the time of casting the slug, switch MS 38 is always unactuated so that current will flow from the common terminal to the normally closed terminal and provide power to the pot pump solenoid.

LEFT-HAND VISE JAW AND POT ADVANCE SAFETY

(See Figures 1 and 1A)

Pot Pump Safety Solenoid L-18 of this safety obtains its 24 volts D.C. power from the N.C. terminal of No Cast Clearing Switch MS 38. MS 38 in turn obtains its 24 volts D.C. power from the ready switch MS 28 (when actuated). Therefore, the pot pump solenoid cannot be energized unless the ready switch MS 28 had been actuated, pulling in K-7, providing a path through the K-7a contacts.

The safety consists of an electrical switch S-7 built into the left-hand vise jaw with a plunger which protrudes from the end of the jaw. This plunger closes the switch when it is depressed flush with the jaw by a full line of matrices, or by the complete closing of the vise jaws. In series with the S-7 switch is the pot pump solenoid L-18 and the pot advance switch MS 40. The pot pump solenoid will operate to permit the pot pump plunger to descend and cast a slug, provided the vise jaw switch S-7 is closed and providing the pot advances fully forward against the mold to actuate the pot advance switch MS 40.

Some Elektrons are equipped with a Pot Pump Lockout Switch S-13, mounted on the upper left side of the keyboard. This S-13 switch is wired in series with one of the leads to the L-18 Pot Pump Solenoid.

The S-13 switch is in normal position when the actuating lever is vertical. If the lever is pressed to the left or right, it will open the circuit to the pot pump solenoid and thus prevent the solenoid being energized to allow the pot pump plunger to descend and cast the slug.

When the lever of switch S-13 is pressed to the left and then released, it will return to normal position. If the lever is pressed to the right, however, the switch S-13 will remain open until the lever is returned to a vertical position.

L.H. VISE JAW & POT ADVANCE SAFETY

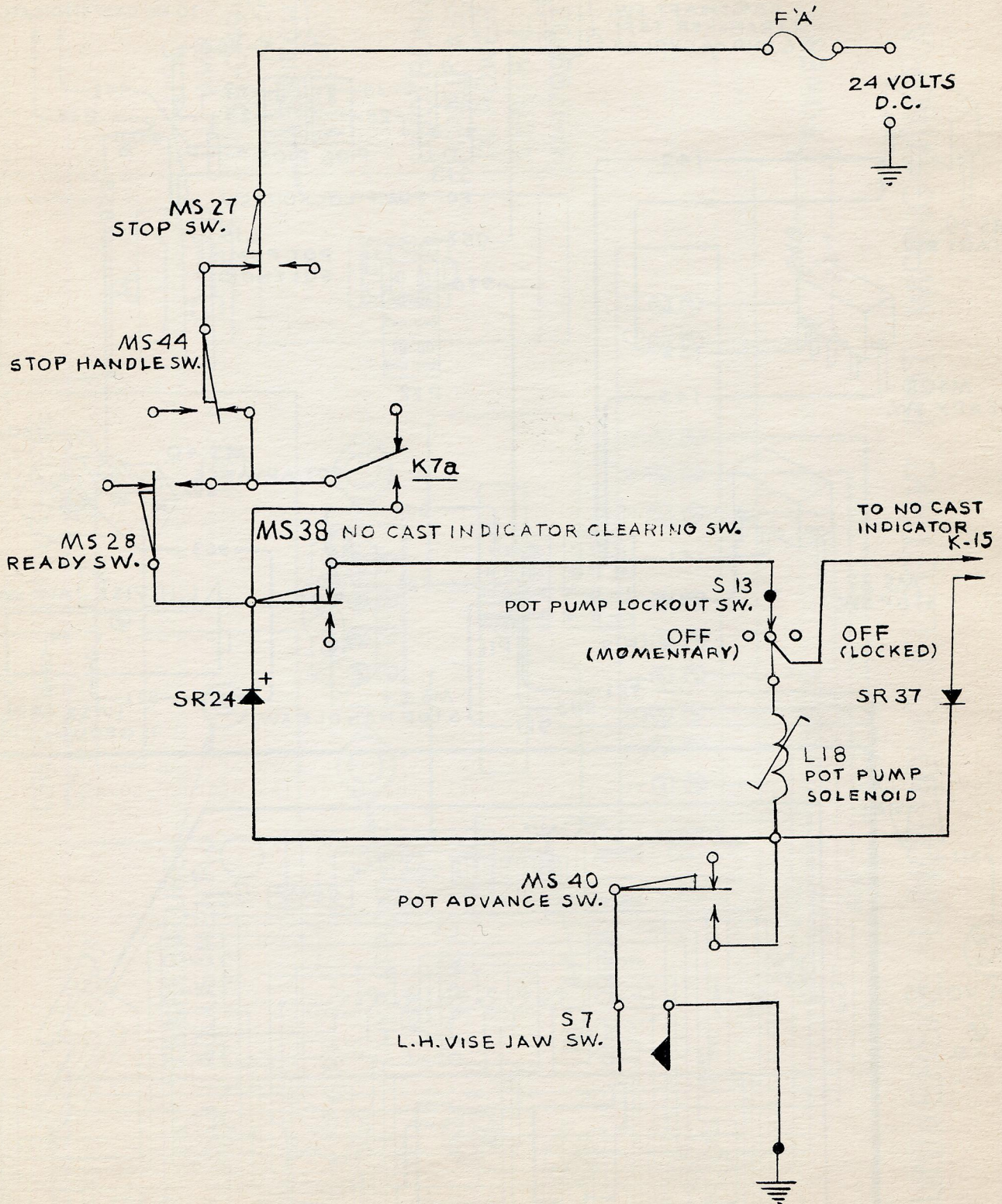

SCHEMATIC

FIG. I

L.H. VISE JAW & POT ADVANCE SAFETY

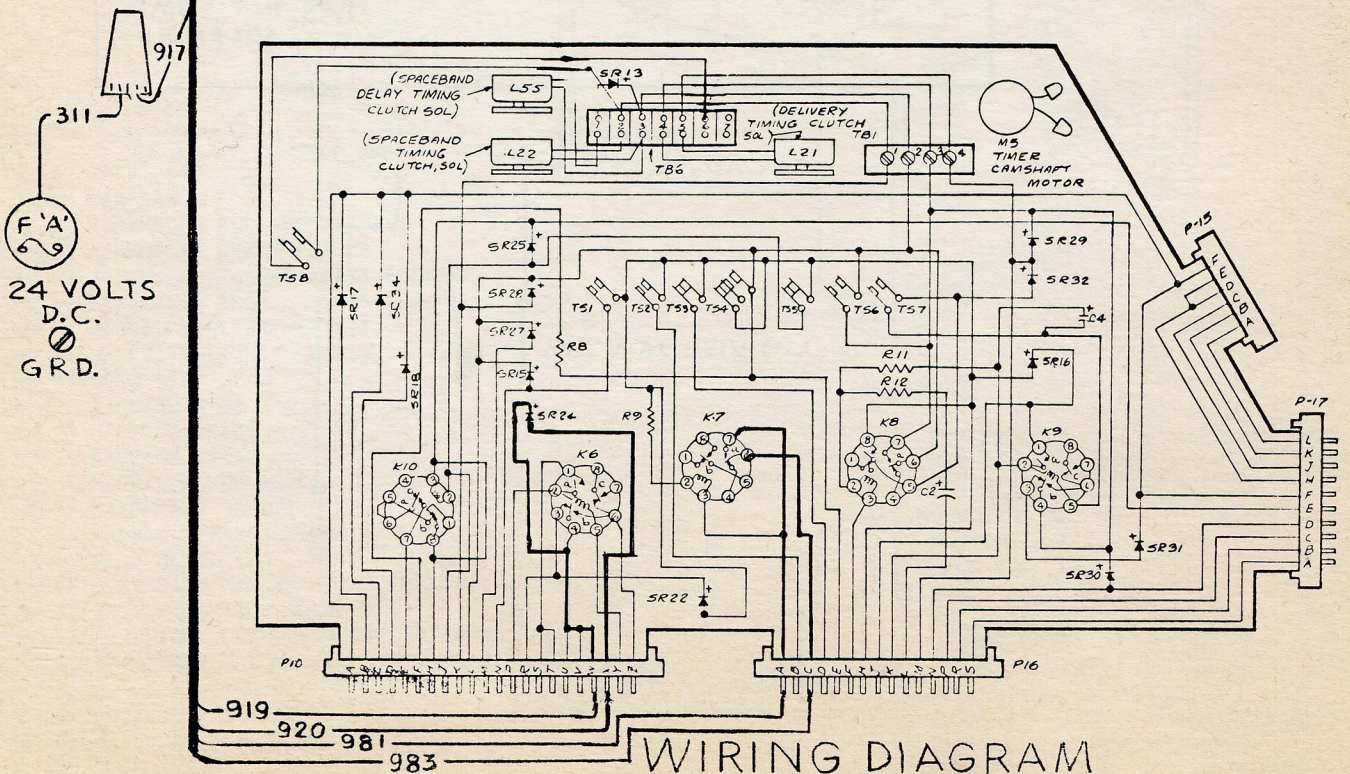
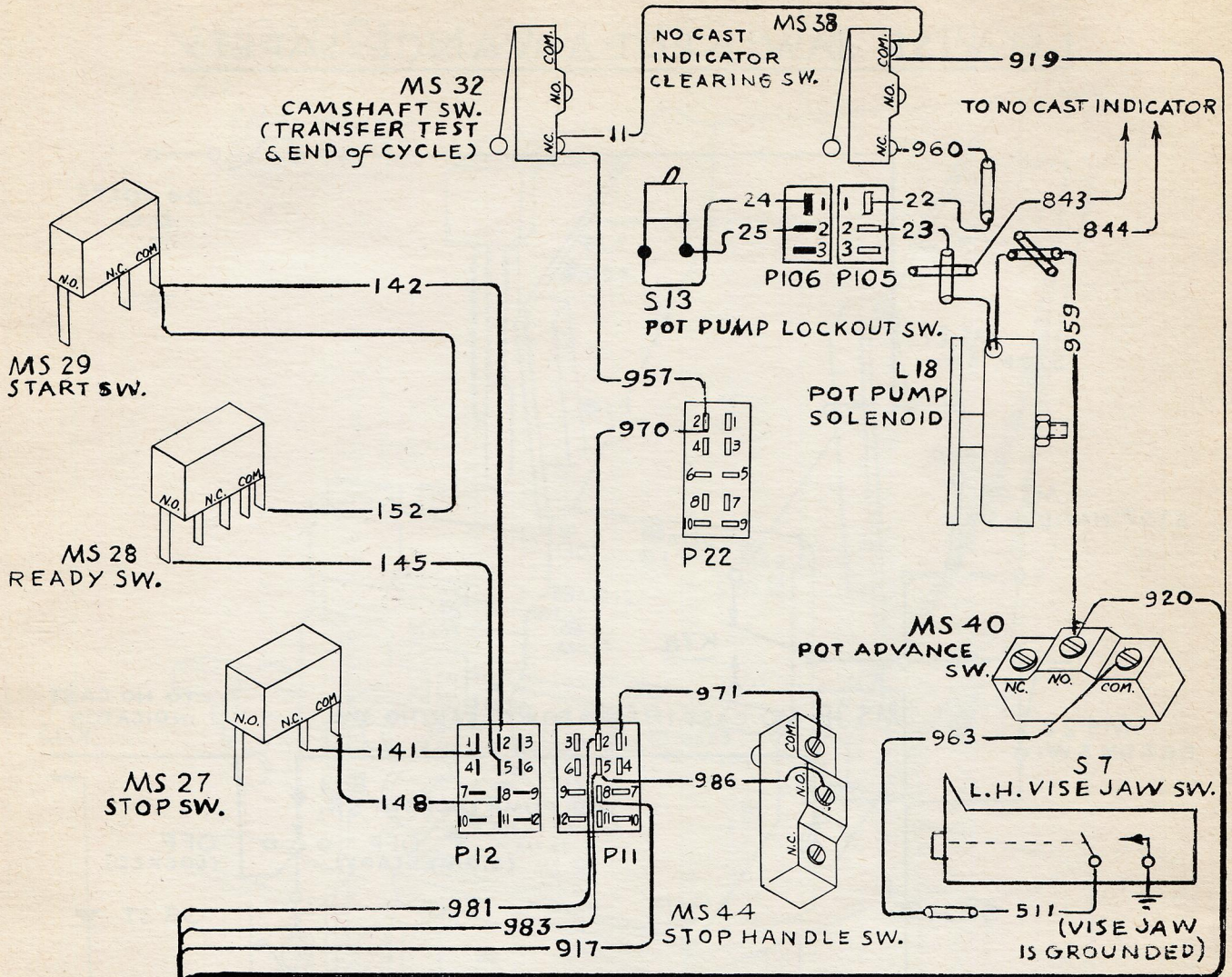

HYDRAULIC JUSTIFICATION
(See Figure 2)

With Hydraulic Justification, the justification bar is driven upward for first and for second justification, to justify the line of matrices, by hydraulic fluid flowing into a cylinder which is coupled to the justification bar assembly.

The fluid is circulated by a hydraulic pump driven by a pulley on the rear of the casting side motor shaft. It drains fluid from the sump located on the left-hand side of the base and circulates it through an electric control valve and back to the sump. When the control valve solenoid is energized, the fluid is directed to the cylinder to force the justification bar upward to justify the line by hydraulic action.

The valve solenoid L-20 is located at the rear left-hand corner of the base and is energized by the closing of the cam shaft justification switch MS 42. Switch MS 42 is located on the right-hand end of the cam shaft and is operated twice (for first and second justification) by two shoes which are fastened to the transfer and delivery cam hub.

Power to energize the justification valve solenoid L-20 is obtained from Fustat "B" via wire 950 to terminal 2 of P-9 and from this terminal via wires 980 and 979 to solenoid L-20, then through the solenoid coil to the common terminal of the cam shaft justification switch MS 42, via wire 978. When switch MS 42 is closed by one of the cam shoes, the circuit is completed to ground via wire 974 and the justification valve solenoid is energized so that the hydraulic fluid will flow to the cylinder to force the justification bar upward against the spacebands to justify the line.

Half wave rectifier SR 27 (in the machine and control printed circuit) is wired across the solenoid L-20 to reduce the arcing of the MS 42 switch contacts.

In addition to wire 974, MS 42 has a wire 976 connected to the N.O. terminal. The other end of 976 is connected to wire 975 of the machine harness at the rear center area of the base. Wire 975 ends at a point where the vise frame pivots and is not connected to anything unless a Hydraquadder is part of the machine equipment.

If a Hydraquadder is on the machine, a MS 43 Hydraquadder justification lockout switch is mounted on the left rear side of the vise frame. The normally closed terminal of this switch is connected to the open end of wire 975 via wire 880. Also wire 974 is removed from the N.O. terminal of MS 42 and placed on the common terminal of MS 43 and grounded on the vise frame.

With this arrangement, whenever the Hydraquadder is set to quad or center, a lever is caused to move which opens the justification lockout switch MS 43 so that the circuit through the L-20 solenoid coil to ground will not be completed to energize the coil, and therefore fluid will not flow to the justification cylinder and the justification bar will not rise.

In the Manual or Electric Hydraquadder on other model Linotypes, a justification lockout lever is moved into position mechanically to prevent the justification bar rising, when the Hydraquadder is set to quad or center. In the Elektron, lockout switch MS 43 prevents justification by preventing the L-20 solenoid from being energized.

HYDRAULIC JUSTIFICATION

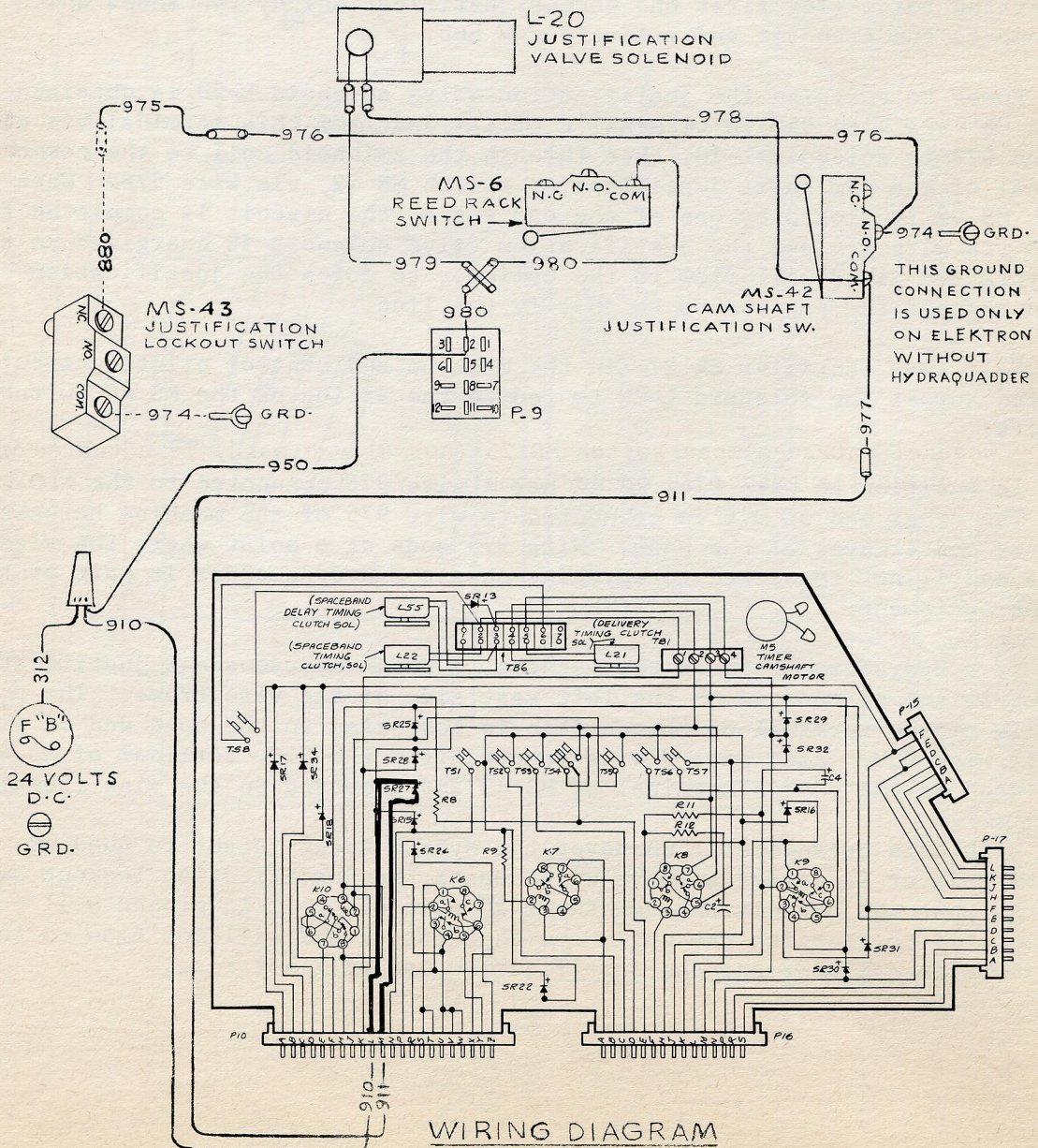
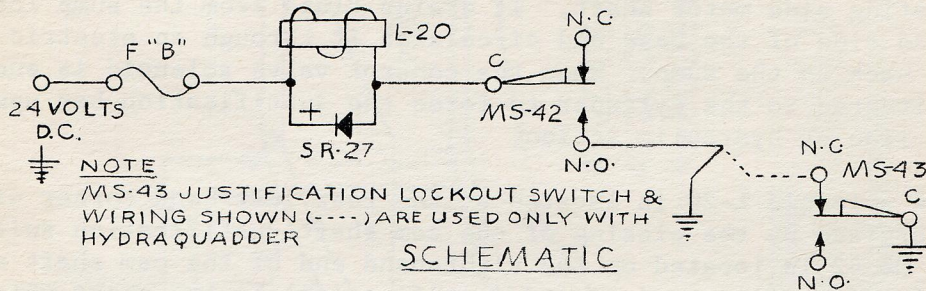

FIG-2

DISTRIBUTOR CLUTCH AND BRAKE
(See Figures 3 and 4)

The distributor electric clutch L-13 is used to couple the drive from the intermediate shaft to the distributor screws. The clutch L-13 is energized to drive the distributor screws as long as the machine power switch is on. If a matrix does not drop from the distributor bar into the channel entrance properly, the lower distributor screw will move to the left which releases a switch MS 26, de-energizing the electric clutch. The electric brake L-12 is then energized simultaneously to stop the distributor immediately.

In the distributor clutch and brake circuit, power is connected to the distributor screw switch MS 26 from Fustat "C". Power to switch MS 26 and to the electric clutch L-13, is by wire 420 from Fustat "C" to terminal T of printed circuit connection P-3 which plugs into the elevating and fanning printed circuit board in the Power Central. A jumper connects terminal T and Y, and wire 435 runs from terminal Y, through socket 15 of P-30 and pin 15 of P-31, to terminal board No. 3 (TB 3) and from TB 3 the wire 936 runs to the common terminal of MS 26.

Since MS 26 is held actuated, the circuit passes from the common terminal through the N-O contact, then to the L-13 solenoid, through the solenoid coil and then to ground to complete the circuit and energizes the electric distributor clutch. The clutch will remain energized to drive the distributor screws unless a matrix jams in the distributor and MS 26 is released, or unless the channel entrance is opened.

When the electric clutch L-13 is de-energized by releasing of switch MS 26, the distributor electric brake L-12 is immediately energized to stop the distributor screws instantly.

Channel entrance open switch MS 25 (normally closed) is actuated whenever the channel entrance is opened completely. This releases the electric brake so that the distributor screws can be turned by hand using the distributor hand wheel.

Whenever the electric distributor clutch L-13 is de-energized, the distributor stop lamp I-6 will be energized and will glow red. If the Elektron is operated by tape, whenever the clutch L-13 is de-energized, the stop relay or stop magnets in the operating unit will be energized through rectifier SR 18, to stop the operating unit and prevent further assembling of matrices.

Mixer Elektrons (Figure 4A)

On Mixer Elektrons there is an upper set of distributor screws and a lower set. MS 26 distributor screw switch is used for the upper set and another switch MS 24 is used for the lower set of distributor screws.

MS 24 is in series with MS 26 so that if either one is actuated, the distributor clutch will be de-energized and the brake energized to stop the distributor. Variable Resistor R 10 is in series with switches MS 26 so that the torque of the distributor clutch can be adjusted. Resistor R 10 should be adjusted so that there is sufficient torque to run the distributor properly under operating conditions.

MS 25 channel entrance open switch is the same switch as used on non-mixer Elektrons, but in the mixer it is actuated when the lower channel entrance is opened completely.

DISTRIBUTOR ELECTRIC CLUTCH & BRAKE

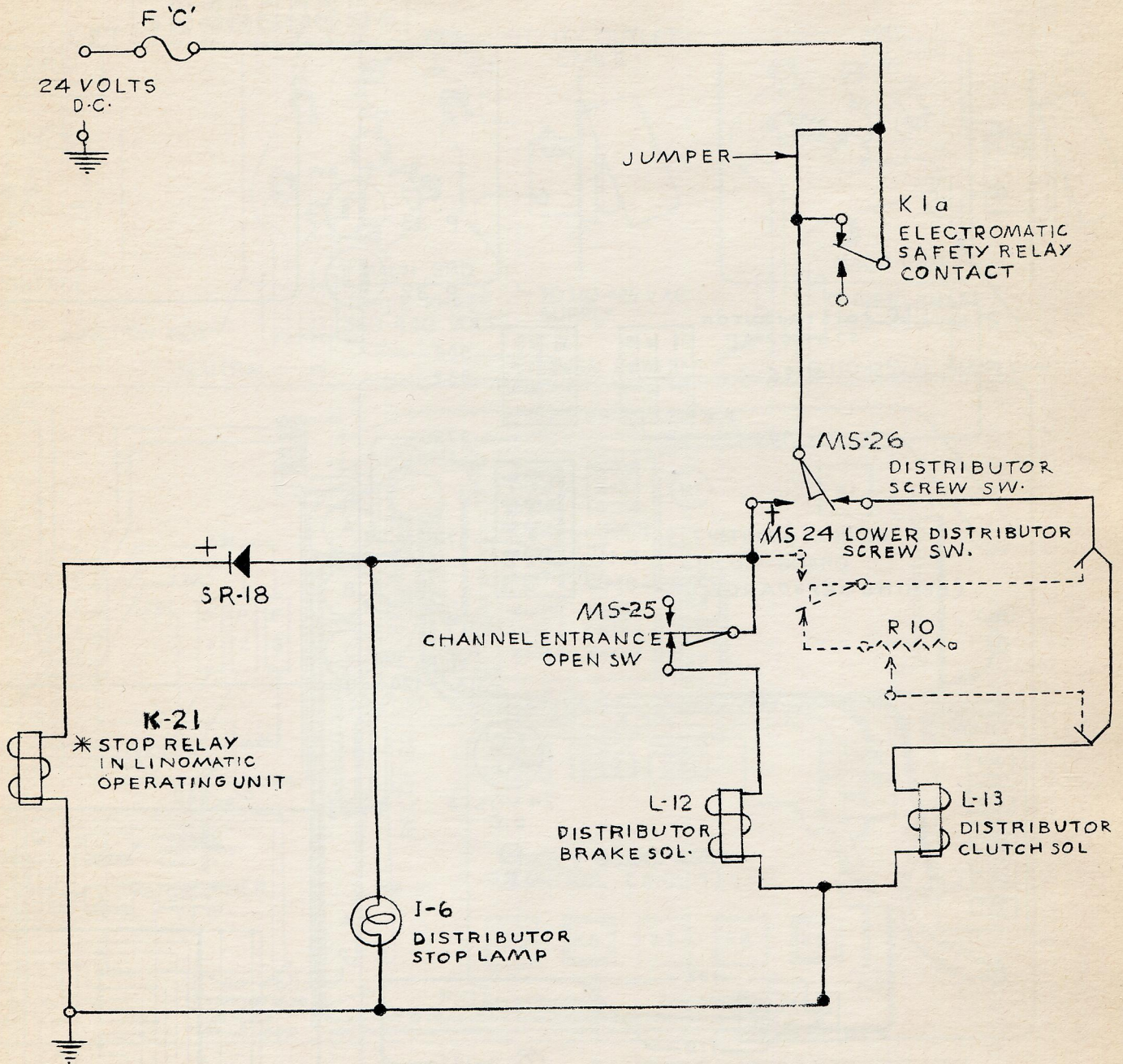

SCHEMATIC

† NOTE:- ON MIXER ELEKTRONS—MS 24 IS IN SERIES WITH MS 26.

* NOTE:- STOP MAGNETS ARE USED FOR THE SAME PURPOSE IN THE TTS OPERATING UNIT.

DISTRIBUTOR ELECTRIC CLUTCH & BRAKE

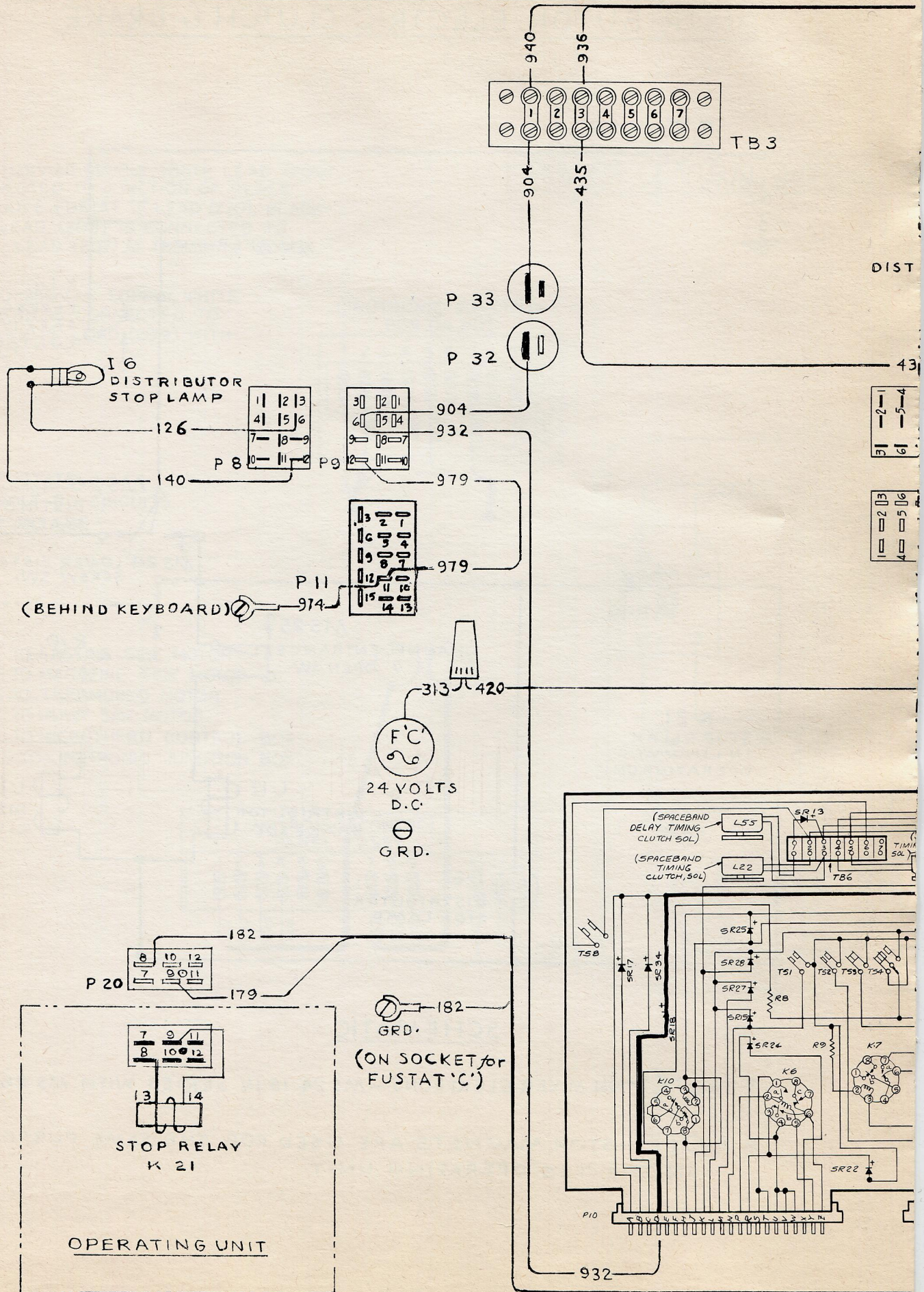
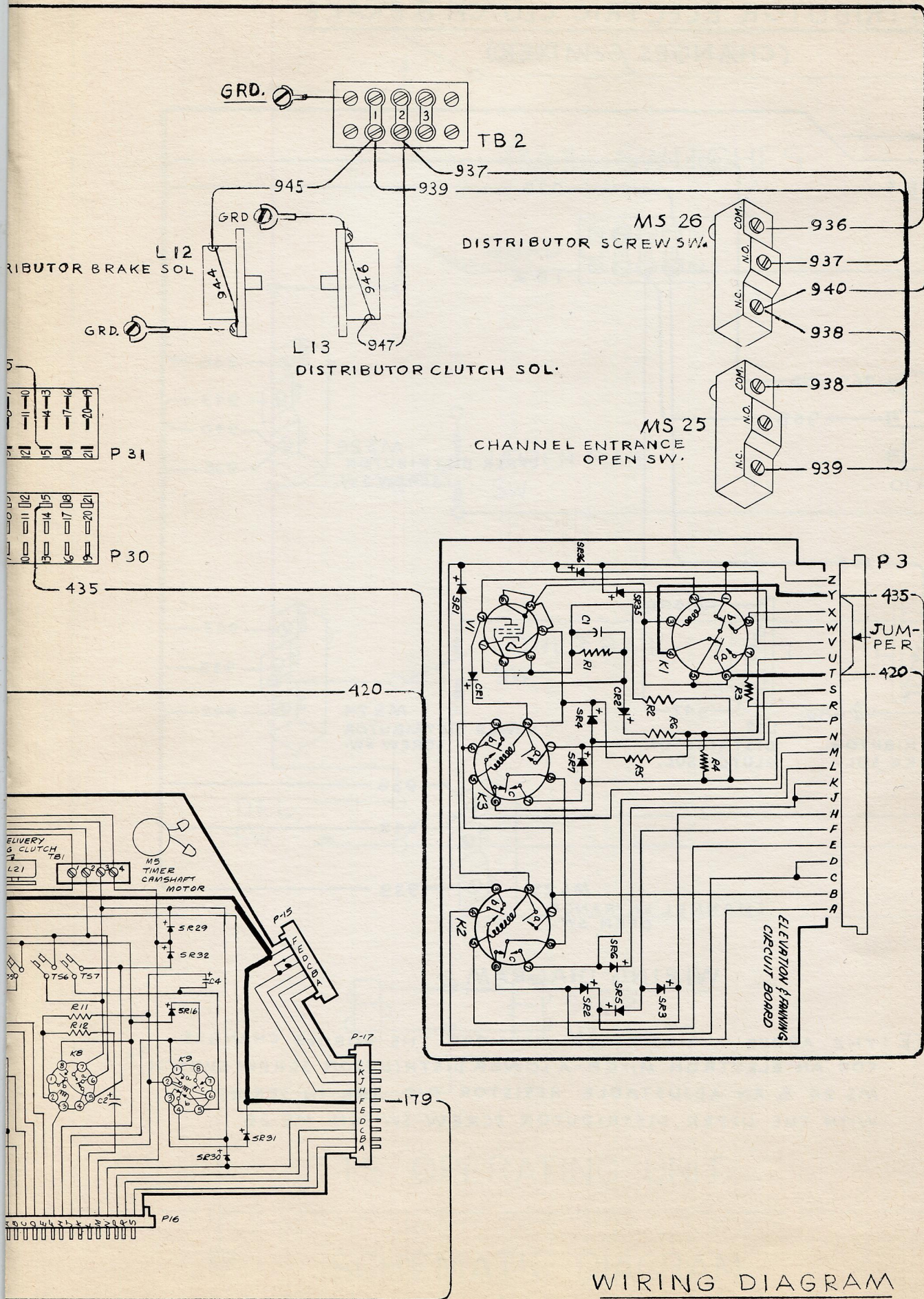

FIG. 4



WIRING DIAGRAM

7-67

DISTRIBUTOR ELECTRIC CLUTCH & BRAKE

(CHANGES for MIXER)

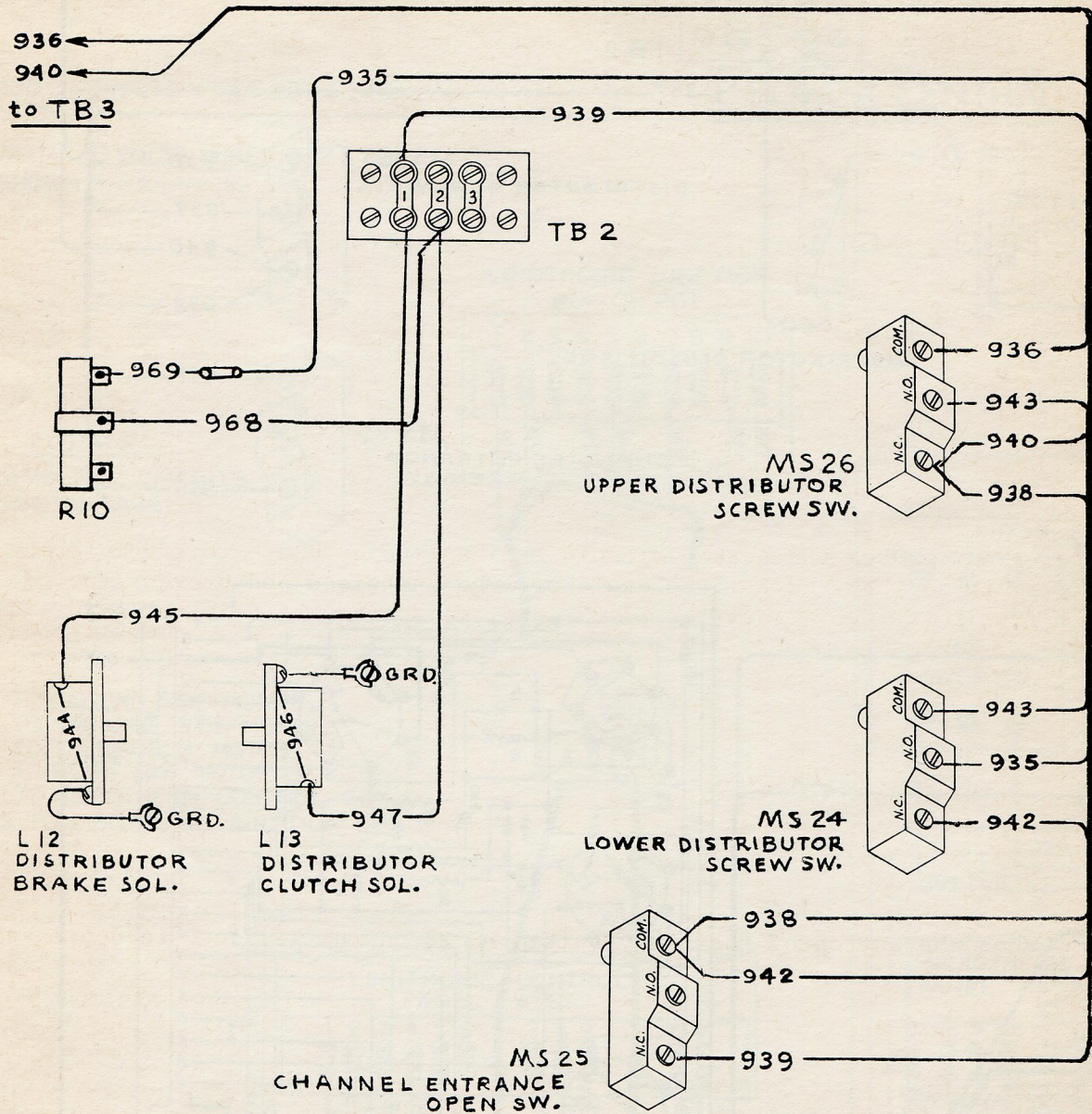

WIRING DIAGRAM

NOTE: THE ABOVE WIRING DIAGRAM SHOWS THE WIRING CHANGES FOR AN ELEKTRON MIXER. A LOWER DISTRIBUTOR SCREW SWITCH MS 24 & AN ADJUSTABLE RESISTOR R10 ARE IN SERIES WITH THE UPPER DISTRIBUTOR SCREW SWITCH MS 26

FIG. 4 A

CAM SHAFT ELECTRIC CLUTCH AND BRAKE
(See Figures 7 and 8)

Cam Shaft Electric Brake

Fustat "A" provides power to the cam shaft electric brake solenoid L-15, via the ready switch MS 28. Whenever the ready switch button is actuated, the L-15 brake solenoid will be energized immediately.

When the ready switch is not actuated, however, 24 volt D.C. power will not get to the brake solenoid and the driving shaft brake will therefore be off. Whenever the ready switch MS 28 is not on, the cam shaft can be turned over manually by use of the hand wheel, without the necessity of turning off the main power switch.

The schematic diagram, Figure 7, shows how 24 volt D.C. power passes from Fustat "A" through switches MS 27, 44 and 28 (when actuated) and then through the "B" contacts of Relay K-6 mounted on the machine control circuit board, then through the brake solenoid L-15 and to ground. This completes the circuit so that the L-15 solenoid will be energized and prevent the cam shaft from rotating. Rectifier SR 22 is wired across the L-15 solenoid.

Cam Shaft Electric Clutch

On other model Linotypes, when a line of matrices is assembled and delivered, the starting and stopping handle must be in its neutral position. This neutral position corresponds to the ready switch MS 28. The ready switch MS 28 must have been depressed before the Elektron can be started either manually by depressing the start button, or automatically when the line is delivered.

When the button of the ready switch MS 28 on the keyboard is depressed, the ready switch lamp I-8 will be energized and will glow, and also the ready relay K-7 will be energized, the K-7a relay contacts will close and will not open unless the stop switch MS 27, or stop handle switch MS 44 is actuated.

When the ready relay K-7 is energized, relay contacts K-7a close and hold the lamp I-8 and K7 relay energized. To turn the cam shaft by motor power, the start switch MS 29 is depressed or the automatic start switch MS 30 is operated by the line delivery slide when a line of matrices has been delivered fully into the first elevator jaw.

Actuation of either the start switch MS 29 or the automatic starting switch MS 30 will energize the cam shaft control relay K-6, providing the spaceband safety switch MS 33 or the Transfer Safety Switch MS 54 is not actuated.

When the relay K-6 is energized, relay contact K-6b opens the circuit to the cam shaft brake solenoid and then closes the power circuit to the cam shaft clutch solenoid L-14 and the cam shaft starts to revolve.

CAMSHAFT ELECTRIC CLUTCH & BRA

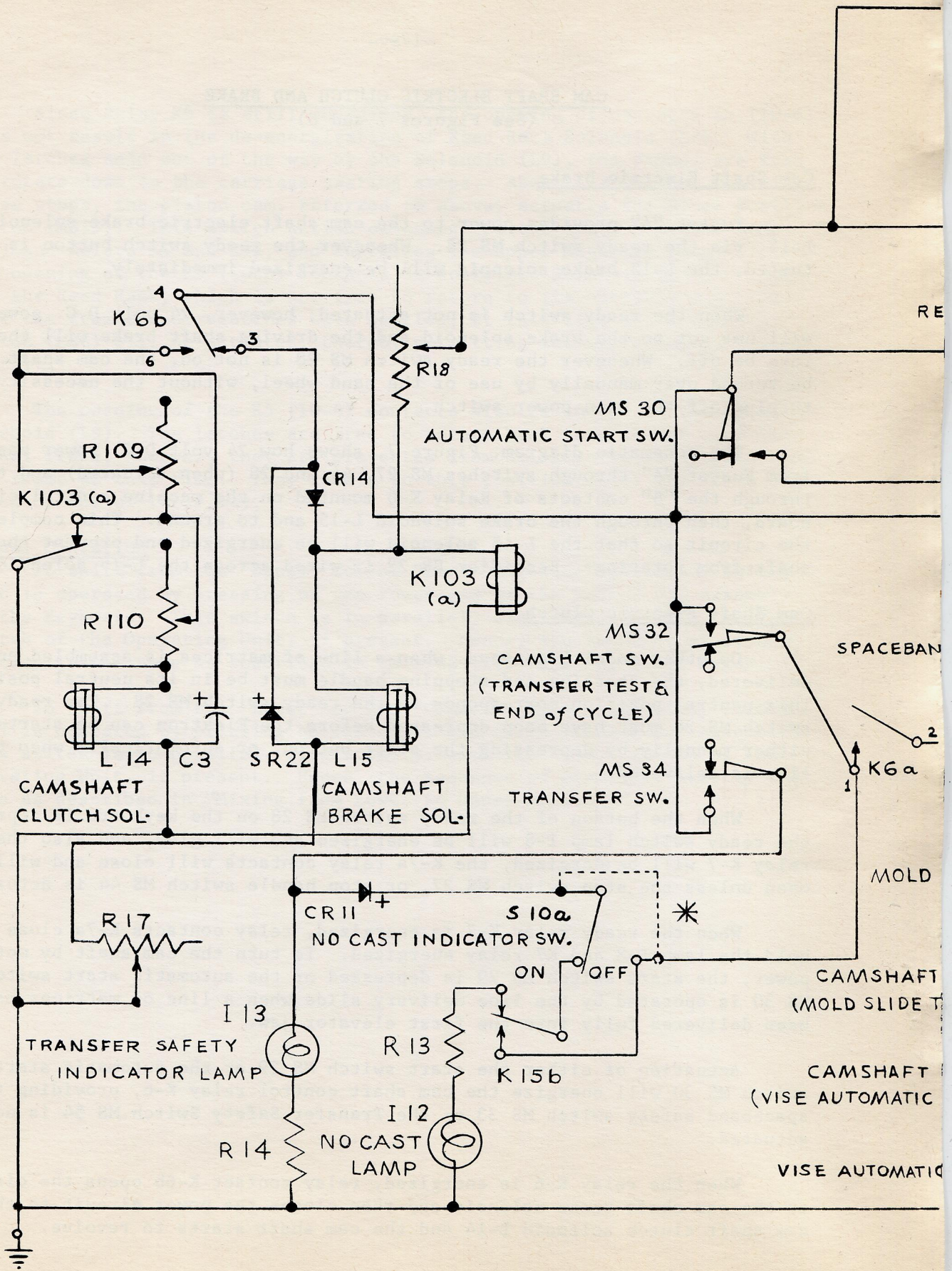

KE

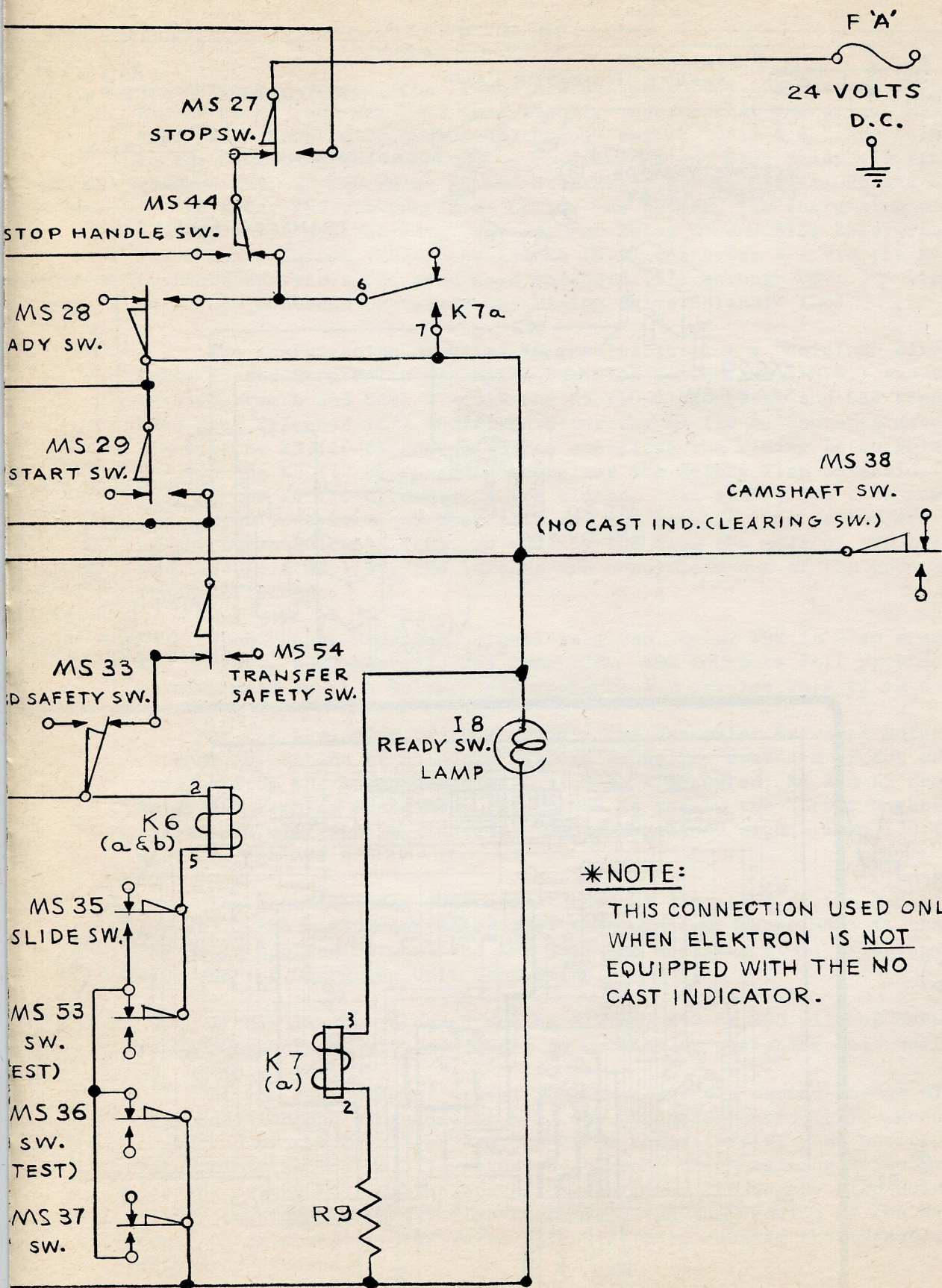

***NOTE:**

THIS CONNECTION USED ONLY
WHEN ELEKTRON IS NOT
EQUIPPED WITH THE NO
CAST INDICATOR.

SCHEMATIC

FIG. 7

7-67

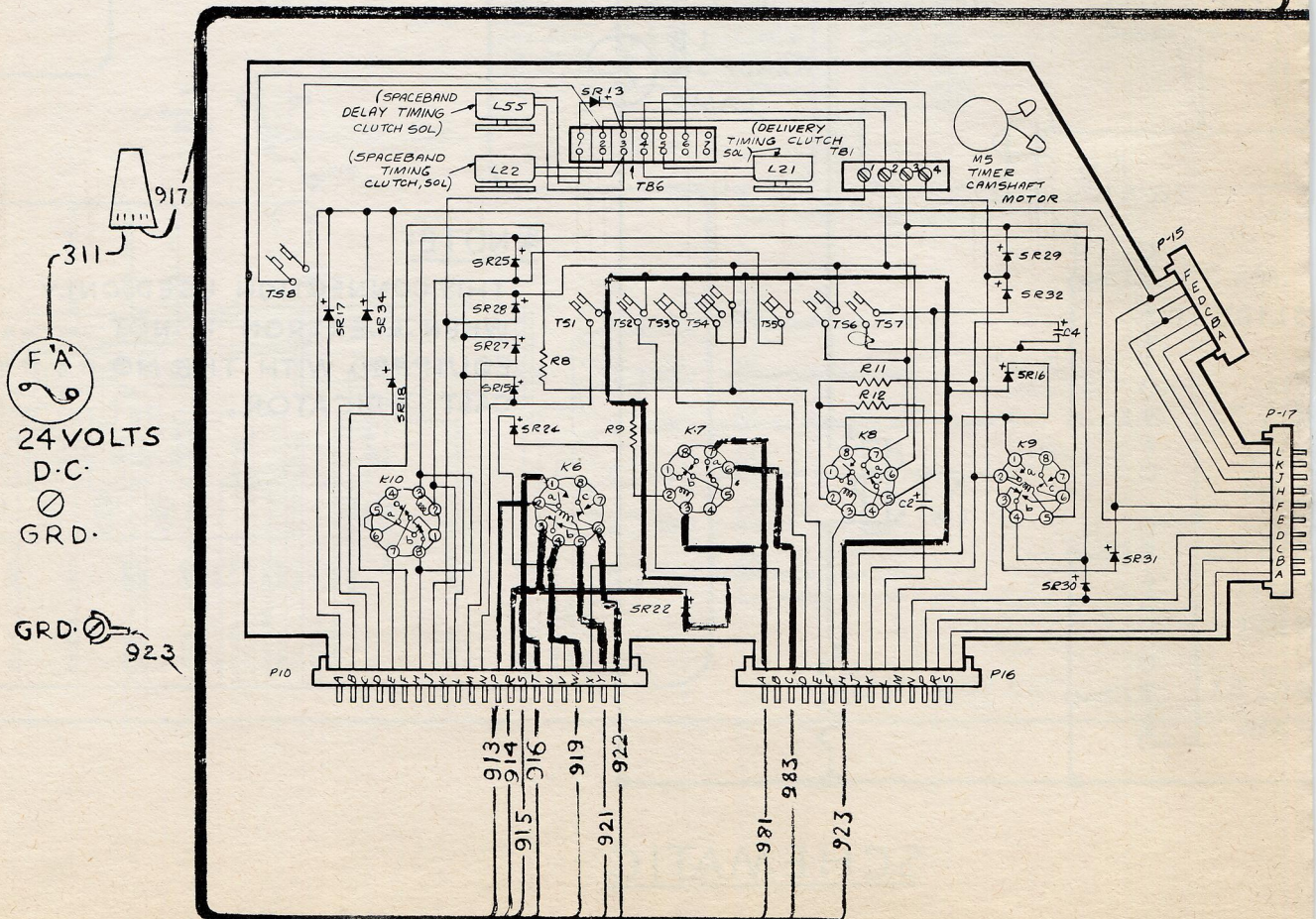
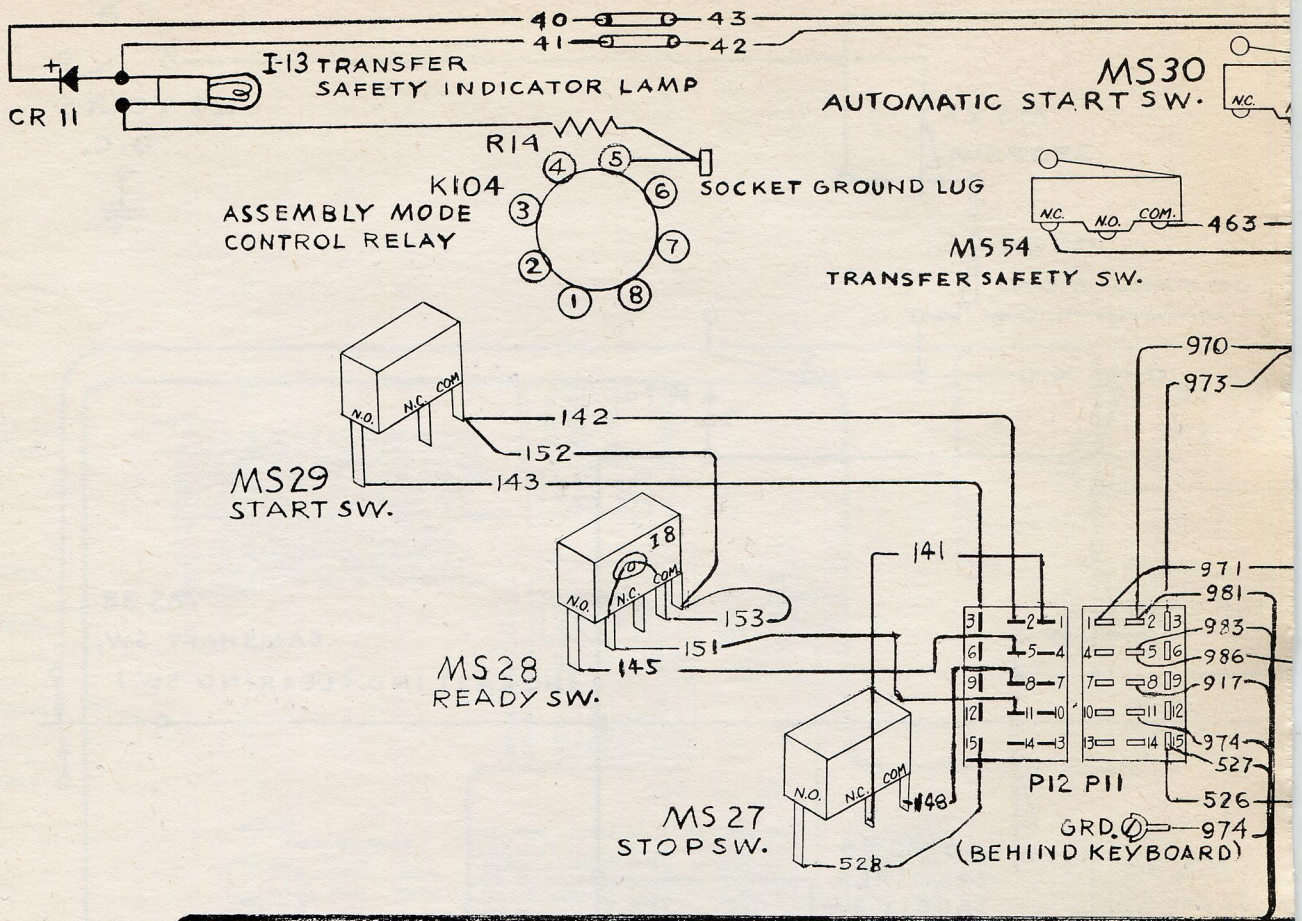

CAM SHAFT ELECTRIC CLUTCH & BRAKE

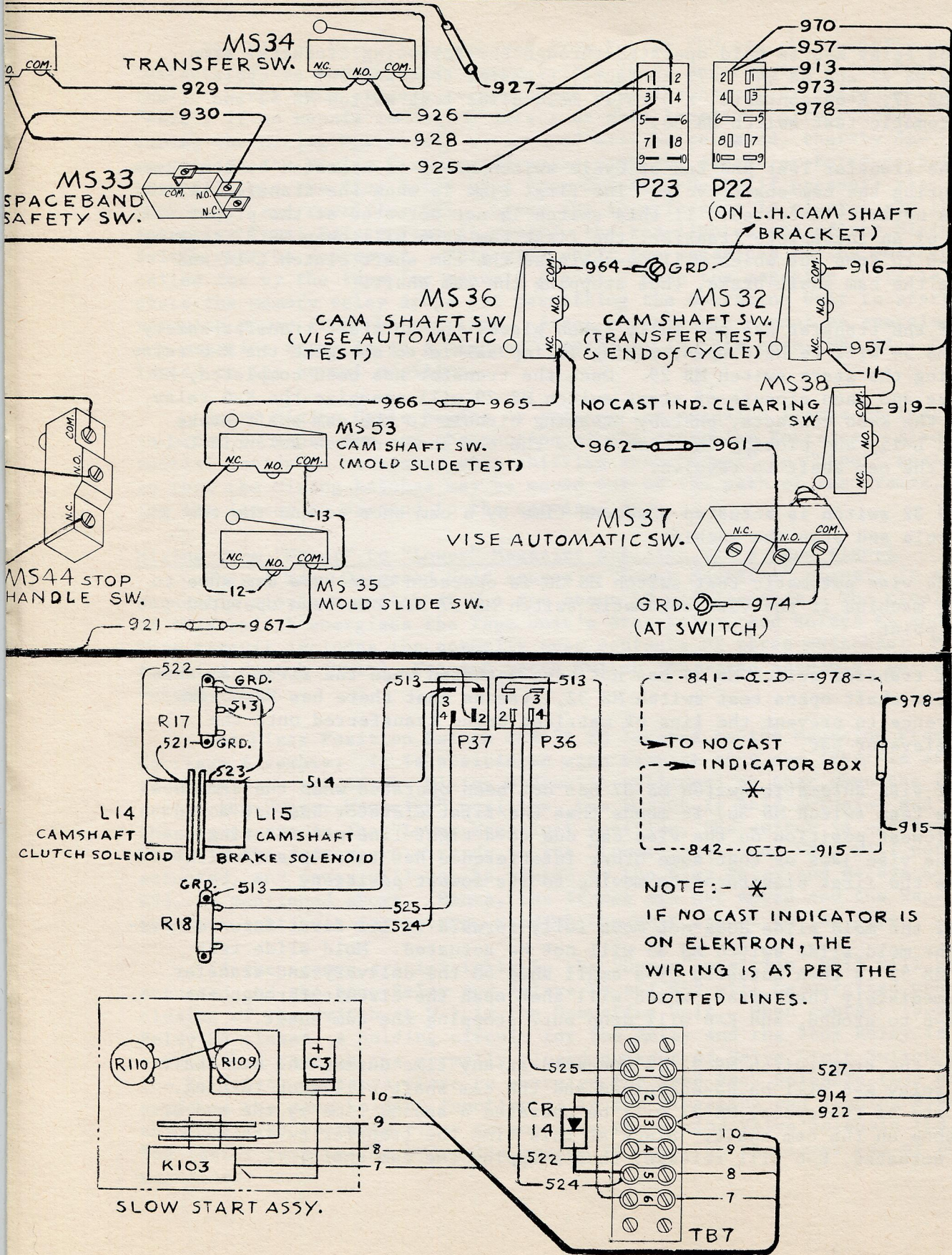

WIRING DIAGRAM

FIG-8

7-67

The relay K-6 is held operated through the following circuits: stop switches MS 27 and MS 44, K-7a contacts, transfer test and end of cycle switch MS 32, K-6a contacts, K-6 coil, mold slide test switch MS 53 and vise automatic test switch MS 36.

The Transfer Test and End of Cycle switch MS 32 is operated by cam shoes twice during the cam shaft cycle. The first time is when the transfer switch MS 34 is normally actuated. If this switch is not actuated at the proper time because of an incomplete transfer, the first cam shoe will open MS 32 causing relay K-6 to drop out which will de-energize the cam shaft clutch L-14 and energize the cam shaft brake, thus stopping the cam shaft.

If the transfer has not fully taken place, the no start transfer safety switch MS 54 will be held open, making it impossible to energize the K-6 relay by closing the start switch MS 29. Once the transfer has been completed, MS 54 closes and then closure of start switch MS 29 will energize the K-6 relay, opening the K-6b contacts, thereby breaking circuit to the cam shaft brake solenoid L-15, and closing the circuit to the cam shaft clutch solenoid L-14 causing the cam shaft to revolve.

MS 32 switch is actuated a second time by a cam shoe to end the cam shaft cycle and stop the machine.

The vise automatic test switch MS 36 is operated once by a cam shoe to stop the machine if the vise automatic switch MS 37 has not been operated at this point.

If transfer switch MS 34 has not been actuated when the first cam shoe on the cam shaft opens test switch MS 32, it means that there has been some interference to prevent the line of matrices being transferred onto the second elevator bar.

If vise automatic switch MS 37 has not been operated when the cam shoe operates test switch MS 36, it means that the first elevator has not moved to its lowest position on the vise cap due to a tight line not entering between the vise jaws or that some other interference has taken place which prevents the first elevator from moving to its lowest position.

If the mold slide does not move fully forward in its first forward movement, the mold slide switch MS 35 will not be actuated. Mold slide test switch MS 53 is then actuated by a small shoe on the delivery and transfer cam, immediately thereafter, which will then open the circuit through the relay K-6 to ground, and K-6 will drop out, stopping the cam shaft.

If the stop switch MS 27 is operated at any time during the cam shaft cycle, relay K-6 will be de-energized and the cam shaft will stop turning. At the end of the cycle, MS 32 will be operated a second time by the end of cycle shoe on the cam shaft. Since at this time the transfer switch MS 34 is not actuated, K-6 will release, thus stopping the cam shaft.

If the start switch MS 29 or automatic start switch MS 30 is depressed at the end of the cycle (and the spaceband safety switch MS 33 is held closed) the next cycle will begin immediately, without K-6 dropping out. This feature of the start switch MS 29 (being able to override the transfer switch MS 34) allows for recasting of a line. When recasting a line, transfer from the first to the second elevator is prevented, thus causing a stop at the transfer testing point in the cycle. At this time, the operator need only press the start switch to continue the cycle to completion.

Once a cycle has started, it will continue to completion, even if the spaceband safety switch MS 33 is released during the cycle (assuming all the other safety switches function properly). A new cycle cannot be initiated, however, until MS 33 has been reset. Resetting MS 33 with the automatic start switch MS 30 actuated will initiate a new cam shaft cycle, if the ready lamp is "on".

Transfer Safety Indicator Lamp

This lamp I-13 is located in the Assembly Mode Control Box and will light whenever the transfer switch MS 34 is actuated by the transfer slide completing its movement to the right to transfer the matrices onto the second elevator bar and the spacebands into the spaceband box.

When MS 34 is actuated, 24 volts D.C. will pass from its common terminal through lamp I-13 and resistor R-14 to ground and the lamp will light. If transfer has not been completed, due to an interference, the machine will stop. Under these conditions lamp I-13 will not be lighted which is a warning to the operator or monitor not to depress the start button, until the interference has been eliminated and the transfer slide allowed to move to its fully transferred position.

When this is done, I-13 will glow "green" which is the signal that the start button can be depressed.

Slow Start Feature

To regulate the starting torque and also the driving torque of the cam shaft clutch, a slow start unit is used. This is a small box mounted just to the rear of the cam shaft reductor, and the box contains two potentiometers (variable resistances) R-109 and R-110, and a relay K-103. R-109 is adjusted for driving torque and R-110 for starting torque.

Referring to schematic diagram Figure 7, whenever the L-15 cam shaft brake solenoid is energized, relay K-103 will be energized and contact K-103a will then open. When K-6 relay is actuated to energize the cam shaft clutch L-14 to rotate the cam shaft, 24 volts D.C. power will then pass through the "b" contact of K-6, through potentiometer R-109 and through potentiometer R-110 (for approximately 1/3 second), then through L-14 solenoid to ground to complete the circuit and energize the L-14 solenoid.

R-109 reduces the voltage to the L-14 clutch depending on its setting, to regulate the driving torque of the clutch. Relay K-103 is a time delay relay and the time delay is regulated at the factory for 1/3 second. When relay K-6 is energized and power to the L-15 brake and to the K-103 relay is interrupted, relay K-103 will not drop out for 1/3 second. This allows the power to pass through potentiometer R-110 and then to clutch L-14 for this short period to allow the clutch to slip slightly when it starts (its starting torque being reduced, depending on the setting of R-110), which results in a slow start instead of an abrupt start.

After the 1/3 second delay in the drop out of relay K-103, the K-103a contact will close and the current will bypass R-110 so that its effect on the starting torque will be removed.

Adjustment of Starting and Driving and Stopping Torque

First set both adjustment controls at approximately the mid-point of their adjustment ranges.

Starting Torque (R-110)

Cycle the machine under power and adjust potentiometer R-110 to the desired starting speed by starting and restarting the machine when the second elevator is at approximately the mid-point of its travel either going up or down.

Driving Torque (R-109)

Cast the longest slug for which the machine is equipped and then stop the machine just prior to ejection. Then adjust the driving torque control R-109 until the torque is just high enough to eject the slug and complete the machine cycle.

Time Delay Relay(K-103)

There is a drop out spring tension adjusting screw in K-103 relay, which can be reached by removing the small plastic plug in the left side of the slow start box. The spring tension is set at the factory to provide a 1/3 second delay in opening the relay. This setting should not be changed unnecessarily.

Normal Stopping Torque (R-17)

Adjust variable resistor R-17 to obtain a "soft" stop at the end of a machine cycle with the MS-32 switch roller approximately centralized on the stopping cam shoe.

Emergency Stopping Torque (R-18)

When an emergency stop is initiated by actuating either stop switches MS-27 or MS-44, the cam shaft brake solenoid L-15 is energized directly through variable resistor R-18. Depress MS-27 when second elevator is approximately half way down to transfer. R-18 should be adjusted to stop the machine quickly but without excessive jarring of the second elevator.

DUPLEX RAIL SOLENOID
(See Figures 9 and 10)

Manual Operation

The duplex rail in the Elektron is a horizontal sliding rail which is moved to the right by action of the duplex rail solenoid L-19, whenever matrices are to be assembled "on the rail", so that the characters in the auxiliary position of matrices will be cast.

As will be noted from the schematic diagram, 24 volts D.C. power is obtained from Fustat "A", and when the manual upper rail switch MS 41 (at the left of the keyboard) is depressed, upper rail lamp I-9 will be energized, together with the duplex rail solenoid L-19 which moves the duplex rail to the right so that matrices can be assembled on the rail. The circuit through the lamp and solenoid is complete to ground through the duplex rail clearing switch TS 5.

When the upper rail switch MS 41 is depressed, relay K-10 in the machine and control circuit board is also energized, causing its two contacts "a" and "b" to close. This provides an alternate circuit through the manual lower rail switch MS 31 which keeps the solenoid L-19, relay K-10 and lamp I-9 energized after upper rail switch MS 41 has been released.

To return the duplex rail to its left or normal position, the lower rail switch MS 31 (on the keyboard) is depressed. This interrupts power to the lamp, solenoid and relay. Relay contacts "a" and "b" will then open and the duplex rail solenoid L-19 will be de-energized, allowing the duplex rail to be returned to its left or normal position by spring action.

Duplex Rail Clearing Switch TS 5

Since the circuit from the L-19 solenoid to ground is via clearing switch TS 5, opening this switch also de-energizes the solenoid allowing the duplex rail to return to normal position for lower rail assembly of matrices.

Switch TS 5 is called the duplex rail and electric quadder first stage clearing switch, and is located on the printed circuit and timer cam assembly (the quadder clearing function of switch TS 5 will be explained under "Electric Hydraquadder"). It is opened by timer cam action during the line delivery cycle, so that the duplex rail will be reset to normal or lower rail position at the end of every line.

Tape Operation

Upper rail and lower rail relays (K-28-K-30) located in the operating unit perform the same function as the manual upper and lower rail switches located on the keyboard. 24 volts D.C. power in this case is obtained from Fustat "B". Restoring of the duplex rail solenoid (L-19) to its de-energized or lower rail position is by opening the normally closed lower rail relay K-30. This interrupts power and opens the relay contacts to de-energize the solenoid.

The holding circuit for the lamp, solenoid and relay is through both lower rail switches, the manual switch on the keyboard and the relay in the operating unit. Actuation of either switch will restore the duplex rail solenoid L-19 to its normal or lower rail position.

Universal Duplex Rail

Manually operated Elektron IIs and mixers are designed to provide the operator with the optional use of the duplex rail as either the lateral type mentioned above or as a receding rail somewhat similar to the standard duplex rail on non-Elektron Linotypes. Choice of either method is accomplished through a manually operated selector lever that will cause the duplex rail to either recede from or project into the assembler channel.

Attached to the selector lever is a small mercury switch (S-14) that renders the Upper Rail Pushbutton Switch (MS 41) inoperative whenever the duplex rail is actuated to the receded position.

Manually operated machines are equipped with the Universal Duplex Rail in order to permit easier manipulation of matrices and hairspaces in the assembler channel.

DUPLEX RAIL SOLENOID

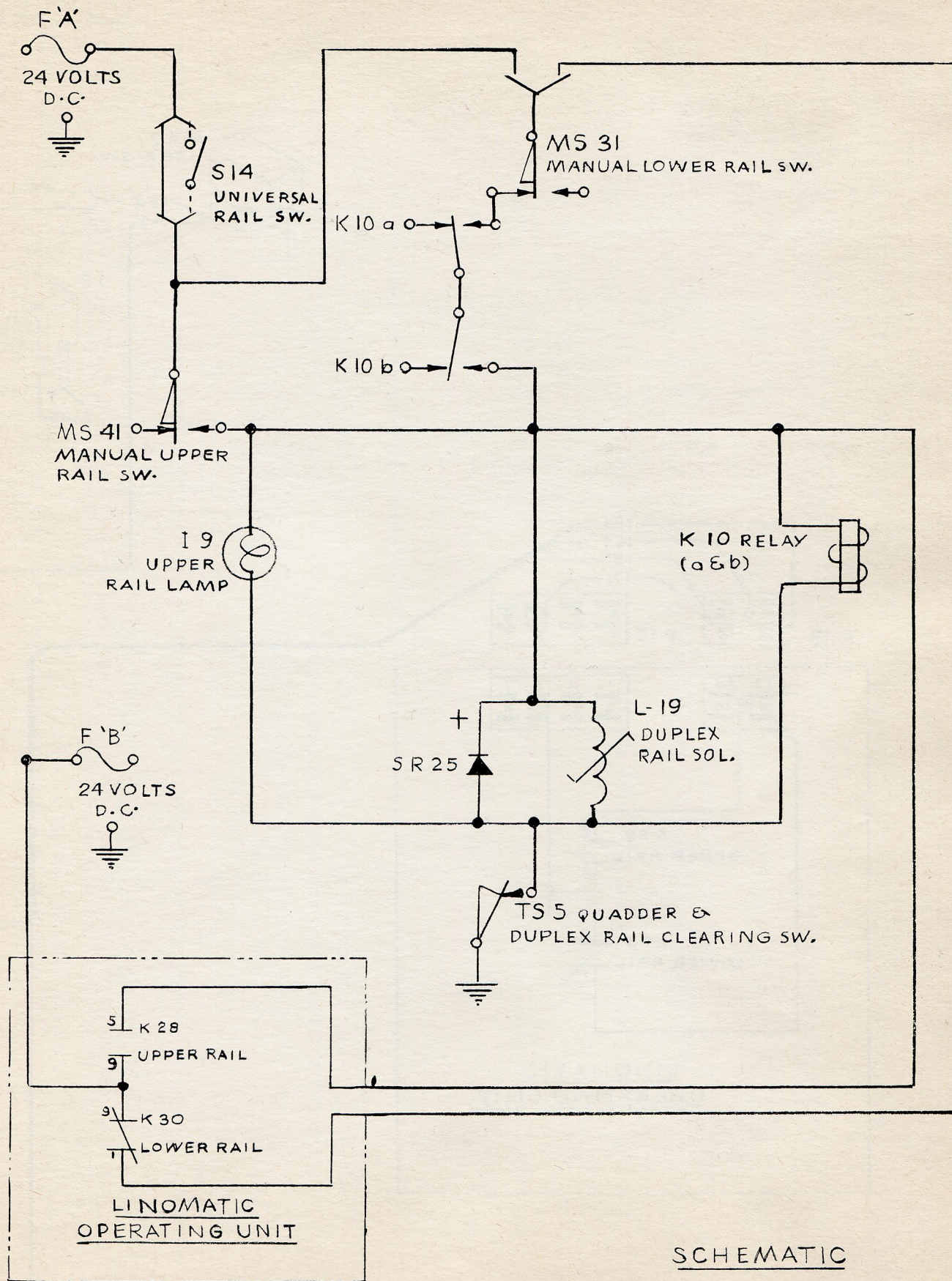
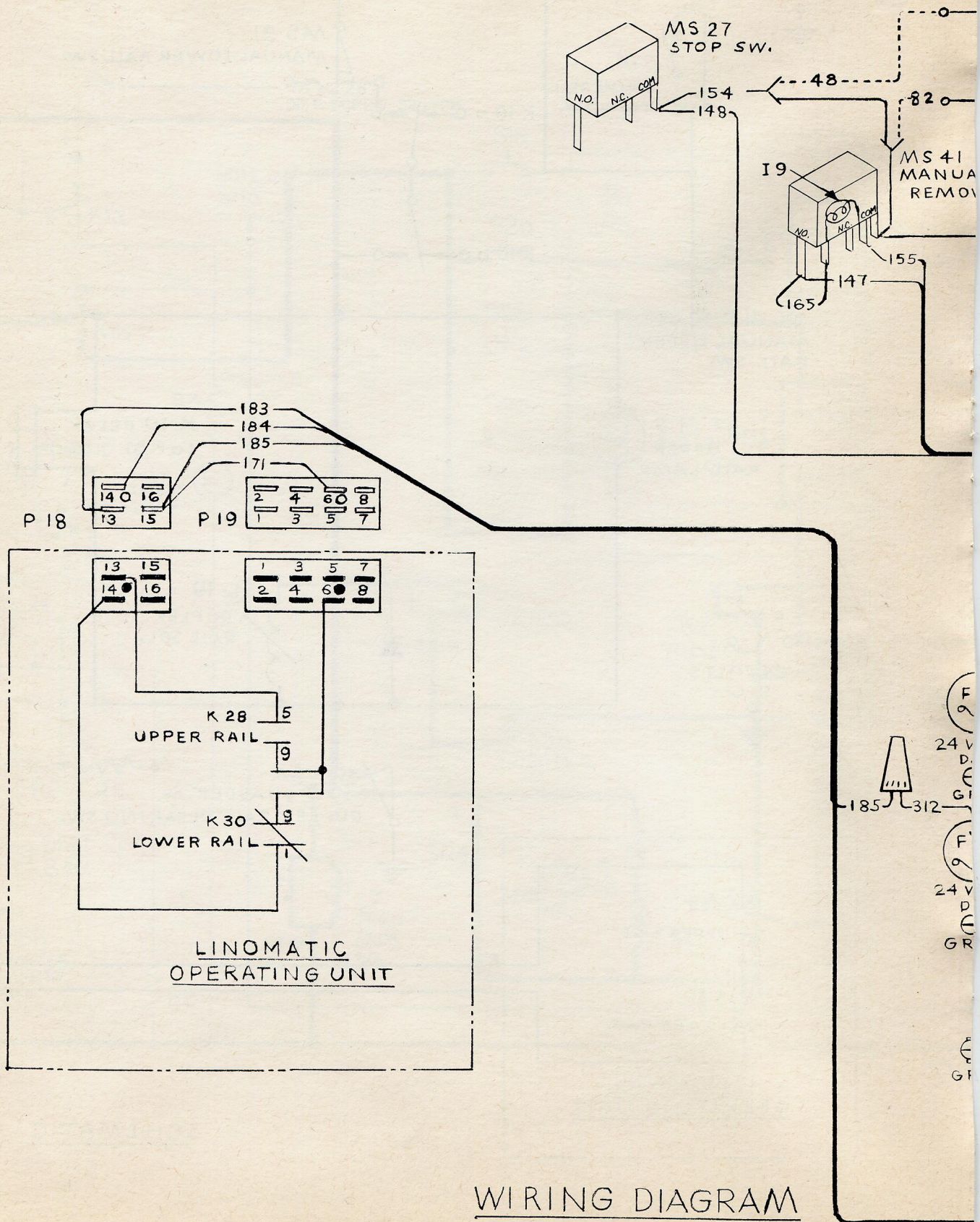

FIG. 9

DUPLEX RAIL



WIRING DIAGRAM

SOLENOID

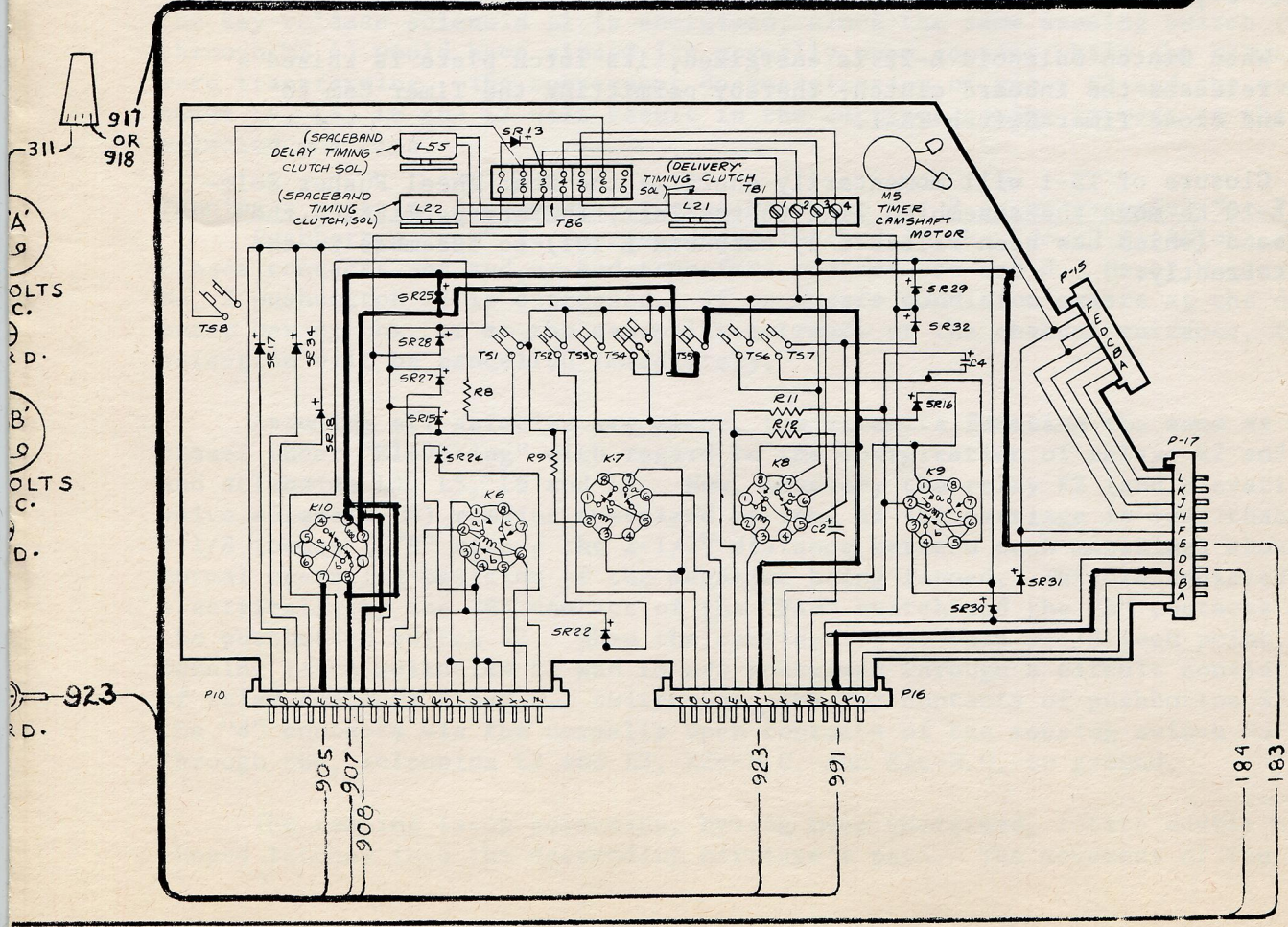
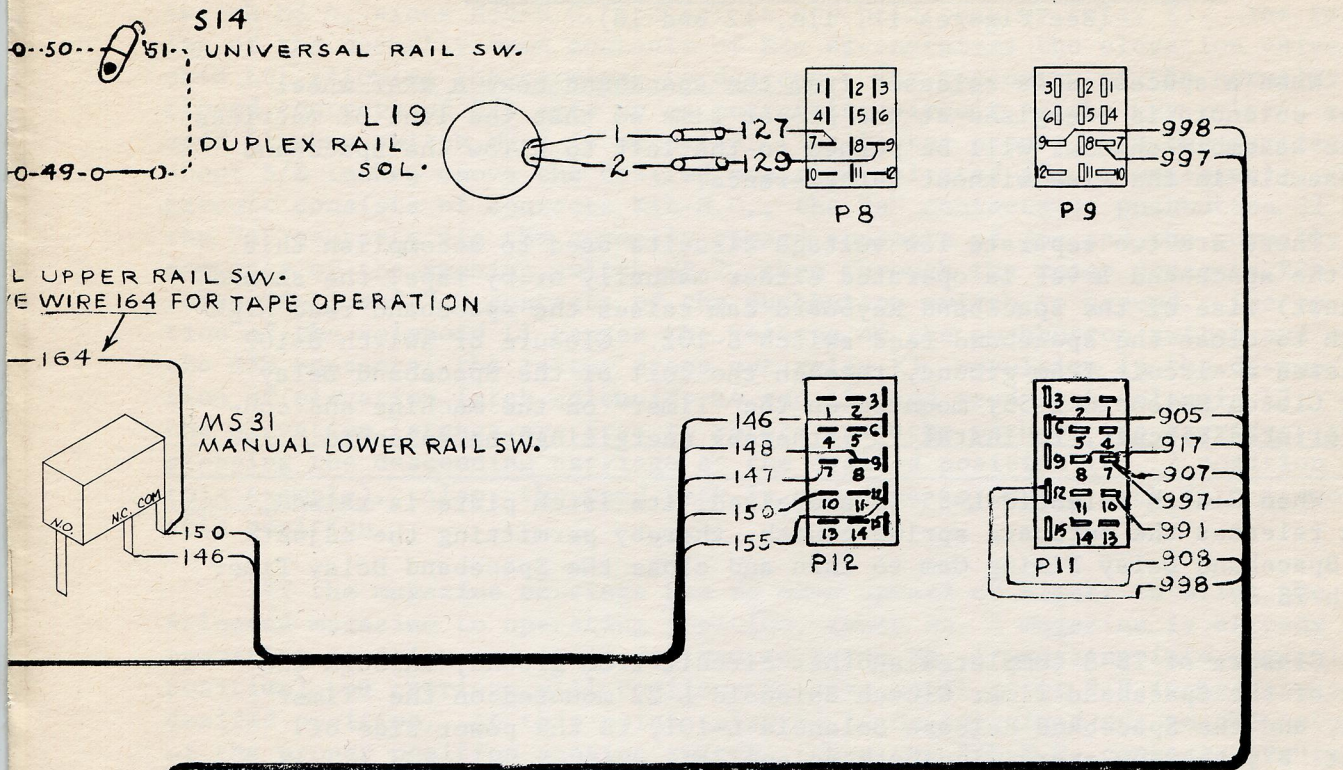

FIG. 10

7-67

SPACEBAND TIMING AND STAR WHEEL PUSHER SOLENOID

(See Figures 11, 11A, 12 and 16)

When a spaceband is released from the spaceband box, a star wheel pusher solenoid is energized at the proper time so that the line of matrices in the assembly channel will be pushed to the left to allow the spaceband to assemble in the line without interference.

There are two separate low voltage circuits used to accomplish this. When the spaceband lever is operated either manually or by tape, the second (highest) rise of the spaceband keyboard cam raises the spaceband reed high enough to close the spaceband reed switch S-102. Closure of switch S-102 completes a circuit from ground, through the coil of the Spaceband Delay Timer Clutch Solenoid L-55, mounted on the "Timer" on the machine and control printed circuit, to fustat "B", thereby energizing the solenoid.

When Clutch Solenoid L-55 is energized, its latch plate is raised, which releases the outboard spring clutch, thereby permitting the adjustable Spaceband Delay Timing Cam to turn and close the Spaceband Delay Timer Switch TS-8.

Closure of TS-8 completes another circuit from ground, through the coils of the Spaceband Timer Clutch Solenoid L-22 mounted on the "Timer" Board, and the Spaceband Release Solenoid L-101, to the power side of Fustat "B", thereby energizing both solenoids.

When Clutch Solenoid L-22 is energized, its latch plate is raised which releases the inboard clutch, thereby permitting the Timer Cam to turn and close Timer Switch TS-1.

Closure of TS-1 will momentarily energize the Star Wheel Pusher Solenoid L-10 to move the assembled line to the left, thereby permitting the spaceband (which has been released by Solenoid L-101) to assemble in the line correctly.

SPACEBAND TIMING

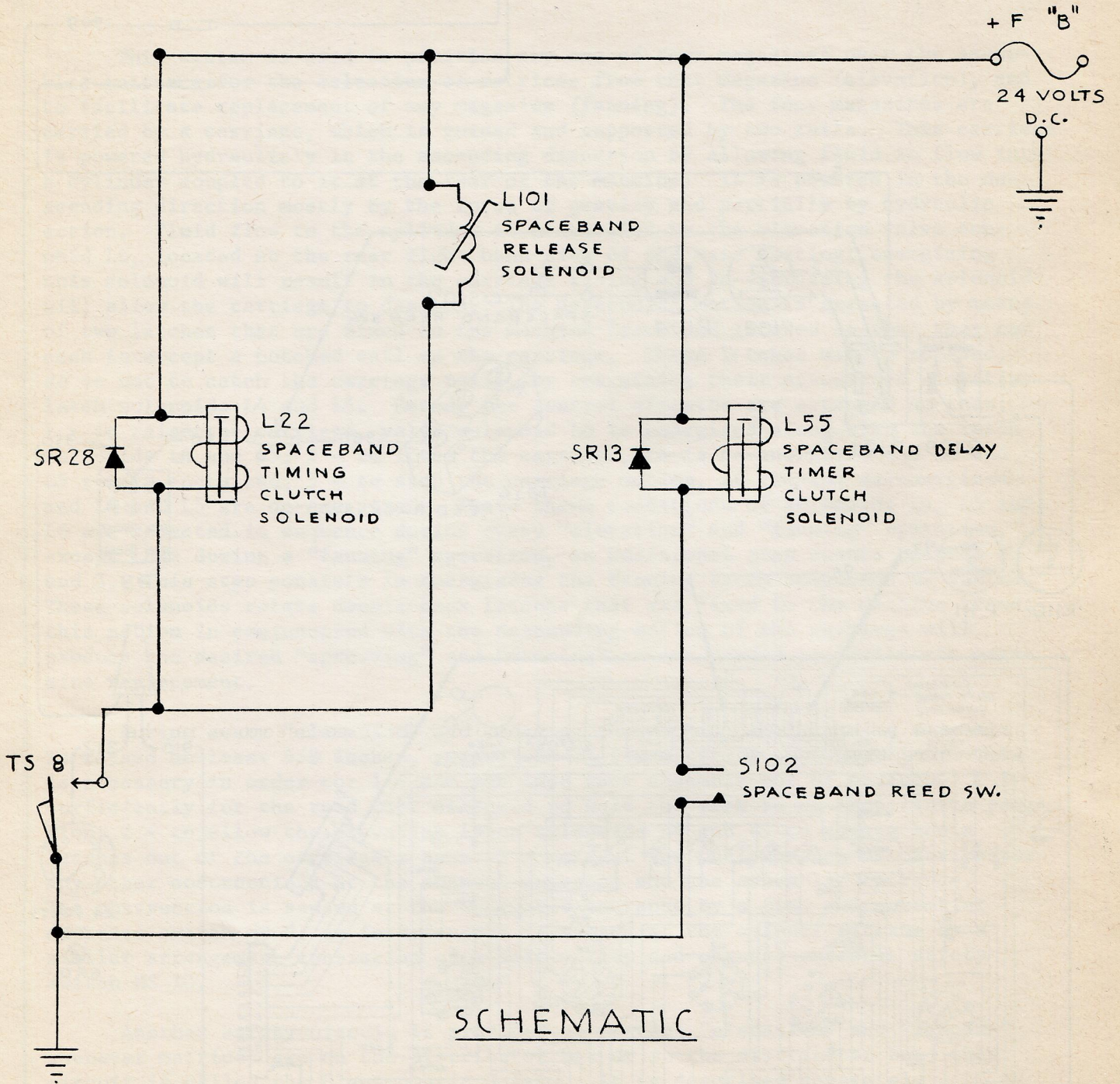
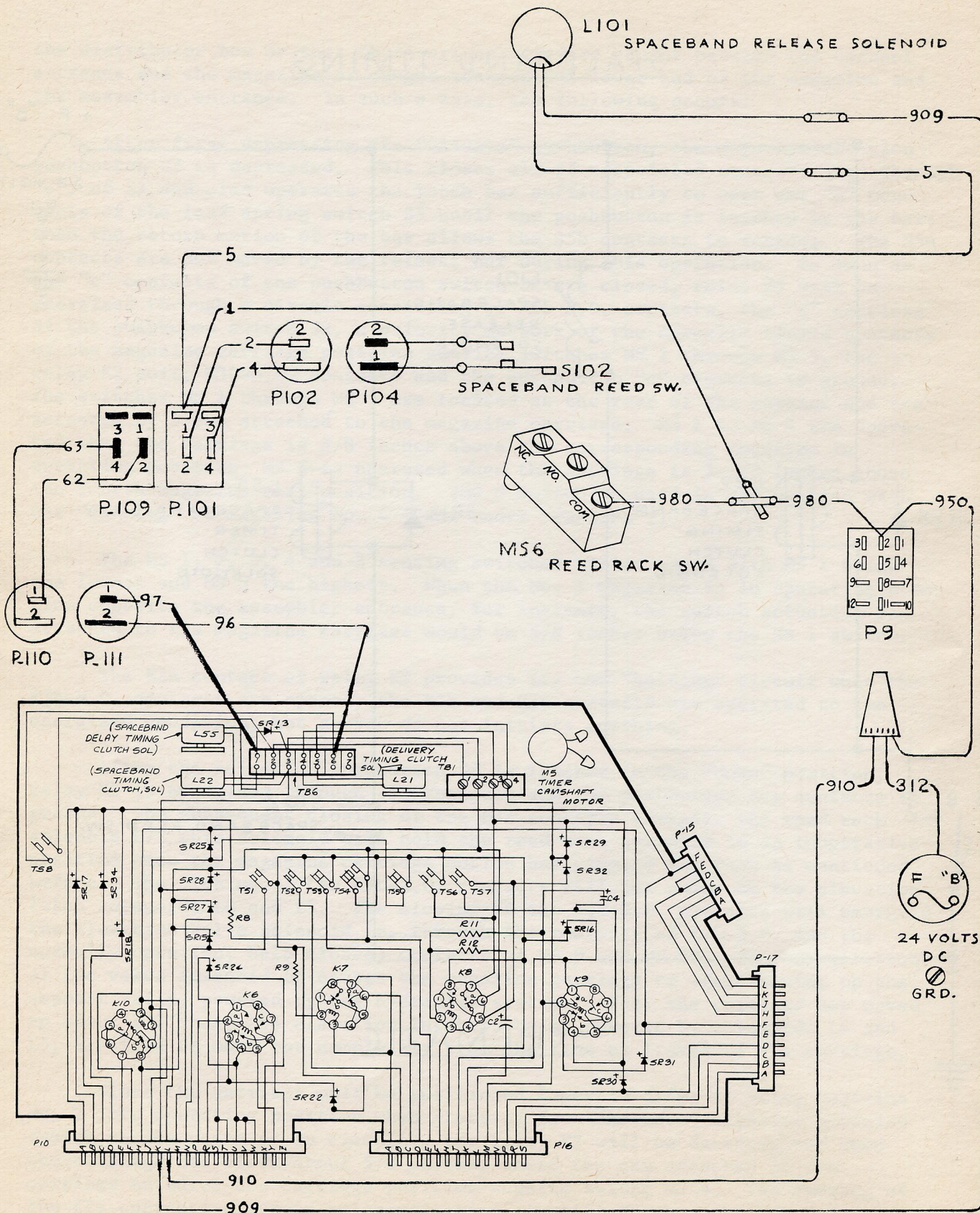

FIG. 11

7-67

SPACEBAND TIMING



WIRING DIAGRAM

FIG. 11A

STAR WHEEL PUSHER SOLENOID

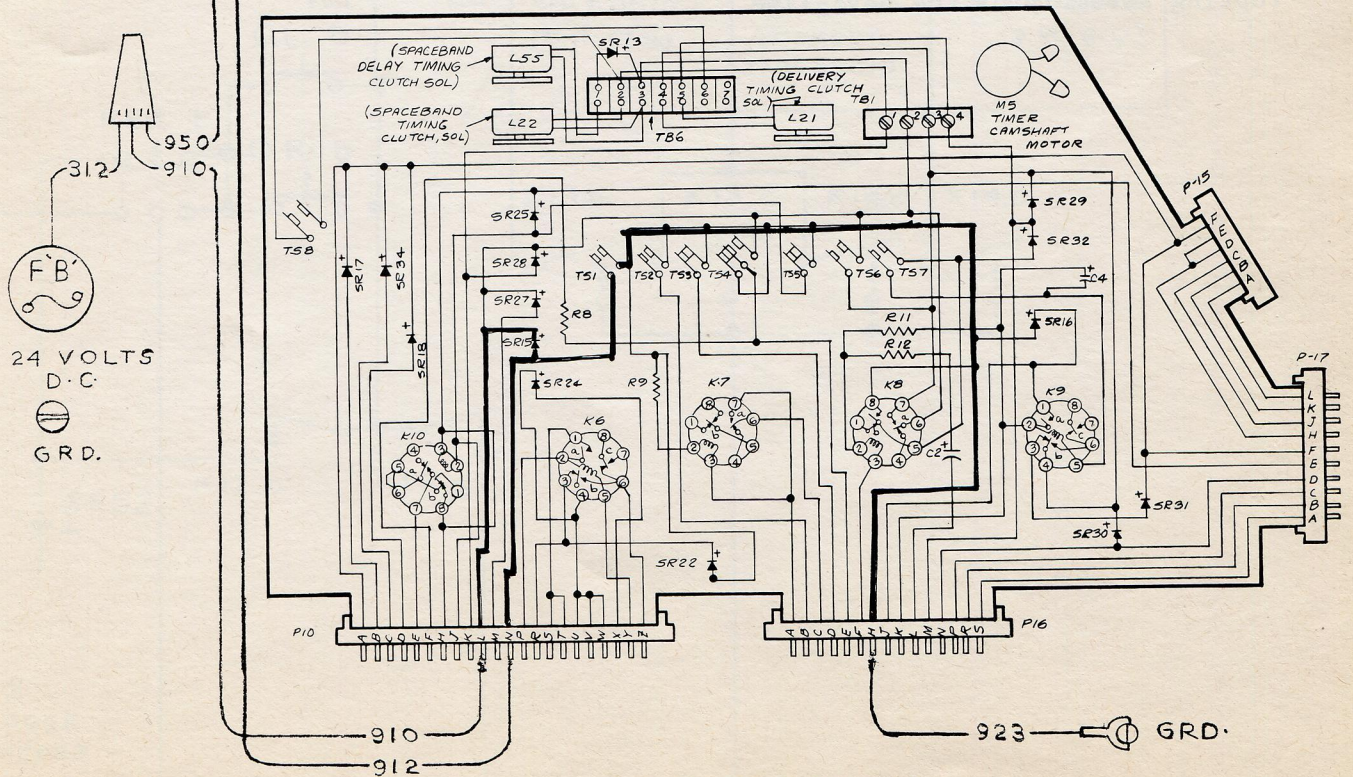
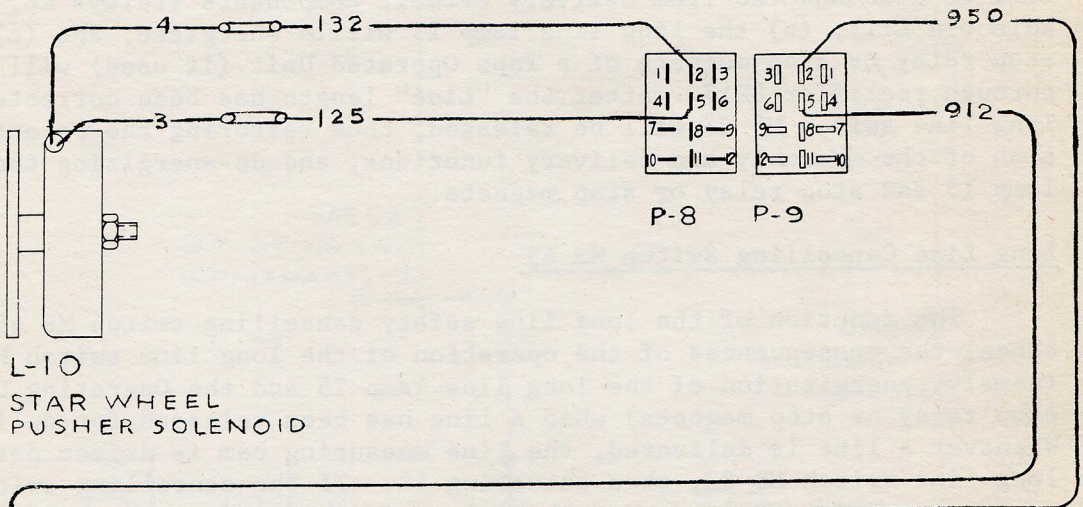
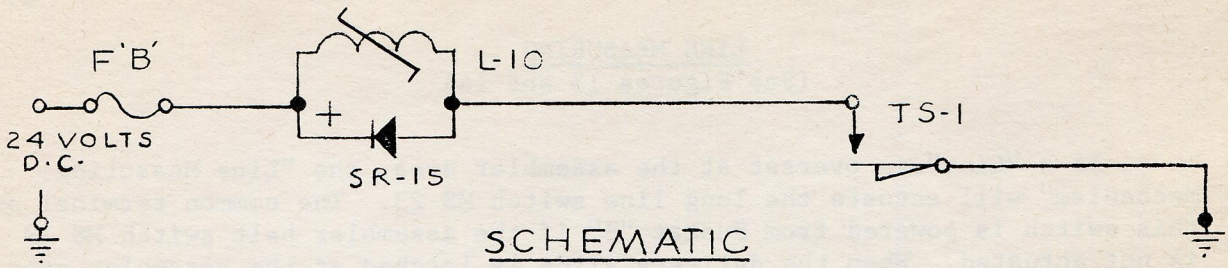

FIG. 12

LINE MEASURING
(See Figures 13 and 14)

If a "Line" is overset at the assembler area, the "Line Measuring Mechanism" will actuate the long line switch MS 23. The common terminal of this switch is powered from Fustat "B" if the assembler belt switch MS 19 is not actuated. When the delivery slide is latched at the assembler area, the long line safety cancelling switch MS 45 is held actuated by the slide. If, at this time, a "Long Line" is sensed, three things occur: (a) power will be disconnected from delivery circuit components (relays K8, K9 and solenoid L11); (b) the long line lamp I5 will be energized; and (c) the stop relay or stop magnets of a Tape Operated Unit (if used) will be powered through rectifier SR17. After the "Line" length has been corrected, the long line switch MS 23 will be released, thus restoring the potential operation of the assembly and delivery functions, and de-energizing the long line lamp I5 and stop relay or stop magnets.

Long Line Cancelling Switch MS 45

The function of the long line safety cancelling switch MS 45 is to cancel the consequences of the operation of the long line switch MS 23 (namely, energization of the long line lamp I5 and the Operating Unit's stop relay or stop magnets) when a line has been released for delivery. Whenever a line is delivered, the line measuring cam is driven past the long line switch MS 23, thus actuating it. If the cancelling switch MS 45 were not present to interrupt the pulse of current from the long line switch MS 23 at the time of delivery release, then the Operating Unit's stop relay or stop magnets would be turned on at this time, thereby interrupting assembly of the next line.

LINE MEASURING ALSO ASSEMBLER BELT & ASSEMBLER CHUTE FINGER SW.

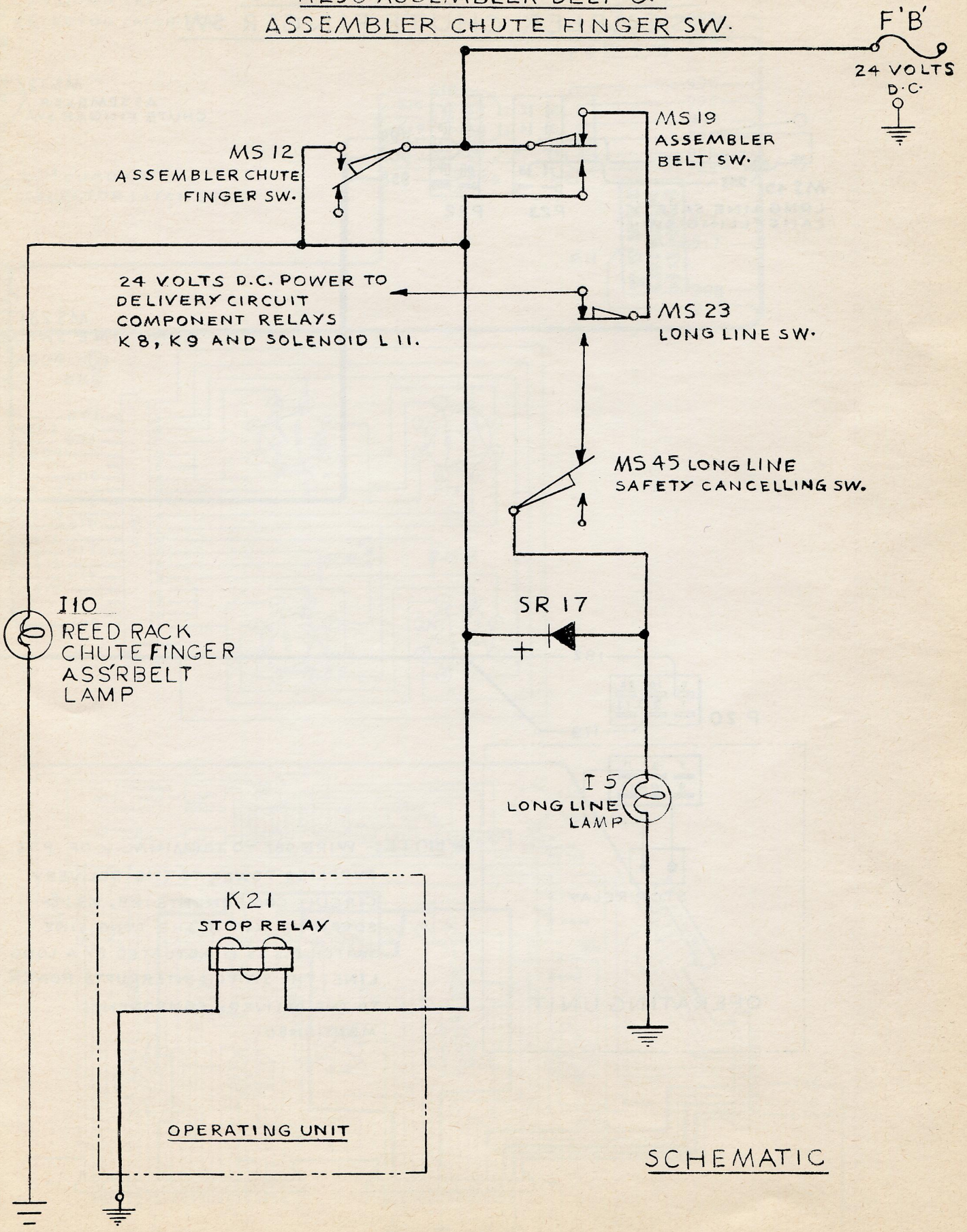

SCHEMATIC

FIG. 13

LINE MEASURING ALSO ASSEMBLER BELT & ASSEMBLER CHUTE FINGER SW.

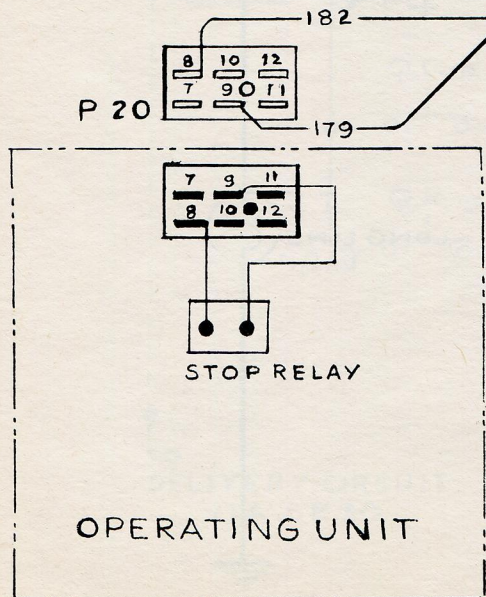
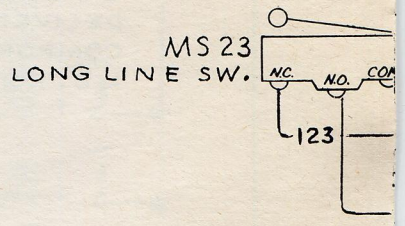
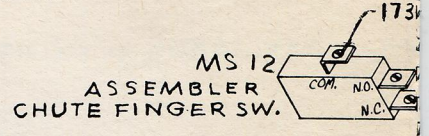
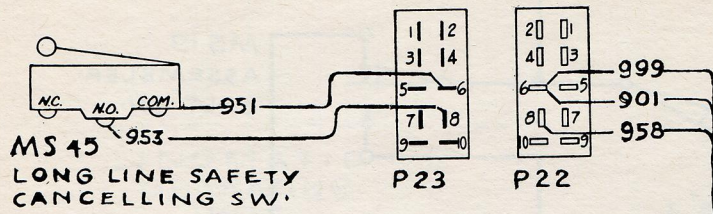

* NOTE:- WIRE 987 TO TERMINAL K OF P 16
SUPPLIES POWER TO THE DELIVERY
CIRCUIT COMPONENTS K8, K9 &
SOLENOID L11. IF THE LONG LINE
SWITCH MS 23 IS ACTUATED BY A LONG
LINE, THE SWITCH INTERRUPTS POWER
TO THE DELIVERY COMPONENTS
MENTIONED.

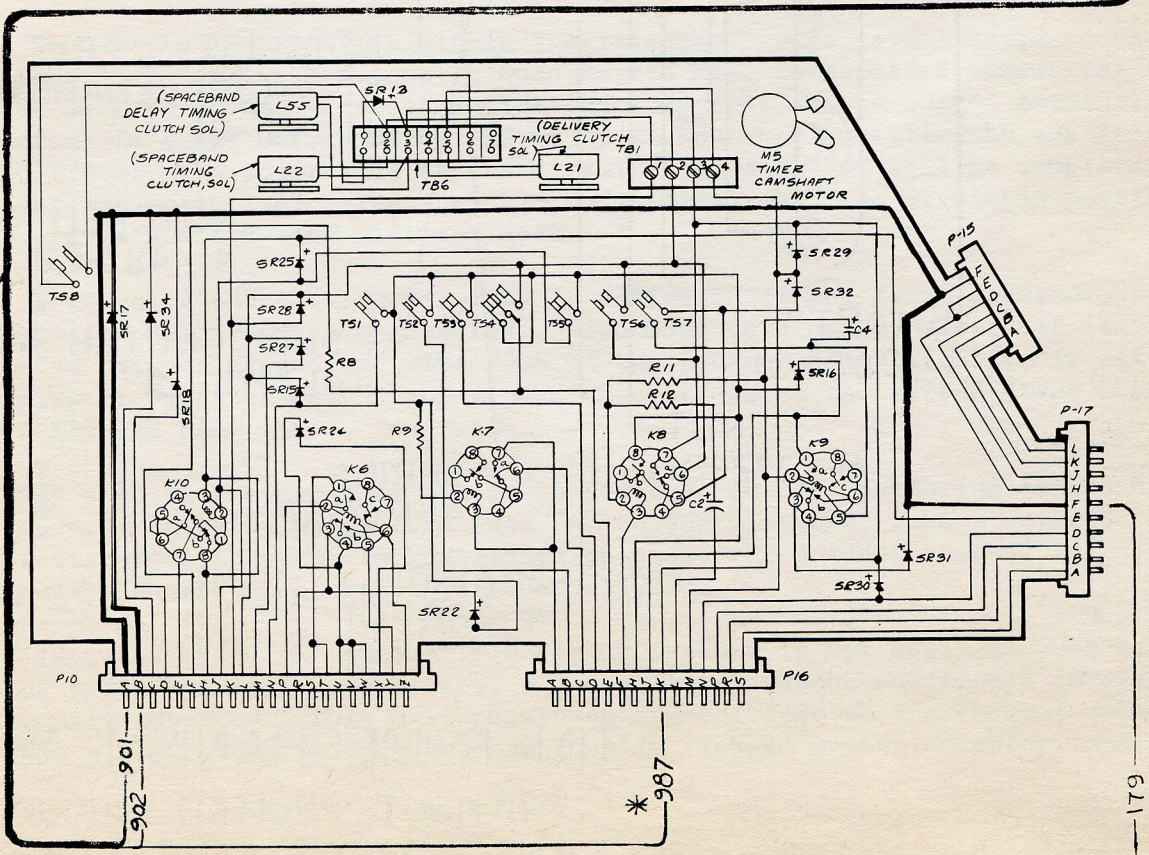
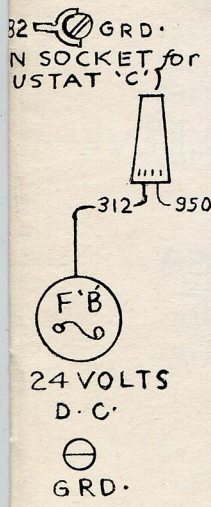
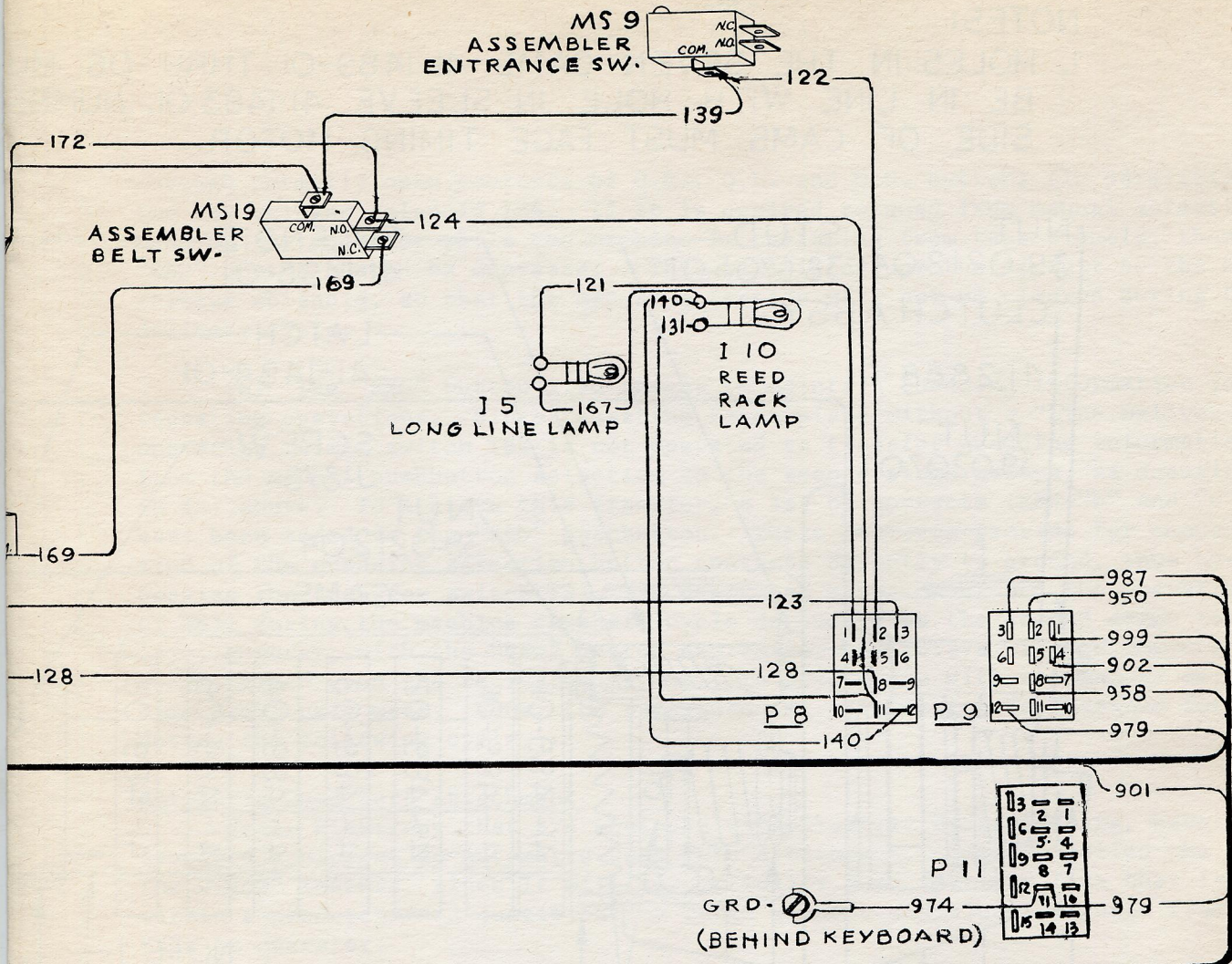

WIRING DIAGRAM

FIG. 14

NOTES:

I. HOLES IN THE SEVEN CAMS 41-1489-01 THRU -06 MU BE IN LINE WITH HOLE IN SLEEVE 41-1483-01. NUMBE SIDE OF CAMS MUST FACE TIMING MOTOR.

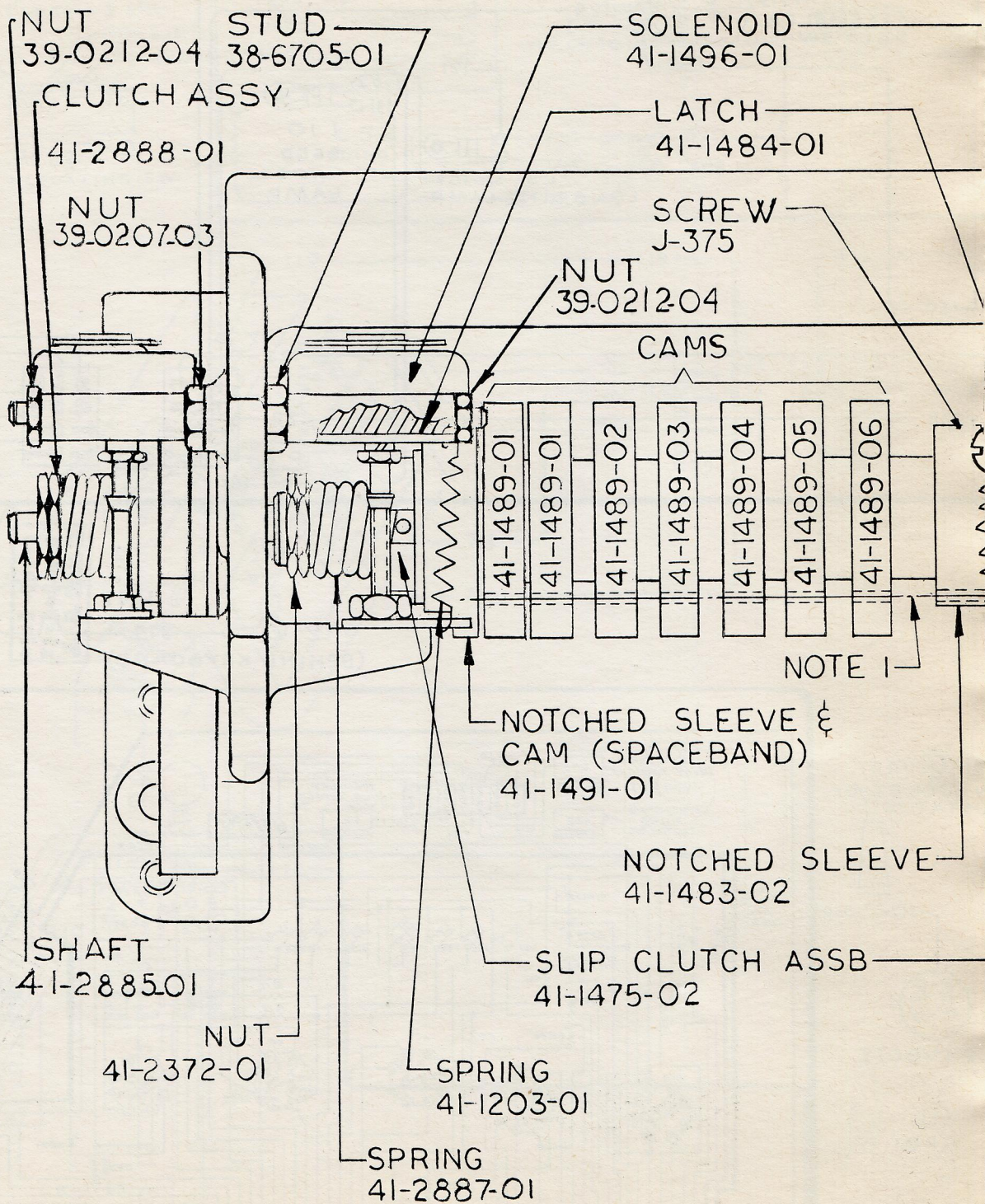

TIMER MECHANISM ASSEMBLE
(WITHOUT PRINTED CIRCUIT BOARD)
TIMER MECHANISM ASSEMBLE
(WITH PRINTED CIRCUIT BOARD)

FIG. 14A

ST
RED

- TIMER OIL
- 40-2527-01 1 OZ CAN
- 40-2527-03 3 OZ CAN
- TIMER REDUCTION
- GEAR GREASE
- 40-2515-01 1 OZ TUBE
- 40-2515-03 3 OZ TUBE

COTTER PIN
39-0354-07

MOUNTING BRACKET
41-2620-01

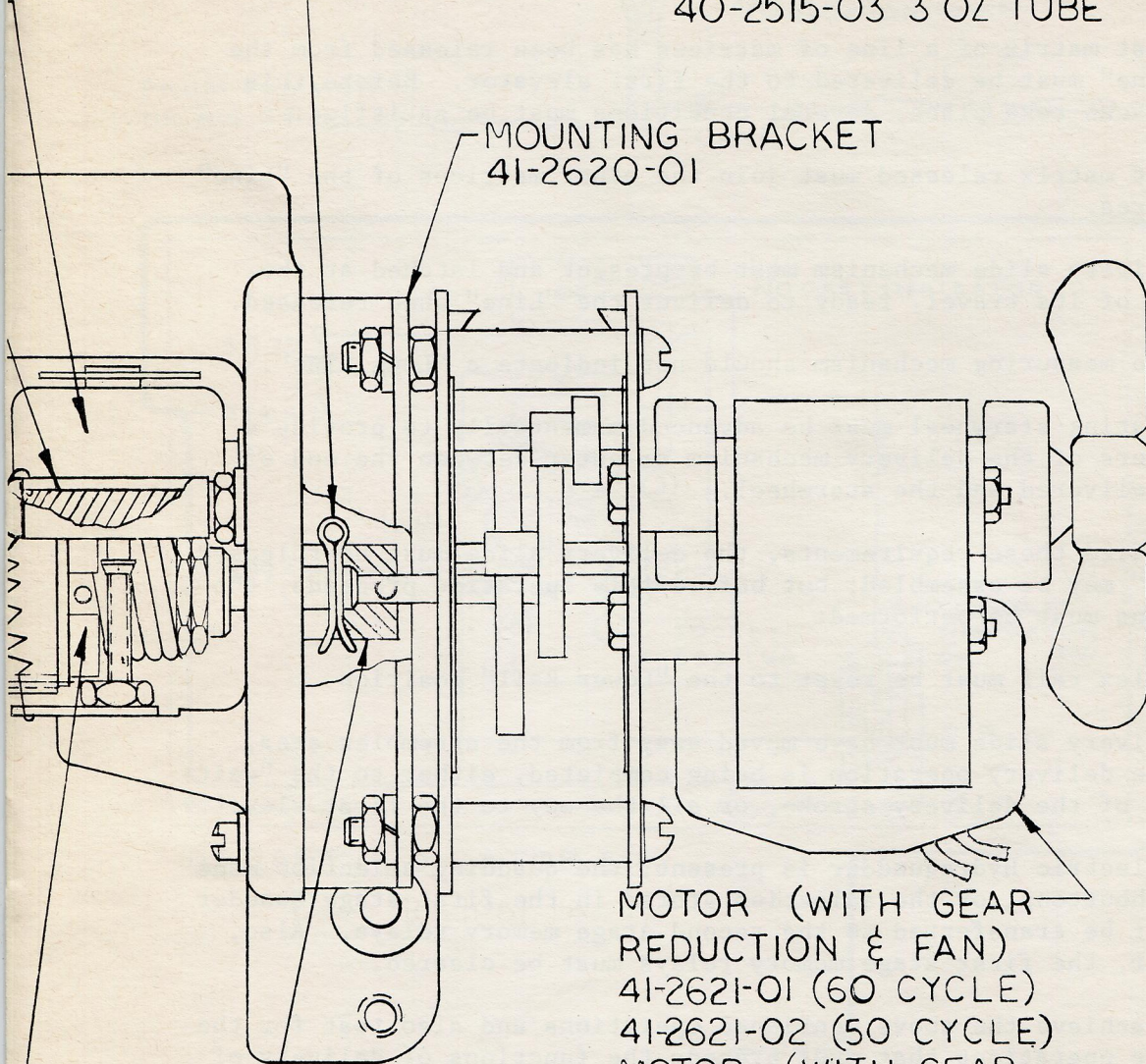

COUPLING
41-2619-02

HOUSING
41-1474-02

- MOTOR (WITH GEAR
REDUCTION & FAN)
- 41-2621-01 (60 CYCLE)
- 41-2621-02 (50 CYCLE)
- MOTOR (WITH GEAR
REDUCTION & FAN &
MOUNTING BRACKET)
- 41-2355-01 (60 CYCLE)
- 41-2355-02 (50 CYCLE)

- D 41-1472-03 (60 CYCLES)
 - 41-1472-04 (50 CYCLES)
 - D 41-1470-01 (60 CYCLES)
 - 41-1470-02 (50 CYCLES)
- } WITHOUT RELAYS

LINE DELIVERY
(See Figures 14A-20)

After the last matrix of a line of matrices has been released from the magazines, the "Line" must be delivered to the first elevator. Before this delivery operation can take place, several conditions must be satisfied:

- (a) The last matrix released must join the other matrices of the "Line" at the assembler area.
- (b) The delivery slide mechanism must be present and latched at the assembler area end of its travel, ready to deliver the "Line" when released.
- (c) The line measuring mechanism should not indicate a "Long Line".
- (d) The rotating starwheel must be advanced momentarily to provide a space for the fingers of the delivery mechanism to enter between the end of the "Line" being delivered and the starwheel.

Having satisfied these requirements, the delivery slide must be released. Now the next "Line" may be assembled; but before this operation proceeds, the following operations must be performed:

- (a) The duplex rail must be reset to the "Lower Rail" position.
- (b) The delivery slide must have moved away from the assembler area, indicating that the delivery operation is being completed, either to the "waiting line" position of the delivery stroke, or all the way to the first elevator.
- (c) If an Electric Hydraquadder is present, the quadding selection made via the manual pushbuttons, or the selection stored in the first stage quadder memory relays, must be transferred to the second stage memory relays. Also, after this transfer, the first stage memory relays must be cleared.

In order to achieve the above mentioned operations and also test for the completion of those operations that must precede the functions of delivery of a "Line" and assembly of the following "Line", use is made of a Timer Unit (see "Description of Timer Unit"). This unit consists of a continuously rotating synchronous timer camshaft motor M5, which is coupled to a set of seven cams via a spring clutch that is under the control of the delivery timing clutch solenoid L21. Energizing the latter moves a latch plate; this releases the spring clutch assembly so that the cams are coupled to and driven by the motor M5. De-energizing the solenoid L21 allows the latch plate to engage the spring clutch assembly at one of three fixed points during the delivery timing cycle; at these points the motor drive is decoupled from the cams, which stop turning. Each cam actuates one leaf spring switch designated TS-1 to TS-7, for a portion of the delivery timing cycle, depending upon the function of the particular timing switch.

Energizing L21 Delivery Timing Clutch Solenoid (See Figures 17 and 18)

The delivery cycle can be initiated by energizing the L21 solenoid either

manually or from tape signals. When operating with a Tape Unit, delivery is initiated by the delivery switch in the Unit. When operating manually, an impulse relay circuit K8 provides a timed impulse K8a similar to that obtained from the Tape Unit's delivery switch. This works as follows: normally a capacitor C2 is charged with energy from Fustat "B" through the switch MS 19, switch MS 23, resistors R11 and R12, C2 and switches MS 22 and MS 21 to ground (switch MS 21 is used on Elektrons for manual operation, or equipped with a Linomatic Operating Unit). When MS 21 is not present, MS 22 normally-closed terminal is connected to ground. Operation of MS 21 or MS 22 causes capacitor C2 to discharge into the impulse relay coil K8 through R12. This energizes relay K8 and contact K8a closes and power will pass from Fustat "B" through contacts K8a, L21 solenoid coil, switch MS 18, then either from MS 18 normally closed contact to switch TS3 to ground to complete the circuit and energize L21 solenoid, or from MS 18 normally open contact to check switch TS4 to ground. When the charge of C2 has been dissipated, K8 will become de-energized, although the manual delivery switch MS 21 or MS 22 may still be depressed by the Operator.

When operating from tape, the delivery switch does three things: (a) it energizes the delivery timing clutch solenoid L21; (b) it actuates the Tape Unit's stop magnets or stop relay through SR 30, K9b contacts and SR 31; (c) it energizes the Hydraquadder pushbutton key release solenoid L54 if a manual quadding selection has been made without depressing the "REG" button. The circuit to solenoid L21 is as follows: Fustat "B", rectifier SR 30, solenoid L21, delivery slide switch MS 18, then either from MS 18 - normally closed contact to delivery slide check switch TS3 to ground, or from MS 18 - normally open contact to delivery completion check switch TS4 to ground, since both TS3 and TS4 are held actuated at this time by their respective cams on the Timer Unit. The circuit is completed to ground regardless of the position of the delivery slide, which actuates the delivery slide switch MS 18 when the slide is latched at the assembler area.

Operation of Delivery Timer Cams and Switches (See Timing Chart, Fig. 15)

Having energized the delivery timing clutch solenoid, the timer cams will start turning; cam switch TS6 (end-of-cycle) is operated after about 10° of rotation - this switch provides an alternate path from Fustat "B" to the clutch solenoid L21 and the Tape Unit's stop relay or magnets. After another 20° of rotation, the delivery slide check switch TS3 is released. If the delivery slide switch MS 18 is not held operated at this time (indicating that the slide is not latched at the assembler area), the clutch solenoid L21 will be de-energized, and the drive to the cams will be disengaged when the latch plate intercepts one of three fixed notches of the spring clutch assembly (approximately 90° from the normal stop position). When MS 18 is closed, the clutch L21 will be energized again through TS4 to ground; the latch plate will release the spring clutch, thus re-engaging the drive to the cams. During the next 30° of rotation, three things occur: (a) TS3 is operated, once again providing a path to ground from MS 18 - normally closed contact; (b) TS2 (Quadder transfer switch) is closed, providing for the transfer operation to take place in the Electric Hydraquadder (see under "Electric Hydraquadder"); (c) TS1 (starwheel pusher solenoid switch) is closed, energizing the pusher solenoid L10 that advances the starwheel in the assembler area to make room for the delivery slide fingers. (The TS1 switch is also operated by a cam controlled by the timer clutch solenoid L22 during the assembly of the line, whenever

a spaceband is released.

After another 30° of rotation, TS 5 (duplex rail and quadder clearing switch) is released (see under "Duplex Rail" and also "Electric Hydraquadder"). This switch accomplishes the automatic reset of the "Lower Rail" position mentioned above under "Duplex Rail Solenoid". It also provides for the first stage memory relay clearing function in the Electric Hydraquadder.

Delivery of Line (See Figures 19 and 20)

The cams continue to rotate for another 20°, when TS7 (delivery release relay switch) is operated by its cam. If the assembler belt switch MS 19 and long line switch MS 23 have not been operated, the closing of TS7 will energize relay K9 through a circuit consisting of MS 19, MS 23, K9 coil, TS7, SR 32, MS 18 - normally open contact, and TS4 to ground. Relay K9 controls two sets of contacts; (a) the closing of the K9a contacts energizes the delivery release solenoid L11, and (b) the opening of the K9b contacts will de-energize the Tape Operated Unit's stop relay or stop magnets, allowing the Operating Unit to proceed with reading the tap for the assembling of the following "Line". Operation of the delivery release solenoid L11 unlatches the delivery slide fingers, which in turn, unlatch the delivery slide lever. Thus, the "Line" is delivered to the first elevator. While these operations are taking place, the timer cams rotate another 70°. During this portion of the cycle, TS1 is released, thereby de-energizing the starwheel pusher solenoid; TS2 (quadder transfer switch) is released; and TS5 (duplex rail and quadder clearing switch) is reclosed.

To check to see if the "Line Delivery" operation has been completed, TS4 (delivery completion check switch) is next released by its Timer Unit cam. If, at this time, the "Line" is being delivered, MS 18 will be released to its normal position, thus providing an electrical return path for clutch solenoid L21 and K9 to the ground side of the power supply via TS3 (delivery slide check switch). If, however, delivery does not take place (because L11, delivery release solenoid, was not energized, or because of some mechanical interference), then MS 18 will remain operated and when TS4 is released, L21 and K9 will be de-energized.

The releasing of L21 will allow the latch plate to intercept the second stop on the spring clutch sleeve, thus disengaging the drive from the cam assembly. This point is approximately 90° before the end of the cycle normal stop position. The releasing of relay K9 will re-energize the Operating Unit's stop relay or stop magnets via TS6, K9b contacts and SR 31, thus discontinuing the assembling of the following line. The releasing of TS4 will connect power to the delivery stop lamp I7 through resistor R8. Since the cams are stopped, I7 will have sufficient time to heat up and glow.

There are two ways to complete the delivery cycle once the Timer Unit has been latched at the second stop position:

(a) If the delivery slide fingers have been released and some mechanical interference has prevented delivery, then correcting the trouble and allowing the slide to deliver the "Line" will release MS 18 (delivery slide switch). This action will automatically energize both clutch solenoid L21 and (if MS 19 and MS 23 are not operated) also the relay K9. Thus, the spring clutch will

again couple the drive to the cams and the Operating Unit will restart. The subsequent operation of TS4 will turn off the stop lamp I7. Finally, TS6 and TS7 will be released, thereby de-energizing the clutch solenoid L21 and relay K9, respectively. This allows the latch plate to intercept the third (normal) stop on the spring clutch sleeve, thus latching the delivery timer cam assembly in the "Normal" position, from whence it may start a new cycle.

(b) If the delivery slide fingers had not been released (because either the long line switch MS 23, or the assembler belt switch MS 19, was operated), then the delivery cycle can be completed by first resetting the safety switch (MS 23 or MS 19) and pressing the manual delivery switch (MS 21 or MS 22) on the keyboard assembly. This operation will energize relay K8 via the discharge of capacitor C2, through the K8 coil. The closing of K8a contacts at this time, is inconsequential since TS6 is operated continuously at this time. The closing of K8b contacts energize relay K9 through TS7 which is held operated when the cams are latched in the second stop position. As described above, the K9a contacts of relay K9 energize the delivery release solenoid L11. This, in turn, releases the fingers, which unlatch the slide, allowing the "Line" to be delivered. Thus, MS 18 (delivery slide switch) is released and the cycle is completed as described under (a).

TIMING CHART FOR OPERATION

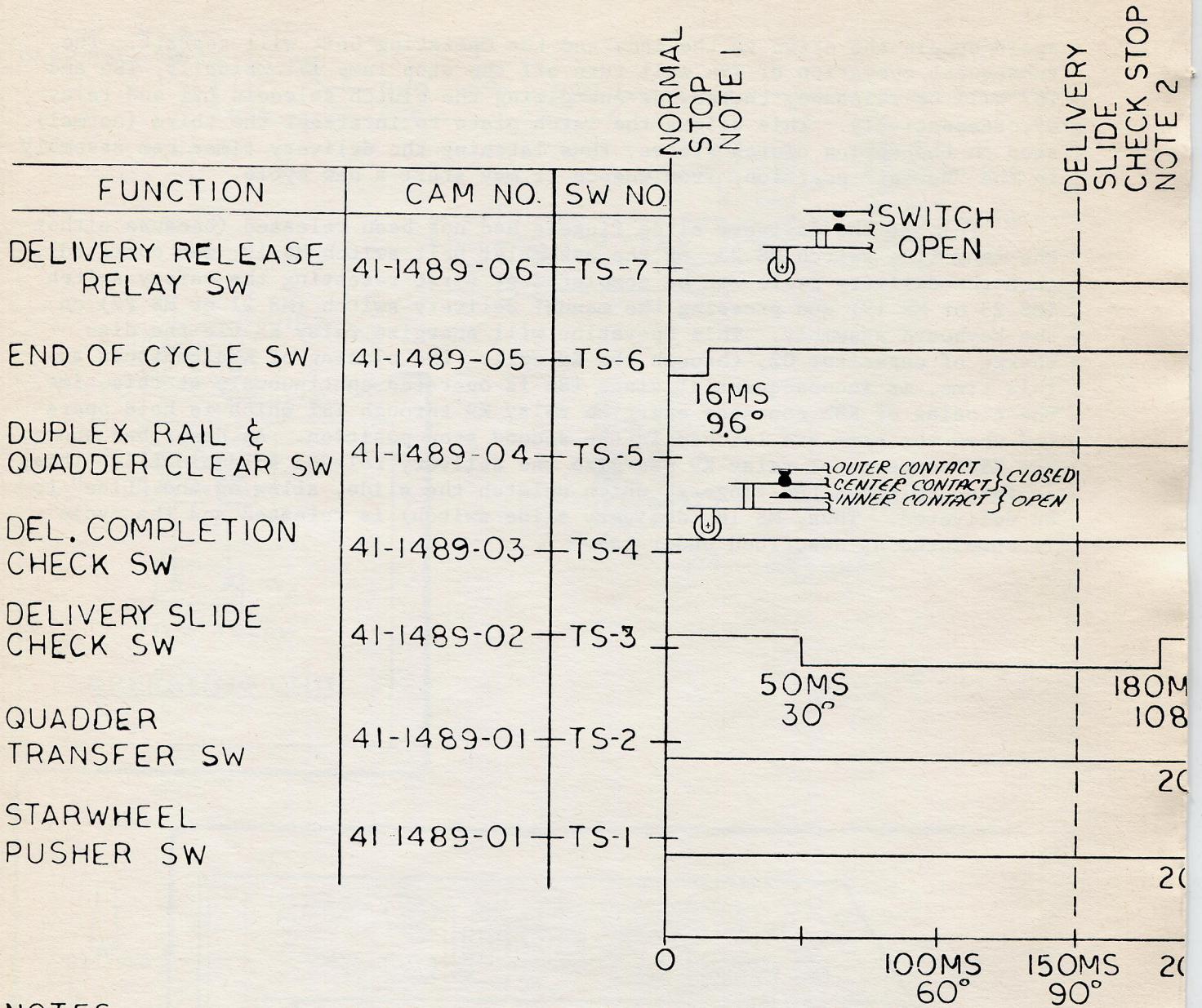

NOTES:

1. "NORMAL STOP" CORRESPONDS TO POINT OF CYCLE WHERE SWITCH ABOUT TO START UP CAM RISE.
2. WHEN CAMS ARE AT POSITION CORRESPONDING TO "DELIVERY SLIDE CHECK SW" OPEN.
3. WHEN CAMS ARE AT POSITION CORRESPONDING TO "DELIVERY SLIDE CHECK SW" MUST BE OFF CAM MAJOR DIAMETER SO THAT THE CENTER CONTACT IS IN CONTACT TO THE ROLLER, & OPEN WITH RESPECT TO THE OUTER CONTACT. THE OUTER CONTACT MUST BE CLOSED.
4. THE DOTTED REGIONS ON THIS TS-4 TIMING CHART INDICATE PERIODS DURING SWITCH OPERATION WHEN NEITHER SET OF CONTACTS IS CLOSED.

FIG. 15

OF SWITCHES TSI TO TS7

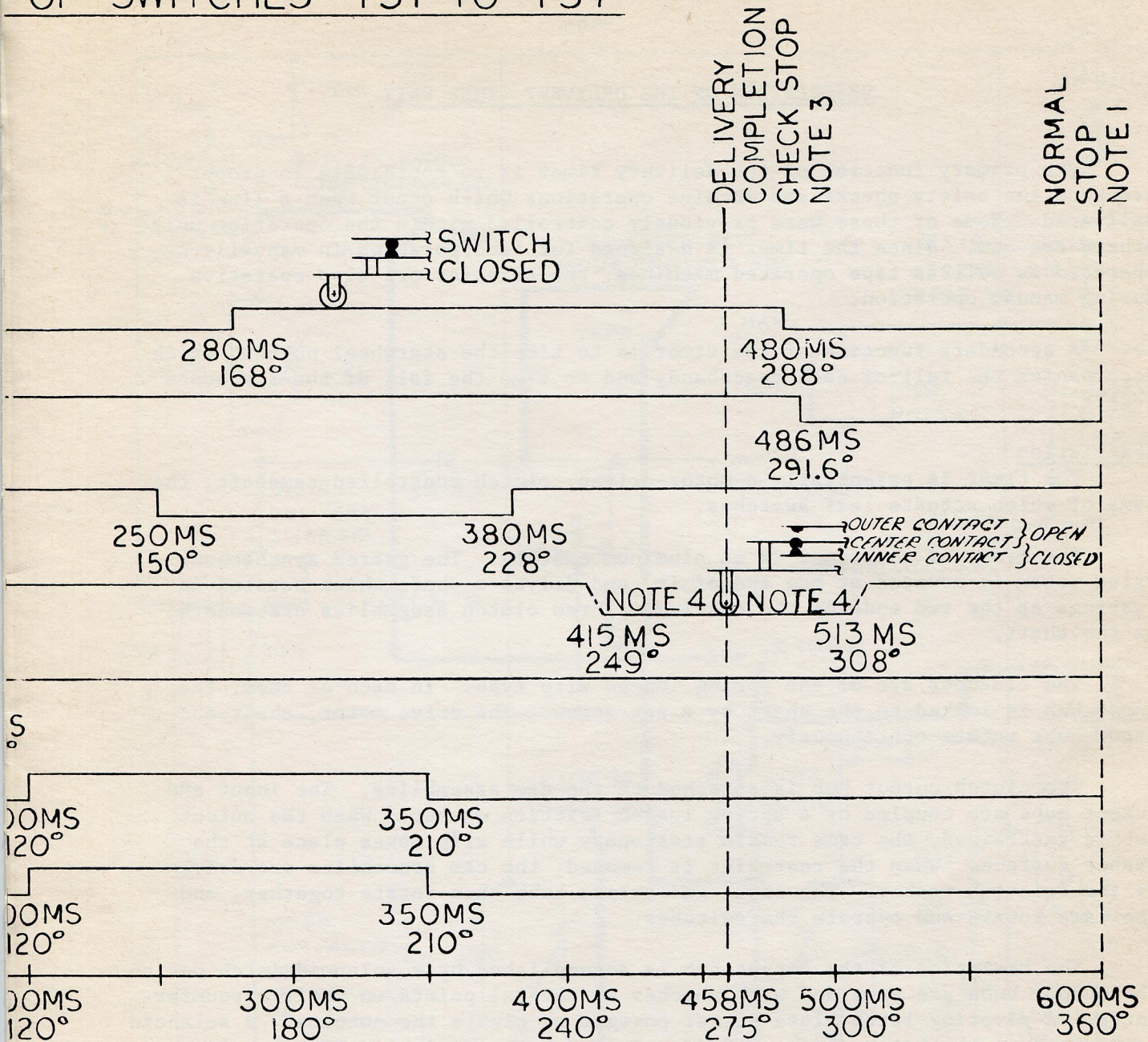

TS-6 IS OPEN, BUT ROLLER OF TS-6 IS

"SLIDE CHECK STOP" SWITCH TS-3 MUST BE

"COMPLETION CHECK STOP", THE ROLLER OF TS-4 CONTACT IS CLOSED ON THE CONTACT CLOSEST TO CONTACT, ALSO SWITCHES TS-6 & TS-7

THAT THERE SHOULD BE A DEFINITE PERIOD OF TS-4 IS CLOSED.

DESCRIPTION OF THE DELIVERY TIMER UNIT

The primary function of the delivery timer is to coordinate in proper sequence the safety checks and machine operations which occur when a line is delivered. Some of these were previously controlled within the operating unit; others are new. Since the timer is designed for incorporation in manually operated as well as tape operated machines, the safeties are also operative during manual operation.

A secondary function of the timer is to time the starwheel pusher, which accompanies the fall of each spaceband, and to time the fall of the spaceband itself.

Description

The timer is essentially a motor-driven, clutch controlled camshaft, the cams of which actuate leaf switches.

The frame of the timer is an aluminum casting. The geared synchronous drive motor is mounted at one end of it, and drives a shaft which rotates in bearings at the two ends of the casting. Three clutch assemblies are mounted on the shaft.

The clutches are of the spring loaded slip type. In each of them, the input hub is locked to the shaft by a set screw. The drive motor, shaft and input hubs rotate continuously.

The clutch output hub is attached to the cam assemblies. The input and output hubs are coupled by a spring loaded friction washer. When the output hub is restrained, the cams remain stationary while slip takes place at the washer surface. When the restraint is removed, the cam assemblies are driven by the friction washer. The input and output hubs then rotate together, and the cams rotate and operate the switches.

The restraint of the output hub is accomplished by a solenoid latch device. The output hubs are provided with notches at several points on their circumferences. A pivoting latch plate either engages or clears the notches. A solenoid is mounted on the latch plate, and its plunger butts against a fixed anvil. When the solenoid is energized, the plunger remains almost stationary, but the solenoid frame and therefore the latch plate move so as to clear the output hub notches. When the solenoid is de-energized, gravity and an extension spring make the latch fall so as to ride the output hub and engage the first notch to arrive. This arrangement has been aptly dubbed "the piggy-back solenoid latch".

The combined operation of the solenoid latch and slip clutch may be summarized as follows: energizing the solenoid permits cam rotation, de-energizing the solenoid stops cam rotation.

The output hub of the right hand clutch drives a cluster of seven cams, associated with delivery functions. The output hub of the center clutch carries a single cam, which operates the starwheel pusher solenoid switch TS1, as does the left hand clutch which operates the Spaceband Delay Switch TS 8.

The center clutch hub has three equally spaced notches, and the single cam has three equally spaced lobes. The clutch solenoid L22 is momentarily energized whenever the spaceband release solenoid L101 is energized to release a spaceband from the spaceband box. Thus the cam switch TS1 is operated and energizes the starwheel pusher solenoid. Since the initiating impulse is momentary, the clutch solenoid drops out shortly after the cam begins to rotate and the clutch hub is arrested at the next notch. Thus, one cycle of the spaceband push operation is associated with 120° of rotation of the clutch hub and cam.

Delivery of the Line

A description of the operation of the L21 delivery timing clutch solenoid, which permits the camshaft of the Timer Unit to revolve, and a description of the delivery cam and operation of the seven timer switches TS1 to TS7, have been given under "Delivery of the Line".

Spaceband Timing

A description of the operation of the L22 Starwheel Pusher Timing Clutch solenoid and the L55 Spaceband Delay Timing Clutch solenoid have been given under "Spaceband Timing and Starwheel Pusher Solenoid".

Timer Switches TS1 to TS8

The leaf switch contacts should be kept clean and in proper adjustment as outlined in Service Instruction No. 22, and the timing should be as shown on the Timing Chart (Figure 15). Listed on the following pages is the results of timer switch malfunctions.

Quick Check Procedure

To check for proper operation of the Delivery Timer, place Timer in normal position. To find normal, count contact switches left to right, and find TS 6. This switch should be open (off cam).

With power on but ready button not lit:

1. Depress Delivery Switch (MS 21 or MS 22). Line should deliver to first elevator jaws. (Timer cams should make one complete revolution).
2. With Delivery Slide in first elevator position, depress Delivery Switch again. Timer should now rotate to first stop position.
3. Manually depress Delivery Slide Switch MS 18 and hold. Timer should now rotate to second stop position. In this position, the Delivery Stop Lamp will light.
4. Release MS 18. Timer should rotate to normal position.
5. Repeat several times.

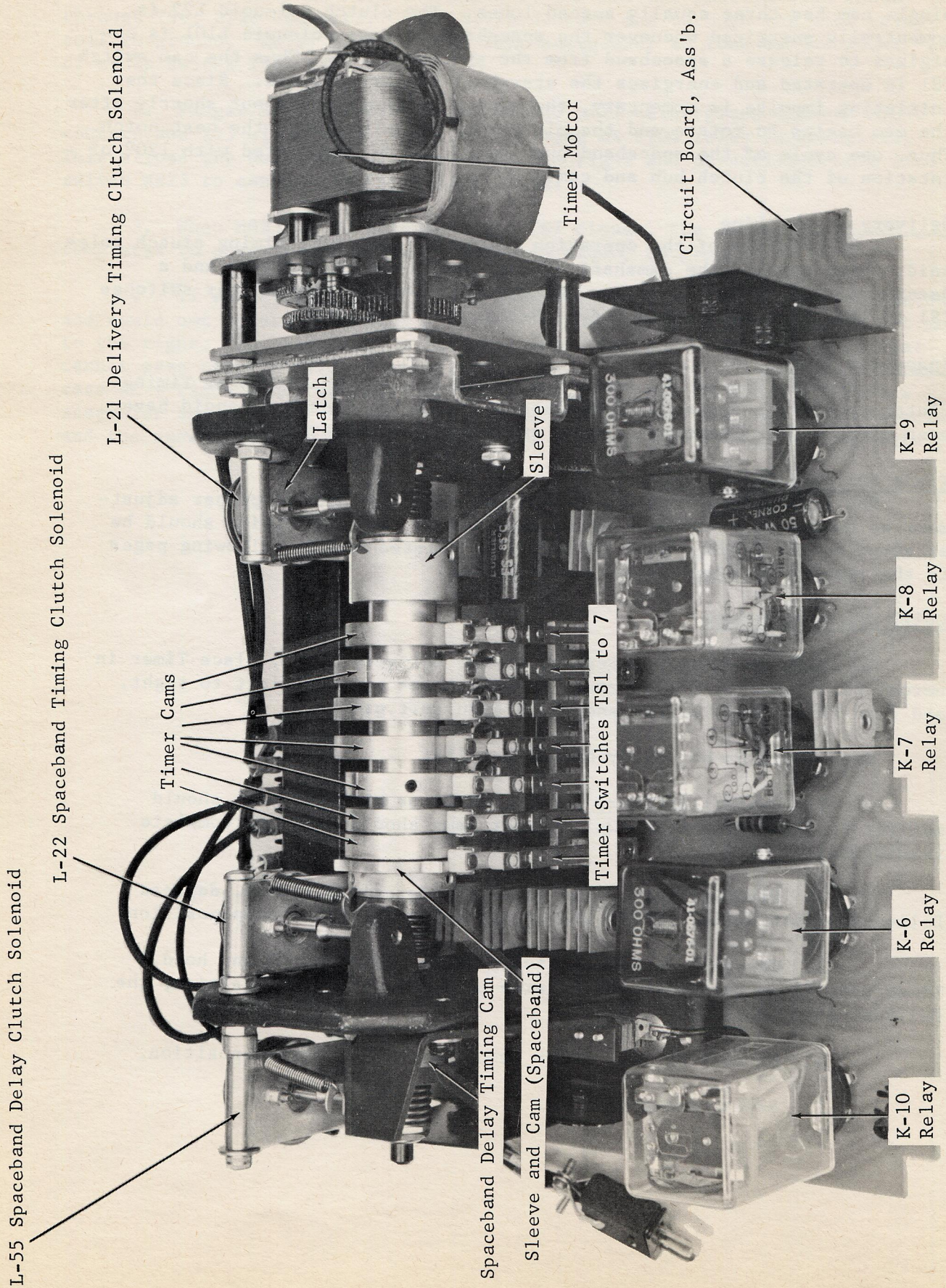

TIMER ASSEMBLY MOUNTED ON MACHINE AND CONTROL CIRCUIT BOARD

Fig. 16

DELIVERY TIMER SWITCH MALFUNCTIONS

Switch - TS 1

1. If switch does not make contact -
 - a. Starwheel Pusher is inoperative.
2. If switch does not open -
 - a. Starwheel Pusher remains in operated position.

Switch - TS 2

1. If switch does not make contact -
 - a. Quad signals will not be transferred from First Stage Relays (K-11, K-12) to Second Stage Relays (K-13, K-14).
2. If switch does not open -
 - a. Manual operation of Quadder. The signal stays in for one additional machine cycle after the regular push button is actuated.
 - b. Tape Operation. Signal goes directly into second stage relays.

Switch - TS 3

1. If switch does not make contact -
 - a. Causes Timer Solenoid Latch to stop cams at second stop and lights Delivery Stop Light but does not interfere with Delivery Release function.
 - b. Prevents Quad Relays from operating.
 - c. Duplex Rail will not release and Delivery Lamp is lighted.
 - d. Operating Unit will not start and Delivery Lamp is lighted.
2. If switch remains closed -
 - a. Will not cause delivery to release if Delivery Signal is put in before Delivery Slide returns to normal.
 - b. Operating Unit does not stop.

Switch - TS 4

1. If switch does not make contact -

Outer Contact -

- a. Timer Cams will not rotate and will stay at the normal position.
- b. Does not deliver - Delivery Timer Solenoid does not energize.
- c. Delivery Stop Lamp lights only while Delivery Release Lever or Button is held actuated.

Inner Contact - If inner contact does not close -

- a. Timer Cams will make complete cycle even if Delivery Fingers do not come down or Delivery Slide fails to move from normal position.
- b. When Delivery Release Button or Lever is actuated on overset line, Timer Cams will not release Delivery Slide automatically when Delivery Slide is released to legitimate length line. Also Delivery Stop Light will not light.

NOTE: If both inner and outer contacts are closed at same time, fuse blows.

Switch - TS 5

1. If switch does not make contact -

- a. First Stage Quad Relays will not energize and quadder will not function from tape.
- b. Duplex Rail Relay (K10) will not be energized.

2. If switch remains closed -

- a. Does not de-energize U.R. when line is delivered.
- b. First Stage Quad Relays (K11 and K12) remain energized.

Switch - TS 6

1. If switch does not make contact -

- a. Timer Cams will remain in second latched position.

- b. First actuation of Delivery Release Lever or Button causes timer to move to first latch position. Repeat actuation of Delivery Release Lever or Button causes timer to latch in second position, and causes continuous repeat of delivery release.
 - c. If Delivery Release Lever or Button is held actuated, timer will latch at second position and causes continuous repeat of delivery release.
 - d. Quad signals will not be released from second stage relays.
 - e. Starwheel Pusher will not actuate at delivery release.
2. If switch remains closed -
- a. Repeated delivery of line.

NOTE: If switch is set too close and timer shaft is eccentric, it will cause switch to open each timer shaft cycle to trigger LOU Decoder Switch.

Switch - TS 7

1. If switch does not make contact -
- a. Timer stops at second latched position and delivery will not release.
 - b. Delivery Stop Lamp will light.
2. If switch remains closed -
- a. Repeats delivery of line.

Switch - TS 8

1. If switch does not make contact -
- a. L22 Spaceband Timing Clutch Solenoid will not be energized.
 - b. L101 Spaceband Release Solenoid will not be energized.
2. If switch remains closed -
- a. L22 Spaceband Timing Clutch Solenoid will remain energized.
 - b. L101 Spaceband Release Solenoid will remain energized.

DELIVERY TIMING CLUTCH SOLENOID (L 21)

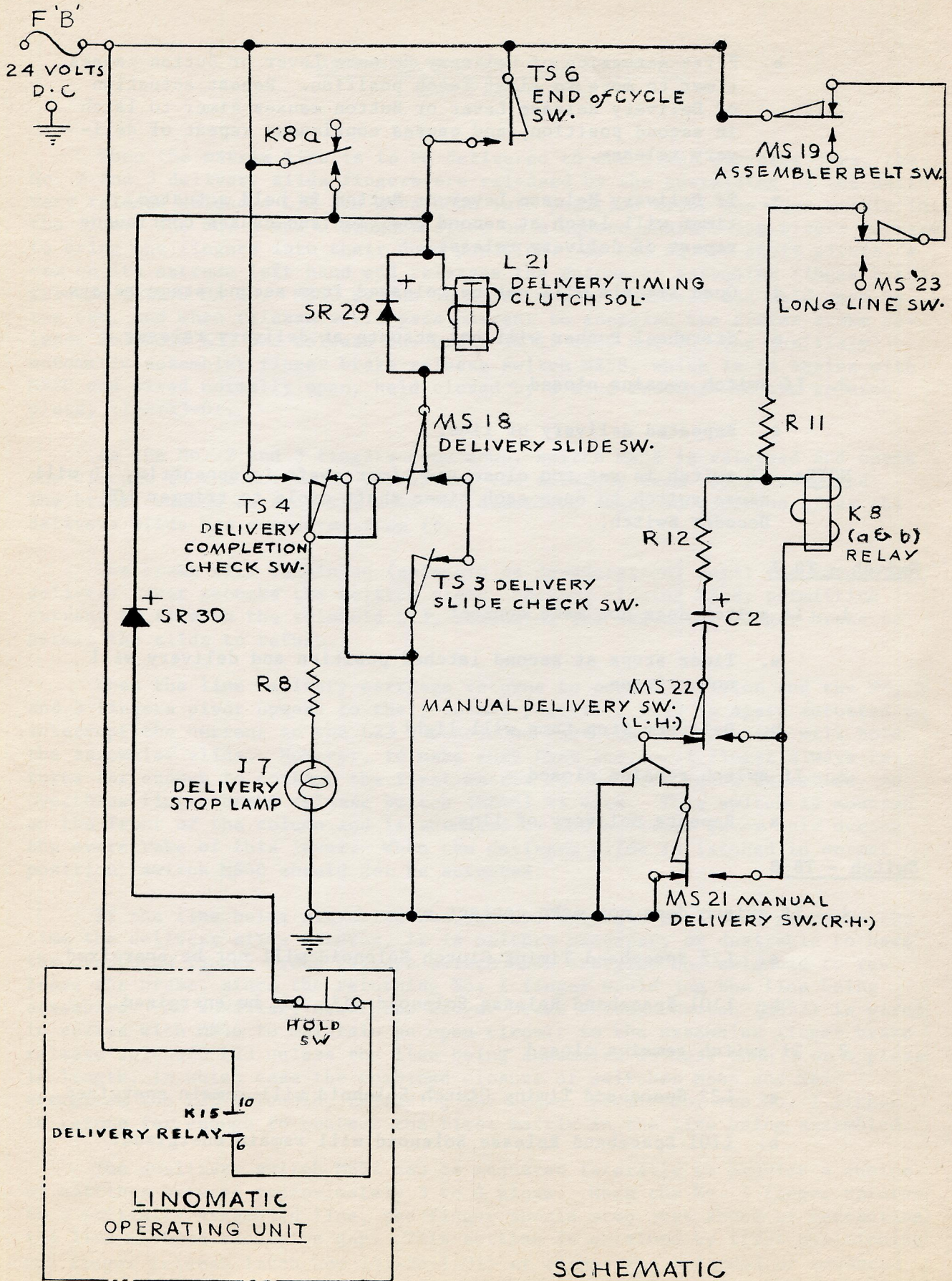

SCHEMATIC

FIG. 17

DELIVERY OF THE LINE

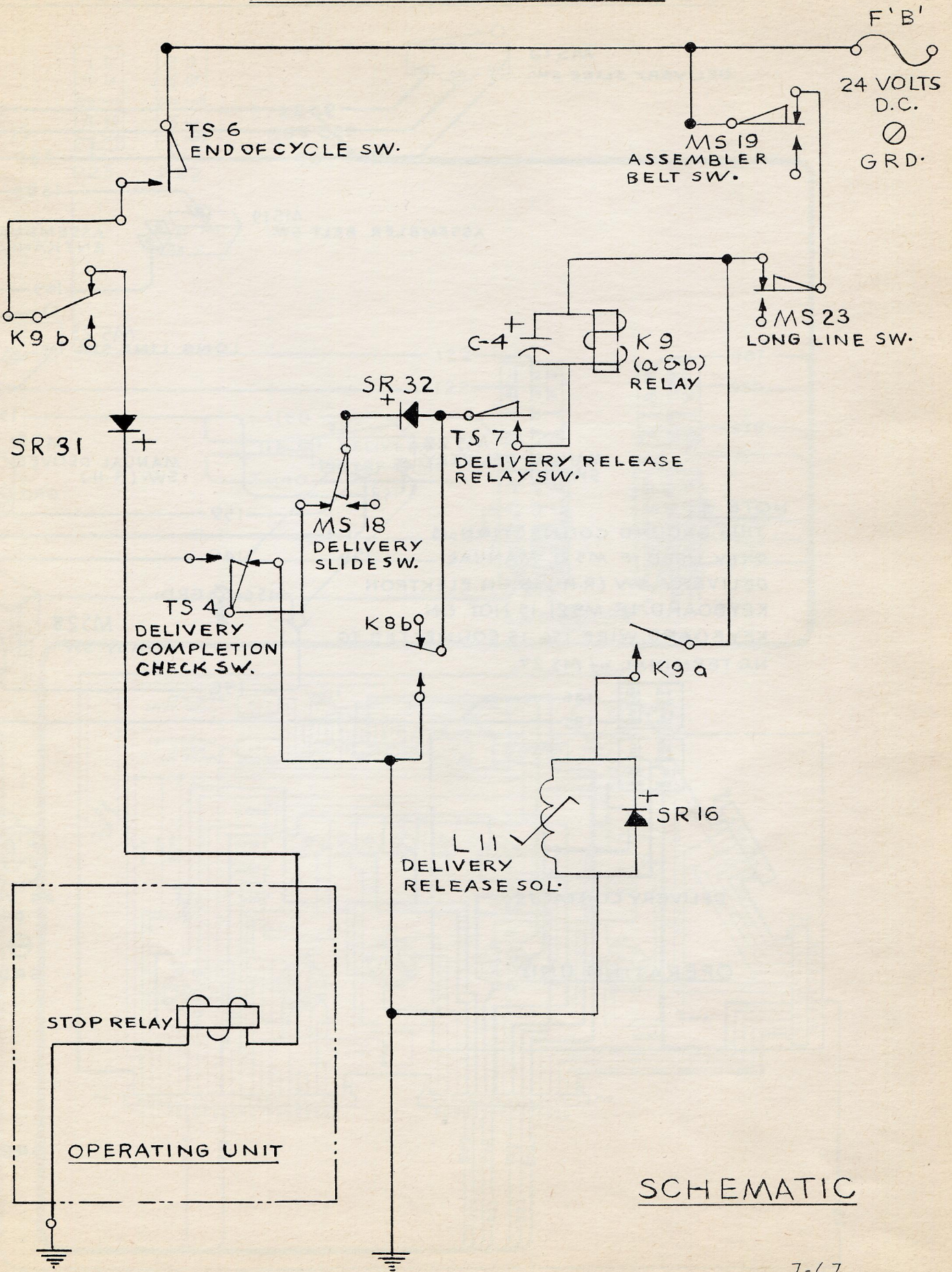

SCHEMATIC

7-67

FIG. 19

DELIVERY TIMING CLUTCH SOLENOID ()

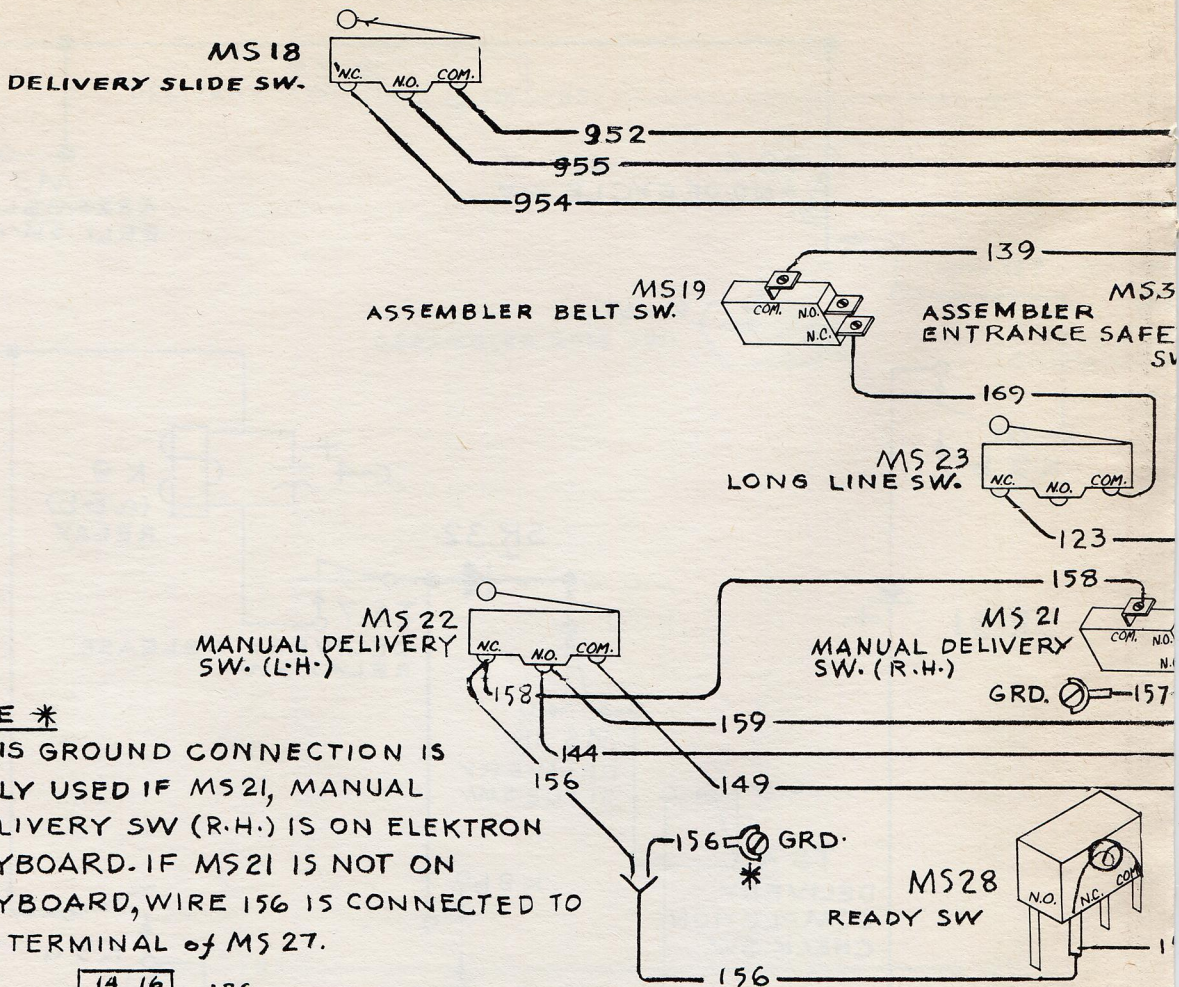

NOTE *

THIS GROUND CONNECTION IS ONLY USED IF MS21, MANUAL DELIVERY SW. (R.H.) IS ON ELEKTRON KEYBOARD. IF MS21 IS NOT ON KEYBOARD, WIRE 156 IS CONNECTED TO N.C. TERMINAL of MS 27.

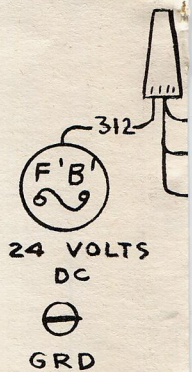
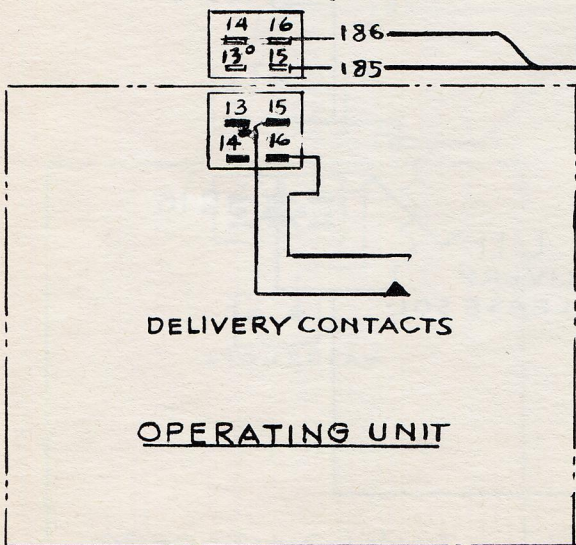

GRD.

21)

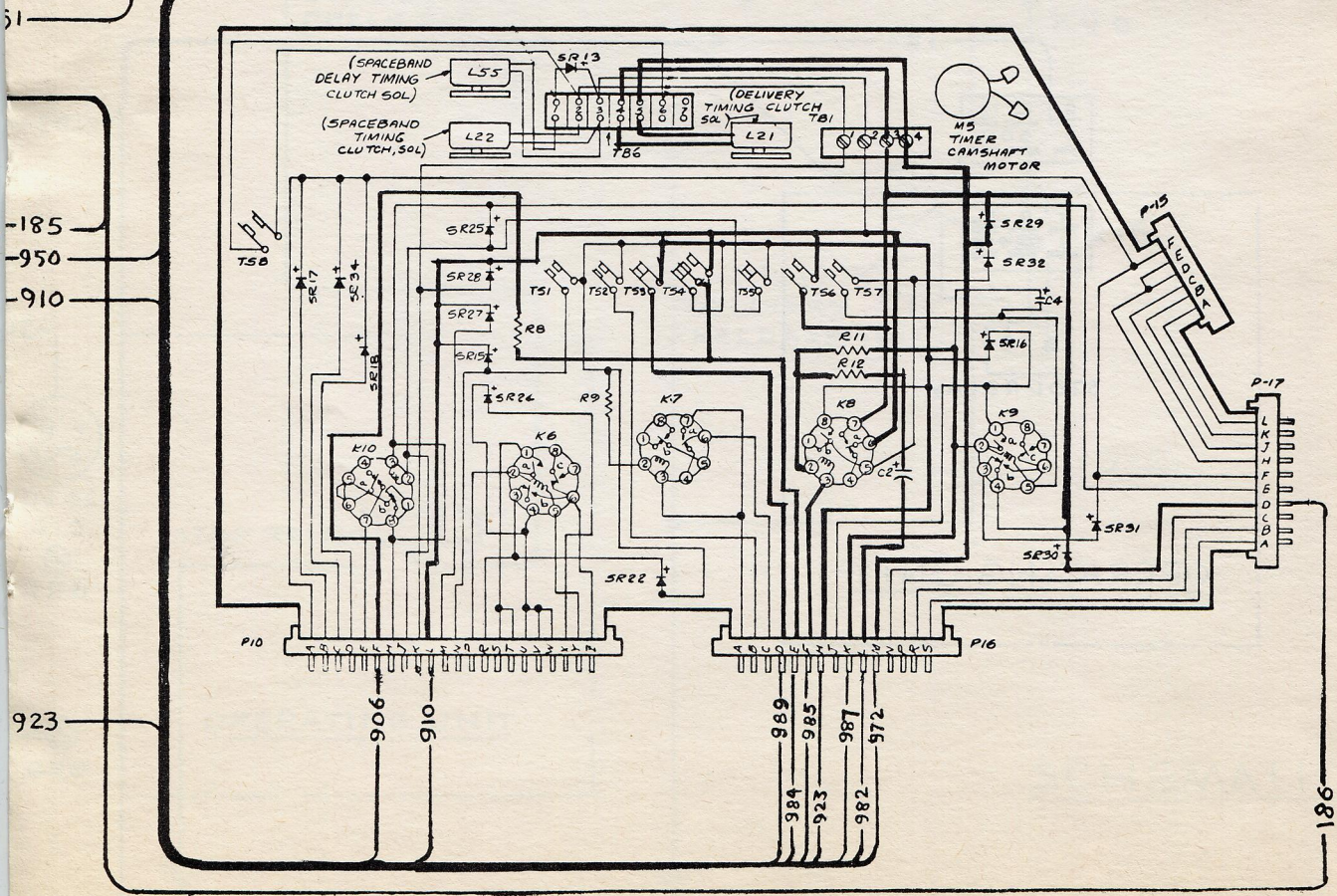
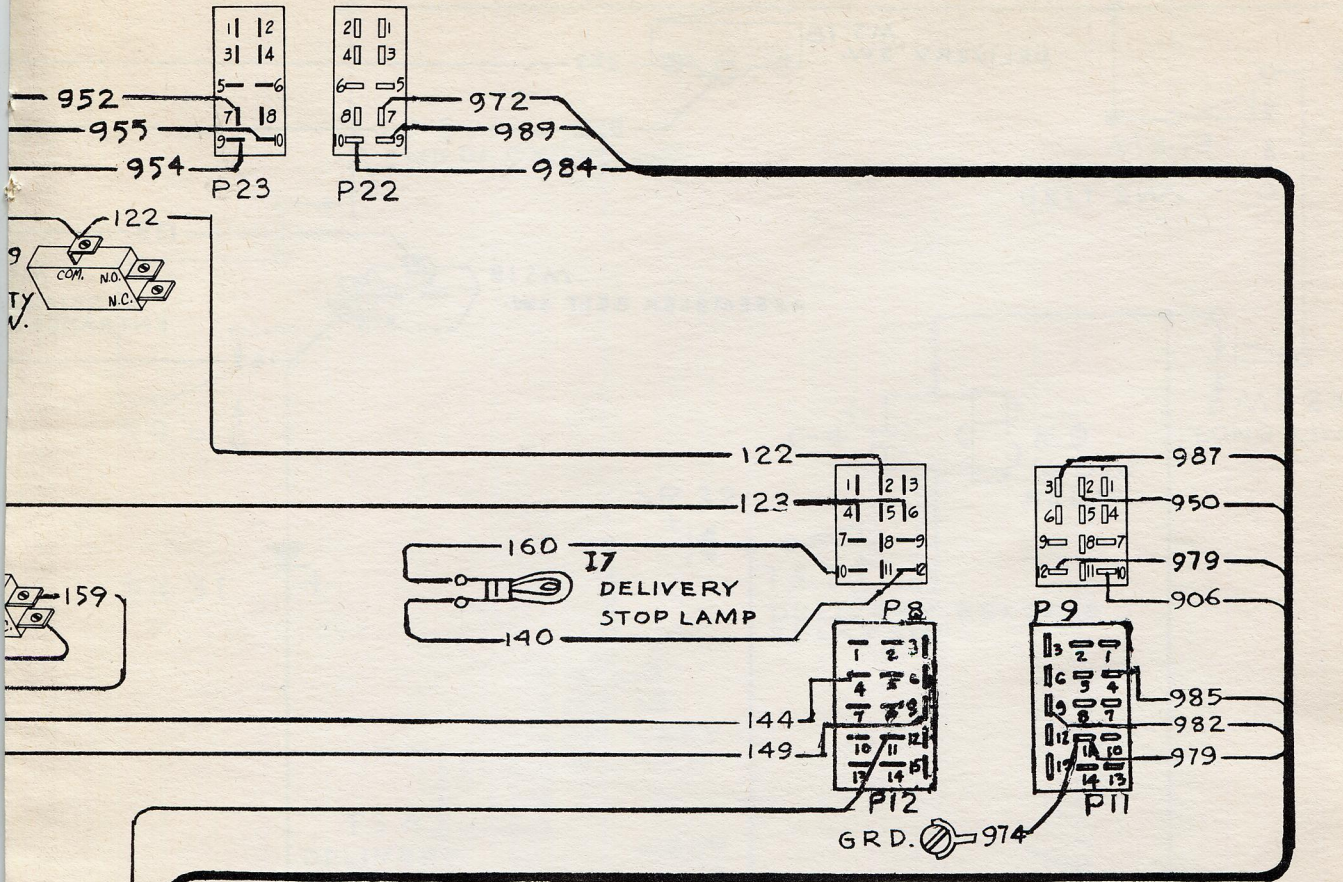

WIRING DIAGRAM
FIG. 18

7-67

DELIVERY OF THE LINE

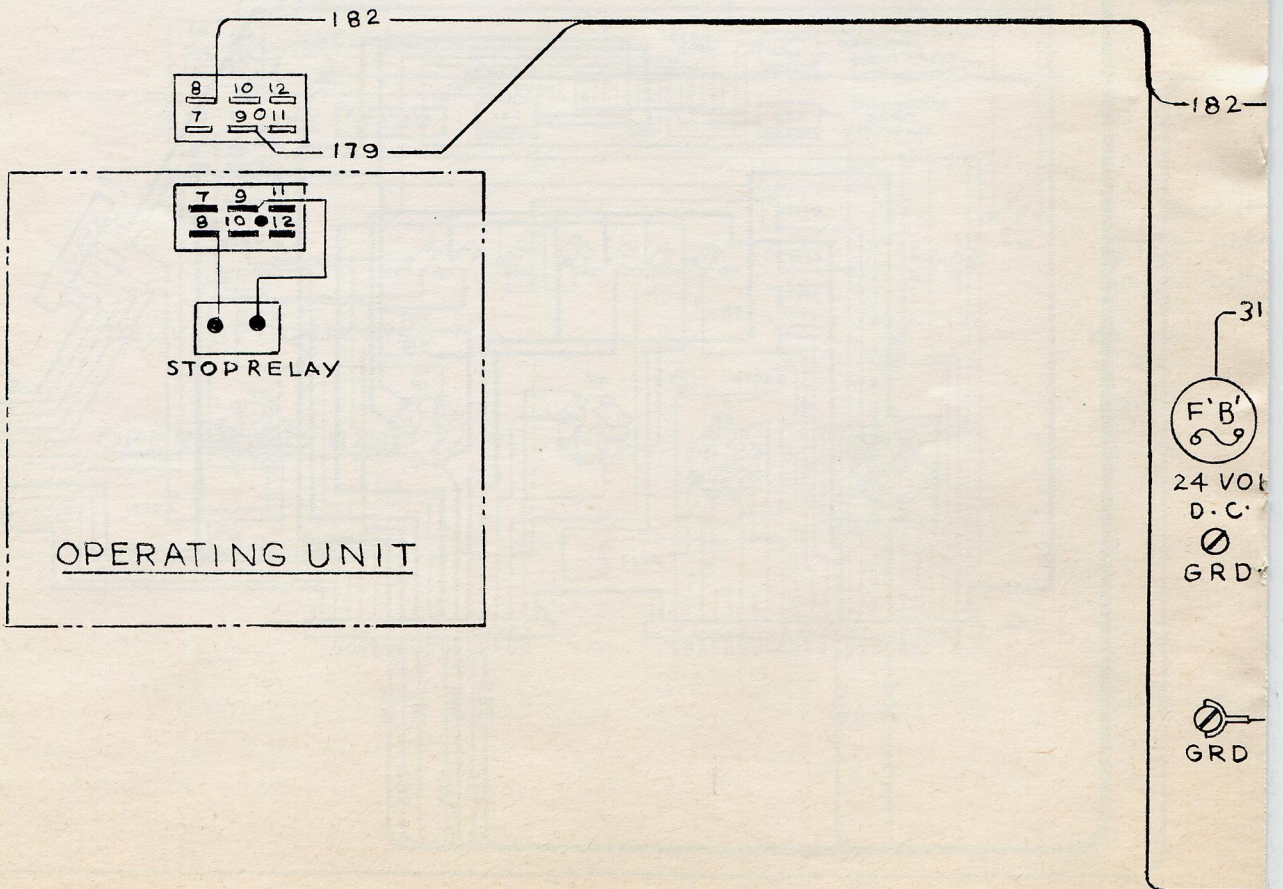
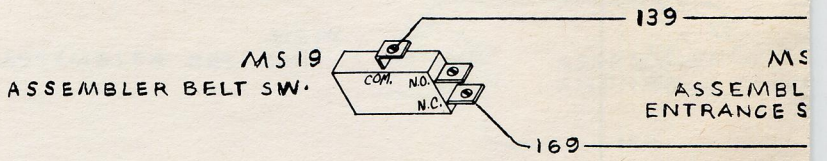
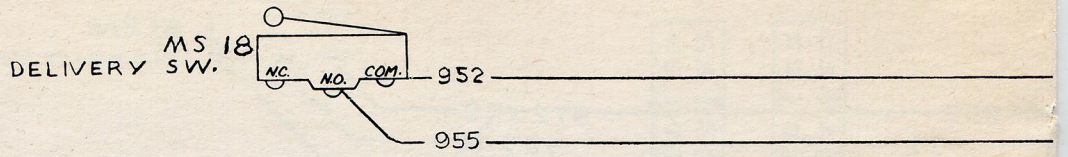

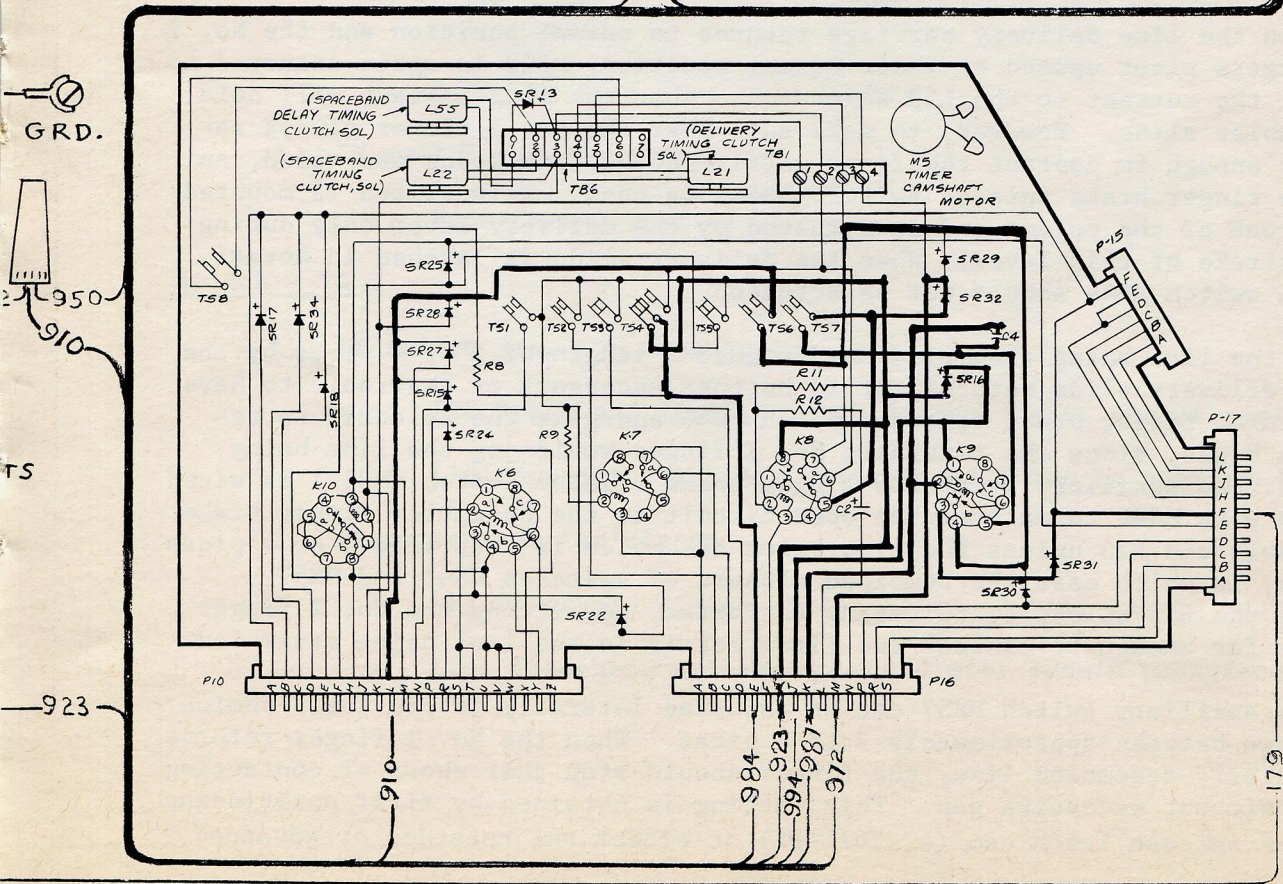
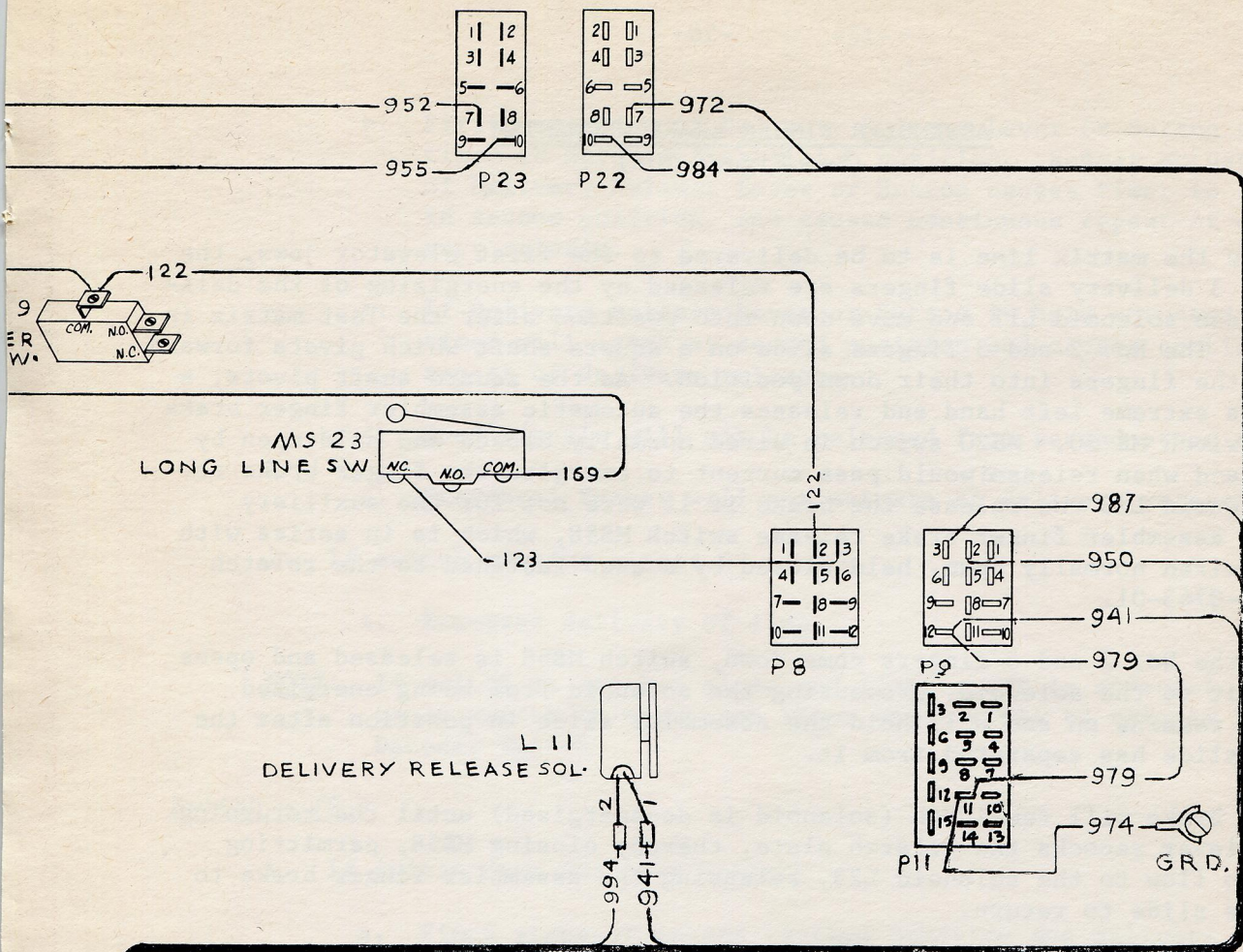

WIRING DIAGRAM
FIG. 20

7-67

ASSEMBLER FINGER BRAKE MECHANISM
(See Figure 20A)

When the matrix line is to be delivered to the first elevator jaws, the No. 2 and 3 delivery slide fingers are released by the energizing of the delivery release solenoid L11 and move down into position after the last matrix in the line. The No. 2 and 3 fingers slide on a square shaft which pivots forward to bring the fingers into their down position. As the square shaft pivots, a cam on its extreme left hand end releases the automatic assembler finger brake release switch MS 20. MS20 switch is wired normally closed and held open by the cam, and when released would pass current to energize the finger brake release solenoid L23 and release the brake if it were not for the auxiliary automatic assembler finger brake release switch MS58, which is in series with MS20 and wired normally open, held closed by a stud fastened to the relatch plate, 41-0743-01.

As the No. 2 and 3 fingers come down, switch MS58 is released and opens the circuit to the solenoid, preventing the solenoid from being energized. The brake remains on and will hold the assembler slide in position after the delivery slide has separated from it.

The brake will remain on (solenoid is de-energized) until the returning delivery lever recocks the relatch plate, thereby closing MS58, permitting current to flow to the solenoid L23, releasing the assembler finger brake to permit the slide to return.

When the line delivery carriage returns to normal position and the No. 2 and 3 fingers pivot upward to their normal position, MS20 is again actuated to interrupt the current to the L23 solenoid so that the finger brake will hold the assembler slide. However, to make sure that the No. 1 finger always returns far enough to contact the first matrix in the line being assembled, an overthrow finger brake release switch (MS46) is used. This switch is mounted on the front of the column and is actuated by the delivery lever only during the overstroke of this lever. When the delivery slide is latched in normal position, switch MS46 should not be actuated.

If the line being assembled has reached a length of 3 or 4 picas by the time the delivery slide returns, it is neither necessary or desirable to have the overthrow finger brake release switch MS46 energize the solenoid to release the brake, since the returning No. 1 finger would jog the line being assembled. An auxiliary overthrow finger brake release switch (MS57) is wired in series with MS46 to maintain an open circuit to the assembler finger brake release solenoid L23 unless the line being assembled is less than 3 or 4 picas in length, in which case the combined closure of switches MS46 and MS57 energizes the L23 solenoid, releasing the brake, permitting the No. 1 finger to return far enough to contact the first matrix in the line being assembled.

The auxiliary switch MS57 can be adjusted laterally to provide a choice of settings between approximately 3 to 4 picas. When the No. 1 finger returns to a partially assembled line, the finger should stop just short of contacting the line without excessive gap. This setting is obtained by first positioning the finger release latch cam (41-2611-01) at either the retarded or advanced

position, and then making the final setting by adjusting the timing of the automatic assembler finger brake release switch actuating cam which is located on the extreme left hand end of the delivery slide square shaft.

When the finger brake release bar is depressed manually, it releases the manual assembler finger brake release switch MS13, which is normally held actuated. This energizes the solenoid L23 to release the brake.

To Check Operation of Brake With Power On:

- a. Push brake release bar front of swinging front to actuate solenoid.
- b. Depress MS 46 overthrow switch manually. Brake solenoid should NOT energize.
- c. Actuate MS 57 Auxiliary overthrow switch and MS 46 simultaneously. The brake release solenoid SHOULD ENERGIZE.
- d. With Delivery Slide in normal, MS 58 (Switch with long actuator) will be held closed. However, the circuit to the brake is not completed, since this switch is wired in series with MS 20. The Brake solenoid should only actuate when MS 20 is closed.
- e. Close MS 20 by rotating fingers down. Brake solenoid SHOULD ENERGIZE.

ASSEMBLER FINGER BRAKE RELEASE SOLENOID

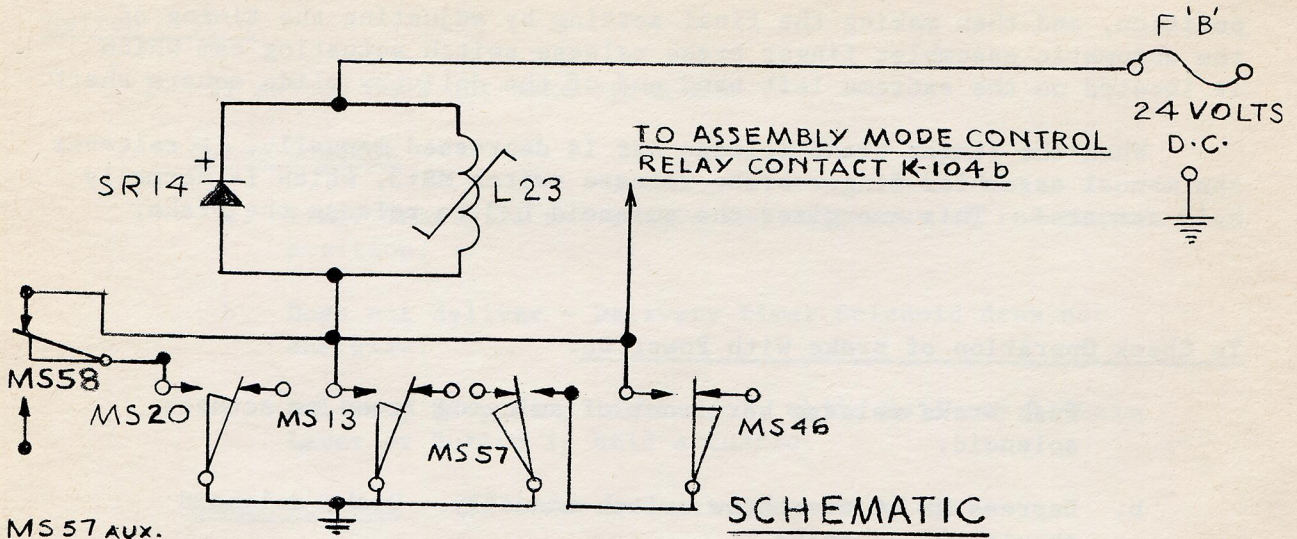

MS 57 AUX.
OVERTHROW FINGER
BRAKE RELEASE SW.

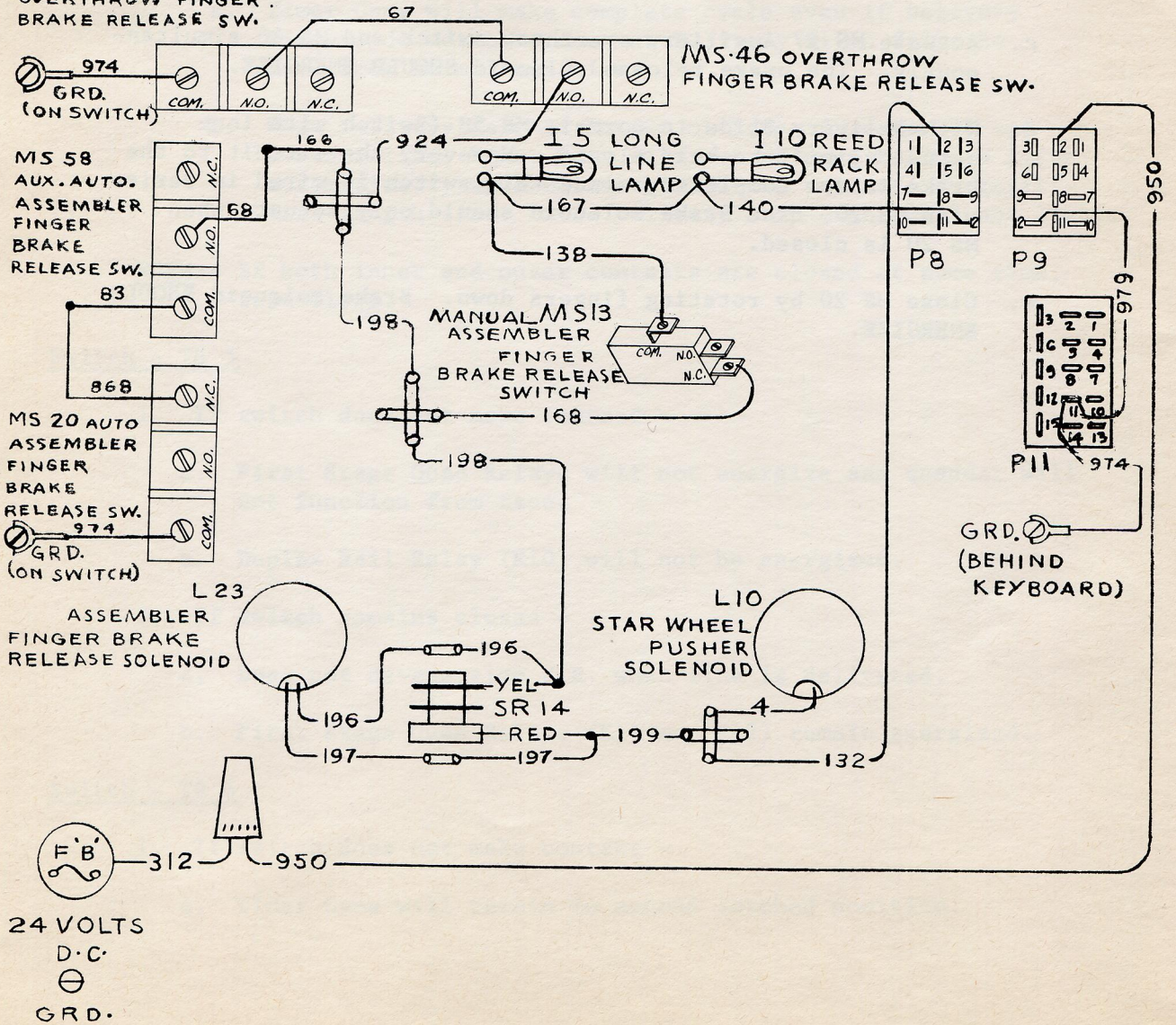

WIRING DIAGRAM
FIG. 20A

ASSEMBLY MODE CONTROL
(See Figures 20B and 40)

This unit consists of a relay K104 and a two-position slide switch S12, enclosed in a small box, mounted just above the "No Cast Indicator" box. The purpose of the Assembly Mode Control is to eliminate delivery stops due to false tight lines in tape operation and to automatically release the assembler finger brake, when the tight line lamp is on, for either tape or manual operation.

The schematic diagram for the Assembly Mode Control is shown in Fig. 20B. The circuit for the Assembly Mode Control is shown in dark lines, indicating how the operation of this unit eliminates the effect of false tight lines. The wiring diagram for this unit is incorporated in the Machine Control Circuit wiring diagram, Fig. 40.

Slide Switch S12 in Manual Position

If a false tight line occurs when assembling a line of matrices, long line switch MS23 will be actuated. The current will then pass from Fustat "B", through MS19, the normally open contact of MS23, through MS45, the coil of relay K104 and to ground to complete the circuit and energize K104. As soon as the coil of relay K104 is energized, relay contact K104b will close. The current from Fustat "B" will then pass through the coil of the Assembler Finger Brake Solenoid L23, and through contact K104b to ground. Solenoid L23 will thus be energized and will release the brake on the assembler slide and the No. 1 finger will move to the right.

Since the tight line was not an actual tight line, the No. 1 finger can move to the right and this will de-activate the long line switch MS23 automatically. The long line lamp I5 will then go out and relay K104 will be de-energized, allowing the assembler finger brake to return to its normal position.

If the tight line is a legitimate one, the No. 1 finger cannot move to the right and long line switch MS23 will remain actuated. Current cannot then pass to the delivery relay K9 and the line of matrices will not be delivered. In such a case, the operator should press in on the knob to stop the assembler and then correct the tight line. After the line has been corrected, the assembler is started and the delivery switch button depressed to deliver the line.

Slide Switch S12 in Tape Position

If a false tight line occurs while the line is being assembled but not simultaneous to a delivery signal, the same action will occur as when switch S12 is in Manual position, i.e., the assembler finger brake will be released allowing the No. 1 finger to move to the right and automatically de-activate long line switch MS23 and the assembled line may be delivered.

If a false tight line occurs simultaneously to a line delivery signal, relay K104 will be energized, its contacts "a", "b" and "c" will close and the following will occur:

1. Relay K104 is held energized by the current passing from Fustat "B", through TS6, S12a contacts, CR10, K104a contact and through the K104 relay coil to ground. Relay K104 is thus kept energized, as long as the timer "end of cycle switch TS6" is closed.

2. Finger Brake Release Solenoid L23 will be energized through K104b contact and L23 will remain energized as long as K104 relay is energized. This allows the No. 1 finger to move to the right and de-activate long line switch MS23 to cancel the false tight line.

3. When MS23 is de-activated and TS7 closes, the circuit will be completed to energize K9, through S12b and K104c, to ground.

4. If an actual tight line is assembled, switch MS23 will be actuated and could not return to normal position, since the No. 1 finger could not move to the right. In this case, a delivery stop will occur, since the current cannot pass through MS23 to energize the coil of delivery relay K9. In the case of a tight line, the monitor should press in on the knob to stop the assembler and then correct the tight line. After the line has been corrected, and the assembler knob is pulled out, the line will be delivered immediately.

ASSEMBLY MODE CONTROL

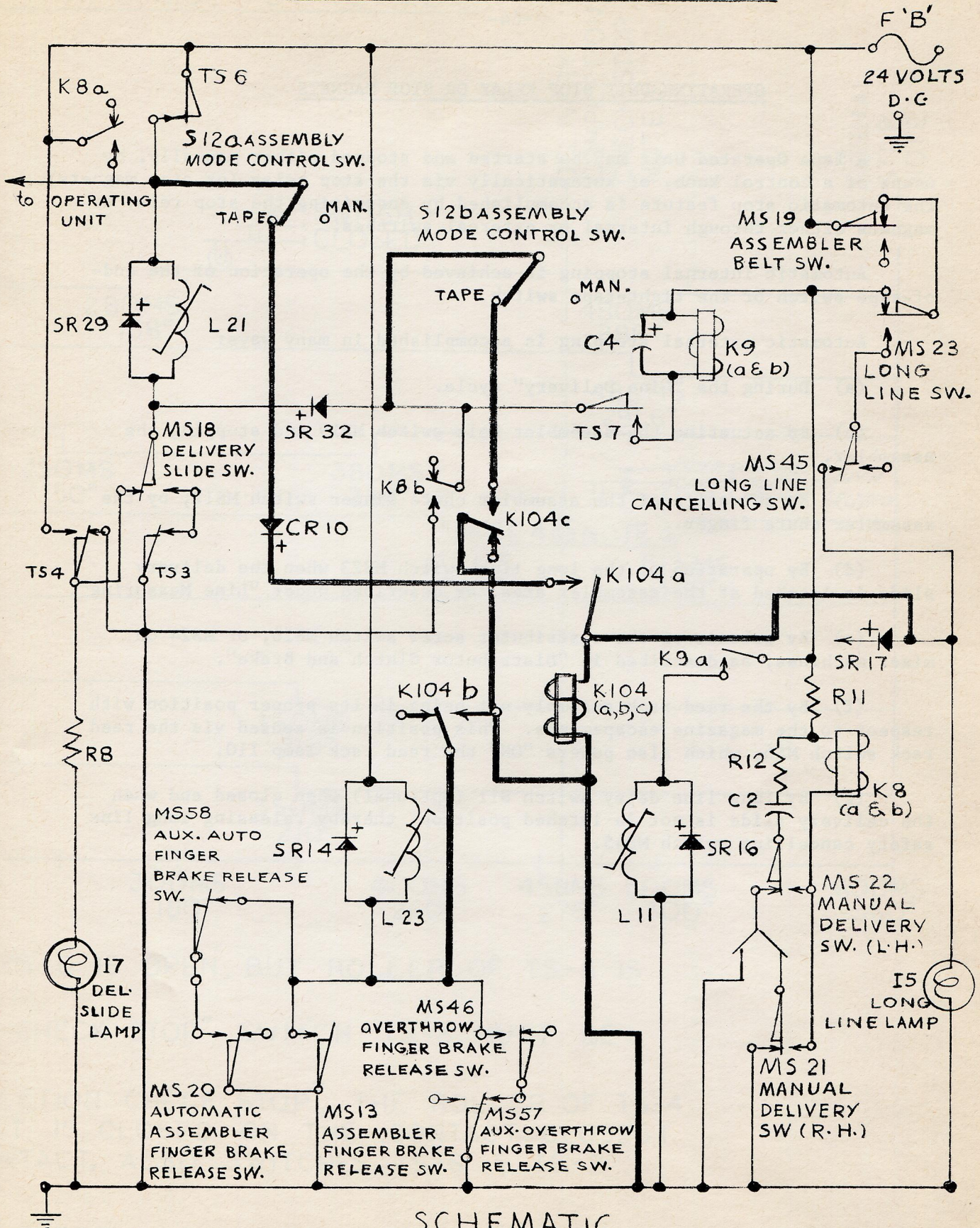

SCHEMATIC

NOTE: THE DARK LINES SHOW THE CIRCUIT FOR THE ASSEMBLY MODE CONTROL:

FIG. 20 B

OPERATING UNIT STOP RELAY OR STOP MAGNETS

A Tape Operated Unit may be started and stopped either manually, by means of a control knob, or automatically via the stop relay (or stop magnets). The automatic stop feature is accomplished by energizing the stop relay or magnets either through internal or external switches.

Automatic internal stopping is achieved by the operation of the end-of-tape switch or the tight-tape switch.

Automatic external stopping is accomplished in many ways:

- (a) During the "Line Delivery" cycle.
- (b) By actuating the assembler belt switch MS19 and stopping the assembler.
- (c) By actuation of the assembler chute finger switch MS12, by the assembler chute finger.
- (d) By operation of the long line switch MS23 when the delivery slide is latched at the assembler area, as described under "Line Measuring".
- (e) By release of the distributor screw switch MS26, or MS24 on mixer machines, as described in "Distributor Clutch and Brake".
- (f) By the reed rack assembly not being in its proper position with respect to the magazine escapements. This position is sensed via the reed rack switch MS6, which also powers "ON" the reed rack lamp I10.
- (g) By long line delay switch S11 (optional) when closed and when the delivery slide is not in latched position, thereby releasing long line safety cancelling switch MS45.

ASSEMBLER BELT SWITCH AND ASSEMBLER CHUTE FINGER SWITCH
(See Figures 13 and 14)

The schematic diagram and the wiring diagram for "Line Measuring" illustrates the results of the action of the above switches.

If the assembler stop is operated manually to stop the assembler, the assembler belt switch MS19 is actuated. This connects 24 volts D.C. power to the stop relay or stop magnets in the operating unit, and this unit then stops immediately, so that no matrices can be released from the magazine.

The assembler chute finger switch MS12 is connected in parallel with the MS19 assembler belt switch. The assembler chute finger is adjusted so that the largest matrix to be assembled will pass through the assembler chute finger and be assembled in the line of matrices. However, if for any reason a matrix does not assemble properly, and a "jam up" occurs in the assembler chute, the first few matrices assembled from the magazine will raise the chute finger sufficiently to release the switch MS12. This will connect 24 volts D.C. power to the stop relay or stop magnets in the operating unit to immediately stop it and thus prevent further matrices from being released from the magazine.

On newer machines, wire 124 from the normally open terminal of the assembler belt switch MS19 is connected to pin 11 of plug 8, (rather than pin 4), as shown in Figure 14. This will cause the I10 lamp to be energized whenever the assembler belt switch MS19 or the assembler chute finger switch MS12 is actuated.

REED RACK SWITCH MS 6
(See Figure 21)

The reed rack switch MS6 is held in actuated position by the reed rack when this rack is in normal position. When the reed rack is not in normal or proper position, MS6 is released and power will then pass from the common terminal of this switch to the N.C. terminal and then to the stop relay in the operating unit through rectifier SR34, and from the stop relay to ground to complete the circuit, to energize the stop relay and immediately stop the operating unit.

When MS6 is released, the reed rack safety lamp I10 is also energized to indicate that the reed rack is not in proper position.

The schematic diagram for MS6 is incorporated in the complete schematic diagram, Figure 39. The wiring diagram is shown in Figure 21.

REED RACK SWITCH MS 6

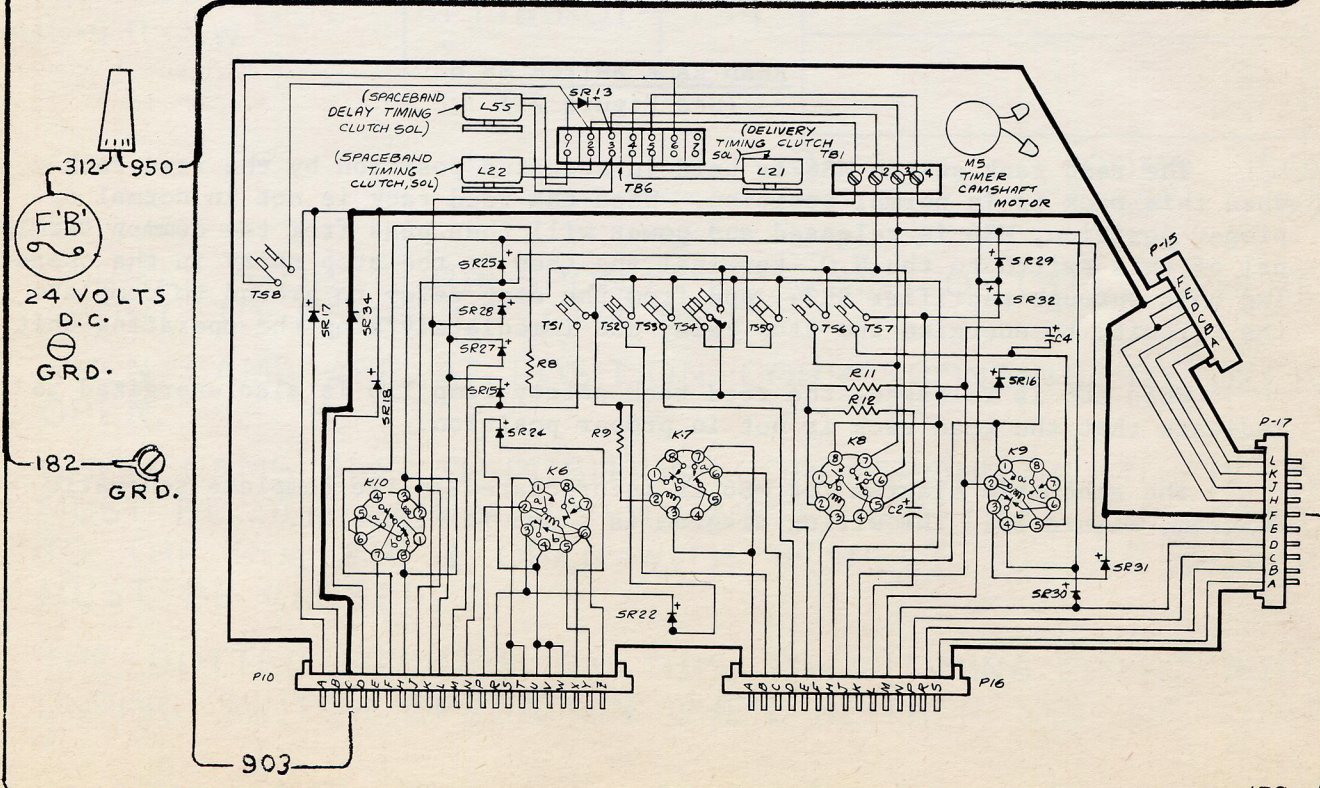
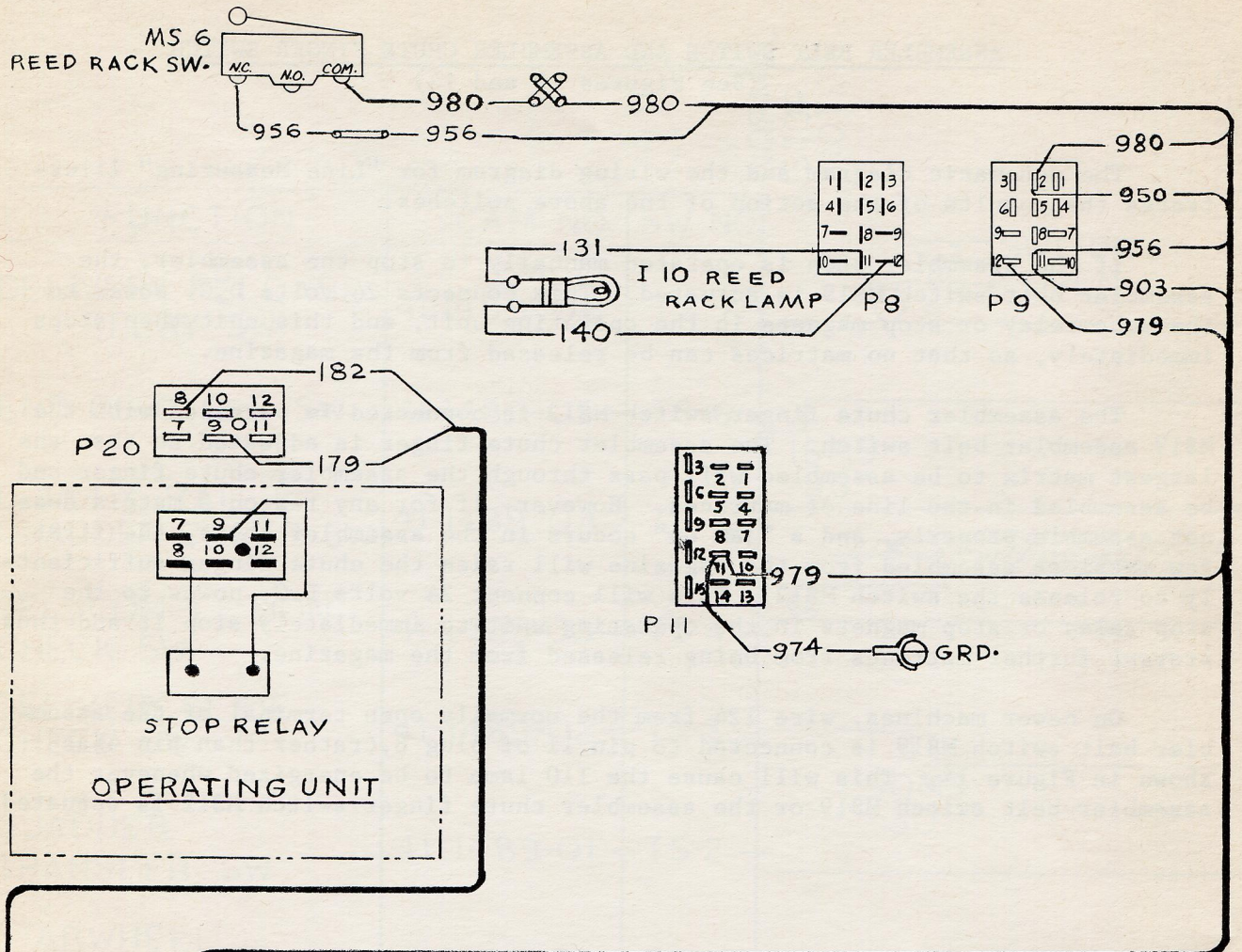

FIG. 21

WIRING DIAGRAM

NO CAST INDICATOR
(See Figures 22 and 23)

The No Cast Indicator is contained in a box mounted on the left hand side frame. It contains a relay K15, No Cast Lamp I12, on and off switch S10, plus resistor R13 and rectifier SR37. Whenever a line fails to cast, a no cast lamp I12 will glow red and the Elektron will stop at that point in its cycle where the line has just been transferred to the second elevator.

The No Cast Indicator on-off switch S10 must be in the "on" position for the unit to function. The coil of no cast indicator relay K15 is wired in parallel with the pot pump solenoid L18 as will be noted from the schematic diagram.

Whenever the pot pump solenoid L18 is energized to allow the pot pump plunger to descend to cast the slug, relay K15 is energized and its contact "a" closes while its contact "b" opens. K15 relay is held energized by its "a" contact. When casting is complete, L18 pot pump solenoid is de-energized. However, no cast indicator relay K15 remains energized through its K15 "a" contacts. The blocking action of rectifier SR37 prevents the K15 "a" contacts from keeping the L18 solenoid energized.

The relay K15 is returned to its normal de-energized state at the end of every machine cycle, by operation of the MS38 No Cast Indicator Clearing switch. Although Figure 22 shows MS38 receiving power directly from Fustat "A", the circuit is actually through the "Ready" circuitry, which must be activated first. See Figure 39 for this part of the circuit.

If the line does not cast, K15 relay will not be energized and when the camshaft test switch MS32 is opened, the camshaft relay K6 will be de-energized and the camshaft will stop at transfer. Power will then be directed through the no cast indicator switch contact S10a, through the resistor R13 and through the I12 lamp to ground, causing the lamp to light indicating that the line did not cast.

To start the Elektron after a "No Cast" stop, start switch MS29 should be depressed. The No Cast Indicator can be disconnected from the machine circuit by moving the on-off switch S10 to its "off" position.

NO CAST INDICATOR

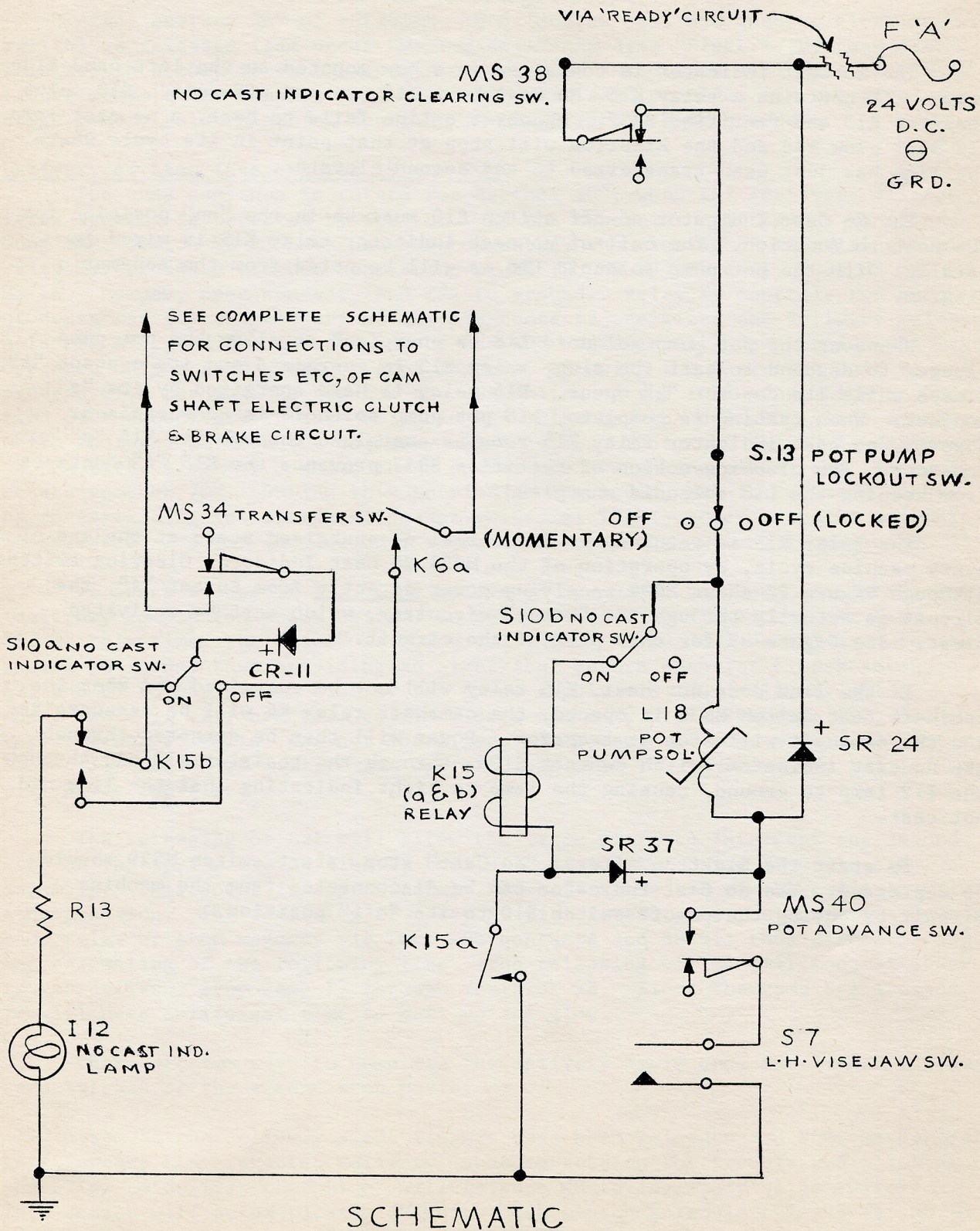
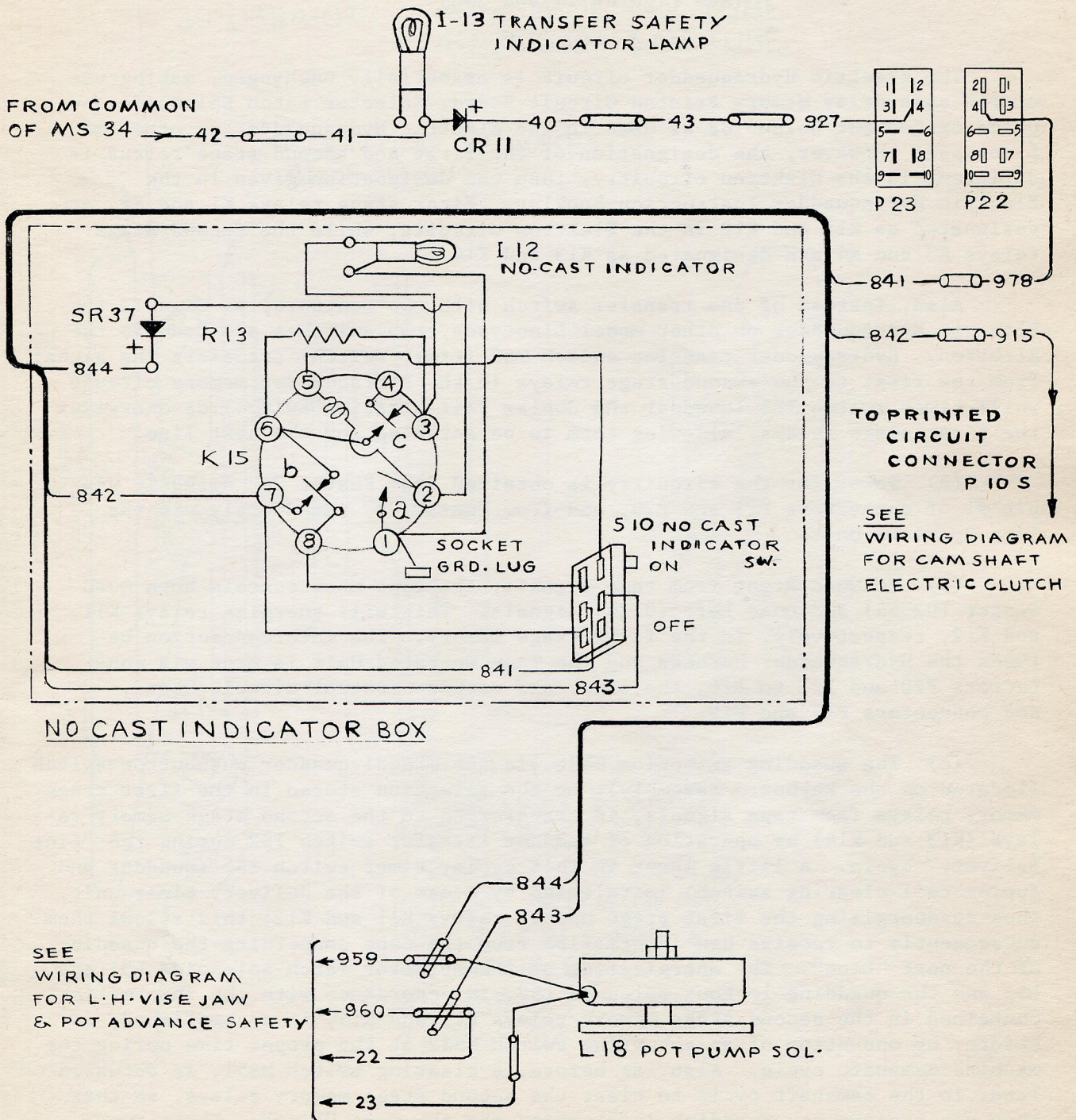

FIG-22

NO CAST INDICATOR



WIRING DIAGRAM

ELECTRIC HYDRAQUADDER
(See Figures 24 and 24A)

The Electric Hydraquadder circuit is essentially unchanged, making use of the same Relay Memory Printed Circuit Board, Selector Latch Solenoids and Quadding Lockout Solenoids as used in the Electric Hydraquadder on other model Linotypes. However, the designation of the first and second stage relays is different in the Elektron circuitry, than the designation given in the Electric Hydraquadder Instruction Booklet. First stage relays K1 and K2, are designated as K11 and K12 in the Elektron circuits, while the second stage relays K3 and K4 are designated as K13 and K14.

Also, instead of one transfer switch with two contacts, as used in the Electric Hydraquadder on other model Linotypes, two switches are used in the Elektron. Hydraquadder transfer switch TS2 (timer switch) transfers the signal from the first to the second stage relays in the Hydraquadder memory circuit while timer switch TS5 (quadder and duplex rail clearing switch) de-energizes the first stage relays, allowing them to be actuated for the next line.

(a) Power for the circuitry is obtained from Fustat "A" directly via pin #1 of connectors P21 and P28, and from Fustat "B" immediately via the Tape Operated Unit.

(b) To Quad Right from tape signals, the tape must contain both Quad Center (02345) and Quad Left (0134) signals. This will energize relays K11 and K12, respectively, in the first stage memory. The interconnection between the Hydraquadder harness and the Tape Operated Unit is made via connectors P28 and P21 to P16, the timer and machine control circuit board, and connectors P17 and P19.

(c) The quadding selection made via the manual quadder pushbutton switch (located on the keyboard assembly), or the selection stored in the first stage memory relays from tape signals, is transferred to the second stage memory relays (K13 and K14) by operation of quadder transfer switch TS2 during the "Line Delivery" cycle. A little later in this cycle, timer switch TS5 (quadder and duplex rail clearing switch) is released by a cam of the delivery timer unit, thus de-energizing the first stage memory relays K11 and K12; this allows them subsequently to receive new information from the tape concerning the quadding of the next "Line". The energization of the selector latch solenoids L51 and L53 and the quadding lockout solenoid L52, in accordance with the information contained in the second stage memory relays K13 and K14, is accomplished, as before, by operation of an actuating switch MS52 at the proper time during the machine camshaft cycle. Also, as before, a clearing switch MS51, is actuated later in the camshaft cycle to clear the second stage memory relays, so that they can receive new quadding information for the next "Line". These two switches MS51 and MS52 are located at the rear, left hand corner of the camshaft, near the camshaft cycle "test" switches MS32 and MS36.

(d) The Tape Operated Unit's delivery switch is used by the Hydraquadder circuit to clear any manual quadding selection made, if the "REG" button has not also been depressed. This is accomplished by a circuit from the Tape Unit's delivery switch through a normally closed contact of the "REG" button and then

through normally open contacts of Q.R., Q.L. and Q.C. buttons (in parallel) to the key release solenoid L54. If it is desired to quad from manual selections made by the operator while the machine is operating from tape signals, then the "REG" button should be depressed. This will interrupt the circuit to the key release solenoid, so that the manual selection will not be cleared during the delivery cycle.

(e) The "REG" button also serves to maintain quadding information for recasting operations. Since recasting takes place without a "Line Delivery" operation, timer switch TS2 is not operated to transfer quadding information from the manual pushbutton selection to the second stage relays, as described in (c) above. To achieve this transfer, a set of contacts (REG-"b" and "c") have been added to the "REG" pushbutton. These contacts provide for connection of the quadding selection button contacts directly to ground, thus bypassing the transfer switch TS2. As described above under (c) the operation of MS51 during the machine camshaft cycle de-energizes the second stage relays; however, with the "REG" button depressed, the relays will be immediately re-energized upon the reclosing of MS51, in accordance with the manual selection previously made. Thus, the same quadding information is retained for use during the following cycle.

Automatic Quad Left Attachment

Newer Elektrons that are equipped with Electric Hydraquadders, have as standard equipment an Automatic Quad Left Attachment, commonly called the "Quad-the-Widow" feature, since it will automatically quad left any line that is not within a predetermined justification range without additional signals from tape or operator.

Whenever a line that is within justification range is delivered to the first elevator jaws, the Automatic Quad Switch MS55 is actuated completing a circuit between ground, through indicating lamp I14, to the common terminal of the Automatic Start Switch MS30. If relay K7 has been energized by the Ready Switch (MS28), the power side of the circuit from fuse "A" will be completed to light the green indicating lamp I14, signifying the line is within justification range and the line will not quad.

Whenever a short (widowed) line is delivered to the first elevator jaws, micro-switch MS55 remains unactuated. With MS55 unactuated, a circuit is completed between ground and wire #708 of the Lockout Solenoid L52. In effect, this circuit bypasses the "C" or grounding contacts of the second stage memory relays K13 and K14.

As soon as the camshaft starts to revolve, quadder actuating switch MS52 is actuated, bringing power from fuse "A" to energize the lockout solenoid L52. This action positions the lockout latch to cause the quadder to quad left the particular "short" line which has been delivered.

In cases where the Automatic Quadding feature is not desired, such as recasting or specialized composition, a manual latch can be positioned to keep MS55 continually actuated. This will retain an open circuit to the lockout solenoid L52, and will be indicated by the continually lighted green indicator lamp I14.

ELECTRIC HYDRAQUADDER

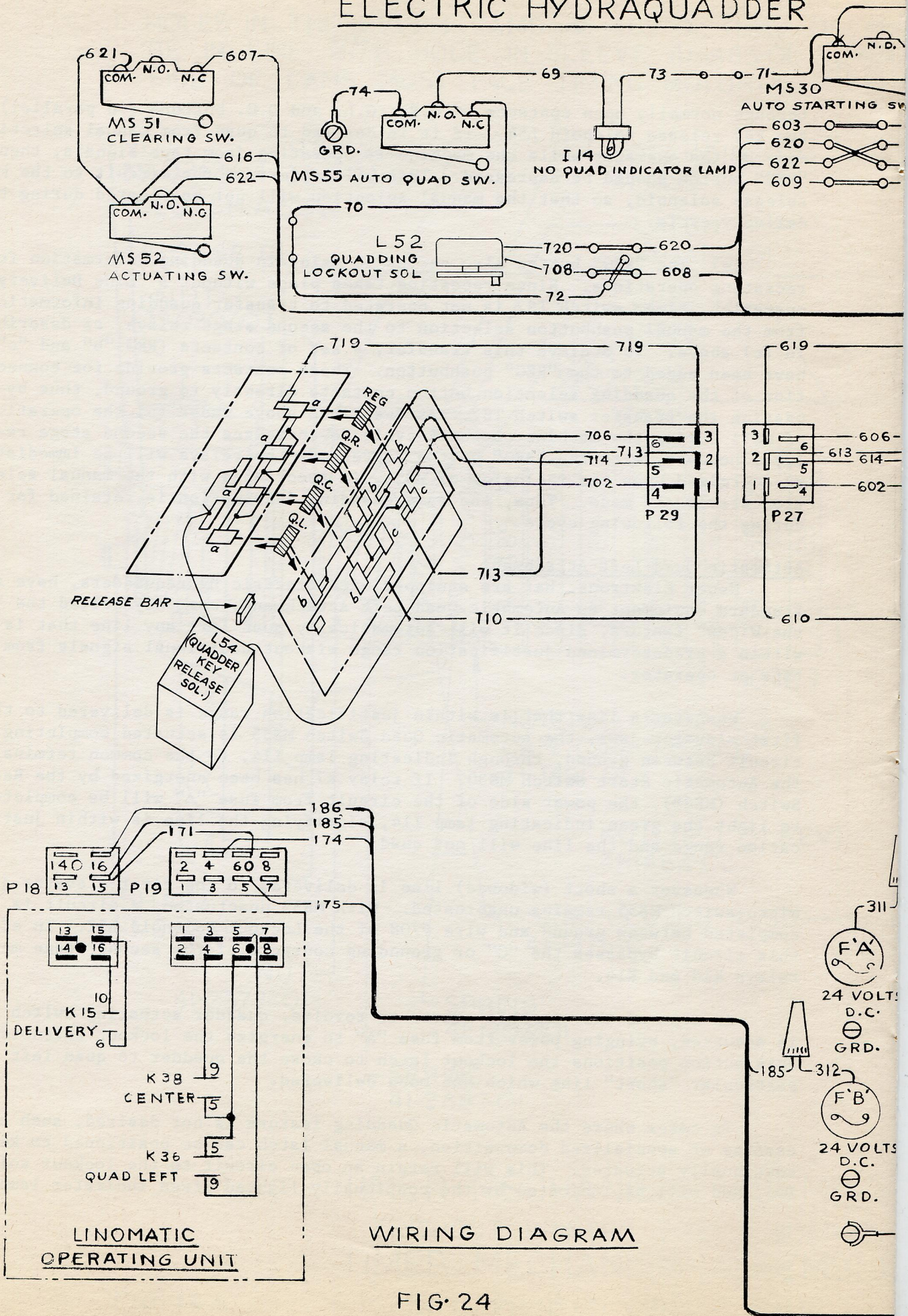

WIRING DIAGRAM

FIG. 24

FROM FUSE 'A' (VIA READY CIRCUIT)

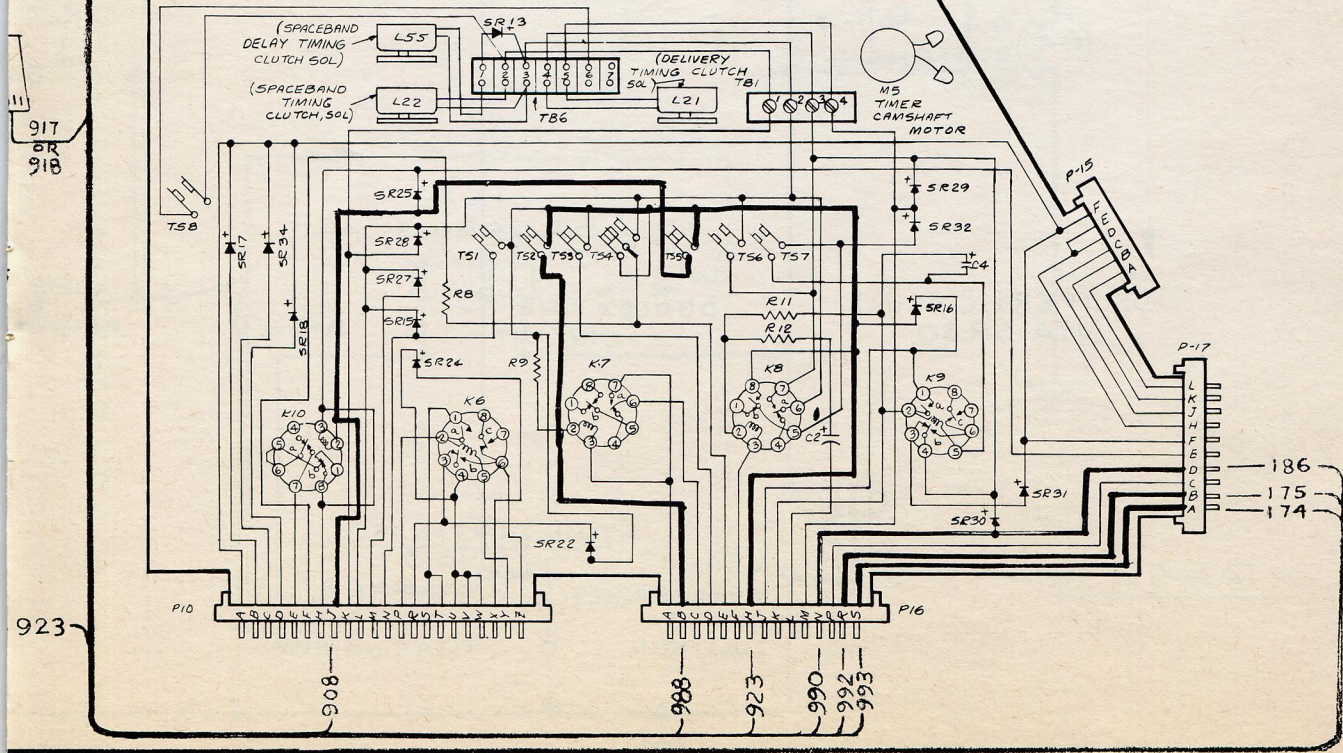
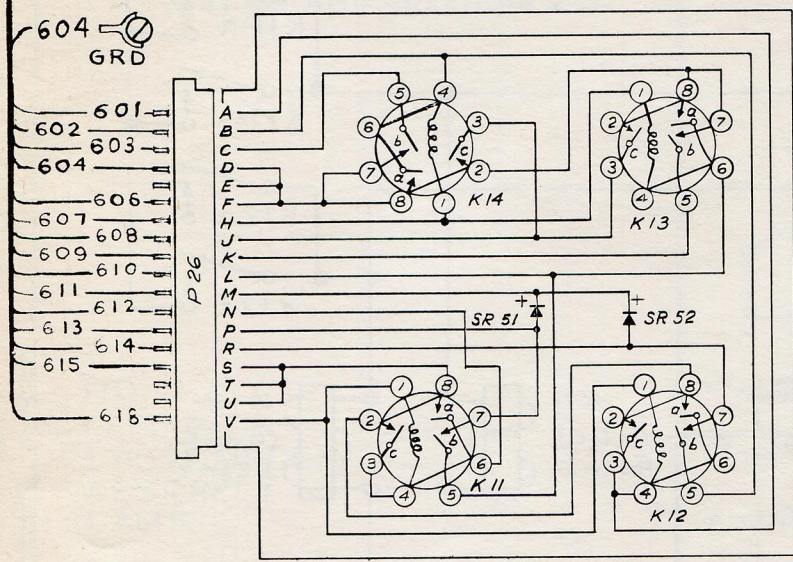
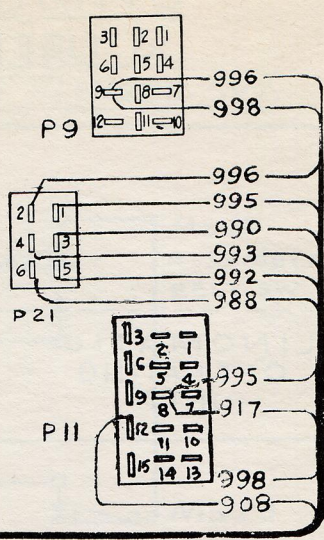
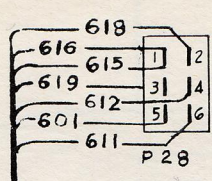
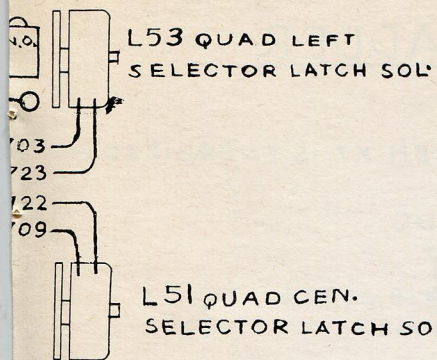

ELECTRIC-HYDRAQUADDER

from F'A" WHEN K7 IS ENERGIZED

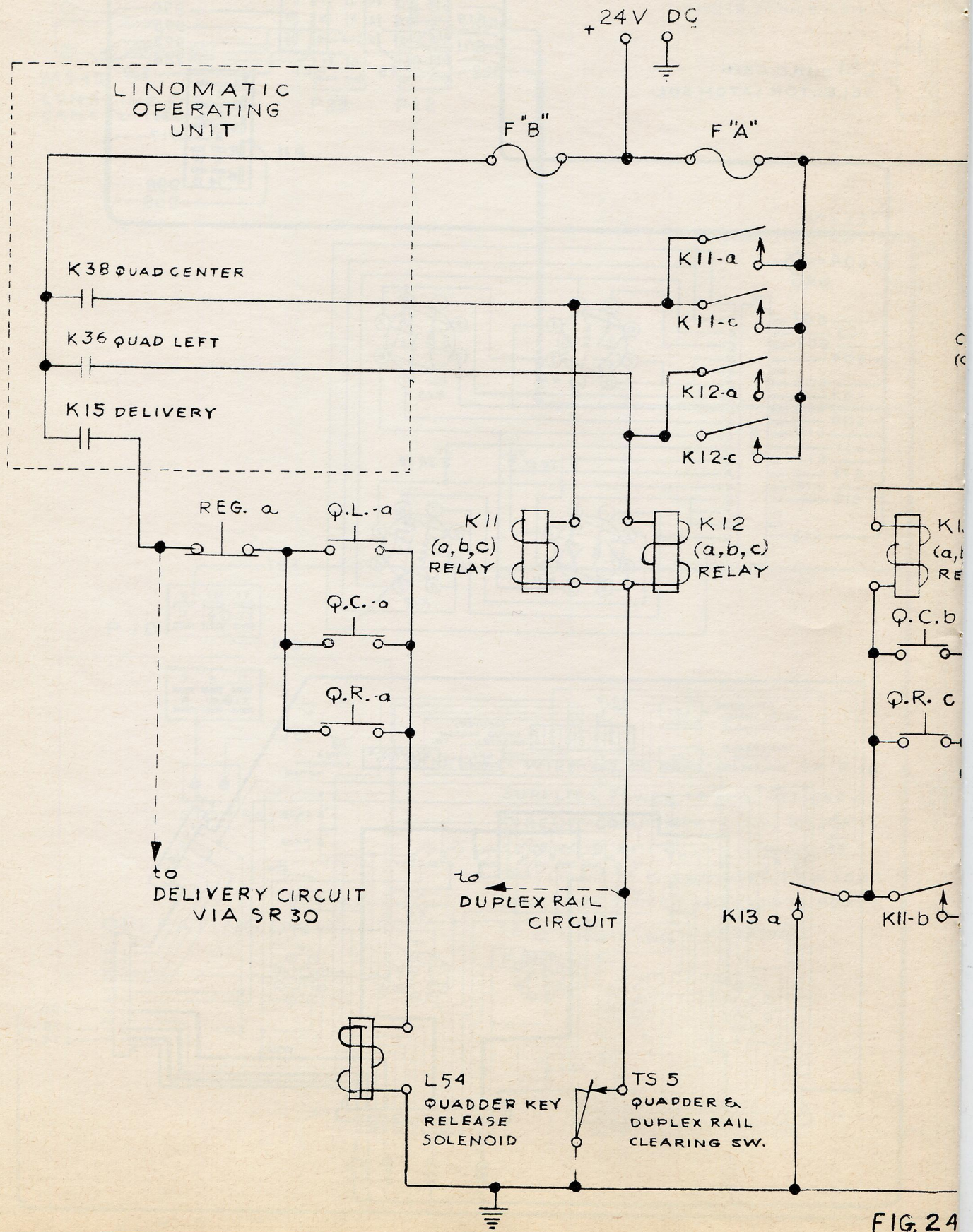
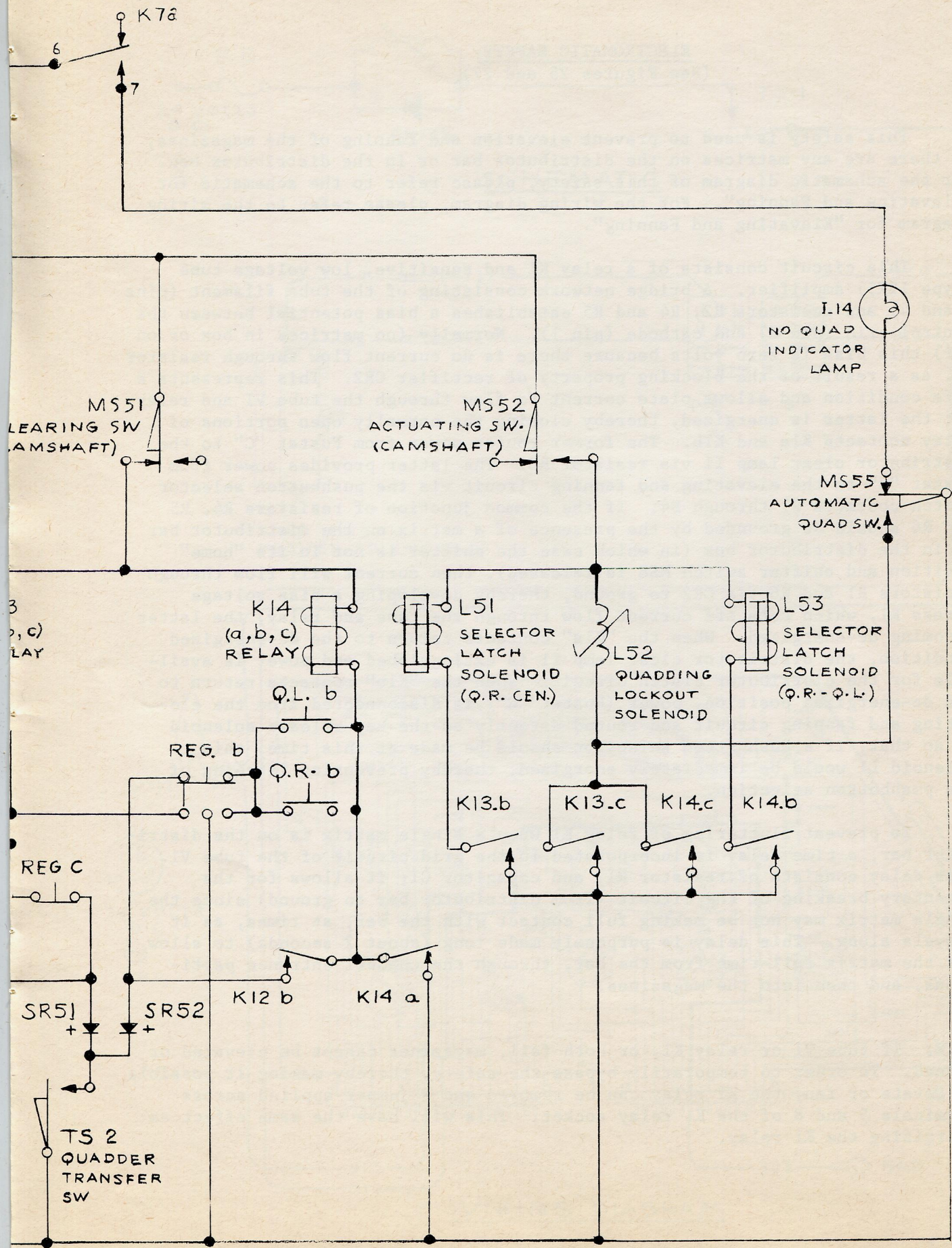

FIG. 24



SCHMATIC

A

ELECTROMATIC SAFETY
(See Figures 25 and 27)

This safety is used to prevent elevation and fanning of the magazines, if there are any matrices on the distributor bar or in the distributor box. For the schematic diagram of this safety, please refer to the schematic for "Elevating and Fanning". For the wiring diagram, please refer to the wiring diagram for "Elevating and Fanning".

This circuit consists of a relay K1 and sensitive, low voltage tube (type 12K5) amplifier. A bridge network consisting of the tube filament (pins 3 and 4) and resistors R2, R4 and R5 establishes a bias potential between the control grid (pin 2) and cathode (pin 1). Normally (no matrices in box or on bar) this bias is zero volts because there is no current flow through resistor R1, as a result of the blocking property of rectifier CR2. This represents a safe condition and allows plate current to flow through the tube V1 and relay K1; the latter is energized, thereby closing the normally open portions of relay contacts K1a and K1b. The former routes power from Fustat "C" to the distributor clear lamp I1 via resistor R3. The latter provides power from Fustat "C" to the elevating and fanning circuit via the pushbutton selector switch contacts S1 through S4. If the common junction of resistors R4, R5 and R6 should be grounded by the presence of a matrix on the distributor bar or in the distributor box (in which case the shifter is not in its "home" position and shifter switch MS8 is released), then current will flow through resistors R1 and R6 via CR2 to ground, thereby developing a bias voltage across R1, which cuts off current flow through the tube and relay, the latter becoming de-energized. When the "K1a" contacts return to the de-energized condition, the distributor clear lamp I1 is extinguished and power is available for the distributor clutch circuit. When the "K1b" contacts return to the de-energized position, power (Fustat "C") is disconnected from the elevating and fanning circuit and routed directly to the key release solenoid L1 so that, if a pushbutton selection should be made at this time, this solenoid L1 would be immediately energized, thereby preventing latching of the pushbutton selection.

To prevent fluttering of relay K1 when a single matrix is on the distributor bar, a time delay is incorporated in the grid circuit of the tube V1. This delay consists of resistor R1, and capacitor C1; it allows for the momentary breaking of the circuit (from distributor bar to ground) since the single matrix may not be making full contact with the bar, at times, as it travels along. This delay is purposely made long (about 2 seconds) to allow for the matrix fall-time from the bar, through the channel entrance partitions, and then into the magazines.

NOTE: If tube V1 or relay K1, or both fail, magazines cannot be elevated or fanned. In order to temporarily bypass the safety, thereby making it possible to elevate or fan, the K1 relay can be removed and a jumper applied across terminals 5 and 8 of the K1 relay socket. This will have the same effect as energizing the K1 relay.

ELEVATING AND FANNING SYSTEM
(See Figures 25, 26 and 27)

This system is used to position any one of four magazines over the assembler entrance for the selection of matrices from that magazine (elevation), and to facilitate replacement of any magazine (fanning). The four magazines are carried by a carriage, which is guided and supported by two rails. This carriage is powered hydraulically in the ascending direction by allowing fluid to flow into a cylinder coupled to it at the rear of the machine. It is powered in the descending direction mostly by the force of gravity and partially by hydraulic action. Fluid flow to the cylinder is controlled by the elevation valve solenoid L6, located at the rear right hand side of the base casting; energizing this solenoid will result in the carriage rising and de-energizing the solenoid will allow the carriage to descend. The descending motion is arrested by means of two latches that are fixed to the machine frame and located so that they can each intercept a notched rail on the carriage. These latches may be rotated, so as not to catch the carriage rails, by energizing their associated elevation latch solenoids L4 and L5. Hence, the control circuits are arranged so that: 1 - to raise the carriage, valve solenoid L6 is energized along with the latch solenoids L4 and L5; 2 - to lower the carriage, L6 is de-energized and L4 and L5 remain energized; 3 - to stop the carriage motion, L6 remains de-energized and L4 and L5 are de-energized. These three conditions of solenoids L4, L5 and L6 are repeated in sequence during every "elevation" and "fanning" operation, except that during a "fanning" operation, an additional step occurs between 2 and 3. This step consists in energizing the fanning latch solenoids L2 and L3. These solenoids rotate double-hook latches that are fixed to the machine frame; this action in conjunction with the descending motion of the carriage will produce the desired "spreading" and "fanning" action needed to facilitate magazine replacement.

During every "elevation" and "fanning" operation, the magazine carriage is raised at least 5/8 inches, regardless of its ultimate rest position. This is necessary in order to: 1 - cam the reed rack assembly out of position sufficiently for the reed rack solenoid to hold the rack in an inoperative position; 2 - to allow the elevation latch solenoids L4 and L5 to rotate their latches out of the carriage's path; 3 - to test for the presence of matrices or any other obstructions at the channel entrance and the assembler entrance. The obstruction is sensed at the assembler entrance by a flap and assembler entrance switch MS 9; an interference is sensed at the channel entrance by a similar arrangement consisting of a safety flap and channel entrance safety switch MS 10.

Another safety circuit is provided to prevent "elevation" and "fanning" whenever matrices are on the distributor bar or in the distributor box; this circuit is called the Electromatic Safety. It is described separately under its own heading.

Elevating or Lowering Magazines into Operating Position (See Fig. 25)

As an example, let it be assumed that it is desired to move magazine No. 2 into operating position, whereas magazine No. 4 is already in operating position. Also, let it be assumed that there are no matrices on the distributor bar, in

the distributor box or that there are no matrices caught between the channel entrance and the magazine or caught between the lower end of the magazine and the assembler entrance. In such a case, the following occurs:

After first depressing the "elevate" pushbutton, the magazine selection pushbutton S2 is depressed. This closes all of associated contacts ("a" through "e") of S2 and also operates the latch bar sufficiently to open the "b" contacts of the leaf spring switch S5 until the pushbutton is latched by the bar; then the return motion of the bar allows the S5b contacts to reclose. The S5a contacts are not moved by the release bar during this operation. As soon as the "c" contacts of the pushbutton switch S2 are closed, relay K2 will be energized through a circuit consisting of K1b-N.O. contacts, the "a" contacts of the pushbutton switch S2, a priority network of the normally closed contacts of the magazine carriage position sensing switches MS 2 through MS 5, the relay K2 coil, K3b-N.C. contacts and the pushbutton "c" contacts to ground. The switches MS 1 through MS 5 are located at the rear of the machine and are actuated by a cam attached to the magazine carriage. MS 1 to MS 4 are operated when the carriage is 5/8 inches above the corresponding magazine in operating position; MS 5 is operated when the carriage is 3-1/8 inches above the fourth magazine rest position. (MS 5 switch is used in conjunction with the "fanning" of magazine No. 4 - see under "Fanning".)

The MS 1, 2, 3, 4 and 5 sensing switches are arranged with MS 1 being the lowest and MS 5 the highest. When the No. 1 magazine is in operating position opposite the assembler entrance, for instance, the switch actuating cam attached to the magazine carriage would be 5/8 inches below the MS 1 switch.

The K2a contact of relay K2 provides its own "holding" circuit when the K3b-N.C. contacts are opened, the K2b and K2c contacts are operated to the energized condition, but as yet do not initiate anything.

After the selection pushbutton S2 is latched in the "down" position, relay K3 is energized through S5b contacts and the pushbutton S2c contacts to ground. The subsequent closing of the K3a contacts energize the reed rack solenoid L7; this solenoid will hold the reed rack assembly in an inoperative position once the magazine carriage motion has pivoted the rack as mentioned before. The closing of the K3b-N.O. contacts will put power on the elevation latch solenoids L4 and L5. The closing of the K3c-N.O. contacts will energize the elevation valve solenoid L6, through the contacts of K2c-N.O. and the normally open (but held closed) contacts of MS 9 and MS 10. The energization of the valve solenoid L6 causes the magazine carriage to start moving up the support rails, powered by the hydraulic system. After the carriage has moved up about 1/2 inch, the elevation latches, being powered by solenoids L4 and L5, are free to move out completely from the line of travel of the carriage.

Since the carriage must be positioned lower in order to bring magazine No. 2 into operating position when starting from the No. 4 magazine position (which we are using as an example), the relay K2 will be de-energized when the carriage has risen about 5/8 inches, where the cam attached to the carriage actuates the carriage position sensing switch MS 4. The opening of the K2a contacts prevents re-energization of relay K2 when the cam releases

switch MS 4, since K3b-N.C. contact is now held open by relay K3. The releasing of the normally open contacts of K2c de-energizes the elevation valve solenoid L6, allowing the carriage to descend. The reclosing of the normally closed contacts of K2b sets up an energizing circuit to the key release solenoid L1 when switch MS 2 is actuated. The latter occurs when the carriage is about 5/8 inches above the desired position selected (No. 2 magazine). The circuit consists of contacts K1b-N.O., the "a" contacts of pushbutton S2 to the "e" contacts via the normally closed contacts of S6c and the normally open contacts of the sensing switch MS 2, then through the relay contacts K2b-N.C., solenoid L1 and "c" contacts of the pushbutton switch to ground. The operation of the solenoid L1 causes the release of the pushbutton switch and opens the S5b contacts; the latter drops out relay K3, resulting in the de-energization of elevation latch solenoids L4 and L5, and reed rack solenoid L7. Thus, the elevation latches are free to rotate into the path of the carriage, thereby stopping the descending carriage at the desired position (No. 2 position in this example). Also, the reed rack is now free to rotate back into its operable position.

If the magazine carriage has to move upward or higher to bring the selected magazine to operating position, (when No. 2 magazine is already in operating position and it is desired to bring No. 4 magazine into operating position) the carriage will continue to rise until it is 5/8 inches above the desired position. At this point relay K2 is de-energized due to the actuation of the proper position sensing switch. When the K2b-N.C. contacts are reclosed, the key release solenoid L1 is energized, since the same sensing switch (MS 1 through MS 4) would have closed its normally open contact while the K2b contacts were transferring. The subsequent de-energization of relay K3 and the solenoids L4, L5, L6 and L7 will result in the carriage coming to rest at the selected position.

Fanning a Magazine for Removal (Using Magazine No. 2 as an example)(See Fig. 26)

Pushbutton "FAN" is depressed and latched in the "down" position; this closes contacts S6a and e, and transfers contact S6c and d. Next, Magazine No. 2 pushbutton S2 is depressed. If an unsafe condition exists at the distributor bar or box, or at the assembler entrance or the channel entrance, the selection will be cancelled immediately.

Assuming all safeties are clear, the circuits function the same as discussed under "Elevating" with regard to the energization of relays K2 and K3 and solenoids L4, L5, L6 and L7. Now, however, the relay K2 (and elevation valve solenoid L6) remains energized as long as the carriage is less than 3-1/8 inches (5/8" rise / the 2-1/2" distance between each magazine) above the normal operating position of the magazine being fanned. This is achieved electrically by the S6a contact of the "FAN" switch and the "b" contacts of the pushbutton switch S2. When the carriage is at this 3-1/8 inch point, the fanning latch solenoids L2 and L3 are energized through a circuit consisting of relay contacts K1b-N.O., switch S6a, the "b" contacts of pushbutton S2, to the "d" contacts via the normally open contacts of the sensing switch MS 3 through S6e, solenoids L2 and L3, K2c-N.C. and K3c-N.O. to ground.

The fanning latch solenoids, having been energized, rotate double hook shaped latches into the descending carriage's path. The movement of the left

hand latch also releases the fanning latch switch MS 7, whose normally closed contacts, along with MS 9-N.O. and rectifier SR 5, provides a "holding" circuit for the solenoids L2 and L3. The hooks intercept pins attached half-way up the sides of the magazine frames, and as the carriage continues to descend the desired "spreading" and "fanning" action will be accomplished. When the carriage has descended to a point about 5/8 inches above its final rest position, the key release solenoid L1 is energized (via a circuit that includes the "a" and "e" contacts of the pushbutton S2 and the "c" contacts of S6, the carriage position sensing switch MS 2 and contacts K2b-N.C.) The subsequent dropping out of relay K3 de-energizes solenoids L2, L3, L4, L5 and L7, allowing the carriage to seat on the elevation latches. Thus, the fanning latch solenoids are de-energized at the end of the operation, but, because the fanning latches are hooked to the magazine frame, the fanning latch switch MS 7 is still released.

Electrical Safeties to protect Elektron during Elevating or Fanning of Magazines

If an unsafe condition exists at the distributor bar or box, the electro-matic relay K1 will not be energized, and the key release solenoid L1 will be energized as soon as the "c" contacts of the selection pushbutton switch are closed. This solenoid moves a latching bar, thus preventing latching of the selection button. Also, a leaf spring switch S5 is operated by the motion of the latching bar. This switch has two sets of contacts; the S5a contact serves no purpose and is purposely bent to prevent closure. The opening of the S5b contacts will interrupt the energization of relay K3, preventing any additional operations from taking place.

Assembler entrance safety switch MS 9 and channel entrance safety switch MS 10 also energize the key release solenoid L1 when an unsafe condition exists. The unsafe condition is indicated by energization of the assembler entrance safety lamp I2 or the channel entrance safety lamp I11. The former (I2) is powered via MS 9-N.C. contact (then through SR 36 to solenoid L1); the latter (I11) is powered via MS 9-N.O. contact to MS 10-N.C. contact (then through SR 35 to solenoid L1). The powering of the solenoid L1 will cancel the selection made and allow the carriage to return to its initial rest position.

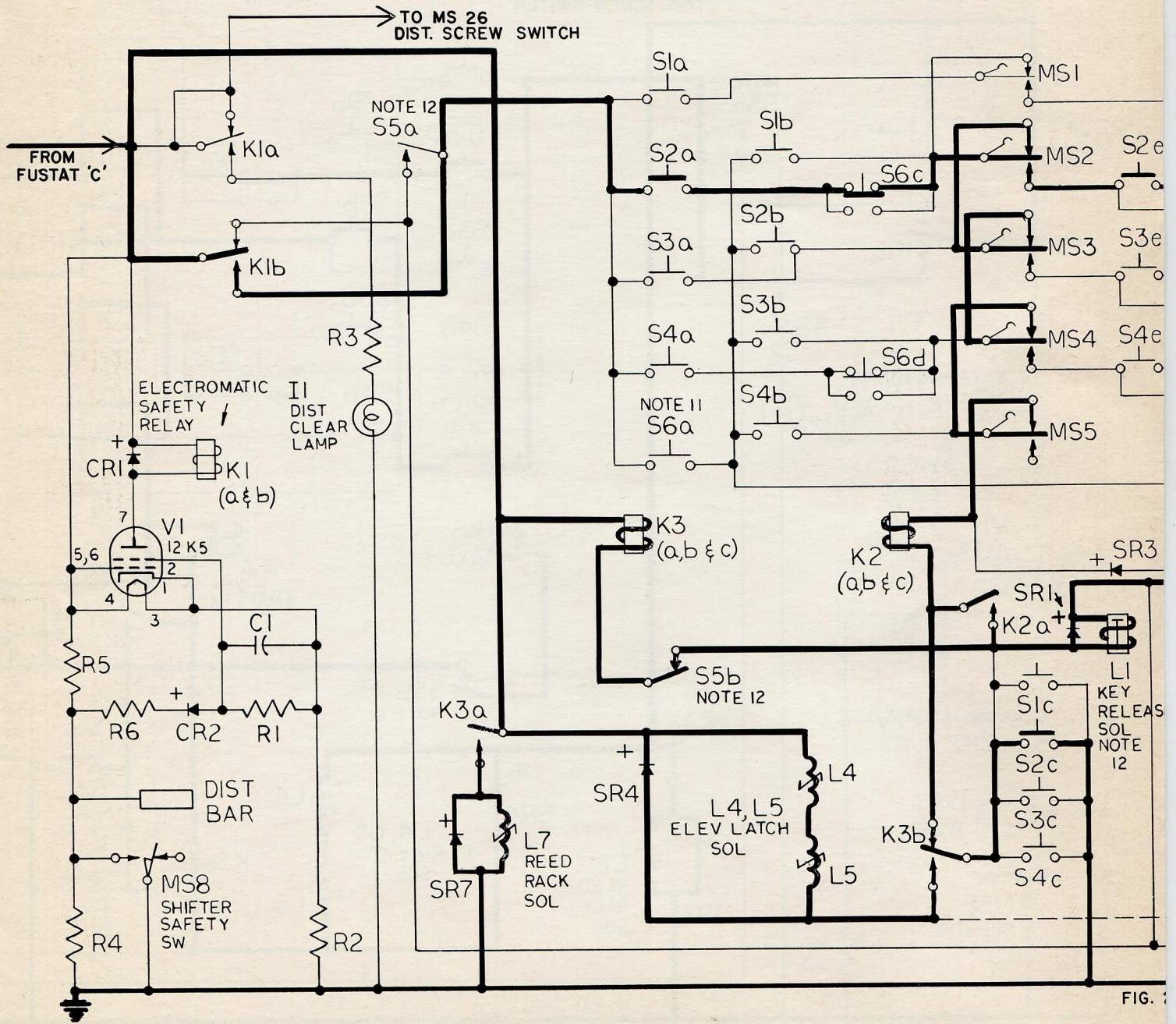

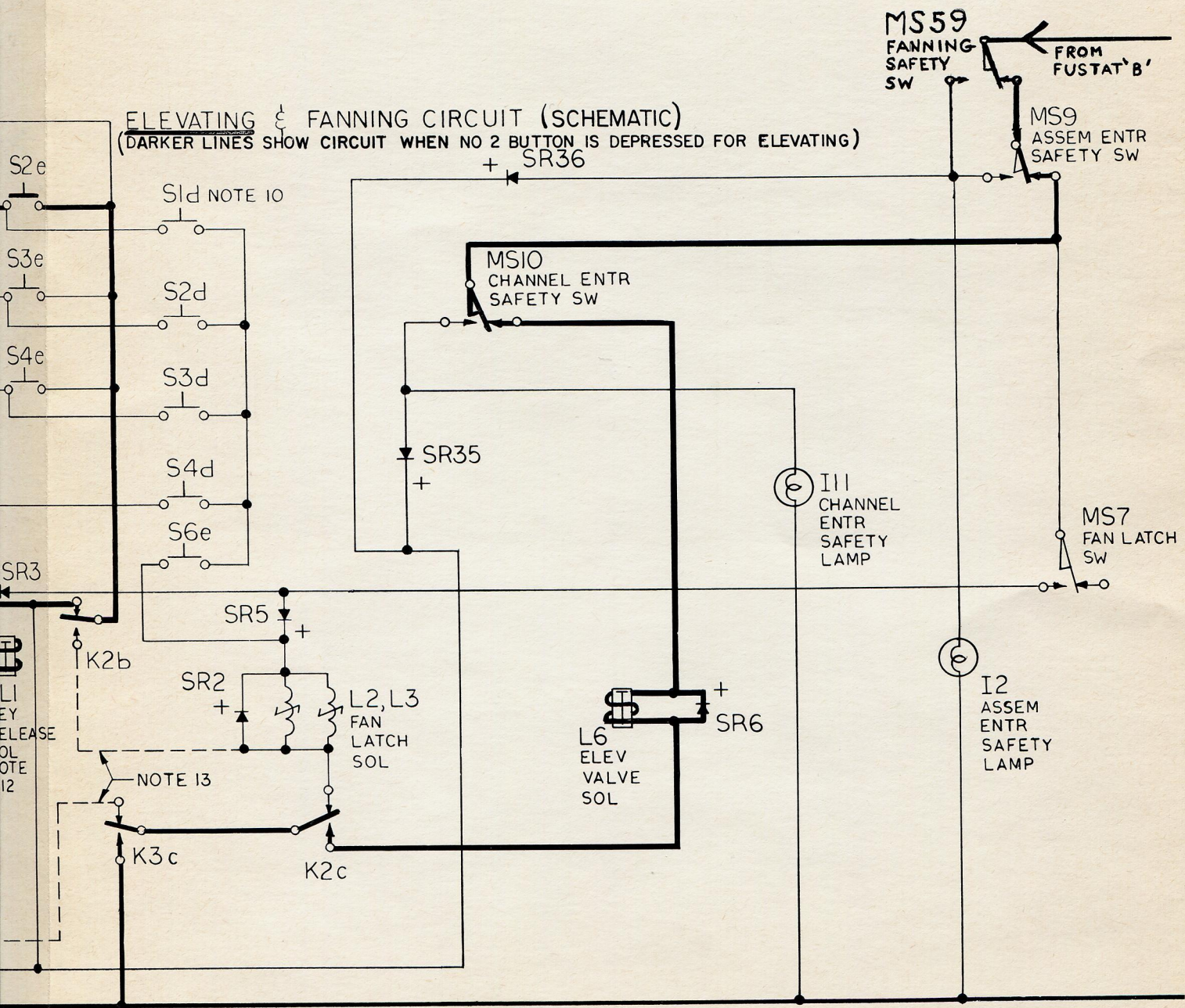
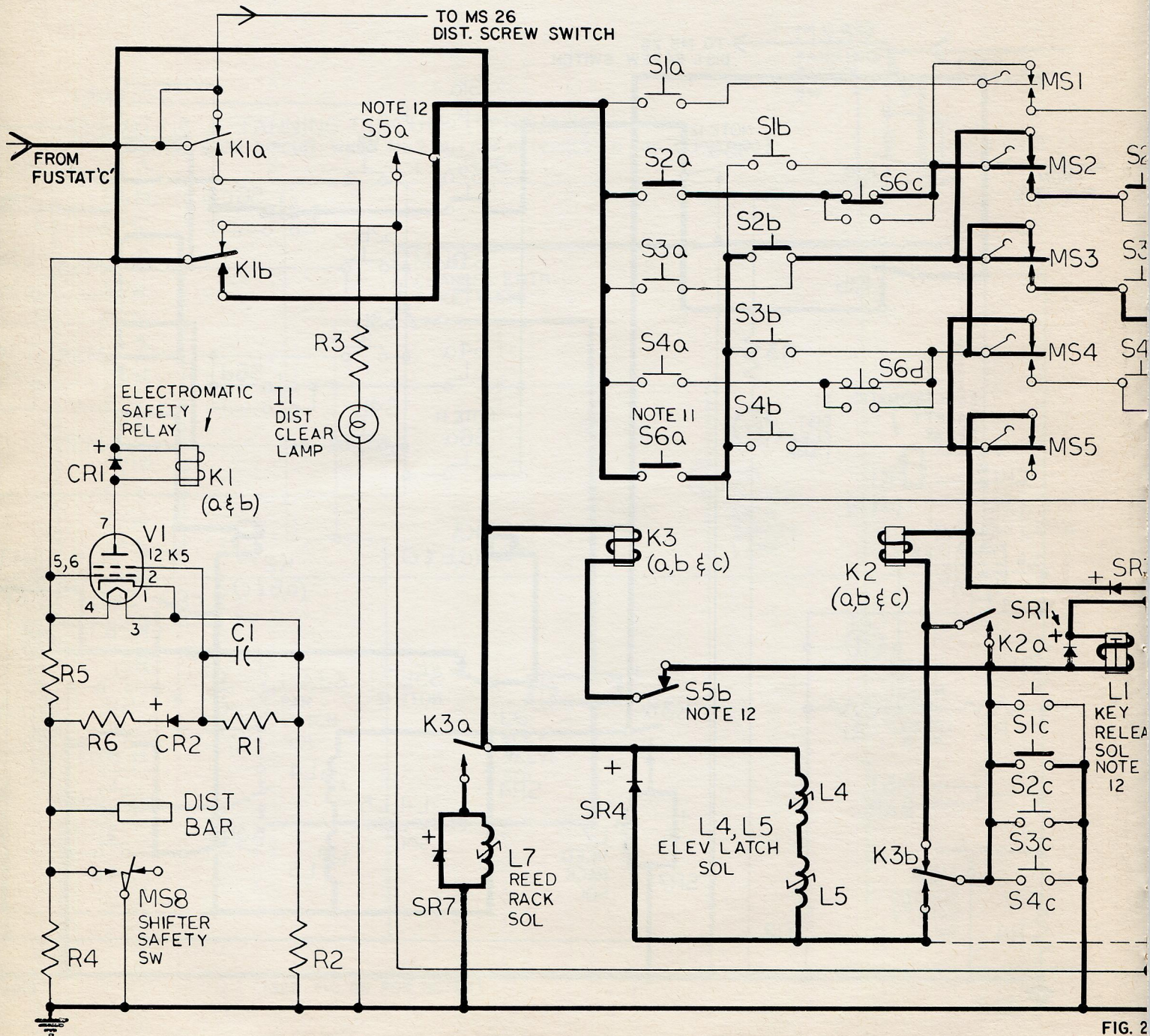
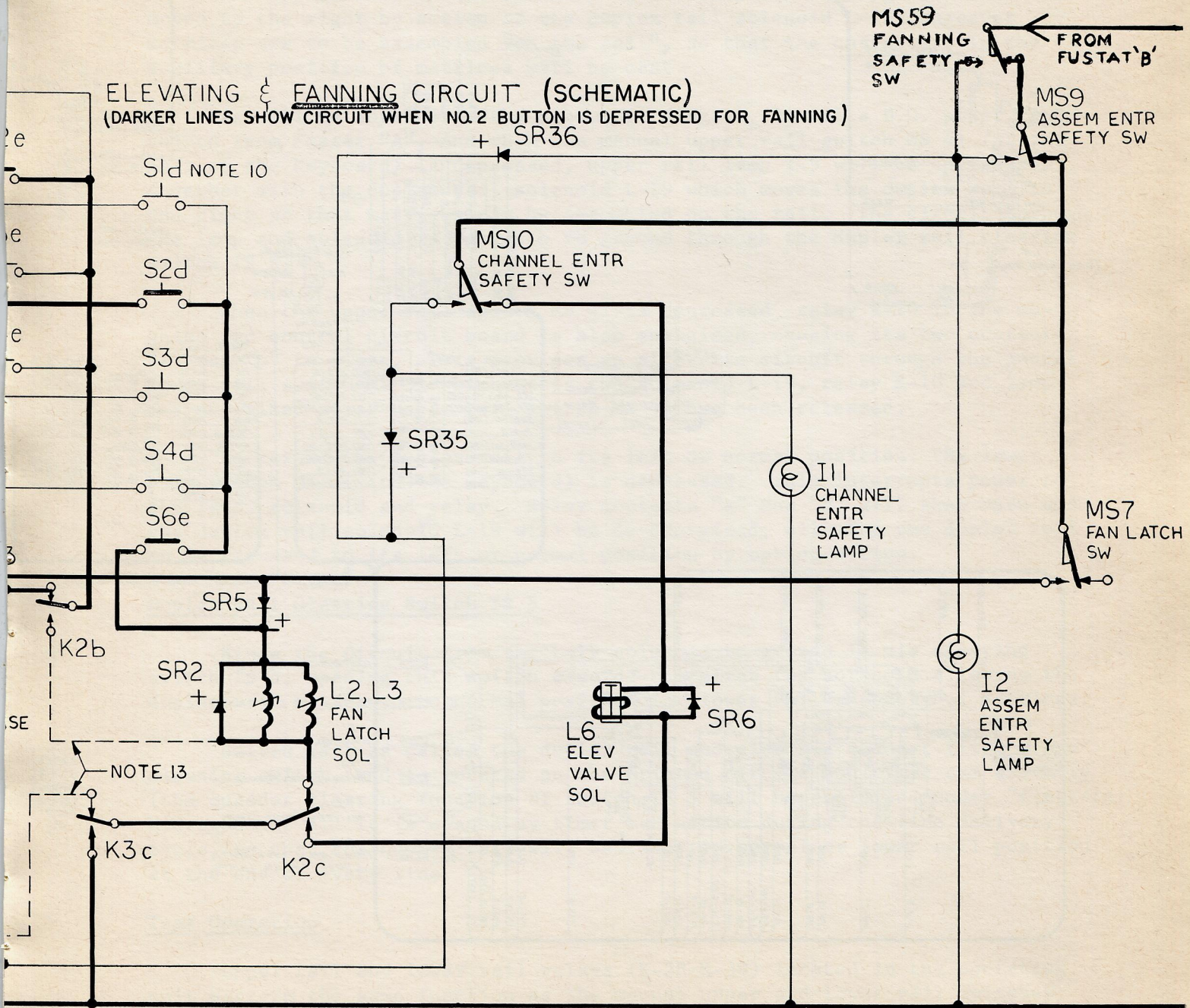

FIG. 25

(SEE FIG. 40 FOR NOTES)



ELEVATING & FANNING CIRCUIT (SCHEMATIC)
(DARKER LINES SHOW CIRCUIT WHEN NO.2 BUTTON IS DEPRESSED FOR FANNING)
+ SR36



(SEE FIG. 40 FOR NOTES)

7 67

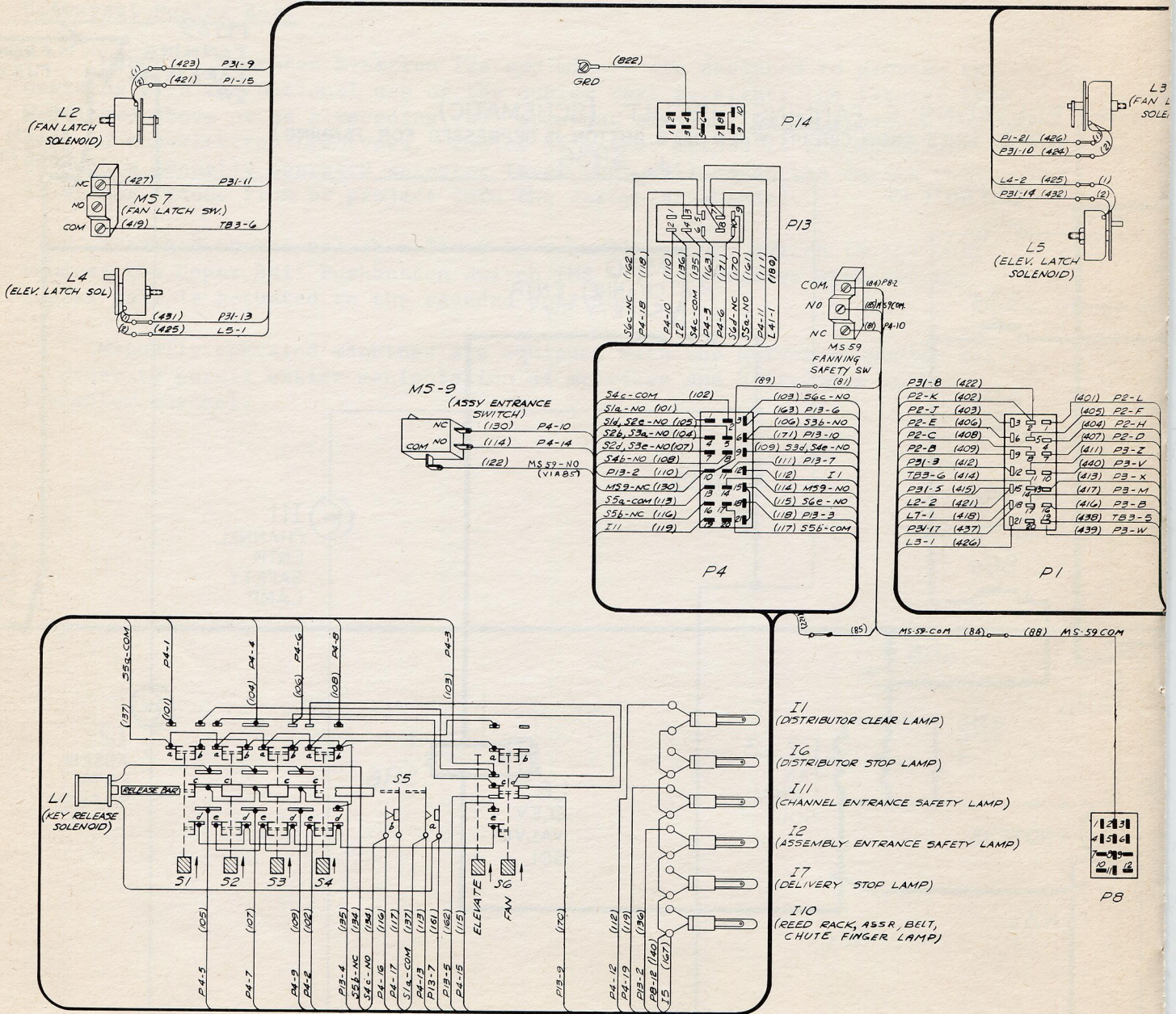

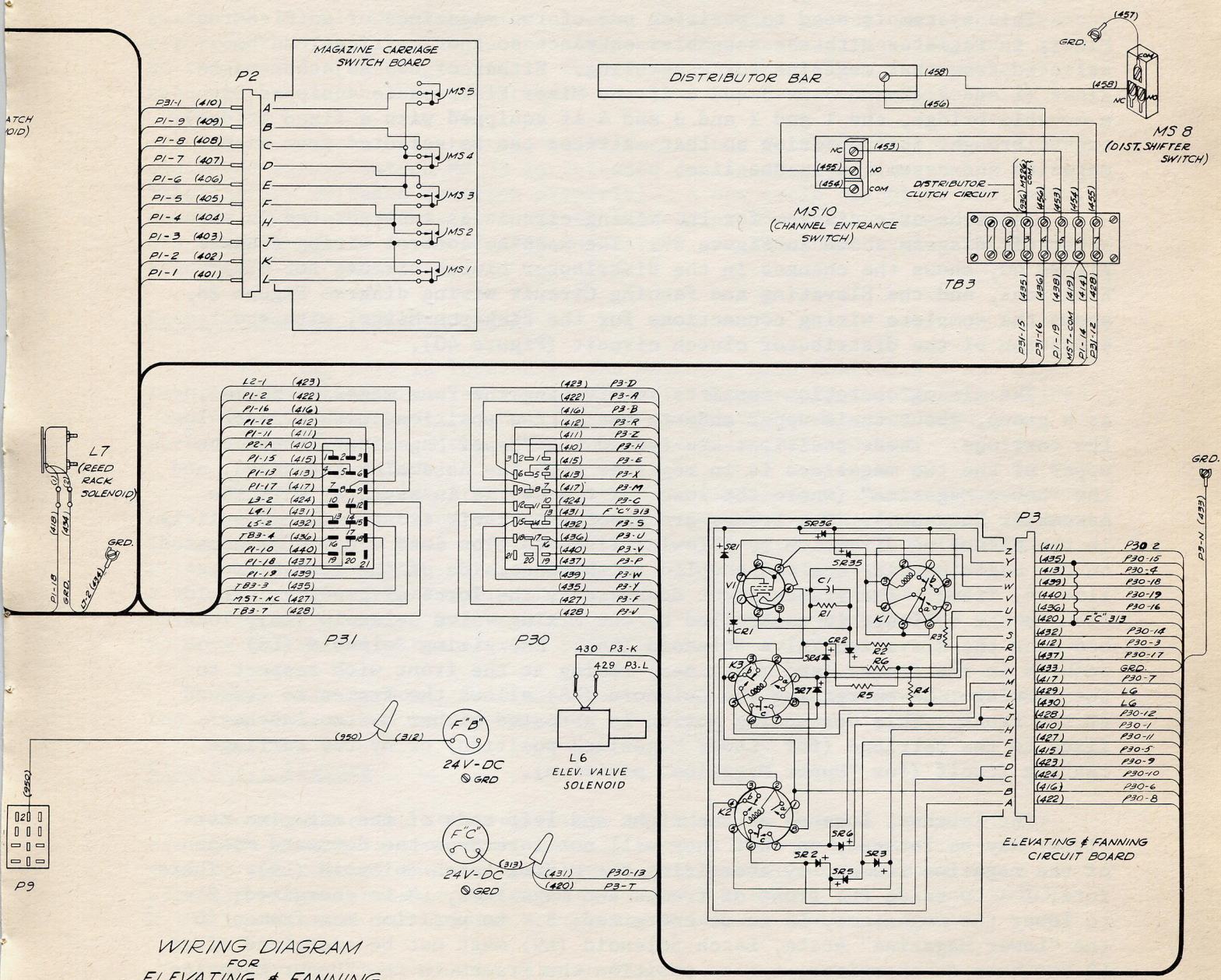

FIG 27

MIXING SYSTEM USED IN THE ELEKTRON MIXER

(See Figures 28, 39, 40)

Description

This system is used to position one of two magazines of an Elektron Mixer, in register with the assembler entrance so that matrices can be selected from that magazine for assembling. Either of two adjacent magazines (1 and 2, 2 and 3 or 3 and 4 if the Mixer Elektron is equipped with a movable bridge, and 1 and 2 and 3 and 4 if equipped with a fixed bridge) can be brought into position so that matrices can be selected from either magazine and assembled in one line.

The schematic diagram for the mixing circuit is incorporated in the schematic diagram shown in Figure 39. The machine control wiring diagram Figure 40, shows the changes in the distributor clutch circuit for Mixer Elektrons, and the Elevating and Fanning Circuit wiring diagram Figure 28, shows the complete wiring connections for the Elektron Mixer, with the exception of the distributor clutch circuit (Figure 40).

The mixing operation consists in pivoting the four magazine frames, as a group, about their upper ends to one of two positions with respect to the carriage. These positions are termed the "Upper Magazine" (where the upper of the two magazines is in register with the Assembler Entrance), and the "Lower Magazine" (where the lower of the two is in register with the Assembler Entrance). The frames are pivoted at their front ends hydraulically in the ascending direction by allowing fluid to flow into a cylinder mounted on the magazine carriage and coupled to the underside of the lowest (magazine #4) frame. The frames pivot downward by the force of gravity. Fluid flow to the cylinder is controlled by the Mixing Valve Solenoid (L8), located near the Elevation Valve Solenoid (L6). Energizing Solenoid (L8) results in the frames (and magazines) rising at the front with respect to the carriage; de-energizing the Solenoid (L8) allows the frames to descend at the front. This descending motion is arrested either by two latches fixed to the carriage (for "Lower Magazine" position) or by the carriage casting itself (for "Upper Magazine" position).

The latches, located at the right and left ends of the magazine carriage, may be rotated, so that they will not intercept the downward motion of the magazine frames, by energizing the Mixing Latch Solenoid (L9). Therefore: 1 - to raise the front of frames and magazines, L8 is energized; 2 - to lower the magazines, L8 is de-energized; 3 - to position the frames in the "Lower Magazine" state, Latch Solenoid (L9) must not be energized after L8 has been de-energized; 4 - to position the frames in the "Upper Magazine" state, Latch Solenoid (L9) must be energized, after L8 has been de-energized, until the front of the frames have descended to a position where the latches cannot check their downward motion.

Mixing may be initiated automatically via a Tape Operated Unit, or manually by depressing either the "upper" magazine switch MS 17 or the "lower" magazine switch MS 16. These two switches are located in the right side of the keyboard.

The Mixing Circuit is powered from Fustat "B" via the normally open contacts of the Assembler Entrance Switch (MS9) and Fanning Latch Switch (MS7). Hence, the circuit is dependent upon the Assembler Entrance being "safe"; if an unsafe condition exists at this location, either before or during the Mixing Operation, switch MS9 will be released, thereby de-energizing the Mixing Circuit and energizing the Assembler Entrance Safety Lamp (I2) and the Stop Relay of a Tape Operated Unit (if present) via "MS9-N.C." and rectifier CR5. After the interference is cleared and the Assembler Front Safety Flap is closed, the red-lighted end of the Mixing Switch must be depressed. This will shift the magazines to the position called for by the tape (or manual) signal. When the magazine shift is complete the memory relay drops out permitting the Operating Unit to start, and removing power from the red lamp. Also, the circuit cannot be energized if any magazine frame is in a "fanned" position; in this case, MS7 will be released to its normal position.

Every Mixing Cycle begins by raising the magazine frames at least 5/8" in order to sense for any obstruction at the Assembler Entrance. Also, this initial motion is necessary when shifting from "Lower" to "Upper" position so that the Mixing Latches may be moved out of the path of the frames, allowing the latter to descend to the carriage stop.

Mixing from "Upper" to "Lower" Magazine position via a tape signal

When a Tape Operated Unit senses a "Lower Magazine" signal, it subsequently closes a switch (L.M.) for about 50 milliseconds. The closing of this switch energizes the Tape Unit's Stop Relay, and Relays K4 and K93. This circuit includes the normally open contacts of three switches: Mixer Position Switch (MS15), Fanning Latch Switch (MS7) and Assembler Entrance Switch (MS9).

The Mixer Position Switch (MS15) is located on the Magazine Frame Carriage Assembly. It is positioned with respect to a cam (that is attached to the piston rod of the Mixing hydraulic cylinder) so that when the frames are in the "Upper Magazine" position, the switch is held actuated and when the frames are in the "Lower Magazine" position, the switch is not actuated. Thus, if the frames are already in the "Lower" position, MS15 will not be actuated, and power will not be routed to the Stop Relay and Relays K4 and K93, as mentioned above. Hence, the frames are not moved and the Tape Operated Unit continues to operate, reading the next signal in the tape.

If the frames are initially in the "Upper" position, MS15 will be actuated and the Stop Relay and Relays K4 and K92 will be energized upon the closing of the switch (L.M.) in the Operating Unit. When contact (9-5) of Relay K4 closes, a holding circuit for the Relay and the Stop Relay is established through the normally closed contact of Valve Limit Switch (MS14); the K4 (10-6) contacts close to energize the Reed Rack Solenoid (L7) which performs the same holding function as in the Elevating and Fanning System; the K4 (12-8) contacts close to energize the Mixing Valve Solenoid (L8). The latter permits the hydraulic system to drive up the lower end of the magazines.

When "Lower Magazine" signal is given, relay K93 is also energized. K93 contacts 6-10 energize red lamp I71. K93 contacts 7-11 provide another holding path to Stop Relay. K93 contacts 5-9 provide holding path for K93.

If Assembler Entrance Safety Switch MS9, is released, Relay K4 will drop out (discussed above). Relay K93 stays energized. After the interference is cleared and Switch MS9 is reset, the "Upper Magazine" lamp (white) I4 will remain lighted, indicating magazine position. "Lower Magazine" signal indicator lamp I71 (red) will also be lighted showing position called for by mixing signal. Since K93 is still energized, the Operating Unit cannot start.

The manual mixing switch must then be depressed, at the red lighted end (lower). The mixing operation will then proceed. When MS15, Mixer Position Switch, is transferred, 24V B+ will be applied between K93 Coil and Resistor R140, dropping out K93, I71, and the Operating Unit Stop Relay.

The Mixer Position Switch (MS15) is released when the frames have risen about 1/2 inch, since the piston rod and attached cam moves along with the frames. This action de-energizes the Upper Magazine Lamp (I3) and K93 and energizes the Lower Magazine Lamp (I4); it also puts Relay K4 under the control of only the Valve Limit Switch (MS14). After the lower ends of the magazines have risen a total of 3-1/8 inches, the piston rod cam actuates the Limit Switch (MS14), located on the Carriage Assembly near MS15. This interrupts power to Relay K4, which drops out, thereby de-energizing the Valve Solenoid (L8) and Reed Rack Solenoid (L7). The frames now start to descend, but this motion is checked by the Mixing Latches; these latches are now in the path of the lowest frame because the return spring of the latches rotated them into position while the frames were at the upper limit of their travel.

During the initial movement of the frames, the Reed Rack Assembly is cammed out of operable position and held in this position by the Reed Rack Solenoid (L7). This action releases the Reed Rack Switch (MS6); this switch energizes the Reed Safety Lamp (I10) and provides a "holding" circuit to the Stop Relay via rectifier SR34. Therefore, when Relay K4 is de-energized, the Operating Unit does not restart, because from this point on the Stop Relay is held energized until the Reed Rack has returned to operable position. The latter condition is satisfied only when the frames (and magazines) have returned to a rest position. When this position is reached, the switch MS6 is actuated by the Reed Rack; the Stop Relay is released and the Operating Unit proceeds to read the next signal in the tape.

Mixing from "Lower" to "Upper" magazine position via a tape signal

When a Tape Operated Unit senses an "Upper" Magazine signal, it closes a switch (U.M.) for about 50 milliseconds. Assuming the safety switches MS7 and MS9 are in their "safe" condition, the closing of the "U.M." switch will energize relays K4, K5 and K92 and the Stop Relay if the Mixer Position Switch (MS15) is in the "Lower" Magazine position (not actuated). If this switch (MS15) should be actuated (indicating that the magazines are in the "Upper" position), then the Relays K4, K5 and K92 and Stop Relay will not

be energized. Hence, the frames are not moved and the Operating Unit continues on to read the next tape signal. Assume that the switch MS15 is not actuated. Power will be routed through switch "MS15-N.C." and "U.M." switch in the Operating Unit, then: 1 - to Relay K5 and Stop Relay via rectifier CR4 and CR9; 2 - to relay K4 and Stop Relay via rectifier CR3 and CR140; and 3 - to Relay K92 via rectifier CR110. As before, the energizing of Relay K4 results in: 1 - a "holding" circuit for Relay K4 and Stop Relay via the Valve Limit Switch (MS14) and the K4 (9-5) contacts; 2 - via the K4 (10-6) contacts energizes the Reed Rack Solenoid (L7) through CR7; 3 - via the K4 (12-8) contacts energizes the Mixing Valve Solenoid (L8).

The energization of Relay K5 results in: 1 - a "holding" circuit for Relay K5 and Stop Relay via Mixer Position Switch (MS15-N.C.) and the K5 (9-5) contacts and CR9; 2 - via the K5 (10-6) contacts and CR8 keeps the Reed Rack Solenoid (L7) energized after the K4 (10-6) contacts have reopened; 3 - via the K5 (10-6) contacts also energizes the Mixing Latch Solenoid (L9); 4 - via the K5 (12-8) contacts energizes the Safety Flap Solenoid (L41) so long as the K4 (10-6) contacts are closed. The frames are thus powered up by the hydraulic system; as they lift off the latches, the latter are rotated by the Latch Solenoid (L9), so that by the time the ends of the magazines have been lifted 1/2", the latches are completely out of the path of the magazine frames.

When "Upper Magazine" signal is given, relay K92 is also energized. K92 contacts 6-10 energize red lamp I70. K92 contacts 7-11 provide another holding path to Stop Relay. K92 contacts 5-9 provide holding path for K92.

At the beginning of this travel, the Assembler Entrance Safety Flap extends, by action of Solenoid L41, to sense the presence of any matrix protruding from the Lower Magazine. If MS9 is actuated, K4 and K5 drop out. Relay K92 remains energized. After MS9 is reset, the "Lower Magazine" lamp (white) I4 will remain lighted. "Upper Magazine" signal lamp I70 (red) will be lighted.

The manual mixing switch must then be depressed at the red lighted end (upper). The mixing operation will then proceed. When MS15 is transferred, 24V B+ is applied between the K92 Coil and Resistor R139, dropping out K92, I70, and the Operating Unit Stop Relay.

If MS9 is not released during mixing, K92 or K93 will be dropped out as MS15 transfers, with no effect on machine or operating unit operation.

At the beginning of travel, the Reed Rack is cammed out of its operable position and subsequently held out by the Solenoid (L7). When the lower end of the Magazines are 5/8" from their initial rest position, the Valve Limit Switch MS14 is actuated, thereby de-energizing Relay K4; the opening of the K4 (10-6) contacts de-energizes the Safety Flap Solenoid (L41), causing the Safety Flap to retract and the opening of the K4 (12-8) contacts de-energizes the Valve Solenoid (L8), causing the magazines and frames to descend.

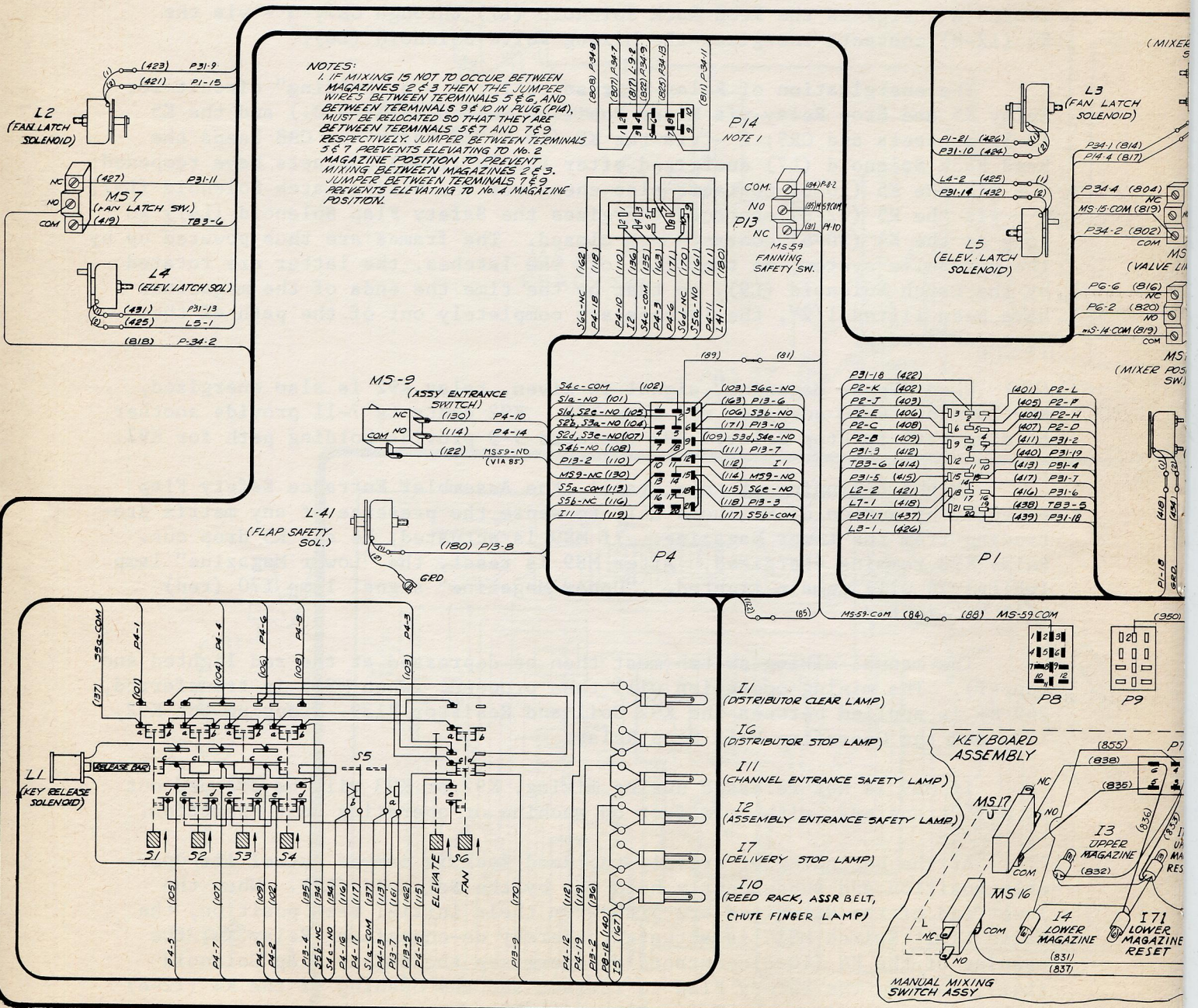

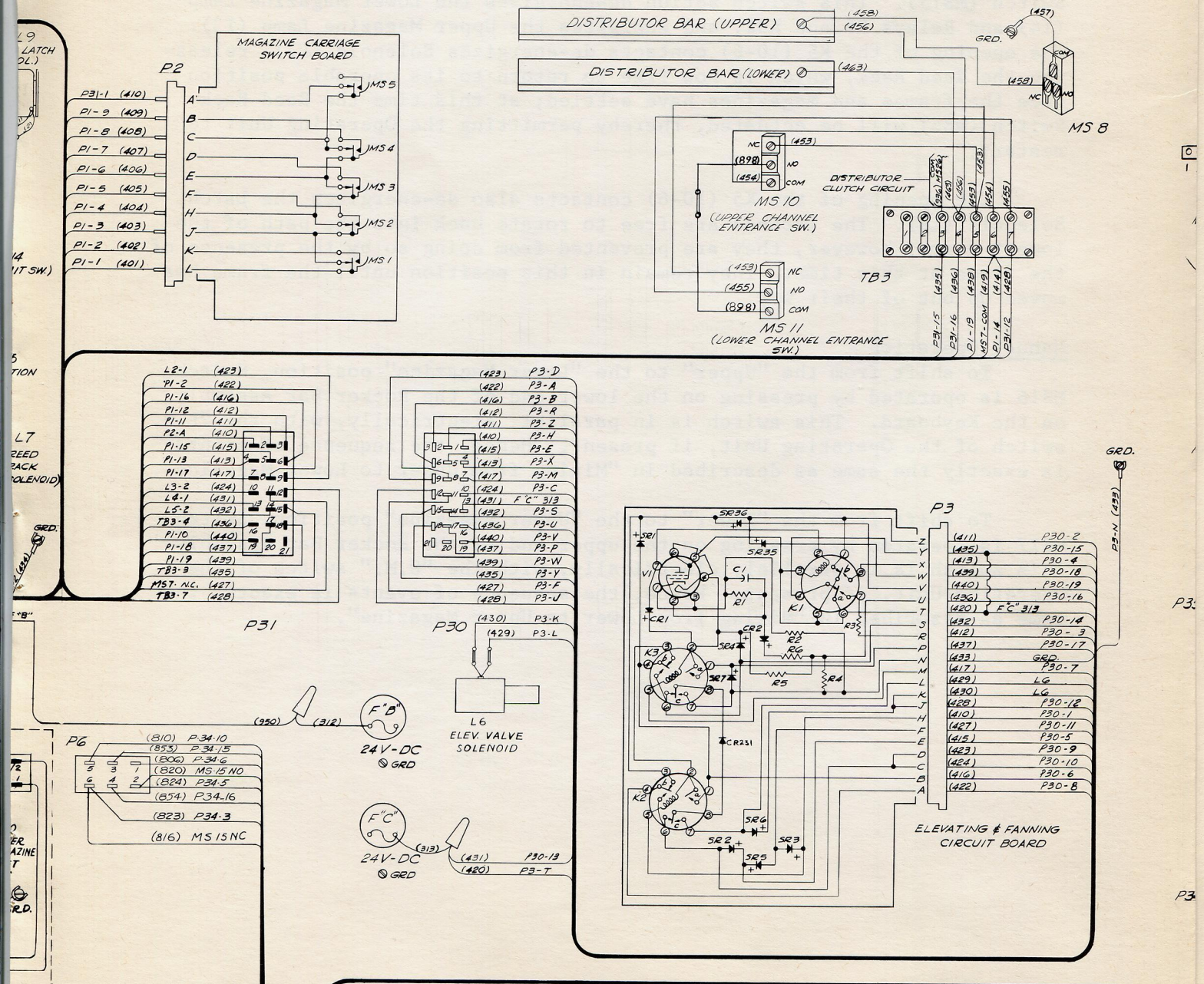

WIRING DIAGRAM FOR
ELEVATING, FANNING & MIXING
FOR MIXER ELEKTRON
FIG. 28

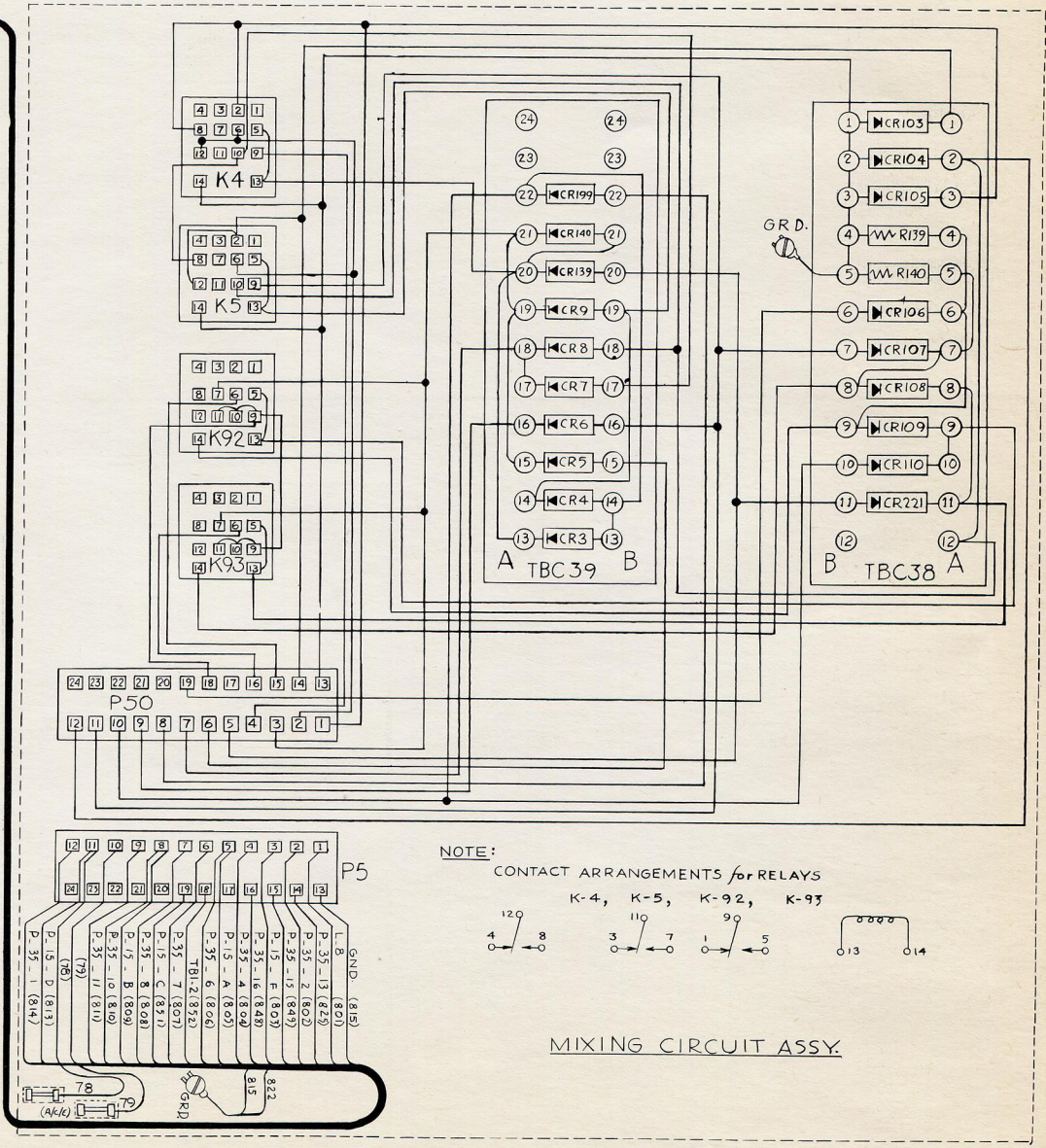
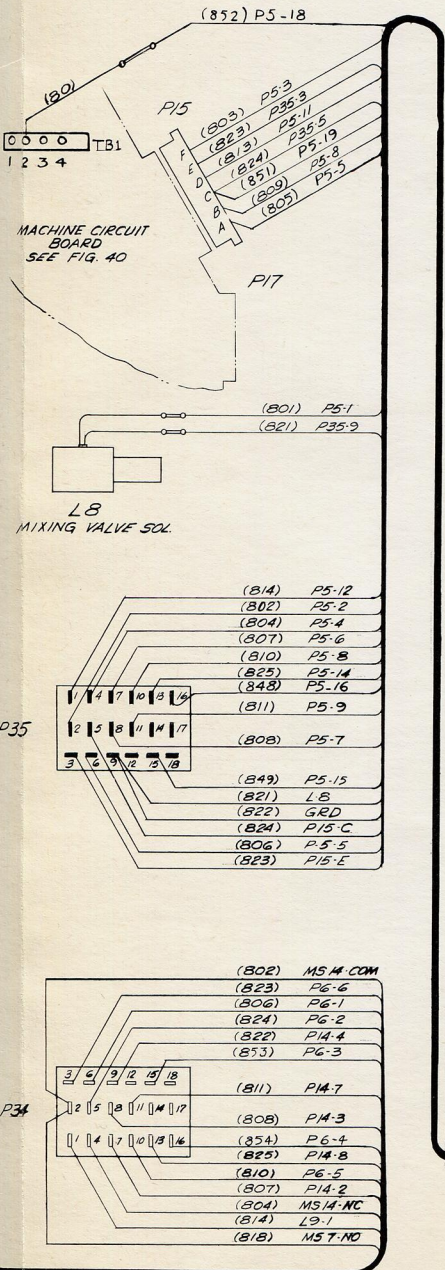

Since Relay K5 is still energized, the opening of contacts K4 (10-6) does not result in the de-energization of Reed Rack Solenoid (L7). With the latches held out of the way by the Solenoid (L9), the frames are free to rotate down to the carriage casting stops. About 1/2" before reaching these stops, the piston cam, referred to above, actuates the Mixer Position Switch (MS15). This switch action de-energizes the Lower Magazine Lamp (I4) and Relays K5 and K92, and energizes the Upper Magazine Lamp (I3). The opening of the K5 (10-6) contacts de-energizes Solenoid (L7), releasing the Reed Rack, which is now free to return to its operable position once the frames and magazines have settled; at this time the Reed Rack Switch (MS6) will be actuated, thereby permitting the Operating Unit to restart.

The opening of the K5 (10-6) contacts also de-energizes the Latch Solenoid (L9). The latches are free to rotate back into the path of the lowest frame; however, they are prevented from doing so by the presence of the frame at this time. They remain in this position until the frame has moved up out of their way.

Manual Operation

To shift from the "Upper" to the "Lower Magazine" position, Switch MS16 is operated by pressing on the lower end of the Rocker Bar Assembly on the Keyboard. This switch is in parallel, electrically, with the "L.M." switch of the Operating Unit, if present. Hence, the sequence of events is exactly the same as described in "Mixing from Upper to Lower Magazine".

To shift from the "Lower" to the "Upper Magazine" position, Switch MS17 is operated by pressing on the upper end of the Rocker Bar Assembly. This switch is in parallel, electrically, with the "U.M." switch of the Operating Unit, if present. Hence, the sequence of events is exactly the same as described in "Mixing from Lower to Upper Magazine".

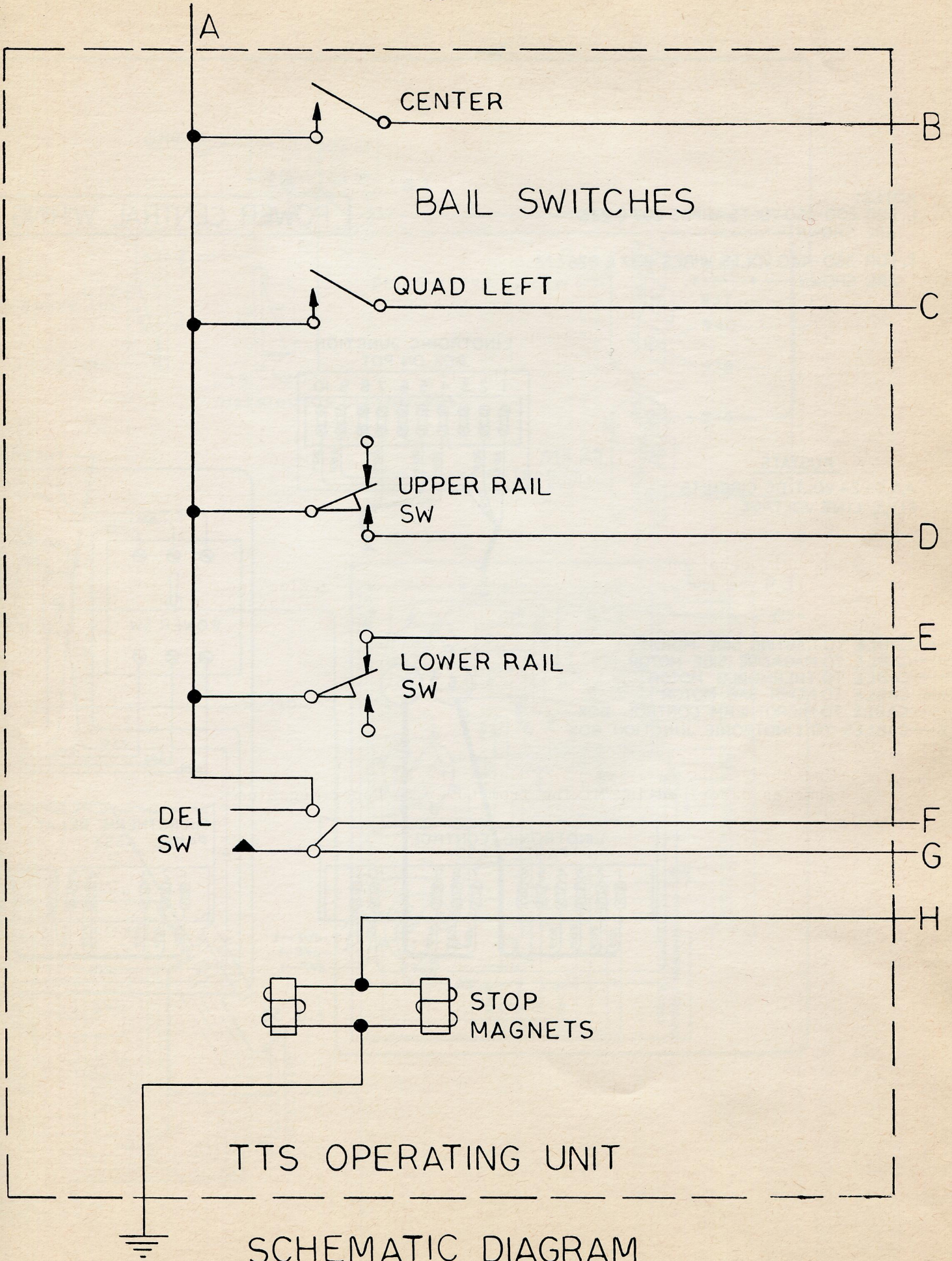

TTS OPERATING UNIT
SCHEMATIC DIAGRAM

FIG. 29

NOTES:

1. FOR 200-250 VOLTS WIRES 207 & 226 ARE SHOWN - - - - -.
2. FOR 360-440 VOLTS WIRES 207 & 226 ARE SHOWN — + — +.

FUSTATS

A,B,C-24 VOLT DC CIRCUITS
F1,2,3, LINE VOLTAGE

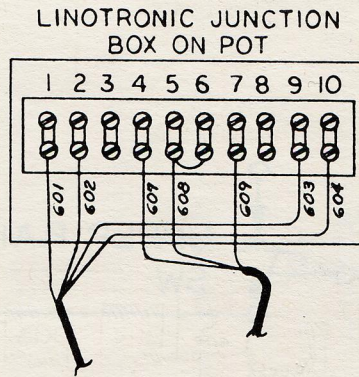

POWER CENTRAL WIRING - TH

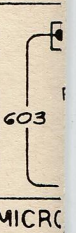

- 1—CABLE TO CASTING SIDE MOTOR
- 2—CABLE TO MAGAZINE SIDE MOTOR
- 3—CABLE TO THERMOBLO MOTOR
- 4—CABLE TO MOHR SAW MOTOR
- 5—CABLE TO MICROTHERM CONTROL BOX
- 5,6—CABLES TO LINOTRONIC JUNCTION BOX

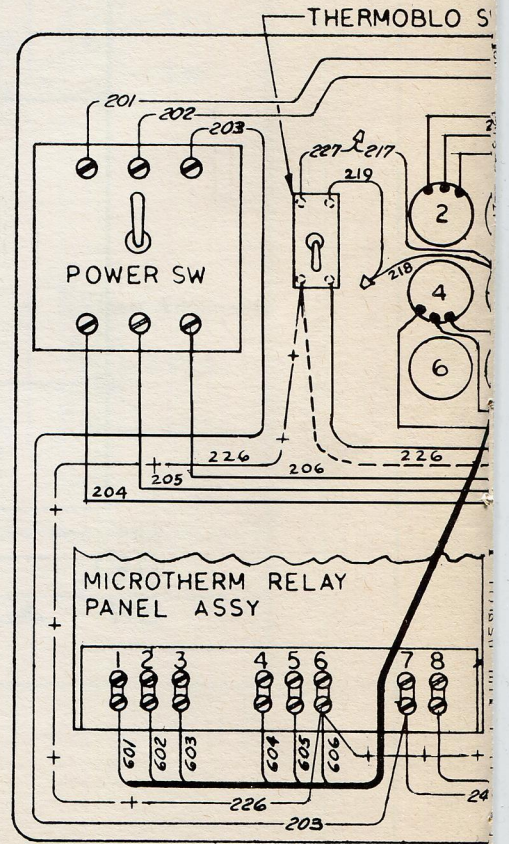
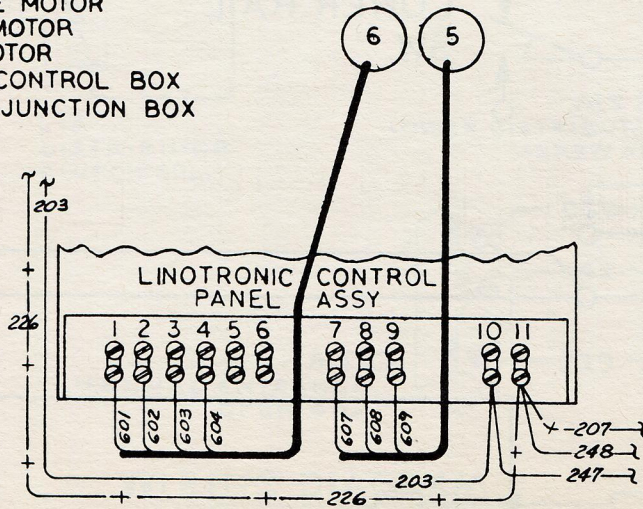
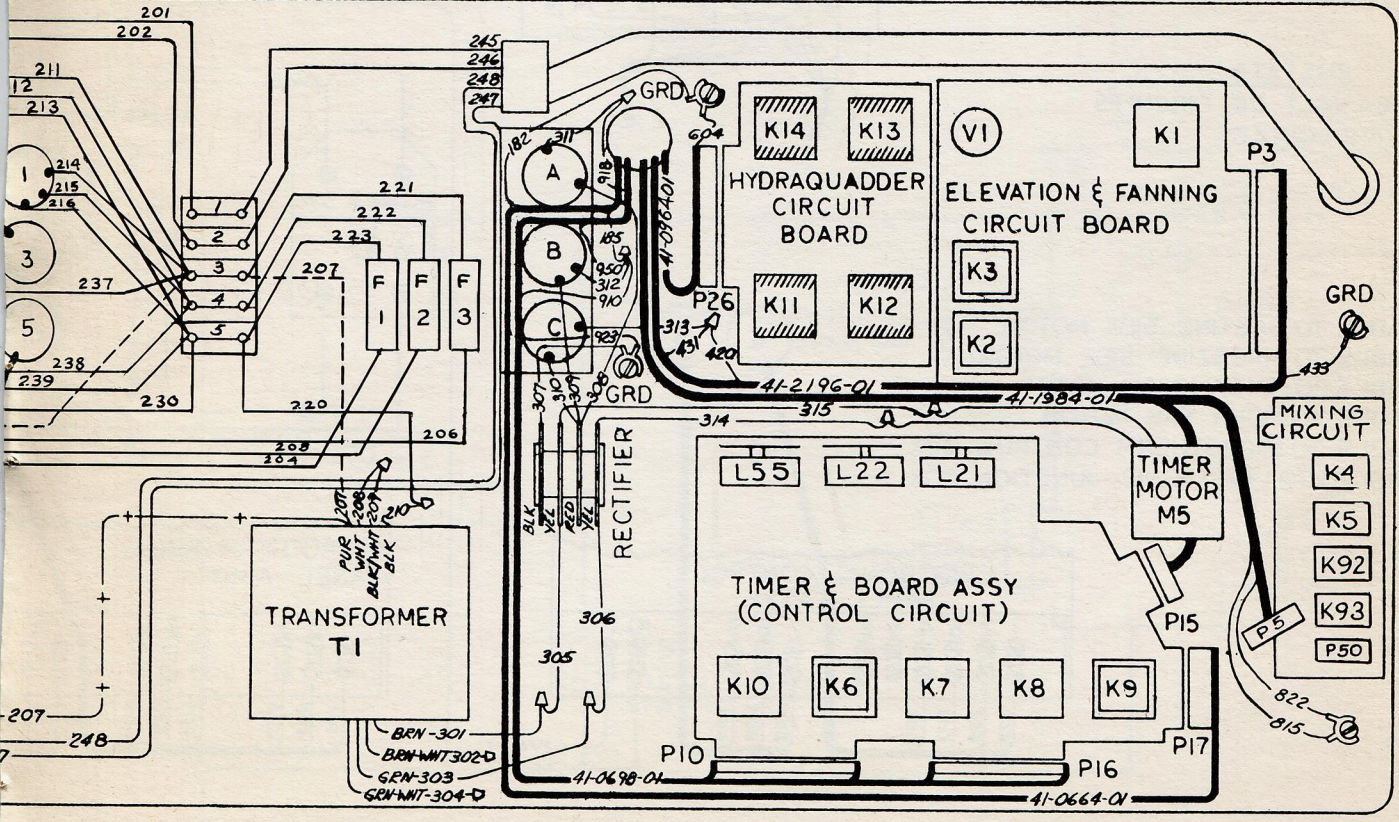
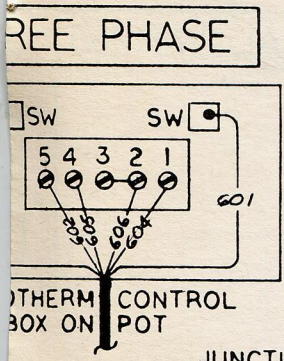
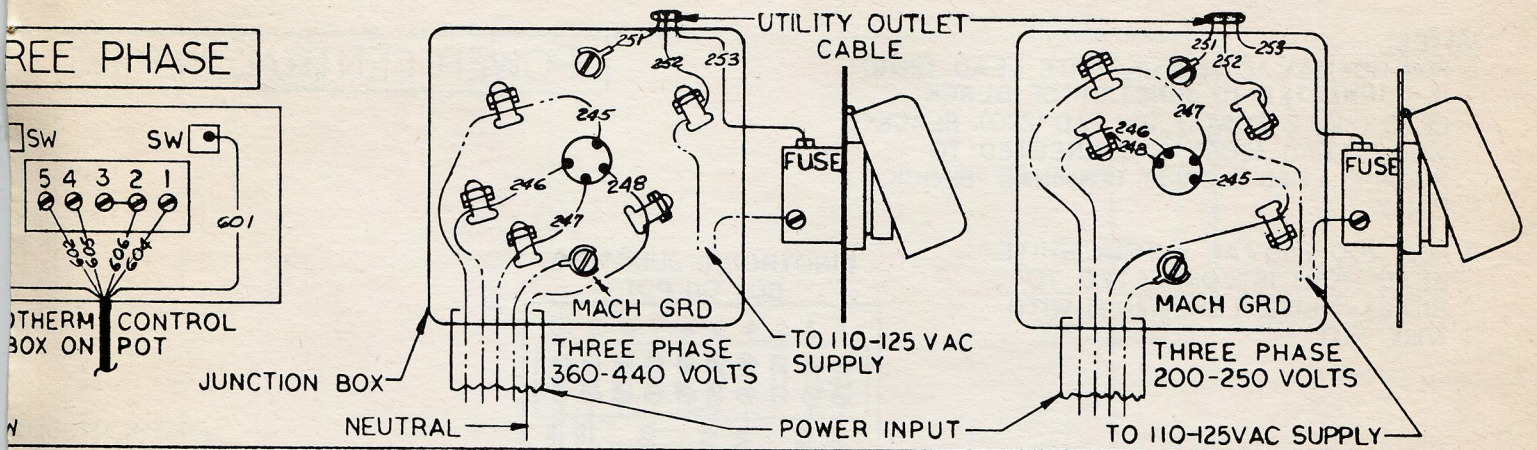

FIG. 30



NOTES:

1. FOR 110-125V AC SUPPLY, WHITE LEAD (208) IS CONNECTED TO JUNCTION OF BLACK LEAD (210) & FUSTAT "J" LEAD (220). BLACK-WHITE LEAD (209) IS CONNECTED TO PURPLE LEAD (207) AT TERMINAL BLOCK PIN 3.
2. FOR 200-250V AC SUPPLY, WHITE LEAD (208) IS CONNECTED TO BLACK-WHITE LEAD (209) WITH WIRE NUT.

POWER CENTRAL WIRING - S

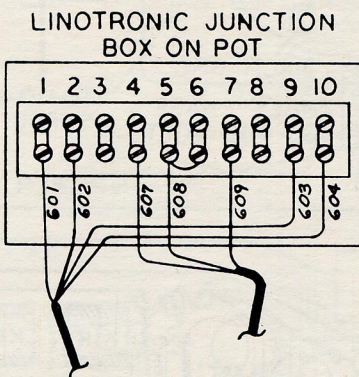

FUSTATS
A,B,C-24 VOLT DC CIRCUITS
F,1,2 LINE VOLTAGE

1. CABLE TO CASTING SIDE MOTOR
2. CABLE TO MAGAZINE SIDE MOTOR
3. CABLE TO THERMOBLO MOTOR
4. CABLE TO MOHR SAW MOTOR
5. CABLE TO MICROTHERM CONTROL BOX
- 5,6. CABLES TO LINOTRONIC JUNCTION BOX

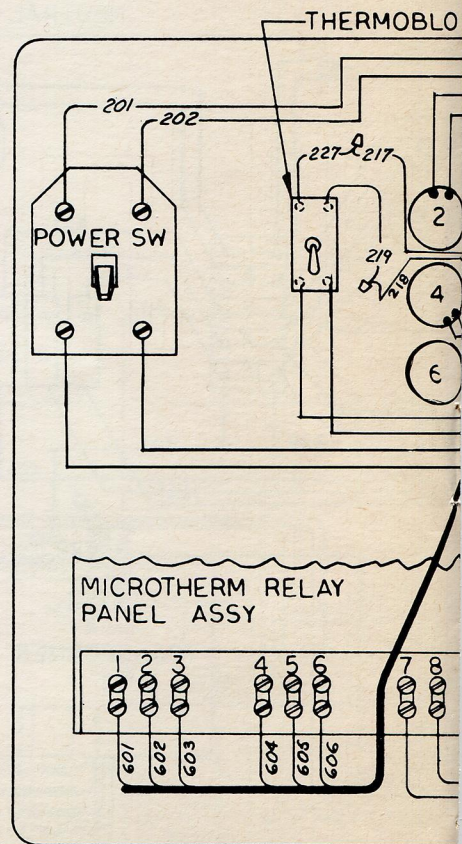
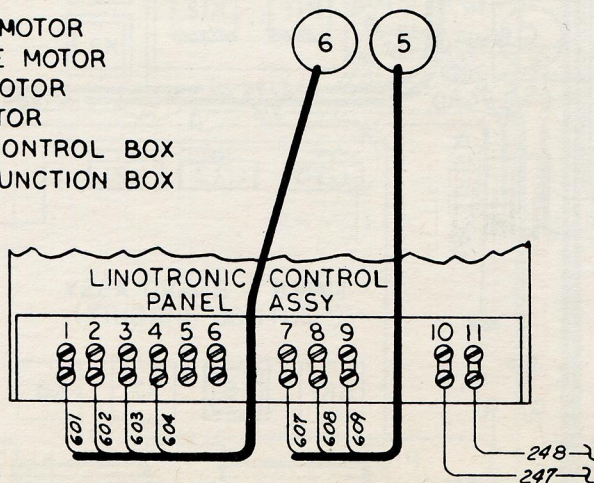

SINGLE PHASE

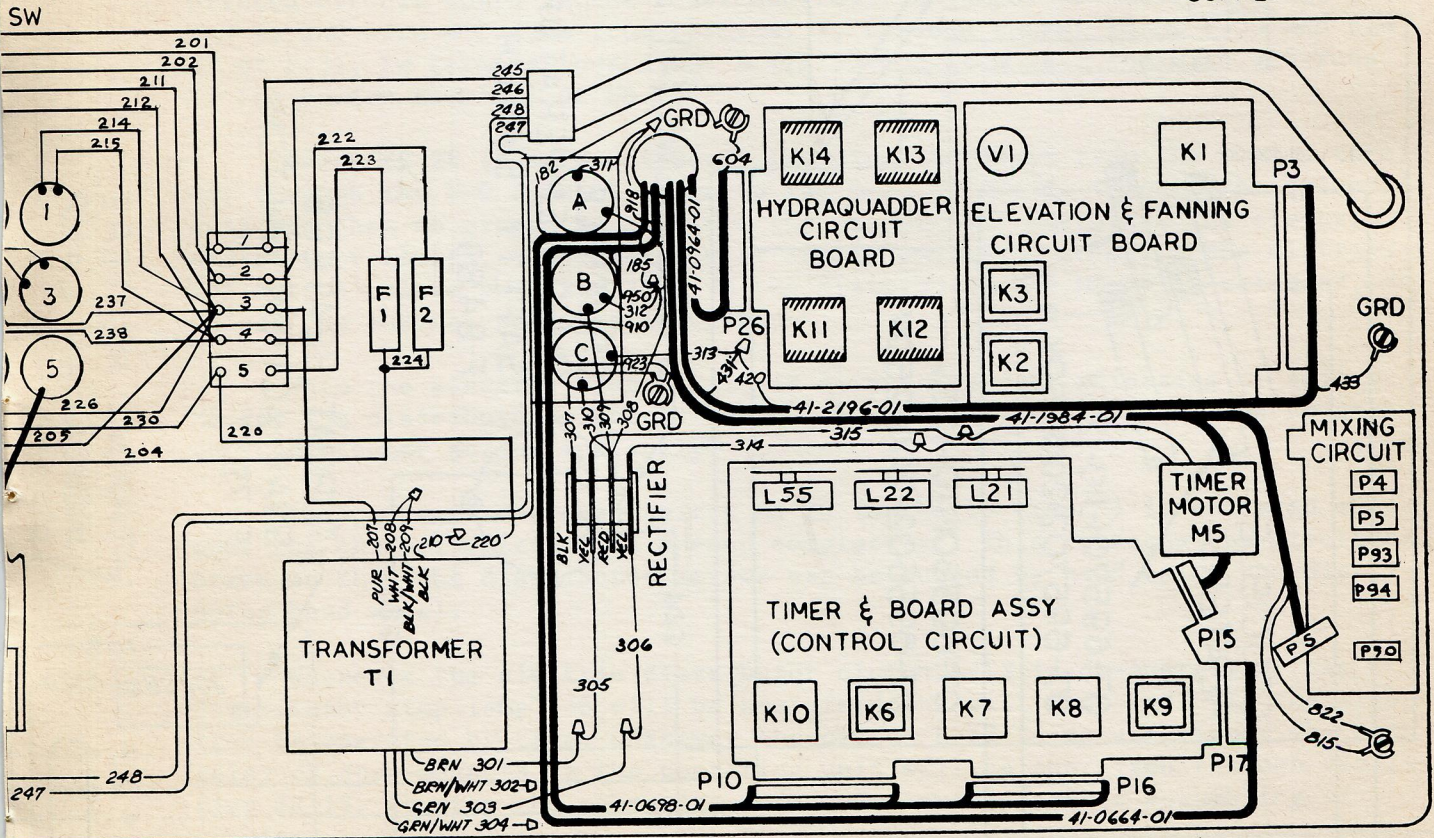
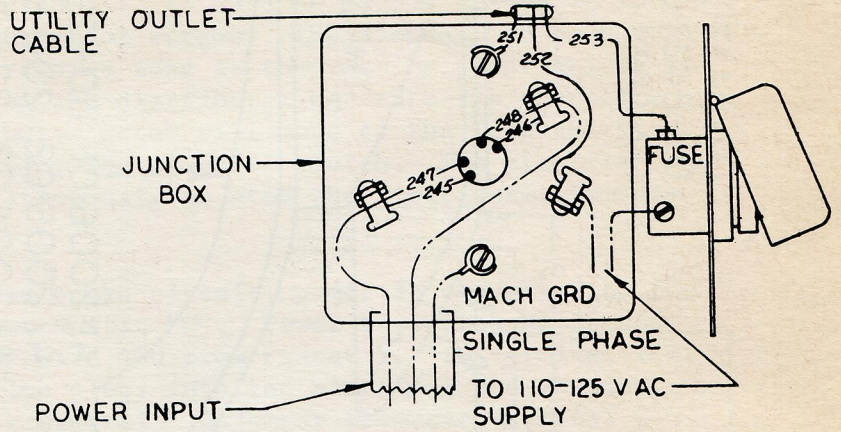
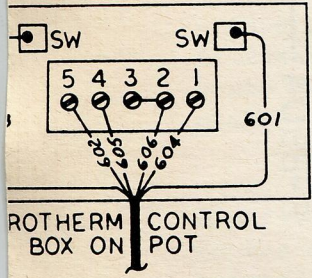
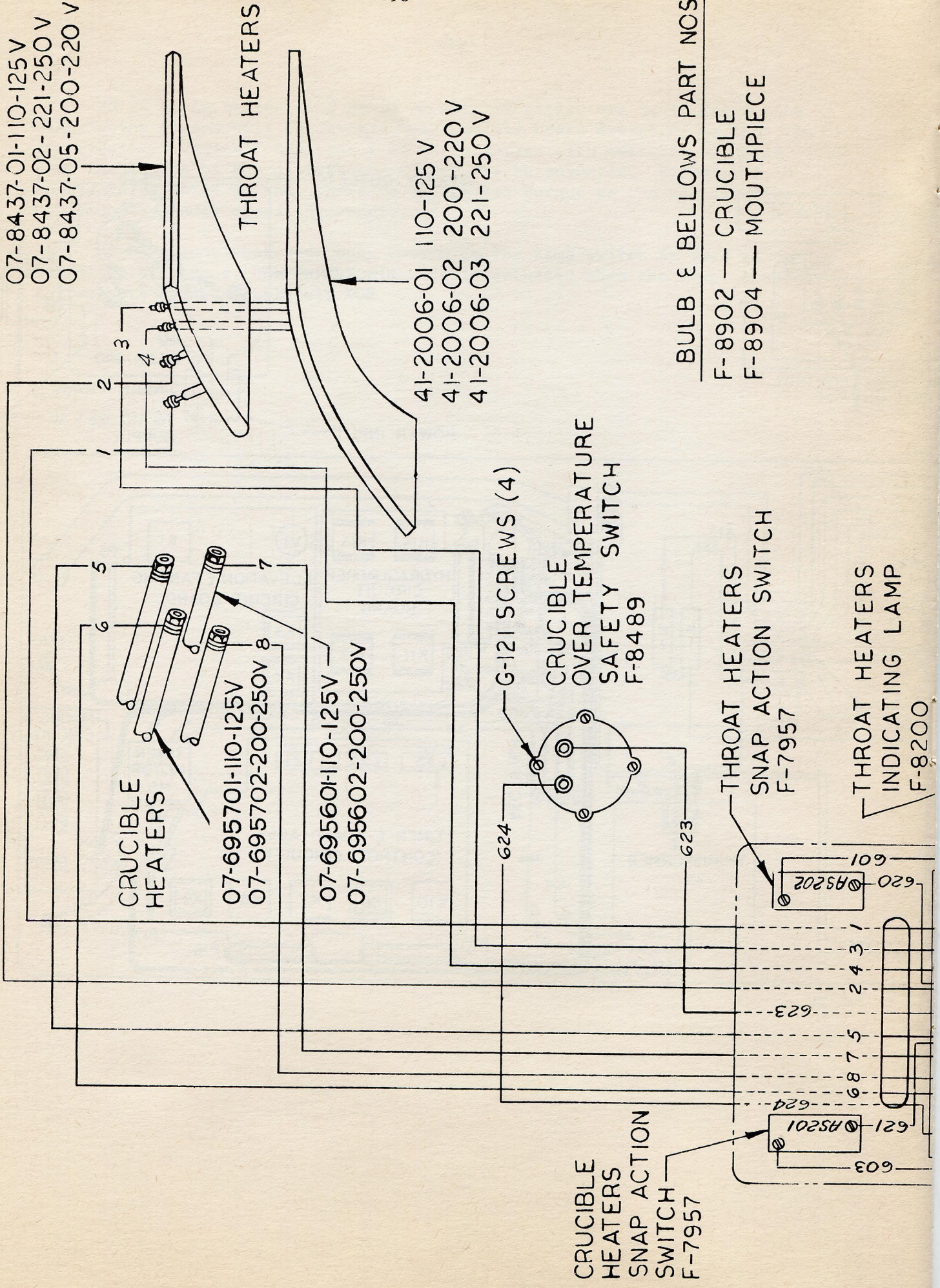

FIG. 31



- BULB & BELLOWS PART NOS
- F-8902 — CRUCIBLE
- F-8904 — MOUTHPIECE

CRUCIBLE HEATERS SNAP ACTION SWITCH F-7957

CRUCIBLE OVER TEMPERATURE SAFETY SWITCH F-8489

THROAT HEATERS SNAP ACTION SWITCH F-7957

THROAT HEATERS INDICATING LAMP F-8200

CRUCIBLE HEATERS

07-695701-110-125V
07-695702-200-250V

07-695601-110-125V
07-695602-200-250V

07-8437-01-110-125V
07-8437-02-221-250V
07-8437-05-200-220V

THROAT HEATERS

41-2006-01 110-125V
41-2006-02 200-220V
41-2006-03 221-250V

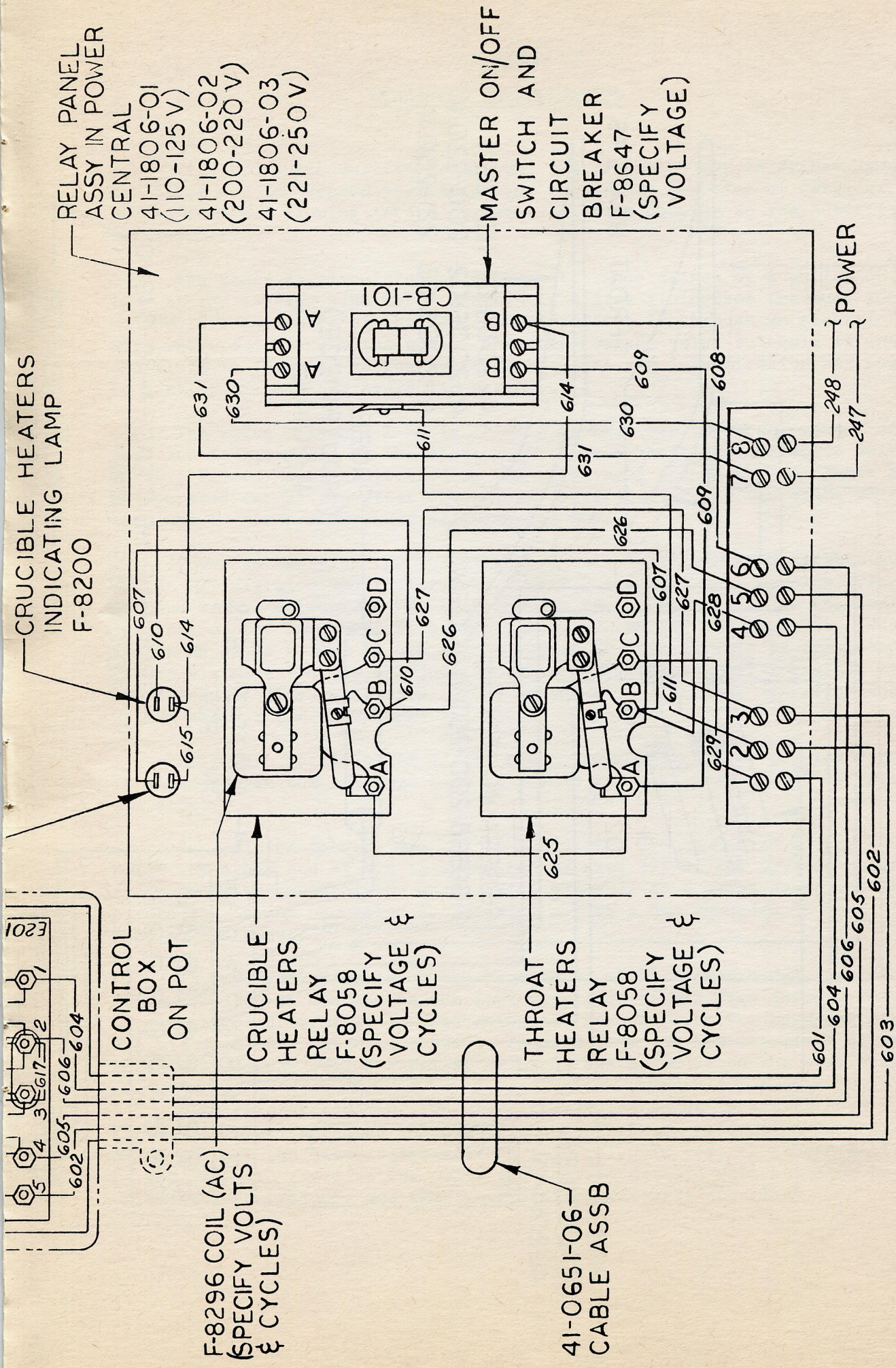

UNIVERSAL MICRO-THERM ELECTRIC POT WIRING DIAGRAM

FIG. 32

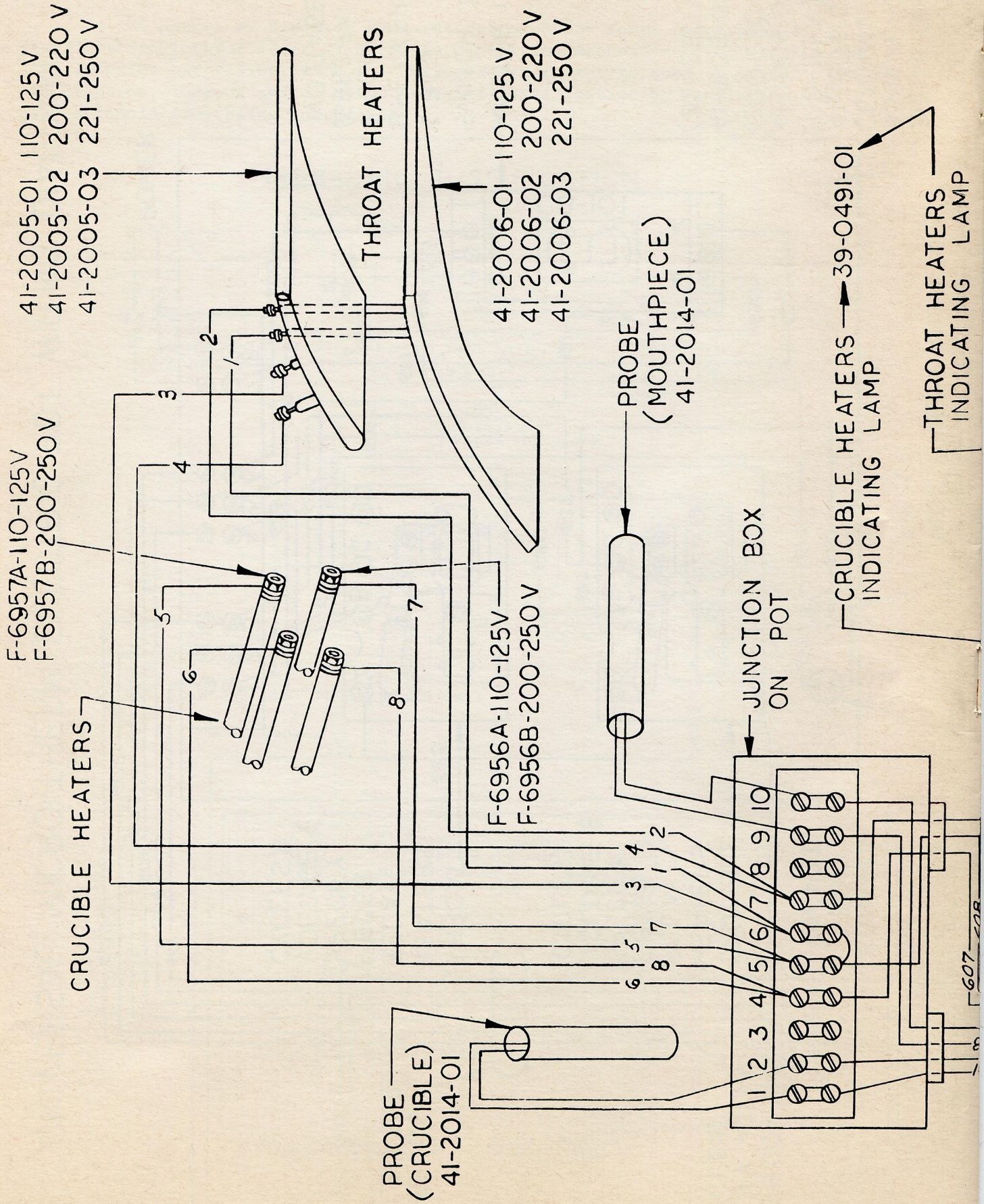

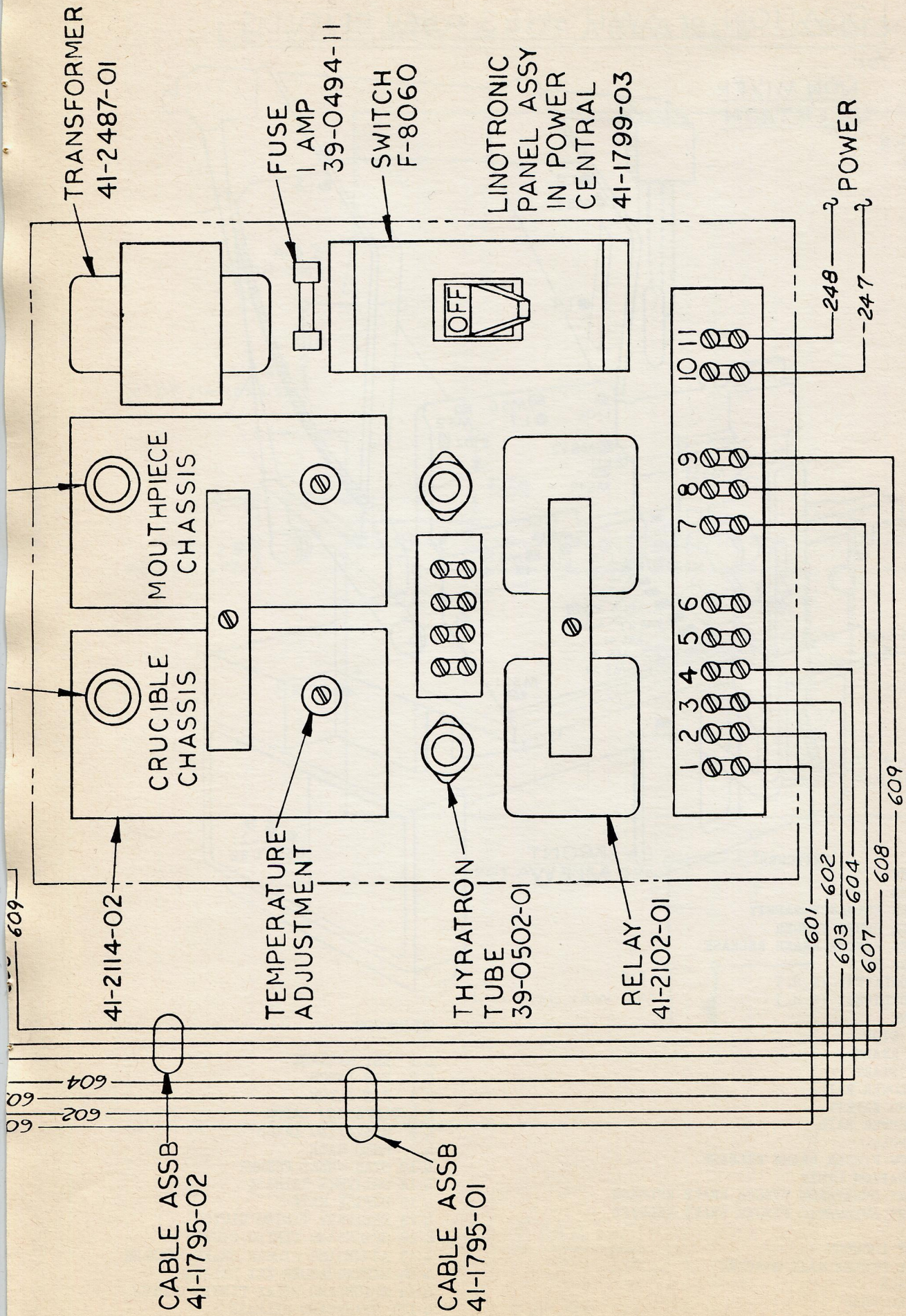

UNIVERSAL LINOTRONIC ELECTRIC POT WIRING DIAGRAM

FIG. 33

LOCATION of SWITCHES & SOLENOIDS

for
NON MIXER
ELEKTRON

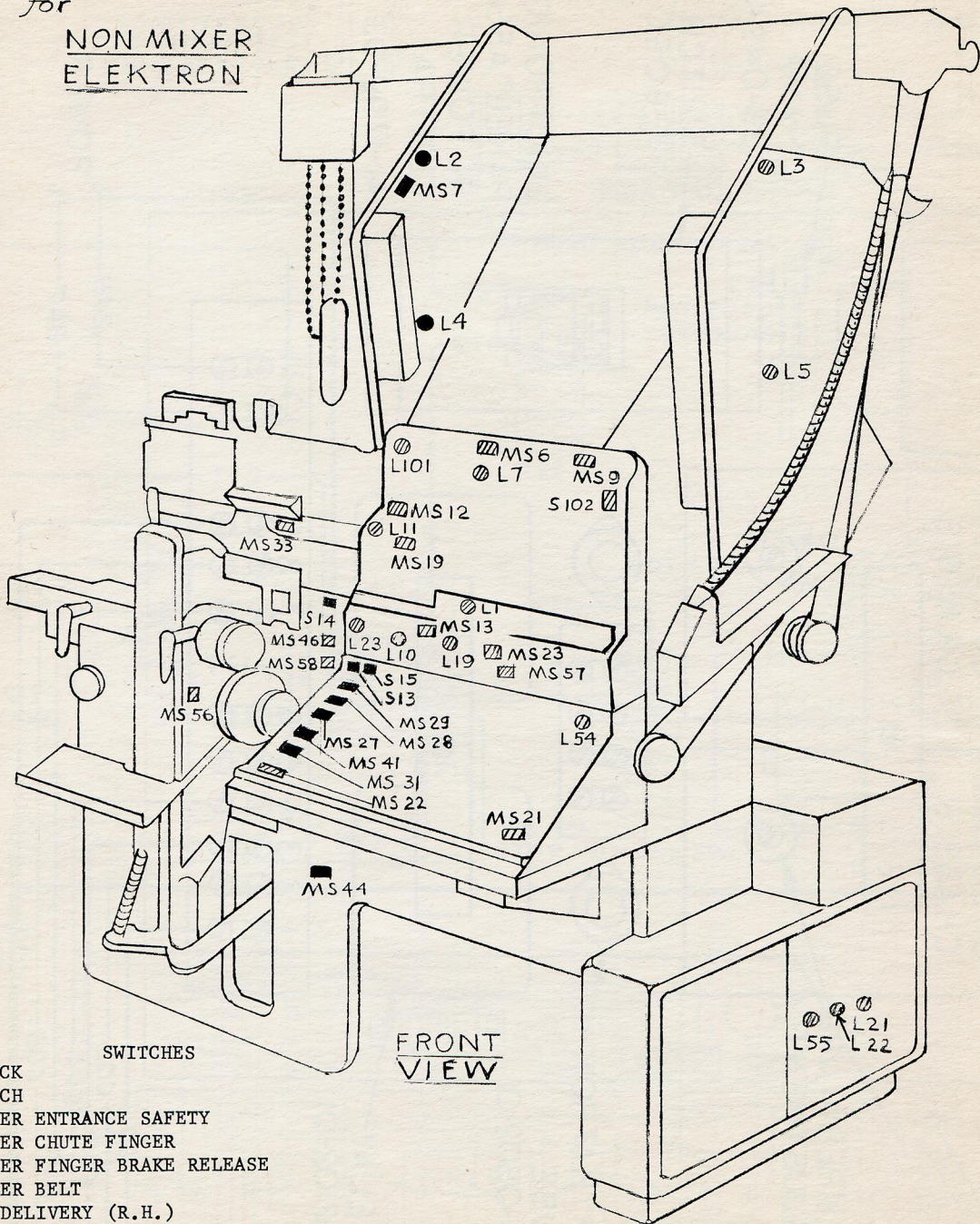

SWITCHES

FRONT
VIEW

L21
L22
L55

- MS 6 REED RACK
- MS 7 FAN LATCH
- MS 9 ASSEMBLER ENTRANCE SAFETY
- MS 12 ASSEMBLER CHUTE FINGER
- MS 13 ASSEMBLER FINGER BRAKE RELEASE
- MS 19 ASSEMBLER BELT
- MS 21 MANUAL DELIVERY (R.H.)
- MS 22 MANUAL DELIVERY (L.H.)
- MS 23 LONG LINE
- MS 27 MACHINE STOP
- MS 28 MACHINE READY
- MS 29 MACHINE START
- MS 31 MANUAL LOWER RAIL
- MS 33 SPACEBAND SAFETY
- MS 41 MANUAL UPPER RAIL
- MS 44 STOP HANDLE
- MS 46 OVERTHROW FINGER BRAKE RELEASE
- MS 56 JUSTIFICATION LIMIT
- MS 57 AUXILIARY OVERTHROW FINGER BRAKE RELEASE
- MS 58 AUXILIARY AUTOMATIC FINGER BRAKE RELEASE

- S 13 POT PUMP LOCKOUT
- S 14 UNIVERSAL DUPLEX RAIL MERCURY
- S 15 HAIR SPACE
- S 102 SPACEBAND REED

SOLENOIDS

- L 1 KEY RELEASE
- L 2 FAN LATCH
- L 3 FAN LATCH
- L 4 ELEVATING LATCH
- L 5 ELEVATING LATCH
- L 7 REED RACK
- L 10 STAR WHEEL PUSHER
- L 11 DELIVERY RELEASE
- L 19 DUPLEX RAIL
- L 21 DELIVERY TIMING CLUTCH
- L 22 SPACEBAND TIMING CLUTCH
- L 23 ASSEMBLER FINGER BRAKE RELEASE
- L 54 HYDRAQUADDER KEY RELEASE
- L 55 SPACEBAND DELAY TIMING CLUTCH
- L 101 SPACEBAND RELEASE

FIG. 34

LOCATION of SWITCHES & SOLENOIDS

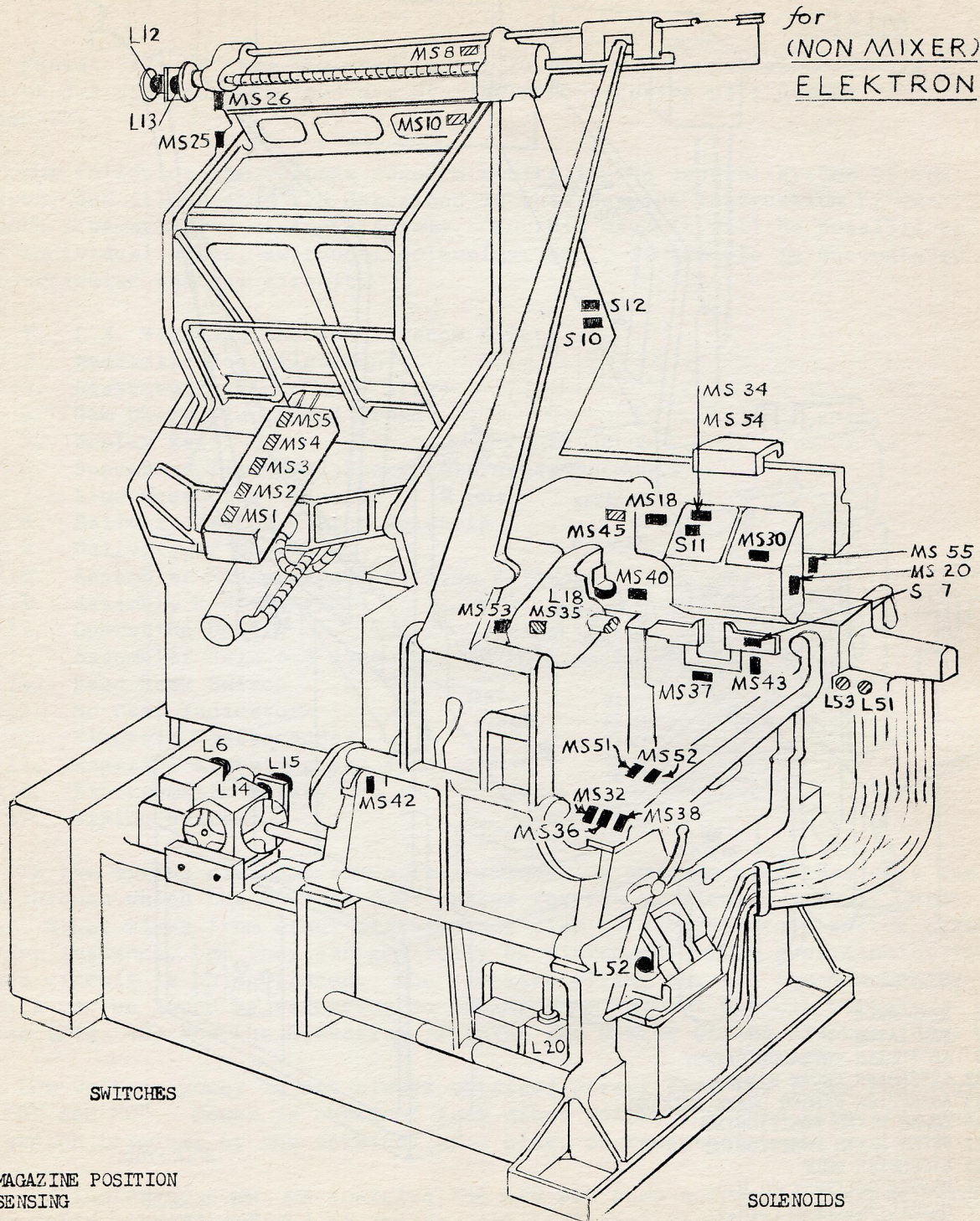

SWITCHES

- MS 1
- MS 2
- MS 3 } MAGAZINE POSITION
- MS 4 } SENSING
- MS 5 }
- MS 8 DISTRIBUTOR SHIFTER SAFETY
- MS 10 CHANNEL ENTRANCE SAFETY
- MS 18 DELIVERY SLIDE
- MS 20 AUTOMATIC ASSEMBLER FINGER
BRAKE RELEASE
- MS 25 CHANNEL ENTRANCE OPEN
- MS 26 DISTRIBUTOR STOP
- MS 30 AUTOMATIC START
- MS 32 TRANSFER TEST & END OF CYCLE
- MS 34 TRANSFER
- MS 35 MOLD SLIDE
- MS 36 VISE AUTOMATIC TEST
- MS 37 VISE AUTOMATIC
- MS 38 NO CAST INDICATOR CLEARING
- MS 40 POT ADVANCE
- MS 42 CAM SHAFT JUSTIFICATION

- MS 43 JUSTIFICATION LOCKOUT
- MS 45 LONG LINE CANCELLING
- MS 51 HYDRAQUADDER CLEARING
- MS 52 HYDRAQUADDER ACTUATING
- MS 53 MOLD SLIDE TEST
- MS 54 TRANSFER SAFETY
- MS 55 AUTOMATIC QUAD LEFT
- S 7 L.H. VISE JAW
- S 10 NO CAST INDICATOR
- S 11 LONG LINE DELAY
- S 12 ASSEMBLY MODE CONTROL

SOLENOIDS

- L 6 ELEVATING VALVE
- L 12 DISTRIBUTOR BRAKE
- L 13 DISTRIBUTOR CLUTCH
- L 14 CAM SHAFT CLUTCH
- L 15 CAM SHAFT BRAKE
- L 18 POT PUMP
- L 20 JUSTIFICATION VALVE
- L 51 SELECTOR LATCH (Q.R.-GEN)
- L 52 HYDRAQUADDER LOCKOUT
- L 53 SELECTOR LATCH (Q.R.-Q.L.)

FIG. 35

LOCATIONS of SWITCHES & SOLENOIDS

for
MIXER
ELEKTRON

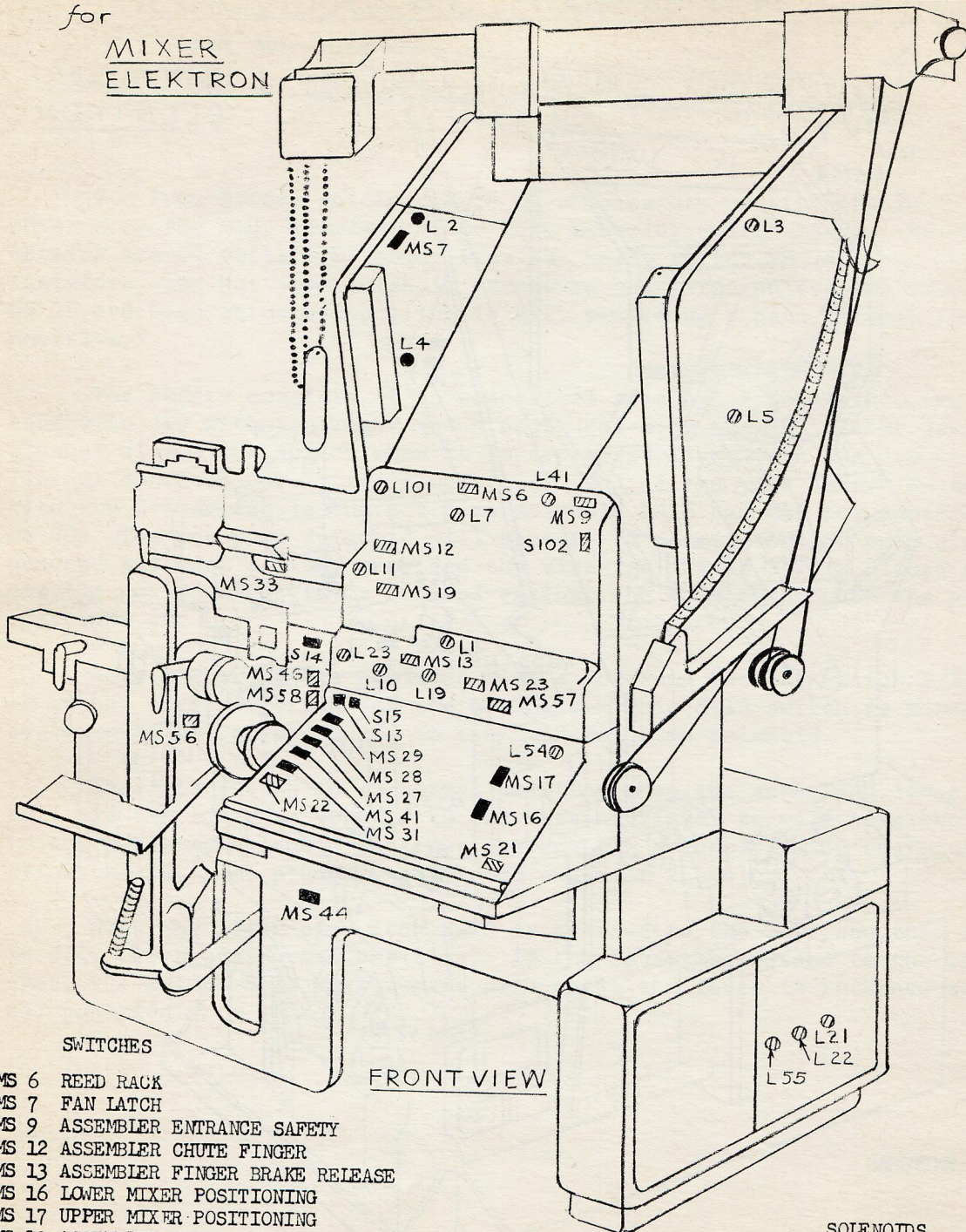

SWITCHES

- MS 6 REED RACK
- MS 7 FAN LATCH
- MS 9 ASSEMBLER ENTRANCE SAFETY
- MS 12 ASSEMBLER CHUTE FINGER
- MS 13 ASSEMBLER FINGER BRAKE RELEASE
- MS 16 LOWER MIXER POSITIONING
- MS 17 UPPER MIXER POSITIONING
- MS 19 ASSEMBLER BELT
- MS 21 MANUAL DELIVERY (R.H.)
- MS 22 MANUAL DELIVERY (L.H.)
- MS 23 LONG LINE
- MS 27 MACHINE STOP
- MS 28 MACHINE READY
- MS 29 MACHINE START
- MS 31 MANUAL LOWER RAIL
- MS 33 SPACEBAND SAFETY
- MS 41 MANUAL UPPER RAIL
- MS 44 STOP HANDLE
- MS 46 OVERTHROW FINGER BRAKE RELEASE
- MS 56 JUSTIFICATION LIMIT
- MS 57 AUXILIARY OVERTHROW FINGER BRAKE RELEASE
- MS 58 AUXILIARY AUTOMATIC FINGER BRAKE RELEASE

- S 13 POT PUMP LOCKOUT
- S 14 UNIVERSAL DUPLEX RAIL MERCURY
- S 15 HAIR SPACE
- S 102 SPACEBAND REED

SOLENOIDS

- L 1 KEY RELEASE
- L 2 FAN LATCH
- L 3 FAN LATCH
- L 4 ELEVATING LATCH
- L 5 ELEVATING LATCH
- L 7 REED RACK
- L 10 STAR WHEEL PUSHER
- L 11 DELIVERY RELEASE
- L 19 DUPLEX RAIL
- L 21 DELIVERY TIMING CLUTCH
- L 22 SPACEBAND TIMING CLUTCH
- L 23 ASSEMBLER FINGER BRAKE RELEASE
- L 41 ASSEMBLER ENTRANCE SAFETY
- L 54 HYDRAQUADDER KEY RELEASE
- L 55 SPACEBAND DELAY TIMING CLUTCH
- L 101 SPACEBAND RELEASE

LOCATION of SWITCHES & SOLENOIDS

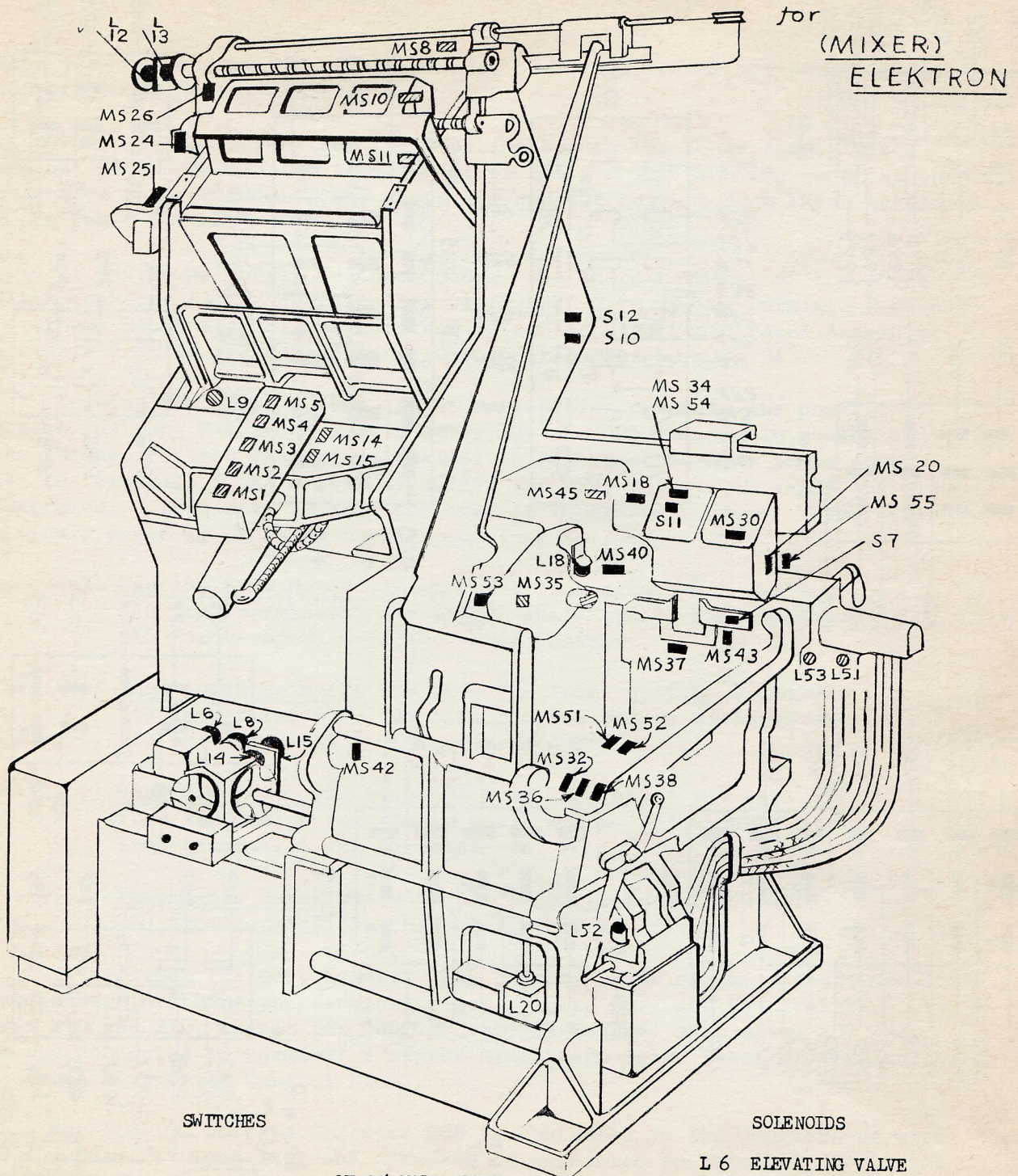

SWITCHES

SOLENOIDS

- MS 1 }
- MS 2 } MAGAZINE
- MS 3 } POSITION
- MS 4 } SENSING
- MS 5 }
- MS 8 DISTRIBUTOR SHIFTER SAFETY
- MS 10 CHANNEL ENTRANCE SAFETY
- MS 11 LOWER CHANNEL ENTRANCE SAFETY
- MS 11 MIXING VALVE LIMIT
- MS 15 MIXING POSITION
- MS 18 DELIVERY SLIDE
- MS 20 AUTOMATIC ASSEMBLER FINGER
BRAKE RELEASE
- MS 24 LOWER DISTRIBUTOR STOP
- MS 25 CHANNEL ENTRANCE OPEN
- MS 26 UPPER DISTRIBUTOR STOP
- MS 30 AUTOMATIC START
- MS 32 TRANSFER TEST & END OF CYCLE
- MS 34 TRANSFER

- MS 35 MOLD SLIDE
- MS 36 VISE AUTOMATIC TEST
- MS 37 VISE AUTOMATIC
- MS 38 NO CAST INDICATOR CLEARING
- MS 40 POT ADVANCE
- MS 42 CAM SHAFT JUSTIFICATION
- MS 43 JUSTIFICATION LOCKOUT
- MS 45 LONG LINE CANCELLING
- MS 51 HYDRAQUADDER CLEARING
- MS 52 HYDRAQUADDER ACTUATING
- MS 53 MOLD SLIDE TEST
- MS 54 TRANSFER SAFETY
- MS 55 AUTOMATIC QUAD LEFT

- S 7 L.H. VISE JAW
- S 10 NO CAST INDICATOR
- S 11 LONG LINE DELAY
- S 12 ASSEMBLY MODE CONTROL

- L 6 ELEVATING VALVE
- L 8 MIXING VALVE
- L 9 MIXING LATCH
- L 12 DISTRIBUTOR BRAKE
- L 13 DISTRIBUTOR CLUTCH
- L 14 CAM SHAFT CLUTCH
- L 15 CAM SHAFT BRAKE
- L 18 POT PUMP
- L 20 JUSTIFICATION VALVE
- L 51 SELECTOR LATCH (Q.R.-CEN.)
- L 52 HYDRAQUADDER LOCKOUT
- L 53 SELECTOR LATCH (Q.R.-Q.L.)

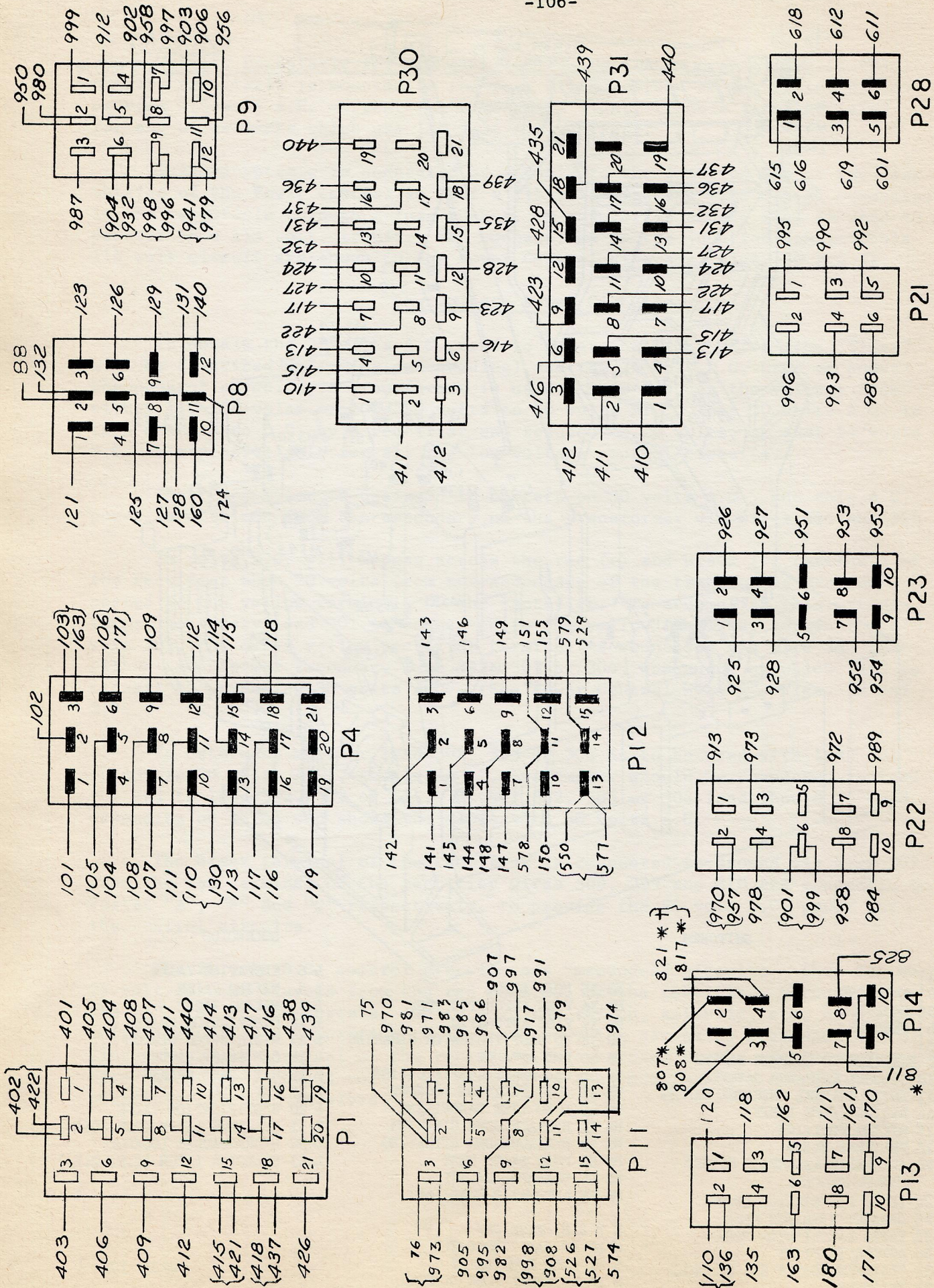

COMPLETE WIRE CONNECTIONS TO PLUGS & RECEPTACLES

t- ON SINGLE DISTRIBUTOR ELEKTRON
 822 IS CONNECTED TO GROUND.

FIG. 37

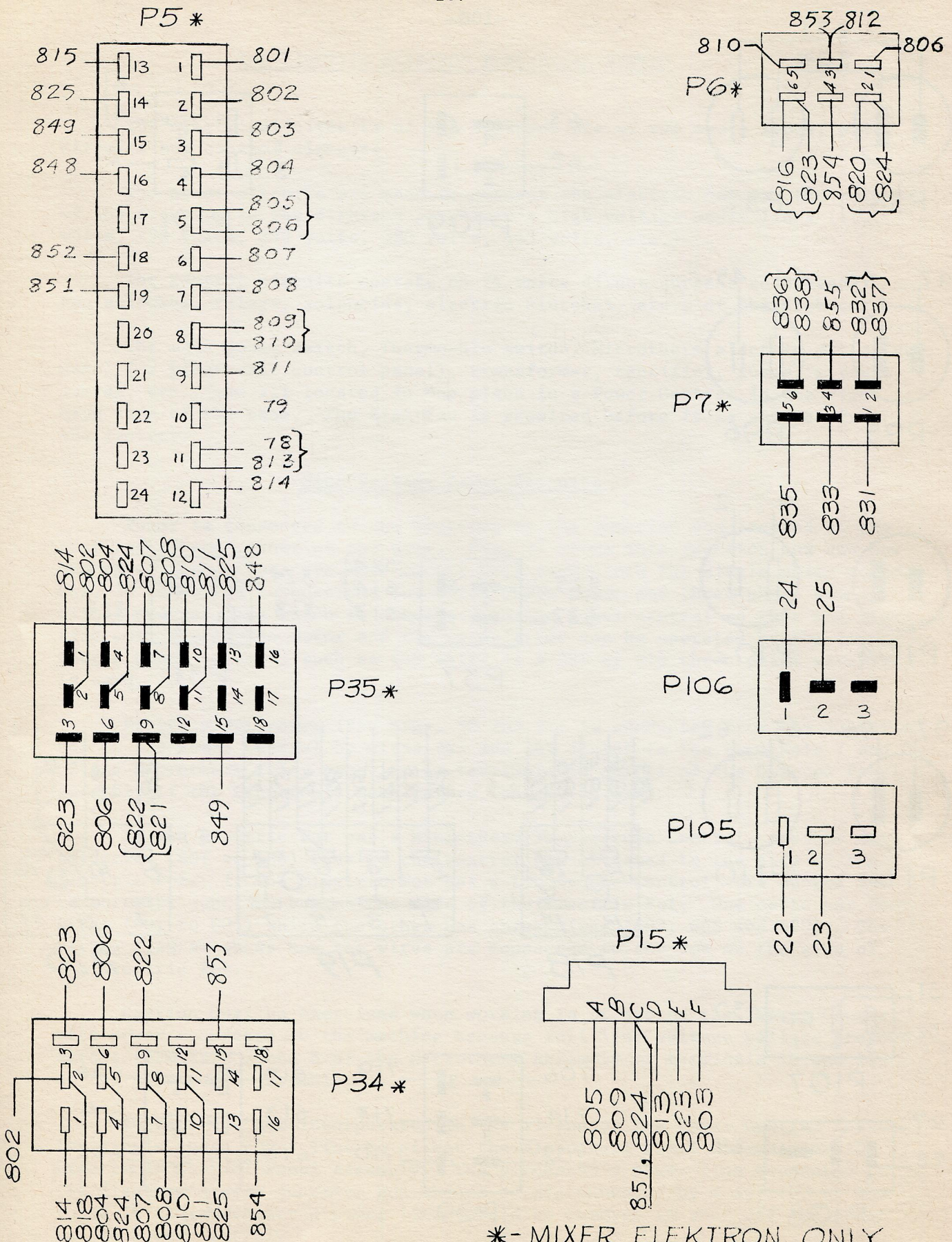

*- MIXER ELEKTRON ONLY.

COMPLETE WIRE CONNECTIONS TO PLUGS & RECEPTACLES.

FIG. 37A

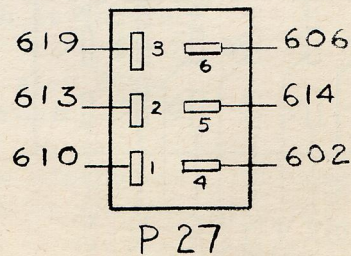
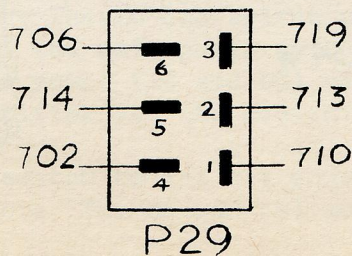
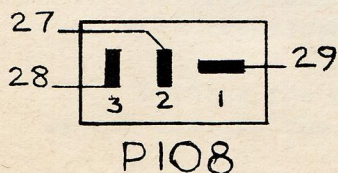
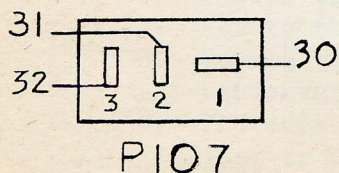
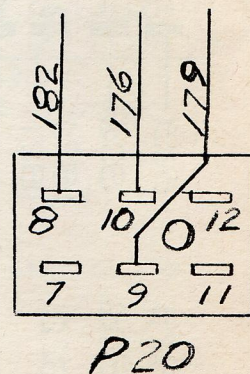
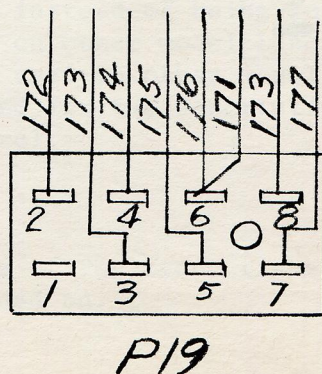
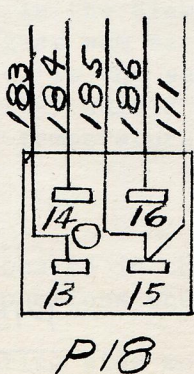
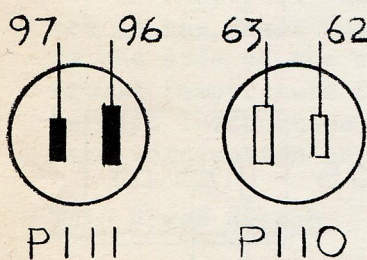
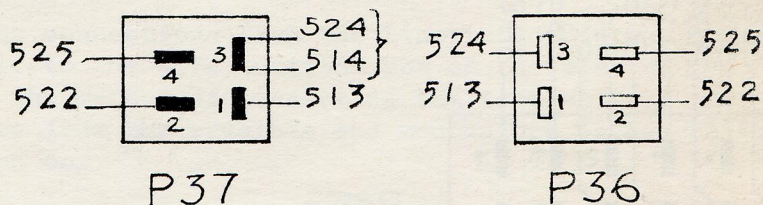
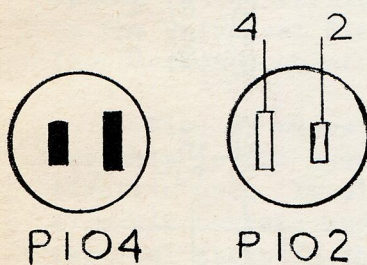
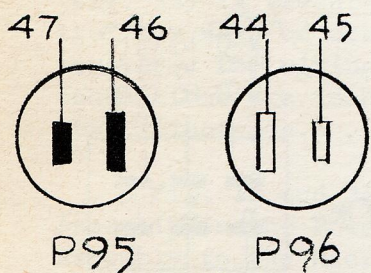
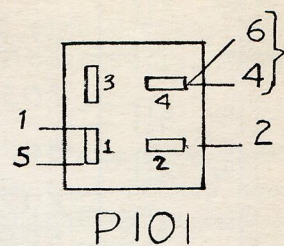
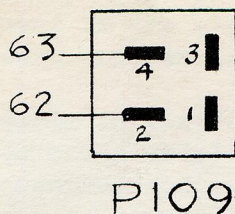
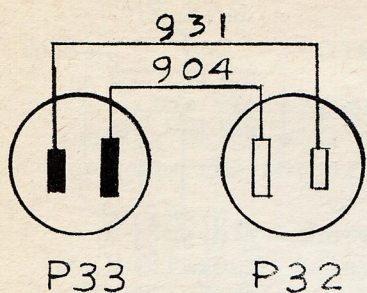

COMPLETE WIRE CONNECTIONS TO PLUGS & RECEPTACLES.

FIG. 37B

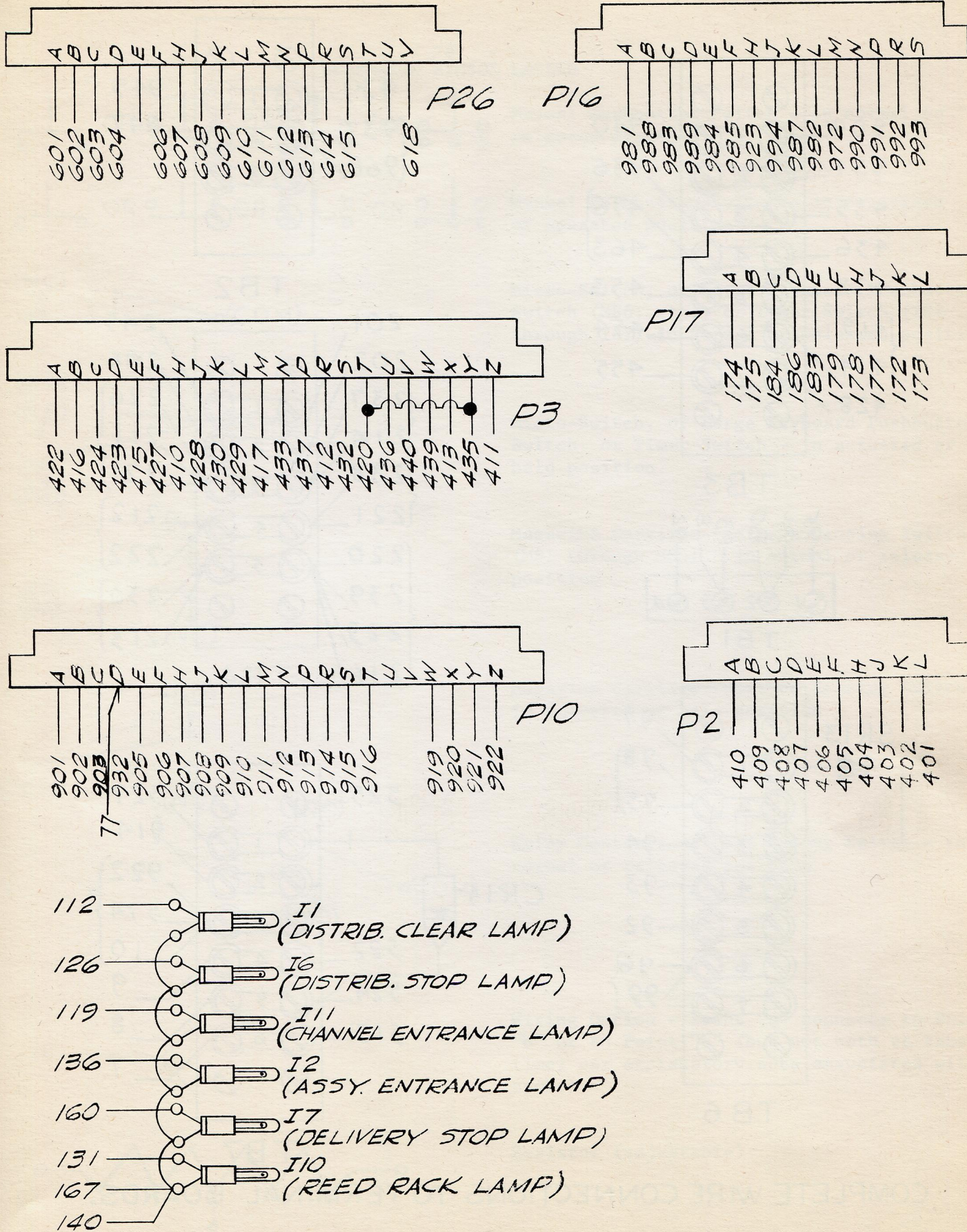

COMPLETE WIRE CONNECTIONS TO PRINTED CIRCUIT CONNECTORS,
AND INDICATING LAMPS

*-MIXER ELEKTRON ONLY.

FIG. 38

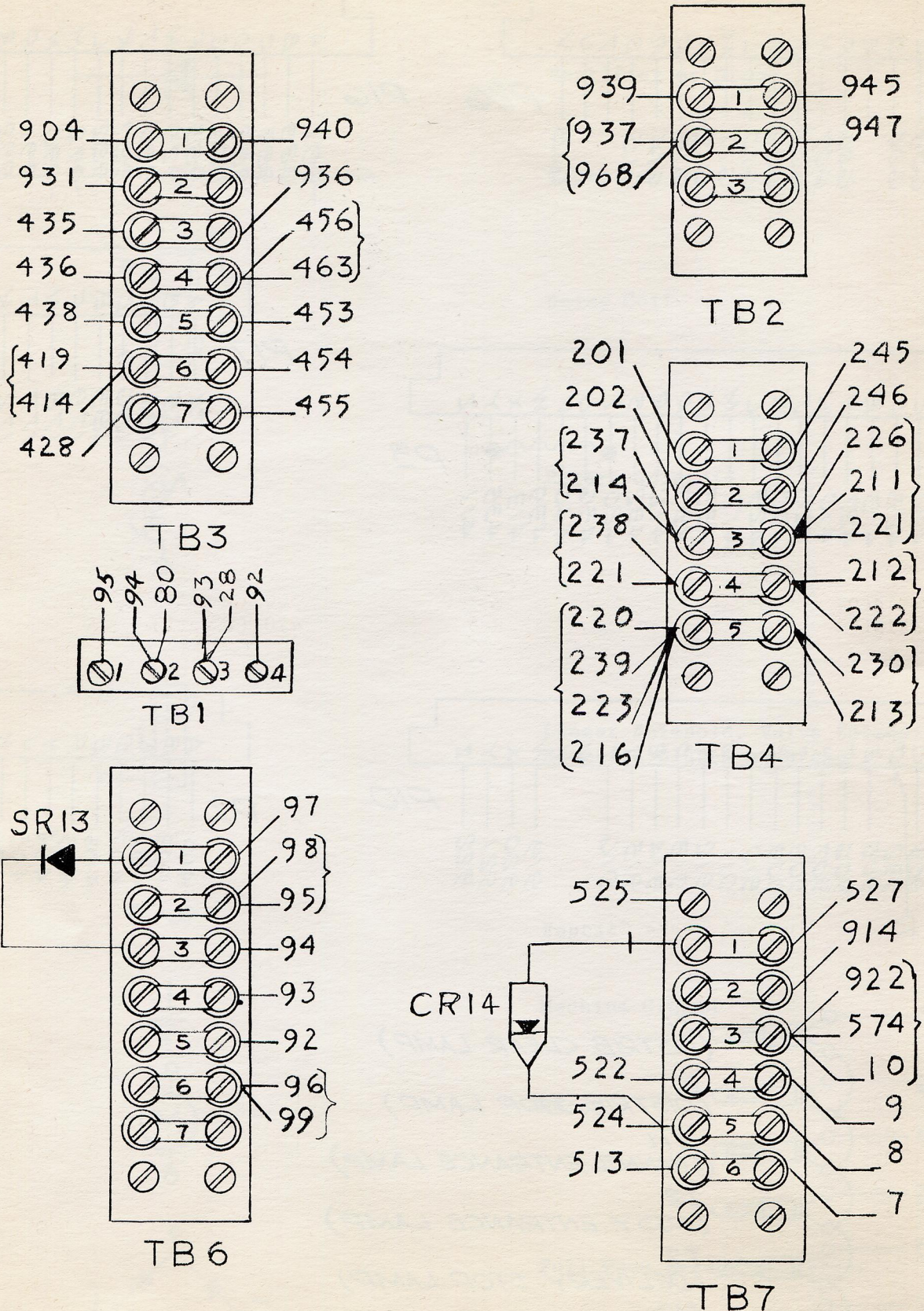

COMPLETE WIRE CONNECTIONS TO TERMINAL BOARDS.

FIG. 38A

ELECTRICAL SPECIFICATIONS OF SOLENOIDS, RELAYS AND RESISTORS

<u>Circuit Components</u>	<u>Electrical Symbol</u>	<u>Resistance in Ohms</u>	<u>Powered from Fustat</u>
<u>Assembler Finger Brake and Assembly Mode Control Circuits</u>			
Solenoid	L-23	57	B
Relay	K-104	227	B
<u>Cam Shaft Clutch & Brake Circuit</u>			
Clutch Solenoid	L-14		A
Brake Solenoid	L-15	107	A
Relay	K-6	227	A
Relay	K-7	500	A
Relay	K-103	300	A
Resistor (Adjustable)	R-17	500 (10 watt)	A
Resistor (Adjustable)	R-18	500 (10 watt)	A
Resistor (Variable)	R-109	500 (4 watt)	A
Resistor (Variable)	R-110	500 (4 watt)	A
Resistor	R-9	470 (1 watt)	A
<u>Delivery Circuit</u>			
Delivery Timer Clutch Solenoid	L-21	43	B
Delivery Release Solenoid	L-11	30	B
Starwheel Pusher Solenoid	L-10	19	B
Relay	K-8	500	B
Relay	K-9	227	B
Resistor	R-8	180 (2 watt)	B
Resistor	R-11	1K (1 watt)	B
Resistor	R-12	470 (1 watt)	B
<u>Distributor Clutch & Brake Circuit</u>			
Clutch Solenoid	L-13	147	C
Brake Solenoid	L-12	147	C
*Clutch Solenoid	L-13	170	C
*Brake Solenoid	L-12	170	C
*Resistor (Adjustable)	R-10	1000 (10 watt)	C
<u>Duplex Rail Circuit</u>			
Solenoid	L-19	30	A or B (1)
Relay	K-10	500	A or B (1)
<u>Elevating and Fanning Circuit</u>			
Key Release Solenoid	L-1	21	B & C (3)
Fan Latch Solenoid	L-2, 3	30	B & C (4)
Elevating Latch Solenoid	L-4, 5	30	C
Elevating Valve Solenoid	L-6	16	B

* Used on Mixer Elektrons only.

ELECTRICAL SPECIFICATIONS OF SOLENOIDS, RELAYS AND RESISTORS

<u>Circuit Components</u>	<u>Electrical Symbol</u>	<u>Resistance in Ohms</u>	<u>Powered from Fustat</u>
<u>Elevating & Fanning Circuit (Cont'd.)</u>			
Reed Rack Solenoid	L-7	30	C
Relay	K-1	500	C
Relay	K-2	227	B & C (2)
Relay	K-3	227	C
Resistor	R-1	1.0 Meg. (1 watt)	C
Resistor	R-2	25 (25 watt)	C
Resistor	R-3	120 (2 watt)	C
Resistor	R-4	0.22 Meg. (1 watt)	C
Resistor	R-5	0.1 Meg. (1 watt)	C
Resistor	R-6	10 K (1 watt)	C
<u>Electric Hydraquadder Circuit</u>			
Quadder Key Release Solenoid	L-54	21	B
Selector Latch Solenoid	L-53	43	A
Quadder Lockout Solenoid	L-52	32	A
Selector Latch Solenoid	L-51	43	A
First Stage Relay	K-11	480	A & B (5)
First Stage Relay	K-12	480	A & B (5)
Second Stage Relay	K-13	480	A
Second Stage Relay	K-14	480	A
<u>Hydraulic Justification Circuit</u>			
Valve Solenoid	L-20	16	B
<u>Mixing Circuit</u>			
Mixing Valve Solenoid	L-8	16	B
Mixing Latch Solenoid	L-9	30	B
Assembler Entrance Safety Solenoid	L-41	25	B
Relay	K-4	310	B
Relay	K-5	310	B
Relay	K-92	310	B
Relay	K-93	310	B
Resistor	R-139	125 (10 watt)	B
Resistor	R-140	125 (10 watt)	B
<u>No Cast Indicator Circuit</u>			
Relay	K-15	227	A
Resistor	R-13	120 (2 watt)	A
<u>Pot Pump Circuit</u>			
Solenoid	L-18	30	A

ELECTRICAL SPECIFICATIONS OF SOLENOIDS, RELAYS AND RESISTORS

<u>Circuit Components</u>	<u>Electrical Symbol</u>	<u>Resistance in Ohms</u>	<u>Powered from Fustat</u>
<u>Spaceband Timing Circuit</u>			
Spaceband Release Solenoid	L-101	32	B
Spaceband Delay Clutch Solenoid	L-55	43	B
Spaceband Timing Clutch Solenoid	L-22	43	B
Starwheel Pusher Solenoid	L-10	19	B

- NOTES: (1) On Manual Machine, the Duplex Rail Circuit is powered from Fustat "A". On Tape Operated Machine, the Duplex Rail Circuit is powered from Fustat "B", except that manual operation is initiated via Fustat "A" (through MS 41), but held via Fustat "B".
- (2) When "Elevating" or "Fanning" from a "Fanned" position, Relay K2 is held energized via Fustat "B" (through MS 7) as long as a magazine is still hooked on the Fanning Latches.
- (3) Key Release Solenoid is energized via Fustat "B" only when an unsafe condition exists at the Assembler Entrance (MS 9), or Channel Entrance (MS 10).
- (4) Fan Latch Solenoids are picked up via Fustat "C" (through MS 1 to MS 4), but held via Fustat "B" (through MS 7).
- (5) Relays K-11 and K-12 are energized via Fustat "B" (through the Tape Operated Unit's Quadding Switches), but held via Fustat "A".

LOCATION OF TERMINAL BOARDS AND PLUGS

Terminal Boards

TB 1	Delivery Timer Board
TB 2	Top of Distributor Drive
TB 3	L.H. Distributor Bracket
TB 4	High Voltage Terminal Strips (Behind Pot Control Panel Cover)
TB 6	On Timer Casting
TB 7	On Base, near Main Drive

Plugs

P 1)	Behind Reed Rack (Top)
P 4)	
P 2	Magazine Carriage Position Sensing Switch Board
P 3	On Elevate and Fan Printed Circuit Board
P 4	Behind Reed Rack Top
P 5	Mixing Printed Circuit Board
P 6)	Behind Keyboard - Mixer Circuit Harness
P 7)	
P 8)	Behind Reed Rack
P 9)	
P 10	Bottom of Timer Printed Circuit Board
P 11)	Keyboard Harness - Behind Keyboard
P 12)	
P 13)	Swinging Frame Harness (to Mixing Circuit)
P 14)	
P 15	Mixing Harness on Timer Printed Circuit
P 16	Machine Control on Timer Printed Circuit
P 17	T.O.U. Harness on Timer Board. R.H. side.
P 18	To Operating Unit
P 19	To Operating Unit
P 20	To Operating Unit
P 21)	Hydraquadder - Under Keyboard
P 28)	
P 22)	Face Plate Harness (Near S.B. Release Solenoid)
P 23)	
P 24	Unassigned
P 25	Unassigned
P 26	Quadder Printed Circuit Board

Plugs (Cont'd.)

P 27) Electric Hydraquadder Push Button Harness Under Keyboard
P 29)
P 30) Under Back Step, near Elevate Solenoid Valve
P 31)
P 32) Two Wire Plug in Box Frame
P 33)
P 34) Under Back Step (near Elevate Solenoid Valve (For Mixer Only)
P 35)
P 36) Main Drive Harness (On Main Drive)
P 37)
P 50 Mixer Circuit in Power Central
P 95) Hair Space Switch (Behind Keyboard)
P 96)
P 101 Under Machine Spaceband Timer Harness (or on Spaceband Phaser)
P 102 Harness, Spaceband Reed Switch on Reed Rack
P 104 Spaceband Switch on Reed Rack
P 105) Pot Pump Lockout (Side of Keyboard)
P 106)
P 107) Mode Control at Timer Printed Circuit
P 108)
P 109 Spaceband Timer Harness under Keyboard
P 110) Spaceband Timer Harness (on Timer)
P 111)

Special Connections

<u>Wire No.*</u>	<u>Location</u>	<u>Function</u>
75	P11-2	ACE connection
76	P11-3	ACE connection
77	P-10D	ACE connection
78	P5-11	ACE connection
79	P5-10	ACE connection
80	TB1-2	Mixer Connection
187	P20-12	TTS Signal Leads
188	P20-7	TTS Signal Leads

* These wires are included in machine harnesses to facilitate application of "Special" attachments.

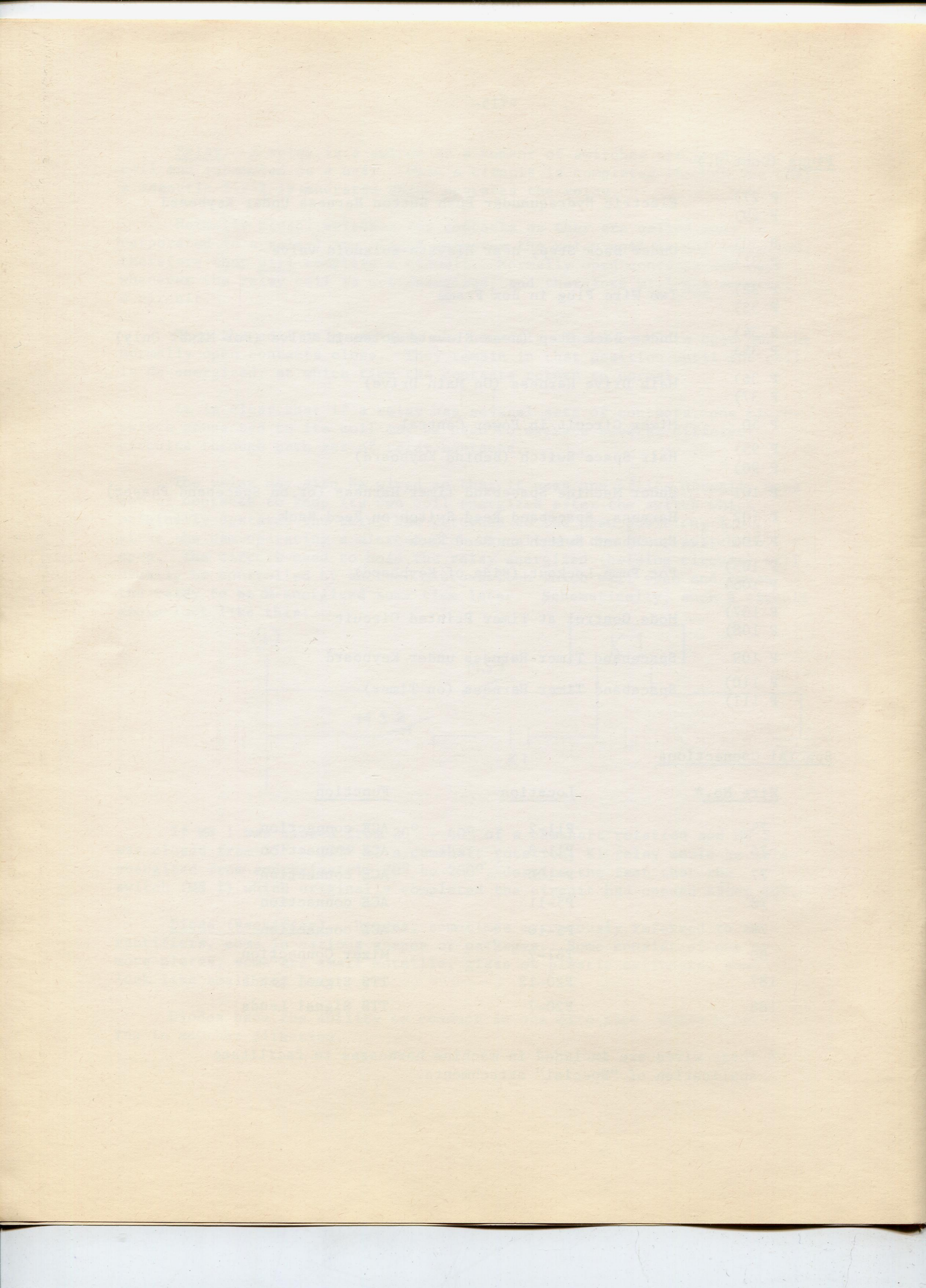

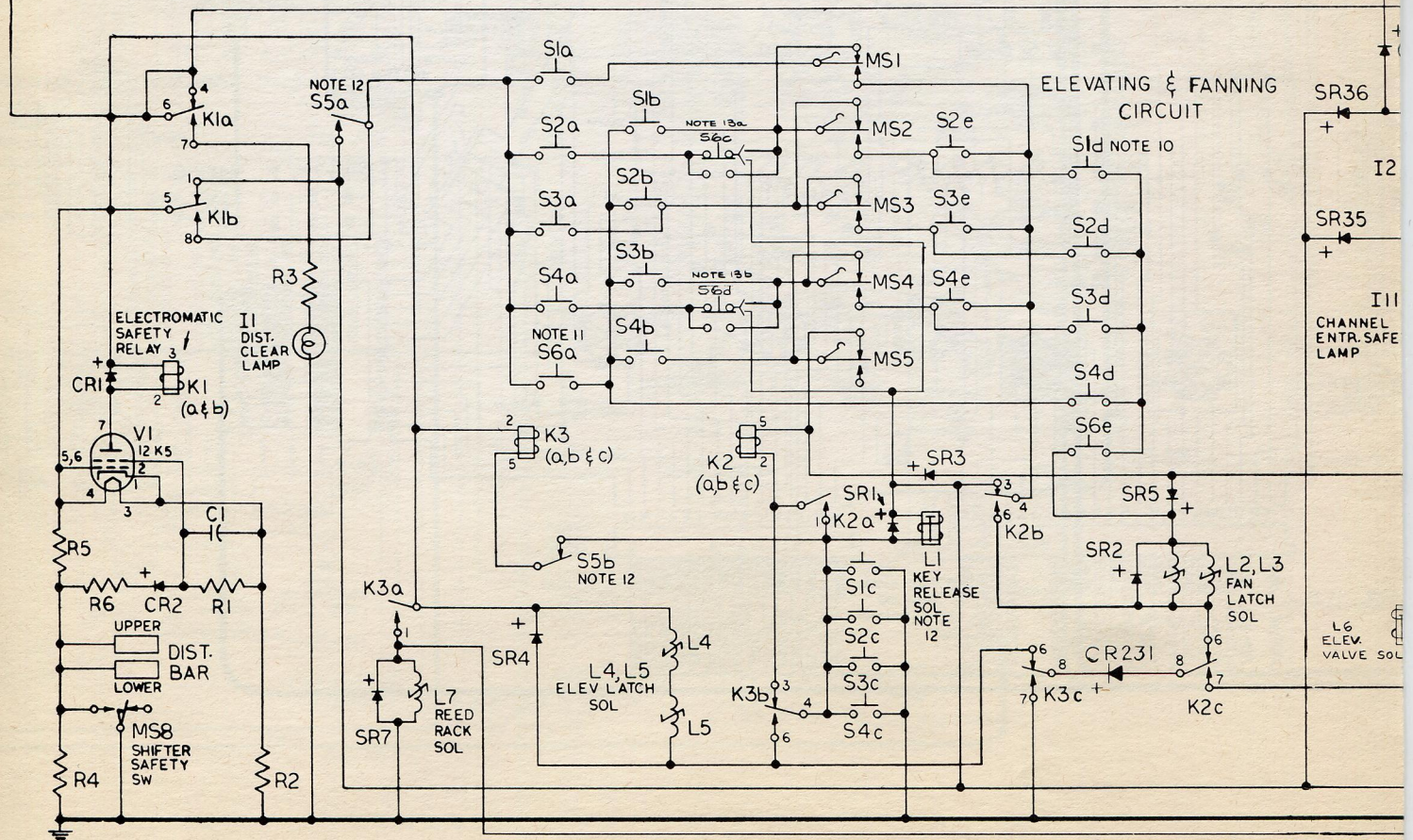
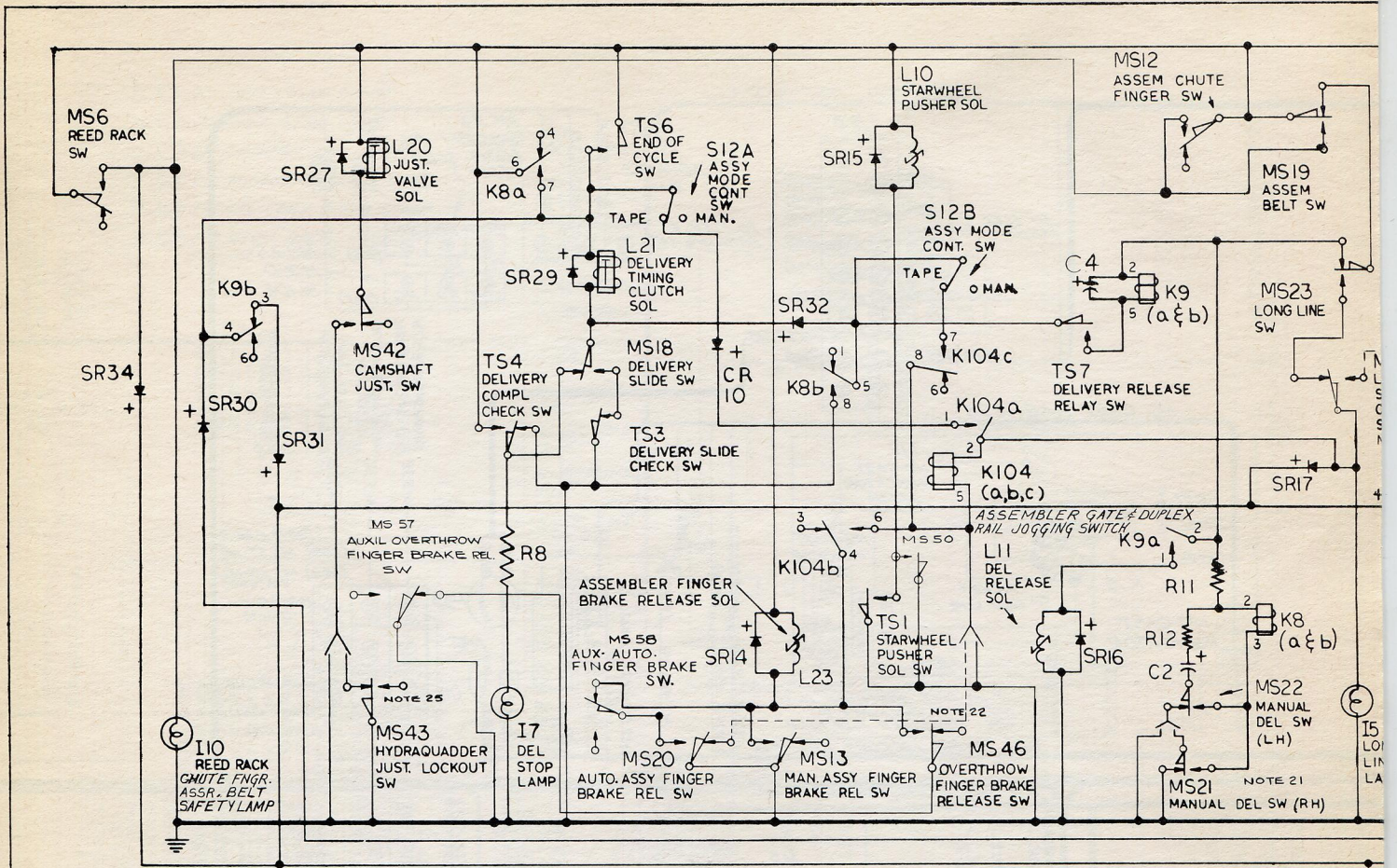

MACHINE CONTROL CIRCUIT

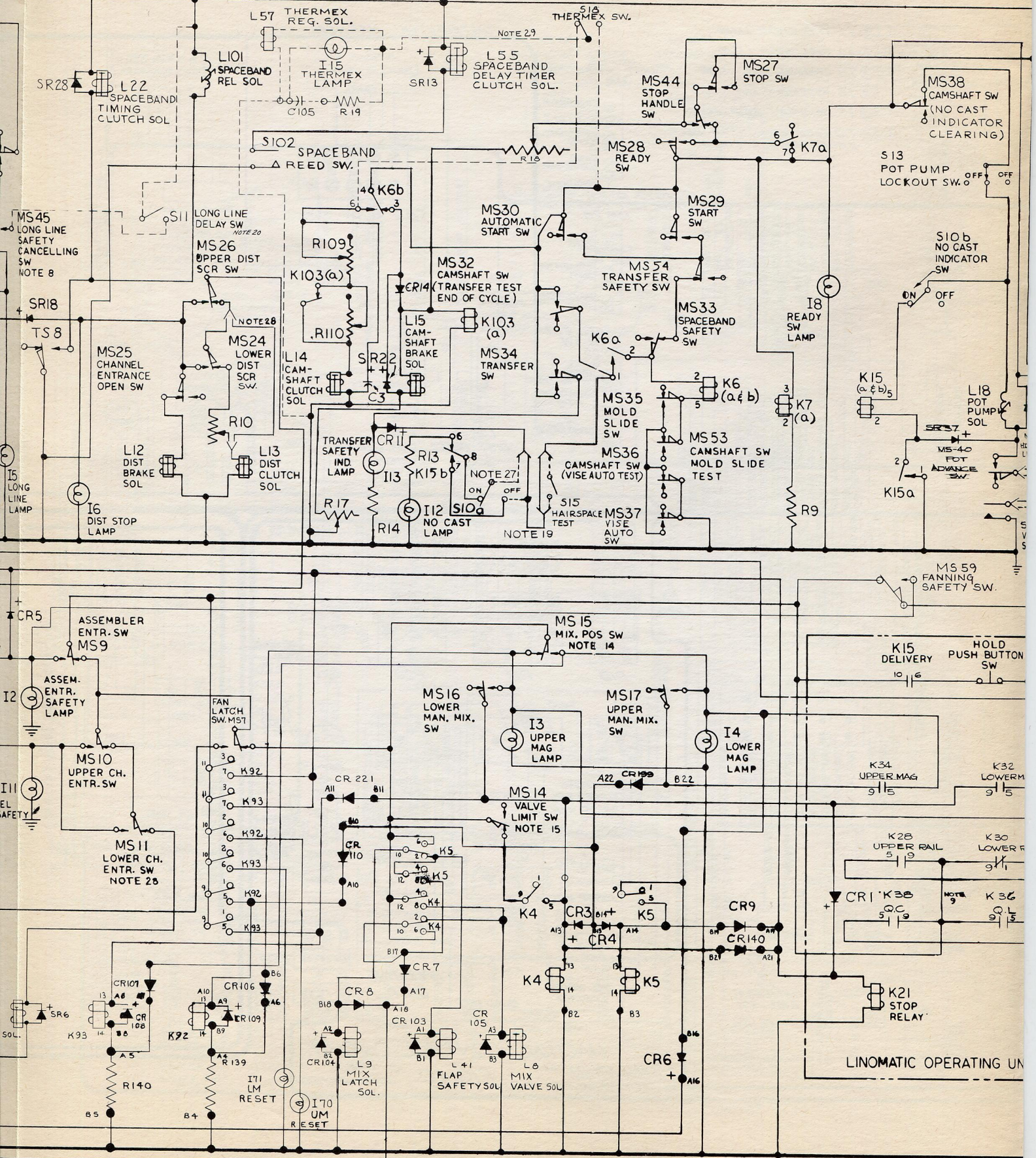
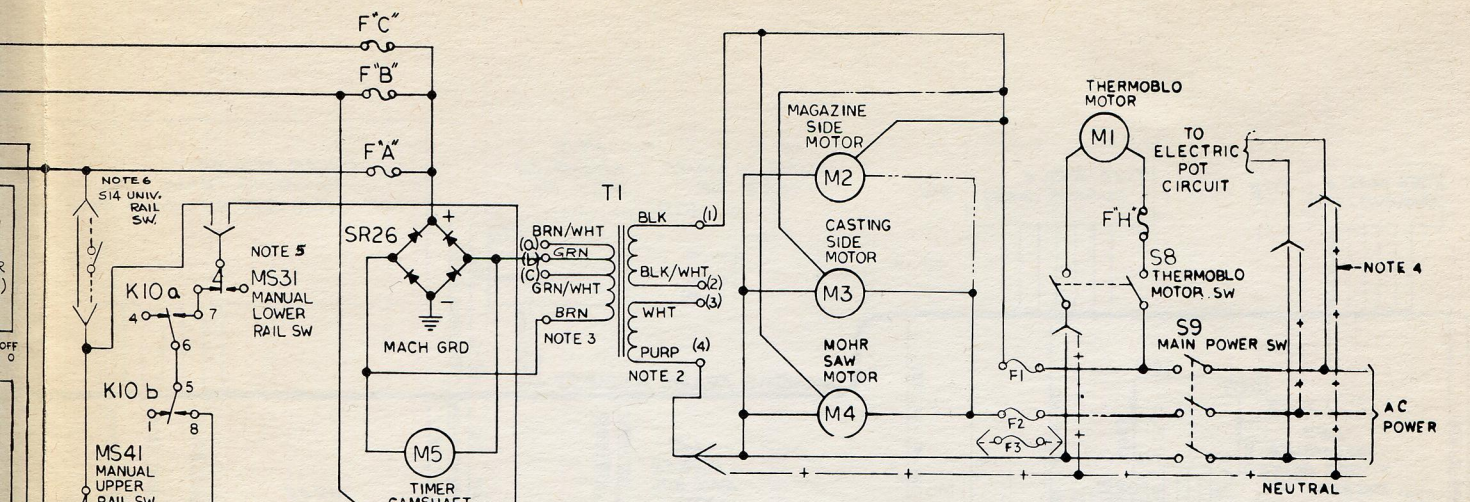
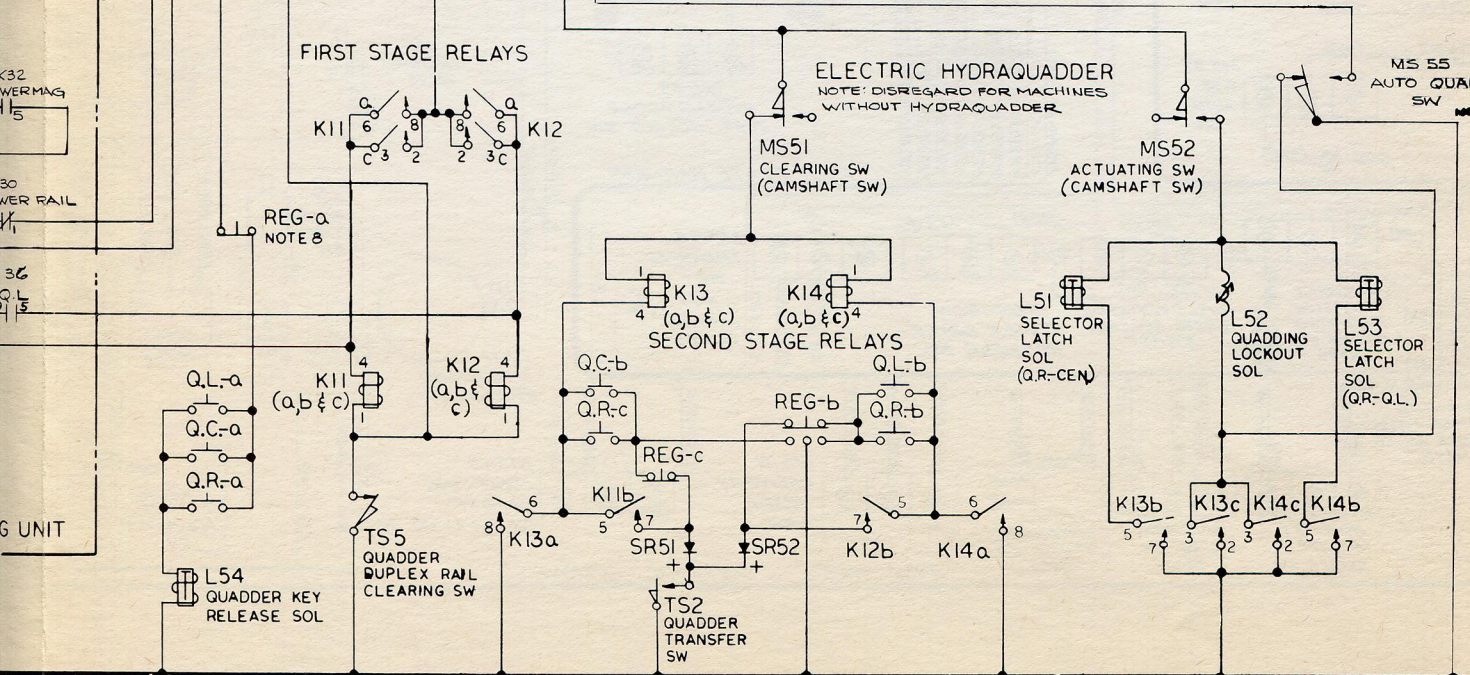

FIG. 39



ALL SWITCHES ARE SHOWN WITH MACHINE STOPPED IN NORMAL POSITION, DELIVERY SLIDE LATCHED AT THE ASSEMBLER AREA DELIVERY TIMER LATCHED IN NORMAL STOP POSITION AND NO PUSHBUTTONS DEPRESSED. ALL RELAY CONTACTS SHOWN WITH THEIR COILS DE-ENERGIZED

- NOTE:
- Wiring shown as (---) required only with three phase machines.
 - Wiring for T-1 Transformer Primary is as follows:
For 220 Volts A.C., connect Terminal 2 to 3.
For 110 Volts A.C., connect Terminal 1 to 3 and Terminal 2 to 4.
 - Either lead (a) brown and white, (b) green or (c) green and white is used depending on which lead together with brown lead produces closest to 30 Volts A.C. input to Bridge Rectifier SR26.
 - When 385 Volt or 415 Volt, three phase circuit is used, the Electric Pot, the Transformer Primary and the Thermo-Blo Motor Circuit, are connected between one line wire and the neutral wire as shown by the (---) wiring option.
 - On tape operated machines, common terminal of Switch MS31 (manual lower rail sw.) is connected to lower rail switch in operating unit.
 - Mercury Switch S14 is installed on machines equipped with Universal Rail attachment.
 - Pushbutton switches designated "Q.R.", "Q.C." and "Q.L." (and associated contacts a, b, etc.) are manually operated selector switches which are ganged together with the "Reg." pushbutton switch.
 - To Quad right from Tape Signals, the tape must contain both "Quad Left" and "Quad Center" signals.
 - Switches S1 to S4 (and associated contacts S1a, S1b, etc.) correspond to Magazines 1 to 4.
 - Switch S6 (contacts a, b, etc.) is a four circuit pushbutton switch for fanning magazines.
 - Key Release Solenoid (L1) operates switch S5 (a & b) and releases any pushbutton switch (S1 to S4) depressed. The "b" contacts of switch S5 are open when a pushbutton switch (S1 to S4) is being depressed and are closed when the pushbutton is latched.
 - S6c is connected to common of MS2 when it is desired to be able to elevate to Magazine Position 2. On Mixer machines without a movable bridge, S6c is usually connected to (L1) Key Release Solenoid to prevent elevating to Magazine Position 2.
 - S6d is connected to common of MS4 when it is desired to be able to elevate to Magazine Position 4. On Mixer machines, S6d is usually connected to (L1) Key Release Solenoid to prevent elevating to Magazine Position 4.
 - Mixing Position Switch MS15 is shown in upper Magazine Mixing Position.
 - Valve Limit Switch MS14 is operated when Magazine Frame raises 5/8" above lower magazine mixing position.
 - Automatic Quad Switch MS35 and No Quad Indicator Lamp are installed on machines with Electric Hydraquadders.
 - Hairspace switch S15 is optional. It is used to stop the machine in transfer position to remove hairspace mats.
 - Long Line Delay Switch S11 is optional. It is used to stop operating unit when delivery slide is away from latched position in order to allow time for mats to redistribute on long measures.
 - Manual Delivery Switch (RH) MS21 is not installed on machines with TTS Operating Units.
 - K104 is connected to N.O. contact of MS20 on machines equipped with gear rack type delivery slides when using long line delay switch S11.
 - Hydraquadder Justification Switch MS43 is installed only on machines equipped with Electric Hydraquadder.
 - Optional Hydraulic Justification Limit Switch MS56.
 - This connection is used only on machines not equipped with No Cast Indicators.
 - Lower Distributor Switch MS24; Resistor R10 and Lower Channel Entrance Switch are installed on Mixer machines only.
 - Wiring option for machines equipped with Thermex Mold Disk.



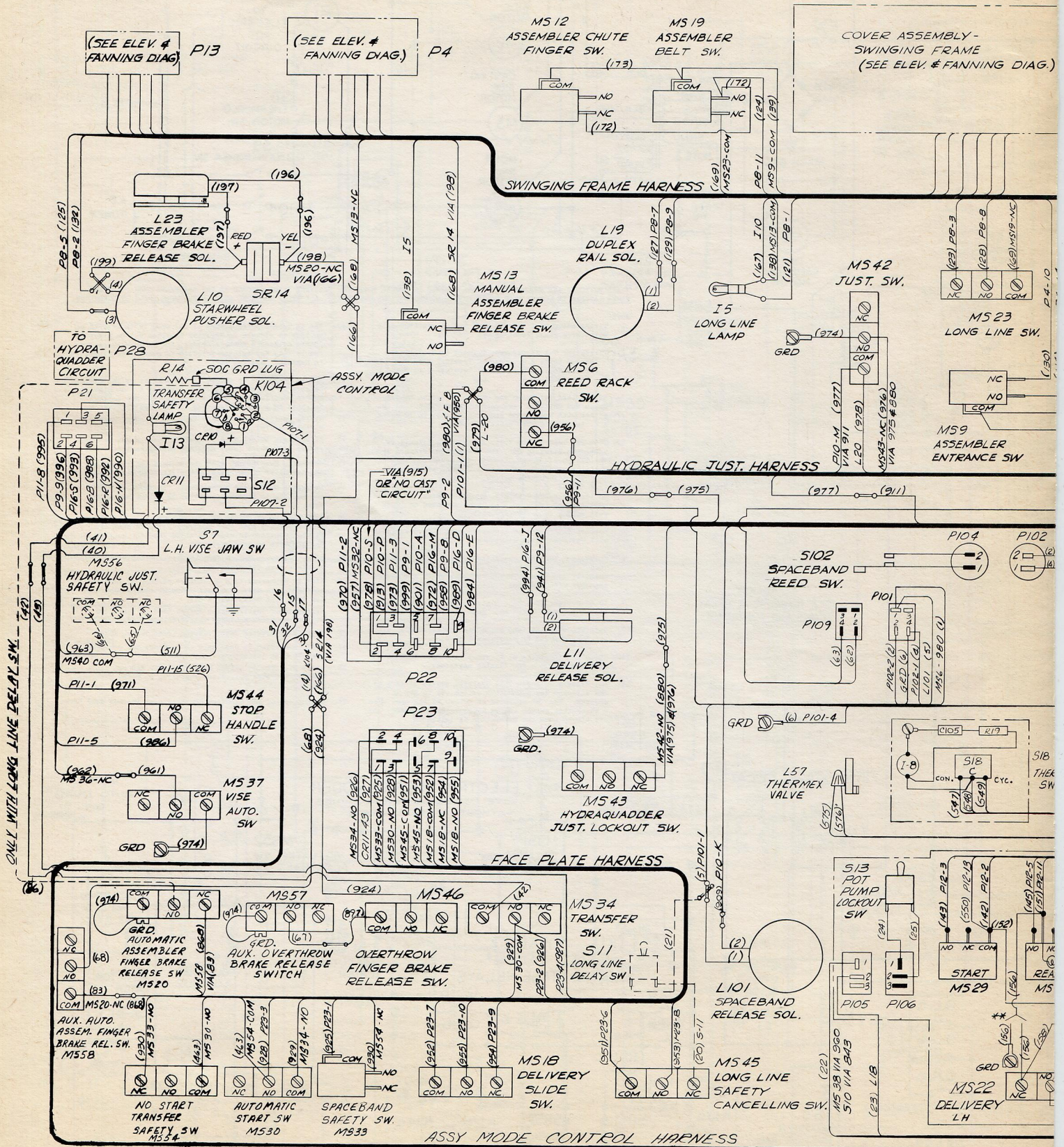

(SEE ELEV. # FANNING DIAG.) P13

(SEE ELEV. # FANNING DIAG.) P4

COVER ASSEMBLY-SWINGING FRAME (SEE ELEV. # FANNING DIAG.)

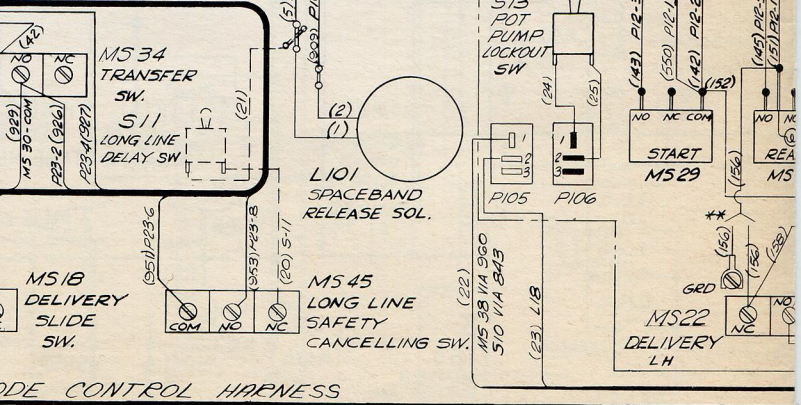
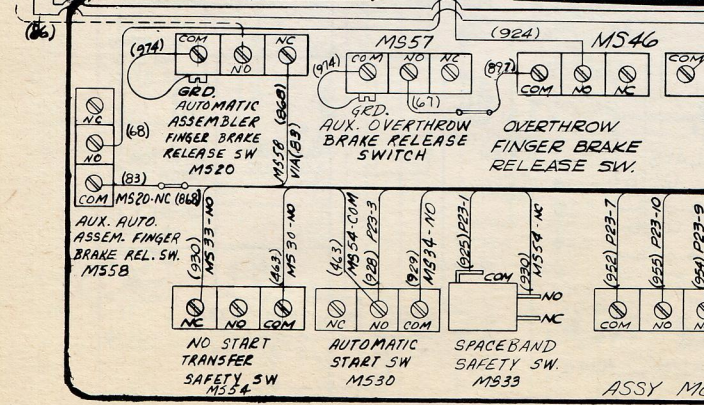
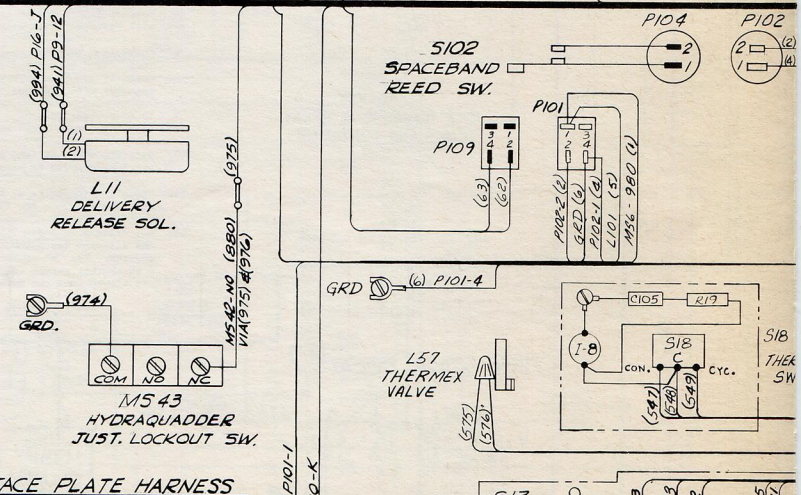
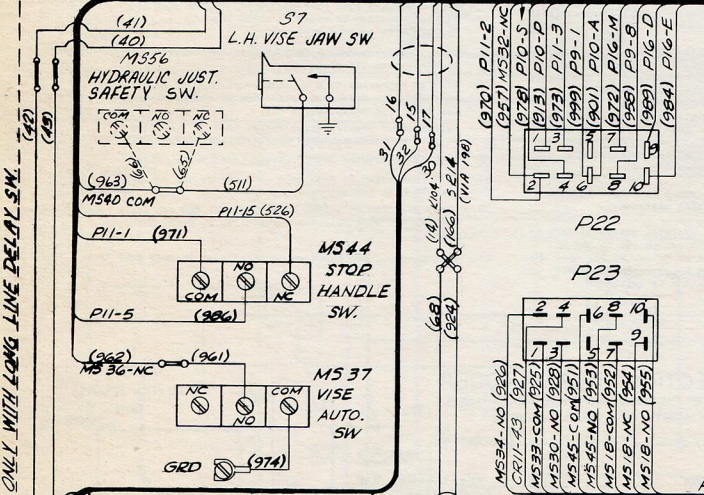
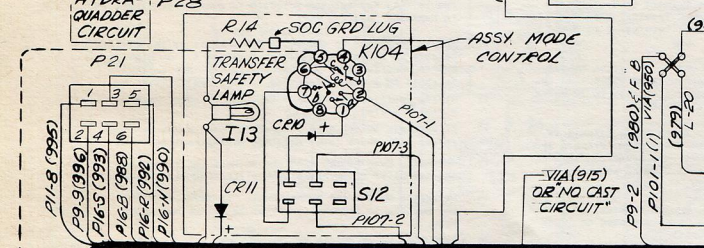
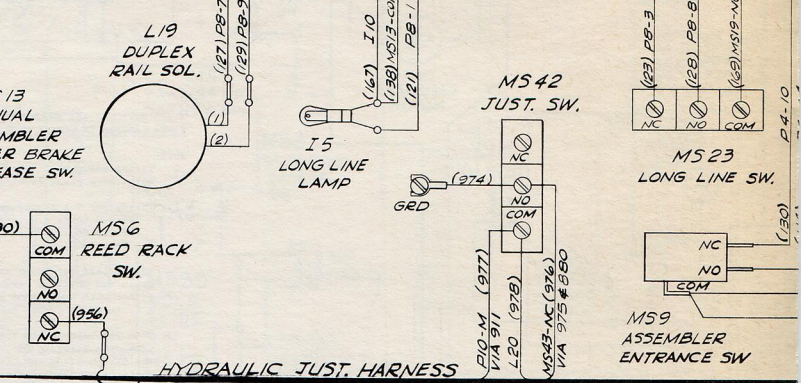
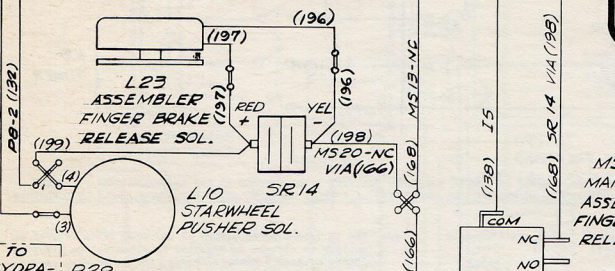
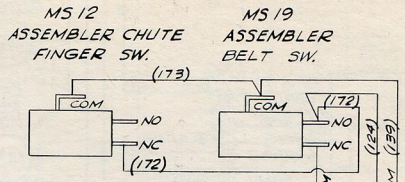

ASSY MODE CONTROL HARNESS

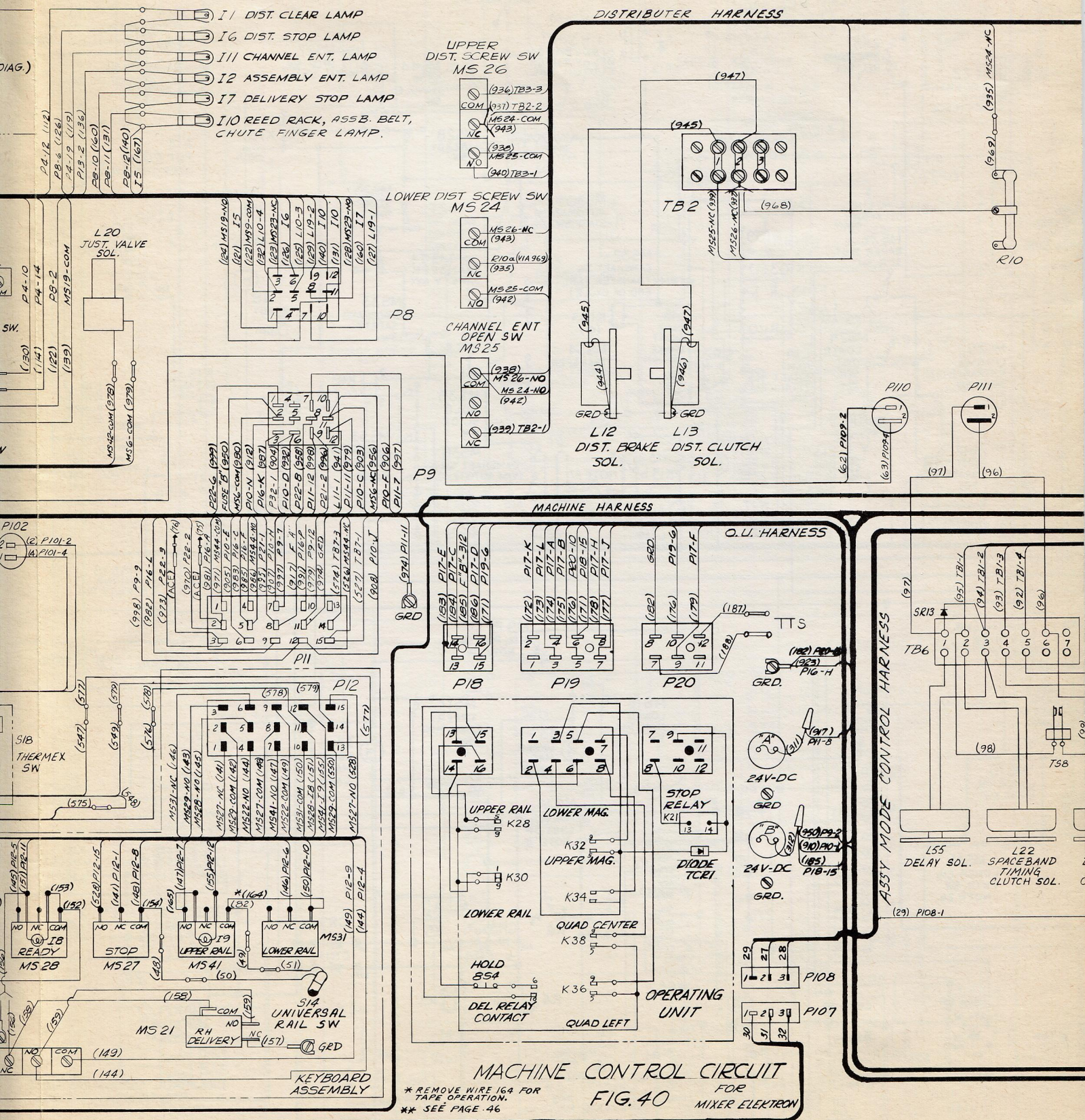

FIG. 40

* REMOVE WIRE 164 FOR TAPE OPERATION.
 ** SEE PAGE 46

MACHINE CONTROL CIRCUIT FOR MIXER ELEKTRON
 FIG. 40

