

*Operation of Trains
and Stationwork*

PRIOR



Class TF550

Book P82

Copyright N^o 1919

COPYRIGHT DEPOSIT.

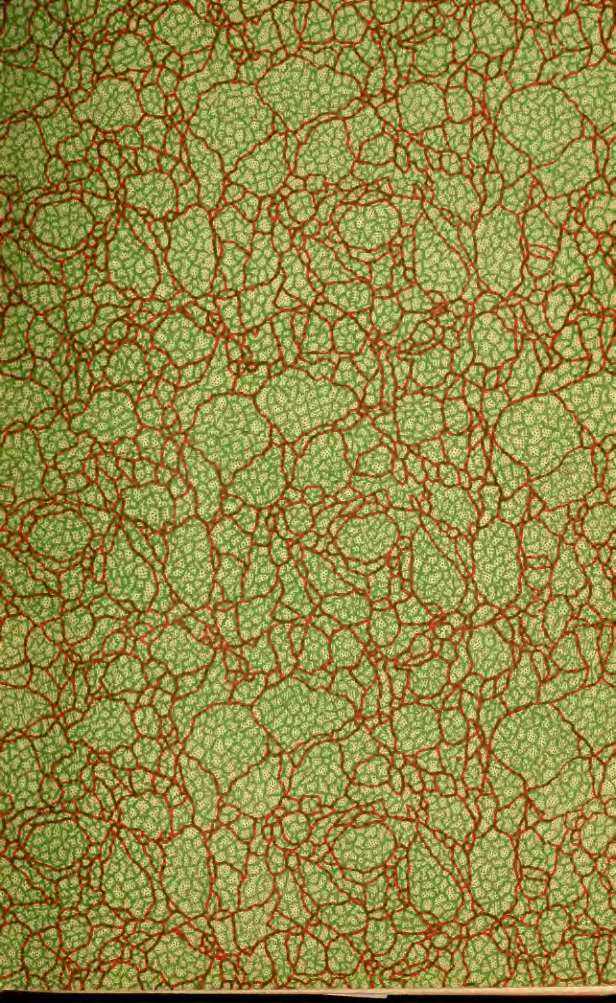

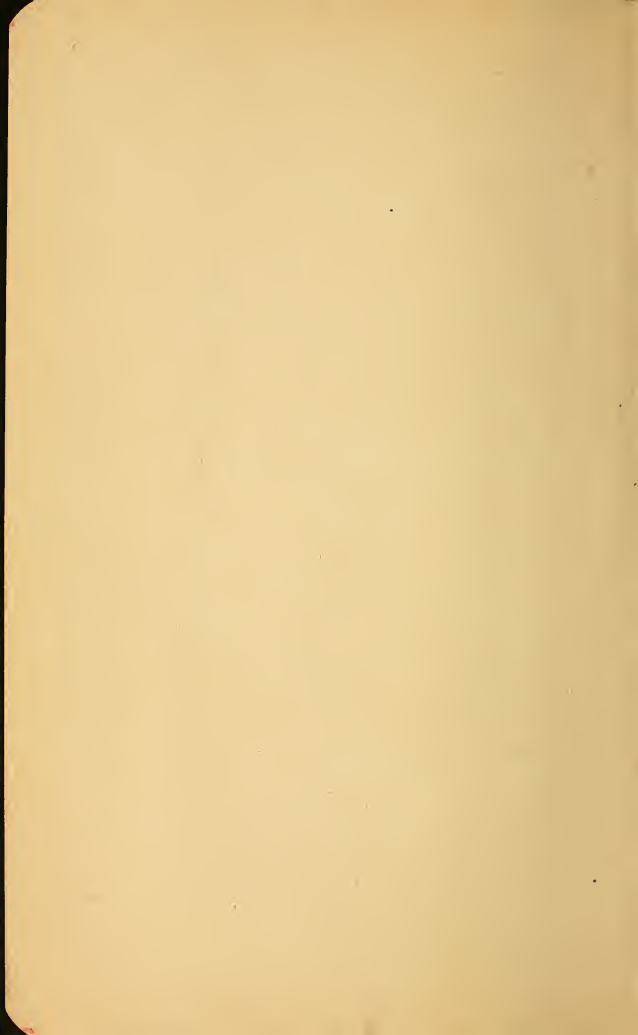

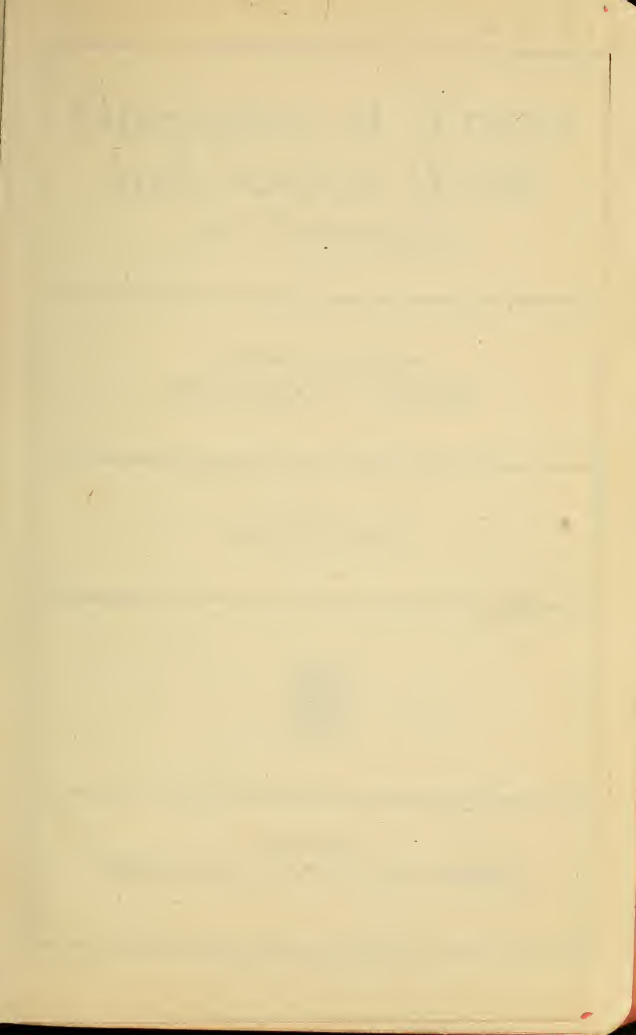



Operation of Trains and Station Work *and* Telegraphy

COMPILED AND EDITED BY
FREDERICK J. PRIOR

ILLUSTRATED



CHICAGO
FREDERICK J. DRAKE & CO., PUBLISHERS

Operation of Tents
and Tents
and Tents

TF550
P82
1919

Copyright, 1919, 1916, 1914 and 1907
by

Copyright, 1919, 1916, 1914 and 1907
by
FREDERICK J. DRAKE & CO.
Chicago

MAR 10 1938
19-4256

©Cl.A512630

no 1

TABLE OF CONTENTS

PART I.

The train brakeman.....	5
The passenger conductor	9
Dispatchers: Trainmaster: Division Superintendent....	15
Color blindness—How to detect it.....	27
Heating passenger cars	41
Heating cars with electricity.....	115
Catechism of steam heating.....	122
Lighting passenger cars.....	133
Acetylene car lighting.....	150
Electric car lighting system.....	166
Car generator	177
Standard code train rules.....	203
Rules for single track	206
Rules for movement by train orders.....	220
Forms of train orders.....	228
Movement of trains.....	241
Rules for movement by train orders.....	243
Trainmen's examination	250
Rulings of the American Railway Association.....	314
Interlocking rules	343
Block signal rules.....	350
Enginemen and trainmen.....	359
Train order signals.....	375
Block signal examination.....	427
Signalling catechism	432
Signals of interlocking plants.....	443
Pointers for conductors.....	453
Pointers for brakemen.....	457
Rules for operation of trains and handling of freight and passengers	458
Trainmen handling brakes.....	474
Appendices	493

TABLE OF CONTENTS—Continued.

PART II.
TELEGRAPHY.

Instructions for beginners.....	3
Adjustment of instruments.....	30
Wire signals used in taking circuit from others.....	41
General rules and instructions for telegraph employes...	52
General instructions in train order wire work.....	60
General instructions in railway message wire work.....	69
General instructions in commercial wire work.....	78
Indexes, Part I and Part II.	

THE TRAIN BRAKEMAN.

As a rule, young men who decide to engage in the railroad service as brakemen do so because there is a certain fascination connected with the business, due to the fact that they are privileged to ride through various sections of the country, with advantages similar to those for which others have to pay, affording them an opportunity to visit different villages and cities, which serve to satisfy the natural longing for travel and desire for change of scene felt by young men, especially between the ages of seventeen and twenty-five.

It is the exception instead of the rule for a man who changes from one road to another to be successful; for this reason a young man who decides to enter the railroad world as brakeman, before making application for a position, should carefully consider his future chances in connection with the position and the field for advancement; whether or not the climate in the section of country through which he would run will agree with his health; also, if the community in which the majority of the trainmen have their "lay over" is all that he would desire as a location to be made his home.

To make a good brakeman, a young man should be possessed of the average amount of good common sense, should have a good memory and a quick ear, should incline toward being shrewd and business-like, should be active, possessed of a sound body and a steady nerve. He should be firm in his decisions, following closely his

instructions and looking to the best interests of the company, and should always be civil and polite.

If he conducts himself in a respectable manner, and keeps himself neat and clean when surrounding circumstances permit, he will command respect wherever he goes; and if possessed of ordinary good sense and ability, is bound to be successful.

He should, so far as lies in his power, see that the proper temperature is maintained in the cars, and that they are properly ventilated; also, when running at night, he should see that the lamps are burning properly, and in a general way look after the comfort of the passengers.

FREIGHT BRAKEMAN.

The young man who starts in the train-service as freight brakeman, should at once begin to study a copy of the rules and instructions furnished by his employer, with the object in view of familiarizing himself with them to such an extent that he will make a showing as good as, if not better than usually made by young men on their first trip, as upon this and the following two or three trips depend his chances, while serving in that capacity, especially if there are several extra brakemen.

During the first few months of his railroad experience, especially, he should use the utmost care in everything he does, in fact doing nothing that he does not know to be right. When throwing switches he should see that the rails "line" properly or points close up tightly. He should never stand beside a "switch" when a train is approaching or passing, in order to guard against the unaccountable impulse of "throwing" a switch that is properly set. When setting brakes he should be careful to

avoid the sliding, and consequent destroying of wheels. When "dropping cars in" at stations he should always consider it down grade until he is assured that it is not; in so doing he will leave no chance for them to get beyond his control; and when leaving them, if equipped with air-brakes, and the hand brakes are in proper working order, the latter should be used to secure them. The air-brakes should not be depended upon, as in time they may release, leaving an opening for an accident.

When giving signals with a lantern he should use judgment. When he wishes an engineer to move slowly or a short distance, signal should be given accordingly; emphasizing it when emphasis is needed. In fact, cool and deliberate judgment should be exercised in every move; it is essential to the proper performance of duty in any department of a railroad.

He should never absent himself from duty at the different terminals without permission, when there is a possible chance for his "crew" to be used; and such permission should not be requested unless there are good reasons for so doing.

Instead of a young man, after entering the railroad service, "falling in" with the "rougner" class of men with the object of becoming "one of the boys," thinking that is the only way of securing friends among railroad men, drifting along until his will power is so weakened by dissipation that he has not the moral courage to leave his so-called "friends," and in preference, sacrificing his position, losing all ambition in life and becoming what is termed a "traveling railroad man," he should keep none but good company, and never miss an opportunity to gather information concerning the running of a freight train, so that when called upon to make his first

trip as a freight conductor he will be able to make a good showing.

Once started, it is seldom one forsakes the hope that some day he will reach the goal of his ambition and be classed as a master of intricate and numerous train rules, acquired not by the study alone of books, but by the hard grind of an everyday practical contact with ever changing conditions that crop up almost every hour, and must frequently be dealt with in a way possible only to those whose sole dependence is the judgment necessary to improvise for emergencies.

When his bills or slips are handed him for the first time, none feels more elated than he, for his highest ambition for years has been secured, and he begins to reflect on how to advance further.

After learning the rudimentary principles of freight, and perhaps in addition yard service, he feels that he possesses qualifications fitting him for advancement, and because of this confidence, inspired by years of successful work, is finally promoted to passenger service.

PASSENGER CONDUCTOR.

The first duty of a conductor is to be absolutely certain that his train is perfectly protected and safe, protected against accidents by being supplied with the proper signals; and in case a train is delayed, to see that the rear man goes back with danger signals to warn an approaching train. This is a very important duty, and no conductor can be too careful in properly protecting his train, as many accidents have happened by short flagging.

He must know his engineer and men, and keep in touch with them, and notify them of all orders received, and must know and be familiar with all signals and orders received from train master and other officials.

He must be vigilant and watchful—careful as to the safety and comfort of the passengers and property entrusted to his care, always keeping in mind that he represents the owners and officials of the railway he is employed upon—and, as he is the man who comes directly in contact with the public as the representative of the railway company, he must be a good judge of human nature and be thoughtful and intelligent in the transaction of the company's business affairs, careful not to allow any loss to occur on any account, and be courteous, gentlemanly and business-like, always endeavoring to avoid giving offense to any one.

He should also see that the cars are clean and properly heated and well ventilated. At each terminal he should make correct reports of all trains and the time, and re-

turn same to the proper officials. Before starting on a trip he should know that his train has been properly inspected, that he has the authority for the movement of all cars in his train, that the air brakes are in proper working order, that he has the proper train orders or clearance in his possession to move, and that all over-due trains have arrived and departed, and that he has the right of track to proceed before giving the signal that starts the train. While train is running, it is his duty to keep a sharp lookout to see if any of the journals are running hot, brake-shoes sticking, etc.

Not only does the responsibility for the safety of the train devolve upon the conductor, calling for an everlasting alertness while on the road, but the numerous forms of transportation must be watched, and the bulletins and instructions carried out. It is an easy matter for a conductor to involve his company in a suit by improperly handling a "crank" who has been sold a ticket to a point at which the train does not stop, or one whose transportation is questionable. There are a great many things which must be left to the conductor's judgment, as all emergencies cannot be covered by instructions.

In the collection of transportation he must be careful not to accept any ticket or pass the limit of which has expired, or one that has been advertised as lost or stolen. He must be familiar with all forms of tickets issued by other roads, and be able to answer all questions intelligently in regard to connections, leaving time of trains at junction points, etc. In fact he is a walking encyclopædia and timetable, all of which must be done in a pleasant manner as the popularity of the road depends in a great measure on the way passengers are treated by the employees.

The duties of the conductor vary according to the run, whether it is local or a through run. On a through run a conductor reports in full uniform thirty minutes before leaving time, inspects train and reports any defects to the division superintendent or other proper officer to whom such reports are to be made; sees that trainmen are on duty in full uniform and that it is neat and clean; ascertains engine number, engineer and fireman's names, number and names of coaches in train; makes out wheel report to Car Accountant; and during the trip makes out trip report, showing time of train passing different stations; makes a notation of detention and causes for same, and reports them by wire at division terminal to Division Superintendent; collects transportation in coaches and in sleeping cars; collects transportation of passengers to destination of car, enclosing it after detaching his coupon in separate envelopes, one for each sleeper, and turns them over to connecting conductor at junction point.

On arrival at end of his run he makes out cash report showing cash collected during trip and also makes out mileage report of tickets, turning them in with all collections to the proper officer on his line to whom they should be sent.

Diplomacy and tact are essential in bringing harmony out of confusion, in preventing complaints from real or fancied grievances, and in avoiding claims for damages when conciliation as a preventive may be successful.

The conductor being the captain of his train, should instill in the members of his crew the principles of efficiency, deportment, studiousness in their efforts to practice economy, fidelity to the interests of their employers and the comfort and convenience of passengers entrusted to their care.

While acting as a passenger conductor, he should direct his attention toward the several branches connected with the operating department, acquainting himself (at times when it does not interfere with his own duties) with the men on the line in a general way, the duties of the agents and operators, as well as all other employees in the operating department, how many loaded and empty cars the different size engines are capable of handling over the different parts of the line, whether there have been any changes in the number of loaded and empty cars that is considered a full train, owing to the changes in the capacity of cars or engines, since he served as a freight conductor, how the passenger and freight trains are switched and the yards handled at the different points along the line, which way the tide of business is from time to time, etc., so that if the train master is promoted, transferred, dismissed or resigns, he can, without being unreasonable, figure that he may be called upon to fill the vacancy.

FREIGHT CONDUCTOR.

The freight conductor must show his ability in a different manner. The through freight man is in a class by himself. His duties are to get over the road with as much dispatch as possible, keep the dispatcher posted as to how his train is moving, and by so doing help the dispatcher make his meeting points for him. The local conductor comes last, but not least. He is born, not made. His duties are endless. He can make himself valuable to his company, but to do so depends a good deal on his disposition, as he comes more in contact with the patrons of the road than his brother on the through freight.

A young man while acting as an extra freight conductor, when it comes to the matter of running on short time against, or ahead of, a superior train, or about as close time as old and experienced conductors would attempt to run on, should, as in everything else, make safety the first consideration, *and not go*, as he has not established a reputation as a conductor, and if everything does not work as anticipated and trouble ensues, his future on that road is injured for a year or more, if not for all time.

He should perform his whole duty as a conductor, and should never depend upon his engineer or brakeman to do a part of it. While running between stations, and not otherwise engaged, he should ride in the cupola of the caboose, so as to be able to assist promptly, should it become necessary to make an emergency stop, on account of a disabled engine, car in train breaking down, train parting, etc.

When expecting to stop at a station for the purpose of doing work he should go forward as the train approaches the station instead of waiting to be drawn to the station platform in caboose. He should see that the switching is carefully done. If in his opinion his engine can draw one or two more cars over a certain piece of track than her "rate," if the tide of business is in that direction, he should haul them. In short, he should run his train in the interest of the company, just as he would if he owned the road, and where he notices that an improvement can be made, even though it is not directly in his line of business, he should lay the matter before his superior officer. He should make his reports at the end of each trip, and answer all correspondence promptly.

He should be especially watchful not to become in-

fluenced by, or associated with, railroad men or others, who incline toward gambling, regardless of their position as compared with his own. He should at all times conduct himself in a gentlemanly manner and should leave nothing undone in regard to learning the duties of a passenger conductor, as he may be called upon at any time, on account of sickness or death, or urgent business, to run a passenger train to the next terminal, or to remain on the run for a time. Upon his actions in connection with this trial, his doing a certain percentage of the extra passenger running, acting as conductor of special trains, etc., depends to quite a great extent.

DISPATCHERS; TRAINMASTER; DIVISION SUPERINTENDENT.

TRAIN DISPATCHER.

Train dispatchers are almost invariably promoted from the ranks of operators entitled to promotion. The duties of a train dispatcher require him to be possessed of a fair general knowledge of the workings of the operating department of a railroad, an adept at figures, and he should have a keen foresight, so he can quickly and correctly execute a number of moves ahead and provide for that which may not work just as anticipated. He should also be possessed of a clear head and even temper *and should drink no intoxicating liquors.*

On going to work, his first duty should be to get an understanding of all orders in force and see that they are correct, then ascertain the location of trains on the "train sheet," and keep close watch that all which is done will insure safety as well as the prompt movement of trains.

He must constantly bear in mind that the success of a railroad depends to quite a great extent on the safety and dispatch with which the business tendered by its patrons is handled, and be governed by this in giving preference to trains, taking into consideration the kind and class.

He should endeavor to get the ideas of his superiors so fixed in his mind that when left to his own resources he may act properly and in accordance with their wishes. He should be governed by the instructions of those in authority and never encourage or conceal any violations

of rules by others. He should not allow a desire for popularity among those in the train or telegraph service to influence him in any way and should show no partiality.

There is a constant strain on the nerves of a train dispatcher, on which account his hours of duty are generally short, which gives him considerable leisure time, a portion of which should be spent in broadening his views of the world in general and his branch of the business in particular, so that he may be fitted to accept the position of chief train dispatcher when opportunity offers.

CHIEF TRAIN DISPATCHER.

To be fitted for the position of chief train dispatcher a man should be a proficient operator, quick of perception, possessed of good business tact and such a mind as will enable him to read human nature with such accuracy that he may properly discipline those under his jurisdiction, and yet obtain and hold their loyal support.

He should know the respective ability of the dispatchers under him, giving personal attention to the manner in which they perform their duties and instructing them from time to time as to the movements of trains, recording of delays and accidents, etc.

He should see that perfect order and decorum are observed by dispatchers on duty, and by all other employees of the office, and that only those persons whose duties require it have access to the dispatcher's office, in order that those employed therein may be able to give their undivided attention to the work before them.

He should endeavor to keep a competent force of operators on the line, and from their work on the wires,

or otherwise, be able to judge as to their ability and disposition. He should require prompt and proper transmission of all orders, messages, etc., and permit no abusive or vulgar language to be indulged in over the wires.

He should know the location of "line repair men" at all times, and make every effort to perfect the mechanical working of the telegraph service.

His personal attention should be given to the answering of correspondence, the abuse of car service, the selection and placing of operators, never depending upon subordinates to relieve him of such duties except in case of sickness, etc. In cases where their chief displays the slightest tendency toward indifference in his manner of doing business, employees are quick to take advantage of it, and, failing to throw the necessary energy into their work, the result is not only detrimental to the best interests of the company, but injurious to the aspirations and ambitions of all employees in this department.

From practical experience as a dispatcher, or otherwise, he should have indelibly fixed upon his mind a profile of the road in general, such as the lay of the track, the location of all stations and sidings, capacity of each, and all connections of his line with foreign roads.

The responsibility of opening the line when blockaded, and, when necessary in such cases, or prompt action in securing transportation for important trains over foreign roads, devolves upon the chief dispatcher, in the absence of his superior officers; and, having previously studied their wishes, he should follow their ideas as far as practicable. He should also know the position of "tool" and "derrick cars," and "construction" and "wrecking" crews, thus enabling him, when through accident or other cause his line becomes impassable, to concentrate a sufficient

force of men and tools at the point of trouble in such a short space of time as to remove the obstruction with the least possible delay.

He should have a thorough knowledge of the number and capacity of all locomotives and different kinds of cars owned and in use by his own company, as well as the cars of other roads and private corporations that may be operating over, or in connection with, his line. He should watch closely the movement of foreign cars and foreign loading at home stations, special attention being given competitive shipping stations, and see that all orders for cars are promptly filled, loading foreign empties "home" when practicable, otherwise returning them by the shortest route.

He should keep himself well informed as to the future prospects for business and at what point and to what extent it will reach his line, carefully distributing engine and train crews so that the power will be utilized to the best possible advantage, leaving no opening for the necessity of running crews in both directions with less than full "hauling-rates" over the same part of the line at the same time. This matter should be constantly borne in mind, as thousands of dollars annually can be saved to the company, and much dissatisfaction among engine and train men avoided, if the power is economically and intelligently handled. He should also realize that the patronage of his road depends to quite a considerable extent upon promptness in the provision of cars and upon the dispatch and safety with which all traffic is moved.

He should be familiar with the make-up of passenger trains on his line and the location and condition of all extra equipment, keeping well informed on all happenings of note, especially those which would probably pro-

duce extra travel between points on the line, and see that proper facilities for transportation are provided.

In addition to keeping a close check on his own department, he should endeavor to secure a wider knowledge of the world and railroad work in general, since a fair proportion of the business of all branches is done through his office and in his sight or hearing.

If he displays the proper energy in the management of his own department, and embraces the opportunities afforded him to broaden his views, he may reasonably expect promotion to a superior position when a vacancy occurs.

THE TRAINMASTER.

The trainmaster makes the schedules, assigning the men on the trains to their duties; fills the places of the absent ones, sometimes on woefully short call; listens to complaints and grievances; regulates, adjusts or dismisses them; investigates sins of omission and commission resulting in poor service; and digs out evidence, fixing responsibility for derailments and accidents of various sorts. To him are sent the complaints of passengers against the men, some of merit, many without it, but all to be impartially investigated, and his findings in each case sent to the Superintendent, together with whatever recommendations or suggestions may seem proper from his point of view.

He must exercise a general supervision over all employees, not only in train service, but also in yard and station service on his division, keeping a watchful eye upon station buildings inside and out, to see that they are kept up to a proper standard of neatness. He must be familiar with the actual conditions that govern

yard and switching facilities in detail at terminals, in order that no "song and dance explanation," as the boys call it, be received in cases of derailment or other mis-happening; know whether this train can get along with one less car, or the other train is being run with enough cars; watch the time and stops of trains to ascertain if they are doing the best they can; see that cars are properly and regularly distributed; keep in touch with the dispatcher twenty-four hours a day, and be ready on short call at night to get into his boots and breeches whenever there is a wreck on the line. It is a strenuous life and full of incident, but trainmasters as a rule are a healthy lot, and are generally recruited from the ranks, where they have learned that in order to do good work they must take good care of their bodies.

Informal meetings are frequently held where the trainmaster catechizes his men as to their understanding of the rules; such meetings are productive of wonderfully good results; they keep the men on edge, and lots of spirited discussions take place at these times. A much higher standard of train service is required, and given, than there used to be; a perfunctory knowledge of the rules of operation was once deemed to be sufficient. Nowadays, the men are not only required to know the rules, but to understand the fundamental principles that brought them individually into being, and it is part of the duty of the trainmaster to make that clear to them. This, however, is not a difficult task; for, thanks to a system that provides intelligent men to start with, the average man in train service today is of somewhat superior calibre to his brethren in the earlier days of railroads. He earns more money and works less hours for it than formerly, and more is expected of him in a better stand-

ard of service. In these and many other directions the trainmaster acts as a lieutenant to his superintendent, making himself useful to him, and when the time comes as it does to some trainmasters, when he is made superintendent with larger responsibilities, the knowledge and experience gained in this subordinate capacity are of very material benefit to him.

A trainmaster, to fill his position satisfactorily, should have a thorough and intimate knowledge of the character and capabilities of his men, as a trustworthy and competent employee who performs his duties properly and well, is a twofold factor in the service, for individually he gives his employers the best that is in him, and by force of example exerts an influence over his less careful brother that may and frequently does incite him to do better work. He should possess the fullest confidence of his men in their knowledge of his fairness and freedom from personal feeling in his treatment of them, dealing with them fairly and squarely as men, with the human element of sympathy with their affairs, which, when properly exercised, can never conflict with firm disciplinary action. If they do right, they are all right; if they do wrong, they must be brought to a realizing sense of their error by measures of discipline, to fit the case; for men, as a rule, no matter what they may protest to the contrary, *know* when they are in the wrong, and what good discipline requires in the way of penance, and the quality of the service is the gauge that shows whether the trainmaster also recognizes this important fact.

The points of contact between the trainmaster and his men are many, and in his dealings with them various subjects of mutual interest are threshed out, and valuable suggestions "hot off the bat" are thrown out in the

course of their arguments. Discussion of everyday matters of operation with whose general scope all are more or less familiar, frequently develops problems that require considerable thought to solve. This broadening process is of proved efficiency; but the matter of the greatest underlying importance is that it brings out the actual knowledge of his business possessed by each man. There are two features in connection with this close relationship between the trainmaster and the men, one of which is that it promotes an *esprit de corps* that really animates, and the other is that it in like degree tends toward perfect service.

DIVISION SUPERINTENDENT.

A superintendent should be a model man among his employees, honorable and just in all his dealings with them, possessed of business thoughts and ideas on a broad scale and should have a deep insight into human nature. Although as a rule he should be firm in his decisions, his temper should be even, and when convinced that he has erred, he should in a broad, liberal way admit it, regardless of whether the party who furnishes the evidence occupies an inferior or superior position.

He should be personally acquainted with the heads of all departments and be able to call by name all the employees (such as those in the train, locomotive, track and bridge departments, as well as the dispatchers, agents and operators, and the heads and their lieutenants, of the different offices of the freight and passenger departments) who have been in the service under him six months, or longer, and should have a fair general idea of their ability in their respective positions.

He should give employees to understand that all rules

in effect, and those which are issued from time to time, no matter how trivial they may seem, are to be obeyed and will be enforced to their fullest extent. If there are any rules in effect which cannot or should not be enforced, they should not exist and should be annulled, as nothing will demoralize the operation of a railroad as will the understanding among its employees that the officers do not expect certain rules or orders enforced.

In case of accident he should not act too hastily, and when employees are responsible for such accidents, their past record should be taken into account. He should never censure or pass judgment upon his subordinates on information gathered outside of the service, or from employees whose object in giving it is anticipation of reward in the way of promotion, without giving the accused a hearing, and when giving them such hearing, consideration should be given their intellect and powers of expression. If they have not such a command of language that they can make themselves clear, or if bashful and timid, allowance should be made accordingly. On the other hand, if the accused are especially gifted with a command of language it should also be considered, in order that justice should be done both company and employees.

Often statements of employees are handled in a perfunctory manner by superintendents or their representatives; and knowing this, employees make statements which would not be made if it were known that such statements would have to stand a test by having them placed in the hands of all others interested. The sooner officials adopt the principle, and have it clearly understood, that each statement, written or verbal, will be tested in such a manner that the facts, nothing more or

less, will be brought out, so much sooner will justice be meted out to all concerned and the service improved accordingly. To bring about such results the official should be lenient as he can consistently, when it is demonstrated that an employee, after getting into some difficulty, has made a ruthless statement, and as can readily be perceived, the better class of employees will be incited to truthfulness on account of the fact that the official displays his appreciation of principle, and the lower class of employees will be incited to truthfulness because they can clearly see that the truth will ultimately be brought to the surface and they will be severely dealt with if they do not tell the truth.

To enforce good discipline among men and be recognized as their superior officer, it is not necessary for him to be "distant" with them, if he is possessed of the ability to draw the line at the proper place. All that is necessary is, in a quiet, firm manner, little by little, to educate the employees to the understanding that nothing but business is acceptable in connection with business.

As a rule, employees in order to keep their respective departments up to what they consider the proper standard, are naturally a little more extravagant in the way of making improvements, adding to their supplies, etc., than is usually necessary, and a superintendent should be possessed of such judgment and business tact that he can "draw the line" at the proper time and place, and in such a way that he will not wound the feelings of his lieutenants, but make them feel that he has confidence in their judgment and ability, that he may retain their loyal support.

He should be well informed on the cost of constructing track, placing the different kinds of ballast under

it, and what it costs to renew or maintain it, the shortest degree curves and steepest grades practicable, considering the kind and size of engines in use, etc. He should have a good practical idea of the lay of the track, condition of all culverts and bridges on the line, and any portions of the track which are exceptionally liable to damage by severe storm, etc.

He should be able to talk intelligently with his bridge superintendent or foreman about the cost of repairing, or building new bridges of the different sizes and styles, and should also be capable of forming a good estimate of the cost of repairing, replacing or building new, station houses, freight rooms, machine shops, turn-tables, terminal facilities, reservoirs, water tanks, etc.

He should be conversant with the earnings of the passenger and freight departments as a whole; the earnings of each passenger train per mile, the cost of renewing and maintaining all passenger and freight equipment, the condition and drawing capacity of all locomotives over the different portions of the line, as well as their cost and what it costs to maintain and operate them.

No superintendent who has his followers and places them irrespective of the interests of the company he is serving, or the ability of the men in the employ of the company before he took charge, can hope to be successful; as it is a fact that many a young official who has had a bright future before him, has lost all by losing his influence and control over the men on account of using undue partiality of this kind. Ability, intelligence and gentlemanly deportment are working their way into the railroad world to such an extent that they are, and must be, recognized without partiality.

All connected with the operating department, especially

superintendents and others directly in charge of trains and their movements, should realize that their methods and manner of handling the business are as crude, compared with the methods of those who will be occupying similar positions twenty-five years hence, as the methods of their predecessors twenty-five years ago were, compared with those of today.

THE MANIFESTATIONS OF COLOR BLINDNESS —HOW TO DETECT IT.

A general impression prevails that color blindness is inherited, that a person is born color blind. It is not so. Sometimes it is the result of accident, illness, or overtaxing of the eyes, so it is possible for one whose eyesight is perfect today to be color blind tomorrow. Sometimes persons thus afflicted are totally ignorant of it for a long time, because while one may be color blind it does not necessarily follow that the eyesight is not good in other respects. Men are more frequently color blind than women, due, probably, to the fact that it may be caused by the excessive use of alcohol or tobacco or both. In warning those who are testing for color blindness, Dr. Stillings says: "It is a well-known fact that color blind persons, by exercising their faculty of judgment, can aid their want of sensibility and so conceal their defect to a certain extent. They have learned the names of colors quite as well as normal sighted people; and by the help of every outward sign they have acquired a certain knowledge of those pigments to the characteristic tints of which they are blind."

Again, one who is color blind "can sort and place in correct order a series of shades of red or green much better and more quickly than the normal eyed, because to them the color is but so much light and dark. A color blind person is asked to buy a skein of red worsted to match a pattern. He asks the attendant in the store for red worsted, and selects the one which corresponds

in luminosity with his pattern. Such a test apparently forbids the idea of any chromatic defect. But we will suppose the worsted attendant is away, and another, who is also color blind, hands over the greens to the purchaser, the latter will then complacently select the one which matches in luminosity with his red pattern. If he is green-blind, he will select a lighter green—if red-blind, a darker—than his pattern. This sensitiveness to light shade has enabled color blind painters to follow their profession with success, and even avoid discovery, until accident or design has interchanged, for instance, their reds or greens.”

The orbit of vision is much restricted, for on this point Dr. Jeffries in his valuable book, says:

“Our point of best vision on the retina is directly in the center, and over but a small space here; so that, to see an object distinctly, we must carefully turn the eye, to keep the picture on this portion. In looking at a long word on a page, we unconsciously travel along it to catch all the letters. If we keep our eye fixed on one point, and move a letter away from this point, its form is soon lost, and we fail to recognize it; let one eye be closed, and the other fixed on a bright red object, like a wafer, held before it; when moved gradually out from the central field of vision, the wafer will decrease in brightness, and finally appear black. Its form we may still discern. This is not color blindness. Whenever the retina is tired out with one color, it can only perceive the complementary one. If with one eye we gaze steadily for some seconds at a bright green disk on a white ground, and then quickly look at another white surface, we shall see a red disk. Gazing fixedly at the setting sun when a deep red, and turning quickly to the

east, we shall see a rising green sun. I hardly need say this also is not color blindness. The crystalline lens in the eye becomes, with age, harder, and of a yellowish color—up to positive blackness. When opaque, it prevents, of course, the passage of light through the pupil; it is called cataract. This opaque lens we then remove from the eye, and replace it by a strong convex lens in the spectacles. This is not true color blindness. Another physiological fact in relation to color perception is very important, and seems to be generally quite unknown or neglected. Around the point of best vision in the center of the retina is a zone where we perceive all of the three so-called base colors—red, green, and violet. Outside of this there is another zone, in which we have a perception of only two, namely, green and violet; and again, beyond this, on the retina, only blue or violet is perceived.”

Thomas Young and Professor Helmholtz describe the physiology of color blindness as follows:

“There are in the eye three kinds of nerve fibres. Stimulation of the first produces the sensation of red, the second that of green, and the third the sensation of violet. Objective homogeneous light excites these three kinds of fibres in varying degree according to the wave lengths. The red perceptive fibres will be strongest stimulated by light of the greatest wave length, the green perceptive by light of medium wave length, and the violet perceptive by light of the smallest wave length. Here must not be excluded, but rather accepted in explanation of a series of phenomena, that each spectral color excites all three kinds of fibres—but one less, the others more strongly. Simple red strongly stimulates the red perceptive, less the other two; sensation, red.

Simple yellow stimulates moderately the red and green perceptive, feebly the violet; sensation, yellow. Simple green stimulates strongly the green perceptive, much less the other two; sensation, green. Simple blue stimulates moderately the green and violet perceptive fibres, feebly the red; sensation, blue. Simple violet stimulates strongly the violet perceptive, feebly the other fibres; sensation, violet. Equally strong stimulation of all the fibres gives the sensation of white or whitish colors. The term *color blindness* indicates a genuine blindness to one of the primary colors. In this way, therefore, we distinguish, according to the kind of element wanting, three classes of blindness—red blindness, green blindness, violet blindness. Blindness to red is due to the absence or paralysis of the organs perceiving red. Red blindness has, then, but two fundamental colors, which, adhering strictly to the theory, are green and violet. Green blindness derives its origin from the absence or paralysis of the perceptive elements of green. The green-blind have, therefore, but two fundamental colors, red and violet. Violet blindness (or blue) is due to the absence or paralysis of the elements perceiving violet. The two primitive colors of the violet-blind are, then, according to theory, red and green.”

Regarding how color blind people see, one who was thus afflicted, has described his experiences:*

“In the first place, the color blind see white and black, and their intermediate or compound gray (provided they are free from alloy with other colors), precisely as others do. Yellow and blue, also, if unalloyed, we see, as far as can be ascertained, in the normal manner. But these two are the only colors of which we have any

*Wm. Pole.

sensation. We do see all such things, but they do not give us the color sensations correctly belonging to them; their colors appear to us varieties of the other color sensations which we are able to receive. Take first the color red. A stick of red sealing wax conveys to me a very positive sensation of color, by which I am perfectly able to identify, in a great number of instances, bodies of this hue. But, when I examine more closely what I really do see, I am obliged to come to the conclusion that the sensation I perceive is not one that I can identify separately, but is simply a modification of one of my other sensations, namely yellow. The appearance of green to the color blind corresponds exactly to that of red. Green, in its true aspect, is invisible to them, and, consequently, when neutral, i. e., unmixed with any other color—it presents to their eyes the appearance of gray. When, however, it is mixed with yellow (and most of the greens in nature are yellow greens), they see the yellow only, but diluted or darkened by the invisible green element; and in less frequent cases, where the green is mixed with blue, they see the blue element only in like manner. It is therefore easily understood how so simple a defect of vision gives rise to a complex series of symptoms. Take first the color red. If it is a scarlet variety, as the majority of reds are, presenting the appearance of yellow to the color blind, they may naturally confound it with the latter color, as well as with orange, with yellow-green, and with brown, all of which cause to them the same sensation. If, on the other hand, the red contains a predominance of blue, it may be confounded on the same principle with blue or violet. If it is a neutral red, lying between the two, it will be confounded with black or gray. A pale pink,

though very distinctly colored to the normal eyed, often offers so little color to the color blind as to be mistaken for white or very light gray. The same explanation will apply to green. Its yellow varieties may be compounded with red, orange, yellow and brown; its blue varieties with blue and violet and its neutral hue with black or gray, or, if pale, with white."

Persons blind to red are said to exceed all others in the ratio of four to one. Professor Holmgren says: "He whom we call color blind is not, correctly speaking, at all blind to colors. He perceives, in the main, the same kind of light as the normal observer, but sees a part of it in another manner. In the system according to which he arranges his colors, he has fewer kinds than the normal observer. A color blind person can no more accustom himself to seeing colors as the normal observer does, than the red blind can see colors in the same way that the green blind does, or conversely. To judge correctly of color blindness, and the various practical questions connected with it, it is of the highest importance to observe distinctly the difference between the manner in which the color blind person sees, and the manner in which he names colors."

The violet-blind are rare.

Statistics resulting from the examination of about ten thousand persons showed conclusively that four per cent of men have defective eyesight in that they are unable to discern between red and green colors: This is a very serious matter with men employed in train service. The reason is at once obvious.

Therefore, color blindness being an established fact, the question is, How can it be best detected? The most natural answer given without reflection, would be. take

them to the different railway signals, and let them describe the colors. But this will not do. The test must be made scientifically, or else those disposed to conceal the defect in their vision will sometimes be able to hide it, or at least render it somewhat difficult to discover. Probably the best method is that described and recommended by Dr. Jeffries, as prescribed by Prof. Holmgren, who says:

“Our method demands neither costly apparatus nor a special place for the examination. The only necessary elements are a number of variously colored objects; it consists of taking one from a number of objects promiscuously thrown together, and asking the person examined to select from amongst them all the others corresponding with the first in color.”

Prof. Holmgren considers woollens preferable to paper, glass, wafers, powders, solutions, thread, wood or porcelain, and gives good reasons for his preference. He says:

“One of the chief advantages of Berlin worsted is, that it can be procured in all possible colors corresponding to those of the spectrum, and each in all its shades from the darkest to the lightest. Such selections may be found in trade, and are easily procured when and where desired. It can be used at once and without any preparation for the examination, just as delivered from the factory. A skein of Berlin worsted is equally colored, not only on one or two sides, but on all, and is easily detected in a large pile, even though there be but one thread of it. Berlin worsted is not too strongly glaring, and is, moreover, soft and manageable, and can be handled, packed, and transported as desired, without damage, and is conveniently ready for use whenever needed.” His selection of colors would include: “Red,

orange, yellow, yellow-green, pure green, blue-green, blue violet, purple, pink, brown, gray, several shades of each color and at least five gradations of each tint, from the deepest to the lightest. Green and gray, several kinds each of pink, blue, and violet, and the pale gray shades of brown, yellow, red and pink, must especially be well represented. According to our method the examiner selects from the collection of Berlin worsted in a pile on a convenient table, and lays aside a skein of the especial color desired for this examination; then he requires the one examined to select the other skeins most closely resembling the color of the sample, and to place them by its side. The chromatic sense of the individual is decided by the manner in which he performs his task. The result of comparison which the examined makes—in other words, the little skein of worsted which he selects and places by the test—shows us in reality what colors seem alike to him, and thus tells us his relative color perception. The rapidity with which this examination is made does not seem to correspond directly with the nature of the chromatic sense, but to depend wholly upon the character of the person examined. One of intelligence, with a quick, practical mind, is examined in less than a minute. In this time, in fact, a normal eye could easily find the four or five skeins of the same color as the sample, and the color blind make a sufficient number of characteristic mistakes to establish the diagnosis thoroughly. A practical surgeon can often detect color blindness by the first gesture of the examined, and make his diagnosis before the end of the trial. He can, according to the manner in which the task is performed, form a judgment of a feeble chromatic sense, in instances which are proved correct by the final re-

sult. He also can and must see whether the result is erroneous, simply on account of a misunderstanding or a want of intelligence, just as he can see whether the really color blind succeeds, in a certain degree, from much previous exercise or a considerable amount of caution. In short, the method supplies us with all necessary information; so that, by an examination made with its assistance, a defective chromatic sense, no matter of what kind or in what degree, cannot escape observation. The principle of our method depends, as we have said, on the test calling for the selection of but one color among many. It may be asked, what need of such a number of colors? Would not a smaller answer? We reply that the color blind avoids detection with more difficulty, and the diagnosis hence is more readily made, the greater the number of the various colors. The normal eyed readily selects the right ones from the mass; whilst the color blind, although the right ones are directly before him, picks out the wrong ones, thereby disclosing the character of his defect. Therefore the greater the number of colors, the better, of course, within certain limits. What color shall we take for our sample? It is necessary to select as a suitable color for discovering a feeble chromatic sense, either the lightest or darkest shades. The well-defined kinds and degrees of a defective chromatic sense confound only colors of mean intensity. I have selected, to determine whether the chromatic sense is or is not defective, a light green (dark green may also be used), because green, according to the theory, is the whitest of the colors of the spectrum, and consequently is most easily confused with gray. For the diagnosis of the especial kinds of partial color blindness, I have selected purple (pink)—that is, the whole group

of colors in which red (orange) and violet (blue) are combined in nearly equal proportions—at least in such proportions that no one sufficiently preponderates over the others, to the normal sense, so as to give its name to the combination. Purple is of especial importance in the examination of the color blind, for the reason that it forms a combination of two fundamental colors—the two extreme colors—which are never confounded with each other. In fact, from a color blind point of view, one or two things must happen, according to the theory; either it excites but one kind of perceptive organs, or it excites them all. It appears, then, either like a simple color—that is to say, like one of the two colors of the combination—or like white (gray). Experiment has confirmed this hypothesis. Our sample colors, therefore, are the two complementary colors of each other—green and purple. In the examination of the chromatic sense of a large number of individuals, it is, of course, of importance to decide quickly, first whether the chromatic sense of the individual is or is not normal. It is only after establishing the existence of a defect that its nature or degree must be determined. The sample colors are therefore employed with more advantage in a certain order, as the test must be accomplished as a whole, according to a plan that experience has proved the surest, most rapid, and, finally, most suitable for the purpose. The Berlin worsteds are placed in a pile on a large plane surface, and in broad daylight; a skein of the test color is taken from the pile, and laid aside far enough from the others not to be confounded with them during the trial; and the person examined requested to select the other skeins most resembling this in color, and place them by the side of the sample. In the first place it is

necessary that he should thoroughly understand what is required of him—that is, that he should search the pile for the skeins making an impression on his chromatic sense independent of any name he may give the color, similar to that made by the sample. The examiner should explain that resemblance in every respect is not necessary; that there are no two specimens exactly alike; that the only question is the resemblance of the color; and that, consequently, he must endeavor to find something similar of the same shade, something lighter or darker of the same color, etc. If the person examined cannot succeed in understanding this by a verbal explanation, we must resort to action. We must ourselves make the trial by searching with our own hands for the skeins, thereby showing in a practical manner what is meant by a shade, and then restoring the whole to the pile, except the sample skein. As it would require much time to examine each individual in this way, it is advisable, when examining a large number at the same time, to instruct all at once, and, moreover, to ask them to observe attentively the examination of those preceding them, so as to become more familiar themselves with the process. By this, time is saved, without loss of security; for no one with a defective chromatic sense finds the correct skeins in the pile the more easily from the *f^resa* of having the moment before seen others looking for and arranging them. He makes the same characteristic mistakes; but the normal observer, on the other hand, generally accomplishes his task much better and more quickly after having seen how it must be done, and this is the advantage of our method. The principle of our method is to force the one examined to reveal himself, by an act of his own, the nature of his

chromatic sense. The method of scrutiny here described is able to detect, as we have seen, not only complete or incomplete color blindness, but a feeble chromatic sense. Moreover, it has been proved that there is a perfect gradation, from complete color blindness on one side, to normal chromatic perception on the other. The question naturally arises, from our practical point of view, whether it is possible to draw a dividing line between the kinds and degrees of defective color vision which would except those who could not cause any inconvenience to the railway service, and, in case of an affirmative answer, where such limit is to be found."

The subject in all its different phases is treated at great length by Dr. Jeffries. He dwells upon its prevalence and its detection. But only the more salient features in connection with color blindness in its relation to railway operation have been given here. The subject is one of much interest, however, and should be studied by those interested in it. The time may not be far distant when, in America, as in Europe, the Government may require railroads to have their employes who have to do with the movement of trains subjected to far more rigid examination in regard to vision than is now the case with most roads. Dr. Jeffries predicts that the safety of the traveling public will demand it.

It is pointed out that to examine railway men by the signals with which they are familiar is not altogether safe, because color blind persons can by the difference in light and shade alone often distinguish the signals. He thinks the examination ought to be scientific, and that it should be conducted by none but experts.

Some states have had the matter of such compulsory examinations up for discussion, and Connecticut did

once pass such a law. It requires all employes in any way connected with the operation of trains, to pass an examination made by experts appointed by the Governor. They were to be tested for visual defects, including, of course, color blindness, the examination being made, however, in accordance with the rules of the State Board of Health.

This law went into effect in 1880, with the immediate result that many trainmen could not correctly match colored worsteds or pass the other required tests, notwithstanding they had never before shown any apparent difficulty in distinguishing the signals in use. So great was the outcry against the measure by railway men that the act was soon repealed.

The Massachusetts legislature referred the matter of making a similar law in that state to the railroad commissioners, with the result that, after an investigation, they made a report, a few extracts from which will serve to show its tenor:

“Of course it is unsafe to employ a man afflicted with color blindness. But it would be at once foolish and cruel to remove three or four per cent of our railroad employes if they are in fact fully qualified to perform their duties. Persons who have been pronounced to be color blind prove on examination to have full perception of the colors of lanterns when placed at great distances and under trying circumstances. Employes who are theoretically color blind promptly distinguish white, red, blue and green lights at a great distance while engines are going out and coming in, with all the attendant annoyances of smoke and steam. The same men also distinguish by daylight red, green and white flags at a like distance without failure, while a person totally color

blind who happened to be present on one occasion pronounced a scarlet flag to be black when it was held directly before his face. Nor is any case recorded, so far as is known to this board, of a color blind man who could distinguish red from green in clear weather and who has mistaken red for green in foggy weather." The conclusions of the board are as follows: "That the existence of color blindness, total and partial, is a well established fact, and that there are men who, by reason of such defect, are unfit for positions on railroads requiring ability to distinguish color signals; that the extent of dangerous color blindness (i. e., such color blindness as unfits persons for railroad employment) has been greatly exaggerated; that examination may be properly made by persons not medical experts, and that such examination will certainly be sufficient if doubtful cases are referred to such experts; the board recommends that every railroad company shall have an annual examination of every employe whose duties require or may require capacity to distinguish form or color signals, and that no one shall be so employed who has not been thus examined; the examination should refer to color blindness and to other defects in vision; it should include all who are in any way connected with the movement of trains."

Afterward the legislature of Massachusetts passed a law requiring all railroad employes whose duties required them to distinguish form and color signals to be examined at least once in two years for color blindness and other defective sight.

HEATING PASSENGER CARS.

The heating of passenger coaches has always been a problem. At first large stoves were used at each end of a coach and no practicable substitute for stoves was found for many years, notwithstanding the subject exercised the ingenuity and thought of inventors and railway managers from the start. While apparently simple it was really quite complicated, being not merely a question of satisfactorily warming cars, but of preventing danger from fire in case of accident. So great, however, has been the progress made in devising and improving systems of heating, that it seems now as though perfection had been reached. Indeed, the subject of heating passenger coaches may be said to have passed through several stages in its evolution, in exactly the same ratio of progress as many other phases of railway operation. There are now several systems of heating in operation which may be described as follows:

THE BAKER SYSTEM.

To Mr. William C. Baker belongs the credit of having devised the first practicable, scientific system for heating passenger coaches.

When the Baker system was first introduced, the danger from hot coals being scattered, in case of a wreck, had not been removed, as will be seen by reference to Fig. 1, illustrating and describing the first style of heater, some of which are still in use. This is known as the original or old style ordinary Baker heater.

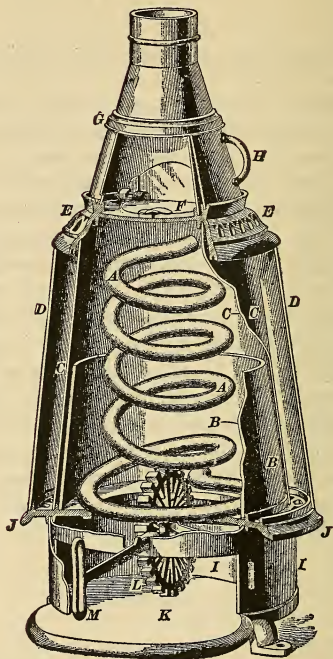

FIG. 1. THE ORIGINAL OR OLD STYLE ORDINARY BAKER HEATER.

A—Generator or Water Coil.

B—Fire-pot.

C—Inside Casing.

D—Outside Casing.

E—Top Casting.

F—Safety Plate.

G—Base of Smoke Flue.

H—Feed-door.

I—Ash-pit.

J—Ash-pit Casting.

K—Base of Stove and Bottom of Ash-pit.

L—Grate in Position to Dump.

M—Rocking Bar and Shaker for Grate.

E J—Perforated Castings Permitting Upward Air Circulation Through Space Between Casings C and D.

The air between the casings when heated expands and therefore rises, permitting cool air to be forced in through the perforated holes in the casting J, to take its place, and so an upward circulation of air is maintained. The generator coil A is connected to the heating system and as it is always filled with water (usually salt water or brine) it is heated by the fire and expands rapidly. The water as soon as it expands rises and passes out of the coil at the top, and cooler water passes into the coil at the lower end, taking the place of the heated water, and so an upward circulation is maintained through this coil.

The fire enclosure and water coil comprise the heater, but there are in addition some other apparatus used in connection with the system. These consist of a circulating or expansion drum, radiating pipes, cocks, etc., which serve to carry the hot water and distribute or radiate the heat throughout all parts of a coach.

Figure 2 is an illustration of a circulating drum. This drum is always attached to the highest point of the heater—preferably the roof of the car. It holds the water needed for circulation after the pipes have been filled. It also serves as a reserve tank. It is set horizontally as shown in Figure 3. The position of cock C enables the lower half of the drum to be used for storing water. The upper half is used as an air chamber which serves as an expansion chamber to secure free circulation. The air freed from the pipes after the water is heated rises and gathers in the upper half of the drum. There are two tapped holes in the bottom of the drum, a and b; the upper pipe from the heater enters one and from the other runs the circulating or down-flow pipe which carries the hot water through the car.

Should the fire be allowed to burn unchecked or the

water circulation be impeded the pressure in the heater might become dangerously high. To provide for such a contingency an appliance of cast iron called a safety vent, indicated at v in Figure 2, is screwed into the top of the circulating drum. It is a single casting without joints; at the top it is thinned down to a specified thickness which serves as a weak spot to yield, allowing the top to be blown off when the pressure reaches a certain point. More or less water is lost when a top blows off, which should be renewed. As soon as a safety vent blows

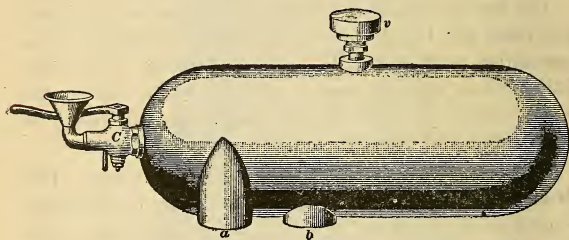

FIG. 2. CIRCULATING DRUM, OR WATER RESERVOIR AND EXPANSION CHAMBER.

V—Safety Vent.

C—Cock.

a b—Tapped Holes for the Upflow and Downflow Pipes.

out the fire should be put out to protect the coil. Of course, when a safety vent top is blown out it should be replaced with a new one, although the bushing may be used again.

The piping arrangement is shown in Figure 3. The expansion drum D is placed horizontally upon the roof, the heater being upon the floor of the car immediately beneath, as indicated by the coil A. The inflow pipe or riser R conveys the heated water to drum D from which

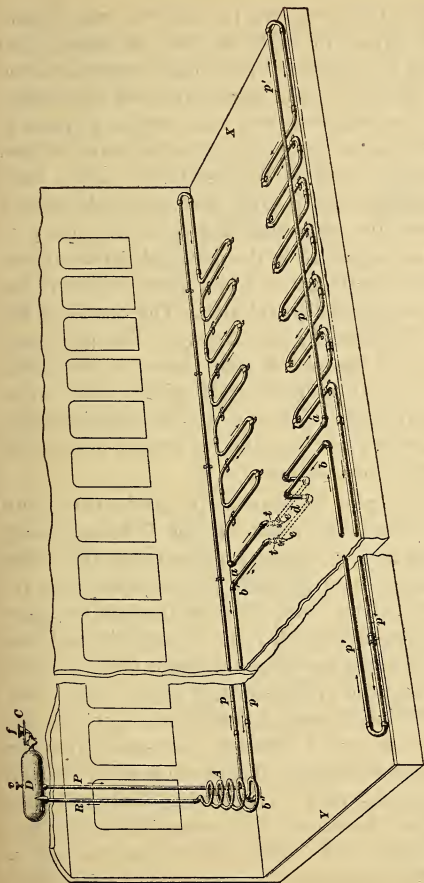

FIG. 3. SHOWING PLAN OF PIPING, COIL, AND CIRCULATION DRUM.

D—Expansion Drum.
 R—Riser.
 P—Downflow Pipe.
 A—Coil (Inside Heater).

P—Piping.
 Y—Heater End of Car.
 X—Other End of Car.
 C—Cock.
 f—Funnel.

v—Safety Vent.
 e—Position of Drain Cock.
 t—Tee Fitting.
 d—Space Beneath Flooring.

it descends into the car again through the pipe P and thence on its circuit through the line of piping p to which the pipe P is joined. The piping extends to the other end of the car X and then turns and in a series of loops, each one being under a seat, returns to point a, thence it crosses to the other side. The hot water is thus conveyed from one end of the car to the other, back again in a zig-zag circuit along the same side, thence across the car to the other side, and down the pipe p to X as before, back again as on the other side to the return bend at Y, recrosses the car at b and thence re-enters the heater at the bottom of the coil at b. The course of the circulation is indicated by the arrows. The pipe goes below the floor of the car at d as shown, a tee fitting being placed at t. In order to drain off the water when necessary a drain cock is placed at e. For better elucidation the illustration represents the car broken in two, the two parts being close together.

As the water in pipe R heats and expands, rising into the expansion drum, the water in pipe P being cooler, it weighs more and so exerts a pressure on the water in pipe p, causing it to circulate in the piping and re-enter coil A at its lower end. Passing through the pipes in the fire it is again heated, rises through the coil into the drum and is again discharged through the other pipe leading from the drum to the radiating pipe. Thus a continued up-flow of hot water is maintained through the coil into the drum, and a constant down-flow from the drum to the pipes in the car. The drum is filled through the funnel f and the cock C. After being filled the funnel should be turned downward to prevent dirt or cinders from accumulating in it. The cock is provided with a drip pipe. The foregoing describes the construction,

pipng and method of water circulation of the ordinary Baker heater, but, as already stated, the danger from hot coals being scattered in case of accident was not eliminated by the introduction of this heater. This led to an

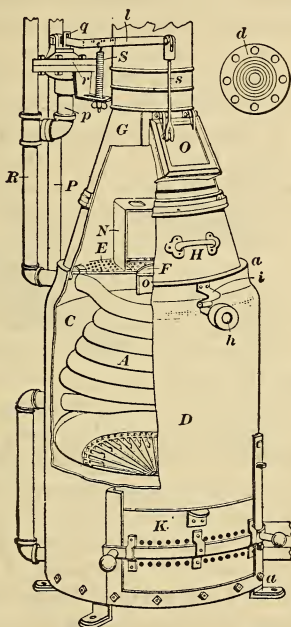

FIG. 4. IMPROVED FIRE-PROOF HEATER.

- | | |
|-------------------------------|------------------------|
| A—Coil. | F—Safety Plate. |
| K—Ash-pit Door. | i—Spring. |
| G—Smoke Flue Case. | D—Fire Safe. |
| E—Top Plate with Small Holes. | a—Indicating Depth. |
| N—Smoke Screen. | C—Sheet-iron Casing. |
| o—Coal Feed Chute. | d—Regulator Diaphragm. |

improved or Baker Fire-proof Heater being invented, a description of which follows:

There is a fire-safe consisting of an outside shell or casing made of a flexible grade of steel, without joint or seam. See Figure 4. D is the fire-safe; the depth of the casing or shell is indicated from a to a. On the inside of the shell are sheets of asbestos and next to these layers of asbestos is a sheet-iron casing C, enclosing the coil A; the space between casing C and coil A serves as an air space for the hot gases from the fire, and the space inside the coil A serves as a fire chamber. The fire is accordingly within four casings: (1) A water casing consisting of the closely wound coil A filled with water; (2) a casing of sheet-iron; (3) a casing of asbestos layers; and (4) an outer casing of steel plate.

The small holes in the draft, or ash pit, door K are the only open means of communication between the fire and the outer air; therefore, should the heater have the smoke-flue base G moved in a wreck, the only place through which fire could escape would be through the small holes in the top of E, and as these holes are so small there would be no danger of hot coals escaping.

The smoke screen N is a cone shape casting, as shown in Figure 4 for feeding the coal in at the front, the opening being just behind the feed-door. The coal goes down through the bottom of the casting, thence through the coal feed-chute o into the fire. Safety plate F, which is controlled by the hand lever h (the latter being held in place by the spring i), closes the hole in the bottom of the screen N, the top of which has small holes as shown, for the smoke to pass through.

The different casings which enclose the fire, the safety plate which covers the feed-chute, and the cinder-proof

door which closes in the ash-pit, together with the asbestos sheeting between the ash-pit bottom and the sheet-iron bottom of the heater render this style of heater practically fire-proof; because the smoke-pipe and smoke-flue base might be broken off in a wreck without exposing the fire in the fire-chamber, the latter being practically fire-proof.

Another style of Baker fire-proof heater is the "two coil" with a distinct circulation for each side of a car, thus doubling the capacity. See Fig. 6.

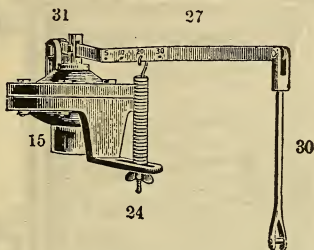

FIG. 5. AUTOMATIC REGULATOR AND PRESSURE INDICATOR.

15—Fire Regulator Bowl.

24—Adjustable Draft Regulator Spring.

27—Regulator Lever and Pressure Indicator.

30—Forked Connection and Door Rod.

31—Piston, Brass Connecting Lever.

The fire-proof heaters just described have an automatic arrangement for regulating the fire according to the pressure in the heater and the temperature in the radiating pipes. It is in effect a draft regulator, as shown by the letter *r* in Figure 4. It is also shown in detail in Figure 5. It will be seen that a pipe indicated by *p* leaves the riser *R* at the point shown and runs into the regulator

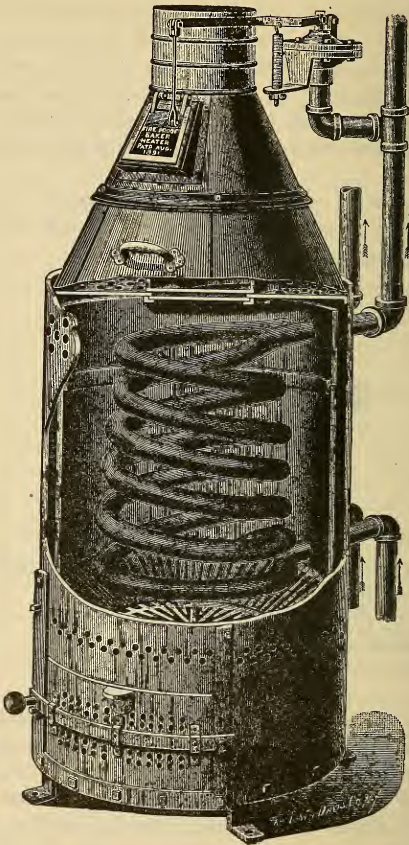

FIG. 6. DOUBLE COIL OR TWO CIRCULATION HEATER.

bowl, which consists of two concave pieces bolted together. Between the two parts of the bowl is a diaphragm *d* made from corrugated steel, as shown separately at the right. The steel is tempered and has a thin sheet of copper on each side. This diaphragm is bolted between the parts of the regulator bowl as described; the under side of which is exposed to the pressure in the pipe *R*. The rod *q* passes through the top of the bowl and rests upon the diaphragm *d*.

The pressure in *R* and in the bowl gradually increases, forcing up the middle flexible portion of the diaphragm and thus the rod *q* is lifted against the action of the spring *S* and the lever *l*, and so raises rod *s* and counter-draft door *O*, thus checking the draft through the fire. When the pressure in *R* decreases the diaphragm moves downward, the spring *S* pulls the lever *l* down and so closes the door *O*, causing more draft. The spring *S* has a loop at the upper end so it may be placed in any of the holes shown in the lever *l*. The closer to *q* it is the less force on the diaphragm is required to raise *l*. Each hole is marked with the pressure at which the door will open when the spring is in it, and this pressure corresponds with the pressure in the heater. Therefore *r* is really a temperature regulator, because the temperature varies with the pressure.

The water used is preferably salted, almost like brine. This prevents the pipes from freezing when not in use. Fresh water may be used, but it freezes at a temperature of 32° F., so there would be some danger and annoyance likely when starting fires. Salt water has a much lower freezing point than fresh water and the more salt it holds in solution the lower is the freezing point in the temperature. So with the brine properly prepared

the pipes will not freeze though the car should stand for several days without a fire and the temperature be 30° below zero. Salt water does not injure the pipes, neither do they rust. Heaters in use for several years have been examined and found free of rust or salt deposits. The brine should be prepared in a barrel or other vessel, and more salt than immediately dissolves should be put in and stirred up occasionally from the bottom; after twelve hours the excessive salt will have gone to the bottom, the water appearing clear above it. The salt deposit at the bottom of the barrel should not be disturbed, only the clear salt water should be used to fill the heater system, which will be salt enough to stand a very low temperature without freezing.

An absolutely solid body of water in the pipes is essential to proper circulation. Therefore all air, dirt and scale should be expelled from the pipes and they should then be filled with water free from air bubbles, as follows:

All draw-off or drain cocks in the circulation piping should be opened, the safety valve removed, and the combination cock kept closed. Then a half-inch pipe should be run from the topmost tapping in the expansion drum as shown at A A, Figure 7. This piping must be absolutely tight. It should be extended down outside the car and connected to the upper end of a coil or pipe in the barrel or tank, the latter being put as close as possible to the car. Coil B should be about 2 inches smaller in diameter than the inside of the barrel and should be coiled as closely as possible to insure a large amount of heating surface. Near the lower end should be a tee (T) fitting shown at a (see (b)) and an angle valve b should be connected to the tee (T) as indicated. A metal strainer c should be attached to the angle valve

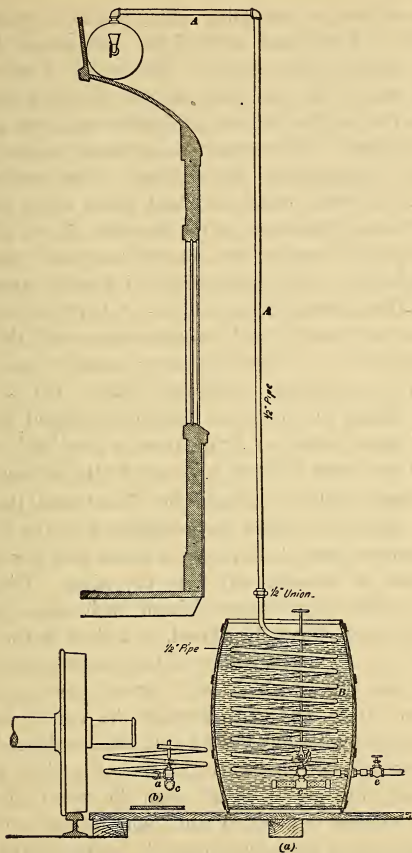

FIG. 7. ARRANGEMENT ILLUSTRATING METHOD OF FILLING THE HEATER CIRCULATION SYSTEM.

to prevent salt or any other solid matter from entering the pipes. The lower end of the coil should be connected with the Globe valve e. The water, if salt, should be sufficient to fill the pipes without drawing down too close to the surplus salt at the bottom and not too near to the strainer. The water level should never be less than four inches above the strainer. One hundred feet of 1¼-inch piping will hold about seven and a half gallons of water; therefore, if the number of feet of circulation piping is known the quantity of water can easily be calculated. As a precaution an excess quantity of about a third should be provided. A barrel of the ordinary size will usually hold enough water to fill the heater in a standard car; and the same quantity suffices for one-half of a double circulation heater, but to guard against taking air into the pipes care should be taken to have more water or brine than is absolutely needed so as to not draw it down too near to the strainer.

The angle valve b should be closed and the globe valve e opened; a steam hose connected to the draw-off cock furthest from the expansion drum and about 25 or 30 pounds of steam blown into the pipes. Directly it issues in full volume freely from each open draw-off cock that cock should be closed, and thus in the course of a few moments every foot of the heater pipes will be full of live steam which will force its way into the expansion drum and out through the coil B and the globe valve e, carrying the air and the condensed water with it, which will be discharged from the globe valve e. Should any live steam escape with the water, the valve should be closed a little, or until nothing but water and air escape. The steam will heat the water in the barrel to the boiling point when all the air has been expelled;

and boiling will expel the air held in suspension in a body of cool water; then, if the boiling water will float a potato it is salt enough to use in the circulation pipes.

The globe valve outside the barrel and also the draw-off cock through which steam enters the pipes should be closed and the steam hose disconnected. The angle valve inside the barrel should be opened, whereupon the steam from the pipes will continue to enter the brine until the pressure is reduced. The steam which remains in the pipes will condense and form a vacuum into which the boiling hot brine is forced by atmospheric pressure, completely filling the pipes in a few moments. It may be known the pipes are completely filled by the water level in the barrel remaining stationary.

The half-inch piping should be disconnected after the circulation piping is filled, whereupon it will be discovered the drum is full to the top. This excess may be drawn off through the combination cock to the level of the cock and then the safety valve should be replaced. When, after a few hours, the water has cooled, it will have contracted to some extent, so a small quantity may be added by hand through the combination cock. The heating system will then be ready for service. In the case of double-coil circulation systems they should be treated as though each were a separate car.

The fire should be started slowly when first it is lighted, it is best to begin with a wood fire. It should burn gradually until the circulation of the hot water is complete, which is indicated by the entire piping system being hot. Then the fire should be allowed to die down and the water to cool. Probably two or three firings and coolings may be necessary before all the air is exhausted from the pipes and the water becomes "solid."

Usually after the first firing the heater needs more water. For the first few days the renewing of water should be carefully attended to, a small deficit may have to be made good every day for the first week or two. When, however, the water becomes solid throughout the heater and circulation pipes no further renewal will be necessary; but nevertheless frequent tests should be made to ensure that everything is working right.

To test for the amount of water in the drum and piping the fire should be low and no pressure in the heater. The height of the water in the drum should be noted by means of the combination cock C, Figure 5. If the water is at the right height it will run out of the drip pipe when the cock C is opened. To renew water when necessary to do so, it should be put in through the filling funnel f, which is attached to the cock C. When through the cock should be closed and the funnel turned down.

To empty water from the heating system, if occasion requires, it should be drawn off through the cock e in the crossover pipe, Figure 3. At the same time cock C in the drum should be opened to serve as an air vent, thus admitting atmospheric pressure to assist in discharging the water more freely. Should there be any extra drain cocks where water could be pocketed in the piping they should be opened also to drain out the water. The circulation system should never be emptied unless absolutely necessary.

If the water should ever be allowed to get low enough so that the drum is emptied, circulation will stop, the pressure will increase rapidly, and the safety vent probably blow out. Should it get so low as to leave none in the coil the latter would burn out; but if the water is

always kept solid the circulation throughout the entire system will be satisfactory, without any pressure in the heater. Should a safety vent blow out, the fire should be immediately drawn, the water renewed to the level of the combination cock C, another vent v screwed into the drum and the fire again started.

On the old style Baker heater the safety vent consisted of a rubber ball held between two brass plates. The screws which hold these plates must not be interfered with nor should the plates be screwed any closer together than was originally intended. Every time the valve blows out it spoils the ball, therefore a new one should be put in, but the cast-iron vent is far more reliable.

The pressure gauge indicates the pressure within the heater.

The New Style of Baker Heater Steam Attachment consists of four $\frac{3}{4}$ -inch copper pipes screwed into brass fittings, and placed vertically into a 3-inch wrought iron cylinder, three and one-half feet long. Into this cylinder steam is admitted from the locomotive through a $\frac{3}{8}$ -inch branch pipe leading up from the train pipe, to top of cylinder. By this arrangement, steam instead of fire in the Baker heater is used, if desired, to circulate the water, or steam can be used at the same time as the fire, to heat up quickly.

When used in connection with a heater, it is placed at the back of the heater, as shown in Figure 8, between the return pipe and the pipe connecting top of the coil to the drum. (The heater coil can be cut out if so desired.)

The steam is controlled by an angle valve, placed at the top of the $\frac{3}{8}$ -inch supply pipe. The position of the valve is such that all water from the condensed steam will run from it.

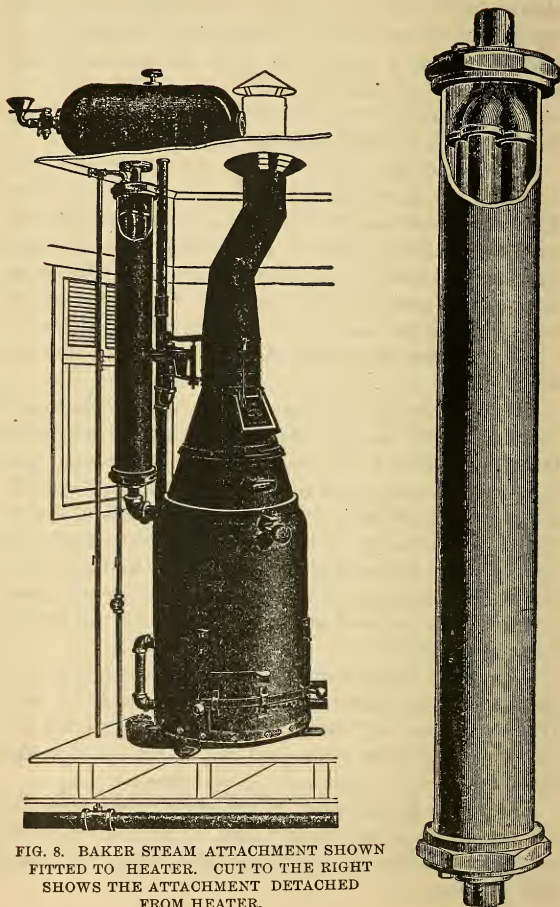

FIG. 8. BAKER STEAM ATTACHMENT SHOWN
FITTED TO HEATER. CUT TO THE RIGHT
SHOWS THE ATTACHMENT DETACHED
FROM HEATER.

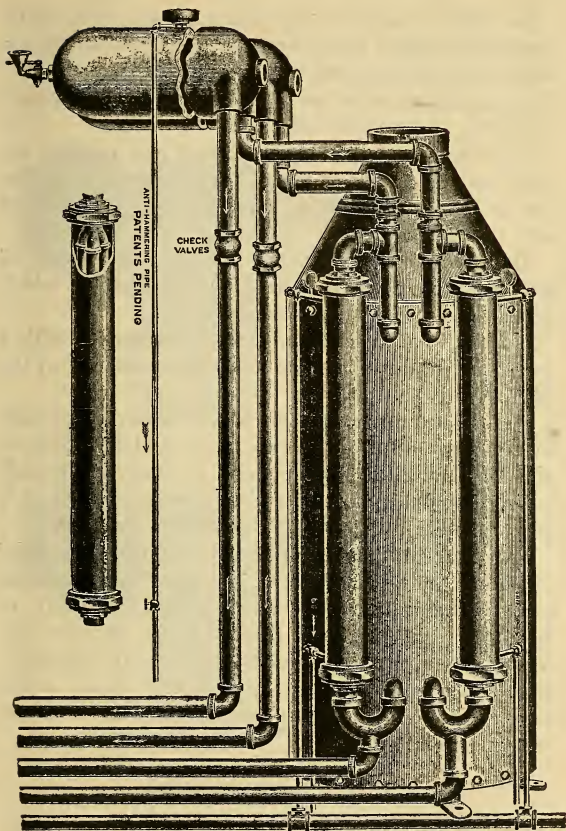

FIG. 9. DETAILS OF IMPROVED BAKER STEAM ATTACHMENT.
(See Fig. 8 for Same Shown Attached to Heater.)

No "trap" is used for the release of the water of the condensed steam, but instead a simple blow-through valve on a $\frac{3}{8}$ -inch drip pipe, operated inside the car. The seat of this valve has a small groove, which allows the escape of condensed water, even if closed. a

A check valve is placed in the feed pipe between the drum and the radiating pipes, insuring positive circulation in the right direction when the heater coil is cut out.

An anti-hammering pipe is connected to the top of the circulating drum to relieve any air pressure which thereby prevents the hammering.

In using this steam attachment in connection with a double coil heater, each side works independently of the other.

It is claimed that circulation is obtained in 40 minutes, with only 15 or 20 pounds of steam, and that best results are obtained by turning steam on slowly at 5 pounds—and up to 15 or 20. After circulation is complete, it is said to require but from 5 to 7 pounds to maintain.

The steam attachment can also be used independently of any heater in connection with the expansion drum and hot water radiating pipes. When used independently of the heater, an attachment (jacketed with asbestos covering) can be placed on each side of the car, if desired, thus doing away with the "cross-over," which, it has been asserted, is a very objectionable feature in car heating.

STANDARD HEATING SYSTEM.

This system has as its basis the ordinary hot water circulating system, with the Baker heater stove. The heat of the fire in the stove being replaced with steam

drawn from the locomotive; of course the fire in the Baker heater stove may be started whenever necessary. To use the steam thus drawn from the locomotive steam jackets are used, one being located near the heater, on

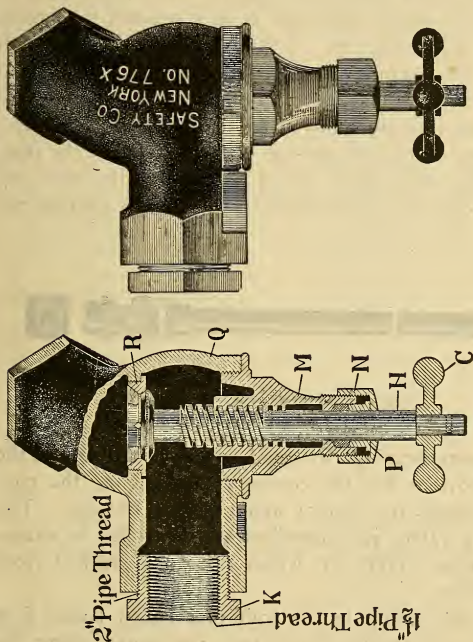

Plan

Section

FIG. 10. TRAIN PIPE VALVE.

C—Hand Wheel. K—Bushing. N—Gland Nut. Q—Body. R—Removable Seat.
M—Bonnet. P—Gland.

the pipe which leads to the bottom of the coil, the others on the pipes which lead to and from the radiating pipes on the side of the car opposite the heater side, known as "cross-overs," or, in the case of a double circulation

car they are connected into the circulation near the middle of the car. The steam thus drawn from the locomotive is conducted from car to car by means of suitable flexible couplings and pipes beneath the floor; these pipes are called train-pipes, and they are so arranged as to admit of gravity drainage from a selected high point to each end of the car. A fitting is placed at this high point which permits the necessary quantity of steam to be withdrawn from the train-pipe for use in heating the car. Two train-pipe valves, Figure 10, one at each end of the car, control the passage of steam through the pipe, both being kept open, except the one at the rear end of the rear car, which should be closed to prevent the

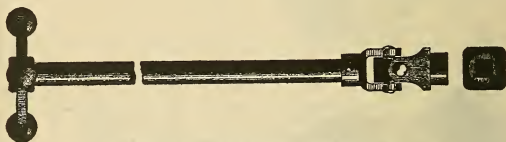

FIG. 11. EXTENSION HANDLE.

steam from escaping. A small groove in the seat of the valve provides for the continual draining of the condensed steam (or water) and prevents freezing. The train-pipe valves just described are controlled by extension handle, Figure 11, which is readily reached from the car step.

From the fitting in the train-pipe steam passes first through a controlling valve, near the heater, along the truss plank to the low end of the jacket nearest the heater and from this jacket by connecting pipes to the other jackets in series. These jackets have each an inclination upward in the direction of the circulation of

the water, steam entering and leaving the low end of each jacket. The steam pipes should maintain a gradual fall from the controlling valve to the low end of the last jacket and then to the automatic trap.

In all jackets the water contained within the outer pipes is heated by the passing steam, thus aiding in the circulation, and also reducing to from one-third to one-sixth the time required to cause complete circulation of hot water in all parts of the system. While the steam at the pressures used is far below the temperature of fire, its application in this way, at various points of circulation instead of at one point (the heater coil), results in a more uniform heating, and higher average temperature of the pipes throughout the car. The principle is the same in a double circulation car, the only difference being in the location of the jackets, which are connected into the circulation as shown.

It will be noted that the entire water circulating system is a "closed" one, and that when once filled with water to the proper level, requires no further attention.

The heat required for the car is regulated by a controlling valve which admits steam to the jackets, and by which means a uniform temperature is easily maintained.

To discharge the condensed steam (or water) from the steam pipes, and yet prevent steam from escaping, an automatic steam trap is used, Figure 12. This trap is adjusted by loosening the locknut F, on the end, the trap is then opened by screwing out the seat (which is controlled by the smaller square stem D) until steam escapes freely, then it should be closed until a point is reached where just a little steam escapes with the water. When the seat is adjusted properly the locknut should

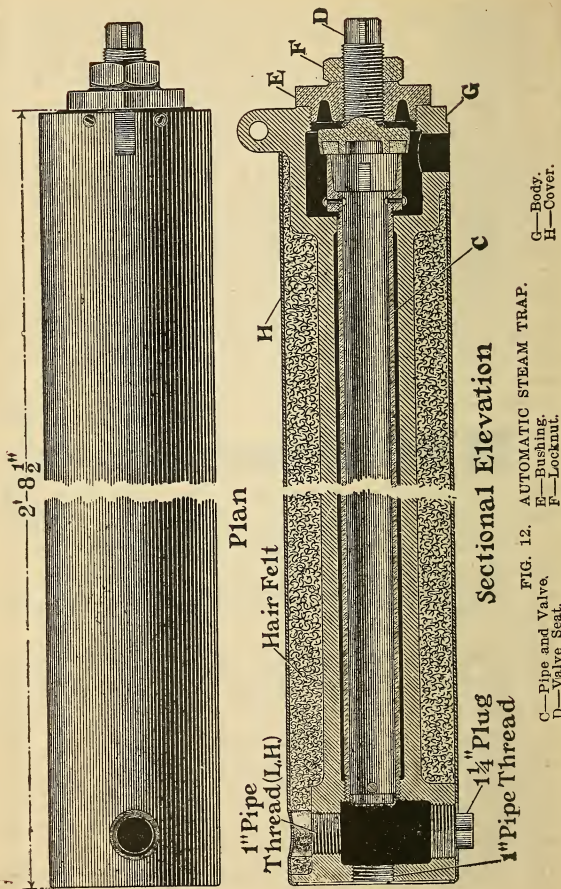

Sectional Elevation

FIG. 12. AUTOMATIC STEAM TRAP.

G—Body.
H—Cover.

E—Bushing.
F—Locknut.

C—Pipe and Valve.
D—Valve Seat.

Plan

Hair Felt

1" Pipe Thread (L, H)

1 1/4" Plug

1" Pipe Thread

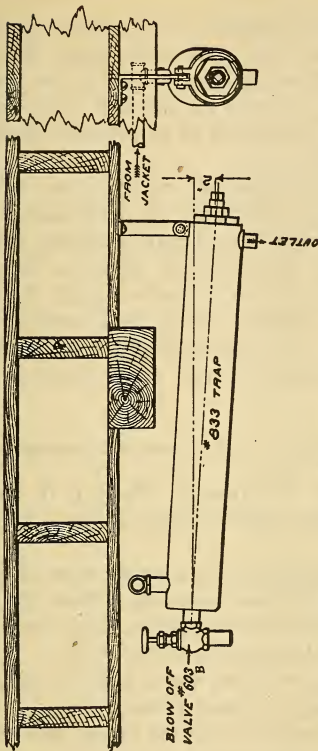

FIG. 13. DIAGRAM SHOWING MINIMUM PITCH TO BE GIVEN TO STEAM TRAP (FIG. 12) AND ALSO THE BLOW-OFF COCK SHOWN CONNECTED.

be tightly screwed up, care being taken not to let the seat move while doing so.

The minimum pitch which should be given to the trap to ensure that the water of condensation drains through the outlet is shown in Figure 13, which also shows a

blow-off valve connected to the one-inch pipe thread in the end of the trap. This valve serves to remove any dirt or scale from the trap, and it also permits the quick discharge of condensed steam. It is usually so arranged that it may be controlled by an extension handle through the floor of the car.

Should steam be entirely cut off at any time, the trap will immediately discharge all condensation which remains in the pipes. Or, it may be quickly discharged by means of the blow-off valve above the trap, which is generally controlled by a handle through the floor. The trap is fully capable of being used without recourse to this auxiliary, it is merely there for use in the event of most extraordinary and very severe conditions.

DIRECT STEAM HEATING SYSTEM.

This system, illustrated by Plates I, II, and III, is a simple and easily applied heater for cars. It is illustrated on Plate III.

Steam is supplied to the cars by means of an ordinary train-pipe, with flexible couplings between the cars. This train-pipe drains from the center to each end of the car, and at the middle point is a cross, 638.

Two train-pipe valves, one at each end of the car, control the passage of steam through the pipe, both being kept open, except the rear one of the rear car, which is closed to prevent the escape of steam. A small groove in the seat of the valve provides for the continual draining of the condensation in the train-pipe and avoids freezing. These train-pipe valves are controlled by extension handles, which may be readily reached from the steps of the car.

222

6
2
1
1
1

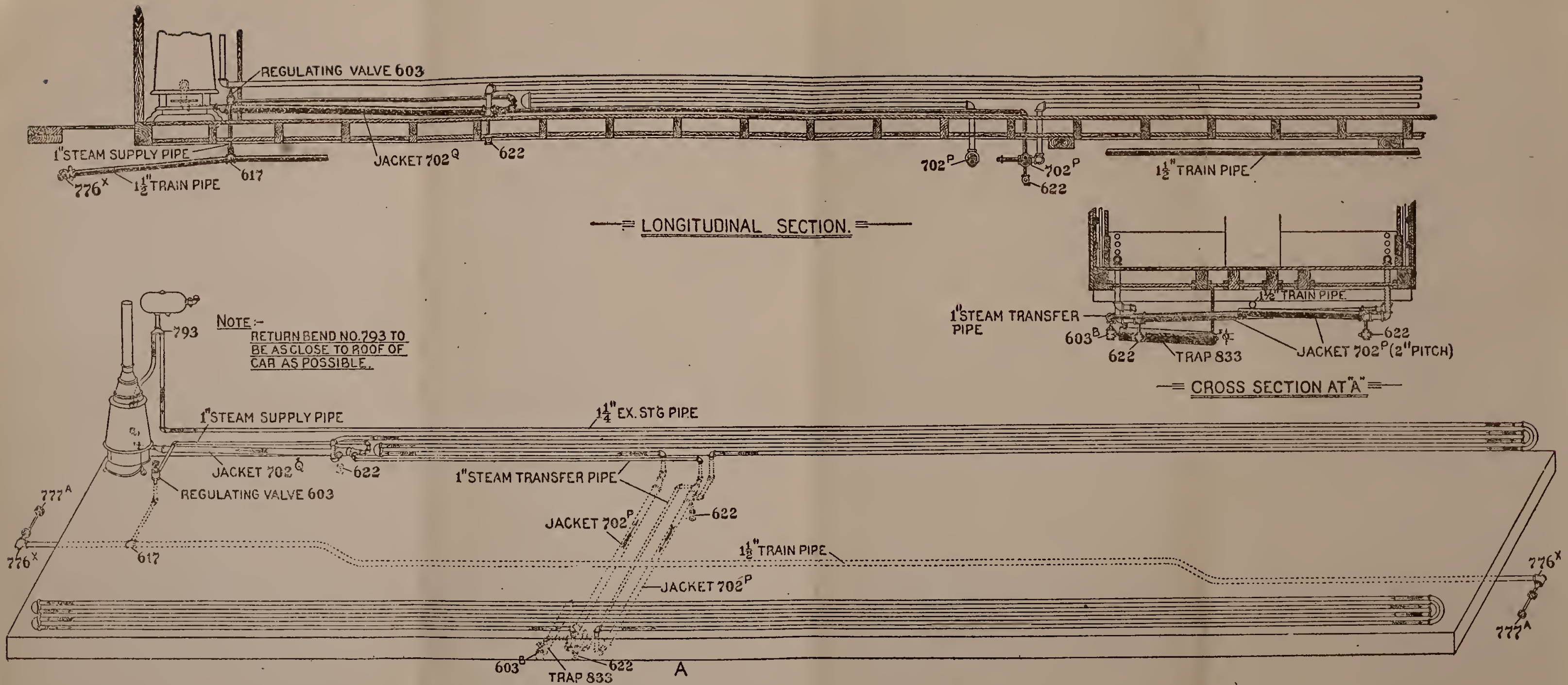

PLATE 1. Design showing Standard Heating System as used with Single Circulation Baker Heaters.

blow-
the er
dirt or
discha
that it
the flo

Sho
will ir
mains
means
genera
trap is
this au
most e

This
simple
on Plat

Stear
train-pi
train-pi
and at

Two
trol the
kept op
closed to
the seat
of the c
These t
dles, wh
car.

in

1914

... ..
... ..
... ..

... ..
... ..
... ..

... ..
... ..
... ..

... ..
... ..
... ..

... ..
... ..
... ..

... ..



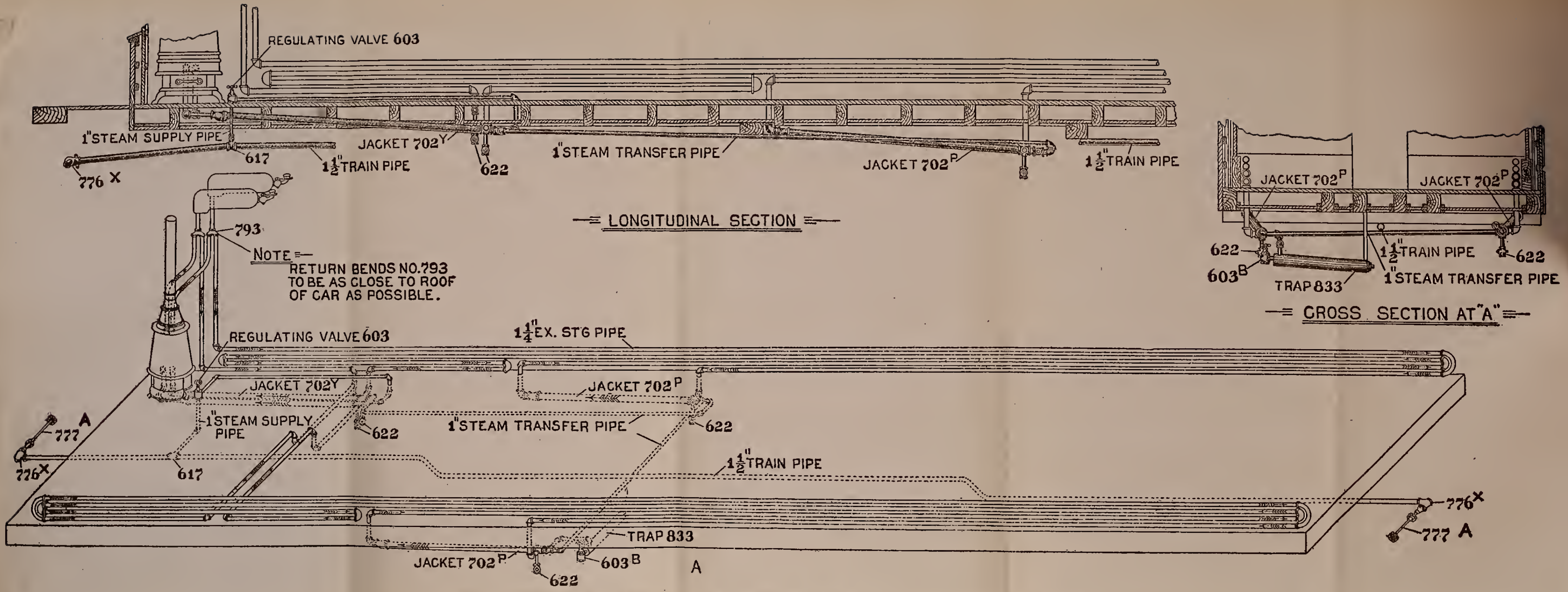

PLATE 2. Design showing Standard Heating System as used with Double Circulation Baker Heaters.

blow
the
dirt
discl
that
the

Sl
will
main
mea
gene
trap
this
mos

sin
on

tr:
tr
ar

ti
k
close
the :
of th
The:
dles,
car.



<
 2
 |
 4
 |
 1

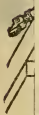

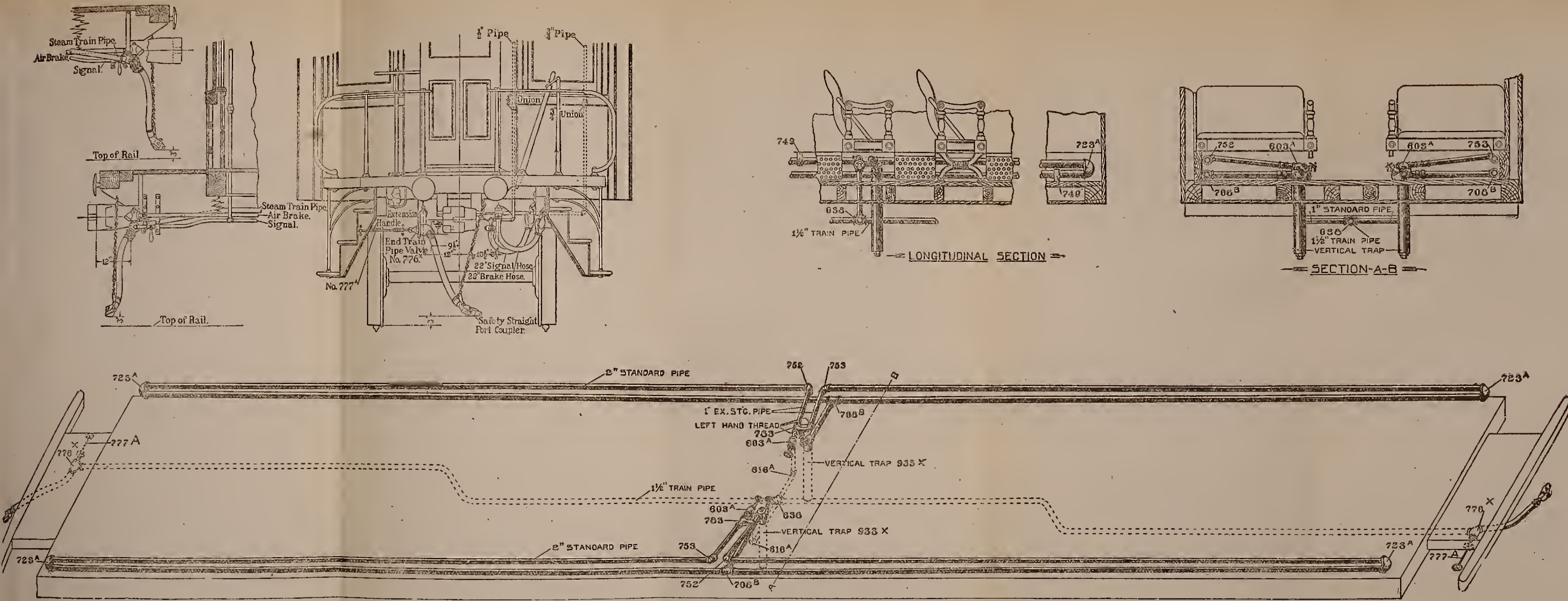

PLATE 3. Diagram illustrating design for Direct Steam Heating System.

blow
the
dirt
disc
that
the
S
will
mai
mea
gen
trap
this
mos

T
sim
on
:
tra
tra
an

tr
k
clo
the
of
Th
dle
car



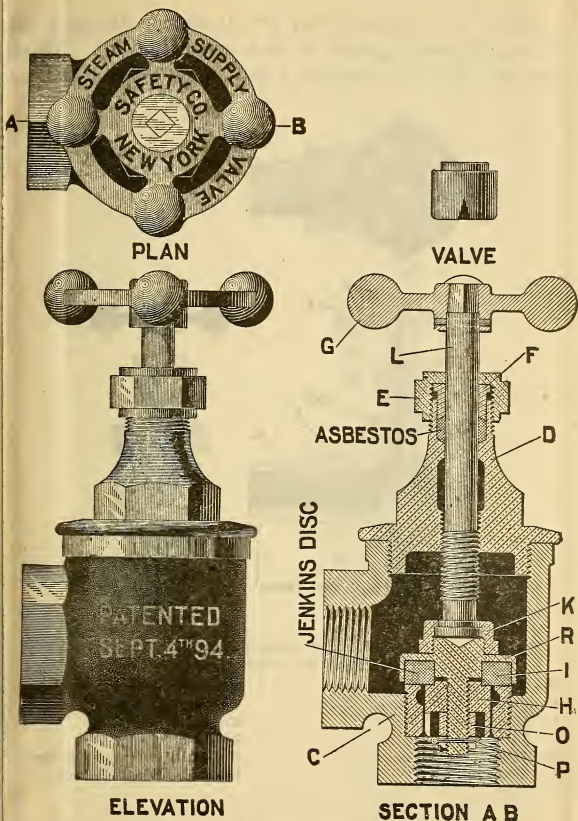

FIG 14. STEAM INLET VALVE.

LIST OF PARTS.

C—Body.
D—Bonnet.
E—Cap Nut.

F—Gland.
G—Hand Wheel.
H—Valve.

I—Disc.
K—Stem Nut.
L—Stem.

O—Valve Nut.
P—Cotter Pin.
R—Disc Case.

Steam is supplied from the train-pipe through the cross, 638, and it passes to each side of the car. Rising through the floor beneath a seat, it is controlled by a

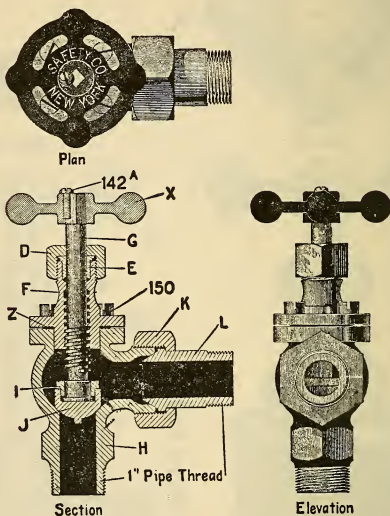

FIG. 15. ANGLE VALVE.
(Used on Locomotive.)

D—Cap Nut.
E—Gland.
F—Bonnet.
G—Stem.
H—Body.
I—Stem Nut.
J—Valve.

K—Union Nut.
L—Union Nipple.
X—Hand Wheel.
Z—Gasket.
No. 142A—Retaining Screw.
No. 150—Bonnet Screw.

steam inlet valve, Figure 14, which is capable of very fine adjustment. By means of this valve the requisite amount of steam necessary to heat the car is admitted.

... which from the steam box.



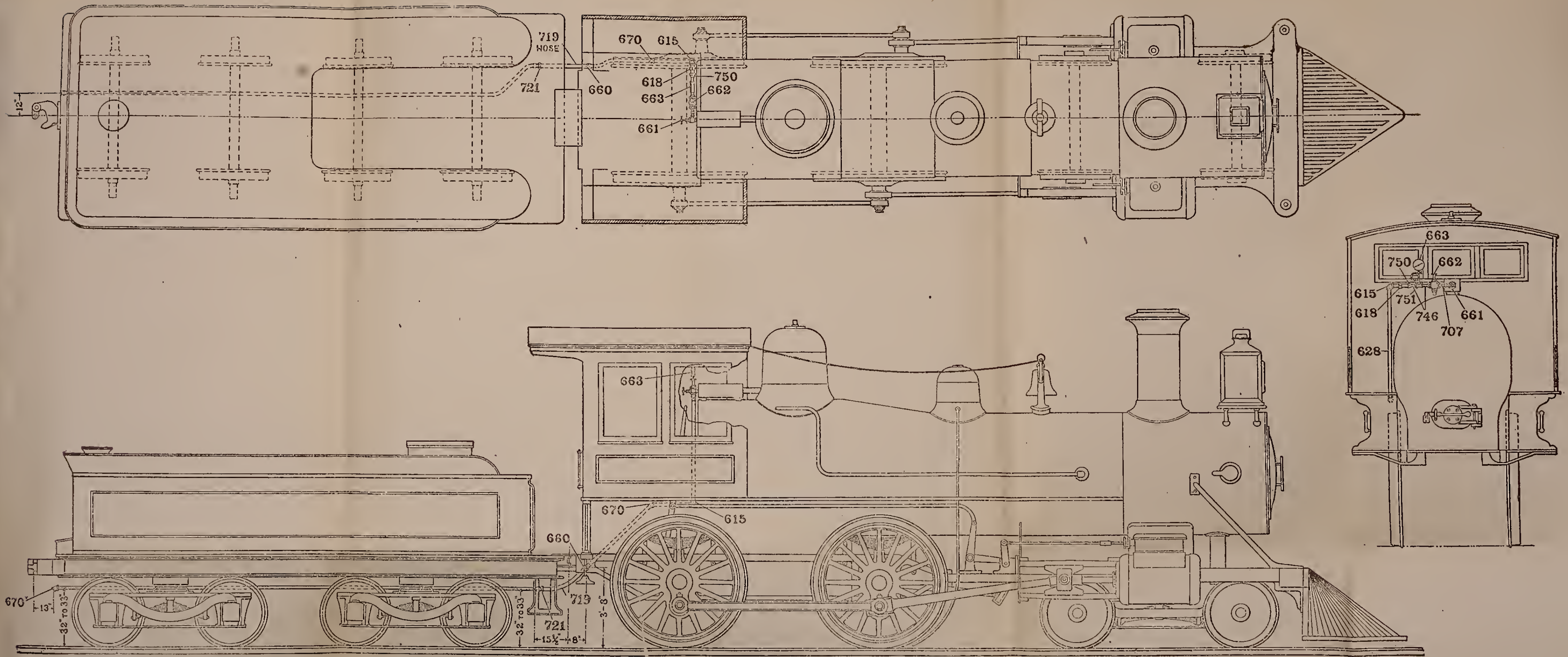

PLATE 4. Locomotive Steam Heating Equipment for Furnishing Steam to the Coaches.



of steam necessary

Along the truss plank is a radiator of two (2) inch pipes, and the steam from the inlet valve enters the upper one first through a back outlet return bend, 783, and expansion bend. This 2-inch pipe has an inclination from the center toward each end of the car, and the steam follows these inclinations, entering the lower pipe from the ends and returning toward the center. At the center is a

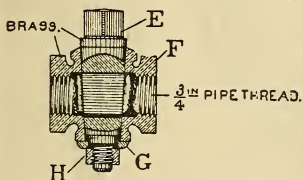

FIG. 16. REDUCING VALVE.

(Used on Locomotive.)

E—Plug.
F—Body.

G—Washer.
H—Nut.

tee, 708b, from which a 2-inch pipe is taken to a vertical automatic trap, which regulates the discharge of the condensation.

The radiation of the heat from the two pipes along the truss plank heats the car, the area of radiating surface being proportioned to the size of the car.

Plate IV illustrates in a general way the method of equipping a locomotive for use with steam heated cars. Steam is usually taken from the "steam box."

Angle Valve, Figure 15, Reducing Valve, Figure 16, and Gauge, Figure 17, are placed in the relationship shown on the drawing. The first is for admitting the steam supply, and the Reducing Valve is for controlling the pressure on the Train-Pipe and should never be used as a shut-off valve.

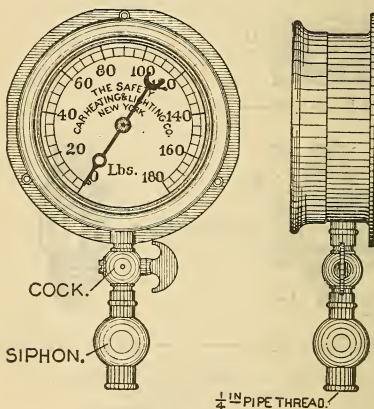

FIG. 17. GAUGE FOR STEAM HEATING.
(On Locomotive.)

Experience has shown that it is best to carry a pressure of 40 lbs. on the train-pipe for a train of eight cars or less, and that for a greater number of cars, the pressure should be increased five pounds for each car above eight. It is better to have a pressure higher than is needed than one that is too low, and it is *not* a serious drain on the locomotive. The amount of extra work put on a locomotive, by the steam heating of its train, is measured by

the amount of water condensed by each car, and is roughly about 40 to 60 lbs. per hour per car.

Care should be taken to keep the steam gauge, Figure 17, in good order, and it should be tested and corrected, if necessary, at least once each season. Many cases of reported failures of trains to heat properly are found to be due to errors of gauges, the pressure actually supplied being far below that indicated by the gauge.

STEAM COUPLER TROUBLES.

Owing to modern passenger traffic conditions, with the constantly increasing demands made on locomotives, improvements to prevent leaks and effect economy of steam have been made and upon many railroads have been adopted. We give, therefore, a concise description of new style steam couplers made by the Consolidated Car Heating Company.

Serious steam losses result from imperfect connections of steam hose couplers. Constant efforts have been made to construct a satisfactory coupler. Coupler heads are hammered together, and locking devices are applied in an attempt to force a tight joint—and still the drain on the locomotive has increased and the delays to trains on account of leaky couplers have been as frequent and annoying as ever.

The Consolidated Car-Heating Company claim to have overcome this condition by the development of the type of coupler we describe (see Figure 18). The essential points in the construction of this type of coupler are: (1) an automatic locking device, (2) all the points of engagement are carefully machined, (3) the opening through the head can be adjusted from $1\frac{1}{4}'$ to $1\frac{1}{2}'$, (4)

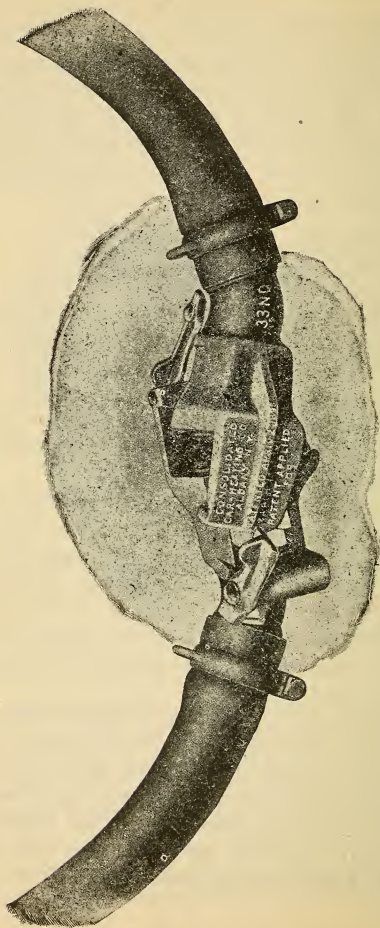

FIG. 18. COUPLING OF HEADS.

the liability to hose kinking is prevented by the increased angle of the coupler nipple, (5) should the train part the coupler automatically separates, (6) on sharp curves or under strain of the draft rigging the coupler will not open and leak steam, (7) the wear and gasket losses are reduced to a minimum through the novel and efficient method of holding gaskets.

The gasket is applied to the coupler by sliding it into the machined groove, and is firmly locked in place by slightly bending the steel lug formed on it. Springs are not used to hold it in place, neither are they necessary, because there is no obstruction in the steam passage. It is moulded into one piece and has wide faces at the front and back, making a positive seat and steam tight joint.

When a coupling of the heads is being made, the locks are turned to one side so that the lug and clutch can engage each other. The locks are then snapped into position (see Figure 19).

The small degree of lift of the heads with the attending slight bend of the hose in the coupling will be noted. This feature is the result of the increased angle of the coupler head nipple. It produces the important advantage of ease in making the coupler connection, of effecting a more positive automatic coupling, and of greatly lessening the amount of bending at the hose when coupling and uncoupling. It is the bending of the hose which proves so destructive to its life—especially in regard to the larger sizes. The increased angle of the nipple permits of a natural set form to the hose when coupled. The bending strain is distributed over the entire length of the hose instead of being confined to the point just back of the nipple and causing kinking, as is the case when the angle of the elevation of the nipple is less. The service

application of the coupler locks is shown in Figure 19 and is as follows: Points A and A¹ acting as fulcrums, through the compression of the specially oil tempered spiral steel springs, B and B¹, cause the locks to exert a downward pressure of 35 to 40 pounds at the extreme tip of each of the coupler wings, C and C¹. Point D acting as a hinge, the two gaskets are brought into definite and fixed contact, and a steam-tight connection is effected.

The automatic locking device is, perhaps, the most important feature in the effective operation of this coupler; it is claimed for it that, a steam tight joint is insured under all conditions, that the gaskets are brought together and locked as one piece, that when coupled with heads of other types the locking effect is interchangeable, that heads are prevented from lifting and leaking on sharp curves or under strain of draft rigging, that the necessity of hammering heads in an attempt to get tight joints is entirely done away with, and that in event of the train parting for any cause there is no tearing out of hose or pulling out of train line.

In case of accidental break-in-two of the train the coupler wings are forced up by the straightening of the hose, D acting as a hinge, and the pressure of the lock springs B and B¹ being overcome until the line of draft reaches a higher plane than the line of contact, when the coupler heads part without damage to hose or train line.

THE ECONOMY CAR HEATING SYSTEM.

This system is designed to heat passenger trains with the *exhaust steam* from Air Pumps *instead of live steam* from the locomotive boiler.

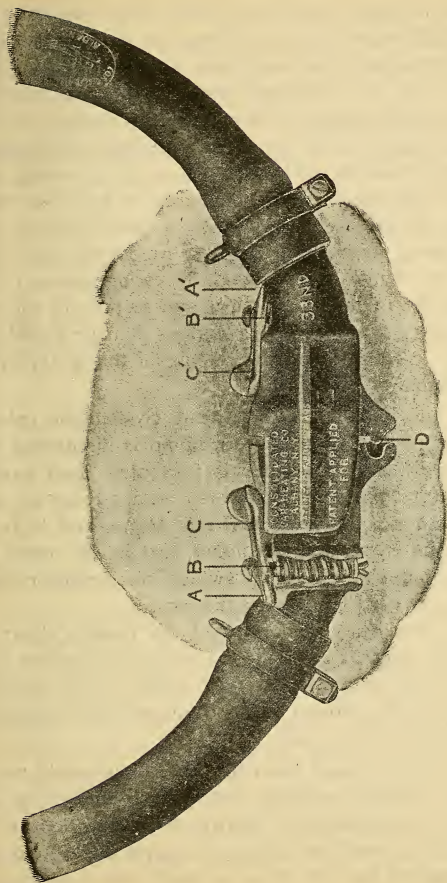

FIG. 19. ACTION OF THE LOCKS.

Many attempts have been made in the past to utilize the exhaust steam from Air Pumps for heating purposes, but without success, as no means were provided for taking care of the condensed water discharged from the pump with the steam. The manufacturers state that the action of the Air Pump on the road being *intermittent*, constantly stopping and restarting, and so causing considerable condensation to take place in both the steam cylinder of the Air Pump and its steam supply pipe, which, being discharged by the Air Pump upon each restarting, can, if carried into the heating system of the cars, fill the radiators and pipes and so prevent the cars from being properly heated. Serious damage would also be likely to result from the freezing of this water in the car radiators and pipes.

With the Economy Car Heating System the exhaust steam and water from the Air Pump is discharged into a *Reservoir*, and the water is prevented from passing into the train pipes and radiators. In the Reservoir also all the *water* is *re-evaporated into steam*, and both the *heat* in the *steam* and the *latent heat* in the *water* exhausted from the Air Pump (which has heretofore been *wasted*) are used for *heating* the cars.

It has been fully demonstrated, the makers claim, on a large number of railroads, on which this system is in use, that the average passenger train can be properly heated with the exhaust steam from the Air Pump *without the use of live steam*.

In case the exhaust from the Air Pump should not be sufficient to heat the train, *live steam* to supply the deficiency is *automatically* drawn from the locomotive boiler. This condition might arise with limited express trains making but few stops, or with very heavy trains

in extremely cold weather. In this event, *all the heat* from the Air Pump exhaust would be *utilized*, and the boiler would furnish *only the excess* quantity of live steam necessary to heat the train.

This system is claimed to be *perfectly automatic* and *requires no attention* on the part of the engine crew on the road. The "Relief Valve" is set at the maximum and the "Pressure Regulator" at the minimum pressures before the train is started, and the steam pressure in the train heating system is absolutely confined between these two pressures.

Fuel and water are also saved by the removal of the Air Pump exhaust from the stack, it being a well-known fact that the discharge of the exhaust steam from the Air Pump into the stack, which is the practice on many railroads, causes a *constant draft on the fire* and a considerable *waste of coal*. Steam and water are also wasted by the frequent opening of the pop valves and the operation of the injectors to maintain the proper water level.

The *noise* from the Air Pump exhaust is *avoided*, which is an advantage of no little importance, especially with locomotives standing under covered stations.

A very perceptible improvement in the *steaming* of locomotives has resulted, it is stated, from their equipment with this heating system, especially in the case of locomotives that had previously *steamed poorly* in cold weather. This has been due to the fact that practically all of the steam generated in the boiler has been available for use in the locomotive cylinders, and the constant *drain of live steam* for heating trains has been *eliminated*. Locomotives have, therefore, been able to make their time, and the delays caused by "low steam" have been avoided.

No change whatever is required in the *car heating equipment*, the apparatus being applied to the locomotive in a manner for use in conjunction with the car heating system already in service, which can also be used *independently* of the Economy Car Heating System, with live steam direct from the boiler, if desired.

The effect upon the Air Pump from its operation under back pressure is the same only as would result from an increase of the main reservoir pressure.

PIPE CONNECTIONS.

One set of the Economy Car Heating Apparatus consists of a Reservoir, Three-way Cock, and "E. C. H." Relief Valve.

Various types of locomotives require different locations of the apparatus. The material for the pipe connections depends upon the respective locations of the Air Pump and Reservoir.

Pipe of the *1 1/4 inch size* should be used.

The Reservoirs are made in four sizes, 44 inches in length, and 14, 16, 18, and 20 inches outside diameter respectively, of *steel*, carefully tested under 250 pounds pressure. They are first covered with asbestos cloth, then lagged with wood one inch thick, and fitted on the outside with an iron jacket.

The largest size of Reservoir that will clear the cab line should be used, especially for locomotives hauling long or heavy trains. For trains consisting of not more than four cars a Reservoir of the 14-inch size is amply large.

The Reservoir should be attached to the running board *directly under the cab* and on the *same side* of the loco-

motive as the Air Pump, so that the pipe connecting the Air Pump and the Reservoir will be the shortest possible. The location of the Reservoir on the same side of the locomotive as the Air Pump is not absolutely necessary, and, in case the driver brake auxiliary reservoir, triple valve, signal valve, etc., are on the same side of the locomotive as the Air Pump, the Reservoir may be attached to the running board directly under the cab on the opposite side, and the exhaust pipe from the Three-way Cock carried back into the cab, across the boiler butt, and down through the running board into the Reservoir.

If the space on both sides is already occupied and it is impossible to locate the Reservoir below the running board directly under the cab, and on locomotives having the Wooten type of firebox, the Reservoir should be attached below the running board *forward of the Air Pump*.

The Reservoirs have two openings in one end and one opening in the other end. The Reservoir with the end having the *two openings* should be placed at the *forward* end, and the *single opening* on the *rear* end should be at the *lowest point*. A pipe should be connected from the *single opening* on the rear end of the Reservoir direct to the train heating pipe under the locomotive tender.

The Three-way Cock should be located in the exhaust pipe of the Air Pump and *close to it*, fitted with a rod leading back into the cab and a handle convenient for operation by the engineer (see Figure 20). A pipe should be connected from the Three-way Cock to one of the openings in the *forward* end of the Reservoir. Quarter-turns and tees should *not* be used with the pipe leading from the Three-way Cock to the Reservoir, but the pipe should be *bent* if necessary. A pipe should be con-

nected from the other, or third opening in the Three-way Cock to the stack or saddle as heretofore.

A pipe should be connected from the direct steam pressure regulator to one of the openings in the *forward* end of the reservoir, and from this same pipe a pipe should

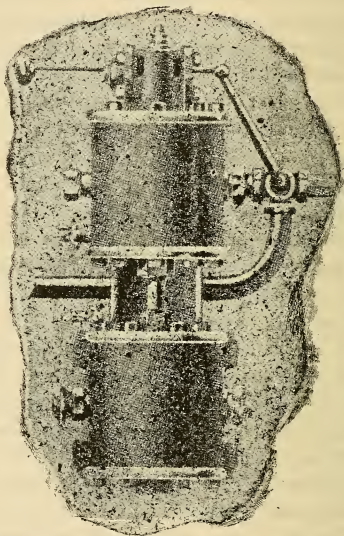

FIG. 20. SHOWS THE THREE-WAY COCK LOCATED IN THE EXHAUST PIPE CLOSE TO THE AIR PUMP, WITH THE OPERATING ROD LEADING BACK INTO THE CAB.

be connected to the "E. C. H." Relief Valve. A pipe should also be connected from the "E. C. H." Relief Valve to vent the surplus steam either through the roof of the cab or forward into the saddle or stack, as may be preferred.

OPERATION.

Before the train is started adjust the Pressure Regulator for the *minimum* pressure and the "E. C. H." Relief Valve for the *maximum* pressure required to heat the train. The steam pressure on the train heating system will therefore be confined between these two pressures.

Pull back the handle of the Three-way Cock, to discharge the exhaust steam from the Air Pump into the Reservoir, and open the boiler valve in the direct heating system.

To shut off the steam from the train, close the boiler valve and push the handle of the Three-way Cock *forward* to discharge the exhaust from the Air Pump into the stack or saddle.

The Three-way Cock must be kept in either the *extreme forward or back position*, as any intermediate position would close the exhaust pipe from the Air Pump.

To increase the pressure on the train heating system, slacken the Cross Bar Check Nut of the "E. C. H." Relief Valve and turn the hand wheel from *left to right*; to decrease the maximum pressure, turn the hand wheel from *right to left* and tighten the Cross Bar Check Nut.

It will be found that average trains can be properly heated with the exhaust steam from the Air Pump without opening the boiler valve in the direct steam heating system. In case, however, the Air Pump exhaust is not sufficient to maintain the required pressure, open the boiler valve and the Pressure Regulator will furnish live steam to supply the deficiency.

The locomotive shown in Figures 21 and 22 has the air pump and Economy Car Heating Apparatus on the

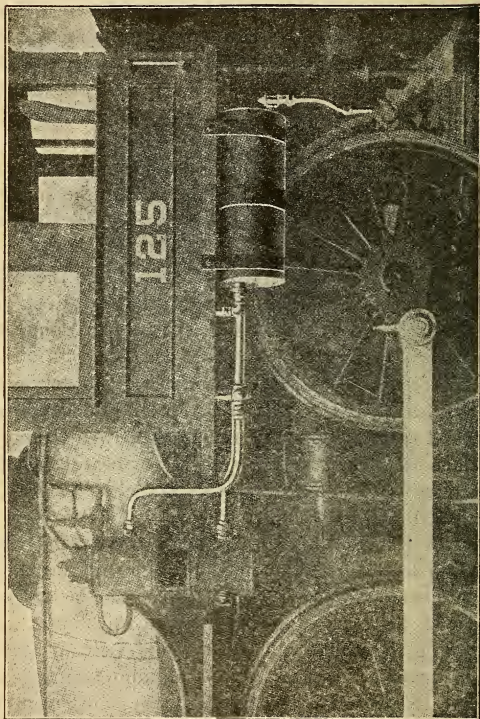

FIG. 21. SHOWING LOCATION OF APPARATUS.

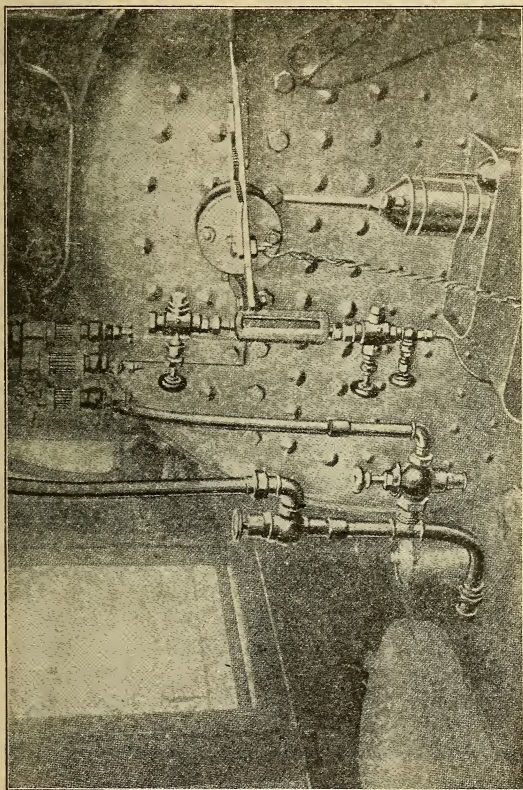

FIG. 22. SHOWING THE PIPING OF ECONOMY CAR HEATING APPARATUS.

left hand side. The three-way cock is located near the reservoir directly under the cab. The outlet of the "E. C. H." Relief Valve is piped to discharge the surplus steam through the roof of the cab. The locomotive shown in Figure 23 has air pump and Economy Car Heating Apparatus on the left hand side, with the three-way cock forward of and close to the air pump, and the exhaust pipe leading to the reservoir fitted with asbestos covering.

When the Economy Car Heating System was first introduced, an ordinary open pop valve located outside, on top of the locomotive cab, was used as a relief valve to vent the surplus pressure from the train heating system. Experience demonstrated that an adjustable relief valve, conveniently located for operation by the engineer inside the cab, was both desirable and necessary to enable him to vary the steam pressure to suit trains of different lengths. A steam pressure of 20 pounds would be ample to heat a train of two or three cars, but a steam pressure of 40 pounds or more might be necessary to insure a circulation of steam at the rear end of very long and heavy trains, especially in extremely cold weather.

The "E. C. H." Relief Valve, illustrated Figure 24, is an improved form of valve with *duplex spring*, especially adapted for the Economy Car Heating System, for which United States Letters Patent have been applied.

The "E. C. H." Relief Valve is located inside the cab, with its pipe connections so arranged that the surplus steam from the train heating system will be discharged either through the roof of the cab or into the saddle or front end of the locomotive, if it is desired to avoid the noise and annoyance of the escaping steam.

Its peculiar merits over all *single spring* relief valves are the increased range of steam pressures at which it will

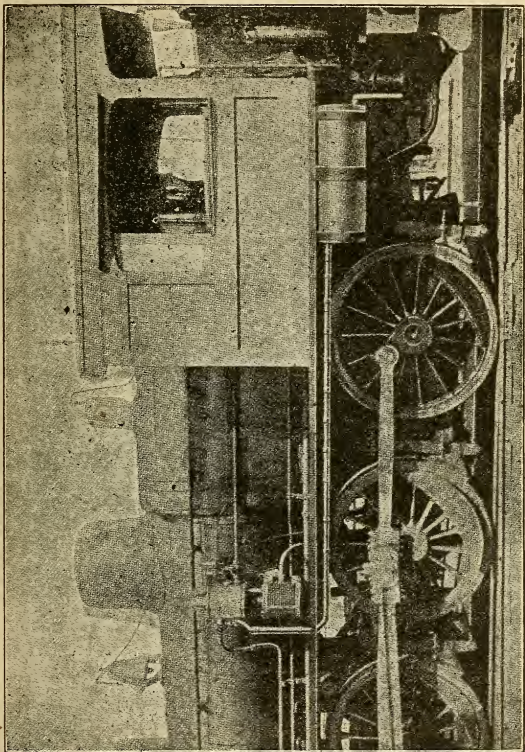

FIG. 23. SHOWING LOCATION OF APPARATUS.

work satisfactorily *without change of spring* and the ease with which it can be adjusted for any desired change of working *steam pressure*.

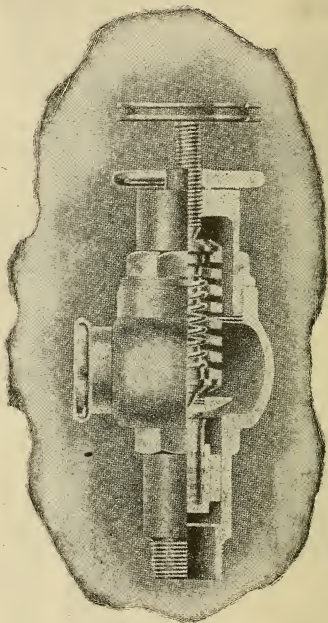

FIG. 24. "E. C. H." RELIEF VALVE.

It will give an *automatic and full relief* at any steam pressure between 15 and 60 pounds per square inch. This is accomplished by the *duplex spring*, the *outer spring* being *under tension* at all pressures, while the *inner spring*

(of smaller diameter) is *under tension only* at the *higher pressures*.

The springs are adjusted for the valve to relieve at the desired pressure, by means of a hand wheel on the top, *outside* of the valve body. To obtain a higher working pressure, slacken the Cross Bar Check Nut and turn the hand wheel *from left to right*; for a lower working pressure turn the hand wheel *from right to left* and tighten the Cross Bar Check Nut.

Another important feature of the "E. C. H." Relief Valve is that it can be *taken apart* and *cleaned* if necessary *without* disconnecting the pipe connections at either the inlet or outlet.

The "E. C. H." Relief Valve is made entirely of high grade composition metal with springs of *Jessop's steel*.

GOLD'S STEAM HEATING APPARATUS.

As in other systems of heating the cars with steam from the locomotive, the equipment on the engine and tender is not complicated, but is, on the contrary, quite simple. All pipes should pitch to avoid water pockets and any exposed pipes should be covered well. Fig. 25 shows the method of taking steam at the fountain, by means of a locomotive starting valve, with a Tobin bronze spindle. This valve also has a hard metal seat and a malleable iron handle. The inlet is screwed into a 2-inch port in the fountain, and from this inlet runs a 1½-inch extra heavy pipe to the inlet of the regulator. The pressure regulator is provided with brass unions at both sides, the inlet being 1½ inches and the outlet 2 inches. A 2-inch nipple runs from the pressure regulator outlet to a tee which is tapped for ¼-inch pipe connection

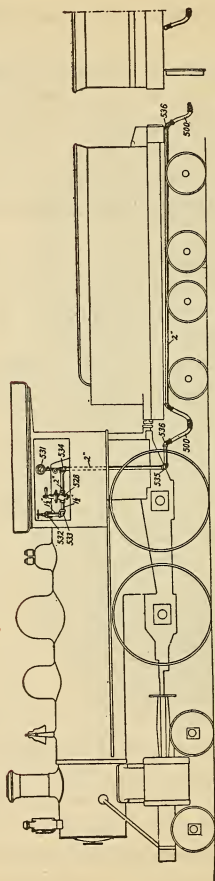

FIG. 25. GOLD'S HEATING APPARATUS, ITS APPLICATION TO LOCOMOTIVE.

532—Starting Valve.

528—Improved Pressure Regulator.

531—Steam Gauge.

500—Steam Coupler.

533—Ell, 1- $\frac{1}{2}$ "

534—Tee 2" x $\frac{1}{4}$ " x 2".

535—Ell, 2".

536—Ell, 2" x 1 $\frac{1}{2}$ ", 65°.

552—Coupling, 2", R. and L.

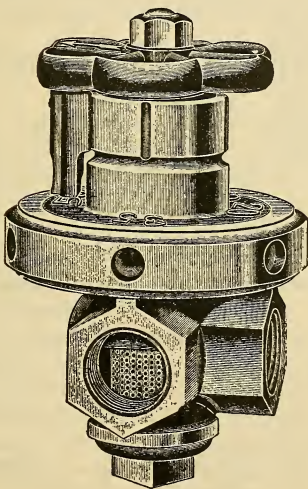

FIG. 26. IMPROVED TEMPERATURE REGULATOR.

to the steam gauge which indicates the steam pressure delivered to the train. The 2-inch line runs down to a suitable place at the side of the boiler and thence goes horizontally to a point where the 2-inch by 1½-inch sixty-five degree ell is situated. To this elbow a steam hose coupler is attached, and the nearby coupler is attached to the pipe under the tender by means of a similar ell. A 2-inch line runs to the back of the tender with a pitch to the rear and then a 2-inch by 1½-inch sixty-five degree ell is fitted and the steam coupler connected.

An improved temperature regulator and stop valve shown in Figures 26 and 27 reduces the steam pressure to that needed for heating and maintains whatever pressure is desired in the train-pipe regardless of varying conditions on each side of the valve.

Figure 27 shows a sectional view of the temperature regulator.

Steam from the train line enters at "R."

As the wheel "G" is turned from left to right, the spring "C" compresses, and its force, acting through the diaphragm, opens valve "L" and "M." Steam then passes to the radiator.

After the required pressure has been delivered, any increase will overcome the tension of spring "C," and as valves "L" and "M" are perfectly balanced, the lower spring "N" will immediately lift them to their seats, thus stopping the admission of steam.

As the pressure decreases in the regulator it also relaxes under the diaphragm, and the tension on the spring "C" again forces the valves "L" and "M" downward and holds them open until enough steam is admitted to compensate for the amount lost by radiation. When the required pressure is again delivered, the valves close automatically as before.

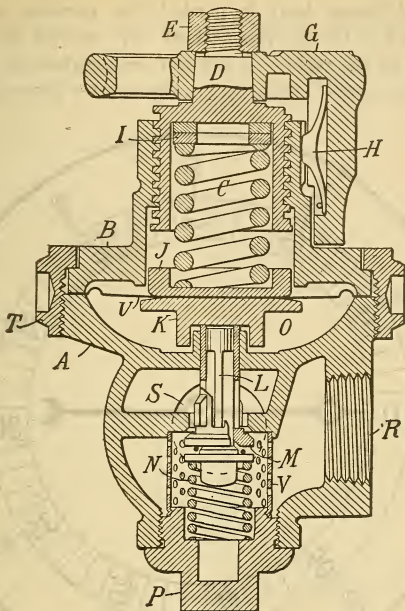

FIG. 27. SECTIONAL VIEW IMPROVED TEMPERATURE REGULATOR.

Parts of Gold's Improved Temperature Regulator.

- | | |
|----------------------|----------------------------|
| A—Body of Regulator. | L—Auxiliary Valve Spindle. |
| B—Dome of Regulator. | M—Main Valve Spindle. |
| C—Top Spring. | N—Bottom Spring. |
| D—Adjusting Screw. | P—Bottom Plug. |
| E—Top Nut. | R—1-Inch Inlet. |
| G—Wheel. | S—1-Inch Outlet. |
| H—Indicator Spring. | T—Spanner Nut. |
| I—Washer. | U—Diaphragm. |
| J—Top Flange. | V—Strainer. |
| K—Bottom Flange. | |

If additional heat is needed, the pressure must be increased. To do this, wheel "G" should be turned further to the right. If a lower temperature be desired, the wheel should be moved in the reverse direction.

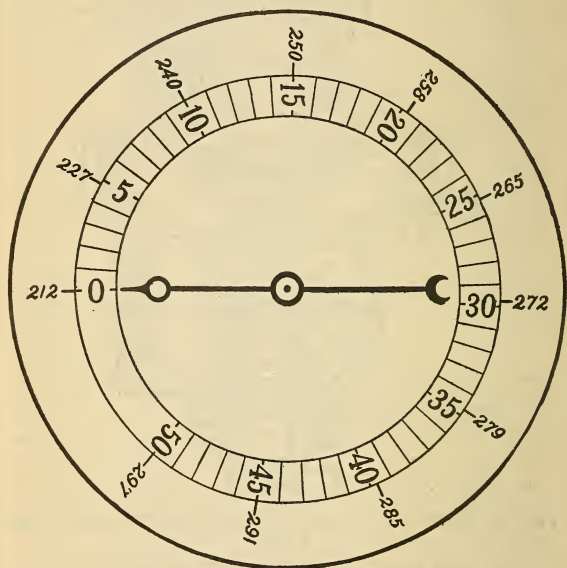

FIG. 28. PRESSURE RADIATOR DIAL.

The figures on the dial indicate pressure in radiator (see Figure 28). A number of grooves are provided in which the spring "H" may rest. These provide a friction lock. They are so arranged that the regulator will deliver 5—10—20—35 or 50 pounds. When wheel "G"



GOLD'S IMPROVED TEMPERATURE REGULATOR & STOP VALVE.

POSITION
No 1.

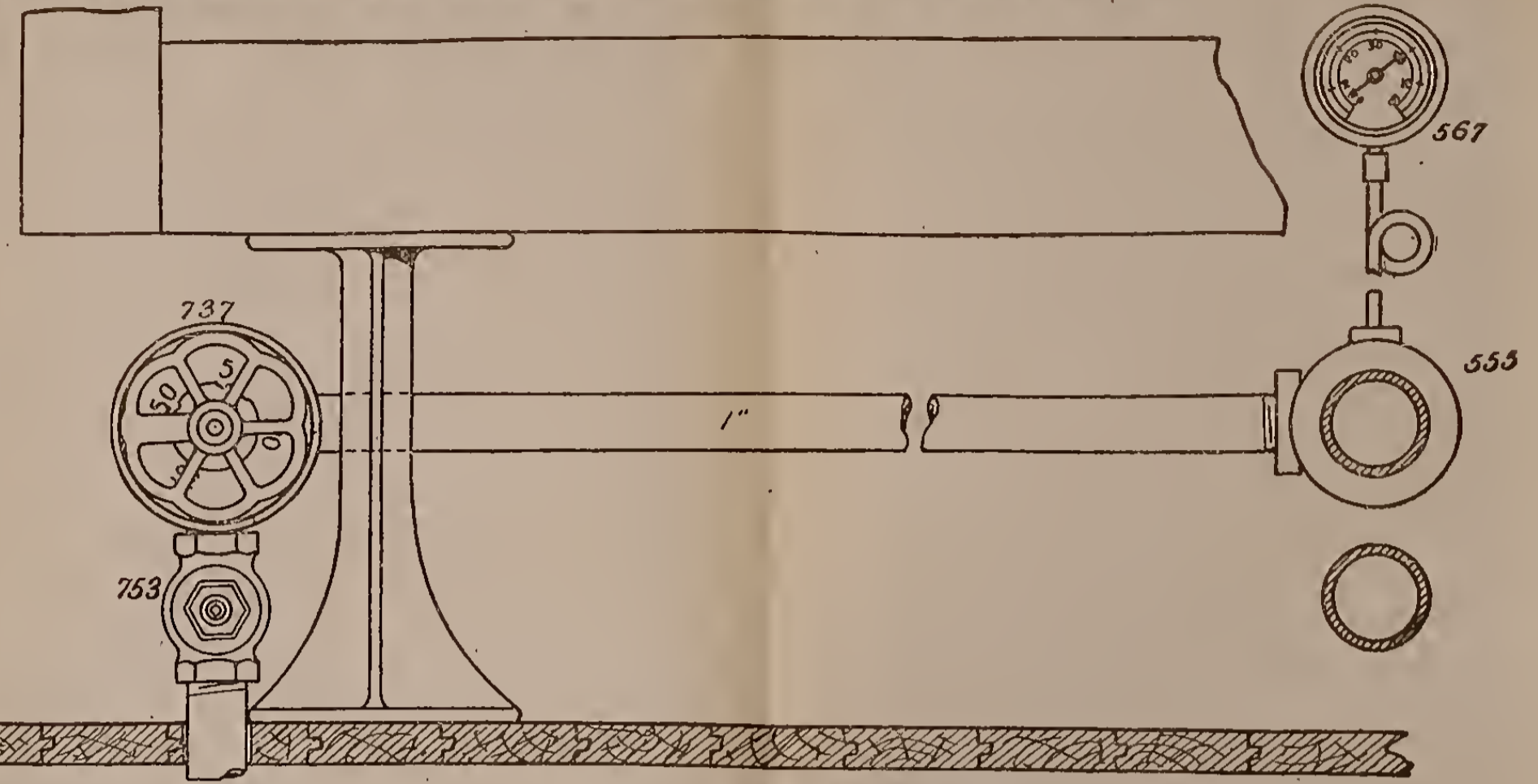
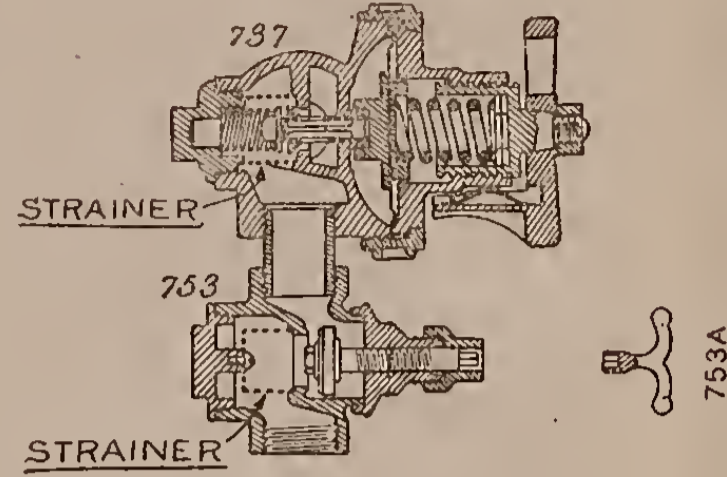
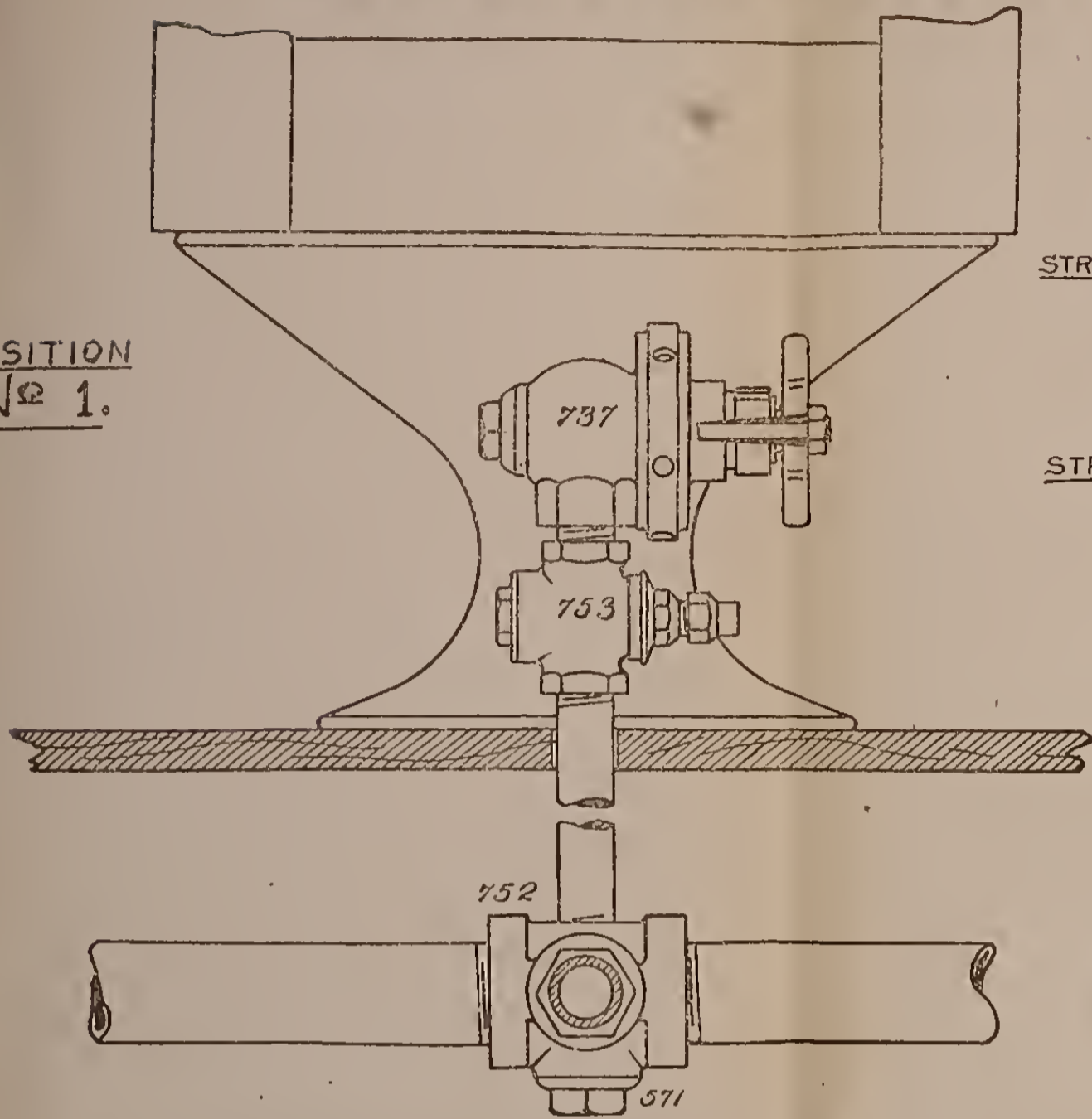

TEMPERATURE OF STEAM
FROM ATMOSPHERIC TO 50 LBS. PRESSURE

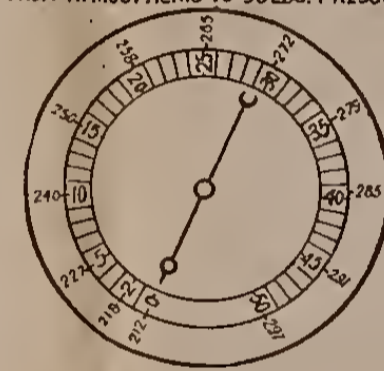

POSITION
No 2.

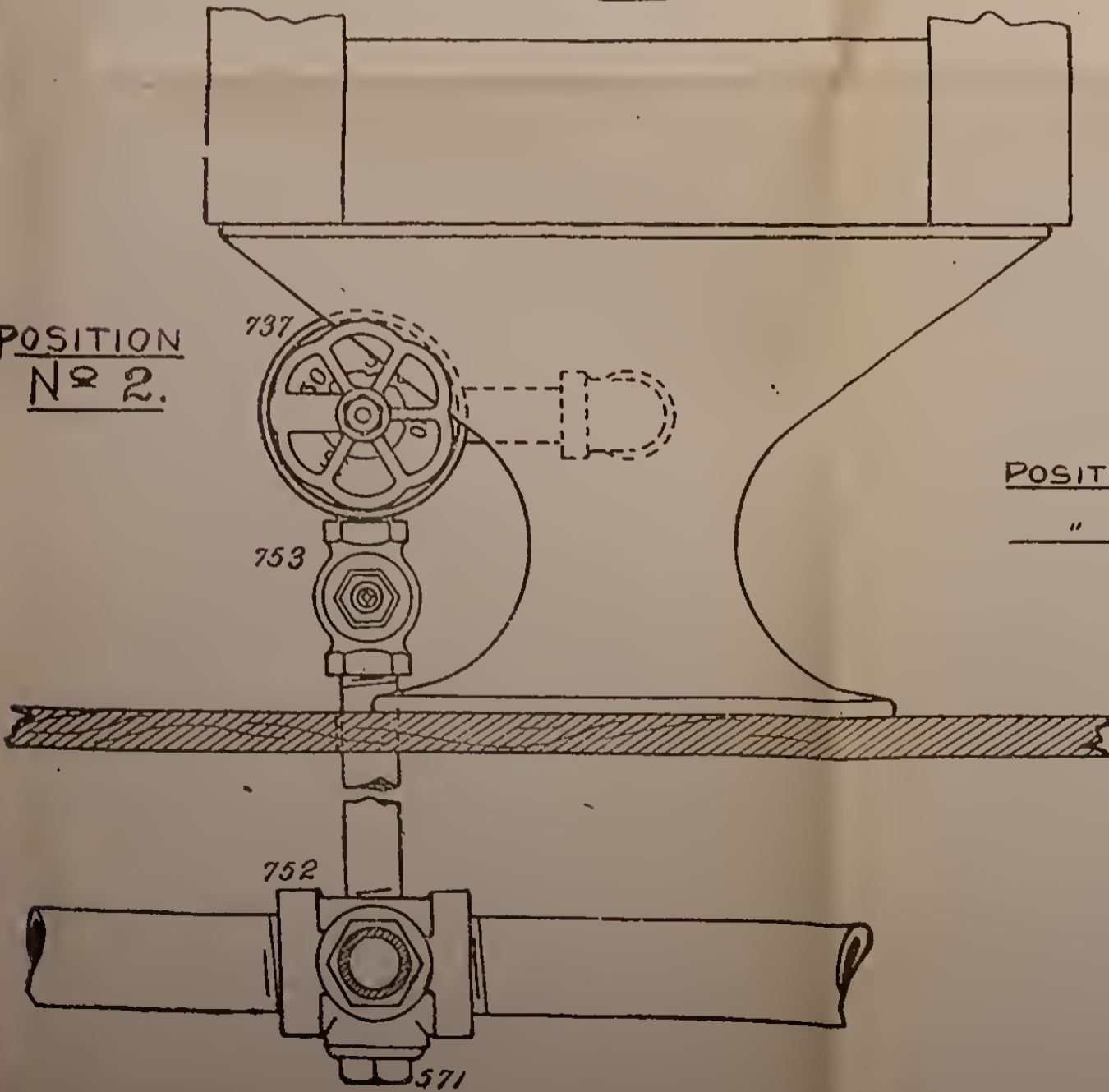

- 542 - 1 1/4" ELL.
- 550 - 1/2" R&L. COUPLING.
- 555 - 2"x1" TEE 1/4" TOP OUTLET.
- 567 - 60" STEAM GAUGE
- 571 - STRAINER CROSS CAP.
- 737 - TEMPERATURE REGULATOR.
- 750 - STRAINER NIPPLE.
- 752 - 2"x2"x1 1/2"x1 1/2" CROSS WITH BOTTOM OUTLET
- 753 - 1" STRAINER STOP VALVE

POSITION No 1 - SHOWS VALVE HANDLE
FACING DOOR.
" " 2 - SHOWS VALVE HANDLE
FACING AISLE.

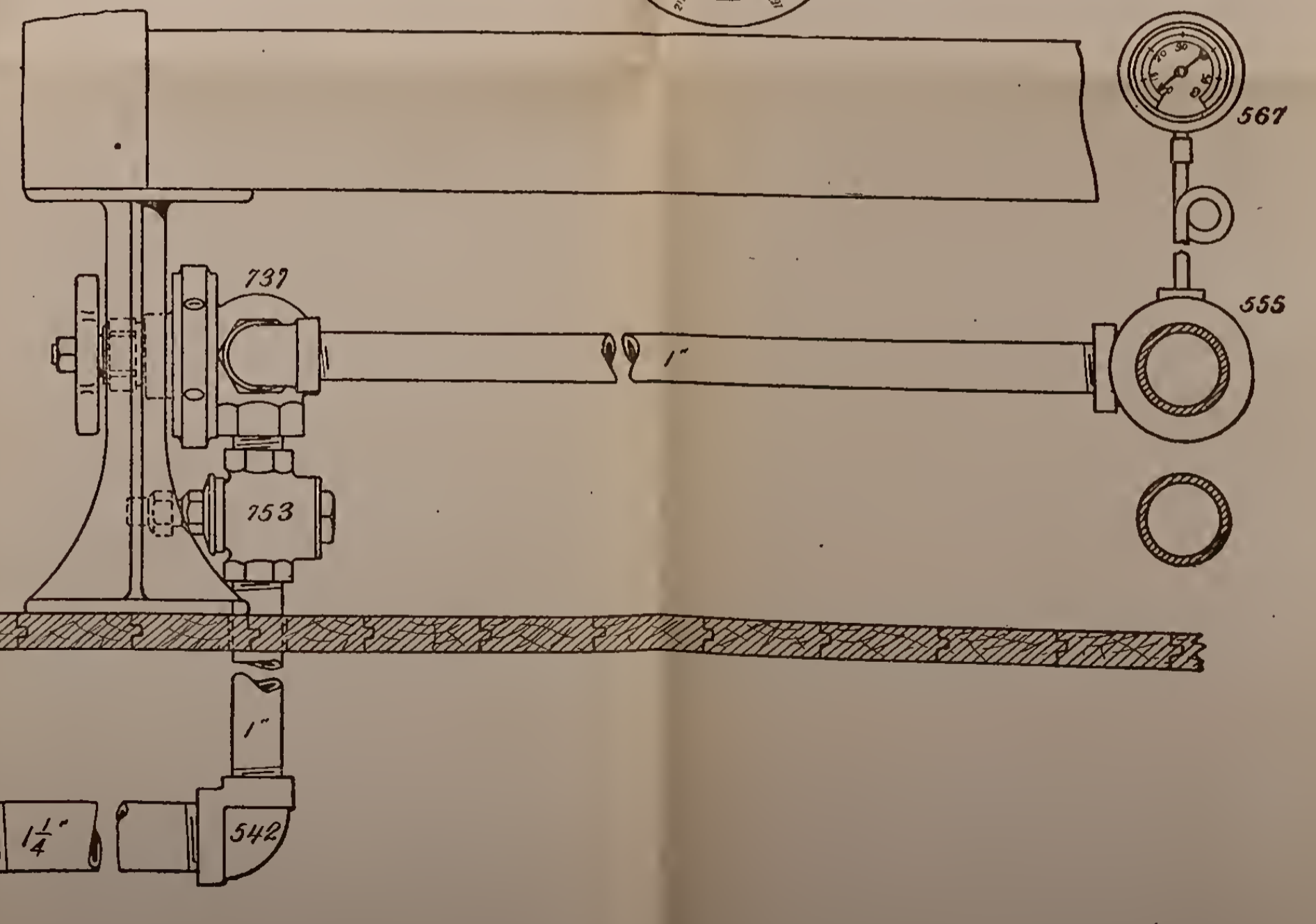

ii
f
t

is turned clear back to the stop, the valve will then supply only 2 pounds pressure.

Steam condenses in chamber "O" and this forms a water seal which prevents chattering.

The smaller valve "L" is the medium which affords a proper balance. When both valves are seated the spindle of "L" extends one thirty-second of an inch beyond that of "M." As the plate "K" travels downward, the valve "L" is opened first and passes steam to the low pressure side through the slotted openings in the spindle of valve "M."

This auxiliary valve is the medium which admits of a supply of a very limited quantity of steam when occasion demands.

Plate I shows the way the piping is laid out and also the regulator connections. It is explained as follows:

EXPLANATION OF PLATE V.

No. 752 is the cross fitting in the train-pipe, from either side of which branches lead into the cars.

The strainer nipple (750), is screwed into the cross, fitting in such a manner that it extends a short distance into the main line. The object is to so locate the end of this strainer that steam in passing back and forth will keep it perfectly clean.

The right and left coupling (550) is attached and a $1\frac{1}{4}$ -inch pipe runs to the ell (542). From the upper side of this ell 1-inch pipe leads to the lock shield stop valve (753), which is connected to the temperature regulator by a close shoulder nipple.

The lock shield stop valve (753), which is provided with a strainer, is operated by a key (753a) and is to be

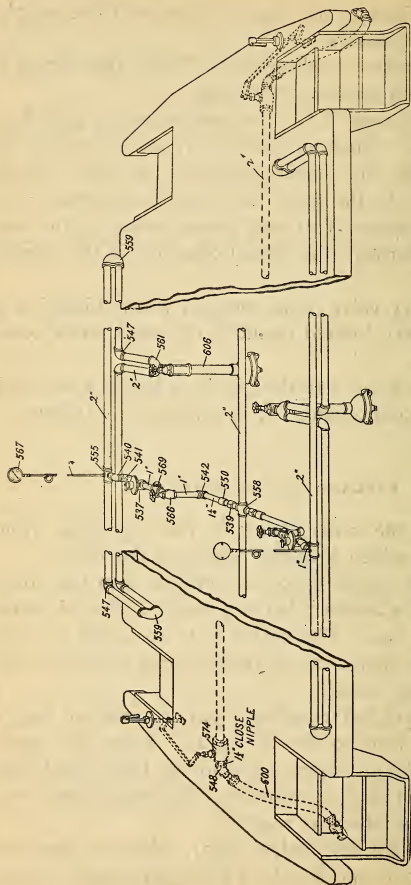

FIG. 29. GOLD'S IMPROVED DIRECT SYSTEM FOR HEATING PASSENGER CARS.

- 500—Gold Steam Coupler.
- 574—Gold End Train Pipe Valves.
- 537—Gold Temperature Regulator.
- 569—Strainer Tee.
- 567—Car Gauge.
- 590—Gold Improved Tee Trap.
- 566—1" Supply Valve.
- 555—2"x2"x1" Tee, 1/4" Side Outlet.
- 559—2" R. and L. Return Bend.
- 547—2" R. and L. Ell.
- 560—2" Return Bend, 1 1/2" Side Outlet.
- 545—1 1/2" Ell.
- 539—Strainer Nipple.
- 558—2"x2"x1 1/4"x1 1/4" Cross.
- 548—1 1/2" 65° Ells.
- 550—1 1/4" R. and L. Coupling.
- 542—1 1/4"x1" E.L.
- 540—1" Ell.
- 541—1" R. and L. Ell.

closed only when it is desired to shut all steam from the radiating pipes.

Gold's Direct Steam System—(Improved): A two-inch train line is located under the car, at the middle of it a cross (558) Figure 29, is placed, from which fitting branches lead to either side. There should be a pitch from the cross to the valves at either end. Each side of the car is controlled by a separate admission valve and temperature regulator. By referring to the illustration it will be seen that the heating surface consists of two courses of two-inch pipe along the truss-planks, expansion loops being provided as shown. The two-inch return bends (559) used for these loops are tapped to spread. The upper line has to be in line with the top of the truss-plank, so only the lower pipe pitches downward because of the special tapping. The lower radiator pipes run to loops which end in the special bends (560), and from the side of these bends a one and a half drip pipe is carried down through the floor to the automatic tee traps. All the pipes which lead to traps have to pitch downward so the water of condensation may always readily pass to the

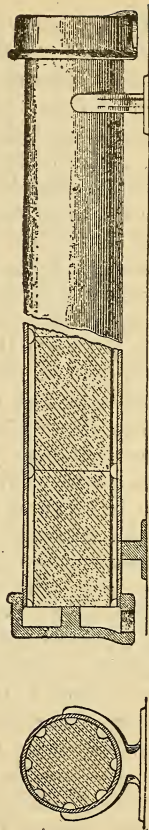

FIG. 30. CYLINDER CONTAINING BRICKS FOR STORING HEAT.

outlet; and particular care ought always to be taken to avoid water pockets.

Gold's Improved Storage System for Heating Compartment Cars: This is a system which, it is claimed, combines rapid and effective heating with great economy; the construction of the heater being based upon scientific principles and in accordance with the well-known laws of natural philosophy. The storage is provided for by Terra Cotta Sections, as shown in Figure 30 where they appear like bricks in a cylinder. The latter is usually a five-inch boiler tube and the bricks which fit snugly inside are twelve inches long, as many bricks being put inside the tube as are needed to fill the heater which is to be used. When steam is let in to the heater it passes through the corrugations of the bricks and circulates around them, thus the cylinder is immediately heated while the bricks absorb very readily the hot condensed steam. Thus the car is rapidly warmed and the heat is stored in the cylinder at the same time. The surplus condensation passes out at the opposite end of the heater, down through a drip pipe, and is discharged at a trap. The train pipe is under the car and has a gravity pitch to either end of it. Steam is taken from this train line and after it has passed through a strainer nipple, goes through a one-inch pipe to an angle valve, then through a strainer tee, and directly to the temperature regulator; this latter admits whatever quantity of steam is needed to the separate supply pipe, and from this pipe branches are run directly to the several heaters in the car. The storage heaters rest on stands and are slightly pitched from the inlet toward the outlet side, the object being to allow the surplus condensation to pass readily to the traps. The separate supply pipe

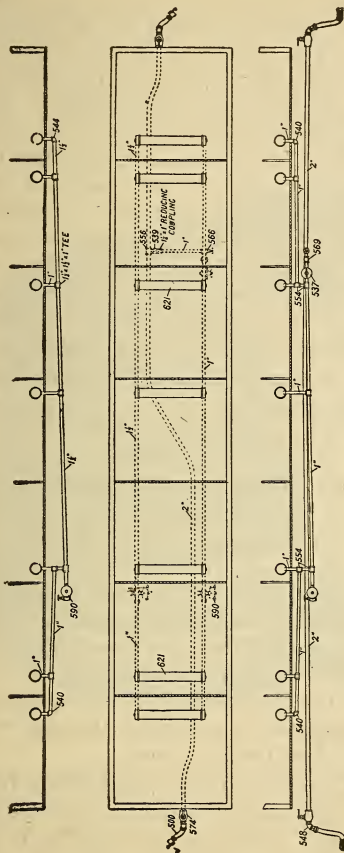

FIG. 31. GOLD'S IMPROVED STORAGE SYSTEM FOR HEATING COMPARTMENT CARS.

- 500—Steam Coupler.
 574—End Train Pipe Valves.
 537—Temperature Regulator.
 569—Strainer Tee.
 590—Improved Tee Trap.
 566—Supply Valve, 1".
 539—Strainer Nipple.
 621—Storage Heater.
 623—High Storage Heater Stand.
 624—Low Storage Heater Stand.
 552—Couplings, 2", R. and L.
 548—Ells, 1½" x 65°.
 546—Tee, 2" x 2" x 1¼".
 544—Ell, 1½" x 1".
 554—Tee, 1".
 540—Ell, 1".

should pitch downward from the regulator to the trap, and the main condensation pipe should also pitch downward to the trap. The heaters are located under the seats, and owing to the large surface of radiation the temperature in the car can be very rapidly raised. The storage capacity of the terra cotta sections is so great that the heat is retained by them and is radiated from the cylinder for several hours after the steam has been shut off from the car. One heater is placed in each compartment, so the space is warmed very quickly indeed (see Figure 31). The amount of heat may be regulated according to the weather, the temperature regulator making it possible to have any desired pressure of steam and accordingly whatever amount of heat is desired.

Gold's Improved System of Hot Water Circulation: Two duplex coils are placed in a Baker or similar heater as shown in Figure 32a. The outer and inner pipes end in fittings specially designed for the purpose. As shown in Figure 32b the smaller pipe passes through the entire length of the larger pipe and extends a short distance beyond it. When the circulating pipes are filled, water occupies the space between the outside of the smaller pipe and the inside of the larger pipe. If fire is used the water is heated by direct contact of the outer pipe, but when steam is used it is heated by the inner pipe. Steam can be used independently of the fire or both may be used at the same time. The convenience of this arrangement is not only its adaptability, but likewise the ease with which cars may be piped for this system.

At the top of each of the coils are special fittings from which quarter inch pipes connect to the inlet of the sealed jet. (See Figure 33.) From the top of the jet to the expansion drum a short and heavy brass nipple is run.

From the bottom outflow, pipes run around the car and return to the coil as shown. Figure 33 shows how one part of this bend is carried through and inside the other and is slightly tapered at the end. The heated water goes up through the riser and enters the inlet of this

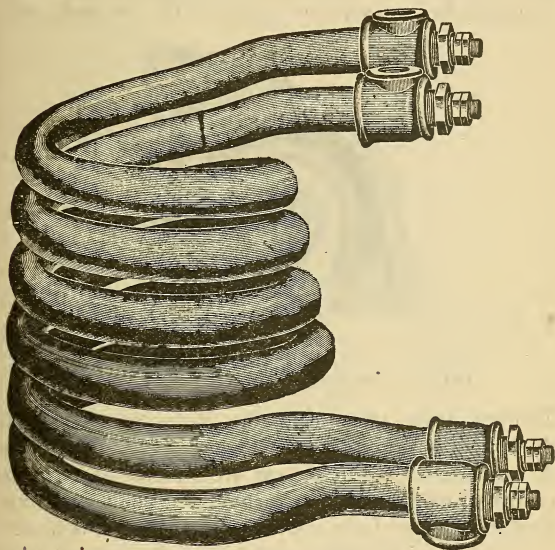

FIG 32A. DUPLEX COILS.

sealed jet. It then moves around the bend, and owing to the taper of the nozzle and the energy behind, is forced downward into the outflow pipes with much velocity. Any air which is mingled with the water separates at the jet and passes up to the drum. The small hole near

the top of the directing bend is there to release any air that might otherwise accumulate at that point when the pipes are being filled with water.

Steam is taken from the train-pipe through an inch and a quarter pipe to the inside of the car. From that point an inch pipe goes to the top of the heater where it is connected by two separate valves to the one inch coils.

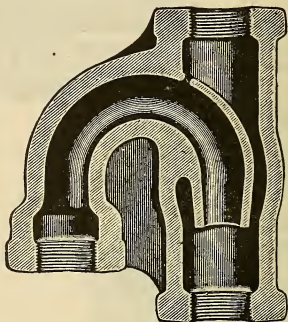

FIG. 32B. SECTIONAL VIEW DUPLEX COILS.

Through these inner coils the steam passes out at the bottom to drip pipes which run directly to the traps. Thus the two sides of the car are separate and may be controlled independently of each other. The temperature regulator is placed at a convenient point near the heater.

A system of hot water circulation with vertical traps is shown in Figure 34. It will be noticed that the plan of piping is the same as that shown in Figure 33 with the exceptions as follows: The vertical style is shown in place of the automatic tee trap, and instead of the end train pipe valve step attachment a platform operating mechanism is substituted.

- 500—Gold Steam Couplers.
 574—Gold End Train Pipe Valve.
 537—Gold Temperature Regulator.
 569—Strainer Tee.
 608—Low Coil.
 590—Gold Improved Tee Trap.
 616—Sealed Jet.
 618—Ideal Safety Valves.
 567—Car Gauges.
 566—1" Supply Valves.
 539—Strainer Nipple.
 556—2"x2"x1 1/4" Tee.
 548—Two 1 1/2" 65° Ells.
 50—1 1/4" R. and L. Coupling.
 549—1 1/4" R. and L. Coupling.
 543—1 1/4" R. and L. Ell.
 542—1 1/4"x1" Ell.
 540—1" Ell.
 541—1" R. and L. Ell.
 553—1"x1"x1/4" Tee.
 554—1" Tee.
 545—1 1/2" Ell.
 544—1 1/2"x1" Ell.

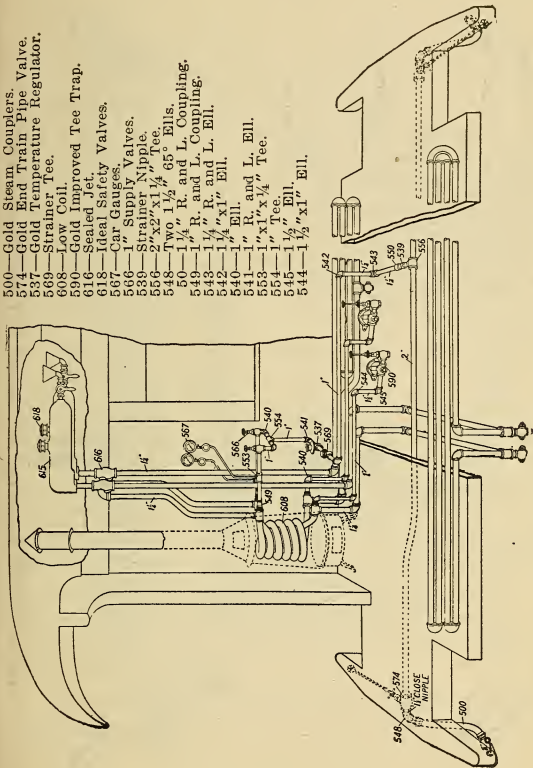

FIG. 33. GOLD'S IMPROVED SYSTEM OF HOT WATER CIRCULATION.

- 500—Gold Steam Coupler.
 574—Gold End Train Pipe Valve.
 537—Gold Temperature Regulator.
 569—Strainer Tee.
 609—High Coil.
 606—Gold Improved Vertical Traps.
 567—Car Gauges.
 566—1" Supply Valves.
 616—Sealed Jets.
 618—Ideal Safety Valves.
 539—Strainer Nipple.
 556—2"x2"x1 1/4" Tee.
 548—1 1/2" 65° Ell.
 550—1 1/4" R. and L. Coupling.
 543—1 1/4" R. and L. Ell.
 542—1 1/4" "x1" Ell.
 540—1" Ell.
 541—1" R. and L. Ell.
 553—1"x1"x1/4" Tee.
 554—1" Tee.
 549—1" R. and L. Coupling.

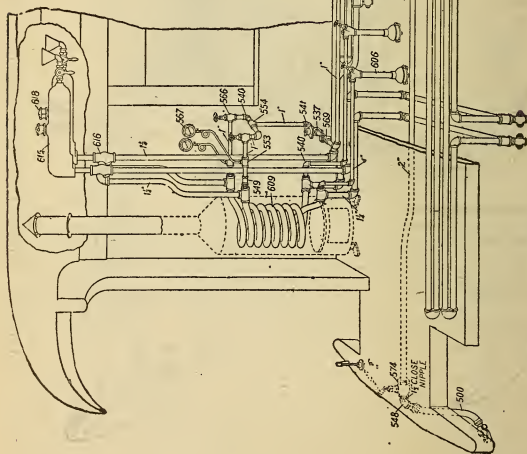

FIG. 34. GOLD'S IMPROVED SYSTEM OF HOT WATER CIRCULATION.

COMBINATION AUTOMATIC LOCK AND HOSE SUPPORT
(GOLD'S).

This device is designed to accomplish two purposes—the automatic locking of steam hose couplers and the proper support of the hose and coupler.

The advent of larger hose and heavier couplers necessary to heat the long passenger trains now in common use made the problem of tight joints and hose protection one of greater importance than ever before, and, taken in connection with the higher steam pressures carried in the train line to satisfactorily effect the heating of these long trains, the jarring on fast runs causes considerable leakage of steam, especially in passing around curves. In the new arrangement the hose is relieved of the weight of the couplers both when coupled and when separated, the couplers being supported by means of a chain attached to the platform and sill, and a connection between the chain and coupler is made by means of a lever or lock hinged onto the coupler attached to the same car and bearing on the mating coupler of the adjacent car in such a manner as to force the gaskets into close contact. This removes all the weight from the hose, and presses the gaskets together with a force much greater than that due to their weight and the action of the cam and wedge, which are still retained as integral parts of the coupler.

Figure 35 shows the device and Figure 36 shows it attached to a car.

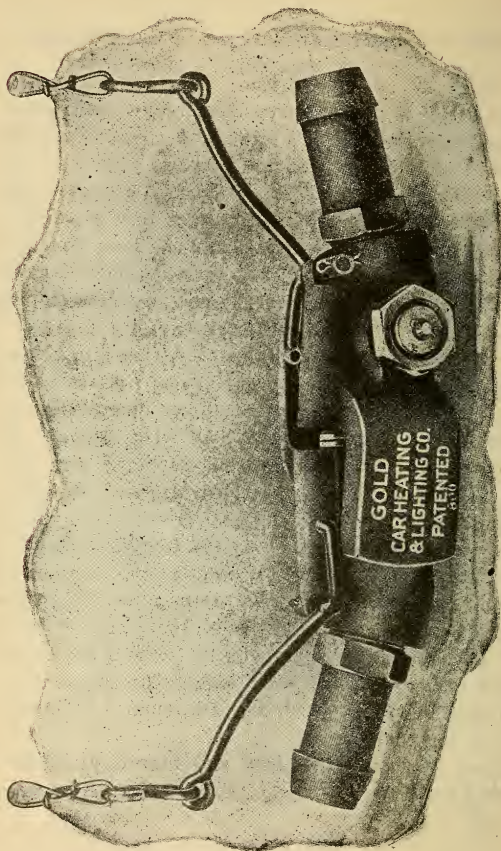

FIG. 35. COMBINATION AUTOMATIC LOCK AND HOSE SUPPORT.

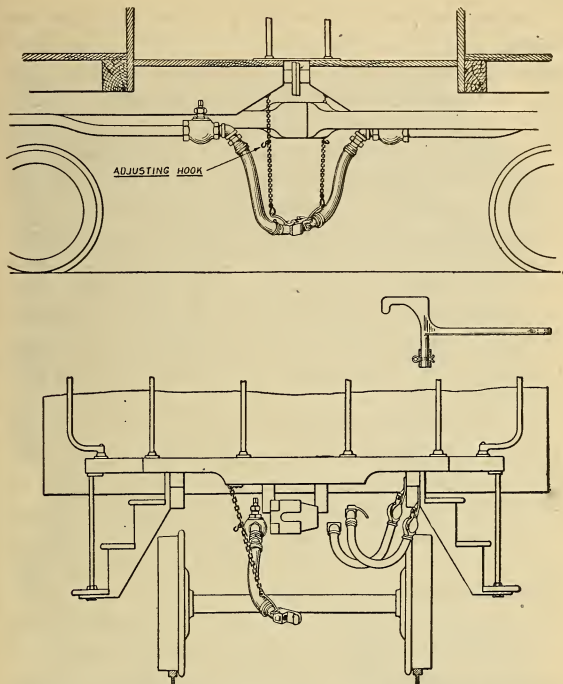

FIG. 36. COMBINATION AUTOMATIC LOCK AND HOSE SUPPORT ATTACHED TO A CAR.

VAPOR SYSTEM OF CAR HEATING.

This is a system of car heating which is manufactured by the Chicago Car Heating Co. It is an exceedingly simple apparatus, and the principle upon which the system operates is equally simple.

The temperature of the escaping condensation from the heating pipes is used to operate and control in an automatic manner the inflow of the steam from the train pipe to the heating pipes which are inside the car, instead of its being used to control the outlet or discharge. Thus the entire heating pipes are left open to the atmosphere all the time and the condensation flows out by gravity immediately it reaches the lowest points of the heating pipes, and in consequence of the entire absence of water in the pipes through "backing up" the possibility of freezing is completely done away with. The pipes are automatically filled with steam at atmospheric pressure (which is equal to 212 degrees, or the same temperature as boiling water), thus a very agreeable heat is radiated.

The heat of the escaping condensation has, in other systems, been used to automatically operate some form of a trap or discharge valve located in the outlet or the lowest part of the heating pipes, which has resulted in carrying about the same pressure in the radiating pipes inside the cars as was carried in the train pipe located underneath the cars.

In the vapor system train pipe pressure only reaches the inlet of the radiating system, as shown in the comparison of systems in Plate VI, but in the case of the steam pressure system train pipe pressure goes through the entire radiating system to the outlet. This method of carrying train pipe pressure in the heating pipes inside the car has frequently resulted in the cars being over-heated, because of the high train pipe pressure necessary. The trap or valve which has been placed at the outlet has, it is claimed, caused more or less backing

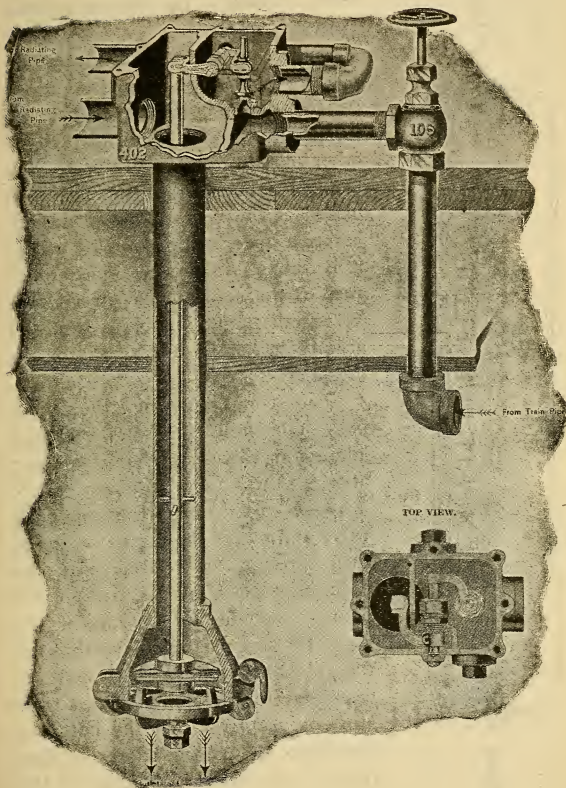

FIG. 37. VAPOR HEATING—SECTIONAL VIEW.

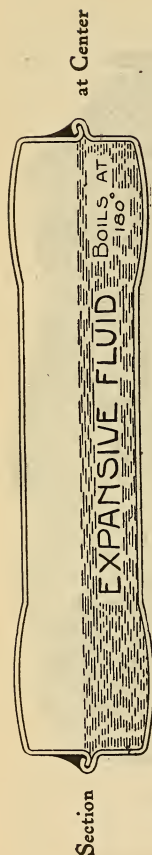

FIG. 38. EXPANSIVE DIAPHRAGM.

up of water in the pipes, and this has often resulted in the apparatus being frozen.

Figure 37 shows a sectional view of the piping arrangement. The expansive diaphragm (see Figure 38) is combined with and adapted to other parts of the apparatus to control the admission of steam. It is placed at the very outlet of the apparatus underneath the car, where it is subject to the combined influence of the cold outside air and the hot condensation pressing over and around it before it reaches the atmosphere.

The steam entering the pipes passes through the hand operated admission valves in the usual way and into the Vapor Regulator, where it passes up through the automatic valve and out of the regulator again, then through the feed pipe to the radiating pipes along the truss plank, finally reaching the bottom of the regulator and passing down through the discharge pipe and around the expansive diaphragm and out to the atmosphere. Instantly the hot condensation and steam reach the diaphragm at the very bottom of the apparatus, it expands it about a quarter of an inch, causing it to push up the operating rod and close down the automatic valve, thus

closing the supply of steam to the radiating pipes at the inlet of the Vapor Regulator. The instant the supply of steam to the radiating pipes is thus shut off, the diaphragm in the outlet of the apparatus starts to cool, and contracts just enough to permit sufficient steam to pass the automatic inlet valve to make up for whatever is lost in condensation in the radiating pipes and still maintain a temperature of 200 degrees at the outlet point underneath the car at which the diaphragm is located. Less than 200 degrees temperature around the diaphragm at the bottom causes it to contract and open the admission valve until sufficient steam is passing into the apparatus to give 200 degrees at the very outlet. A temperature of much over 200 degrees at the outlet expands the diaphragm and cuts down the admission of steam until the temperature at the outlet reaches 200 degrees. Therefore the temperature of the outlet of the apparatus (which contains the diaphragm, Figure 38) is automatically maintained at a temperature of about 200 degrees, and necessarily all the pipes between this outlet and the inlet are maintained at a temperature of between 200 degrees at the outlet point, and about 212 degrees at the inlet point.

DETAILS OF OPERATION.

The Vapor Regulator is divided by partitions into three parts (see Figure 39), a high pressure chamber directly under the automatic valve "A," a low pressure or supply chamber directly above the automatic valve, and an outlet chamber where the return or drain pipe from the heating pipes inside of the car is connected to the regulator.

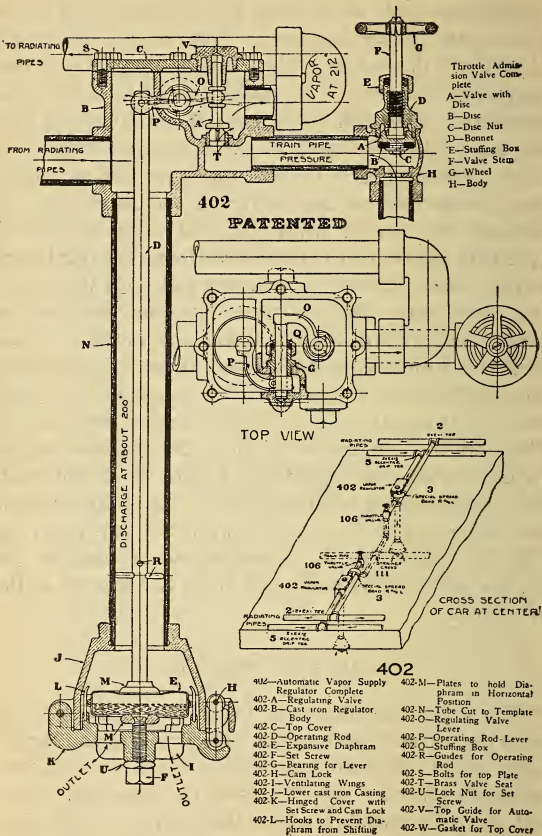

FIG. 39. DETAILS OF VAPOR REGULATOR.

Steam leaves the train pipe at the strainer cross (No. III), and passes through the admission valve into the high pressure chamber. After passing through the automatically operated valve "A" into the low pressure chamber it passes out of the Vapor Regulator again, and through the feed pipes into the radiating pipes at the

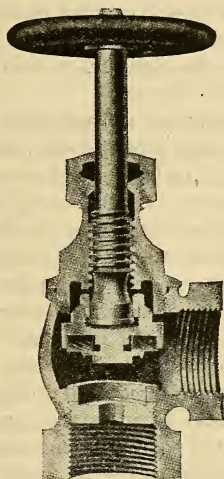

FIG. 39A.

side of the truss pipe where it branches and flows to each end of the car, returning again to the center where it joins again in one pipe and flows through this pipe into the outlet chamber of the vapor regulator and down through the tube and around the expansive diaphragm and out to the atmosphere.

As already explained, the heating of the diaphragm to about 200 degrees at the outlet causes the closing of the automatic valve "A" sufficiently to pass just enough steam into the radiating pipes to circulate entirely through them and maintain a temperature of 200 degrees at the outlet point, and it should be remembered that if the temperature around this outlet drops below 200 degrees the diaphragm will contract instantly just enough to open the automatic valve "A" to permit sufficient steam to pass into the apparatus to *raise the temperature at the outlet to 200 degrees.*

Until the steam passes the automatic valve "A" it is, of course, under train pipe pressure, but after it passes the valve "A" it is under atmospheric pressure, and in just sufficient quantity to pass entirely through the pipes and give the required 200 degrees at the outlet.

It is found that this automatically maintained temperature of 200 degrees at the outlet point underneath the car gives an actual temperature of about 208 degrees in the bottom or coolest pipes inside the car and 212 degrees in the top of the pipes where the steam first enters, and a temperature of 213 degrees immediately after the steam leaves the automatic valve, and these temperatures are found to *remain the same* regardless of what pressure or temperature the steam may be when it enters the Vapor Regulator from the train pipe.

This condition of affairs continues indefinitely as long as steam is on the apparatus.

As the radiating pipes are open to the atmosphere it will be readily understood that their temperature can never exceed 212 degrees at the hottest point.

Inasmuch as at no time is there any pressure backed up in the radiating pipes, and as the outlet point is auto-

matically maintained at a normal temperature of 200 degrees, necessarily the discharge at the outlet must be nothing but actual condensation which will do no injury to varnish or sheathing. This overcomes a serious defect in steam traps which always discharge condensation under a pressure—resulting in scorching the side of car.

The passage for the discharge of condensation from the pipes to the atmosphere contains no trap valve or stoppage of any kind, and condensation is free to escape by gravity from the pipes to the atmosphere, as will be seen from the cut.

Motion from the diaphragm at the outlet, to the automatic valve "A" at the inlet, is transmitted through the dividing partition by means of the lever "P" passing through the stuffing box "Q."

As the pressure is inappreciable on either side of this stuffing box, and as the motion of the axis of the operating lever amounts to almost nothing, it will be evident that the wear of this packing is practically nothing and need not be considered as a feature needing attention after the device is in service. When valve 4 is a quarter of an inch, the weight of the rod D will keep the valve A open when the diaphragm is cold. To remove the automatic valve unscrew the brass guide cap V, open the hinge cover K at the bottom, allowing the rod D to drop down, then the automatic valve A can be easily lifted out. To get at the entire inside of the top part of vapor regulator, remove the brass stud bolts S, allowing the top plate to be removed.

The Expansive Diaphragm.—Figure 38, already referred to, is round, being about four inches in diameter and three-quarters of an inch thick, is made of phosphor bronze, and is filled about half full of a mixture of

which alcohol forms the greater part, and it is hermetically sealed.

This mixture boils at a temperature of about 180 degrees, and when confined in the diaphragm and subjected to a surrounding temperature of between 200 and 212 degrees, a sufficient internal pressure is created to cause the diaphragm to expand about three-eighths of an inch and when the diaphragm is placed in the device and adjusted with the set screw so that the maximum movement cannot exceed a quarter of an inch, it will exert sufficient force to close a three-quarter inch valve seat against a pressure of as high as a hundred and twenty pounds to the square inch.

As the temperature surrounding the diaphragm falls, it begins to contract until at 180 degrees it is again at its original or normal thickness of three-fourths of an inch.

Plate VII shows the Vapor System applied to a standard passenger coach. The details of the Vapor Regulator are shown in the sectional view, Figure 39.

HEATING CARS WITH ELECTRICITY.

FIRST PRINCIPLES.

The conversion of electrical energy to heat takes place in accordance with well known laws, and in known proportions. One British Thermal Unit of heat is equivalent to 1047.3 watts, and cannot be produced without the expenditure of that amount of energy. A resistance coil which will pass a certain amount of current may be made of a short length of wire of high resistance, or of a long wire of low resistance. If the resistances of the coils are equal, the same amount of current will flow through each, and each coil will give off the same amount of heat. Consequently a short coil of high-resistance wire having a small surface must necessarily operate at an excessively high temperature, in order to dissipate the same amount of heat as the longer coil of low-resistance wire having a much larger surface. In this principle lies the success of the Consolidated Electric Heaters, which have a large heating surface and operate at a moderate temperature.

It is claimed by the manufacturers that experience has demonstrated that galvanized iron wire, which has been specially galvanized for the purpose, makes the best resistance coils, and that by reason of the large radiating surface made possible by the McElroy spiral coil construction, the wire is heated only to a moderate degree, thus the excessive temperature to which a high resistance wire is necessarily subjected, usually resulting

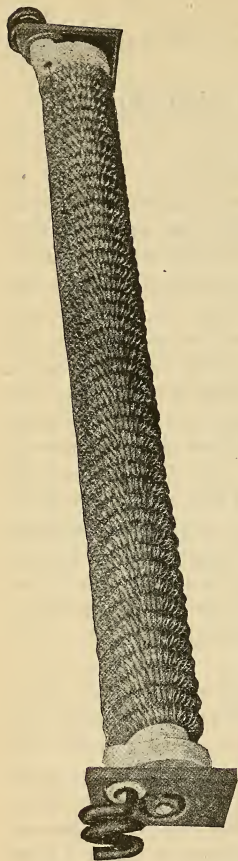

FIG. 40. COMPLETED COIL FOR NO. 143LL HEATER SHOWING RESISTANCE COIL, PORCELAIN BUSHINGS, END PLATES AND LEAD WIRES.

in crystallization of the wire if accompanied by vibration, is overcome.

In each heater there are two resistance coils placed, one above the other. The upper coil is of greater resistance and consumes less current than the lower. The coverings of lead wires to the two coils are different colors, and thus may be easily distinguished. The top coils of all the heaters in the car are in series, and the bottom coils of all the heaters are in series. Thus, wherever current is used, heat is given out the full length of the casing of every heater in the car. At the same time this method of wiring is said to be the simplest and most economical in time of equipping and material used. All this type of heaters are said to secure convenience, simplicity and durability.

A coil for heater, showing resistance coil, porcelain bushings, end plates and

lead wires is shown in Figure 40.

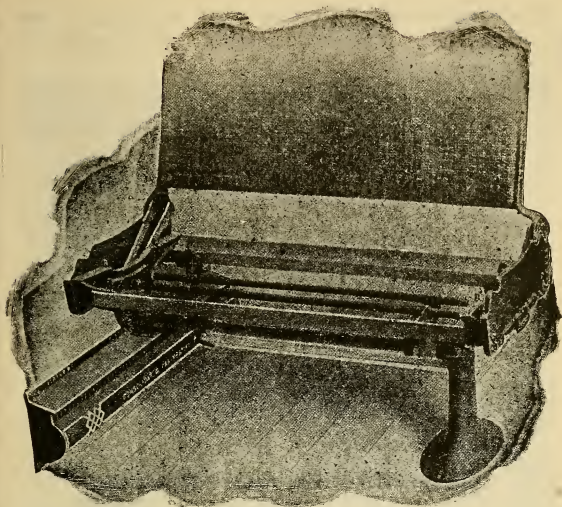

FIG. 41A. ELECTRIC HEATER IN POSITION.

FIG. 41B. HEATER ENCLOSED IN INSULATED IRON CASING;
WIRING SHOWN IN MOULDING.

A heater for a cross-seat car or parlor car is shown in Figure 41. It is designed to attach to the truss plank, and is designed to occupy about the same space as the steam pipes do when the steam heating system is employed. The coils are, it will be noticed, covered by an iron case of attractive design, which is insulated.

The arrangement for wiring when electricity is employed for heating cars is shown by the diagrams in Figure 42.

The coupler shown in Figure 43 is used for the purpose of connecting the heat and light circuits in trains.

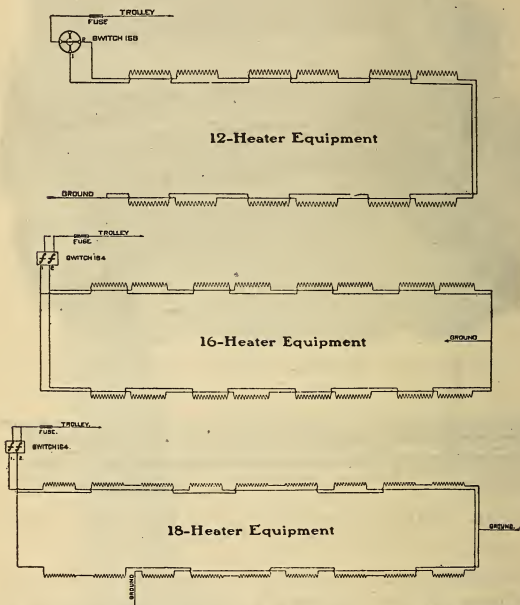

FIG. 42. DIAGRAMS OF WIRING ELECTRIC HEATING SYSTEM.

With this coupler there are no exposed contacts. The contact finger is mounted on the inside of a protecting casing which is attached at the end of the car, either

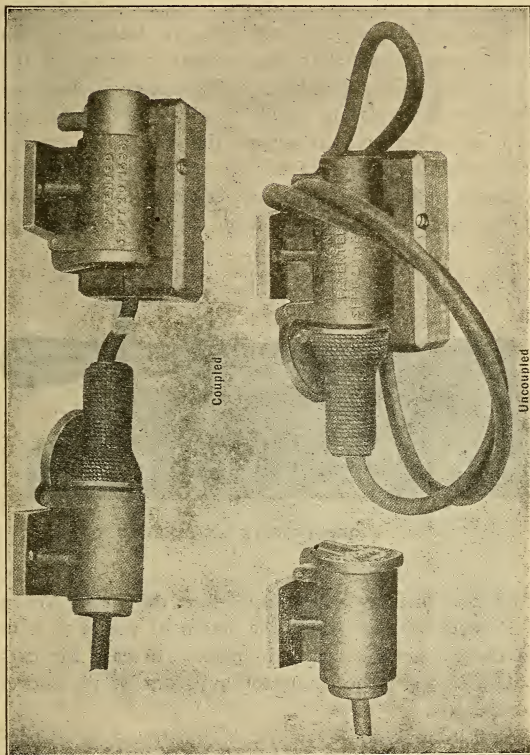

FIG. 43. ELECTRIC COUPLERS USED FOR HEATING TRAINS BY ELECTRICITY.

under the platform sill or under the hood, and the opening to this casing is covered with a spring door.

On the end of the flexible cable is securely attached a hollow cylindrical contact piece which slides over the contact finger mounted in the protecting casing on the opposite car. This cylindrical contact piece is mounted securely in an insulating handle which covers it not only on the sides, but projects beyond the end of the contact piece leaving no portion of the contact piece unprotected. No danger of short circuit occurs either in handling it or in allowing the connector to drop to the rail, since the

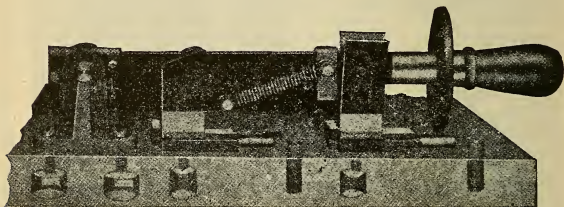

FIG. 44. A QUICK-BREAK KNIFE SWITCH.

cylindrical contactor is not exposed at the ends. When the contacts are once made the action of the door is to hold the contactor securely in place. In case the cars should pull apart the connector pulls out of the socket automatically.

A quick-break knife switch is illustrated in Figure 44. It has double contacts, and is intended for service on 600-volt circuits. Slate bases free from metallic veins are used to mount the switches upon, and as the

slates are drilled to a templet and counter-sunk all current carrying parts are brought below the surface on the back of the slate. It is considered by the manufacturers advisable that all switches used for heating or lighting purposes should be placed on the bulkhead above the windows, either in the vestibule or the car body.

CATECHISM OF STEAM HEATING.

ON TRAINS EQUIPPED WITH THE STEAM HEATING SYSTEM
OF THE SAFETY CAR HEATING AND LIGHTING
COMPANY.

DIRECTIONS FOR THE MANAGEMENT OF 'STEAM HEATING ON TRAINS.

MAKING UP TRAINS.

When a train is made up all steam hose should be coupled and all cocks or valves in the steam train pipe, the whole length of the train, should be opened.

When signal is given steam should be turned on at the cab and allowed to blow through the entire length of the steam train pipe.

After steam issues from the rear end of the train pipe, the rear train pipe valve of the last car should be closed. This valve is slotted and will allow a little steam to escape through the rear coupling.

REGULATION OF TEMPERATURE.

To heat cars, open steam inlet valve in each car and regulate the temperature with this valve. Do not ask the engineer to vary the steam pressure for the purpose of regulating the temperature of cars.

Steam inlet valves must not be shut tight in freezing weather.

Traps should be set at terminal points so that a little steam will escape with the water. Readjustment is seldom necessary.

CHANGING ENGINES.

Five minutes before arriving at terminals or stations where engines are to be changed, the rear train pipe valve must be opened wide, and just before coming to a stop at such stations the engineer should shut off steam at locomotive valve. Do not use reducing valve for this purpose. This valve is to be set at 40 pounds when the engine is placed in service and not changed thereafter, except in zero weather, when 5 pounds should be added for each additional car over eight.

Trainmen should see that steam is shut off at engine before uncoupling hose.

When cars are to be laid up all valves must be left open.

CATECHISM OF STEAM HEATING APPARATUS ON TRAINS.

I. DESCRIPTION OF THE APPARATUS.

Question. What is the advantage of using steam heat on trains?

1. Answer. Safety to trains as well as passengers by replacing the heat of the fire with the heat of steam, and for economy of operation.

Ques. How are cars heated by steam?

2. Ans. Either by direct steam, that is the admission of steam to radiating pipes in car, or on cars with Baker heaters, by means of steam jackets applied to the water circulation pipes.

Ques. How should the jackets be applied?

3. Ans. They should be located at nearly equal distances apart in the water circulating pipes, and to secure rapidity of circulation should have an upward slant of two or more inches in the direction the water flows.

Ques. How do the jackets operate?

4. Ans. As the circulating water passes through the jackets, it is heated by the steam. The water does not come in direct contact with the steam.

Ques. How is steam conducted to the jackets?

5. Ans. By a branch pipe from train pipe, leading through inlet valve to ends of jackets in series.

Ques. How many heating jackets are used on a car?

6. Ans. Ordinarily two or three with single coil heaters and twice the number with double coil heaters.

Ques. In what direction does the water flow when using steam?

7. Ans. In the same direction as when using a fire in the heater.

Where are the following parts located (a), and what are their functions (b)?

Ques. Locomotive valve?

8. Ans. (a) At the steam box in cab or other source of dry steam supply.

9. Ans. (b) To control the supply of steam to train pipe.

Ques. Reducing Valve?

10. Ans. (a) In cab.

11. Ans. (b) To control the pressure of steam in the train pipe.

Ques. Train pipe?

12. Ans. (a) Underneath tender and cars.

13. Ans. (b) To conduct steam to the cars.

Ques. How should the train pipe be applied?

14. Ans. So as to drain to each end of car, thereby avoiding pockets for the collection of condensation water, the prescribed measurements being closely followed in locating the ends of train pipes, in order to prevent the couplers from opening on curves.

Ques. Steam couplers?

15. Ans. (a) At ends of train pipe.

16. Ans. (b) To connect train pipes between cars.

Ques. Steam coupler safety chain?

17. Ans. (a) Under platform buffer timber; in accordance with standard measurements.

18. Ans. (b) To prevent the steam coupler from being injured.

Ques. Train pipe valve?

19. Ans. (a) At ends of train pipes, in accordance with standard measurements.

20. Ans. (b) To close rear end of train pipe, and to control same without disturbing passengers, also for protection in handling steam couplers.

Ques. Inlet regulating valve?

21. Ans. (a) Inside of cars—usually at heater room with cars having a Baker heater, and at inlet of radiators of cars having direct steam.

22. Ans. (b) To supply steam to heating jackets or direct steam pipes and to regulate the temperature in car.

Ques. Steam traps?

23. Ans. (a) Horizontal Trap No. 833 is underneath car at the lowest point in the steam transfer pipe, and should have a drain of two inches.

24. Ans. (a1) Vertical Trap No. 933 (used with direct steam only), at the lowest point in the steam radiators, extending through the car flooring.

25. Ans. (b) To automatically discharge the condensation water from the heating jackets or direct steam heating pipes.

Ques. Trap blow-off valve?

26. Ans. (a) At the inlet end of trap.

27. Ans. (b) To discharge the accumulation of dirt and scale from the trap.

Ques. Trap adjustment?

28. Ans. (a) At the low end of trap.

29. Ans. (b) For setting so as to allow a little steam or vapor to escape with the condensation water.

Ques. When should the trap be set?

30. Ans. When cars are tested with steam previous to being placed in service.

Ques. Why?

31. Ans. So that it will not be necessary to adjust the trap on the road.

Ques. How should the trap be set?

32. Ans. First open the adjustment wide; then after all pipes have become hot close it down until a little vapor escapes with the water of condensation.

Ques. What causes the trap to operate automatically?

33. Ans. The difference in expansion between the brass tube and the iron shell enclosing it.

II. OPERATION OF THE APPARATUS.

Ques. When should the reducing valve in cab be set?

34. Ans. When the engine is placed in service.

Ques. At what pressure should the reducing valve be set?

35. Ans. Forty pounds.

Ques. Under what conditions should the pressure on reducing valve be increased?

36. Ans. When there are more than eight cars, adding 5 pounds for each additional car in zero weather.

Ques. Should the reducing valve on engine be closed?

37. Ans. It should never be used as a shut-off valve.

Ques. What valve should control the supply of steam to train pipe?

38. Ans. The locomotive valve.

Ques. When should the locomotive valve be closed?

39. Ans. Five minutes before arriving at points where engines are to be changed, or terminals where

train is to lay up and always before hose are uncoupled.

Ques. Should the locomotive valve be closed under any other condition?

40. Ans. Never while heat is required in the cars, except in cases of emergency.

Ques. Why?

41. Ans. To prevent condensation water in train pipe from freezing.

Ques. When should steam be admitted to train pipe?

42. Ans. After all steam hose are coupled and all inlet and train pipe valves are open, signal the engineer to open locomotive valve.

Ques. What is the next move?

43. Ans. Close end train pipe valve on rear car after train pipe is thoroughly blown out.

Ques. How is the end train valve operated?

44. Ans. By the extension handle operated at step side, or through an opening in step riser, thereby preventing the passengers from tampering with same from inside of vestibule.

Ques. When should the condensation water be blown out of the train pipe?

45. Ans. When the train is made up, also on approaching and before leaving points where engines are changed or the train laid up, and occasionally on the road, the rear valve only being used for this purpose.

Ques. When should traps be adjusted?

46. Ans. Traps should be inspected often to see if a little steam or vapor is being discharged with the water of condensation and reported at terminals if not working properly. Only adjust traps on the road when absolutely necessary.

Ques. Why should a little steam issue from the rear train pipe valve on the road?

47. Ans. To prevent the accumulation of condensation water and to have live steam throughout the entire length of the train pipe in order to avoid freezing.

Ques. What temperature should be maintained in cars?

48. Ans. About 70 degrees Fahrenheit, with proper ventilation.

Ques. How should this temperature be regulated?

49. Ans. By adjusting the inlet valve.

Ques. When the steam supply is cut off from cars having Baker heaters, what should be done?

50. Ans. Start a fire in the heater.

III. CARE OF THE APPARATUS.

What test or inspection should be given the parts following?

Ques. Reducing valve?

51. Ans. It should be taken apart and thoroughly cleaned, oiled and tested before the steam heat season opens.

Ques. Gauge?

52. Ans. Should be tested with test gauge before season opens and occasionally in service.

Ques. Valves?

53. Ans. Before season opens, all valves and seats should be repaired, or renewed if necessary, and all valve stems repacked.

Ques. Traps (horizontal No. 833, vertical No. 933)?

54. Ans. Remove adjustment from low end and

valve from high end of trap, allowing steam to blow through until thoroughly cleaned, and renew Jenkins discs if necessary.

Ques. Steam couplers?

55. Ans. These should be removed from cars at the end of the season and stored at the shop after being repaired and tested and made ready for the next season. Cap or plug the opening in the end train pipe valve.

Ques. What is the proper method of filling heater pipes with water?

56. Ans. At the beginning of the steam heat season, open all draw-off cocks on water circulating pipe. After water is drained, blow steam through water circulating pipes, making attachment at draw-off cocks nearest heater. When pipes are clean, shut off steam, close draw-off cocks, remove safety valve in circulating drum and run a half-inch pipe thence to a coil in a barrel of water.

Then turn on steam again and boil water in barrel. After this, disconnect steam and close draw-off cocks and the water in barrel will syphon into and fill circulating pipes. After standing some time, the water, having cooled, will contract to some extent and a small amount of water may then be poured in through the combination cock. Then turn on steam at inlet valve and if water circulates quickly the pipes are properly filled. If water does not circulate properly, let water out of pipes and repeat operation.

Ques. How often should inspections be made to ascertain that water is at the proper height in circulating drums?

57. Ans. During the heating season they should be examined when cars reach terminals or yards.

Ques. Should Baker heater pipes be kept filled with water during summer?

58. Ans. Yes, as they will not rust so rapidly as when empty.

IV. RESPONSIBILITY OF EMPLOYES.

What are the duties for which the following employes are held responsible?

Ques. The repair shop employes?

59. Ans. For the proper application of and for the thorough overhauling and testing of the heating apparatus when cars are in shop.

Ques. The engineer?

60. Ans. For turning steam on or off at the locomotive valve when the prescribed signals are given, and for supplying the proper amount of steam for heating the train.

Ques. The conductor?

61. Ans. For knowing the pressure of steam supplied to the train and seeing that the proper temperature and ventilation is maintained and knowing that the other members of the crew are familiar with the operation of the steam heating apparatus.

Ques. The brakeman or flagman?

62. Ans. For blowing the condensation water out of the train pipe before arriving at terminals or stations where engines are to be changed, also at stations where there are no car inspectors, and for leaving all valves open when cars are to be laid up.

Ques. The round house inspector?

63. Ans. For the condition of the steam heating

equipment on the engine before it leaves the round house, and knowing that an extra steam coupler is carried.

Ques. The car inspector?

64. Ans. For the condition of the car heating apparatus and for blowing the condensation water out of train pipe before trains leave terminals and stations; for knowing that an extra steam coupler is carried on train and for having a supply of steam couplers and gaskets on hand.

l
a
a
of the arms of the lamp, designated as the gas-way

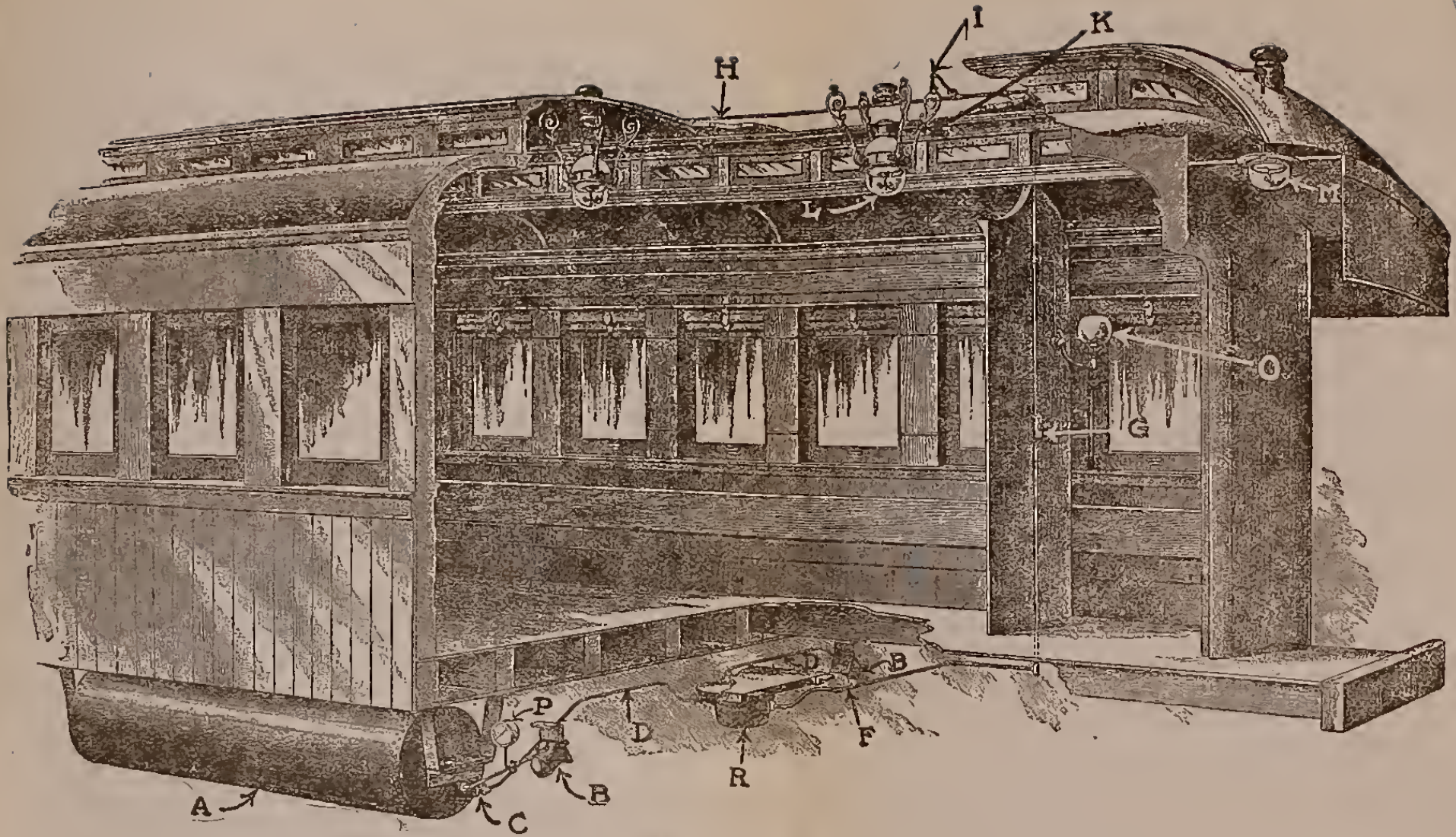

GENERAL ARRANGEMENT OF APPARATUS ON A CAR

Fig. 45.

A—Storage Tank.
 B—Filling Valve.
 C—Tank Valve
 D—Extra Heavy Pipe.
 F—Outlet Pipe.
 G—Main Cock.
 H—Main Pipe.

I—Branches from Main Pipe.
 K—Gas Cock.
 L—Lamp Burner.
 M—Vestibule Lamp.
 O—Bracket Lamp.
 P—Gauge.
 R—Regulator.



LIGHTING PASSENGER CARS.

The Pintsch Gas Lighting System. The general arrangement of this system of lighting is shown in Figure 45, which also shows the general relation of the parts.

"A" represents the storage tank, in which a sufficient supply of gas is carried to maintain the lights in the car the desired length of time, the number and size of the tanks varying in proportion to the requirements of the service. The gas is supplied to these tanks under pressure at regular filling stations, a hose connection being made between the supply pipe and the filling valve "B," which in turn are connected with the storage tank by means of the extra heavy pipe "D" connecting into the tank valve "C." The pressure in the tank is at all times indicated on the gauge "P." From a branch in pipe "D" the gas is conducted through the reducing valve or regulator "R," in which the pressure is so reduced and governed as to maintain a constant pressure of one-third of an ounce on the outlet pipe "F," irrespective of the pressure in the tank. The regulator controls the gas pressure on the lamps in a perfectly uniform and automatic manner, whether the pressure in the tank is two pounds or one hundred and fifty pounds. From the regulator the gas passes into the car at any convenient point and terminates in a main pipe "H" extending along and on the roof of the car, from which branches "I" are taken off at each lamp, connection being made to one of the arms of the lamp, designated as the gas-way

arm, which contains a tube through which the gas passes down into the burner of the lamp "L." The gas is turned off and on by means of a gas cock "K" on the gas-arm of each lamp, but if desired all of the lamps can be regulated at once by means of the maincock "G" placed in the pipe "F" shown on the wall, or the gas can be shut off entirely at this same point. "O" represents a bracket lamp for use in toilet rooms and passage ways. "M" is a vestibule lamp used for lighting the platform and vestibule of a car.

The arrangement of the gas holder (or holders), the regulator, piping for gas under pressure, filling valves, etc., is shown in Figures 46, 47, 48 and 49. The way the connections are made for an equipment as shown in Figure 45 is shown in Figures 46, 47 and 48 as indicated by the full or solid lines. The method of connecting a second holder on that side of the car is likewise shown as indicated by the broken lines in Figure 46. Two holders, one on each side, are shown in Figure 49 as indicated by the full lines, and a third holder on one side is shown also, as indicated by the broken lines.

These holders are usually hung about one inch from the sheathing, as far as possible away from the sides of the car, the inlet connection end being away from the nearest truck, and the flat side of the angle iron upwards. Figures 48 and 49 show forms of the hanging irons, and another form is shown in Figure 50. The holder valve (53b), Figure 51, is attached to the holder by a flange (3) which is screwed on the holder inlet bushing, and a flange (3a) which is screwed on (53b) in a similar manner, the whole being secured with screws (150). The regular board is shown in

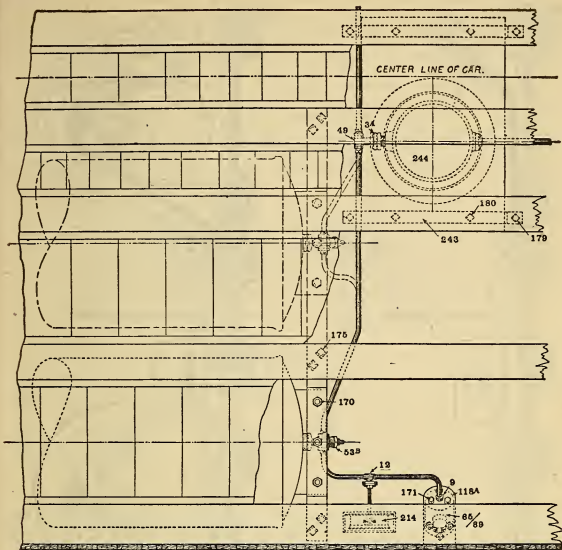

FIG. 46.

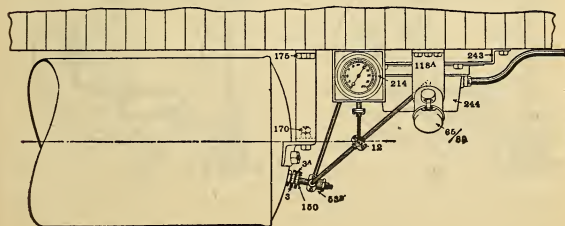

FIG. 47.

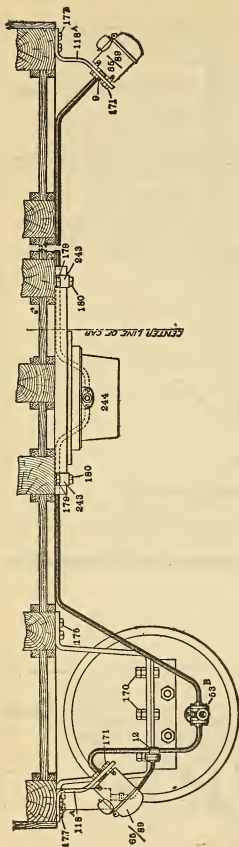

FIG. 48.

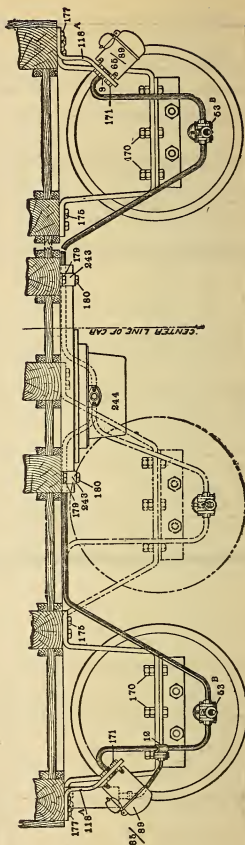

FIG. 49.

detail in Figure 52. The recess, in one face of this board, receives the upper part of the regulator cover. This board with the regulator attached is secured to the car body (see Figures 46, 48 and 49) by means of straps (243) and lags (180) passing through both the board and the straps and lags (179) passing through the straps only. Filling valve brackets (118a) are located

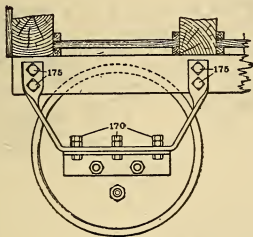
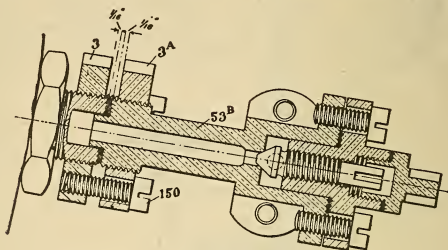

FIG. 50.

as desired, but they have to be far enough back to insure that the filling valve does not project beyond the edge of the car body. The brackets are usually located between the end of the holder and a needle beam. The gauge should be enclosed in a box with a glass face and screwed to the under side of the car as shown in Figure 47.

The pipes are bent for gas under pressure, as shown in Figures 46, 47, 48 and 49. All pipes are usually made to drain to the holder fittings (53b) and the gauge pipe must drain to the fitting (12). The threads on the bent pipes are tinned, and are fitted in place after the flanges are screwed on. The brass flanges, etc., are thoroughly soldered to the pipes when all the pipes for gas under

pressure have been fitted. The pipe leading to No. 65 is put through (118a) before No. 9 is soldered on. Filling bracket (118a) is then securely fastened to the car and all the pipes strapped up securely.



OLD FORM.

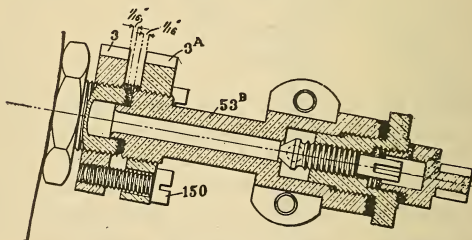

PRESENT FORM.

FIG. 51.

The filling valve and cover (65) (89) are attached by removing the cover (89) from the valve (65) and bolting valve to the bracket. This is done by opening port covers P and T, unscrewing and removing packing nut R (but set screw B should not be unscrewed nor should valve stem nut M be loosened), screws (148) are

taken out and No. 89 is held to the back flange of the No. 65 valve and the threaded end of the valve is rapped on a block of wood.

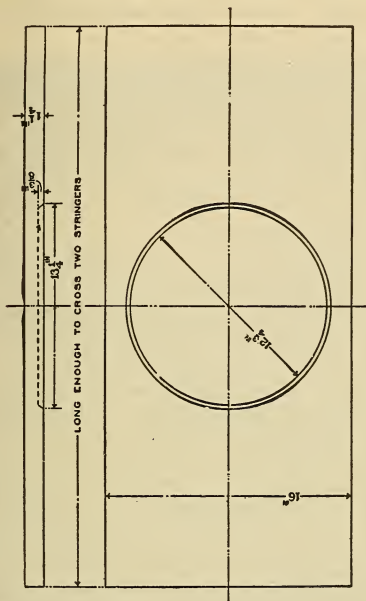

FIG. 52.

The number and character of fixtures required for the proper equipment of any car depends upon the class or kind of the car, the divisions of its space (as into state-rooms, toilets, smoking-rooms, passageways, etc.), the spacings of the ceilings or headlinings, and the amount of light required in the particular service for which the car is destined.

The consumption for each kind of lamp is about as follows:

4 flame lamps, $2\frac{1}{2}$ cubic feet per hour.

2 flame lamps, $1\frac{1}{2}$ cubic feet per hour.

Vestibule lamps, 1 cubic foot per hour.

1 flame bracket, $\frac{3}{4}$ of a cubic foot per hour.

Argand bracket, $2\frac{1}{2}$ cubic feet per hour.

The necessary number and sizes of holders or tanks is figured from the above calculated results, combined with the following:

A holder 9' 6" long, $20\frac{1}{2}$ " diam. contains when filled to 10 atm.* 211.8 cubic feet.

A holder 8' 6" long, $20\frac{1}{2}$ " diam. contains when filled to 10 atm. 188 cubic feet.

A holder 7' 10" long, $20\frac{1}{2}$ " diam. contains when filled to 10 atm. 175 cubic feet.

*Ten atmospheres is the standard pressure to which cars are filled, and is therefore taken as the basis of calculation.

The term "Atmosphere" (atm.) is used to indicate the pressure of the gas in the holders. Each atmosphere as indicated by the Pintsch gauges is $14\frac{7}{10}$ pounds per square inch above the outside air. The gauge, connected with a holder into which its own cubical contents of gas has been forced, will indicate one atmosphere increase in pressure. If twice its cubical contents has been forced in, then the gauge will show two atmospheres increase in pressure. If ten times, then ten atmospheres. Each atmosphere of pressure indicated, multiplied by the cubical volume of the holder or holders, gives the available gas supply. Example—A car with two holders, each of 18.8 cubic feet of volume, and filled to 8 atmospheres, has on hand as available gas $2 \times 18.8 \times 8 = 300.8$ cubic feet. When filled to 10 atmospheres these holders would contain 376 cubic feet, and would supply five four-flame lamps, two vestibule lamps and two bracket lamps, consuming altogether 16 cubic feet an hour, for about 24 hours' full burning.

A holder 7' 2 $\frac{1}{4}$ " long, 20 $\frac{1}{2}$ " diam. contains when filled to 10 atm. 157 cubic feet.

A holder 6' 1" long, 20 $\frac{1}{2}$ " diam. contains when filled to 10 atm. 135 cubic feet.

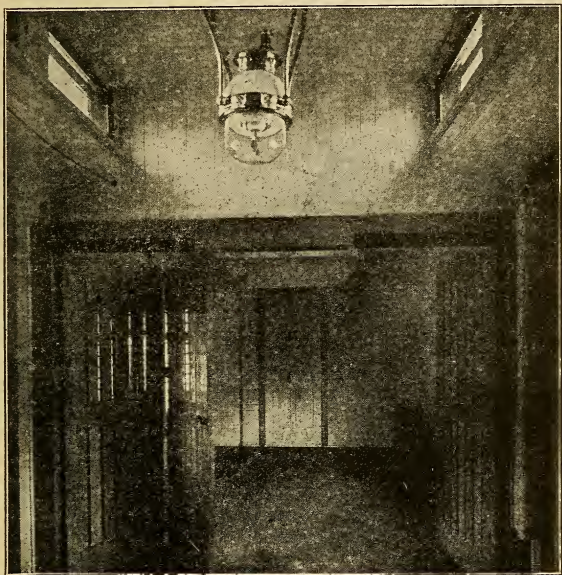

FIG. 53. SHOWING A TWO-FLAME ORDINARY PINTSCH GAS LAMP, IN BAGGAGE CAR.

A holder 6' 1" long, 18 $\frac{1}{2}$ " diam. contains when filled to 10 atm. 110 cubic feet.

A holder 6' 1" long, 16 $\frac{1}{2}$ " diam. contains when filled to 10 atm. 88.5 cubic feet.

One of the ordinary style two-flame burners is shown in Figure 53, illustrating its application to a baggage car.

Special inverted mantle burners for use with Pintsch gas are now used. By their use it is claimed a steady white light is produced and the candle increased more than three fold. The regulator has to be arranged so as to give an outlet pressure of one pound per square inch.

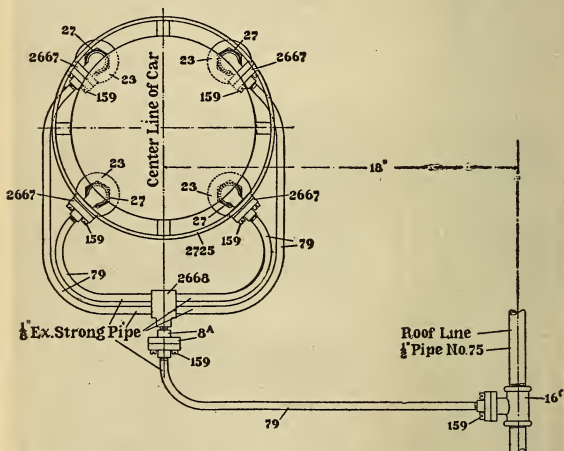



FIG. 54. THE REGULATOR USED WITH THE MANTLES FOR INVERTED BURNERS.

See Figure 54. This illustration shows the gas pipe connections for two mantle lamps, as shown in Figure 55, which gives the details of the lamp, arrangement of parts and shows the flow of gas. The delivery of gas is the same as for ordinary lamps, until it reaches fitting



The proper flame from the burner is shown in Figure 56. This flame has seven short light blue cones surrounded by a very light gaseous flame.

To light the lamps: If the main cock is closed it should be opened full, then the lamp cock should be opened, and the flame of a match or taper held ju-st en

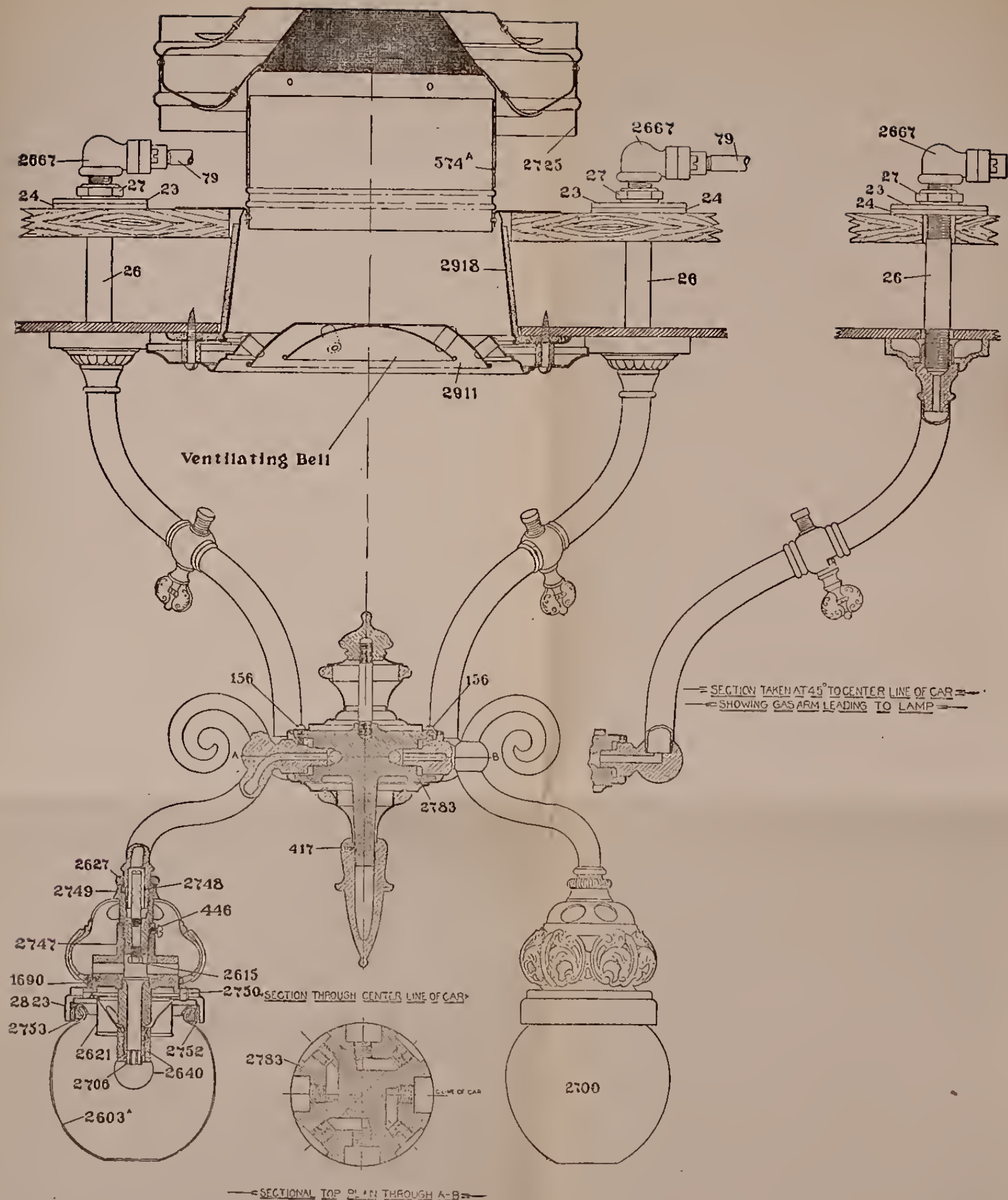

FIG. 55. SECTIONAL VIEW OF LAMP—DETAILS AND PARTS SHOWN.

23—Iron Washer.
 24—Rubber Washer.
 26— $\frac{3}{8}$ in. Nipple, 6 in. long.
 27— $\frac{1}{2}$ in. Locknut.
 79— $\frac{1}{2}$ in. Extra Strong Pipe.
 156—Screw for Center Casting.
 417—Screw for Pendant.
 446—Set Screw for Extension Pillar.
 574a—Roof Thimble.
 1690—Screw for Ornamental Body.
 1862—Woodscrew for Ventilating Bell.

2603a—Opal Bowl.
 2615—Gas Tip.
 2621—Mantle and Globe Holder.
 2627—Locknut.
 2640—Mantle.
 2667— $\frac{3}{8}$ in. x $\frac{1}{8}$ in. Angle Flange.
 2700—Incandescent Gas Bulb. Complete; Includes Nos. 2603a, 2621, 2640, 2752 and 2753.

2706—Burner Nozzle.
 2725— $6\frac{1}{2}$ in. Ventilator.
 2747—Lamp Body.
 2748—Gas Strainer.
 2749—Extension Pillar.
 2750—Spring Lock.
 2752—Outer Globe Ring.
 2753—Inner Globe Ring.
 2783—Center Casting.
 2823—Shield.
 2911—Ventilating Bell.
 2918—Lower Thimble.

1

in
c
g
v
tl
to

26

F1



See Figure 54.
connections for tv
55, which gives th
parts and shows
is the same as for

pe
re
of
as
ng

2615, which has at its end nearest the burner a very fine drilling through which the gas issues, mixing itself with the air which burns with a jet downwardly into the globe 2603A. The mantle is designated by 2640.

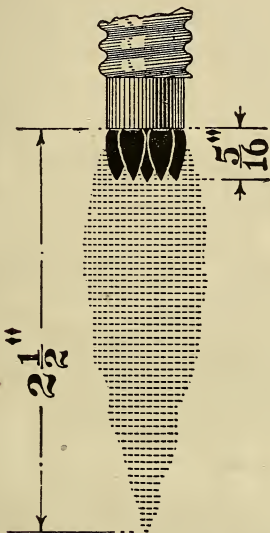

FIG. 56. SHOWING PROPER FLAME.

The proper flame from the burner is shown in Figure 56. This flame has seven short light blue cones surrounded by a very light gaseous flame.

To light the lamps: If the main cock is closed it should be opened full, then the lamp cock should be opened, and the flame of a match or taper held just

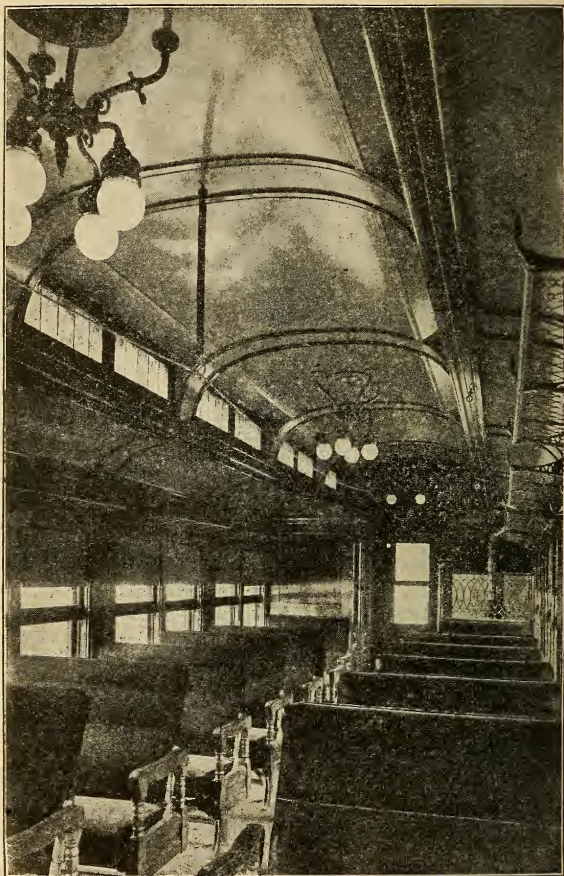

FIG. 57. INVERTED BURNER LAMPS IN PASSENGER COACH.

at the bottom opening of each small globe, the flame only being allowed to extend into the globe.

To extinguish lights: Simply turn off the gas at each gas cock.



FIG. 58. INVERTED BURNER LAMPS IN DINING CAR.

Care of mantles: When a burner becomes defective it is indicated by an inferior light. In which case a new bulb should be substituted. To do this the light should be extinguished and when cool enough the glass bulb and its holder should be removed. Care should be taken

to see that the holder unscrews with the bulb. Then light all flames and if any are found to be defective, there is probably some obstruction in the gas supply. In which case, it should be reported at the terminal, as should all other matters in connection with the lighting apparatus needing attention. When a new bulb is substituted it should be screwed slowly on the lamp with the flame burning.

Two styles of lamps in which inverted mantles are used in connection with Pintsch gas are shown in Figures 57 and 58, one illustrating the lighting of a passenger coach, and the other a dining car.

INSTRUCTIONS TO FOREMEN AND INSPECTORS FOR THE USE OF PINTSCH GAS EQUIPMENT AT TERMINAL POINTS.

When a gas car arrives at a terminal, the lamps should be thoroughly cleaned and carefully looked over, and if any parts are found to be defective, repairs must be made promptly. After testing, and replacing all defects, close cock at each lamp separately, then close main cock in gent's toilet room, using gas key furnished for that purpose.

See Trainmen's Rule posted in toilet room in regard to turning off lamps first, then shut off main cock. Also that mantle lamps must be turned on full, or turned off entirely.

Lampmen and Inspectors must report immediately if a car is found with lamps turned on and main cock turned off in toilet room, and report made to Car Foreman or Master Car Builder.

The small pipes under the car connecting the tanks, regulator, and filling valves are made of $\frac{1}{4}$ in. extra heavy iron pipe with brass flanges soldered on to connect the pipes together. A small lead washer is used between the faces of the flanges to make a tight joint, slot headed bolts used to draw the flanges together.

Should a leak be discovered in these flanges, the leak may be stopped by tightening the slot headed bolts in the brass flanges with a screw driver. If leak does not then stop, remove old and apply new washer.

Should it become necessary to disconnect these pipes to re-solder a joint or to replace a washer, the gas will have to be shut off at tank valves. This must be done by removing cap from tank valve which will expose stem of tank valve, turn these stems to the right until valves are closed, using same kind of brass key as in toilet room.

After these connections are repaired, turn on the gas at tank valves, replace valve caps and see that all joints are tight.

Never use a light to locate leaks. Depend on the sense of smell or use soap suds applied with a brush.

If a filling valve should be found to be leaking it may be stopped by being turned down tighter by brass key from toilet room. These valves are left hand, to shut them off turn them to the left.

Should a filling valve leak so badly that it cannot be repaired the gas must be turned off at the tanks, and the Foreman notified.

INSTRUCTIONS TO TRAINMEN FOR THE CARE OF PINTSCH
GAS CAR EQUIPMENT.

Read instructions to trainmen in regard to lighting lamps and emergency outfit which is posted in toilet rooms.

Before the gas is turned on at the main cock in the toilet room see that all lamps in the main part of the car and the bracket lamps in the passageways and toilet rooms are turned off. After the gas has been turned on at the main cock in the toilet room all lamps may be lighted.

Should one of the lamps be leaky or defective, turn it off and report it at the next terminal point to the Car Foreman, or the man in charge of the lamps.

Should lights fail when there is gas in the tanks, thaw out the gas regulator under the car with steam or hot water.

Should a leak be discovered in any part of the car the gas *must* be shut off at once at the main cock in the toilet room.

Should a leak occur in the filling valve under the car or in the connections between the gas tanks, the gas must be turned off at both tanks. To do this, take brass key from toilet room, using large socket to unscrew caps of tank valves. After these have been removed, the stems of the tank valves will be exposed, then use the small socket of the key to shut off valves turning them to the right.

Torches or lamps of any kind must not be used while working around the connections and tanks under the car, and any employe looking for a leak with a light will be discharged.

In turning off the light turn off each lamp separately. After that is done turn off the gas at the main cock in the toilet room.

Should the odor of gas be detected in any part of the car, report it promptly to the Car Foreman, Inspector, or man in charge of lamps, at the next terminal point.

Trainmen must use discretion in regard to using the light during their respective runs. In first class and second class coaches where there are four or five centre lamps in the body of the car it will be sufficient to have two lamps burning after 11 p. m. The balance should be shut off entirely. In sleeping cars lamps should be turned out in the main body of the car, as per general instructions.

After 12 o'clock midnight the lamps in sleeping car smoking rooms should also be turned out.

GOLD'S IMPROVED SYSTEM OF ACETYLENE CAR LIGHTING.

The gas generator may be either inclosed in a locker, toilet room, or any other convenient part of a car or may be put in one corner of a car without being enclosed in any way. Its appearance is neat, the absence of moving parts or complicated valves makes it possible to place it in any desired position in a car. All the charging and cleaning is done from the outside of the car, as the only inside connections are permanent ones. The charging and cleaning is done by car men and is only done at terminals. The gas is made by the generators only as needed and the apparatus needs no attention from trainmen, beyond the lighting and putting out of lamps. The amount of carbide a generator will hold is enough for several nights, and recharging may be done at any point to which carbide can be shipped, thus no charging plants are necessary. It is claimed by the makers that a burner will last for years without renewal, thus there is no occasion for continual renewal of burner parts as in the mantle system.

Figure 59 shows the interior of a second class coach with gas generator installed. The cylindrical generator passing through the car from floor to roof; the water tank over the door, the condenser in the corner of the clear deck, gas outlet pipe from the generator to the bottom of the condenser and gas pipe coming out the side of the condenser. A cut-out cock is shown on the

gas pipe to the condenser for cutting off the generator at terminal when being charged.

A charge of 140 pounds of carbide is put into the generator from the roof of the car. The water tank holding sufficient supply of water has an extension up through the roof where water is also supplied from

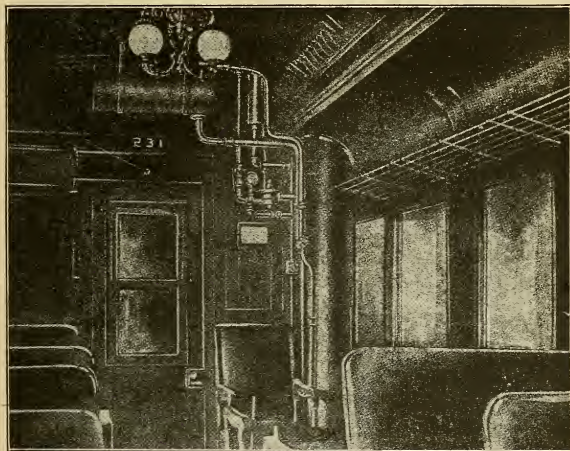

FIG. 59. INTERIOR OF COACH, WITH GAS GENERATOR INSTALLED.

without. An outlet is provided beneath the floor of the car for cleaning out the residue at the end of long runs, or after four or five nights' heavy service, as cars equipped with these generators are in transcontinental service as well as running on remote branch lines. When the car equipped with this generator leaves the terminal,

train crews and porters light or turn off the gas the same as one does at his city residence; the generator supplying the gas according to the consumption. All attendance to the generator is done by the car men while the cars are in the yards being cleaned.

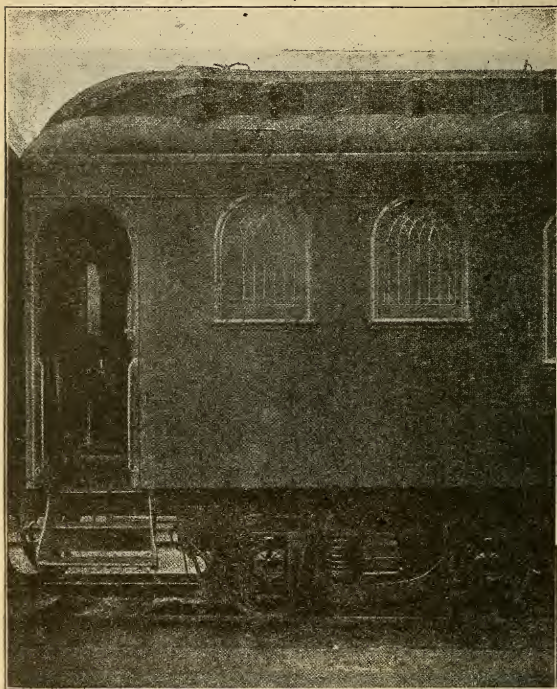

FIG. 60. TOP OF GENERATOR PROJECTING THROUGH ROOF OF SLEEPING CAR.

Figure 60 shows a view of a compartment sleeping car, the top of the generator, it will be noticed, is projecting through the roof. This generator applied to a coach is shown in Figure 61. The simplicity of the generator is plainly indicated with its carbide chamber at the top extended downward about three feet and terminating in a grating to form the bottom of this receptacle. The bottom being filled with water and connecting with the overhead supply tank which raises the water up to the grate where it comes in contact with the carbide generating gas as it does so, and at the same time slacking the carbide, allowing the residue to drop down to the bottom of the generator. This forms a slight pressure above the water, causing it to recede until the gas is sufficiently drawn off in using, thus automatically regulating the making of gas according to the consumption.

Other accompanying apparatus is used, but such as does not in any way complicate the installation as a whole. A condenser, storage reservoir and regulator to insure pure dry gas at a steady pressure, giving the soft white light characteristic of this gas.

In the event of accidents there is no escape of highly compressed gas to be contended with. The generator is provided with a safety valve which would not allow building up any high pressure under any emergency, and the system which causes the water to recede when a pressure is built up which exceeds the weight of the column of water due to the height of the water supply perfectly controls the ordinary pressure of gas in the system.

Cars equipped with the Pintsch gas system can be

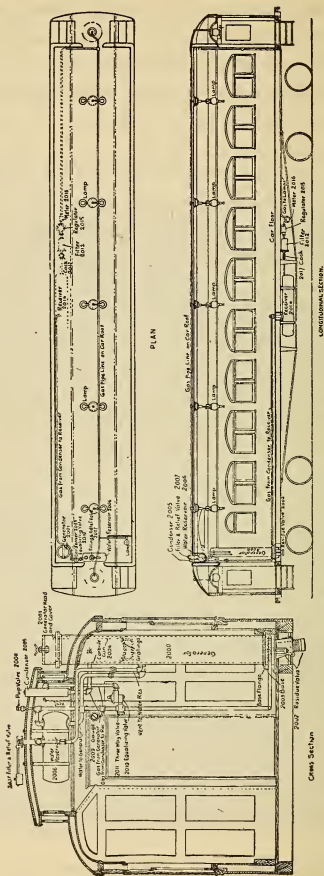

FIG. 61. GENERATOR APPLIED TO A COACH—SECTIONAL VIEW.

converted to this system when desired, the same lamps being changed over to suit, or new ones of special design substituted.

THE SAFETY STORAGE SYSTEM OF ACETYLENE LIGHTING FOR RAILWAY CARS.

This system of lighting is similar to other gas storage systems, in that it consists of a cylindrical tank charged with gas; in connection with which are a pressure regulating valve and pressure gauge, all of which are placed under the car.



FIG. 62. SAFETY STORAGE TANK BROKEN TO SHOW THE ASBESTOS DISCS.

The tanks used in the Commercial Acetylene Company's patented safety storage system contain no free gas. They are packed with asbestos discs, as shown in Figure 62, before the ends are brazed in. This asbestos is then saturated with acetone (a species of wood alcohol) which, at ten atmospheres, or 150 pounds pressure, absorbs twenty-five times its own volume of the gas at a normal temperature, thereby increasing the storage capacity of the tank ten-fold. The regular railway cylinder is a trifle smaller than those used in other gas storage systems, measuring 114" in length by 20" in diameter; at a charging pressure of 150 pounds it will contain 2,000 cubic feet of gas.

Though the tremendous storage capacity is realized, what it really means is better understood when the high candle power of the gas is appreciated. For instance, one cubic foot yields 50 candle power. Thus a tank of 2,000 cubic feet equals 100,000 candle power; enough to light a car for several transcontinental trips.

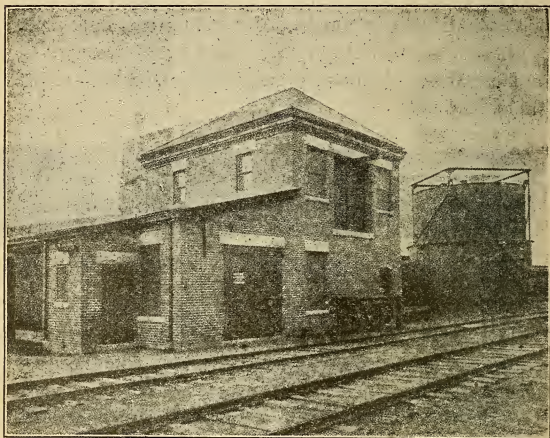

FIG. 63. CHARGING PLANT OF THE N. Y., N. H. & H. R. R., PROVIDENCE, R. I., SHOWING 5,000 CU. FT. HOLDER.

The generating and compressing plant consists of a two-story building for the generating, with a one-story addition for the compressing room, with room for motor on side, and a shed containing the storage cylinders in back. (See Figures 63, 64, 65, 66 and 67.)

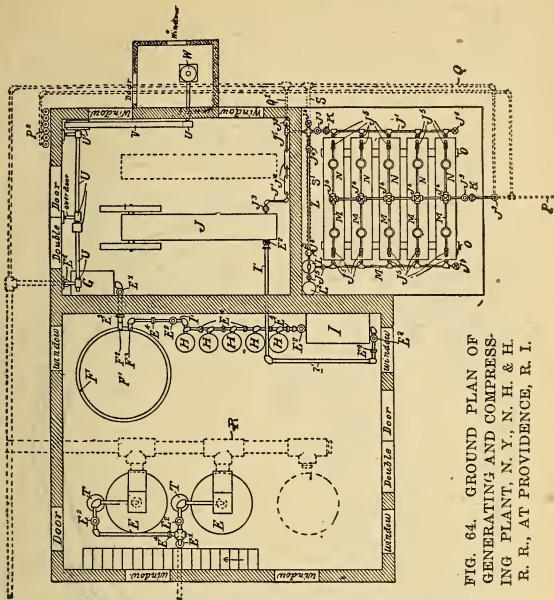
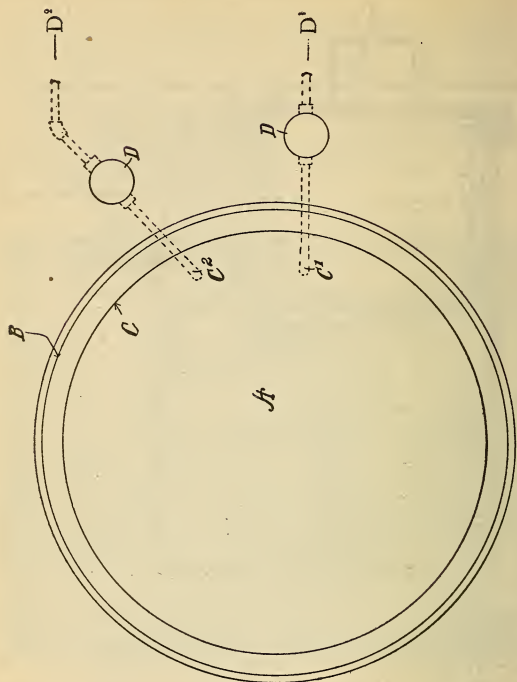

FIG. 64. GROUND PLAN OF GENERATING AND COMPRESSING PLANT, N. Y., N. H. & H. R. R., AT PROVIDENCE, R. I.

E—Generators.
 E1—4" Gate Valves.
 E2—3" Gate Valves.
 E3—4" Flanged Unions.
 E4—3" Flanged Unions.
 F—Cushion Holder Tank.
 F1—Bell of Cushion Holder.
 F2—4" Inlet to Cushion Holder.
 F3—3" Outlet from Cushion Holder.
 G—Meter.
 H—Dryer Cylinders.
 I—Scrubber.
 I1—3" Main to Compressor.
 J—Compressor.
 J1— $\frac{3}{4}$ " H. P. Line to Storage Cylinders.
 J2—Oil Separators.
 J3— $\frac{3}{4}$ " H. P. Globe Valves.
 J4— $\frac{1}{4}$ " H. P. Globe Valves.
 J5— $\frac{1}{4}$ " H. P. Globe Valves.
 J6— $\frac{3}{4}$ " Pop Valves.
 K—Filter Cases.

L— $\frac{1}{2}$ " H. P. Line to Acetone Cylinder.
 L1—Acetone Cylinder.
 L2—Acetone Filler.
 M— $\frac{1}{4}$ " Special Steel Pipe.
 N—Storage Cylinders.
 O—Saddles for Storage Cylinders.
 P—Yard Line.
 P1—Yard Line Valves.
 P2—Nest of Valves for Charging Cylinders on Flat Cars.
 Q— $\frac{3}{4}$ " Pipe to Release Gas in Yard Line Back to Holder.
 Q1— $\frac{3}{4}$ " Pipe to Release Gas in Compressor Back to Holder.
 R—12" Connection to Sewer.
 S— $\frac{3}{4}$ " Pipe to Release Acetone Cylinder Back to Holder.
 T—Water Seal Blow-Off.
 U—Shafting, Hangers and Pulleys.
 V—Belt.
 W—Motor.



Ground Plan of Gas Holder.
 FIG. 65. GENERATING AND COMPRESSING PLANT, N. Y., N. H. & H. R. R., AT
 PROVIDENCE, R. I.

A—Gas Holder.
 B—Tank of Gas Holder.
 C—Bell of Gas Holder.
 C1—Inlet to Gas Holder.

C2—Outlet from Gas Holder.
 D—Drip Pots.
 D1—4" Main to Holder.
 D2—4" Return Main.

These plans in detail apply to all charging plants built for this system of lighting, the various sizes varying, of course, according to the capacity of the plant

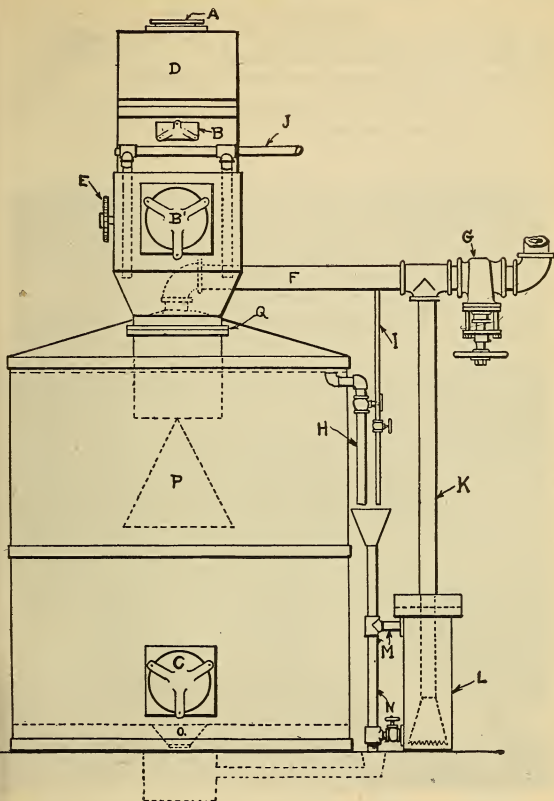

FIG. 66. GENERAL ACETYLENE GENERATOR.

SEE PAGE 160 FOR EXPLANATION.

EXPLANATION OF FIG. 66.

- A—Hand Hole through which Hopper is filled with Carbide.
 B—Hand Hole for cleaning Feed Drum.
 C—Hand Hole giving access to Generating Chamber.
 D—Carbide Hopper.
 E—Ratchet Wheel operating Feed Drum.
 F—Gas Main from Generator.
 G—Gate Valve.
 H—Over Flow Pipe.
 I—Vent Pipe.
 J—Water Supply Pipe.
 K—Blow Off Pipe.
 L—Blow Off Seal.
 M—Blow Off Seal Overflow.
 N—Drain Pipe.
 O—Drain Valve.
 P—Carbide Deflector.
 Q—Flange Joint connecting Hopper with Generating Chamber.

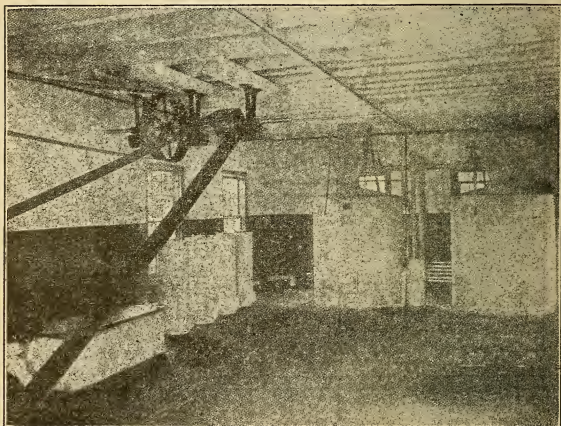

FIG. 67. GENERATING AND COMPRESSING PLANT OF THE
 D., L. & W. R. R. AT HOBOKEN, N. J.

South end of first floor, showing: two General Acetylene Generators with Carbide Chamber or Hopper passing up through ceiling to second floor, 4 Driers, 1 Scrubber.

The hoppers, or carbide chambers, of the generators run up through the ceiling of generating room, and the carbide is fed into same from the second floor, which is also used for storage of carbide.

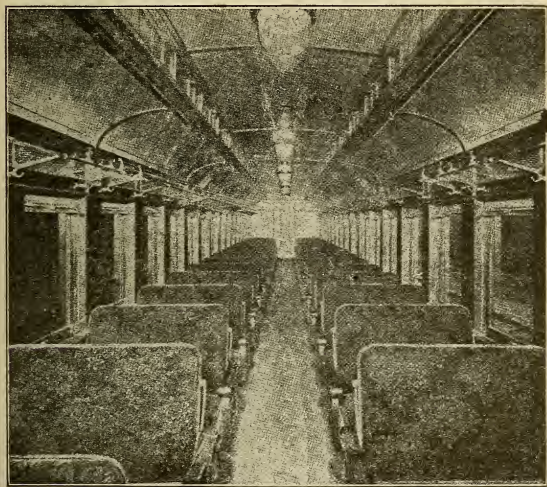

FIG. 68. N. Y. C. & H. R. R. DAY COACH EQUIPPED WITH THE SAFETY STORAGE SYSTEM. -
(Converted Pintsch Lamps.)

Where meter is not desired, the cushion bell, F' , can be dispensed with, as its use is only to equalize the flow through meter and protect it from the drag of the compressor's intake.

This system of lighting is shown in a series of illustrations showing the interiors of a day coach and a mail car, and also a café car. The exterior of a standard coach is shown likewise to indicate the storage tank, etc. See Figures 68, 69, 70 and 71.

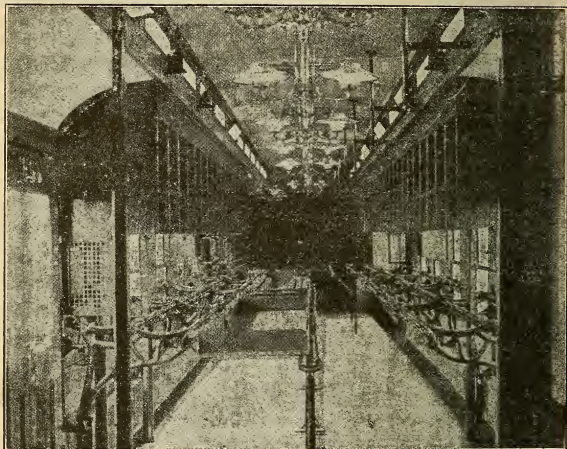

FIG. 69. ERIE MAIL CAR 699

Built by Standard Steel Car Co., Equipped with the Safety Storage System. Finest Lighted Car in the World.

Sections of cars showing the equipment, and also the names of parts are illustrated in Figure 72.



FIG. 70. D., L. & W. CAFE CAR 781.
Equipped with the Safety Storage System.

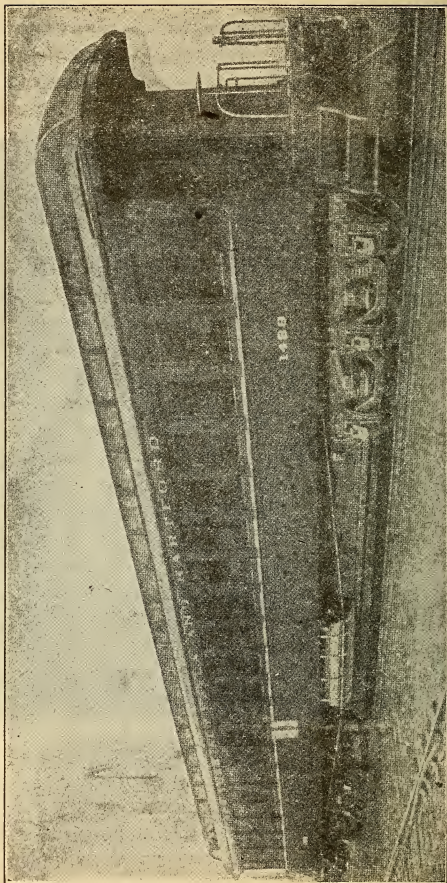

FIG. 71. N. Y., N. H. & H. CAR EQUIPPED WITH THE SAFETY STORAGE SYSTEM.

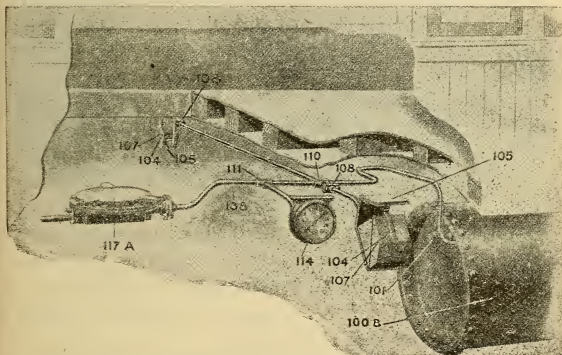
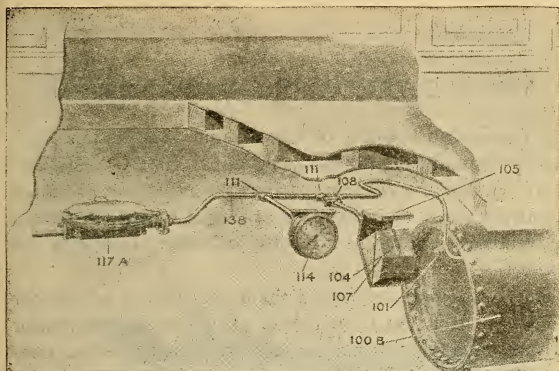

FIG. 72. SECTIONS OF CARS SHOWING EQUIPMENT.

101—Stud Valve.

104—Filling Valve.

105—Filling Valve Bracket.

107—Filling Valve Cover.

108— $\frac{1}{4}$ " Flange Union—(H.P.)

110— $\frac{1}{4}$ " Steel Cross.

111— $\frac{1}{4}$ " Steel Tee.

114—Gauge for Car.

117—A Regulating Valve.

138— $\frac{1}{4}$ " Extra Strong Pipe.

THE ELECTRIC CAR LIGHTING SYSTEM.

The electric lighting of cars by the Bliss system consists essentially of the following apparatus:—

1. A dynamo electric machine or generator, mounted upon the truck frame and so arranged that its armature is rotated by means of a mechanical connection with the axle.

2. A regulator mounted upon the bottom of the car body, the function of which is to control the generator output, and to maintain constant the lamp voltage, irrespective of the speed of the car or the number of lamps in use.

3. An automatic switch, mounted inside the car, the function of which is to control the connection of the generator with the rest of the system.

In addition to these three elementary devices, an electrically lighted car must be equipped with: *First*, a suitable storage battery, and *Second*, the usual wiring, fixtures, lamps, circuit switches, etc., as may be necessary.

The apparatus consists of the three essential elements above mentioned, namely, generator, regulator and automatic switch, together with certain minor auxiliary parts, the function of which is of a protective nature, or which promote convenience in installation.

GENERATOR.—The generator in operation is essentially similar to a stationary generator used for ordinary lighting work.

REGULATOR OR "BUCKER."—In any car lighting system employing a variable speed generator, it is necessary to

provide regulation in two circuits: *First*, the generator field circuit to prevent undue increase in voltage as the speed increases, and *Second*, between the battery terminals and the lamp mains, to prevent the full charging voltage of the battery being impressed on the lamps. In the ordinary system, this regulation is obtained more or less effectually by means of automatically operated rheostats. In the Bliss System, the automatic rheostat with the attendant mechanical

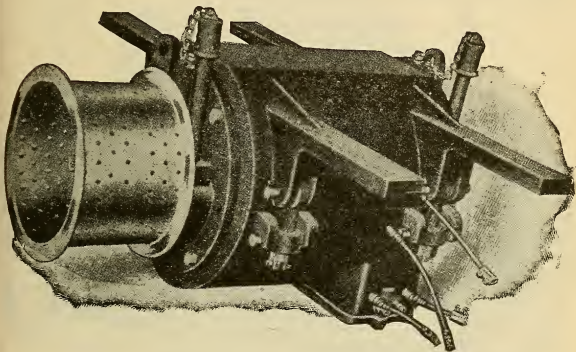

FIG. 73. GENERATOR SHOWING PERFORATED PULLEY AND SUPPORTING ARMS.

complications, is eliminated, and regulation is obtained by opposing the flow of the current by means of counter voltage, which varies with the operating conditions. This counter voltage may be said to "buck" the current which tends to flow through the generator field circuit, and also from the battery terminals to the lamps, and in conse-

quence of this action, the regulator has come to be generally termed the "Bucker."

Mechanically considered, it consists of two armatures of sufficient size to permit rugged construction, both mounted on a single shaft, and enclosed within a single casing. One of these armatures, with its corresponding field, forms a simple shunt motor, and the other armature constitutes the regulating device and is provided with two windings and two commutators, one connected in the generator field circuit, and the other between the battery terminals and the lamps.

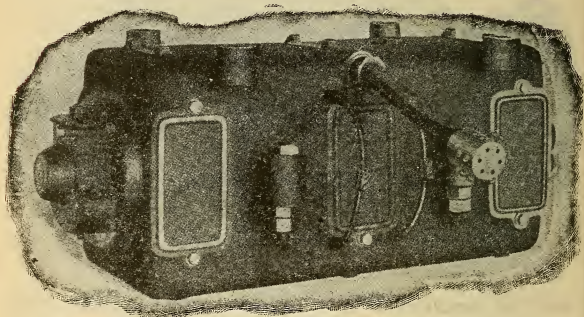

FIG. 74. SIDE VIEW OF BUCKER SHOWING COUPLER HEAD.

The required counter voltages are generated automatically in these two windings, one providing the necessary regulation for the generator field as the speed increases, and the other increasing as the charging voltage of the battery increases, thus keeping the lamp voltage constant.

AUTOMATIC SWITCH.—The connection between the generator and the rest of the system is controlled by means of an automatic device called the “generator switch.” It is simply a solenoid composed of two coils, one the lifting or closing coil, the other the releasing or opening coil. These coils act upon a plunger, which is drawn up by the lifting coil. When so drawn up, a metal brush attached to the plunger connects two termi-

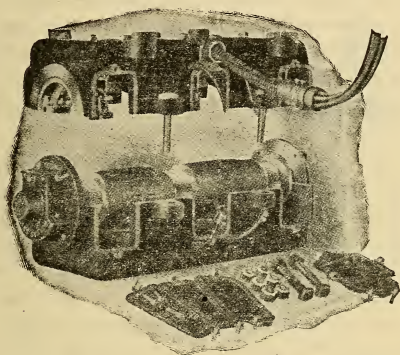

FIG. 75. BUCKER WITH LOWER FRAME REMOVED SHOWING ARMATURE IN LOWER FRAME.

nals thus connecting the generator to the battery. The solenoid switch closes the connection between the main wires when the generator has attained an operating speed and opens automatically when the generator drops below the operating speed.

STORAGE BATTERY.—In general, two groupings of storage battery have been standardized for railroad work,

i. e., 16 cells with operating voltage of 30 to 32, and 32 cells with operating voltage of 60 to 64. Where only single car lighting is considered, it is probable that neither system presents any marked advantage over the other, and decision has been based on individual operating conditions.

The 16-cell equipment reduces the number of connections in the battery, and also tends to reduce the cost of inspection and maintenance, on account of the smaller number of battery units. The 32-cell system, on the contrary, entails more apparent complication and inspection, but in the minds of many this is compensated for by the reduction in wiring cost, and the assurance of more perfect operation, due to the smaller currents to be handled.

Where any extended system of train lighting, as distinguished from car lighting, is considered, the 32-cell system has been almost universally adopted, and the 16-cell system has been set aside on account of the enormously increased copper section necessary to carry the current, and the difficulty of providing sufficient contact surface in connectors. In consequence, where an extended system of lighting is considered, the decision should be in favor of the higher voltage and increased number of cells, even on single car lighting apparatus, in order that the equipment may be interchange-throughout, so far as is possible.

WIRING, FIXTURES AND LAMPS.—Car wiring and fixtures may be as ornate and elaborate or as plain and simple as taste or expediency may dictate. Lamp practice, however, has become fairly standardized. Both 30 and 60-volt lamps are procurable in 6, 8, 10, 12 and 16 C. P. sizes, the 8 C. P. lamp being the one most universally

used. The 30-volt lamp, in general, has the advantage that its filament is short, of greater cross-section, and consequently less affected by vibration. The 60-volt lamp, on the contrary is generally cheaper, easier to procure and is considered less special than the 30-volt by the lamp manufacturers.

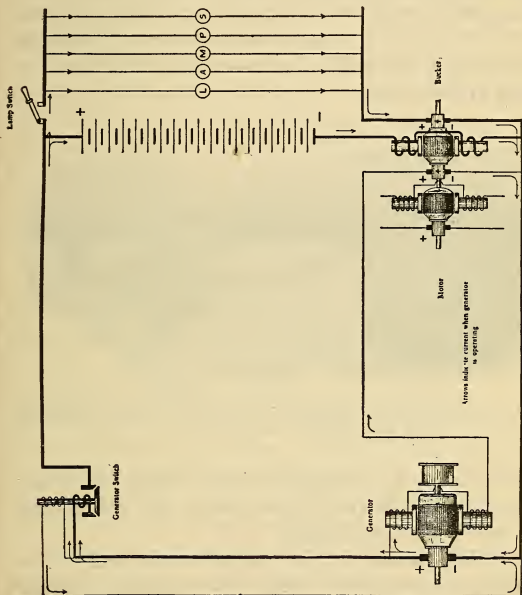

Partial Theoretical Wiring Diagram.
FIG. 76. PARTIAL THEORETICAL WIRING DIAGRAM.

Under normal conditions, the Bliss single car equipment has a capacity of 2,200 watts in the lamp circuit, in addition to the current which simultaneously charges

the batteries, thus providing lighting for from 70 to 75 eight C. P. lamps, this being the maximum which is ordinarily installed. As pointed out later the maximum output capacity of the generator is in excess of this figure.

GENERAL OPERATION.—As the car accelerates, the generator develops an increasing voltage, sending current through the various circuits connected with it, and starting the motor armature of the buckler. When the car reaches the operating speed, the generator will develop normal lamp voltage and the motor and buckler will be running at full speed.

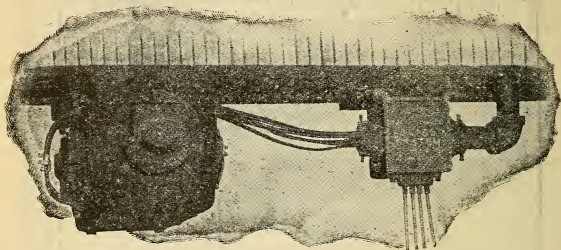

FIG. 77. RELATIVE POSITION OF BUCKER AND JUNCTION BOX ON BOTTOM OF CAR BODY.

At this point, the automatic switch closes, connecting the generator to the rest of the system, and the feeding of current to the lamps begins.

On further increase of speed, which would tend to correspondingly increase the voltage, the opposing influence of the buckler in the field circuit comes into play, weakening the field as the speed increases, and keeping the output of the generator within the predetermined limits. At the same time the opposing effect of the buckler in the

lamp circuit takes effect, and prevents the lamp voltage from rising co-incident with the speed and voltage of the generator as the car increases in speed. The apparatus is so adjusted that even at train speeds of 75 miles per hour or higher, the output of the generator is confined within safe limits by the field buckler winding, and the lamp voltage is maintained constant at its normal value through the action of the lamp buckler winding, thus meeting all operating conditions.

In addition, the lamp voltage will remain constant, irrespective of the number of lamps in use, since the "bucking" effect is the same irrespective of the current which may flow against it. This is not true in rheostatic regulation, in which the amount of resistance must be varied, not only as the battery voltage changes, but as the number of lamps may be altered.

ARRANGEMENT OF CIRCUITS.—By reference to the wiring diagram shown, it will be seen that the current flowing from the positive terminal of the generator passes through the automatic switch, and then divides, a certain portion of it passing through whatever lamps may be in use, the other portion passing through the storage battery in a charging direction, and also through the field winding of the buckler. Again, the current which has passed through the lamps, and that which has flowed through the battery and the field coil of the buckler unite and return to the negative terminal of the generator.

It will be noted that the current for exciting the field magnet of the generator flows from the positive terminal of the same through the generator shunt field, and thence through the brushes of the commutator on one side of the buckler armature. It will further be noted that the current which has passed through the lamps is caused to

flow through the other set of brushes, and the other commutator of the buckler armature. The two commutators referred to are each connected to an independent winding, wound on the same core. These windings are totally distinct, and insulated from one another, the one in the circuit of the generator field being composed of a large number of turns of comparatively fine wire, while that in the lamp circuit is composed of a small number of comparatively heavy turns. On the same shaft with this armature is another armature provided with the usual field magnet, which forms the shunt motor which has already been referred to. The connections of the shunt motor are obvious and have been omitted in the diagram for the sake of clearness.

The field coil which acts upon the buckler armature is connected so that the current which flows through the battery must pass through it, and the buckler armature being in rotation at constant speed, it is obvious that an increase in the current flow through the battery, due to increase in generator voltage, will increase the counter voltage generated by the field buckler, thus tending to weaken the generator field and reduce the increased current flow to the battery. Simultaneously, the counter voltage of the lamp buckler will be increased, thus compensating for the rise of voltage on the battery terminals and maintaining constant voltage on the lamp mains.

Essentially considered, these operations constitute the regulation provided by the Bliss System, *and maintain predetermined operating conditions in the battery and lamp circuits, irrespective of the speed of the car.* In this connection, it should be noted that the regulating effects do not take place by steps, as in the case of rheostatic regulation, but are regular and infinitesimally small changes.

BATTERY CURRENT REGULATION.—The connection of the buckler field coil in the battery circuit serves an important function, on which depends the satisfactory performance of the apparatus on the road. It insures that, irrespective of the lamp load, the battery shall always receive a practically constant and predetermined charge, and the batteries are thus always charged, provided the car is run sufficiently to make up the losses at terminals. No current is taken from the batteries when running at average speed, irrespective of what the lamp load may be.

“Total current regulation,” on the contrary, which is the method ordinarily employed in other systems, and which inherently regulates to keep the generator output at a predetermined amount, must involve the disadvantage that the charging current is variable and uncertain. With no lamps in circuit, the charging current may be equal to the total output capacity of the generator. With all lamps lighted, the charge is not only reduced, but may even be turned into a discharge, the batteries helping the generator to carry the load. As it is impracticable to control the extent to which lights may be used on the road, and as the tendency is always to use them more than freely, it is obvious that during a considerable portion of the running time, the battery in a system employing “total current regulation” may be discharging instead of charging, as is absolutely essential to good service.

In any system employing “total current regulation” certain disadvantageous conditions result, which are inherent and cannot be avoided. The battery is charged at uncertain rates at uncertain intervals, resulting in an indeterminate condition of charge, and also total uncertainty as to battery condition at any time. This makes

necessary terminal charging, which, aside from being in itself objectionable, is usually carried on under disadvantageous conditions, resulting in largely increased battery deterioration. "Battery current regulation," as employed exclusively in the Bliss System, insures charging at predetermined times and at predetermined minimum rates, thus providing that the battery is at all times fully charged. Terminal charging is eliminated, and the battery being always charged at the lowest consistent rate, deterioration is reduced to a minimum.

CAR GENERATOR—TYPE C.

Outside Suspension.

Straight Line Belt Tension—Split Frame.

Type C Generator is a truck mounted, belt driven machine supported on what is commonly known as an outside suspension. The latter consists of two $3\frac{1}{2}$ "x1"

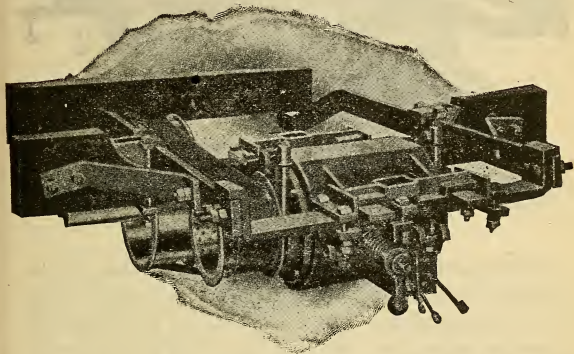

FIG. 78. CAR GENERATOR SHOWING OUTSIDE SUSPENSION, PULLEY END.

wrought iron suspension bars, which hook under the transom and pass over the end sill and are secured upon the latter by wrought iron or open hearth steel clamps. The details of this fastening may differ with different types of truck, but the same general plan is applicable to all M. C. B. trucks. The suspension bars extend beyond

the end sill about 30", and across their outer ends is bolted a 4"x1" wrought iron cross bar, which is laid flat and bent downward between the suspension bars, so that its upper surface is level with and equal in width to the top of the end sill. The frame is additionally stiffened laterally by means of two diagonal wrought iron braces, bolted to the end sill and suspension bars.

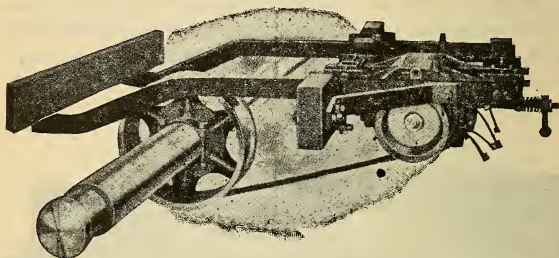

FIG. 79. SIDE VIEW OF GENERATOR SHOWING ARMATURE PULLEY, AXLE PULLEY, BELT AND TENSION MECHANISM.

ARRANGEMENT OF GENERATOR.—The frame of the generator consists of cylindrical open hearth steel casting, divided longitudinally into an upper and lower portion. Upon the upper are cast four longitudinally projecting arms or lugs, under each of which is placed a roller bearing and plate. The generator supported by these four lugs, is placed upon the end sill and cross bar, and is thus *suspended outside*, and clear of the truck. The armature shaft of the generator is set parallel with the car axle. Similar open hearth steel guides are clamped upon the end sill and cross bar, respectively, and secure the arms or lugs of the generator frame against lateral

and vertical displacement, although three inches of longitudinal movement of the generator upon the suspension frame is provided to allow for adjusting the tension of the driving belt. The guide upon the end sill is secured by means of bolts and wrought iron clamps, it being unnecessary to bore any holes through the end sill.

BELT TENSION MECHANISM.—The guide upon the cross bar is interchangeable with the guide on the end sill, and is secured by bolts and clamps, one of which is an open hearth steel casting and forms, in addition, a bracket for the belt tension rod, and a seat for the belt tension spring. The tension rod is attached to the generator frame by means of a clevis and pin, passes through a hole in the tension bracket, and then through the tension spring. The tension on the latter is adjusted by means of the tension nut, which consists of an iron casting, forming a spring seat and nut, and a weighted handle, which prevents the nut from turning by vibration, and renders the use of a wrench and locking device unnecessary. The roller bearings under the supporting arms reduce the belt tension to a minimum.

PULLEYS AND BELTS.—In standard equipment, the generator is provided with a flanged pulley, 10" diameter and $6\frac{1}{4}$ " face, crowned slightly, and accurately balanced. This pulley is fitted and keyed to the tapered armature shaft, and is interchangeable with the $8" \times 6\frac{1}{4}"$ pulley and the fibre and steel pinions used on Forms 1 and 2 generator.

The axle pulley is likewise flanged, 21" or 23" diameter, 7" face and is flat. It is split and provided with a split bushing which is bored to fit the taper of the axle, and is clamped thereon by means of $\frac{3}{4}"$ bolts. Any form of belt may be used, but should not be more than

5" wide, and in thickness no lighter than the equivalent of four-ply rubber. One belt of proper dimensions with suitable fastenings is provided with each generator.

The alignment of the belt can be adjusted by loosening the guide and clamps on the cross bar and shifting the two outboard arms of the generator to one side or the other and then reclamping.

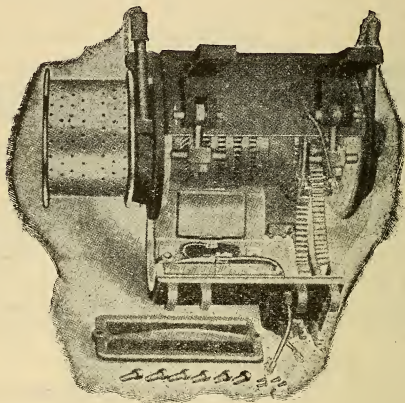

FIG. 80. SIDE VIEW OF GENERATOR SHOWING LOWER FRAME SWUNG DOWN, EXPOSING INTERNAL PARTS, ARMATURE REMAINING IN UPPER FRAME.

ADVANTAGES OF BLISS SUSPENSION.—The advantages of this form of suspension over all others are:

I. The generator being supported entirely by the upper portion, the lower portion is left free and clear for inspection and repairs; the lower half of the field frame, armature, bearings, pulleys and all other parts can be removed without disturbing the supporting framework.

2. The adjustment of the belt tension is effected by means of a direct longitudinal movement of the generator, which is the universal practice with all stationary belt driven generators and motors, the roller bearings practically eliminating all sliding friction. The generator not being pivoted is not tipped or otherwise drawn out of its proper position in making wide adjustments of the belt tension.

3. The entire generator may be removed from the truck by removing the guides on the end sill and cross bar and unbolting the cross bar from the suspension bars.

4. The iron work is of the simplest possible design. There are no welds, and the amount of boring or other work on the truck frame is reduced to a minimum. One man and helper familiar with the work can install generator on truck in four hours.

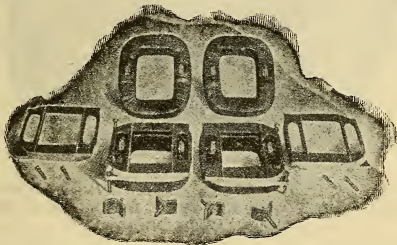

FIG. 81. GENERATOR FIELD COILS AND RETAINERS.

FIELD FRAME, MAGNETS AND BEARINGS.—All four forms of car generator are identical so far as the armature, field magnets and brush mechanism are concerned and these parts are all interchangeable. The generator proper is of the iron clad type, having four internal radial

salient poles. The poles are placed at an angle of 45° with the horizontal, two poles being in the upper, and two in the lower half of the generator, which is divided longitudinally in a horizontal plane. The casing, which forms the yoke of the fields, is extended parallel with the axis of the shaft and is then turned in at right angles, thus forming ends which are bored out and have fitted into them round head-like castings which hold the armature shaft bearings and oil wells. This construction was originated by the Bliss Company. When these heads are

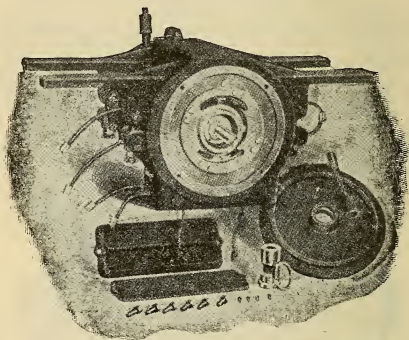

FIG. 82. END VIEW OF GENERATOR, SHOWING BEARING HEAD AND HAND HOLE COVER REMOVED, EXPOSING AUTOMATIC BRUSH MECHANISM.

in place, the generator is almost hermetically sealed, and is absolutely dust and water proof. A suitable hand-hole is provided in the generator casing for purposes of inspection, etc.

The two heads which carry the armature bearings are each held in place by four bolts, two of which are tapped

into each half of the generator casing. By this construction, the lower half of the generator may be removed, leaving the armature in the upper half, or the armature may be removed with the lower half. The heads being nicely fitted to the casing, insure perfect alignment of the armature shaft, no steady pins or other truing devices being required.

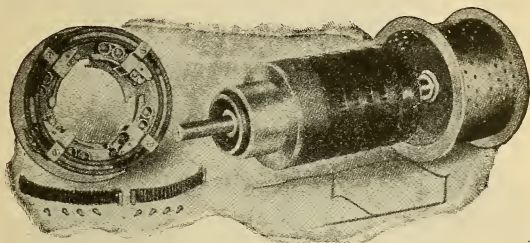

FIG. 83. COMPLETE GENERATOR ARMATURE AND PULLEY, AUTOMATIC BRUSH MECHANISM AND ARMATURE COIL.

By removing the head casting at the commutator end of the generator, and detaching the flexible cables from their respective brush-holders, the entire brush mechanism, as well as the armature, may be removed without disturbing any of the other parts.

ARMATURE.—The armature is of the four-pole drum type, having a two-circuit singly re-entrant drum winding of the straight-out, or barrel type. The coils are wound on formers and afterward placed on the core, thus providing a perfectly balanced winding, both electrically and mechanically.

The armature coils are assembled on the armature in the usual manner and specially banded. With this con-

struction, it is possible to remove a single damaged coil by simply lifting out one-quarter of the coils, when the damaged coil can be replaced by a new one. While this feature is extremely valuable in facilitating repairs, and has been adopted for this reason, we have no record of the burn-out of a generator armature.

SPIDER AND REMOVABLE SHAFT.—The core of the armature consists of the usual annular stampings, slotted to receive the coils, and mounted on a ventilated spider.

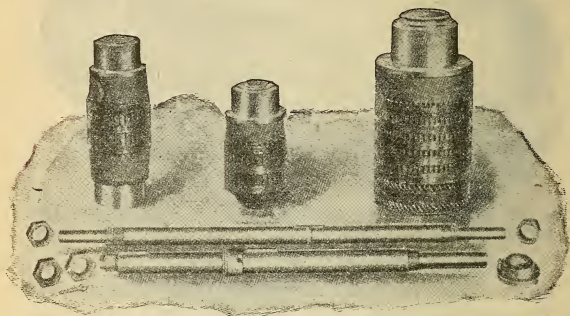

FIG. 84. ARMATURE SHAFTS AND NUTS OF GENERATOR AND BUCKER, SHOWING SPIDER AND REMOVABLE SHAFT CONSTRUCTION.

The central portion of the spider forms a sleeve which is extended at one end to support the commutator. The sleeve is bored to take the armature shaft, which is suitably keyed and otherwise secured. This construction is unusual in work of this capacity, and is only found in car lighting apparatus of our manufacture, and although entailing greater expense in construction, has been

adopted on account of its value from an operating standpoint.

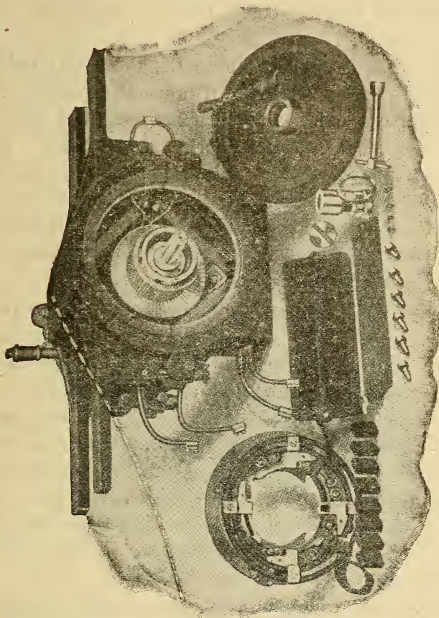

FIG. 85. END VIEW OF GENERATOR SHOWING BEARING HEAD AND HAND HOLE COVER REMOVED, EXPOSING ARMATURE, COMMUTATOR, BRUSH MECHANISM AND FIELD COILS.

This arrangement permits the armature and commutator to be quickly taken off the shaft without disturbing the windings, thus affording a ready means for making repairs, either to the shaft or to the armature itself.

JOURNALS AND LUBRICATION.—The armature shaft is extremely large for a machine of this capacity, and is manufactured from a fine grade of high carbon steel. The journals are unusually ample in their proportions, the commutator end bearing being $1\frac{1}{4}'' \times 4''$, the pinion end bearing $1\frac{1}{2}'' \times 4\frac{1}{2}''$.

The lubrication is entirely automatic, and is effected by oil rings operating in oil wells of unusual capacity. All the running parts are heavily proportioned and are designed to resist the heaviest shocks and stresses. The generator is connected as a plain shunt wound machine and is self-exciting. Hence, there is but a single winding on the field, each pole being excited by a single coil, which is held in place by a special clamping device of extremely heavy construction.

BRUSHES.—The armature winding, being of the two-circuit type, requires but a single pair of brushes to take the current from the commutator, but, for purposes hereinafter explained, two pairs of brushes are employed.

CAPACITY AND RATING.—The generator is nominally rated at 4 kilowatts, 80 volts and 50 amperes or 40 volts and 100 amperes, this being its normal *continuous* safe load. The 50 ampere generator, however, has been successfully operated at 90 amperes for five hours without undue rise in temperature. Few cars can possibly utilize such a large output to advantage.

BRUSH MECHANISM AND AUTOMATIC POLE CHANGER.—The polarity of the terminals of the generator is preserved in the following manner: The brush-holders are mounted on a carrier, which is supported on anti-friction bearings, which enable it to rotate freely within the casing of the generator. The friction between the brushes and the commutator is sufficient to cause the brushes,

and with them the carrier, to be dragged around as the commutator revolves. The angular motion of the carrier is arrested by means of a removable stop.

When the armature revolves in a right-hand direction, the brushes and carrier are rotated to the right and arrested by the stop in the correct position for commutation, and vice versa. It is obvious that the rotation of the armature having been reversed, and also the position of the brushes, the actual polarity of the generator terminals is preserved. It will be apparent that the angular

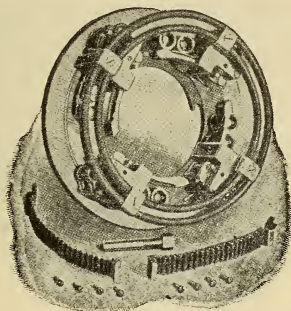

FIG. 86. AUTOMATIC BRUSH MECHANISM AND FLEXIBLE CABLES.

motion of the brush carrier need be but 90° in a four-pole generator. The motion however is made a few degrees greater than a quadrant, thus providing a certain lead which aids commutation. Lead is impossible with any other type of pole changer.

A single pair of brushes would suffice to take the current from the commutator, but by using four brushes, or

two pairs, a short commutator is possible, a more symmetrical disposition of the brushes is secured, and adequate contact between the brushes and the commutator is obtained, without undue pressure on a single brush. The brushes of similar polarity are connected together in the usual manner, while flexible cables, readily detachable, convey the current from the brushes to the stationary terminals of the generator.

The preservation of the polarity of the brushes is thus secured mechanically, and without resort to contacts, switch-blades or other devices, which break or interfere with the continuity of the circuit. The friction between the brushes and the commutator cannot be avoided, and in the Bliss System is utilized to advantage.

The stop which arrests the motion of the carrier is removable, in order that, for inspection purposes and the renewal of brushes, the carrier may be turned completely around, and all the brushes and holders brought opposite the hand-hole in the generator casing.

BUCKER— TYPE B.

Provided with Coupler.

The bucker is the distinctive feature of the Bliss System, and was devised for both regulating an axle generator and maintaining constant lamp voltage in connection with a generator and storage battery. It is a separate auxiliary and self-contained machine, which is bolted to the bottom of the car in any convenient place. This machine contains a revolving shaft, on which are mounted two armature cores. One of these armatures, with its commutator and field, constitutes a plain shunt motor which takes its power from the generator mains, and

whose sole function is to rotate the shaft. It is obvious that this motor runs only when the generator is in operation.

The other armature has two windings and two commutators, and revolves in a field excited by the current flowing through the battery. This doublewound armature, with its two commutators and field, constitutes the "bucker" proper. The motor simply drives it. The

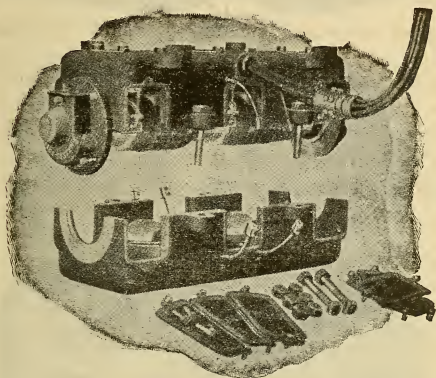

FIG. 87. BUCKER WITH LOWER FRAME REMOVED SHOWING ARMATURE IN UPPER FRAME.

winding connected in the lamp circuit is called the "lamp bucker," and the winding connected in the field circuit of the generator the "field bucker." The field of the bucker is referred to as the "series field;" that of the motor as the "motor field."

As will be seen, by referring to illustrations, the bucker is entirely enclosed and hence is dust and water proof. It

is impossible for anyone to tamper with it, and it contains no delicate or complicated parts.

ARMATURES.—The motor and bucker armatures are drum-wound for bipolar fields. They are built up of slotted annular punchings, and mounted, together with



FIG. 88. COMPLETE BUCKER ARMATURE AND SHAFT.

their commutators, on a sleeve which is fitted and keyed to the shaft. The construction is very similar to, and possesses all the advantages of that employed in the generator armature previously described. There is no pulley or external mechanical connection on this machine.

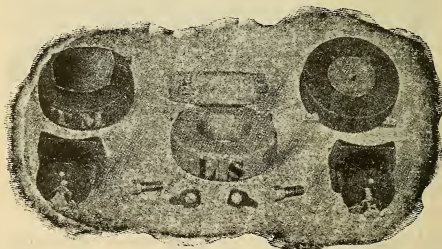

FIG. 89. BUCKER FIELD COILS AND POLE PIECES.

FIELD MAGNETS.—The field is of the bipolar, iron clad type. Each armature core revolves between two salient pole pieces, which are bolted into the casing, and consist of a pole shoe and core. Upon each core is placed a heav-

ily taped and painted coil. The pole pieces are placed in a vertical line, so that one pole and coil for each armature core is in the upper, and one in the lower part of the machine.

BRUSH HOLDERS.—The brush holders are mounted rigidly in the upper half of the machine. The springs and fingers are interchangeable with those of the generator. In taking off the bottom half of the casing, or in removing the armature, no wire connections need be disturbed beyond disconnecting the upper and lower field leads.

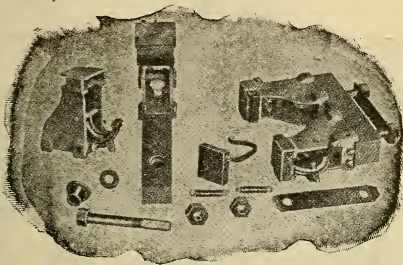

FIG. 90. BUCKER BRUSH HOLDERS AND DETAILS.

BEARINGS.—The head castings, containing the armature shaft bearings, are secured to the casing by four bolts, thus permitting the lowering of the bottom half of the casing with or without the armature. The illustration shows the armature entirely removed, together with the head castings and armature shaft bearings. The separate parts of this machine are light enough to be easily handled, no jacks or lifting devices being necessary. By referring to the cuts, it will be seen that large hand hole covers are provided over each brush holder, thus affording, by their removal, easy access to all internal parts.

TERMINALS AND CONNECTIONS.—The wiring of the bucker is entirely inside the casing. All of the leads (six in number) are brought out through a single opening provided with proper outlet bushing. These leads terminate in a coupler head carrying six terminal sockets, each provided with two binding screws. A corresponding

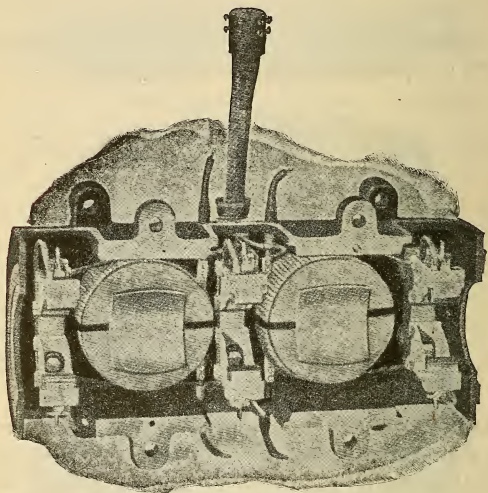

FIG. 91. INTERIOR VIEW OF BUCKER SHOWING CONSTRUCTION OF UPPER FRAME, BRUSH HOLDERS AND WIRING.

coupler block is furnished with each bucker, in which the six leads of the car wiring are secured. Ferrules are provided, which are soldered over the ends of the car wires, after the insulation has been removed, and the wires threaded through the coupler block. One of the ferrules is larger in diameter than the others, as is also

the hole in the corresponding terminal socket, thus providing a registering device which automatically insures the correct connection of the buckler to the car wires. The advantages of this construction are simplicity in installation, elimination of mutilated wire ends, and certainty of correct connections.

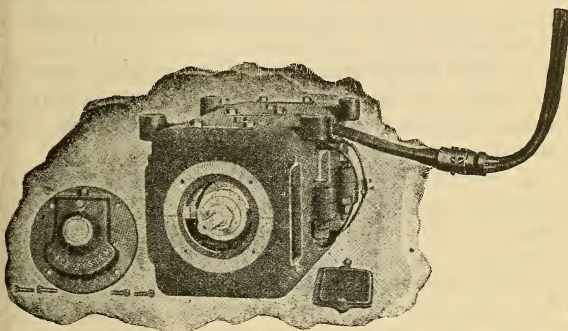

FIG. 92. END VIEW OF BUCKER SHOWING COMPLETE COUPLER HEAD AND BLOCK AND METHOD OF CONNECTING CAR WIRES. BEARING HEAD AND HAND HOLE COVER REMOVED EXPOSING MOTOR COMMUTATOR.

OPERATION OF THE BUCKER.—It is obvious that when no current flows through the battery, none flows through the series field, since they are in series with one another, and hence no electro-motive-force is generated in the buckler; but when current flows through this series field, electro-motive-forces are generated in the buckler, and in almost exact proportion to the strength of the field. (After the closing of the automatic generator switch, the motor runs at almost constant speed, its slight acceleration as the generator voltage rises from normal lamp

voltage to maximum being an advantage, as it compensates for the drooping curve of magnetization in the series field.)

No current will flow through the series field under the following conditions :

1. When the generator is inoperative, automatic generator switch open, and no lamps lighted; for example, car standing still in day-time.

2. When the generator is operative, automatic generator switch closed, no lamps lighted and the generator voltage equal to the battery voltage; for example, running at cutting-in speed in day-time.

3. When the generator is operative, automatic generator switch closed, lamps lighted, and generator just carrying the lamp load, batteries neither charging nor discharging.

Under these three conditions, no regulation of generator or lamps is necessary.

Only one condition obtains when regulation is necessary, and that is:

4. When the generator speed and voltage have risen and the battery is being charged; for example, running above operating speed, day or night. Then the voltage at the lamps tends to rise, and it must be kept constant, whether the lamps are lighted or not.

CONSTANT LAMP VOLTAGE.—The voltage at the terminals of the battery rises approximately in proportion to the current forced through them. The magnetism of the series field increases in proportion to this current. The counter voltages of the buckler increase in proportion to its field magnetism. Hence, the counter voltages of the buckler increase in proportion to the rise of electro-motive-force at the battery terminals. The lamp buckler,

which is in the lamp circuit, will, therefore, produce a counter voltage always equal to the excess electro-motive-force necessary to impress on the batteries to charge them. The result will be a constant lamp voltage, independent of the number of lamps in use, or the speed of the train, since the latter now affects the charging current only.

REGULATION OF THE GENERATOR.—The field buckler is connected inversely in series with the field of the generator, and generates a counter voltage which weakens the field of the latter to such a degree that the voltage of the generator is just sufficient at the maximum train speed to force the maximum predetermined current through the battery and series field. The regulation tends to maintain constant current through the battery and series field at a given train speed. The lamp load is carried by the generator precisely as in the case of a constant potential machine and does not affect the charging current flowing through the battery.

ECONOMY OF THE BUCKER.—Since the buckler receives or absorbs energy from the lamp circuit and the field circuit of the generator, such energy is transformed into mechanical power and tends to revolve the shaft and thus relieve the motor of that work. In fact, when the apparatus is fully loaded, the motor becomes a generator and puts back into the system about 60% of the energy consumed by the buckler in effecting regulation.

GENERATOR SWITCH.—It is necessary to provide an automatic switch which will complete the circuit between the generator and the storage battery whenever the speed of the former and consequently its voltage, is equal to or greater than that of the battery. On the other hand, this switch must likewise break that circuit whenever the

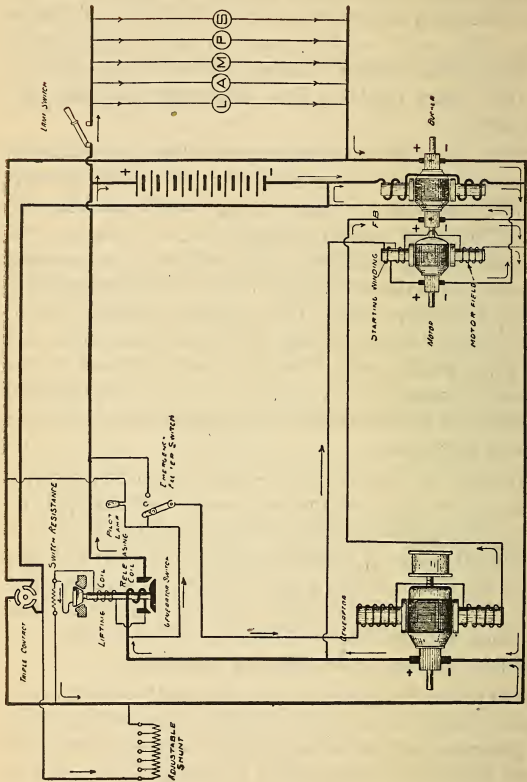

Complete Theoretical Wiring Diagram
 FIG. 93. COMPLETE THEORETICAL WIRING DIAGRAM

voltage of the generator is less than that of the storage battery, by virtue of a reduced or zero speed. The automatic generator switch opens and closes the circuit between the generator and the storage battery electrically, and is closed directly by the generator voltage.

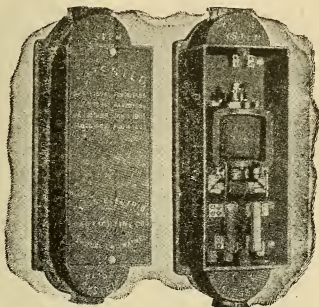

FIG. 94. GENERATOR SWITCH IN SINGLE SECTION IRON BOX.

CONSTRUCTION.—The generator switch consists of a rectangular iron frame, which forms the magnetic circuit of a solenoid and supports the insulated contacts. Within the frame are two concentric coils, constituting the solenoid. They are made entirely separate, to facilitate construction and repairs, and are held in place by a central tube. The inside, or lifting coil, is wound with fine wire, and is connected across the terminals of the generator. The outside, or releasing coil, is edgewise wound out of copper bar, and connected in series with the generator and storage battery. Within the central tube, and free to work in a vertical direction, is a soft iron plunger, attached to and insulated from a laminated metal brush.

OPERATION.—When the generator develops normal lamp voltage the switch will close, as the fine wire, or lifting coil, raises the plunger and causes the metal brush to make connection between the two metallic contacts. As the speed and generator voltage increase, current will flow through the contacts, brush and releasing coil, and through the battery, the releasing coil being wound in such a direction that this current aids the lifting coil in holding up the plunger and brush, maintaining a better contact for increasing current.

When, however, the voltage of the generator becomes less than that of the battery, current will flow from the battery in a reverse direction, through the releasing coil and generator, and oppose the action of the lifting coil. The weight of the plunger and brush is then sufficient to cause the opening of the switch by gravity. No springs are used to secure the adjustment, which is made by varying the length of the air-gap, and when once made is permanent. Renewable carbon contacts, on which the final break takes place, protect the metallic parts against injury by arcing.

TRIPLE CONTACT.—Upon the top of the iron frame of the automatic generator switch is mounted a triple contact, consisting of a three-part segmental socket and a conical plug fitting the same. The function of the triple contact is to short-circuit the lamp buckler and series field, thus avoiding the drop that would otherwise take place in the lamp circuit when the battery was discharging, and to render the buckler inoperative below operating speeds, when the generator switch is open.

The plug is raised and lowered by means of a tail-rod attached to the plunger of the switch. When the plunger is down and the generator switch open, the plug con-

nects the three segments together. When the plunger and plug are raised by the lifting coil, the triple contact is broken. The plug is insulated from the tail-rod and a flexible conductor permanently connects the plug with an insulated terminal, mounted on a tarsite base.

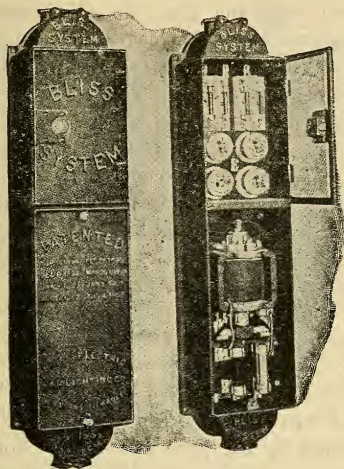

FIG. 95. GENERATOR SWITCH WITH FOUR-CIRCUIT PANEL BOARD IN DOUBLE SECTION IRON BOX.

One lead of a resistance coil is connected to this insulated terminal, and the other lead is connected to the rear segment of the triple contact. The negative lead of the generator is also connected to this segment. The leads of the lifting coil are connected, respectively, to the positive main contact, and the terminal to which the flexible conductor is attached. Thus it will be seen that when

the plug establishes the triple contact it also short-circuits the resistance coil. When the plug is raised, it throws the resistance into series with the lifting coil.

Two advantages result from inserting resistance into the lifting coil circuit: First, to reduce the current and consequent heating in the coil, which would otherwise change its resistance and alter the adjustment of the switch; second, to reduce the magnetizing effect of the coil, so that less discharge current will be required in the releasing coil to open the switch, as above explained.

FUSE DECK.—The generator switch is mounted on a tarsite base and enclosed in an iron box provided at top and bottom with suitable conduit fittings. On the lower part of the base is mounted the fuse deck, which supports all the positive terminals, the negative terminals being on the base below and back of the fuse deck. As the name implies, the fuse deck also carries the fuses for the generator and battery. By the removal of these fuses, and the insertion of a special ammeter connection, readings of current can be quickly and easily made without the use of tools and the attendant danger of short circuit.

ADJUSTABLE SHUNT.—In order to adjust the charging current delivered by the generator to the storage battery, an adjustable shunt is provided which consists of a number of steps of resistance enclosed in a small cast iron case which is mounted inside the car and as near the switch box as convenient. This shunt is connected across the terminals of the series field of the buckler and serves to divert a certain portion of the charging current from said field. A number of binding posts are provided on the shunt so that its resistance may be varied, which is done by shifting one connecting wire from post to post until the proper adjustment has been secured and then

the wire is made permanently fast. This shunt acts exactly like the shunt on the series field of a compound generator. It affords a simple and easy method of adjustment and by its use the charging current can be varied about 100%.

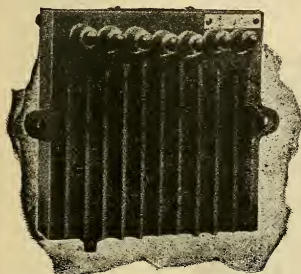

FIG. 96. ADJUSTABLE SHUNT.

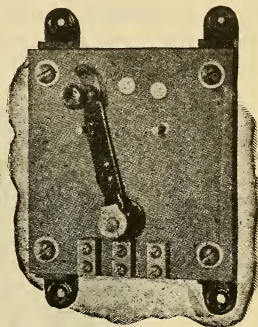

FIG. 97. EMERGENCY EXCITER SWITCH.

EMERGENCY EXCITER SWITCH.—This switch consisting of a spring actuated lever turning upon two contact buttons, provides a quick and certain method of exciting the field of the generator directly from the storage battery in case of loss of residual magnetism or any other cause preventing the generator from “picking up.” Ordinarily the field circuit is completed through this switch so that the generator is self-exciting, but by throwing the lever to the right, the field is connected directly to the battery, and of course excited. Upon letting go of the lever, the spring restores the original connection. This switch may be shifted while the apparatus is at rest or in motion and its manipulation will not affect the apparatus in the slightest.

JUNCTION BOX.—To facilitate and simplify the wiring of the apparatus, a cast iron junction box has been provided, into which all the wires from the different pieces of apparatus are led. This box is secured to the bottom of the car body in any convenient location, and if possible, should be installed about six inches from the edge of the car body, and as near the generator as proper clearance will permit.

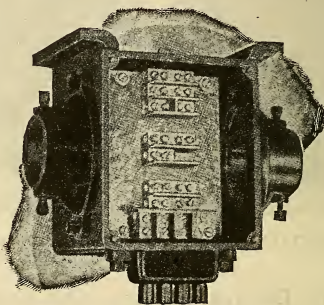

FIG. 98. FRONT VIEW JUNCTION BOX, WITH COVER REMOVED.

The two side openings are designed to receive two-inch iron pipe or conduit, which should be used for enclosing and protecting all of the wiring on the bottom of the car. On the underside of the junction box is a fitting, into which are fastened four insulating bushings for the reception of the four wires which lead to the generator. By properly securing these wires into the bushings, the fitting may be removed bodily from the bottom of the junction box, whenever it is necessary to remove the car truck. This renders it certain that the wires will be properly replaced when the generator is reconnected.

THE STANDARD CODE TRAIN RULES.

AMERICAN RAILWAY ASSOCIATION.

GENERAL RULES.

A. Employes whose duties are prescribed by these rules must provide themselves with a copy.

B. Employes must be conversant with and obey the rules and special instructions. If in doubt as to their meaning they must apply to proper authority for an explanation.

C. Employes must pass the required examinations.

D. Persons employed in any service on trains are subject to the rules and special instructions.

E. Employes must render every assistance in their power in carrying out the rules and special instructions.

F. Any violation of the rules or special instructions must be reported.

G. The use of intoxicants by employes while on duty is prohibited. Their use, or the frequenting of places where they are sold, is sufficient cause for dismissal.

H. The use of tobacco by employes when on duty in or about passenger stations, or on passenger cars is prohibited.

J. Employes on duty must wear the prescribed badge and uniform and be neat in appearance.

K. Persons authorized to transact business at stations or on trains must be orderly and avoid annoyance to patrons.

L. In case of danger to the Company's property, employes must unite to protect it.

DEFINITIONS.

Engine—A locomotive propelled by any form of energy.

Train—An engine, or more than one engine coupled, with or without cars, displaying Markers.

Regular Train—A train authorized by a time-table schedule.

Section—One of two or more trains running on the same schedule displaying signals, or for which signals are displayed.

Extra Train—A train not authorized by a time-table schedule. It may be designated as:

Extra—For any extra train, except work extra.

Work Extra—For work train extra.

Superior Train—A train having precedence over other trains.

Train of Superior Right—A train given precedence by train order.

Train of Superior Class—A train given precedence by the timetable.

Train of Superior Direction—A train given precedence in the direction specified in the time-table as between trains of the same class.

Note—Superiority by direction is limited to single track.

Time-table—The authority for the movement of regular trains subject to the rules. It contains the classified schedules of trains with special instructions relating thereto.

Schedule—That part of a time-table which prescribes class, direction, number and movement for a regular train.

Division—That portion of a railway assigned to the supervision of a ———.

Subdivision—A part of a division so designated on the timetable.

Main Track—A track extending through the yards and between stations, upon which the current of traffic may be in either specified direction.

Single Track—A track upon which trains are operated in both directions.

Double Track—Two main tracks, upon one of which the current traffic is in a specified direction, and upon the other in the opposite direction.

Current of Traffic—The movement of trains on a main track in one direction, specified by the rules.

Station—A place designated on the time-table by name, at which a train may stop for traffic, or to enter or leave the main track, or from which fixed signals are operated.

Siding—An auxiliary track for meeting or passing trains, limited to the distance between two adjoining telegraph stations.

Fixed Signals—A signal of fixed location indicating a condition affecting the movement of a train.

Note to Definition of Fixed Signals—This definition covers such signals as slow boards, stop boards, yard limits, switch, train order, block, interlocking, semaphore, disc, ball or other means for indicating stop, caution or proceed.

Yard—A system of tracks within defined limits provided for the making up of trains, storing of cars and other purposes, over which movements not authorized

by time-table, or by train orders, may be made, subject to prescribed signals and regulations.

Yard Engine—An engine assigned to yard service and working within yard limits.

Pilot—A person assigned to a train when the engineer or conductor or both are not fully acquainted with the physical character or running rules of the road, or portion of the road, over which the train is to be moved.

RULES FOR SINGLE TRACK.

STANDARD TIME.

1. Standard Time obtained from ——— observatory will be telegraphed to all points from designated offices at ———, ———m. daily.

NOTE to Rule 1.—In order to detect possible errors at junction points and to secure uniformity, the Committee recommends that the time be disseminated to all points at the same hour. The Committee considers it of great importance that the time be obtained from some observatory of recognized standing.

2. Watches that have been examined and certified to by a designated inspector must be used by the conductor, enginemen and —*. The certificate in prescribed form must be renewed and filed with ——— every ———.

*The committee recommends that in filling the blank each company add such other classes of employes as it may desire.

(Form of Certificate.)

CERTIFICATE OF WATCH INSPECTOR.

This is to certify that on 19....
 the watch of
 employed as on the

 was examined by me. It is correct and reliable, and in
 my judgment will, with proper care, run within a varia-
 tion of thirty seconds per week.

Name of maker

Brand

Number of Movement.....

Open or Hunting Case.....

Metal of Case.....

Stem or Key Winding.....

Signed,

Inspector.

Address

3. Watches of conductors, enginemen and ——*
 must be compared, before starting on each trip, with a
 clock designated as a Standard Clock. The time when
 watches are compared must be registered on a prescribed
 form.

NOTE to Rule 3.—The conditions under which con-
 ductors and enginemen whose duties preclude access to
 a standard clock are required to obtain standard time,
 vary so much on different roads that the Committee
 recommends that each adopt such regulations to cover
 the case supplementary to this rule, as may best suit its
 own requirements.

TIME-TABLES.

4. Each timetable, from the moment it takes effect, supersedes the preceding timetable, and its schedules take effect on any division (or subdivision) at the leaving time at their initial stations on such division (or subdivision). But when a schedule of the preceding timetable corresponds in number, class, day of leaving, direction, and initial and terminal stations, with a schedule of the new timetable, a train authorized by the preceding timetable will retain train orders and assume the schedule of the corresponding number of the new timetable.

Schedules on each division (or subdivision) date from their initial stations on such divisions (or subdivisions).

5. Not more than two times are given for a train at any station; where one is given, it is unless otherwise indicated the leaving time; where two, they are the arriving and leaving time.

Unless otherwise indicated, the time applies to the switch where an inferior train enters the siding; where there is no siding, it applies to the place from which fixed signals are operated; where there is neither siding nor fixed signal, it applies to the place where traffic is received or discharged.

Schedule meeting or passing points are indicated by figures in full-faced type.

Both the arriving and leaving time of a train are in full-faced type when both are meeting or passing times, or when one or more trains are to meet or pass it between those times.

When trains are to be met or passed at a siding extending between two adjoining stations, the time at each end of the siding shall be shown in full-faced type.

Where there are one or more trains to meet or pass a train between two times, or more than one train to meet a train at any station, attention is called to it by —.

NOTE to Rule 5.—The Committee recommends that each company adopt such method as it may prefer in filling the blank.

6. The following signs when placed before the figures of the schedule, indicate:

“s”—Regular stop.

“f”—Flag stop to receive or discharge passengers or freight.

—Stop for meals.

“L.”—Leave.

“A.”—Arrive.

SIGNAL RULES.

7. Employes whose duties may require them to give signals must provide themselves with the proper appliances, keep them in good order and ready for immediate use.

8. Flags of the prescribed color must be used by day, and lamps of the prescribed color by night.

9. Night signals are to be displayed from sunset to sunrise. When weather or other conditions obscure day signals, night signals must be used in addition.

VISIBLE SIGNALS.

10. COLOR SIGNALS.

(a) *Color, Red.*—*Indication.*—Stop.

(b) —.—Proceed, and for other uses prescribed by the rules.

(c) —.—Proceed with caution, and for other uses prescribed by the rules.

(d) Green and white.—Flag stop. See Rule 28.

(e) Blue.—See Rule 26.

NOTE to Rule 10.—The Committee has omitted giving the colors of signals “b” and “c” in Rule 10, leaving it discretionary with each road to use such colors as it may prefer.

11. A fusee on or near the track, burning red, must not be passed until burned out. When burning green it is a caution signal.

12. HAND, FLAG, AND LAMP SIGNALS.

(a) *Manner of Using*, Swung across the track.—*Indication*.—Stop.

(b) Raised and lowered vertically.—Proceed.

(c) Swung vertically in a circle at half-arm’s length across the track when the train is standing.—Indication, “Back.”

(d) Swung vertically in a circle at arm’s length across the track, when train is running.—Train has parted.

(e) Swung horizontally above the head when the train is standing—“Apply air-brakes.”

(f) Held at arm’s length above the head, when train is standing—Release air-brakes.

13. Any object waved violently by anyone on or near the track is a signal to stop.

AUDIBLE SIGNALS.

14. Engine Whistle Signals.

Note.—The signals prescribed are illustrated by “o” for short sounds; “—” for longer sounds. The sound

of the whistle should be distinct, with intensity and duration proportionate to the distance signal is to be conveyed.

(a) o.....Stop. Apply brakes.
 (b) — — — —....Release brakes.
 (c) — — ooo.....Flagman go back and protect rear of train.

(d) — — — —....Flagman return from west or south.

(e) — — — — —..Flagman return from east or north.

(f) — — — — —. When running, train parted; to be repeated until answered by signal prescribed by Rule 12 (d). Answer to 12 (d).

(g) oo.....Answer to any signal not otherwise provided for.

(H.) ooo....When train is standing back. Answer to 12 (c) and 16 (c). When train is running, Answer to 16 (d).

(j) oooo.....Call for signals.

(K.) —oo....To call the attention of yard engines, extra trains or trains of the same or inferior class or inferior right of signals, displayed for a following section.

(l) — — — — o o..Approaching public crossings at grade.

(m) — — — — —.....Approaching stations, junctions and railroad crossings at grade.

A succession of short sounds of the whistle is an alarm for persons or cattle on the track.

15. The explosion of one torpedo is a signal to stop; the explosion of two not more than 200 feet apart is a signal to reduce speed, and look out for a stop signal.

16. AIR WHISTLE OR BELL CORD SIGNALS.

Sound.

Indication.

- (a) Two.....When train is standing, start.
- (b) Two.....When train is running, stop at once.
- (c) Three.....When train is standing, back the train.
- (d) Three.....When train is running, stop at next station.
- (e) Four.....When train is standing, apply or release air-brakes.
- (f) Four.....When train is running, reduce speed.
- (g) Five.....When train is standing, call in flagman.
- (h) Five.....When train is running, increase speed.

TRAIN SIGNALS.

17. The head-light will be displayed to the front of every train by night, but must be concealed when a train turns out to meet another and has stopped clear of main track, or is standing to meet trains at the end of double tracks or at junctions.

18. Yard engines will display the head-light to the front and rear by night. When not provided with a head-light at the rear, two white lights must be displayed. Yard engines will not display markers.

19. The following signals will be displayed one on each side of the rear of the train as markers, to indicate the rear of the train: By day, green flags. By night, green lights to the front and side, and red lights to the rear, except when the train is clear of the main track, when green lights must be displayed to the front, side and rear.

20. All sections, except the last, will display two green flags, and, in addition, two green lights by night, in the places provided for that purpose on the front of the engine.

21. Extra trains will display two white flags, and in addition, two white lights by night, in the places provided for that purpose on the front of the engine.

22. When two or more engines are coupled, the leading engine only shall display the signals as prescribed by Rules 20 and 21.

23. One flag or light displayed where in Rules 19, 20 and 21 two are prescribed, will indicate the same as two; but the proper display of all train signals is required.

24. When cars are pushed by an engine (except when shifting or making up trains in yards), a white light must be displayed on the front of the leading car by night.

25. Each car on a passenger train must be connected with the engine by a communicating signal appliance.

26. A blue flag by day and a blue light by night, displayed at one or both ends of an engine, car or train, indicates that workmen are under or about it. When thus protected it must not be coupled to or moved. Workmen will display the blue signals and the same workmen are alone authorized to remove them. Other cars must not be placed on the same track so as to intercept the view of the blue signals, without first notifying the workmen.

USE OF SIGNALS.

27. A signal imperfectly displayed, or the absence of a signal at a place where a signal is usually shown, must be regarded as a stop signal, and the fact reported to the —.

28. A combined green and white signal is to be used to stop a train only at the flag stations indicated on its schedule. When it is necessary to stop a train at a point that is not a flag station on its schedule, a red signal must be used.

29. When a signal (except a fixed signal) is given to stop a train, it must, unless otherwise provided, be acknowledged as prescribed by Rule 14 (g) or (h).

30. The engine-bell must be rung when an engine is about to move.

31. The engine-bell must be rung on approaching every public road crossing at grade, and until it is passed; and the whistle must be sounded at all whistling-posts.

32. The unnecessary use of either the whistle or the bell is prohibited. They will be used only as prescribed by rule or law, or to prevent accident.

33. Watchmen stationed at public road and street crossings must use red signals only when necessary to stop trains.

SUPERIORITY OF TRAINS.

71. A train is superior to another train by right, class, or direction.

Right is conferred by train order; class and direction by timetable.

Right is superior to class or direction.

Direction is superior as between trains of the same class.

72. Trains of the first class are superior to those of the second; trains of the second class are superior to those of the third; and so on.

Trains in the direction specified by the timetable are superior to trains of the same class in the opposite direction.

73. Extra trains are inferior to regular trains.

MOVEMENT OF TRAINS.

82. Timetable schedules, unless fulfilled, are in effect for 12 hours after their time at each station.

Regular trains 12 hours behind either their schedule arriving or leaving time at any station lose both right and schedule, and can thereafter proceed only as authorized by train order.

83. A train must not leave its initial station or any division (or sub-division), or a junction or pass from double to single track, until it has been ascertained whether all trains due, which are superior or of the same class, have arrived or left.

84. A train must not start until the proper signal is given.

85. When a train of one schedule is on the time of another schedule of the same class in the same direction, it will proceed on its own schedule.

Trains of one schedule may pass trains of another schedule of the same class, and extras may pass and run ahead of extras.

86. An inferior train must clear the time of a superior train in the same direction not less than five minutes, but must be clear at the time a first-class train, in the same direction, is due to leave the next station in the rear where time is shown.

87. An inferior train must keep out of the way of opposing superior trains, and failing to clear the main

track by the time required by rule, must be protected as prescribed by rule 99.

Extra trains must clear the time of regular trains — minutes unless otherwise provided, and will be governed by train orders with respect to opposing extra trains.

88. At a meeting point between trains of the same class the inferior train must clear the main track before the leaving time of the superior train.

At meeting points between extra trains, the train in the inferior timetable direction must take the siding, unless otherwise provided.

Trains must pull into the siding when practicable; if necessary to back in, the train must first be protected as prescribed by Rule 99, unless otherwise provided.

89. At meeting points between trains of different classes the inferior train must take the siding and clear the superior train at least five minutes and must pull into the siding when practicable. If necessary to back in, the train must first be protected as per Rule 99, unless otherwise provided.

NOTE to Rules 88 and 89.—The Committee recommends that where greater clearance is necessary, Rule 88 should require a clearance of FIVE minutes, and Rule No. 89 of TEN minutes.

90. Trains must stop at schedule meeting stations, if the train to be met is of the same class, unless the switch is right and the track clear. When the expected train of the same class is not found at the schedule meeting station, the superior train must approach all sidings prepared to stop, until the expected train is met.

Trains must stop clear of the switch used by the train to be met in going on the siding.

91. Unless some form of block signals is used trains

in the same direction must keep at least five minutes apart, except in closing up at stations.

NOTE to Rule 91.—The Committee recommends, that where greater clearance is necessary, Rule No. 91 should allow a clearance of TEN minutes or more.

92. A train must not arrive at a station in advance of its schedule arriving time.

A train must not leave a station in advance of its schedule leaving time.

93. Within yard limits the main track may be used, protecting against ——— class trains. ——— class and extra trains must move within yard limits, prepared to stop unless the main track is seen or known to be clear.

94. A train which overtakes another train so disabled that it cannot proceed, will pass it, if practicable, and if necessary will assume the schedule and take the train orders of the disabled train, proceed to the next open telegraph office, and there report to the ———. The disabled train will assume the schedule and take the train orders of the last train with which it has exchanged and will, when able, proceed to and report from the next open telegraph office.

When a train, unable to proceed against the right or schedule of an opposing train, is overtaken between the telegraph stations by an inferior train or a train of the same class having right or schedule which permits it to proceed, the delayed train may, after proper consultation with the following train, precede it to the next telegraph station, where it must report to ———. When opposing trains are met under these circumstances it must be fully explained to them by the leading train that the expected train is following.

95. Two or more sections may be run on the same schedule.

Each section has equal timetable authority.

A train must not display signals for a following section without order from the ———.

96. When signals displayed for a section are taken down at any point before that section arrives, the conductor will, if there be no other provision, arrange in writing with the operator, or if there be no operator, with the switchtender, or in the absence of both, with a flagman left there for the purpose, to notify all opposing inferior trains or trains of the same class leaving such point, that the section for which signals were displayed has not arrived.

NOTE to Rule 96.—The Committee recommends, if a company desires to have all opposing trains notified, that the last sentence of Rule 96 be changed to read: "To notify all opposing trains that the section for which signals were displayed has not arrived."

97. Extra trains must not be run without orders from the ———.

98. Trains must approach the end of double track, junctions, railroad crossings at grade, and drawbridges, prepared to stop, unless the switches and signals are right and the track is clear. When required by law, trains must stop.

99. When a train stops or is delayed, under circumstances in which it may be overtaken by another train, the flagman must go back immediately with stop signals a sufficient distance to insure full protection. When recalled he may return to his train, first placing two torpedoes on the rail when the conditions require it.

The front of a train must be protected in the same way, when necessary, by the ———.

100. When the flagman goes back to protect the rear of his train, the ——— must, in the case of passenger trains, and the next brakeman in the case of other trains, take his place on the train.

101. If a train should part while in motion, trainmen must, if possible, prevent damage to the detached portion. The signals prescribed by rules 12 (d) and 14 (f) must be given.

The detached portion must not be moved or passed until the front portion comes back.

102. When cars are pushed by an engine (except when shifting and making up trains in yards), a flagman must take a conspicuous position on the front of the leading car.

103. Messages or orders respecting the movement of trains or the condition of track or bridges must be in writing.

104. Switches must be left in proper position after having been used. Conductors are responsible for the position of the switches used by them and their trainmen, except where switchtenders are stationed.

A switch must not be left open for a following train unless in charge of a trainman of such train.

105. Both conductors and enginemen are responsible for the safety of their trains and, under conditions not provided for by the rules, must take every precaution for their protection.

106. In all cases of doubt or uncertainty the safe course must be taken and no risks run.

RULES FOR MOVEMENT BY TRAIN ORDERS.

201. For movements not provided for by timetable, train orders will be issued by authority of the ———. They must contain neither information nor instructions not essential to such movements.

They must be brief and clear; in the prescribed forms when applicable; and without erasure, alteration or interlineation.

202. Each train order must be given in the same words to all persons and trains addressed.

203. Train orders will be numbered consecutively each day, beginning with No. — at midnight.

204. Train orders must be addressed to those who are to execute them, naming the place at which each is to receive his copy. Those for a train must be addressed to the conductor and engineman, and also to any one who acts as its pilot. A copy for each person addressed must be supplied by the operator.

Orders addressed to operators restricting the movement of trains must be respected by conductors and enginemen the same as if addressed to them.

205. Each train order must be written in full in a book provided for the purpose at the office of the ———; and with it recorded the names of those who have signed for the order; the time and the signals which show when and from what offices the order was repeated and the responses transmitted; and the train dispatcher's initials. These records must be made at once, and never from memory or memoranda.

206. Regular trains will be designated in train orders by their numbers, as "No. 10." or "2d No. 10," adding engine numbers if desired.

Extra trains will be designated by engine numbers and the direction as "extra 798 'East' or 'West'." Other numbers and time will be stated in figures only.

207. To transmit a train order, the signal "31" or the signal "19" followed by the direction must be given to each office addressed, the number of copies being stated, if more or less than three—thus: "31 West copy 5," or "19 East copy 2."

NOTE to Rule 207.—Where forms "31" and "19" are not both in use the signal may be omitted.

208. (A.) A train order to be sent to two or more offices must be transmitted simultaneously to as many of them as practicable. The several addresses must be in order of superiority of trains, each office taking its proper address. When not sent simultaneously to all, the order must be sent first to the superior train.

208. (B.) A train order to be sent to two or more offices must be transmitted simultaneously to as many of them as practicable.

The several addresses must be in order of superiority of trains, and when practicable must include the operator at the meeting or waiting point, each office taking its proper address.

When not sent simultaneously to all, the order must be sent first to the superior train.

Copies of the order addressed to the operator at the meeting or waiting point must be delivered to all trains affected until all have arrived from one direction.

209. Operators receiving train orders must write them in manifold during transmission, and if they cannot at one writing make the requisite number of copies, must trace others from one of the copies first made.

NOTE to Rule 209.—If the typewriter is used for

copying train orders, when additional copies are made, the order must be repeated from such copies to the train dispatcher, and complete, given in the usual manner.

210. When a "31" train order has been transmitted, operators must (unless otherwise directed) repeat it at once from the manifold copy in the succession in which the several offices have been addressed, and then write the time of the repetition on the order. Each operator receiving the order should observe whether the others repeat correctly.

Those to whom the order is addressed, except enginemen, must then sign it, and the operator will send their signatures preceded by the number of the order to the ———. The response "complete," and the time, with the initials of the ———, will then be given by the train dispatcher. Each operator receiving this response will then write on each copy the word "complete," the time, and his last name in full, and then deliver a copy to each person addressed, except enginemen. The copy for each engineman must be delivered to him personally by ———.

NOTE to Rule 210.—The blanks in the above rule may be filed for each road to suit its own requirements. On roads where the signature of the engineman is desired, the words "except enginemen," and the last sentence in the second paragraph may be omitted. If preferred, each person receiving an order may be required to read it aloud to the operator.

211. When a "19" train order has been transmitted, operators must (unless otherwise directed) repeat it at once from the manifold copy, in the succession in which the several offices have been addressed. Each operator receiving the order should observe whether the

others repeat correctly. When the order has been repeated correctly by an operator, the response "complete" and the time, with the initials of the ———, will be given by the train dispatcher. The operator receiving this response will then write on each copy the word "complete," the time, and his last name in full, and personally deliver a copy to each person addressed without taking his signature.

But when delivery to engineman will take the operator from the immediate vicinity of his office, the engineman's copy will be delivered by ———.

When a "19" train order restricting the superiority of a train is issued for it at the point where such superiority is restricted, the train must be brought to a stop before delivery of the order.

212. A train order may, when so directed by the train dispatcher, be acknowledged without repeating, by the operator responding: "X ——— (number of train order) to ——— (train number)," with the operator's initials and office signal. The operator must then write on the order his initials and the time.

213. "Complete" must not be given to a train order for delivery to an inferior train until the order has been repeated or the "X" response sent by the operator who receives the order for the superior train.

214. When a train order has been repeated or "X" response sent, and before "complete" has been given, the order must be treated as a holding order for the train addressed, but must not be otherwise acted on until "complete" has been given.

If the line fails before an office has repeated an order or has sent the "X" response, the order at that office

is of no effect and must be there treated as if it had not been sent.

215. The operator who receives and delivers a train order must preserve the lowest copy.

216. For train orders delivered by the train dispatcher the requirements as to the record and delivery are the same as at other points.

217. A train order to be delivered to a train at a point not a telegraph station, or at one at which the telegraph office is closed, must be addressed to

“C and E. ——— (at ———), care of ———.”

and forwarded and delivered by the conductor or other person in whose care it is addressed. When form 31 is used “complete” will be given upon the signature of the person by whom the order is to be delivered, who must be supplied with copies for the conductor and the engineman addressed, and a copy upon which he shall take their signatures. This copy he must deliver to the first operator accessible, who must preserve it, and at once transmit the signatures of the conductor and engineman to the train dispatcher.

Orders so delivered must be acted on as if “complete” had been given in the usual way.

For orders which are sent, in the manner herein provided, to a train the superiority of which is thereby restricted, “complete” must not be given to an inferior train until the signature of the conductor and engineman of the superior train have been sent the ———.

218. When a train is named in a train order by its schedule number alone, all sections of that schedule are included, and each must have copies delivered to it.

219. Unless otherwise directed, an operator must not repeat or give the “X” response to a train order for a

train which has been cleared or of which the engine has passed his train-order signal, until he has obtained the signatures of the conductor and engineman to the order.

220. Train orders once in effect continue so until fulfilled, superseded or annulled. Any part of an order specifying a particular movement may be either superseded or annulled.

Orders held by or issued for, or any part of an order relating to, a regular train, become void when such train loses both right and schedule as prescribed by rules 4 and 82, or is annulled.

221. (A). A fixed signal must be used at each train-order office, which shall indicate "stop" when there is an operator on duty, except when changed to "proceed" to allow a train to pass after getting train orders, or for which there are no orders. A train must not pass the signal while "stop" is indicated. The signal must be returned to "stop" as soon as a train has passed. It must be fastened at "proceed" only when no operator is on duty.

Operators must have the proper appliances for hand signaling ready for immediate use if the fixed signal should fail to work properly. If a signal is not displayed at a night office, trains which have not been notified must stop and ascertain the cause and report the facts to the ——— from the next open telegraph office.

Where the semaphore is used, the arm indicates "stop" when horizontal, and "proceed" when in an inclined position.

NOTE to Rule 221 A.—The conditions which affect trains at stations vary so much that it is recommended each road adopt such regulations supplementary to this rule as may best suit its own requirements.

221 (B). A fixed signal must be used at each train-order office, which shall indicate "stop" when trains are to be stopped for train orders. When there are no orders the signal must indicate "proceed."

When an operator receives the signal "31" or "19," followed by the direction, he must immediately display the "stop signal" for the direction indicated and then reply "stop displayed," adding the direction; and until the orders have been delivered or annulled the signal must not be restored to "proceed." While stop is indicated, trains must not proceed without a clearance card (Form—"A").

Operators must have the proper appliances for hand signaling ready for immediate use if the fixed signal should fail to work properly. If a signal is not displayed at a night office, trains which have not been notified must stop and ascertain the cause, and report the facts to the —— from the next open telegraph office. Where the semaphore is used, the arm indicates "stop" when horizontal, and "proceed" when in an inclined position.

NOTES to Rules 221 A and 221 B.—The Committee has recommended two forms of Rule 221, leaving it discretionary to adopt one or both of these forms according to the circumstances of the traffic.

222. Operators will promptly record and report to the —— the time of departure of all trains and the direction of extra trains. They will record the time of arrival of trains and report it when so directed.

223. The following signs and abbreviations may be used:

Initials for signature of the ——.

Such office and other signals as are arranged by the

C. & E.—For Conductor and Engineman.

X—Train will be held until order is made "complete."

Com.—For Complete.

O. S.—Train Report.

No.—For Number.

Eng.—For Engine.

Sec.—For Section.

Psgr.—For Passenger.

Frt.—For Freight.

Mins.—For Minutes.

Jct.—For Junction.

Dispr.—For Train Dispatcher.

Opr.—For Operator.

31 or 19—To clear the line for Train Orders, and for operators to ask for Train Orders.

S. D.—For "Stop Displayed."

The usual abbreviations for the names of the months and stations.

General Note.—Blanks in the rules may be filled by each road to fill its own organization or requirements.

FORMS OF TRAIN ORDERS.

FORM A. FIXING MEETING POINTS FOR OPPOSING TRAINS.

- (1.) _____ meet _____ at _____.
- (2.) _____ meet _____ at _____ _____ at _____
- (and so on).

EXAMPLES.

- (1.) No. 1 meet No. 2 at "B."
No. 3 meet 2d No. 4 at "B."
No. 5 meet Extra 95 East at "B."
Extra 652 North meet Extra 231 South at "B."
- (2.) No. 2 and 2d No. 4 meet Nos. 1 and 3 at "C"
and Extra 95 West at "D."
No. 1 meet No. 2 at "B" 2d No. 4 at "C" and
Extra 95 East at "D."

Trains receiving these orders will run with respect to each other to the designated points and there meet in the manner provided by the Rules.

FORM B. DIRECTING A TRAIN TO PASS OR RUN AHEAD OF ANOTHER TRAIN.

- (1.) _____ pass _____ at _____.
- (2.) _____ pass _____ when overtaken.
- (3.) _____ run ahead of _____ _____ to _____.
- (4.) _____ run ahead of _____ _____ until overtaken.
- (5.) _____ pass _____ at _____, and run ahead of _____ _____ to _____.

EXAMPLES.

- (1.) No. 1 pass No. 3 at "K."
- (2.) No. 6 pass No. 4 when overtaken.
- (3.) Extra 594 East run ahead of No. 6 "M" to "B."
- (4.) Extra 95 West run ahead of No. 3 "B" until overtaken.
- (5.) No. 1 pass No. 3 at "K" and run ahead of No. 7 "M" to "Z."

When under (1), a train to pass another, both trains will run according to rule to the designated point, and there arrange for the rear train to pass promptly.

Under (2) both trains will run according to rule until the second-named train is overtaken, and then arrange for the rear train to pass promptly.

Under (3) the second-named train must not exceed the speed of the first-named train between the points designated.

Under (4) the first-named train will run ahead of the second-named train from the designated station until overtaken, and then arrange for the rear train to pass promptly. When an inferior train receives an order to pass a superior train, right is conferred to run ahead of the train passed, from the designated point.

FORM C. GIVING RIGHT TO A TRAIN OVER AN OPPOSING TRAIN.

_____ has right over _____ to _____.

EXAMPLES.

- (1.) No. 1 has right over No. 2 "G" to "X."
 - (2.) Extra 37 East has right over No. 3 "F" to "A."
- This order gives right to the train first named over the other train between the points named.

If the trains meet at either of the designated points, the first-named train must take the siding, unless the order otherwise prescribes.

Under (1), if the second-named train reaches the point last named before the other arrives, it may proceed, keeping clear of the opposing train as many minutes as such train was before required to clear it under the Rules.

Under (2) the regular train must not go beyond the point last named until the extra train has arrived, unless directed by train order to do so.

FORM E. TIME ORDER.

(1.) _____ run _____ late _____ to _____.

(2.) _____ run _____ late _____ to _____ and
_____ late _____ to _____ etc.

(3.) _____ wait at _____ until _____ for _____.

(4.) _____ wait at _____ until _____
_____ until _____
_____ until _____

EXAMPLES.

(1.) No. 1 run 20 min. late "A" to "G."

(2.) No. 1 run 20 min. late "A" to "G," and 15 min. late "G" to "K," etc.

(3.) No. 1 wait at "H" until 10:00 a. m. for No. 2.

(4.) Nos. 1 and 3 wait at "N" until 10:00 a. m.
"P" until 10:30 a. m.
"R" until 10:55 a. m.

Etc.

(1) and (2) make the schedule time of the train named, between the points mentioned, as much later as

stated in the order, and any other train receiving the order is required to run with respect to this later time, as before required to run with respect to the regular schedule time. The time in the order should be such as can be easily added to the schedule time.

Under (3) the train first named must not pass the designated point before the time given, unless the other train has arrived. The train last named is required to run with respect to the time specified at the designated point or any intermediate station where schedule time is earlier than time specified in the order, as before, required to run with respect to the schedule time of the train first named.

Under (4) the train (or trains) named must not pass the designated points before the times given. Other trains receiving the order are required to run with respect to the time specified at the designated points or any intermediate station where schedule time is earlier than the time specified in the order as before required to run with respect to the schedule time of the train or trains named.

All of these examples may be used in connection with an extra train under example (3) of form G, and the times at each point stated in the example have the same meaning as "schedule times" in the foregoing example.

FORM F. FOR SECTIONS.

(1.) _____ display signals and run as _____ _____
to _____

(2.) _____ run as _____ _____ to _____

(3.) _____ display signals _____ to _____ for

- (6.) _____ is withdrawn as _____ at _____
 (7.) _____ instead of _____ display signals and run
 as _____ to _____
 (8.) _____ take down signals at _____
 (9.) _____ and _____ reverse position as _____
 and _____ to _____

EXAMPLES.

(1.) *Eng. 20 will display signals and run as 1st No. 1 A to Z.*

(2.) *Eng. 25 run as 2d No. 1 A to Z.*

(3.) *No. 1 display signals A to G for Eng. 65. 2d No. 1 display signals B to E for Eng. 99.*

These examples may be modified as follows:

(4.) *Engs. 20, 25 and 99 run as 1st, 2d and 3d No. 1 A to Z.*

Example (1) is to be used when the number of the engine for which signals are displayed is unknown, and is to be followed by example (2), both being single order examples.

Under examples (2) and (3) the engine named will not display signals.

Under (4) the engine last named will not display signals.

FOR CHANGING SECTIONS.

To add an intermediate section the following modification of example (1) will be used.

(5.) *Eng. 85 display signals and run as 2d No. 1 N to Z. Following sections change numbers accordingly.*

Under (5) Eng. 85 will display signals and run as directed, and following sections will take the next higher number.

To drop an intermediate section the following example will be used:

(6) *Eng. 85 is withdrawn as 2d No. 1 at H. Following sections change numbers accordingly.*

Under (6) Eng. 85 will drop out at H, and following sections will take the next lower number.

To substitute one engine for another on a section, the following will be used:

(7.) *Eng. 18 instead of Eng. 85 display signals, and run as 2d No. 1 R to Z.*

Under (7) Eng. 85 will drop out at R, and Eng. 18 will run as directed.

If Eng. 85 is last section, the words "display signals and" will be omitted. Following sections need not be addressed.

To discontinue the display of signals the following example will be used:

(8.) *2d No. 1 take down signals at D.*

Under (8) 2d No. 1 will take down signals as directed, and a following section must not proceed beyond the point named.

To pass one section by another, the following will be used:

(9.) *Engs. 99 and 25 reverse positions as 2d and 3d No. 1 H to Z.*

Under (9) Eng. 99 will run ahead of Eng. 85 to Z, and, if necessary, both engines will arrange signals accordingly. Following sections, if any, need not be addressed.

The character of a train for which signals are displayed must be stated. Each section affected by the order must have copies and must arrange signals accordingly.

To annul a section for which signals have been displayed over a division or any part thereof, when no train is to follow the signals, form K must be used.

FORM G. EXTRA TRAINS.

(1.) Eng. _____ run extra _____ to _____

(2.) Eng. _____ run extra _____ to _____ and
return to _____

EXAMPLES.

(1.) Eng. 99 run extra "A" to "F."

(2.) Eng. 99 run extra "A" to "F" and return to "C."

Under (2) the extra must go to "F" before returning to "C."

(3.) Eng. _____ run extra leaving _____ on _____
as follows with right over all trains:

Leave _____.

" _____.

Arrive _____.

EXAMPLE.

(3.) Eng. 77 run extra leaving "A" on Thursday, Feb. 17th, as follows, with right over all trains:

Leave "A" 11:30 p. m.

Leave "C" 12:25 a. m.

Leave "E" 1:47 a. m.

Arrive "F" 2:22 a. m.

This order may be varied by specifying the kind of extra and the particular trains over which the extra shall or shall not have right. Trains over which the extra is thus given right must clear the time of the extra _____ minutes.

FORM H. WORK EXTRA.

(1.) ——— works ——— until ——— between ———
and ———.

EXAMPLE.

(1.) *Eng. 292 works 7 a. m. to 6 p. m. between D and E.*

Under (1) the work extra must, whether standing or moving, protect itself against extras within the working limits in both directions, as prescribed by rule. The time of regular trains must be cleared.

This may be modified by adding:

(2.) *Not protecting against (eastward) extras.*

(3.) *Not protecting against extras.*

Under (2) the work extra will protect only against (westward) extras. The time of regular trains must be cleared.

Under (3) protection against extras is not required. The time of regular trains must be cleared.

When a work extra has been instructed by order to not protect against extra trains, and afterwards it is desired to have it clear the track for (or protect itself after a certain hour against) a designated extra, an order may be given in the following form:

(5.) *Work extra 292 protects against No. 55 or (— class trains) between D and E.*

Under (5) the work extra may work upon the time of the train or trains mentioned in the order, and must protect itself against such train or trains as prescribed by rule 99. The regular train or trains receiving the order will run expecting to find the work extra protecting itself.

When a work extra is to be given exclusive right over all trains, the following form will be used:

(6.) *Work extra 292 has right over all trains between D and E 7 p. m. to 12 night.*

This gives the work extra the exclusive right between the points designated between the times named.

Work extras must give way to all trains as promptly as practicable.

Whenever extra trains are run over working limits, they must be given a copy of the order sent to the work extra. Should the working order instruct a work extra to not protect against extra trains in one or both directions, extra trains must protect, as prescribed by rule 99, against the work extra; if the order indicates that the work extra is protecting itself against other trains, they will run expecting to find the work extra protecting itself.

The working limits should be as short as practicable, to be changed as the progress of the work may require.

FORM J. HOLDING ORDER.

Hold———

EXAMPLES.

Hold No. 2.

Hold all (or —— ward) trains.

When a train has been so held, it must not proceed until the order to hold is annulled or an order given to the operator in the form:

“———. *may go.*”

These orders will be addressed to the operator and acknowledged in the usual manner, and will be delivered to conductors and enginemen of all trains affected.

Form J will only be used when necessary to hold trains until orders can be given, or in case of emergency.

FORM K. ANNULING A SCHEDULE OR A SECTION.

(I.) ——— of ——— is annulled ——— to ———.

EXAMPLES.

No. 1 of Feb. 29 is annulled "A" to "Z."

2d No. 5 of Feb. 29th is annulled "E" to "G."

The schedule or section annulled becomes void between the points named and cannot be restored.

FORM L. ANNULING AN ORDER.

"Order No. ——— is annulled."

EXAMPLE.

"Order No. 10 is annulled."

If an order which is to be annulled has not been delivered to a train, the annulling order will be addressed to the operator, who will destroy all copies of the order annulled but his own, and write on that:

"Annulled by Order No. ———."

An order that has been annulled must not be reissued under its original number.

FORM M. ANNULING PART OF AN ORDER.

That part of Order No. ——— reading ———, is annulled.

EXAMPLE.

That part of Order No. 10 reading No. 1 meet No. 2 at "S," is annulled.

FORM P. SUSPENDING AN ORDER OR PART OF AN ORDER.

This order will be given by adding to prescribed forms the words "instead of _____."

- (1.) _____ meet _____ at _____ instead of _____.
- (2.) _____ has right over _____ _____ to _____ instead of _____.
- (3.) _____ display signals for _____ _____ to _____ instead of _____.

EXAMPLES.

- (1) *No. 1 meet No. 2 at "C" instead of "B."*
- (2) *No. 1 has right over No. 2 "G" to "R" instead of "X."*
- (3) *No. 1 display signals for Eng. 85 "A" to "Z" instead of "G."*

An order that has been superseded must not be reissued under its original number.

RULES FOR DOUBLE TRACK.

NOTE—The rules which are marked "No Change," are the same as the rules of corresponding number for single track, and to save room they have not been repeated here.

STANDARD TIME.

Rules 1, 2 and 3 same as for single track.

TIME-TABLES.

Rule 4 same as for single track.

D—5. Not more than two times are given for a train at any station, where one is given, it is, unless otherwise

indicated, the leaving time; where two, they are the arriving and leaving time.

Unless otherwise indicated, the time applies to the switch where an inferior train enters the siding; where there is no siding it applies to the place from which fixed signals are operated; where there is neither siding nor fixed signal, it applies to the place where traffic is received or discharged.

Schedule passing stations are indicated by figures in full-faced type.

Both the arriving and leaving time of a train are in full-faced type when both are passing times, or when one or more trains are to pass it between those times.

When trains are to be passed at a siding extending between two adjoining stations, the time at each end of the siding will be shown in full-faced type.

Where there are one or more trains to pass a train between two times, attention is called to it by ———.

Rule 6. Same as single track.

SIGNAL RULES.

Rules 7, 8, 9, 10, 11, 12 and 13. Same as for single track.

The indication for D—14 (k) is changed to read to call the attention of yard engines of trains moving in the same direction to signals displayed for a following section.

Rules 15 and 16. Same as for single track.

TRAIN SIGNALS.

D—17. The headlight will be displayed to the front of every train by night, but must be concealed when a train

is standing to meet trains at the end of double track or at junction points.

Rule 18. Same as for single track.

D—19. The following signals will be displayed, one on each side of the rear of every train, as markers, to indicate the rear of the train: By day, green flags; by night, green lights to the front and side and red lights to the rear, except when the train is clear of the main track, when green lights must be displayed to the front, side and rear, and except when a train is turned out against the current of traffic, when green lights must be displayed to the front and side and, to the rear, a green light toward the inside and a red light to the opposite side.

Rules 20, 21, 22, 23, 24, 25 and 26. Same as for single track.

USE OF SIGNALS.

Rules 27, 28, 29, 30, 31, 32 and 33. Same as for single track.

SUPERIORITY OF TRAINS.

D—71. A train is superior to another train by right, class or direction.

Right is conferred by train order; class and direction by time-table.

Right is superior to class or direction.

D—72. Trains of the first classes are superior to those of the second; trains of the second class are superior to those of the third; and so on.

Rule 73. Same as for single track.

MOVEMENT OF TRAINS.

Rule 82. Same as for single track.

D—83. A train must not leave its initial station on any division (or sub-division) or a junction, until it has been ascertained whether all superior trains due have left.

Rule 84. Same as for single track.

D—85. When a train of one schedule is on the time of another schedule of the same class it will proceed on its own schedule.

Trains of one schedule may pass trains of another schedule of the same class.

A section may pass and run ahead of another section of the same schedule, first exchanging orders, signals and numbers with the section to be passed. Extras may pass and run ahead of extras.

D—86. An inferior train must clear the time of a superior train not less than five minutes; but must be clear at the time a first-class train in the same direction is due to leave the next station in the rear where time is shown. Extra trains must clear the time of regular trains ——— minutes unless otherwise provided.

Rules 87, 88, 89 and 90 omitted. Not applicable to double track.

D—91. Unless some form of block signals is used, trains must keep at least five minutes apart, except in closing up at stations.

NOTE to Rule *D—91.* The Committee recommends that where greater clearance is necessary, Rule *D—91* should allow for a clearance of ten minutes or more.

Rule 92. Same as for single track.

D—93. Within yard limits the main tracks may be

used, protecting against ——— class trains, ——— class and extra trains must move within yard limits prepared to stop unless the main track is seen or known to be clear.

D—94. A train which overtakes a superior train so disabled that it cannot proceed, will pass it, if practicable, and, if necessary, will assume the schedule and take the train orders of the disabled train, proceed to the next open telegraph office, and there report to the ———. The disabled train will assume the schedule and take the train orders of the last train with which it has exchanged, and will, when able, proceed to and report from the next open telegraph office.

D—95. Two or more sections may be run on the same schedule.

Each section has equal time-table authority. A train must not display signals for a following section, except as prescribed by Rule D—85, without orders from the ———.

Rule 96 omitted. Not applicable to double track.

D—97. Extra trains must not be run without orders from the ———.

Work extras must move with the current of traffic unless otherwise directed.

Rules 98, 99 and 100. Same as for single track.

D—101. If a train should part while in motion, trainmen must, if possible, prevent damage to the detached portions. The signals prescribed in Rules 12—D and 14—F must be given.

The detached portion must not be moved or passed until the front portion comes back.

The enginemen and trainmen of the front portion must give the train-parted signal to trains running on

the opposite track. A train receiving this signal, or being otherwise notified that a train on the opposite track has parted, must immediately reduce speed and proceed with caution until the separated train is passed.

When a train is disabled so it may obstruct the opposite track, trains on that track must be stopped.

Rules 102, 103, 104, 105 and 106. Same as for single track.

D—151. Trains must keep to the ———, unless otherwise provided.

D—152. When a train crosses over to, or obstructs, the other track, unless otherwise provided, it must first be protected as prescribed by Rule 99 in both directions on that track.

D—153. Trains must use caution in passing a train receiving or discharging passengers at a station, and must not pass between it and the platform at which the passengers are being received or discharged.

RULES FOR MOVEMENT BY TRAIN ORDERS.

Rules 201, 202, 203, 204, 205, 206 and 207. Same as for single track.

D—208. A train order to be sent to two or more offices must be transmitted simultaneously to as many of them as practicable. The several addresses must be in the order of superiority of trains, each office taking its proper address. When not sent simultaneously to all, the order must be sent first to the superior train.

Rules 209 to 223 inclusive. Same as for single track.

FORMS OF TRAIN ORDERS.

Form A—Omitted. Not applicable.

Form B—Same as for single track.

Form C—Omitted. Not applicable.

D—FORM E.

This form is the same as for single track, except that example 3 and the note to example 3 are omitted.

D—FORM F.

This form is the same as for single track, except that example 9 and note are omitted.

Form G. Same as for single track.

D—FORM H.—WORK EXTRA.

Eng. _____ works on _____ track _____ to _____
between _____ and _____.

EXAMPLE.

*Eng. 292 works on eastward track (or on both tracks)
7 a. m. to 6 p. m. between "D" and "E."*

Under (1) the work extra must, whether standing or moving, protect itself within the working limits against extras moving with the current of traffic on the track or tracks named, as prescribed by Rule 99. The time of regular trains must be cleared.

This form may be modified by adding:

(2.) *Not protecting against extras.*

Under (2) protection against extra trains is not required. The time of regular trains must be cleared.

To enable a work train to work upon the time of a regular train, the following form may be used:

(3.) *Work extra 292 protects against No. 55 (or _____ class trains) between "D" and "E."*

Under (3) the work extra may work upon the time of the train (or trains) mentioned in the order, and must protect against such train (or trains) as prescribed by Rule 99.

The regular train or trains receiving the order will run expecting to find the work extra protecting itself.

When it is desired to move a train against the current of traffic over the working limits, provision must be made for the protection of such movement.

When a work extra is to be given exclusive right over all trains, the following form will be used:

(4.) Work extra _____ has right over all trains on _____ track between _____ and _____ m to _____ m.

EXAMPLE.

(4.) *Work extra 275 has right over all trains on eastward and westward tracks between "G" and "H" 7 p. m. to 12 night.*

This gives the work extra the exclusive right to the track (or tracks) mentioned, between the points designated, between the times named.

Work extras must give way to all trains as promptly as practicable. Working limits should be as short as practicable; to be changed as the progress of the work may require.

Forms J, K, and L. Same as for single track.

D—FORM M—ANNULLING PART OF AN ORDER.

That part of order No. ——— reading ——— is annulled.

EXAMPLE.

That part of order No. 10 reading Extra 263 West pass No. 1 at "S" is annulled.

D—FORM P. SUPERSEDING AN ORDER OR PART OF AN ORDER.

This order will be given by adding to the prescribed forms the words "instead of ———."

- (1.) ——— pass ——— at ——— instead of ———.
- (2.) ——— display signals for ——— ——— to ——— instead of ———.

EXAMPLES.

- (1.) *No. 1 pass No. 3 at "C" instead of "B."*
- (2.) *No. 1 display signals for Eng. 85 "A" to "Z" instead of "G."*

An order which has been superseded must not be reissued under its original number.

D—FORM R. PROVIDING FOR A MOVEMENT AGAINST THE CURRENT OF TRAFFIC.

- (1.) ——— has right over ——— on ——— track ——— to ———.

(1.) No. 1 has right over opposing trains on No. 2 (or eastward) track "C" to "F."

A train must not be moved against the current of traffic

until the track on which it is to run has been cleared of opposing trains.

Under this order the designated train must use the track specified between the points named, and has right over opposing trains on that track between those points. Opposing trains must not leave the point last named until the designated train arrives.

An inferior train between the points named moving with the current of traffic in the same direction as the designated train must receive a copy of the order, and may then proceed on its schedule, or right.

This order may be modified as follows:

(2.) After _____ arrives at _____, _____ has right over opposing trains on _____ track _____ to _____.

EXAMPLE.

After No. 4 arrives at "C" No. 1 has right over opposing trains on No. 2 (or eastward) track "C" to "F."

Under (2) the train to be moved against the current of traffic must not leave the first named point until the arrival of the first-named train.

D—FORM 'S. PROVIDING FOR THE USE OF A SECTION OF DOUBLE TRACK AS SINGLE TRACK.

_____ track will be used as single track between _____ and _____.

If it is desired to limit the time for such use, add (from _____ until _____.)

EXAMPLE.

No. 1 (or westward) track will be used as single track between "F" and "G."

Adding if desired:

From 1:00 p. m. until 3:00 p. m.

Under this order, all trains must use the track specified between the points named, and will be governed by rules for single track.

Trains running against the current of traffic on the track named must be clear of the track at the expiration of the time named, or protected as prescribed by Rule 99.

RULES REGULATING MOVEMENT OF TRAINS AGAINST THE CURRENT OF TRAFFIC ON DOUBLE TRACK BY

MEANS OF BLOCK SIGNALS.

NOTE.—Roads operating under these Rules must provide proper signals to control the approach and movement of trains.

1. On portions of the road so specified on the timetable, trains will run against the current of traffic by block signals, whose indications will supersede timetable superiority and will take the place of train orders.
2. The movement of trains will be supervised by the _____* who will issue instructions to signalmen.
3. A train must not cross over, except provided in Rule 1, without authority from the _____†.
4. Except as affected by these rules, all block signal and train rules remain in force.

*Superintendent or train dispatcher.

†Train dispatcher or signalman.

RULES GOVERNING THE MOVEMENT OF
TRAINS WITH THE CURRENT OF TRAF-
FIC ON DOUBLE TRACK BY MEANS
OF BLOCK SIGNALS.

ADOPTED OCT. 28, 1903.

1. On portions of the road so specified on the time-table, trains will run with the current of traffic by block signals whose indications will supersede time-table superiority.

2. The movement of trains will be supervised by the _____*, who will issue instructions to signalmen when required.

3. A train having work to do which may detain it more than _____ minutes, must obtain permission from the signalman at the last station at which there is a siding, before entering the block in which work is to be done. The signalman must obtain authority to give this permission from _____.*

4. Except as affected by these rules, all block signal and train rules remain in force.

*Superintendent or Train Dispatcher.

TRAINMEN'S EXAMINATION

A COMPLETE SERIES OF

QUESTIONS AND ANSWERS

COVERING THE

STANDARD CODE OF RULES

NOTE TO STUDENTS—The letter or number (in parenthesis) at the end of each question, refers to the particular Standard Code rule on which the question and answer is based.

GENERAL RULES.

Question 1.—Have you studied the book of rules of this company? (based on the Standard Code)? (A).

Answer.—Yes, I have.

Question 2.—Do you clearly understand the rules and instructions in so far as they apply to your own duties? (B).

Answer.—I do.

Question 3.—In case you are in doubt as to the exact meaning of any rule or special instruction, what are you to do? (B).

Answer.—Ask superior officer to explain it.

Question 4.—Are you aware that all trainmen must pass the prescribed examinations? (C).

Answer.—I am.

Question 5.—Are there any employees on a train who

are not governed by the rules and special instructions? (D).

Answer.—No. All employees on trains, no matter what kind of service they are engaged in, are subject to the rules and special instructions.

Question 6.—What is it your duty to do in carrying out the rules and special instructions? (E).

Answer.—To render every assistance in my power by carrying them out faithfully, and thus promoting the efficiency of the service.

Question 7.—In case you know of any violation of a rule or special instruction by a fellow employee, what are you expected to do? (F).

Answer.—Report it to proper officer.

Question 8.—Do you understand that employees are absolutely forbidden to use intoxicants while on duty? (G).

Answer.—Yes.

Question 8A.—Do you understand that to use intoxicants, or to frequent places where they are sold, may be considered sufficient cause for dismissal? (G).

Answer.—Yes.

Question 9.—Are employees allowed to use tobacco while on duty in or about passenger stations or on passenger cars? (H).

Answer.—No.

Question 10.—Are employees allowed on duty without badges or uniforms? (J).

Answer.—No.

Question 10A.—Do you understand that employees on duty must keep themselves neat in personal appearance? (J).

Answer.—Yes.

Question 11.—Is disorderly conduct, or conduct that may give annoyance to patrons, allowed on the part of anyone at stations or on trains? (K).

Answer.—No.

Question 12.—What are employees expected to do in case of danger to any property of the company? (L).

Answer.—They should make a united effort to protect it.

Note:—Students should be thoroughly informed concerning the proper use of technical terms and definitions as explained in the Standard Code, before attempting to pass an examination on train rules.

RULES FOR SINGLE TRACK. STANDARD TIME.

Note.—Under the Standard Code as amended, April, 1906, not only conductors and enginemen, but also such other classes of employees as the company may wish to specify, are required to have their watches inspected, and to keep standard time.

Question 13.—Where is standard time obtained from? (1).

In answering this question the student will designate the particular office which sends the telegraphic time signal daily over the portion of the system on which he is employed.

Question 14.—At what time each day is the time signal received? (1).

Student will here state the exact hour at which the time signal is sent each day over the company's telegraph lines.

Question 15.—What conditions are laid down as to the watches used by conductors, enginemen, etc.? (2).

Answer.—Only watches that have been examined and certified to by a designated inspector, shall be used.

Question 16.—How often must a watch certificate be renewed, and with whom must it be filed? (2).

Answer.—How long certificates hold good, and the officer who keeps them on file, are discretionary with the company, and are covered in special instructions to employees. The usual term is six months, and files are kept in the superintendent's office. Student will answer according to his special instructions.

Question 17.—How great a variation is allowed in watches? (2).

Answer.—They must not run ahead or behind, more than 30 seconds a week.

Question 18.—What clocks may be used in comparing time? (3).

Answer.—Only those designated as "Standard Clocks."

Question 19.—How often must watches be compared with standard time? (3).

Answer.—Before starting on each trip.

Question 19a.—After comparing watch with standard timepiece, what should at once be done? (3).

Answer.—Enter time when comparison was made, on registry form prescribed for the purpose.

Question 20.—In case no standard clock is accessible, how are conductors and enginemen to obtain the time? (3).

Answer.—From other conductors or enginemen who have registered; from the superintendent; or in some other way specified by the company.

retain the corresponding number on the new time table.

Question 23.—In the case of a train, the number of which does not correspond in number, class, day of leaving, direction, initial and terminal station, how should it proceed? (4).

Answer.—Only by train order.

Question 24.—In the case of a new schedule in a time table, when do they take effect? (4).

Answer.—At the time for leaving the initial station on that division or subdivision.

Question 25.—In what way is the date of a schedule arrived at? (4).

Answer.—By the time of leaving its initial station on that division or subdivision.

Question 26.—Is it permissible for more than one schedule of the same number and date to be in force on any division or subdivision? (4).

Answer.—It is not.

NOTE.—The foregoing answers based on the Standard Code, Rule 4, have been framed in accordance with the sense of the ruling rather than in exact accordance with its wording. By carefully reading the rule, it will be clearly seen that without exception the schedules of a new time table take effect on any division or sub-division at the initial station and leaving time.

Question 27.—How many times are specified on the time table at any station? (5).

Answer.—Never more than two.

Question 28.—When only one time is shown, what is it? (5).

Answer.—Always the leaving time.

Question 29.—When two are shown what do they indicate? (5).

Answer.—The arriving and the leaving time.

Question 30.—At what particular place does the time at a station apply? (5).

Answer.—It applies to a switch where an inferior train takes the siding unless otherwise indicated. If there is no siding it applies to the point from which fixed signals are operated. Should there be neither siding nor signals, it will then apply where traffic is received and discharged.

Question 31.—In what manner are the meeting or passing points shown in the schedule? (5).

Answer.—The figures are usually printed in full face black type.

Question 32.—If the arriving and leaving of a train are both shown in full face black type, what does it mean? (5).

Answer.—That it is a meeting or passing point or that one or more trains are to be met between those times.

Question 33.—If a train takes a siding between two adjoining telegraph offices, to be passed by one or more trains, how will the schedule show this? (5).

Answer.—In full face black type and showing the time at each end of the siding.

Question 34.—If one or more trains are to meet or pass a train between two times, how is attention called to it? (5).

Answer.—

Question (b).—If more than one train is to meet a train at any station, in what manner is attention called to it? (5).

Answer.—

NOTE.—With reference to the answers to the two questions immediately above, the Standard Code leaves the sign to the discretion of the respective Railway Companies.

Question 35.—In what manner are meal stops, flag stops and regular stops shown on the schedule? (6).

Answer.—By a paragraph sign. for meal stops; by the letter "F" for flag stops and by the letter "S" for regular stops.

Question 36.—When the letters "L" or "A" are shown in the schedule, what does it mean? (6).

Answer.—"L" means Leave and "A" means Arrive.

SIGNAL RULES.

Question 37.—In the case of employees whose duty it is to give signals, state what appliances must be provided and when should they be ready for use? (7).

Answer.—They should be provided with the proper appliances, placed so as to be ready for immediate use when necessary.

Question 38.—State what signals are used by day and what signals are used at night? (8).

Answer.—By day, flags of the prescribed color must be used and at night lamps of the prescribed color must be used.

Question 39.—What is considered the length of time that night signals should be shown? (9).

Answer.—From sunset to sunrise.

Question 40.—In case of foggy weather or other unusual conditions which obscure day signals, what should be done? (9).

Answer.—In addition to the day signals, night signals should also be used.

VISIBLE SIGNALS.

Question 41.—What does it signify when red is shown? (10).

Answer.—Danger; Stop.

Question 42.—If white is shown what does it signify? (10).

Answer.—Line clear; proceed; and other uses indicated in the rules.

Question 43.—What does it signify when green is shown? (10).

Answer.—Use caution; proceed carefully; and for other uses indicated in the rules.

NOTE.—It should always be remembered that green is used for markers, for fusees, and is also carried in the front of an engine to indicate when a section of the same numbered train is following. The color of the signal indicating "Proceed" and "Caution" has been left to the discretion of each road by the Standard Code Committee. Sometimes green is used for proceed and on some roads green and red for caution, while others use yellow for caution and green for proceed. The original recommendation by the Committee on Train Rules of the American Railway Association, specify white for proceed and green for caution, as indicated by the above two questions immediately preceding this note.

Question 44.—What does it signify when green and white are shown together? (10).

Answer.—Not a regular stop but one known as a flag stop for passengers or freight.

Question 45.—If blue is shown, what does it signify? (10).

Answer.—That cars must not be moved when thus protected.

Question 46.—When may a red fusee be passed when one is found burning? (11).

Answer.—When it is completely burned out.

Question 47.—What does it signify when a green fusee is shown burning? (12).

Answer.—It is a signal of caution.

NOTE.—To avoid the danger of fire care should be used when throwing fusees to see that they do not fall near wooden structures.

HAND, FLAG AND LAMP SIGNALS.

Question 48.—When the hand, flag or lamp signals are swung across the track, what does it indicate? (12).

Answer.—Stop!

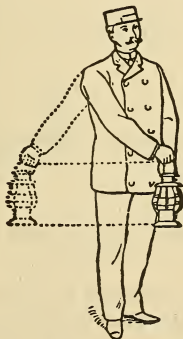

STOP—Swung across the track.

Question 49.—When raised and lowered vertically what is indicated? (12).

Answer.—Proceed.

Question 50.—What signals should be given by hand, flag or lamp if a train is to back? (12).

Answer.—They should be swung vertically in a circle at half arm's length across the track when train is standing.



PROCEED—Raised and lowered vertically.



BACK—Swung vertically in a circle across the track.

Question 51.—What signals should be given if a train has parted? (12).

Answer.—Swung vertically in a circle at arm's length across the track while train is running.

Question 52.—What signal should be given to apply the air brake? (12).

Answer.—Swung horizontally in a circle while train is standing still.

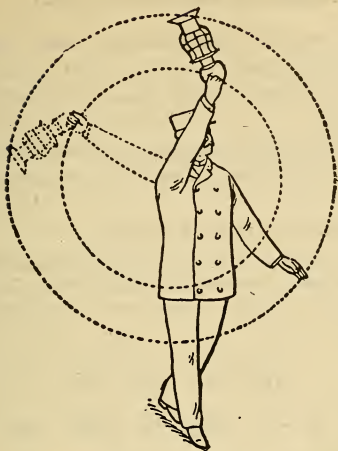

TRAIN HAS PARTED—Swung vertically in a circle at arm's length across the track.

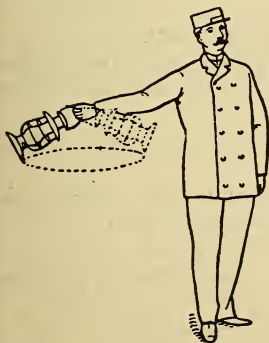

APPLY AIR BRAKES—Swung horizontally in a circle,



RELEASE AIR BRAKES—Held at arm's length above the head.

Question 53.—To release the air brake, what signal should be given? (12).

Answer.—At arm's length above grade while train is standing still.

Question 54.—When anyone on or near the track violently waves any object, what is it considered a signal for? (13).

Answer.—It is a signal to stop.

NOTE.—The manner in which a signal should be obeyed is indicated by the speed at which it is given. When given rapidly, it indicates to move rapidly. When given slowly, it indicates to move slowly.

AUDIBLE SIGNALS.

Question 55.—To apply the brakes what signal is given? (14A).

Answer.—One short blast of the whistle.

Question 56.—To release the brakes, what signal is given? (14B).

Answer.—Two long blasts of the whistle.

Question 57.—When the engineer desires the flagman to go back and protect the rear of the train, what signal does he give? (14C).

Answer.—One long and three short blasts of the whistle.

Question 58.—When a flagman is called in from the south and west, what signal is given? (14D).

Answer.—Four long blasts of the whistle.

Question 59.—When the flagman is called in from the north and east, what signal is given? (14E).

Answer.—Five long blasts of the whistle.

Question 60.—When the engineman signals that the train is parted, what signal does he give? (14F).

Answer.—Three long blasts of the whistle.

Question 61.—How often is the signal repeated? (14F).

Answer.—Until answered.

Question 62.—When a signal is given that the train is parted, what signal does the engineman give in answer? (14F).

Answer.—Three long blasts of the whistle.

Question 63.—What signal should trainmen give in answer to a signal from the engineman that train has parted? (14F).

Answer.—Hand, flag or lamp swung vertically in a circle at arm's length across the track.

Question 64.—For answering signals not otherwise provided for, what signal does the engineman give? (14G).

Answer.—Two short blasts of the whistle.

NOTE.—Enginemen are not required to answer fixed signals. All other signals given to stop a train either by hand, lamp, flag, fuses or torpedoes should be answered by two short blasts of the steam whistle. Three long blasts of the whistle should be used when answering a signal that the train has parted.

Question 65.—When a train is standing, what is the signal to back? (14H).

Answer.—Three short blasts of the whistle.

Question 65A.—When train is running what is indicated by three sharp blasts of the whistle? (14H).

Answer.—It is an answer to the conductor's signal to stop at the next station.

Question 66.—When an engineman wants to call for signals from switchmen, watchmen, trainmen and others, what signal does he give? (14J).

Answer.—Four short blasts of the whistle.

Question 67.—When crews of trains of the same or inferior class must have attention called to signals displayed for following sections what signal is used? (14k).

Answer.—One long and two short blasts of the whistle.

Question 67a.—Is the attention of crews, yard engines and extra trains called to signals displayed for following sections by the same signal: viz., one long and two short blasts of the whistle? (14k).

Answer.—Yes.

Question 68.—At public grade crossings, what signal is given? (141).

Answer.—Two long and two short blasts of the whistle.

NOTE.—The American Railway Association failed to approve of a whistle signal for meeting point. Probably the middle order is the best way to protect the meeting point.

Question 69.—For approaching stations, railroad crossings and junctions what is the signal? (14m).

Answer.—One long blast of the whistle.

Question 70.—When several short blasts of the whistle are given, what does it indicate? (14).

Answer.—The warning or alarm for persons or cattle on the track and also for calling attention to danger ahead.

NOTE.—In giving these signals correctly every care should be taken and prompt attention given to any infraction of these rules. Extraordinary precautions in giving whistle signals in stormy weather should be used and care exercised to make signals clear and distinct.

Question 71.—What is indicated by the explosion of one torpedo? (15).

Answer.—Come to a dead stop.

Question 72.—What is indicated when two torpedoes explode not more than 200 feet apart? (15).

Answer.—Speed should be reduced and a sharp lookout kept for the stop signal.

NOTE.—Care should be taken not to place torpedoes at crossings or stations where people are likely to pass them. For various reasons torpedoes should not be wholly depended upon to stop trains.

AIR-WHISTLE OR BELL-CORD SIGNALS.

Question 73.—When train is standing what is indicated by two blasts of the air-whistle? (16a).

Answer.—Start.

Question 74.—What is indicated when two blasts of air-whistle are given when train is running? (16b).

Answer.—Stop.

Question 75.—When train is standing and three blasts of air-whistle are given what does it indicate? (16c).

Answer.—Back.

Question 76.—When train is running and three blasts of air-whistle are given what does it indicate? (16d).

Answer.—Come to a stop at next station.

Question 77.—When train is standing and four blasts of air-whistle are given what does it indicate? (16e).

Answer.—Apply or release the brakes.

Question 78.—When train is running and four blasts of air-whistle are given, what does it indicate? (16f).

Answer.—Reduce speed.

Question 79.—When train is at a standstill what does five blasts of the air-whistle indicate? (16g).

Answer.—Call for the flagman to come in.

Question 80.—When train is running and five blasts

of the air-whistle are given, what does it indicate? (16h).

Answer.—Speed should be increased.

NOTE.—When a stop is to be made at the next station, signals should be given as soon as possible after leaving previous station, to avoid the possibility of mistaking the engineman's answer for an answer to a flagman's signal.

TRAIN SIGNALS.

Question 81.—After sunset what signals should be provided on front of a train? (17).

Answer.—A head-light.

Question 82.—When a train starts out to meet another and has stopped clear of main track, or is standing to meet train at the end of a double track or at junctions, what should be done to the head light? (17).

Answer.—It should be covered.

Question 82a.—Should the head light be covered before the train is clear and the switch right? (17).

Answer.—No.

Question 82b.—Suppose there are two trains at a station for an opposing train and the second train is unable to clear on account of a too short siding, would they depend for protection on the head light on being streamed on the leading train? (17).

Answer.—They would not. In such a case a flagman should be immediately sent out by the second train to afford full protection.

Question 82c.—Then where is the necessity of leaving the head light on the leading train uncovered? (17).

Answer.—Because the train cannot properly be considered clear of the main track while the main track switch remains open for the second train. Not until the switch is properly closed, may the head light be covered.

Question 82d.—Would not the head light of the leading engine be likely to have a blinding effect upon the eye sight of the engineer of the approaching train to such an extent that he would be unable to see the flagman from the train following. (17).

ANSWER.—It would hardly interfere with his vision to the extent of preventing his seeing the flagman. The headlight is of itself an indication that the train is not clear, therefore the approaching train ought to be moving with caution, fully prepared to stop at the switch. If the leading train had its headlight covered the opposing train would approach at a much higher rate of speed so that the flags from the following train might be much less effectual than the headlight on the leading train.

NOTE.—At a meeting point where there are more trains than the siding will hold the headlight of the leading train should not be concealed.

Question 83.—After sunset, what signals must the out engine display? (18).

Answer.—Head light at front and rear or two white lights.

Question 84.—Should yard engines display markers? (18).

Answer.—No.

Question 85.—What are markers? (19).

Answer.—By day green flags; by night a green light to side and front and in the rear a red light.

Question 86.—Where are markers displayed? (19).

Answer.—The rear of a train.

Question 87.—What do markers indicate? (19).

Answer.—The rear end of a train.

Question 88.—Should a train meet or pass your train at a meeting or passing point without displaying markers, what would you do? (19).

Answer.—I would signal the passing train and remain in the clear until the rear portion of same train has passed because the absence of markers would indicate a train had parted.

Question 89.—What change must be made in the markers when a train is clear of the main track? (19).

Answer.—At front, side and in the rear, green lights must be displayed.

Question 90.—When must the signals be displayed again? (19).

Answer.—After the train to be met has gone or passed.

Question 91.—What signal must all sections of a train, except the last, display on the front of the engine when it is running in two or more sections? (20).

Answer.—Two green flags during the day and at night two green lights in addition.

Question 93.—When a train carries two white flags by day and at night two white lights in addition on the front of the engine what does it indicate? (21).

Answer.—An extra train.

Question 93a.—When should the white signals be removed from an extra train? (21).

Answer.—When it has reached the end of its run and is entirely clear of the main track.

Question 94.—When two or more engines are coupled together and carrying signals, how must they be displayed? (22).

Answer.—On the leading engine only.

Question 94a.—When two or more engines coupled together are running backward as a section of a train carrying signals for following section on which engine

will the display markers be placed, and on which engine the classification signals be shown? (22).

Answer.—The classification signal must be displayed on the leading engine in the place provided for it near the head light. The display markers on the place provided for them on the pilot of the rear engine.

NOTE.—When two or more engines are coupled together the sounding of signals and operation of the air should be done by the engineer of the leading engine. When running as an extra, the number on the leading engine is applied to the extra and orders addressed to this train should be addressed to the leading train, because the train is identified by its number. Copies of all clearances and all train orders must be provided for the engineer of each engine.

Question 95.—How must one flag the light up ahead when displayed as a classification signal? (23).

Answer.—In the same manner as if it were not displayed.

Question 96.—What must be displayed on the front of the leading car when cars are being pushed by an engine at night? (24).

Answer.—A white light.

Question 97.—Is there any exception to this rule? (24).

Answer.—There is. It need not be done when switching or making up trains in yards.

Question 98.—In the case of a passenger train must each car have communication with the engine? (25).

Answer.—Yes.

Question 99.—For this purpose what appliance is used? (25).

Answer.—Air whistle signals or gong and cord.

Question 100.—What must be done before coupling to, moving, or placing other cars in front of cars, engine,

or train, when protected by a blue signal if shown on the end of the car, engine or train? (26).

Answer.—It must be removed by the person who placed it there.

Question 101.—Is it permissible to place other cars on the same track, thereby intercepting view of the blue signals. (26).

Answer.—It is, provided the railroad men have first been notified.

USE OF SIGNALS.

Question 102.—In the event of the absence of a customary signal or a signal imperfectly displayed, how should it be regarded and what is your duty in such cases? (27).

Answer.—It should be regarded as a signal to stop and your duty would be to report it to a superior officer.

NOTE.—All fixed signals which include white lights are referred to by Rule 27.

Question 103.—What are the purposes for which the colors green and white are used? (28).

Answer.—To stop trains at block stations.

Question 104.—May the colors green and white be used to stop a train at a point other than a block stop for that particular train? (28).

Answer.—No. In such a case a red signal must be used.

Question 105.—When a signal other than a fixed signal is given to stop a train how must it be acknowledged? (29).

Answer.—By two short blasts of the whistle.

Question 106.—At what times is it absolutely requisite that the engine bell be rung? (30 & 31).

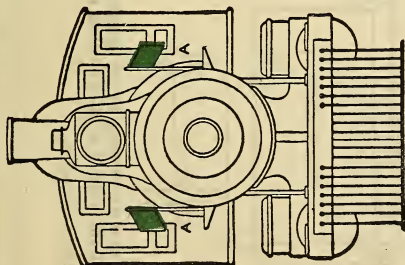

ENGINE RUNNING FORWARD BY DAY DISPLAYING SIGNALS FOR A FOLLOWING SECTION.

Green flags at A. A.

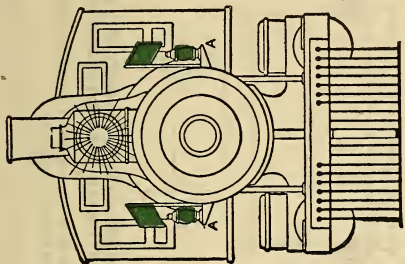

ENGINE RUNNING FORWARD AT NIGHT DISPLAYING SIGNALS FOR A FOLLOWING SECTION.

Green lights and green flags at A. A.

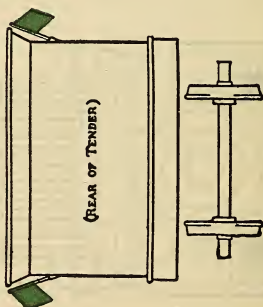

**ENGINE RUNNING FORWARD BY DAY, WITHOUT CARS
OR AT THE REAR OF A TRAIN PUSHING CARS.**

Green flags, as markers.

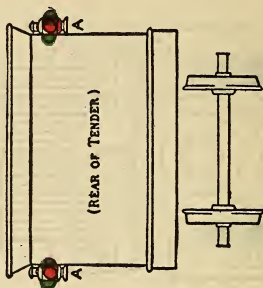

**ENGINE RUNNING FORWARD BY NIGHT, WITHOUT CARS
OR AT THE REAR OF A TRAIN PUSHING CARS.**

Lights at A, as markers, showing green to the front and side and red to rear.

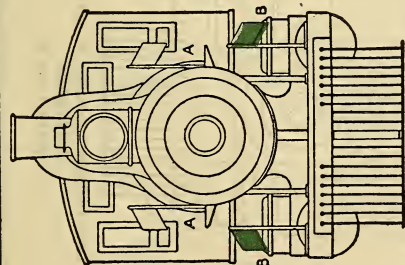

ENGINE RUNNING BACKWARD BY DAY AS AN EXTRA TRAIN, WITHOUT CARS OR AT THE REAR OF A TRAIN PUSHING CARS.

White flags at A.A.

Green flags at B B, as markers.

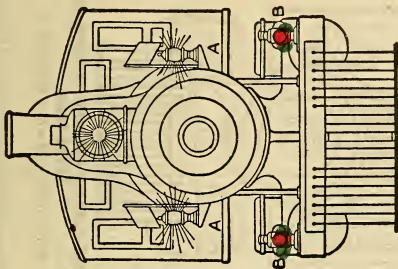

ENGINE RUNNING BACKWARD BY NIGHT AS AN EXTRA TRAIN, WITHOUT CARS OR AT THE REAR OF A TRAIN PUSHING CARS.

White lights and white flags at A.A.

Lights at B B, as markers, showing green at side and in direction engine is moving and red in opposite direction.

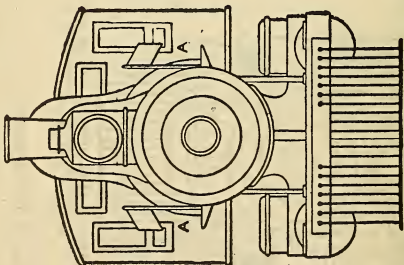

**ENGINE RUNNING FORWARD BY DAY AS AN
EXTRA TRAIN.**

White flags at A. A.

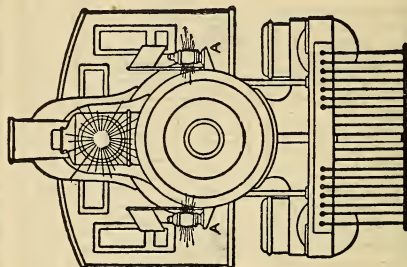

**ENGINE RUNNING FORWARD BY NIGHT AS AN
EXTRA TRAIN.**

White lights and white flags at A. A.

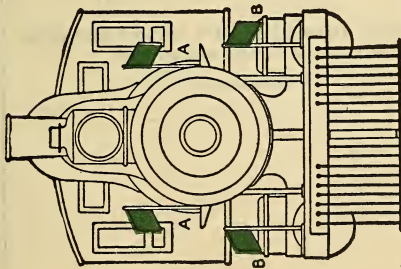

ENGINE RUNNING BACKWARD BY DAY, WITHOUT CARS OR AT THE REAR OF A TRAIN PUSHING CARS, AND DISPLAYING SIGNALS FOR A FOLLOWING SECTION.

Green flags at A A.
Green flag at B B, as markers.

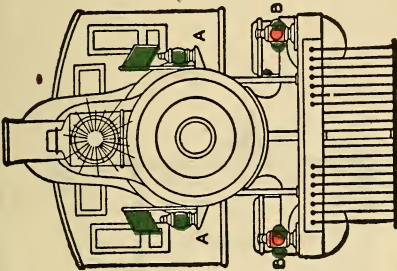

ENGINE RUNNING BACKWARD BY NIGHT, WITHOUT CARS OR AT THE REAR OF A TRAIN PUSHING CARS, AND DISPLAYING SIGNALS FOR A FOLLOWING SECTION.

Green lights and green flags at A A.
Lights at B B, as markers, showing green at side and in direction engine is moving and red in opposite direction.

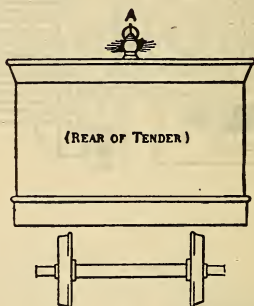

**ENGINE RUNNING BACKWARD BY NIGHT WITHOUT CARS OR AT
THE FRONT OF A TRAIN PULLING CARS.**

White light at A.

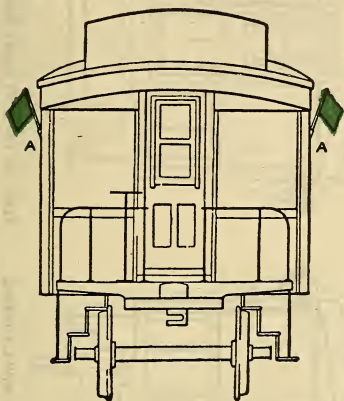

REAR OF TRAIN BY DAY

Green flags at A A, as markers

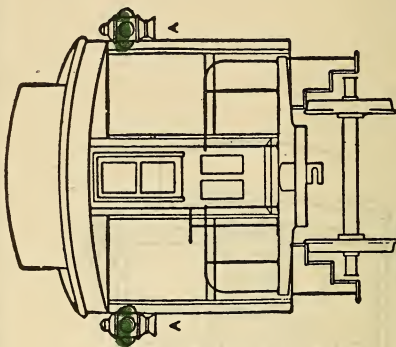

REAR OF TRAIN BY NIGHT WHEN ON SIDING TO BE PASSED BY ANOTHER TRAIN.

Lights at A A, as markers, showing green toward engine, side and to rear.

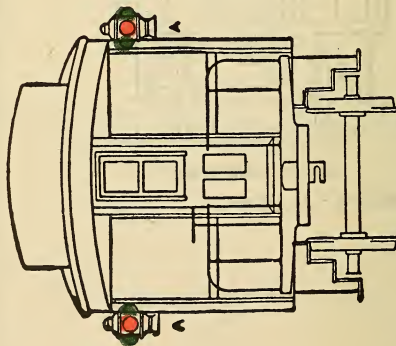

REAR OF TRAIN BY NIGHT WHILE RUNNING.

Lights at A A, as markers, showing green toward engine and side and red to rear.

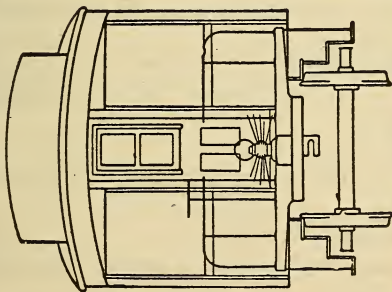

**PASSENGER CARS BEING PUSHED BY AN ENGINE
BY NIGHT.**

White light on front of leading car.

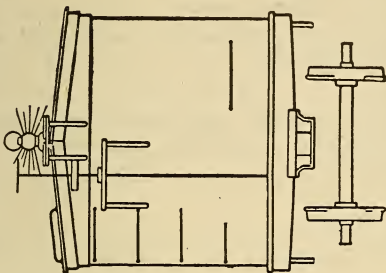

**FREIGHT CARS BEING PUSHED BY AN ENGINE
BY NIGHT.**

White light on front of leading car.

Answer.—Always when the engine is about to move when approaching every public road crossing at grade.

Question 107.—At what other places must the whistle always be sounded? (31).

Answer.—At all whistling posts.

Question 108.—Is it prohibited to use the bell and whistle unnecessarily? (32).

Answer.—Yes.

Question 109.—At Public roads and street crossings when will the rights be used by switchmen? (33).

Answer.—Only when necessary to stop trains.

SUPERIORITY OF TRAINS.

NOTE.—Except in the case of extra trains moving in the same direction on which the time table confers superiority by permitting it to hold the main track at a meeting point with an opposing extra train, there is no superiority between extra trains.

Question 110.—In what manner is one train superior to another? (71).

Answer.—By right, class or direction.

Question 111.—In what manner does a train acquire its rights? (71).

Answer.—By a train order.

Question 112.—How does a train acquire its class and direction? (71).

Answer.—By the time table.

Question 112a.—Explain which is superior, right, class or direction? (71).

Answer.—Right is superior to class or direction and direction is superior when governing trains of the same class.

Question 112b.—Explain relative superiority of trains to their respective classes. (72).

Answer.—First class trains are superior to trains of the second class and all successive classes. Second class trains are superior to third and all successive classes and so on. Trains in the direction as specified in the time table are superior to the trains of the same class running in the opposite direction.

Question 112c.—In this division in which direction are trains superior to trains of the same class in an opposite direction? (72).

Answer.—

Question 112d.—Are extra trains inferior to regular trains? (73).

Answer.—They are.

MOVEMENT OF TRAINS.

NOTE.—No matter how late they may be all schedule trains should register on the page which corresponds with the date on which the train is due to arrive or leave a station. Extra trains register on the page corresponding with the date they actually do arrive.

Question 113.—How late must a regular train be, before it loses both right and class? (82).

Answer.—After regular trains have become twelve hours late from schedule arriving or leaving time at any station they lose both right and schedule and thereafter proceed only as authorized by train order.

Question 114.—Suppose No. 6 is due to arrive at — at 9:30 a. m. and leave at 10:30 a. m., when will it have lost both its right and class? (82).

Answer.—If it fails to arrive at — before 9:30

p. m. or to leave ——— before 10:30 p. m., it will have lost its rights.

Question 115.—In such a case may No. 6 flag into ——— at 9:40 p. m. and leave there as No. 6 if it can get out before 10:30 p. m. and so retain its rights? (82)

Answer.—No, it cannot.

Question 116.—Would it be possible for it to leave as No. 6 before 10:30 p. m. providing the dispatcher authorizes it by train order? (82).

Answer.—Yes.

NOTE.—When trains are run in sections, any section which becomes twelve hours late on schedule, loses both its rights and class according to Rule 82, no allowance being made for sections running five minutes apart. A train which holds an order to run late, will lose both right and class as soon as it is twelve hours behind its schedule time. The fact that it has an order permitting it to run late does not lengthen the life of a train. In every case the schedule time as shown upon the time table is referred to by Rule 82.

Question 116a.—Suppose an opposing train has an order to meet No. 6 at a certain station and No. 6 came twelve hours late in arriving at that particular station, should the opposing train proceed against No. 6? (82).

Answer.—Yes.

Question 117.—Before leaving a junction terminal or any other stopping point or before passing from a double to a single track what must be ascertained? (83).

Answer.—It must be positively ascertained that all trains of the same or superior class have gone.

NOTE.—Rule 83 has reference to trains of the same class, even though they may be moving in the inferior direction, for the reason that a train of superior direction must approach all sidings prepared to stop, until in accordance with Rule 99 such train is met.

Question 118.—Without a proper signal may a train start? (84).

Answer.—No.

Question 119.—May a train proceed in advance of a train of the same class in the same direction? (85).

Answer.—Yes.

Question 120.—May one extra train pass another extra or may one train of a certain class pass a train of the same class? (85).

Answer.—Yes.

Question 121.—How must the time of a superior train be cleared by an inferior train going in the same direction? (86).

Answer.—By not less than five minutes.

Question 121a.—How must a first class train be cleared by an inferior train going in the same direction? (86).

Answer.—The inferior train must be cleared at the time the first class train is due to leave the next station, in the rear where the time is shown.

Question 121b.—With respect to approaching superior trains what is required of an inferior train? (87).

Answer.—It must keep out of the way.

Question 121c.—How must a train be protected which fails to clear the main track as required by rules? (87).

Answer.—In accordance with rule 99, it must be protected by flag.

Question 121d.—By how many minutes must the time of regular trains be clear by extras? (87).

Answer.—By _____ minutes.

Question 121e.—With respect to opposing extras how should extras be governed? (87).

Answer.—By train order.

Question 122.—Between trains of the same class at

meeting points, when must the inferior train clear the main track? (88).

Answer.—Before the leaving time of the train of the superior class.

NOTE.—Trains should not wait on a siding an unreasonable length of time for another train. In such cases a communication should be opened with the telegraph office for further instructions. When holding the main track at the meeting point or passing point, care should be taken to adjust the switch for other trains.

Question 123.—What must be done should it become necessary to back in, in order to clear the main track? (88).

Answer.—In accordance with rule 99, a flagman must be sent out unless other provision has been made.

Question 123a.—Which extra should take the siding when two extras pass at a meeting point? (88).

Answer.—The extra in the inferior time table direction.

NOTE.—When Rule 88 was adopted in the Convention it was the sense of the Convention that at a meeting point should an inferior train have occasion to back, it must stop the superior train before passing the switch where the inferior train enters. If the back-in provision is covered by a train order or special instruction it would be unnecessary to stop the superior train before backing in, although the flagman should be sent out in accordance with Rule 99 before the switch has been passed by the inferior train.

Question 124.—At meeting points between trains of unequal classes, by how many minutes must the inferior train clear? (89).

Answer.—The inferior train must take the siding and by at least five minutes, clear the time of the superior train.

Question 125.—What must be done in case the inferior train has to back in? (89).

Answer.—In accordance with rule 99, a flagman must be sent out to protect the train.

Question 126.—By how many minutes must an inferior train clear the time of a superior train going in the same direction? (89).

Answer.—Five minutes.

Question 127.—When are trains required to stop at scheduled meeting or passing points, although of the same class. (90).

Answer.—They are required to stop unless they can plainly see that the switch was right and the track clear.

Question 128.—At what point should the train be stopped? (90).

Answer.—It should be stopped clear of the switch in which the train to be met or passed uses when going on the siding.

Question 129.—Suppose a train to be met or passed is not the schedule meeting or passing point, in what way would the train be governed which has the right of track? (90).

Answer.—It should proceed with caution, approach the sidings prepared to stop, under full control until the expected train is met or passed.

Question 130.—In the absence of block signals, by how many minutes must trains going in the same direction be kept apart? (91).

Answer.—They should be kept at least five minutes apart in closing up at stations.

Question 130a.—Suppose trains No. 2 and No. 4 to be of the same class and No. 2 is scheduled to pass No.

4 at ——. In the event No. 2 or No. 4 should be late would it affect its passing point? (91).

Answer.—It would not. If number 4 were late, No. 2 would proceed to ——— and wait there for No. 4 to pass.

Question 130b.—If it were desirable that No. 2 should proceed ahead of No. 4, what form of order should be issued? (90).

Answer.—An order issued to read, "No. 4 will pass No. 2 at ———." (See form B, example 1 Standard Code).

Question 131.—Is it permissible for train to leave at a station in advance of the schedule time shown for it to leave? (92).

Answer.—No.

Question 132.—May a train leave a station before its leaving time as shown in the schedule? (92).

Answer.—No.

Question 133.—What class of trains may hold the main track by protecting against other trains when within yard limits. (93).

Answer.————— Class.

Question 133a.—When moving within yard limits, how should ——— class and extra trains proceed? (93).

Answer.—In full control, prepared to stop unless main track is seen or known to be clear.

Question 134.—Suppose a train overtakes another train of the same or superior class unable to move because of a breakdown, what should be done? (94).

Answer.—Assume the schedule and take the orders of the disabled train, if necessary, proceed to the next open telegraph office and report the particulars to the superintendent.

Question 135.—When a disabled train has surrendered its orders and rights to a following train that has passed it, on what rights does the disabled train then move? (94).

Answer.—On the rights of the train with which it exchanged orders?

NOTE.—If a disabled train has rights of its own to make the next telegraph office it is unnecessary for a passing train to assume its schedule and take its train orders. An exchange of orders and schedule would avail nothing in case the disabled train had been so long delayed that it had forfeited all rights to proceed. In that case the following train might have no rights and so both trains would be tied up. The exchange of orders and schedules should always be made complete. (See Rule 94.)

Question 135a.—If a train of inferior or the same class with rights or schedule to proceed should overtake a train between telegraph offices which is unable to proceed against the right of schedule of an opposing train, how should they be governed? (94).

Answer.—After proper consultation with the following train the delayed train precedes it to the next telegraph station, where it will report to —.

Question 135b.—What should be done when opposing trains are met under these circumstances? (94).

Answer.—It must be fully explained by the leading train that the excepted train is following.

Question 136.—Is it allowable for more than one section of a train to be run on the same schedule? (95).

Answer.—Yes.

Question 137.—Where there are more than one section of a train, does each section have equal timetable authority? (95).

Answer.—Yes.

Question 137a.—When signals are displayed by whose authority is it done? (95).

Answer.— —.

NOTE.—The practice varies on different railroads. Yardmasters are authorized to issue instructions to a train to display signals on some roads. Where the business is heavy, and the issuing of such orders by the Dispatcher would interfere with his other duties, it is customary for the yardmaster to issue such instructions. This practice is considered safe, because all sections must examine the register to ascertain before leaving that the section ahead of them has registered signals.

Question 139.—On a single track when signals displayed for following train are taken down at any point before the following train arrives, how should a conductor be governed under the respective conditions as follows: (96).

A. At a point where there is an agent, operator, switch tender or register book.

Answer.—Arrangements should be made by the Conductor with the agent, operator or switch tender to notify opposing train of same or inferior class.

B. Where there is no agent, operator or switch tender, what should be done?

Answer.—In this case, a flagman must be left to notify opposing train of the same or inferior class.

Question 139a.—How should these arrangements be made, verbally or in writing? (96).

Answer.—In writing.

Question 140.—When extra trains are run, by whose authority do they move? (97).

Answer.— —.

NOTE.—The displaying of signals or running of an extra train is left by the Standard Code to the discretion of the railroad. Usually for this purpose the Superintendent's initials are used.

Question 141.—When approaching the end of a double track, railroad crossings at grade, draw-bridges and junctions, how should trains proceed? (98).

Answer.—Under control prepared to stop unless switch and signals are right and track clear. In cases when it is required by law, trains must stop.

Question 142.—How must a train be protected which becomes delayed or stops under circumstances in which it may be overtaken by another train? (99).

Answer.—Flagman must immediately go back a sufficient distance to procure full protection provided with the usual stop signals.

Question 143.—Before returning, when the flagman is recalled to his train, what should he do? (99).

Answer.—Place two torpedoes on the rails.

Question 144.—When moving on a single track, how should front of engine be protected? (99).

Answer.—It should be protected by flag which should be shown by the head brakeman and in case he is unable to go by the fireman.

NOTE.—In regard to Rule 99, it may be noted the flagman must immediately go back without waiting for the conductor to send for him or the engineman to whistle him back.

Question 145.—Who must take the place of the flagman after he has gone back to protect the rear of the train? (100).

Answer.—The ———, if it is a passenger train and in the case of other trains, the next brakeman.

Question 146.—If a train should part while in motion, what should be done? (101).

Answer.—The train parted signals should be given as prescribed by rules 12 (d) and 14 (f) and attempt made

to prevent the detached portions from becoming damaged. The detached portion should not be moved or passed until the front portion (which has right of track to return) comes back. If the vision is obstructed, a flagman should be sent ahead to the foremost portion which must run with great caution.

Question 147.—How would you proceed in case you overtook a train that had parted? (101).

Answer.—Would neither move or pass around the rear portion.

Question 148.—What precaution must be taken to insure safety when train is being pushed by an engine? (102).

Answer.—In order to signal in case of necessity the flagman must ride on the head car.

Question 149.—In what form ought messages to be given respecting the movements of trains or condition of track and bridges? (103).

Answer.—In writing.

Question 150.—After using switches how should they be left? (104).

Answer.—In proper position.

Question 151.—What member of the train crew is responsible for the proper adjustment of switches? (104).

Answer.—Except in cases where switch tenders are stationed, the conductor.

Question 152.—If a section of a train is following, is it permissible to leave the switch open? (104).

Answer.—It is not, unless it is in charge of a trainman of the following train.

Question 153.—What members of the train crew are held responsible for the safety of their train? (105).

Answer.—The Conductor and the Engineman.

Question 154.—What must be done by Conductors and Enginemen when an emergency arises that is not covered by the rules? (105).

Answer.—Every precaution must be taken to prevent accident.

Question 155.—What should be done in case of doubt or uncertainty? (106).

Answer.—The safe course must always be taken and no risks run.

RULES FOR MOVEMENT BY TRAIN ORDERS.

Question 156.—Why are train orders used and in what form should they be issued? (201).

Answer.—To govern the movements of trains not provided for by timetable; they must be issued in the prescribed forms.

Question 156a.—What must train orders contain and how should they be worded? (201).

Answer.—They must contain only information and instruction governing the movements of trains; in their wording they must be brief and clear.

Question 156b.—Is it proper to accept train orders which show erasures and interlineations? (201).

Answer.—No.

Question 157.—When the same train orders are issued to various persons or trains, must they be given in exact form and wording to each? (202).

Answer.—Yes.

Question 158.—When a new series of numbers for train orders is started, at what time each day will it begin and in what order are they numbered? (203).

Answer.—A new series begin at midnight and they are numbered in consecutive order.

Question 159.—When train orders are issued, to whom are they addressed? (204).

Answer.—When issued to a train, they must be addressed to the conductor, engineman and also to anyone who acts as pilot and in other cases to those who are to carry them into execution.

Question 159a.—Should each engineman have copies of all orders affecting a train when two or more engines are attached to it? (204).

Answer.—Yes.

Question 159b.—May the train order issued to one train be applied to and used by any other train? (204).

Answer.—No.

Question 159c.—When train orders are addressed to operators, restricting movements of trains, how should they be respected by conductors and enginemen? (204).

Answer.—The same as if addressed to them.

Question 160.—Must train dispatchers keep a record of train orders, and if so, when must such records be made? (205).

Answer.—The train dispatcher must keep a full record of all train orders issued in a book provided for the purpose, must record the names of those who have signed for the orders, the time, signals and from what office the order was repeated and the response transmitted. Must also have the train dispatcher's initials. Such record must be made immediately at time orders are given and completed and never from memory or memorandum.

Question 161.—In what manner are regular trains designated in train orders? (206).

Answer.—Always by their numbers. For example,

"first No. 6 or second No. 6" and where desirable the engine number may also be added.

Question 161a.—How are extra trains designated in train orders? (206).

Answer.—Extra trains are designated by their engine numbers with the direction of the train added. For example, "Extra 678 West."

Question 161b.—How should train numbers and time be stated on train orders? (206).

Answer.—Only in figures.

Question 162.—When dispatcher is transmitting an order what signal does he give to each office? (207).

Answer.—"31 or 19" followed by direction and by information that more or less than three copies are desired, the operator is informed. For example, "31 West copy 5" or "19 East copy 2."

NOTE.—These signals may be omitted where figures 31 and 19 are not both in use.

Question 163.—When a train order is to be sent to two or more offices, in what manner must it be sent? (208a).

Answer.—Simultaneously to as many as practicable.

Question 163a.—In what order must several addresses be given when a number of orders are sent simultaneously? (208a).

Answer.—In the order of superiority of trains, each office taking its proper numbers.

Question 164b.—When train orders are not sent simultaneously to all, how will the order be sent? (208a).

Answer.—To the superior train first.

Question 164c.—What will the operator at the meeting or waiting point do with the train orders? (208b).

Answer.—Deliver copies of the order to all trains affected, until all have arrived from one direction.

Question 165.—When operators are transmitting train orders should they make copies of them on manifold blanks and in case he fails to make enough copies how may he supply them? (209).

Answer.—He must write copies in manifold and failing to make sufficient number must trace others from one of the copies first made.

Question 166.—When operators have a “31” order to repeat, how should they proceed? (210).

Answer.—They must repeat the order immediately from the manifold in the succession in which the several offices have been addressed and watch to see that others repeat it correctly unless otherwise directed.

Question 167.—Who is to sign for it after the order has been repeated? (210).

Answer.—The person to whom the order is addressed, except enginemen.

Question 168.—What must the operator do after the order has been signed? (210).

Answer.—Send the signature to the dispatcher who will then give the “complete” and time; also the initials of the ——— after which the operator will write on each copy the word “complete,” the time and his last name in full and deliver a copy to each person addressed except the engineman. The copy to each engineman must be delivered to him personally by ———.

NOTE.—In regard to Rule 210, the blanks may be filed to suit the requirements of each road. On roads where the signature of the engineman is desired the words “except engineman” may be omitted. If preferred each person receiving an order may be required to read it aloud to the operator.

Question 169.—What must be done when a “No. 19” order is received? (211).

Answer.—Unless otherwise directed the operator must repeat it at once from the manifold copy in the succession in which the several offices have been addressed, care being taken by each operator to see that the others repeat it correctly. When the order has been correctly repeated the response “complete” and the time with the initials of the —— will be given by the train dispatcher. The operator will then write on each copy the word complete, the time and his last name in full and personally deliver a copy to each person addressed without taking his signature. If in order to deliver a copy to the engineman the operator must leave the immediate vicinity of the office, the engineman’s copy will be delivered by ——.

Question 169a.—How will delivery be made when a “19” train order is issued for a train at a point where its superiority is restricted by such an order? (211).

Answer.—Train must be brought to a stop before delivery of an order.

Question 170.—When may “X” response be given in acknowledgment of a train order having been delivered? (212).

Answer.—A train order may, when so directed by the train dispatcher, be acknowledged without repeating by the operator and he will say “X” (order) No. —— to (train) No. ——, giving also his initials and office signal. After having done this he will write on the order his initials and the time.

Question 171.—In the case of an inferior train when may “complete” be given? (213).

Answer.—When the order has been repeated or “X” response has been sent by the operator who receives the order for the superior train.

Question 172.—Before “complete” has been given and

after it has been repeated or "X" response sent, how is an order regarded? (214).

Answer.—As a holding order.

Question 172a.—When a train order has been repeated or "X" response sent and before "complete" has been given how then must the order be treated? (214).

Answer.—As a holding order for train addressed.

Question 172b.—In case the wire fails after a "31" order has been sent and repeated or "X" response sent and before "complete" has been received, has the train the right to proceed to which the order is addressed? (214).

Answer.—No.

Question 172c.—If before an office has repeated an order or "X" response has been sent the wire should fail, would the order be effective? (214).

Answer.—No.

Question 173.—Which of the copies of the train order should be kept by the operator? (215).

Answer.—The lowest copy.

Question 174.—When train orders are delivered by the train dispatcher what are the requirements as to record and delivery? (216).

Answer.—Same as at other points or offices.

Question 175.—In the case of a train order being delivered to a train at a point not a telegraph office or at a station at which the telegraph office is closed, how should it be addressed? (217).

Answer.—Conductor and Engineman at _____ No. _____ care _____.

Question 175a.—When form "31" is used, whose signature must be taken before "complete" is given and what copies should the person delivering the order have? (217).

Answer.—The person in whose care the order is sent should sign it and should have one copy for the engineer, one for the conductor and one for the person who delivers the order.

Question 175b.—Whose signature must appear on the copy which he retains and what must he do with it? (217).

Answer.—The signature of the conductor and engineer of the train to which the order applies. It should be delivered to the telegraph office which he can first reach.

Question 175c.—Is the order to be regarded as if “complete” had been given in the usual manner by the train receiving it and so be governed accordingly? (217).

Answer.—Yes.

Question 175d.—May “complete” be given to an inferior train when orders are sent as above, before the signature of the conductor and engineer of the superior whose rights are thereby restricted? (217).

Answer.—No.

Question 176.—When a train is running in more than one section, are all its sections included when it is named in an order unless particular sections are specified and should copies of the orders be furnished to each section? (218).

Answer.—Yes.

Question 177.—May the “X” response or repeat be given by an operator to a train order for a train, the engine of which has passed the train order signal before they ascertained that the conductor and engineer had been notified that he has orders for them? (219).

Answer.—No, not unless otherwise directed.

NOTE.—The “X” response is to be used to save time in getting an inferior train started. Quite a saving of time is effected when

several orders are concerned. The Dispatcher, however, should require a repetition of the order as soon as he can get it when the "X" response has been used.

Question 178.—After train orders have once taken effect, how long do they continue in force? (220).

Answer.—Until fulfilled, superseded or annulled.

Question 179.—May a particular portion of an order which specifies a particular movement be annulled or superseded? (220).

Answer.—It may.

Question 179a.—Suppose a train has lost its rights as per rule 4 and 82, would orders held by or issued for it be effective? (220).

Answer.—No.

Question 179b.—Suppose a certain part of an order relating to a regular train should become void when such a train has lost both right and class in accordance with rule 4 and 82 or is annulled, does that part of the order become void? (220).

Answer.—It does.

NOTE.—The annulment indication of the signal on some roads is "proceed." Where such is the case, the following five questions do not apply.

Question 180.—When the operator is on duty at train order office, what does the fixed signal indicate? (221a).

Answer.—Stop.

Question 180a.—When a stop signal is displayed may a train pass? (221a).

Answer.—No.

Question 180b.—When is this signal fastened at "Proceed?" (221a).

Answer.—When there is no operator on duty.

Question 181c.—What is required of conductor and engineer if the train order signal is not displayed at a night office? (221a).

Answer.—Bring the train to a stop, learn the cause and report the facts from the next open telegraph office.

Question 181d.—In case fixed signals fail, what signals must operators keep on hand to use in their stead? (221a).

Answer.—Hand signals.

NOTE.—Where the annulment indication of the signal is “stop,” as it is on some roads, the following seven questions will not apply.

Question 182.—At a train order office what is indicated when fixed signal is displayed and there are no orders? (221b).

Answer.—Proceed.

Question 182a.—When there are orders what will the fixed signals indicate? (221a).

Answer.—Stop.

Question 182b.—In case an operator receives the signal “31” or “19” what should he do? (221b).

Answer.—Display the stop signal immediately and reply “Stop and Display.”

Question 182c.—When the dispatcher gives the “31” or “19” signal must he give the direction also? (221b).

Answer.—Yes.

Question 182d.—Under what conditions may a train pass a train order stop signal? (221b).

Answer.—When a clearance card is issued.

NOTE.—No trains must pass while a train order signal remains at block, notwithstanding they may have received orders without first getting a clearance card.

Question 183e.—What must be done if signals are not displayed from a night office? (221b).

Answer.—Bring the train to a stop, learn the cause and report at the next open telegraph office.

Question 183f.—When the signal indicates stop, in what position is it? (221b).

Answer.—————.

Question 183g.—In case these signals fail what must operators have on hand ready for use? (221b).

Answer.—Hand signals.

NOTE.—If an operator changes signal from stop to proceed after the train has stopped the conductor may signal it to leave, and it may proceed without orders or clearance card, provided that the engineman can see the signal is clear.

Question 184.—Should operator record the time of trains and report same? (222).

Answer.—Yes.

Question 185.—What abbreviations are customary? (223).

Answer.—

Signs for the signature of the ———.

Such offices and other signals as are arranged by the

C. & E.—for Conductor and Engineman.

“X”—Train will be held until order is made “complete.”

Com.—for Complete.

O. S.—for train report.

No.—for Number.

Eng.—for engine.

Sec.—for section.

Psgr.—for passenger.

Frt.—for freight.

Mins.—for minutes.

Jct.—for junctions.

Dispr.—for dispatcher.

Opr.—for operator.

“31” or “19” to clear the line for train orders and for operators to ask for train orders.

S. D.—for Stop and Display.

The usual abbreviations for the minutes and the stations.

FORMS OF TRAIN ORDERS.

After a train has been signed for by the conductor, he is held responsible for his train being safely moved or held in accordance with the order. After the engineman has received his copy of the order he is held equally responsible with the conductor. Unless he is positive that he has his train fully under his control the conductor has not the right to sign for an order.

When a train is running extra on a schedule it does not lose its rights when it is twelve hours late.

Question 186.—How would the conductor or engineman of train No. 4 be governed if holding an order which read: “No. 4 meet No. 3 at D.” In case No. 3 arrived at D displaying signals?

Answer.—Should hold No. 4 at D for following sections because no particular section having been specified in the order, all sections are included and should be given copies of the order.

Question 187.—Suppose an order that train No. 4 would meet second No. 3 at D and then that second No. 3 arrived with signals. No. 4 being a train of superior class what should be done?

Answer.—A particular section being mentioned in the order and therefore no other section being included No. 4 would proceed.

Question 188.—In the event second No. 3 carried no markers and arrived without signals would train No. 4 proceed?

Answer.—No. Until its markers have arrived a train is considered not to have been met.

NOTE.—Let us suppose the following orders have been issued: “No. 3 will meet No. 4 at D. No. 4 will sidetrack.” “No. 3 will meet No. 4 at E. instead of D.” Now which of these two trains will take the siding at E.? According to the rules No. 4 should go on the sidetrack at E., because the first was a two-movement order yet only one movement has been superseded. It is clearly to be seen that No. 4 has certain privileges, one or more of which it may have taken away by a train order. For instance, No. 4 being a train of superior direction may proceed against No. 3. But, if a meeting point is fixed with No. 3, the privilege to proceed against No. 3 beyond the specified meeting point is lost to No. 4, although No. 4 still has the privilege of holding main track at the meeting point indicated in the order, unless the privilege also has been taken away. Each of these privileges is distinctly separate and the superseding of the portion of the order relative to the meeting point does not operate to supersede the sidetracking provision. In the same manner and by the same principle superseding the sidetracking provision does not supersede the meeting point provision.

Question 189.—Suppose the Conductor or Engineman of train No. 4 held an order reading: “No. 4 meet first No. 3 at C and second No. 3 at E,” and if upon arrival at E another order were received reading: “No. 4 meet second No. 3 at F,” how should they be governed?

Answer.—They should stay at “E” until proper orders were received because as the order to meet at “F” did not say “instead of” it does not supersede the former order.

Question 190.—Suppose train No. 1 holds order No. 4 to meet No. 2 at B and first No. 2 should arrive at B with signals and the dispatcher gave train No. 1 order No. 5

reading: "No. 1 will meet second No. 2 at C," what would be the effect on the movement of train No. 2?

Answer.—It could not proceed. The words "instead of" not being in order No. 5 prevents it superseding the original order and besides it is not a proper form or order to give. It ought to read: "No. 1 will meet second No. 2 at C instead of B." If thus worded No. 1 could proceed to C.

Question 192.—What should train No. 1 do supposing it held orders No. 4 and No. 6 in case second No. 2 should arrive at C with signals?

Answer.—Expecting third No. 2 to be on the way to B by reason of the right of order No. 4, train No. 1 must immediately get clear, as in that case only that part of order No. 4 was superseded which had reference to No. 2.

FORM B.

Question 193.—Suppose an order reading: "No. 5 pass No. 7 at H," how should the Conductor or Engineer of No. 5 be governed thereby?

Answer.—They should approach H under control prepared to stop unless it should be clearly seen that No. 7 was in the clear and the switches set right.

Question 194.—Suppose an order reads: "Extra 690 East run ahead of No. 8 D to E," how should the Conductor or Engineer be governed thereby?

Answer.—Would neither pass the extra specified in the order nor exceed their speed between the points named, and should approach E prepared to stop unless Extra 690 East was clear and the switches right.

Question 195.—If Extra 24 received an order reading: "Extra 24 pass No. 4 at E," would the order be sufficient

authority for the extra to pass and proceed ahead of No. 4?

Answer.—It would. An order for an inferior to pass a superior train is proper authority for the inferior train to proceed ahead of the superior one.

Question 196.—Must trains of any one class have orders to pass trains of the same class in the same direction?

Answer.—No.

Question 197.—Do extra trains require orders to pass extras?

Answer.—They do not.

FORM C.

Question 198.—Suppose the Conductor or Engineer of train No. 4 held an order reading: "No. 3 has right over No. 4, A—to B—," should No. 4 pass B before arrival of No. 3?

Answer.—Yes, in case the running time and clearance of No. 4 would enable it to make an intermediate point for No. 3.

Question 199.—If an order reads: "Extra East, 769—has right over No. 5, G to K," would No. 5 go beyond K before the arrival of the extra; if not, why?

Answer.—It would not, because the time of Extra 769 would not be restricted by the time-card.

Question 200.—How should the Conductor or Engineer of Extra 769 be governed?

Answer.—Proceed against No. 5 G— to K— and at K— take the siding.

Question 201.—Suppose the order to the Conductor or Engineer of the extra extended beyond K and No. 5

had failed to arrive on arrival of Extra 769 at K, would the extra proceed against No. 5 and under what circumstances?

Answer.—In case of sufficient time for the Extra to make a point beyond K and to clear the time of No. 5 would proceed and clear the time of No. 5 as provided by the rule.

Question 202.—Suppose the Conductor of No. 4, a superior train, held an order which read: "No. 3 has right over No. 4 B— to G—," and he received another order reading: "No. 4 will meet No. 3 at —," should he pass by?

Answer.—Yes; he would have the right to proceed to D— and go on sidetrack for No. 3. The right of a track order merely operates to reverse the rights of the trains only between the points mentioned in the order.

Question 203.—Suppose the Conductor of No. 4 held the same orders excepting that the meeting point were B, would he then go on the sidetrack?

Answer.—He would not. If the trains met between the designated points No. 4 must sidetrack. If, however, they meet at one of the points specified No. 3 must go on the sidetrack.

Question 204.—If an order giving right of track is issued to a train of an inferior class against a train of a superior class to a certain named point, which of the two trains must go on the sidetrack?

Answer.—If they meet between the points named in the order the train of the superior class will take the siding.

Question 205.—If, under the conditions indicated in the foregoing questions, a train of superior class should reach the second point indicated in the order before the

train of the inferior class arrived there, could it proceed and if so under what circumstances?

Answer.—It may proceed by keeping clear of the opposing train's time by as many minutes as such train was, under the rules, before required to clear it.

Question 206.—If an extra train gets a right of track order against a train of superior class to a specified point, may the superior train proceed beyond the point named in case the extra fails to arrive?

Answer.—No.

Question 207.—We will suppose that No. 4 of superior direction receives an order that second No. 3, a train of the same class, has right over No. 4—B to E, the regular schedule meeting point for No. 3 and 4. It is expected that first No. 3 will make E on time, but because of a hot-box No. 3 takes the sidetrack for No. 4 at D, a blind siding. In that case, what should No. 4 and second No. 3 do?

Answer.—No. 4 should go on to D against first and second No. 3, because the form C order merely reversed the rights of the trains. No. 4 possessing rights over first No. 3 would proceed against second No. 3 until meeting first No. 3. In such a case second No. 3 would have no authority to use the schedule time of No. 3 ahead of the signals carried by the latter. Before second No. 3 gets authority to pass a given point the signals carried by first No. 3 must have passed that point.

FORM E.

Question 208.—How should the conductor of No. 4 be governed if he held an order reading: "No. 4 wait at Hinsdale till 11:00 a. m. for No. 1?"

Answer.—He should not pass Hinsdale before 11:00 a. m. unless No 1 had previously arrived.

NOTE.—Trains using the same time must clear such time the same as before required to clear the regular schedule time when moving under direction of a Form E. order.

Question 209.—How should the conductor of No. 3 be governed seeing that both are trains of the first class?

Answer.—He should proceed to Hinsdale and go on sidetrack to clear the main track by 11:00 a. m.

Question 210.—Suppose the conductor or engineer of a train of inferior right received an order reading: "No. 3 will run 20 minutes late Hinsdale to Aurora," how should he be governed thereby?

Answer.—He should consider the schedule time of No. 3 to be 20 minutes later than its time as indicated on time-card between Hinsdale and Aurora.

Question 211.—Suppose the conductor of an inferior opposing train received an order reading: "No. 3 run two hours late Galesburg to Chicago," how much time would he have in which to make Galesburg?

Answer.—One hour.

NOTE.—Under Form E. only may the trains use the time, and then only between the points named in the order, and never from an intermediate point beyond the point named to make either of the points specified in the order.

FORM F.

Question 212.—Suppose an order were issued which read: "No. 3 display signals Galesburg to Chicago for engine 52," would that give authority to engine 52 to proceed, and if so, as what?

Answer.—Yes. It should proceed as second No. 3. (See example (3) under Form F, Standard Code.)

Question 213.—How should engine 60 run under the following order: “Engine 52, 60 and 75 run as first, second and third No. 3. Aurora to Hinsdale?”

Answer.—Engine 60 would run as second No. 3 with signals.

Question 214.—What form must be used when it becomes necessary to annul a section for which signals have been displayed over a division or any part thereof, when no train is to follow the signals?

Answer.—Form K.

Question 215.—Suppose second No. 3 received an order at Downer's Grove, an intermediate station, reading: “Engine 60 is withdrawn at Downer's Grove following section change numbers accordingly.” What should be done?

Answer.—Get into the clear on the sidetrack and remove signals as rights would then have been lost.

Question 216.—As what would engine 75 run from Downer's Grove?

Answer.—As second No. 3 without signals.

FORM G (EXTRA TRAINS.)

Question 217.—If an order reads: “Engine 99 run extra A to D,” how would it proceed?

Answer.—It would run to D, taking care to keep clear of all regular trains.

NOTE.—Upon reaching the last station specified in their orders extra train must take the sidetrack at switches where inferior trains going in that direction clear for superior trains. The main track must not be held by extras at their originating or terminating points.

Question 218.—Under the order immediately preceding the above note must opposing trains be protected against?

Answer.—No.

Question 219.—Under this order is the right given to occupy the main track at D?

Answer.—No. The siding at D must be taken.

Question 220.—What trains and by how much time must extra trains clear?

Answer.—All regular trains and by five minutes.

Question 220a.—Suppose engine 85 had an order to run extra A to F—and return, would it have to go to F as extra 85 before making the return trip?

Answer.—Yes. Because failing so to do the order would not have been fulfilled.

Question 220b.—If according to examples 3, under Form G, Standard Code, engine 65 held an order to run extra would it lose its right when it became twelve hours late?

Answer.—No.

Question 220c.—If engine 69 held order No. 1 to run extra A to F and meet No. 36 at F and should be given order No. 2 upon arrival at F to run extra F to G and meet No. 36 at G, should it be regarded as a proper order?

Answer.—Yes; because when engine 69 arrived at F its order was fulfilled and it ceased to be an extra, therefore it possessed no further rights; but upon receiving order No. 2 it again became an extra.

Question 220d.—Suppose engine 69 arrived at F under order No. 1 and was given order No. 3 to run extra to G instead of F and was given also order No. 4 to meet No. 36 at G, could it run to G for No. 36?

Answer.—No. Order No. 3 would not make engine 69 a new extra from F, therefore order No 4 would be improper by not stating “instead of.”

NOTE.—The dispatcher should in each and every case, when originating an extra, fix a meeting place for them with all opposing extras, that one extra would wait for another extra until a certain time at a designated station. Such an order is an improper one for the protection of extra trains, as it fails to restrict the rights of opposing extras.

FORM H (WORK EXTRA).

Question 221.—Suppose an order were issued to the engineman on engine 292 reading: “Engine 292 works 7:00 a. m. to 6:00 p. m. between D & E,” how should he be governed thereby?

Answer.—He should clear the time of regular trains and protect against extras in both directions.

Question 222.—Suppose the order specified, “Not protecting against extras,” then how should he be governed?

Answer.—He should clear the time of regular trains, but should not protect against extras.

Question 223.—What governs in case extra 292 should receive an order reading: “Work extra 292 clears (or protects against) extra 64 east between D and E after 2:10 p. m.?”

Answer.—Extra 292 would have to either clear at 2:10 p. m. or protect as directed.

Question 224.—How would the order affect extra 64 east, and in what way would it proceed?

Answer.—It would not enter the prescribed limits before 2:10 p. m. After that time it would proceed in expectation of finding a clear main track or the work extra protecting as directed by the order.

Question 225.—What should be done if a work extra received an order reading: “Work extra 292 protects against No. 35 between D & E?”

Answer.—It should work on the time of No. 35, protecting in accordance with rule 99.

(See examples under “Form H,” Standard Code.)

FORM J.

Question 226.—If an operator held an order reading: “Hold No. 2,” how should it be respected by the conductor or engineer of No. 2?

Answer.—Exactly the same as though addressed to them. They should not leave until an order was received annulling the order, or until an order was received by the operator reading: “No 2 may go.” (See examples in Standard Code.)

Question 227.—In what manner should the operator handle this form of orders?

Answer.—He should acknowledge them in the usual manner and deliver them to the conductors and engineers of all trains affected by them.

Question 228.—What is a Form J order called?

Answer.—An holding order.

Question 228a.—When should a Form J order be used?

Answer.—Only to hold trains until orders can be delivered or in cases of emergency.

Question 229.—May a train proceed after having been held by a Form J order if it receives an order reading: “_____ may go,” and yet the signal remains at “Stop?”

Answer.—No. The order permitting it to go merely

clears the train on the "Hold" order, not, however, clearing it on the stop signal; therefore, without first receiving a clearance card, in addition to the "may go" order, it cannot proceed while the signal remains at stop. In accordance with Rule 221, a clearance card is positively necessary.

FORM K.

Question 230.—How would the rights of train No. 1 be affected, if under Form K an order were issued reading: "No. 1 of Feb. 29th is omitted A— to Z—?"

Answer.—It would lose all rights between the points designated.

Question 231.—When a train is annulled to a given point, are its rights beyond that point affected by the annulling order?

Answer.—No.

Question 232.—May a train thus annulled between given points be restored by special order?

Answer.—No.

Question 233.—Suppose an order were held by a conductor reading to meet No. 1 at Hinsdale and later he received an order to the effect that No. 1 had been annulled, how should he proceed?

Answer.—The order reading to meet No. 1 should be considered void according to Rule 220.

Question 234.—How would the rights of No. 1 be affected by an order reading: "Second No. 1 of Feb. 29th is annulled E to G?"

Answer.—It would have no rights or schedule between the points designated. (See examples given in Standard Code under Form K.)

FORM L.

Question 235.—How should an order read which is to annul an order previously issued?

Answer.—“Order No. —— is annulled.”

Question 236.—Should it be numbered, transmitted and signed for the same as other orders?

Answer.—Yes.

Question 237.—When an order has been annulled or superseded, may it be restored under its original number?

Answer.—No.

FORM M.

Question 238.—May a part of an order be annulled when it provided for two or more movements, and if so, how?

Answer.—It may. By an order reading: “That part of order No. —— reading —— is annulled.”

Question 239.—Would a form M order so issued affect either of the other movements not so annulled?

Answer.—No.

FORM P.

Question 240.—When it is necessary to supersede an order or a part thereof, how should it be done?

Answer.—By adding to the prescribed forms the words, “instead of ——.”

Question 241.—May an order when once superseded be again issued under its original number?

Answer.—No.

RULINGS OF THE AMERICAN RAILWAY ASSOCIATION.

Question.—Who fills out the “Train Number” on bottom of 31 orders?

Answer.—It is the opinion of the committee on Train Rules that the conductor, when he signs the order, should indicate the train he is running in the space provided for the purpose.

Question.—At the last change of time, on one of our divisions, the time-table went into effect at 12:30 a. m., Sunday, Sept. 25th. On the old card train No. 1 left “A” at 6:30 p. m., arriving at “B”—the end of the run—at 10:00 p. m. On the new card this train (No. 1) was scheduled to leave “A” at 6:20 p. m., and run through to “D,” leaving “B” at 9:50 p. m., and arriving at “D” at 11:40 p. m. No. 1 was daily except Sunday, on both cards. The question is, would No. 1, leaving “A” Saturday, the 24th, have a right to proceed north of “B” after 12:30 a. m. of the 25th?

Answer.—In answer to the question: “Would No. 1, leaving ‘A’ Saturday, the 24th, have a right to proceed north of ‘B’ after 12:30 a. m. of the 25th?” It is the opinion of the committee that it would not.

Question.—Under the Standard Code of Train Rules, can a light engine running as first section of regular train No. 2 (a mixed train) be given an order by the dispatcher to run ahead of time?

Answer.—The Standard Code does not provide for the running of a regular train ahead of time. In the opinion of the committee, the practice should not be permitted.

RIGHTS OF TRAINS IN YARD LIMITS.

Where yard limits are defined by yard limit boards, does it authorize yard engine, or in fact any train within those limits, to occupy main line on the time of same or superior class trains without protection? For example: Extra arrives at station where yard limits are defined by yard limit boards. Can it proceed with its work in yard limits without protection on the time of regular trains?

Answer.—No.

Ruling Sept. 24, 1900.

YARD ENGINES.

Is it supposed to be understood that yard engines will conceal their headlights when they are working on tracks in yards adjacent to the main track? I do not find where this question has been discussed and will thank you for any information you can give me on the subject. We have discussed the question several times at our local meetings, but are undecided whether headlights of switch engines in yards should be concealed or not.

Answer.—Yard engines under the rules are not required to conceal the headlights in yards.

Ruling Sept. 24, 1900.

RULE 82.

Under Rule 82. A train scheduled to arrive at B at, say 10:00 a. m., leaves B at 10:30 a. m. and to arrive at C at 11:00 a. m., fails to reach B before 10:00 p. m. and flags itself to B. Has it a right under the rules to pro-

ceed to C provided it can leave B before 10:30 p. m. and arrive at C at or before 11:00 p. m.?

Answer.—No; unless authorized by train order.

Ruling Sept. 24, 1900.

REGULAR TRAINS PASSING.

Say a local freight, No. 1, was scheduled at B to arrive at say 9:00 o'clock and leave at 9:30. A through freight, No. 3, of the same class and running in the same direction, scheduled to pass B at 10:00 o'clock. If No. 3 finds No. 1 at B at 10:00 o'clock, or at any time thereafter, and not ready to leave, can No. 3 run ahead of No. 1 without train orders?

Answer.—No; unless No. 1 is disabled.

Ruling Sept., 1900.

EXTRA TRAINS PASSING.

When an extra overtakes another extra, has it a right to pass the first extra without orders?

Answer.—One extra has no right to run around another extra moving in the same direction without special orders.

Ruling Sept., 1900.

RULE 17 (NEW RULE 3).

We have seven branches on which one or more of the crews start in the morning from the end of the road, come to the junction point with the main line and return to the end of the road in the afternoon. It is our intention to have standard clocks at junction points, and I

would be pleased to know if we would be conforming to the rule by having the men regulate their watches when they arrive at the junction point, or whether we should have a standard clock at the end of each of these branches.

* * *

Answer.—The committee decides that it would be entirely in conformity with the spirit of the rule to put standard clocks at the junction points, covering the same by special instruction.

Ruling March 19, 1902.

19 ORDER.

Can a 19 form of train order be used in moving trains whose rights might thereby be restricted? It is not considered good practice to use this form of order, will you kindly advise the purpose of showing "X" response on the Standard train order blank for this form of order? Heretofore, our company has not used a 19 order for a train whose rights would be restricted thereby.

Answer.—Yes; but the restriction of the use of the 19 order by any road so desiring, is permissible under the standard code.

RULE 210 AS TO OK.

Under Rule 210, should train dispatcher acknowledge repetition of a train order by the operator by giving OK?

Answer.—In reply to this question, the committee is of the opinion that while there is no objection to the use of the OK as suggested, the rules do not require it. It was considered by the committee not to be necessary for the safety of operation, and was, therefore, omitted.

Ruling 1902.

31 ORDER.

Order No. 50, sent June 30th, at 10:15 p. m., for engine 15 to run extra A to Z OK given at 10:20 p. m. I will ask if this order given June 30th and OK at 10:20 p. m. signed and made complete July 1st 12:15 a. m., was sufficient orders for the train to move? Or, in other words, does the fact that this order was placed on June 30th and OK'd on that date and not signed for three hours, which put it in another month (July) and complete given at 12:15 a. m., made it of no value?

Answer.—A train order is in effect when it has been repeated or "X" response sent as provided in Rule 214. Train orders once in effect continue so until fulfilled, superseded or annulled as per Rule 220.

RULE 3.

1. The schedule leaving time of train 800 at Dover, a terminal station, is 1:10 p. m. The schedule arriving time of train 801 at Dover is 1:10 p. m. Is Dover a regular meeting or passing point for those two trains, and is it to be indicated on the time-table in full faced type? Trains 800 and 801 are first-class trains, No. 800 being the train of superior right.

2. The schedule leaving time of train 800 being 1:11 p. m. and the schedule arriving time of train 801 being 1:10 p. m., is Dover still to be regarded as a regular meeting or passing point and full-faced type used? If the response to the second query be "yes," then what difference in the leaving and arriving times will warrant us in regarding Dover as no longer the regular meeting or passing point?

Answer.—In response to the first question, the committee's answer is "yes," and to the second question, "no."

NEW TIME TABLE.

"A" contends that under Standard Rule 4 (b) a train on the old time table due at a division terminal prior to the new time table takes effect and failing to make such division terminal by the time new card becomes effective loses its right and class, and cannot assume the rights of corresponding number on new time table.

"B" contends that its time at division terminal has no bearing on the rule, and that such train can assume the rights and time of corresponding number on new card.

A ruling on the above will be appreciated.

Answer.—Under Rule 4 (b) the train in question would retain its train orders and take the schedule of the train of the same number on the new time table.

NEW TIME-TABLE.

No. 1 runs daily, except Sunday, on both the old and the new time-table. The new card takes effect 12:01 a. m. Sunday. No. 1 leaves A 7:00 a. m., arrives at terminal F 7:00 p. m. At 12 o'clock Saturday night No. 1 is at D, has No. 1 any right to complete their schedule on Sunday—they not being represented to run until Monday—or is it your opinion train should be given orders to proceed as an extra?

Answer.—Yes. Rule 4-B authorizes a train to retain its train orders, and take the schedule of the train of the same number on the new time-table. Rule 82 permits No. 1 to be on the road until it is twelve hours behind its schedule time.

Ruling March 19, 1902.

NEW TIME-TABLE.

Train No. 1, under the old time table, leaves B at 10:00 a. m. The new time table takes effect at 10:00 a. m., June 1st. On the new time table No. 1 leaves B at 9:00 a. m. and C at 10:00 a. m. Does the new time table provide for No. 1 between B and C on June 1st, or is the train annulled? If annulled, is it annulled only between B and C or is it annulled from B to the end of the division? If not annulled, should No. 1 consider itself one hour late and govern itself accordingly?

Answer.—In reply to this question, the committee would say that, should an instance occur as stated, the plain duty of the superintendent is to conform to Rule 2, and issue special instructions to provide for such a contingency, as it can only affect the train for one day.

RULE 4-B.

I am not satisfied with the American Railway Association time table Rule 4-B; at least, I have some misgivings as to whether it reads the way it should in order to convey the meaning that I believe it is intended of the committee to convey. The first instance completely eliminates the preceding time table. The next sentence states that "a train of the preceding time table (which has been suspended as per the first sentence) shall retain its train orders," etc. I am preparing a new book of train rules, and I wish to submit to the committee my substitute for their Rule 4-B, and expect to change standard

Rule 4-B to read as below, unless the committee can give me some good reason why my wording of the rule is not better, or at least as good, as the committee's Rule 4-B. In my opinion, my substitute covers the ground more fully. Our suggestion is that this rule should read as follows: "Each time table from the moment it takes effect, supersedes the preceding time table; but each train on the new time table shall retain the train orders and take the schedule of the train of the same number on the old time table. A train running in accordance with the schedule of the new time table which had not the same number on the preceding time table shall not run on any division until it is due to start from its initial point on that division after the time table takes effect."

Answer.—It is undesirable to change Rule 4-B in the Standard Code, since the language clearly defines the action necessary.

Ruling March 19, 1902.

RULE 14 (K).

To call the attention of trains of the same or inferior class to signals displayed for a following section.

Engine steam whistle 14 (k) is to call the attention of the *same or inferior class (only)* to signals displayed for a following section.

If, therefore, No. 23, a second class train, which is displaying signals for a following section, receives an order as per Train Order Form A, in which order no particular sections of No. 23 are specified, and, therefore, as per rule 218, all sections are included, to meet No. 4, a first-class train, at B, No. 23 is not required, as No. 4 is a

train of superior class, to give whistle signal 14 (K) to it at B.

Is it not as important in such a case that whistle signal 14 (k) be given to a train of superior class as to a train of the same or inferior class?

Answer.—Whistle signal 14 (k) is merely an auxiliary requirement, and the identity of trains is not dependent thereon; therefore it is non-essential, and might be dispensed with altogether without jeopardizing safety of operation.

In the opinion of the committee it would be objectionable to extend its application to superior trains for the reason that the great increase of whistling that would result therefrom would be seriously annoying to passengers, particularly at night.

In framing Rule 14 (k) the committee relied upon the provisions of Rule 218, which, in the case referred to, would require the conductor of No. 4 to find out and meet all the sections of No. 23.

RULE 206.

When there are two or more engines coupled to an extra train, which engine number should be used to designate the extra train under Rule 206? Rule 22 prescribes that the leading engine shall display the green or white signals, but the question is whether the number of the leading engine should be used to designate the extra train.

Answer.—The recommendation of the committee is that the number of the leading engine should be used.

Ruling Sept. 24, 1900.

ARRIVING TIME.

Referring to Rule 92, second clause. A train must not leave a station in advance of its schedule leaving time. In consideration of this rule by the Committee on Train Rules, kindly advise if it was understood that a train would have the right to go to a station in advance of schedule leaving time or in advance of time shown in time table when it was understood that such time was leaving time. Under this rule it is possible for a freight train to leave a station on time at schedule leaving time and reach the next station in advance of schedule leaving time. Some of our division superintendents want to make the rule that where only one time is shown at a station that it should be both arriving and leaving time, in order to prevent train from coming to station ahead of schedule leaving time.

Answer.—Unless the arriving time is shown there is nothing in the Standard Code to restrict a train from arriving at a station ahead of its leaving time.

Ruling Sept. 24, 1900.

CLEARANCE CARD.

It is suggested that the Standard Code clearance card be changed so as to show the numbers of train orders delivered to the trains receiving the card. So that if any question should arise as to whether or not an order, possibly an 19 order which was not signed for, was delivered, the clearance can be produced as an actual record of the delivery or non-delivery.

Answer.—The clearance card as printed in the Standard Code, gives all the information necessary. The requirement of further information might lead to error on the part of the operator.

PILOT.

The responsibilities of a pilot are the same as the responsibilities of the engineman or conductor, or both, whom he pilots.

DIRECTION.

The American Railway Association recommends that odd numbers shall be given west and southbound trains, and even numbers to east and northbound trains.

COLOR.

Recommend that no cross-arm or telegraph poles be painted red or green.

BLUE SIGNAL.

A question has been asked in regard to Rule 38 (present Rule 26), as to whether or not it is intended to cover the case where a fireman or some one else is underneath an engine, cleaning out the ashpan, etc.

Answer.—The committee would state that the rule is only intended to protect car inspectors at work under or about the car or train, and, while admitting the force of the suggestion to protect the fireman or other persons under the engine cleaning out the ashpan, etc., the committee finds so many other cases where it is dangerous

to move the car or train that it will be impossible to modify the rule to cover all the cases, and thinks it is a proper matter for each superintendent to formulate special rules to cover the particular exigencies on his division.

SWITCH LIGHTS.

A letter was submitted in regard to the proper color to be used for switch lights. It is the unanimous opinion of the committee that red and white are the proper colors, but it has purposely omitted any mention of the same in the Rules, believing that the signification of the colors determines same, there being no question about the use of red for open switches. If white is used, it means that there is no restriction as to speed unless otherwise ordered. If green is used, it means that caution is to be used, and it is a signal to go slow.

FORM A.

Assuming that a road is working under Standard Rule for single track, and is double track between A and B, single track between B and C, and double track between C and D.

In case order is issued: "Engine 1 will run extra A to D and meet No. 2 at C." Will it be necessary for extra 1 to wait at C until No. 2 arrives, in the absence of any orders regarding No. 2 using the track which extra 1 would use under time table rules C to D, both B and C being register points, so that No. 2 would know that extra 1 had arrived at C?

Answer.—In answering, attention is called to the fact that the inquiry is based on the use of a wrong form of

order, and therefore is not one which the committee can rule on. An order as per Form C should have been used, reading: "Extra 1 has right over No. 2 B to C."

Ruling Sept. 11, 1901.

FORM A AND C.

I would be pleased to have a ruling as to the proper interpretation of the following train orders: At A extra 375 receives order No. 50 to meet No. 25 at B. Upon arrival of extra 375, at B, conductor was proffered order No. 51, giving him right over No. 25 to C. Conductor refused to accept order No. 51 until order No. 50 had been annulled. The dispatcher proceeded to annul order No. 50, completing order No. 51, then extra 375 proceeded towards C. Previous to annulment of order No. 50 to extra 375 at B, No. 25 had received and accepted both orders, Nos. 50 and 51, at B, and had departed. Having in their possession two orders, neither of which had been annulled to them, and with no intervening telegraph station between D and C, upon their arrival at C they proceeded towards B and met extra 375 on main line. The mistake of the dispatcher is unquestioned. What I desire to have your ruling on is as to the manner in which No. 25, with two orders, should have observed them. In other words, should No. 25 have attempted to pass C before the arrival of extra 375, and if so, in what manner?

Answer.—In the opinion of the committee No. 25 should not have passed C before the arrival of extra 375.

Ruling Sept. 21, 1904.

FORM B.

The question has been asked me whether train order Form B (3) gives the first-named train the right to run on time of the second-named train, and if so, under what regulations?

Answer.—Yes; under the restrictions as given in the last paragraph of Form L.

Ruling Sept. 24, 1900.

FORM C.

There has recently been considerable discussion among transportation men in this locality embracing several of the larger railroads, in regard to Form C, and by a number it is stated that this rule is not clearly understood, although embodied generally in all Books of Rules.

We think we understand all but the last paragraph, wherein it specifies, that if the second named train, "before meeting," reaches a point within or beyond the limits named in the order, the conductor must stop the other train where it is met and inform it of his arrival.

We do not see how the second train can get beyond the limits without a second order making a meeting point or in some similar manner advising the first named train of the identity of the second train. If so, this necessity for stopping and advising what train it is appears to us to be superfluous.

The special point in this paragraph is the words "before meeting," which causes difference of opinion.

Answer.—Form C was formulated for the purpose of reversing the superiority of trains, the inferior train becoming superior within the limits named in the order.

The intention is that the second named train may continue until it meets the first named train, clearing it properly within the limits named in the order.

Ruling March 11, 1903.

The paragraph to which reference is made is intended to insure the identification by the first named train of the second named train wherever they may meet, so that the first named train may continue beyond the limit named in the order.

SUPERSEDING AN ORDER.

What is the general practice where rights are extended as well as shortened? For example, Order No. 1: No. 1 has right over No. 2 A to D. Order No. 2: No. 1 has right over No. 2 to G, would you say No. 1 has the right over No. 2 to G instead of D?

Answer.—The examples here given are not in accord with the Standard Code practice. The question may be answered by simply quoting from the Standard Code the forms therein provided, and which should be used:

Form C, Order No. 1: No. 1 has right over No. 2 A to D. Form P, Order No. 2: No. 1 has right over No. 2 A to G instead of D.

Ruling Sept. 21, 1904.

MEETING POINT.

We have recently had a bad accident that occurred through an engine man overlooking his meeting orders and inability of the conductor to stop the train. * * * Feeling the necessity for a rule requiring communications between conductors and engine men of passenger

trains, I have prescribed the following for use on our lines, * * * and I would bring to the attention of the Association the necessity of incorporating some such signal in the Code Rules: "Conductors of passenger trains when approaching meeting points, whether by schedule or train order, must in all cases give two long and one short blast of the air whistle, as notice to the engine man that the train is approaching a meeting point, and the engine man must promptly acknowledge his understanding of the same as provided in Rule 14-G.

Answer.—Rule supplementary to the Code may be formulated by railways upon which the conditions of the service are not fully met by the Code Rules, when such supplementary rules are in accordance with the principles of the Code. The committee does not deem it wise to incorporate in the Code rules which are of special application to the requirements of particular railways, and objectionable for use on other railways, upon which it may be advisable and proper to provide for conditions in a different manner.

Ruling March 19, 1902.

FORM E.

No. 1 is instructed to run 10 minutes late New York to Rochester; they pass Syracuse 10 minutes' late, which is the last station they are timed at east of Rochester, which is the leaving time, and, consequently, there is no time for them to arrive 10 minutes late by. Their running time from Syracuse is slow enough to enable them to make up this 10 minutes and be ready to leave Rochester on time, or within one or two minutes of it, and as their order expired as soon as they arrived at Rochester,

what prevents them from leaving Syracuse 10 minutes late and arriving at Rochester at their leaving time, they have no arriving time and its being generally understood that train is due to reach next station (if no arriving is given) as soon as they can get there after leaving the last station as ordered or required by schedule.

Answer.—No. 1 with an order to run 10 minutes late New York to Rochester, should leave all intermediate stations 10 minutes late, and arrive at Rochester (as no arriving time is shown there) as much ahead of its leaving time as it would be permitted to do when running without an order, that is to say, the only difference this order makes is that the figures on the time table are changed 10 minutes later between the points specified in the order, and, as there is only one time given at Rochester, which is the leaving time, the order practically expired when the train left Syracuse.

FORM E.

Under example 1, Form E, special East leaves Omaha with an order that No. 1 will run 30 minutes late New York to Chicago. Will this give the special until 3:25 to reach Chicago, or must they reach there at 2:55? If they must reach there by 2:55 of course they are not aided any against No. 1 by the order, as they have a right to go there at 2:55, 3 o'clock being the leaving time of No. 1. It is argued that No. 1's order has expired on her arrival at Chicago 30 minutes late, at 3 o'clock, and has nothing to do with her leaving at 3 K or 3:01, provided her work is done, or she has none to do, and of course, in this event the special would not be helped any by the

order. A great many conductors have said they would run against No. 1 until 3:25 to make Chicago.

Answer.—Inasmuch as the order delivered to the special at Omaha did not control the movement of No. 1 west of Chicago, the order could not have been used by the special until after its arrival at Chicago. It was therefore an improper order to issue to move the special from Omaha to Chicago. If it was the purpose to move the special to Chicago against No. 1 the order prescribed in No. 2 (now No. 3), Form E, should have been used. In the opinion of the committee the issuing of this order as stated, gave rise to the difficulty which the gentleman mentions.

FORM E.

The question has been raised whether, under "Form E, Example 2," of the rule governing forms of train orders, a train can properly be held at more than one point in one order for the same opposing train.

For instance: No. 1 will wait at A until 2:40 p. m. for No. 2, and will wait at B until 3:01 p. m. for No. 2.

Form E does not specifically authorize such an order.

Answer.—The reply of the committee is that under the Revised Code, Form E, Example 3, a train can properly be held at more than one point in one order for the same opposing train.

Ruling Sept. 24, 1900.

FORM F.

Please refer to Form F, Standard Code, which reads as follows: Engines 70, 85 and 90 will run as 1st, 2d and 3d No. 1, London to Dover.

In the event that it is desired to cut out the second section of No. 1 at Chatham, would it be necessary under the rule to give notice of such change to Engine 70, representing first section of that schedule?

The above proposition has brought out considerable discussion among our local people here, and I am desirous of having the Committee on Train Rules pass upon the question.

Answer.—When this form of the order is used the first section should have a copy of the order annulling the second section.

Ruling Sept. 24, 1900.

FORM G.

Will you kindly say if special trains should carry a white signal? There is a wide difference of opinion on the subject, and I respectfully refer the matter to you.

Answer.—A train running under example 1, Form G, would carry the white classification signals, because it is a train not represented on the time table, and is therefore an extra train. A train running under example 2 (this is the form used for running a train on a schedule and making it a supplement to the time table; it is no longer a Standard Code example), Form G, would not carry the white classification signals, because the order expressly states that its schedule is a supplement to the current time table, and therefore makes it a regular train.

Ruling Sept. 24, 1900.

FORM G.

I beg to submit to the Committee on Train Rules the following inquiry, in regard to Form G, Extra Trains, under example (1): Engine 99 will run extra, Berber to Gaza.

Supposing Gaza to be a way station, to which point within the somewhat indefinite limits of Gaza, does the order give the extra the right to run?

A definite ruling on this point seems important, especially when we consider that it is perfectly competent for the train dispatcher to give an extra running in the opposite direction a similar order from some other point to Gaza, and that, so far as the rules provide, neither extra would have any information as to the destination or existence of the other.

Answer.—Presuming that Gaza is an intermediate station on a division, the order gives the extra the right to run to the entrance switch of the siding and clear the main track.

Ruling Sept. 24, 1900.

FORM H.

Under Form H, paragraph f, is a work train authorized to flag against all regular trains? (The Form H, paragraph d, of the new rules.)

Answer.—The form does not permit a work train to occupy the main line until the arrival of regular trains, but it does permit a work train to occupy the main track until the arrival of an extra from either direction by properly protecting itself.

ANNULLING A SECTION.

After a section of a train has been run over one portion of a road, and that annulment of the section issued, would it be competent to run the same section of the same train over a different portion of the road? That is, if three sections of No. 23 are started out from A and at

C the order is issued 3d 23 is annulled from C, could there be a 3d No. 23 run from D to E? An intermediate section can be annulled and following section take that section's number from where the change is made, but in that case the conductor or engine number is mentioned as being annulled as 3d section.

Answer.—Assuming the points named are all in the same dispatching division, the answer is No. Under the last paragraph of Form K, which reads, "When a train has been annulled it must not be again restored under its original number by special order."

I am in receipt of the report of the Committee on Train Rules of the American Railway Association, New York, October 6th. I find an inquiry submitted in regard to annulling a section of a train to which the committee replied, "No." While I admit that the inquiry was probably not put as it should have been, I do think that the committee should have made itself plain, as that ruling is going to confuse almost all roads which are endeavoring to follow out the ruling of the Train Rule Committee. I would like to ask, for instance, if Engine 214 was 3d No. 23, and from some cause was disabled at B, what is to hinder the dispatcher from annulling Engine 14 as 3d No. 23 at B, and when he gets a relief engine, 216, to that point, giving it an order to run as 3d No. 23 from B to the point to which signals are carried by the leading section? Of course the committee had in mind that if 3d No. 23 was annulled from B the train could not be represented, but as long as the signals were carried beyond that point and intermediate train not notified, I would like to ask, as information, why 3d No. 23 could not be represented by another engine?

Answer.—There is nothing to hinder the dispatcher from annulling 3d No. 23, but the change of an engine does not necessarily involve such annulment.

DOES NOT SUPERSEDE.

Suppose an order is issued to No. 1 at A and No. 2 at C, reading: "No. 1 will wait at B until 5:00 p. m. for No. 2." No. 1 being the superior train. Subsequently an order is issued to No. 1 at B and No. 2 at C, reading: "No. 1 and No. 2 will meet at C." Does the latter order cancel the previous time order?

Answer.—The committee refers to the first paragraph of Rule 473. (Now Rule 220.) "Train orders once in effect continue so until fulfilled, superseded or annulled." Therefore, if the train order had not expired at B, then that order must be annulled before the meeting order would be effective. Under the conditions named the second order should preferably read, "Order No. — is annulled. No. 1 and No. 2 will meet at C."

RULE 210.

An operator repeating a train order to the dispatcher, which was sent by him, and, while repeating it the conductor and engine man both sign the order, and after the order is repeated and without stopping to receive "O. K." from dispatcher, the operator sends in signature of conductor and engine man. Is such an action in accordance with the ruling of your committee or should the operator stop, after repeating the order, and wait for O. K. from dispatcher before sending the signatures of the conductor and engine man? If there is no objection to the opera-

tor repeating the signatures, should the dispatcher give "O. K. and complete" at the same time? The point I wish to make clear is whether or not the blank on the bottom of standard "31" order, reading, "Time received," "O. K.," "given at" should be filled in each case.

Answer.—The committee ruled that the conditions mentioned in the letter are plainly in violation of Rule 459 (this rule has been modified and is now rule 210), and the operator should wait for the O. K. from dispatcher before sending the signatures of conductor and engineman.

WORK TRAIN.

"No. 40 and work extra 237 will meet at Rome." At 8 p. m. on the expiration of the work limits, work extra has not reached Rome. How are both trains to be governed after this hour?

Answer.—No. 40 could not pass Rome without orders, and if work extra 237 had orders to work only to 8 p. m., it has no right to the track after that hour. Under the circumstances, the Form E should have been used.

REVERSE MOVEMENT.

In running a train over opposite track it is necessary or customary to state the cause, as "northbound track obstructed," etc., or simply give 19 order to trains to use that track, and when they receive orders to use the opposite track do they understand that they are governed by single track rules? That is, they are superior to trains which, under the time table rules, they would be superior to on single track and inferior to trains which they

would be inferior to under single track rules while running on that track?

Answer.—The committee does not consider it necessary to state the cause.

Ruling Sept. 11, 1901.

SIZE OF BLANK.

Is there any objection to using form of train order book size $7\frac{1}{2} \times 10\frac{3}{4}$ inches beyond perforated line at top, and $7\frac{1}{2} \times 11\frac{1}{8}$ inches over all?

Answer.—The committee believes that the form recommended in the Standard Code is best suited for the use of railroads generally. Larger blanks are permissible, but in the opinion of the committee, are undesirable.

RULE 92.

It has been suggested to me that Rule 92, of the Code, is incomplete without the addition of an explanatory cause, such as follows: "Under this rule it will be understood that where the inferior train is shown to arrive on the leaving time of the superior train, or where a train is shown to arrive on the leaving time of a train of the same class, the inferior train has the right to arrive five minutes before the time shown."

I should be glad to have the benefit of the expression of the opinion of the Committee on Train Rules on this matter.

Answer.—Where the arriving time of a train is the same as the leaving time of an opposing superior train, the inferior train has not the right to arrive before the

arriving time shown. (See Rule 92.) The arriving time, when shown, should provide for the clearance required by the rules.

Ruling March 11, 1903.

RULE 18.

Our suggestion is that Rule 18 should read as follows: "Yard engines will display a reflecting light to the front and rear by night. When not provided with a reflecting light at the rear, two white lights must be displayed. Yard engines will not display markers." We think this suggestion is better than to say, "Display a head-light to the rear." At least, this is the way we propose to publish it in our new book of rules.

Answer.—The term "head-light" as used in Rule 18 is simply employed in its technical sense and is intended to describe a pattern of lamps, and not the special direction in which the light may be displayed.

Ruling March 19, 1902.

FORM E.

No. 2 is due at A 1 p. m., C 1:15 p. m., D 1:30 p. m.
No. 2 is given an order to run 30 min. late A to D.
Can No. 2 arrive at C or D ahead of this time?

Answer.—The train receiving this order will run with respect to this latter time, as before required to run with respect to the regular schedule.

Ruling March 19, 1902.

The interpretation of the definition of "yard" as set forth in the standard rules, and the matter of proper regulations concerning movements within defined yard

limits are questions now being fiercely discussed and agitated on railroad lines of this vicinity.

It is contended that the definition of "yard" provides, broadly speaking, that the Time-Table, Rules Governing Movement of Trains and Rules for Movement by Train Orders have no jurisdiction or authority in yards. In other words, a yard is a fenced-up baseball park, and all movements made within the same by trains, yard engines, light engines, etc., shall be made subject to the regulations governing this particular yard, and that the Time-Table, Rules Governing Movement of Trains, and Rules for Movement of Trains by Train Orders shall absolutely cease the instant a train arrives at the "baseball park" fence—or rather, the "main line" ceases at this point.

On the other hand, it is contended that the Time-Table, Rules for Movement of Trains, and Rules for Movement by Train Order govern in yards as well as at other stations, except to the extent that they might be modified, restricted, superseded or annulled by special instructions relating to all or individual yards.

The circumstances in question are as follows: Our special instructions governing Movements in Yards provide that all trains, yard engines, etc., must proceed under control within yards.

Another special instruction defines "Under Control" as being able to stop within the distance the track is seen to be clear. Under these instructions yardmen maintain they have as much right within this Mystic Circle as a passenger train, or any other train or engine, and without flag protection, etc., notwithstanding the rules for Movement of Trains provide that inferior trains, etc., shall clear the time of superior trains, etc.

The yard crew also object to being referred to as a "train" in any shape, manner or form, and give this as another reason why rules for movement of trains and for movements by train orders are not applicable to yard engines—and for no other reason than that a yard engine is not a train. The crew state, however, that they expect to keep out of the way of all important trains as much as possible, and endeavor to give them a clear track at all times, avoiding delay, etc., on the other hand, they expect all these trains to be under control, thus avoiding the necessity of flag protection on the part of yard crews, and also as a matter of protection to the trains themselves in case they should find their progress obstructed by switch engines, cars or otherwise in yards.

Another question is put up about as follows: The Time-Table, Rules for Movement of Trains, and Rules for Movement by Train Orders, have authority in any yard, and in this particular yard we find the customary regulation, providing that all trains shall proceed under control within the same, etc. Now, we will assume that this yard is located in Buffalo, and we find a special train running from Chicago to New York, through Buffalo, and with it a train order giving it right over all trains.

Does this order give it right to proceed through Buffalo yard regardless of other trains, yard engines, etc.? If so, then it necessarily follows that the train dispatcher must receive an acknowledgment from all yard engines, etc., at Buffalo, before he can permit the special train to pass through that place.

Of course you understand I am referring to single track yards, because we have practically no double track.

Personally, I am decidedly of the opinion that a "yard" should be operated entirely independent of the "Main Track," and there should be rules for this independent operation in the same manner that we have independent rules for operating double track, block signals, etc. I am also of the opinion that under the definition "Yard" it is intended that the Time-Table, Rules for Movement of Trains and Rules for Movement by Train Orders should not govern, and that each railroad company is to provide its own regulations for movements within yards, however, it is not exactly plain in this respect, and on this account there is room for much good argument pro and con.

Of course you understand in this country it is not always possible to lay out yards to the best advantage in the way of obscured views, etc.

On the other hand, nearly all our yards contain many curves, and view is often obstructed by rock bluffs, mountain sides, etc.

Will you kindly set us right in the premises?

Answer.—The Standard Code definition of a yard is:

Yard. A system of tracks within defined limits provided for the making up of trains, storing of cars and other purposes, over which movements not authorized by time-table, or by train orders, may be made, subject to prescribed signals and regulations."

Nothing in this definition contemplates the abrogation of the authority of trains to move on the main track.

Special instructions authorized by or in force on any railroad are matters of detail for that railroad, and are not intended to be covered by Standard Code rules. The difficulty here appears to be caused by incomplete special instructions governing movement in yards. The

definition for a yard being interpreted to include a main track—

A yard engine is not a train within the meaning of the Standard Code, it having no authority to move upon a main track unless specially authorized—

The hypothetical case of a special train running from Chicago to New York passing through Buffalo yard and holding a train order giving it right over all trains, can best be answered by quoting a new rule which the committee on train rules has recommended to the association for adoption as follows:

“93. Within yard limits the main track may be used, protecting against —— class trains —— class and extra trains must move within yard limits prepared to stop unless the main track is seen or known to be clear.

With this rule in force there can be no question about the movement of a special train through Buffalo yard.

The adoption of new rule 93, in connection with definition of a yard will answer the various questions and clear the situation.

Ruling March 21, 1906.

INTERLOCKING RULES

Adopted October 24, 1900

DEFINITIONS.

Interlocking.—An arrangement of switch, lock and signal appliances so interconnected that their movements must succeed each other in a pre-determined order.

Interlocking Plant.—An assemblage of switch, lock and signal appliances, interlocked.

Interlocking Station.—A place from which an interlocking plant is operated.

Interlocking Signals.—The fixed signals of an interlocking plant.

Home Signal.—A fixed signal at the point at which trains are required to stop when the route is not clear.

Distant Signal.—A fixed signal used in connection with a home signal to regulate the approach thereto.

Dwarf Signal.—A low fixed signal.

RULES.

SIGNAL	OCCASION FOR USE	INDICATION	NAME
Color	The signal will be displayed when	For enginemen and trainmen	As used in rules
(a) Red	Route is not clear	Stop	Stop-signal
(b) ———	Route is clear	Proceed	Clear-signal

Where the semaphore is used, the governing arm is displayed to the right of the signal mast as seen from an approaching train, and the indications are given by positions:

Horizontal as the equivalent of (a).

Vertical or Diagonal ———* as the equivalent of (b).

NOTE TO RULE 601.—*Angle above or below the horizontal.

602. Interlocking signals, unless otherwise provided, do not affect the movements of trains under the timetable or train rules; nor dispense with the use or the observance of other signals whenever and wherever they may be required.

SIGNALMEN.

611. The normal indication of Home Signals is Stop.

612. Levers, or other operating appliances, must be used only by those charged with the duty and as directed by the rules.

613. Signal levers must be kept in the position giving the normal indication, except when signals are to be cleared for an immediate train or engine movement.

614. When the route is clear the signals must be cleared sufficiently in advance of approaching trains to avoid delay.

615. Signals must be restored so as to give the normal indication as soon as the train or engine for which they were clear has passed ———.

616. If necessary to change any route for which the signals have been cleared for an approaching train or

GENERAL NOTE.—The Committee has found it desirable to leave blanks (——) in certain rules to be filled by each company adopting them, as may best suit its own requirements.

engine, switches must not be changed or signals cleared for any conflicting route until the train or engine, for which the signals were first cleared, has stopped.

617. A switch or facing point lock must not be moved when any portion of a train or an engine is standing on, or closely approaching, the switch or detector bar.

618. Levers must be operated carefully and with a uniform movement. If any irregularity, indicating disarranged connections, is detected in their working, the signals must be restored so as to give the normal indication and the connections examined.

619. During cold weather the levers must be moved as often as may be necessary to keep connections from freezing.

620. If a signal fails to work properly its operation must be discontinued and the signal secured so as to give the normal indication until repaired.

621. Signalmen must observe, as far as practicable, whether the indication of the signals corresponds with the position of the levers.

622. Signalmen must not make nor permit any unauthorized alterations or additions to the plant.

623. If there is a derailment or if a switch is run through, or if any damage occurs to the track or interlocking plant, the signals must be restored so as to give the normal indication, and no train or switching movement permitted until all parts of the interlocking plant and track liable to consequent injury have been examined and are known to be in a safe condition.

624. If necessary to disconnect a switch from the interlocking apparatus the switch must be securely fastened.

625. During storms or drifting snow special care

must be used in operating switches. If the force whose duty it is to keep the switches clear is not on hand promptly when required, the fact must be reported to _____.

626. If any electrical or mechanical appliance fails to work properly ——— must be notified and only duly authorized persons permitted to make repairs.

627. When switches or signals are undergoing repairs, signals must not be given for any movements which may be affected by such repairs, until it has been ascertained from the repairmen that the switches are properly set for such movements.

628. Signalmen must observe all passing trains and note whether they are complete and in order; should there be any indication of conditions endangering the train, or any other train, the signalmen must take such measures for the protection of trains as may be practicable.

629. If a signalman has information that an approaching train has parted he must, if possible, stop trains or engines on conflicting routes, clear the route for the parted train, and give the Train-parted signal to the engineman.

630. Signalmen must have the proper appliances for hand-signaling* ready for immediate use. Hand signals must not be used when the proper indication can be displayed by the fixed signals. When hand signals are necessary they must be given from such a point and in such a way that there can be no misunderstanding on the part of enginemen or trainmen as to the signals, or as to the train or engine for which they are given.

NOTE TO RULE 630.—*Hand signaling includes the use of lamp, flag, torpedo and fusee signals.

631. If necessary to discontinue the use of any fixed signal, hand signals must be used and —— notified.

632. Signalmen will be held responsible for the care of the interlocking station, lamps and supplies; and of the interlocking plant, unless provided for otherwise.

633. Lights in interlocking stations must be so placed that they cannot be seen from approaching trains.

634. Lights must be used upon all fixed signals from sunset to sunrise, and whenever the signal indications cannot be clearly seen without them.

635. If a train or engine over runs a Stop-signal, the fact, with the number of train or engine, must be reported to ——.

636. Only those whose duties require it shall be permitted in the interlocking station.

ENGINEMEN AND TRAINMEN.

661. Trains or engines must be run to but not beyond a signal indicating stop.

662. If a clear signal, after being accepted, is changed to a stop signal before it is reached, the stop must be made at once. Such occurrence must be reported to ——.

663. Enginemen and trainmen must not accept clear hand signals as against fixed signals until they are fully informed of the situation and know that they are protected. Where fixed signals are in operation trainmen must not give clear hand signals against them.

664. The engineman of a train which has parted must sound the whistle signal for Train-parted on approaching an interlocking station.

665. An engineman receiving a Train-parted signal from a signalman must answer by the whistle signal for Train-parted.

666. When a parted train has been re-coupled the signalman must be notified.

667. Sand must not be used over movable parts of an interlocking plant.

668. Conductors* must report to ——— any unusual detention at interlocking plants.

NOTE TO RULE 668.—*Or enginemen of yard engines.

669. Trains or engines stopped in making a movement through an interlocking plant, must not move in either direction until they have received the proper signal from the signalman.

REPAIRMEN.

681. Repairmen are responsible for the inspection, adjustment and proper maintenance of all the interlocking plants assigned to their care.

682. Where the condition of switches or track does not admit of the proper operation or maintenance of the interlocking plant, the fact must be reported to ———.

683. When any part of an interlocking plant is to be repaired a thorough understanding must be had with the signalman, in order to secure the safe movement of trains and engines during repairs. The signalman must be notified when the repairs are completed.

684. If necessary to disconnect any switch it must be securely fastened before any train or engine is permitted to pass over it.

685. Alterations or additions to an interlocking plant must not be made unless authorized by ———.

686. Repairmen when on duty, or subject to call, must keep ——— advised as to where they can be found, and respond promptly when called.

STANDARD CODE OF THE AMERICAN RAILWAY ASSOCIATION
BLOCK SIGNAL RULES.

DEFINITIONS.

Block.—A length of track of defined limits, the use of which by trains is controlled by block signals.

Block Station.—A place from which block signals are operated.

Block Signal.—A fixed signal controlling the use of a block.

Home Block Signal.—A fixed signal at the entrance of a block to control trains in entering and using said block.

Distant Block Signal.—A fixed signal used in connection with a home block signal to regulate the approach thereto.

Advance Block Signal.—A fixed signal used in connection with a home block signal to sub-divide the block in advance.

Block System.—A series of consecutive blocks.

Telegraph Block System.—A block system in which the signals are operated manually, upon information by telegraph.

Controlled Manual Block System.—A block system in which the signals are operated manually, and so constructed as to require the co-operation of the signalmen at both ends of the block to display a clear signal.

Automatic Block System.—A block system in which the signals are operated by electric, pneumatic or other agency actuated by a train, or by certain conditions affecting the use of a block.

RULES.

301.

HOME SIGNALS.

SIGNAL	OCCASION FOR USE	INDICATION	NAME
Color	The signal will be displayed when	For enginemen and trainmen	As used in rules
(a) Red	Block is not clear	Stop	Stop-signal
(b) ———	Block is clear	Proceed	Clear-signal
(c) ———	Block is not clear	Proceed with caution.	Caution-signal

Where the semaphore is used, the governing arm is displayed to the right of the signal mast as seen from an approaching train, and the indications are given by positions:

Horizontal as the equivalent of (a).

Vertical or Diagonal ———* as the equivalent of (b).

Diagonal ———* as the equivalent of (c).

NOTE TO RULE 301.—*Angle above or below the horizontal.

302. Block signals control the use of the blocks, but, unless otherwise provided, do not affect the movements of trains under the time-table or train rules; nor dispense with the use or the observance of other signals whenever and wherever they may be required.

SIGNALMEN.

311. The normal indication of Home Block Signals is Stop.

312. Signals must be operated carefully and with a uniform movement. If a signal fails to work properly its operation must be discontinued and the signal secured so as to give the normal indication until repaired.

313. Signalmen must observe, as far as practicable, whether the indication of the signals corresponds with the position of the levers.

314. Signalmen must not make nor permit any unauthorized alterations or additions to the apparatus.

315. A block record must be kept at each block station.

NOTE TO RULE 315.—The different times to be entered on the block record have not been prescribed in this rule, but it has been left to each road to complete the rule by adding such items as may be necessary to meet the conditions governing its traffic.

316. The prescribed telegraph signals are as follows:

- 1—Display Stop-signal. Answer by S D or 5.
- 2—Block clear. Answer by 13.
- 3—Block wanted. Answer by 2 or 5.
- 4—Train has entered block. Answer by 13.
- 5—Block is not clear.
- 7—Train following.
- 8—Opening block station. Answer by Nos. of trains in the extended block with time each train entered the block.

GENERAL NOTE.—The Committee has found it desirable to leave blanks (—) in certain rules to be filled by each company adopting them, as may best suit its own requirements.

9—Closing block station. Answer by "13" after receiving transfer of the records of trains which are in the extended block.

13—I understand.

71—Train following display Stop-signal. Answer by S D.

NOTE TO RULE 316.—Additional signals may be used if desired. The signals prescribed under the Controlled Manual Block Signal System should be used for such additional signals wherever applicable.

317 (a). To admit a train to a block the signal is clear, will give "1 for ——" to the next block station in advance. The signalman receiving this signal, if the block is clear, must display the Stop-signal to opposing trains, and reply "S D for ——." If the block is not clear, he must reply "5 of ——." The signalman at the entrance of the block must then display the proper signal indication of the train to be admitted.

A train must not be admitted to a block unless it is clear, except as provided in Rule 331 or by special order.

NOTE TO RULE 317 (A).—317 (A) is for absolute block for following and opposing movements on the same track.

317 (b). To admit a train to a block the signalman must examine the block record, and if the block is clear, will give "1 for ——" to the next block station in advance. The signalman receiving this signal, if the block is clear, must display the Stop-signal to opposing trains and reply "S D for ——." If the block is not clear, he must reply "5 of ——." The signalman at the entrance of the block must then display the proper signal indication to the train to be admitted.

A train must not be admitted to a block which is

occupied by a passenger train, except as provided in Rule 331 or by special order.

To permit a train to follow a freight train into a block, the signalman must give "71 for ——" to the next block station in advance, to which the reply "5 of —— S D for ——" must be made. The approaching train will then be admitted to the block ——.*

NOTES TO RULE 317 (B).—

*Under Caution-signal or with Caution Card.

Rule 317 (B) is for absolute block for opposing movements and permissive block for following movements on the same track.

318 (a). To admit a train to a block the signalman must examine the block record, and if the block is clear, will display the proper signal indication to the train to be admitted, reporting its movement as per Rule 319.

A train must not be admitted to a block unless it is clear, except as provided in Rule 311 or by special order.

318 (b) To admit a train to a block the signalman must examine the block record, and if the block is clear, will display the proper signal indication to the train to be admitted, reporting its movement as per Rule 319.

A train must not be admitted to a block which is occupied by a passenger train, except as provided in Rule 331 or by special order.

A train may be permitted to follow a freight train into a block ——.*

NOTES TO RULE 318 (B).—

*Under Caution-signal or with Caution Card.

Rule 318 (B) is for permissive block for following movements only.

NOTE TO RULE 317 (A), 317 (B), 318 (A) AND 318 (B).— Where it is desired that train dispatchers shall control the display of block signals, roads may modify Rules 317 (A), 317 (B), 318 (A) and 318 (B) so as to provide for such practice.

319. When a train enters a block the signalman must give "4 ———" and the time, to the next block station in advance and when the train has passed the home block signal and the signalman has seen the markers he must display the Stop-signal, and when the rear of the train has passed ———feet beyond the home block signal he must give "2 of ———" and the time to the next block station in the rear.

This information must be entered on the block records.

320. Unless otherwise provided, signalmen must not give "1" or "3" until they have received "4" from the block station in the rear.

321. Signalmen must observe all passing trains and note whether they are complete and in order, and the markers properly displayed. Should there be any indication of conditions endangering the train, or a train on another track, the signalman must notify the signalman at the next block station in advance. A signalman having received this notice must display Stop-signals in both directions and answer "S D." Should a train going in the opposite direction be stopped it may be permitted to proceed when it is known that the track on which it is running is not obstructed.

322. Should a train pass a block station without markers, the signalman must notify the signalman at the next block station in each direction, and must not report that train clear of the block until he has ascertained that the train is complete.

323. Should a train pass a block station in two or more parts, the signalman must notify the signalman at the next block station in advance. A signalman having received this notice must stop any train running in the opposite direction. The Stop-signal must not be dis-

played to the engineman of the divided train if the block in advance is clear, but the Train-parted signal must be given. Should a train going in the opposite direction be stopped, it may be permitted to proceed when it is known that its track is not obstructed.

324. A signalman informed of any obstruction in a block must display the Stop-signal and notify the signalman at the other end of the block. The signalman at the other end of the block must immediately display the Stop-signal. The Clear-signal for that block must not be displayed until the obstruction is removed.

325. When a train takes a siding the signalman must know that it is clear of the block before giving "2" or displaying a Clear-signal for that block.

The signalman must obtain control of the block before permitting a train on a siding to re-enter the block.

326. To permit a train to cross-over or return the signalman must examine the block record, and if all the blocks affected are clear of approaching trains he will arrange with the signalmen at the next block station on either side to protect the movement, and when the proper signals have been displayed permission may be given. Until the block is clear no train must be admitted in the direction of the cross-over switches except under Caution-signal or with Caution Card. All cross-over movements must be entered on the block records.

327. When, as provided for in Rule 364, coupled trains have been separated, the signalman must regard each portion as an independent train.

328. If necessary to stop a train for which a Clear-signal (or a Caution-signal) has been displayed and accepted, the signalman will give hand signals in addition to displaying the Stop-signal.

329. A signalman having orders for a train must display the block signal at "Stop." He may permit trains so stopped to proceed under block signal rules after complying with Rules for Movement by Train Orders.

330. If from the failure of block signal apparatus the block signal cannot be changed from the normal indication, a signalman having information from the signalman at the next block station in advance, that the block is clear, may admit a train to the block by the use of Clearance Card.

331. If from the failure of telegraph line or other cause, a signalman be unable to communicate with the next block station in advance, he must stop every train approaching in that direction. Should no cause for detaining the train be known, it may then be permitted to proceed, provided ——— minutes have elapsed since the passage of the last preceding train, using Caution Card.

332. Signalmen must have the proper appliances for hand signaling* ready for immediate use. Hand signals must not be used when the proper indication can be displayed by the fixed signals. When hand signals are necessary they must be given from such a point and in such a way that there can be no misunderstanding on the part of enginemen or trainmen as to the signals, or as to the train or engine for which they are given.

NOTE TO RULE 332.—*Hand signaling includes the use of lamp, flag, torpedo and fusee signals.

333. Signalmen will be held responsible for the care of the block station, lamps and supplies; and of the signal apparatus unless provided for otherwise.

334. Lights in block stations must be so placed that they cannot be seen from approaching trains.

335. Lights must be used upon all block signals from

sunset to sunrise and whenever the signal indications cannot be clearly seen without them.

336. If a train over runs a Stop-signal, the fact, with the number of train, must be reported to ———.

337. If a Stop-signal is disregarded, the fact with the number of train, must be reported to the next block station in advance and then to ———.

338. To open a block station the signalman must give "8" to the next block station in each direction and record the trains that are in the extended block. He must then display the normal signal indication and notify the block station in each direction that the station is open.

When trains, which were in the extended block when the station was open and which had passed his station before it was opened, clear the block in advance he must repeat the record to the block station in the rear.

He must not display the Clear-signal until all trains are clear of the block in advance.

339. A block station must not be closed except upon authority of ———; nor when trains are approaching which are to meet or pass at that block station.

340. To close a block station the signalman must first obtain "2" for trains which he has admitted to the blocks in each direction.

He must give "9" to the next block station in each direction and transfer the records of the trains in the extended block. He must then enter on his block record "13" with the time it is received from each block station.

The block signals must then be ———, all lights extinguished and the block wires arranged to work through the closed station.

NOTE TO RULE 340:—The arrangement of the block signal under the third paragraph of Rule 340 is left for each road to determine in accordance with its local requirements.

ENGINEMEN AND TRAINMEN.

361. Block signals apply only to trains running in the established direction.

362. Trains must not pass a Stop-signal without receiving a Caution Card, a Clearance Card or a special order.

363. An engineman holding a Caution Card must deliver it to the signalman at the next block station and personally ascertain from him that the block in advance is clear before proceeding.

364. Unless directed by special instructions, when two or more trains have been coupled and so run past any block station, they must be uncoupled only at a block station and the signalman notified.

365. When a train takes a siding it must not again enter the block without the permission of the signalman.

366. When it is necessary for a train to cross-over, the conductor before crossing or returning, must notify the signalman and obtain permission to do so.

367. Enginemen and trainmen must not accept clear hand signals as against block signals.

368. The engineman of a train which has parted must sound the whistle signal for Train-parted on approaching a block station

369. An engineman receiving a Train-parted signal from a signalman must answer by the whistle signal for Train-parted.

370. When a parted train has been recoupled the signalman must be notified.

371. At a block station where the signalman is absent or incapacitated, so that instructions cannot be ob-

tained, trains must wait ——— minutes and then proceed with caution to the next block station, where the conductor must report accordingly to the ———.

372. If the track is obstructed between block stations notice must be given to the nearest block signalman.

373. If a train is held by a block signal to exceed ——— minutes, the conductor must ascertain the cause.

374. Conductors must report to ——— any unusual detention at block stations.

375. A block station must not be considered as closed, except as provided on time-table or by special instructions.

NOTE.—Rules 301 to 375, inclusive, apply to this system without any of the “adjuncts.”

CONTROLLED MANUAL BLOCK SYSTEM.

A series of consecutive blocks controlled by block signals operated manually, and so constructed as to require the co-operation of the signalmen at both ends of the block to display a clear signal.

CONSISTING OF:

1. Signals of prescribed form, the indications given by two positions; and, in addition, at night, by lights of prescribed color.

2. The apparatus so constructed that the failure of any part directly controlling a signal will cause it to give the normal indication.

3. Signals, if practicable, either over or upon the right of and adjoining the track upon which trains are governed by them. For less than three tracks signals

for trains in each direction may be on the same signal mast.*

*The word "mast" refers to the upright to which the signals are directly attached.

4. Semaphore arms that govern, displayed to the right of the signal mast as seen from an approaching train.

5. The normal indication of Home Block Signals—Stop.

6. The apparatus so constructed that the failure of the block signal instruments or electric circuits will prevent the display of the clear signal.

7. The relative position of the home signal, and track instrument or releasing circuit, such as to make it necessary that the rear of a train shall have passed ——— feet beyond the Home Block Signal before the signal at the preceding block station can be released.

ADJUNCTS.

The following may be used:

(A) Distant Block Signals* interlocked with Home Block Signals; normal indication—Caution.

(B) Advance Block Signals† interlocked with Home Block Signals, and with Distant Block Signals, if used; normal indication—Stop.

(C) Track circuits.

(D) Repeaters or audible signals to indicate the position of signals to the signalman operating them.

(E) The automatic release of signals to give the normal indication.

(F) The interlocking of switches with block signals.

(G) Bell circuits* for signaling between a block station and outlying switches.

(H) Unlocking circuits between a block station and outlying switches.

*When Distant Block Signals are used the following should be added to Rule 401:

SIGNAL	OCCASION FOR USE	INDICATION	NAME
(c)——	Home (or advance) signal at (a)	Proceed with caution to the home (or advance signal)	Caution-signal
(d)——	Home (and advance) signal at (b)	Proceed	Clear-signal

Where the semaphore is used, the governing arm is displayed to the right of the signal mast as seen from an approaching train, and the indications are given by positions:

Horizontal as the equivalent of (c).

Vertical or diagonal — (angle above or below the horizontal) as the equivalent of (d).

†When Advance Block Signals are used that name should be added to the caption of Rule 401 so as to read "HOME AND ADVANCE SIGNALS," and Rule 411 should be changed to read "The normal indication of Home and Advance Block Signals is Stop."

RULES.

401.

HOME SIGNALS.

SIGNAL	OCCASION FOR USE	INDICATION	NAME
Color	The signal will be displayed when	For enginemen and trainmen	As used in rules
(b) Red	Block is not clear	Stop	Stop signal
(a)——	Block is clear	Proceed	Clear signal

*See note on following page.

Where the semaphore is used, the governing arm is displayed to the right of the signal mast as seen from an approaching train, and the indications are given by positions:

Horizontal as the equivalent of (a).

Vertical or Diagonal ——* as the equivalent of (b).

NOTE TO RULE 401.—*Angle above or below the horizontal.

402. Block signals control the use of the blocks, but, unless otherwise provided, do not affect the movements of trains under the time-table or train rules; nor dispense with the use or the observance of other signals whenever and wherever they may be required.

SIGNALMEN.

411. The normal indication of Home Block Signals is Stop.

412. Signals must be operated carefully and with a uniform movement. If a signal fails to work properly its operation must be discontinued and the signal secured so as to give the normal indication until repaired.

413. Signalmen must observe, as far as practicable, whether the indication of the signals corresponds with the position of the levers.

414. Signalmen must not make nor permit any unauthorized alterations or additions to the apparatus.

415. If any electrical or mechanical appliance fails to work properly —— must be notified, and only duly authorized persons permitted to make repairs.

GENERAL NOTE.—The Committee has found it desirable to leave blanks (——) in certain rules to be filled by each company adopting them, as may best suit its own requirements.

*When bell circuits for signaling between a block station and outlying switches are used, Rule 420 will be amended to include the following signals, which will be given and observed by signalmen and conductors:

1-2-3—Train has gone on siding. All clear. Switch closed. Answer by 1-2-3.

3-4—Train is ready to leave siding. Answer by 3-4 or 5. Conductor when ready to go will give 3-4, and will not start his train until 3-4 has been given in reply, and this must not be given by the signalman unless the block is clear.

416. A block record must be kept at each block station.

NOTE TO RULE 416.—The different items to be entered on the block record have not been prescribed in this rule, but it has been left to each road to complete the rule by adding such items as may be necessary to meet the conditions governing its traffic.

417. Block signal instruments and bells must be used only by signalmen and as directed by the rules.

418. Bells must not be used for any purpose other than to give the prescribed signals.

419. Bell signals must be given deliberately and distinctly, and answered promptly. All signals must be repeated until answered.

420. The prescribed Bell Signals are as follows:

1—(Long stroke.) Answer telegraph call.

2—All right. Yes.

3—Unlock my lever. Answer by unlocking, or 5, or 3-1.

4—Train has entered block.

5—Block is not clear.

6—Has a train entered this block? Answer by 2, or 2-1.

1-2—Clear. Train has cleared block.

1-4—1-4—Stop train approaching and have it examined. Answer by 1-4—1-4.

2-1—No.

2-2-2—Previous signals given in error. Answer by 2.
 2-3-2—Train has passed without markers. This signal to be given to station in advance. Answer by 2-3-2.

2-4—Has train cleared block? Answer by 1-2, or 5.

2-4-2—Repeat previous signal.

3-1—Have unlocked. If levers are not released, instrument must be out of order. Block is clear. This signal must be answered by 3-1 and the answer acknowledged by 2. It must not be used unless the block is known to be clear. A signalman having received 3-1 and answered it by a 3-1 and received 2 in acknowledgment, may allow train to proceed under Rule 434, announcing it by 4.

3-3—Train in block will take intermediate siding. Answer by 3-3.

3-3-3—3-3-3—Train in block has broken apart. Answer by 3-3-3—3-3-3.

4-3-4—Train from intermediate siding is proceeding toward you. Answer by 4-3-4.

4-4-4—Cars running away in the wrong direction and proceeding toward you. Answer by 4-4-4.

4-6-4—Cars running away in the right direction and proceeding toward you. Answer by 4-6-4.

5-2-5—Train has passed without markers. This signal to be given to station in rear. Answer by 5-2-5.

5-5-5—Obstruction in block. Stop all trains approaching this station. Answer by 5-5-5.

6-6-6—Testing. Answer by 6-6-6.

NOTES TO RULE 420.—

(-) signifies pause between beats.

Additional bell signal may be used if desired. The telegraph or other equivalent may be used instead of the bell for transmitting signals.

421. To receive and forward a train, the block being clear, and signals giving the normal indication:

In answer to 3 from the next block station in the rear, the signalman must unlock by closing the circuit, and unless otherwise provided hold it closed until acknowledged.

In answer to 4 from the next block station in the rear, he must give 2, then give the block station in advance 3. If released, he must give 2 in acknowledgment, then clear the signals. When the train enters the block in advance, he must give 4 to the next block station in advance. When the rear of the train has passed _____ feet beyond the home block signal and he has seen the markers he must give 1-2 to the station in the rear.

422. Block signals must be restored to the normal indication as soon as the train for which they were cleared has passed _____.

423. Unless otherwise provided, signalmen must not give 3 until they have received 4 from the next block station in the rear, nor unlock the next block station in the rear before receiving 3.

424. Signalmen must observe all passing trains and note whether they are complete and in order and the markers properly displayed. Should there be any indication of conditions endangering the train, or a train on another track, the signal 1-4—1-4 must be given to the next block station in advance and the signalman must display Stop-signals, in both directions, and then answer 1-4—1-4. Should a train going in the opposite direction be stopped, it may be permitted to proceed when it is known that the track on which it is running is not obstructed. When practicable, the signalman giving 1-4—

I-4 must inform the signalman at the other end of the block why the signal was given.

425. Should a train pass a block station without markers, the signalman must give 2-3-2 to the next block station in advance and 5-2-5 to the next block station in the rear, and must not report the block clear nor unlock the next block station in the rear until he has ascertained that the train is complete.

426. Should a train pass a block station in two or more parts, the signalman must give 3-3-3—3-3-3 to the signalman at the next block station in advance. A signalman having received this signal must stop any train running in the opposite direction. The Stop-signal must not be displayed to the engineman of the divided train if the block in advance is clear, but the Train-parted signal must be given. Should a train going in the opposite direction be stopped, it may be permitted to proceed when it is known that its track is not obstructed.

427. Should cars run away in the wrong direction, the signal 4-4-4 must be given to the next block station in the rear. Should cars run away in the right direction, the signal 4-6-4 must be given to the next block station in advance. Signalmen receiving either of these signals must take such measures for the protection of trains as may be practicable.

428. A signalman informed of any obstruction in a block must display the Stop-signal and give 5-5-5 to the signalman at the other end of that block. A signalman receiving 5-5-5 must immediately display the Stop-signal and then answer by 5-5-5. The Clear-signal for that block must not be displayed until the obstruction is removed.

429. When a train takes a siding the signalman must know that it is clear of the block before giving 1-2 or displaying a Clear-signal for that block.

A signalman, after having unlocked the next block station in the rear or given 3-1, must not permit train or switching movements that will endanger an approaching train.

430. A train must not be admitted to a block unless it is clear, except as provided in Rule 436, or by special order.

431. When, as provided for in Rule 464, coupled trains have been separated, the signalman must regard each portion as an independent train.

432. If necessary to stop a train for which a Clear-signal has been displayed and accepted the signalman must give hand signals in addition to displaying the Stop-signal.

433. A signalman having orders for a train must display the block signal at "Stop." He may permit trains so stopped to proceed under block signal rules after complying with Rules for Movement by Train Orders.

434. If from the failure of block signal apparatus the block signal cannot be changed from the normal indication, a signalman having information from the signalman at the next block station in advance, that the block is clear, may admit a train to the block by the use of Clearance Card.

435. When a train is admitted to a block as provided in Rule 436, both signalmen must use every precaution to prevent a second train from entering the block until it is clear.

436. If from the failure of bell circuits, telegraph line or other cause a signalman be unable to communi-

cate with the next block station in advance he must stop every train approaching in that direction. Should no cause for detaining the train be known, it may then be permitted to proceed, provided ——— minutes have elapsed since the passage of the last preceding train, using Caution Card.

437. Signalmen must have the proper appliances for hand signaling* ready for immediate use. Hand signals must not be used when the proper indication can be displayed by the fixed signals. When hand signals are necessary they must be given from such a point and in such a way that there can be no misunderstanding on the part of enginemen or trainmen as to the signals, or as to the train or engine for which they are given.

NOTE TO RULE 437.—*Hand signaling includes the use of lamp, flag, torpedo and fusee signals.

438. Signalmen will be held responsible for the care of the block station, lamps and supplies; and of the signal apparatus unless provided for otherwise.

439. Lights in block stations must be so placed that they cannot be seen from approaching trains.

440. Lights must be used upon all block signals from sunset to sunrise and whenever the signal indications cannot be clearly seen without them.

441. If a train over runs a Stop-signal, the fact, with the number of train, must be reported to ———.

442. If a Stop-signal is disregarded, the fact, with the number of train, must be reported to the block station in advance and then to ———.

ENGINEMEN AND TRAINMEN.

461. Block signals apply only to trains running in the established direction.

462. Trains must not pass a Stop-signal without receiving a Caution Card, a Clearance Card or a special order.

463. An engineman holding a Caution Card must deliver it to the signalman at the next block station and personally ascertain from him that the block in advance is clear before proceeding.

464. Unless directed by special instructions, when two or more trains have been coupled and so run past any block station, they must be uncoupled only at a block station and the signalman notified.

465. When a train takes a siding it must not again enter the block without the permission of the signalman.

466. When it is necessary for a train to cross-over, the conductor before crossing or returning, must notify the signalman and obtain permission to do so.

467. Enginemen and trainmen must not accept clear hand signals as against block signals.

468. The engineman of a train which has parted must sound the whistle signal for Train-parted on approaching a block station.

469. An engineman receiving a Train-parted signal from a signalman must answer by the whistle signal for Train-parted.

470. When a parted train has been recoupled the signalman must be notified.

471. At a block station where the signalman is absent or incapacitated, so that instructions cannot be obtained, trains must wait ——— minutes and then proceed with caution to the next block station, where the conductor must report accordingly to the ———.

472. If the track is obstructed between block stations notice must be given to the nearest block signalman.

473. If a train is held by a block signal to exceed _____ minutes, the conductor must ascertain the cause.

474. Conductors must report to _____ any unusual detention at block stations.

475. A block station must not be considered as closed, except as provided on time-table or by special instructions.

NOTE.—Rules 401 to 475, inclusive, apply to this system without any of the “adjuncts.”

AUTOMATIC BLOCK SYSTEM.

A series of consecutive blocks controlled by block signals operated by electric, pneumatic or other agency, actuated by a train or by certain conditions affecting the use of a block.

CONSISTS OF:

1. Signals of prescribed form, the indications given by not more than three positions; and, in addition, at night by lights of prescribed color.

2. An apparatus so constructed that the failure of any part controlling the Home Block Signal will cause it to indicate—Stop.

3. Signals, if practicable, either over or upon the right of and adjoining the track upon which trains are governed by them. For less than three tracks, signals for trains in each direction may be on the same signal mast.*

*The word “mast” refers to the upright to which the signals are directly attached.

4. Semaphore arms that govern, displayed to the right of the signal mast as seen from an approaching train.

5. Switches in the main track so connected with the block signals that the Home Block Signal in the direction of approaching trains will indicate Stop when the switch is not set for the main track.

6. Signal connections and operating mechanism so arranged that a Home Block Signal will indicate Stop after the ———† of a train shall have passed it.

†The head, or rear.

ADJUNCTS.

The following may be used:

(A) Distant Block Signals* connected with corresponding Home Block Signals and so constructed that the failure of any part controlling the signal shall cause it to indicate—Caution.

(B) Track Circuits.

(C) Indicators at main track switches.

*When Distant Block Signals are used the following should be added to Rule 501:

DISTANT SIGNALS.

SIGNAL	OCCASION FOR USE	INDICATION	NAME
Color	The signal will appear when	For enginemen and trainmen	As used in rules
(d)_____	Home signal is at (a) or track obstructed between distant and home signal	Proceed with caution to the home signal	Caution-signal
(e)_____	Home signal is at (b)	Proceed	Clear-signal

Where the semaphore is used, the governing arm is displayed

to the right of the signal mast as seen from an approaching train, and the indications are given by positions:

Horizontal as the equivalent of (*d*).

Vertical or Diagonal — (angle above or below the horizontal) as the equivalent of (*e*).

Where a single disc is used for two indications these are given by position of a — (color) disc as seen from an approaching train:

Disc displayed as the equivalent of (*d*).

Disc withdrawn as the equivalent of (*e*).

RULES.

HOME SIGNALS

SIGNAL	OCCASION FOR USE	INDICATION	NAME
Color	The signal will appear when	For enginemem and trainmen	As used in rules
Red	Block is not clear	Stop	Stop-signal
—	Block is clear	Procede	Clear-signal
—	Block is clear	Approach next home signal	Caution-signal
	Second block in advance is not clear	prepared to stop.	

Where the semaphore is used the governing arm is displayed to the right of the signal mast as seen from an approaching train, and the indications are given by positions:

Horizontal as the equivalent of (*a*).

Vertical or Diagonal —* as the equivalent of (*b*).

Diagonal —* as the equivalent of (*c*).

Where a single disc is used for two indications these are given by position of a —† disc as seen from an approaching train:

NOTES TO RULE 501.—

*Angle above or below the horizontal.

†Color.

Disc displayed as the equivalent of (a).

Disc withdrawn as the equivalent of (b).

502. Block signals control the use of the blocks, but, unless otherwise provided, do not affect the movements of trains under the time-table or train rules; nor dispense with the use or the observance of other signals whenever and wherever they may be required.

503. Block signals apply only to trains running in the established direction.

504. When a train is stopped by a block signal it may proceed when the signal is cleared.

Or it may proceed—

(A) After waiting ——— minutes and then running under caution;

Or—

(B) Preceded by a flagman to the next clear signal.

NOTE TO RULE 504.—The Committee has provided for alternatives in Rule 504, considering either to be safe practice.

505. When a signal is out of service the fact will be indicated by ———.

Trains finding a signal out of service must, unless otherwise directed, proceed with caution to the next signal.

506. When a train is stopped by a signal which is evidently out of order, and not so indicated, the fact must be reported to ———.

NOTE.—Rules 501 to 506, inclusive, apply to this system without any of the “adjuncts.”

GENERAL NOTE.—The Committee has found it desirable to leave blanks (——) in certain rules to be filled by each company adopting them, as may best suit its own requirements.

TRAIN ORDER SIGNALS.

THE TELEGRAPH plays an important part in governing the movement of trains, and the train order signal is no less important. At every station from which train orders are given out it is a permanent fixed signal, and its position, together with the rules which govern its use, will either hold a train or permit it to proceed without hindrance.

Train order signals are of several forms. Different forms of the well-known target signal are shown in Figure 99. This signal is painted either green or red, but it is most generally painted red. The illustration shows it in the "stop" or "danger" position. When the track is clear and it is desired to show the "clear" signal the target is turned parallel with the track, and is, therefore, not visible to approaching trains. The colors used on this signal at night are usually red for "stop" and either green or white for "proceed."

These signals cannot, as a rule, be seen for any great distance by the engineers of approaching trains because they are usually attached to the side of a station building or else under wide spreading eaves. The great speed at which many trains are now run makes it necessary that all signals are of such form and position as will ensure that they may be plainly seen, in order that approaching trains not required to stop for orders or any other reason may not lose any time provided the signal be at "clear" and yet give sufficient time in which to

bring the train to a standstill in case the "stop" or "danger" signal is shown.

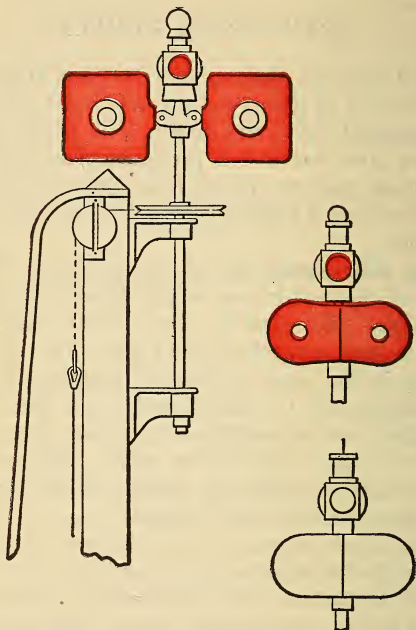

FIG. 99. TARGET SIGNALS.

This imperative need led to the introduction of the signal known as the semaphore, which has been very generally adopted, and which for train orders and general signalling is very satisfactory.

There are various forms of semaphore signals, the two in most general use are shown in Figures 100 and 101, the difference between them being the angle to which the arm is allowed to drop when at the "clear" position. One it will be observed is oblique, and the other is almost, if not quite, vertical. The horizontal position in any semaphore is the "stop" signal.

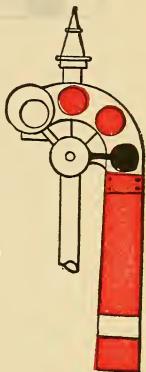

FIG. 100.

FIG. 101. SEMAPHORES,
COMMON TYPES.

When a semaphore is used to signal trains proceeding in one direction only, the arm pointing to the right of the post is the one from which the indication is given, the arm to the left of the post has, in that instance, no significance whatever. See Figure 102. If, however, a single, or one arm semaphore, is used for train order signals, it governs trains proceeding in either di-

rection. On a single track a one arm semaphore is often used, but on a double track never. (See Figure 103.) As a rule, on single track the double arm is generally used, one for trains proceeding in either direction.

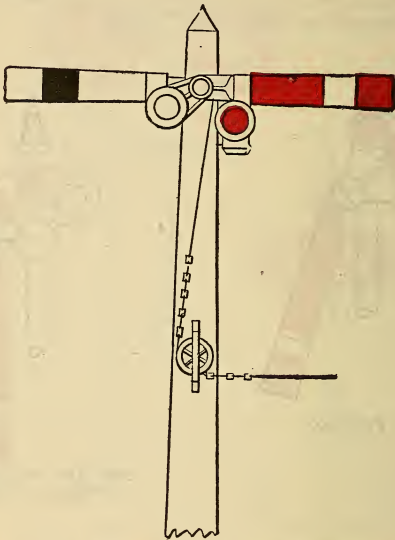

FIG. 102. A TWO-POSITION TRAIN-ORDER SIGNAL.

Only two indications are necessary for train order signals. But if the block system is in operation it is advisable to have a third for indicating "caution" when it is used for blocking. This signal may be and in some instances is used for train orders and block work also,

yet the only positions which come under the rules governing the train order signal are those already mentioned, "stop" and "proceed."

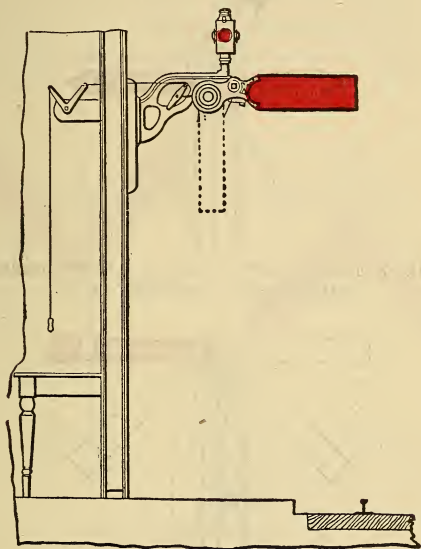

FIG. 103. A TRAIN-ORDER SIGNAL.

Two forms of signals are shown in Figures 104 and 105 which are capable of three positions. The upward inclination of the arm which is shown in Figure 104 indicates "caution," whereas the downward inclination shown in Figure 105 indicates the same signal, but it

cannot be confused with "clear" because that signal is indicated by the vertical position.

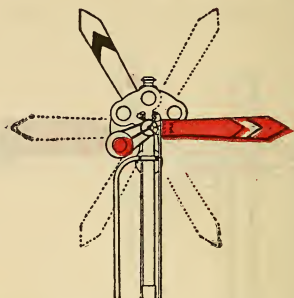

FIG. 104. A THREE-POSITION SIGNAL. "STOP"-HORIZONTAL; "CAUTION"-UP; "PROCEED"-DOWN.

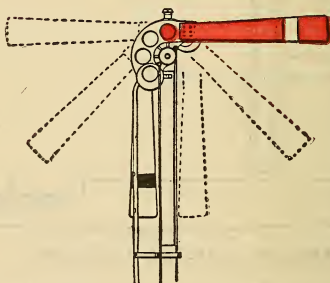

FIG. 105. DIFFERENT TYPE OF THREE-POSITION SIGNAL. "STOP"-HORIZONTAL; "CAUTION"-INCLINED; "PROCEED"-DOWN.

Red is the color employed when semaphores are used for train order signals, that is to say, it is the prevailing color; some few lines, however, use yellow. The stand-

ard color for use at night has, until recently, been for "stop" or "danger," red; for "proceed," white; and when necessary for "caution," green. There has been of late considerable discussion regarding a suitable standard color for the caution and proceed signals, and as green is by many considered better than white for many reasons, that color is used on some roads for the "proceed" signal. For "caution" orange or yellow have

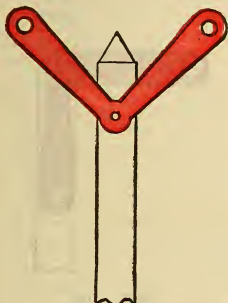

FIG. 106.

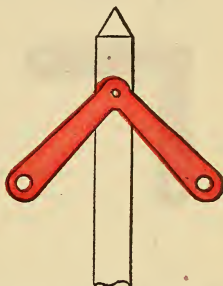

FIG. 107. A RIGHT-ANGLE SEMAPHORE FOR BLOCK SIGNALS WHEN USED ON A DOUBLE TRACK, FOR TRAIN-ORDER SIGNALS ON SINGLE TRACK.

(See also Figures 108 and 109.)

been mostly favored, although a few roads have adopted a combined green and red light. But it should be borne in mind that for train order work there are but two indications, "stop" and "proceed."

A unique form of signal has been adopted by one great railroad, although it is peculiar to that particular line. It can be used either for train orders or blocking

and either on double or single track lines. It is known as the "Right-Angle Semaphore," it revolves about its axis, and thus makes a number of indications. The pole is hollow and a lamp is suspended therein which is raised or lowered as the signal revolves. By means of colored glass inserted where the lamp stops, any night signal can be shown to correspond to any position of



FIG. 108.



FIG. 109.

(Same as Figures 106 and 107.)

the arms. On single track the position shown in Figure 106 denotes a train order signal "stop" and the position shown in Figure 107 is the signal to "proceed." The other indications (Figures 108 and 109) are used for any special signals on single track and they may be used block signals on double track.

STANDARD CODE, RULE 221, which follows, authorizes the adoption of two forms:

"221. (A). A fixed signal must be used at each train-order office, which shall indicate "stop" when there is an operator on duty, except when changed to "proceed" to allow a train to pass after getting train orders, or for which there are no orders. A train must not pass the signal while "stop" is indicated. The signal must be returned to "stop" as soon as a train has passed. It must be fastened at "proceed" only when no operator is on duty.

Operators must have the proper appliances for hand signaling ready for immediate use if the fixed signal should fail to work properly. If a signal is not displayed at a night office, trains which have not been notified must stop and ascertain the cause and report the facts to the _____ from the next open telegraph office.

Where the semaphore is used, the arm indicates "stop" when horizontal, and "proceed" when in an inclined position.

NOTE to Rule 221 A.—The conditions which affect trains at stations vary so much that it is recommended each road adopt such regulations supplementary to this rule as may best suit its own requirements.

221. (B). A fixed signal must be used at each train-order office, which shall indicate "stop" when trains are to be stopped for train orders. When there are no orders the signal must indicate "proceed."

When an operator receives the signal "31" or "19," followed by the direction, he must immediately display the "stop signal" for the direction indicated and then reply "stop displayed," adding the direction; and until the orders have been delivered or annulled the signal must not be restored to "proceed." While stop is indicated, trains must not proceed without a clearance card (From—"A").

Operators must have the proper appliances for hand signaling ready for immediate use if the fixed signal should fail to work properly. If a signal is not displayed at a night office, trains which have not been notified must stop and ascertain the cause, and report the facts to the _____ from the next open telegraph office. Where the semaphore

is used, the arm indicates "stop" when horizontal, and "proceed" when in an inclined position.

NOTE to Rules 221 A and 221 B.—The Committee has recommended two forms of Rule 221, leaving it discretionary to adopt one or both of these forms according to the circumstances of the traffic."

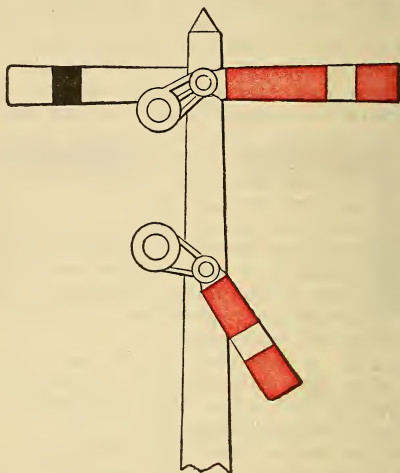

FIG. 110. SEMAPHORE, (DOUBLE ARM) FOR USE ON SINGLE TRACK.

(The small arm is for train-order signals.)

It will be seen that one form provides that the normal position of the signal shall be "stop" except where it is changed to "proceed" in order to permit a train to pass. The other form provides that the signal shall stand in the "proceed" position unless there are orders for a train, when the signal must indicate "stop."

Sometimes on single track lines the train order signal is used for blocking also. In that event the conductor and engineer are unable to know whether the train is being stopped for an order or is merely being held in the block. If for orders the conductor should go to the telegraph office to obtain them, whereas if for a block only the signal may be changed to "proceed" or "clear" before the conductor has had time to reach the office. A small semaphore is used on some roads, which is below the double arm semaphore used for block signalling, and located on the same post. This is used for train order signals and so provides a separate indication. (See Figure 110.) Of course, it may not be so clearly visible at a distance, but whenever it is used, the double arm semaphore may also be shown at "stop" until both have been observed by the engineer and conductor of an approaching train.

THE UNIVERSAL SEMAPHORE.—The American Railway Engineering and Maintenance of Way Association has recommended a standard casting which it thinks should be used for semaphore arms which are capable of being used in either two or three positions:

Two positions,—horizontal and vertical.

Three positions,—horizontal, inclined downward, vertical.

By merely changing the glass in the spectacles it may be used to indicate any color desired for any position at night. If the lamp is placed upon the top of the post it will answer for two arms, one in either direction. If only two indications are necessary, viz., horizontal and vertical, the color which is to indicate "stop" can be inserted in the two upper spectacles, and thus it will

be shown until the arm has quite reached the position indicating "proceed," and in this way a false night indication is prevented. Figures 111 to 115, inclusive, illustrate this form of semaphore.

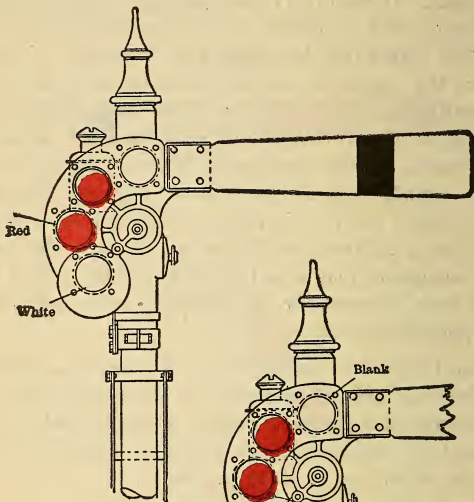

FIG. 111.

FIG. 112. TYPE OF SEMAPHORE ARM,
CONSIDERED STANDARD.

MEANS EMPLOYED FOR IDENTIFYING TRAINS.—The great importance of being able to positively identify trains cannot be too strongly impressed upon all who

have anything to do with their movement on the road. Operators ought to keep an accurate record, for by so doing he not only contributes to the expeditious movement of trains and the safety of lives and property, but

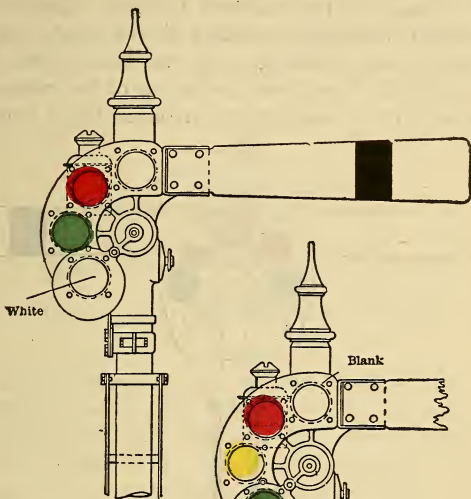

FIG. 113.

FIG. 114. TYPES OF STANDARD SEMAPHORE ARMS.

also makes the duties of the Train Dispatcher less arduous, and his own connection with the Dispatcher's office more satisfactory, if not pleasant.

Almost all roads have provision made for describing regular trains in train orders, although it is not in the Standard Code. It is generally the custom to give the number of the engine; some roads give the conductor's name; and in a few instances the engine number and also the name of the conductor is given. Extra trains are almost universally described by the number of the locomotive, and sometimes with the name of the conductor added. Sometimes the cupola of the caboose is provided with a transparency, trainmen being required

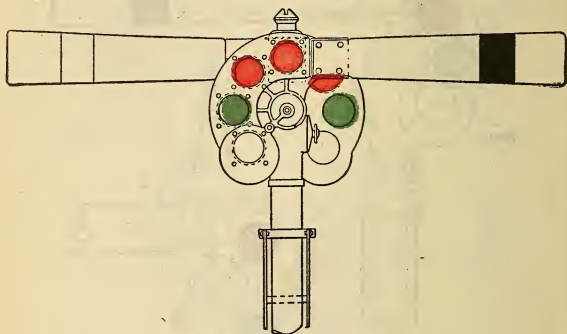

FIG. 115. SEMAPHORE ARM.

to exhibit at all times the prescribed characters, numbers or letters for the purpose of enabling their train being readily identified. See illustration, Figure 116. Each road has its own particular form of indication for the use of identifying its trains, although the common practice is to use a number (preferably the train's number)

in the case of regular trains, and also which section it is. If another section is not following, the letter "L," meaning "last," usually indicates that fact.

If regular train No. 45, for instance, has a second section following the indication would show: "1-45," but if another section is not following it would show: "L-45." If an extra train it would be designated by "X," and the number of the engine.



FIG. 116. CUPOLA IDENTIFICATION METHOD.

TRAIN MOVEMENT ON DOUBLE TRACK.—The movement of trains on double track, or on three tracks or on four tracks is quite different from the movement of trains on single track. Of course there are no "meeting points" for trains to make, but moving trains with the least delay possible is equally as serious a problem as that of making "meeting points." The reason for this is that the Standard Code of Double Track Rules formulated by the American Railway Association are, it is claimed, a modification of single track rules, and thus they are often inadequate to meet the rapidly changing conditions incident to the tremendous growth of traffic. Consequently the subject has been given considerable attention of late years; and as there are only a few rules

and forms of train orders prescribed particularly to meet the existing conditions, the need of a more uniform system for governing the movement of trains on double track is apparent, and more effort toward that end is being made.

On American roads the right-hand track is, as a rule, used by trains. There are a very few cases, however, where the English custom of using the left-hand track is followed. Cross-overs are sometimes used for passing, although passing tracks are provided at suitable intervals. As a general thing trains do not use cross-overs without express permission, and when using cross-overs they must be protected by a flag against trains on the opposite track. Passing tracks are generally located outside the main tracks, but the "middle track," which is a "siding" between the main tracks, and is accessible from either, is sometimes used. The one great thing which dispatchers aim to do is to keep slow trains on the move so they will not interfere with fast trains; and "keeping a train out of the way" is often a hard problem for the train dispatcher directing train movement on double track.

There is but one order prescribed by the Standard Code by which an inferior train may be moved ahead of a delayed regular train. It is D-Form E, an order which when used on double track is as unsatisfactory as when it is used on single track. There are one or two roads where no distinction of "class" in trains is made, a train being allowed to run until ordered to permit another train to pass it. On some lines trains are run on the opposite track for a little distance, if they can be kept moving thereby, instead of having to wait on a siding

for a superior class train to pass. And on some other roads, unless in case of accident, the established direction of the current of traffic is always maintained.

The practice varies concerning its use, on roads provided with a third track. One track is sometimes operated as a single track line, being used by trains in both directions under the rules governing single track. That still leaves two for double track use. In some cases, where that is done, the third track is used solely for trains in one direction during certain hours of the day when the amount of traffic necessitates it, the direction being reversed at other hours of the day. But the roads having three tracks are but few, because generally when the traffic becomes too great in volume to be handled on double track it is converted into a four-track road.

Nearly all, if not all, roads having a double track have some form of block signaling in operation. More expensive and efficient system than the telegraph block signal system have been widely introduced of late years, although the telegraph system is still in use to some extent. It embodies the use of station train order signals, the telegraph operators, of course, communicating by means of the telegraph with each other. What is known as the Right-Angle Semaphore (already referred to as being in use on one great railway system) is used in connection with the Telegraph Block System. This particular form of semaphore is illustrated and its different indications shown in Figs. 106 to 109 inclusive.

THE MANUAL CONTROLLED SYSTEM.—These are signals that are so interlocked that a signal cannot indicate "clear" if there is a train in the block. They are usually of the semaphore form, and are operated by a signalman.

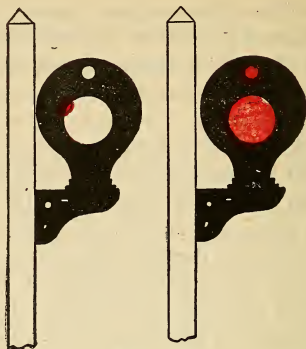

FIG. 117A.



FIG. 117B. THE DISC TYPE OF SEMAPHORE.

AUTOMATIC SIGNALS.—This form of signal is in use on some of the large railroads. Figs. 117A and 117B illustrate the disc type, and Figs. 118 and 119 show the semaphore type. These are provided to serve for both

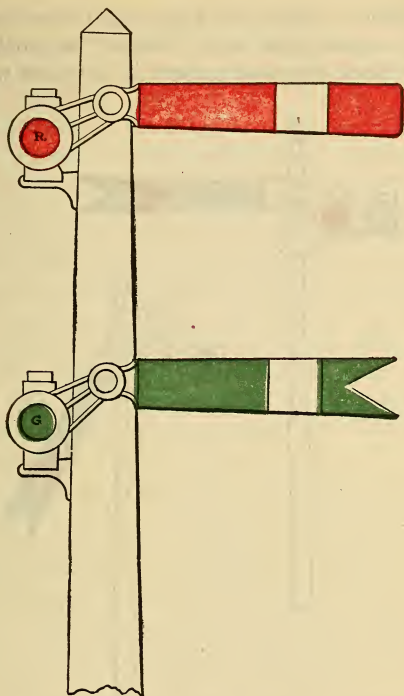

FIG. 118. "HOME" AND "DISTANT" SIGNALS.

"home" and "distant" signals. Sometimes at the entrance to each block there is a home and distant signal as illustrated in Fig. 118, the next block ahead being given by the distant signal. Thus an engineer may know there are two clear blocks ahead of him if both signals

show "clear." Should the home signal show "proceed" and the distant signal show "caution" he would know that the block immediately ahead is clear, but would be

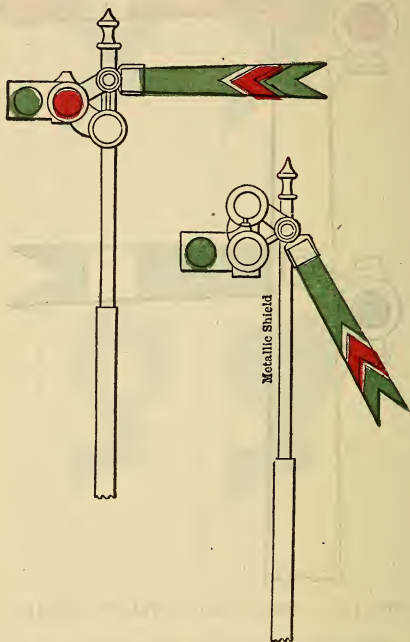

FIG. 119. "CLEAR" INDICATED BY GREEN LIGHT.

prepared to find "stop" shown at the next home signal, and would accordingly run with the train under full control.

The construction of automatic signals is such as to permit of either "stop" or "proceed" being the normal position shown. The "normally clear" position is the one most in favor.

Signals stand in the "stop" position with the "normally at danger" method, until a train approaches the entrance to a block, when, if the block is clear it will automatically change to "proceed," the change taking place in view of the engineer, with his train far enough away from the signal to avoid delay, then just as the locomotive reaches the signal it automatically returns to "stop," remaining in that position until that train is out of the block and another train is ready to enter it. Engineers are expected to see to it that the proper changes do take place, because failing so to do, it would indicate that they were not in order, and the fact should be immediately reported to the proper official.

NIGHT COLORS.—The tendency to change from green to white as a night color indication for "proceed" has already been mentioned. Where this is done there is difficulty in finding a suitable color for "caution." When a single color is substituted for green, for use as the "caution" signal, the color mostly chosen is yellow. But on one or two lines a combined green and red light indicates caution; the red light is concealed when the semaphore is dropped to the "clear" position, the green only showing. But as one lamp serves to show both colors in this combination, no light would be shown should the light be accidentally extinguished. See Figure 119.

THE ELECTRIC TRAIN STAFF SYSTEM.—Where this system is installed it has the effect of a mechanical operator issuing metal train orders, such orders being issued

only under the general direction of the train dispatcher, and such orders when issued give a train the right only over a certain section of track. This "mechanical operator" can issue but one such order at a time for any section, with the exception of following trains, in which case the permissive system is used; thus the risk of "lap orders" is entirely obviated.

This system does not eliminate the train dispatcher, but it does relieve his mind from the constant strain, because the train staff system is claimed to remove all danger of collision, and it does away with the telegraph train orders entirely. Thus it gives him more time to issue orders for the proper movement of trains on the division under his control.

In its operation the track to be protected is divided into blocks or sections of such length as will best accommodate local and traffic conditions. These blocks usually terminate at existing stations or telegraph offices, though occasionally, as in the telegraph block system, additional block stations have to be installed, when the distance between any two existing stations is too great for the expeditious handling of traffic. Each section is controlled by two instruments (Figure 120), one at each end, "X" and "Y." Each instrument is equipped with a sufficient number of staffs (varying from ten to twenty-five per section) to take care of the traffic conditions. No train is permitted to proceed between "X" and "Y" in either direction unless the conductor or engineer has in his possession one of these staffs, which, as has been already stated, serves as a "metal train order." The instruments at "X" and "Y" are electrically connected and synchronized so that the withdrawal of a staff from either can

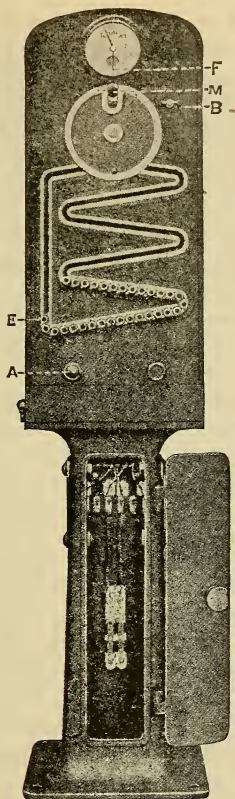

FIG. 120. ABSOLUTE STAFF INSTRUMENT WITH PEDESTAL.
Front View Showing Door of Pedestal Open.

only be effected by the joint action of the operators at "X" and "Y," and but one staff can be put out of both instruments at any one time. To move a train from "X" to "Y" the manipulation of the instrument is as follows: The operator at "X" presses bell key (Figure 120-A) the number of times prescribed in the bell code, which rings bell (Figure 121-L) at "Y." The operator at "Y" first acknowledges receipt on his bell key, ringing bell at "X" (Figure 121-L). After ringing the bell through this circuit, he then holds it closed, thereby deflecting the "current indicating needle" (Figure 122-F) at "X," to the right. This informs "X" that "Y" has furnished current and he proceeds to remove the staff by turning the preliminary spindle handle (Figure 120-B) to the right as far as it will go, which raises the armature (Figure 125-J) up to the magnets (Figure 125-K), transferring the current from the bell "L" to the magnet, K-88, thus closing the circuit. The magnet K (Figure 125) is in fact made up of two units, K-88 and K-360. Its construction is explained on page 402. The preliminary spindle handle (Figure 120-B) is permitted to automatically return to its normal position. This unlocks the revolving drum (Figure 125-C) and indicates the fact by displaying a white instead of a red disc in the indicator at Figure 122-H. The operator now moves the end staff (Figure 120-E) up the vertical slot into engagement with the drum (Figure 125-C), the outer guard (Figure 122-N) having first been turned to the right position, revolves the latter through a half turn, using the staff as a handle, and finally withdraws the staff through the opening at Figures 120 and 124-M. In making the half turn the drum (Figure 125-C) has reversed the polarity of the

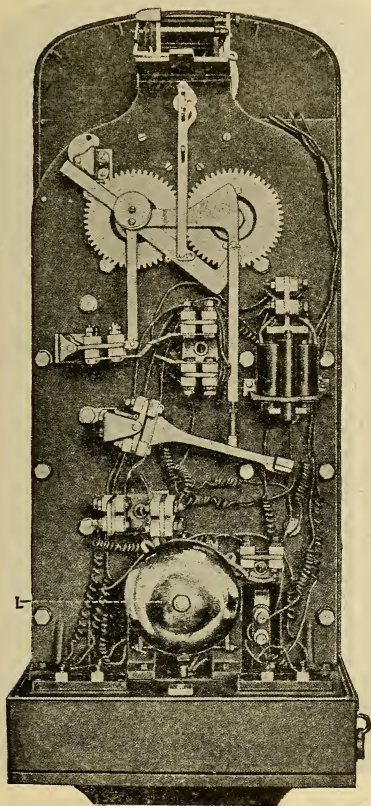

FIG. 121. ABSOLUTE STAFF INSTRUMENT.
Rear View with Cover Removed Showing Armature Dropped.

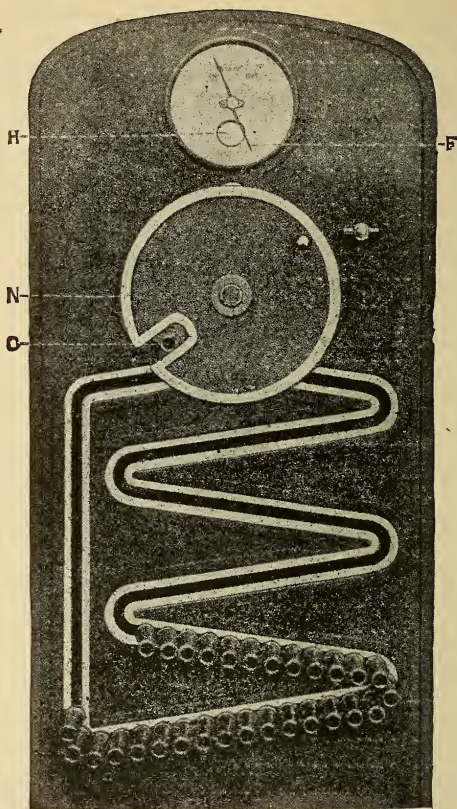

FIG. 122. ABSOLUTE STAFF INSTRUMENT.

Front View of Instrument in Condition for Removal of a Staff.

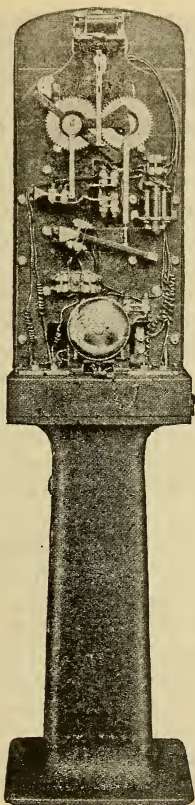

FIG. 123. ABSOLUTE STAFF INSTRUMENT WITH PEDESTAL.
Rear View with Cover Removed Showing Armature Raised.

operating current, thereby throwing the instruments at "X" and "Y" out of synchrony with each other and moving the "staff indicating needle" at "X" (Figure 124-G) from "Staff In" to "Staff Out." Immediately on withdrawing the staff, the operator at "X" once more presses the bell key "A," which indicates to the operator at "Y" by moving his needle from "Staff In" to "Staff Out" that the operation is completed. The staff withdrawn is now delivered to the train by hand if the train is at rest, or passing at a speed of less than twenty-five miles per hour. For higher speeds the staff is placed in a special holder and delivered by methods similar to those followed in the Railway Mail Service, the locomotive being fitted with a catching and delivering device. The illustrations will serve to make this perfectly clear.

As before mentioned, in taking out a staff the polarity of the operating current is reversed. This prevents a second staff from being taken out of either instrument, as follows:

The polarity of the current flowing through magnet K-360, Fig. 125, is never changed, the current for the same being local. The polarity of the current flowing through K-88, Fig. 125, is changed each time its staff is put in or taken out of either instrument. This puts the instruments either in or out of synchrony. The magnet (Figure 125-K) is formed of two separate coils, one energized by the local and one by the line battery. The construction of this magnet is such that when the currents in both coils flow in the same direction, the lines of force flow round the cores and connecting straps, thus forming no point of attraction for the armature. When the current is reversed in one coil, the lines of force op-

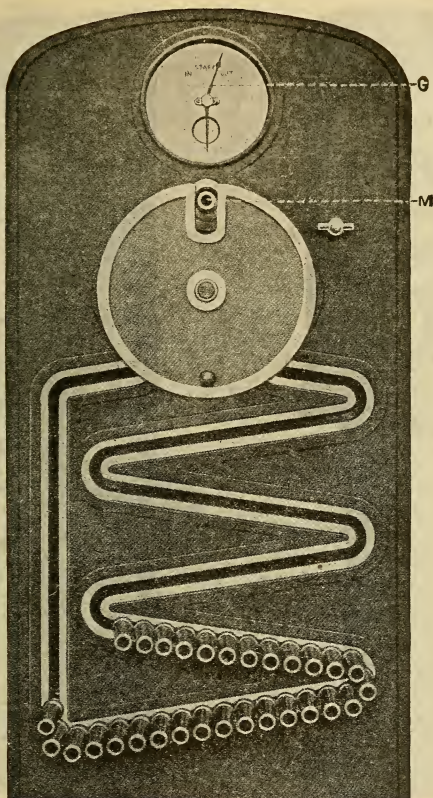

FIG. 124. ABSOLUTE STAFF INSTRUMENT.

Front View of Instrument when a Staff is Released or about to be Replaced.

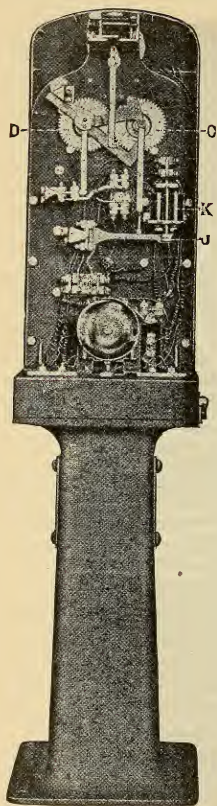

FIG. 125. ABSOLUTE
STAFF INSTRUMENT
WITH PEDESTAL.
Rear View with Cover Removed
Showing Armature Dropped.

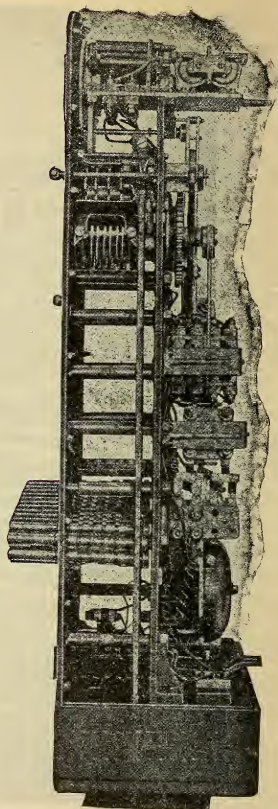

FIG. 126. ABSOLUTE STAFF
INSTRUMENT.
Side View with Cover Removed.

pose each other and the armature being brought to the point of attraction is held there. With the staff out, if an attempt be made to release another staff, it will fail because the circuit still remains closed, with the polarity of the current flowing through magnet K-88 reversed. This action is due to the construction of the magnet K as explained on page 402. Under the conditions as cited above the currents flowing through magnet K-360 and magnet K-88 are both in the same direction, thus preventing the release of a second staff. On arrival of the train at "Y" the staff is delivered either by hand or delivered to the operator who, having seen that the train is complete by observing the rear end markers, places the staff in the opening (Figures 120 and 124-M) of his instrument, having first turned the outer guard (Figure 122-N) to place, moves the staff into engagement with and revolves drum (Figure 125-D) through one half turn, using the staff as a handle (see Figure 127) and allows it to roll down the spiral. He then presses his bell key the prescribed number of times, thus notifying "X" that the train is out of the section, which operation also moves the "staff indicating needle" at "X" from "Staff Out" to "Staff In." The operator at "X" presses his bell key in acknowledgment and by doing so moves "staff indicating needle" at "Y" from "Staff Out" to "Staff In" (see Figure 127). The machines are now synchronized and another staff can be obtained from either in the manner above described.

The staff being put in the instrument at "Y," the circuits for releasing a staff at "X" or "Y" would again be in their normal condition ready for service.

While it takes some little time to describe the method of operating the staff instruments, yet, as a matter of fact,

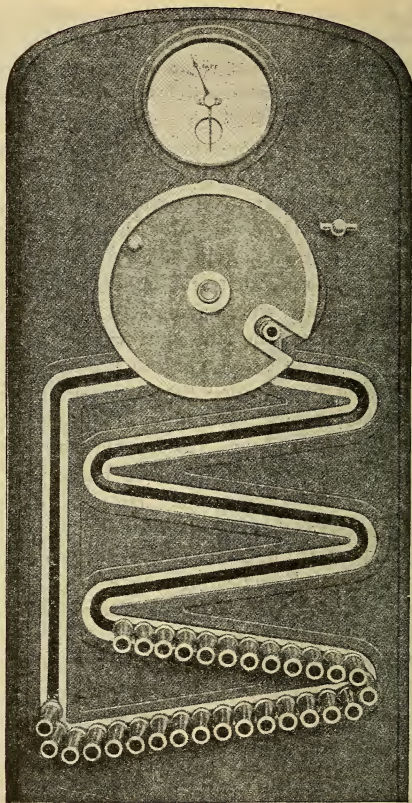

FIG. 127. ABSOLUTE STAFF INSTRUMENT.

Front View of Instrument when a Staff has been Replaced.

the removal of a staff actually takes less than five seconds, and the operation of putting one in an instrument less than two seconds, under ordinary conditions.

The same methods are followed at each succeeding staff station, but no two adjacent sections use the same design of staff; that is to say, the staff used between "X" and "Y" will not fit the instruments which control the section between "Y" and "Z."

Usually four different designs of staffs are employed in actual practice, to avoid any possibility of their being improperly used.

THE PERMISSIVE FEATURE.—While the absolute train staff system, where but one train is allowed in any section, is the ideal arrangement, yet cases occur where it is desirable to allow several trains to follow each other a block at short intervals. This may be done by the use of the "permissive system," which consists of an attachment to the absolute machine at each end of the section with *one* permissive staff; this instrument is shown in Figure 128.

To use it, an absolute staff is withdrawn from the instrument at "X" and is used as a key with which to unlock the base containing the permissive staff to be removed, which action locks the absolute staff in the permissive attachment until the permissive staff is returned. The permissive staff is a steel rod and eleven removable rings, any of which will authorize a train to pass through the section to Y. If less than twelve trains are to follow each other, the last one takes *the remaining rings and the rod*. When all the rings are received at "Y" the operator returns them to the permissive staff, places it in the permissive attachment or base, and locks it by

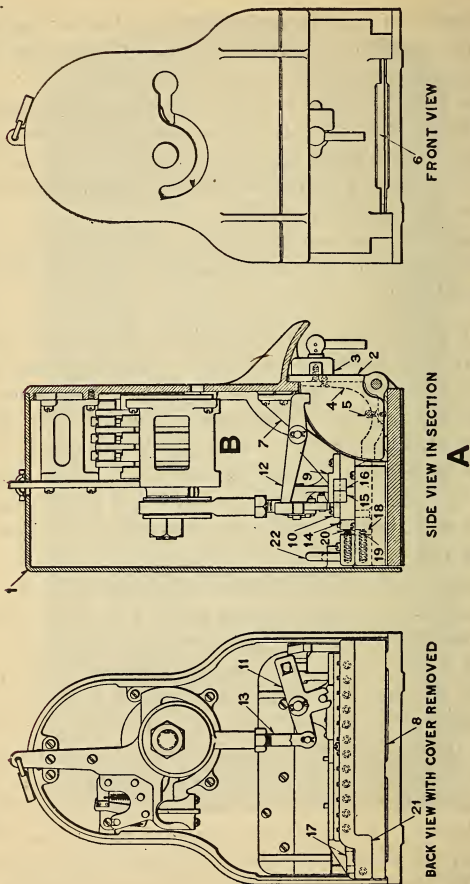

FIG. 128. PERMISSIVE ATTACHMENT.

the absolute staff already in the lock. This releases the absolute staff, which put in the absolute instrument in the regular manner. That synchronizes the machines so that a movement can be made with an absolute staff in either direction and from "Y" to "X" with the permissive staff.

When next it becomes necessary to move a number of trains in rapid succession from "X" to "Y" under the permissive system, the permissive staff must be obtained by "Y" as before described and forwarded to "X" as a whole by the first train moving in that direction. The entire permissive staff confers the same rights as does an absolute staff.

CONTROL OF SIGNALS.—In its capacity as a key the absolute staff has a number of uses in addition to those already described. Where signals are used to indicate to an approaching train whether or not it will receive a staff, an instrument known as the staff and lever lock is attached to each lever operating such signals (see Figure 129). To clear a signal, the staff after being withdrawn is first used to unlock the lever lock, the signal is then cleared, the staff removed from the lock and delivered to the train.

To insure the signal being placed at danger behind a train the act of unlocking the signal lever opens the staff circuit, and no communication can be made between the two staff stations until the signal is at danger and the lever locked in that position. This does not indicate, however, that the operator will have the staff ready for delivery by hand, or in the mechanical deliverer. To cover that point an electric slot is attached to the signal governing train movements into the staff section, which slot is controlled by the staff and lever lock and the mechanical deliverer, so that before the signal can be cleared

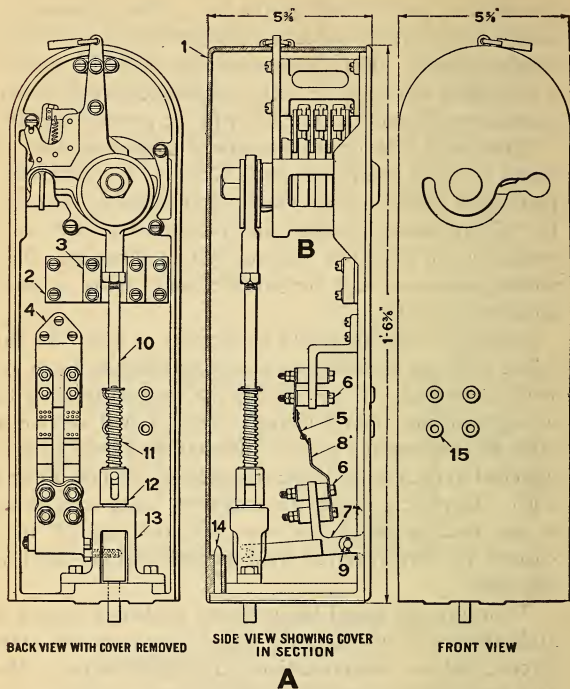

FIG. 129. STAFF LEVER LOCK.

the staff must be released, used to unlock the signal lever and put in the staff deliverer, which closes the circuit on the electric slot. The signal can then be cleared. With this arrangement, therefore, a clear signal cannot be given until the staff is actually in the deliverer.

When the train picks up the staff, the circuit on the slot is opened, automatically setting the signal to danger, and it cannot again be cleared until the operation is repeated.

SWITCH LOCKING.—The staff is also used as a key to unlock siding switches which may occur between staff stations, the switch locks being so designed that the staff cannot be removed from the lock until the switch is set and locked for the main line, thus providing absolute protection against misplaced switches.

INTERMEDIATE SIDING AND JUNCTION INSTRUMENTS.—In some sections there is a siding of sufficient length to hold a train, but traffic would not warrant placing a staff station there. That the usefulness of this siding may not be lost, a special instrument is placed at the siding which enables it to be used for meeting or passing trains.

A junction or diverging line may be situated between two points most suitable for staff stations, but, on account of the small amount of traffic over the diverging line, it would not be desirable to make it a staff station. Such a point can be controlled in a similar manner. The circuits and operation of both the siding and junction instruments are the same.

To move trains between "X" and "Y" the manipulation of the instruments is the same as that previously described in connection with the absolute instruments.

To move a train from "X" to the siding or junction, a staff is released at "X" by "Y" in the regular manner (see page 398). The operator at "X" gives the staff to the train with instructions to proceed to the siding or junction. Unlocking the switch with the staff, the train takes the siding or junction, closes and locks the switch,

places the staff in the siding or junction instrument, and turns the drum to the right. The staff is now locked in the instrument and the staff instruments at "X," "Y" and junction or siding are synchronized. (See Figure 129.)

When a movement is to be made from the siding or junction to "X" or "Y" (all staffs being in the instruments), "X" and "Y," acting in conjunction, can release a staff at the siding or junction (as required), which on being removed changes the circuits so that no other staff can be released either at "X," "Y," siding or junction until this staff is replaced in one of the instruments. The train then unlocks the switch, passes out on the main track, locks switch and proceeds to "X" or "Y."

PUSHER ENGINE ATTACHMENT.—Another adjunct to the staff system is known as the pusher engine attachment and staff, which is used on heavy grades where pusher engines are required, and is intended to both obviate the necessity of the pusher engine proceeding through the entire staff section, and to better equalize the traffic. It can readily be seen from the foregoing description of the staff system, that under ordinary rules every train having a pusher engine attached would receive one staff to proceed up grade, as from "Y" to "X." On arrival at "X" pusher engine would necessarily have to receive a staff to return to "Y." Supposing the traffic up and down grade to be equal, and that each train going up grade requires a pusher, it is apparent that twice as many staffs would go down hill as came up, resulting eventually in all the staffs arriving at the foot of the grade "Y," from whence they could only be returned to "X" by some special person authorized to unlock the instruments and remove the staffs by hand.



FRONT VIEW

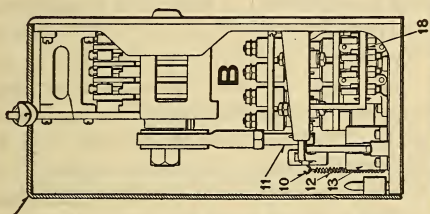

SIDE VIEW SHOWING COVER IN SECTION

A

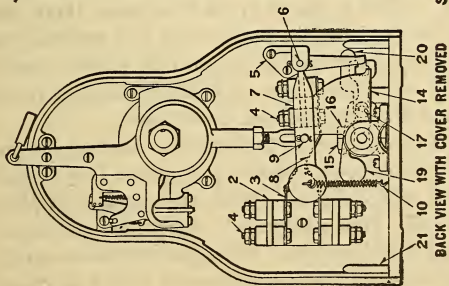

BACK VIEW WITH COVER REMOVED

FIG. 130. PUSHER ATTACHMENT.

Furthermore, the summit of the grade may be half way between "Y" and "X," but under the rules a pusher could not cut off at the summit and return to "Y," but would have to continue on to "X" and receive a staff to return.

To overcome these two objections the pusher attachment (see Figure 130) is employed. It consists (like the permissive attachment) of a separate device which may be attached to any absolute instrument, and contains a staff of special design which can only be released by an absolute staff, though, unlike the permissive staff, it can be out of its receptacle at the same time as the absolute staff.

The operation is as follows: A train with a pusher engine wishes to proceed from "Y" to "X." "X" releases staff at "Y" (page 398) and "Y" uses this staff to release pusher staff. This operation opens the controlling circuits of the system and closes the circuits on the pusher bells (page 402). "Y" then hands the absolute staff to the train and the pusher staff to the pusher engine. The train passes through the section and delivers the absolute staff at "X." This is placed in the instrument there, the pusher engine retaining the pusher staff and returning to "Y." Until this latter staff is put into the pusher attachment at "Y" and locked, the staff circuits are not re-established and no other staff can be released.

CIRCUIT CONTROLLER ATTACHMENT.—Another attachment called the circuit controller attachment (see Figure 131) is used where electric signals are operated in place of mechanical. This attachment is arranged to control the staff and signal circuits. The signal circuits controlling the signals for a through movement cannot be closed until the staff has been used to release same, which staff can be taken out when said release is made.

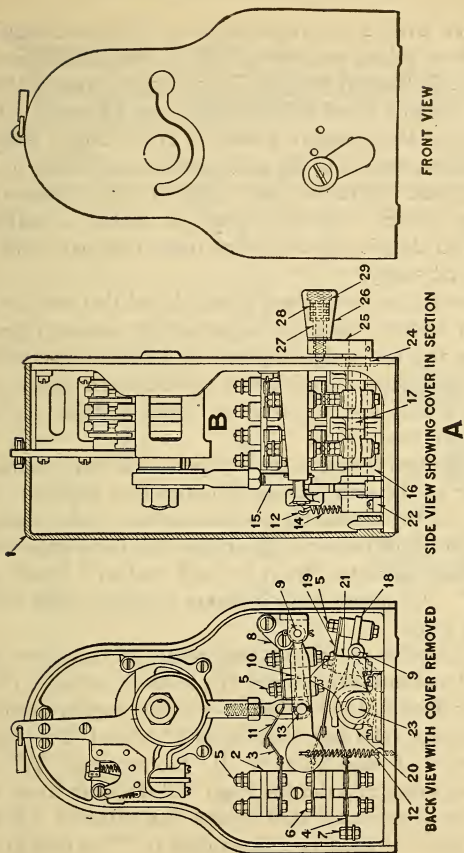

FIG. 131. CIRCUIT CONTROLLER ATTACHMENT.

STAFF SYSTEM ON THE SOUTHERN PACIFIC RAILWAY.—There is a long continuous staff blocking on the Southern Pacific Railway between Truckee and Colfax, California, a distance of 98 miles, divided into 37 blocks. This portion of the Southern Pacific is in the Sierra Nevada Mountains, and 14 of the staff stations are located in the snow sheds. Here the staff station is at the center of a passing siding. The staff system is worked in conjunction with electric signals so that trains may pass with facility and safety.

Through the snow sheds it was found that neither the modern electric semaphore signal nor the ancient types of banner and banjo signals could be installed, so Mr. W. W. Slater, Signal Engineer of the Southern Pacific, designed a neat and compact disc signal suitable for this particular condition.

The general arrangement of signals and their operation at each of the staff stations is outlined as follows: All signals in the horizontal position indicate "take siding." Upper blade of two-arm signal clear and independent distant clear indicates "stop at staff station," "staff not ready." All signals clear indicates "proceed, staff ready and in crane."

The circuits controlling the signals in the above described movements are wired in a manner similar to those already described in connection with the regular absolute staff service, releasing a staff at both "A" and "C." Upon the arrival of these trains at "B," the one from "A" will take the siding and the one from "C" the main track, the latter stopping at the staff station (as ordered). If the train from "A" should get into siding at "B" in time to enable operator to put the staff into the instrument and get another released and put in the crane, the signals for the

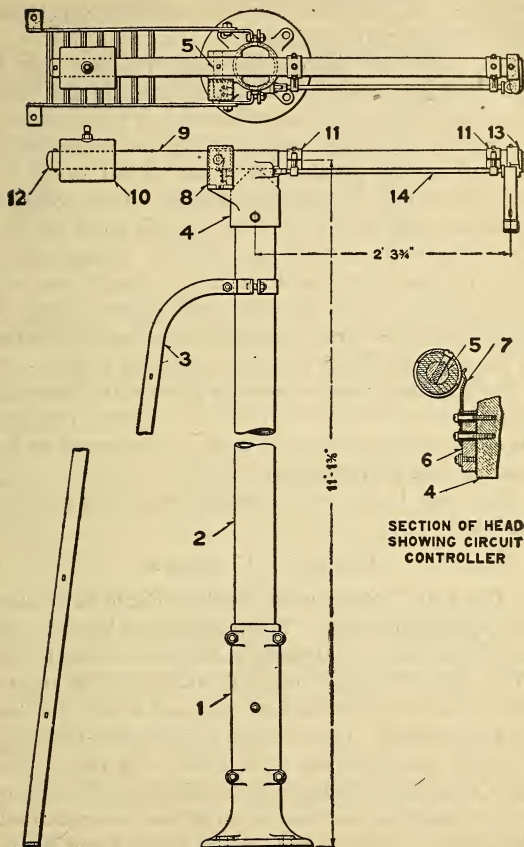

FIG. 132. CRANE STAFF DELIVERER.

train from "C" could be cleared as explained on page 416, thus preventing its stopping.

The home and independent distant signals can be cleared at any time by moving the handle of the circuit controller attachment from the normal or first position to the middle or second position, allowing trains to approach the staff station, but the staff distant signal on the two arm post cannot be cleared until the circuit controller attachment has been released by a staff, when the handle can be removed from the middle or second position to the reverse or third position, thereby closing one point in the circuit of the aforesaid staff distant signal, the other point in the circuit being closed by putting the staff in the crane ready for the train to take as it passes.

Two opposing signals cannot be given at the same time, circuits of each being controlled by the other, making it necessary for one of the two to be in the normal or first position, thus preventing confusion.

The crane in use in this installation is shown in Figure 132.

THE A. B. C. SYSTEM.

"The A. B. C. Rules on the Northern Pacific have passed the experimental stage. Their value is no longer a matter of speculation. Apparently they have come to stay. From every viewpoint they are, without doubt, superior to any single track system of rules and orders that have yet been devised. They are now used on sixty-three miles of track, from Spokane to Ritzville. On this territory there are fifteen telegraph offices and three blind sidings. It is all main line and handles a traffic so heavy that with the ordinary system of train orders it was found impossible to keep trains moving.

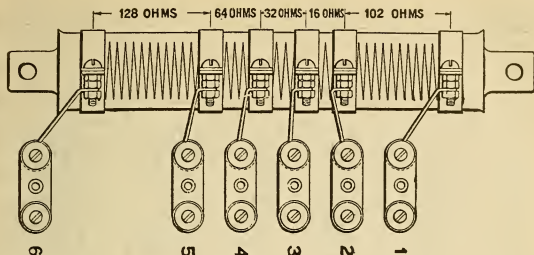

FIG. 133.

The distance between two staff instruments depends upon traffic conditions and therefore the resistance of the line wire in series with the line coil of the lock magnet varies considerably. The local coil of the lock magnet should have a variable resistance in series with it in order that it may balance perfectly with the line coil. This is accomplished by using the adjustable resistance tube shown diagrammatically in Fig. 133.

The table gives the required information for connecting up the adjustable resistance tube for any ordinary condition.

Column 1 represents the total resistance of the two line wires connecting a pair of instruments.

Column 2 shows the normal voltage required to operate. (This is 50% above the minimum voltage required and gives a large working margin.)

Column 3 shows the corresponding number of dry cells required to secure the voltages shown in Column 2.

Column 4 shows the ohms resistance to be inserted in series with the local coil to balance the line resistances as given in Column 1.

Column 5 shows the proper terminal to which one wire leading from the local coil of the lock magnet should be connected to get the resistance shown in Column 4. **THE OTHER SHOULD ALWAYS BE CONNECTED TO TERMINAL 1.**

Column 6 shows the additional connections to be made in order to get the resistances shown in Column 4.

EXAMPLE. Two staff instruments are $5\frac{3}{4}$ miles apart. No. 12 B. & S. copper line wire is used. Total length of line wire will be $11\frac{1}{2}$ miles. Total resistance of line will be 96 ohms. Consulting the table we see that 30 cells of dry battery should be used to operate and that 262 ohms should be put in series with the local coil. Columns 5 and 6 show that to get this resistance we connect terminals 2 and 3 together and also terminals 4 and 5 together. We then connect terminals 1 and 6 into the local circuit.

1	2	3	4	5	6
Ohms Resistance in Line.	Volts Required to Operate.	Number Cells of Dry Battery Required to Operate.	Ohms Resistance to be Added to Local Circuit.	Terminal of Adjustable Resistance Tube to be Connected in Local Circuit.	Terminals of Adjustable Resistance Tube to be Connected Together.
16	30.2	22	102	2	None
24	31.4	22	118	3	None
32	32.5	23	134	4	2 & 3
40	33.6	24	150	4	None
48	34.8	25	166	5	2 & 4
56	35.9	26	182	5	3 & 4
64	37.	26	198	5	2 & 3
72	38.2	27	214	5	None
80	39.3	28	230	6	2 & 5
88	40.5	29	246	6	3 & 5
96	41.6	30	262	6	2 & 3—4 & 5
104	42.7	30	278	6	4 & 5
112	43.9	31	294	6	2 & 4
120	45.	32	310	6	3 & 4
128	46.1	33	326	6	2 & 3

FIG. 134. TABLE OF RESISTANCES FOR ELECTRIC TRAIN STAFF SYSTEM.

“No train orders are issued and there are no time-table schedules except for information to the public that passenger trains may be expected at certain times. A train obtaining a clear signal at a telegraph office and obtaining a clearance card from the operator has absolute right to the next telegraph station. There it receives further instructions by means of a three-position semaphore either to stop and wait, to take siding or to proceed to the next station. Clearance cards are delivered to conductor and engineman by means of hoops and no reduction of speed is necessary.

“Experience has shown surprisingly satisfactory results. It has long been realized that an important element in the cost of handling traffic is the length of time consumed by trains in passing over the road. Delays are very expensive. They consume coal, produce wear and tear on the engine and necessitate overtime to employes. With the A. B. C. Rules all these items of expense are reduced to the lowest possible figure. Receipts for freight charges are the same no matter whether the movement is speedy or otherwise, so that the saving in expense is clear gain.

“It is difficult to arrive at an exact statement of increase of efficiency, but a comparison of statistics for one month with that of the corresponding period a year previous shows that the average speed of all freight trains in passing over this portion of the track was eleven miles per hour, as compared with 8.6 miles per hour the previous year. This includes all delays of whatever kind and also includes the movement of two way freights doing work and a goodly amount of switching. Omitting the locals the record of the through freight trains shows

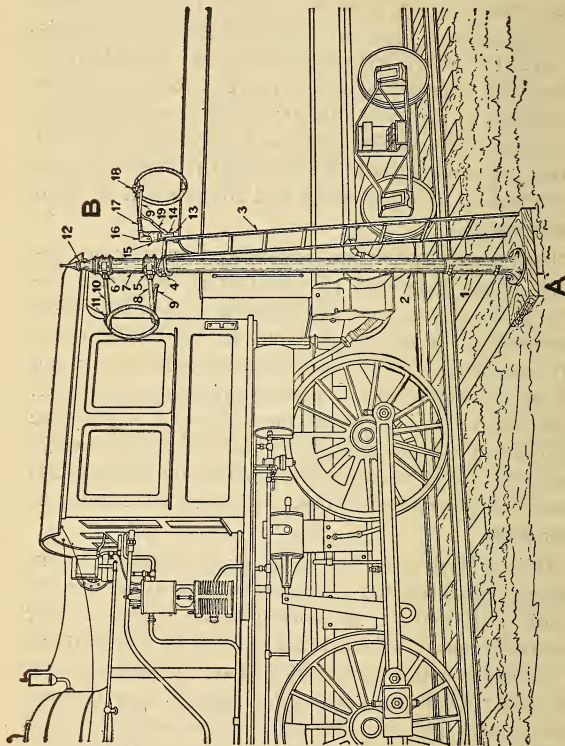

FIG. 135. STAFF CATCHER AND DELIVERER

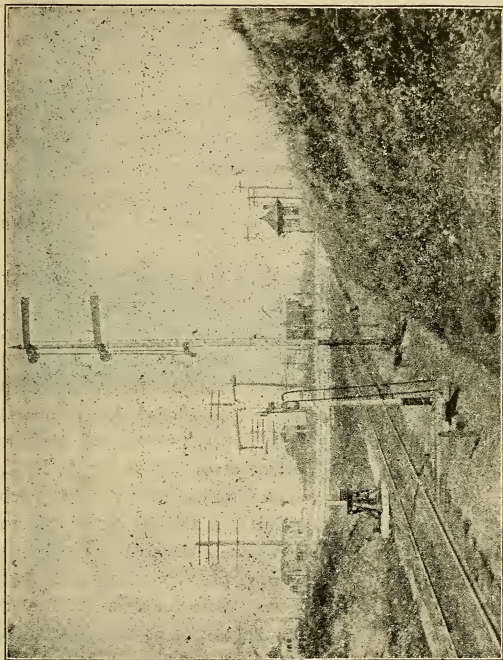

FIG. 136. VIEW SHOWING STAFF IN CRANE STAFF DELIVERER
READY TO BE TAKEN BY A PASSING TRAIN.

an average speed of fourteen miles per hour, which is an excellent showing for a single track road. The average increase of speed is 30 per cent. and the average decrease of time spent on the road is almost 22 per cent. The earning capacity of engines and cars shows an increase of over 20 per cent.

“All this is accomplished with practically the same number of men and the same equipment of signals, etc., as was required for the old method, which involved the use of train orders. The great success of the venture is attributed in some measure to the hearty co-operation of the dispatchers, trainmen and operators concerned in handling the trains. All contribute toward attaining the desired results.

Not the least important feature of the plan is that it may be termed absolutely safe. In handling trains according to the Standard Code there is the ever-present element of danger. The best and most careful man is liable to error. Dispatchers, operators, conductors and enginemen are all in positions where oversight and forgetfulness are always possible. Experience has proven this so true that further comment is unnecessary. With the A. B. C. System three men must act simultaneously with each other. No move can be authorized and no signal can be cleared unless they three give their consent. The operator who is to clear the train first examines his own block record, and if the track is clear asks the dispatcher for a clearance. The dispatcher looks at his train sheet and if found proper issues the necessary authority. The operator then asks permission of the operator at the next station to admit the train to the block. If the latter is satisfied that the track is clear he gives his consent. All

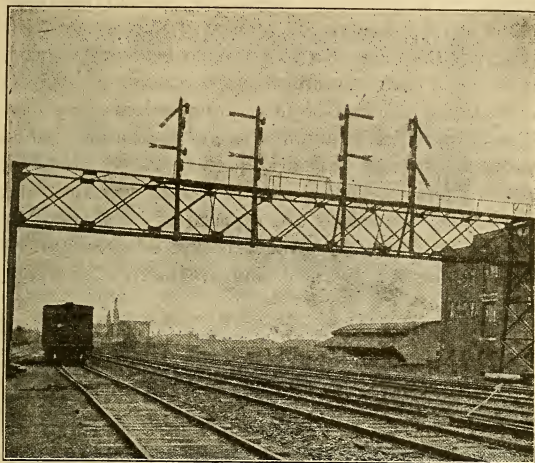

FIG. 137. EIGHT SEMAPHORE SIGNAL BRIDGE EQUIPPED WITH THE SAFETY STORAGE SYSTEM.

(Cylinder indicated by arrow.)

Owing to the great penetrating power of Acetylene and the absence of the yellow rays, it is of great value for Signal Lighting. All colors hold their true value under this marvelous illuminant, which makes it possible to use a wider range of colors for signals. Through heavy storms and fogs that obscure other lights and make it necessary for the engineer to slow down, and sometimes almost stop, to make the signal, the Acetylene signal shines clearly and the signal can be seen without any trouble.

The illustration shows an eight semaphore light signal bridge equipped with the Safety Storage System. The cylinder seen at the foot of the right-hand end of the bridge is one of our old style 20 1-4 inches by 124 inches, containing 2,200 cu. ft. of gas at 150 lbs. pressure. One such cylinder will supply the eight light bridge for five months, lights burning night and day, requiring no attention except to clean lamps every thirty days.

three must make a mistake if the wrong authority is granted, and it would seem impossible that an error could be thus made. The record of four months shows that nothing approaching such an error has been experienced. The duties of each man are so simple, compared with the handling of a hundred or more train orders every day, and he has practically but one thing to do at a time, while a dispatcher on an ordinary district has sometimes a dozen matters requiring attention, and operators and trainmen have numerous orders, each of which must be delivered and executed without failure or oversight."—*From Locomotive Firemen and Engineers' Magazine, May, 1908.*

BLOCK SIGNAL EXAMINATION.

QUESTIONS WITH ANSWERS.

Q. What is a block signal? A. A telegraph station with all the necessary signals for blocking trains.

Q. What is a block. A. The distance between the outer approaching switches of two block stations.

Q. What is a positive block? A. A Block where there is only one train allowed at a time.

Q. What is a cautionary or permissive block? A. A block where two trains are allowed by the use of a cautionary card or signal.

Q. Are block signals used for any other purpose than blocking trains? A. They may be used for stopping trains for telegraphic orders.

Q. What rules besides block signal rules apply to them? A. Train order rules.

Q. What is a block signal? A. A semaphore where arms govern by day, and red, green and white lights by night.

Q. Which arm and light of the block signal govern trains approaching such signal? A. The right arm and the light facing the train.

Q. What does the horizontal position of the arm or red light signify? A. Danger.

Q. What does the diagonal position of the arm or green light signify? A. Caution; another train is in the block.

Q. What does the vertical position of the arm or the white light signify? A. Clear; no train in the block.

Q. When a clear signal is given how far does it indicate that block is clear? A. To outer approaching switch of the block station ahead.

Q. What switch is meant by the outer approaching switch of the block station ahead? A. The one farthest out from that station.

Q. At what position must signals always be kept except when changed to permit a train to pass? A. Horizontal or danger.

Q. While you have train orders on hand, at what position must block signals be left? A. Horizontal or danger.

Q. What must be done before issuing clearance cards to trains to which you have delivered orders? A. Ascertain that there are no more orders and that the block is clear.

Q. If you have no orders for a train, which is approaching, and block ahead is clear, when should you give clear signal to that train? A. As early as possible in order that they will not reduce speed.

Q. When is the proper time to report a train clear of a block? A. One hundred yards past the block station.

Q. When is a proper time to replace danger signals after a train has passed? A. Immediately after the markers have passed the block station.

Q. How are you to know when an entire train has passed your station? A. By the markers.

Q. What are the markers? A. Red and green lights by night and green flags by day.

Q. If a train passes with no markers displayed what would you infer, and what action would you take? A. Notify block stations on each side and report to train dispatcher that train has parted.

Q. If you are notified by next block station in either direction that a train which had entered block has parted what would you do? A. Give "train parted" signal to engineer as front portion approached.

Q. What is a "train parted" signal? A. A lamp or flag swung vertically at arm's length across the track.

Q. For what purpose is a cautionary block signal or card used? A. To allow a train to enter a block which is not clear.

Q. Suppose that two or more sections of a train were to meet an opposing train at your station; would you give the opposing train a clear signal before all the sections had passed and all others had been completed and delivered or cancelled or while there was another train in the block? A. No.

Q. What record of movements of train is to be kept and at what time must the record commence? A. A record of train movements should be kept on a train register sheet and should be commenced at midnight daily.

Q. How are trains to be reported? A. To offices both in advance and rear.

Q. What does signal B signify? A. Block.

Q. What must be done with regard to an approaching train if a train from an opposite direction upon single track has entered the block? A. Leave danger signal displayed to hold the approaching train.

Q. What should be done upon the approach of a train? A. If block is clear, and if you hold no orders for the train, display white or clear signal allowing it to proceed.

Q. What would be done in case you could not raise the next block station to get him to block trains and you could not raise train dispatcher for instructions? A. Issue a caution card stating the facts of the case. The

train could then proceed only as in accordance with the time schedule.

Q. Under what conditions may a train be permitted to enter a block before a preceding train has cleared that block? A. Under a cautionary signal or card.

Q. How must your signals be displayed when trains are to meet at your station? A. They should be held at danger until one train is clear on the side track.

Q. What must be done in case a train is to use a cross-over switch or enter the opposite or wrong-going track? A. The conductor must notify the operator, at the block station to be last passed, of his intentions, who will notify the operator in the block station in advance, to use the danger or cautionary signals for all opposing trains until informed that the train which crossed over has reached his or another block. Station on the right track.

Q. If a train enters a siding at your station to be met and passed by another train what must you know before reporting the block clear? A. That the markers on the rear of the train are clear on siding and that the switch is closed.

Q. If it should be necessary to stop a train while it is passing your station for which you have given a clear or caution which signal would you use?

A. The danger signal, also hand signal.

Q. After an engine or train has passed your office and you are offered an order for that train, or you are ordered to block it, what would you do? A. Refuse by stating the circumstances and then endeavor to stop the train.

Q. What must be done before closing a block signal

station? A. Get relief from the train dispatcher and notify the offices on each side.

Q. When block offices are closed what must be done with the signals? A. Leave them at white.

Q. What must be done when an office is reopened? A. Report to the train dispatcher for duty and notify the stations on each side.

Q. What must be done before allowing the first train to pass? A. Ascertain if block is clear.

Q. When should hand signals be used? A. At any time when the proper indications cannot be given by the fixed signal.

SIGNALLING CATECHISM.

Q. What do block signals control?

A. The use of certain blocks.

Q. Do they affect the movement of trains under time table or train rules?

A. No.

Q. Do you consider that a block signal relieves you in any way from protecting your train by flagman?

A. No.

Q. Explain the position of block signal when "Clear" and at "Stop."

A. When at "Clear" they will show a diagonal arm by day and a green light at night. When at "Danger" a horizontal arm or a red light at night.

Q. When signal is clear to what point does it give you a clear track?

A. To the outer approaching switch at the next station.

Q. What is meant by the outer approaching switch at station?

A. The first switch reached.

Q. Do block signals control trains standing on side track?

A. No.

Q. What authority is necessary before train on side track can proceed?

A. Authority from the signal man.

Q. Of what does such authority consist?

A. A caution card and release, a release stamped

"Block is Clear," a train order stamped "Block is Clear" or train orders and a caution card.

Q. How must trains moving under caution card expect to find main track?

A. Occupied in that block.

Q. When two or more trains coupled together enter a block when can they be uncoupled and what is your duty?

A. Only at a block station and signalman to be notified.

Q. What is necessary before train crosses from one main track to another?

A. A cross-over permit.

Q. After clearing a block what are instructions relative to re-entering or backing into same?

A. Must not back within 300 feet of the block without authority from the signalman.

Q. How long are trainmen required to watch block signal to see that position does not change?

A. Until the entire train has passed.

Q. If you came to a block signal where a signalman is regularly employed and found no signalman there what would you do?

A. Would wait ten minutes, then proceed to the next block station, and report the fact to the train dispatcher. This applies to an intermediate station where there are no sidings.

Q. When parted train has been recoupled who must conductor notify?

A. The signalman.

Q. Will hand signals be accepted against block signals?

A. No.

Q. What is required of conductor when track is obstructed between block stations?

A. Conductor should notify the nearest block signalman.

Q. Upon entering a siding at a block station what notice is required of conductor to signalman when train is clear of main track and switch is locked?

A. He must personally notify the signalman that train is clear of main track.

Q. What is an intermediate siding?

A. A side track between two open block stations.

Q. What is required of an inferior train accepting a clear signal, intending to proceed to next block station on its right, but which through delay cannot reach such station, and an intermediate siding is located between blocks? What is required of a superior train?

A. They must take the intermediate siding, or if unable to reach same they should protect themselves with flagman. The superior train would proceed by authority of caution card.

Q. What form of release is required where two trains are scheduled to meet at an intermediate siding?

A. A release showing that train order signal is displayed for these two trains to meet at the intermediate siding.

Q. If the inferior train fails to make the meeting point how will the superior train be governed.

A. It will proceed on its time table rights and the same as on caution card.

Q. When two trains meet by special order at an intermediate siding what is necessary besides the order before entering the block?

A. A release stating that signal is displayed for such trains to meet at the intermediate siding.

TEN MINUTE BLOCK.

Q. In districts not controlled by telegraph block how far apart must trains in the same direction keep?

A. Ten minutes.

Q. If you are passed by any train at an intermediate siding how long would you wait before proceeding?

A. Ten minutes.

DEFINITIONS.

Q. Define a block?

A. A length of track of stated limits, controlled by a block signal.

Q. A positive block?

A. One in which only one train is allowed at a time.

Q. A permissive block?

A. One in which two or more trains are allowed.

Q. A block station?

A. A place from which block signals are operated.

Q. A block signal?

A. A fixed signal controlling the use of a block.

Q. A home block signal?

A. A fixed signal at the entrance of a block to control trains entering same.

Q. A distant signal?

A. A fixed signal used in connection with the Home signal to indicate that the Home signal may be at "Stop" when the distant signal is at "Caution" or that the Home signal is clear when the distant signal is clear.

- Q. An advance block signal?
- A. A fixed signal used in connection with a Home block signal to subdivide the block in advance.
- Q. What is a block system?
- A. A series of consecutive blocks.
- Q. A telegraph block system?
- A. A block system in which the signals are operated manually upon information by telegraph.
- Q. A controlled manual block system?
- A. A block system in which the signals are operated manually and so constructed as to require the co-operation of the signalman at both ends of the block to display a clear signal.
- Q. What is an automatic block system?
- A. A block system in which the signals are operated by electric, pneumatic or other agency actuated by a train or by certain conditions affecting the use of the block.

SIGNALS USED IN AUTOMATIC BLOCK.

- Q. What signals are used in connection with the automatic block system?
- A. Either the semaphore or the enclosed disc.
- Q. How are the signal indications given by day and by night?
- A. By not more than two positions of an arm or disc, and at night by light of prescribed colors.
- Q. Explain where you would look for these signals on single, double and three tracks?
- A. Over or upon the right of the track to which they refer, and on double track to the left of the track to which they refer, for one or two tracks the signals may

be attached to the same mast. For three tracks, usually over the running track.

Q. When these signals are located on bracket posts what signal would you read for the track on which you are running?

A. The signal on the right hand mast refers to the track furthest to the right, the next signal to the left refers to the next track to the left and so on.

Q. To what side of the signal mast are semaphore arms displayed as seen from an approaching train?

A. To the right of the mast.

Q. What would a distant block signal set at caution indicate?

A. A distant block signal indicates the position of the Home signal ahead.

Q. When the indicator disc is visible at a main track switch what would it indicate?

A. It would indicate that the head of an approaching train had reached a point within 1,000 feet in advance of the block signal protecting the switch.

Q. By what signal are the indications for the main running track given?

A. By a high Home signal.

Q. In what direction do even numbered signals govern?

A. South or East.

Q. Odd numbered signals?

A. North or West.

Q. Where a semaphore signal is used where are the arms displayed and how many positions are there?

A. To the right of the mast. There are two positions.

Q. How at night?

A. It will show a green light when at clear and a red light when at danger.

Q. Where signal disc is used how are the indications given?

A. By a position of a red or clear disc.

Q. How at night?

A. By the light of the same color.

Q. What is the "Stop" and "Proceed" signal on a Home Semaphore by day and by night?

A. When at stop it will show a horizontal arm to the right of the mast and at night a red light. When "Clear" it will show a diagonal arm by day and a green light by night.

Q. Where two signals are displayed from the same mast what does the upper arm indicate?

A. The upper one is the Home block signal for the block in advance.

Q. What does the lower arm indicate?

A. It is the distant signal for the second block, in advance.

Q. What is a caution signal on a Distant Semaphore signal?

A. The arm displayed in a horizontal position and at night a green and red light.

Q. What is a Clear signal on a distant Semaphore signal?

A. The arm displayed diagonally and at night a green light.

Q. What is a Stop signal on a Home Disc signal by day and by night?

A. A red disc and at night a red light.

Q. What is a Clear signal on a Home Disc signal by day and by night?

A. The red disc withdrawn from view and at night a green light.

Q. What is the Caution signal on a Distant Disc signal by day and by night?

A. A green disc with a white cross on its face or a red and green light at night.

Q. What does such Caution signal mean?

A. To proceed with caution to the Home signal.

Q. What is a "Clear" signal on a Distant Disc signal?

A. The disc withdrawn from view and at night a green light.

Q. When a train is stopped by an automatic block signal when may it proceed and how will it run?

A. When the signal is cleared, or after waiting one minute for signal to clear. It should run with caution to the next clear signal.

Q. What is the indication when a signal is out of service and how will you proceed?

A. It will be covered with a white shield. Would proceed with caution to the next signal.

Q. What is necessary when you find a signal out of order?

A. Would notify superintendent.

Q. When a Home signal indicates "Stop" what does it mean?

A. It indicates that the block is occupied, that a switch is wrong in the block, that a car is foul of the main track or that the signal apparatus is out of order.

Q. If you desire to pass from a side track to the main track and you find a red disc visible in the indicator box, what would you do?

A. Would not open switch until red disc disappeared from view.

Q. Can a switch be opened to permit a train to move from the main to a side track when the red disc is visible in the indicator box at the switch?

A. Yes.

SIGNALS OF INTERLOCKING PLANTS.

Q. What is a high signal?

A. A signal supported on a mast 20 feet or more high.

Q. A mast?

A. An upright to which signals are attached.

Q. A Home signal?

A. A fixed signal at which trains are required to stop when the route is not clear.

Q. A distant signal?

A. A fixed signal used in connection with the Home signal to indicate that the Home signal may be at "Stop" when the Distant signal is at "Caution" or that the Home signal is at "Clear" when the Distant signal is "Clear."

Q. A Dwarf signal?

A. A low Home signal.

Q. What signal is used at interlocking plants?

A. The Semaphore signal.

Q. How are the indications given by day and by night?

A. By semaphore arms by day and lights of prescribed color by night.

Q. Where are these signals located on single, double and three tracks?

A. On single track they are either over or to the right

of the track to which they refer, on double track they are located to the left of the track to which they refer, on three tracks usually over the running track.

Q. To what side of the mast are the arms displayed as seen from an approaching train?

A. To the right.

Q. Explain the position of signal on bracket posts and what track they control?

A. The signals on the right hand mast refer to the track furthest to the right; the signals on the next mast to the left refer to the next track to the left, and so on.

Q. When the train service on one main track is superior to that of another how will the signals be displayed?

A. The signals for the superior track will be placed six feet higher than those for the inferior track.

Q. By what will the indication for main running track in the established direction be given?

A. Home signal.

Q. At junction points where two signals are located on the same mast what route will the top signal govern?

A. The superior route.

Q. What is the indication for a diverging movement from the main running track in the established direction to a secondary or side track?

A. By a Dwarf signal.

Q. Where will the Dwarf signal be located?

A. To the right of the track to which it refers, and either at the foot of or opposite the high Home signal.

Q. How will the light on the Dwarf signal show to indicate a diverging movement?

A. It will show either a diagonal arm or a green light.

Q. How will the high Home signal show?

A. It will indicate "Stop."

Q. By what signal will the indication for a reverse movement from the established direction on or from a main running track, or for a movement to or from a side track in either direction be given?

A. By a Dwarf signal.

Q. What does a Home signal in a horizontal position or a red light by night denote?

A. Stop.

Q. What does it mean when the arm is inclined diagonally downward or a green light is shown?

A. Proceed.

Q. What does it mean when the Distant signal is in a horizontal position or a red and green light is shown?

A. It would indicate that the Home signal may be at danger and train should proceed with caution prepared to stop before Home signal is reached.

Q. What does it indicate when Distant signal is in a diagonal position or a green light is shown?

A. It means that the Home signal is at clear.

Q. When a signal indicates "Stop" where must engine be stopped?

A. Before signal is passed.

Q. If after receiving a "Clear" signal the semaphore is placed in the "Stop" position what should be done?

A. Train should stop at once.

Q. What report should be made of same?

A. It should be reported to the Superintendent.

Q. In case you experience an unusual delay at an interlocking plant what report should be made of same?

A. Report should be made to the Superintendent.

SIGNALS OF INTERLOCKING PLANTS.

Q. What is a high signal?

A. A signal supported on a mast 20 feet or more high.

Q. A mast?

A. An upright to which signals are attached.

Q. A Home signal?

A. A fixed signal at which trains are required to stop when the route is not clear.

Q. A Distant signal?

A. A fixed signal used in connection with the Home signal to indicate that the Home signal may be at stop when the Distant signal is at caution or that the Home signal is at clear when the Distant signal is at clear.

Q. A Dwarf signal?

A. A low Home signal.

Q. What signal is used at interlocking plants?

A. The Semaphore signal.

Q. How are the indications given by day and by night?

A. By semaphore arm by day and light of prescribed colors at night.

Q. Where are these signals located on single, double and three tracks?

A. On single track they are either over or to the right of the track to which they refer; on double track they are located to the left of the track to which they refer (or as the case may be).

Q. To what side of the mast are the arms that govern displayed as seen from an approaching train?

A. To the right of the mast.

Q. Explain the position of signals on bracket posts and what tracks they control?

A. The signals on the right hand mast refer to the track furthest to the right; the signals on the next mast to the left refer to the next track to the left, and so on.

Q. When the train service on the main track is superior to that of another how will the signals be displayed?

A. The signals for the superior track will be placed six feet higher than those for the inferior track.

Q. By what will the indication for main running track in the established direction be given?

A. A Home signal.

Q. At junction points where two signals are located on the same mast what route does the top signal govern?

A. The superior route.

Q. What is the indication for a diverging movement from the main running track in the established direction to a secondary or side track?

A. By a Dwarf signal.

Q. Where will the Dwarf signal be located?

A. To the right of the track to which it refers and either at the foot of or opposite the high Home signal.

Q. How will the light on the Dwarf signal show to indicate a diverging movement?

A. It will show either a diagonal arm or a green light.

Q. How will the high Home signal show?

A. It will indicate stop.

Q. By what signal will the indication for a reverse movement from the established direction on or from a main running track or for a movement to or from a side track in either direction be given?

A. By Dwarf signals.

Q. What does a Home signal in a horizontal position or a red light by night denote and how would you be governed?

A. It indicates stop and I would not pass it while in that position.

Q. What does it mean when the arm is inclined diagonally downward or a green light is shown?

A. Proceed.

Q. What does it mean when the Distant signal is in a horizontal position or a red and green light is shown and how would you be governed?

A. It indicates that the Home signal may be at danger and train should proceed with caution.

Q. What does it indicate when distant signal is in a diagonal position or a green light is shown?

A. It means that the Home signal is at clear.

Q. When a signal indicates stop, where must engine be stopped?

A. Before signal is passed.

Q. If after receiving a "Clear" signal the semaphore is placed in a stop position what should be done?

A. Train should stop at once.

Q. What report should be made of same?

A. It should be reported to the Superintendent.

Q. What is your duty when approaching interlocking stations when train is parted?

A. To sound the train parted signal.

Q. What is your understanding about allowing sand to be dropped and overflow from ejector to run down on track in the vicinity of interlocking plants?

A. It should not be done.

Q. In case you experience an unusual delay at an interlocking plant what report must be made of same?

A. Report should be made to the Superintendent.

SIGNALMEN AT INTERLOCKING PLANTS.

Q. Have you received a copy of the Rules and Regulations of the Railway Company, effective ———, 19—, and do you understand that they supersede all previous rules and regulations?

A. Yes.

Q. Have you read the Rules and Regulations; are you conversant with them and will you obey the instructions contained therein?

A. Yes.

Q. Do you understand that in accepting employment you assume its risks, and that each employe is responsible for his own safety, and must exercise care to avoid injury to others?

A. Yes.

Q. What is the rule in regard to the use of liquor, the frequenting of places where liquor is sold and the use of tobacco?

A. The use of liquor and the frequenting of places where sold is prohibited, and the use of tobacco in and about passenger stations and on passenger cars is not allowed.

Q. When are night signals displayed?

A. From sunset to sunrise, except in heavy weather, when they should be displayed to suit conditions.

DEFINITIONS.

Q. What is a high signal?

A. A signal supported on a mast at least 20 feet above the track.

Q. A mast?

A. An upright to which the signals are attached.

Q. A Home signal?

A. A fixed signal at a point at which trains are required to stop when the route is not clear.

Q. A Distant signal?

A. A fixed signal used in connection with the Home signal to indicate that the Home signal may be at stop when the Distant signal is at caution; or that the Home signal is at clear when the Distant signal is clear.

Q. A Dwarf signal?

A. A signal indicating a diverging movement from the main track.

Q. What is the normal position of Home and Distant signals?

A. The normal indication of Home signal is at stop and of Distant signal at caution.

Q. On what side of mast are arms displayed for trains in a particular direction?

A. To the right of the mast.

Q. When the train service on one main running track is superior to that of another how are the signals arranged for each track?

A. The signals for the superior tracks are located $6\frac{1}{2}$ feet higher than those for inferior tracks.

Q. How is the signal for a main running track movement given?

A. By a high Home signal.

Q. At junction points where two signals are located on the same mast what route does the top signal govern?

A. A superior route.

Q. What is the indication for a diverging movement from the main running track in the established direction to a secondary or side track?

A. A Dwarf signal with a diagonal arm or a green light.

Q. Where will the Dwarf signal be located?

A. On the right of and adjoining the track to which it refers and either at the foot of or opposite the high Home signal.

Q. How will the light on the Dwarf signal show to indicate a diverging movement?

A. Green.

Q. How will the high Home signal show when the Dwarf signal indicates diverging movement?

A. Stop.

Q. By what signal will the indication for a reverse movement from the established direction, on or from the main running track, or for a movement to or from a side track, in either direction be given?

A. By a Dwarf signal.

Q. When the route is not clear how does the Home signal show by day and by night?

A. A horizontal arm by day and in addition a red light by night.

Q. How does it show when clear by day and by night?

A. The arm in diagonal position and in addition at night a green light.

Q. How does the Distant signal show when at caution by day and by night?

A. The arm in a horizontal position and in addition a red and green light at night.

Q. How does the Distant signal show when the route is clear by day and by night?

A. The arm in a diagonal position and in addition a green light at night.

Q. What persons are allowed to operate levers and other appliances at interlocking towers?

A. Only those whose duties require them to operate them.

Q. Except when signals are cleared for the passage of trains how should they be left?

A. In the normal position.

Q. When should signals be cleared for approaching trains?

A. In sufficient time to avoid delay to the train.

Q. After a train has passed when should signals be restored to normal position?

A. As soon as the train has passed to Home signal limits.

Q. If, after having given a train clear track it is necessary to change the route, what must be done before switches are changed?

A. The train must be stopped.

Q. What about moving a switch when a train is standing close to same?

A. It should not be done.

Q. If any indication of derangement of the signal apparatus, what must be done before operating same?

A. They should be examined.

Q. What is necessary in cold weather to prevent connections from freezing?

A. Signal should be operated frequently to prevent freezing.

Q. What is necessary when a signal fails to work properly?

A. It should not be used and should be secured to give the normal indication until repaired.

Q. What about allowing alterations or additions to interlocking plants?

A. It should not be done without proper authority.

Q. If there is a derailment or switch run through at an interlocking plant, or if any damage occurs to same, what is required?

A. The signal should be placed to give the normal indication and no train allowed to use the same until they have been put in order.

Q. What is necessary when a switch is disconnected from interlocking apparatus?

A. It must be securely fastened.

Q. What is necessary during snow storms?

A. To know that switches are properly cleaned.

Q. If any electrical or mechanical appliance fails to work properly what is required of signalman?

A. Notice should be sent to the Division Superintendent and the repairman.

Q. When switches or signals are being repaired what is required of signalman?

A. He should have an understanding with repairman before operating such signals.

Q. What is your duty in regard to observing passing trains and what would you do in case you found anything wrong with same?

A. I would do everything possible to prevent damage or injury.

Q. If you have information that an approaching train has broken in two what is your duty?

A. I would use every effort to give the train a clear route and give train parted signals to enginemen.

Q. What danger signal should be kept on hand at interlocking towers?

A. Red lamps and flags, torpedoes and fuses.

Q. If necessary to discontinue the use of any signal how will signalman handle trains?

A. By hand signal.

Q. Who is held responsible for the care of an interlocking station and its appliances?

A. The signalman.

Q. How should lights in an interlocking station be placed?

A. So they cannot be seen from the approaching train.

Q. What should be done when a train runs by a stop signal?

A. The Division Superintendent should be notified.

Q. What persons are allowed in an interlocking station?

A. Only those whose duties require them to be there.

REPAIRMEN.

Q. Who is responsible for the proper inspection and adjustment of interlocking plants?

A. The repairman.

Q. What report must be made when track or switches do not permit of proper operation?

A. A report should be sent to the Superintendent.

Q. When repairing interlocking plants with whom must you have an understanding and whom must you notify when such repairs are completed?

A. The signalman.

Q. What is necessary when any switch is disconnected?

A. It should be securely fastened before any train is permitted to pass over it.

Q. By whom are alterations or additions to interlocking plants authorized?

A. The Chief Engineer.

Q. To whom must you report your whereabouts?

A. The Division Superintendent.

POINTERS FOR CONDUCTORS.

Conductors should remember that they were once brakemen themselves, and should bear in mind that a kind word and genial manner often secures better results than a sullen demeanor and gruff manner; besides it makes friends of their worthy fellow employes and the public generally, in addition to elevating them in the estimation of their immediate superior officers.

Conductors should be at their trains at terminal stations at least thirty minutes in advance of the schedule leaving time, or the time at which they were called to leave, and so far as their personal attention will permit should insure leaving promptly on time.

They are responsible for the safe management of their train, and for the strict performance of duty on the part of the men engaged with them. In order to secure effective work, conductors should be familiar with the duties required of train employes.

They should require their brakemen to assist ladies, children and infirm persons off and on the cars, and should render such assistance themselves when necessary.

They are clothed by law with the power of sheriffs in order to quell disturbances or to protect property or persons upon their trains. Should it ever become necessary to make arrests upon such occasions, the offenders should be secured and delivered to the sheriff or police at the first station where such officers may be found.

When a conductor discovers anything wrong with the

track, bridges or culverts, likely to cause an accident to a following train, he should not wholly depend upon the telegraph in order to notify other trains, but should leave a flagman and in addition notify the nearest section foreman.

When notified of a defect in the telegraph line they should instruct their brakemen to watch for it, and when it is found its character and location should be reported to the telegraph operator at the next office.

When an accident occurs which involves loss of life, serious injury of persons, damage to property or the obstruction of the track, or when the track is impassable because of snow or damage by flood or any other cause, conductors should report the fact to the proper official by telegraph as soon as possible, giving all the information necessary to a clear understanding of the case, such as the location, nature, cause and extent of the injury, damage or obstruction, and they should state what relief or assistance is required.

In the train register book at all terminal stations, or wherever such books are kept, they should enter immediately before departing and upon arrival, the time of departure or arrival of their trains, the number of the engine, name of the engineer, and whether or not signals are carried and also other entries required by their company.

The signal for starting passenger trains from division terminals should always be given by conductors with the air signal cord from the rear of the train.

Particular attention should be given to the safety and comfort of passengers. Careful attention should also be given to the heating, lighting and ventilating of cars, and the supply of drinking water in the tanks.

Shortly before reaching a station at which the train stops, brakemen or porters should pass through it, except the sleeping and dining cars, and announce distinctly twice in each car (with the doors closed) the name of the station the train is approaching, and if, for any reason, the train is thereafter stopped before reaching the station so announced, the passengers should be apprised thereof to prevent them from leaving the train at the wrong place.

At junction stations and crossings, where trains leave in different directions, conductors should cause to be announced before starting distinctly in each coach the direction in which their trains are to go, and the names of the principal stations on the route. Conductors should also notify passengers of the departure of their train in time before leaving meal stations.

Conductors should see that passengers are seated and should not permit them to ride on coach platforms.

Freight conductors should allow none but the train crew to ride on their trains without a special permit.

Conductors of passenger trains are generally required to wear the uniform adopted by the company in whose employ they are.

When from any cause conductors leave cars at a station without having received orders to do so they should notify the proper official by telegraph, giving the initials, numbers and kind of cars, the siding where left, the reasons for having left them. They should also examine the train equipment and see that necessary tools and supplies are on hand and in their proper places.

Conductors should comply with the directions of agents in placing cars and doing other station work; when it is

necessary to move cars that are placed for loading or unloading, they should be replaced.

In case an agent's orders appear to be unreasonable the fact should be reported to the proper officials.

Conductors, or trainmen should part their trains to the full width of the highway in order to clear all crossings while standing at stations.

In no case should cars be switched or the train backed over a public crossing, or highway, unless a man is on the forward end of the first approaching car to see that the crossing is clear; if at night he should display a light.

When cars leave the track they should not be turned over, thrown down embankments, or broken up, merely to get them out of the way. Every effort should be made by trainmen to set them on the track, and they should take the damaged cars to the nearest available siding; the conductor should, when necessary, call on section men or any other available force for assistance, which should be rendered promptly.

Conductors of trains carrying live stock should consult the stockmen in matters pertaining to the care and comfort of the stock and in warm weather hogs should be watered as often as necessary.

The doors of empty cars hauled in a train should be kept closed.

Conductors should carefully examine the seals and locks and keep a record of their condition in order to be in a position to give definite and clear answers to inquiries.

POINTERS TO BRAKEMEN.

Brakemen as a rule aspire to become conductors. They should bear in mind that in addition to the faithful discharge of their duties the department has much to do with their promotion. Brakemen are usually under the orders of the conductor and should be at the terminal station not later than thirty minutes before the departure of their train.

Neatness in personal appearance and civility towards passengers and fellow workmen cut quite a figure.

They should have their lamps trimmed and ready for lighting. If in passenger service they should see that the heating and ventilation of the coaches are properly regulated.

When on duty passenger brakemen are usually required to wear the regulation uniform and badges adopted by the company in whose service they are.

On steep grades the rear brakeman should remain on the caboose to take care of the rear end and stop it in case the train should break in two.

Brakemen should familiarize themselves with the duties of a conductor in order to be able to take charge of their train in case of accident or sickness.

When a brakeman goes out as a flagman he is equally responsible with the conductor for the faithful discharge of his duties.

When it can be done tail lights or markers should be taken to the rear of passenger trains without passing through the sleeping or dining cars.

Head end brakemen when riding on the engine should comply with the orders of the engineer in all matters pertaining to the safety of the train.

GENERAL RULES COVERING THE OPERATION OF TRAINS AND HANDLING OF FREIGHT AND PASSENGERS.

Not to go to Meals Without Permission. Conductors and enginemen should not go to meals nor delay their trains from any cause after receiving an order allowing them to proceed without asking for and obtaining special permission to do so from the train dispatcher. In case a train has work to do they should immediately notify the train dispatcher of the probable length of time before they would be ready to leave. After receiving permission, the conductor should report when he is ready to go, and ask if there are any further orders. All communications from conductors, enginemen and others concerning train orders should be addressed to the train dispatcher in writing.

Changing Off. When enginemen or conductors change off before the completion of their trips, they should carefully change any orders they may have and should see that they are perfectly understood by those to whom transferred. Changes of this kind should not be made without the consent of the train dispatcher.

Train Baggage-men and Freight Men. Train baggage men and freight men are under the immediate charge of the conductor of the train and when not in conflict with the Company's rules must obey his orders. Train baggage men ought to provide themselves with a copy of the rules and regulations issued by the Company's general baggage agent and observe them.

Riding Cars and Switching. None but train men or switch men should be allowed to ride cars, or in any way assist in switching trains on the road or at terminals.

Riding on Locomotive Pilots. No person should be allowed to ride upon the pilot of a locomotive either in dispatch of duty or otherwise.

Track Scales. Switches should be set for dead rails over track scales when they are not being used for weighing purposes.

Turn-tables Locked. Turn-tables should be locked with a switch lock, by enginemen immediately after use unless in charge of employees. When turn-tables are found unlocked or locks are discovered to be out of order the fact should be immediately reported to the Superintendent by wire.

Taking Coal and Water. When it is necessary to take coal or water, freight trains of more than 20 cars in length should be stopped 100 feet from coal or water stations and engine uncoupled. Before starting again the engineman should know that the aprons and spouts have been properly placed to clear passing trains.

Engines Standing in Highway Crossings. Engines should not be permitted to stand nearer than 100 feet to street or highway crossings, nor under a bridge if it can be avoided, neither in the vicinity of waiting rooms, offices or cars occupied by passengers where the noise or smoke is likely to disturb the occupants.

Dead Engines in Transit. When more than one engine is to be hauled as freight in a train at least three box or stock cars should be placed between them unless otherwise instructed. Dead engines should not be hauled without side-rods unless by permission of the superin-

tendent and then their speed should not exceed that prescribed under such circumstances.

Closed Doors. The door of freight cars ought to be kept closed when not in use.

Flagging. The utmost care should be observed by brakemen in watching train to see it does not part. In case a train should part in two they are required to protect their train with the utmost promptness. As required by the rules they should not wait for instructions from the conductor to protect train by flagging and to this end brakemen should be fully acquainted with the Standard Code of Rules on this point and the rules of the company by which they are employed.

Trains Parting. Should trains part from any cause, the facts should be reported to the Superintendent on the prescribed form. Full information should also be given by the conductor in person to the car inspector or his representative at the first terminal.

Use of Cars. Economy in the use of cars should be practiced as much as possible. Cars ought never to be forwarded with less than 2,000 pounds, small lots being loaded into passing trains. At junction points if cars contain less than 2,000 pounds they should be unloaded and consolidated with other lots and forwarded without unreasonable delay.

Transportation of a Corpse. A corpse should not be received for transportation unless accompanied by a physician's certificate or certificate of inquest from the coroner or by a permit for transportation from the clerk of the Board of Health of the county or city through which trains happen to be passing. There should likewise be a certificate from the undertaker, showing that the person did not die of a contagious disease. In no case should

it be received for transportation if perceptibly offensive, no matter whether accompanied by a physician's certificate or not.

Unchecked Baggage, Etc. Unchecked articles or baggage should not be received for transportation unless authorized by the general baggage agent, general superintendent or superintendent. The Company's business always excepted.

Money Packages. Letters or packages containing money whether registered or not should not be forwarded in the baggage cars, train baggage men should refuse to receive from any employee packages of this description marked "Railway Business." If a baggage-man should discover after leaving a station that a money-letter or package has been given him with other mail for transportation, he should retain it in his possession until his return trip and then deliver it at the station from which he received it, sending a full report of the transaction to the general baggage agent of the Company by whom he is employed.

Mail Matter. Under no circumstances ought mail to be received for transportation (as Railway business) unless it is known to actually pertain to the service of the Railway Company. All other mail matter must be sent by United States mail.

Freight to and From Prepaid Stations. Agents receiving freight for shipment to stations at which there is no agent should require pre-payment of the charges and should note on the receipt given that it is received upon conditions that the Company is not to be held responsible for it after it has been unloaded at destination. Freight so received should be way-billed by the Forwarding Agent to the first station at which there is an agent

beyond its destination, but at rates current to the station to which consigned. Instructions to the conductor should be noted in ink on the face of the way-bill to unload the shipment at its proper destination. Conductors when unloading consignments of this sort, should, when practicable, take receipt for it on the way-bill from the consignee, leaving the way-bill at the first station at which there is an agent beyond the point of delivery. Should the consignee not be on hand to receive the shipment, and in case it is of much value or likely to suffer from exposure to the weather, conductors should take it and deliver it, together with the way-bill, at the first station at which there is an agent beyond the designated point.

Handling Special Shipments. Shipments consigned "to order" or "to notify" or "to be delivered only on surrender of bill of lading" should be taken by the conductor to the first station at which there is an agent. When shipments are offered to conductors for transportation at stations where there is no agent they should refuse to accept it unless accompanied by full shipping directions in writing, giving name of consignor and consignee, destination, and number and mark on packages. Conductors should hand such shipping directions to the agent at the first regular station beyond the point where he received the shipment and that agent should immediately make a way-bill covering the shipment from his station but at rates current from the station at which the shipment was received, noting on the face of the way-bill the name of station, from which the shipment was loaded.

Cars Unsafely Loaded. Conductors should refuse to accept cars which in their judgment appear to be unsafely loaded and should report the facts to the train dispatcher.

Refrigerator Cars. When refrigerator cars are not

in a train for its regular run in accordance with the schedule the train dispatcher should be immediately notified by telegraph. Conductors ought to examine the bunkers in refrigerator cars to ascertain whether sufficient ice has been provided to carry car to its destination. Should the car have any need of re-icing, the conductor should notify the train dispatcher and agent at the first terminal.

Loading Merchandise. Merchandise such as flour, sugar, butter or commodities of a similar nature or class should not be loaded in cars formerly used for oil, lime, coal and other freight of the same class. Agents should be careful to see that floors of cars are clean for such merchandise. When cars are not loaded with bulk grain, agents should see that grain doors are properly raised.

Load in Station Order. Goods should not be mixed in loading. Whenever practicable each lot should be kept separate. If goods are loaded into a car from more than one station, the freight to be unloaded first, ought to be loaded into the car last. Goods for each station should be kept together and each lot of goods by itself. Conductors should report to the superintendent any neglect of agents in this matter. Agents and conductors should see that all goods in their charge are carefully handled and loaded in such a manner that no damage will result in transit by leakage of liquids, chafing of bales, etc. After freight has been unloaded from a car which contains other freight for other stations, conductors ought to see that the merchandise left in the car is properly secured by leveling down the piles of goods and blocking them with other freight so damage may be prevented. Casks, barrels, and other packages containing oil, turpentine, fish, tar, molasses and other goods of similar character

should be safely blocked, and not loaded in cars containing merchandise liable to damage by leakage or by being scented by odors.

Checking Freight. Way freight loaded into passing trains should be checked into the car by the conductor and any discrepancy or damage should be noted upon the way-bill.

Loads Extending Over and Off Cars. It is exceedingly important that all cars loaded with lumber, timber, iron pipe, posts, etc., or other freight liable to project beyond the ends of a car should be carefully examined before being moved. Agents should exercise the utmost care in examining all such goods before forwarding, they should see that no part of the load extends beyond the end of the car, should see that it does not interfere in any way with free access to and working of the brakes, except in cases of very long timber requiring two cars, in which case the brakehead and stem may be removed if necessary, but it should be carefully attached to the car and forwarded with a notification to that effect on outside of way-bill. Whenever possible, flat cars to be loaded double should be switched with brakes on the outer end. Conductors should examine all cars before placing them in their trains and should refuse to accept any not properly and safely loaded, reporting the same by wire with number of car to the superintendent or any other proper official.

How to Load. (a). "Telegraph poles and piles should be loaded with tips and butts alternating."

On One Car. (b). "When telegraph poles are loaded on one car, six good hardwood stakes may be placed on each side of same and four strands of new telegraph wire Standard size (8) to each pair

of stakes should be tied across the car when one-third loaded and four strands tied over top of the load when the loading is completed, the stakes being notched to prevent the wire from slipping."

On Two Cars. (c). "Telegraph poles, etc., which require the use of two cars for loading, should be kept clear of car floors throughout by placing one good sound bearing piece of saddle (10" x 10") of sufficient length to reach across the car, on each car, and six bearing pieces or saddles may be brought to any point between and sufficiently near each other to prevent the shortest timber from working out from between the stakes. In addition to this there should be fixed to each side of the car over all, two good hardwood stakes, tied across with new telegraph wire of Standard size (8)."

Loading Long and Short Poles, Etc. (d). "When necessary to load a few long poles or timber, on top of two cars containing short ones, in order to keep the long timber clear from the short ones, beneath,

a bearing piece must be securely fastened on the top of each car, on the short timbers in order to allow the car to curve freely, and two stakes on each side of both cars near the end where the cars are coupled together must be run to the top of the long timbers and securely fastened with wire as already explained."

On Three Cars. (e). "When the timber or poles are too long to be safely carried on two cars and three cars must be used, bearing pieces are placed on each of the end cars, so as to keep the load entirely free from the center car

Two Shipments. (f). "When two shipments similar to that referred to in the preceding clause are to be handled, each having timbers to be safely carried on two

cars but not requiring more than one-half the length of another car, they ought to be placed so that the projecting ends rest on the additional car, placed in the center with bearing pieces of sufficient thickness to keep the load clear from the car floor throughout, at a point between the trucks of each car and near to those next to the end of load, the load to be placed, tied and staked as described above.

Stakes. (g). "Stakes ought to be placed in a perpendicular position and in no case should it exceed the width of the car. Poles and timber must not extend beyond the end of the car."

Overloading. (h). "In order to prevent overloading (when load necessitates the use of more than one car) the weight to be carried should not exceed the capacity of one car provided the load rests on only one pair of trucks of each car. If the load is distributed between both pairs of trucks of each car, the combined capacity of both cars, may be allowed as a maximum weight."

Inspection. (i). At stations where telegraph poles, ties, etc., are to be loaded, agents should note personally that the cars are loaded in accordance with the foregoing instructions. In case there is no agent, conductor should see that the cars are loaded in accordance with the foregoing, before accepting them for their trains. Inspectors at division points should carefully examine all such freight and if cars are improperly loaded the fact should be immediately reported to the agent.

Bonded Merchandise. Agents and conductors should refuse to accept cars loaded with bonded merchandise unless the following rules regulating the transportation of the same have been fully complied with:

(1). Cars containing bonded goods should always be secured with custom seals and tags which should be removed by none but the customs officer.

Any unauthorized person removing or tampering with these seals and tags renders himself liable to imprisonment for not less than six months.

U. S. CUSTOMS.

Unappraised Merchandise. IN BOND

From _____

Forwarded _____ 190__

To _____

Arrived _____ 190__

NOTICE Seals attached to this car are to be removed by Customs Officers only. Unauthorized persons who wilfully break, cut or remove Customs Seals are liable to a fine of \$1,000, or imprisonment not exceeding Five years, or both.

U. S. CUSTOMS

BONDED MERCHANDISE

From _____

(Departure.) Date _____ 190__

To _____

(Arrival) Date _____ 190__

NOTICE Seals attached to this car are to be removed by Customs Officers only. Unauthorized persons who wilfully break, cut or remove Customs Seals are liable to a fine of \$1,000, or imprisonment not exceeding Five years, or both.

Cards on Side of Car. (2). Every car which contains appraised bonded goods must have on its side a red card $3\frac{1}{2}'' \times 4\frac{1}{2}''$ in size, and every car containing unappraised bonded goods must have on its side a yellow card $6'' \times 6''$ in size with the words in black letters as shown in figures. These cards to be furnished and pasted on the car by the agent at the time of shipment.

Conductors to Examine Seals, Etc. (3). When receiving cars and manifests, conductors should carefully examine custom seals to determine whether or not such seals are intact. If they find them broken or that they show signs of having been tampered with en route, the

matter should be immediately reported to the superintendent.

Trans-shipment. (4). In case of accident necessitating the trans-shipment of the contents of the car or in case of trans-shipment for any cause it must be made under the supervision of a customs officer.

Packages Corded and Sealed. (5). Bales and packages "corded and sealed" need not be transported in cars sealed with customs seals and may be transferred without the supervision of the customs officer. Such shipments must in all cases be accompanied by a manifest.

Freight Goods with Bonded. (6). Freight goods may be conveyed in the same car with bonded goods but in that case the car must be sealed, etc., as indicated in the foregoing sections 1 and 2. Care should be taken not to accompany bonded goods with freight goods destined for intermediate stations where there is no customs officer to open and re-seal the car.

Sealing Cars. Agents should securely fasten the end doors and seal the side doors of all cars loaded by them immediately upon completion of the loading, except in those which contain rough stone, common bricks, sand, railroad ties, poles, posts, firewood, iron ore, iron or steel rails for railroad tracks and coal. When a shipper has especially requested it and is willing to have a notation made on the contract, bill of lading or shipping receipt and also on the way-bill that it is done at his risk car doors may be left open.

Breaking Seals. Agents should keep a complete seal record in their seal book (when one has been provided) showing all cars left at and taken from their stations, or which were sealed or unsealed by them, including seals removed from or placed on passing way freight cars at

their station. They should invariably note on the face of each way-bill receipted by them over their own signature, the number of all seals broken by them on cars mentioned in the way-bill. In the case of cars containing freight for stations at which there are no Agents, conductors may break the seal, recording the number of same and reason for breaking them on the face of the way-bill and should have the car resealed upon its arrival at the first regular station.

Seals Placed so Doors Cannot be Opened. Seals should be so placed on car doors by agents, to prevent doors being opened without seals being broken. They should be so placed that the numbers can be readily taken. Agents and conductors should report to the superintendent or other proper official the initials and numbers of cars which they discover to have been improperly sealed.

Sealing Material. Seals and seal presses ought to be under lock and key when not in use. None but the station agent or his authorized employee should be allowed to seal and unseal cars.

Foreign Seals. Agents at junction stations who receive loaded cars from connecting lines (which the rules of the Company by which they are employed do not require to be sealed) need not attach seals providing those of connecting lines are found on car and in good order in every respect. Otherwise it is good practice to attach the Company's seal and notify the proper agent of the connecting line in writing. Where foreign seals are intact they are usually treated the same as if they were the Company's seals with the exception that any initials or other peculiarities should be observed and recorded in addition to the numbers shown.

Examining Seals. Conductors should carefully examine seals before leaving their trains at end of run, when cars are set out en route and at all points where their train remains a sufficient time to permit an examination and they should ascertain whether the seals have been broken and in case any are found to have been broken the facts should be noted in the train book and if it cannot be accounted for by the conductor, an immediate report should be made to the train dispatcher, superintendent or other official.

Responsibility of Conductors. Conductors are deemed responsible for all freight in their charge. They are expected to see to the loading and unloading of way freight and to note that all freight billed that is loaded or unloaded by them as the case may be and also required to see that all way-bills are properly checked and that no discrepancy or damage which they may discover to any property whether loaded or unloaded by them or otherwise, is noted on the way-bill. They are required to cause the marks and contents of the packages to be called out as they are taken from the car. When they find freight in a car for which they have no freight-bill they should unload it at the station marked on package, if they discover it in time, otherwise they should unload it at the next regular station, and call the attention of the agent at that station to the package. Agents are expected to tally freight as it is unloaded from cars and advise the conductor at the time of unloading of any "short," "over" or "damaged freight."

Delivering Freight at Stations. When unloading way freight at stations, conductors are usually expected to place it in the ware-house or such other place as the agent may designate.

Care in Handling Freight. Conductors ought to see that trainmen are careful in handling freight.

Work Trains Carrying Laborers. Cars in which workmen are riding ought never to be pushed in front of an engine. They should be handled at the rear end of a train following the engine regardless of the direction in which the engine may be moving.

Perishable Property. Cars containing perishable property should have precedent over other freight and ought never to be left at any station short of its destination unless for repairs. If repairs cannot be made within twelve hours, attention ought to be called to the fact and instructions obtained.

Property Wrecked. In case property is wrecked in transit, but is afterward forwarded to its destination, the original way-bill should accompany it, bearing notation therein, showing where damage occurred. When property is not forwarded to its original destination, the way-bill should be turned over to the superintendent or other proper official in charge of clearing up the wreck.

Disabled Cars. When a car disabled is left at a station at which there is no agent, or is left at such station for any other cause the conductor should deliver the bill to the agent at the next regular station, and endorse on way-bill when, where, and why the car was left, and report the same to the train dispatcher or other proper official. The same action should be taken by the conductor in case he leaves a disabled car at a regular station except that way-bills may be delivered to the agent at the station where the car is left. When it becomes necessary to transfer freight from one car to another, while en route, the fact should be noted on the way-bill and the numbers and initials of the cars into which the property was trans-

ferred, together with the date and station where the transfer was made, should be shown thereon. The goods should be carefully checked from the way-bill and the condition of same at time of such transfer noted thereon at the same time, and a record of the transaction made in the conductor's train book.

Leaving Cars on Sidings. Cars should not be left on sidings unless by authority of a train dispatcher.

Station Grounds and Sidings. Station and track employees should see that material stored along the track and at stations is neatly piled and that the "right-of-way" and station grounds are kept in an orderly condition, the material should not be piled within six feet of the nearest rail of any main track, siding or yard track.

Duties of Agents, Operators and Watchmen. Station agents, telegraph operators and watchmen, should immediately report to the superintendent or other official any severe rainstorm, high wind, or sudden rise of streams in their vicinity and in case of emergency should see that the section foreman and his men are on hand to protect the track from damage. They should see that cars have not been moved by the wind so as to endanger the passage of trains, and in such circumstances should remain on duty unless excused. If for any cause the superintendent's office cannot be reached by wire, the roadmaster should be notified, if possible, and all trains in the vicinity of the storm should be provided with notices.

Caution During Storms, Etc. When overtaken between stations by severe storms or indications of high water which threaten danger, conductors and enginemen should proceed with the utmost caution, keeping the train under complete control, and proceeding at a speed which will permit it to be stopped any time to prevent accident.

They ought always to examine bridges and culverts or other places liable to be damaged by high water, and if they find any indications of danger should, on arrival at the first telegraph station notify the agent or operator and report the fact by wire to the superintendent, asking if necessary for instructions and ought not to proceed until instructions have been received.

Caution. Trains running upon or near the "time of a train" in the same direction, scheduled to carry passengers should exercise extreme caution in approaching or passing through stations where such trains are scheduled to stop, expecting to find persons crossing the tracks.

TRAIN-MEN HANDLING BRAKES.

When making up trains always begin at the rear end of train; closing angle cocks and hanging the hose properly in the dummies at rear end of last car; coupling hose and opening all angle cocks wide open and seeing that brakes are cut in until arriving at the engine; after coupling hose between tender and train, always open the angle cocks on the tender first. In coupling to cars after cutting crossings, always open the angle cock nearest the engine first.

Always give the engineer time to charge the train pipe and auxiliaries before signalling to test brakes; always give the signal to apply them from the front end of first car and signal to release from rear end of last car, examining on your return to the front end to see that all brakes are off.

If any defect is discovered it must be remedied and the brakes tested again—the operation being repeated until it is ascertained that everything is right. The conductor and engineer must then be notified that the brakes are all right. This examination must be made every time any change is made in the make-up of the train. *Read Rule for Testing Brakes.* At points where there are no inspectors, trainmen must carry out these instructions. No passenger train must be started out from an inspection point with the brakes upon any car out or in a defective condition without special orders from the proper officers. In freight trains, when hand brakes are used in conjunction with the air brake, they must be applied upon those cars next behind the air braked cars.

DETACHING ENGINE OR CARS.

First close the cocks in the train pipes at the point of separation, and then part the couplings, always by hand. If the brakes have been applied do not close the cocks until the engineer has released the brakes upon the whole train.

COUPLINGS FROZEN.

If the couplings are found to be frozen together or covered with an accumulation of ice, the ice must first be removed and then the couplings thawed out by a torch to prevent injury to the gaskets.

TRAIN BREAKING INTO TWO OR MORE PARTS.

First close the cock in the train pipe at the rear of the first section and signal the engineer to release the brakes. Having coupled to the second section, observe the rule for making up trains—first being sure that the cock in the train pipe at the rear of the second section has been closed, if the train has broken into more than two sections. When the engineer has released the brakes on the second section the same method must be employed with reference to the third section, and so on. When the train has been once more entirely united the brakes must be inspected on each car to see that each is released before proceeding.

CUTTING OUT THE BRAKE ON A CAR.

If, through any defect of the brake apparatus while on the road, it becomes necessary to cut out the brake upon any car, it may be done by closing the cock in the cross-over pipe near the center of the car where the quick

acting brake is used, or by turning the handle of the cock in the triple valve to a position midway between a horizontal and vertical where the plain automatic brake is used. When the brake has been thus cut out, the cock in the auxiliary reservoir must be opened and left open upon passenger cars, or held open until all the air has escaped from the reservoir upon freight cars. *The brake must never be cut out upon any car unless the apparatus is defective*, and when it is necessary to cut out a brake the conductor must notify the engineer and also send in a report stating the reasons for so doing.

CONDUCTOR'S VALVE.

Should it become necessary to apply the brakes from the train, it may be done by opening the conductor's valve, placed in each passenger equipment car. *The valve must be held open until the train comes to a full stop, and then must be closed again.*

This method of stopping the train must not be used except in case of absolute emergency.

BURST HOSE.

In the event of the bursting of a brake hose, it must be replaced and the brakes tested before proceeding, provided the train be in a safe place. If it is not, the train pipe cock immediately in front of the burst hose must be closed, and the engineer signaled to release. All the brakes to the rear of the burst hose must then be released by hand, and the train must then proceed to a safe place where the burst hose must be replaced and the brakes again connected and tested as in making up a train.

BRAKES NOT IN USE.

When the air brakes are not in use, either upon the road or in switching, the hose must be kept coupled between the cars or properly hung up in the dummies.

RETAINING VALVE.

The retaining valve is used for keeping brakes partially set on trains on heavy down grades equal to good hand brakes, controlling the speed of the train while auxiliaries are being recharged, and for no other purpose.

At top of grades designated by special rules, the trainmen will turn the handles horizontal on as many valves as will be required to control the train, and at the foot of the grade will turn the handle downward again. This valve must be tested before leaving terminals at same time brakes are tested.

TRAIN AIR SIGNAL.

In making up trains, all couplings and car discharge valves on the cars must be examined to see if they are tight. Should the car discharge valve upon any car be found to be defective while on the road, it may be cut out of use upon that car by closing the cock in the branch pipe leading to the valve. The conductor must always be immediately notified when the signal has been cut out upon any car, and he must report the same for repairs.

In using the signal, pull directly down upon the cord during one full second, for each intended blast of the signal whistle, and allow two seconds to elapse between the pulls.

REPORTING DEFECTS TO INSPECTORS.

Any defects in either the air brake or air signal apparatus discovered upon the road must be reported to the inspector at the end of the run; or, if the defect be a serious one in passenger service, it must be reported to the nearest inspector, and it must be remedied before the car is again placed in service.

STARTING TRAINS.

When ready to start, the starting signal must be given to the engineer by the air signal whistle. Trains equipped with the air signal must not be started by hand or lantern signal when air signal is in working order.

The division time card or special rules of different companies specify the smallest proportion of freight cars, with the air brakes in good condition, which may be used in operating the train as an air brake train.

THE AIR BRAKE ASSOCIATION'S QUESTIONS AND ANSWERS FOR TRAINMEN.

Question. How should the conductor's valve be operated when necessary?

Answer. It should be pulled wide open and held open until the train stops, and then before leaving it, the valve should be closed.

Question. Why is it necessary to hold the conductor's valve open until the train is stopped?

Answer. Because if it is closed and the engineer has not placed the brake valve on lap position, the brakes will release.

Question. What does this valve do when it is opened?

Answer. It simply makes an opening from the train pipe to the atmosphere, very much the same as would be done if an angle cock is opened, or a hose coupling parted.

Question. Can brakes be released by the conductor's valve?

Answer. No; it must be remembered that to release brakes it is necessary to either put air into the train pipe or take it out of the auxiliary reservoirs. The conductor's valve will not do either of these.

BURSTED HOSE AND BROKEN TRAIN PIPES.

Question. Should the brakes apply suddenly, without the aid of the engineer or train crew, what should be looked for?

Answer. Either a bursted hose or the train parted.

Question. In the event of a bursted hose on a passenger train, and there was no extra hose in the supply box, what could be done?

Answer. Remove the hose from the rear end of the last car and use it.

Question. Should the cross-over pipe be broken, is it necessary to shift this car to the rear of the train?

Answer. No; if the break is between the stop cock and the triple valve, the stop cock should be closed and the release valve opened. If the pipe is broken between the stop cock and the main train pipe, it may be plugged.

Question. In passenger service, if the train pipe should burst or be broken, should the car be shifted to the rear of the train?

Answer. Not necessarily; a section of freight hose can be telescoped over the broken pipe and wrapped with

a cord. Again, air may be made to pass to the rear through the signal pipe on the disabled car by the use of combination signal and train pipe couplings, which will allow of the signal pipe of the disabled car being attached to the train pipe of its adjoining cars. It is the general practice, however, to switch such cars to the rear on account of the lack of the material to make the changes mentioned.

Question. When such a car is put on the rear end of a passenger train, what precautions should be taken?

Answer. The hose should be coupled between it and the car ahead of it, and the angle cock opened on the car ahead, but the angle cock on the disabled car closed. This keeps air pressure in the hose couplings, and if the train should part there, the brakes would apply on the head section. It is also good practice to have a man remain on the disabled car all the time if practicable.

BREAK-IN-TWOS.

Question. In case of a train parting between air-braked cars on the head end, the train being partially equipped, say 5 air-braked and 25 non-air-braked cars, what should the engineer do?

Answer. Close the engine throttle immediately and place the brake valve handle on lap position.

Question. Why not try to pull away from the rear end of the train?

Answer. He could not get away a safe distance, and a short distance would only increase the violence of running together. By shutting off steam immediately the distance of separation would be short and the shock of running together would be proportionately slight, both sections of the train being in motion at the time.

Question. Upon coupling up after parting a train of air-braked cars, should the rear brakes refuse to release in any number, would it be advisable to "bleed" them off?

Answer. No; by so doing we have no assurance that the engine is cut into the rear end of the train. They should in all cases be released by the engineer.

Question. What should he do to release them?

Answer. Place the brake valve handle on lap position and secure excess pressure. By throwing this into the train pipe quickly it should release them if they are all cut in.

Question. Why is it not advisable to pump brakes off?

Answer. Because the train pipe pressure would be raised so slowly it might cause brakes to stick on the rear end of the train.

Question. Is it necessary to make a test of the brakes after the train has been parted?

Answer. Yes; in all cases, to ascertain if the train pipe is open throughout the train.

USE OF HAND BRAKES.

Question. In assisting the engineer with hand brakes, where the train is only partially equipped with air brakes, where should the hand brakes be set?

Answer. Immediately behind the air-braked cars.

Question. Why not near the rear of the train?

Answer. Because of the liability of breaking in two if the engineer releases when going slowly.

Question. Do the hand brakes work in unison with the air brake on passenger equipment cars?

Answer. Not on all cars, although it is now becoming the general practice to have them do so.

Question. In setting off cars what should be done?

Answer. The stop cocks, or angle cocks, should be closed first and the hose parted by hand and hung up properly, the car set on the side track, the air brake released if applied, and the hand brake set before leaving it.

Question. Why not set the hand brake before releasing the air brake?

Answer. On some cars it would be set too tight and be liable to break the chain when the pressure on the piston of the brake cylinder was released; on others it would not be set at all.

Question. Where cars are to be left alone for any length of time on a grade and have the air brakes applied, what should be done?

Answer. The air brakes should be released and hand brakes set.

BLEEDING OFF BRAKES.

Question. In cutting out a brake, why is it necessary to always bleed the auxiliary reservoir?

Answer. This is to insure that the brake will not creep on and give trouble, which it might do if leakage exists around the triple valve or branch pipe.

Question. What is the proper way to release a brake with the release valve?

Answer. The release valve should be held open only until the air commences to escape from the triple valve. It should then be closed, as, if it is held open longer, it has a tendency to set the other brakes.

Question. In picking up cars, if they are found cut out, is it an assurance that the brakes are in bad order on those cars?

Answer. No; they should be cut in and tested, unless it is plainly seen that they are in bad order.

Question. When is it permissible to cut out cars?

Answer. Only when they are in such condition as to render it impossible to operate them.

Question. Are small leaks sufficient cause for cutting out cars?

Answer. No; only when they are of such size that the air pump cannot supply them.

Question. Which is preferable, a few cars cut in and working at full pressure, or all cars cut in and operated at a comparatively low pressure?

Answer. All cars at a lower pressure. The train will brake smoother, and in a case of a break-in-two there would be less likelihood of damage.

Question. If the train line leaks, would it be best to cut out cars?

Answer. No; fix the leak and keep all cars cut in.

Question. If there are numerous small leaks throughout the train, and combined they make sufficient leakage to prevent the pump from making the required amount of air pressure, which cars should be cut out first?

Answer. The worst leaks; if that is not sufficient or all leaks about the same size, then the poorest brakes, not more than three or four consecutive cars being cut out, however. If possible, the cut out cars should be distributed throughout the train.

RULES FOR GIVING FIRST AID TO THE INJURED.

When an accident happens there is usually not much time to decide what is best to be done. Help, to be effectual, must be prompt, and often delay implies farther injury or loss of life.

It is well to fix in the mind a few general principles of treatment in the more common accidents. When the emergency arises these are recalled instinctively and form the basis of action. The means by which they are to be carried into effect follow naturally and the necessity is met.

SHOCK.

A person who has sustained a railroad or machinery accident, a bad burn, or even a sudden fright, is liable to suffer from shock. He lies breathing feebly, the face pale, pinched and anxious, the pulse feeble and often absent at the wrist, the skin is cold and there may be shivering. In most cases reaction will take place in a few hours; in others no reaction takes place, and the person dies.

A great deal may be done to relieve a person suffering from shock. If there is severe bleeding it must be stopped, but no attempt to do more than this to the injury should be made until after attending to the shock.

Place the patient in a horizontal position, the head slightly raised; give a teaspoonful of whiskey or other alcoholic liquor in a tablespoonful of hot water every ten minutes until five or six doses have been taken. Wring out flannels in hot water and lay them on the chest and abdomen, then cover the patient with a blanket to keep

in the heat. To warm and stimulate the patient in every way is the object of the treatment.

If the injury is to the head follow out the above treatment as regards warmth but do not give any alcoholic stimulant.

CRUSHED LIMBS.

If a foot, or hand, or any other part is crushed, any displaced tissue is to be put back and the injured member made to assume as nearly as possible its original shape, by carefully molding it with the hands, without using much force or causing much pain.

Then, unless bleeding is profuse, when cold cloths must be used, wrap the part in cloths dipped in warm water, and cover the whole up warmly with cotton wool or a blanket. If a long bone is fractured in a crushed wound, a splint may be applied before moving the patient.

In all such wounds be careful to watch for symptoms of shock, as they require as careful attention as the wound itself.

BROKEN LIMBS.

A broken bone need not be set immediately. This knowledge saves much unnecessary anxiety when the doctor cannot be procured at once.

The parts must be put in as comfortable a position as possible and most nearly corresponding to the natural one. It is necessary to give support above and below the break.

Handle the injured part very carefully not to force the rough ends of bone through the skin.

Improvise splints of some kind—two strips of wood, a

couple of stout book covers, or pieces of pasteboard. Place one on each side when it is a limb that is injured, and bind them in place with handkerchiefs. A long pillow firmly tied will answer the purpose, or in case of injury to a leg it may be fastened to its fellow if nothing better can be done, remembering to tie it above and below the injury.

Broken bones are easily recognized by the grating of the ends on each other, by the unusual bending of the limb, and by the pain caused by motion at this point. A fracture is called compound when the end of the bone protrudes through the skin. Whenever such protrusion is seen the part should be cleansed and at once covered with adhesive plaster or a piece of linen saturated with white of an egg. All fractures should be attended to by a surgeon; consequently the dressings suggested here are only temporary, and intended to protect the parts from further injury.

In fracture of the arm above the elbow, bandage the upper arm to the side of the chest, and place the hand in a sling.

In fracture of the arm below the elbow, bend the arm at the elbow at a right angle, place the thumb uppermost, and bandage the limb between two padded splints, reaching from elbow to ends of the fingers, one being placed on the back of the arm and the other on the front, and place the hand in a sling.

In fracture of the leg below the knee, extend the leg beside the sound one, giving it the same position, place a pillow beneath from the knee down, fold the sides of the pillow over the leg, and secure it in that position by bandages.

In fracture of the thigh bone, place the patient on the

back in bed, relax the muscles of the leg by drawing the feet up toward the body sufficiently, bind splints to the outer and inner side of the broken thigh, then bind both legs together, and turn patient on the side with the injured limb uppermost.

In fracture of the knee-cap bind the whole limb to a splint on the back of it, being careful to place a sufficiently large pad beneath the bend of the knee.

In fracture of the collar bone, place the patient on his back on a hard bed without any pillow.

In fracture of the lower jaw, close the mouth and bandage so as to keep the two rows of teeth together.

In fracture of the skull, lay the patient down and apply cold, wet cloths to the head.

When the shoulder bone is broken place the arm on the injured side across the chest, the hand touching the opposite shoulder, and fasten it in place by passing a broad bandage around the body.

In fracture of the ribs pin a towel around the body until the doctor comes.

In other fractures, place the patient in the most comfortable position possible, keep him quiet and apply cold water to prevent swelling.

In a dislocation the bone is forced out of its socket at the joint. There is more or less deformity, and it is difficult to move the limb. The last point helps to distinguish it from a fracture. Time is of importance, as the swelling which supervenes increases the difficulty of reducing it or returning the bone to its proper place. Hot applications may be made if the surgeon cannot be had immediately.

A sprain occurs when a joint is twisted but not dislocated. The ligaments which hold the bones together are

stretched and sometimes torn. Immersing the part in very hot water for a time, and then keeping it surrounded with hot water bags, usually gives relief. The joint should be firmly, but not too tightly, bandaged from the fingers to toes upward. After a time gentle rubbing is useful.

TRANSPORTATION OF THE INJURED.

Make a soft and even bed for the injured part, and if possible obtain a stretcher, a door, shutter, settee or some firm support; lift steadily and don't keep step.

BRUISES.

Lay over the bruise a cloth saturated with hot water, or with half water and half alcohol, or Pond's Extract, or any household remedy that contains alcohol.

WOUNDS OR CUTS.

If the wound opens a vein the blood flows evenly and steadily and is dark red or purple. If an artery is divided the blood flows in jets or in an interrupted stream and is bright red. Owing to the fact that as a rule the arteries and veins run side by side, it generally happens that when an artery is divided a vein is also opened. The blood from the two vessels becoming mixed makes it impossible to determine whether both vessels have been opened or only an artery or a vein. For this reason it is better to learn the methods of controlling bleeding that will answer for every case.

Stop the hemorrhage by means of pressure, position, heat or cold, and, if necessary, styptics.

When a large vein or an artery has been severed it is sometimes a difficult matter to stop the flow of blood. If the cut is on a limb tie a hard knot in a towel, place the knot inside the arm or leg as high as possible and twist the towel firmly round the limb. A stick can be thrust through it and used as a handle to twist by if necessary. This is called a tourniquet. This stops the circulation and cuts off the supply of blood. It should not be kept up more than one hour on the arm and rather longer on the leg.

Ice, or very hot water applied with a sponge, or cloth, will check the bleeding when it comes from a number of small points.

When possible the wounded part should be raised so the blood will flow away from it toward the heart.

Binding a bunch of cobwebs or a handful of flour on the wound, or bathing it in strong vinegar is sometimes effectual.

Bleeding stops from the blood coagulating or clotting. All our efforts should be directed toward helping it to accomplish this by every available means.

If the blood is bright and comes in jets, apply firm pressure upon the artery above the cut, nearer the heart. If bleeding is from the leg, the artery in the groin must be compressed very forcibly with three fingers, aided by the weight of the body.

If the blood comes in a steady stream, apply pressure just below the cut.

If ignorant of the location of vessels, press with the fingers or a wad of cloth directly into the wound.

After the bleeding is controlled, improvise a tourniquet as above directed, excepting for the artery in the groin.

For a slight cut let the blood flow for half a minute; then dip in cold water, or apply ice. Draw the edges together with sticking plaster, or unglazed paper. Paint collodion over the paper. Bandage if necessary, and keep the part quiet and not dependent for a few days.

BURNS AND SCALDS.

The pain from slight burns is very great. An excellent application is a thick paste of common baking soda moistened with water, spread on a piece of linen or cotton, and bound on the part. This can be kept wet by squeezing water on it from a sponge or cloth until the smarting is soothed.

A thick coating of starch can be used instead of the soda, or wheat flour if nothing better can be had, but neither should be applied if the skin is broken. In this case it is better to use vaseline, olive or linseed oil. The doctor will apply some preparation containing carbolic acid.

If the air can be effectually excluded from a burn the pain is relieved.

Blisters should be pricked and the fluid absorbed with a soft cloth before applying a dressing.

If the clothing adheres to the skin the loose part should be cut away and the patches of material soaked off with oil or warm water.

When the injury is extensive the sufferer will be prostrated and may die from the shock. Heat should be applied to the extremities and over the heart, and hot drinks given until the doctor comes.

In burns from a strong acid the part should be covered with dry baking soda or lime, as the alkali will neutralize

the acid. No water should be used, but a dressing of cosmoline or oil applied after the alkali has been brushed off.

When the burn has been caused by an alkali an acid must be used. A person recovering from the effects of a burn requires very nourishing food.

ELECTRIC SHOCK ACCIDENTS

are liable to occur now that electric machinery is being introduced in many shops. In cases where a man has received a serious shock and life appears to be extinct, efforts similar to those employed in cases of drowning should be made to restore animation.

Lay the patient on his back in the open air. Remove his neck-cloth and unfasten his shirt. Make a roll of clothes, or anything at hand, and place it under his shoulders so as to support the spine and allow the head to fall downwards and backwards. Open his mouth, and taking hold of the front part of the tongue with your fingers—either bare or covered by a handkerchief—very slowly draw the tongue forward and as gently let it go back again 16 times to a minute. Be sure that the root of the tongue is acted upon and drawn forward. Continue this action until signs of re-animation are observable, which should be the case in from ten to twenty minutes. The motion thus imparted to the tongue should be regular and rythmical in both its tractions and relaxations.

Another treatment is as follows: Kneel behind the patient and grasp the elbows and draw them over his head so as to bring them together above it, and hold them so for some two seconds. Then carry them down to the sides and front of the chest, firmly compressing it. After two seconds repeat the action and continue it at the

rate of 16 times per minute. This action expands the chest walls, causes air to rush into the lungs and finally expels it. The action must be regular and persisted in until respiration has become normal. It is possible that this may not be assured in less than an hour. If an assistant is at hand both systems may be employed, one man working the arms, the other the tongue, and both operating in unison.

HEAD FOR INFORMATION TO THE DIRECTOR
OFFICE OF THE DIRECTOR

NO.	DATE	NAME	ADDRESS	REMARKS

APPENDICES

CLEARANCE CARDS

AND

OTHER BLANKS

NO.	DATE	NAME	ADDRESS	REMARKS

NO.	DATE	NAME	ADDRESS	REMARKS

PUNCH

HERE.

RETURN OF CASH FARES COLLECTED.

I hereby certify that the following is a true statement of all money collected by me on the trips designated hereon, and that the rates, extensions and footings as stated are correct.

_____ Conductor.

STATEMENT OF AMOUNT COLLECTED.

From	To	No. Fares.	Rate.	Amount.	Remarks.

STATEMENT OF RECEIPTS ISSUED FOR FARES COLLECTED.	Commen'g No.	Closing No. (Lowest No. on hand.)	No. Issued

	Dollars.	Cents.
Amount Collected North or West,		
Amount Collected South or East,		
Total,		

Train run between _____ and _____

No. _____ Going North or West _____ 189 _____

No. _____ Going South or East _____ 189 _____

NOTE.—If no fares are collected, a blank form must be returned.

CONDUCTOR'S BALANCE SHEET FOR THE MONTH OF _____

DR.

Conductor, _____

Division. _____

CR.

To Balance of last month's return to my debit, \$ _____

To Difference to my debit last month, as per statement received, \$ _____

To amount of Cash Collections during the Month, as per Returns rendered to the Ticket Auditor, as follows, viz.:

Date of Return.	Train Nos.	Amt.	Date of Return.	Train Nos.	Amount.
	&	\$ _____		Bro't Forw'd.	\$ _____
	"	_____		"	_____
	"	_____		"	_____
	"	_____		"	_____
	"	_____		"	_____
	"	_____		"	_____
					\$ _____

By Balance of last month's return to my credit, \$ _____

By Difference to my credit last month, as per statement received, \$ _____

By Remittances made to Bank, credited to me during the Month, described in detail below, viz.:

Date of Remittance.	Date Remittance was Credited.	Amount.
_____	_____	\$ _____
_____	_____	_____
_____	_____	_____
_____	_____	_____
_____	_____	_____
_____	_____	_____
		\$ _____

Standard Train Order Blank for 19. Order:

FORM
19

FORM
19

(NAME)

COMPANY.

TRAIN ORDER No. 10

March 27 19 02

To

At

X (INITIALS)

Opr.;

1 45 A M

.....
Conductor and Engineman must each have a copy of this order.

Made Complete time. 2 16 P M.

Black Opr.

Standard Train Order Blank for 31 Order.

FORM 31		FORM 31			
(NAME)		COMPANY.			
TRAIN ORDER No. ¹⁰					
March 27 19 02					
To	At				
X	(Initials.)	Opr.; 1 45 A M			
.....					
Conductor and Engineman must each have a copy of this order.					
<i>Repeated at 2 30 A M.</i>					
Conductor	Engineman	Train	Made	Time	Opr.
Jones	Brown	45	Compl. to	2 20 a.m.	Black
	(Omit this column where Engineman is not required to sign.)				

Form 629.

CHICAGO, ST. PAUL, MINNEAPOLIS & OMAHA R'Y CO.

CROSS-OVER PERMIT.

..... *Block Station*190.....

To Conductor and Engineman Train No.....

I have complied with the Rules. You may use.....bound track at..... by protecting your train as provided in the General Rules.

.....
Signalman.

This permit does not relieve the train crew from any responsibility in connection with the Time-Table or Rules and Regulations.

CHICAGO, ST. PAUL, MINNEAPOLIS & OMAHA R'Y CO.

TRAIN ORDER NO.10.....

To |
..... | *At*..... *Station.*
..... |
..... |

Nov. 27, 1902.

X **INITIALS** *Opr.* 1.45 *M*

12.....
Chief Train Dispatcher

Repeated at **2.30 A M.**

Conductor	Train	Made	Time	Dispr.	Opr.
13 JONES	45	O. K.	2.20 AM	A B C	BLACK
13					
13					
13					
13					
13					
13					

Conductor and Engineman must each have a copy of this order.

Train ahead left at **12.30 A M,**

Form 547.

CHICAGO, ST. PAUL, MINNEAPOLIS & OMAHA R'Y CO.**CLEARANCE.***There are NO ORDERS*

at *Station*
for Train No......*due at said station at*.....*M.*
 *190*.....

Stop signal is displayed for.....

Last train ahead, No......*left here at*..... *M.*

Remarks.....

This does not interfere with or countermand any order, you may have received.

Time issued *M.*

Signed.....*Operator.*

NOTE.—Should any train have orders not to pass any station "WITHOUT ORDERS," the reception of this blank does not release it, but in such cases regular orders must be obtained.

In case "stop signal" is not displayed, operators will write "not displayed" after the words "Stop signal is displayed for....."

Operators are required to fill in blank in duplicate for trains for which they have no orders. Fill in exact time clearance is given.

Conductor must see that the number of his train is entered in above form correctly.

FORM — (A).

COMPANY.

(NAME.)

CLEARANCE CARD.

Dove

9 15 A M

March 25

19 03

Conductor and Engineman No 12

I have no (further) orders for your train.

Signal is out for Extra 45?

This does not interfere with or countermand any orders you may have received

John Jones

Operator.

Conductor and Engineman must each have a copy, and see that their train is correctly designated in the above form.

RAILWAY YARDS AND HANDLING CARS.*

“The main functions of a railway yard are to receive trains passing over the road, to separate and classify the cars for their proper destinations and to put the cars together into trains for forwarding. An important consideration is that this should be done in the most economical way, both as to time and cost, and the evidence at hand seems to show very conclusively that these results can best be attained in the “hump” type of yard. In the replies received by the committee the opinions expressed were almost universally in favor of the hump yard as compared with other types, and the advantages were summarized by one writer as follows:

“‘Hump yards, in my opinion, are very much more rapid in their work and in the handling of cars than any other types of yards in general use. If thoroughly equipped with engines of sufficient tractive power, humps of proper grades, enough riders to handle each cut of cars without delay and a proper system of marking cuts and indicating to the switchmen where they go, the yard will not only work faster than any other type, but will do it at less cost and with much less damage to the cars and to the merchandise handled in them.’”

“On the other hand, it must be remembered that the hump yard is still in its infancy as to design and in a minority as to actual numbers. Consequently an absolute unanimity of opinion can not be looked for, and this type must be expected to have some opponents. One

*From a committee report to the American Railway Engineering and Maintenance of Way Association.

objection that has been made is that cars are more liable to be damaged when handled in this way by gravity, but this is quite at variance with the experience of most of those who have had such yards under their charge. It is, of course, possible that in a yard improperly handled considerable damage might be done, but this is no argument against the type of yard.

“A hump yard is one in which the movement of cars is produced by pushing them over a summit, beyond which they run by gravity. A train of cars to be separated or classified is slowly pushed over the summit, each car or cut of cars being uncoupled and acquiring an impetus on the steep down grade which enables it to run on to the proper classification track by gravity without other assistance. A car rider or brakeman boards each car or cut of cars as it starts down the grade and controls it so as to stop it at the desired point on its tracks and to prevent damage due to cars being run together at too high a speed. The movement from the base of the summit may be facilitated by an assisting grade. Connecting or run-around tracks provide for the movement of cars which do not require to pass over the hump.

“To provide for the proper performance of its work the yard should comprise receiving tracks, classification tracks and departure tracks. The receiving tracks should be of sufficient length to hold a maximum train, and sufficient in number to receive in quick succession a number of trains which may have been detained out on the line by a wreck or other cause. This number of tracks will, of course, depend upon the amount of traffic on the road. The grade of the receiving tracks should be such that one engine can push the entire train over the hump.

“The receiving tracks are connected with the classification tracks over the hump by switches in such a way that cars on any receiving track can be pushed over the hump into any classification track. The tracks approaching the summit should be on a slight up grade to insure that the cars are closed up so that they can be readily uncoupled at the hump without causing delay.

“Hump yards can not be properly operated without riders on the cars, and in considering the accelerating grades for the hump this fact must be borne in mind. The descending or accelerating grades of the hump should be such that the cars will run by gravity from the summit to their proper destinations on the classification tracks. The exact grades must be determined by experience with the class of business handled and the local conditions. The amount of elevation and rates of grade required will vary with different kinds of cars and traffic handled, and also with the varying climatic conditions; that is to say, loaded cars will run more easily than empty cars, and the cars will run more easily in summer than in winter. The details, therefore, vary in practice in different yards.

“The tracks in the classification yard need not, as a rule, be of sufficient length to hold full or maximum trains. Their length will depend upon local conditions and the number of classifications needed. A length sufficient for half a train is usually enough, provided a sufficient number of tracks can be put in to allow of the number of classifications wanted for the different destinations and for bad-order and hold-over cars. It is desirable to keep the distance from the hump to the end of the switches as short as possible, and for this purpose the “double V” shaped layout for switches is usually the best.

“Beyond the classification tracks are located the departure tracks. These should be of full length to take a maximum train, and of sufficient number so that trains can be pushed from the classification tracks as soon as they are made up. These tracks should be provided with a compressed air plant for testing the train brakes and hose so that there will be no loss of time by requiring the road engine to do this service. In some cases the cars are made up into trains on the classification tracks, which thus serves the double duty of classification tracks and departure tracks. The tracks of a classification yard so used should be of full train length.

“The cars on any one track in the classification yard are, as a general thing, not arranged in proper order for handling in trains. A considerable amount of shifting has therefore to be done in order to put the cars in proper train order, and it has been suggested that this part of the work might be greatly facilitated by passing the cars over a second hump into the departure yard. Inquiry was made by the committee to see if this plan would be considered advisable, but the replies received were almost unanimously opposed to the use of a second hump for this purpose.”

HANDLING CARS IN YARDS.*

“The office work connected with yard operations may be divided into three distinct parts: (1) “receiving,” or “in-freight;” (2) “forwarding,” or “out-freight;” and (3) “transfer,” or receiving from and delivering to connecting lines. In immediate charge of this work is a chief clerk, who must be a man of considerable execu-

*F. S. Atkin.

tive and business ability, since he is virtually the acting superintendent many times in a day.

“1. *In-freight*. The clerical routine arising from the receiving of freight arriving in trains from off the company's lines, demands, for its handling, a force consisting of a “train clerk,” “number-takers,” “seal-takers,” “carders,” a “transfer clerk,” a “grain-sealer,” a “rate clerk,” and an “expense bill clerk,” besides, of course, the chief clerk.

“On the arrival of a train in the yard, the number-takers secure a list of the numbers and initials of all cars in the train, also noting the condition of loads on open cars—whether they are low enough to clear tunnels, bridges, etc., and whether staked on the cars, etc. All the doors—side, end, and roof—are inspected by a seal-taker, who records the seals attached to them. The seals now generally employed are made of tin, with a circular piece of lead attached. The tin band bears a serial number, and the lead disk, after a car-door has been sealed, bears the impression of the seal-punch used—either letters or numbers identifying the station where the punch is used. All of these seal numbers or letters must be taken, and a copy made in an impression-book for future reference.

“In the meantime the train clerk examines the way-bills as carefully as possible for “hold” or “diversion” orders, and makes a transcript of them on the “train-sheet,” stating the car number, initial, forwarding station, destination, contents, and via what connecting line. After the train clerk has completed the transcript, a carder tacks on each car a card showing the road to which the car is to be transferred, or should it be destined for the home road, the switching district to which it is to be

taken. The train is then ready to be switched into the classification-yard.

“Some of the incoming cars may have to be transferred to other railroads, and a record of all such is kept by a transfer clerk, the expense-bill clerk making out an expense bill for every loaded car thus handled. In connection with this work, the latter clerk also sees that the bills are properly extended, and it is the usual practice for him to call back the expense bills to the clerk so as to check any possible error.

“There is a rate clerk who revises rates, or rather checks them over to see that the freight has been billed at a proper classification, and also to make sure, in case of through-bills, that his company is given its proper proportion of the through-rate. He is held responsible for all errors in wrong rates or extensions made by the billing agent.

“Where cars contain grain for inspection, a grain-sealer accompanies the grain inspector, his duty being to reseal all cars opened for inspection or samples.

“2. *Out-freight.* In the “forwarding,” or “out-freight” work, there are, as in the “in-freight” department, the usual number-takers, seal-takers, carders, rate clerks, and clerks taking care of way-bills. As the out-bound cars are made up into trains, they are checked as before for their car numbers and initials, and all loaded cars are properly sealed and reported to the train clerk, who then checks up the list of cars and furnishes a way-bill for each loaded car, showing the contents, destination, etc. In the case of “foreign” empty cars, a way-, or card-, bill is furnished.

“The conductor of the train also takes a list of the number of all cars in his train, which list is checked with

that of the number-taker, and if they agree, and correspond with the numbers on the way-bills, he receives his way-bills for the cars. In addition, the list made by the number-taker is given to the car record clerk, who records the numbers of the cars, date of leaving, train number, and destination.

“3. *Transfer freight.* As regards transfer freight—or the receiving of freight from, and the delivery of it to, connecting lines—cars are usually classified for the various roads when first switched, and are then made up into “transfer” trains. A record is made of all cars loaded or empty. Duplicate expense bills are made for each car in the transfer train, showing the name of the consignee, destination, contents, weight, charges, car number, and initial. Both of the bills are sent to the road receiving the cars, one copy to be signed and returned by the agent of the receiving road, and the other to be retained by the receiving road for its record. Any car received in a damaged condition, or short as to its billed contents, must be noted on the expense bill returned to the delivering road. This is also true as to seals, which, if defective, must be immediately reported to the delivering road by the receiving agent, giving the car number and initial, date of its arrival, and a statement of the trouble. If the expense bill is returned to the delivering road without any such addition, it is an indication that the shipment has been received in good order; and the transaction, so far as the actual transfer is concerned, is closed.

“Young men seeking employment with railroad companies dislike to take positions in terminal yards, as the pay is small, the hours long, and the work very exacting. Yet no one expecting at some future time to occupy the position of agent of a terminal station can afford to

neglect this work. As agent he would not be able to manage the station so successfully if he did not have the experience to be acquired in the terminal yard. Here is the first round of the ladder, and a person familiar with the small details can handle the general business to better advantage. It is a wide field, and I know of none better suited for a young man making his start in railroad-ing."—F. S. Atkin, Sup't Terminals, C. M. & St. P., in "Railway Organization and Working."

DISTRIBUTION OF CARS.

"The conditions surrounding car distribution are dependent upon the commodities and the geographical location of the railroad. For instance, it is much more difficult to handle car distribution on a road whose particular product is grain or hay, than on a road where the particular commodity is coal or stock; and, again, it is more difficult to handle distribution on a road with a great number of branches or feeder lines, than on a road that has a straight main line.

"The first essential and all-important requisite is that the person in charge of distribution thoroughly familiarize himself with the products originating on his line, and the seasons during which they move. He should also know the destination of such commodities, in order that he may, prior to their movement, gradually accumulate the surplus equipment in the section where it will be needed, and thus avoid hauling the empty cars out of the territory shortly before they will be required for loading. In this manner the empty car mileage, which is one of the large items of operating expenses, is reduced to a minimum.

“The Car Distributor must know at all times where his equipment is located. Such information is furnished him by wire every twenty-four hours, giving the total number of each class of car on hand loaded, empty, held for movement, and in bad order. These data are compiled on each train district by the Chief Dispatcher at a given hour each day, the agent telegraphing the Chief Dispatcher, on a printed form, the number of cars waiting for movement east and the number of cars waiting for movement west, over or less than forty-eight hours; the number of cars held for unloading at his station; the number of empty cars of each class—box, stock, coal, etc.—on hand; the number of cars required for loading, under which item are specified the product awaiting shipment, the destination of the shipment, and, if beyond the home road, the route over which the consignment will be sent, so that the Chief Dispatcher may utilize foreign railroad cars belonging to lines over which the business will move.

* * * * *

“For certain commodities, such as lumber, machinery, and ties, shippers frequently order coal- or flat-cars, it being more convenient to load the product into these than into box- or stock-cars. When such orders are placed, showing the commodity, destination, etc., the Chief Dispatcher can, however, often prevail on the shippers to use box- or stock-cars, when it is to the interest of the road to do so. For example, a railroad may have a shipment in southern Illinois for points in Iowa or Minnesota. The shipper calls for coal-cars, which, if loaded into Iowa, where the road has no return traffic for them, must come back empty. On the other hand the road may have some stock- or box-cars moving west

empty, which, if utilized, would save the empty haul into Iowa, and, in addition, would save the empty haul from Iowa back to the southern Illinois mines, if the coal- or flat-cars were used. Again, a shipper may order, for instance, Illinois Central large-capacity box-cars for a shipment of grain, cotton, or any other commodity. If he did not insist upon knowing its destination and route, the Dispatcher might furnish Illinois Central cars for it. The shipment is, however, destined for New York or New England points, to which some eastern foreign cars, then on the division, may be utilized."

"In accordance with the system of car distribution, the shipper must order the cars he requires from the agent at the station where he will load. The agent, at the usual hour each day, will order the cars from his Chief Dispatcher. In case the Chief Dispatcher is unable to furnish all of the cars ordered from his district, he calls upon the Superintendent of Transportation to help him from other divisions or sources. Hence, a shipper cannot order cars direct from the Superintendent of Transportation, or from the Chief Dispatcher, without creating confusion. If the Superintendent of Transportation accepted an order of that kind, and directed the Chief Dispatcher to take care of it, the latter might order the cars to the station direct; but when they reached there the agent would know nothing about the order. He would ask the Chief Dispatcher what the cars were sent for. The Chief Dispatcher, not knowing about the order, would no doubt instruct the agent to bill them and send them on to some other point where he knew they were required. Had the order been transmitted through the proper channel, when the cars reached the station, the agent would know all the facts connected with it, and there would be no hitch in taking care of the shipment.

“The commodities to be moved, and their seasons for shipment, must be carefully watched. The condition of the crops as they mature, and the prospects for marketing them, must likewise be closely studied. On the Illinois Central, for example, we know that fruit and vegetables begin to move in refrigerator-cars from Louisiana points the latter part of March, and keep gradually increasing in volume as the shipping territory expands, until by the middle of June we are loading fruit and vegetables all the way from New Orleans as far north as Centralia, Ill.—a territory of over seven hundred miles. To know what the requirements will be, it is necessary for the Car Distributor to get reports of the condition of the crops as they progress, and of the acreage planted. Frost may kill the tomato or peach crop, in which case he must make his deductions in figuring on the supply of equipment necessary to take care of it, in order to prevent hauling more refrigerator-cars into that section than are actually required for the business; thereby avoiding the return of empty cars, which involves an enormous unnecessary expense.

“There are other factors to consider, in addition to the maturing of the crop. The market price may be extremely low, in which case the grain will not move in such volume as it would if the price were high. The shippers who can afford to store it will naturally do so until the market is favorable. Again, the size of the grain crop is not an indication as to the volume that will move to early market. The crop of the preceding year may have been very poor. In that event a good portion of the present year’s crop will be held over for the following year, for feeding and other local consumption, by reason of the supply having been exhausted during the current summer.

“The importance of a uniform system in doing work of this kind, which is more or less complicated, and the advantage of a simple method or system, cannot be too strongly emphasized. Let us take the loading of tomatoes, for example. At * * * * *, a town of 1,100 people—we are to load a maximum of forty-five carloads of tomatoes in one day. The refrigerator-cars, after having been iced, are placed on long loading-tracks. The men who receive the tomatoes from the farmers divide the cars before any loading is done, by placing flags in the car doors. A white flag indicates that the teams having green, or unripe, tomatoes are to bring them to that car; a red flag denotes that those having ripe tomatoes are to unload them in that car; and a half-red and half-white flag means that the medium-ripe tomatoes are to go in that car. In this way the teamsters have no trouble whatever in lining up for the proper car, the tomatoes having been sorted in the fields before being loaded on the wagons. The object of loading them in this manner is to enable the shipper to route the green product to the most distant point, and the ripe product to the nearest market. If a car was loaded with half-ripe and half-green tomatoes, and shipped to a reasonable distance, the chances are that the ripe tomatoes would age and decay in transit, and long before the green tomatoes were in a marketable condition. I cite this simply to show what good results may be obtained by some plain, simple system. This principle of a uniform system is at the foundation of the successful operation of railroads as well as of other large corporations.

“The distribution of coal-cars is, as a rule, very difficult, the mines, located on branches and spur-tracks, be-

ing badly scattered. The supply of empty coal-cars comes principally from the large manufacturing centers, where the coal is consumed, and in order to afford the mines in the various localities their equal proportions of the cars, it is necessary to keep in close touch with the movement of the empty cars in different directions. It is impossible for the men in charge of large terminals, like Chicago and St. Louis, to notify the Car Distributor at three, four, or five o'clock in the afternoon how many empty coal-cars they will be able to forward between six in the afternoon and six the following morning. The Distributor is, therefore, unable to instruct the Superintendent or the Dispatcher how to divide, between his own and other divisions, the equipment he receives during the night. Consequently the Distributor places an arbitrary distribution order on the percentage basis.

* * * * *

“It is also the duty of the Car Distributor, Dispatcher, agent, conductor, and all concerned in the distribution and furnishing of cars, to see that large-capacity cars are furnished for shipments that will load to the capacity of the car, and that small, light cars are furnished for the light traffic. For example, it is not good policy to furnish an 80,000 pounds' capacity box-car to handle 6,000 or 7,000 pounds of merchandise, when it is just as easy to furnish a 40,000 pounds' capacity car. Neither is it good practice to furnish two 40,000 pounds' capacity box-cars for shipment of grain, when the shipment could have been loaded into one 80,000 pounds' capacity car. It is more difficult to haul the two than the one, and, in addition, they occupy double track-room in yards, and also entail double the switching expense on terminals.

“The Car Distributor must keep in touch with the repairs to cars, in order that he may get the class of equipment which he requires for immediate use—*i. e.*, box, stock, coal, and refrigerator-cars—given preference on the repair tracks over the class of car which he does not so require. He should also keep informed as to the location of his cars on the tracks of foreign roads, so as to prevent too many of them getting into fields where they will be tied up and delayed. This information is furnished him from the car-record room.

“Each railroad car in existence bears the initials of the road owning it, and an individual number which remains with the car from the day it is built to the day it is destroyed. Railroads exchange information showing the disposition of each other’s cars. For example, the Illinois Central loads ten cars at Omaha for Boston. When the ten cars are delivered to the Lake Shore & Michigan Southern at Chicago, the agent of the Illinois Central at this point makes a report to the Car Accountant of his own road, showing the initial and number of each of the ten cars, the date they were delivered to the Lake Shore, their contents, and their destination. When the Lake Shore delivers the ten cars to the New York Central at Buffalo, it mails to the Car Accountant of the Illinois Central—because they are Illinois Central cars—a postal card giving the number of each car and date they were delivered to the New York Central. The New York Central, in turn, furnishes similar information, showing the date the cars were delivered to its connections. In addition to furnishing information showing the present location of the cars, this system also enables the owner to check their per-diem earnings. When the record shows that a connecting line has a great

many more of our cars than we have of theirs, the Car Distributor makes extraordinary efforts to get that connection to furnish us more of their cars, in order to protect loading originating on our line destined to points on theirs. This is especially true during the busy season, where there is a shortage of cars.”—J. M. Daly, Ill. Central R. R., in “Railway Organization and Working.”

EDITOR'S NOTE: There is probably no more earnest advocate of system in railway working than Mr. John M. Daly, and certainly none better qualified through experience in bringing “order of chaos” by devising systematic plans and demonstrated their practicability. The fuller treatment of this subject by him in the very valuable book referred to is worthy the careful study of all interested in the expeditious movements of freight cars.—
THE EDITOR.

LIST OF FREIGHT CARS.

Box	Car.	Common type.
“	“	Furniture and Vehicles.
“	“	Wooden Ware.
“	“	Hearse.
“	“	Ventilated.
“	“	Ice.
“	“	Charcoal.
“	“	Lime.
Refrigerator	“	Common.
“	“	Beer.
“	“	Dressed Beef.
“	“	Dairy Products.
“	“	Ventilated Fruit.
Stock	“	Common.
“	“	Double Decks.
“	“	Single Deck Feed and Water.

Stock	Car	Palace Horse with Stalls.
"	"	" Stock " "
Flat	"	Common.
"	"	Logging.
"	"	Barrel Racks.
"	"	Machinery.
"	"	Gun Trucks.
"	"	Water Tanks.
Gondola	"	Common.
"	"	Hopper Bottom.
"	"	" " Steel,
"	"	Drop Ends.
Ore	"	Iron, etc.
Tank	"	Oil, etc.
Live Poultry	"	
Ballast	"	
"	"	Distributers.
Lidgerwood Rapid		Unloaders.
Caboose Cars.		
"	"	Stockmen's Sleepers.
Excavator	"	
Derrick and Wrecking		Cars.
Pile Driver		"
Ditching		"
Side Dump		"
Rotary Snow Plow		"
Flanger		"
Form C. S. 21.		(See page 128.)

EXTRACTS FROM THE CODE OF RULES

Governing the Condition of, and Repairs to Freight Cars for the Interchange of Traffic.

ADOPTED BY THE MASTER CAR BUILDERS' ASSOCIATION.

NOTE:—These rules make car owners responsible for, and therefore chargeable with, the repairs to their cars necessitated by ordinary wear and tear in fair service, so that defect cards will not be required for any defects thus arising.

Railroad companies handling cars are responsible for damage done to any car by unfair usage, derailment or accident, and for improper repairs made by them, and they should make proper repairs at their own expense, or issue defect card covering all such damage or improper repairs.

CARE OF FOREIGN FREIGHT CARS.

RULE 1. Each railway company shall give to foreign cars, while on its line, the same care as to oiling, packing and inspection, that it gives to its own cars.

INTERCHANGING FREIGHT CARS.

RULE 2. Cars offered in interchange must be accepted if in safe and serviceable condition, the receiving road to be the judge in cases not provided for in Rules 3 to 56, inclusive.

USE OF DEFECT CARD.

RULE 3. Defect cards shall be $3\frac{1}{2}$ inches by 8 inches, and of the form shown below. They should be printed in red ink on both sides, and shall be filled in on both sides with ink or black indelible pencil. The cards must plainly specify in full each item for which charges are authorized, indicating on which end of the car the defects exist. The end of the car upon which the brake staff is located shall be known as "B" end, and the opposite end shall be known as "A" end. Where there are two brake staffs on same car, the end toward which the cylinder push rod travels shall be known as "B" end.

M. C. B. DEFECT CARD.

(Name of Road.)

Car No.....Date.....

InitialLine.....

Will be received at any point on this company's line with the following defects:

NOTE.—Fill in defects on both sides with ink or black indelible pencil. Attach this card with four tacks on outside face of intermediate sill, between cross-tie timbers.

.....

Inspector at.....

Send bill on this card to

RULE 4. Defect cards shall not be required for defects for which owners are responsible, except for missing material on cars offered in interchange, as provided for in Rules 27 and 41, neither shall they be required of the delivering road for improper repairs that were not made by it, with the exception of the cases provided for in Rules 31, 42, 43 and 44.

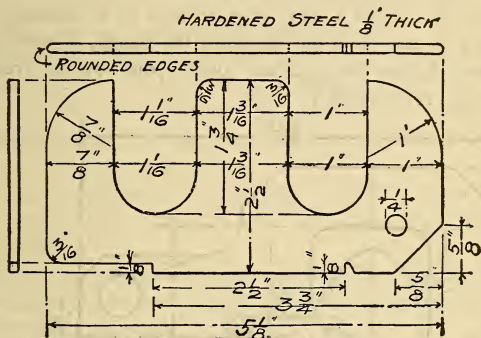

Fig. 1.

RULE 5. If a car has defects for which the owners are not responsible, but which do not render it unsafe to run, nor unsafe to trainmen, nor to any lading suitable to the car, the receiving road may require that a defect card be securely attached to the car with four tacks, preferably on the outside face of intermediate sill, between cross-tie timbers, on wooden cars; and on steel cars to cardboard located either on cross-tie under car or on inside of side sill at the end of car.

RULE 6. Duplicate defect cards shall be furnished for lost or illegible cards.

or flange 1 inch thick or less. Wheels under cars of 80,000 pounds capacity or over, with flanges having flat vertical surfaces extending more than $\frac{7}{8}$ inch from tread, or flange less than 1 1-16 inches thick. (See Figs. 4 and 4a.) (Owners responsible.)

Worn flange; steel and steel-tired wheels with flanges having flat vertical surfaces extending more than one inch from tread, or flange one inch thick or less. (See Figs. 4 and 4a.) (Owners responsible.)

RULE 11. Thick flange: flange over 1 7-16 inches thick. (See Fig. 2.) (Owners responsible.)

RULE 12. Tread worn hollow: if the tread is worn sufficiently hollow to render the flange or rim liable to breakage. (Owners responsible.)

RULE 13. Burst: if the wheel is cracked from the wheel fit, outward, by pressure from the axle. (Owners responsible.)

RULE 14. Broken flange, caused by seams, worn through chill or worn flange. (See also rules 20 and 21.) (Owners responsible.)

RULE 15. Broken or chipped rim, caused by defective casting, if the tread, measured from the flange at a point $\frac{5}{8}$ inch above tread, is less than $3\frac{3}{4}$ inches in width. (See Fig. 5.) (See also Rules 20 and 21.) (Owners responsible.)

RULE 16. Cracked tread, cracked plate, one or more cracked brackets, or broken in pieces under fair usage. (See also Rule 20.) (Owners responsible.)

Steel or steel-tired wheels loose, broken or cracked hubs, plates, bolts, retaining ring or tire under fair usage. (Owners responsible.)

RULE 17. Wheels loose or out of gauge. (See Fig. 6.) (Owners responsible.)

RULE 18. Chipped flange: if chip is on the outside of the flange and exceeds $1\frac{1}{2}$ inches in length and $\frac{1}{2}$ inch in width, or if it extends $\frac{1}{8}$ inch past the center of flange. (Owners responsible.)

RULE 19. Flat sliding: if the spot caused by sliding is $2\frac{1}{2}$ inches or over in length. (Care should be taken to distinguish this defect from *worn through chill*.) Delivering Company responsible.)

RULE 20. Broken flange, except as in Rule 14; chipped flange, if chip is on throat side of flange, and exceeds $1\frac{1}{2}$ inches in length and $\frac{1}{2}$ inch in width, or if it extends $\frac{1}{8}$ inch past the center of flange; broken rim, if not caused by defective casting, if the tread, measured from the flange at a point $\frac{5}{8}$ inch above tread, is less than $3\frac{3}{4}$ inches in width (see Fig. 5), or any breakage caused by unfair usage, derailment or accident. (Delivering Company responsible.)

RULE 21. The determination of flat spots, worn flanges and chipped treads shall be made by a gauge as shown in Fig. 1. The determination of thick flanges shall be made by a gauge as shown applied to M. C. B. standard wheel tread and flange in Fig. 2.

The following engravings of the wheel defect gauge, Fig. 1, show the method of using it:

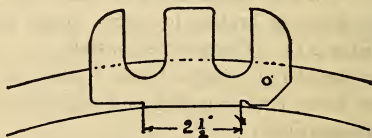

Method of Gauging Shelled and Flat Spots. See Rules 7 and 19.

Fig. 3.

For wheels under cars of less than 80,000 pounds capacity, and steel or steel-tired wheels with flanges 1 inch thick or less; 80,000 pounds capacity or over, with flanges less than 1 1-16 inches thick.

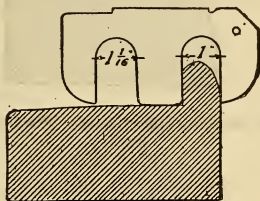

Method of Gauging Worn Flanges. See Rule 10.

Fig. 4.

For wheels under cars of less than 80,000 pounds capacity, and steel or steel-tired wheels 1 inch from tread; 80,000 pounds capacity or over, 7/8 inch from tread.

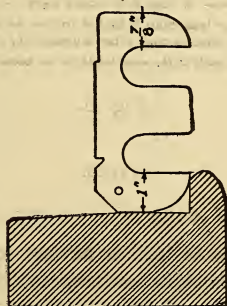

Method of Gauging Worn Flanges. See Rule 10.

Fig. 4a.

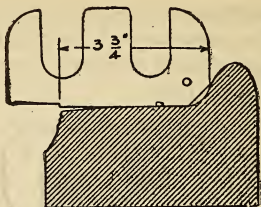

Method of Gauging Chipped Rings. See Rules 15 and 20.

Fig. 5.

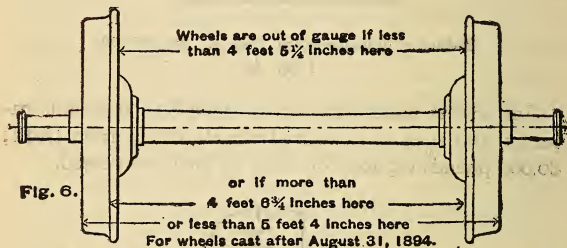

Measurements to be made at the same height on the wheels as the center of the axle.

Fig. 6.

AXLES.

Defects of Axles Which Justify Renewal.

RULE 22. Axles broken, or having seamy journals, fillets at the back shoulder worn out, or with collars broken or worn to $\frac{1}{4}$ inch or less, under fair usage.

RULE 23. Axles less than the following prescribed limits:

For Cars Marked with "Capacity."

Capacity of Car.	Journal.	Wheel Seat.	Center.
100,000	5 inches.	6 $\frac{3}{4}$ inches.	5 $\frac{7}{8}$ inches.
80,000	4 $\frac{1}{2}$ "	6 $\frac{1}{4}$ "	5 5-16 "
70,000	4 "	5 $\frac{5}{8}$ "	4 $\frac{7}{8}$ "
60,000	3 $\frac{3}{4}$ "	5 "	4 $\frac{3}{8}$ "
50,000	3 $\frac{1}{2}$ "	4 $\frac{3}{4}$ "	4 $\frac{1}{8}$ "
40,000	3 $\frac{1}{4}$ "	4 $\frac{5}{8}$ "	3 $\frac{7}{8}$ "
30,000	3 "	4 $\frac{1}{4}$ "	3 $\frac{1}{2}$ "

For Cars Marked "Maximum Weight."

Maximum Weight.	Journal.	Wheel Seat.	Center.
161,000	5 inches.	6 $\frac{3}{4}$ inches.	5 $\frac{7}{8}$ inches.
132,000	4 $\frac{1}{2}$ "	6 $\frac{1}{4}$ "	5 $\frac{3}{8}$ "
112,000	4 $\frac{1}{4}$ "	6 "	5 $\frac{1}{4}$ "
95,000	3 $\frac{3}{4}$ "	5 $\frac{1}{2}$ "	4 $\frac{3}{4}$ "
79,000	3 $\frac{1}{2}$ "	5 $\frac{1}{4}$ "	4 $\frac{5}{8}$ "
66,000	3 $\frac{1}{4}$ "	4 $\frac{7}{8}$ "	4 $\frac{1}{4}$ "
58,000	3 "	4 $\frac{3}{4}$ "	4 $\frac{1}{8}$ "

All cars to have their light weight and capacity or their light weight and maximum weight stenciled on them. (Owners responsible.)

RULE 24. Cut journals, axles bent or axles rendered unsafe by unfair usage, derailment or accident. (Delivering Company responsible.)

TRUCKS.

Defects of Trucks Which Justify Repairs if Owners Are Responsible, or Repairs or Carding if Delivering Company Is Responsible.

RULE 25. Defective, missing or worn-out parts of trucks not elsewhere provided for, which have failed under fair usage, or if any part of the truck frame or attachments is less than $2\frac{1}{2}$ inches above the top of the rail. (Owners responsible.)

RULE 26. Damage of any kind to the truck due to unfair usage, derailment or accident. (Delivering Company responsible.)

RULE 27. Material missing from trucks of cars offered in interchange. (Delivering Company responsible.)

RULE 28. Journal bearings and journal box bolts which require renewal by reason of change of wheels or axles for which the delivering company is responsible, regardless of the previous condition of the bearings. (Delivering Company responsible.)

BRAKES.

Defects of Brakes Which Justify Repairs.

RULE 29. Defective, missing or worn-out parts of brakes, not elsewhere provided for, which have failed under fair usage, except missing material on cars offered in interchange. (Owners responsible.)

RULE 30. Cylinder or triple valves of air-brake cars not cleaned and oiled within twelve months and the date of last cleaning and oiling marked on the brake cylinder with white paint. (Owners responsible.)

RULE 31. If 1-inch hose and fittings are found on 1¼-inch train pipe. (Delivering Company responsible.)

RULE 32. Missing or torn air-brake hose or missing or broken air-brake fittings, angle cocks, cut-out cocks cylinders and reservoirs, triple valves, release valves and pressure-retaining valves or parts of any of these items (Delivering Company responsible.)

RULE 33. Damage to any part of the brake apparatus caused by unfair usage, derailment or accident. (Delivering Company responsible.)

RULE 34. If the car has air-signal pipes or air-brake pipes, but no air-brakes, the hose and couplings on the car are at owner's risk, unless the car is stenciled that it is so equipped. (Owner's responsibility qualified.)

RULE 35. Cars equipped with air-brake hose other than M. C. B. Standard hose on and after March 1, 1908. (Owners responsible.)

Except cars offered in interchange, where delivering company is responsible. (Delivering Company responsible.)

RULE 36. On and after September 1, 1907, all cars offered in interchange must be equipped with air-brakes.

BODIES.

Defects of Bodies Which Justify Repairs if Owners Are Responsible, or Repairs or Carding if Delivering Company Is Responsible.

RULE 37. Locks, side doors, end doors, roof doors, grain doors and all inside or concealed parts of cars missing or damaged under fair usage, and failure or loss under fair usage of any part of the body of the car, except

as provided for in Rules 41 and 87. (Owners responsible.)

RULE 38. Cars not within the limits of standard height for couplers, 31½ inches to 34½ inches for standard gauge cars. (Owners responsible.)

RULE 39. Steps, ladders, handholds or running boards in bad order or insecurely fastened, or absence of grabirons or handholds as required by law. Handholds or grabirons must be of wrought iron or steel and secured by bolts or lag screws. (Owners responsible.)

RULE 40. Damage of any kind to the body of the car due to unfair usage, derailment or accident. (Delivering Company responsible.)

RULE 41. Material missing from body of cars offered in interchange, except locks, grain doors and all inside or concealed parts of car. (Delivering Company responsible.)

RULE 42. M. C. B. couplers not equipped with steel or wrought-iron knuckles. (Delivering Company responsible.)

RULE 43. Cars intended to be equipped with metal brake beams and so stenciled, if found with wooden brake beams. (Delivering Company responsible.)

RULE 44. Cars equipped with M. C. B. couplers having pocket rear-end attachments and so stenciled, if found with tail-pin attachments instead of pocket. (Delivering Company responsible.)

RULE 45. Uncoupling attachments of M. C. B. couplers offered in interchange must be made operative before moving from interchange points. (Delivering Company responsible.)

Improper Repairs.

RULE 46. Any company making improper repairs is solely responsible to the owners, with the exception of the cases provided for in Rules 31, 42, 43, 44, 45, and also in case it should be necessary to replace spindle with pocket attachment. (Company making repairs responsible.)

RULE 47. The company making such improper repairs shall place upon the car, at the time and place that the work is done, an M. C. B. defect card, which card shall state the wrong material used. (Company making repairs responsible.)

*Combinations of Defects Which Denote Unfair Usage if
Caused at One and the Same Time and
at the Same End of Car.*

RULE 48. Damaged coupler, accompanied by damage to either coupler stop, filling block, draft timber or its substitute, or end sill.

RULE 49. Damaged coupler pocket, accompanied by damage to either draft timber or its substitute, or end sill.

RULE 50. Damaged coupler stop or filling block, accompanied by damage to either coupler or end sill.

RULE 51. Damaged draft timber or its substitute, accompanied by damage to either coupler, coupler pocket, or to end sill.

RULE 52. Vacant.

RULE 53. Damaged end sill, accompanied by damage to either coupler, coupler pocket, coupler stop, filling block, draft timber or its substitute, or longitudinal sill.

RULE 54. Damaged longitudinal sill, accompanied by damage to end sill.

RULE 55. Damaged longitudinal sills, if necessitating replacement or splicing of more than two sills.

RULE 56. Damaged corner and end posts, if necessitating the replacement of, or repairs to, more than two end or two corner posts at one end, or more than one end and one corner post at same end of car.

The word "coupler" in the above rules, 48 to 53, inclusive, means the coupler body or knuckle.

An American continuous draft key shall not enter into a combination of defects denoting unfair usage.

It will be assumed that a missing coupler and attachments are damaged unless shown to the contrary. This only refers to cases where the coupler if broken would enter into the combination of defects.

INSTRUCTIONS TO REPAIR MEN.

RULE 57. Any car having defects which render it unsafe to run, unsafe to trainmen, or to any lading suitable to the car, may be repaired.

RULE 58. Repairs to foreign cars shall be promptly made, and the work shall conform in detail to the original construction, and with the quality of material originally used, except as provided for in Rules 62 and 63. Malleable iron, M. C. B. standards, may be substituted for gray iron, M. C. B. standards, but the net cost to car owner in such cases must be no greater than if the original kind and weight of material had been applied. Gray iron, M. C. B. standards, may be substituted in place of malleable, M. C. B. standards, but in such cases the debits and credits must be for what is actually applied and removed. Repair cards and stubs must state kind of material applied and removed.

RULE 59. In repairing damaged cars M. C. B. standards may be used when of dimensions that do not impair the strength of the cars, in lieu of the parts forming its original construction. When using materials for repairs to foreign cars for which the Master Car Builders' Association has adopted specifications as a standard, the materials must comply with the requirements of these specifications.

RULE 60. In making repairs for which owners are responsible, wheels other than 33-inch may be replaced with 33-inch wheels, if practicable. If changes are necessary in order to bring the car to the proper height, the cost of so doing shall also be chargeable to the car owner.

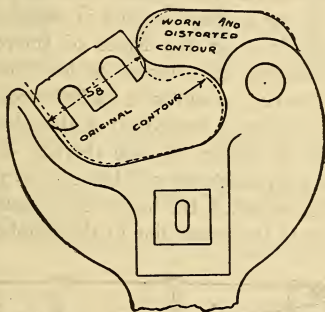

Fig. 7.

RULE 61. Couplers of the vertical plane type other than M. C. B. replaced with M. C. B. standard, the expense of alteration thus necessitated shall be chargeable to car owners. Couplers that exceed the distance of $5\frac{1}{8}$ inches between point of knuckle and guard arm measured

perpendicularly to guard arm must be repaired. (See drawing.)

RULE 62. When M. C. B. couplers of another make are placed upon a car, the uncoupling arrangements shall be made operative at the expense of the company making the repairs.

RULE 63. When M. C. B. couplers, knuckles, metal brake beams, wheels or axles are replaced under conditions which make them chargeable to the owner, it must be plainly stated on the repair card and stub whether the material is new or second-hand.

RULE 64. Any company finding cars not within the limits of standard height for couplers may make repairs and charge to owners. Cars should be adjusted in height when empty, as far as possible, and in order to justify a bill for this work under the Rules of Interchange, an empty car measuring $32\frac{1}{2}$ inches or less should be adjusted to $34\frac{1}{2}$ inches, or within $\frac{1}{4}$ inch thereof, and when it is necessary to alter a loaded car it should be adjusted to $33\frac{1}{2}$ inches, or within $\frac{1}{4}$ inch thereof, or as nearly as possible to such height as will bring it to $34\frac{1}{2}$ inches, when the car is unloaded, the height to be measured from top of the rails to the center line of the coupler shank.

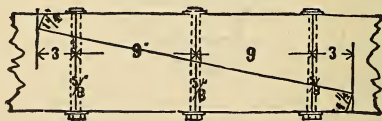

FIG. 8.

RULE 65. Draft timbers must not be spliced. All longitudinal sills may be spliced once. Longitudinal sills, other than center sills, when less than 12 inches in depth,

the plan shown in Fig. 8 is to be followed; when the sills are 12 inches or more in depth the plan shown in Fig. 9 is to be followed; when center sills are spliced the plan shown in Fig. 9a is to be followed.

The splice may be located either side of body bolster, but the nearest point of any splice must not be within 12 inches of same, excepting center sills, which must be spliced between body bolster and cross-tie timbers and not within 30 inches of either. The splicing of two adjacent sills at the same end of the car, or the splicing of any sill between cross-tie timbers, will not be allowed.

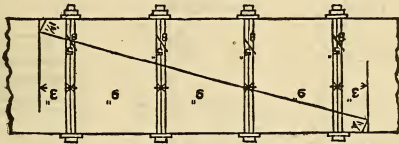

Fig. 9.

Steel sills may be spliced as shown below in Figs. A, B and C.

RULE 66. Wheels on the same axle must be of the same circumference.

RULE 67. New wheels must not be mated with second-hand wheels.

RULE 68. Prick punching or shimming the wheel fit must not be allowed.

RULE 69. The wheel seats of foreign axles must not be reduced more than 1-16 inch to fit the wheels, and in no case must they be reduced below the limits given in Rule 23.

RULE 70. Any company repairing foreign cars with wrong material, and not in compliance with the Rules 57

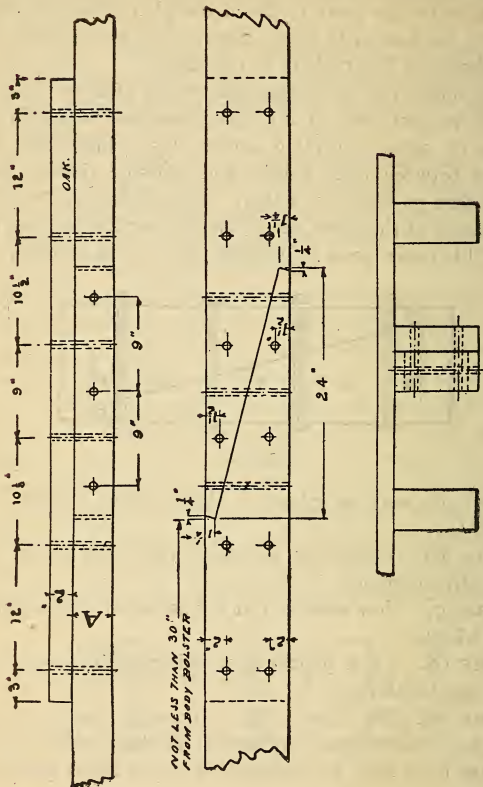

Fig. 9a.

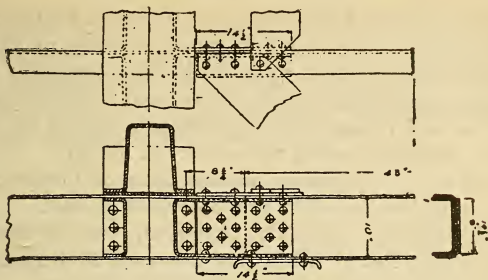

Fig. A.

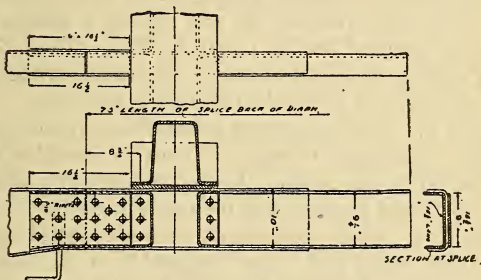

Fig. B.

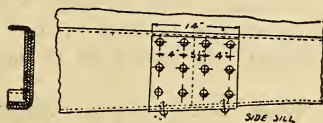

Fig. C.

to 70, inclusive, shall be liable to the owners for the cost of changing such car to the original standard, or to the requirements of these rules, except that companies applying axles smaller than the limits given in Rule 23 shall not be held responsible for improper repairs if the car is not stenciled showing the capacity of the car.

RULE 71. In replacing air-brake hose on foreign cars for which bills are made, new hose must be used.

Air-brake hose applied to foreign cars shall be considered wrong repairs unless they are made in accordance with the M. C. B. specifications and are so labeled.

RULE 72. If the weight of a car is found to vary more than 500 pounds from the light weight stenciled on the car a railroad company having the car in its possession may weigh and restencil the car, making a charge for each car weighed and so reported. The railroad company making the bill shall notify the owner, giving the date and point at which the reweighing was done.

RULE 73. Cars undergoing extraordinary repairs, such as sills, resheathing, roofing, etc., must be reweighed and restenciled by the company having the car in its possession at its own expense, and the owner notified.

RULE 74. When second-hand axles are applied under conditions which make them chargeable to the owners, the diameters of the wheel seats and center must not be less than, and the diameter of the journal must be $\frac{1}{8}$ inch greater than the limiting diameters given in Rule 23. If cars are marked with the word "Capacity," the first set of limits must be followed. If cars are marked "Maximum Weight," the second set of limits must be followed.

RULE 75. When two or more cars chained together, or any cars which require switch chains to handle them,

are delivered at an interchange point, the receiving road shall deliver to the delivering road at the time, an equivalent number of switch chains of the same size as the chains so used on the cars delivered, or, in lieu thereof, furnish a defect card for such chains.

USE OF REPAIR CARD.

RULE 76. When repairs of any kind are made to foreign cars a repair card shall be securely attached to outside face of intermediate sill between cross-tie timbers on wooden cars, and on steel cars to cardboard located either on cross-tie under car or on inside of side sill at the end of car. This card shall specify fully the repairs made, and reason for same, the date and place where made, and name of road making repairs; also show location of parts repaired or renewed. The end of car on which brake staff is located shall be known as "B" end, and the opposite end as "A" end. Where there are two brake staffs on the car, the end toward which the cylinder push rod travels shall be known as "B" end. The card shall be provided with a stub, which will duplicate information on the card and the stubs must be forwarded with the bill.

If no bill is to be rendered, the repair card stub must be forwarded on or before the twentieth day of each month, with the words "no bill" written across the face of the repair card stub. In case it is not the intention to render bill, the words "no bill" shall be written across the face of the repair card.

RULE 77. The repair card shall be $3\frac{1}{2}$ by 8 inches, and the stub $3\frac{1}{2}$ by 4 inches. The card shall be printed on both sides in black ink, and shall be filled in on both sides with ink or black indelible pencil, and be of the following form:

The cards and stubs must state whether solid or filled journal bearings are applied or removed; also, length of bearing. In the case of couplers applied and removed, they shall state the make and kind of material in couplers and the size of shank. In the case of knuckles, they must state whether open or closed knuckles are removed and applied. In the case of brake shoes removed and applied, they shall state the kind of shoe.

RULE 78. Any road making partial repairs of defects on a car which are covered by defect cards will have the defects repaired crossed off the original card with ink or indelible pencil and card placed back on car. A copy of the card accompanying the bill with the defects which were not repaired crossed off will be sufficient authority to bill.

RULE 79. Duplicate repair cards shall be furnished for lost or illegible cards.

INSTRUCTIONS FOR BILLING.

RULE 80. Bills may be rendered for work done under Rule 57, except in cases where owners are not responsible and the car bears no defect card covering the defects repaired, stating upon the bill the date and place where the repairs were made; the repair card stub or defect card to accompany the bill.

RULE 81. Car owners may require receipt of repair card or stub before payment of bill for repairs.

RULE 82. For repairs made on defect cards, the card must accompany the bill as voucher for the work done, but no bill shall be rendered for repairs which have not been made.

RULE 83. When improper repairs of owner's defects have been made and bill rendered, the owner may counter bill against the company making the wrong repairs for the cost of changing the car to the original standard, or to the requirements of Rules 57 to 79, inclusive, if the work is done.

RULE 84. When improper repairs of defects for which owners are not responsible are made, the owner may make bill against the company making the improper repairs for the cost of changing the car to the original standard, or to the requirements of Rules 57 to 79, inclusive, if the work is done.

RULE 85. The evidence of a joint inspector or the joint evidence of two persons, one representing the owner of the car, and the other representing the delivering road, that the repairs are not proper, shall be final. A joint evidence card shall be used for this purpose, which shall describe and show location of parts repaired or renewed. The end of the car on which the brake staff is located shall be known as "B" end, and the opposite end as "A" end. Where there are two brake staffs on the car, the end toward which the cylinder push rod travels shall be known as "B" end. This card shall be of the following form:

RULE 86. The joint evidence card, accompanied by a proper repair card, upon which a bill has been made, shall be used as authority for rendering bill, but if unaccompanied by such repair card, the joint evidence card shall be sent to the company against which the evidence has been presented, and it shall furnish a defect card covering the wrong repairs if it made them.

RULE 87. Bills may be rendered against car owners for the labor only of replacing couplers, brake beams (in-

REPORT OF IMPROPER REPAIRS TO.....CARS

Station.....190..

Car No.....Initial.....Received from.....Ry. At.....Date.....190..

Description of wrong Repairs..... How Repairs should be made.....

Show how Carded on other Side. We Certify Above to be Correct. Inspector for.....Ry. Inspector for.....Ry.

THE RAILWAY CO.

M. C. B. DEFECT CARD. Issued by.....Ry. At.....Date.....190....

Inspector.....

.....Reading as follows.....

.....

.....

.....

.....

.....

M. C. B. REPAIR CARD. Issued by.....Ry. At.....Date.....190....

Inspector.....

.....Reading as follows.....

.....

.....

.....

.....

.....

DISPOSITION OF CAR. Carded to.....Shop; Repaired; went forward without Repairs,

cluding their attachments, such as shoes, heads, key bolts, jaws and hangers), brake levers, top and bottom brake rods that have been lost on the line of the company making the repairs. Coupler springs, followers and yokes may be included in the above, providing they have been lost with the couplers.

RULE 88. In making bills under these rules, the information necessary for the car department should be embodied on the following forms, whether the same is made as a bill or a statement to accompany a bill:

RULE 89. Bills rendered for wheels and axles shall be in accordance with the following schedule of prices for material, with the proper debits and credits:

	New.	Second-Hand.	Scrap.
One 36-in. cast-iron wheel.....	\$10.00	\$ 7.50	\$5.00
One 33-in. cast-iron wheel... ..	8.50	6.75	4.50
One axle, 100,000 lbs.....	24.00	13.50	7.75
One axle, 80,000 lbs.....	19.00	11.00	6.50
One axle, 60,000 lbs.....	14.00	7.75	5.25
One axle, 50,000 lbs. (or under)....	12.00	6.50	4.50

and with an additional charge for all labor for each pair of wheels and axles removed from all arch bar trucks of \$1.75, and from all solid pedestal trucks of \$2.00. If new wheels and axles are substituted for second-hand wheels and axles, proper charges and credits shall be allowed, although such substitution be made on account of only one loose or defective wheel, or a defective axle, with the following exceptions: In case the owner of a car removes a damaged wheel or axle, no charge shall be made for any difference in value between the parts used and those removed that are not damaged.

All steel or steel-tired wheels of the different makes to be charged at current market prices, less freight charges.

Removing, turning and replacing a pair of steel or steel-tired wheels; \$5.50 for pedestal type of truck and \$5.00 for archbar truck.

Loss of service metal from steel or steel-tired wheels for defects for which the delivering company is responsible, to be charged for at the rate of \$1.50 per 1-16 inch thickness of tread or tire.

RULE 90. If car owner elects on account of improper repairs to remove M. C. B. standard axles suitable to the capacity of the car, he shall make charge for second-hand axles and allow credit for secondhand axles if they are in good order. Axles removed below the journal limit of 100,000 pounds, 80,000 pounds, 60,000 pounds and 40,000 pounds capacity to be credited as scrap when removed.

RULE 91. Bills for wheel and axle work must make specific mention of each axle and wheel removed or applied.

RULE 92. Bills which do not embody all the information called for by the headings of the columns may be declined until made to conform to the requirements of the rule. If no marks are found on wheels or axles removed, a notation to that effect must be made on face of bill.

RULE 93. In noting on bills the cause of removal of wheels and axles, the terms used in Rules 7 to 24, inclusive, shall be used, and the dimensions of the defect or variations from the prescribed limits should be carefully specified.

RULE 94. Bills for repairs made under these rules and for material furnished shall be in conformity with schedules of prices and credits for the articles enumerated. (See tables in unabridged code.)

RULE 95. Not more than one pound of mineral paint can be charged for 15 square feet of surface covered, and not more than one pound of lead paint for 12 square feet of surface covered. No charge to be made for lettering.

RULE 96. Whenever scrap credits are allowable the weights of scrap credited shall be equal to the weights of the new metal applied, except as otherwise provided in the rules, and except in the case of scrap M. C. B. couplers, and parts of same, and material applied on defect cards, in which cases the weight and kind of metal removed shall be credited.

RULE 97. In the application of channels they should be charged out at the current market price plus the necessary labor for drilling, etc.; credit should be at prices quoted above for similar metal.

RULE 98. Bills shall not be rendered for amounts less than 25 cents in aggregate, but charges for items less than 25 cents may be held until they amount to that sum, provided said aggregate is rendered within 60 days. No bill shall be returned for correction on account of error for less than 100 cents in aggregate of bill, but said bill shall be passed for payment at once, and the alleged error brought to the attention of the road rendering the same within sixty days from date of bill. The receiving road shall at once issue a letter of authority for counter bill to cover the acknowledged error, said letter to be attached to the bill as authority.

No bills shall be returned for correction on account of wrong car numbers, but road rendering bill should be

communicated with by letter, and if, after investigation, it is found to be a fact that wrong car number has been given, correct number shall be furnished or credit covering amount of charge allowed on next month's bill.

When necessary to return bills for correction, all defect cards and repair card stubs should be detached except those covering repairs to cars, the charge for which there may be some question as to its correctness.

RULE 99. All companies rendering bill should consolidate all charges against any one company into one monthly bill.

RULE 100. Journal bearings having a lining $\frac{3}{8}$ inch thick or thicker, shall be charged as filled journal bearings, and not as lined journal bearings.

RULE 101. In rendering bills for owner's defects, the following should be observed:

No credit for scrap and no charge for labor shall be allowed in renewing brake shoes.

RULE 102. When M. C. B. coupler parts or metal brake beams are replaced, good secondhand material may be used, but they must be charged at seventy-five per cent of the prices when new. The credits for similar parts released from service in good condition must also be seventy-five per cent of the prices when new.

RULE 103. Manufactured articles not included in the above list must be charged at current market prices, without freight charges.

RULE 104. No percentage to be added to either material or labor.

RULE 105. Bills for the following work, to make cars conform to United States laws and to conform to the requirements of Rule 64, must be rendered within 60

days after the work is done, and must state the height of the car before and after altering:

Altering height of one end of one car, net.....\$1.00

Putting on one handhold or grabiron, net..... .25

RULE 106. The table (see unabridged code) shows the number of hours which may be charged for labor in doing the various items of work enumerated, which includes all work necessary to complete each item of repairs, except in so far as labor is already included in charges for materials:

RULE 107. No charge to be made for labor of replacing or applying M. C. B. knuckles, knuckle pins, locking pins, clevises, clevis pins, lift chains, brake shoes or brake-shoe keys, except on the authority of a defect card.

RULE 108. When it is necessary to apply an M. C. B. coupler complete, on account of a broken or missing knuckle, the usual labor charge for replacing a coupler can be made.

RULE 109. No additional labor to be charged for applying center pins or friction rollers or for putting car on center when center-plate bolts or center plates are renewed on same end of car.

RULE 110. No additional labor to be charged for renewing dead block or platform plank if end sill at same end is renewed or replaced.

RULE 111. No additional labor to be charged for replacing or renewing coupler when one or both draft timbers are replaced or renewed at the same end of car at the same time.

RULE 112. The table (see unabridged code) shows the labor charges allowable in cents for the items named in air-brake work: The letters "R. & R." mean "removed and replaced."

RULE 113. The settlement prices of new eight-wheel cars shall be as shown (see unabridged code), with an addition of \$27.50 for each car equipped with air brakes. The road destroying a car with air brakes may elect to return the air-brake apparatus, including such attachments as are usually furnished by the air-brake manufacturer, complete and in good condition.

RULE 114. In the case of wooden cars, the depreciation due to age shall be estimated at 6 per cent per annum upon the yearly depreciated value of the bodies and trucks only. In the case of all steel cars and cars with steel underframes, the depreciation shall be 5 per cent per annum for the bodies of all steel cars; for bodies of cars with steel underframes the depreciation shall be at the rate of 6 per cent per annum with the exception of flat cars with wooden floors, which shall be 5 per cent per annum. The depreciation on the value of trucks of steel cars shall be 6 per cent per annum. Allowances for depreciation shall in no case exceed 60 per cent of the value new. The amount \$27.50 for air brakes shall not be subject to any depreciation.

RULE 115. The bodies of refrigerator cars, special stock cars, tank cars, except the tanks, and other freight cars, designed for special purposes, not referred to above, shall be settled for at the present cost price, as may be agreed to by the parties in interest, less the deduction for depreciation due to age, which shall be on the same basis as for regular freight equipment.

RULE 116. In rendering bills, cars shall be treated as belonging to companies or individuals whose name or initials they bear, except in case of Line Cars where the equipment list of the general officers of the Line designates a party to make settlement.

RULE 117. Switching roads will only be allowed to render bills against car owners for the following defects repaired by them: Roof lost on account of decay or faulty construction, worn-out brasses, broken truck springs, truck transoms, arch bars, draft-timber bolts, column bolts, truck hangers, truck transom truss rods, truck bolsters, truck bolster truss rods, oil boxes, spring planks, truck hanger pins, side bearings and center plates, center-plate bolts, center pins, followers, American continuous rods or keys, draft springs, couplers, knuckles and drawbar pockets and rivets, defective wheels as specified in Rules 7 to 18, inclusive, defective axles as described in Rules 22 and 23, cars not within the limits of standard height for couplers, as per Rule 38, safety appliances as prescribed by Rule 39, and grain doors and all inside or concealed parts of bodies of cars missing or damaged under fair usage as prescribed in Rule 37, provided the damage has not been caused by derailment or rough usage. They will be allowed to render bills direct against car owners on all car owners' defects on cars received by them from a railroad company, provided they procure joint evidence from the delivering road that such car owners' defect existed when the car was delivered by the railroad company, joint evidence to accompany the bill against the car owner.

RULE 118. A switching road is a corporation doing the major part of its business on a switching charge.

RULE 119. Bills may be rendered against car owners for the cost of applying temporary running boards and hand rails to make cars safe for trainmen.

DESTROYED CARS AND THE RETURN OF TRUCKS.

RULE 120. The company on whose line the bodies or trucks are destroyed shall report the fact to the owner.

immediately after their destruction, and shall have its option whether to rebuild or settle for the same.

RULE 121. If the company on whose lines the car is destroyed elects to rebuild either body or trucks, or both, the original plan of construction must be followed, and the original kind and qualities of materials used. The rebuilding must be completed within 60 days from the original date of damage or destruction. In such cases no allowance shall be made for betterments.

RULE 122. If only the body of a car is destroyed, and the company destroying it elects to return the trucks, they shall be put in good order, or accompanied by a defect card, covering all defects or improper repairs made by them for which owners are not responsible, and forwarded, within 60 days, free of freight or other charges, to the nearest point on the line of the company owning or operating the car, and the number, line and class of car destroyed shall be stenciled or painted on each truck so returned.

RULE 123. The company on whose line the body or trucks of a car are seriously damaged, but not destroyed, may notify the owner and ask an appraisalment on the damage done to the car as a basis for the disposal of the damaged car.

RULE 124. For the mutual advantage of railway companies interested, the settlement for a car owned or controlled by a railway company, when damaged or destroyed upon a private track, shall be assumed by the railway company delivering the car upon such tracks.

SENDING HOME WORN-OUT AND DAMAGED CARS.

RULE 125. A car unsafe to load on account of general worn-out condition, due to age or decay, shall be reported

to its owner, who must be advised of all existing defects. If the owner elects to have it sent home, he shall furnish two home cards, noting upon them existing defects and the route over which the car is to be returned to its owner. If the route coincides with that over which the car passed to the point where it became unserviceable, no liability shall be incurred as between the owner and the road handling the car, either for freight charges in handling the car or for car service during this movement.

Such cards shall be attached to each side of the body of the car. They shall be $3\frac{1}{2}$ by 8 inches, and of the form shown below. They shall be printed on both sides, and shall be filled in on both sides with ink or black indelible pencil:

FROM	
.....	R. R.
TO	
.....	R. R.
VIA	
.....	
.....	
Car No.	Initials.....
To be shopped for.....	
.....	
.....	
(Head of Car Department.)	

RULE 126. A car which is safe to run, but unsafe to load on account of serious damage caused by wreck or accident, shall be reported to the owners for appraisal and disposition, and disposed of as provided in Rule 125, if the owner so elects.

RULE 127. In case of cars of private ownership sent home an account of general worn-out condition due to age or decay, such cars shall be entitled to as many miles of homeward movement, free of charge to owners, as they may have been handled over said line under load, and to mileage to be paid to owners by roads handling. If the haul necessary to get cars home is in excess of such loaded mileage, said excess will be billed against the owner at regular freight rates and the owner notified.

RULE 128. Private line cars sent home to owners on account of being wrecked or damaged in accident shall be regularly billed home free of charge to owners and owners notified, providing such homeward movement passes over roads which have handled the cars loaded, previous to their homeward empty movement; otherwise the damaged cars to travel home empty, free of charges and free of mileage according to home route; or, if owners prefer to have them billed home via direct line, then charges to accrue to such line over which cars were not entitled to free movement.

FURNISHING MATERIALS.

RULE 129. Companies shall promptly furnish to each other, upon requisition, and forward free over their own road, material for repairs of their cars injured upon foreign lines that can not be procured in open market. Requisition for such material shall state that it is for

repairs of cars, and shall give the number and lettering of such cars and pattern number of castings required when possible.

CONDITIONS OF ACCEPTANCE OF THIS CODE.

RULE 130. Any car owner or railway company may become a party to this Code of Rules by giving notice through one of its general officers to the Secretary of the Master Car Builders' Association.

Railroad companies becoming subscribers to this Code of Rules must have a representative member in the Master Car Builders' Association.

RULE 131. Any car owner or railway company that is a party to this Code of Rules shall be bound by same through its successive revisions, until one of its general officers files with the Secretary of the Master Car Builders' Association its notification of withdrawal.

RULE 132. Acceptance or rejection of this Code of Rules must be as a whole, and no exception to an individual rule or rules shall be valid.

SETTLEMENT OF DISPUTES.

RULE 133. In order to settle disputes arising under the rules, and to facilitate the revision of the rules at the annual conventions of the Association, an Arbitration Committee of five representative members shall be appointed annually by the Executive Committee; three members of this committee to constitute a quorum.

In case of any dispute or question arising under the rules between the subscribers to said rules, the same may be submitted to this committee through the secretary,

in abstract, jointly, said abstract setting forth the point or points at issue, and each party's interpretation of the rules upon which its claim is based, clearly and concisely, not exceeding three typewritten pages of letter size, single space, which shall be signed by both parties to the dispute. Should one of the parties refuse or fail to furnish the necessary information, the committee shall use its judgment as to whether, with the information furnished, it can properly give its opinion. The decisions of the committee shall be final and binding upon the parties concerned. This committee shall report its decisions to the Association, and its report shall be incorporated in the annual report of proceedings of the Association.

CODE OF RULES

GOVERNING THE CONDITION OF, AND REPAIRS TO, PASSENGER EQUIPMENT CARS IN INTERCHANGE.

1. Each Railway shall give to foreign cars, while on its line, *the same care and attention that it gives its own cars*, except in case of cars on which work is done under special agreement existing between the company owning the cars and the Road operating the same.

2. The expenses of maintenance of Passenger Equipment operated in interchange or line service, shall be divided into three classes, namely:

- (a) Owner's defects.
- (b) Delivering Company's defects.
- (c) Line expenses proratable against the roads comprising the lines on a mileage basis.

3. (a) Owner's defects are those due to ordinary wear and tear.

(b) Delivering company's defects are those due to unfair usage, derailment or accident. Delivering company is solely responsible to car owners for any improper repairs made by them.

(c) Line expenses shall consist of the expense of terminal cleaning, lubrication (oil, waste, tallow and labor), lighting (oil, wicks, chimneys, burners, shades, gas, candles and broken glass).

4. The railway making the repairs for the defects not proratable against the line is privileged to bill the car owner for these repairs, unless there is evidence to indicate that the damage was occasioned by unfair handling on the part of the delivering company.

5. Information as to mileage made by cars must be furnished promptly on request of owners by railways over which cars are run.

6. (a) Cars shall be thoroughly oiled at terminals.

(b) No charge to be made for lubrication at intermediate points.

7. Only one journal bearing per journal may be charged per trip.

8. No labor charge shall be made for applying brake shoes, journal bearings, hose (air, steam or signal) or for icing, filling lamps, gassing tanks or coaling cars.

9. No credit to be allowed for scrap brake shoes removed.

NOTE—Steel back brake shoes not to be removed if over one-half ($\frac{1}{2}$) inch thick; grey iron shoes not to be removed if over three-quarter ($\frac{3}{4}$) inch thick.

10. Loss of metal from tires of steel-tired wheels, caused by flat sliding, is chargeable to the company on whose road the damage is inflicted.

NOTE—Loss of service metal from steel-tired wheels as a result of sliding to be measured from point where slide begins. One-sixteenth ($\frac{1}{16}$) inch of metal to be allowed for flat spots under two and one-half ($2\frac{1}{2}$) inches long and one-eighth ($\frac{1}{8}$) inch of metal to be allowed for flat spots two and one-half ($2\frac{1}{2}$) to three and one-half ($3\frac{1}{2}$) inches in length, both inclusive.

11. (a) Axles broken under fair usage or having journals one-half ($\frac{1}{2}$) inch or more under the standard for car (except for three and three-quarters by seven ($3\frac{3}{4}$ by 7) which will be condemned at three and one-half ($3\frac{1}{2}$) inches) may be renewed at the expense of the car owner.

(b) Cut journals, axles bent or broken or rendered unsafe by unfair usage, derailment or accident, shall be renewed at the expense of the railway on whose line damage is inflicted.

(c) Where necessary to true up axles in cases of cut journals, where the journal is reduced below the limit as prescribed in Rule 11-a, axle must be changed at the expense of company cutting journal.

Charge for car heating to be 10 cents per day per car.

12. Cars lying at stations for over forty-eight hours, expense of heating to be borne by railway in whose possession cars may be.

13. (a) Brakes must be in perfect working order. Cylinders and triple valves must have been cleaned and oiled within six (6) months, and in case of cars equipped with high speed brakes, triple and high-speed valves must be cleaned every three (3) months and date of last cleaning and oiling stenciled on brake cylinder and triple valve with white paint.

(b) The adjustment of piston travel based on not less than seventy (70) pounds initial pressure must not be less than five (5) inches nor more than eight (8), inches.

DEFECTS IN WHEELS—OWNERS RESPONSIBLE.

14. (a) Loose wheels.

(b) Variation from gauge if less than 4 feet $5\frac{1}{4}$ inches inside of wheel at flange, or, if more than 4 feet $6\frac{3}{4}$ inches outside of flange or less than 5 feet 4 inches outside of tread.

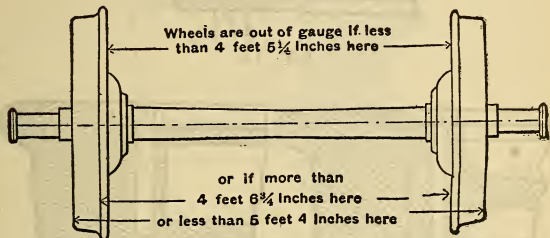

Fig. 10.

WHEELS—CAST-IRON.

15. (a) Shelled out; wheels with defective treads on account of pieces shelling out; if the spots are over one (1) inch or so numerous as to endanger the safety of the wheel.

(b) Tread worn hollow; if tread is worn hollow $\frac{1}{8}$ inch or over.

(c) Worn flanges; flanges having flat vertical surfaces extending more than $\frac{3}{4}$ inch from tread, or, flanges less than $1\frac{1}{8}$ inches thick.

(d) Burst; if wheel is cracked from wheel fit outward by pressure from axle.

(e) Flange, rim, tread, plate brackets or any other part of wheel, either cracked, chipped or broken under fair usage.

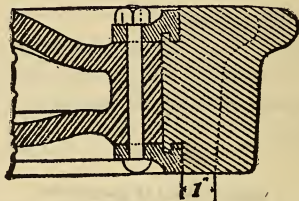

Fig. 11.

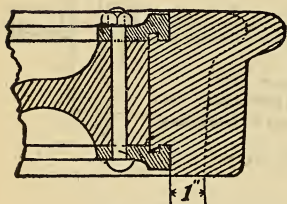

Fig. 12.

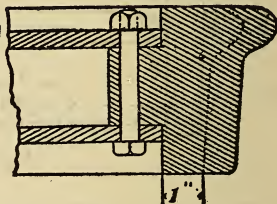

Fig. 13.

WHEELS—STEEL-TIRED.

16. (a) Loose, broken or cracked hubs, plates, bolts, retaining ring or tire, occurring under fair usage.

(b) Worn flange or tire; with flange less than 1 inch thick or having flat vertical spot extending more than $\frac{3}{4}$ inch from tread, or with tire thinner than shown in Figs. 11, 12, 13 and 14.

DELIVERING COMPANY RESPONSIBLE.

17. Flat spots; if flats spots, caused by sliding, exceed one inch in length.

18. (a) If a car is transferred from the service of one railroad to that of another, the receiving road shall issue gas certificate authorizing the delivering road to bill against it for the number of atmospheres of gas and number of holders at the time car was received.

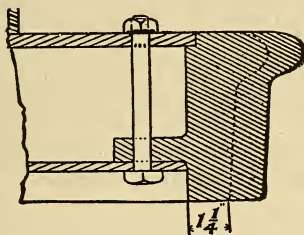

Fig. 14.

(Name of Road.)
GAS CERTIFICATE.

.....
 Car Number..... Initial.....
 Number of Atmospheres.....
 Number of Holders.....
 Size of Holders.....
Station,190..
Inspector.

(b) Cars in interchange requiring holders to be filled, the receiving road shall be charged for the quantity of gas supplied.

(c) For cars stored in shops for repairs the company having car in its possession shall be responsible to the delivering company for the gas in holders. This will apply to sleeping-car companies when cars are in their possession and out of service.

19. The depreciation of all passenger equipment cars due to age shall be 3 per cent per annum, to continue not to exceed 50 per cent of the original value of car body. The depreciation of trucks shall be 3 per cent per annum, to continue not to exceed 50 per cent of the original value. No depreciation shall be allowed on the value of air brakes.

20. This code of rules is understood to apply to all equipment interchanged in passenger trains.

21. Bills for line charges shall be made and rendered monthly and prices for materials and labor shall be in accordance with accompanying schedule.

CATECHISM

OF THE RULES GOVERNING CONDITION AND REPAIRS OF FREIGHT CARS FOR THE INTER- CHANGE OF TRAFFIC.

Q. 1. What are the Master Car Builders' Rules?

A. A code of rules governing the condition of and repairs to freight cars for the interchange of traffic.

Q. 2. What is the object of the M. C. B. Rules?

A. To facilitate the interchange of freight cars, establish responsibility for defects, and uniformity of practice in inspecting and repairing cars in service and in rendering bills for repairs made.

Q. 3. What is the underlying idea or principle of these rules?

A. To make owners of cars responsible for and chargeable with certain repairs to their cars.

Q. 4. Under what conditions do they make the owners responsible for the cost of repairs to their cars?

A. When repairs are rendered necessary by ordinary wear and tear in fair service.

Q. 5. Has this not always been the rule of the M. C. B. code?

A. No, not to the same extent as at present. Prior to September 1, 1896, car owners were not responsible for ordinary wear and tear of all parts of cars, especially bodies, and this led to vexatious delays and numerous disputes as to responsibility.

Q. 6. What has been accomplished by the extension of the principle referred to?

- A. The delivering line (road handling the car) is not now held responsible for defects arising from ordinary wear and tear in handling cars, with the exception of missing material on cars offered in interchange.

Q. 7. When is a company, operating the cars of another company responsible for defects of such cars?

A. When the defects are due to unfair usage, derailment or accident, and further for improper repairs made by it to such cars, and for missing material on cars offered in interchange.

Q. 8. When a company is thus responsible what should it do?

A. It should either make proper repairs at its own expense or issue a defect card covering the defects or improper repairs.

Q. 9. To what does Rule 1 of the M. C. B. code relate?

A. To the care of foreign cars.

Q. 10. What is meant by a foreign car?

A. Any car handled by a railroad in its trains which does not belong to that railroad but to another company or individual.

Q. 11. What care should be given to foreign cars by the company hauling them?

A. The same care in oiling, packing and inspecting that it gives to its own cars.

Q. 12. To what does Rule 2 of the M. C. B. code relate?

A. To the interchanging of freight cars.

Q. 13. What is meant by interchanging cars?

A. Passing them in service from one road to another.

Q. 14. What cars must be accepted in interchange?

A. All cars that are in a safe and serviceable condition.

Q. 15. Who is the judge as to the safe and serviceable condition of cars offered in interchange?

A. The receiving road in all cases not specifically provided for in Rules 3 to 56.

Q. 16. To what do Rules 3 to 56 of the M. C. B. code relate?

A. To instructions for inspectors, and they are of the greatest importance.

Q. 17. To what subjects do these Rules principally relate?

A. To the use of defect cards, to defects of wheels, axles, trucks, brakes and car bodies, and to improper repairs and definitions of unfair usage.

Q. 18. What is a defect card?

A. A card describing certain defects existing in a car at the time of its receipt in interchange. It is $3\frac{1}{2}$ inches by 8 inches, and is printed on both sides in red ink to distinguish it from Repair Cards which are printed in black.

Q. 19. What is printed on the defect card?

A. A standard form of words giving information which identifies the date, the car and the owner and the existing defects and the inspector who issues the card.

Q. 20. Who fills out the defect card?

A. The inspector of the delivering road.

Q. 21. How does he fill it out?

A. By writing in ink or black indelible pencil, on both sides of the card, the number and initials of the car, date, and full description of each item for which charges are authorized, indicating on which end of the car the defects exist. The end of the car upon which the brake

staff is located shall be known as "B" end, and the opposite end shall be known as "A" end. Where there are two brake staffs on same car, the end toward which the cylinder push rod travels shall be known as "B" end.

Q. 22. What is done with the card after it is filled out?

A. It is fastened with four tacks on the outside face of the intermediate sill, between cross-tie timbers on wooden cars and on steel cars to cardboard located either on cross-tie under car or on inside of side sill at the end of car.

Q. 23. Under what conditions would you, as delivering inspector, issue a defect card?

A. When the company which I represent is responsible for the defects for which the card is requested by the receiving inspector.

Q. 24. Under what conditions would you refuse to issue a defect card?

A. If the owner of the car is responsible, under the M. C. B. rules, for the defects.

Q. 25. Is there no exception to this?

A. Yes; missing material is excepted, as provided for in Rules 27 and 41.

Q. 26. Are these the only exceptions?

A. No. Rules 31, 40, 42 and 43 specify other exceptions relating to improper repairs of air brake hose and fittings and M. C. B. couplers.

Q. 27. Under what conditions, then, are you obliged to accept a car which has defects for which the owner is not responsible?

A. I am obliged to accept the car so long as its defects do not render it unsafe to run, unsafe to trainmen

or to any suitable lading, but I can demand that a card describing the defects be securely attached to the car.

Q. 28. What is done in case a defect card is lost or is illegible?

A. A duplicate must be furnished by the road which issued the original card.

Q. 29. What else is treated of in the instructions for Inspectors?

A. Rules 7 to 20 refer to defects of wheels which justify removal. It divides these defects into two classes.

Q. 30. What are the two classes?

A. Defects for which the owner is responsible, and defects for which the delivering company is responsible.

Q. 31. What are the defects of wheels for which owners are responsible?

A. Shelled out¹, Seams², Worn through chill³, Worn flange⁴, Thick flange⁵, Hollow tread⁶, Burst wheel⁷, Broken flange⁸, Broken or chipped rim⁹, Cracked tread¹⁰, Cracked plate¹⁰, Cracked brackets¹⁰, Broken in pieces (under fair usage)¹⁰, and Loose wheels¹¹ or Wheels out of gauge¹¹, and Chipped flange¹².

(See following notes.)

1. Shelled out; wheels with defective treads on account of pieces shelling out, if the spots are over $2\frac{1}{2}$ inches, or are so numerous as to make the wheel unsafe.

2. Seams, one inch long or over at a distance of $\frac{1}{2}$ inch or less from the throat of the flange, or seams three or more inches on any other point of the tread.

3. Worn through chill; when the worn spot exceeds $2\frac{1}{2}$ inches in length. Care must be taken to distinguish the defect from flat spots caused by sliding wheels.

4. Worn flange; wheels under cars less than 80,000 pounds capacity, with flanges having flat vertical surfaces extending more than 1 inch from tread, or flange 1 inch thick or less. Wheels under cars of 80,000 pounds capacity or over with flanges having

flat vertical surfaces extending more than $\frac{7}{8}$ inch from tread, or flange less than 1 1-16 inches thick. (See Figs. 4 and 4a.)

Worn flange: steel and steel-tired wheels with flanges having flat vertical surfaces extending more than one inch from tread, or flange one inch thick or less. (See Figs. 4 and 4a.)

5. Thick flange; flanges over 1 7-16 inches thick. See Figure 2.

6. Tread worn hollow; if the tread is worn sufficiently hollow to render the flange or rim liable to breakage.

7. Burst; if the wheel is cracked from the wheel fit outward, by pressure from the axle.

8. Broken flange; caused by seams, worn through chill, or worn flange. Compare Rule 20, Question 32.

9. Broken or chipped rim; caused by defective casting, if the tread, measured from the flange at a point $\frac{5}{8}$ inch above tread, is less than $3\frac{3}{4}$ inches in width. Compare Rule 20, also see Fig. 5.

10. Cracked tread; cracked plate, one or more cracked brackets, or broken in pieces under fair usage. Compare Rule 20, Question 32.

Steel or steel-tired wheels loose, broken or cracked hubs, plates, bolts, retaining ring or tire under fair usage.

11. Wheels loose or out of gauge. Compare Figure 6.

12. Chipped flange; if the chip is on the outside of the flange and is more than $1\frac{1}{2}$ inches long and $\frac{1}{2}$ inch wide, or if it extends $\frac{1}{8}$ inch past the center of flange.

Q. 32. For what defects is the delivering company responsible?

A. For flat spots caused by sliding, if $2\frac{1}{2}$ inches or more in length, and all defects caused by unfair usage, derailment or accident, also a number of cases named in Rule 20, which reads: Broken flange except as in Rule 14; chipped flange, if chip is on throat side of flange and exceeds $1\frac{1}{2}$ inches in length and $\frac{1}{2}$ inch in width, or if it extends $\frac{1}{8}$ inch past the center of flange; broken rim, if not caused by defective casting; if the tread measured from the flange at a point $\frac{5}{8}$ inch above tread is less than $3\frac{3}{4}$ inches in width (see Fig. 5), or any breakage caused by unfair usage, derailment or accident."

Q. 33. What is the definition of each of the various defects you named before, and where can it be found?

A. Rules 7 to 20 define these defects in the order named and give measurements for determining many of them.

Q. 34. How can you obtain these measurements accurately?

A. By the use of the M. C. B. wheel defect gauge.

Q. 35. Where is description of the gauge to be found?

A. In the Master Car Builders' Rules governing repairs. The wheel defect gauge is shown (Fig. 1), and the flange thickness gauge (Fig. 2), several different applications of the wheel defect gauge are shown. (Figs. 3, 4, 4a and 5.) (See foregoing rules.) The last four cuts illustrate the application of this gauge for determining flat and shelled spots, worn flanges and chipped rims, and make the method of using it perfectly clear.

This gauge also embodies the worn coupler limit dimensions.

Q. 36. How is the proper distance apart of wheels on the axle determined?

A. The diagram in M. C. B. rules shows the proper method of gauging. (See Fig. 6.)

Q. 37. What is the next subject after "Wheels?"

A. Defects of axles which justify renewal. Rules 22 and 23 treat of axle defects for which owners are responsible, and Rule 24 of defects for which the delivering company is responsible.

Q. 38. For what defects in axles are owners responsible?

A. For axles broken or having seamy journals, fillets at the back shoulder worn out, or with collars broken or

worn to $\frac{1}{4}$ -inch or less under fair usage, or axles worn to less than the M. C. B. prescribed limits.

Q. 39. Upon what are these M. C. B. limits based, and what are they?

A. They are based upon the capacity of the car upon the principle that the heavier the load to be carried the larger must be the axle to carry it. The prescribed dimensions are given under Rule 23 of the M. C. B. rules.

Q. 40. What parts of the axle are limited or prescribed by the M. C. B. rules?

A. The center, the wheel seat, and the journal.

Q. 41. How can we tell whether a car is too heavy for its axle or not?

A. All cars interchanged are required to have their light weight and capacity or their light weight and maximum weight stenciled on them and the table of axle dimensions for each capacity or maximum weight of car is given in Rule 23.

Q. 42. For what defects in axles are delivering roads responsible?

A. For cut journals, axles bent or axles rendered unsafe by unfair usage, derailment or accident.

Q. 43. What is the fourth subject treated of under "Instructions for Inspectors."

A. Rules 25 to 28 relate to defects of trucks which justify repairs if owners are responsible, or repairs or carding if delivering company is responsible.

Q. 44. For what defects in trucks are owners responsible?

A. Defective, missing or worn out parts of trucks not elsewhere provided for, which have failed, under fair usage, or if any part of the truck frame or attachments is less than $2\frac{1}{2}$ inches above top of rail.

Q. 45. For what defects in trucks is the delivering road responsible?

A. For all missing material, for journal bearings which require renewal by reason of change of wheels or axles, for which the delivering company is responsible, regardless of the previous condition of the bearings, and for damages of any kind due to unfair usage, derailment or accident.

Q. 46. What is the fifth subject treated of in these "Instructions?"

A. Brake defects which justify repairs.

Q. 47. For what brake defects are owners responsible?

A. Defective, missing and worn-out parts of brakes not elsewhere provided for, which have failed under fair usage except missing material on cars offered in interchange* and cylinders and triple valves when they have not been cleaned and oiled within twelve months.

Q. 48. How can you tell whether the cylinder and triple valve have been oiled within twelve months?

A. The rules require that the date shall be marked with white paint on the cylinder when they are cleaned and oiled.

Q. 49. What parts of the air brake do the rules declare cannot be missing under fair usage?

A. Missing or torn air-brake hose or missing or broken air-brake fittings, angle cocks, cut-out cocks, cylinders and reservoirs, triple valves, release valves and pressure-retaining valves or parts of any of these items, thus placing the responsibility for these on the delivering roads.

*The idea being to punish the delivering road for not having made proper repairs and charging them to the owner.

Q. 50. For what further brake defects are delivering roads responsible?

A. For wooden brake beams on cars intended to be equipped with metal brake beams and so stenciled (see Rule 43, under "Bodies"); and for damage to any part of the brake apparatus caused by unfair usage, derailment or accident, also missing material on cars offered in interchange.

Q. 51. If a car should be equipped with air signal pipes or air brake pipes, but not with air brakes, at whose risk would the hose and couplings be?

A. At the owner's risk unless the car is stenciled as being so equipped, in which case the answer to Question 52 applies.

Q. 52. What is the rule in regard to the use of M. C. B. standard air brake hose?

A. If cars are not so equipped subsequent to March 1, 1908, the car owner is responsible except on cars offered in interchange in which case the delivering road is responsible.

Q. 53. When was it necessary to have all cars equipped with air brakes?

A. On and after September 1, 1907, all cars offered in interchange had to be equipped with air brakes.

Q. 54. What is the sixth subject treated of in "Instructions for Inspectors?"

A. Car bodies and the defects of same which justify repairs or carding.

Q. 55. For what defects to the body of a car are its owners responsible?

A. Locks, side doors, end doors, roof doors, grain doors, and all inside or concealed parts of cars missing or damaged under fair usage, and failure or loss, under

fair usage, of any part of the body of the car except in the cases named in Rule 87 (where only the labor of repairing is charged), and Rule 41. Further, couplers not within the limits of height (see Question 56 and answer thereto), steps, ladders, handholds or running boards in bad order or insecurely fastened, or absence of grab-irons or handholds as required by law.

Q. 56. What does the limit of height of couplers mean?

A. That the distance from the top of the rail to the center line of the coupler shank must not be less than $31\frac{1}{2}$ inches nor more than $34\frac{1}{2}$ inches, for a standard gauge car.

Q. 57. Of what material are handholds or grab-irons to be made, and how secured to car?

A. They must be made of steel or wrought iron and securely fastened with lag screws or bolts.

Q. 58. For what defects in the body of a car is the delivering road responsible?

A. For damage of any kind caused by unfair usage, derailment, or accident. Further, for all missing material on cars offered in interchange (except the locks, grain doors and interior or concealed parts already shown to be chargeable to owners),* M. C. B. couplers not equipped with steel or wrought iron knuckles. Wooden instead of metal brake beams, if car is stenciled for the latter. Further, for M. C. B. couplers, attached by tail pin on cars intended to have pocket attachments and so stenciled, and for uncoupling attachments (release rig) of M. C. B. couplers, if inoperative when offered in interchange; they must be made operative before moving from interchange points.

*See answer to Question 55.

Q. 59. For what defects is the company making the repairs responsible?

A. A company is responsible to the owners for improper repairs.

Q. 60. Are there any exceptions to this rule?

A. Yes; the cases provided for in Rules 33, 42, 43, 44 and 45, which treat respectively of M. C. B. couplers not equipped with steel or wrought iron knuckles; wooden in place of metal brake beams; cars having wrong tail end attachments and for M. C. B. couplers with inoperative release rigging.

Q. 61. When a company is obliged to make improper repairs, what must it do to call attention to such repairs?

A. It must attach an M. C. B. defect card to the car stating the wrong material used.

Q. 62. What is meant by the expressions "unfair usage" or "rough usage," which have occurred in some of the foregoing questions and answers?

A. Such usage of a car as gives rise to damage other than that due to the ordinary and careful handling of the car; usually careless handling and rough shifting.

Q. 63. How can the question be decided as to what is fair and what is unfair usage?

A. The M. C. B. rules give a number of combinations of injuries to a car which in practice are held to show that the car must have received unfair usage. They are fully described in Rules 48 to 56 inclusive. The following graphic table shows at a glance what combinations of injuries constitute unfair usage under the rules.

Q. 64. What instructions come next in the M. C. B. code?

A. Rules 57 to 79 contain instructions to repair men, showing them what repairs to make and what material to use. They are very important rules, and should be carefully studied.

Q. 65. To what does Rule 57 relate?

A. It defines the defects of cars which should be repaired.

UNFAIR USAGE OF CARS.

Damage to one or more parts on left side of each bracket, if accompanied by simultaneous damage to one or more parts on right side of same bracket, is considered unfair usage, and car owners are not responsible.

- RULES
- 48—Coupler..... { Coupler Stop, Filling Block.
Draft Timber or its Substitute.
End Sill.
 - 49—Coupler Pocket..... { Draft Timber or its Substitute.
End Sill.
 - 50—Coupler Stop, Filling Block... { Coupler.
End Sill.
 - 51—Draft Timber or its Substitute. { Coupler Pocket.
End Sill.
 - 52—Coupler. { Coupler.
 - 53—End Sill..... { Coupler Pocket.
Coupler Stop, Filling Block.
Draft Timber or its Substitute.
Longitudinal Sill.
End Sill.
 - 54-55—Longitudinal Sill..... { If necessitating replacement of, or splicing of more than two sills in a car.

56—Damage to Corner and End Posts, if necessitating replacement of, or replacement of more than two end or two corner posts at one end, or more than one end and one corner post at same end of car, is unfair usage.

NOTE—The word "coupler" in the above rules, means the coupler body or knuckle.

" An American continuous draft key shall not enter into a combination of defects denoting unfair usage.

" It will be assumed that a missing coupler and attachments are damaged unless shown to the contrary. This only refers to cases where the coupler, if broken would enter into the combination of defects.

Q. 66. What is the nature of these defects?

A. Any defect in a car which makes it unsafe to run, unsafe for trainmen, or unsafe to any suitable lading.

Q. 67. In making repairs to foreign cars what general principles should be observed?

A. The repairs should be promptly made to prevent unnecessary detention to the cars; the repairs should also conform in detail to the original construction of the car and should be made with the same quality of material as originally used, except as provided for in Rules 59 and 60. Malleable iron, M. C. B. standards, may be substituted for gray iron, M. C. B. standards, but the net cost to car owner in such cases must be no greater than if the original kind and weight of material had been applied. Gray iron, M. C. B. standards, may be substituted in place of malleable, M. C. B. standards, but in such cases the debits and credits must be for what is actually applied and removed. Repair cards and stubs must state kind of material applied and removed.

Q. 68. Suppose it is not possible to procure the same material as originally used, what can be done?

A. The rules provide for certain exceptions which are likely to occur.

Q. 69. What are some of these exceptions?

A. M. C. B. standards may be used when of dimensions that do not impair the strength of the car, in lieu of the parts forming its original construction. When using materials for repairs to foreign cars for which the Master Car Builders' Association has adopted specifications as a standard, the materials must comply with the requirements of these specifications.

In making repairs for which owners are responsible, wheels other than 33-inch may be replaced with 33-inch

wheels, if practicable. If changes are necessary in order to bring the car to the proper height, the cost of so doing shall also be chargeable to the owner.

Couplers other than M. C. B. Standard, may be replaced with M. C. B. couplers in which case the expense may be charged to the owners.

Couplers that exceed the distance of $5\frac{1}{8}$ inches between point of knuckle and guard arm measured perpendicularly to guard arm must be repaired. (See cut shown in Rule 61.)

M. C. B. couplers of a different make may be applied, but when this is done, and the release rigging already on the car is inoperative for the M. C. B. coupler applied, the release rigging must be made operative at the expense of the company applying the coupler.

Q. 70. Is it ever allowable to use second-hand materials in such repairs?

A. Yes, when they are good and serviceable, second-hand M. C. B. couplers, knuckles and metal brake beams and wheels and axles may be used, but if the repairs are chargeable to the owner the repair card and stub must plainly state whether the material is new or second-hand.

Q. 71. When the repair man finds a car of wrong height for couplers, what can he do?

A. He may adjust the height to the standard and charge the expense to the owners.

Q. 72. What is the standard height?

A. $34\frac{1}{2}$ inches when the car is empty, or $31\frac{1}{2}$ inches when loaded.

Q. 73. How is that height measured?

A. From the top of the rails to the center of the coupler shank.

Q. 74. Must the adjustment be exactly to these heights, or is any variation allowed?

A. The adjustment should be as exact as possible, but a total variation of $\frac{1}{4}$ inch is allowed by the rules.* In case of adjusting a loaded car, it should be adjusted as nearly as possible to such a height as will bring it to $34\frac{1}{2}$ inches when unloaded.

Q. 75. May draft timbers be spliced?

A. No; draft timbers should never be spliced.

Q. 76. May sills be spliced or must they be renewed?

A. All longitudinal sills may be spliced once.

Q. 77. How are the splices to be made?

A. Longitudinal sills, other than center sills, when less than 12 inches in depth, the plan shown in Fig. 8 (see code) is to be followed; when the sills are 12 inches or more in depth the plan shown in Fig. 9 (see code) is to be followed.

Q. 78. Where may the splice be located?

A. On either side of the body bolster, but the nearest point of the splice must not be within 12 inches of the bolster.

Q. 79. How are center sills to be spliced?

A. When center sills are spliced the plan shown in Fig. 9a (see code) is to be followed.

Q. 80. Where must the splice in center sills be located?

*Cars should, as far as possible, be adjusted in height when empty; and, in order to justify a bill for this work under the Rules of Interchange, an empty car measuring $31\frac{1}{2}$ inches, or less, should be adjusted to $34\frac{1}{2}$ inches, or within $\frac{1}{4}$ inch thereof; and when it is necessary to alter a loaded car it should be adjusted to $33\frac{1}{2}$ inches, or within $\frac{1}{4}$ inch thereof, or as nearly as possible to such height as will bring it to $34\frac{1}{2}$ inches when the car is unloaded.

A. Between the body bolster and cross-tie timbers and not within 30 inches of either.

Q. 81. May any number of splices be used?

A. No; it is not allowed to splice two adjacent sills at the same end of the car, nor to splice any sill between cross-tie timbers.

Q. 82. How are steel sills to be spliced?

A. Steel sills may be spliced as shown below in Figs. A, B and C. (See Rule 65, code.)

Q. 83. What should the repair man take especial note of in regard to wheels?

A. Wheels on the same axle must be of the same circumference. New wheels must not be mated with second-hand wheels. Prick-punching of the wheel seat is not allowed, nor shimming the axle to make the wheel fit.

Q. 84. How much may be turned off from a foreign axle to fit a wheel to it?

A. On the wheel seat not more than 1-16 inch may be turned off to fit the wheel, and they must never be reduced below the figures given in Rule 23, which range from $6\frac{3}{4}$ inches for a 100,000-pound car, to $4\frac{1}{4}$ inches for a 30,000-pound car, for the wheel seat.

Q. 85. Who is responsible for repairs made with wrong material?

A. The company repairing foreign cars with wrong material and not in compliance with Rules 57 to 71, is liable to the owners of the car for the cost of changing the car back to the original standard or to the requirements of this rule.

Q. 86. Is there any exception to this rule of responsibility?

A. Yes; one. If the car is not stenciled with its ca-

capacity, and the company making the repairs applies an axle smaller than the one designated in Rule 23, for the capacity of the car, it cannot be held responsible for improper repairs.

Q. 87. What is the rule about replacing air-brake hose?

A. In replacing air-brake hose on foreign cars, for which bills are made, new hose must be used. Air-brake hose applied to foreign cars shall be considered wrong repairs unless they are made in accordance with the M. C. B. specifications and are so labeled.

Q. 88. If a railroad company finds a foreign car on its line with wrong weight stenciled on it, should the car be reweighed?

A. If the weight of a car is found to vary more than 500 pounds from the light weight stenciled on the car a railroad company having the car in its possession may weigh and restencil the car, making a charge for each car weighed and so reported. The railroad company making the bill shall notify the owner, giving the date and point at which the reweighing was done.

Q. 89. Are there any other occasions when foreign cars should be weighed?

A. Yes. Cars undergoing extraordinary repairs, such as sills, resheathing, roofing, etc., must be reweighed and restenciled by the company having the car in its possession, at its own expense, and the owner notified.

Q. 90. What is the rule in regard to applying second-hand axles?

A. When second-hand axles are applied under conditions which make them chargeable to the owners, the diameters of the wheel seats and center must not be less than, and the diameter of the journal must be $\frac{1}{8}$ inch

greater than the limiting diameters given in Rule 23. If cars are marked with the word "Capacity," the first set of limits must be followed. If cars are marked "Maximum Weight," the second set of limits must be followed.

Q. 91. How are switch chains handled at interchange points?

A. When two or more cars chained together, or any cars which require switch chains to handle them, are delivered at an interchange point, the receiving road shall deliver to the delivering road at the time, an equivalent number of switch chains of the same size as the chains so used on the cars delivered, or, in lieu thereof, furnish a defect card for such chains.

Q. 92. What is a repair card?

A. It is a card $3\frac{1}{2}$ inches by 8 inches, with duplicate stubs $3\frac{1}{2}$ by 4 inches, printed on both sides in black ink. (See diagram, Rule 77, code.)

Q. 93. Are these the same cards as those described in Rule 3?

A. No; they are entirely different and for a different purpose. The card described in Rule 3 is called an M. C. B. Defect Card, and the one we are now speaking of is called an M. C. B. Repair Card.

Q. 94. How are these cards used?

A. When repairs of any kind are made to foreign cars, a repair card is securely attached to the outside face of intermediate sill between cross-tie timbers on wooden cars and on steel cars to cardboard located either on cross-tie under car or on inside of side sill at the end of car.

Q. 95. How must the card be filled?

A. In ink or black indelible pencil.

Q. 96. What must this repair card show?

A. It must fully specify all of the repairs which have been made, and the reason for making them, and must give the date and place of making the repairs and the name of the road making them, also show location of parts repaired or renewed. The end of car on which brake staff is located shall be known as "B" end, and the opposite end as "A" end. Where there are two brake staffs on the car, the end toward which the cylinder push rod travels shall be known as "B" end.

Q. 97. What is the purpose of the repair card?

A. To show where the repairs were made so that responsibility for improper repairs, if any, can be placed.

Q. 98. If the car owners find repairs improperly made what is done?

A. They make claim on authority of joint evidence against the road which made the wrong repairs.

Q. 99. What is "joint evidence"?

A. The evidence of a joint inspector or the joint evidence of two persons, one representing the owner of a car, and the other representing the delivering road, that the repairs are not proper, shall be final. A joint evidence card shall be used for this purpose. The end of the car on which the brake staff is located shall be known as "B" end, and the opposite end as "A" end. Where there are two brake staffs on the car, the end toward which the cylinder push rod travels shall be known as "B" end. This card shall be of the form shown in code Rule 85.

Q. 100. If the repair card goes away with the car, what record has the repair man?

A. The repair card is provided with duplicate stubs, which must be filled out with an entry duplicating all the information on the card.

Q. 101. What is finally done with these stubs?

A. One stub is kept by the company issuing the card, as a permanent record, and the other is forwarded with the bill for repairs, and is used as a check on the charges.

Q. 102. If no bill is to be rendered, what is done with the stub?

A. In this case it must be forwarded to the owner on or before the 20th day of each month and the words "no bill" written across the face. When no bill is to be rendered the words "no bill" must be written across the face of the repair card when it is attached to the car.

Q. 103. What special information must be shown on repair cards and stubs?

A. The cards and stubs may state whether solid or filled journal bearings are applied or removed, also length of bearing. In the case of couplers applied and removed, they shall state the make and kind of material in couplers and the size of shank. In the case of knuckles, they must state whether open or closed knuckles are removed and applied. In the case of brake shoes removed and applied, they shall state the kind of shoe.

Q. 104. If a road makes only part of the repairs which are covered by a defect card, what should be done?

A. Any road making partial repairs of defects on a car which are covered by defect cards, will have the defects repaired, crossed off the original card with ink or indelible pencil and card placed back on car. A copy of the card accompanying the bill with the defects which were not repaired crossed off will be sufficient authority to bill.

Q. 105. What is done in case a repair card is lost or is illegible?

A. A duplicate must be furnished.

Q. 107. What is covered by Rule 85?

A. Joint evidence of wrong repairs which is referred to in Question 99.

Q. 108. To what does Rule 117 refer?

A. To switching roads.

Q. 109. What is a switching road?

A. A corporation doing the major part of its business on a switching charge, and therefore should be held responsible for all damages to cars handled by it, with certain exceptions.

Q. 110. What are these exceptions?

A. Switching roads, according to Rule 115, may render bills against car owners for the following defects repaired by them: Roof lost on account of decay or faulty construction, worn out brasses, broken truck springs, truck transoms, arch bars, draft timber bolts, column bolts, truck hangers, truck transom truss rods, truck bolsters, truck bolster truss rods, oil boxes, spring planks, truck hanger pins, side bearings and center plates, center plate bolts, center pins, followers, American continuous rods, or keys, draft springs, couplers, knuckles and drawbar pockets and rivets, defective wheels as specified in Rules 7 to 18, inclusive, defective axles as described in Rules 22 and 23, cars not within the limits of standard height for couplers, as per Rule 38, safety appliances as prescribed by Rule 39, and grain doors and all inside or concealed parts of bodies of cars missing or damaged under fair usage as prescribed in Rule 37, provided the damage has not been caused by derailment or rough usage.

Q. 111. What should be done if a car is offered by a switching road with new defects of any kind, except those named in Rule 117.

A. A defect card should be demanded from the switching road to cover such defects.

Q. 112. Are switching roads allowed to render bills against owners direct for repairs of any other defects than those named in Rule 117?

A. Yes; but only when the switching road procures joint evidence from the delivering road that such defects existed when the car was delivered to the switching road.

Q. 113. What is the subject of Rule 125?

A. Rule 125 gives instructions for sending home worn out and damaged cars.

Q. 114. What are the instructions?

A. A car unsafe to load on account of general worn out condition, due to age or decay, shall be reported to its owner who must be advised of all existing defects.

Q. 115. Then what is done?

A. If the owner wishes the car sent home, two home route cards are furnished, $3\frac{1}{2}$ by 8 inches, of the form shown in code, Rule 125, which shall be filled out on both sides with ink or indelible pencil and attached to each side of the car.

9. What do the remaining rules cover?

A. Instruction for billing, scale of prices, settlement for cars destroyed, a code of rules for the interchange of short passenger cars, and a list of railroads which have adopted the code.

NOTE: Station Agents, Car Inspectors or others having use for charts showing parts of cars, and other useful information may obtain the same free by addressing, The McConway & Torley Co., Pittsburg, Pa., the original publishers of the foregoing catechism.

TRAIN DISPATCHING BY TELEPHONE.

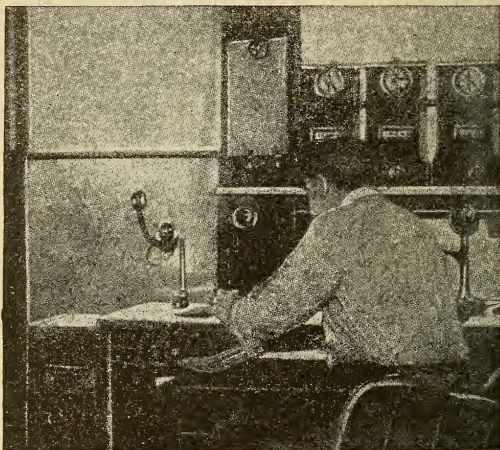

Train Dispatcher's Desk, Showing Selective Signaling Devices and Telephone Sets.

When the use of the telephone for handling trains shall have become universal a new era in railway history will have begun.

The telegraph was a long stride in the right direction. But, to quote the language of a prominent railway official: "Since what can be done with the telephone has

been fully demonstrated, I marvel that we placed such implicit faith in the telegraph for so long a time."

Not only does the telephone render possible the faster, surer and safer handling of trains; but it provides direct communication between the dispatcher and his train or enginemen without any go-between. It also makes provisions for the handling, by experts, of such track blockades as may occur, much more rapidly, and with a world more of satisfaction, than can be had with the telegraph.

It has been readily conceded by everyone that the telephone system using ordinary bells and a system of code ringing is out of the question on a line carrying from fifteen to fifty stations. The continuous ringing of bells would be a serious obstacle to the proper reception of signals and would render careless the operators in charge with the result that it would be as difficult to "raise" operators by the telephone as it has been found to be by telegraph. The use of selective signalling overcomes this difficulty entirely and by the use of a loud ringing bell at the way station secures immediate attention of the operator in charge, if he be within hearing distance, which may be two or three hundred feet from the office. So great an advantage has this proven to be that not only have the calls been reduced to a minimum, but the general efficiency of the service has been materially increased.

There are a number of systems of selective signalling which work satisfactorily for a few stations and there are several systems which have been designed for a considerable number of stations and work to some degree of satisfaction when the line conditions are perfect. The principal defect with these systems is the method of signalling which in most cases is a "step-by-step" method, which is not only slow but uncertain. In stormy weather the

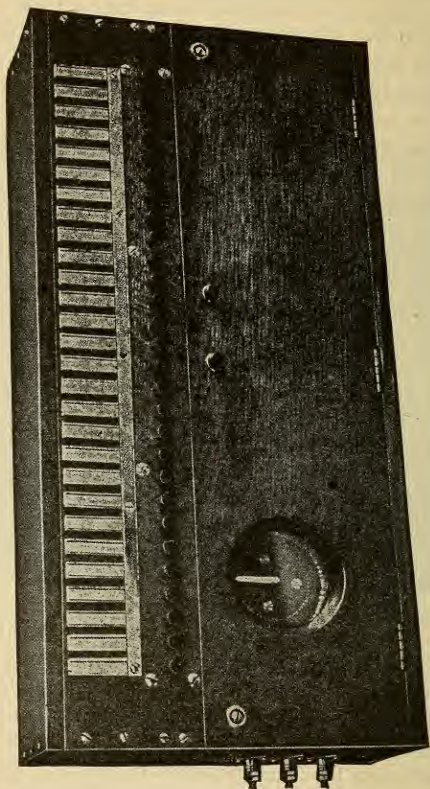

Fig. 14.

electrical discharges break up the chain of signals and consequently it is extremely difficult to reach the desired station. The dispatcher must find an interval of time between lightning flashes sufficiently long for him to operate his "step-by-step" signals, and on a line of considerable length this is no easy matter, as it requires but a very small discharge to place an additional "step" in the signal and as a result the wrong party is called.

With the system which has been adopted by the Burlington Railroad the dispatcher can call any or all stations with a single operation, while with other systems it is necessary for the dispatcher to go through as many operations as there are stations to be called.

The system of selective signalling is of the synchronous type and uses for its synchronous mechanisms standard lever escapement clock movements. On the dispatcher's selector is a dial having fifty-six contact points, each of which may represent a way station, while in a twenty-eight station system the points diametrically opposite are wired in parallel. A brush is arranged to pass over these points on the dial, completing a circuit in series with each station key that has been operated, thus causing current to flow out on the line during the interval of time in which the brush is passing over such points. (Fig. 15.)

The selector keys are arranged in a row in front of the dispatcher, one key being required for each station. Below this row of keys are two other keys, one for starting the clock movements and one for releasing any selector key. This last mentioned key is for the convenience of the dispatcher in releasing any selector key he has operated by mistake and is used only for this purpose, as all keys are automatically released after the party has been called. The arrangement of the keys is shown in the accompanying illustration. (Fig. 14.)

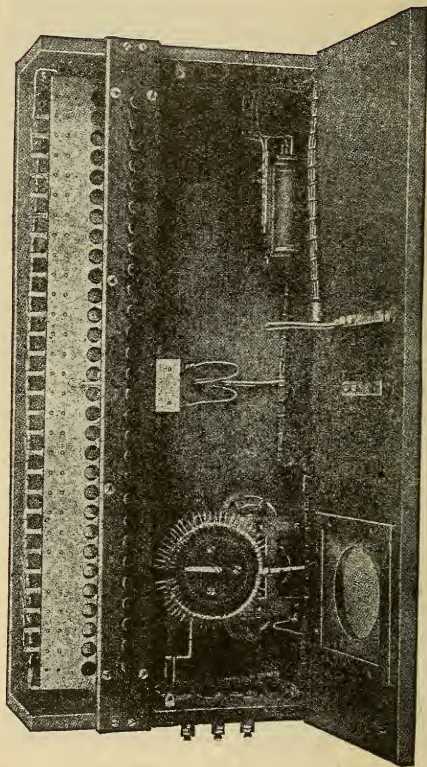

Fig. 15.

The clock mechanism at each way station is equipped with a small commutator having two contacts located diametrically opposite for the twenty-eight station system, while one contact only is required for the fifty-six station system. This commutator revolves as the second hand of of

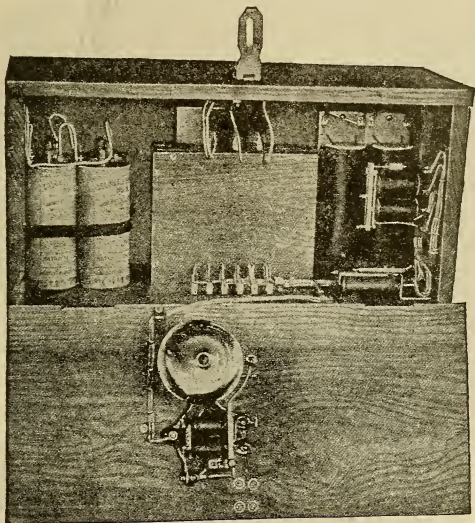

Fig. 16.

a clock and as it brings the contact point under the brush a circuit is completed through a relay, provided the dispatcher has operated the key associated with this particular station. This relay is so wired that when once energized it remains in the operated position until released by the station agent in charge. The operation of

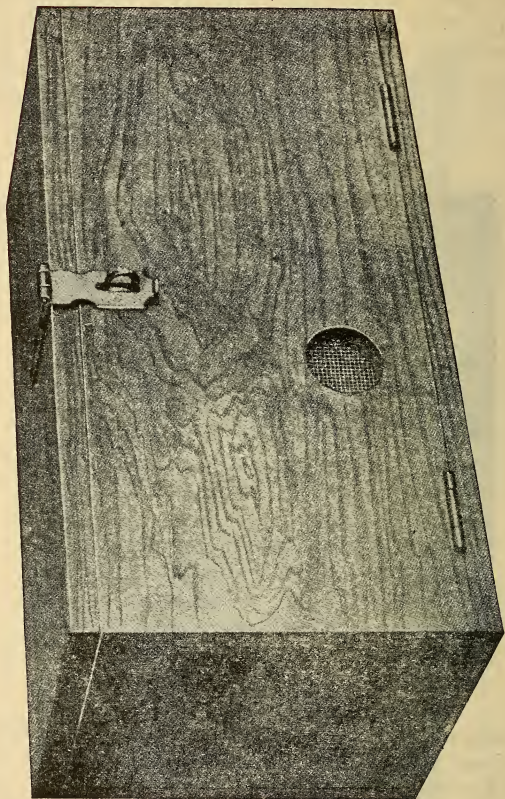

Fig. 17.

the relay completes the bell circuit, which is entirely independent of the line. The bell used in this circuit is of the vibrating type, is provided with a four-inch gong and has sufficient power to be heard for a long distance. (Fig. 18.)

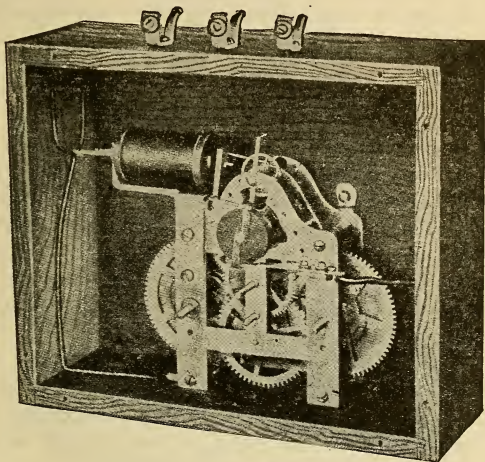

Fig. 18.

Example.—The dispatcher desires to speak with the agent at way station No. 71. He first operates key No. 7 and then presses the starting key which releases all the clock movements in the system, and as the brush passes over contact No. 7 on the dial at the dispatcher's office, the selector at station No. 7 has caused its commutator to revolve so that the contact point has come under the brush; thus the two selectors together complete the necessary circuits at the same instant and conse-

quently the relay is operated, cutting the bell into circuit. This will continue to ring until the attendant answers. Should the dispatcher want a group or even all the station agents on the line at one time he operates such station keys as he desires, presses the starting button and each bell starts to ring in turn as the selector brush passes over the different contact points on the dial.

DISPATCHER'S OFFICE EQUIPMENT.

The equipment for the dispatcher's station consists of (Fig. 19) telephone talking apparatus, together with the necessary apparatus for signalling the various stations along the line. The selector equipment, which consists of the master selector, the selector keys, starting key and the releasing key, magnet and relay are all contained in a neat oak cabinet, which can be placed on the dispatcher's table. (Figs 14 and 15.)

The selector keys are arranged in a row across the front of the box and above each key is placed a small holder in which designation cards with the name of the associated station or any other information can be inserted.

Fig. 15 is a view of the cabinet with the hinged front opened, the top and front strip above the keys removed to expose the working parts. This view gives a good idea of the equipment arrangement.

The dispatcher is provided with a breast plate transmitter and head band receiver (Fig. 19), so as to permit the free use of his hands for writing, operating the selector or any other work he may have. He is expected to have his receiver on his head at all times, when on duty. A transmitter cut-out key is provided, inclosed in a suit-

able box for mounting in a convenient location on the dispatcher's desk. (Fig. 20.) This key is for the use

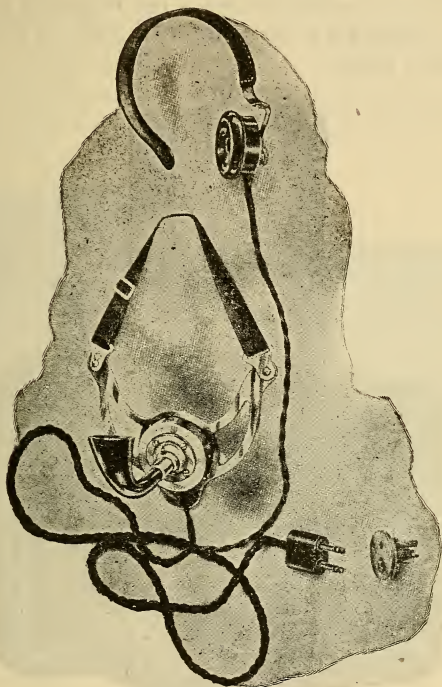

Fig. 19.

of the dispatcher in cutting out his transmitter circuit while receiving, thus eliminating any noises that his transmitter might pick up.

If for any reason the dispatcher takes his receiver from his head he can be signalled, as a hand generator is furnished at each sub-station and a bell is bridged across the two line wires at the dispatcher's desk. In Fig. 21 this bell is shown.

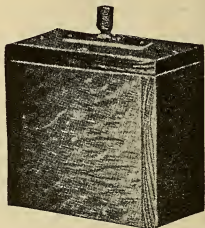

Fig. 20.

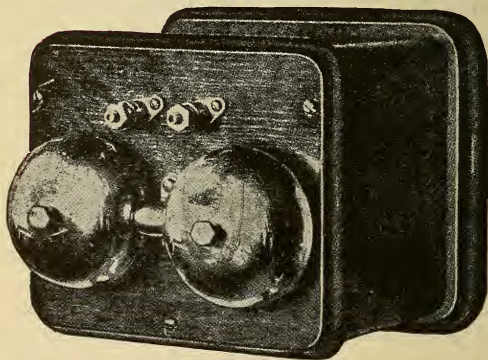

Fig. 21.

The battery equipment necessary at the dispatcher's office consists of 3 sets of cells: The talking battery consisting of five Edison cells (3.5 volts), the battery for

operating the various relays and magnets comprised of ten Edison cells (7 volts), and the battery for signalling the sub-stations consisting of a sufficient number of dry cells to produce from 100 to 200 volts, depending on the length of the line and the number of stations.

The line in entering the office should pass through fuses and carbon lightning arrester so as to protect the station equipment.

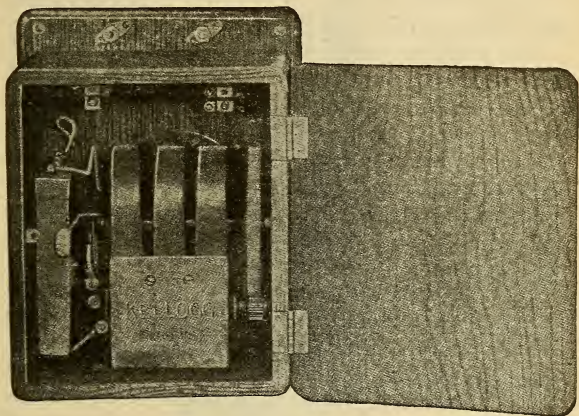

Fig. 22.

SUB-STATION EQUIPMENT.

The equipment required at the different sub-stations is even less complicated than that required at the dispatcher's station. The apparatus for receiving the signals from the dispatcher's office consisting of the selector, relays, bell, retardation coils, condenser and dry battery,

are mounted in a substantial box. (See Figs. 16 and 17.) This box is so arranged as to be locked to prevent anyone from tampering with the signalling equipment. It may be installed under the desk or any out of the way place.

The sub-station selector is contained in a small wooden box with screw terminals on the outside for connecting with the rest of the apparatus.

Four dry cells are used to operate the bell, bell relay and selector starting magnet.

The telephone equipment consists of an oak desk set box, containing the hand generator, induction coil and condenser (Fig. 22), and the "Flexiphone," consisting of a transmitter, head receiver, hookswitch and an adjustable arm. (See Fig. 23.) The desk set box should be mounted in a convenient place on the end of the desk or a nearby wall so that the station agent can readily reach the generator crank for signalling the dispatcher if occasion requires.

The Flexiphone can be mounted on the end or the top of desk or on the wall, as is most convenient. The arm permits its being put in any desired position, either horizontal or vertical, and it remains in the position last placed without being held. With the use of the head receiver this type of telephone permits of the free use of both hands, which is of advantage in taking train orders or doing other work while carrying on a conversation. If the standard type of desk telephone is desired the same will be furnished.

For the use of the trainmen there is a telephone which can be installed in a waiting room. This set is placed in a strong box locked to prevent any but authorized persons from using the same. When a trainman desires to get train orders he opens the box which automatically

connects the 'phone to the line and then speaks to the dispatcher. This telephone is of especial advantage at stations which are closed for a portion of each day, as it enables the dispatcher to make meeting points for trains.

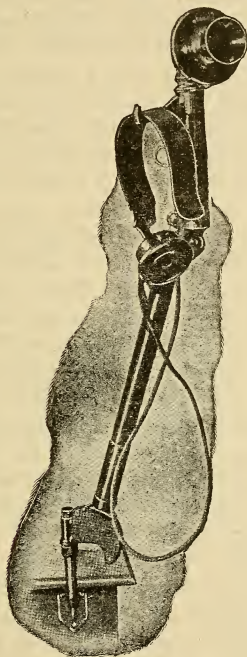

Fig. 23.

The foregoing is a description in general terms, of the system of telephonic train dispatching as installed upon

the Burlington. The following comparative detailed description of the operation of two styles of selective alarms, one on the Burlington, as already described, the other on the New York Central, as well as details of the various uses a railway may make of the telephone, for expediting its business, will doubtless prove instructive.

In describing the tests on the New York Central, the writer* states that after several months' use on a busy main line division, it was never necessary to have recourse to the telegraph, not even when there was trouble on the telephone circuit. He further says:

"The line used is a metallic circuit of 210-lb. copper wire and connection is established with sixteen stations along the section. Special signalling devices are used on this circuit, which enable the dispatcher, located at Albany, to call any one station without calling the others, or while talking to one station he may call another without interfering with the conversation. These selectors are operated by a relay of low impedance connected in series with the line, and are arranged to close a local bell circuit when operated by a combination of electrical impulses sent out over the circuit by the dispatcher. The dispatcher is furnished with a set of automatic calling keys, one for each station on the line, so arranged that the proper combination of impulses will be sent out over the line to operate the various selectors.

"The selecting current, supplied by a grounded battery located at the dispatcher's office, is applied to the neutral point of a bridged impedance coil, and the current is completed to ground at the distance end of the line through another impedance coil similarly connected. In

*Extracts from a copyrighted paper by W. E. Harkness, read before the New York Telephone Society

this way stations can be called while a conversation is being held on the line without interference from the signaling current impulses.

“Further, as has been demonstrated in practice, the stations on one side of the circuit may be signaled in case one side of the line should open, and conversation can even be carried on with the stations with the line in this condition.

“This illustrates one of the great advantages of the telephone over the telegraph—namely, that even though the line may be in trouble, conversation can be carried on over a line which, if used for telegraph, would be entirely out of service.

“The selection of any station is done in about eight seconds, and the local bell circuit closed by the selector remains closed until the operator answers the call by closing a key. The arrangements are such that the dispatcher receives an automatic answer-back signal from the station called. This signal is given by the bell at the station, so that if the answer back is received by the dispatcher there can be no question as to the ringing of the bell at the station.

“The dispatcher is equipped with a chest transmitter and a head telephone. The transmitter circuit is normally open, and his receiver is bridged across the line at all times. In this way he can be reached simultaneously by any operator coming in on the line. A key for closing the transmitter circuit is provided and also one to connect a howler signaling circuit to the line, this latter being used when stations fails to disconnect their sets from the line after finishing their conversation.

“The stations are equipped with special telephone sets, consisting of a special desk arm, to which is secured a

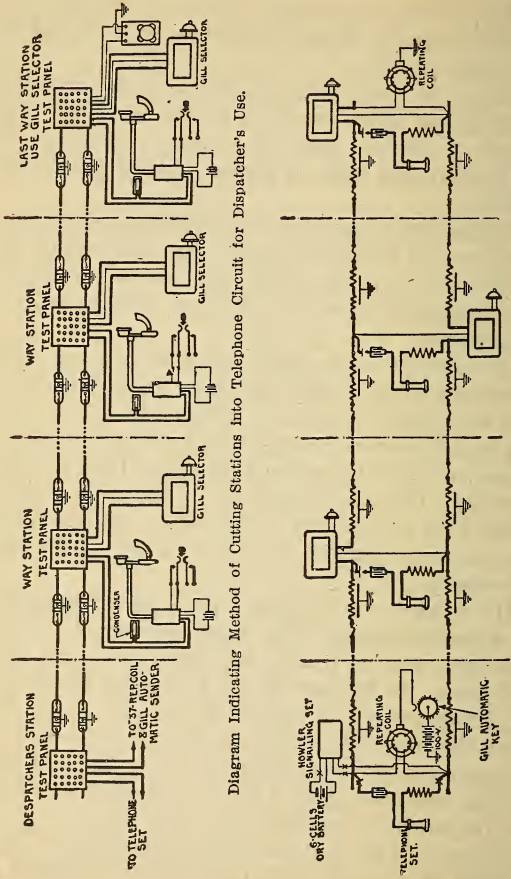
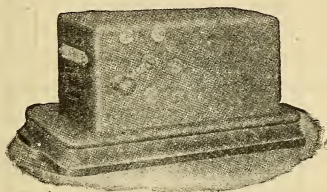

Diagram Indicating Method of Cutting Stations into Telephone Circuit for Dispatcher's Use.

Simplified Telephone Circuit for Dispatcher's Use, Extending Through Several Way Stations. Type Used on New York Central Lines.

special hand set, somewhat similar to the one used by telephone linemen, together with the usual induction coil and batteries. A key for closing the transmitter circuit is also provided. The special equipment was necessary, owing to the fact that the operators in the stations were obliged to attend to the switches and signals, and, to do this properly, should not be obliged to have to bother with a head telephone; further, by having the relative positions of the transmitter and receiver fixed, it was believed that better transmission would be obtained, as the operator is obliged to hold his ear to the receiver to receive his orders, and when in this position he has the transmitter directly in front of him. In issuing orders over this circuit the general rules governing the movement of trains previously given are followed.



Automatic Answer-Back for Telegraph Station.

Fig. 24.

“The dispatcher calls the various stations desired by operating the automatic keys, and as each man answers his call he is told to prepare to take an order. The order is then given by the dispatcher, word by word, and written out by the operators. The dispatcher writes the order, word for word, as he issues it to the operators, and in this way prevents too rapid dictation and ensures

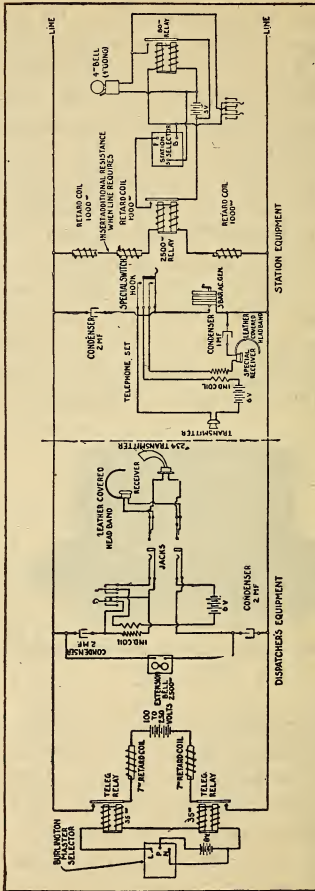

Dispatcher's Telephone Circuit of the Type Used on the Burlington System.

the accuracy of his own record. It is then repeated back by each operator, and as each word is repeated back the dispatcher underscores it in his book. The underscoring is done each time the order is repeated by the different operators, so that if the order is issued to three operators and properly repeated by them each word in the dispatcher's book will be underscored three times.

"It may be well at this point to state that the check on telegraphic train orders is usually done by an operator other than the dispatcher, who copies all the orders as given by the dispatcher and repeated by each operator.

"The New York Central equipment has been subject to careful observation by the operating officials of the road, and it has been found that the trains on the division operated by telephone have been handled with safety, and, in addition, with greater speed than when operated by telegraph. In fact, it has been found that the dispatcher operating this circuit is busy about 55 per cent. of his time, while the other dispatchers handling the same trains on the remaining sections of the same division are kept busy all of the time. This, however, is not the greatest advantage of the system. It has been found that the dispatchers and operators are in closer touch with each other on the telephone circuit and assume more personal relations, and, due to this, more detailed information regarding the movement of trains is transmitted when conversing by telephone than was possible by telegraph. The number of small matters which are called to the attention of the dispatcher affecting the movement of trains can be taken care of instantaneously and instructions issued as quickly as the information is received. If necessary, the conductor of the train or the engineman can be called to the telephone and the details

of existing conditions received at first hand rather than through an operator. It further permits the superintendent of the division, or higher officials, to talk with the man on the ground in case of accident or unusual delay, and issue instructions, if necessary. The telephone circuit has been found to operate under all conditions of weather which ordinarily would interfere with the operation of a telegraph circuit.

"The amount of money which it is possible to save in this way cannot be estimated, but it is greatly in excess of the cost of the telephone line and equipment necessary to accomplish these results.

"The Chicago, Burlington & Quincy Railway installed the telephone for despatching service on its main line between Aurora and Mendota, a distance of 37 miles, and between Aurora and Savannah, a distance of 108 miles—in all about 191 miles.

"The method of wording and issuing the orders on these circuits is practically the same as that used on the New York Central, but the method of selective signaling and the apparatus used are quite different.

"Each station is equipped with a special transmitter arm and head telephone with the necessary induction coil and batteries. A high resistance and high impedance relay is bridged across the line at each station. A selective device, consisting of a clockwork on which is mounted a commutator having two narrow segments, diametrically opposite each other, is also located at the station.

"These segments are connected together and form part of the circuit of a locking relay, controlling the signal bell. The circuit of this locking relay is completed through a brush resting on the surface of the commutator, which momentarily makes contact with one of the

segments during each half revolution of the commutator, and also the contacts of the bridged line relay. The clockwork is prevented from running continuously by a stop, which is electrically controlled. The stop, or starting relay as it may be called, is controlled by the relay bridged across the telephone circuit, and is operated when an impulse of current is sent out over the line by the dispatcher.

“The mechanical arrangements are such that after the clockwork has been released and starts to run, the commutator is permitted to make a half revolution, the continued operation being prevented by a mechanical stop, and the mechanism is again ready for the next call. By this arrangement the direction of rotation of the commutator is always the same, no reversal being necessary to restore it to normal. The half revolution of the commutator is completed in 30 seconds, and, by locating the segments on the commutators at the various stations at different points on the circumference, it is possible to have the local circuit of the various stations closed in successive order, or according to any pre-arranged plan.

“At the dispatcher’s office is installed a master clock, which differs from those at the stations, in that its commutator contains 30 segments on each half, or a total of 60, the ones diametrically opposite being connected in multiple. This commutator is stationary, and contact is established with the segments by means of a revolving brush. The motion of this brush is controlled in the same manner as the commutators at the stations and during a half revolution it makes contact consecutively with each of the 30 segments on the commutator, and then comes to rest and is ready for the next call.

“Each of the thirty segments on the commutator of the

master clock is connected to one contact of an individual key, the other contact of the key being connected to the winding of a local relay, its circuit being completed through the brush of the master clock. When operated, this relay sends an electrical impulse out over the telephone line.

“From this it will be seen that thirty individual keys are provided, one for each station. These keys, when depressed, are mechanically locked, and are arranged so that when the master clock comes to rest after making a call, all of the keys which have been locked are released and restored to normal.

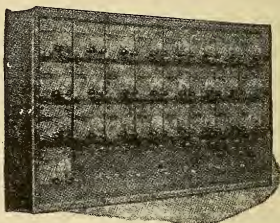

**Train Dispatcher's Automatic Sending Device—Capacity 32 Stations—
Equipped for 25, 7 blanks.**

Fig. 25.

“The dispatcher is also furnished with a starting key, which, when depressed, sends an impulse of current out over the telephone line, and starts the master clock and all of the station clocks, which continue to run for 30 seconds, being then stopped mechanically, as previously mentioned.

“To signal or select a station, the dispatcher depresses the individual key associated with the particular station

desired, and then starts the clocks by pressing the starting key. As the brush on the master clock passes over the segments on the commutator, and when in contact with the one connected to the station key which has been depressed, it completes the circuit of the local relay, sending a second impulse of current out over the line. At the instant this second impulse of current is applied to the line, the brush and segment of the particular station desired are in contact, and the locking relay controlling the signal bell being operated by the bridged-line relay causes the bell to ring, which continues until the relay is released by the station operator pressing a key.

"No 'answer-back' signal is given to the dispatcher, so that he is unable to tell whether or not the signal has been received until the operator answers.

"This arrangement permits of more than one station being called at the same time; in fact it is possible to call all of the stations, if so desired, in the 30 seconds. The average time for an equipment of thirty stations would be 15 seconds, which is greater than that of the system used by the New York Central; and, further, while some stations can be called in 3 or 4 seconds, it will require 26 or 28 seconds to call others.

"The great advantage which is claimed for the system used by the Burlington, is the calling arrangement, which permits one or all of the stations being called in one operation by the dispatcher. It is believed, however, that this is not as important as one would imagine, as it is seldom necessary to call all of the stations, three or four being the usual number, and as it takes from 1 to 5 minutes to raise a single station by telegraph, and since, with a selective device, it is possible to call, say, three stations in 24 seconds, it is so great an improve-

ment over the old method that a further gain of 4 or more seconds is not of any great importance.

"The multiple calling has a further disadvantage in that two or more operators are liable to come in on the circuit at the same time, and break in on the conversation and cause confusion similar to that produced by telephone operators breaking in on a call circuit; in straightening out a situation of this kind, more time is lost than is gained by calling several stations at the same time.

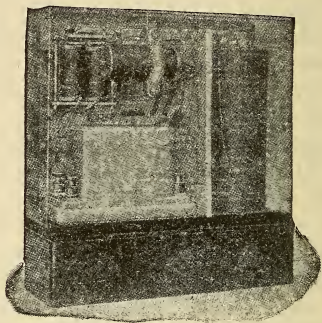

lector Box with Answer-Back for Telephone Station.

Fig. 26.

"The New York Central system, taking 8 seconds for calling each station, permits the dispatcher to call one station, and while instructing the operator at the first station to prepare to take an order, calls the second station, and while instructing the second operator, call the third, the whole transaction taking about 24 seconds without confusion.

"So far, all of the telephone apparatus furnished for

dispatching purposes has been special, and the indications are that this will continue for some time to come, as each railway official has ideas of his own which he naturally thinks are the best, and which he will insist on trying.

“In addition to the roads mentioned above as actually despatching by telephone, the many other large roads are installing telephone despatching systems, and expect eventually to operate by this system exclusively.

BLOCK-SIGNAL TELEPHONES.

“A further use of the telephone in connection with the movement of trains is with the operation of block signals. The usual method of communication between block-signal towers is by means of telegraph or bell signals. Some roads are using the telephone for this purpose, and have found it superior to either the telegraph or bell signals, as it enables more detailed information to be passed between the adjacent towers and movements of trains effected, which was not possible under the old systems. In this way the handling of traffic is facilitated and the operating expense caused by delayed trains reduced.

“Of the various railroads, approximately 100 are using block signals, and of these 77 are using the telegraph, 16 the telephone and 10 bell signals. About 8 per cent. of the trackage operated is handled by telephones, 2 per cent. by bell signals, and the remaining 90 per cent. by telegraph. The largest user of the telephone for this purpose is the Atchison, Topeka & Santa Fé, which operates its 1,800 miles of track by telephone exclusively. The Burlington is operating some 1,100 miles, and the Illinois Central about 800 miles of track in the same way.”

SIDING TELEPHONES.

“On many of the Western roads there are sidings located at some distance from the regular stations, and in some cases between stations, where trains must await the passing of other trains. Telephones are located at these sidings in booths or boxes on the poles, and the train crews report their arrival and the passing of other trains to the nearest station and receive instructions governing their movements. This arrangement does away with the opening of many telegraph offices which would otherwise be necessary. Some railroads equip their trains with portable telephone sets, which may be used for this purpose or in cases of accident. In this case connection is established with one of the telephone or composited telegraph lines and the nearest station called.”

TELEPHONES FOR CALLING TRAIN CREWS.

“At large terminals or division headquarters where freight trains are made up, it is necessary to notify the train crews when to report for duty. The usual method of doing this is to send a boy to the residence of each member of the train crew as soon as the leaving time of the train is determined, so as to have them ready to take out the train. The delays to trains occasioned by failure to get this information to the crews promptly occasion a large loss to the railroads, as it frequently happens that some of the members of the crew are found to be sick or cannot be located, and other men must be sent for. To overcome this difficulty, some of the roads are installing telephones in the residences of their crews,

and are calling them by telephone instead of by messenger, in this way getting prompt replies as to whether they can report, and, if not, another man can be quickly called to take the place of the first and thus get the train out on time. A further saving in the labor expense is thus made, as these crews are usually paid by the hour when delays occur."

"At Altoona, Pa.—one of the largest division points of the Pennsylvania Railroad—525 telephones have been installed by the railroad company in the residences of their employees for this purpose. These sets are connected four on a line, and are handled by one operator at the private branch exchange where the lines terminate. This installation does the work of fifteen call boys, and has been found more satisfactory in every way, including greater economy."

TELEPHONE SERVICE FOR ROUNDHOUSES.

"In making up trains it is necessary to provide for notice being given to the motive power department to prepare the necessary locomotives, and when the trains are made up, to send them from the roundhouse to the freight yard or passenger station. This, in many cases, is being done by telephone in place of by telegraph."

WRECKING-TRAIN SERVICE.

"In case of a wreck occurring on a railroad, it is necessary to send out the wrecking train at the earliest possible moment, and to do this the special crew for this train must be assembled quickly. Some roads have con-

structed special lines to the residences of these crews for this purpose exclusively, and in this way are able to assemble a crew and start a train very quickly.

“Portable telephone sets are furnished the wrecking trains, so that connection may be established with telephone circuits along the line, or, if these are not available, with composited telegraph lines, and in this way keep the officials informed as to conditions and receive instructions.”

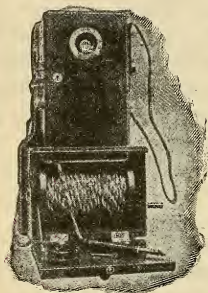

Magneto Portable Car Telephone.

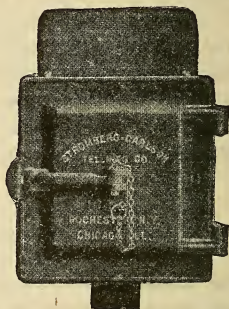

Magneto Iron Clad Telephone.

Fig. 27.

TELEPHONE SERVICE IN FREIGHT YARDS.

“In large freight yards clerks are employed to report the names and numbers of all cars entering or leaving the yards, and a record of the movement of every car is made in the car accountant’s office.

“These yard reports are usually sent to the car accountant in writing, which, of course, requires labor and time, and delays the entries on the records. In some

yards these reports are made by telephone, the yard clerk reading from his memorandum record to the clerk in the car accountant's office, thus permitting records to be made promptly.

"Where perishable freight is being handled, a delay due to cars being held in the yards by mistake, or for repairs, often causes a considerable loss to the railroad. The use of the telephone by the yard clerk or the train master often enables these cars to be moved or repaired promptly, thus preventing the loss and rendering better service to the shipper."

COMPOSITE SERVICE.

"One of the objections raised by the railroads, where an attempt is made to introduce the telephone on their lines, is the expense of the necessary wire plant to meet their requirements. To meet this objection, special telephone sets have been designed, which may be connected to existing telegraph circuits without interfering with the operation of the telegraph, and without the latter interfering to any great extent with the telephone service.

"In this way a fair grade of telephone service can be rendered at a small expense for equipment, and experience has shown that this leads to a demand for better service and equipment.

"The telephone sets and other apparatus used for this railway composite service differ from that used in either magneto or central-battery exchange service. The signaling is done by means of an alternating current of high frequency, generated by a vibrator and induction coil in the set. This induction coil is also used for transmission purposes. The signal-receiving device, or

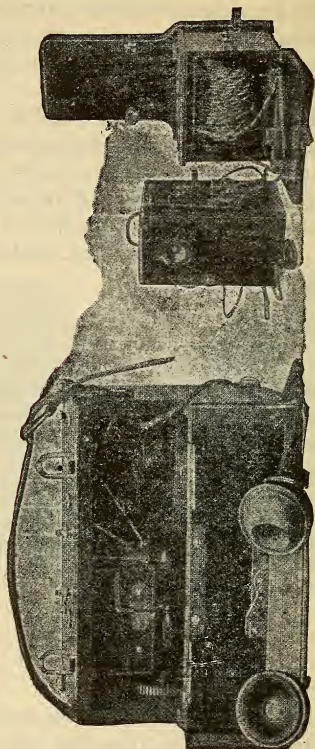

Magneto Car Telephone.

Magneto Lineman's Telephone.

Fig. 28.

howler, as it is called, consists of a special high-resistance telephone receiver, equipped with a resonating horn, to amplify the sound caused by the vibration of the diaphragm responding to the high-frequency signaling current coming over the line from the calling station.

"The intermediate telegraph stations on composited lines are equipped with a special 1 M.F. condenser and a 1,000-ohm non-conductive resistance, the condenser being bridged around the relay and key, so that telephonic transmission will not be interrupted when the telegraph key is operated. It also offers a path of low impedance for the high-frequency signaling current, and prevents the operation of the telegraph relay being affected by this current. The non-inductive resistance is bridged across the terminals of the telegraph relay to prevent the discharge of the condenser or the high-frequency signaling current affecting the operation of the telegraph relay. An impedance coil and condenser are necessary at the terminal telephone stations to reduce the interference from the telegraph impulses.

"The telephone service rendered by these sets, while not equal to that obtained on a straight telephone line, is, in many cases, good enough for the service required and, as stated before, has created a demand for better service, and has led to the construction of metallic telephone circuits.

"There are now several thousand of these sets in use throughout the country, principally in the Middle and Extreme West, where stations are far apart and the cost of constructing telephone lines correspondingly high.

"Two types of sets for this purpose are furnished—a wall set, in general appearance similar to the standard central battery-wall set with writing shelf, and a portable set. This latter is for use on trains, so that communication may be established with the nearest station at any point along the line, the connection with the telegraph line being made by means of a jointed pole, which is carried in the car."

“These portable sets are used extensively by some of the large Western roads, who carry one on every train.

“The length of line over which satisfactory service can be rendered by these sets varies with the kind, size and age of the line wire and the number of intermediate telegraph stations on the circuit. In general, 100 miles of No. 8 iron and 200 miles of No. 12 copper may be taken as the limit of this service.

LONG-DISTANCE SERVICE.

“The use of the railway composite sets has shown the railroad officials the advantage of telephone service between distant points, such as division headquarters and general offices, and in many cases this system is used between such offices. Where distances or the condition of the lines were such as to prevent satisfactory service, regular copper metallic-circuit telephone lines have been constructed. The distances covered in this manner vary from 100 to over 900 miles. For example, the New York Central and the Lake Shore Railways have a through metallic-circuit line from New York to Chicago. This line is used in sections between main points, as, for instance, New York and Albany, Albany and Buffalo, Buffalo and Cleveland, etc., for service between division offices, and is connected straight through when a New York-Chicago connection is desired.

“The Illinois Central has a similar line from Chicago to New Orleans, used in the same general way.

“The Pennsylvania lines also have their own long-distance telephone lines between important points.

“The development of this particular service has been confined principally to the larger systems, as the neces-

sity for such service on the smaller systems does not exist, and, further, the expense of constructing and maintaining such lines is considerable, causing an annual charge which would be greatly in excess of obtaining the required service over the lines of the American Telephone & Telegraph Company.

“As a temporary means of securing this long-distance service, many of the roads are compositing their copper duplex or quadruplex wires, and in this way obtaining first-class telephone service at a small expense. The Union Pacific has recently composited two duplex wires for this purpose between Omaha, Neb., and Cheyenne, Wyo., a distance of 500 miles, and is obtaining excellent service. In addition to using this telephone circuit for conversation between officials, messages are being sent over the circuit which were formerly sent by telegraph, operators being located at each end to send and receive messages by telephone. Those messages are written out in the same way as telegrams, and are handled exactly the same way, except as to the method of transmission.”

“The Canadian Pacific has composited a circuit from Montreal to Winnipeg, a distance of 1,430 miles, with intermediate telephone stations at Fort William and North Bay. The Pennsylvania lines are also compositing their duplex and quadruplex circuits to obtain additional telephone facilities. The indications are that this particular branch of railway telephone service will show a marked development during the next few years, and will do much toward the further introduction of the telephone for railway purposes.

SERVICE WITH OTHER ROADS.

"The interchange of business between different roads entering large centers presents a further use of telephone service which has been found of great value.

"In many cases the private branch exchanges of connecting roads are connected with direct trunk lines, which permit of connections being established between the various telephone lines centering at these switchboards. This enables the transfer of cars to be facilitated and irregularities in these transactions to be cleared up in a few minutes which by usual methods would take days and frequently cause delays to shipments and in the case of perishable freight the loss of the shipment.

"The passenger departments also find this service of value, as it enables them to arrange for transportation and berths for their patrons who continue their journey on other lines and to clear up any misunderstandings which may occur, with greater speed than if they were obliged to connect through several exchanges.

OWNERSHIP OF EQUIPMENT.

"One of the problems in connection with railway telephone service which is now receiving the attention of railway officials responsible for this branch of the work, is that of the relative merits of leasing or owning their own telephone equipment.

There are advantages and disadvantages to both schemes, both from the standpoint of the railroad and of the operating telephone company, and no general decision seems possible, as the conditions in each case differ and the effect which the purchase of equipment would

have on the business in general is such as demand a careful consideration of the matter.

"The objections which immediately suggest themselves are, the maintaining of a satisfactory grade of service, and also the use and maintenance of the proper equipment, together with the loss in rentals of the operating company.

"Under present conditions the railroads can obtain at reasonable cost, apparatus of the same kind and quality as that now being leased.

"The larger roads are supervising their service with great care and are, in many cases, maintaining their equipment, in fact there are over 100 private exchange switchboards and nearly 5,300 leased telephone stations which are now being maintained by railroad companies throughout the country and apparently rendering service satisfactory to the telephone companies.

"All of the larger railroads have in their employ capable telephone men, who look after their service and maintain their plant, and those who are planning to extend their telephone systems are inquiring for men with telephone experience.

"Owing to the fact that the requirements of the railroad demand special apparatus, the investment is comparatively high. The maintenance of the apparatus is also higher than that experienced in the average plant, owing to inaccessibility of many of the stations, and the exposure of the apparatus to frequent use and also abuse.

"It is believed that the various new conditions which will arise in connection with the future development of railway telephone service will be met by the operating companies in such a manner as to retain this class of service, and that the next few years will see a development which will greatly exceed that of the past."

POINTS IN FAVOR OF TELEPHONY.

Some of the advantages of train dispatching by telephone are:

The ease and rapidity of handling trains.

Selective signaling of any or all stations.

More detailed information of train movement possible.

Short interval of time to signal stations.

Eliminating of noisy telegraph systems.

Direct connection with trainmen when necessary.

In case of accident to operator, anyone can answer a telephone.

Train dispatcher can issue general orders to all stations at the same time when necessary.

Increase in the safety of train operation.

It is possible to arrange apparatus in superintendent's office so that he can listen to actual work of the dispatchers and operators, and check up any tendency of slackness.

PART II.

TELEGRAPHY



Sam. F. B. Morse

INSTRUCTIONS FOR BEGINNERS.

No duties devolve upon the operator which persons with ordinary ability cannot perform, if they give careful thought and study to the work, which is no more than is expected of anyone who wishes to succeed in any profession of life.

No business or profession can be learned in a day; and telegraphy requires much careful thought and practice, together with untiring application. Do not expect to absorb telegraphy. Great results cannot be expected from little labor. If telegraphy is worth learning at all it is worth learning well. Do not aim to be as good an operator as some person you happen to know, but strive to be a little better; then you will never be looking for a job, as the profession of telegraphy recognizes only ability. Much depends upon getting started well and laying the proper foundation. Never leave a point or lesson until you have completely mastered it and have it thoroughly fixed in your mind; some elementary principles hurried over or neglected will debar one from making the progress anticipated.

There always has been and always will be a great demand for competent operators. Success in life depends upon being ready when the opportunity comes.

LEARNERS' INSTRUMENTS AND HOW TO CONNECT FOR PRACTICE.

The only instruments required for a person to begin the study, are the ordinary Morse Key and Sounder on

the same base or separate, and the battery for generating the electricity. The dry battery will be found very satisfactory for working one instrument for practice. When the instrument is not in use the circuit should be left open as a dry battery soon loses its strength when left on a closed circuit. The circuit closer is often removed from the key when a dry battery is used, as this will avoid any chance of the circuit being left closed when the instrument is not in use. For line work the gravity battery will be found to give better satisfaction because the circuit must be kept closed. The instrument arranged on the same base will be found to have two binding posts to receive the ends of the wires. To connect an instrument of this kind for practice, it should be securely fastened to the table at a position where it can be reached leaving room for the arm to rest upon the table while sending; small holes should be bored opposite the two binding posts for the wires; connect a wire to one of the binding posts of the instrument and the other end to one pole of the battery, from the other pole of the battery connect a wire to the other binding post of the instrument.

If two instruments of this kind are to be connected for line practice, connect a wire to the zinc pole of the first battery thence to one binding post of the first instrument, from the other binding post of the first instrument to one binding post of the second instrument, from the other binding post of the second instrument to the copper pole of the first battery; if more than two batteries are to be used the batteries should be connected running from copper to zinc and zinc to copper, zinc should never be connected to zinc or copper to copper as they will neutralize each other and no circuit be produced.

If the key be separate from the base of the sounder it is better to arrange the key a little to the right-hand side, in such a position that it can be reached while the arm rests on the table in sending; place the sounder at the left-hand side; to receive the wires small holes should be bored opposite the two binding posts of the sounder and for the legs of the key. Connect a wire to one binding post of the sounder, the other end to one pole of the battery, from the other pole of the battery connect a wire

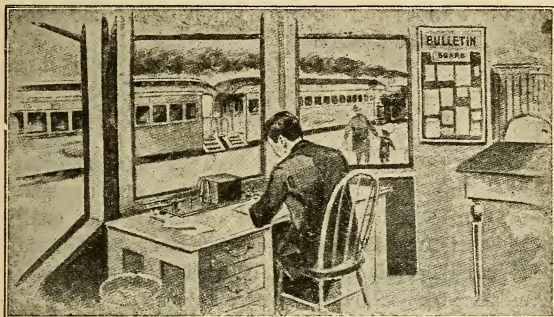

with one leg of the key on the under side of the table between the two washers in order that good connections may be had; from the other leg of the key connect a wire to the other binding post of the sounder.

To connect two separate keys and sounders together for line practice begin by running a wire from one binding post of the first sounder to the copper pole of the first battery, from the zinc pole of the first battery to one leg of the first key, from the other leg of the first key to one binding post of the second sounder, from the other bind-

ing post of the second sounder to the copper pole of the second battery, from the zinc pole of the second battery to one leg of the second key, from the other leg of the second key return the wire to the remaining binding post of the first sounder, this last wire is known as the return wire and will work much better on a short circuit than the ground wire.

Ground wire may be used by connecting the last leg of the second key with the earth, also the remaining binding post of the first sounder with the earth. Explanation of how to fix a ground wire will be found under the heading of "Ground Wire."

THE MORSE ALPHABET.

Morse in the arrangement of his telegraphic alphabet took as a unit of space or length the shortest possible length of time, technically termed a dot. He then made his alphabet, formed from three elements: the dot, the space, and the dash arranged in various combinations representing the following relative values:

The dot	One unit
The break between the elements of a letter....	One unit
The space, employed in the "spaced letters"...	Two units
The space, separating the letters of a word..	Three units
The space separating words.....	Six units
The short dash.....	Three units
The long dash.....	Six units

The student should commit the alphabet to memory without reference to position of other characters, so each can be called to mind at will without hesitation before commencing to practice them; when once the letters are

thoroughly memorized so that the mind has nothing to do but attend to the mechanical movement, learning at the instrument will be found much easier and more rapid.

LETTERS.

a	b	c	d	e	f
..	---	...	---	.	---
g	h	i	j	k	
---	----	---	
l	m	n	o	p	q
---	---	----
r	s	t	u	v	
..	...	-	---	----	
w	x	y	z	&	
----	

NUMERALS.

1	2	3	4	5
----	----	----	----	----
6	7	8	9	0
.....	---	----	----	---

PUNCTUATION, ETC.

period [.]	comma [,]	interrogation [?]
exclamation [!]	paragraph [drop a line]	
colon [:]	colon dash [:-]	
colon quotation [:""]	semi-colon [;]	
hyphen [-]	dash [—]	
beginning quotation [“"]	ending quotation [””]	
apostrophe ['] or quotation within a quotation [“ ‘ ’ ”]		
beginning parenthesis [(]	ending parenthesis [)]	
brackets ([])	capitalized letters	
italics or underline ..- ..-		
dollars [\$]	cents [c]	
decimal point [.]	pound sterling [£]	
shilling mark [/]	pence [d]	

TRANSMISSION.

Transmitting or "sending" is the first requirement necessary for the beginner, and is the art of forming telegraphic signals upon an instrument called a key which being connected with Relay, Sounder and Battery produces sound signals which are arranged in the form of an alphabet enabling us to send communications, one to another, at various distances.

The student should bear in mind that in order to be accurate with his sending is of greater importance than his speed. Take great care that you send slowly at first, striving for a firm, even, smooth style of sending. Speed will come by practice; never to send more than one third faster than you receive is a splendid rule for any beginner, and if strictly adhered to will in time make you a more correct sender than any rule that can be laid down. The customary idea that sending is more easily and more readily learned than receiving is entirely wrong, because a person unless he or she be able to read ordinarily rapid work is unable to be a good judge of sending therefore will not be able to correct their own sending as it should be until after receiving be learned.

The custom of timing for the purpose of finding the rate of speed attained should be seldom indulged in except under the careful direction of his or her instructor, as it is apt to cause the student to become careless in the formation of characters.

POSITION.

Place the two first fingers on the farthest side of the key-button with the thumb under the edge; curve the first and second fingers so as to form a quarter section of

a circle; partially close the third and fourth but not enough to cramp them; never allow them to touch the table. Rest the arm on the table at the elbow; let the grasp upon the key-button be firm but not rigid; while sending never allow the fingers or thumb to leave the key or the elbow to leave the table. Learn to handle the key as easily as you would a pen.

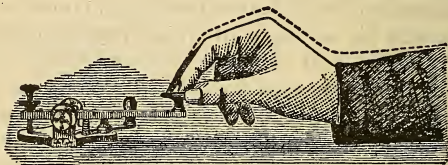

POSITION OF HAND AND MOVEMENT.

Fig 1

MOVEMENT.

The motion should be directly up and down; avoiding all side pressure; it should be made principally at the wrist although the fingers and hand should be perfectly limber; the fingers, hand and arm should move uniformly in the same direction.

Tapping upon the key should be carefully avoided and never try to write with the finger movement alone; the fingers are used merely as a leverage and to hold the key-button.

The downward movement produces the dots and dashes while the upward movement the breaks and spaces. A dot (.) is made by a single instantaneous

downward stroke of the key, while a dash (—) is made by holding the key down as long as it would take to make three dots; a long dash as in the letter L, or the numeral cipher 0 should be made by holding the key down as long as it would take to make five and six dots respectively.

The space is produced by the upward movement of the key and consists of four different lengths which indicate the intervals between the elements of a letter, between the letters of a word, and between the words in a sentence. The first, or break is one unit in length and is the instantaneous interval between the dots and dashes of a letter and is found in every letter and character except E, T, L, O, and the numeral cipher. Second, the space in the space letters which are six in number O, C, R, Y, Z, and the character (&) is given two units in length or equivalent to one dot and break; great care should be given to the correct transmission of the space letters; the letter O should require the same time as the letter S, the letters C and R the same time as the letter H, the letters Y, Z and the character (&) the same time as the letter P. Third, the space between the letters of a word is three units in length or equal to two dots and breaks, an exception to this rule may be made in case of the double E which should be nearly the same as between words. Fourth, the space between words is six units in length or equal to three dots and break.

EXERCISES IN SENDING.

After the student has made careful study of the preceding subject and has a thorough knowledge of the arrangements of the alphabet spacing, correct position, how the wrist is to be used in the movement, the following

exercises should be practiced in their regular order. Much success in sending depends upon these exercises being thoroughly mastered in regular order, as each is the key which unlocks the exercises following, therefore each and every character should be repeated over and over until it can be made at will and without mistake before the next exercise is taken up.

FIRST EXERCISE.

Learn the movement first on dots, make one each second then two and three each second with as much regularity as possible and gradually increase until a speed of 360 per minute can be made with as uniform order as the tick of a watch.

.....

Separate the dots representing the letter E.

.

SECOND EXERCISE.

Learn the movement on dashes by commencing at the rate of about one a second and gradually increase until a speed of about 115 per minute can be made uniform and with ease. Special care should be taken to make the breaks between the dashes as short as possible. If a good, free movement is used the dashes cannot be made too close together. The tendency is to space dashes and great care should be taken to overcome this; remember where there are no spaces, the characters must be made compactly together. Hold the key down the length of

three dots for the ordinary dash or long enough to pronounce the word "seat."

Separate the dashes representing the letters T, L, and the numeral cipher o.

THIRD EXERCISE.

Make a dash closely followed by a dot representing the letter N. This exercise will be found more difficult, be sure that the dash is a dash and the dot a dot and make them compactly together, it might be timed by pronouncing the word NINE-TY holding the dash while the first syllable is pronounced and making the dot when pronouncing the last.

— . — . — . — . — . — . — . — . — .

FOURTH EXERCISE.

Make a dot closely followed by a dash representing the letter A. There is a great tendency to space this character and make the dot too long and the dash too short; watch it closely. It might be timed by pronouncing the word AGAIN making the dot while saying A and the dash while saying GAIN.

— . — . — . — . — . — . — . — . — .

FIFTH EXERCISE.

e	i	s	h	p	6
.
o	c	r	y	z	&
..	... ²

SIXTH EXERCISE.

t	<u>l</u>	m	5	0
-	---	--	---	---
a	u	v	4	
..	
n	d	b	8	
..	

SEVENTH EXERCISE.

f	g	j	k	q
---	---	---	---	---
w	x	1	2	3
---	---	---	---	---
	7		9	
	---		---	

EIGHTH EXERCISE.

period [.]	comma [,]	interrogation [?]
.....	---
exclamation [!]		paragraph [drop a line]
---		---
dollars [\$]	cents [c]	decimal point [.]
.....	...	---

NINTH EXERCISE.

colon [:]	colon dash [:—]
— . . .	—
colon quotation [:“]	semi-colon [;]
—
hyphen [-]	dash [—]
.
beginning quotation [“]	ending quotation [”]
.
apostrophe [’] or quotation within a quotation [“ ‘ ’ ”]	
.	
beginning parenthesis [(]	ending parenthesis [)]
.
brackets [[]]	capitalized letters
.
italics or underline	
pound sterling [£]	shilling mark [/]
.
pence [d]	
. . .	

FORMATION.

The letter j should be formed as tae, k as ta, q as ue, x as ai. The numeral 1 as we, 2 as ui, 3 as ve, 9 as tu. The period as ud, comma as aa, interrogation as tue, beginning quotation as qn, ending quotation as qj, beginning parenthesis as pn, ending parenthesis as pj, brackets

as bx, hyphen as hx, dash as dx, colon as ko, semi-colon as si, colon-dash as kx, colon-quotation as kq, capitalized letters as cx, dollar mark as sx, cents as c, decimal point as tw, italics or underline as ux, apostrophe, or quotation within a quotation, as qx, pound sterling as px, shilling mark as ut, pence as d.

TENTH EXERCISE.

Air, care, thanks, maple, use, keep, injuries, young, frequently, zinc, next, verily, cottage, error, erie, loop, little, practically.

ELEVENTH EXERCISE.

Use a good free movement in this exercise:

Every good student employs every moment of his time.

Be an honest and faithful worker, doing your best and never grumbling.

Firm and smooth sending goes hand in hand, speed comes from practice.

TWELFTH EXERCISE.

A comma or a space is used to divide numerals into hundreds, thousands, etc. The abbreviations hnd, tnd, mln or myn are used for transmitting ciphers; hnd, stands for two ciphers, tnd for three ciphers, and mln or myn for six ciphers. Example: 500 would be transmitted (5hnd); 4,000 (4tnd); 3,000,000 (3mln); 300,000,000 (3hnd mln).

79, 8,610, 23,100, 405,631,000, 900,000, 215,000,647.

THIRTEENTH EXERCISE.

In fractions the letter E or a dot is used for the dividing or fraction line. Example: the fraction $\frac{1}{2}$ would be transmitted I e 2 3-32 as 3 e 32.

1-2, 1-3, 2-5, 7-8, 3-16, 11-12, 10-32, 2 1-2

FOURTEENTH EXERCISE.

The decimal point is transmitted by either using the decimal point character which is formed of the letters TW or by spelling out the word Dot. the word DOT is most commonly used. The dollar mark is SX. Example: \$133.53 would be transmitted SX 133 dot 53.

3-5, 99-4, \$1.23, \$51.46, \$826.98, \$400.10 $\frac{1}{2}$.

HINTS IN SENDING.

In telegraphy, the same as in penmanship a careful and thorough study of the movement should not be slighted; the more attention given the correct position and movement the better and faster will be the gain in sending. Firm, smooth sending should be attained at the expense of time and practice. The great idea among beginners, is that it is an easy matter to learn to send and that to be able to send and receive rapidly is all that is required; hence, they neglect the necessary careful practice which should be employed to gain proficiency in sending, but on the other hand acquire a habit of careless sending which is caused by sending too fast with no regard for uniform spacing or proportion of characters to each other. Some are inclined to put the characters in letters too closely together, which creates

jerky, uneven sending which is not only hard to copy but hard to read, thus we are unable to tell what they are going to make until the last letter of each word is received; on the other hand with good firm, even sending it is possible to tell when "press" is being sent some few words ahead what the sender is going to make.

Uniform spacing is of the greatest importance in making sending easy to read. This applies to the characters in letters, between letters in words and between words in sentences. Remember when there are no spaces in the letters, the dots and dashes should follow each other closely.

A very good rule for a beginner to observe in order to get good spacing between letters in words and words in sentences, is to pronounce each letter after it is made, then the word after you have pronounced the last letter of each word; you will note if you pronounce the last letter of a word after you make it and then the word, you will be giving about twice the space between the words that you do between the letters of the words, which is correct.

Due caution should be exercised in transmitting words which contain either all dot letters or a number of them together. The spaces should be longer than usual between the letters in the following words as well as a great number of similar ones. Be sure and make them slowly and distinctly, as: seen, choice, error, piece, price, voice, bicycle.

A decided distinction should also be made wherever the letter "t" follows the letter "l," or vice versa, as in the following words: title, altogether, little, altitude, battle, alternate.

If an error is made in sending, the interrogation mark

should be made as a "break." If an error is made on the first letter of a word, make the interrogation mark and repeat the word immediately preceding it; if on any other letter of the word, make the interrogation mark and repeat only the word in which the error was made. In case a different word than the one which appears on the copy has been sent make the interrogation mark followed by the abbreviation "msk."

PUNCTUATION.

Punctuation marks are not always sent as they would appear in print or as they should be used. The period is very seldom used except at the beginning of the body of a message or train order. The comma is perhaps most used, and often used in place of the period and conveys several meanings according to where it is placed; take for instance after the two or three lines of the address of a message, it is used and means the same as "Drop a line." The interrogation or question mark is many times used out of place, for instance if an operator miss what is being said to him he uses it meaning "What did you say?" or if he makes a mistake in transmission he uses it as a break, or if he be sending a message and wishes to explain something he uses it there. Punctuation marks should always be sent at nearly twice the rate of the other sending and should be made compactly together as one letter. Punctuation marks are not used after abbreviations or initials, example: Mrs. J. H. Brown, N. Y.

RECEIVING.

After all the letters and characters have been thoroughly memorized so that the student can send readily and correctly, receiving may be then taken up. It is necessary in receiving that another person manipulate the key which operates the sounder; the one receiving should not watch the hand of the sender or the lever of the sounder; let your receiving be done by sound from the very start. The person sending should send slowly and distinctly, the one receiving naming each letter as sent; this practice of calling each letter should be kept up until the speed is so fast that the receiver has not time to pronounce the letters; then the receiving of words may be taken up, pronouncing each word as sent until able to receive from twelve to fifteen words per minute, counting five letters to a word. Then commence the practice of sentences, press, train orders, messages, etc. The student should bear in mind that there is no change in the tone of the sounder, the letter being determined by the time or times the lever is up or down. The sound produced by the upward movement of the lever is as necessary in receiving as the sound produced by the downward movement of the lever, for without it the duration or length of dashes could not be determined. The sound made by the upward movement of the lever is dull and will not confuse the student when he puts his mind on the downward movement for the dots and dashes and the upward movement for the breaks and spaces. To become a good receiver of rapid sending it is necessary that the receiver be able to copy behind the sounder several words; this

will be found quite difficult for the beginner and much time should be employed in dividing attention between receiving and copying, only a letter at a time may be the starter but with unwearied application the student can advance from one letter to several words. The practice of copying five words to each line when copying with a pen or pencil should be commenced early in the work as it will be found very useful when the subject of messages is taken up.

Read the daily papers, markets, etc., and familiarize yourself with every line of business; study the names of different towns and work hard on the spelling of the same, and receiving will become easier.

PENMANSHIP.

The subject of penmanship is not given proper attention by the student of telegraphy. A good, legible business hand-writing is a very desirable accomplishment in any occupation, but nowhere is it more needed than in the telegraph business, because your hand-writing must be handed out to the general public to read, and so we would earnestly request that you waste no time beginning to carefully prepare for this all important part of the work. Upon applying for a position about the first thing asked is "let me see your hand-writing." We would not attempt to lay down any rules in regard to penmanship, only give a few suggestions.

Ornamental styles, and graceful and shaded curves are entirely out of place in the telegraph business. What is needed is to make the letters of the shortest length practicable, without curves where it is possible to retain the general outline of the letter without them.

Hold the pen as close to the paper as possible and use a full muscular movement. Adopt as a standard, one plain simple form for each letter and figure, and always use the same form. It is a customary idea with beginners in telegraphy that to have from three to five different forms for each letter will enable them to gain faster speed; this is wrong as you would have too many forms to learn, "a sort of jack of all trades and a master of none." A medium or small hand is written with more ease and rapidity than a large hand from the fact that the pen can be carried over short spaces in less time than over complicated ones. We sometimes think that good penmanship is a natural gift to some, but all can by patient and studious efforts and careful study of all letters and figures be able in time to write a plain, readable hand.

BATTERY.

The gravity or what is more commonly known as the crow-foot battery is one most generally used for the production of electric current for telegraph purposes; although during the last few years dynamos have been introduced into the production of electricity for the telegraph and to a certain extent have lessened the use of the gravity battery in the larger offices.

The gravity battery consists of a glass jar, a zinc, and a copper plate. The zinc is the positive plate and the copper is the negative plate. It must be remembered that the positive current always moves away from the battery and the negative returns toward it even if we have the circuit grounded. The current starts from the zinc plate (which dissolves or is eaten away) then through the solution to the copper plate and finds its

outlet through the wire which leads from the copper and we have the positive current to the line coming from the copper plate and the negative current returning to the zinc pole of the battery; hence positive means copper to the line and negative zinc.

Battery.

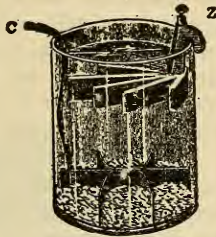

Fig. 2.

The arrangement of the battery is as follows: the leaves of copper are spread and placed at the bottom of the jar and should be nearly covered with blue vitriol; the zinc suspended from the top of the jar and the jar filled with soft water to within an inch from the top; it will require from three to four days for a battery of this nature to work up to full strength, the circuit of course being closed. When a battery is in good working order if the circuit can be left open when not in use, it will strengthen and greatly save the battery.

About every two to four months the zinc and the copper should be taken out and thoroughly washed and cleaned and the clean liquid poured into a clean vessel, and the dirt which has accumulated by the decomposition

of the zinc plate thrown out, and the jar cleaned. Arrange the battery as before, adding more vitriol, and pouring in the clean liquid and enough water to make the battery complete.

CONDUCTORS AND INSULATORS.

Those bodies are commonly called conductors which conduct electricity readily; metals, water, charcoal, and animal bodies. Among the metal conductors; silver, copper and gold are the best; the two former will conduct about five times as well as iron or platinum. The principal conductors used are copper, iron, brass and platinum.

Those bodies are insulators which conduct slowly; glass, sulphur, resin, ice, dry-air, dry-wood, varnish, porcelain, etc., any of these bodies will conduct under certain conditions or when covered with moisture.

MAGNETISM.

Magnetism is that form of electricity which exists in the magnet or load-stone. The electrical action is supposed to travel in circles or lines around bodies which it may traverse. Thus it was discovered if a piece of steel or hard iron be encircled by fine insulated wire and an electric current applied to the wire the iron would become magnetized and remain a magnet, as hard iron or steel when once magnetized will retain its magnetism for a long time; therefore soft cores of iron are always used for electro magnets as soft iron can be magnetized and demagnetized several thousand times a second.

ELECTRO-MAGNET.

The Electro-Magnet consists of two cores of soft iron about the size of an ordinary lead pencil, upon which is wound a great many feet of fine insulated copper wire, each core being wound in the same direction and covered with a casing of polished, vulcanized rubber having heads of the same material, thus making spools of each; and screwed to a flat connecting bar known as the heel piece; both inside ends of the wires are connected together, and the outside ends of the wire are

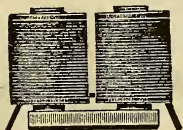

Fig. 3.

connected together and the outside ends connected to the instrument binding posts to receive the wires which conduct the current. When the circuit is closed, the current by passing through the turns of the wire called the "helix of the magnet" causes the soft cores of iron to become magnetized, possessing the power of attracting with considerable force any piece of iron brought near the ends and ceasing when the circuit is open.

THE KEY.

The principal use of the key is to open and close the circuit to produce the dots and dashes. It is a mechanical device manipulated by hand to transmit telegraph

signals. It consists principally of a metallic lever upon a trunnion supported by screws on the elevated sides of a metallic base. Beneath the base are two metallic legs which extend through the table; these legs hold the key firmly to the table and connect with the two ends of the main line wire. The front leg and lip is separated from the base of the key by a non-conducting material which insulates it from the frame, so the current cannot pass through, except when the lever is down or the circuit closer under the lip. On the top and in the

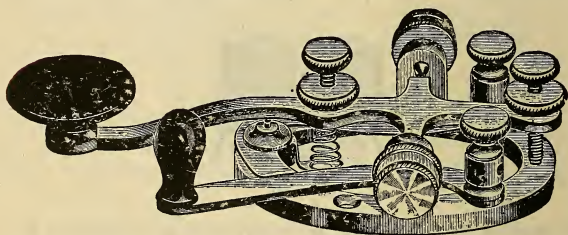

Fig. 4.

center of this is inserted a small piece of platinum; above this on the under side of the metallic lever is another piece of platinum. The spring is arranged to separate the two platinum points, thus opening the circuit. A metallic arm or circuit closer is attached to the base of the key near the second leg, so arranged that it can slide under the lip directly connected with the first leg thus closing the circuit when the key is not in use. To prevent the operator from receiving an electrical shock the finger pieces of both the level and the circuit closer are of non-conducting material.

THE RELAY.

The chief use of the relay is to resist all over-production of current. It has its connections with both main line and local circuits. It consists of an electro-magnet horizontally arranged upon wood and metallic base; the small magnet wires go through the base and connect directly with the main line binding posts. In front of the electro-magnet a metallic armature with a platinum

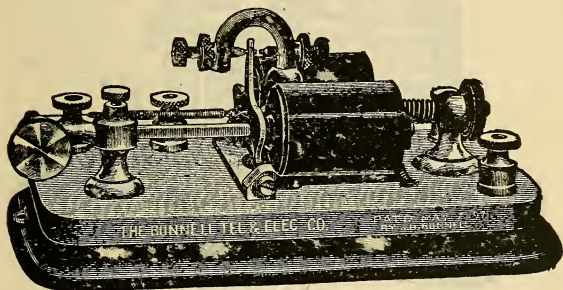

Fig. 5.

point in its lever (connected by a fine wire running through the base to one local binding post) is perpendicularly arranged to work freely by the action of the electric current produced in the magnets, which strikes against a platinum point arranged in the adjusting screw, in the yoke or frame (which is also connected by a fine wire running to the other local binding post) which closes the local circuit through the sounder, which also has its connection with the local binding posts and the battery. One other adjusting screw in the yoke or

frame with an insulated point, governs the play of the levers from the magnets. An adjusting spring is attached to the armature and its purpose is to draw the lever away from the magnets when the magnets are de-magnetized.

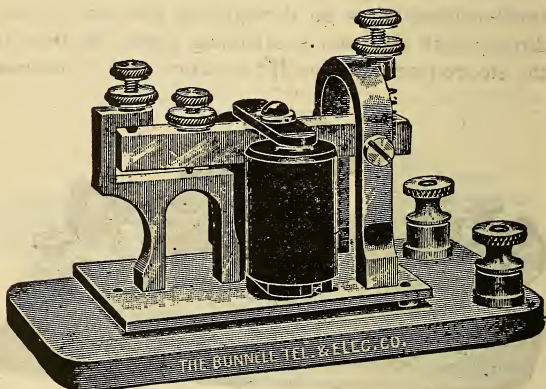

Fig. 6.

THE SOUNDER.

The chief use of the sounder is to aid the receiving operator. It consists of an electro-magnet perpendicularly arranged upon a metallic frame which is securely fastened to a wooden base. The fine wires of the electro-magnet are connected by running through the wood and metallic base to the two binding posts. Directly above the electro-magnet an armature is horizontally arranged upon a lever in a frame to work freely by the action

of the electric current. A spring is used to draw the lever away from the magnet when the circuit is open. There are two adjustable screws, one in the lever which governs the movement toward the magnet; the other in the frame which governs the reverse movement. The sounder is connected with the local circuit only; having its connections attached with the two local binding posts of the relay and the two poles of the local battery.

ADJUSTMENT OF INSTRUMENTS.

THE KEY.

The movement of the key should always be free; that is, do not have the side screws tight enough to bind the lever and not enough of the reverse movement to allow it to play with a side movement. See that the platinum point in the lever strikes the lower point in the front leg squarely on top and keep them free from rust and dirt. The distance between these two points should be equal to the thickness of three to five pieces of ordinary writing paper; this movement being changed by the adjusting screw in the end of the lever, the spring should be strong enough to separate the two platinum points readily but will vary with the person using the key.

THE RELAY.

The relay is the most difficult of the ordinary telegraph instruments to adjust. In most relays the magnet itself can be moved backward and forward thus adjusting its position in front of the armature according to the strength of the current. A strong current requires that the magnet be drawn farther away from the armature and a weak current the reverse. The magnet should never be brought close enough to the armature to prevent the two platinum points striking firmly. It is necessary that the armature be upright and that the two platinum points strike each other

squarely; these points should be kept free from dirt. The play between these points should be from one to three sixteenths of an inch. In wet or damp weather, especially in storms, variations in currents occur when the line is not perfectly insulated, the spring requiring very careful adjustment. It should be tightened enough to draw the armature away from the magnet when the magnet is de-magnetised. The spring adjustment is known as high or low adjustment. A strong current requires a tightening of the spring, or high adjustment, and a weak current the reverse.

THE SOUNDER.

The adjustment of the sounder is similar to that of the relay only the local circuit attached is not subject to change on account of weather and the armature always remains the same distance from the magnets; it should be as close to the magnet as possible without actually touching it. The play of the lever to and from the magnet depends upon the strength of the current attached, a strong current will admit of more play than a weak one, this play however can be too great to give clearness; the spring should be strong enough to draw the lever away from the magnet with all the force possible and still allow the lever to work freely.

THE SWITCH BOARD.

The switch board is a combination of switches adopted to form various combinations of several different circuits. By its use every possible change of circuit or connection can be quickly and easily made, instruments changed

from one wire to another; batteries connected or reversed; loops connected or disconnected and wire-testing operations carried on. It is used in nearly all telegraph offices where there is more than one wire. Probably the switch-board most generally used in this country is the pin plug switch-board. On the front of the pin plug

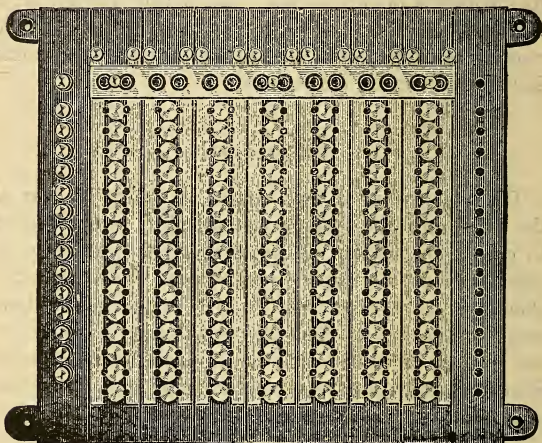

Fig. 7.

switch-board for intermediate offices are two perpendicular bars for each wire. If a wire which runs past our office is to be connected to our switch-board we cut it and bring each end into the office, therefore the need of the two bars for each end of the wire; at the top of these bars are binding posts to receive the ends of the main line wires. Between these bars is a row of discs

which are connected horizontally with each other on the rear of the board by a metallic strap with the exception of the bottom row, each horizontal strap is connected also with a binding post to which is connected the instrument wires. Each disc and each perpendicular bar has a semi-circular hole in its edge so that a metallic plug may be inserted which will connect the perpendicular bar and the horizontal strap on the rear of the board. The ground wire is connected with the top row of discs which are covered by a metallic plate known as the lightning arrester. The lightning arrester and the perpendicular bars have no connection, space enough is allowed for a sheet of writing paper to play freely between them.

GROUND WIRE.

Every office is supplied with a ground wire which consists of a wire attached to a rod driven several feet in the ground, or to a gas or water pipe, the two latter being preferable. The rod of iron should be filed or scraped bright and clean for several inches, and insulated copper wire spliced to five or six feet of bare copper wire wrapped evenly around the brightened part of the rod, then tightly secured and soldered. Only the terminal ground wires are in use upon a line; their use at the intermediate offices is only for testing purposes and in case of interruption of the line to notify the testing operator and receive his instructions. The intermediate stations upon inserting a ground wire divide it into two independent circuits; there must be a main line battery at each terminus in order that the two circuits may work on either side of it.

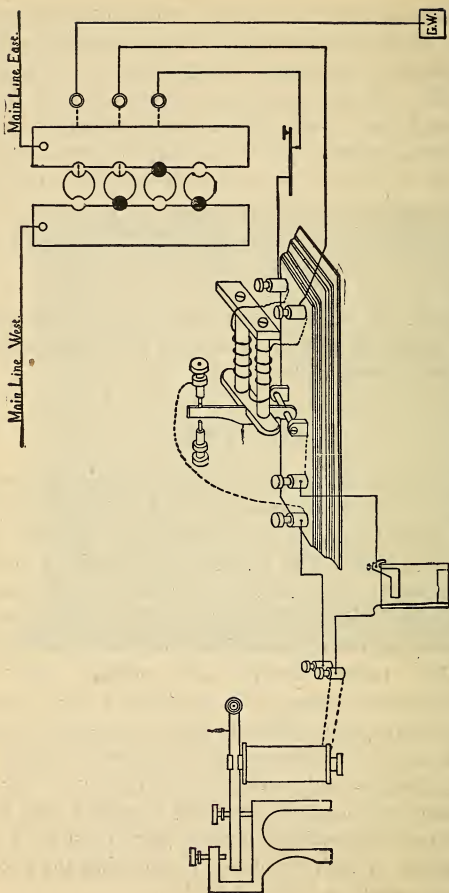

Ground Wire Diagram.

SWITCH BOARD CONNECTIONS.

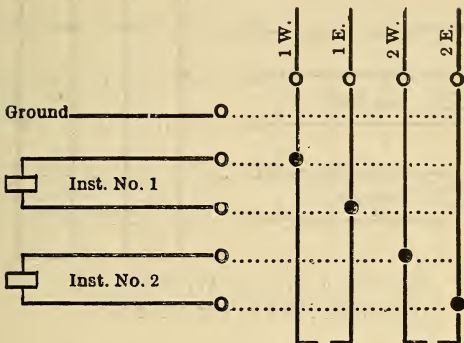

Inst. No. 1 on Line No. 1.

Inst. No. 2 on Line No. 2.

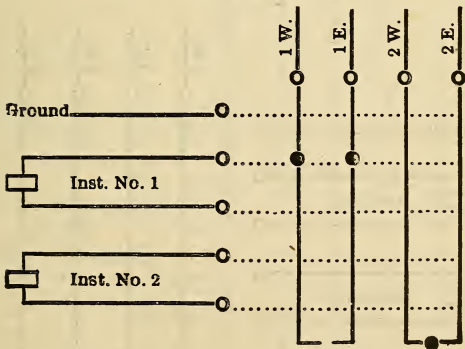

No. 1 cut out with inst. pins.

No. 2 cut out at the bottom.

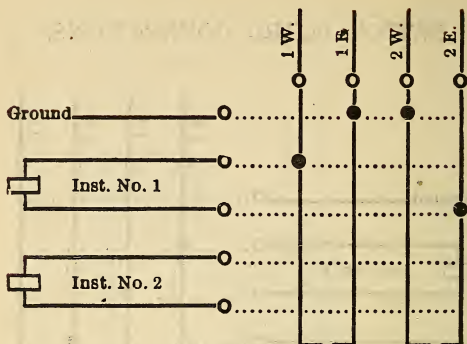

Inst. No. 1 on No. 1 W. to No. 2 E.
Ground on No. 1 E. and No. 2 W

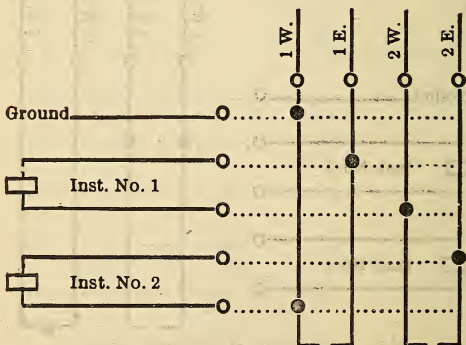

Inst. No. 1 on No. 1 E. to No. 2 W., Ground on No. 1 W.
Inst. No. 2 on No. 2 E. to Ground.

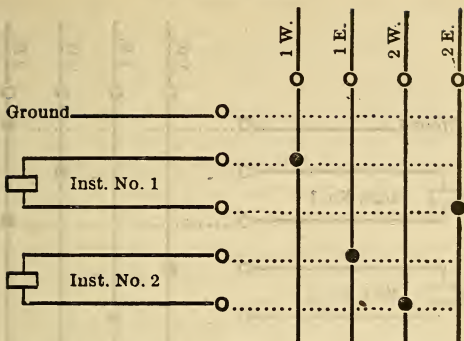

No. 1 W. to No. 2 E., No. 1 E. to No. 2 W.
Insts. on both circuits.

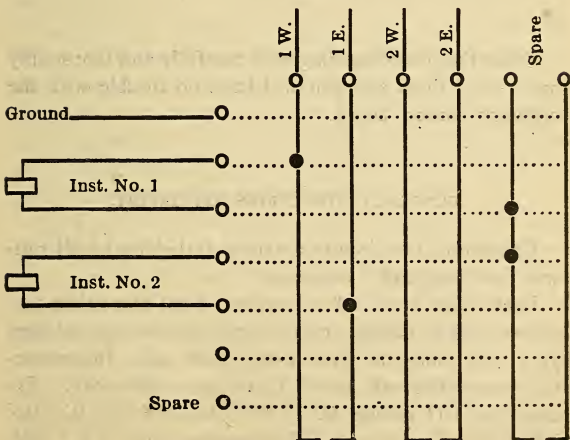

Both Insts. on Line No. 1. No. 2 open at the bottom.

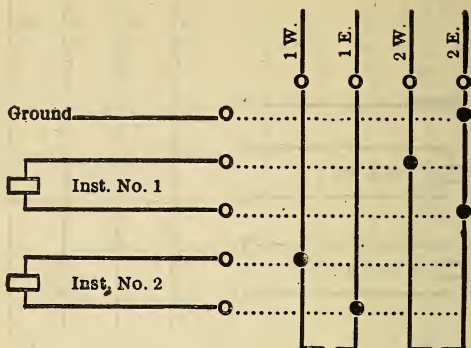

Inst. No. 1 on Line No. 2, Ground on No. 2 E.

Inst. No. 2 on Line No. 1.

Study the preceding diagrams carefully and thoroughly understand them and you will have no trouble with the ordinary station board.

GENERAL INSTRUCTIONS FOR CIRCUIT.

Contention for circuit is strictly forbidden by all railway and telegraph companies.

Each office has a call consisting of not more than two letters, and in calling an office, call continually and sign your own office call after every third call. In answering your office call, say I I and your office call. Example of CH calling BN: BN BN BN CH BN BN BN CH. Example of BN answering call: I I BN. When asked to sign always give your office call.

Each operator will have a personal sign which may consist of one or two letters. Whenever you are asked "wo" always give your PERSONAL SIGN.

Upon hearing the call "OS" sent continually over the wire you will answer giving your office call; it will usually be a message addressed to all Agents, all Operators or some particular class of employees.

If you are receiving at the wire and your instrument fails to work properly you should ask the sending operator to "dot" which he will continue to do until you get adjusted, when you will break in and say "OK" and give the last word received.

If your instrument which is connected with a wire remains quiet for any great length of time, never open your key without first turning your relay adjusting spring high enough to break the local circuit in order to make sure no one else is working your line. If the circuit is found open apply the ground wire to ascertain in which direction from your office the trouble lies, if after careful adjustment no circuit be found, cut in the instrument on another line which is known to be working and if it also opens that line it would indicate the trouble was in your instrument and it should not be cut in on any line until repaired.

If it be found necessary when working on a wire to leave the circuit open for a moment, it is necessary that you make explanation of the matter; if to answer the telephone, say, "ex me fone," if to deliver orders say "ex me trn." The circuit should never be left open longer than a minute in cases of this kind. If you are busy on another wire, or otherwise, and for any reason you cannot answer a call which is given you, you should, if possible, take the time to answer the office

by giving the signal "25" and your office call; it is necessary that you first find out what office is calling you, in order that when you get time you may call it and find out what was wanted, using the signal "5" and your office call.

Whenever you are repeating a message or a train-order and you are told by the sender that a word is an error, you should first open your key, then change your copy and repeat the copy as corrected. If for any reason when you have copied a message you wish to read it over and count the check before giving the OK, you should first open your key and keep it open until you are satisfied it is correct so no one will think you are through and take the circuit from you.

Whenever you are receiving a message and are interrupted by someone breaking in on you who is inclined to be meddlesome or is not adjusted, take the circuit and say "tts nt me" or "tts nt hr ga," adding the last word received, if the trouble continues the sender should make the signal "8" until he believes the person interrupting is adjusted or knows that he is "breaking" someone.

If you are in doubt whether the receiving operator is copying what is being sent him, at the conclusion of some sentence say, "bk u tr?" or "u tr?" If he is receiving what you are sending he will answer by saying "I" and sometimes adding his office call.

In taking the circuit from others you should do so as far as possible between their messages; this will avoid much confusion and error. Offices using the wire when interrupted have the next right to the circuit.

WIRE SIGNALS USED IN TAKING THE CIRCUIT FROM OTHERS.

The word "wire" is used by the wire chief or by operators when given permission by the wire chief or lineman for locating wire trouble, and has preference over all other business on any circuit. The signal "grn" and "stx" may be used for speculative messages. The signal "corn" may be used to make a correction in any message which has already been sent out. The signal "govt" may be used for sending government messages which pertain strictly to the official business of the government. The signal "cable" will be used for sending messages. The last five signals have preference over all other business on any circuit exclusive or train-orders.

NUMERAL WIRE SIGNALS.

There are a few simple sentences which are used so often that figures have been substituted for them and they are used to abbreviate and save time. Some impart special information while others serve to furnish an answer. There is a difference to some extent in their meaning on different lines, but the following are more or less in common use.

1. Wait a minute.
2. Very important.
3. Train reports.
4. Where shall I go ahead?
5. Have you any business for me?
7. Are you ready for business?

8. Close your key; you are breaking.
9. To clear the line for orders and for operators to ask for orders.
12. Do you understand?
13. I, or we, understand.
18. What is the trouble?
19. Train-order.
23. Accident or death message.
25. Busy on another wire.
29. Train dispatcher. Train orders.
30. The end.
31. Train order.
33. Answer paid for.
34. Message for all offices.
55. Important business.
73. Accept my compliments.
92. Deliver quick.
134. Who is at the key?

ABBREVIATIONS.

Abbreviations are used chiefly for wire conversation and are generally made by leaving out the vowels. Some are entirely arbitrary while others are spelled simply by sound. One should not use too many of the arbitrary ones together. The following list will be found quite complete, the student should commit them to memory and practice them upon the wire as soon as possible as they are very important and no good operator can afford to be without them. The conversation on railroads especially is nearly all abbreviated.

A.

abandoned, abnded	answer, ans
about, abt	any, ay
abbreviations, abbn	anything, aytng (or) 5
acknowledge, "x" (used in train orders only.)	April, Apl (or) Apr
account, acct	are, r
action, actn	arrive (or) arrived, "a"
address, ads	ascertain, ascrtn
afternoon, P. M.	assist (or) assistant, asst
agent, agt	Assistant General Freight Agent, A G F A
all right, art	Assistant General Passen- ger Agent, A G P A
always, alwas	attention, attn
amount, amt	attorney, atty
and others, "et al"	August, Aug
annulled, annld.	Avenue, ave
another, ahr (or) anr	

B.

"B" Block (used in block system only)	blanks, blnx
back, bk	block, blk
baggage, bage	board, bd
barrel, brl (or) bbl	body, bdy
battery, baty	book, bk (or) buk
be, b	bought; bot
become (or) became, becm	boulevard, blvd
been, bn	bound, bnd
before, b4	break, brk
better, btr	brakeman, brkmn
between, betwn	building, bldg
bill-lading, "BL"	bushel, bu
black, blk	business, biz
	but, bt
	by, bi

C.

can, cn
 cancel former order, C F O
 cannot, cnt
 cashier, cashr
 cent, ct
 charge, chg
 check, ck
 chief, chf
 circuit, ckt
 clear, clr
 coal and water, C & W
 collect, coll
 collect on delivery, C O D
 combination, combn
 come (or) came, cm
 coming, cmg
 commercial, coml
 Commercial News Department, C N D

commission, comsn
 company, co
 complete, comp (or) "cm"
 compliments, 73
 conductor, condr
 conductor and engineer,
 C & E
 connection, conctn
 copy, cy
 correct, O. K.
 correction, "corn" (used
 only as a wire signal).
 cost, insurance and freight,
 "c if"
 could, cld
 creditor, cr
 crossing, xng

D.

day, da
 day press rate, d p r
 dead head, D H
 debtor, dr
 December, Dec
 decrease, dec
 democrat, dem
 deliver, 92
 delivery, dely

delivery charges guaran-
 teed, dely chgs gtd
 difference, dif
 dinner, dinr
 disregard former service,
 D F S
 district, dist
 division, div (or) divn
 don't, dnt

depart (or) departed, "d"	doubt, dbt
Dispatcher, despr	down, dwn
destroy, bust	dozen, doz
did, dd	draft, dft
double deck, DD	duplicate, dup

E.

east, e	errors and omissions ex-
election, electn	cepted, "e & o e"
empty, em (or) mt	every, evy
engine, eng	excursion, excn
engineer, engr	excuse, ex
enough, enuf	express, ex
errors excepted, ee	extra, exa (or) xtra

F.

favor, fvr	forward, fwd
February, Feb	free on board, F O B
few, fu	freight, frt
for, r	from, fm (or) fr
foreign, forgn	foreman, 4 man

G.

General Baggage Agent, G B A	get, gt
General Freight Agent, G F A	give better address, G B A
General Passenger Agent, G P A	give some address, G S A
	go ahead, G A
	go ahead arrival, G A A
	go ahead departure, G A D

going, gg
 gone, gn
 good, gd
 good afternoon, P M
 good evening, G E
 good morning, G M
 good night, G N
 gossip, "guff"

got, gt
 government, govt
 grain, grn
 great, grt
 ground, gnd
 ground wire, g w
 guaranteed, gtd
 guess, gs

H.

half, hf
 has, hs
 have, hv
 hear, (or) here, hr
 high, hi

how, hw
 hogshead, H H D
 how is, hws
 hundred, hnd
 hundred weight, **cwt**

I.

immediately, immy
 important, impt (or) 55
 increase, inc

instrument, **instmnt**
 invoice, inv

J.

January, Jan
 junction, jct (or) **junc.**

junior, **jr**

K.

knew, nu
 know, no

knows, nos

L.

last month, ult	loads, lds
laugh, ha ha	local, loc
learn, lrn	look, luk
leave, lv	loop, lup
letter, ltr	low, lo
light, lite	limited, ltd

M.

made, md	message, msg
main, mn	messenger, msgr
majority, maj	might, mite
make, mk	mile, mi
manager, mgr	(mill) typewriter
manifold, mfld	million, mln (or) myn
manifest, mfst	minute, min
manufacturer, mfr	mistake, msk (or) bull
manufacturing, mfg	mistaken, mskn
many, mny	Misses, Mrs
March, Mar	Mister, Mr
marked, mkd	months, mos
market, mkt	more, mo (or) mr
matter, mtr	morning, mng (or) A M
May, Ma	much, mch
merchandise, mdse	

N.

namely, viz	never, nvr
near, nr	new, nu
necessary, necy	next month, prox

night, nite—(red)
 night press rate, n p r
 none between, n b
 north, n
 not, nt
 nothing, ntg

November, Nov
 now, nw
 no more, nm
 no such number, N S N
 number, no

O.

obedient, obt
 obtain, obtn
 o'clock, k
 October, Oct
 of, o
 office, ofs
 one hundred, I hnd
 one thousand, I tnd
 O K, correct
 on time, ot

opening, opg
 operator, opr
 opinion, opn
 order, ord
 O S, All offices take notice
 other, otr
 our, r
 "out" (of no account)
 out, ot
 owners' risk, "O R"

P.

package, pkg
 paid, pd
 pair, pr
 passenger, pasgr
 pay, pa
 payment, payt
 people, peo
 pecks, pks
 pink, (rush)]
 pint, pt

please, pls
 pounds, lb
 Post Office, P O
 precinct, prct
 preferred, pfd
 present month, inst
 president, prest (or) pt
 principal, prin
 prohibition, pro

Q.

quick, qk

quotation, qtn (or) tick

R.

railroad, R R

railway, Ry

ready, rdy

rebate, reb

receipts, rects

received, recd

receiving, recg

red, (nite)

refrigerator, refr

release, "rel"

relay, rela

relief, rj

repeat, rept

report, rept

report delivery charges,

rept dely chgs

republican, repn

right, rite

roast, (a great number)

round, rnd

rush, (pink)

S.

said, sd

same, sm

say, sa

second, sec

section, secn

see, c

see former order S F O

see former service, S F S

seen, cn

see your service, S Y S

single deck, S D

sir, sr

slow, slo

some how, smhw

some one, sm I

something, smtng

somewhat, smwt

somewhere, smwr

soon, sun

south, s

speak, spk

special, spl

special delivery guaran-

teed, spl dely gtd

sending, sendg

September, Sept

service, svc	stop for breakfast, sfb
several, svl	stop for dinner, sfd
should, shld	stop for night, sfn
siding, sdg	stop for tea, sft
sight, site,	straight, strate
sign, sine	street, st
signature, sig	superintendent, supt
signed, sined (or) sgd	supper, supr
station, stn (or) sta	suppose, spose
stay, sta	switch, sw
stock, stx (or) stk	system, sys

T.

take, tk	though, tho
talk, tlk	thought, thot
tariff, tf	thousand, tnd
telegraph, tel	through, thru (or) tru
telephone, fone (or) phone	tierce, tc
thanks, tnx	to-day, toda
that, tt	together, togtr
that is, tts (or) "i. e."	tomorrow, tomw
the, t	tonight, tonite
their, tr	took, tuk
them, em	tough, tuf
then, tn	track, trk
there, tr	train, trn
they, ty	transfer, tfr
thing, tng	Traveling Passenger Agt. ,
think, tnk	T P A
this, ts	trouble, tbl
this morning, tsmng (or)	try, tri
ts A M	typewriter, (mill)

U.

unchanged, unchg'd
undelivered, undeld

understand, 13

V.

versus, "vs"

very, vy

W.

was, ws
water, wtr
way, wa
way bill, "W B"
weather, wtr
west, w
wharf, whf
what, wt (or) ?
when, wn
where, wr
while, wile

why, wi
who, wo
will, wi
with, wi
word, wd (or) w
worked, wkd
would, wld
write, rite
wrote, rote
wrong, wng

X.

"X" acknowledge (used in train orders only.)

Y.

yard, yd
yards, yds
yes, es
year, yr
years, yrs
yesterday, estrda

yet, et
you, u
young, ung
your, ur
yes sir, esr

GENERAL RULES AND INSTRUCTIONS FOR TELEGRAPH EMPLOYES.

The telegraph department is under the management of the Superintendent of Telegraph, who will have charge of the telegraph service and other electrical business of the company, including construction and maintenance. The appointment of telegraph operators will be made by the Chief Train Dispatcher, of each division, in his capacity of chief operator. Such appointment must be approved by the Division Superintendent.

The Superintendent of Telegraph will report to and receive his instructions from, the General Superintendent.

CHIEF OPERATOR.

Chief dispatchers acting as chief operators will be intrusted with the ordinary working of the line, testing and changing of circuits, and the direction of operators and repairers in the discharge of their duties. They will report to the Superintendent of Telegraph daily, the state of the weather and the condition of the circuits under their charge, the nature and location of interruptions to the circuits that have existed, or do exist, and what measures have been taken for repairs. They will also report when lines previously reported as in trouble are repaired.

Chief Operators will report any neglect on the part of operators or repairers that may come under their notice, and will at all times, manifest an interest in the successful operation of the wires, and will co-operate

with the Superintendent of Telegraph in securing good working lines.

The night train dispatchers will have charge of the wires on their respective divisions between the hours of 7:00 P. M. and 7:00 A. M., and will assume the duties of the chief operator during that time.

OPERATORS.

Telegraph operators report to and receive instructions pertaining to the business of the railway from the division superintendent or train master, and pertaining to the business of the Telegraph Department from the superintendent of telegraph, and will obey the instructions of the chief train dispatcher of the division.

They are required to be constantly on duty during the hours assigned to them, and must not leave their offices without permission from the Train Dispatcher on duty.

Office hours for operators at stations where there are no night offices are from 7:00 A. M. until relieved by the train dispatcher on duty. Office hours for operators at stations where there are night offices, day operator, from 7:00 A. M. until 7:00 P. M. Operators at such stations are required to come on duty promptly at the regular hour, and remain on duty until relieved by their colleague, or excused by the train dispatcher. At offices where more than one day or night operator are employed, there must be one person on duty at all hours. Day operators must keep the location of their residence posted up inside bill boxes, at stations where there are no night offices, so that trainmen may know where they are to be found.

Operators must not go beyond hearing of their call, nor leave the office without first notifying the train dispatcher and obtaining his permission.

Operators will assist and obey the instructions of the station agent, when it does not interfere with their duties as operators.

There must be no delay in obtaining answers to telegrams. If a reply cannot be had in reasonable time, the sending office must be promptly notified of the reason.

It will be the duty of the agent and operators to see that the train-order signals are kept in good working order and ready for use at all times, and when necessary oil them, using kerosene oil to make them work freely. Should the signal become disabled and out of order, and repairs needed, prompt notice must be sent to the train dispatcher by wire, giving cause of trouble, and stating what material is required for repairs.

Operators are expected to make suggestions and give such information from time to time, as is calculated to improve the service. Should anything occur which does, or is likely to impair the service in any way, it must be reported at once to the Superintendent of Telegraph. Operators will familiarize themselves with the Western Union Book of Rules and obey them.

Operators are required to devote themselves exclusively to the service of the company during business hours; those having other duties to perform in the freight department will not allow such duties to prevent proper attention being given to the telegraph. At offices where there is but one day and night operator, the day operator acts as agent or manager, and is held responsible for all the cash taken in.

Operators are required to be in their offices when trains are due or at their stations and not out on the platform unless the service requires their presence there; they will keep a register of all trains passing their station and the reports from such stations as the train dispatcher may require and report the same promptly to the dispatcher.

They must give public notice upon the bulletin board of the time trains carrying passengers are due, and whether on time or how much late.

All instruments necessary for the use of the telegraph department at each office, will be furnished by the Company, which together with the office furniture and fixtures must be kept clean and in good order. No private instruments will be allowed upon the wires, and no private lines must be connected with any office without the permission of the Superintendent of Telegraph.

Always try to be accommodating, treating all persons with respect, with whom you come in contact. Do not get out of patience if traveling men make what might seem unreasonable requests, or ask a small favor. Be ready at all times to aid feeble or old persons on and off trains, and make yourself of worth to the Company and your services will be rewarded. Remember a good word spoken of you from the traveling public, will soon reach the officials and greatly figure in your chances for promotion.

Do not depend upon any one to do your work for you; or meddle with other employees' business unless your help be requested.

In case of accident, no account or message respecting it, other than regular tariff business, must be sent un-

less to an officer of the Company, signed by an agent, conductor or other authorized person, nor must it be made the subject of conversation or remark over the wire or otherwise. Particulars for the public, or for publication will be furnished only by an officer of the Company, or upon his authority.

Contention for circuit will not be permitted. Any operator who follows this practice will be promptly dismissed. In case of doubt, or when unable to "raise" an office within a reasonable length of time, operators must promptly call upon the Chief Operator or Superintendent of Telegraph for assistance.

Operators must make themselves familiar with their switch-board and cut-outs, so they can connect wires as directed by the testing operator. Always be sure that the testing operator has finished his directions before commencing to connect wires, or to remove ground wire. When directed to cross-connect, open, close or ground a wire, follow directions carefully. When they have been carried out say "now" and always keep an instrument on the wire on which instructions are being given, until communication is restored. Never connect wires vice versa unless directed to do so. Operators must invariably sign their office call when using the line for any purpose whatever.

They will block all trains the required time apart, as provided in the rules, unless otherwise directed, and must keep a full set of signals in good order, and always ready for immediate use, and use them strictly in accordance with the rules and observe the rear of trains and report at once to the superintendent or train master if markers or red lights are not displayed as provided by the rules.

When fixed signals become soiled or faded, operators

will report their condition to the superintendent or train master.

Operators using positive block must not give a train that is blocked a clearance card, unless they are positively sure that the train can proceed.

The day operator will be held responsible for the working condition of the train order signal.

Operators will report the state of the weather in cases of rain, snow, fog or severe storm in their vicinity, day or night, to the train dispatcher.

Where two or more operators are employed, one must always be on duty. Operators going off duty must notify relieving operators of any undelivered orders, relieving operators receipting for them on the face of orders; also notifying relieving operator of any unfinished business.

Operators must not leave their offices before the arrival of an expected train that is due, without permission of the train dispatcher.

They must not leave their office while a train is at the station, unless required by business connected with the train.

When they are given leave of absence, they must before leaving, see that their substitutes are thoroughly acquainted with the duties of the office, the management of the switch-board, instruments, batteries, etc.

Before opening a key, they must adjust the relay, using special care in wet weather, to make sure that the circuit is not in use.

They must in transmitting, write firmly, space carefully and take every precaution to guard against mistakes.

They must use good judgment in working with inex-

perienced operators, and must regulate their speed of transmission to suit the capacity of the receiving operator, to avoid breaking, or possibility of error, and the consequent loss of time.

They must not receive messages to be transmitted free, unless such message pertain to the business of the company, and are signed by an officer, agent, or employe, except answers to such messengers.

They must promptly deliver messages received, consider all messages confidential, and not permit them to be read by any person except those to whom they are addressed, nor make their contents the subject of conversation or remark.

All messages not relating to the business of the company must be paid for, unless otherwise ordered by the proper authority.

They must record in the proper place upon the face of each message received and sent, the time, date, month and year, and the initials of the operator who received and sent it.

No alterations, additions or erasures will be allowed on original messages after transmission, and they will be retained in the files, unless they are called for by the Superintendent or general officer or by Superintendent of Telegraph. If originals are called for, a copy must be left in the files, with a memorandum attached showing the disposition of the original. Railroad messages, after being transmitted, must be carefully filed daily, and preserved for one year, unless otherwise directed.

All telegrams received for delivery to an officer of the company, who may be en route upon the road, must be enclosed in a proper envelope and sealed, and addressed to him before delivery.

Operators should require persons leaving messages at their offices for transmission, to read them aloud before they are accepted.

They must exhibit a courteous disposition at all times, in and about their offices, and over the wire, avoiding unnecessary conversation; be polite to all and prompt in furnishing proper information to those entitled to it. The use of profane, obscene or ungentlemanly language over the wires, or in and about the company's offices, is positively prohibited.

Students must not be allowed to enter or practice in an office without first obtaining permission from the Superintendent of Telegraph. The attention of students must be called to all rules of the company, and particularly to those relating to the privacy of telegrams.

The regular operators will be held responsible for any interruptions that may occur to the line, or delay to business, caused by incompetent or unauthorized persons using the instruments.

THE DOUBLE ORDER SYSTEM.

In the double order system, the dispatcher calls up all offices where orders can soonest be delivered to the train concerned, and sends the order to each at one transmission; the order being worded so that it serves for both trains. This system is considered the most reliable and less liable to error.

Note—Among the points in its favor might be stated that the mental strain upon the dispatcher arising in the single order system where he has to keep several different orders in his mind at the same time, lest he gives different meeting points to different trains, thereby causing

wrecks, is entirely absent in the double order system. In preparing this order the dispatcher cannot possibly give different meeting points, as there is but one message to each train and being sent to both at one sending, each must get the same as the other.

Thus we have several addresses; one for each train concerned which are transmitted in their respective order.

GENERAL INSTRUCTIONS IN TRAIN ORDER WIRE WORK.

Trains are addressed in train orders as follows: "Let HB" be the office call for Hannibal. In addressing an order to 2nd. No. 62 at Hannibal, the following form is used: "To HB C & E 2nd No. 62." For different trains at different stations, substitution is made for the different station office calls in the place of "HB" and the different trains in the place of "2nd. No. 62."

Train orders are numbered in transmitting in succession each day, No. 1 commencing at midnight.

ORDER OF TRANSMISSION.

Order No

Trains addressed to at each station.

Period.

Body.

Signature.

Example of a simple train order as sent on the wire. Letters in the parenthesis () are sent, but not copied by the receiving operator.

(31 copy 3) Order No. 1.

(to) HB C & E No 55

(to) I C & E No 6 (.)

No 55 Eng 286 and No 6 Eng 13 will meet at Callao
instead of Shelbina. (sig) F. W. H.

ACKNOWLEDGMENT OF RECEIPT OF TRAIN ORDERS.

When it is desirable to have the train of inferior right receive its orders and act upon them before the order is completed and delivered to the train of superior right, it is necessary for the dispatcher to receive an acknowledgment (from the operator who has the orders for the train of superior rights) that he will hold the superior train until they get the order before he can allow the train of inferior right to proceed. Example:

No 65

No 66

A.

B.

C.

Let us suppose that No. 65, the inferior train, is now waiting at station "A" and that No. 66, the superior train has not yet arrived at station "C," and they are to meet at station "B." Now if the dispatcher is sure that No. 65, the inferior train, will get a copy of the order, he can allow operator at station "A" to repeat and complete his order first and No. 65 could leave station "A" and proceed to the meeting point, which in case No. 65 was a heavy train, would greatly lessen the cause of delaying No. 66 at the meeting point.

Thus for acknowledging receipt of a train order and assuring the dispatcher, the train addressed will be held until a copy is delivered the form of X ing is used as an abbreviated form.

ORDER OF "X ING."

Form and order No.
 Your office call.
 Train addressed at your station.
 The letter "X."
 Your personal sign.

Example of "Chillicothe" or "HI" office "X ing" Order
 No. 1. "3I No 1 HI C & E No. 6 X Go."

ORDER OF REPEATING.

Form and order No.
 Your office call.
 Train addressed at your station.
 The letter "X."
 Your personal sign.
 Period.
 Body of the order.
 Conductor's signature and his train number.

Example of "Hannibal" or "HB" office repeating
 Order No. 1. "3I No 1 HB C & E No 55 X SN (.)
 No 55 Eng 286 and No 6 Eng 13 will meet at Callao
 instead of Shelbina."

Sig. Johnson condr trn No 55.

HOW TO COPY ORDERS ON THE FORMS.

Let us next make a careful study of the two following forms which are adopted as the standard for copying train orders. On the first "form 31," let us suppose that

time after the letter X..... Opr.....M.
 The dispatcher after giving him OK, would address "HI" as follows: "To HI ga," Operator at "HI" would take the circuit and say, "19 No 10 HI C & E 2nd No 46 X GO," make a period and repeat the body, giving his own name as signature. The dispatcher would then give him complete and the time as follows: "19 No 10 OK & complete 755 P M F. W. H." "To HB ga." Operator at "HI" would write the word complete after the word Made and the time 7:55 PM after the word Timeand his name Gregory, before the wordOpr., and also fill in the spaces X..... Opr.....M., with his initials and the time. Operator at "HV" would then give the circuit as follows: "31 No 10," make a period and repeat the body giving the conductor's name and signature. The dispatcher would then give him complete as follows: "31 No 10 complete 758 PM. F. W. H." Operator at "HB" would write the word Complete in the column headed "Made" and the time in the column headed "Time" and his name in the column headed "Operator." Each operator will fill in the blank places190...., without instructions from the dispatcher.

It must be remembered that No. 31 order cannot be completed until the signature of the conductor, or person addressed is signed to the order, and the same has been transmitted to the dispatcher. Upon repeating back an order, if you have not yet the conductor's signature to send to the dispatcher, you will only receive the OK response and the time, which time goes in the space provided—Repeated.....M. After you have received the conductor's signature to an order, which you have already repeated, you must then get the wire and repeat

MISSOURI
CENTRAL
ROUTE

FORM

19

TRAIN ORDER No. 10

FORM

19

Chicago, Ill., Aug 8th, 1904To C & E 2nd No 46At Chillicothe

STATION.

X GO Opr. 7:55 P M.

Exa 427 West has right of track against
2nd No 46 Eng 928 Hannibal to Callao.

F. W. H.

CONDUCTOR AND ENGINEMAN MUST BOTH HAVE A COPY OF THIS ORDER.

Made Complete time 7:55 P M. Gregory, Opr.

MISSOURI
CENTRAL
ROUTE

FORM

31

TRAIN ORDER No. 10

FORM

31

Chicago, Ill. Aug. 8. 1904.

To C & E Exa 427 West, | At Hannibal STATION.
 X SN Opr. 7:51 P M.

Exa 427 West has right of track against
2nd No 46 Eng 928 Hannibal to Callao.

F. W. H.

CONDUCTOR AND ENGINEMAN MUST BOTH HAVE A COPY OF THIS ORDER.

Repeated at 7:58 P. M.

CONDUCTOR	TRAIN	MADE	TIME	OPERATOR
Jones	427 W	Complete	7:58 P. M.	Seaton

the same to the dispatcher in the following form: "31 Order No 10 sig Jones trn Exa 427 West." The train dispatcher will then give you complete as follows: "31 No 10 complete 758 PM F. W. H."

TRAIN ORDER WIRE WORK.

(As overheard on the wire from start to finish.)

Meaning of the abbreviations used in the following:

"HB"—Office call for Hannibal, "SN"—Operator's personal sign.

"HI"—Office call for Chillicothe. "GO"—Operator's personal sign.

"CU"—Dispatcher's office call. "F. W. H."—Dispatcher's initials.

"Hr—Here 29"—Train dispatcher, train orders. "31 and 19"—Forms of orders."

"Cy—Copy." "U—you." "&—and."

Example of what would be heard go over the wire in the "X" order system as used in the previous order:

(Dspr) Hr 29 HB HB HB 29 CU

(Opr HB) I I HB

(Dspr) 31 cy 3 u & HI 29 HI HI 29 CU HI

(Opr HI) I I HI

(Dspr) 19 cy 3 (.)

Order No 10

To HB C & E Exa 427 West

To HI C & E 2nd No 46 (.) (.)

Exa 427 West has right of track against 2nd No 46
Eng 928 Hannibal to Callao. Sig F. W. H.

To HB X CU

(Opr HB) 31 No 10 HB C & E Exa 427 West X SN

(Dispr) 31 No 10 OK 751 PM F. W. H. To HI ga

(Opr HI) 19 No 10 HI C & E 2nd No 46 X GO (.)
 Exa 427 West has right of track against 2nd No 46
 Eng 928 Hannibal to Callao. (.) Sig Gregory.

(Dspr) OK Hr msg CU FW

Fm Chicago 10

To condr 2nd No 46 (.)

Leave one large box for hay at Shelbina, and one spl
 stock car at Callao (.)

(Sig) F W H

19 No 10 complete 755 PM F. W. H. to HB ga (.)

(Opr HB) 31 No 10 (.)

Exa 427 West has right of track against 2nd No 46
 Eng 928 Hannibal to Callao (.)

Sig Jones trn Exa 427 West

(Dspr) Hr Clip CU FW

Fr Chicago 10

To condr Exa 427 West (.)

Pick up 2 cars cattle at Palmyra Jct and take them
 through (.) Sig F. W. H.

31 No 10 complete 758 PM F. W. H. 29 CU HI HI
 29 CU

(Opr HI) I I HI

(Dspr) OS

(Opr HI) OS OS HI 2nd No 46 by 801 HI

(Dspr) OK CU

BREAKING IN TRAIN ORDERS.

Breaking is to open the key and stop the sending operator when you miss a letter or word. In breaking in an order should you miss the order No, say "No"; in the address say, "To" ADDING YOUR OFFICE CALL; in the beginning of the body, say, "period (.)";

in the body give the last word received; in the signature, say, "sig."

(For other forms of Train orders, see Standard Code as revised by the American Railway Association, in another portion of this book.)

RAILROAD TELEGRAMS.

Railroad telegrams or messages are those which are sent and revised between officials, agents and other employees of a railroad company, and pertain strictly to business of the company. They have no checks, and no record is made of them, are brief and concise as possible and usually composed of many abbreviations, are addressed and signed with full names, except when limited to one division, in which case initials are generally used.

Each message received must show on its face from which office it was sent, the signatures of both sending and receiving operators and the time received.

Telegrams addressed to persons on trains (except those addressed to train men) must be enclosed in sealed envelopes. The contents of all telegrams must be held strictly confidential.

GENERAL INSTRUCTIONS IN RAILWAY MESSAGE WIRE WORK.

The signals "Hr," "Anr," or "Ahr," are used to announce the beginning of a message, and to the operator seem as plain as for some one to say, "Here" or "Here is another," sometimes they say, "Hr msg" or "Hr clip"; any of the above terms mean get your message blank. here is a message for you. Following this will be sent the office call, of the sending office, then the personal sign of the sending operator; following his sign will

come the signal "Fm" or "Fr," which announces that the place from which it is being sent and the date will follow, following the date the signal "To" announces that the address will follow; following the address the signal "period (.)" announces that the body will follow, at the conclusion of the body the signal "sig," announces that the signature will follow. The above signals are sent by the sending operator, but never copied by the receiving operator.

ORDER OF TRANSMISSION.

Office call of sending office.

The sending operator's personal sign.

Place from and date.

Address of the message.

Body.

Signature.

Example of how a Railway message is transmitted. The combinations of letters enclosed in the parenthesis () are sent by the sending operator, but not copied by the receiving operator.

(Hr msg) HB SN

(Fm) Hannibal 12

(To) Bloomdahl, Sect 4 man, HI (.)

Go to Shelbina and help raise track next week work
5 men. (Sig) J. B. D., R. M.

HOW TO COPY MESSAGES ON THE FORMS.

Let us now make a study of the following form which will be found similar to that used on most roads. Let Hannibal be the sending office, "HB" the office call, and "SN" the operator's personal sign. Let Chillicothe be the receiving office, "HI" the office call, and "GO" his

personal sign. After calling "HI" and receiving his reply, "HB" would say, "Hr msg," meaning get your blank I have a message for you; following this he would give his office call "HB" which the operator at "HI" would place in the space under the words office call, next he would give his personal sign, "SN," which the operator at "HI" would place in the space under the words Sent By, and under the words Received By, he would put his own personal sign "GO," and the time received in the space under the word Time, then the operator at "HB" would say, "FM Hannibal 12," operator at "HI" would then write Hannibal 12 opposite the word From and also the year in the place provided 19....; then operator at "HB" would say, "To Agt HI," the operator at "HI" would place the abbreviation "Agt" after the word To and his office call, "HI" after the word At, the operator at "HB" would then make a "Period (.)," which announces the beginning of the body of the message and send the body and signature as follows:

Pls advise how many psngrs for the excn tomorrow
 Sig. W. D. B.

The operator at "HI" would copy the body and signature on the blank space provided for that purpose, and would acknowledge receipt of the message by giving the signal OK, his personal sign and his office call as follows: OK GO HI. After receiving the OK and his personal sign, the operator at "HB" would time the message by placing on its face the receiving office call, the receiving operator's personal sign, his own personal sign and the time as follows: HI 132 PM SN GO.

In copying messages, you should always place your personal sign and the time received, in the proper places

MISSOURI
CENTRAL
ROUTE

MESSAGE.

ALL MESSAGES COPIED ON THIS BLANK MUST BE WRITTEN IN INK.

OFFICE CALL	SENT BY	RECEIVED BY	TIME
HB	SN	GO	1:32 PM.

From Hannibal 12

19 07.

To Agt

At

HI

Pls advise how many psngrs for the excn tomorrow.

W.D.B.

at the same time you are receiving it, then it will never be omitted. This will be found quite difficult at first, but by careful practice from the start it can soon be mastered.

BREAKING IN RAILWAY MESSAGES.

When breaking in railway messages, should you miss the "office call" of the sending office, say "sine"; the personal sign of the sending operator, say, "wo"; the name of the place from which it was sent, say "fm"; in the date say, "date"; in the name or initials of the address say, "to"; in the beginning of the body, say, "period (.)"; in the body, give the last word received; in the signature, say "sig."

TELEGRAPH REPORT CALLED "THE SOUP TICKET"

Callao	Station	8/16	1907.
Train No.	Exa 927 East	Engine No.	927
Arr.	3 10 A M.	Dep.	3 28 A M.
LOADS	EMPTIES	PASSENGER	
Stock	15 N.W.	Mail and baggage	
Time Freights	4	Foreigns	11 Coaches
D Freight	807 Tons	Sleepers	
	Wilson	Conductor.	

The above report would be sent as follows:

(Hr soup tkt) CL AM "S" "4:08 PM."

(fm) Callao 16 (.)

Trn exa 927 East a 310 d 328 Lds 15 Time Frt 4 Mts
Fgn 11 Total Tons 807. (sig) Wilson.

THE DETAIL TRAIN REPORT

To the Train Dispatcher:

Chillicothe 8/16 190 6

Train 116 Left 4:10 PM. Engine 896

Engineer L S Morgan Conductor King

LOADS.

Give contents and destination of each load and state when carded, or Time Freight. Give route of Eastern Time Freight.

No. lbs.	Contents	Destination	Time	Route	Ton- nage
17	Sheep	Kansas City			450
11	Hogs	“			330
1	Horse	Omaha Stk Yd		U P Trns	30

EMPTYES.

Give initials, Kind of Cars, Destination, and Size of Local Box and Stocks.

No. Mts.	Initials	Kind	Destination	Size	Tonnage
4	C & N W	Box	Home		48

King

Cond'r or Agt.

Detail train reports are started the same as "soup tickets," and are sent directly across the page with period made at the end of each line; when through sending, the loads announce the Empties. Example:

(Hr. detail) HI BN "ON" ":25 PM."

(fm) Chillicothe 16

(to) Dspr (.)

Trn 116 d 4 10 PM Eng 896 Engr L S Morgan

Has Lds 17 Sheep Kansas City, Tons 450 (.)

11 Hogs do Tons 330 (.)

1 Horse Stk Yds Via U P Trains Tons 30
(.)

Mts 4 C & N W Bx Home Tons 48. Sig King.

CAR REPORT LOCAL.

These reports differ in form on different roads, but the principle is the same.

In sending this report, announce it as "cars," sign your office call and then send the letter over such part of the report as you have to fill out. Example: B 2 E 1 M 3 Q 4 R 12 U 3 V 8, and again sign your office call. The operator in the dispatcher's office has a similar form upon which he places the numbers under the letters as you name them.

CARS WANTED.				CARS WEST.				CARS EAST.			
Box	Stock	Gond	Flat	Box	Stock	Gond	Flat	Box	Stock	Gond	Flat
A	B	C	D	E	F	G	H	I	J	K	L
	2			1							
TO UNLOAD				EMPTY ON HAND				EMPTY TO SPARE			
Box	Stock	Gond	Flat	Box	Stock	Gond	Flat	Box	Stock	Gond	Flat
M	N	O	P	Q	R	S	T	U	V	W	X
3				4	12			3	8		

In sending this report the tonnage of all cars to be moved either empty or loaded must be included.

CAR REPORT FOREIGN.

Orders for foreign cars are addressed to the train dispatcher but must be on the foreign report. The dispatcher then turns the foreign report over to the Car Service Agent.

Received From	Time Received	Sent By	Received By
CN	3:25 PM.	G	AS

From West Chicago Ill 16

To F.W.H. Chgo

Order No. 4 Time Filed 3:15 PM

A. Cars Wanted (Number) One

B. Initials Mather

C. Class of Cars wanted Feed & Water

D. Size of Cars wanted 36 ft

E. Where Wanted West Chgo

F. Date wanted 19

G. To be loaded with Export Cattle

H. Destination New York City

J. How routed Via Chgo & M C Ry

Signed M Cannon

Agent.

In sending the above report, it should be announced by the Form Number, or as Foreign and send as follows:

(Hr 46) CN G "AS"
 (fm) West Chicago III 16
 (to) F. W. H. Chgo
 Order No 4 Filed 315 PM
 A One
 B Mather
 C F & W
 D 36 ft
 E West Chgo
 F 19
 G Export Cattle
 J Via Chgo & M C Ry
 Sig M Cannon Agt.

An accident report will be sent similar to the above by cipher letter; they are used to save time; at the same time to give clear account of what is wanted.

GENERAL INSTRUCTIONS IN COMMERCIAL MESSAGE WORK.

In handling commercial messages in the ordinary telegraph office, two sets of message blanks are used; each set is composed of one sending, and one receiving message form, the sending and receiving forms in each set are exactly alike. One set, which is used for Day messages, is printed in black ink, and is called Black, or day message forms; the other, which is used for Night messages, is printed in red ink, and is called Red, or Night message forms.

A message addressed to a place to which it is being sent (one which is not to be relayed or transferred), is called a CITY.

A message addressed to some place other than the place

to which it is being sent, (one which is to be relayed or transferred), is called a THROUGH.

A message will be understood to be a Day, or on a black form, unless the word Red or Night, is made in the signals announcing the beginning of the message.

If we have a day message addressed to some person in Chicago, and we can by using our line or wire, communicate direct with Chicago office, as soon as the operator at Chicago would answer his call, we would give him the following signals, "Hr city." He would at once know that we have a Day message addressed to some person in Chicago, and would copy on the black form. In case it was a night message, we would say, "Hr city red," or "Hr city nite," in which case he would copy on the night message form.

If our message was a day and addressed to some person in Boston, Mass., and Chicago was our relay office, we would say, "Hr tru." The operator at Chicago would at once know we have a message to be copied on the day form which is to be relayed or sent on some other line from his office to destination. In case the message was a night, we would say, "Hr tru red," or "Hr tru nite." He would then copy on the night message form.

Thus we have the following signals which are used to announce the beginning of a message:

Hr city	Black form
Hr tru	Black form
Hr city red	Red form
Hr tru red	Red form
Hr city govt	Black form
Hr tru govt	Black form
Hr city red govt	Red form

Hr tru red govtRed form
 Hr CableCable form

Any of the above signals mean get your message blanks, I have a message for you, and are sent by the sending operator but never copied by the receiving operator. Messages between the larger offices, which have considerable business, are numbered commencing with No. 1 at the opening. Sent messages to each office being numbered separately, received messages from each office being numbered separately.

After the signals announcing the beginning of a message, will be sent the number of the message and the office call of the sending office, then the sending operator's sign; following his sign "ck" indicates the check which gives the number of words subject to tariff, and tells whether a message is paid, to be collected, or free; (if free, explaining why) will follow; then the signal "fm" announces the place from and the date will follow, then the signal "to" announces that the address will follow; then the signal "period (.)" announces the beginning of the body will follow; then the "sig" announces that the signature will follow.

ORDER OF TRANSMISSION.

1. The number of the message and official call of the sending office.
2. The sending operator's personal sign.
3. The check of the message.
4. The place from and date of the message.
5. The address of the message.
6. The body of the message.

7. The signature of the message.

Example of transmitting a simple commercial message :

Hr city No 1 BN AH ch 5 Paid

fm Shelbina No 19

to Adams Bros. & Co.

Brookfield, Mo.

Will arrive five ten tomorrow. Sig James Parker.

THE SENDING FORM.

Let us now make a study of the following form, which being printed in black ink, and a sending form, indicates that it is a day sending blank.

RECEIVER'S No. refers to whoever accepts or received the message from the customer. In the large commercial offices, the person who accepts the messages from the public is known as the receiving clerk, and he would place under the words, "Receiver's No." his personal sign and also number it. Operators at small stations would place only their personal sign under the words, "Receiver's No." The object being to have the sign of the person who receives the message from the customer, upon the blank, in case the message be not understood the same can be referred to him.

TIME FILED refers to the time the message was presented by the sender at the sending office for transmission, but has no reference to the time it is transmitted by wire.

Check refers to the number of words contained in the message which are to be counted and charged for, except in the case of collect message. The word "collect" is added in the check to assist in indicating that the tolls of the message are to be collected. The word collect in the check of the message is never charged for.

THE WESTERN UNION TELEGRAPH COMPANY.

INCORPORATED

23,000 OFFICES IN AMERICA. CABLE SERVICE TO ALL THE WORLD.

This Company TRANSMITS and DELIVERS messages only on conditions limiting its liability, which have been asserted to by the sender of the following message. Errors can be guarded against only by repeating a message back to the sending station for comparison, and the Company will not hold itself liable for errors or delays in transmission or delivery of **Unrepeated Messages**, beyond the amount of tolls paid thereon, nor in any case where the claim is not presented in writing within sixty days after the message is filed with the Company for transmission. This is an **UNREPEATED MESSAGE**, and is delivered by request of the sender under the conditions named above.

ROBERT C. CLOWRY, President and General Manager.

NUMBER	SENT BY	RECD BY	CHECK
1 HI	AH	VC	6 Paid.

RECEIVED at Brookfield Mo 9:25 AM 7/19 1904

Dated Chillicothe Mo 19

To James Perkins,

931 Main St.,

Brookfield, Mo.

Come home at once mother worse.

Walter Perkins.

Let us now presume that the above message has been presented at Chillicothe, Mo., office for transmission, and as it meets all the requirements of Rule 1, the operator will observe Rule 2 and see that the month, and the day, are correctly noted thereon; by referring to his time-piece he finds the time it was presented to him to be sent was 9:19 A. M., which he will place under the words, "Time Filed"; he will place his personal sign, which we will presume as "AH," under the words "Receiver's No." Now by carefully reading every word, he finds according to Rules 3 to 8 inclusive, there are six words to be counted and charged for, which makes the check 6 paid. If the sender had desired it sent collect, and met all the requirements of Rule 13, he would have made the check 7 collect, instead of 6 paid.

He should obtain and file the address of the sender, if not well known, in case any reply or service should be received pertaining to the message, the sender can be notified.

RECEIVING FORM AND HOW TO COPY ON THE SAME.

Let us presume that the operator at Chillicothe, who has the message for Brookfield, sends it over the wire while the operator at Brookfield makes a copy of the same on the receiving form below. Office call for Chillicothe, "HI;" Brookfield, "BF;" Operator's personal sign at Chillicothe, "H;" Brookfield, "VC."

RECEIVING FORM.

After calling "BF" and receiving his reply, operator at "HI" would say, "Hr city." The operator at "BF" would at once know that "HI" had a message for him,

THE WESTERN UNION TELEGRAPH COMPANY.
INCORPORATED
21,000 OFFICES IN AMERICA. CABLE SERVICE TO ALL THE WORLD.

ROBERT C. CLOWRY, President and General Manager.

Receiver's No.
AH

Time Filled
9:19 AM

Check
6 Paid

SEND the following message subject to the terms {
on back hereof, which are hereby agreed to.

Chillicothe Mo 7/19 1904.

James Perkins

931 Main Street

Brookfield. Mo.

Come home at once mother worse.

Walter Perkins.

1 BF 9:25 AM AH VC.

TELEGRAPHY

READ THE NOTICE AND AGREEMENT ON BACK.

and it is a day message, and to be copied on a day message form. He would, therefore, get the above form and copy as follows: Operator at "HI" after giving him the signal "Hr city," would send the number of the message, and his office call which being the first message to-day would be "No 1 HI." Operator at "BF" would write "1 HI," under the word number, operator at "HI" would then send his personal sign "AH," which the operator at "BF" would write under words, "Sent By," and would write under his own personal sign "VC" under the words "Received By," operator at "HI"; would then say, "Ck 6 Paid." Operator at "BF" would write, "6 Paid" under the word "Check"; operator at "HI" would then say, "fm Chillicothe Mo 19." Operator at "BF" would write "Chillicothe Mo 19" on the same line after the word, "Dated"; operator at "HI" would then say, "to James Perkins." Operator at "BF" would write the name of "James Perkins" after the word "To"; operator at "HI" would then make a "comma (,)" which in this case means to the receiving operator, drop a line for the address, following the comma the operator at "HI" would say, "931 Main St." The operator at "BF" would write on the line below the name commencing about half way under the name, "931 Main St," operator at "HI" would make another "comma (,)" Brookfield, Mo." Operator at "BF" would observe the comma this time also and commence about half way under the street address and write, "Brookfield, Mo.;" operator at "HI" would then make a "period (.)" and send the body and signature as follows: "Come home at once mother worse sig Walter Perkins." Operator at "BF" would then copy the body and signature on the blank space provided for that purpose, omitting the ab-

breviation "sig." On the line, "Received at 190.." the operator at "BF" will observe Rule 32 and place "Brookfield, Mo., 9.25 A. M., July 19, 1904," and will count the number of words in the body of the message, see that they agree with the check, and otherwise satisfy himself that the message is correct in every way, and then will acknowledge receipt of the same by giving the signal OK, his personal sign and office call as follows: "OK VC BF." The operator at "HI" will time his sent copy according to the following form.

TIMING OF SENT COPIES.

Copies of sent messages when transmitted should be timed in the following form: 1 BF 9.25 AM AH VC. "1" is the number of the message to Brookfield office on that day; "BF" the office call for Brookfield to which the message is being sent; "9:25 A. M." the time transmitted; "AH" the sending operator's personal sign; and "VC" the receiving operator's personal sign.

It is quite customary for the sending operator to place this form upon the sending blank with his left hand while transmitting the message with the right. It is found quite difficult for operators of considerable experience but with constant trials the beginner can soon master this important step.

BREAKING IN COMMERCIAL MESSAGES.

When breaking in commercial messages, should you miss in the message number, say—"No;" in the sending operator's personal signal say—"wo;" in the check, say—"ck;" in the name of the place from which it was sent, say—"fm;" in the state,—say "state;" in the date, say—"date;" in the name of the addressee, say—"to;" in the street number, or in the case of the party in whose care addressed, say—"comma (,);" in the beginning of the body or text, say ("period (.);" in the body or text give the last word received; in the signature, say "sig." If for any reason you should fail to receive a message after a part or all of it has been transmitted, or in case you make a "bull" in your copy which would make it necessary to have the message repeated, say—"ga anr" or "ga ahr."

MISTAKES IN CHECKS.

Suppose that in the following message either the sending operator had failed to send, or the receiving operator had failed to copy, the word "wire."

21 MD CR BP 10 Paid.

Madison Wis. 22

James Person,

Kankakee, Ill.

Can you meet me Great Northern Chicago Monday wire answer.

MILTON CLARK,

10:14 AM.

The receiving operator would at once discover that there was only nine words, in which case he would say, "9 w," meaning I have only "9 words." The sending operator would review his copy and find ten words, and would say "ck 10 Paid and make a period and repeat the first letter of each word as follows: c y m m g n c m w a." By following each letter closely the receiving operator would discover that he had no word which commenced with "w" after the word Monday and would say "ga monday;" the sending operator would repeat "monday wire answer" and the error would be corrected.

COMMERCIAL MESSAGES EXPLAINED.

In the following messages the combinations of letters inclosed in the parenthesis () are sent by the sending operator, but not copied by the receiving operator; those in quotations " " are copied by the receiving operator, but not sent by the sending operator.

MORE THAN ONE ADDRESS.

When a message is addressed to two persons in the same place or town and delivery is to be made to each, it will be charged for as two messages.

Example :

(Sturges receives city.)

(Hr city mk 2 cys No) 1 BN AN "HW" (ck) 10 Paid.

(fm) Hannibal Mo 22

(to) C L Brown and Geo Clark,

Sturges, Mo.

(.) Meet me Kansas City Hudson House Eleven oclock
Monday bring papers.

(sig) P D KITT

"11:15 AM"

The manner of transmitting the above message will be determined by the manager or chief operator of the sending office. It may be sent to both persons at one transmission, or to each one separately; if only one transmission is made the sending operator who makes the last transmission should tell the receiving operator to make 2 copies, as follows: (Hr city mk 2 cys) so he may at one writing with manifold make a copy for each address.

When a message is addressed to two persons in the same place or town and delivery is to be made to either, it will be charged as only one message, but the second address together with the connecting word "or" will be included in the count and charged for.

Example:

(Brookfield received city.)

(Hr city No) 4 MR ED "RD" (ck) 14 Paid 3 exa wds.

(fm) Palmyra Mo 22

(to) J K Wheeler, or Ed Page,

Care Bacon Elevator,

Brookfield Mo

(.) Phone Ella I bought load mules waiting for car home tomorrow.

(sig) Wm Hopper

"12 K Noon"

In the above message we have 3 extra words which are the three extra words in the address, "or Ed Page" while there are only eleven body words. They are called extra words because they are not a part of the body, yet must be counted and charged for; therefore, they are mentioned in the check as extra words. All words in a message which according to the rules must be counted and charged for, and are not in the body, are mentioned in the check as so many extra words.

STREET ADDRESSES.

Great care should be taken to obtain from the sender a good, clear address for each message. The importance of the address cannot be over-estimated. When the address given seems insufficient a better one should be requested. Example:

(Moberley receives City.)

(Hr City No) 41 BF FS "JK" (ck) 8 Paid

(fm) Brookfield Mo 22

(to) M L Quinn,

Traveling salesman for Hibbard Spencer Bartlett & Co.,
 Try Hotels and 326 Wentworth Ave.,
 Moberley, Mo.

(.) Go to St Louis first train meet George answer.
 (sig) Mrs M L Quinn
 "3:15 P M"

In the above address it might seem that extra words appear to be used, but whenever it is necessary to make a lengthy address, which will insure prompt delivery, do so rather than necessitate sending several service messages.

MORE THAN ONE SIGNATURE.

Whenever a message has two or more signatures and they are not in the nature of a firm, Mr & Mrs, or John Smith & Family, all will be counted and charged for except the last. Example:

(Shelbina receives City.)

(Hr city No) 16 GH OA "HX" (ck) 16 paid 3 exa wds.

(fm) Birmingham Mo 22

(to) Rev A L Appleby,

Pastor M E Church

Shelbina, Mo

(.) Will you meet our Sunday School at picnic at Seven Oak Farm Friday.

(sig) S M McGee, Elmer Ford.

"4:25 PM"

In this message we also have 3 extra words, as we count and charge for all signatures when there are more than one except the last.

TITLE WORDS.

Whenever a signature has a title of more than two words or whenever there are words after the signature which are not title words, each word will be counted and charged for. Example:

(Hannibal received Relayed.)

(Hr tru No) 23 BN WR "GR" (ck) 12 Collect 3 exa wds

(fm) St Louis Mo 22

(to) Melvin Clarksdale,

On Train No 6, H & St J Ry,

Monroe Mo

(.) Work Shelbina Geo Thompson here have wired firm.

(Sig) Geo M. Holder,

Agent Deering Machine Co

"8:29 AM"

In the above message we have four words after the signature, only one of them being a title word, "Agent" (which is allowed free) therefore, we count and charge for "Deering Machine Co" as 3 extra words together with 8 body words and the word "collect" in the check which is counted but not charged for.

REPORTING DELIVERY.

Whenever the sender of a message wishes the company to notify him of its delivery.

Example.

(Kansas City receives Relayed.)

(Hr tru No) 8 CL CR "RG" (ck) 18 Paid 2 exa wds

Rept Dely

(fm) Chicago Ill 22
 (to) Dr J B Freeman,
 68 Main St,
 Macon, Mo

(.) Will send papers today Title will have to be made perfect before I can accept it.

(sig) Dr N J Moreland,

"12:27 PM"

In the above message there are two extra words in the check "Rept Dely" which are counted and charged for and placed there by the sending office to notify the receiving office, that a notice of delivery must be given.

Example:

(Kansas City receives Relayed.)

(Hr tru No) 3 CN RG "CR" (ck) 11 collect

(fm) Macon Mo 22

(to) Dr N J Moreland

Chicago, Ill.

(.) Delivered your message to Dr J B Freeman nine AM.

(sig) L S McDonald,

Manager "2:10 PM"

REPEATED MESSAGE.

Whenever the sender wishes his message repeated or telegraphed back to the originating office for comparison.

Example:

(Kansas City receives City.)

(Hr city No) 9 GH NS "G" (ck) 11 Paid 2 exa wds

Rept Bk

(fm) Birmingham Mo 22

(to) Adams Bros & Co,
Kansas City Mo

(.) Send by express Range casting twenty nine fifty four,
(sig) Field Hdw Co.

"7:14 PM."

In the check of the above message there are two extra words "rept Back" which are counted and charged for. They are placed in the check by the sending office to notify the receiving office, that the message must be repeated for comparison, which should be done immediately before giving OK. A half rate will be charged for the repetition in addition to the charge for the message.

SPECIAL DELIVERY.

Delivery charges to be paid by the sender.

Whenever a message is to be especially delivered beyond the free delivery limits of the terminal office, and for which the delivery charges are not given in the tariff book and the charges are to be paid by the sender.

Example:

(Bucklin received City)

(Hr city No) 12 CD SR "B" (ck) 11 Paid exa wds

Rept Dely Chgs

(fm) Laclede Mo 22

(to) L A Martin,

3 1-2 miles southeast town,

Bucklin, Mo

(.) When can you meet me to arrange contract.

(sig) George Perdin.

"10:18 AM"

The above message is to be delivered by special messenger 3 1-2 miles southeast of Bucklin Mo and the

charges are to be paid by the sender. In which case the sending office inserts in the check the word "Rept Dely Chgs" which are counted and charged for. They are placed in the check to notify the receiving office to have the message delivered and notify them by Service of the amount of charges so they can be collected from the sender.

When the charges are to be paid by the addressee.

Whenever a message is to be specially delivered beyond the free delivery limits of the terminal office, and for which the delivery charges are not given in the tariff book, and the charges are to be paid by the addressee.

Example:

(Ottumwa receives relayed)

(Hr tru No) 5 CR MK "JF" (ck) 12 Paid 3 exa wds
Dely Chgs Gtd.

(fm)Des Moines Ioa 22

(to) S O Warren,

Cattle Breeder 5 miles east, Chillicothe, Mo

(.) Offer twenty five good steers average four five
twenty.

(sig) W A Drake,
"9:03 AM"

In this message we also have 3 extra words in the check "Dely Chgs Gtd" which are counted and charged for and placed there by the sending office to notify the receiving office, that the charges are guaranteed, but should be paid by the addressee.

EXTRA DATES.

Whenever a message is to be forwarded according to Rules. The name of the originating office and the date

will be counted and charged for as a part of the message. Example:

(As message appears when first received at Boston.)

25 BN FN WR 11 Collect

Buffalo N Y 22

John Brown,

Transient,

Boston, Mass.

Meet me next Monday at ten oclock in the forenoon.

H Smith,

8:19 AM

For example, if the above message had been sent by "this" line from Buffalo to Boston, and John Brown had left Boston before the message arrived and had left a request, that all messages received for him be forwarded care Hudson House, Fall River, Mass. Boston would mark out certain words and add others as per following example:

8:25 AM 15

~~25 BN FN WR 11~~ Collect 33 & 35 4 exa wds.

Buffalo, N.Y. 22, Via Boston Mass. 22

John Brown,

~~Transient~~

Care Hudson House,

~~Boston, Mass.~~

Fall River, Mass.

Meet me next Monday, at ten o'clock in the forenoon.

H. Smith,

~~8:19 AM~~

(As message appears marked ready to forward.)

You will notice in the above message four extra words appear which are the originating office and the date (Buffalo, N. Y. 22) which are to be counted and charged for. In the check, numbers appear which are the tolls to be collected. Suppose the rate from Buffalo to Boston to be 35 and 2 and from Boston to Fall River 25 and 2: then a 11 collect message from Buffalo to Boston would cost 35c and a 15 collect message from Boston to Fall River 33c. The message being a "received collect" message, in which case Boston would check it so the rate from Boston to Fall River which is 33c would appear in the check first, as the "this" line tolls, and the rate from Buffalo to Boston which is 35c would appear in the check second, as the "other" line tolls.

(As message appears when copied at Fall River.)

B FB P 15 Colect 33 & 35 4 exa wds.

Buffalo N Y. 22, Via Boston, Mass. 22,

John Brown,

Care Hudson House,

Fall River, Mass.

Meet me next Monday at ten oclock in the forenoon.

H Smith

8:39 AM.

Fall River would deliver and collect from Brown 33 & 35 or the total 68c.

OTHER LINE MESSAGES.

Whenever a message is to go over any "other" lines to reach the destination, the name of the transfer station should appear on the check from the originating office to the transfer office. Example:

(Kansas City receives Relayed.)

(Hr tru No) 7 HI MS "WF" (ck) 7 Paid Via St Louis
(fm) Chillicothe Mo 22

(to) Alvin Perryman,
Ballwin, Mo

(.) Meet George St Louis Friday important business
answer.

(sig) M L Hardlin,
"8:28 AM"

In the check of the above message we have the words
"Via St. Louis" which are not counted or charged for,
only placed in the check to indicate that the message is
paid Via St. Louis.

Whenever a message is received over "other" lines at
the proper station indicated by the tariff book, the name
of the transfer office and also the date should appear on
the same line with the originating office. Example:

(Chillicothe receives City.)

(Hr city No) 12 KC WF "MS" (ck) 9 Collect an ans
(fm) Ballwin Mo 22 Via St Louis Mo 22

(to) M L Hardlin,
Chillicothe Mo

(.) Will meet George Union Station ticket office Friday.

(sig) Alvin Perryman,
"1:28 PM"

It might seem in the above message that there were
extra dates, but by referring to the tariff book we find
that St. Louis is one of the proper places for a message
from Ballwin to reach this Company's lines, and it is
placed there, so the office of destination may know both

the originating and the transfer office, in order that the tolls may be computed Via the transfer office.

You will note that the above message is an answer to the preceding message and it is customary to send the answer to a message, when such message makes some request of the addressee, collect. In the check we find the words "an answer" which are placed there to remind the receiving office that it is an answer to some message which has been sent from his office; in case a prepaid message requires an answer the addressee may send an answer collect and will not be required to make a deposit.

WHEN AN ANSWER IS PREPAID.

Whenever the sender of a message wishes to prepay for an answer to his message, the sending office will place in the check the wire signal "33" which will not be counted or charged for. Example:

(Cameron receives City.)

(Hr city No) 32 HB B "AS" (ck) 10 Paid & 33

(fm) Hannibal Mo 22

(to) Geo Thompson

Mgr Foot Ball Team,

Cameron, Mo

(.) Can you accept our offer for thirteenth others wanting date.

(sig)

M L Stevens,

"8:10 AM"

Upon receipt of a message bearing the wire signal "33" in the check, the receiving offices will if possible obtain an answer and send the same "collect" without requiring any deposit from the sender.

NIGHT MESSAGES.

A night message will be written upon a night message form; they are sent at reduced rates and if presented any time during the day, and it is so requested, they will be accepted at night rates and held until 6 PM and sent as soon thereafter as possible. Example:

(Kansas City Receives Relayed.)

(Hr red tru No) 5 KG AN "SN" (ck) 12 Collect Night
(fm) Breckenridge Mo 22
(to) J L McCandlish

Indianapolis, Ind

(.) Offer ten cars good mill screenings seven ten immediate acceptance.

(sig) Breckenridge Elevator Co.

"9:45 AM"

In the above message the word "red" is found in the signals which announce that it is to be copied on Night Message Form, and also in the check the word "night" is placed, indicating that the message will be charged for at night rates. ALWAYS begin night messages with the word RED and also send the word NIGHT in the check. An office which is not kept open, will before closing, transmit its "night" messages; if any night messages are left over until morning they will be transmitted before new business is taken up.

CODE MESSAGES.

Code messages are composed of words found in the ordinary dictionaries but so arranged as to give no meaning without the use of a code book; such messages are transmitted at ordinary tariff rates. Example:

(Kansas City receives Relayed.)

(Hr code tru No) 3 GH ED "MA" (ck) 6 Paid

(fm) Birmingham Mo 22

(to) Warner & Wilbur,

Commission Merchants,

Chicago, Ill.

(.) Alert Anvil and abacus demand probable.

(sig) Robert Elliott

"8:16 AM"

A code message is usually preceded by the word "code" which puts the receiving operator on his guard. The above message, to an operator, has no meaning, but should be handled very carefully and every letter sent and copied unmistakably correct, and be very particular, crossing every "t" and dotting every "i," so they may be readily translated by the addressee. Translated the above message would read "Buy 10,000 bushels No 2 wheat for May delivery and buy 100 bales of January cotton margin twenty points." Much money is therefore saved in telegraphing by the use of codes. All leading branches of business have separate and different codes and it would be useless to try to decipher their messages without a copy of their code book.

CIPHER MESSAGES.

Cipher messages are in reality used for the same purpose as code messages. They are composed in whole, or part, of figures, letters, characters or words not contained in dictionaries or a combination of either or all of them, having no sense unless interpreted by means of a key in possession of the sender and receiver. Example:

(St. Joseph receives City.)

(Hr city No) 5 BN RK "TD" (ck) 29 Paid Cipher.

(fm) Hannibal Mo 22

(to) Keller Mfg Co.

1225 Madison St.

St. Joseph Mo

(.) Maeotis qr7ef 1740 aedeui zyrstf96 heavy qzrnm
9658. (sig) Johnson & Co.

"9:19 AM"

To count the above message study the rule covering such messages. The receiving operator should not OK a cable, code, or cipher message until he has repeated the body to the sending operator for comparison. This should be done to protect against possible errors, regardless of the requirements of the rules.

GOVERNMENT MESSAGES.

Government messages relate to the official business of the government and have preference over all other business. Example:

(Moberly receives City.)

(Hr pink govt No) 56 KC FL "Z" (ck) 13 Paid Govt.

(fm) Washington D C 22

(to) Weatherman,

Moberly, Mo

(.) Generally fair tonight and Tuesday warmer west portion tonight.

(sig) Cox

"4:38 PM"

In all government messages you count the address, body words and the signature, or commence after the word "to" and count everything. ALWAYS begin a government message with the word GOVT, and also put the word GOVT in the check.

DEAD-HEAD MESSAGES.

Messages of employes of an urgent social or domestic character may be sent free and the check will show the reason for its acceptance without payment of the tolls. Example:

(Sturges receives City.)

(Hr City No) 5 MA RN "Q" 9 D H Opr

(fm) Ottumwa Ioa 22

(to) Edgar P Walker,

Sturges, Mo

(.) Mother and Mollie leave tonight meet them seven o'clock.

(sig) G L Walker

"7:33, PM"

A message of this sort must be approved by the manager or superintendent in accordance with the rules.

CABLES.

Cable messages sent or received should be written on cable blanks and must always be prepaid. Example:

(Form of Transmission)

(Hr Cable No) 8 CN MS

(fm) Liverpool 5

(to) Sherlock

St. Louis (Mo)

(.) Abhor 36-4

(sig) Ole

In cables the check is not sent, only the number of words which appear immediately after the originating point. No date is given in transmission, but is filled in by both sending and receiving operator. To count cables begin at the word "to" and count everything except where the state is in parentheses (). It is not to be counted. If it is not in the parentheses it is to be counted. Counting of cables will be found different from messages, and a thorough study of the cable rules is needed. ALWAYS repeat the cables, and time them on the face with both sending and receiving operator's signal.

A press message, or query, should be written upon a pink blank at a relay office, and should receive prompt service. The check of such message shall contain the words "Day Press rate" or "Night press rate" the same as press for publication.

They are sent by some newspaper correspondent to some newspaper stating some happening or occurrence

CABLE MESSAGE. THE WESTERN UNION TELEGRAPH COMPANY.

INCORPORATED

All CABLE MESSAGES received for transmission must be written on the Message Blanks provided by this Company for that purpose under and subject to the conditions printed thereon, and on the back hereof which conditions have been agreed to by the sender of the following message

THOS. T. ECKERT, President and General Manager

TWO AMERICAN CABLES FROM NEW YORK TO GREAT BRITAIN.
CONNECTS ALSO WITH FIVE ANGLO-AMERICAN AND ONE DIRECT U. S. ATLANTIC CABLES.
DIRECT CABLE COMMUNICATION WITH GERMANY AND FRANCE.
CABLE CONNECTION WITH CUBA, WEST INDIES, MEXICO AND CENTRAL AND SOUTH AMERICA.
MESSAGES SENT TO, AND RECEIVED FROM, ALL PARTS OF THE WORLD.

OFFICES IN AMERICA:

All Offices (21,000) of the Western Union Telegraph Company and its Connections.

OFFICES IN GREAT BRITAIN:

LIVERPOOL: No. 8 Rumford Street.
GLASGOW: No. 29 Gordon St. and No. 4 Waterloo Street.
BRISTOL: Backhall Chambers.

LONDON:
No. 21 Royal Exchange, E. C.
No. 109 Fenchurch Street; E. C.

RECEIVED at

8 CN MS ON

Liverpool 5

Sherlock,

St Louis (Mo)

Abhor 36/4.

01e.

OK MS & ON 8:54 AM.

(* Form as received and copied.)

and inquiring the amount of matter desired for publication; they are charged for at the same rate as press for publication. No message to be rated less than ten words. Example:

(Kansas City receives Relayed.)

(Hr tru pink No) 12 Hi Z "DA" (ck) 18 Collect N P R.

(fm) Chillicothe Mo 22

(to) Chicago Record,

Chicago, Ill

(.) Nancy Bell takes three out of five best time 216 3-4

Good story how much.

(Sig) Morgan,
"7:55 PM"

PRESS SPECIAL.

A despatch addressed to some newspaper containing an account of some happening or occurrence for publication, is charged for at press rates. Example:

(Chillicothe receives press special.)

(Hr spl No) 29 KC AB "B" (ck) 70 Collect N P R

(fm) St Louis Mo 22

(to) Constitution,

Chillicothe Mo

(.) Tony Faust's restaurant on Broadway, opposite the Olympic, was the scene of a robbery some time during the early hours of this morning, in which \$4,100 in cash was stolen. The police are looking for Henry Stetten, alias Henry Stegger, who was employed as a bartender at the catering establishment, and who is suspected of having some knowledge of the crime.

Filed 7:10 PM

(sig) Hemmings
"7:25 PM"

In the foregoing press message we have 70 words, 64 of which are the body, 1 in the check, and 5 in the Filing Time, which when placed in the body of despatches will be transmitted, counted and charged for.

SERVICE MESSAGES.

A message, pertaining to messages, which have been sent, regarding their delivery, collection of charges, etc., is called a service message.

ABBREVIATIONS USED.

- N S N—No such number.
- B B A—Give better address.
- G S A—Give some address.
- S F S—See former service.
- S Y S—See your service.
- D F S—Disregard former service.
- 92—Deliver.
- Deld (or 92d)—Delivered.
- Undeld—Undelivered.
- Dely—Delivery.
- Dely chgs gtd—Delivery charges guaranteed.
- Rept dely chgs—Report delivery charges.
- Rept dely—Report delivery.
- Spl dely—Special delivery.
- Sgd (or) sined—Signed.
- Gte—Guarantee.

FORMS USED IN TRANSMISSION.

(Hr tru No) 28 MO K. "FQ" (ck) Svc (or) Ofs.
 (to) Omaha Nebr
 (.) S F S yours red date Williams sgd Harrison 92d
 OK.

(sig) Monroe Mo. 22 -
 "5:46 PM"

You will note that the above service or office message has no "from" and the number of the words are not mentioned in the check; it is also addressed to the name of an office and signed by the name of an office; the signature also contains the date. Never address a service message to an operator, agent, or any other person, except in making an answer to some service from a large office which might be signed for example: "Clark Chicago Ill 22," in which case you would address your service message to "Clark Chicago Ill."

EXPLANATION AND DIFFERENT FORMS USED.

Whenever a message is received with a request in the check to "Rept dely chgd," the receiving office will have the message delivered, pay the special messenger and send a service. Example:

To Laclede, Mo.

Dely chgs yours date Martin sgd Perdin One dollar
 which we check you other lines.

Bucklin, Mo. 22.

Whenever a message is received with the words "Dely chgs gtd" in the check, and the addressee refuses to pay

for the special delivery, the receiving office will pay the special messenger and in accordance with the RULES, send a service. Example:

To Cameron, Mo.

We check you One Fifty other lines Dely yours date
Warren sgd Drake.

Chillicothe, Mo. 22.

Whenever a message is received, and the addressee lives outside the free delivery limits, and the delivery charges have not been provided for, ask about the delivery charges by service. Example:

To Madison Wis.

John Benson lives four miles out do you gte One Twenty
Five Dely yours date sgd Clark.

St. Louis Mo. 22.

When a service similar to the above is received and the delivery charges are guaranteed by the sender.

Example:

To St. Louis, Mo.

SYS we gte One Twenty Five Dely chgs ours date Ben-
son sgd Clark.

Madison Wis. 22

The above service must be charged for in accordance with the RULES.

WHEN CHARGES ARE NOT GUARANTEED.

To St. Louis, Mo.

S Y S ours date Benson sgd Clark chgs not gtd, pls drop
in P. O.

Madison Wis. 22

WHERE THE STREET NUMBER MENTIONED IN THE ADDRESS
OF A MESSAGE CANNOT BE FOUND.

Example:

To Battle Creek, Mich.

N S N as 324 East Lake St and Huffman & Son un-
known at 324 West Lake St, G B A or cant 92 your
date sgd Peterson.

Indianapolis, Ind. 22.

WRONG ADDRESS.

To Geneva, Ill.

M L Sacket unknown at 1262 Wentworth Ave, G B A
or cant 92 yours date sgd Mitchell.

Clark, Chicago, Ill. 22.

CORRECTED ADDRESS.

To Clark Chicago, Ill.

Ours date Sacket sgd Mitchell is addressed to 1282
Wentworth Ave, Not 1262 we repeat 1282, S Y S
and advise.

Geneva, Ill. 22.

WHEN MESSAGE IS DELAYED.

To St Joseph, Mo.

Can't 92 until 8 AM yours Meek & Co sgd Clayball, of-
fice closed for the night and residence unknown.

Boston, Mass. 22.

IF THE ADDRESSEE OF A COLLECT MESSAGE REFUSES TO
PAY FOR THE SAME.

To New York, N. Y.

Collect there yours date Hutson sgd Reedy payment re-
fused. Toledo, Ohio. 22.

WHEN A MESSAGE HAS BEEN LOST OR NOT UNDERSTOOD,
ASK FOR DUPLICATE.

To Quincy, Ill.

Duplicate quick yours date Carlton sgd Manning, mes-
sage not understood.

Galesburg, Ill. 22.

ASKING FOR DUPLICATE OF A CERTAIN WORD.

To Rawlins, Wyo.

Duplicate eighth body word yours Nelson sgd Hender-
son. Medicine Bow, Wyo. 22.

DUPLICATING A CERTAIN WORD.

To Medicine Bow, Wyo.

S Y S eighth body word ours date Nelson sgd Hender-
son is "waste" we repeat it "waste."

Rawlins, Wyo. 22.

WHEN NO STREET ADDRESS IS GIVEN.

To Adams, Nebr.

G S A or can't 92 your red 21st Parker sgd Ammer-
man. Englewood, Ill. 22.

Whenever the check in a message is anything else
than "Day," it should be mentioned as in the above mes-
sage.

WHEN A SERVICE HAS BEEN SENT AND ANOTHER FOLLOWS
CHANGING THE FIRST.

To Adams, Nebr.

D F S have 92 OK your Red 21st Parker sgd Ammer-
man. Englewood, Ill. 22.

WHEN THE ADDRESSEE HAS CHANGED RESIDENCE.

To Pattensburg, Mo.

Clifton Pub Co. have moved from 936 West Clay St and
present address unknown G B A or can't 92 yours
yesterday sgd Adams Bros. Clark, Chicago, Ill. 22.

WHEN THE ADDRESSEE LEAVES TOWN BEFORE A COLLECT
MESSAGE ARRIVES FOR HIM.

To South Bend, Ind.

Allen Thompson left city before yours date sgd Mer-
dock arrived. Collect there. Warsaw, Ind. 22.

WHEN A MESSAGE IS SENT TO WRONG DESTINATION.

To St Joseph, Mo.

File but do not check ours red 21st Randall sgd Peterson
should have been sent to St Louis, Mo. have resent
it to St. Louis. Chillicothe, Mo. 22.

ASKING FOR QUICK ANSWER.

To Milwaukee, Wis.

Pls get quick answer or reason why ours yesterday Stock-
ton sgd Clemons. ¹Minneapolis, Minn. 22.

NUMBER SERVICE MESSAGES.

To Chicago, Ill.

Yesterday sent 97 received 210. Kansas City, Mo. 22.

To Kansas City, Mo.

No record your No 97 yesterday, Pls give skeleton.

Hitchcock, Chicago, Ill. 22.

GIVING SKELETON.

To Hitchcock, Chicago, Ill.

Ours yesterday No 97 to you ck 13 Paid fm Brecken-
ridge, Mo. to James Armstrong Milwaukee, Wis. sgd
Widley Bros. recd opr MA 2:25 PM, S Y S and ad-
vise. Kansas City, Mo. 22.

COMMERCIAL NEWS DEPARTMENT.

That department of commercial telegraph which gathers and furnishes by wire, quotations and other news of grain and provision market.

The grain and provision market opens at 9:30 A. M. on the board of trade, and the quotations are sent out at different times until 1:15 P. M., except on Saturdays, when the close is sent at twelve o'clock, noon.

ABBREVIATIONS.

GRAIN.

W Wheat
C Corn
O Oats

PROVISIONS.

P Pork
L Lard
S R (or) R ... Short Ribs

OPTION MONTHS.

F	January	N	July
G	February	Q	August
H	March	U	September
J	April	V	October
K	May	X	November
M	June	Z	December

GRAIN C N D.

(Hr end No) 4 CH AC "GO" (ck) C N D

(fm) Chicago Ill 22

(to) Quincy Ill

(.) WZ 1.05¼, K 1.04¼
 CZ 41¾, K 40¾@40⅞
 OZ 30, K 29½

(sig) 9:30 AM Opening.
 "9:41 AM"

PROVISIONS C N D

(Hr end No) 5 CH AC "GO" (ck) C N D

(fm) Chicago Ill 22

(to) Quincy Ill

(.) PZ 13.00, K 12.50
 LZ 7.65, K 7.85
 SRZ 9.70, K 10.00

(sig) 9:30 AM Opening.
 "9:43 AM"

ABBREVIATIONS USED IN LIVE STOCK C N D

A	Exact Receipts	M	Heavy
B	Exports	N	Light
C	Sales	P	Premium
J	Left Over	X	Mixed
K	Receipts Day Before		

OPENING LIVE STOCK C N D.

(Hr cnd No) 2 KC NF "SR" (ck) C N D

(fm) Kansas City Mo 22

(to) Cameron Mo

(.) Hogs 20,000 prospects stronger.

Cattle 10,000 prospects steady.

Sheep 6,000 prospects unchanged.

(sig) 7:10 AM Opening.
"7:18 AM"

THE 8:40 AM C N D.

(Hr cnd No) 25 KC NF "SR" (ck) C N D

(fm) Kansas City Mo 22

(to) Cameron Mo

(.) A 20,000 B 11, 292 C 5,121 J 2,854 K 21,000 average higher. M 500@517½ N 460@505, P 500@517, X 460@505. Cattle 10,000 including 300 southern. Native steers 400@625. Southern Steers 250@375. Native Cows and Heifers 150@450. Stocker and Feeders 225@425. Westerns 300@450. Sheep, 6,000. Muttons 325@380. Lambs 400@415. Range wethers 325@400. Ewes 275@360.

(sig) 4:40 AM
"8:48 AM"

GRAIN SPECIAL FOR PUBLICATION.

(Hr spl No) 56 KC J "AD" (ck) Collect D P R
 (fm) Kansas City Mo 22
 (to) The Gallatin Democrat,
 Gallatin, Mo

(.) Wheat—198 cars—Dec. \$1.05¼; May, \$1.04¼;
 cash No. 2 hard, \$1.07¼@1.10; No. 3, \$1.04@1.08; No.
 4, 96c@\$1.04; rejected, 85@94c; No 2 red, \$1.12; No.
 3, \$1.08@1.10; No. 4, 98c@\$1.06.

Wheat—Higher.

Corn—Dec. 41¾; May 40¾@40⅞; cash; No. 2
 mixed, 48c; No. 3, 47½ No. 2 white, 48½; No. 3, 48@
 48¼c.

Oats—No. 2 white, 30@32c; No 2 mixed, 29½c.

(sig) Watkins

Filed 4:37 PM.

"4:40 PM."

INDEX

MOVEMENT OF TRAINS.

The Train Brakeman.....	5
Freight Brakeman.....	6
Passenger Conductor.....	9
Freight Conductor.....	12
Dispatchers; Trainmaster; Division Superintendent..	15
Chief Train Dispatcher.....	16
The Trainmaster.....	19
Division Superintendent.....	22
The Manifestations of Color Blindness—How to De- tect It	27
Heating Passenger Cars.....	41
The Baker System.....	41
The Original or Old Style Ordinary Baker Heater	42
Circulating Drum, or Water Reservoir and Ex- pansion Chamber	44
Showing Plan of Piping, Coil, and Circulation Drum	45
Improved Fire-Proof Heater.....	47
Automatic Regulator and Pressure Indicator...	49
Double Coil or Two-Circulation Heater.....	50
Arrangement Illustrating Method of Filling the Heater Circulation System.....	53
Baker Steam Attachment Shown Fitted to Heater	58
Details of Improved Baker Steam Attachment..	59
Standard Heating System.....	60

Heating Passenger Cars—Continued.

Train Pipe Valve.....	61
Extension Handle.....	62
Automatic Steam Trap.....	64
Diagram Showing Minimum Pitch to Be Given to Steam Trap.....	65
Direct Steam Heating System.....	66
Steam Inlet Valve.....	67
Angle Valve.....	68
Reducing Valve.....	69
Gauge for Steam Heating.....	70
Steam Coupler Troubles.....	71
Coupling of Heads.....	72
The Economy Car Heating System.....	74
Action of the Locks.....	75
Pipe Connections.....	78
Three-Way Cock Located in the Exhaust Pipe..	80
Operation	81
Showing Location of Apparatus.....	82
Showing the Piping of Economy Car Heating Apparatus	83
Showing Location of Apparatus.....	85
Relief Valve.....	86
Gold's Steam Heating Apparatus.....	87
Gold's Heating Apparatus, Its Application to Lo- comotive	88
Improved Temperature Regulator.....	89
Sectional View Improved Temperature Regu- lator	91
Pressure Radiator Dial.....	93
Explanation of Plate V.....	93
Gold's Improved Direct System for Heating Pas- senger Cars	94

Heating Passenger Cars—Continued.

Cylinder Containing Bricks for Storing Heat...	95
Gold's Improved Storage System for Heating Compartment Cars	97
Duplex Coils	99
Sectional View Duplex Coils.....	100
Gold's Improved System of Hot Water Circula- tion	101
Gold's Improved System of Hot Water Circula- tion	102
Combination Automatic Lock and Hose Support.	103
Combination Automatic Lock and Hose Support.	104
Combination Automatic Lock and Hose Support, Attached to a Car.....	105
Vapor Heating	107
Expansive Diaphragm.....	108
Details of Operation.....	109
Details of Vapor Regulator.....	110
Heating Cars with Electricity.....	115
Completed Coil for No. 143-LL Heater Show- ing Resistance Coil, Porcelain Plates and Lead Wires	116
Electric Heater in Position.....	117
Heater Enclosed in Insulated Iron Casing; Wir- ing Shown in Moulding.....	117
Diagrams of Wiring Electric Heating System...	118
Electric Couplers Used for Heating Trains by Electricity	119
A Quick-Break Knife Switch.....	120
Catechism of Steam Heating.....	122
Making Up Trains.....	122
Regulation of Temperature.....	122
Changing Engines.....	123

Catechism of Steam Heating Apparatus of Trains.....	124
Operation of the Apparatus.....	127
Care of the Apparatus.....	129
Responsibility of Employes.....	131
Lighting Passenger Cars.....	133
Present Form	138
Old Form.....	138
Showing a Two-Flame Ordinary Pintsch Gas Lamp, in Baggage Car.....	141
The Regulator Used with the Mantles for In- verted Burners	142
Showing Proper Flame.....	143
Inverted Burner Lamps in Passenger Coach....	144
Inverted Burner Lamps in Dining Car.....	145
Instructions to Foremen and Inspectors for the Use of Pintsch Gas Equipment at Terminal Points	146
Instructions to Trainmen for the Care of Pintsch Gas Car Equipment.....	148
Gold's Improved System of Acetylene Car Lighting..	150
Interior of Coach with Gas Generator Installed..	151
Top of Generator Projecting Through Roof of Sleeping Car	152
Generator Applied to a Coach.....	154
The Safety Storage System of Acetylene Light- ing for Railway Cars.....	155
Safety Storage Tank Broken to Show the Asbes- tos Discs.....	155
Charging Plant of the N. Y., N. H. & H. R. R., Providence, R. I., Showing 5,000 Cu. Ft. Holder	156

Gold's Improved System of Acetylene Car Lighting—
Continued.

Ground Plan of Generating and Compressing Plant, N. Y., N. H. & H. R. R., at Provi- dence, R. I.....	157
Ground Plan of Gas Holder.....	158
General Acetylene Generator.....	159
Generating and Compressing Plant of the D., L. & W. R. R. at Hoboken, N. J.....	160
N. Y. C. & H. R. R. Day Coach equipped with the Safety Storage System.....	161
Erie Mail Car.....	162
D., L. & W. Cafe Car.....	163
N. Y., N. H. & H. Car Equipped with the Safety Storage System.....	164
Sections of Cars Showing Equipment.....	165
The Electric Car Lighting System.....	166
Generator Showing Perforated Pulley and Sup- porting Arms.....	167
Side View of Bucker Showing Coupler Head...	168
Automatic Switch.....	169
Bucker with Lower Frame Removed Showing Armature in Lower Frame.....	169
Wiring, Fixtures and Lamps.....	170
Partial Theoretical Wiring Diagram.....	171
Relative Position of Bucker and Junction Box on Bottom of Car Body.....	172
Arrangement of Circuits.....	173
Battery Current Regulation.....	175
Car Generator.....	177
Car Generator Showing Outside Suspension Pul- ley End.....	177

Car Generator—Continued.

Side View of Generator Showing Armature Pulley, Axle Pulley, Belt and Tension Mechanism	178
Belt Tension Mechanism.....	179
Pulleys and Belts.....	179
Side View of Generator Showing Lower Frame Swung Down, Exposing Internal Parts, Armature Remaining in Upper Frame.....	180
Advantages of Bliss Suspension.....	180
Generator Field Coils and Retainers.....	181
End View of Generator, Showing Bearing Head and Hand Hole Cover Removed, Exposing Automatic Brush Mechanism.....	182
Complete Generator Armature and Pulley, Automatic Brush Mechanism and Armature Coil.	183
Armature	183
Spider and Removable Shaft.....	184
Armature Shafts and Nuts of Generator and Bucker, Showing Spider and Removable Shaft Construction	184
End View of Generator Showing Bearing Head and Hand Hole Cover Removed.....	185
Journals and Lubrication.....	186
Brushes	186
Capacity and Rating.....	186
Brush Mechanism and Automatic Pole Changer.	186
Automatic Brush Mechanism and Flexible Cables.	187
Bucker	188
Bucker with Lower Frame Removed, Showing Armature in Upper Frame.....	189
Armatures	190
Complete Bucker Armature and Shaft.....	190

Car Generator—Continued.

Bucker Field Coils and Pole Pieces.....	190
Field Magnets.....	190
Brush Holders.....	191
Bucker Brush Holders and Details.....	191
Bearings	191
Terminals and Connections.....	192
Interior View of Bucker Showing Construction of Upper Frame, Brush Holders and Wir- ing	192
End View of Bucker Showing Complete Coupler Head and Block and Method of Connecting Car Wires	193
Operation of the Bucker.....	193
Constant Lamp Voltage.....	194
Regulation of the Generator.....	195
Economy of the Bucker.....	195
Generator Switch	195
Complete Theoretical Wiring Diagram.....	196
Generator Switch in Single Section Iron Box... Construction	197
Operation	198
Triple Contact.....	198
Generator Switch with Four-Circuit Panel Board in Double Section Iron Box.....	199
Fuse Deck	200
Adjustable Shunt	200
Emergency Exciter Switch.....	201
Junction Box.....	202
Front View Junction Box, with Cover Removed.	202
The Standard Code Train Rules.....	203
General Rules	203
Definitions	204

Rules for Single Track.....	206
Standard Time.....	206
Certificate of Watch Inspector.....	207
Time Tables.....	208
Signal Rules.....	209
Visible Signals.....	209
Hand, Flag and Lamp Signals.....	210
Audible Signals.....	210
Air Whistle or Bell Cord Signals.....	212
Train Signals.....	212
Use of Signals.....	213
Superiority of Trains.....	214
Movement of Trains.....	215
Rules for Movement by Train Orders.....	220
Forms of Train Orders.....	228
Fixing Meeting Points for Opposing Trains....	228
Directing a Train to Pass or Run Ahead of An- other Train	228
Giving Right to a Train over an Opposing Train.	229
Time Order.....	230
For Sections	231
For Changing Sections.....	232
Extra Trains.....	234
Work Extra.....	235
Holding Order.....	236
Annulling a Schedule or a Section.....	237
Annulling an Order.....	237
Annulling Part of an Order.....	237
Suspending an Order or Part of an Order....	238
Rules for Double Track.....	238
Signal Rules.....	239
Train Signals.....	239
Use of Signals.....	240

Forms of Train Orders—Continued.

Superiority of Trains.....	240
Movement of Trains.....	241
Rules for Movement by Train Orders.....	243
Form of Train Orders.....	244
Work Extra.....	244
Annuling Part of an Order.....	246
Providing for a Movement Against the Current of Traffic.....	246
Providing for the Use of a Section of Double Track as Single Track.....	247
Rules Regulating Movement of Trains Against the Current of Traffic on Double Track by Means of Block Signals.....	248
Rules Governing the Movement of Trains with the Current of Traffic on Double Track by Means of Block Signals.....	249
Trainmen's Examination.....	250
General Rules.....	250
Rules for Single Track Standard Time.....	252
Time Table.....	254
Signal Rules.....	257
Visible Signals.....	258
Hand, Flag and Lamp Signals.....	259
Audible Signals.....	262
Air-Whistle or Bell-Cord Signals.....	265
Train Signals.....	266
Use of Signals.....	270
Superiority of Trains.....	280
Movement of Trains.....	281
Rules for Movement by Train Orders.....	291
Forms of Train Orders.....	301

Trainmen's Examinations—Continued.

Extra Trains.....	308
Work Trains.....	310
Rulings of the American Railway Association.....	314
Rights of Trains in Yard Limits.....	315
Yard Engines.....	315
Regular Trains Passing.....	316
Extra Trains Passing.....	316
Order.....	317
New Time Table.....	319
Arriving Time.....	323
Clearance Card.....	323
Pilot.....	324
Direction.....	324
Color.....	324
Blue Signal.....	324
Switch Lights.....	325
Superseding an Order.....	328
Meeting Point.....	328
Annuling a Section.....	333
Does not Supersede.....	335
Work Train.....	336
Reverse Movement.....	336
Size of Blank.....	337
Interlocking Rules.....	343
Definitions.....	343
Rules.....	343
Signalmen.....	344
Enginemen and Trainmen.....	348
Repairmen.....	348
Block Signal Rules.....	350
Home Signals.....	351

Enginemen and Trainmen.....	359
Controlled Manual Block System.....	360
Adjuncts	361
Signalmen	363
Enginemen and Trainmen.....	369
Automatic Block System.....	371
Adjuncts	372
Distant Signals	372
Train Order Signals.....	375
Target Signals.....	376
Semaphores, Common Types.....	377
A Two-Position Train-Order Signal.....	378
A Train Order Signal.....	379
A Three-Position Signal.....	380
Different Type of Three-Position Signal.....	380
Semaphore (Double Arm) for Use on Single Track	384
The Universal Semaphore.....	385
Type of Semaphore Arm, Considered Standard.....	386
Types of Standard Semaphore Arms.....	387
Semaphore Arm	388
Cupola Identification Method.....	389
The Manual Controlled System.....	391
The Disc Type of Semaphore.....	392
Home and Distant Signals.....	393
Clear Indicated by Green Light.....	394
Night Colors	395
The Electric Train Staff System.....	395
Absolute Staff Instrument with Pedestal.....	397
Absolute Staff Instrument.....	399
Absolute Staff Instrument.....	400
The Permissive Feature.....	407
Control of Signals.....	409

Train Order Signals—Continued.	
Staff Lever Lock.....	410
Switch Locking.....	411
Intermediate Siding and Junction Instruments..	411
Pusher Engine Attachment.....	412
Pusher Attachment.....	413
Circuit Controller Attachment.....	414
Circuit Controller Attachment.....	415
Staff System on the Southern Pacific Railway..	416
Crane Staff Deliverer.....	417
The A. B. C. System.....	418
Table of Resistance for Electric Train Staff System	420
Staff Catcher and Deliverer.....	422
View Showing Staff in Crane Staff Deliverer Ready to be Taken by a Passing Train....	423
Eight Semaphore Signal Bridge Equipped with the Safety Storage System.....	425
Block Signal Examination.....	427
Signalling Catechism	432
Ten Minute Block.....	435
Definitions	435
Signals used in Automatic Block.....	436
Signals of Interlocking Plants.....	440
Signals of Interlocking Plants.....	443
Definitions	447
Repairmen	451
Pointers for Conductors.....	453
Pointers to Brakemen.....	457
General Rules Covering the Operation of Trains and Handling of Freight and Passengers.....	458
Train-men Handling Brakes.....	474
Detaching Engine or Cars.....	475

Trainmen Handling Brakes—Continued.

Coupling Frozen.....	475
Train Breaking into Two or More Parts.....	475
Cutting out the Brake on a Car.....	475
Conductor's Valve.....	476
Burst Hose	476
Brakes Not in Use.....	477
Retaining Valve	477
Train Air Signal.....	477
Reporting Defects to Inspectors.....	478
Starting Trains	478
The Air Brake Association's Questions and Answers for Trainmen.....	478
Bursted Hose and Broken Train Pipes.....	479
Break-in-Twos	480
Use of Hand Brakes.....	481
Bleeding-Off Brakes	482
Rules for Giving First Aid to the Injured.....	484
Shock	484
Crushed Limbs	485
Broken Limbs	485
Transportation of the Injured.....	488
Bruises	488
Wounds or Cuts.....	488
Burns and Scalds.....	490
Electric Shock Accidents.....	491
Appendices	493

ADDENDA

Railway Yards and Handling Cars.....	503
Hump Yards	503
Classification Tracks	505
Cars: Handling in Yards.....	506
In-Freight	507
Out-Freight	508
Transfer Freight	509
Distribution of Cars	510
Conditions Surrounding Distribution.....	510
The Car Distributor	511
The Chief Dispatcher	511
Other Factors	513
Coal Cars	514
List of Freight Cars.....	517
Repairs to Freight Cars.....	519
M. C. B. Code of Rules.....	519
Defect Card—Use of.....	520
Wheels—Defects of	522
Axles—Defects of	526
Trucks—Defects of	528
Brakes—Defects of	528-9
Bodies—Defects of	529
Combinations of Defects.....	531
Instructions to Repair Men.....	532-539
Repair Card—Use of.....	539
Billing—Instructions for	541-553
Destroyed Cars—Return of Trucks.....	553
Damaged Cars—Sent in ^r Home.....	554

INDEX

Furnishing Materials	556
Disputes—Settlement of	557
Repairs to Passenger Cars.....	558
M. C. B. Code of Rules.....	558
Interchange of Equipment.....	558
Wheels—Defects in	561
Wheels—Steel-tired	562
Responsibility—Whose	563
Gas—Certificate required	563
Questions and Answers:	
Examination Catechism covering Standard Rules	
Governing	565-587
Repairs to Freight Cars for the Interchange of	
Traffic	565-587
Train Dispatching by Telephone.....	588
The C., B. & Q. System.....	591-595
An Example of How It Works.....	595
Dispatcher's Office Equipment	596
Sub-Station Equipment	599
The New York Central System.....	602-613
Block-Signal Telephones	613
Siding Telephones	614
Calling Crews by Telephone.....	614
Telephones in Wrecking Train Service.....	615
Freight Yards—Telephone Service in.....	616
Composite Service	617
Long Distance Service	620
Canadian Pacific System	621
Interchange of Business.....	622
Ownership Problems	622
Summary of Points in Favor of Phones.....	624

INDEX—PART II.

<i>Instructions for beginners</i>	3
Learners' instruments, how to connect for practice	3
Morse alphabet	6
Transmission	9
Position	9
Movement	10
Exercises in sending.....	11
Hints in sending.....	17
Punctuation	19
Receiving	20
Penmanship	21
Battery	22
Conductors and insulators.....	24
Magnetism	24
Electro-Magnet	25
Key	25
Relay	27
<i>Adjustment of instruments</i>	30
Key	30
Relay	30
Sunder	31
Switch board	31
Ground wire	33
General instructions for circuit.....	38
<i>Wire signals used in taking the circuit from others</i> ..	41
Numeral wire signals.....	41
Abbreviations	42

INDEX

<i>General rules and instructions for telegraph employes.</i>	52
Chief operator	52
Operator	53
Double order system.....	59
<i>General instructions in train order wire work.....</i>	60
Order of transmission.....	60
Acknowledgment of receipt of train orders.....	61
How to copy orders on the forms.....	62
Train order wire work.....	67
Breaking in train orders.....	68
Railroad telegrams	69
<i>General instructions in railway message wire work... 69</i>	69
Order of transmission.....	70
How to copy messages on the forms.....	70
Breaking in railway messages.....	73
Car report local.....	75
Car report foreign.....	77
<i>General instructions in commercial wire work..... 78</i>	78
Order of transmission.....	80
Sending form	82
Receiving form and how to copy on same.....	83
Receiving form	84
Timing of sent copies.....	87
Breaking in commercial messages.....	87
Mistakes in checks.....	88
Commercial messages	88
More than one address.....	89
Street addresses	90
More than one signature.....	91
Title words	92
Reporting delivery	92
Repeated message	93

Special delivery	94
Extra dates	95
Other line messages.....	97
When an answer is prepaid.....	99
Night messages	100
Code messages	101
Cipher messages	102
Government messages	102
Dead-head messages	103
Cables	104
Cable message form.....	105
Press special	106
Service messages	107
Abbreviations used	107
Forms used in transmission.....	108
Explanation and different forms used.....	108

DRAKE'S MECHANICAL BOOKS

*Title

| Style | Price

Electrical Books

Electrical Tables and Engineering Data	*Lea.	\$1.50
Electrical Tables and Engineering Data	*Cloth	1.00
Motion Picture Operation.....	*Lea.	1.50
Motion Picture Operation.....	*Cloth	1.00
Alternating Current	Lea.	1.50
Alternating Current	Cloth	1.00
Wiring Diagrams and Descrip- tions	*Lea.	1.50
Wiring Diagrams and Descrip- tions	*Cloth	1.00
Armature and Magnet Winding..	*Lea.	1.50
Armature and Magnet Winding..	*Cloth	1.00
Modern Electric Illumination....	*Lea.	1.50
Modern Electric Illumination....	*Cloth	1.00
Modern Electrical Construction..	*Lea.	1.50
Modern Electrical Construction..	*Cloth	1.00
Electricians' Operating and Test- ing Manual	*Lea.	1.50
Electricians' Operating and Test- ing Manual	*Cloth	1.00
Drake's Electrical Dictionary....	Lea.	1.50
Drake's Electrical Dictionary....	Cloth	1.00
Electric Motors, Direct and Alter- nating	*Lea.	1.50
Electric Motors, Direct and Alter- nating	*Cloth	1.00
Electrical Measurements and Me- ter Testing	Lea.	1.50

NOTE.—New Books and Revised Editions are marked*

DRAKE'S MECHANICAL BOOKS

*Title

| Style | Price

Electrical Books—Continued

Electrical Measurements and Meter Testing	Cloth	\$1.00
Drake's Telephone Handbook....	Lea.	1.50
Drake's Telephone Handbook....	Cloth	1.00
Elementary Electricity, Up-to-Date	*Cloth	1.25
Electricity Made Simple.....	*Cloth	1.00
Easy Electrical Experiments.....	*Cloth	1.00
Wireless Telegraph and Telephone Handbook	Cloth	1.00
Telegraphy, Self-taught	Cloth	1.00
Dynamo-Electric Machines	Cloth	1.50
Electro-Plating Handbook	Lea.	1.50
Electro-Plating Handbook	Cloth	1.00
Modern American Telephony....	Lea.	2.00
Handy Vest-Pocket Electrical Dictionary	Lea.	.50
Handy Vest-Pocket Electrical Dictionary	Cloth	.25
Storage Batteries	Cloth	.50
Elevators—Hydraulic and Electric	Cloth	1.00
How to Become a Successful Motorman	Lea.	1.50
Motorman's Practical Air Brake Instructor	Lea.	1.50
Electric Railway Troubles.....	Cloth	1.50
Electric Power Stations.....	Cloth	2.50
Electrical Railroading	Lea.	3.50

NOTE.—New Books and Revised Editions are marked*

DRAKE'S MECHANICAL BOOKS

*Title	Style	Price
Automobile Books		
Brookes' Automobile Handbook..*	Lea.	\$2.00
Automobile Starting and Light- ing	*Lea.	1.50
Automobile Starting and Light- ing	*Cloth	1.00
Ford Motor Car and Truck and Tractor Attachments.....*	Lea.	1.50
Ford Motor Car and Truck and Tractor Attachments.....*	Cloth	1.00
Automobile Catechism and Repair Manual	*Lea.	1.25
Practical Gas and Oil Engine Handbook	*Lea.	1.50
Practical Gas and Oil Engine Handbook	*Cloth	1.00
Farm Books		
Farm Buildings, With Plans and Descriptions	*Cloth	\$1.00
Farm Mechanics	*Cloth	1.00
Traction Farming and Traction Engineering	*Cloth	1.50
Farm Engines and How to Run Them	Cloth	1.00
Shop Practice Books		
20th Cent'y Machine Sh'p Practice	Cloth	\$2.00
Practical Mechanical Drawing....	Cloth	2.00
Sheet Metal Workers' Manual...*	Lea.	2.00
Essential of Sheet Metal Work and Pattern Drafting.....*	Cloth	1.50
Oxy-Acetylene Welding and Cut- ting	*Lea.	1.50
Oxy-Acetylene Welding and Cut- ting	*Cloth	1.00
20th Century Toolsmith and Steel- worker	Cloth	1.50
Pattern Making and Foundry Practice	Lea.	1.50
Modern Blacksmithing.....	Cloth	1.00

NOTE.—New Books and Revised Editions are marked*

DRAKE'S MECHANICAL BOOKS

*Title

Style | Price

Steam Engineering Books

Swingle's Handbook for Steam Engineers and Electricians....	*Lea.	\$3.00
Steam Boilers, Construction, Care and Operation	*Lea.	2.00
Complete Examination Questions and Answers for Marine and Stationary Engineers	*Lea.	2.00
Swingle's Catechism of Steam, Gas and Electrical Engineering.*	Lea.	1.50
The Steam Turbine, Its Care and Operation	Cloth	1.00
Calculation of Horse Power Made Easy	Cloth	.75

Railroad Books

Modern Locomotive Engineering.*	Lea.	\$3.00
Locomotive Fireman's Boiler Instructor	*Lea.	1.50
Locomotive Engine Breakdowns and How to Repair Them.....	*Lea.	1.50
Operation of Trains and Station Work	*Lea.	2.00
Construction and Maintenance of Railway Roadbed and Track...	Lea.	2.00
First, Second and Third Year Standard Examination Questions and Answers for Locomotive Firemen	*Lea.	2.00
Complete Air Brake Examination Questions and Answers.....	*Lea.	2.00
Westinghouse Air Brake System.	Cloth	2.00
New York Air Brake System....	Cloth	2.00
Walschaert Valve Gear Breakdowns	Cloth	1.00

NOTE.—New Books and Revised Editions are marked*

DRAKE'S MECHANICAL BOOKS

*Title	Style	Price
Carpentry and Building Books		
Modern Carpentry. Two volumes.	Cloth	\$2.00
Modern Carpentry. Vol. I	Cloth	1.00
Modern Carpentry. Vol. II	Cloth	1.00
The Steel Square. Two volumes..	Cloth	2.00
The Steel Square. Vol. I	Cloth	1.00
The Steel Square. Vol. II	Cloth	1.00
A. B. C. of the Steel Square	Cloth	.50
A Practical Course in Wooden Boat and Ship Building	*Cloth	1.50
Common Sense Stair Building and Handrailing	Cloth	1.00
Modern Estimator and Contrac- tor's Guide	*Cloth	1.50
Light and Heavy Timber Framing Made Easy	Cloth	2.00
Builders' Architectural Drawing Self-taught	Cloth	2.00
Easy Steps to Architecture	Cloth	1.50
Five Orders of Architecture	Cloth	1.50
Builders' and Contractors' Guide	Cloth	1.50
Practical Bungalows and Cottages	*Cloth	1.00
Low Cost American Homes	*Cloth	1.00
Practical Cabinet Maker and Fur- niture Designer	Cloth	2.00
Practical Wood Carving	Cloth	1.50
Home Furniture Making	Cloth	.60
Concretes, Cements, Mortars, Plas- ters and Stuccos	Cloth	1.50
Practical Steel Construction	Cloth	.75
Practical Bricklaying Self-taught.	Cloth	1.00
Practical Stonemasonry	Cloth	1.00
Practical Up-to-date Plumbing	Cloth	1.50
Hot Water Heating, Steam and Gas Fitting	*Cloth	1.50
Practical Handbook for Mill- wrights	Cloth	2.00
Boat Building for Amateurs	Cloth	1.00

NOTE.—New Books and Revised Editions are marked*

DRAKE'S MECHANICAL BOOKS

*Title

Style | Price

Painting Books

Art of Sign Painting.....	*Cloth	\$3.00
Scene Painting and Bulletin Art..	*Cloth	3.00
"A Show at" Sho'Cards.....	*Cloth	3.00
Strong's Book of Designs.....	*Lea.	3.00
Signist's Modern Book of Alpha- bets	Cloth	1.50
Amateur Artist	Cloth	1.00
Modern Painter's Cyclopedia.....	Cloth	1.50
New Stencils and Their Use.....	*Cloth	1.25
Red Book Series of Trade School Manuals—		
1. Exterior Painting, Wood, Iron and Brick.....	Cloth	.60
2. Interior Painting, Water and Oil Colors	Cloth	.60
3. Colors	Cloth	.60
4. Graining and Marbling.....	Cloth	.60
5. Carriage Painting.....	Cloth	.60
6. The Wood Finisher.....	Cloth	.60
New Hardwood Finishing.....	Cloth	1.00
Automobile Painting.....	*Cloth	1.25
Estimates, Costs and Profits—		
House Painting and Interior Decorating	*Cloth	1.00

NOTE.—New Books and Revised Editions are marked*

DRAKE'S HOME-STUDY BOOKS

*Title	Style	Price
General Instruction and Reference Books		
Putney's Law Library (12 volumes)	Buckram	\$60.00
Bookkeeping Self-taught	Cloth	1.00
Complete Courses in Bookkeeping, Including Blank Books and Supplies	Cloth	7.50
Elementary Chemistry Self-taught	Cloth	1.00
Picture Making for Pleasure and Profit	Cloth	1.25
Complete Courses in Civil Service.*	Cloth	1.50
Felt's Parliamentary Procedure..	Cloth	.60
McClure's Horse, Cattle and Sheep Doctor	*Cloth	1.25
Practical Lessons in Hypnotism and Magnetism	Paper	.50
Practical Lessons in Hynotism and Magnetism	Cloth	1.00
Chadman's Dictionary of Law....	$\frac{1}{2}$ Lea.	6.00
Modern Magician's Handbook....	Cloth	1.50
White House Handbook of Ora- tory	Cloth	1.00
Standard Cyclopedia of Receipts.	Cloth	1.25
American Star Speaker and Elo- cutionist	Cloth	1.25
Swimming and Life Saving.....	Paper	.30
Words as They Look (Webster's System of Memorizing Easy and Difficult Words).....	Cloth	.50
Astrology (Were You Born Under a Lucky Star?).....	Cloth	1.00

NOTE.—New Books and Revised Editions are marked*

DRAKE'S HOME-STUDY BOOKS

*Title	Style	Price
General Instruction and Reference Books		
Ropp's Calculator—		
Style A. Large Size....	Moroccoline	1.25
Style B. With Flap....	Leather....	1.00
Style C. Pocket Size....	Moroccoline	.50
Style D. Vest Pocket...	Leather....	.50
Albertus Magnus (Egyptian Secrets)	Cloth	1.00
Sixth and Seventh Books of Moses.	Cloth	1.00
Drinks as They Are Mixed.....	Cloth	.25
Drinks as They Are Mixed.....	Lea.	.50
Guide to Successful Auctioneering.	Paper	.25
Safe Methods of Stock Speculation	Cloth	.50
Gypsy Witch Fortune Telling Cards	Per Pack	.50
Mrs. Parker's Monologues and Plays		
Monologues, Stories, Jingles and Plays	*Cloth	\$1.00
New Monologues and Dialect Stories	Cloth	1.00
Mary Moncure Parker's Plays—		
Powder and Patches.....	Paper	.25
When Your Wife's Away.....	Paper	.25
Love Behind the Scenes.....	Paper	.15
Mrs. Gadabout's Busy Day.....	Paper	.15
Black Art	Paper	.15
A Day at the Know-It-All Woman's Club	Paper	.25
The Rehearsal	Paper	.15
The Princess Innocent.....	Paper	.15
A Quiet Evening at Home.....	Paper	.15
A Colonial Dream.....	Paper	.15

NOTE.—New Books and Revised Editions are marked*

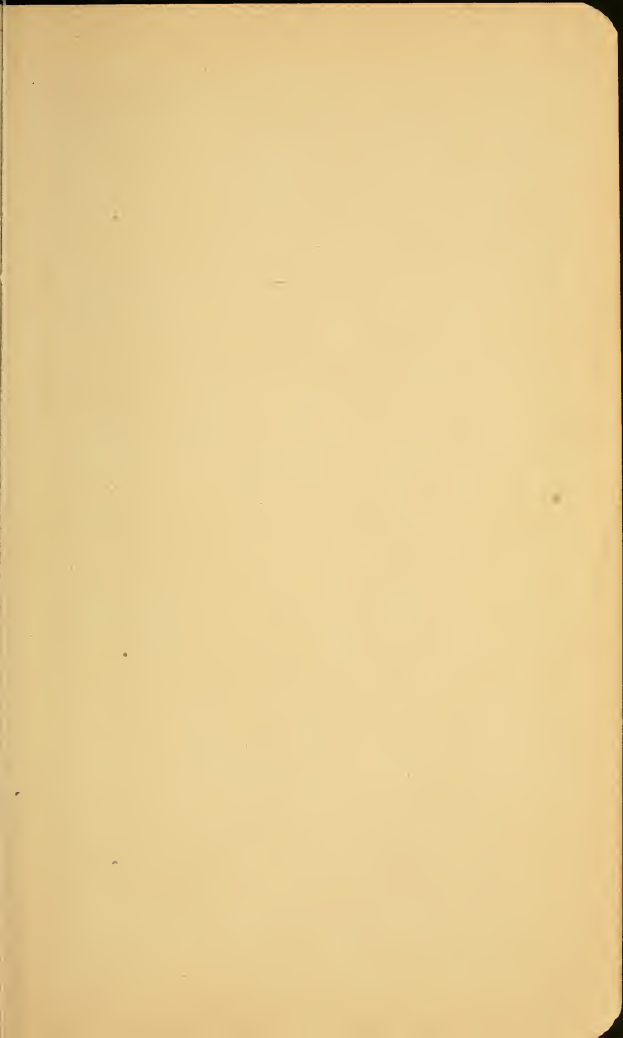

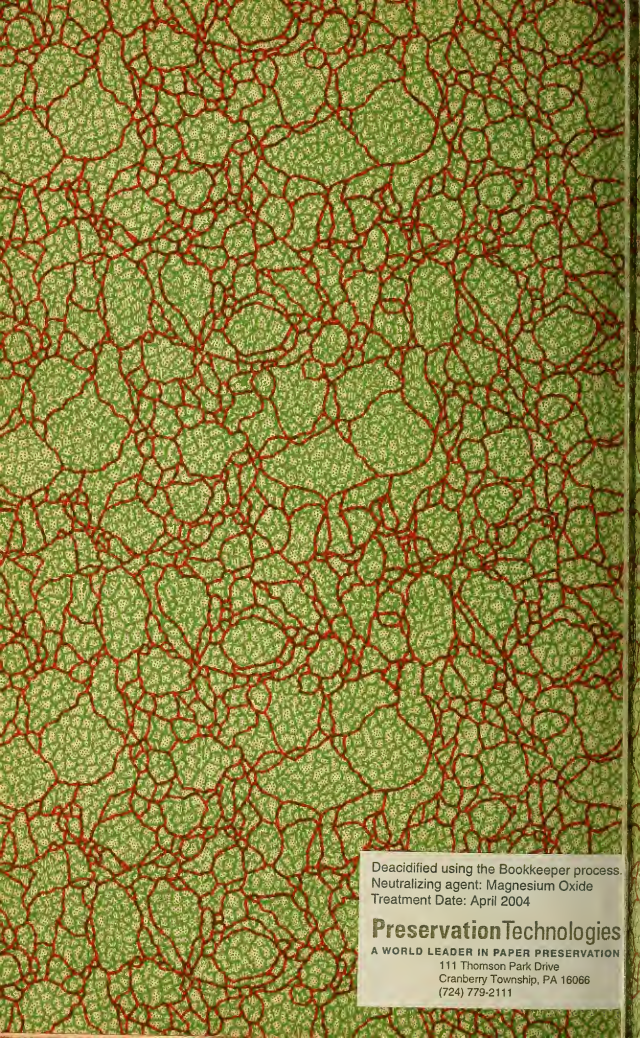

Deacidified using the Bookkeeper process.
Neutralizing agent: Magnesium Oxide
Treatment Date: April 2004

Preservation Technologies

A WORLD LEADER IN PAPER PRESERVATION

111 Thomson Park Drive
Cranberry Township, PA 16066
(724) 779-2111

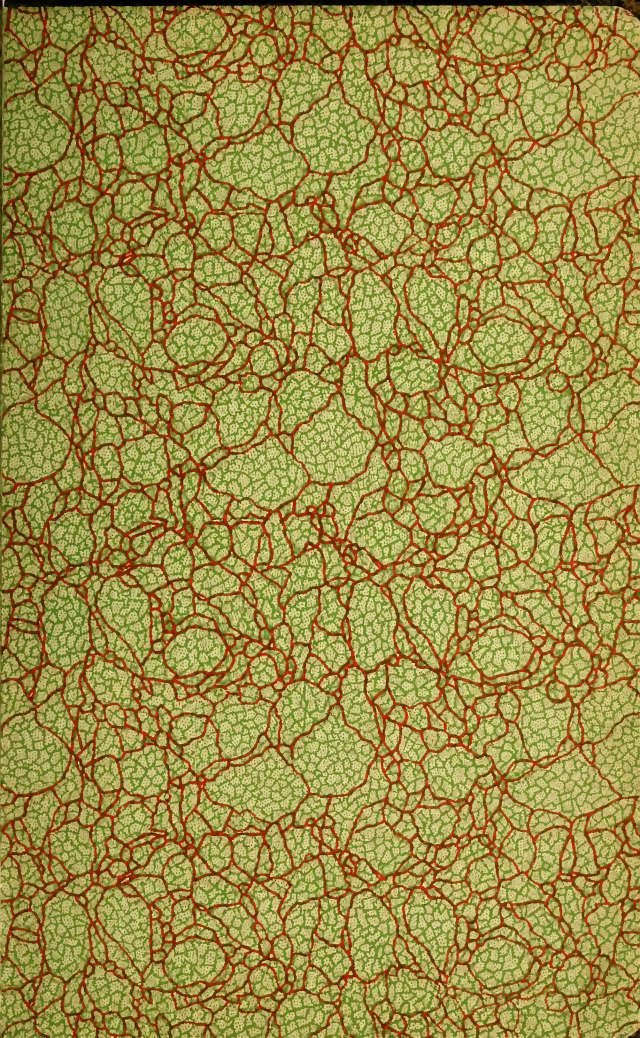

LIBRARY OF CONGRESS



0 012 158 505 4

