



Class TK6540

Book R3

Copyright N^o _____

COPYRIGHT DEPOSIT.

GPO

Scanned from the collections of The Library of Congress



Packard Campus
for Audio Visual Conservation
www.loc.gov/avconservation

Motion Picture and Television Reading Room
www.loc.gov/rr/mopic

Recorded Sound Reference Center
www.loc.gov/rr/record

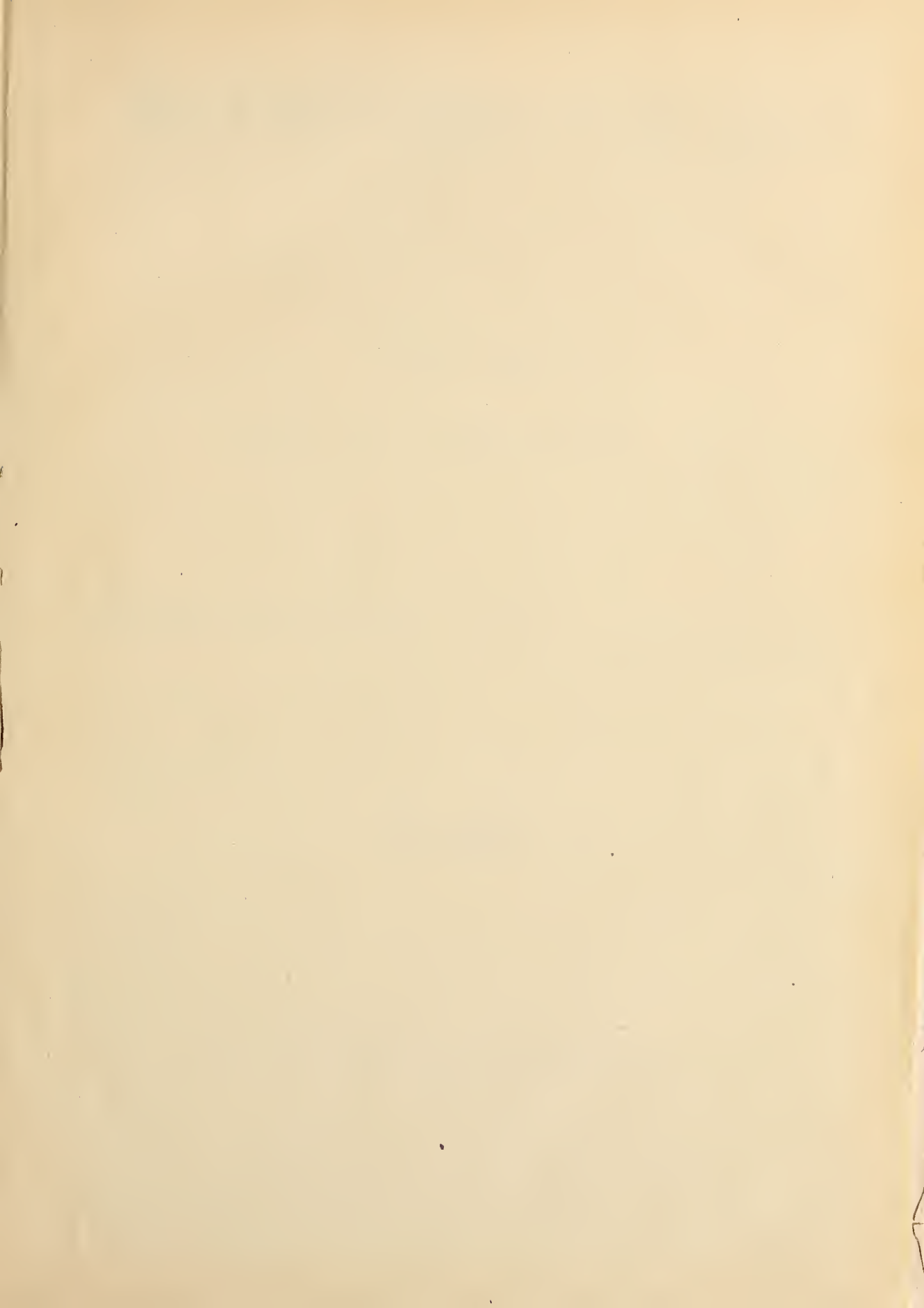

RADIO BROADCAST

VOLUME I

MAY, 1922, to OCTOBER, 1922

RADIO FOR EVERY PLACE AND PURPOSE



GARDEN CITY NEW YORK
DOUBLEDAY, PAGE & COMPANY
1922

TK 6570

R3

Copyright, 1922, by
DOUBLEDAY, PAGE & COMPANY



Essential for GOOD Reception



**Weston
Filament
Voltmeter**

GIVES you your proper voltage instantly—thus greatly simplifies tuning. Saves its cost over and over by eliminating hazardous guesswork and making it possible to get doubled or trebled life out of each tube. A premature tube "burn-out" is practically an unknown occurrence with a Weston Voltmeter—if you use it properly.

Your dealer can supply you, or if he cannot, we will. Don't take a substitute if you want best results. Write for Radio Circular J.

Weston Electrical Instrument Co.
179 Weston Ave. Newark, N. J.



"STANDARD" *The World Over*
**ELECTRICAL
INSTRUMENTS**

*An Indicating
Instrument for
Every Individual
Need and Industrial
Purpose*

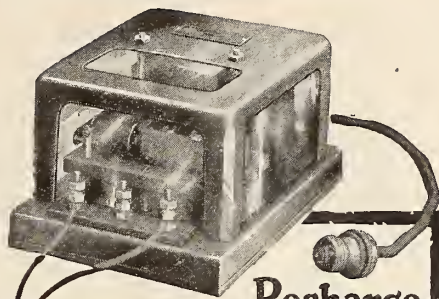

Recharge Your Battery at Home

Charges Both A and B Radio Batteries

Don't be without the use of your Radio Receiving Set while your battery is being charged. Get a Valley Charger and charge your battery right at home. Attach the Charger to your home lamp socket—attach the clips to the battery terminals and you will get a quick, tapering charge which just exactly charges your battery, but cannot over-charge or harm it in any way.

Will charge the A 6 volt battery at a 5 ampere rate, and the B 22½ volt battery at the required ½ ampere rate. 45 volt B batteries may be connected in parallel so that they can also be charged.

SATISFACTION GUARANTEED If your local distributor cannot supply you, write direct to

VALLEY ELECTRIC COMPANY,
Department G ST. LOUIS, MO.

\$18.00
F. O. B. St. Louis

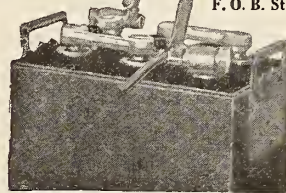

JAXON "B" STORAGE BATTERY AND CHARGER

\$5.75



Jaxon "B" Storage Battery

Variable Voltage 18-20-22-24 Volts. Made of only new materials. Batteries are delivered fully charged. Rubber and wood separators used; the good qualities of both with none of their faults.

Price each \$5.75



"B" Battery Charger

For use on AC Current, will fully charge "B" Battery for a few cents in about ten hours. Simple to operate, highly efficient.

Price each, without mason jar 75c

Write for prices on "A" Storage Batteries.
JACKSON BATTERY COMPANY 1121B Jackson Blvd., Chicago, Ill.

COMPLETE RADIO SET READY TO LISTEN IN

\$14.50
C. O. D.

**FOR THE COMPLETE SET,
INCLUDING AERIAL.**

(Regular price: \$25)

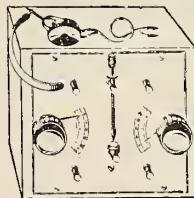

This outfit is intended for the fan that appreciates a good thing. It includes a high grade tuner with a 40 to 60 mile radius, 1200 ohm phone, insurance, and complete aerial set.

SEND NO MONEY unless you wish. Simply send us your name and address, and we will mail immediately. You pay Postman on arrival, our price, plus postage. Satisfaction guaranteed, or money refunded.

THE UNWIN TRADING CO.
55 Broadway New York

Don't You Want the Best Radio Station in Your Town?

FALL is here and the loud, clear signals from far-distant stations may be taken right out of the air.

The biggest, best year radio has ever had is just beginning and now is the time for you to get ready for the enjoyable evenings radio offers you. There are more and better broadcasting stations and it is now possible for you to enjoy the concerts regardless of your location.

Radio transmitting and receiving units have been developed to a remarkable degree of perfection during the past few months and RADIO BROADCAST is making an effort to let you have the benefit of this improvement.

We have had samples from many manufacturers and have selected those which may be counted upon to give you satisfactory service.

There is a great list of the best devices, made by reliable manufacturers, from which you may make a selection of the parts you need to bring your station up to date.

There are telephone receivers, vacuum tubes, tube sockets, spark gaps, inductances, meters of all kinds—in fact parts for all kinds of transmitting and receiving stations, for you to choose from.

And the most interesting part of our announcement is:

THE PARTS NEED NOT COST YOU A PENNY.

Let RADIO BROADCAST tell you how this is possible.

**Circulation Dept., Radio Broadcast
Doubleday, Page & Co., Garden City, N. Y.**

Please send me complete information about your plan for selecting radio material from your list by return mail.

.....
.....
.....

RADIO "A" & "B" STORAGE Batteries CHARGED at Home for a Few Cents Overnight with "The PATENTED FULL WAVE" 105-125 Volt 60 Cycle A. C. Magnetic Taper Charge Design

F-F RADIO RECTIFIER

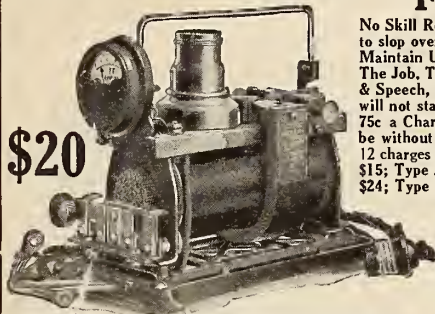

\$20

No Skill Required. It Charges Automatically. Being Clean it can be placed anywhere. Nothing to slop over, be filled, burn out, need attention or cause trouble. Carbon Rectifying Brushes Maintain Uninterrupted Service at Constant Efficiency. INSIST on RECTIFIER that Is Built For The Job. The F-F RADIO. Is it not gratifying to be Always Ready for Radiophone Broadcast Music & Speech, when Friends Call? Do not think Your Battery is dead and worn out, simply because it will not start Your Car. Buy an F-F RADIO RECTIFIER and Fill It With Life. They Save You 75c a Charge and Last a Lifetime. It Costs Less To Buy an F-F BATTERY BOOSTER than to be without one. POPULAR PRICES: Type 6 charges "A" 6 Volt Battery at 6 amperes \$15; Type 12 charges 12 Volt Battery at 5 amperes \$15; Type B charges Radio "B" Batteries up to 120 Volts \$15; Type A-B charges both "A & B" Batteries \$20; Type 166 charges 6 Volt Battery at 12 amp res \$24; Type 1612 charges 12 Volt Battery at 7 amperes \$24; Type 1626 is a Combination of Types 166 and 1612 and Charges Both 6 and 12 Volt Batteries \$36. The Larger Types are recommended for heavy Batteries, or where time is limited. Shipping Weights Complete with AMMETER & BATTERY CLIPS 11 to 15 lbs. Purchase from Dealer, or Mail Check for Prompt Express Shipment; include Postage & Insurance Charges for P. P. Shipment, or Write us to Ship Type desired C. O. D. For GROUP CHARGING up to 12 Batteries, Automatically, with Real Economy In First Cost and Service. Write for Free F-F ROTARY RECTIFIER Bulletin 41A. ORDER Now, or WRITE Immediately for FREE Descriptive BOOSTER Bulletin 41.

They Also CHARGE AUTO Batteries

THE FRANCE MFG. CO., CLEVELAND, OHIO, U. S. A.
Canadian Representative: Battery Service & Sales Co., Hamilton, Ontario, Canada.

THORNTON

Audio Frequency Amplifying

"The Transformer Supreme"

Jobbers' Territory Open—
Write for Particulars

**Thornton
Transformer
Company, Inc.**

30 Church St., New York



RADIO MAILING LISTS

7062 Retail Radio Dealers covering the United States,
by states, price per thousand, \$7.50
1084 Radio Manufacturers per list, 10.00
1307 Radio Supply Jobbers " " 12.50
260 Owners of Radio Stations " " 4.00
14000 Radio Amateurs and Managers of Radio Stations, per M 7.50

These neatly typewritten and ready to send you on receipt of remittance covering the amount guaranteed 98% correct.
Trade Circular Addressing Co., 166 West Adams St., Chicago, Ill.

PAPER TUBES FOR RADIO

We Manufacture both Parallel and Spiral Wound
Samples and Prices on Request

LOWELL PAPER TUBE CORPORATION
42 Warren Street Lowell, Mass.

CHASLYN PATENTED "SINK-OR-SWIM" BALL BATTERY TESTER **\$1.00**

Specific gravity shown instantly by floating or sinking of colored balls. Accurate—Simple—Won't break if dropped

Tester, Water Filler and Depth Gauge
All For a Dollar Bill

Send One Dollar and your dealer's name and address and set will be mailed you

THE CHASLYN COMPANY
4313 Kenmore Ave. Chicago



WONDER STATE CRYSTAL



Richer in Silver, harder, denser, makes better contact than Galena detectors found elsewhere. New Style Mounting (pat. applied for) as superior to present method as soldered connection is to unsoldered in electric wiring.

Mounted, 50c; Unmounted, 25c.
Special terms to dealers.

WONDER STATE CRYSTAL CO.
BATHURST BLDG., LITTLE ROCK, ARK.

Circuits of Victory

By A. LINCOLN LAVINE

THE dramatic story of the Signal Corps in the war. The circuits of victory were the important arteries that, through the medium of the telephone, the telegraph, cable, and radio, made possible intelligent communication among the forces on land and sea and in the air. A brilliant chapter in America's war history.

\$3.00 at Bookstores

DOUBLEDAY, PAGE & CO., Garden City, N. Y.

FOR SALE

Transmitter—De Forest, 1-KW transmitter complete. Latest model, perfect condition. Price \$2,500.00. This outfit has perfect modulation and great range. Immediate delivery.

DANIELS RADIO SUPPLY COMPANY
Independence Kansas

JOY-KELSEY CORPORATION
Manufacturers
RADIO EQUIPMENT
4021 West Kinzie St. Chicago Ill.



RADIO CLUB PINS

An emblem made to order for your Club will work wonders—write to-day for free 52-page catalogue showing Radio emblems, class rings and pins. Samples loaned to officers.

METAL ARTS CO., Inc.

No. 937
7785 South Avenue

Rochester, N. Y.

**ALL THE PARTS FOR A VACUUM TUBE
REGENERATIVE RECEIVING SET FOR \$10**

NOT ONLY All the Parts for a Modern Three
Circuit Receiver for Practical Use
Designed by a Recognized Radio Expert

BUT Full, Clear, Explicit Instructions, with Diagrams,
How to Make and Assemble Them from the
Material Supplied in

The Practical Radio Book
**"THE HOW AND WHY OF
RADIO BROADCASTING"**

HERE'S WHAT YOU GET FOR ONLY \$10

1. "The How and Why of Radio Broadcasting"—the book that tells you just what you need to know about radio.
2. Parts for the receiver cabinet.
3. Specially finished front panel.
4. All the parts, including stators, rotors, axles, friction washers, rotor balls, and wire for two variometers.
5. All the parts for one vario-coupler.
6. Metal indicators.
7. Control knobs for tuning devices.
8. Vacuum tube socket.
9. Rheostat.
10. Wire for winding vario-coupler and variometers.
11. Grid leak and condenser unit.
12. Inductance switches for vario-coupler.
13. Contact points for vario-coupler.
14. Spring connectors for making an easy job of the wiring.
15. Eight binding posts.
16. Hard drawn copper wire for making substantial, bus-type connections.
17. Metal foil for making the shield which cuts out "howling," due to "body capacity" effect.
18. Complete soldering outfit, including soldering iron, solder, resin and scraper—just the thing for radio work.

Everything is here to enable you to build a receiver, without any special tools, without requiring any knowledge of radio, without any complicated parts—but with all the advantages of an expensive receiver at about one-sixth its usual cost. And you have all the fun of making it. Send money order for

KD-10

KAY-DEE RADIO SUPPLY CO.
133 Johnson St., Brooklyn, New York.

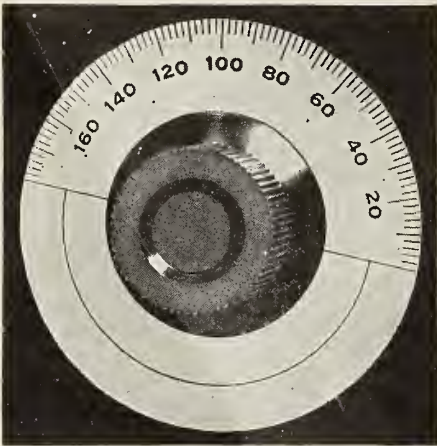

A Quality Dial For a Dollar!

Bakelite knob to fit $\frac{1}{8}$ " or $\frac{3}{16}$ " shaft. Silvered dial, 3 $\frac{1}{2}$ " diameter, which may be grounded to prevent capacity effects from the hand. Space for writing in station call letters. Guaranteed.

Sent Postpaid if Your Dealer Has None in Stock **\$1.00**

SOMERVILLE RADIO LABORATORY
43 Cornhill Boston, Mass.

Get this

The Music Master
Radio Amplifier
greatly magnifies
volume and repro-
duces sound of un-
equalled resonance,
entirely free from
that harsh metallic
screeching.



21 inch for concert and out-of-doors . . . \$45.00
14 inch for general use in home . . . 35.00

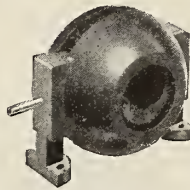

Geraco Variometer
and Variocoupler As-
semblies are a long
step ahead in the de-
velopment of accurate
tuning instruments.

Variometers . \$6.00
Variocouplers . 5.00

Geraco products are the final re-
sult of months of careful experi-
ments. They are the best that
competent experts can do. Thus
"Geraco" is our guarantee to
YOU—and your guarantee to the
Radio devotee.

All Geraco products are made
from only the best dielectric ma-
terial, either hard rubber or
special Geraco compound.

Write for complete information
on Geraco:—

Variometers, complete	Variocouplers, complete
Variometer Rotors	Variocoupler Tubes
Variometer Post Assemblies	Variocoupler Balls
Variometer Stators	Vacuum Tube Sockets
Dials	Crystal Detector Bases
Knobs	Aerial Insulators

The Music Master Radio Amplifiers

Manufacturer, Jobbers and Dealers: Write
at once for complete schedule of discounts

GENERAL RADIO CORPORATION

Manufacturers and Distributors of High-Grade Radio Apparatus
624-628 Market Street PHILADELPHIA, PA.



INDEX

(*Illustrated Articles. Editorials in Italics.)

	PAGE		PAGE
A DVENTURES in Radio:		Books About Radio (John V. L. Hogan)	439
Found by Radio (Pierre Boucheron)	72	British Army Opinions on Radio in the Next War	530
*Married by Radio (Pierre Boucheron)	162	<i>British Columbia, Radio Service for</i>	100
*Sunk by Radio (Pierre Boucheron)	164	British Mullard Tubes, The	99
Aerials and Antennas:		British Valves and Our Vacuum Tubes	443
*Construction and Operation of a Loop Radiophone Transmitter	51	Britain's New Radio Station	60
<i>Lighting Wire as an Antenna, The</i>	461	Broadcasting:	
*Mistakes to Avoid in Erecting Antennas (G. Y. Allen)	145	<i>Better Broadcasting Station, A</i>	196
*Protection of the Receiving Antenna (G. Y. Allen)	214	*Broadcasting Church Services (W. W. Rodgers)	321
*Tuning the Radio Aerial System (John V. L. Hogan)	107	*Broadcasting Nearly to the Arctic Circle (Frazer M. Gerrie)	527
*Will Antennas Be Buried in the Back Yard? (Lewis Wood)	303	*Broadcasting on Power Lines	115
Africa:		Broadcasting Stations in the United States 270, 293, 438	538
Improving the South African Radio Service	530	Church Services by Radio	375
<i>Northern Africa Radio Station</i>	100	*Church with a Mighty Congregation, A (Archie Richardson)	218
Airplane:		<i>Dangers in Unreliable Broadcast Lectures, The</i>	455
<i>Airplane and the Radio Beacon, The</i>	99	England's Broadcasting Problem	442
Radio Cable and Airships, The	62	Experiment in Broadcasting, An	196
"All Red" Radio and World Communication, The	353	*Great Britain's Weather Broadcasts	354
Alternating Current:		<i>How Many Simultaneous Broadcasts Are Possible?</i>	192
Operating Vacuum Tubes on Alternating Current	60	Long Distance Broadcasting of News Radio Broadcasting (R. J. McLaughlin)	136
Amateur:		Radiophone Broadcasting in Paris	254
*Amateur Radio Laboratory, The (Zeh Bouck)	142	*Random Observations on Running a Broadcasting Station (H. M. Taylor)	223
<i>Amateur Radio Reserve, The</i>	281	Revenue for the Broadcasting Organizations	529
Amateur Stations in France	356	<i>War Between Broadcasting Stations</i>	457
Belgian Amateurs Seriously Restricted	529	* <i>What Kind of Broadcasting is Coming?</i>	192
*Our Amateur Radio Reserve (Major Paul W. Evans, U. S. A.)	243	*What the Detroit News Has Done in Radio Broadcasting (R. J. McLaughlin)	136
<i>Arbitration Society of America May End Radio Disputes</i>	463	*When De Wolf Hooper Broadcasted to His Biggest Audience	198
Armstrong:		*Wire Broadcasting (John F. Duncan)	116
*Armstrong Patent, The	71	C ABLE vs. Radio	99
*Armstrong's Super-Regeneration	371	<i>Calling Apparatus, Radio</i>	99
*Armstrong's Super-Regenerative Circuit (Paul F. Godley)	426	*Care and Operation of a Crystal Receiving Set (Edgar H. Felix)	120
Atmospheric Conditions and Radio	61	*Charging the "B" Storage Battery (G. Y. Allen)	413
*Audio Piloting Cable in the Ambrose Channel, The (Donald Wilhelm)	249	China:	
B EGINNING of Broadcasting in England, The	59	China's Radio Telephone Service	355
Belgium:		*Choosing a Radio School (Howard S. Pyle)	493
Belgian Amateurs Seriously Restricted	529	Church Service by Radio	375
Belgium's Expanded Radio Service	444	*Church with a Mighty Congregation, A (Archie Richardson)	218
Giant Belgian Radio Station, A	58	Clearing Up the Ether (Paul F. Godley)	316
Bell, Dr. Alexander Graham:		Coil Antennas:	
*Evening With Dr. Alexander Graham Bell, An (Donald Wilhelm)	205	<i>See Antennas</i>	
Better Equipment for Ship Stations	531		
*Beware of Radio Stock Offerings	284		

INDEX—Continued

	PAGE		PAGE
Collective European Weather Report from the Eiffel Tower	531	*Evening with Dr. Alexander Graham Bell, An (Donald Wilhelm)	205
*Commander Stanford C. Hooper, U. S. N. (Donald Wilhelm)	520	Expediting Port Business with Radio	252
Commercial:		Experiment in Broadcasting, An	196
*Making Radio Sales Pay (Arthur H. Lynch)	166	F ARMING:	
One Commercial Side of Radio (Parkhurst Whitney)	33	Radio and the French Farmer	61
*Compact Portable Wireless Set, A (Arthur H. Lynch)	54	*Fessenden, Reginald Aubrey (Lucille Joyce)	228
Conferences and Conventions:		Few Ideas on Radio, A (W. D. Terrill)	330
International Wireless Conference, The	353	Fishing:	
Constructing:		Radio on Fishing Boats	251
*Construction and Operation of a Loop Radiophone Transmitter	51	Forest Service:	
*How to Build and Operate a V.ry Simple Radio Receiving Set	45	*Radio in the Forest Service (Donald Wilhelm)	407
*Mistakes to Avoid in Erecting Antennas (G. Y. Allen)	145	France:	
*Simply Constructed and Operated Short-Range C. W. Transmitter, A (Zeh Bouck)	240	Amateur Stations in France	356
*Crystal Receiving Set, Care and Operation of a (Edgar H. Felix)	120	Collective European Weather Report from the Eiffel Tower	531
<i>D</i> ANGER from Static	282	French Government Communication Periodical	253
Dangers in Unreliable Broadcast Lectures, The	455	French Military Chain and Others, The	444
Detection:		Powerful French Station Excellent in Tests with New York	529
*King Electron Tells About Detection (R. H. Ranger)	497	Radio and the French Farmer	61
*Developments in High-Power Radio (Commander Stanford C. Hooper, U. S. N.)	399, 484	Radio Broadcasting in Paris	254
De Wolf Hopper:		*Francis Baker Crocker Foundation, The	281
*When De Wolf Hopper Broadcasted to His Biggest Audience	198	French Government Communication Periodical	253
*Did Peter Cooper Hewitt Discover the Grid?	460	French Military Chain and Others, The	444
Direction Finding:		G ERMANY:	
*Radio Fog Signals and the Radio Compass	247	Germany's Distribution of Radio News	352
<i>Distant Control of Apparatus by Radio</i>	283	Increasing the Range of Nauen	444
Distortion:		Radio Telephone on German Railroad	100
Objects that Distort Radio Waves (L. E. Whittemore)	101	Transatlantic Station at Eilvese, The	356
E GYPT:		Giant Belgian Radio Station, A	58
<i>English-Egypt Radio Link, The</i>	99	Goldsmith:	
Inauguration of the Anglo-Egyptian Service, The	354	*Dr. Alfred N. Goldsmith on the Future of Radio Telephony (Edgar H. Felix)	42
*Eliminating "A" and "B" Batteries by Getting Power from the Lamp Socket	462	Great Britain's Weather Broadcasts	354
England:		Great Britain's World-Wide Radio Plans	253
Beginning of Broadcasting in England, The	59	Great Progress in Radio in Italy Since the War	529
Britain's New Radio Station	60	*Grid-Questions and Answers:	
British Army Opinions on Radio in the Next War	530	Amplification, Radio and Audio	360
<i>British Mullard Tubes, The</i>	99	Armstrong's Circuits	448
British Valves and Our Vacuum Tubes	443	*Coil Antenna	76
England's Broadcasting Problem	442	*Compass, Radio	80
<i>English-Egypt Radio Link, The</i>	99	Condensers, Variable	358
Great Britain's Weather Broadcasts	354	Crystals	532
Great Britain's World-Wide Radio Plans	253	Electrons	264
Inauguration of the Anglo-Egyptian Service, The	354	Lamp-Socket Antennas	361
Interesting New Equipment from England	530	Lightning Protection	360
John Bull Considers Broadcasting	354	*Loop Antenna	76, 448
John Bull's World-Wide Radio (J. Conrad Flemming)	536	Miscellaneous	448, 450
		Regeneration	532
		*Rheostat, Use of	264
		*Tuner, The Three-Slide	266
		*Vacuum Tubes, Care of	264
		Wavelength, Determination of	532
		H EWITT, Peter Cooper:	
		<i>Did Peter Cooper Hewitt Discover the Grid?</i>	460
		History:	
		*Review of Radio, A (Lee De Forest, Ph. D., D. S. C.)	332
		*What Everyone Should Know About Radio History (Professor J. H. Morecroft)	199, 294
		*History of the Development of the United Fruit Company's Radio Telegraph System (Roy Mason)	377

	PAGE		PAGE
Holland:		N AVIGATION:	
Radio Broadcasting in Holland.....	58	*Audio Piloting Cable in the Ambrose	
*Hooper, Commander Stanford C., U. S. N.		Channel, The (Donald Wilhelm)...	249
(Donald Wilhelm).....	520	Better Equipment for Ship Stations...	531
<i>How Many Simultaneous Broadcasts Are</i>		*Making Life Safe at Sea (Arthur H.	
<i>Possible?</i>	192	Lynch).....	465
*How Opera is Broadcasted (C. E. Le		*One Vessel That Radio Might Have	
Massena).....	285	Saved (Ortherus Gordon).....	489
*How Radio Came to Independence, Kansas		Radio Equipment of Atlantic Liners..	355
(Thomas M. Galey).....	234	*Radio Fog Signals and the Radio	
*How to Begin to Enjoy Radio (Capt. Leon H.		Compass.....	247
Richmond, U. S. A.).....	151, 236	*Radio for Lifeboats.....	67
*How to Build and Operate a Very Simple		<i>Ships and Airplanes Should Carry</i>	
Radio Receiving Set.....	45	<i>Emergency Antennas</i>	464
I MPROVING the South African Radio Ser-		*New Equipment.....	180, 364
vice.....	530	*New Radio Net for Rogues (Donald Wil-	
Inauguration of the Anglo-Egyptian Service,		helm).....	231
The.....	354	<i>New Russian Station, A</i>	99
Increasing the Range of Nauen.....	444	Newspapers:	
*Increasing the Selection Power of a Radio		*What the Detroit <i>News</i> Has Done in	
Circuit (John V. L. Hogan).....	211	Broadcasting (R. J. McLaughlin)...	136
* <i>Inter-Departmental Advisory Committee to</i>		New York Radio Show, March, 1922.....	58
* <i>Help Regulate All Government Radio</i>	456	<i>Northern Africa Radio Station</i>	100
Interesting Facts About Telephone Receivers..	356	* O BJECTS that Distort Radio Waves (L.	
Interesting New Equipment From England... 530		E. Whittimore).....	101
*Interference in Radio Signaling (John V. L.		*One Vessel That Radio Might Have Saved	
Hogan).....	5	(Ortherus Gordon).....	489
International Loud-Speaker, The.....	252	One Commercial Side of Radio (Parkhurst	
International Wireless Conference, The.....	353	Whitney).....	33
Italy:		Operating:	
Great Progress in Radio in Italy Since		*Care and Operation of a Crystal	
the War.....	529	Receiving Set (Edgar H. Felix)....	120
J OHAN BULL Considers Broadcasting.....	354	*Construction and Operation of a Loop	
John Bull's World-Wide Radio (J. Conrad		Radiophone Transmitter.....	51
Flemming).....	536	*How to Build and Operate a Very	
K EEPING the Stars and Stripes in the		Simple Radio Receiving Set.....	45
Ether (Commander Stanford C. Hooper).....	125	Operating Vacuum Tubes on Alternat-	
King Electron:		ing Current.....	60
*King Electron Tells About Detection		*Simply Constructed and Operated	
(R. H. Ranger).....	497	Short-Range C. W. Transmitter, A	
*King Electron Tells About Radio Re-		(Zeh Bouck).....	240
generation. (R. H. Ranger).....	421	*Our Amateur Radio Reserve (Major Paul W.	
L EAVING their Monuments in the Eternal		Evans, U. S. A.).....	243
Ether (Parkhurst Whitney).....	64	P ACIFIC Coast is on the Air, The (Wilbur	
<i>Lightning Wire as an Antenna, The</i>	461	Hall).....	157
Line Radio:		<i>Passing of the "Radio Review," The</i>	280
**"Space Radio" and "Line Radio"		Personalities:	
(Dr. Louis Cohen).....	28	See Radio Personalities	
Long Arm of Soviet Russia, The.....	354	Powerful French Station Excellent in Tests	
Long Distance Broadcasting of News.....	444	With New York.....	529
Loop Antennas:		*Progress of Radio in Foreign Lands	
See Antennas		251, 352, 442, 529	
* M AKING Life Safe at Sea (Arthur H.		*Prominent Radio Editors (4 photos with cap-	
Lynch).....	465	tions only).....	135
*Making Radio Sales Pay (Arthur H. Lynch)		*Protection of the Receiving Antenna (G. Y.	
Making the Telephone Receiver More Sensi-		Allen).....	214
tive.....	252	Publications, Periodicals:	
*March of Radio (Articles published under		*Books About Radio (John V. L.	
this head indicated by italics)		Hogan).....	439
* <i>Marconi's Visit</i>	367	<i>Passing of the "Radio Review," The</i> ...	280
*Married by Radio (Pierre Boucheron).....	162	R ADIO at the Pole.....	375
Merchandising (See Sales)		<i>Radio Beacon, The Airplane and the</i>	99
Mexico:		Radio Cables and Airships, The.....	62
When Mexico Refused Radio Sta-		<i>Radio Calling Apparatus</i>	99
tions.....	355	* <i>Radio Current Generators</i>	373
*Mistakes to Avoid in Erecting Antennas (G.		<i>Radio Current: An Editorial Interpretation</i>	
Y. Allen).....	145	(J. H. M.).....	1
<i>Mullard Tubes, The British</i>	99	Radio Editors:	
		*Prominent Radio Editors (4 photos	
		with captions only).....	135
		Radio Equipment of Atlantic Liners.....	355

INDEX—Continued

	PAGE		PAGE
*Radio Fog Signals and the Radio Compass..	247	What to Expect from Your Receiver (Arthur H. Lynch).....	37
*Radio for Lifeboats.....	67	<i>Reflection and Absorption of Radio Waves</i>	368
*Radio Frequency Amplification (Zeh Bouck)	312	Regeneration:	
*Radio Has Gripped Chicago (George P. Stone).....	503	*King Electron Tells About Radio Regeneration (R. H. Ranger).....	421
*Radio Helping Us to Enjoy the Summer (Arthur H. Lynch).....	255	<i>Regenerative Receivers Must Be Con- trolled</i>	458
Radio in Remote Regions:		* <i>Regulation and Standardization by the National Radio Chamber of Commerce</i>	459
*First Ship to Reach Island in a Year Gave Inhabitants News Three Minutes Old.....	262	<i>Report of the Radio Telephone Committee</i>	191
* <i>Radio in the Lonely Places</i>	193	<i>Research Conducted by the International Union of Scientific Radio Telegraphy</i>	530
*Radio on Robinson Crusoe's Isle (W. H. C., Jr.).....	526	Revenue for the Broadcasting Organizations..	529
*Sign in the Wilderness, A (Sue M. Harrison).....	524	*Review of Radio, A (Lee De Forest, Ph. D., D. S. C.).....	332
*Tropical Island Radiophone, A (Charles T. Whitefield).....	68	*Romance of the Radio Telephone (C. Austin).....	9
*Radio in the Forest Service (Donald Wilhelm)	407	Russia:	
* <i>Radio in the Lonely Places</i>	193	Long Arm of Soviet Russia; The.....	354
<i>Radio Might Have Prevented this Accident</i>	279		
*Radio Notes from Home and Abroad.....	58		
Radio on Fishing Boats.....	251		
*Radio on Robinson Crusoe's Isle (W. H. C., Jr.).....	526		
Radio Personalities:		S SALES:	
*An Evening With Dr. Alexander Graham Bell (Donald Wilhelm)....	205	*Making Radio Sales Pay (Arthur H. Lynch).....	166
*Fessenden, Reginald Aubrey (Lucille Joyce).....	228	*Merchandising Radio (A. Henry)....	82
*Godley, Paul F. (A. Henry).....	39	Selectivity:	
*Goldsmith, Dr. Alfred N., on the Future of Radio Telephony (Edgar H. Felix).....	42	*Increasing the Selection Power of a Radio Circuit (John V. L. Hogan).....	211
Heising, R. A. (Edgar H. Felix).....	132	Selective Double-Circuit Receiver, The (John V. L. Hogan).....	211
*Hooper, Commander Stanford C., U. S. N. (Donald Wilhelm).....	520	*Shall We Have Music or Noise? (Perce B. Collison).....	434
Radiophone Broadcasting in Paris.....	254	*Sharpness of Tuning in a Radio Receiver (John V. L. Hogan).....	348
Radiophone Reception as a Side Show.....	531	*Shielded Receivers (Thomas C. Tibbey)....	517
<i>Radio Service for British Columbia</i>	100	<i>Ships and Airplanes Should Carry Emergency Antennas</i>	464
*Radio's Great Future (Herbert C. Hoover)..	433	*Sign in the Wilderness, A (Sue M. Harri- son).....	524
Radio Station on Rundemanden Mt., The....	355	Simply Constructed and Operated Short- Range C. W. Transmitter, A (Zeh Bouck) .	240
*Radio Telegraphy (Guglielmo Marconi).....	341	<i>Some Applications of Vacuum Tubes</i>	100
<i>Radio Telephone Committee, Report of the</i>	191	"Space Radio" and "Line Radio" (Dr. Louis Cohen).....	28
<i>Radio Telephone on German Railroad</i>	100	<i>Standard Tests for Radio Receivers</i>	376
Radio Telephone Where Wires Will Not Go, The.....	63	Static:	
<i>Radio Telephony in Sweden</i>	100	<i>Danger from Static</i>	282
<i>Radio vs. Cables</i>	375	<i>Static Eliminators</i>	282
Radio and Airways.....	59	Storage Batteries:	
Radio and Aviation.....	531	*Charging the "B" Storage Battery (G. Y. Allen).....	413
Radio and the French Farmer.....	61	*Eliminating "A" and "B" Batteries by Getting Power from the Lamp Socket.....	462
*Random Observations on Running a Broad- casting Station (H. M. Taylor).....	223	*Storage Battery in Radio Service, The (John Gary).....	308
<i>R. C. A. Annual Report</i>	97	*Sunken by Radio.....	164
Receiving:		Super-Regeneration:	
*Care and Operation of a Crystal Re- ceiving Set (Edgar H. Felix).....	120	*Armstrong's Super-Regeneration....	371
*How to Build and Operate a Very Simple Radio Receiving Set.....	45	*Armstrong's Super-Regenerative Cir- cuit (Paul F. Godley).....	426
Making the Telephone Receiver More Sensitive.....	252	Sweden:	
*Protection of the Receiving Antenna (G. Y. Allen).....	214	<i>Radio Telephony in Sweden</i>	100
<i>Regenerative Receivers Must Be Con- trolled</i>	458		
*Selective Double Circuit Receiver, The (John V. I. Hogan).....	480	T TELEPHONE Receivers:	
*Sharpness of Tuning in a Radio Receiver (John V. L. Hogan).....	348	Interesting Facts About Telephone Receivers.....	356
*Shielded Receivers (Thomas C. Tib- bey).....	517	Making the Telephone Receiver More Sensitive.....	252
*What Receiving Set Shall I Buy? (J. Conrad Flemming).....	110	That German Invasion.....	254
		Transatlantic Station at Eilvese, The.....	356
		Transmitting:	
		*Construction and Operation of a Loop Radiophone Transmitter.....	51

INDEX—Continued

	PAGE		PAGE
*Simply Constructed and Operated Short-Range C. W. Transmitter, A (Zeh Bouck).....	240	Cohen, Dr. Louis.....	28
*Tropical Island Radiophone, A (Charles T. Whitefield).....	68	*Crocker, Francis Bacon.....	281
Tuning:		Davis, George Schley.....	387
*Sharpness of Tuning in a Radio Receiver (John V. L. Hogan).....	107	De Forest, Dr. Lee.....	94, 299, 337, 340
*Tuning the Radio Aerial System (John V. L. Hogan).....	348	*Delegates to National Radio Chamber of Commerce.....	459
		De Long, A. J.....	452
		Dodd, Mrs. Lucy Williams.....	219
		Edison, Thomas A.....	203
UNCLE SAM in Radio (Donald Wilhelm).....	21	Fessenden, Reginald Aubrey.....	229, 301
<i>Underwriters' Requirements</i>	280	Ford, Henry.....	158
United Fruit Company:		Frost, George.....	159, 505
*History of the Development of the United Fruit Company's Radio Telegraph System (Roy Mason)....	377	Godley, Paul F.....	41, 454
U. S. Weather Reports for Ships Without Radio (S. R. Winters).....	446	Goldsmith, Dr. Alfred N.....	43, 342
Universal Radio Sign Language, A.....	254	Heising, Reginald A.....	133
VACUUM Tubes:		Hemus, Percy.....	287
<i>British Mullard Tubes, The</i>	99	Hewitt, Peter Cooper.....	461
British Valves and Our Vacuum Tubes.....	443	Hinshaw, William Wade.....	287
Care of Vacuum Tubes.....	264	Hogan, John V. L.....	5
Operating Vacuum Tubes on Alternating Current.....	60	Hooper, Commander Stanford C., U. S. N....	521
<i>Some Applications of Vacuum Tubes</i> ..	100	Hoover, Herbert C.....	29, 433
<i>Vacuum Tubes Promised</i>	98	Hooper, De Wolf.....	198
Vienna Will Have Marconi Company Radio Central.....	529	"Impresario" Company.....	289
		Ingersoll, Capt.....	334
		*Interdepartmental Advisory Committee on Government Broadcasting.....	457
		*Langmuir, Irving.....	369
* WANTED: An American Radio Policy (Donald Wilhelm).....	29	Leppert, R. E., Jr.....	245
<i>War Between Broadcasting Stations</i>	457	McGranahan, Thomas.....	287
Waves:		McNeary, William F. B.....	135
Objects That Distort Radio Waves (L. E. Whittemore).....	101	Marconi, Guglielmo.....	1, 342, *369
<i>Reflection and Absorption of Radio Waves</i>	368	Mazarin, Mme.....	333
*What Everyone Should Know About Radio History (Professor J. H. Morecroft)....	199, 294	*New, Harry S.....	97
* <i>What Kind of Broadcasting is Coming?</i>	192	"Pandora" Principals.....	290
What is a Radio Operator?.....	252	Preece, Sir William H.....	295
*What Radio is Doing for Me (A. J. De Long)	452	Pupin, Michael I.....	201, 278
*What Receiving Set Shall I Buy? (J. Conrad Fleming).....	110	Radio Conference in Washington.....	32
*What the Detroit <i>News</i> Has Done in Broadcasting (R. J. McLaughlin).....	136	Randall, Eunice L.....	223
What to Call Them.....	188	Rogers, Dr. J. Harris.....	303, 305, 307
What to Expect from Your Receiver (Arthur H. Lynch).....	37	Sanders, Roy Yates Jr.....	450
*Will Antennas Be Buried in the Back Yard? (Lewis Wood).....	303	*Sisson, Edgar Jr.....	195
*Wire Broadcasting (John F. Duncan).....	116	Slocum, "Bud".....	160
*"With the Night Mail" (Donald Wilhelm)..	512	Stone, John Stone.....	297
*When De Wolf Hopper Broadcasted to His Biggest Audience.....	198	Stratton, Dr. S. W.....	31
When Mexico Refused Radio Stations.....	355	Van Etten, Rev. Edwin J.....	321
<i>When Wireless is Better than Wires</i>	100	Vicarino, Regina.....	287
		Waldeman, Milton.....	135
		Walsh, Frank.....	353
		White, Wallace H. Jr.....	30
		*Whitney, W. R.....	369
		Wible, Omar.....	235
		Wood, Allen H.....	135
		Young, Owen D.....	126
PORTRAITS			
(*Portraits in "The March of Radio")			
Armstrong, E. H.....	72, 366		
Bell, Dr. Alexander Graham.....	190, 207		
Binns, Jack.....	135		
Bryan, William Jennings.....	325		
Buell, Dai.....	225		
Bullard, Rear-Admiral William H. G.....	127		
Burns, William J.....	233		
		AUTHORS	
		Allen, G. Y.....	145, 214, 413
		Austin, C.....	9

INDEX—Continued

	PAGE		PAGE
Boucheron, Pierre.....	72, 162	Le Massena, C. E.....	285
Bouck, Zeh.....	142, 240, 312	Lynch, Arthur H.....	37, 54, 166, 255, 465
C., W. H. Jr.....	526	McLauchlin, R. J.....	136
Cohen, Dr. Louis.....	28	M., J. H.....	1, 95, 191, 279, 367, 455
Collison, Perce B.....	434	Marconi, Guglielmo.....	341
De Forest, Dr. Lee.....	332	Mason, Roy.....	377
De Long, A. J.....	452	Morecroft, J. H.....	199, 294
Duncan, John F.....	116	Pyle, Howard S.....	493
Evans, Major Paul W.....	243	Ranger, R. H.....	421, 497
Felix, Edgar H.....	42, 120, 132	Richardson, Archie.....	218
Flemming, J. Conrad.....	110, 536	Richmond, Leon H.....	151, 236
Galey, Thomas M.....	234	Rodgers, W. W.....	321
Garey, John.....	308	Stone, George P.....	503
Gerrie, Fraser M.....	527	Taylor, H. M.....	223
Godley, Paul F.....	316, 426	Terrill, W. D.....	330
Gordon, Ortherus.....	489	Tibbey, Thomas C.....	517
Hall, Wilbur.....	157	Whitefield, Charles T.....	68
Harrison, Sue M.....	524	Whitney, Parkhurst.....	33, 64
Henry, A.....	39, 82	Whittemore, L. E.....	101
Hogan, John V. L.....	5, 107, 211, 348, 439, 480	Wilhelm, Donald.....	21, 29, 205, 231, 249, 512, 520
Hooper, Commander Stanford C.....	125, 399, 484	Winters, S. R.....	446
Hoover, Herbert.....	433	Wood, Lewis.....	303
Joyce, Lucille.....	228		



MAY, 1922

PRICE 25 CENTS.

RADIO BROADCAST

RADIO FOR EVERY PLACE AND PURPOSE

The Romance of the
Radio Telephone

What to Expect
from Your
Receiver

Uncle Sam
in Radio



LEE THAYER

DOUBLEDAY, PAGE & COMPANY, Garden City, N. Y.

The Twentieth Century ALADDIN'S LAMP



RADIO

—the enchanted masterwork of science—
now unfolds a vast new wealth of educa-
tion and entertainment, flashing its magic
wand o'er ethereal oceans, broadcasting
treasures hitherto undreamed.

From its new branches now being rapid-
ly established throughout the country, the
Twentieth Century Wireless Telephone
Corporation is distributing at wholesale
and retail the radio products of America's
leading manufacturers, Westinghouse,
General Electric, Radio Corporation,
AeroFone, Magnavox and others.

Descriptive pamphlets will be sent free
upon request and a demon-
stration of receiving
sets will be given in the
radio parlors of the near-
est branch.

*Dealers may learn of unassigned
territory by writing to the National
Sales Department.*

Twentieth Century Wireless Telephone Corporation

Executive Offices, 565 Fifth Avenue, New York, N. Y.

Strauss Building, Suite 710

Branches

Newark, N. J.
587 Broad Street

Brooklyn, N. Y.
102 Flatbush Avenue

White Plains, N. Y.
2-4 Mamaroneck Ave.

Detroit, Mich.
2311 Woodward Ave.

National Distributors

Radio Broadcast



CONTENTS FOR MAY, 1922

<i>Guglielmo Marconi</i> - - - - -	<i>Frontispiece</i>
RADIO CURRENTS—AN EDITORIAL INTERPRETATION - - - - -	1
INTERFERENCE IN RADIO SIGNALLING - - - - - JOHN V. L. HOGAN	5
THE ROMANCE OF THE RADIO TELEPHONE - - - - - C. AUSTIN	9
UNCLE SAM IN RADIO - - - - - DONALD WILHELM	21
“SPACE RADIO” AND “LINE RADIO” - - - - - DR. LOUIS COHEN	28
WANTED: AN AMERICAN RADIO POLICY - - - - - DONALD WILHELM	29
ONE COMMERCIAL SIDE OF RADIO - - - - - PARKHURST WHITNEY	33
WHAT TO EXPECT FROM YOUR RECEIVER - - - - - ARTHUR H. LYNCH	37
RADIO PERSONALITIES - - - - -	39
PAUL GODLEY - - - - - A. HENRY	
DR. ALFRED N. GOLDSMITH - - - - - EDGAR H. FELIX	
HOW TO BUILD AND OPERATE A VERY SIMPLE RADIO RECEIVING SET	45
CONSTRUCTION AND OPERATION OF A LOOP RADIOPHONE TRANSMITTER	51
A COMPACT PORTABLE WIRELESS SET - - - - - ARTHUR H. LYNCH	54
RADIO NOTES FROM HOME AND ABROAD - - - - -	58
LEAVING THEIR MONUMENTS IN THE ETERNAL ETHER	
PARKHURST WHITNEY	64
RADIO FOR LIFEBOATS - - - - -	67
A TROPICAL ISLAND RADIOPHONE - - - - - CHARLES T. WHITEFIELD	68
THE ARMSTRONG PATENT - - - - -	71
ADVENTURES IN RADIO - - - - -	72
Found by Radio - - - - - PIERRE BOUCHERON	
THE GRID—QUESTIONS AND ANSWERS - - - - -	76
MERCHANDISING RADIO - - - - - A. HENRY	82

Copyright, 1922, by Doubleday, Page & Co. All rights reserved
TERMS: \$3.00 a year; single copies 25 cents

F. N. DOUBLEDAY, Pres.
RUSSELL DOUBLEDAY, Sec'y.

ARTHUR W. PAGE, Vice-Pres.
S. A. EVERITT, Treas.

NELSON DOUBLEDAY, Vice-Pres.
JOHN J. HESSIAN, Asst. Treas.

DOUBLEDAY, PAGE & CO.

THE WORLD'S WORK COUNTRY LIFE THE GARDEN MAGAZINE

CHICAGO: People's Gas Bldg.

GARDEN CITY, N. Y.

NEW YORK: 120 W. 32nd Street

BOSTON: Tremont Bldg.

LOS ANGELES: Van Nuys Bldg.



© Paul Thompson

GUGLIELMO MARCONI
The father of radio

APR 22 1922

© Cl B 526004

RADIO BROADCAST

Vol. 1 No. 1



May, 1922

RADIO CURRENTS

AN EDITORIAL INTERPRETATION

TWO years ago the only interpretation of the word "receiver" would have been a man appointed by the courts to take over a bankrupt firm. But such is not the case to-day—"receiver" also refers to the hundreds of thousands of people who are nightly "listening in" to the various radiophone broadcasting stations distributed over the country. What attitude are they going to take in the future in regard to the amount and kind of broadcasting these stations give? In other words, are the hundreds of thousands of families which now get their evening entertainment at home instead of going out to the theatre or movie, going merely to receive what is "handed out" to them gratuitously by the manufacturing companies, or are they going to exert their influence in such a way that the entertainment offered them is determined by themselves. The question is a broad one and of rapidly growing importance; there are many peculiar angles to the problem which make it different from any apparently similar one, in fact the problem is probably unique. A few of its phases are pointed out in this discussion.

In this latest application of scientific achievement there are two essential parts, a transmitting station from which the radio broadcasting is done and the station at which it is received. If you have a receiving station, you come under our classification of *receiver*, and it is in your

attitude toward the transmitting station that we are interested. Did it ever occur to you how very helpless you are in this new activity? You turn on your switches and wait—if you hear nothing you conclude the transmitting station has not started so you wait and wonder what is going to be sent out when it does start. It may be a selection from "Aida", wonderfully executed, or it may be nothing but a scratchy, cracked, phonograph record. You have nothing to say about it, you pay nothing for it, and, still more to the point, you have no rights in the matter at all. You are not alone in this game of watching and waiting—there are hundreds of thousands of others, and soon there will be millions of people doing the same thing.

The rate of increase in the number of people who spend at least a part of their evening in listening in is almost incomprehensible. To those who have recently tried to purchase receiving equipment, some idea of this increase has undoubtedly occurred, as they stood perhaps in the fourth or fifth row at the radio counter waiting their turn only to be told when they finally reached the counter that they might place an order and it would be filled when possible. Also to the man who has the reputation among his friends of knowing something about radio, this rapid rise of interest in radio has been forcibly brought home. He is scarcely engaged in conversation before the familiar phrase sounds—"I suppose everybody else has been bothering you, but my boy

wants a radio set and the family— What size wire shall I use, and should the joints be soldered—?” In the ferry boat and in the subway trains we hear of wavelengths, frequencies, capacities, tubes, amplifiers, etc. in connection with strange combinations of letters—KYY, KDKA, and what not. The teacher of radio, judging by the number of applicants for membership in his classes, finds that his subject is really just as important as he always thought it was and perhaps even more so. He finally sees the whole world “coming to its senses” just as the phonograph salesman sees the whole world losing its senses in the same process.

But to probably no other group of men has this tremendous interest in radio come with more force than to the manufacturers of radio apparatus. Anything they could make, good or poor, could be sold before the varnish was scarcely dry. And speed up the shop processes as much as they could the pace was too fast and they fell behind in filling orders. And when the American manufacturer, in a time of general depression such as has existed for the last two years, owns up to the fact that he cannot keep his output to the demand, it is safe to conclude that the rate of increase in the demand for his apparatus has indeed been phenomenal.

The movement is probably not even yet at its height, it is still growing in some kind of geometrical progression. There are to-day probably five hundred thousand receiving stations in the United States, although, of course, any such statement must be based largely on conjecture. It seems quite likely that before the movement has reached its height, before the market for receiving apparatus becomes approximately saturated, there will be at least five million receiving sets in this country. This means that before many years there will be from ten to twenty million people who can be reached by radiophone communication. These millions of people will be dependent upon a few broadcasting stations for their amusement and “up to the minute” news; over the policies and conduct of these transmitting stations this vast army of listeners will have no influence at all, unless some movement for organization is started which is not yet evident.

It might well be thought that there is nothing strange in the situation, that in many other activities in which the public has invested a deal of money, and upon which it is very dependent, a similar condition of helplessness exists for

those who have invested. But closer examination of the question shows this to be not so. If our surmise as to the number of radio receiving stations in the near future is correct, then the situation, in so far as amount of money invested by the public, the number of persons interested, etc., may be somewhat similar to that of the telephone or phonograph.

The telephone subscriber invests perhaps fifty dollars a year for which he gets certain privileges; to get the return on his fifty dollars the company must keep their lines in condition—if they don't the subscriber gets little for his money. But the company does keep up its lines because they expect the subscriber to invest another fifty dollars the next year and so on, so it is to their interest to maintain their service from the standpoint of sales. Also if the lines are not kept in such condition as to render the subscriber satisfactory service, a public utility commission will order them to be so kept. With the lines kept in useable condition the subscriber gets his money's worth; he can telephone when and where he likes. For this privilege the subscriber pays.

The man who invests in a radio outfit however has no such choice; he can simply listen. Of course it is conceivable that he might also have a transmitting outfit and he would then have the same possibility the telephone subscriber has. Such a possibility is extremely remote; instead of increasing the number of transmitting stations in the future in proportion to the number of receiving stations, it seems likely that there will be but little increase, and this increase will include none but public broadcasting stations. The general public therefore must always play the rôle of listener merely, when it comes to radio.

The man who purchases a phonograph is practically dependent upon the manufacturer to get any good out of his investment. For example, if some new type of phonograph should be produced with records cut in such a special way that no one else could furnish them, then the owner of this phonograph would be entirely dependent upon the manufacturer to make his investment good. In this case the manufacturer will naturally furnish as many good records as possible because there is money in the game for him. But if the records had to be supplied to the owner of the phonograph at cost, so that there was no profit in it for the manufacturer, he would probably cut new records just long enough to sell sufficient phono-

graphs to saturate the market. After that, there being no more money in the game for him, he would probably invest in some other enterprise. The excellent service the phonograph companies furnish the public is maintained only because there is a profit in it for them. Because of this profit the list of records available continually grows both in comprehensiveness and quality, so the owner of the phonograph gets continual enjoyment by getting the new records as they appear. It will also be noticed that in the case of the phonograph each family or person may select and play just those records they most enjoy.

Now in the case of the radio receiver it is evident that there is at present practically no choice as to the kind of entertainment furnished—everyone must take the same, whenever he can get it. In some parts of the country the entertainment offered is of high quality, but every one must realize that artists will not continue to give their services for nothing; after the novelty has worn off it will cost money to get talent at the broadcasting station and the question arises—who is going to pay for it?

For some time yet to come it will pay the manufacturing companies to maintain the quality of the entertainment sent out from their broadcasting stations at a high level so that those having receiving outfits will be enthusiastic about it and so get others to buy. The cost of maintaining the transmitting station will, of course, be one of the items fixing the selling price of the receiving apparatus. But after a while the rate of increase in the sales will fall off as the market gets more saturated and the demand will settle down to a comparatively small steady value. If the sale of receiving apparatus is to cover the cost of operating the transmitting stations, it seems likely that the price of receiving sets will have to rise continually—and they are high enough now! The peculiarity in the radio situation, as compared to the phonograph situation, is that the manufacturer's interest in the customer is necessarily much reduced after the sale of the apparatus; there is practically no more profit to be gained from the man owning a set, as the cost of renewal parts of the radio receiver is small, unless the man as he becomes more enthusiastic can be made to buy a better set.

It would seem then that the solution of the problem will finally involve some different scheme of financing than that used at present.

There are various schemes possible, of which the most attractive one, in so far as the general public is concerned, is the endowment of a station by a public spirited citizen. This may sound at present like a peculiar institution to endow, but it seems sure to come. We have gymnasiums, athletic fields, libraries, museums, etc., endowed and for what purpose? Evidently for the amusement and education of the public. But it may well be that in the early future the cheapest and most efficient way of dispensing amusement and education may be by radiophone.

A powerful station in the vicinity of a large city like New York would reach at present perhaps one or two hundred thousand persons. The writer gave a broadcast lecture a short time ago, and the optimistic manager of the station assured him there were probably two hundred and fifty thousand people listening. Such an audience would be impossible by any other scheme. A lecturer can, at such a station, reach more people in one evening than he could on the lecture platform in a year of speech making.

The first cost and maintenance cost of a powerful station are not prohibitive when compared to that of other institutions designed to do as comprehensive a piece of work. Thus a powerful station could be put up and operated at a cost less than that required for a reasonable sized library, and there is no doubt that a properly conducted radio broadcasting station can do at least as great an educational work as does the average library. This is not said to disparage the endowment of libraries but to point out another way for the wealthy citizen to invest part of his excess wealth for the public good. To one with vision of the probable growth of radio communication, the endowment of such a station should appeal strongly and there is much likelihood that many such stations will be operating in the next twenty-five years.

Another possible scheme for the maintenance of suitable broadcasting stations is by contributions to a common fund, which would be controlled by an elected board; this would be one of the more difficult ways of carrying on the work, for the reason that any one can listen in on a broadcasting station whether he contributes to its support or not. The financing of such activities, in which contributions are made by those who choose, the benefits of which all may equally enjoy, is rather difficult,

and the board of managers would have an unenviable task. In certain communities it would undoubtedly work just as do the societies for upholding property restrictions in various localities; voluntary subscriptions support the legal talent required to maintain the restrictions, but all who live in the community obtain equal benefits whether they contribute or not.

A third way, and probably the most reasonable way, to operate the transmitting station is by municipal financing. A weird scheme this will undoubtedly appear to many, but upon analysis it will be found not so strange, even to those who have no socialistic tendencies. In New York City, for example, large sums of money are spent annually in maintaining free public lectures, given on various topics of interest; the attendance at one of these lectures may average two or three hundred people. The same lecture delivered from a broadcasting station would be heard by several thousand people. Because of the diverse interests of such a large city as New York it would probably be necessary to operate two or three stations from each of which different forms of amusement or educational lectures would be sent out. The cost of such a project would probably be less than that for the scheme at present used and the number of people who would benefit might be immeasurably greater.

Of course it has been assumed in the foregoing discussion that the speech or music as delivered by the radio receiving set is practically as good as that delivered by the performers or lecturer at the transmitting station. At present this is certainly not so; the small crystal sets, requiring head telephone sets, do

give fairly good reproduction provided that the transmitting station is functioning properly, but the wearing of a head set is not a pleasant way of spending an evening. When vacuum tube receiving sets are used, attached to amplifiers and loud speaking horns, there is generally a good deal of distortion. In such a case the listener would evidently prefer to listen to the lecturer directly. The end is not yet, however—loud speaking receivers are at present very crude devices compared with what they may be; they nearly all give fair reproduction of music, but for speech they are somewhat lacking in performance. This is not an insuperable difficulty and a good loud speaker is almost sure soon to appear. Then the speech will be clearer than would be the case if the lecturer were in a hall and the listener were one of the audience; the lecture may be enjoyed by the whole family seated in easy chairs and if the lecturer prove to be tiresome the set will be re-tuned to some other station offering a more attractive programme.

As has been stated several times in the foregoing discussion, the day of radio reception is just beginning; as it grows in scope and importance it will be necessary for some of the receivers to see the issue clearly and lead in the movement for better and more diversified broadcasting stations. Troubles from interference between different transmitting stations, government control of licensing, etc., will be necessarily an important part of the scheme of development, but to one understanding the fundamentals of the art these do not offer appreciable difficulties to carrying out the programme suggested above.

J. H. M.

EDITOR'S NOTE

It is of the utmost importance to the radio public who are receiving broadcasting that this business develop to its maximum service and effectiveness. The Editors of RADIO BROADCAST would be glad to hear the opinion of its readers on such questions as:

What voice should the receiving public have in selecting broadcasting programmes?

Should the public get broadcasting free or should it pay for it, and if so how?

If the public should get it free who should pay for it and how are they to be reimbursed?

INTERFERENCE IN RADIO SIGNALLING

By JOHN V. L. HOGAN

Fellow and Past President, Institute of Radio Engineers. Member American Institute of Electrical Engineers

In the following article Mr. Hogan's discussion is based entirely upon the modern and scientifically useful relation of wave frequencies. The more familiar concept of wave length as a basis of tuning is equivalent to the idea of wave frequency, and radio frequencies can be converted into meters wave length simply by dividing into the factor 300,000,000. Thus a frequency of 500,000 cycles corresponds to a wave length of 600 meters or 300,000,000 divided by 500,000. Similarly, the present broadcasting wave length of 360 meters corresponds to a frequency of 300,000,000 divided by 360 or about 833,000 cycles per second.

IN RADIO communication systems the word "interference" has been used for many years to describe what happens when a receiving operator hears, in his instrument, signals from stations other than that from which he desires to take messages. The signals from his own communicating station,

that is, the transmitter to which he desires to listen, may be comparatively loud and clear. In this instance, the sounds heard from the other stations will be relatively feeble and only slight "interference" will be experienced; in other words, the receiver will be troubled only slightly, if at all, by the interfering or disturbing sounds and with little difficulty will be able to concentrate upon and decipher the signals he desires to receive. On the other hand, he may be listening to relatively faint sounds from a distant transmitter, anxious to record every word that is sent out, and without warning a powerful near by sending station may commence operations. In this instance the strong interfering waves produced at so short a distance from the receiving station may blot out completely the signals from the far-away sending plant, thus producing insuperably strong "interference." Between these two extremes all shades and colors of interference may be experienced, from a misty background of buzzing against which the desired signals stand forth strongly and distinctly, to interference between several stations of so nearly equal intensity that (when all are sending) it is impossible to distinguish a word from any one of them. Such a gamut of interference has existed from the earliest days of commercial radio signalling, and its minimization or elimination has long been one of the outstanding problems of radio. The natural consequence of such a problem is that the most skilled scientists in the field have applied themselves to finding the solution; the consequence of such intent study is that vast and indeed gratifying progress has been made in overcoming the difficulties created by interference.

The keynote of the most successful normal systems which have been developed to reduce



JOHN V. L. HOGAN

radio engineer, an early worker with Dr. Lee de Forest. In 1920, President of the Institute of Radio Engineers

interference troubles is the use by different stations of different frequencies of wave vibration. Radio signals, whether telephonic and in the form of music and spoken words, or telegraphic and in the form of Morse dots and dashes, are carried through space across the earth's surface by waves in the ether. Except for their frequencies or rates of vibration, these radio waves are identical with light waves; they pass through the same ether of space which conveys light waves from the sun to the earth and from a candle to our eyes. Like the flash from an exploding bomb, these radio waves rush outward from a wireless sending station at the almost inconceivable speed of 186,000 miles per second; some of them reach listeners at receiving stations (just as some of the bomb-flash strikes the eyes of onlookers) but the greatest part is lost in space. Unlike light waves, however, the radio waves are completely invisible to us; they are passing through us and around us constantly, but our bodies contain no sensory organs which can detect them. Their frequencies of vibration

are so low that the waves cannot produce any physiological effect such as would cause the sensation of light or heat, although the character of the radio waves is exactly that of light waves or heat waves except in the one respect, namely, the number of vibrations per second.

What is the range of frequency of these radio signal waves which we can neither see nor feel? What number of vibrations in one second is too small to set up the sensation of illumination or that of warmth? Curiously enough, these radio frequencies (while far lower in the scale than light or heat) are away beyond the rates of which we usually think. An airplane motor rotates 3,500 revolutions per minute; the middle-C string of a piano vibrates 256 times in one second; everyday radio waves oscillate at the tremendous rates of from 20,000 to 3,000,000 times in one second.

The fact that radio waves may have any frequency from above 3,000,000 to below 20,000 per second opens the way to a great increase in the number of wireless stations which may operate at the same time in the same geo-

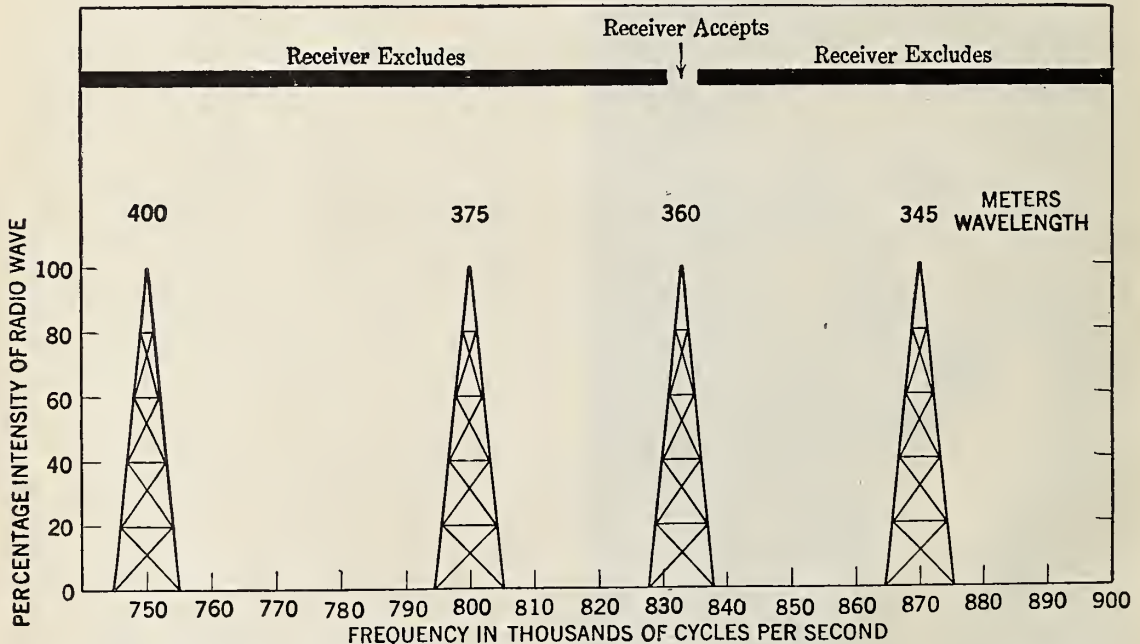

A chart giving an approximate idea of the way in which four transmitting stations of high character will distribute their power in space, if they are of equal power and if they are all equally distant from a receiving station. Each of these stations has its total energy confined to a band of 10,000 cycles, their basic wave frequencies being respectively 750,000, 800,000, 833,000 and 870,000 cycles. These frequencies correspond closely to wavelengths of 400, 375, 360 and 345 meters. The accepting and excluding action of a tuned receiver is indicated by the heavy line above the chart. If this receiver accepts radio waves only within a range of 5,000 cycles, or 2,500 cycles above and below its central frequency, no difficulty would be experienced in receiving exclusively from any one of the four transmitters indicated, with no interference from any of the others. In fact, when adjusted to frequencies intermediate to those of the sending stations (for example 770,000 or 815,000 or 850,000 cycles) nothing would be heard

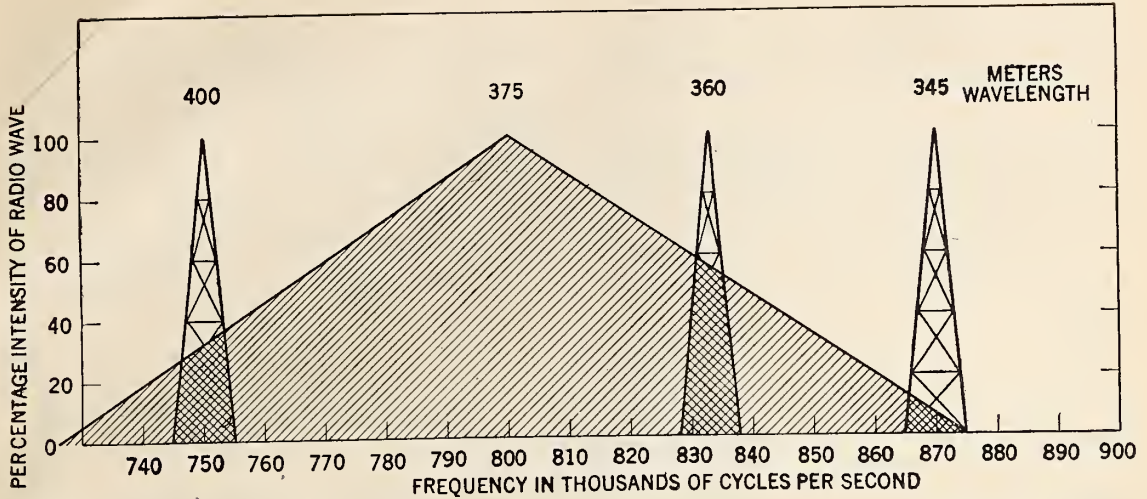

A chart illustrating the changed conditions which would exist if one of the four sending stations radiated a "broad" or poor wave centering on 375 meters wavelengths (800,000 cycles wave frequency) but spreading its energy over a range of 150,000 cycles. No matter how sharply the receiver may be tuned (the four stations still being assumed to be of equal power and at equal distances), some interference will be found on all wave frequencies from 725,000 cycles to 875,000 cycles. Because of the difference in intensity the signals of the fourth (345 meter wavelength) station could be understood in spite of this interference, but it would be much harder to understand the 400 meter station's messages. So much interference (indicated by the shaded area) would be had when tuned for 833,000 cycles (360 meters) that it would be very difficult to interpret the words sent at that frequency

graphical zone without interfering with each other. This is because receiving apparatus has been developed which is highly selective as to wave frequency. With such instruments it is feasible to arrange matters so that signals will be received from all reasonably distant radio transmitters which operate for example at a frequency of 500,000 per second, but that no signals will be heard from equally distant and equally powerful sending stations using frequencies a little above or a little below this value. Design of receiving apparatus has not yet progressed to the point at which it would be possible to select between transmitters using frequencies so close together as 500,000, 500,001, 500,002, 500,003, and 500,004 vibrations (or cycles) per second. Such exactness cannot be even approximated to-day, but, where radio senders emit waves of reasonably pure character and when the arriving signals are of about the same intensity, it is not difficult to discriminate between wave frequencies which are 10,000 cycles apart, such as 500,000, 510,000, 520,000, 530,000, etc., per second.

It is easy to see that if wireless transmitting apparatus is so designed and adjusted that its radiated waves are quite closely of a single frequency, and if radio receivers are "tuned" so as to exclude waves more than 5,000 cycles

above or below the main received frequency a large number of channels for independent communication can be had. One pair of stations can intercommunicate at 3,000,000 cycles per second, another at 2,990,000 cycles, another at 2,980,000 cycles, another at 2,970,000 cycles, another at 2,960,000 cycles, and so on down to the last few pairs at 40,000, 30,000, and 20,000 cycles per second. Each of these frequencies, chosen at 10,000 cycles separation, would constitute what amounts to a radio "private wire" or independent communication channel for the pair of stations using it. Where a division of working time could be made between a number of pairs of stations, all could be operated upon the same wave frequency (which would then become the equivalent of a "party wire" through space). Thus there could be provided room in the ether for a vast number of radio stations to work simultaneously and without interference.

Unfortunately this splendid condition cannot yet be realized in practice. There are three important technical difficulties still to be overcome, as follows:

1. With present-day apparatus the higher frequencies are not suitable for economical and dependable transmission over long distances.
2. Many transmitters now in use, particularly those of the spark type, radiate a large

number (or a wide band) of wave frequencies and so produce interference in receivers sharply tuned to single (or narrow bands of) frequencies.

3. Most radio receivers will select sharply between waves having frequencies a few thousand cycles apart if the intensities of the two

independent-channel condition for radio operations is the restriction of transmitting stations to the modern types which radiate almost their entire power at practically a single basic transmitting wave frequency. This change, which would involve elimination of many spark transmitters from the radio scheme of things (or, at

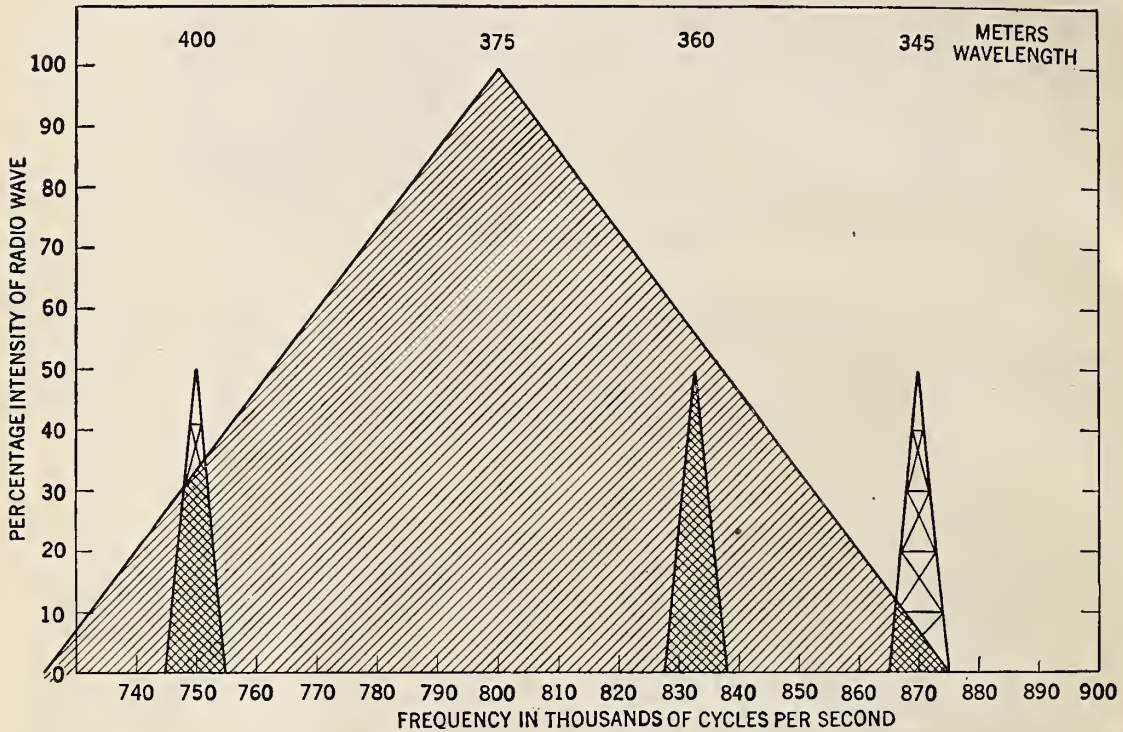

A chart showing, in the same way, the state of affairs which would exist if the interfering broad-wave station were twice as powerful as each of the three others. In this instance the interference would be so powerful over the 725,000 to 825,000 cycle range that the 360 meter station (833,000 cycles) could hardly be heard at all. Even the 400 meter station (750,000 cycles) would be difficult if not impossible to understand. Only at the margins of the interfering wave, as with the 870,000 cycle station (345 meters) would reception be possible at all through the interference

waves are equal, but will not exclude interference from a *very intense* signal wave even though its frequency be widely different from that of the weak desired signal.

Because of these difficulties, the number of independent, or non-interfering channels is still quite highly restricted. In fact, it is safe to say that a closely adjacent wireless transmitter of the spark type can effectively prevent reception (despite the use of the best receivers on the market) from a distant transmitter, even though the interfering spark wave has a basic frequency hundreds of thousands of cycles different from that of the desired signal wave.

The greatest single advance which can now be made toward an interference-free multiple-

least, their segregation upon wave frequencies widely different from those used by high-grade selective sending stations) would give opportunity for the effective use of sharply tuned interference-excluding receivers. The number of stations which could work independently in a given territory would be greatly increased, for the greatest source of radio interference would be done away with. There is a strong probability that this step forward will soon be taken; legislative inquiries are now under way to determine how new laws may be framed to aid in reducing interference, and this particular remedy is receiving such full consideration that it is likely to be among the first which will be adopted.

THE ROMANCE OF THE RADIO TELEPHONE

Being the Story of a Laboratory Toy Which Fell Prey to Unscrupulous Stock Promoters, Became a Scientific Farce, Was Taken Over by Its Supposed Rival, and Turned into a Real Success

BY C. AUSTIN

THE story of the radio telephone is a study of extremes. It is the most popular fad at this moment, yet only a short while ago it was the most unpopular invention ever introduced to the public. To-day it is in many good hands for full and sound exploitation; a dozen years ago the wireless telephone, as it was then called, was the prey of unscrupulous stock promoters who used it as a means of prying money away from a gullible public. In its present state of development, it is a partner of the wire telephone; in its pioneer days it was supposed to be a mortal enemy of the wire telephone, and not a few among laity and technicians alike were ready to sound the death knell of the less spectacular wire telephone.

THE HANDICAP OF BEING MARVELOUS

WHAT could be more startling than the idea of talking through space? Imagine a simple device which, at a stroke, could render the present maze of wires, that connects the telephones of the nation into one complete network, more or less obsolete? Consider for a moment the wireless telephone which could be carried about in one's vest pocket and which, at any desired moment, would enable us to speak with some distant person with no other formality than the opening up of a simple loop of wire!

Even in the light of the present radio telephone success, such suggestions appeal to the imagination and sound possible; yet the truth of the matter is that while we can talk through space, the radio telephone has very definite limitations which prevent its taking the place of the present wire telephone. However, some dozen years ago these word pictures were handed about to a credulous public who were ever ready to place their money in what appeared to them to be a second Bell telephone opportunity.

Most inventions, especially if they are of the highly complicated nature of the radio telephone, must spend a long period of incubation in the laboratory, under the constant nursing of a corps of inventors and technicians. Originally, the radio telephone was in good hands—in the hands of serious electrical engineers who had discovered the peculiar action of an electric carbon arc when connected with a few turns of wire and what is known as a condenser. A condenser is simply two electrical conducting surfaces, separated by a non-conductor. These conductors absorb and hold an electrical charge; but when the charge becomes too great, the condenser lets go, just as a rubber band which has been pulled to its utmost point and beyond finally snaps and lets go, giving off all the power which has been stored up during the stretching process.

An electric carbon arc, when connected with a few turns of wire and a condenser, sets up a vibrating current, so to speak, in the circuit containing the arc, coil of wire, and the condenser. The electrical engineer calls this vibrating current a high-frequency current. Alternating current, which is used to such a large extent for lighting and power purposes, is also a vibrating current, in that it flows first in one direction, and then in the other, changing its direction of flow sixty times per second in the usual power supply line.

Now, when vibrating currents of sufficient frequency are obtained, it is possible to propagate a portion of these currents through space in the form of invisible radio waves. A system of elevated wires, known as the aerial or antenna, and a connection with the ground serve to impart the waves to the air. At some distant point another system of elevated wires known as the antenna, as well as a ground connection, serves to gather an infinitesimal portion of the radio waves which have been extending in all directions, and to lead them to the receiving

set. It is the purpose of the receiving set to convert the radio energy into some form of energy which comes within the scope of our senses. In the case of transatlantic radio stations, photographic recorders are sometimes employed, so that the waves make their presence known by a wavy line on a band of paper. But in most commercial and amateur receiving stations the waves are converted into sound

acteristics which are reproduced in the telephone receivers of the receiving set, instead of the short and long buzzes of the radio telegraph waves.

SHORTCOMINGS OF THE ELECTRIC ARC

ANY one who has had an opportunity of studying the electric arc even superficially must have noted how erratic are its functions. Who does not remember the electric arc lights formerly used in highway and street illumination? These lamps would sputter and flicker almost incessantly. The arc light of a motion picture projector generally kicks up a fuss every so often, causing a change of intensity on the screen. And when these irregularities are coupled up with such a delicate thing as the generation of radio waves, their action is amplified ten thousand fold or more.

At any rate, the pioneers in wireless telephony had the arc to work with. It was to be their generator of radio waves, although one or two workers had constructed special alternating current generators capable of supplying current of very high frequency.

It was the good fortune of the writer to participate in wireless telephony back in 1908 and 1909, with a transmitter of German make. It was a huge affair, about the size of an overgrown upright piano, with a table in front and a tall switchboard at the rear. A series of experiments was being conducted for the United States Signal Corps, with a view to proving the practicability of radio telephony in military communication. The distance to be spanned was some 18 miles, or the air line between Fort Hancock, Sandy Hook, and Fort Wood, Bedloes Island, in the very shadow of the Statue of Liberty overlooking New York Harbor. The high hills of Staten Island intervened, making communication between the two points all the more difficult. By a queer turn of fortune the receiving station was located in the very same radio station building that is now being employed by the Signal Corps for a radio-phone broadcasting station. The main difference is, however, that the present installation works; ours didn't!

Needless to bore the reader with an elaborate description of our pioneer radio telephone. Suffice it to state that it consisted of ten arcs, each arc made up of a copper cylinder closed at the bottom and filled with water so that it wouldn't melt, as well as a large carbon button

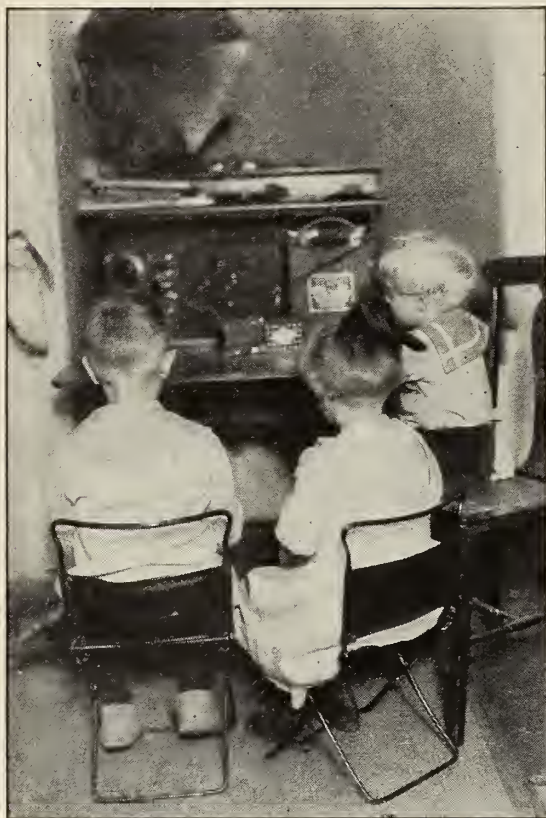

SMALL IN STATURE BUT NOT IN ENJOYMENT
Three youngsters of Morrisville, Pa. listening to a concert

and heard through the medium of telephone receivers or a loud-speaking horn.

If the waves are merely modified into short and long impulses, then we have mere dots and dashes of the telegraph code. Each letter is then represented by a certain combination of dots and dashes, the messages being spelled out letter by letter and word by word, except for certain abbreviations. If, on the other hand, the waves are modulated or moulded, so to speak, with the characteristics of certain sounds, such as the human voice or music, then the resultant waves carry inherent sound char-

pressing up against the copper cylinder and then separated by a quarter of an inch or so to form the arc. Current for the ten arcs, all connected in series, was supplied by a 550-volt motor-generator set. Then there were three meters, indicating the conditions in various circuits. The first part of the programme consisted in taming the ten arcs until the meters stopped their mad antics and their

their characteristic thoroughness and fine workmanship, made the microphone in the form of simple cartridges which fitted into a holder at the small end of a long but narrow cardboard horn. Each microphone did not last much longer than five minutes, after which it was little more than plain junk. While the writer never knew the exact cost of these microphone cartridges, they could hardly have



CONVALESCING TO THE STRAINS OF RADIO MUSIC

© Kadel & Herbert

needles or hands, whichever you wish to call them, came to a genteel repose.

A large megaphone mounted on the rear board of the transmitting set was the mouth-piece. One didn't talk, however; one simply shouted. There was little to say, because if we were heard at the receiving end, it was more of a miracle than anything else. So we simply shouted numbers into the huge horn—"One, two, three, four," and so on, followed by "Fort Wood, Fort Wood, how do you get me now? One, two, three, four," and so on again and again, until the meters dropped their dignity and began cutting up once more.

The microphone, or the instrument which transforms sounds into modifications of an electric current, was a renewable affair. The German builders of the equipment, with all

cost less than \$2.00 each. Imagine wasting a \$2.00 microphone for every five minutes of uncertain telephonic communication, not to mention the time lost in changing microphones!

A STUDY IN DEDUCTION

WHAT of the results? Absolutely impossible! In all the long months of untiring effort to work over the short eighteen-mile span between the stations, the voice and the phonographic music only got through a half dozen times, and then only for a few moments, so that odd bits of conversation or music were heard by the Signal Corps officers gathered at their receiving end. Even in those days the phonograph was employed for radio telephony.

But all the while certain stock promoters

were reaping a harvest. To them the radio telephone presented an exceptional opportunity. The story of the Bell telephone was to be duplicated, but on a larger scale; radio telephones would be installed in every home for communication purposes; wires and cables would be done away with; everyone would carry a vest-pocket or vanity-bag type of transmitter and receiver for instant use in



THE FIRST TOWER AT WGI

Where the American Radio Research Company did some experimental broadcasting in 1915

calling up any one else and so on. These gentlemen may or may not have believed their own word pictures; but the main thing is that a proportion of the public did. And they parted with their money. Even so, never did a stock promoter prophesy radio receiving sets in most American homes for the purpose of listening to speakers and to the world's best music. That would have been too much to spring on the public!

Of course there had to be some proofs. There had to be something more tangible than mere word pictures for the public to part with its money. So, certain demonstrations were arranged for between various points. One of these demonstrations took place between

two cities. Everything worked to perfection. The results were absolutely wonderful, and nothing of the kind had ever before been realized. The public was enchanted, nothing less; but the true scientists and radio workers were completely baffled. Then, when certain interests were closely investigated, an unpaid bill for the leasing of a telegraph line between said two cities on a certain date came to light. Needless to say, the date corresponded with that of the successful test of the wireless telephone. The inference is obvious.

Another time it was a German company's turn to make a demonstration for the German army. The test was to be between Berlin and another city more than one hundred miles distant. Although nothing of much consequence had ever been done with this particular German wireless telephone system, on this occasion it worked like a charm. An inquisitive German officer, seeking some explanation for the sudden jump in radio progress, not to forget the remarkable clearness and loudness of the received conversation, suddenly discovered a telegraph line running directly between the transmitting and receiving stations. There was no physical connection, however, but nevertheless the radio waves had a nice, easy path to travel between the two stations, which made for such clear and loud reception.

There were other cases, too numerous to mention, some being a deliberate attempt to defraud, and others quite innocently helped along by questionable methods.

The arc was an impossible means of radio telephony, at least as it was then employed. Many workers gave much time and more money to the problem, and little by little the distances covered were extended into the hundreds of miles. But the results were always of a laboratory nature and nothing of a commercial character ever appeared likely.

WHEN THE RIVAL BECAME A PARTNER

LET us skip over the ensuing years of radio telephone history, with more and more workers trying to harness the balky arc generator and the troublesome microphone problem. We come to Dr. Lee de Forest, an American radio worker, and his development of the little device known as the vacuum tube, which is little more than an electric lamp with a few elements added. Electrically speaking, it is far more than an electric lamp, because it can do more remarkable things than any piece of

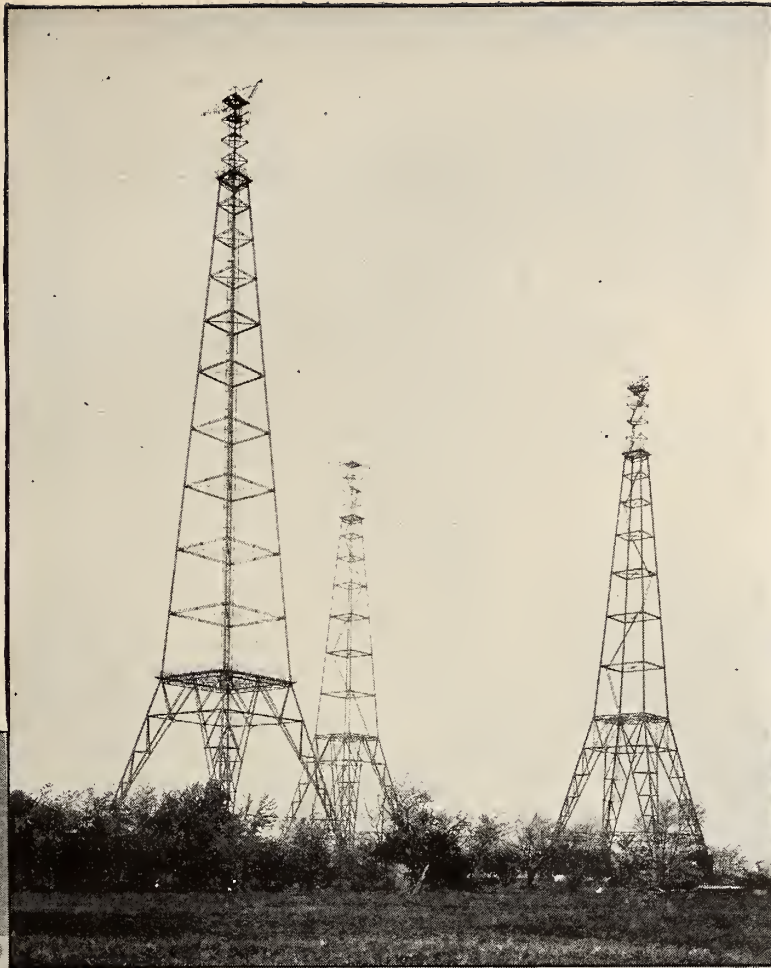

THE TALL RADIO
TOWERS AT AR-
LINGTON, VIRGINIA
near Washington, which first
sent the human voice across
the Atlantic

MAIN SWITCHBOARD IN
THE ARLINGTON RADIO
STATION

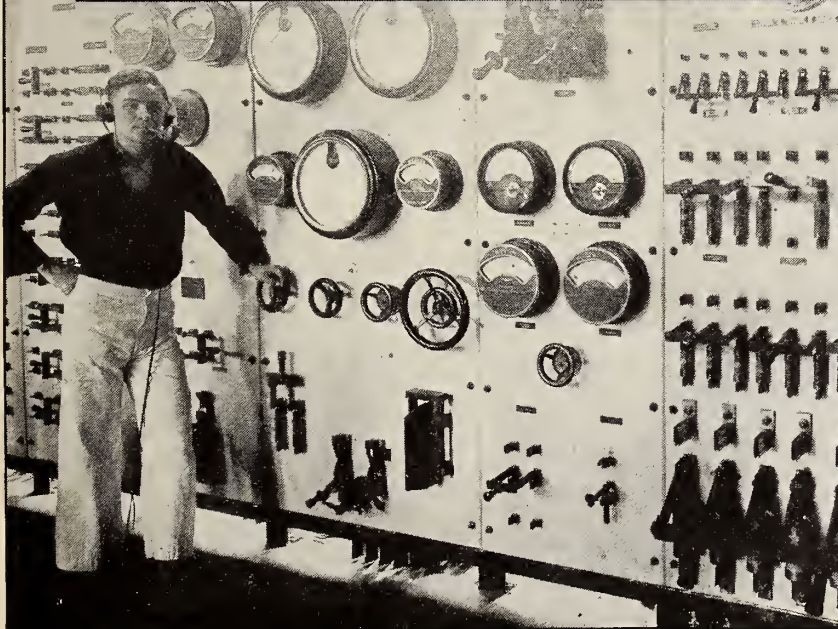
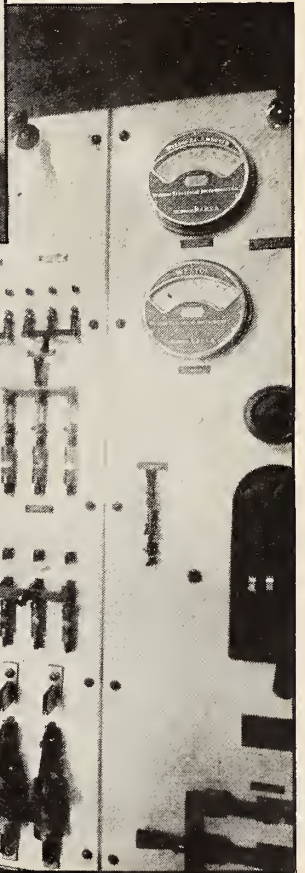

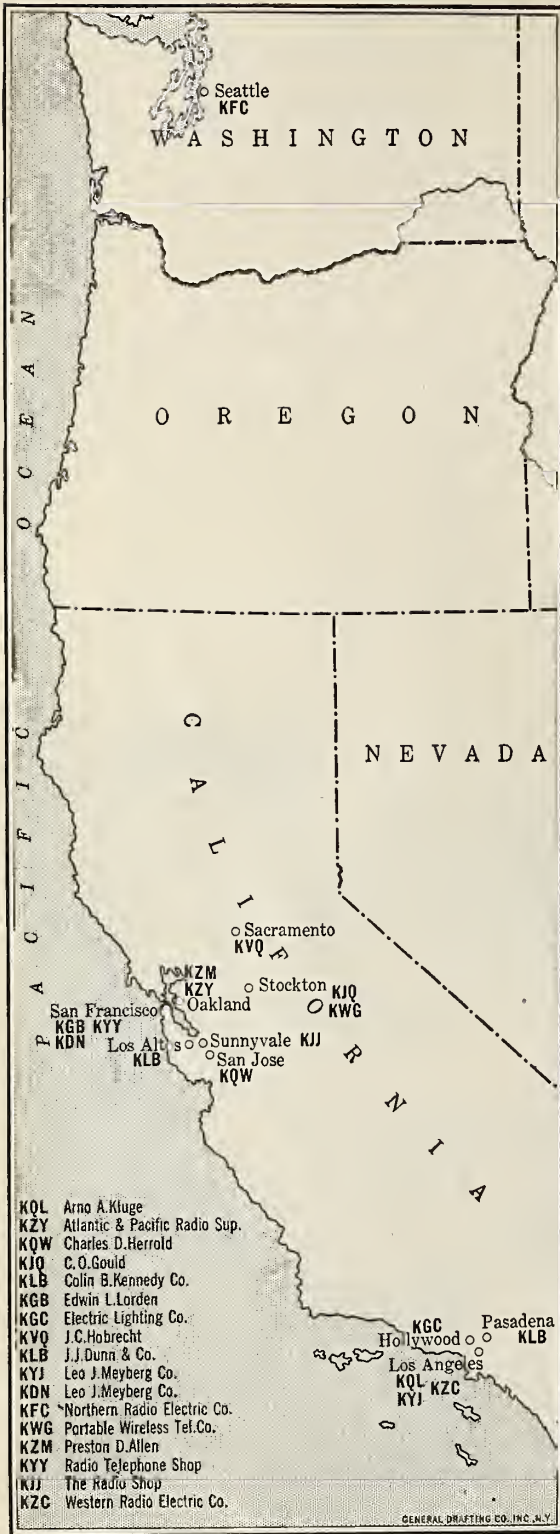

PACIFIC COAST BROADCASTING STATIONS

electrical machinery ever devised; but from the standpoint of the layman it is simply a modified form of electric lamp, with a filament that is heated from a cherry red to incandescence, according to the type of tube, a little helix or fine wire or a length of wire bent in zigzag pattern and called a grid, and finally a cylinder or one or more little squares of nickel or other metal, known as the plate.

The vacuum tube is the modern Aladdin's lamp. It can do so many things in electrical work that it is virtually an acrobat. It generates alternating current of a wide range of frequencies; and as has been demonstrated, currents of high frequencies are suitable for the generation of radio waves. Thus the vacuum tube, which is positive in its operation, becomes an excellent generator of radio waves. Feed it alternating current, on the other hand, and it rectifies it into direct current—current that flows in one direction only. This feature makes it available as a means of recharging storage batteries off alternating current, and a simple outfit now takes the place of the elaborate storage battery recharging sets of but a few years ago. Again, this feature makes it available as a remarkable detector of radio waves for reception purposes. Feed it a slight fluctuating current, such as a telephone current, and it will modulate or modify a far more powerful current in the same manner; in other words, we have a weak current moulding a powerful current; and since this process can go on through several stages, with each stage handling a still more powerful current, we have a means of making very big sounds out of little sounds, which is what our present-day amplifiers do in radio. It is this characteristic, too, which makes the vacuum tube the best telephonic relay or repeater ever used. It is employed in long-distance telephone communication, so that the voice currents, after traveling through hundreds of miles of wire and becoming greatly attenuated, are brought to the grid member of a vacuum tube and thus serve to control a fresh current starting out on the next few hundred miles. The voice characteristics of the weak current are re-impressed on the strong current, so that virtually nothing is lost no matter how great the distance may be. Again, the vacuum tube, because of its modulating characteristics, is the link between the ordinary telephone microphone or telephone transmitter and the powerful current used for

the radio telephone transmitter. At a stroke it eliminates all the troubles that seemed impossible of solution in the early days of the wireless telephone.

Telephone engineers were not slow to see the numerous advantages and possibilities of the vacuum tube. They took the vacuum tube into their family circle, so to speak, and decided to rear it in a safe and sane manner. This they did, and the vacuum tube repaid them in ever so many ways. The trans-continental telephone line, the wired wireless system which makes possible a large number of telephone messages over the same set of wires simultaneously, the amplifying and distribution of a speaker's voice so that it can be heard by 50,000 persons at the place where he is talking or at some remote place or several remote places—these are all the contributions of the vacuum tube to the telephone engineers, repaying them handsomely for their interest in this device.

THE VOICE THAT SPANNED THE ATLANTIC

THE telephone engineers, let it be said, did more for the wireless telephone than could ever have been done by radio organizations of the early days, with their limited capital and facilities. Furthermore, the tele-

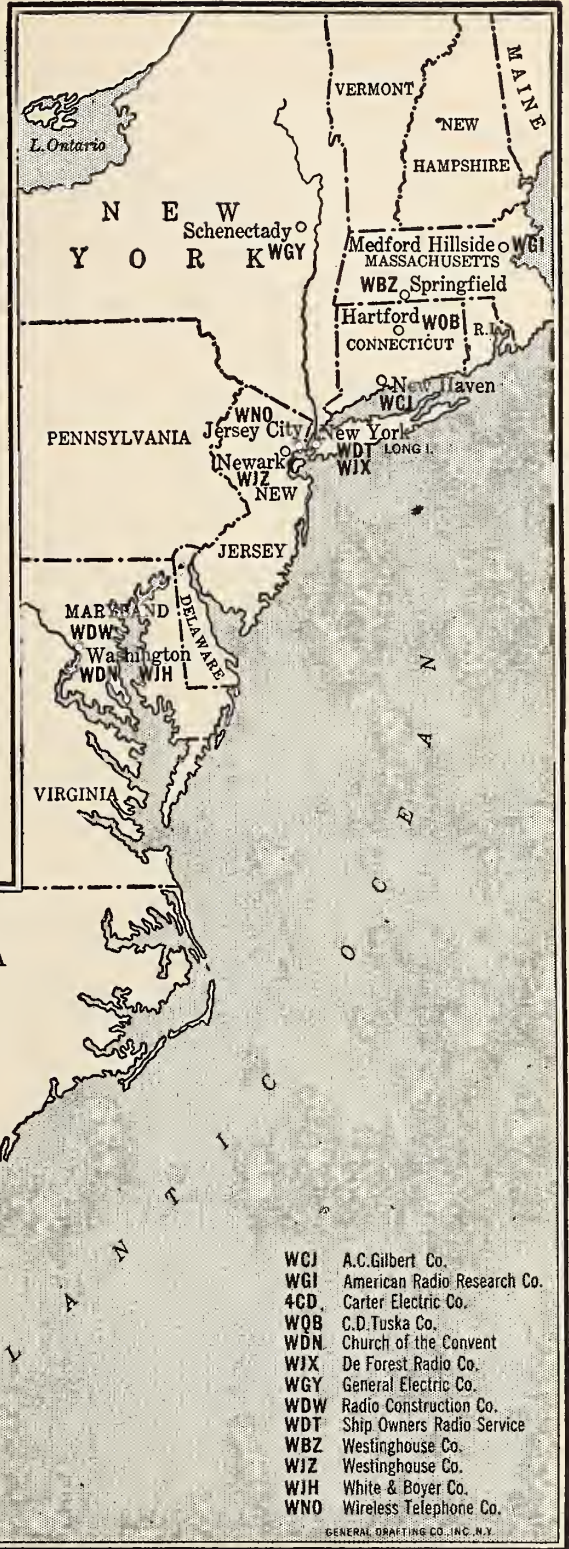

GENERAL BROADCASTING STATIONS ON THE ATLANTIC SEABOARD

phone engineers worked more or less in the privacy of their laboratories, with little or no news of their progress reaching the public at large. Suddenly, without any warning, it came to light that very definite progress had been made in radio telephony. It was in 1915 that the engineers of the American Telephone and Telegraph Company succeeded in telephoning by radio from Arlington, Va., to the

So much for the technical side of radio telephony. But the real success of this invention has been in the broadcasting field, and, fortunately, we do not have to go far back to get to the beginning of this phase of the art.

Probably it is not generally known that the United States Navy is a pioneer of broadcasting, but Navy records and the memories of early radio enthusiasts prove that the Ana-

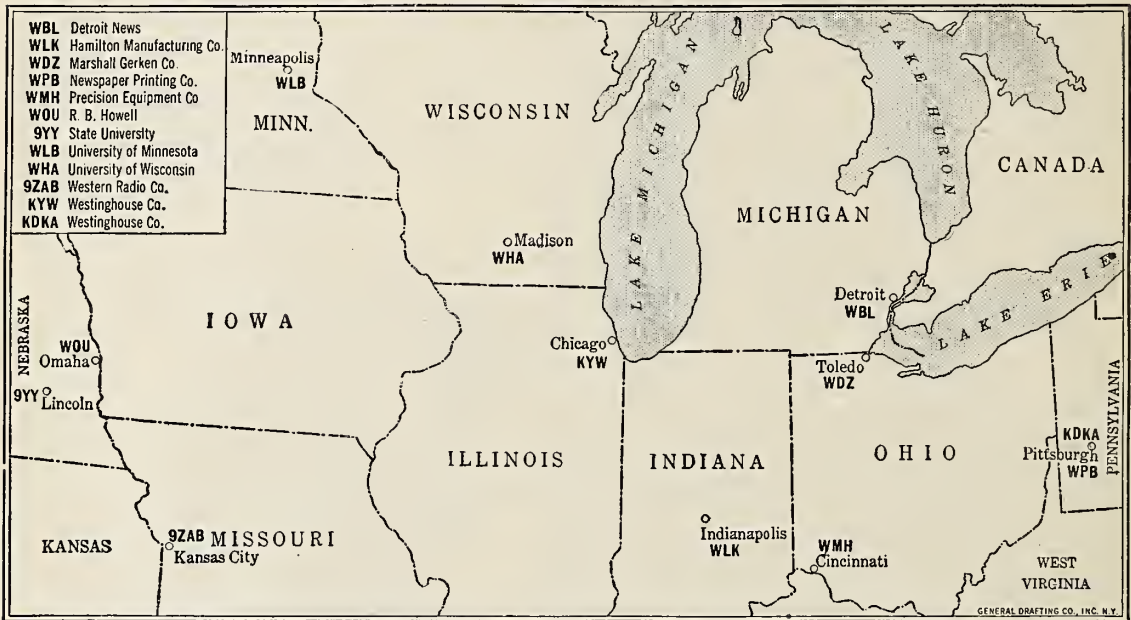

GENERAL BROADCASTING STATIONS IN THE MIDDLE WEST

In the Gulf states there are two stations. WRR, the police department of Dallas, and 5ZU, the State University of Austin, Texas. At Denver also there is station 9ZAF operated by the Reynolds Radio Co.

Eiffel Tower in Paris, France, or over a distance of over 3,000 miles. Over three hundred vacuum tubes were employed for the generation and modulation of the transmitted waves. During the same tests the voice carried out to Hawaii, or a distance of almost 5,000 miles.

Came the war, with the urgent need for some form of rapid and positive communication between airplanes and between airplanes and the ground. The best radio talent was applied to the task, and soon little outfits, not much larger than one foot square, appeared in our airplanes for the purpose of ensuring telephonic communication over some fifteen to twenty-five miles. Progress from that day to this has been rapid, for the foundation for practical development was laid by the telephone engineers for all time.

costia Naval Air Station near Washington broadcasted music by radio phone for the first time on January 17, 1920. The Navy had, of course, been broadcasting by code for some years previously, but this was the occasion of the first radio telephone entertainment. Commander A. Hoyt Taylor was then in charge of the Anacostia station, then the highest powered radio station in the country with a range of 1,000 miles. A phonograph concert was transmitted weekly, followed by technical information for amateurs, for a considerable period. Navy records show that communications were received in February and again in March, 1920, from St. Louis, Minneapolis, and places in Pennsylvania congratulating the Anacostia station on the strength of its signals.

The Westinghouse organization was the first commercial organization permanently in the

field of broadcasting. Under the direction of Mr. J. C. McQuiston it inaugurated its first radio-phone concert through its Pittsburgh experimental station on Nov. 5, 1920. Only a small number of persons heard the musical numbers then sent out by KDKA, as the Westinghouse station is known. These letters, by the way, are the call letters of that station. All stations, whether radio telegraph or radio telephone, have call letters assigned to them by the Department of Commerce which grants licenses for transmitters, just as automobile licenses are granted to autoists and are indicated by the license plates on their cars.

The phonograph was the first source of music, and the operator's announcements sufficed for lectures and talks. The novelty of the feat was sufficient, of course, for the public had not yet been accustomed to the present high-grade programmes. Problems arose over the manner and method of broadcasting, which had to be solved by experiment. There were many times during the first few weeks of broadcasting when the concerts were anything but pleasant to hear. Then, as time passed and, through experience, the operators found out for themselves the kind of phonograph records which transmitted clearly and those which did not, what to avoid in the way of speech, what pleased the public and what did not, and the various other little details which made or marred a radio performance, the concerts became more and more popular.

During the experimental stage, letters began to trickle in from various parts of the country, telling of the reception of music and talks from KDKA. At first, returns were small, and mostly in the way of letters and post cards from established stations, which are always on the lookout for new developments.

Virtually all the broadcasting done by KDKA was pioneering work. For instance, take the case of the radio chapel services, now an established part of every Sunday programme. When the station was first operated, there was no programme developed for Sunday evening. Someone suggested that church services be tried, but there was no precedent for this method of broadcasting church services and it was not known whether the churches would consent to such practice. After some persuasion, however, permission was received from Calvary Episcopal Church of Pittsburgh, to broadcast its services. A district telephone

line was installed between the church and the radio station for the purpose

Four microphones were installed in the church to catch the voice of Edwin J. Van Etten, rector, as well as the choir, the chimes, and the organ. The entire services were first sent out January 2, 1921. No one thing ever broadcasted by the radio station has been so popularly received. Letters poured in by the score to the Westinghouse organization telling of the pleasure and the benefit of this new departure in radio.

PREACHING A SERMON AT A DISTANCE OF FOURTEEN MILES

AFTER a time, when the church services were well known to all radio enthusiasts because of the clearness of transmission, the Westinghouse organization was requested by members of the Herron Avenue Presbyterian Church of Pittsburgh to install a receiving set and loud-speaker to take the place of a long absent pastor. This was done, and the church assembled for an Episcopal service. But it listened to a sermon preached about fourteen miles away. This service was a record, a milestone, an epoch-marking event. It was the first time that a metallic horn took the place of a flesh-and-blood minister.

In the meantime phonograph records comprised most of the evening musical programmes. It was decided to do away as much as possible with the "canned" music and substitute real singers and musicians. Talent was not hard to secure for this work, in most cases volunteering its services gladly. Human voices began to come over the radio telephone instead of phonographic music. Again an improvement was scored in radio-phone broadcasting—another milestone. Not satisfied with having merely local talent, the Radio Division of the Westinghouse organization entered into an agreement with the managers of the local operatic concerts with the result that when stars of the first magnitude came to Pittsburgh, their efforts, vocal or instrumental, were and are being broadcasted over a territory of many hundreds of miles.

Not only in opera, but in the world of sport, the radio-phone service has been introduced. Seeking for features that would enliven the evening programmes, it was decided to broadcast, as an experiment, blow-by-blow returns of a boxing match held in Pittsburgh. A private wire was installed from a boxing club to the

radio station, and a man prominent in sporting circles engaged to render a round-by-round version of the progress of the fight. So KDKA was the first broadcasting station ever to send out fight returns. Afterward, the Dempsey-Carpentier bout in Jersey City was broadcasted by a Radio Corporation station round by round.

One by one other features were added, such as the news of the day, weather forecasts, agricultural reports, bedtime stories, addresses by prominent citizens, and so on, making the radio-phone service of value as well as a means of entertainment.

Naturally enough, the success of the Pittsburgh station created such a demand for radio receiving equipment that the Westinghouse organization as well as other firms engaged in manufacturing radio equipment were virtually buried under an avalanche of orders; and they remain buried even to this day. The Westinghouse organization decided to open up other broadcasting stations so as to extend the territory supplied with their radio-phone service. To this end a station was opened on Oct. 3, 1921, at Newark, N. J., known as WJZ. Another station was opened about the same time at Springfield, Mass., WBZ, and still another at Chicago, known as KWY. It is said that more than 300,000 persons hear the Newark programme every evening, and the number is increasing by leaps and bounds.

This Newark station has had the very great coöperation of the Newark *Evening Call*, the first newspaper in the country to have a radio section. Mr. William F. B. McNeary the Radio editor of the *Call* arranged to broadcast the election returns, the results of the football games, etc. He also is the famous "Man in the Moon" who twice a week talks to the children from WJZ.

In the meantime the American Radio & Research Corporation, of Medford Hillside, Mass., which had done experimental broadcasting in 1915, entered the field in the spring of 1921 with a daily schedule for the general public, and from that time on the development of broadcasting has been swift. Newspapers, wireless companies, department stores, private individuals, and others have begun broadcasting activities. Several broadcasting services issue a printed programme for each week, the programme being mailed to all interested persons. It is estimated that nearly eighty broadcasting stations are now in operation through-

out the country, and anywhere from 500,000 to 750,000 receiving sets are in use. At a time when most lines of business are badly in want of trade to keep their wheels barely turning over, the radio business is working night and day and yet cannot catch up with the demand. A recent report has it that one radio manufacturer alone will do a business in excess of \$50,000,000 for the current year!

BUT WHAT OF THE FUTURE?

AT THIS point we come face to face with the future. We know that the broadcasting service is a success; that the public is buying all kinds of receiving sets, ranging from the little \$15 sets for receiving radio-phone service from near-by stations, to the sets worth \$300 or more which enable the operator to choose the programme of any one of half a dozen or more broadcasting stations, located within a range of 500 miles or over. The receiving set is readily installed, a simple, single wire antenna of 50 to 150 feet in length, as well as a ground connection to water, steam, or gas pipe, representing all the work required.

But what the laity does not appreciate is the fact that the air, like any highway, can stand just so much traffic and no more. With our present system of transmission and receiving, we can accommodate only a few transmitting stations in the same general vicinity, working simultaneously. To permit more stations to operate is only to cause a hopeless confusion in which one station cannot be heard above the indescribable din. If everyone who wants to operate a transmitter were to be granted a license, no one would have any results and all efforts would be nil. It is as though there were but a single narrow highway throughout the width of these United States, and everyone insisted on buying an automobile. Then we would have so many automobiles for the road space available that practically no one would move and every automobile would become useless.

So it has come to pass that for the safety of radio it is necessary that the issuance of transmitting licenses be limited from now on. The majority of the public want good broadcasting service of the kind that is now being supplied. And since the majority must rule, there must not be hundreds and thousands of radio telephones at work in any one territory messing up the work of the radio-phone broadcasting stations and ruining the art for every-

one. The radio-phone is not practical for communication between individuals, because the air will not stand sufficient traffic to enable any number of individuals to use it at the same time. Its main forte, therefore, is in the matter of broadcasting, where it is desired to bring to the attention of a large audience certain facts or reports or even music for their information, education, and entertainment. The wire tele-

But the radio telephone has made good, after all its years of toil under an unlucky star. It has not put the wire telephone out of business, and never will; it has not come down to the vest-pocket or vanity-case type, as yet, and probably never will; it has not afforded us ready means of communicating one with the other, and never can so long as the space or ether is so limited. But it has united an entire



RECEIVING STATIONS THAT HAVE REPORTED HEARING WJZ,
THE WESTINGHOUSE BROADCASTING STATION AT NEWARK

phone continues to be the best and only medium for communication between individuals, except in a few exceptional cases, while the radio telephone is the only satisfactory means of spreading facts or music over a wide territory and to hundreds of thousands of listeners. Here again is a touch of romance, for the radio telephone is being developed along lines which were never foreseen by the pioneer workers.

nation into one huge audience which, for the first time in the history of the world, can be addressed from the various broadcasting stations, entertained with the world's best music, and otherwise kept in touch with the affairs at home and abroad. It has annihilated distances, and any citizen may now keep in touch with the latest developments even in distant cities and markets.



WHEN UNCLE SAM WANTS TO TALK TO ALL HIS PEOPLE

WHERE THE ARMY GETS THE NEWS OF THE WORLD
European Intercept Room, Signal Corps Radio Station, Washington, D. C.

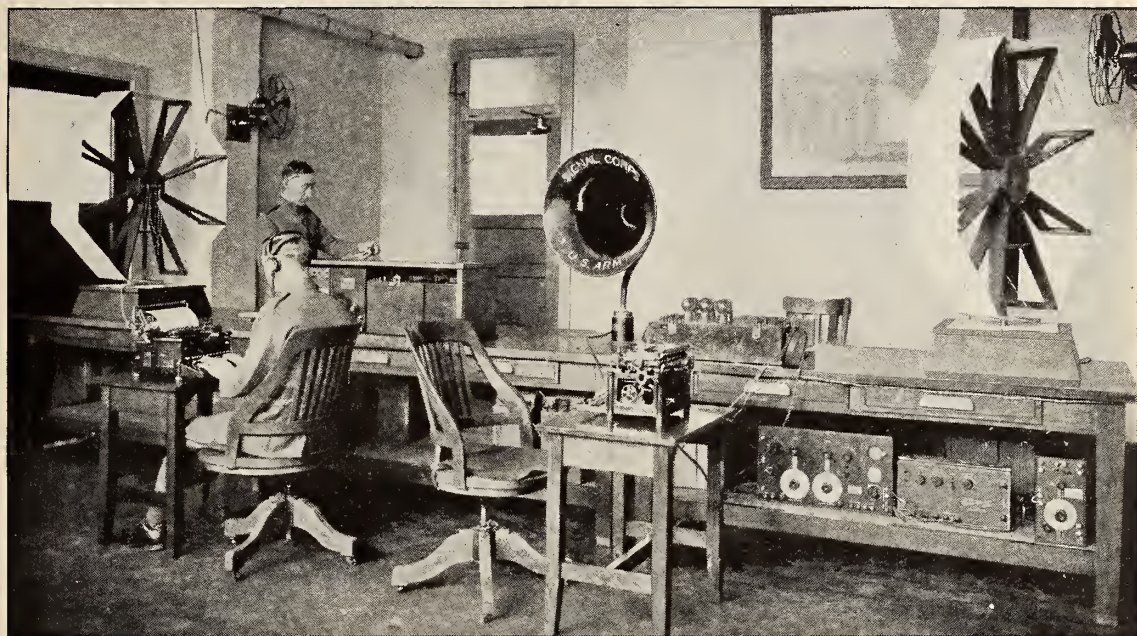

UNCLE SAM IN RADIO

The Most Extensive Radio Equipment of Any Government in the World. The Signal Corp's Continental Net. The Navy's Shore Stations and International Net, the Work of the Bureau of Standards, the Post Office, and the Bureau of Markets

By DONALD WILHELM

STEERING manless airplanes by radio—the Air Service is doing that. Steering, starting, and stopping a manless ship, by radio—the Navy has done that. And guiding torpedoes through the air from planes, and through the water from planes and from ships, by radio—Uncle Sam is also doing that.

But these are only a few of the things Uncle Sam is doing, by radio!

Sending forty telegrams each way along two contiguous wires that at the same time are being used for four telephonic conversations—General Squier, of the Signal Corps, is doing that. And guiding vessels and airplanes to port—no matter what the weather—by radio—Uncle Sam is doing that.

Up aloft Army and Navy planes chat with one another when twenty miles apart, and

with land stations when 300 miles away, by radio. I sat in a radio shack on an aviation field, near an amplifier and beside the bride and mother-in-law of an air officer drilling a flock of planes overhead, by radio—and we heard the officer so plainly that the receiver had to be turned off!

Out in the West, Army cloud punchers, clipping the welkin for the Forest Service, report forest fires—even moonshiners!—by radio. And then comes an Army-Navy football game and long before it starts—by the clock!—bets are being settled in far-away Manila, by radio.

But all this isn't all!

The Navy is being run, by radio, and is finding ways not only to detect sounds under water by radio but actually to communicate with submarines under water. It has radio compasses for airplanes, and direction finders,



THE SIGNAL CORPS AERIALS

Receiving loops of the Signal Corps Radio Station, Washington, D. C.

and cables to right and left of which, on the surface of channels of course, ships steer easily, no matter the weather.

Farmers, too, have lost their isolation, because of radio. Via the Post Office Department, the Bureau of Markets and the Weather Bureau have been supplying them with dignified and important information while farmer boys and girls have used the family receiving sets to listen to a thousand things the wireless waves are saying.

It's really incredible in how many ways Uncle Sam is using radio. The Post Office Department, for instance, now administers its Air Mail by radio; and the Lighthouse Service is setting out radio beacons so that from the bridge of his ship a master can tell precisely where he is, by radio.

But the Navy antedated the Lighthouse Service in this work. The Navy has a chain of

radio compass stations each manned by five men, along both our coasts and at some points in our island possessions, so that naval vessels and others can make port whenever their captains desire. The Navy has more than fifty of these stations, all the product of the last two and one-half years. During the year 1921 alone, when only forty-six of these stations at most were in operation, they gave 53,344 bearings to 21,622 vessels, with a saving in time and life and property not easily calculated, since it costs \$500 and more for many a liner to be forced to lie off port for half a day or so, and blind chance at trying to make port is the parent of innumerable accidents.

But you must go out with the Atlantic Fleet and live for days in its radio shacks if you want to know anything about the innumerable ways in which the Navy uses radio, because there is no branch of naval en-



HEADQUARTERS OF THE ARMY RADIO SYSTEM

In Washington, the control station of the Army radio net, Captain W. B. Wolverton (in right foreground) in charge

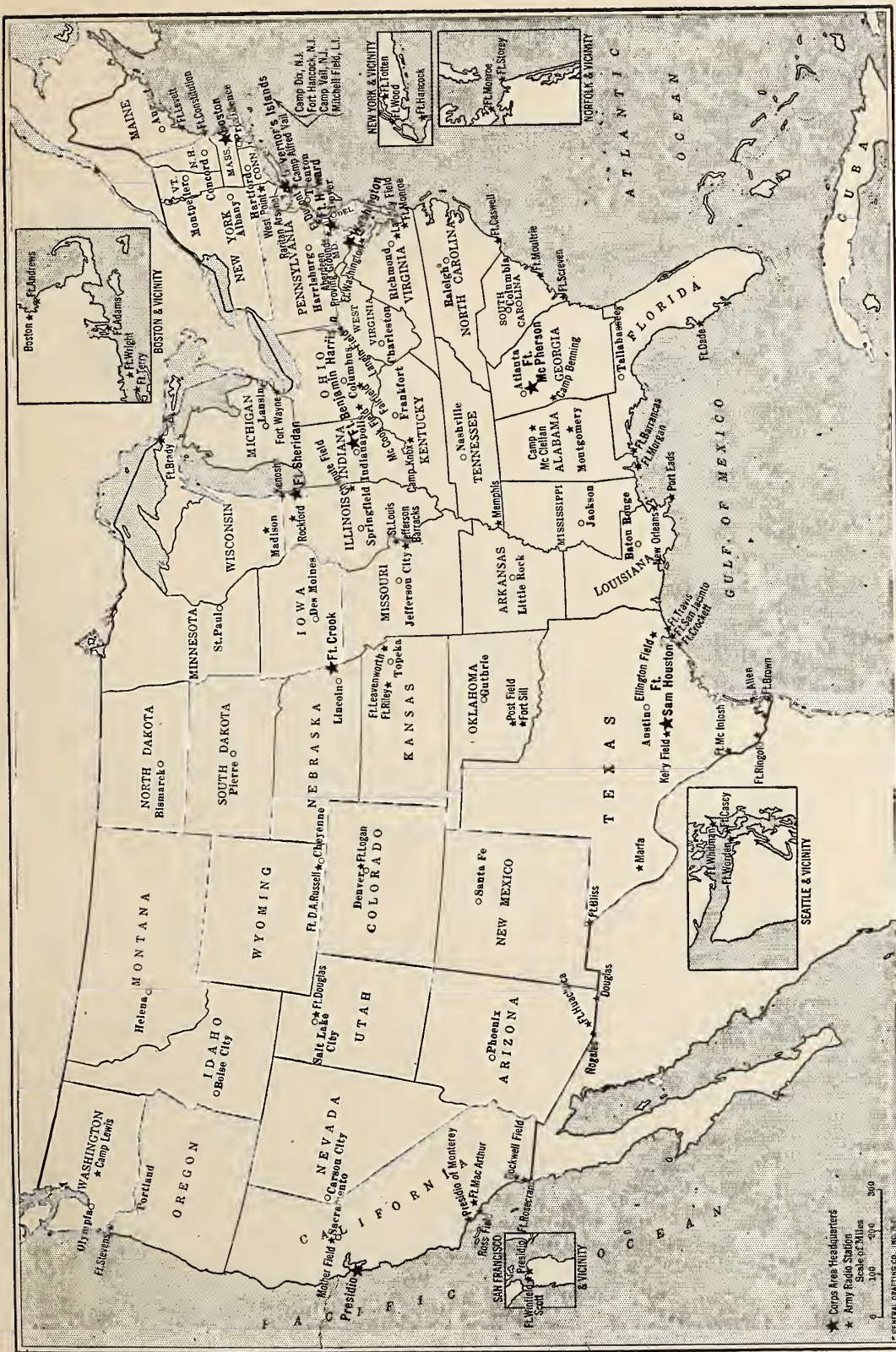

THE ARMY RADIO NETWORK

Which, when completed, will consist of a high power station at each corps headquarters which, with the many lesser stations which, for example, could reach the whole country simultaneously. The Signal Corps now handles its own business by radio and much other Government business besides

* Corps Area Headquarters
 * Army Radio Station
 • Scale of Miles
 0 100 200 300
 GENERAL COASTING CO. INC.

gineering, with the possible exception of aviation, that has so rapidly developed. The Navy has its wig-wag signals, of course. When its ships are in sight of one another it flashes signals by the blinkers or the heliograph, using a searchlight perhaps. It has its red and white vertical signals too. But when the distance is worth noticing, and frequently at other times, radio is the thing! You'd think the air would be gummed with all this sending and receiving, but system is the word. It has to be so. For radio is now as much a part of the every-day,

Langley Field to sink the target—and promptly sank it. Meanwhile, another flock started from its base, a hundred miles away. Then, out from the radio guard ship that day, snapped the order to the leader of this second flock of planes, "Target sunk. Return to base." The leader got the message, barked his orders into a radiophone, and in perfect order his planes turned back. Again, one day, while the experiments were on, the *Shawmut* caught a message from Langley to the planes, "Drop your bombs and return to base. Storm coming up

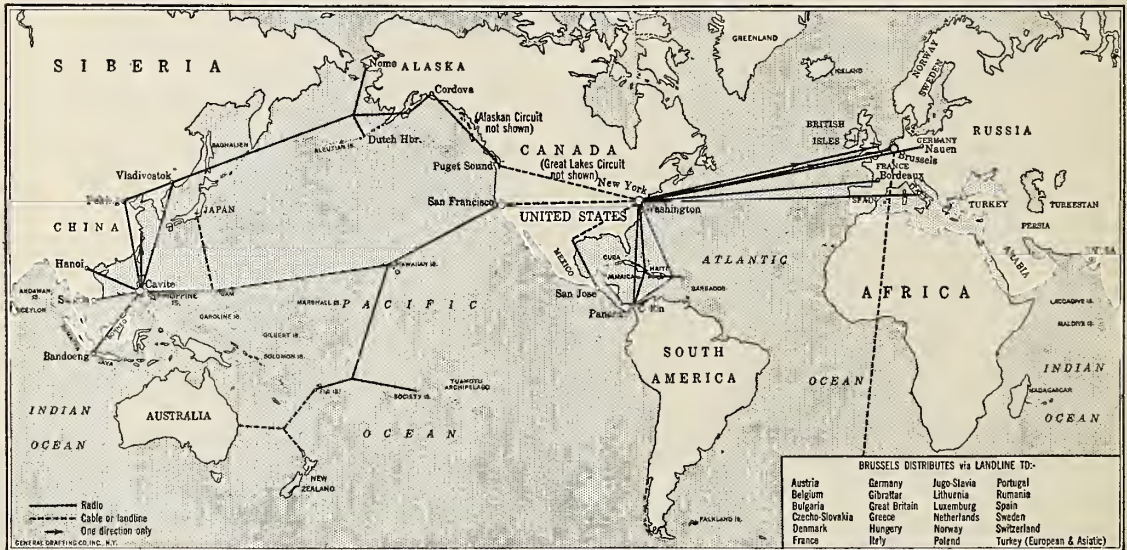

THE NAVY'S INTERNATIONAL RADIO SERVICE

Over the routes shown in this map the Navy handles news and commercial messages as well as its own departmental and other Government matter

every-hour, every-minute routine of the Fleet as the use of engines and rudders. Not only for emergencies, not only for maneuvers, not only for all sorts of general utility work does the Navy use radio; rather, the Navy is simply run by radio. The Secretary of the Navy, let us say, wants to send word via an all-Navy radiogram to all the 650 naval ship stations, all the 102 naval airplane stations, all the 180 shore radio telegraph stations? Very well, he dictates his message, in a trice someone snatches it, in code, down the corridor, and, pronto! it is leaping tell-tale up and down and round the world. And it's just about as easy for him to reach the 1,037 Shipping Board stations and every other thing, almost, that floats. Or, say, you have an event like the bombing experiments in Chesapeake Bay last year. There, one day, a flock of bombers set out from

the Coast." And again, one afternoon, when a bomber was circling overhead, waiting for the inspecting officials to leave the target, it flashed its message down to the radio guard ship, the *Shawmut*, "Unless you leave the target within fifteen minutes we must return to base because our gas is running low." They left!

But such bits of administration as these are commonplace to the Navy. It has a good deal more than \$25,000,000 invested in radio. It is sending a good deal more than 8,000,000 words a month by radio. It is doing \$10,000,000 worth of commercial radio business annually—business at the rates of the commercial companies which they themselves cannot handle. Yet the important thought is this: That our Navy has without question the most comprehensive and effective net of its trans-

oceanic kind in the world. Japan, for instance, in the nature of her possessions, has nothing comparable—actually could not reach by her own radio her merchant ships in remote corners of the world. France's trans-oceanic key strength is mainly that of the Lafayette station, now the most powerful in the world, which our Navy built during the war, which can reach round the world, if conditions are quite right. Italy can reach our eastern Coast, hardly more. Germany is practically out of the running, though she retains two large stations, after having given up Togoland in Central Africa to England, and Tuckerton and Sayville to the United States, since they are on our territory, and various and sundry other possessions to other Allies. So it comes to this again, that the British Empire and Uncle Sam, in the ether as on the seas, come nearest to being on a parity. Yet it is no exaggeration to say that, though the British Empire has available, if it chose to use them, more ships than we have and quite a good deal larger spread of land possessions, still her contemplated Imperial Radio Chain does not as yet favorably compare with the U. S. radio net as a whole, even if we do not include our purely commercial companies—the Federal, in the Far East, and the Radio Corporation of America, which is spreading out through and across Europe and elsewhere.

Our Navy built the first high-power continuous wave station, on the Canal Zone, in 1914. It has blazed the way in many other directions. Its net can broadcast, and as a matter of fact does, everywhere up and down the seven seas.

And now comes the Army with a land net that for solid thoroughness and scope is also unique.

The writer is able for the first time to outline the scope of this net, which for the most part will be in full operation before this article can be read.

The Army, you see, has nine corps areas, since its reorganization following the war. Its radio net will cover all these areas, with its control station in Washington, and all our fourteen aviation fields and all our artillery and other posts will be tied into this net. Ft. Wood, in New York, for instance, is the headquarters of the Second Army Corps, and has in its area the radio stations at West Point, Mitchell Field, Camp Dix, Camp Vail, Rariton Arsenal, and Fort Hancock, all of which, in

turn, use radio for different local as well as larger purposes. Again, in the same way, the Third Army Corps, with headquarters at Ft. Howard, Baltimore, Md., controls Fort Monroe, Langley Field, and the Aberdeen Proving Grounds; while Ft. McPherson, at Atlanta, Ga., headquarters of the Fourth Army Corps, includes the stations at Camp McClellan, Ft. Barrancas, etc. From Ft. Benjamin Harrison, at Indianapolis, Ind., the Fifth Army Corps reaches out through the stations at McCook Field, Camp Fairfield, and Camp Knox; while the Sixth Army Corps, Chicago, has in its net Camp Grant, Ft. Sheridan, and Ft. Brady. Ft. Leavenworth, Kansas, Jefferson Barracks, and other stations, are in the net of the Seventh Army Corps, with headquarters at Ft. Crook, Nebraska. The Eighth Army Corps, at Ft. Sam Houston, Texas, has Ft. Brown, Ft. McAllen, Ft. Ringold, Ft. McIntosh, Ft. Bliss, and Ft. Huachuca. And the Ninth Army Corps, San Francisco, includes the Presidio, Ft. MacArthur, Ft. Douglas, and Ft. D. A. Russell, at Cheyenne, Wyoming.

It is worth noting too that our fourteen major aviation fields, though comprehended in the Signal Corps net as a whole, nevertheless constitute an alert net of their own, so that they can make the fullest and most prompt use of meteorological and other special data.

These Federal agencies, all that have been mentioned here, are by no means all that are using radio.

The Coast Guard, part of the Navy net, employing the Navy waves, uses radio for all manner of purposes—for administrative work, for relieving distress, for warding ships off from the location of icebergs that come cruising down our Atlantic Coast periodically, and for a score of other purposes.

The Prohibition enforcement authorities are also using radio here and there.

The Public Health Service is broadcasting health data by radio, via the Anacostia Station, near Washington, of the Navy, and heretofore via wave length 425.

And then, too, not only is every Federal Department using radio somewhere or other, but Uncle Sam is forging ahead experimentally. The Army Signal Corps, the Navy, the air services of both arms of the service, and other agencies are doing interesting and promising laboratory experimental work of one kind and another; the Air Service of the Army, for instance, has planes equipped experimentally

with radio instruments of one kind and another, and the Navy has a radio experimental ship, the *Ohio*. Then, too, the Post Office Department has done a good deal of experimental work with radio in relation to Air Mail planes. But the Bureau of Standards, of the Department of Commerce, which department controls the licensing of sending stations and the inspection of all ships carrying more than 50 souls, is probably doing as much as any

the Army and the Navy must keep their nets alert. Those nets include, of course, trans-Continental as well as trans-oceanic service, and the Army corps stations, like most of the stations of the Navy, are equipped or can readily be equipped for broadcasting by phone as well as Morse code, or both.

And it would not even require legislation for the most part, for Uncle Sam to use radio for all practicable administrative purposes. Thus

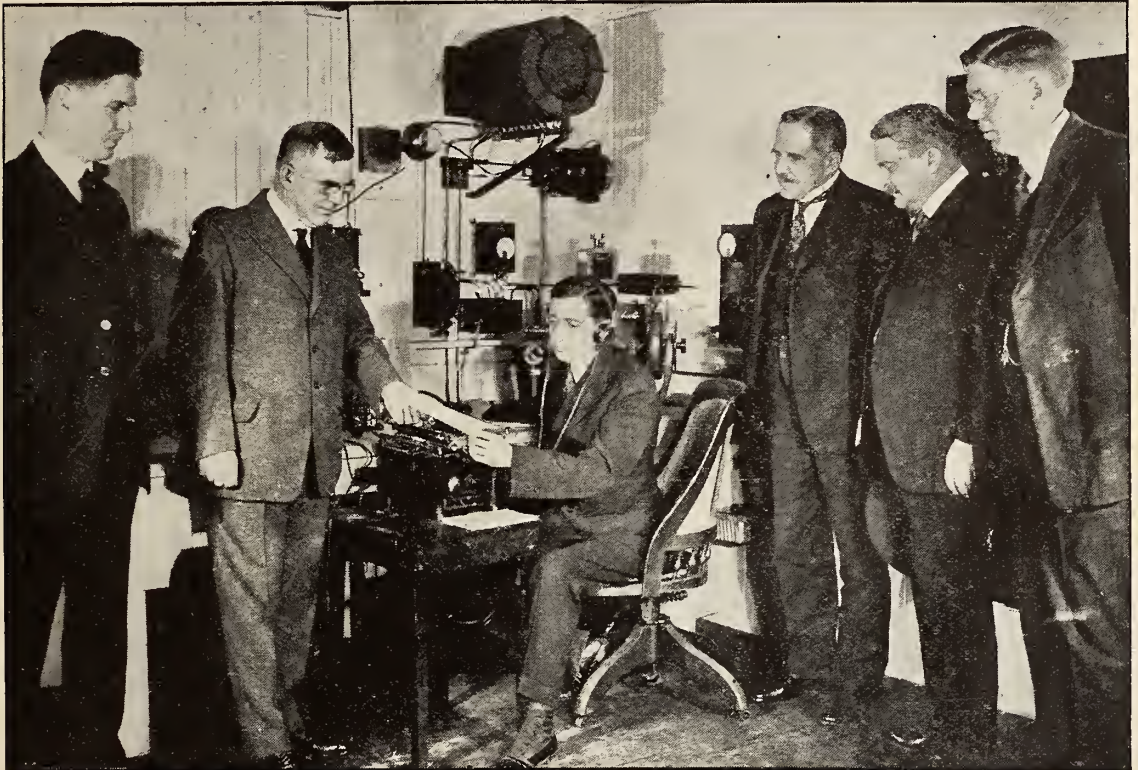

OPENING DAY OF THE RADIO STATION IN THE POST OFFICE DEPARTMENT

Left to right, J. C. Egerton in charge of the station, Secretary Wallace of Agriculture, (then) Postmaster General Hays, Charles F. Marvin, Chief of the Weather Bureau, S. W. Stratton, Chief of the Bureau of Standards, W. A. Wheeler, Director of Markets

other Federal agency, in certain fields at least, to develop radio and its manifold uses to the full.

Now, at last, there is a larger thought—take it as a bit of prophecy, if you will! It's this:

Not only is the time impending when the Navy will be run by radio and when the Army will be run by radio, but when the Federal Government will do all or much of its telegraphic business, along with vast schemes for public enlightenment, by radio.

The figures are in—it's a lot cheaper than the use of leased wires. Besides, above all else

the Army and the Navy are already in agreement: The Army agrees to handle for the Navy all its deferred trans-Continental business, while the Navy agrees to handle all the Army's rush coast-to-coast business; the Navy handles the Army's trans-oceanic business, while the Army handles the Navy's inland business—with recruiting stations, for instance. Both the Army and the Navy can, or could, double their traffic capacity—there is no question on that score.

Why not use Uncle Sam's unparalleled worldwide radio net, for all it's worth?

“SPACE RADIO” AND “LINE RADIO”

By DR. LOUIS COHEN

IN SPEAKING of radio we generally think “space radio,” the usual method of intelligence transmission by means of electromagnetic waves radiating in all directions from a central source, an antenna. In contradistinction to this form of radio, another form, “line radio,” electromagnetic waves guided by wires, the invention of General Squier, is rapidly coming into wide use. These two forms of radio have many things in common yet fill different public needs in the matter of communication. In both methods the engineering practices and methods are identical; high frequency currents are employed, and the same instrumentalities for generating electromagnetic waves, tuning, modulation, detection and amplification are utilized. The methods, however, for transmitting the energy from the transmitter to the receiver are different. In one case the energy is radiated in all directions, broadcasted, and everybody who so desires is at liberty to receive the signals, while in the other case the

energy is confined to a limited region and can be received only at one or more definite points.

At this time of a growing popular interest in “space radio” and increasing demands for the broadcasting of news and information, requiring a greater and greater number of wave channels to carry the broadcasting traffic, it may be well to consider the great possibilities of “line radio” to take care of all individual communications, leaving all the available wave channels in “space radio” for communication between mobile stations, such as ships and airplanes, places inaccessible to wire lines, and broadcasting. By the use of “line radio” the existing telephone and telegraph lines may be loaded up by multiplying the number of messages carried on any single line so as to take care of all possible public requirements for personal communication, and in a very economical manner at that.

It must be remembered that the number of wave channels available for “space radio” are limited. Every communication monopolizes, for the time being, a definite width of wave band and should, therefore, be employed only for such services as will be for the greatest possible public usefulness, or for such other services as cannot be accomplished by the old methods of line telegraphy and telephony or “line radio.” Broadcasting is a service that can be accomplished only by “space radio” and the use of “space radio” should be limited as much as possible to that service. On the other hand, in “line radio” the number of circuit channels can be increased almost indefinitely and always kept up to capacity to meet all public needs for individual communication, personal or business. “Space radio” and “line radio” are two aspects of the same art, both utilizing the same methods and instrumentalities; the developments and improvements in one are generally applicable to the other, but they supplement each other in the matter of use. In considering any new regulations in the matter of wave distribution service, etc., it would be well to keep in mind the possibilities of “line radio” for individual communication, reserving “space radio,” to a very large extent at least, for broadcasting.



DR. LOUIS COHEN
Consulting engineer, Signal Corps, U. S. A.



© Underwood & Underwood

HERBERT C. HOOVER, SECRETARY OF COMMERCE AND RADIO

This is not his official title, but the Department of Commerce is authorized by law to regulate radio traffic in all its forms, and in this capacity it is going to come into immediate contact with the whole public as the whole public becomes radio receivers. At the opening of the Radio Conference Secretary Hoover made the following statement: "We have witnessed in the last four or five months one of the most astounding things that has come under my observation of American life. This Department estimates that to-day more than 600,000 (one estimate being 1,000,000) persons possess wireless telephone receiving sets, whereas there were less than fifty thousand such sets a year ago. We are indeed to-day upon the threshold of a new means of widespread communication of intelligence that has the most profound importance from the point of view of public education and public welfare. The comparative cheapness with which receiving stations can be installed, and the fact that the genius of the American boy is equal to construction of such stations within the limits of his own savings, bids fair to make the possession of receiving sets almost universal in the American home"

WANTED: AN AMERICAN RADIO POLICY

The Problem Confronting Our Interests, Amateur, Commercial and Governmental

By DONALD WILHELM

THE United States is in immediate need of a radio policy, and this fact was the first to confront the Washington Radio Conference, where the opinion on this question was unanimous.

And why?

Said some of the radiolytes present, "The amateurs—they're too much with us!" Answered Mr. Godley, of the American Radio Relay League, and others, "We're tired of being more or less unwittingly misrepresented, we amateurs!" Said others, "Too many

jazz hounds!" Answered some more, "And too many canaries." Agreed everybody, "The air is in a mess." Remarked Chairman Hoover, who called the Conference, "Yes, this is one of the few instances where the country is unanimous in its desire for more regulation." He added that, clearly, what is needed is an ether policy.

And who should form the policy and don uniform and wield the big stick of its enforcement?

Uncle Sam, of course.



© Harris & Ewing

CONGRESSMAN WALLACE H. WHITE, JR.

Who is making a special study of radio conditions and possible radio legislation

To begin with, then, we can put down one very tangible and meritorious result of the Conference: Thanks to the phenomenal popularity of the radiophone in the main, policing of the ether is imperative; Uncle Sam is clearly the only one who can do the job; and so far as non-governmental radio work is concerned, it is now plain that the wholly inadequate authority, force, and funds of the Bureau of Navigation must all be increased.

But there are other results already achieved by this Conference called, at the request of the President and Cabinet, by Mr. Hoover.

Mr. Hoover, himself, indicated some of them. He said that the Conference, with a view to affording the greatest good to the greatest number of Americans, had, clearly, made progress by enlarging and defining the ether rights of the public and the amateur, and by working out and recommending the largest possible permutations of available wave bands with respect to existing priorities, zones, time factors, and the like.

"The Conference," said Dr. S. W. Stratton, Director of the Commerce Department's

Bureau of Standards and chairman of the Conference technical committee, "has already gone a long way in settling what purposes can and should be served by radio and what purposes can still best be served by other means of communication. It established a tentative classification of the agencies that are invaluable in the radio field. It has made progress in the allocation of the channels of communication, i. e., the wave lengths. And it has suggested constructive modifications to be made in the present radio laws, the last of which was passed in 1912 and is now inadequate because of the pressure of later developments."

Also, the Conference made clear that there probably can never be private property rights maintained in the ether. Then, too, it perceptibly diminished the zeal that, at first, some organized groups displayed in gunning for exclusive rights to bands of waves (which rights could be capitalized to the tune of millions of dollars). Moreover, the Conference has made clear that squabbles over wave bands in Uncle Sam's own official family must be settled out of court—that is, the Governmental agencies using radio must forthwith hold a conference of their own, settle their own differences, and establish, perhaps, some kind of a permanent inter-departmental body or board to settle governmental radio problems as they arise. Also, one of the most profound inferential results—and the inferential results of this Conference, like, say, the Washington arms conference, perhaps quite equal in importance the direct results—points to a powerful lot of fuss and fume that the United States delegates are now certain to make at the forthcoming international conference in Paris, to which this Conference is in a sense the preliminary.

But, first, let us glance at some interesting points of view now, rather for the first time, hauled out into the open.

For the American Telephone & Telegraph Company, for instance, Colonel Griswold pointed out that radio is now being used and for every reason should continue to be used for linking up with main lines of communication remote areas or islands, such as Catalina Island, which do not warrant the maintenance of cable or land lines. He described, interestingly, how, even now, in some of these localities a toll subscriber gaily talks over a phone without realizing that he is bridging a goodly space by ether, with wires at the ends only, while enjoying continuous

service. And he stated that the A. T. & T. is making plans to enter the broadcasting field, as a public service.

L. R. Klum, representing the Westinghouse Company, cheerfully volunteered the information that his company had entered into the broadcasting business as a sales device. When Mr. Hoover asked him if he expected the sales of receiving equipment to continue and if there is not likely to be a "saturation point" Mr. Klum said, "I don't believe it. There is no saturation point on automobiles, for instance. We have found a steady increase in sales and we don't anticipate any drop if the quality of the broadcasting is maintained." He also said, "There is a limit to the number of broadcasting stations that can operate successfully. So there must be some regulation and possibly some limitation of the number of these stations. Fifteen could probably cover the country."

The trend of the whole Conference looked to larger and larger public use of radio, and before the sessions had gone far the trend toward enlargement of the supreme rights of the public became apparent. Here, on one hand, you found representatives of city police departments emphasizing the necessity of certain waves being reserved for police use between municipal police stations and patrolmen, motor boats, bicycle police, police automobiles and airplanes, and fire and other moving apparatus. Here, again, you found large city newspapers shown as supplementing their news columns with ether information, even entertainment. Next, emphasis was laid on the undesirability of ether advertising, by department stores or other agencies. Then, also, there were complaints against the selling of inadequate apparatus, such as receiving sets of insufficient range in wave length. Instrument makers had their pros and cons. The amateur repeatedly had his innings. The supreme importance of ship service was hammered home. The appetite of the public for broadcasting of health information, market information, all kinds of information, was dwelt upon at length. Also, often, you found allegations made that this or that company was trying to corner the sale of tubes or other facilities. There was talk, even, of censorship, of the necessity of competition between broadcasting stations in given areas, as between newspaper sending stations, for instance; and predictions, prophecies, and more and more stress on the needs and desires of our



© Harris & Ewing

DR. S. W. STRATTON

Chief of the Bureau of Standards, who was chairman of the technical committee of the Radio Conference which made recommendations for a national radio policy.

old friend, the people. Withal, you got, from sitting in on the Conference, the picture of a great instrumentality coming of age—and as a matter of fact radio is just about twenty-one years of age! It was as if everyone agreed, "Now here's a great big boy of great big stature rising up in our midst. We don't know all about him, yet, but we've got to make room for him. So it's a question of ways and means, to please the people and give us all a good square deal."

Now, by contrast, the last committee appointed by the Secretary of Commerce, Mr. Alexander, to deal with radio and its problems, was inconsequential, from the point of view of public interest.

And when one says that, one gambols ahead in apprehension of the next international conference. Because it's all too evident that no other country in the world has, in the nature of its areas and native problems, the needs and opportunities for radio that we have, and no other nation has even approached in develop-

ment our own amazing interest in phone and Morse Code broadcasting.

So a bit of background is in order:

The regulations now governing international radio communication were drawn in 1912 at the London Radio Telegraphic Convention, and were promulgated by President Wilson on July 8, 1913. Next, in Paris, during and following the war, there were various inter-

conference has been doing, and threshed out wave and other problems. It also drew up its recommendations. These were published in a Government document and the committee expected them to be pushed by our Government, since they had been unanimously adopted and were approved by the War, Navy, and Commerce departments.

But at the 1921 Paris International Confer-



© Harris & Ewing

AT THE RADIO CONFERENCE IN WASHINGTON

Reading from left to right in the front row Secretary Hoover, Mr. Will Hays, then Postmaster General, General George O. Squier chief signal officer U. S. A., Congressman Wallace H. White Jr., Swager Sherley formerly chairman of the Appropriations Committee of the House of Representatives, the first radio lawyer. In the second row behind Secretary Hoover is Dr. Louis Cohen, in the doorway between Postmaster General Hays and General Squier is Mr. E. H. Armstrong the discoverer of the "feed back" circuit, and the second figure to his left is Dr. Alfred Goldsmith, the Secretary of the Institute of Radio Engineers

national radio conferences between the military and naval representatives of the Allies, which conferences dealt with wave allocations and scores of other technical problems, and, of course, had no concern with public broadcasting of the kind that is now our favorite indoor sport.

Next came a preliminary Inter-Allied conference in Washington, in 1920. At that conference were the five principal Allied Powers. It covered the subject of communications generally, including not only radio but wire and cable communication too, and in that respect it made a departure.

Now, mainly in preparation for this preliminary conference, which was to formulate a programme for the main conference to meet in Paris in June, last year, in March, the previous year, Secretary Alexander appointed a committee which held meetings, much as the present

conference the American report was not made the basis of action by the American delegation. It was vigorously supported, in the meetings of our delegation by some of our delegates, notably Dr. J. H. Dellinger, against radically different recommendations by the military and naval representatives composing the majority of our delegation. The upshot of the situation was that our own commercial and private radio interests came from the Paris Conference disgusted, emphatically of the opinion that it had been a military show with all too few privileges accorded commercial and private aspirations. And the disappointment and wrath of our commercial and private interests was all the more intensified because an agreement on a Government policy had supposedly been reached on all controversial matters through the deliberations of the Alexander Committee that had met early in

1920 before both the preliminary and the full international conferences.

Now the United States finds itself confronting another international conference, fully aware that our commercial and private interests were disgusted with the last and for every reason hope for better results from the next especially because of the promise of the naval holiday arranged for by the arms conference. Meanwhile, too, our commercial interests have enormously expanded in scope and are steadily reaching out and up and down the world. And meanwhile the amateurs are crowding the commercial companies for more and larger opportunities, while the commercial interests are crowding the Army and the Navy. Now, to add to the complexity of the situation and to back up the strength of both private and commercial interests, comes the radiophone and its unprecedented, almost universal use, in America, whereas no other nation is, by comparison, using the radiophone.

Sorely needed now, therefore, is a governmental policy. Sorely needed, accordingly, is

a conference among our own governmental agencies, to adjust our National policy to the requirements of the hour. For, clearly, the United States must enter the next conference with a solid front, since, among other complications, not only are the radio facilities that we possess superior to those of any other country, but we are unique in that substantially all our communication services are privately owned.

The immediate results of the Washington Conference are evident enough—the amateur, for instance, got further in it than he himself expected. The commercial companies at least are grateful that the air has been cleared somewhat. The people have had their say and have had an emphatic chance to make their views known.

But the largest results of this conference are inferential after all:

It has hammered home the need of a U. S. radio policy.

It has put Uncle Sam in the way of taking, in radio, the leadership of the world.

ONE COMMERCIAL SIDE OF RADIO

What is the Future of the Radio Business in the United States? Is it to be Like the Telephone, the Automobile, or the Phonograph Business, a Thing that Will Rise Suddenly to Almost Universal Acceptance by the Public and Support Great Manufacturing Plants?

BY PARKHURST WHITNEY

A NEW business has suddenly sprung up in the United States—the making of radio receiving sets and the parts thereof. It is of some importance that the public realize what manufacturers are in it and what are the conditions in which they are producing, and it is interesting to speculate upon the possibilities of this, in some ways, new industry.

It is using a method often employed by get-rich-quick concerns to compare a new business with successful old ones, but if the reader bears in mind that these comparisons show the maximum possibilities and not necessarily anything else, it is permissible.

There are ten million automobiles in the United States. It took twenty years to reach this figure, but in that period the making of

automobiles has developed into one of the largest manufacturing businesses in the country. The average expenditure for cars and parts is about five billions a year.

There are about six million phonographs in the country. In 1914 the output of machines was 514,000, having a value of \$15,291,000; in the same year 27,221,000 records, having a value of \$11,111,000, were made. In 1919, the total output of machines was 2,226,000 valued at \$91,569,000; the total output of records was 106,997,000, valued at \$44,690,000. For purposes of comparison, however, the figures for 1919 in the phonograph industry are not normal. The output for each of the last two years has not approached those figures.

These are all businesses contributing to the

commercial prosperity of the nation and to the intelligence, well-being, and enjoyment of its inhabitants.

In these matters the radio business might be like unto these others. What are its commercial possibilities? How large is it destined to be? It is theoretically possible for every family and every office to have a radio receiving set. Practically, if the radio receivers are looked upon as necessary conveniences, receivers might become nearly universal. If they are considered valuable chiefly as a means of providing amusement or educational information, they will be much less numerous.

The maximum—taking the automobile standard—would be about ten million. The lower figure—taking the phonograph standard—would be about six million. If the average investment for each receiving set were only \$50, the total investment for the lower number would be \$300,000,000. If the country should become saturated with these six million receivers in a period of five years, that would mean \$60,000,000 of new business for each year.

These are the roughest kind of figures upon a very general hypothesis, but they serve to show the possibilities—perhaps not the probabilities, but the possibilities of this new addition to American industry. These possibilities and probabilities are admittedly guess-work, even by those whose financial interests are the greatest, and the records of the business so far are too meagre to do much except to stir the imagination.

To reach anything like these figures, both present sending and receiving apparatus needs improvement, regulation must be both wise and effective, and a skillful direction of broadcasting must be built up on a solid commercial foundation which does not now exist.

In 1919, the selling of radio telephone receiving sets to the public did not exist as a commercial business. There were more than ten thousand sending and receiving sets for radio telegraph work and there were radio telephone receivers in existence, but not in general public use. Nor was there any demand for them, for no stations were broadcasting entertainment or information to the general public.

It is quite likely that the war affected the radio telephone in two ways—hastened its mechanical development and delayed its commercial development. Experiments carried

out in 1915 by the American Telephone and Telegraph Company, and subsequently, when voices at Arlington, Va., were heard in Paris, France, illustrated its possibilities in a striking way. After our entrance in the war our engineers were concerned with the military application of the radio telephone, such as communication between airplanes and the ground, the development of submarine chaser radio telephone sets and miscellaneous sets for field use. These activities resulted naturally in improvements in the apparatus, and likely enough laid some of the ground work for the present interest through the wide contact of men in service with radio telephony. Still, broadcasting to the general public was entirely undeveloped, and that was the situation during two years following the war. The Navy had, of course, used the radio telephone widely during the war, and after the war some messages were broadcasted, but the matter sent out did not start the public buying receivers. In 1915 the American Radio & Research Corporation, of Medford Hillside, Mass, did some broadcasting but not on a regular schedule.

In 1920, however, the Westinghouse Company opened a broadcasting station, at East Pittsburgh, Pa. The programmes of this station and the next one started at Newark were arranged for public consumption and the public was so advised, the station at Newark having the very effective exploitation of the Newark *Call*, the first newspaper to publish the radio section which is now becoming very common.

The East Pittsburgh station was opened November 5, 1920. In the fall of 1920, then, the public first had reason to buy radio telephone receiving sets, and it began to buy. The East Pittsburgh station of the Westinghouse Co. unquestionably began the present sensational developments. The public bought all the equipment that was for sale and from that time to this the manufacturers have never been able to catch up with the demand. The manufacturers of radio receivers and accessories are much in the situation that munition makers were when the war broke. They are suddenly confronted with a tremendous and imperative demand for apparatus. It is a matter of several months at best to arrange for the quantity production of radio receiving apparatus if the type to be manufactured were settled, but the types are no more settled than were the types of airplanes in the war. The

manufacturing companies are, therefore, confronted with carrying on their experimental work, devising new types and at the same time producing the best they can in such quantity as they can, and they must do all this while building up their organizations, working out their policies, and keeping an eye on the activities of the Government so that they can keep in accord with its regulations.

Up to the present, Secretary Hoover estimates that there are 600,000 receiving outfits in the United States, including both those bought complete or nearly so and those constructed by the owners. Even if all the manufacturers' figures were available, it would be difficult to give an exact figure because so many people have bought parts and constructed their own sets. In 1922, there seems indisputable evidence that the sale will equal or exceed 1921. The first quarter of the year has seen an avalanche of ordering. Everything that could be produced has been sold.

The radio manufacturing field differs from the automobile and phonograph industries in their beginnings. The early manufacturers of automobiles and phonographs did not include great establishments already engaged in kindred work, but were chiefly concerns that began in a comparatively small way as automobile makers or phonograph manufacturers.

And the automobile and phonograph businesses grew slowly compared with the radio business. The early automobile and phonograph companies would have been even worse swamped with such a demand as now confronts the radio manufacturers than these concerns are. The reason for this is that in the radio field, besides the manufacturers chiefly engaged on radio apparatus, the big electrical companies, facilities are also available.

Among those companies depending chiefly on the radio business are such manufacturers as the American Radio & Research Corporation, of Medford Hillside, Mass.; The Adams-Morgan Co., Upper Montclair, N. J.; Acme Apparatus Co., Cambridge, Mass.; Atlantic Radio Co., Inc., Boston, Mass.; Clapp-Eastman Co., Cambridge, Mass.; F. A. D. Andrea, New York; A. H. Grebe & Co. Inc., New York; Colin B. Kennedy Co., San Francisco, Cal.; Remler Radio Mfg. Co., Chicago, Ill. These concerns manufacture receiving sets. They are concerns chiefly built upon the radio business.

Then there are such concerns as the Ameri-

can Telephone & Telegraph Co., with its subsidiary the Western Electric Co.; the General Electric Co.; the Western Electric Company; and the Westinghouse Company—the great electrical companies of the country. As four of the largest broadcasting stations are now operated by the Westinghouse Company, and as a great many of the patents on radio receiving sets are owned by these big companies, it is well for the radio user to understand their position and influence in the field.

Ever since radio communication appeared upon the horizon, the American Telegraph and Telephone Co. has continuously spent money experimenting in this field. The General Electric Company likewise spent a great deal of money to perfect apparatus which it hoped to sell to the various transoceanic radio companies. It had very valuable patents, especially on sending apparatus, prior to our entry into the war. During the war the Westinghouse Company did a good deal of work for the Signal Corps, and it likewise acquired valuable patents, the Armstrong and heterodyne patents among others. Practically all of this activity was based upon the transoceanic commercial radio business and the marine business. At this time the Marconi Company was the chief international radio company. In 1919 the General Electric Co. was about to sell its great Alexanderson transmitters to the Marconi Co. when Admiral W. H. G. Bullard and Commander Hooper, U. S. N. suddenly projected themselves into the situation. The Admiral made a vigorous plea to Mr. Owen Young of the General Electric not to sell to the Marconi Company, for both the British and the American Marconi companies were British controlled. The Admiral argued hard for American control. Mr. Young pointed out that the General Electric Company had no market for these machines but the Marconi Co. That did not disturb the Admiral. His answer was to suggest an American company with Government backing, and he tried to get the Government to back a company to keep the American flag in the ether. In this he failed, but he did finally persuade the General Electric Company to see if an American company could not be started without Government help, to keep the United States from having all its overseas radio in foreign hands. How this was finally worked out is another story—and a very dramatic one to be told later. The result was the formation of the Radio

Corporation of America. The Radio Corporation bought out the American Marconi Co. It has now under the American flag the biggest commercial radio business in the world. It is controlled by the General Electric Co. and the American Telephone & Telegraph Co. In its formation these companies granted to the Radio Company the right to sell the radio products of the General Electric Co. and the Western Electric Co. which are the manufacturing subsidiaries of the Telephone Company. They also agreed that the Radio Company was to hold the radio patents of both concerns and that both were free to use any of the patents in manufacture. After this was done, the Westinghouse Co., rather than deal with foreign radio competitors or set up a rival concern, likewise pooled its patents and agreed to sell through the Radio Corporation. In this way the maximum American strength was combined to meet foreign competition in the commercial radio field.

Then, suddenly, broadcasting aroused the demand for receiving sets. The Radio Corporation formed for entirely different purposes found itself besieged with a demand. It has put forward its utmost energy to get equipment from all its manufacturing connections and the fact that the patents of the American Telephone & Telegraph Co., the Western Electric Co., the General Electric Co., and the Westinghouse were all pooled has greatly facilitated the supplying of the public demand.

The results of the pooling of the patents of the big electrical companies makes it seem possible that it might be in the public interest if similar coöperation included the whole field and that the patent situation in radio were worked out by coöperation rather than litigation. This would in no wise impair competition in manufacture. There is now keen competition between the manufacturing concerns who sell through the Radio Corporation as well as between the Radio Corporation and all other manufacturers. The position of the American Telephone & Telegraph Company is a little different from that of any of the manufacturing companies. It makes no instruments. It is not interested in broadcasting as a means of selling instruments. Its business is selling communication. If a man wants to talk from the mainland of California to Catalina Island, the telephone company will give him this service by radio. A similar service is being considered across Albemarle Sound, N. C.

Similarly if a man would like to talk to all his neighbors at once and can pay for it, the American Telephone & Telegraph Company will try to equip itself to provide him the service by radio. The company is completing a broadcasting station for the purpose in New York. But it is frankly an experiment. The demands of the public will determine radio's future in this as in all other respects.

The most obvious motive for wishing to talk to all one's neighbors is for the purpose of selling them something. The Conference under Secretary Hoover's chairmanship agreed that it was against public interest to broadcast pure advertising matter. The American Telephone & Telegraph officials agreed with this point of view. Their experiment is to see whether there are people who desire to buy the right to talk to the public and at the same time tell the public something it will like to hear.

If this experiment succeeds, a commercial basis for broadcasting will have been established. If it does not succeed the public will be left with the free broadcasting of the companies that sell equipment, the newspapers, etc. If the selling of equipment keeps on as at present, the companies that sell largely can perhaps continue to bear the expense of broadcasting. But as the present rate of buying shades down and competition becomes keener and closer, it might not be possible for one company or group to bear the expense of broadcasting which is the stimulant for the demand that all manufacturers enjoy.

These problems affect not only the Westinghouse Co., which operates four stations, but the operators of many other broadcasting stations as well. Altogether, according to present available information, there are more than twenty stations which broadcast extensively. The General Electric Company broadcasts at Schenectady; the American Radio and Research Corporation broadcasts from Medford Hillside near Boston; the C. D. Tuska Co. from Hartford, Conn.; the Carter Electric Co. from Atlanta, Ga.; the Precision Equipment Company from Cincinnati, Ohio; the Western Radio Company from Kansas City, Mo.; the Reynolds Radio Co. from Denver, Col. The state universities at Madison, Wis., Austin, Texas, and at Lincoln, Neb., also broadcast, and on the Pacific Coast a number of commercial houses pay the costs of a broadcasting station for the advertising they receive, although the advertising consists of little more than the mention of

their names. In Seattle, Wash., a newspaper, the *Post-Intelligencer*, also maintains a service, as does the Detroit, Mich., *News*. There are short range stations in many other cities and no doubt the number is constantly increasing.

All these stations give entertainment to which the public listens free of charge. The artists give the entertainment and the concerns that pay for the broadcasting get some incidental advertising. All manufacturers naturally share in the benefits of the sales which such broadcasting stimulates.

Although the Radio Corporation group is made up of the largest electrical companies, it has nothing like a control in the supply of radio equipment. The loud speaker is manufactured under various trade names by such concerns as the Magnavox Co., of San Francisco; John Firth & Co., and the American Pattern Foundry and Machine Co., of New York; Riley-Klotz Mfg. Co., Newark, N. J. Head sets are produced by such concerns as C. Brandes, Inc., New York; Nathaniel Baldwin, Salt Lake City, Utah; William J. Murdock Co., Boston; Stromberg-Carlson, Rochester, N. Y. The Atlantic-Pacific Radio Supplies Co., of San Francisco, is widely known as a maker of tubes.

Under these conditions what is to be the future of radio as a business? Is it to reach its maximum and become a convenient necessity, a common object in nearly every household; or is it to be far less prevalent? The answer lies fundamentally in the character of service performed by the broadcasting stations, and in the refinement of the receiving instruments. Technically neither the sending machinery nor the receiving machinery is as good as it should and will be, and the science of preparing broadcasting programmes is in its infancy.

The basis on which broadcasting will ultimately be paid for is undetermined, and it is not even clear yet who will eventually do the broadcasting, or what will be broadcasted. After the novelty of listening to words and music in the air wears off, the public will listen not for the sake of listening but for what it hears. If what it hears is of compelling interest or importance, the public will listen. If not it will do something else. If listening is to become a national custom, broadcasting must become a high art and some permanent and ample means provided to support this art.

WHAT TO EXPECT FROM YOUR RECEIVER

BY ARTHUR H. LYNCH

RADIO has been surrounded by so much mystery for the last few years that the present stimulation has naturally brought with it a great deal of misinformation. This misinformation has led many people to expect results from their receiving sets which they ought not to expect. There is an unfortunate lack of accurate information covering the range in miles over which various types of receiving sets will function satisfactorily.

Now and again, we find an item in the daily press describing some new form of receiving set made to fit in a match box, a watch case or a thimble, with which it is but necessary to place one's foot against a hydrant and hold an umbrella over one's head to hear signals from infinitely great distances. We hear also of

loop aerials being used to pick up radio concerts from stations hundreds of miles distant.

Unquestionably there are very small receiving sets which actually do operate. There are also certain stations where reception over great distances is possible with a loop aerial. However, the belief that the two may be combined is very far from being correct.

The small set may be operated over comparatively short distances from a broadcasting station, and it is safe to say that the average maximum distance for such reception is 15 miles. Where the loop aerial is used for receiving over long distances, it is necessary to employ accurately designed vacuum tube apparatus which cannot be made to operate satisfactorily by an inexperienced person.

Another common error concerning radio

receiving outfits is the impression that a "loud speaker" attached to a simple crystal receiving set will provide sound great enough to fill an entire room. Except at very short ranges this is not true. Radio "loud speakers" operate on precisely the same principle as the phonograph. A great vibration of the diaphragm produces a great sound and a comparatively smaller vibration of the diaphragm results in the correspondingly decreased sound volume. With phonographs this is brought about by the use of loud and soft tone needles, although the same record may be employed. With radio, the volume of sound produced by a loud speaking device depends upon the energy received from the transmitting station. With a simple crystal receiving set "loud speakers" cannot be employed directly, unless the receiver is located very close to the transmitting station. Where a vacuum tube detector is employed, the distance from the receiving station may be increased somewhat, but even this method is not recommended for general use.

Regardless of what type receiver is employed, where the distance from a broadcasting station is more than a few miles, it is necessary to use an amplifier where a "loud speaker" is desired.

An amplifier is a combination of units, which, working together, build up signal energy from the original energy absorbed from the air by the receiving aerial system. In general, amplifiers comprise one or two vacuum tubes with the necessary connecting equipment and controls, operated by a 6 volt, 40 to 100 ampere hour storage battery and two or three 22.5 volt "B" or plate batteries. Where two tubes are used, the amplifier is called a double stage amplifier, and means is generally provided for making instantaneous connection to the first or second stage at will, thus regulating the volume of the signal produced.

The action of this character of amplifier is quite simple. The incoming radio signal is passed through the tuning elements of the receiver to the detector tube or crystal as the case may be and from here it is carried into the first amplifier tube. This amplifier tube functions as a valve and this valve is controlled by the intensity of the incoming waves. When the energy of the incoming wave is great, the valvular action of the tube is great; when the incoming energy is small, the reverse is true. This valvular action draws a

current from the plate battery which is passed through the telephone receivers or "loud speaker" as the case may be.

For every variation in the antenna current there is a very considerably augmented variation in the plate battery current, so that the resultant signal is very greatly increased. Where two stages of amplification are employed, the signals from the first stage are used to control the valvular action of the second amplifier tube and the resultant energy is carried from that plate circuit to the telephones or "loud speaker." With each stage of amplification of the signal, audibility is increased from six to ten times.

More than two stages of this character of amplification are not recommended for ordinary use because there is a tendency to amplify disturbances from the atmosphere as well as disturbances from local trolley, power, and telephone lines, causing the production of parasitic noises which interfere with the reception of speech or music.

Although the range in miles over which the various classes of receiving outfits may be counted upon to function satisfactorily cannot be judged closely, the following table may be found of value, and where a dealer recommends the use of apparatus listed therein for the accomplishment of greater work, the consumer should investigate very thoroughly before concluding that the information is correct. There are exceptional cases, when the ranges will be found to be greatly extended, but they cannot be considered as standard. For instance, the range for any receiver is much shorter during the day than it is at night, and it is a common thing for stations having a normal range of 15 or 20 miles to receive from distances up to 50 or 60 miles.—

1. Simple crystal receivers with outdoor aerial 15 miles, with indoor aeriols 3 to 5 miles, with loop aerial 1 to 3 miles, with outdoor aerial and "loud speaker" about 2 miles.

2. Vacuum tube receiver operated by dry cell with outdoor aerial—75 miles, with indoor aerial 30 miles, with loop aerial 5 to 10 miles, with a "loud speaker" and outdoor aerial 5 miles.

3. Vacuum tube receiver with two stage amplifier and "loud speaker" 75 miles, with telephones 150 miles. Loop aeriols are not recommended for use except by persons having a thorough knowledge of their capabilities and limitations.

A method has been devised for increasing

the distances over which receiving outfits will function satisfactorily. This method employs what is known as radio-frequency amplification. The beginner should not attempt the use of this method unless he purchases radio-frequency amplifying units complete, because some difficulty may be experienced in assembling the various parts, which go to make an amplifier of this kind.

Where we hear of signals being received over very long distances by stations employing a loop aerial, it is safe to conclude that radio-frequency amplification is being used. With a loop three feet square, wound with five or six turns of lamp cord functioning with suitable radio-frequency amplifiers, very great distances may be covered. The loop form of

reception is very valuable for the reduction of static and interference because it is only influenced by signals from points directly in line with the winding of the loop. That is, in order to receive from any station the loop must be pointed toward that station and interference having its origin in any other direction does not occur. Therefore, the only interference likely to occur is caused by two or more stations operating on the same electrical wave length and located in the same direction from the receiving station. With two stages of radio-frequency, signals have about the same intensity as exists when the average amateur outdoor antenna is used in connection with a standard regenerator circuit employing one vacuum tube.

RADIO PERSONALITIES

I.

PAUL GODLEY

BY A. HENRY

IT IS doubtful whether any one human being in radio circles holds the interest of Americans more completely than Paul Godley. Much of this interest is the direct result of the transatlantic amateur transmitting tests completed a short time ago, in which Mr. Godley played the leading rôle, but he has also taken part in other remarkable radio activities.

Before considering these recent events it is interesting to ponder for a moment or two upon the work this man has done for radio in the past.

Paul Forman Godley was born September 25, 1889, at Garden City, Kansas. His interest in radio began about the time he entered Defiance College in Ohio. His studies there lasted for five years. During his summer vacations, Mr. Godley devoted himself to telegraph work with commercial companies and railroads in various capacities, from operator to train dispatcher.

Being interested in communication, it was quite natural for him to become enthusiastic about radio and he studied all the available literature on radio communication published at that time. In 1908 a commercial wireless station was built in Chicago, to which Mr.

Godley was assigned by the operating company. Once in a position actually to handle commercial radio equipment, Mr. Godley made every effort to become proficient in its installation and maintenance, as well as its actual operation.

The United Wireless Telegraph Company opened a commercial station at Grand Rapids, Michigan, in the summer of 1909 and Mr. Godley was put in charge.

Later in the same year, an agreement was made with Dodges Institute of Telegraphy, Valparaiso, Indiana, to inaugurate a course in wireless telegraphy over which Mr. Godley had jurisdiction.

In 1911, Mr. Godley was placed in charge of a course in wireless telegraphy at the Collegiate Institute, Port Arthur, Texas, and in 1912 he took up the duties of Wire Chief for the Postal Telegraph Company at their main New York office.

The year 1913 found Mr. Godley on the "Amazon-to-the-Andes" radio service for the Brazilian Government, during which time his experiences were as varied as they were instructive. In 1914 Mr. Godley returned to the United States, and began a study of research at his home, Leonia, New Jersey, where he devel-

oped the short wave regenerative receiver now so familiar to American radio enthusiasts.

After a winter of experimentation with receiving outfits, Mr. Godley opened a transmitting station (2 ZE) and many exceptional distance records were made during the time this station was in operation. More than anything else this station became widely known in amateur radio circles for its consistency in daylight work. Communication between Albany, Baltimore, and Philadelphia via Leonia was a regular occurrence.

In 1915 and '16 Mr. Godley was called upon by numerous radio clubs and engineering societies to discuss radio problems, and one of the first appreciations of the great possibilities of the vacuum tube and its application to amateur radio was contained in his paper "Applications of the Audion," read before the Radio Club of America in New York City. Most authorities on radio credit Mr. Godley with having taken the Armstrong Regenerative Circuit, for a time considered impracticable for short wave work, and arranged it to function satisfactorily for the amateur.

Toward the end of 1915, Mr. Godley became a member of the Adams-Morgan Company, Upper Montclair, New Jersey, and he is largely responsible for the production of "Paragon Radio Apparatus."

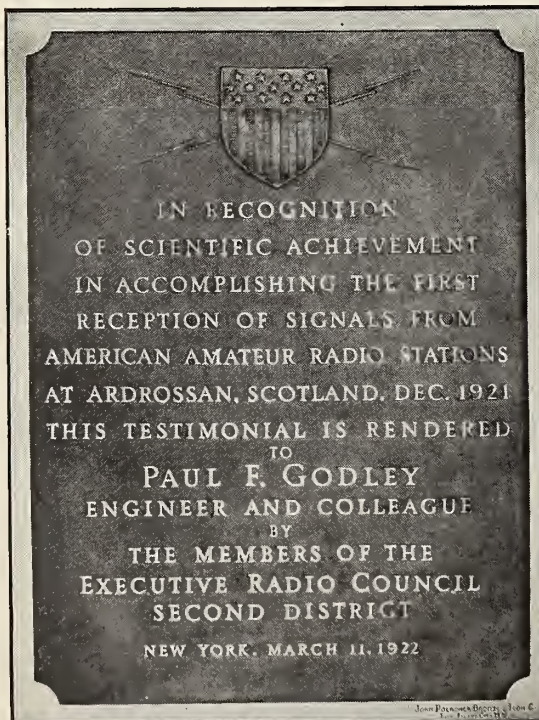

During the war, Mr. Godley served as Designing Engineer at the Marconi Wireless Telegraph Company of America's factory, Aldeen, New Jersey, having charge of receiver design, and the apparatus developed by him during this period for army and navy use has been commented upon very favorably. One particular type of receiving equipment, developed for Signal Corps use, was the only American built apparatus mentioned in the report of the Chief Signal Officer to the Secretary of War.

TRANS-OCEANIC RADIO TESTS

SO MUCH has been said regarding the successful attempt of American amateurs to record their signals in Europe that it is not necessary to go into detail. In brief, Mr. Godley was chosen by the American Radio Relay League to undertake this very important mission and equipped with what he considered suitable receiving apparatus, he left this country and put up a temporary receiving station in Scotland.

Mr. Godley's first attempts to hear American signals were greeted by the English press as more or less problematical and one particular London paper went so far as to ridicule his effort. However, twenty-six American amateur stations were heard during the time Mr. Godley stayed in Scotland; his operations were checked by representatives of radio amateurs in Great Britain as well as executives of large radio companies there.

THE WASHINGTON CONFERENCE

WITH the very marked stimulation in radio communication brought about, no doubt, by the recent development of radio broadcasting, our Government appreciates the fact that existing radio communication laws are not adequate to cope with existing conditions. For this reason, Secretary Hoover called upon a number of radio men to convene in Washington and made suggestions regarding new laws with special attention to the amateur and the radio enthusiasts. When asked for his opinion regarding the conference and its likely outcome, Mr. Godley replied:—

"Brought about by the rapid growth of radio broadcasting, I feel that the conference recently held in Washington developed as fine a working basis as could have been wished by any interest in a very short time. Particu-

larly fortunate were we in having a man of such calibre as Herbert C. Hoover, to steer the course of the commission. On the first day of the conference it had been generally agreed by all concerned that, firstly, for the proper continued growth of the art and industry proper, governmental control was absolutely essential: Secondly—that the order of importance of the various classes of service was (a) insurance of safety of life at sea; (b) radio broadcasting of desirable information and entertainment; (c) a continuance of amateur activities to the fullest possible extent within certain suitable fixed bands and point to point broadcasting to provide communications over stretches where existing systems are impossible.”

A very significant fact brought out at the conference was that material changes in wave lengths are likely to be put in effect in order to eliminate some of the broadcasting problems which now exist. This legislation is highly desirable for at least two very good reasons. Firstly, broadcasting programmes are at present seriously interfered with by “ship to shore” commercial telegraph work even at points remote from the seacoast during certain seasons of the year and with the least selective types of receivers. These programmes are also interfered with to some extent by indiscriminate and improperly regulated amateur transmission. Secondly, broadcasting stations on the shorter wave lengths designed to cover a radius of 150 miles very frequently cover a radius of 1,500 miles and occasionally their range is even greater than that.

This phenomenon which occurs at night during the winter, is known as “fading,” and frequently results in interference and confusion.

It is quite noticeable that fading is comparatively absent on wave lengths of the order of 1,000 or 1,500 meters.

The use of short wave lengths, then, greatly diminishes this reliability of the broadcasting schedules and if broadcasting is to enjoy the very remarkable future which opens up before it, it must be stabilized in every possible manner.

To make broadcasting other than a temporary fad, it must be made dependable and upon its dependability and permanence in the American home rests the future prosperity of those industries built upon it which are now growing so rapidly.



PAUL GODLEY

RADIO BROADCASTING HERE TO STAY

REGARDING this very important phase of radio Mr. Godley made the following statement. “There is little doubt in my mind that radio broadcasting is here to stay, and that before many years it will be utilized in as many as five million American homes, for it may very well come to play a part in our lives equalled only by that of the daily, weekly, and monthly periodical. Like the moving picture industry, it will need to grow from a crude infancy into something greater and grander than is at present possible—its applications may even surpass in their scope the wonders of the motion picture as we know it to-day.

“But this development is very apt to be much more rapid, for, in a great sense, each broadcast

listener will be his own operator, critic, director, and even producer. There will be a great variety to select from, and each of the purveyors of this service will be on the continual lookout for suggestions and criticism.

"Radio broadcasting can never quite become a case of 'see our picture or stay at home' and, besides, the Department of Commerce

promises to follow radio broadcasting very closely in order to make certain that proper and popular programmes are provided. This is as it should be. One might even allow himself to imagine that some time in the future the popularity of a political party in office may hinge entirely upon the quality of broadcasting service."

II

DR. ALFRED N. GOLDSMITH ON THE FUTURE OF RADIO TELEPHONY

BY EDGAR H. FELIX, A. I. R. E.

WHEN Dr. Alfred Norton Goldsmith speaks of the future of radio communication, he speaks with authority. Since 1912 he has been editor of the *Proceedings* of the Institute of Radio Engineers and has for the last five years been the institute's secretary. This body includes in its membership the two thousand leading radio experts, engineers, and executives scattered in all parts of the world. Its *Proceedings* is the recognized technical authority on radio.

But Dr. Goldsmith's position of authority is based upon more than this. He is Director of Research of the Radio Corporation of America, the dominating organization of the radio industry. In this important work he is in closer touch with progress and development of radio communication than any other man in American radio.

For many years, Dr. Goldsmith has directed the radio laboratories of the College of the City of New York. His interest in radio was born here when but a few advanced scientists had recognized the possibilities of the Hertzian experiments as a means of communication.

Professor R. Ogden Doremus, one of the College's leading scientists, was responsible for bringing to the United States several important scientific discoveries. Although the early experiments of Hertz, which laid the foundation of radio communication, did not attract much attention even in the scientific world, Professor Doremus was one of the few who recognized their importance. He therefore, with painstaking accuracy, had exact replicas

of Hertz's apparatus made by one of Hertz's co-workers and they are now a part of the equipment of the College of the City of New York.

Unlike his fellow students, Dr. Goldsmith did not content himself with the brief reference to these experiments which were made at one of the physics classes. He obtained permission to set up the Hertzian apparatus and repeated with the fidelity of a real seeker after the truth the experiments which Hertz reported to the world.

It was in this fashion that Dr. Goldsmith's interest in radio was born. And it is in this fashion, also, that he has kept himself before the radio world as its best informed authority. For instance, when Poulsen announced his first success with the arc for communicating speech, Dr. Goldsmith set up one of the first, if not the first, arc radio telephones in the United States. In this same way, each step in advance has been incorporated in Dr. Goldsmith's wide knowledge by actual experiment, sometimes even before its significance was appreciated by the discoverer himself. It was at City College that Dr. Goldsmith allowed me to hear the signals from the high power station at Honolulu shortly after Armstrong had made his discovery of the feed-back circuit which is now so widely used for reception and transmission.

Dr. Goldsmith has seen radio grow from modest beginnings to a day when its spread resembles that of a hysteria. But, unlike some of his contemporaries, it has not distorted his vision of the future.

"The first thing I wish to make clear is that I do not expect the radio telephone to replace

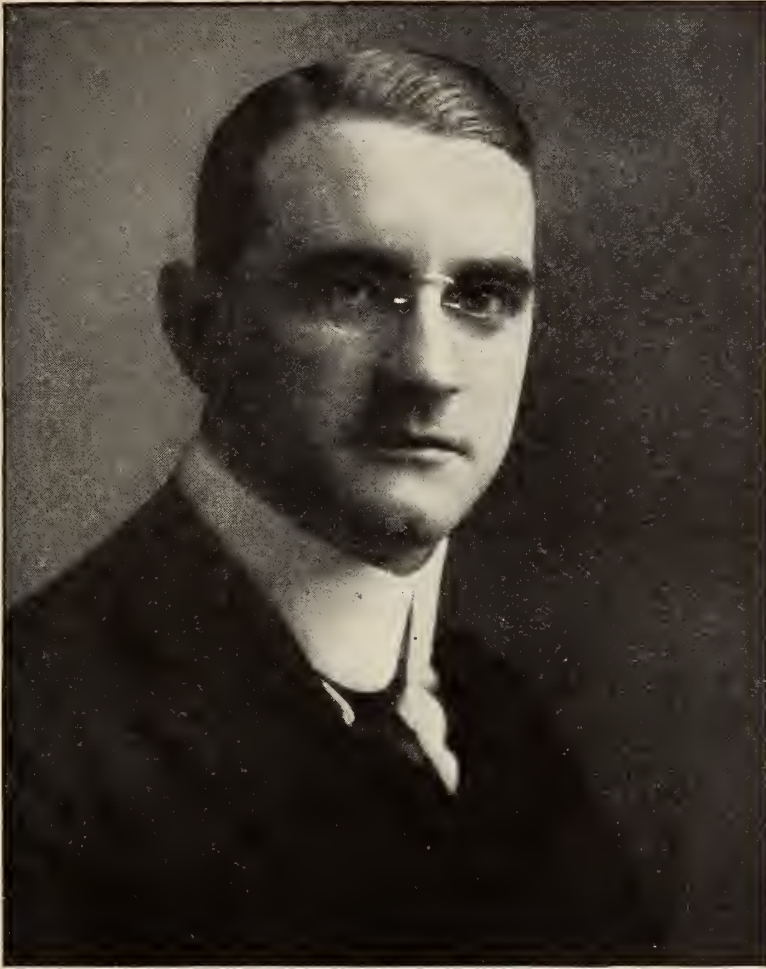

DR. ALFRED N. GOLDSMITH

ocean make wire telephony an impossibility; second, where the barrier of motion, as in the case of aircraft, automobiles, moving trains, and ships at sea, does not permit the use of wire telephony; and third, for broadcasting purposes, where audiences of tens of thousands, hundreds of thousands, and even millions are scattered over large areas."

Speaking of the first field, Dr. Goldsmith stated that the radio telephone will be an important factor in preserving the unity of nations and empires and strengthening the bonds between men and their governments. Rome fell when her outposts were isolated by slow communication. Rome thrived when she could send her centurions over her marvelous system of roads to any outpost where danger threatened before her enemies could assemble in force. Roman roads permitted rapid communication, with the result that the Romans were invariably ready. But the laxity of Roman officialdom, which accompanied

the wire telephone. The radio telephone has its own special fields of utility which will require the full use of all the wave lengths available in the ether for radio telephony. It is conceivable that great progress will be made in tuning apparatus which will allow a greatly increased number of radio telephone transmitters to operate at the same time without interference. But the special fields to which radio telephony is particularly adapted precludes its extended use as a competitor of the wire telephone.

"The radio telephone is a new device with a new sphere of utility heretofore filled by no other agency. In general, there are three classes of communication in which the radio telephone will be supreme: communication where natural barriers, such as deserts, mountains or tropical forests, or great spans of

her social and political decay, led to the neglect of the system of highways. When the advantage of rapid communication was in this way lost to Rome, barbarians overran the Empire.

When Rome fell, ours was a thirty day world. The cable and the radio telegraph has reduced its dimensions to a few hours. The radio telephone will make it a one seventh of a second world.

That coordination and unity of nations is fostered by effective communication is well recognized by our own government. Our Navy Department has established a chain of radio telegraph stations linking America's outposts with the central government. The British Imperial communication chain similarly unites that empire by a series of radio telegraph stations.

. But radio telephony will bring these bonds still closer. National stability and understanding will be enhanced through the simple means of rapid spoken communication.

International relations will be improved if only by the courteous diplomatic amenities which the radio telephone makes possible. Direct negotiation by radio telephony is unlikely because of its present lack of secrecy. Yet better understanding is bound to result when diplomats of all nations are within elbow reach of each other; when they need but to lift the telephone to speak to each other, no matter how far separated.

The relation of world markets will be significantly modified by the radio telephone. The rapid and accurate transfer of trade information from every corner of the globe to every other corner of the globe will bring a new phase of economic relations in which the needs of the world will be quickly met and the danger of oversupply at one point while shortage exists at another will be eliminated.

The pioneer who opens new lands and new resources to the civilized world will find the radio telephone of constant service. No longer will he be handicapped by continued isolation. The radio telephone will keep him in constant touch with the world he has left behind him, whether his exploration be polar or tropical, or through desert or mountain range. The inestimable resources of Africa and South America will be made available to the world half a century sooner because of the influence of the radio telephone.

The second phase of utility of the radio telephone to which Dr. Goldsmith referred is its successful surmounting of the barrier of motion. He considers as most important in this class radio telephony with aircraft in flight. The pilot of the airplane concentrates his attention on the delicate manipulation of controls. In time of danger, he cannot successfully interpret the slow communication of the radio telegraph by means of the Morse Code. In addition, the radio telephone is a quicker means of communication. It can handle five times as many words in a minute as the manually operated radio telegraph.

Man is trained by centuries of speech communication to grasp instinctively the spoken word, in spite of noise, distraction, and presence of imminent danger. The pilot of aircraft will have no difficulty in acting upon meteorological information and facts about the

condition of landing fields as he speeds through the clouds when such information is whispered into his ear through the radio telephone receivers.

Communication from moving trains will probably be handled by means of inductive telephony or wired wireless. The use of the radio telephone for the purpose is unnecessary, and the ether is already overburdened with essential functions. But every train will some day be equipped with receiving sets so that broadcast features will be available to relieve the monotony of travel.

The field of radio telephone communication with moving automobiles is limited, but is nevertheless of some importance. The control of police forces, of emergency gas and electric service units from their respective central headquarters will greatly aid in coping with crime and emergency.

The days, weeks, and even months of separation which a sea journey involves are often of consequence, and it is likely that considerable traffic will be handled between persons at sea and business associates and friends ashore. At present radio telephony is not permitted on commercial ship radio telegraph wave lengths, but it is likely that the radio telephone distress signal will replace the code S. O. S. Not only is speech communication so much more rapid—a factor often of vital importance in case of distress—but the vividness and accuracy of a voice appeal through the ether far surpasses that of the code message.

But when we discuss broadcasting and its possible uses and results, we may well hesitate. Even the most extravagant predictions cannot touch the real possibilities. Dr. Goldsmith suggests an interesting possibility:

“At last we shall have a ‘voice of the government.’ The Government will be a living thing to its citizens instead of an abstract and unseen force. The National Government will speak to every citizen by means of nationally broadcasted proclamations and statements of policy. A new understanding of national problems and national coöperation must necessarily arise.

“The broadcasting of information from our various government departments will not only serve to increase their respective efficiency and their service to the people but will build up in the consciousness of our citizenry a new knowledge of what our government is and what it does. It will elicit a new national

loyalty and produce a more contented citizenry.

"It is proposed that the debates of our Senate and House of Representatives, of state legislatures, and even of municipal governing bodies shall be broadcasted. At last we may have covenants literally openly arrived at, and a new era in politics. Elected representatives will not be able to evade their responsibility to those who put them in office.

"Inventions of the last century have served to make man's life more complex. Although many physical burdens and inconveniences have been removed, every development, except the motion picture and the phonograph, have drawn more and more upon man's nervous energy by increasing the speed at which business is done and the pace of life in general. The radio telephone, however, will bring a new joy into man's life. It will disseminate culture not to thousands but to hundreds of thousands and to millions.

"A man need merely light the filaments of his receiving set and the world's greatest artists will perform for him. Whatever he most desires—whether it be opera, concert, or song, sporting news or jazz, the radio telephone will

supply it. And with it, he will be lifted to greater appreciation. We can be certain that a new national cultural appreciation will result.

"Undoubtedly there will be other features of broadcasting which have not made their appearance. The people's University of the Air will have a greater student body than all of our universities put together. The educational application of radio is an immense field so far untouched.

"But," continued Dr. Goldsmith, "let us content ourselves with this picture. The future of radio telephony and the results it will accomplish is a story which would have staggered the intellect of Jules Verne. What I have given you are merely a few suggestions, the realization of which is only a matter of time. The deliberations of the Radio Telephone Commission at Washington, from which I have just returned, has considered each of the uses of radio telephony because definite plans are already under way to carry out many of these services."

This is an adequate answer to those who consider broadcasting a temporary fad. Let us join the march of progress in which such able men as Dr. Alfred Goldsmith are leading.

HOW TO BUILD AND OPERATE A VERY SIMPLE RADIO RECEIVING SET

This article is Letter Circular L C 43 of the Bureau of Standards, Department of Commerce. The edition of the circular is small and the editors of Radio Broadcast feel it a public service to bring this most authoritative matter within the reach of all beginners.

THIS article describes the construction and operation of a very simple and cheap radio receiving outfit which will enable one to listen both to radio code messages and to music and voice transmitted by radio.

This article shows how to construct the entire receiving station, including antenna as well as a crystal-detector receiving set. This station will enable one to hear the messages sent from medium-power transmitting stations within an area about the size of a large city, and to hear high-power stations within 50 miles, provided the waves used by those stations have wave frequencies between 500 and 1500 kilocycles per second (i. e., wave

lengths between 600 and 200 meters). Much greater distances are often covered, especially at night. If a person constructs the coil and other parts as indicated, the total cost of this set can be kept down to about \$6.00. If, however, a specially efficient outfit is desired, the cost may be about \$15.00.

ESSENTIAL PARTS OF RECEIVING STATION

THERE are five essential parts: the antenna, lightning switch, ground connections, receiving set, and phone. The received signals come into the receiving set through the antenna and ground connection. In the receiving set they are converted into an electric current which produces the sound in the

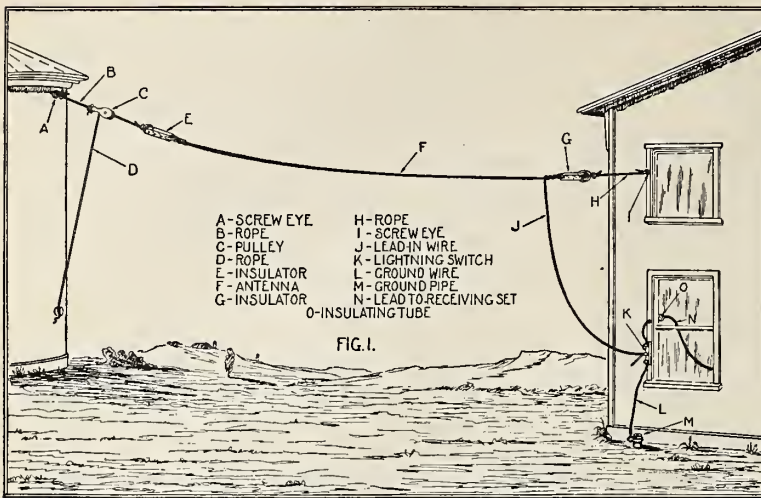

“phone.” The phone is either one or a pair of telephone receivers worn on the head of the listener.

The purpose of the lightning switch is to protect the receiving set from damage by lightning. It is used to connect the antenna directly to ground when the receiving station is not being used. When the antenna and the connection to the ground are properly made and the lightning switch is closed, an antenna acts as a lightning rod and is a protection rather than a source of danger to the building.

The principal part of the station is the “receiving set.” In the set described herein it is subdivided into two parts, the “tuner” and the “detector,” and in more complicated sets still other elements are added.

THE ANTENNA, LIGHTNING SWITCH, AND GROUND CONNECTIONS

THE antenna is simply a wire suspended between two elevated points. Wherever there are two buildings, or a house and a tree, or two trees with one of them very close to the house, it relieves one of the need of erecting one or both antenna supports. The antenna should not be less than 30 feet above the ground and its length should be about 75 feet. (See Fig. 1.) While this figure indicates a horizontal antenna, it is not important that it be strictly horizontal. It is in fact desirable to have the far end as high as possible. The “lead-in” wire or drop-wire from the antenna itself should run as directly as possible to the lightning switch. If the position of the adjoining buildings or trees is such that the distance between them is greater than about 85 feet, the

antenna can still be held to a 75-foot distance between the insulators by increasing the length of the piece of rope (D) to which the far end of the antenna is attached. The rope (H) tying the antenna insulator to the house should not be lengthened to overcome this difficulty, because by so doing the antenna “lead-in” or drop-wire (J) would be lengthened.

Details of Parts.—The parts will be mentioned here by reference to the letters appearing in Figures 1 and 2.

A and I are screw eyes sufficiently strong to anchor the antenna at the ends.

B and H are pieces of rope $\frac{3}{8}$ or $\frac{1}{2}$ inch in diameter, just long enough to allow the antenna to swing clear of the two supports.

D is a piece of $\frac{3}{8}$ - or $\frac{1}{2}$ -inch rope sufficiently long to make the distance

Figure 1. Showing the exterior equipment for the radio telephone receiving set. The antenna does not have to be horizontal

Figure 2. Showing interior arrangement of equipment

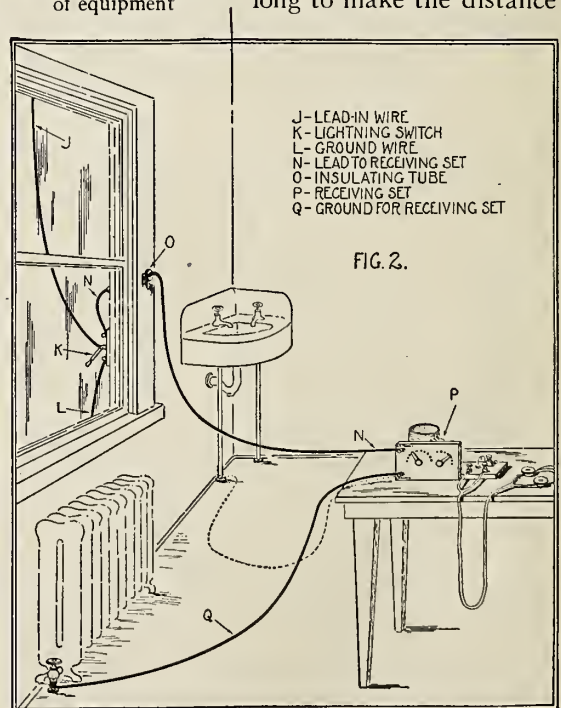

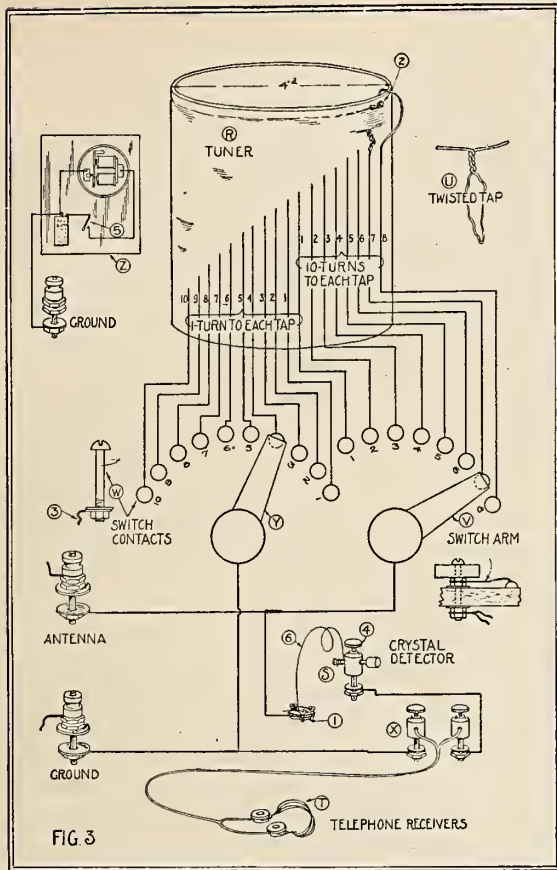

Figure 3. The tuner and certain accessories can be made at home

between E and G about 75 feet.

C is a single-block pulley which may be used if readily available.

E and G are two insulators which may be constructed of any dry hard wood of sufficient strength to withstand the strain of the antenna; blocks about 1½ x 2 x 10 inches will serve. The holes should be drilled as shown in Fig. 1 sufficiently far from the ends to give proper strength. If wood is used the insulators should be boiled in paraffin for about an hour. If porcelain wiring cleats are available they may be substituted instead of the wood insulators. If any unglazed porcelain is

used as insulators, it should be boiled in paraffin the same as the wood. Regular antenna insulators are advertised on the market, but the two improvised types just mentioned will be satisfactory for an amateur receiving antenna.

F is the antenna about 75 feet between the insulators E and G. The wire may be No. 14 or 16 copper wire either bare or insulated. The end of the antenna farthest from the receiving set may be secured to the insulator (E) by any satisfactory method, being careful not to kink the wire. Draw the other end of the antenna wire through the other insulator (G) to a point where the two insulators are separated by about 75 feet, twist the insulator (G) so as to form an anchor as shown in Figure 1. The remainder of the antenna wire (J) which now constitutes the "lead-in" or drop-wire should be just long enough to reach the lightning switch.

K is the lightning switch. For the purpose of a small antenna this switch may be the ordinary porcelain-base, 30 ampere, single-pole double-throw battery switch. These switches as ordinarily available, have a porcelain base about 1 by 4 inches. The "lead-in" wire (J) is attached to this switch at the middle point. The switch blade should always be thrown to the lower clip when the receiving set is not actually being used and to the upper clip when it is desired to receive signals.

L is the ground wire for the lightning switch; it may be a piece of the same size wire as used in the antenna, of sufficient length to reach from the lower clip of the lightning switch (K) to the clamp on the ground rod (M).

M is a piece of iron pipe or rod driven 3 to 6

Figure 4. The completed receiving set

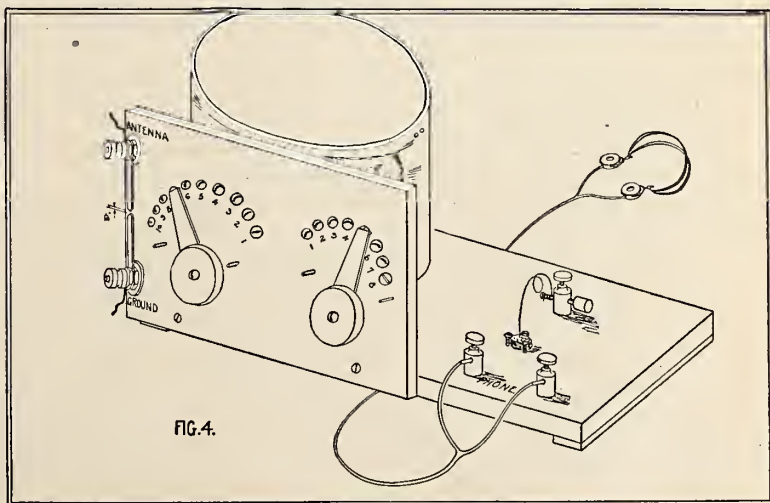

feet into the ground, preferably where the ground is moist, and extending a sufficient distance above the ground in order that the ground clamp may be fastened to it. Scrape the rust or paint from the pipe before driving in the ground.

N is a wire leading from the upper clip of the lightning switch through the porcelain tube (O) to the receiving set binding post marked "antenna."

O is a porcelain tube of sufficient length to reach through the window casing or wall. This tube should be mounted in the casing or wall so that it slopes down toward the outside of the building. This is done to keep the rain from following the tube through the wall to the interior.

Figure 2 shows the radio receiving set installed in some part of the house.

P is the receiving set which is described in detail below.

N is the wire leading from the "antenna" binding post of the receiving set through the porcelain tube to the upper clip of the lightning switch. This wire, as well as the wire shown by Q, should be insulated and preferably flexible. A piece of ordinary lamp cord might be unbraided and serve for these two leads.

Q is a piece of flexible wire leading from the receiving set binding post marked "ground" to a water pipe, heating system or some other metallic conductor to ground, except M, Fig. 1. If there are no water pipes or radiators in the room in which the receiving set is located, the wire should be run out of doors and connected to a special "ground" below the window, which shall not be the same as the "ground" for the lightning switch. It is essential that for the best operation of the receiving set this "ground" be of the very best type. If the soil near the house is dry it is necessary to drive one or more pipes or rods sufficiently deep to encounter moist earth and connect the ground wire to the pipes or rods. This distance will ordinarily not exceed 6 feet. Where clay soil is encountered this distance may be reduced to 3 feet, while in sandy soil it may be increased to 10 feet. If some other metallic conductor, such as the casing of a drilled well, is not far away from the window, it will be a satisfactory "ground."

The detector and phone will have to be purchased. The tuner and certain accessories can be made at home.

Tuner (R, Fig. 3).—This is a piece of card-

board or other non-metallic tubing with turns of copper wire wound around it. The cardboard tubing may be an oatmeal box. Its construction is described in detail below.

Crystal Detector (S, Fig. 3).—The construction of a crystal detector may be of very simple design and quite satisfactory. The crystal, as it is ordinarily purchased, may be unmounted or mounted in a little block of metal. For mechanical reasons the mounted type may be more satisfactory, but that is of no great consequence. It is very important, however, that a very good tested crystal be used. It is probable also that a galena crystal will be more satisfactory to the beginner.

The crystal detector may be made up of a tested crystal, three wood screws, short piece of copper wire, a nail, setscrew type of binding post, and a wood knob or cork. The tested crystal is held in position on the wood base by three brass wood-screws as shown at 1 Fig. 3. A bare copper wire may be wrapped tightly around the three brass screws for contact. The assembling of the rest of the crystal detector is quite clearly shown in Fig. 3.

Phone (T, Fig. 3).—It is desirable to use a pair of telephone receivers connected by a head band, usually called a double telephone headset. The telephone receivers may be any of the standard commercial makes having a resistance of between 2000 and 3000 ohms. The double telephone receivers will cost more than all the other parts of the station combined but it is desirable to get them, especially if one plans to improve his receiving set later. If one does not care to invest in a set of double telephone receivers a single telephone receiver with a head band may be used; it gives results somewhat less satisfactory.

Accessories.—Under the heading of accessory equipment may be listed binding posts, switch-arms, switch contacts, test-buzzer, dry battery, and boards on which to mount the complete apparatus. The binding posts, switch arms and switch contacts may all be purchased from dealers who handle such goods or they may be quite readily improvised at home. There is nothing peculiar about the pieces of wood on which the equipment is mounted. They may be obtained from a dry packing-box and covered with paraffin to keep out moisture.

The following is a detailed description of winding the coil, construction of the wood panels, and mounting and wiring the apparatus.

Tuner.—See R, Fig. 3. Having supplied

oneself with a piece of cardboard tubing 4 inches in diameter and about $\frac{1}{2}$ pound of No. 24 (or No. 26) double cotton covered copper wire, one is ready to start the winding of the tuner. Punch two holes in the tube about $\frac{1}{2}$ inch from one end as shown at 2 on Fig. 3. Weave the wire through these holes in such a way that the end of the wire will be quite firmly anchored, leaving about 12 inches of the wire free for connections. Start with the remainder of the wire to wrap the several turns in a single layer about the tube, tightly and closely together. After 10 complete turns have been wound on the tube hold those turns snugly while a tap is being taken off. This tap is made by making a 6-inch loop of the wire and twisting it together at such a place that it will be slightly staggered from the first tap. This method of taking off taps is shown quite clearly at U, Fig. 3. Proceed in this manner until 7 twisted taps have been taken off at every 10 turns. After these first 70 turns have been wound on the tube then take off a 6-inch twisted tap for every succeeding single turn until 10 additional turns have been wound on the tube. After winding the last turn of wire, anchor the end by weaving it through two holes punched in the tube much as was done at the start, leaving about 12 inches of wire free for connecting. It is to be understood that each of the 18 taps is slightly staggered from the one just above, so that the several taps will not be bunched along one line on the cardboard tube. See Fig. 3. It would be advisable, after winding the tuner as just described, to dip the tuner in hot paraffin. This will help to exclude moisture.

Upright Panel and Base.—Having completed the tuner to this point, set it aside and construct the upright panel shown in Fig. 4. This panel may be a piece of wood approximately $\frac{1}{2}$ inch thick. The position of the several holes for the binding posts, switch arms and switch contacts may first be laid out and drilled. The "antenna" and "ground" binding posts may be ordinary $\frac{1}{8}$ -inch brass bolts of sufficient length and supplied with three nuts and two washers. The first nut binds the bolt to the panel, the second nut holds one of the short pieces of stiff wire, while the third nut holds the antenna or ground wire, as the case may be. The switch arm with knob, shown at V, Fig. 3, may be purchased in the assembled form or it may be constructed from a thin slice cut from a broom handle and

a bolt of sufficient length equipped with four nuts and two washers together with a narrow strip of thin brass somewhat as shown. The switch contacts (W, Fig. 3) may be of the regular type furnished for this purpose or they may be brass bolts equipped with one nut and one washer each or they may even be nails driven through the panel with an individual tap fastened under the head or soldered to the projection of the nail through the panel. The switch contacts should be just close enough so that the switch arm will not drop between the contacts but also far enough apart so that the switch arm can be set so as to touch only one contact at a time.

The telephone binding post should preferably be of the set-screw type as shown as X, Fig. 3.

INSTRUCTIONS FOR WIRING

HAVING constructed the several parts just mentioned and mounted them on the wood base, one is ready to connect the several taps to the switch contacts and attach the other necessary wires. Scrape the cotton insulation from the loop ends of the sixteen twisted taps as well as from the ends of the two single wire taps coming from the first and last turns. Fasten the bare ends of these wires to the proper switch contacts as shown by the corresponding numbers in Fig. 3. One should be careful not to cut or break any of the looped taps. It would be preferable to fasten the connecting wires to the switch contacts by binding them between the washer and the nut as shown at 3, Fig. 3. A wire is run from the back of the binding post marked "ground" (Fig. 3) to the back of the left-hand switch-arm bolt (Y), thence to underneath the left-hand binding post marked "phones." A wire is then run from underneath the right-hand binding post marked "phones" to underneath the binding post (4, Fig. 3), which forms a part of the crystal detector. A piece of No. 24 bare copper wire about $2\frac{1}{2}$ inches long, one end of which is twisted tightly around the nail (the nail passing through binding post 4), the other end of which rests gently by its own weight on the crystal (1). The bare copper wire which was wrapped tightly around the three brass wood-screws holding the crystal in place is led to and fastened at the rear of the right-hand switch-arm bolt (V), thence to the upper left-hand binding post marked "antenna." As much as possible of this wiring is shown in Fig. 3.

After all the parts of this crystal-detector radio receiving set have been constructed and assembled the first essential operation is to adjust the little piece of wire, which rests lightly on the crystal, to a sensitive point. This may be accomplished in several different ways; the use of a miniature buzzer transmitter is very satisfactory. Assuming that the most sensitive point on the crystal has been found by method described in paragraph below, "The Test Buzzer," the rest of the operation is to get the radio receiving set in resonance or in tune with the station from which one wishes to hear messages. The tuning of the receiving set is attained by adjusting the inductance of the tuner. That is, one or both of the switch arms are rotated until the proper number of turns of wire of the tuner are made a part of the metallic circuit between the antenna and ground, so that together with the capacity of the antenna the receiving circuit is in resonance with the particular transmitting station. It will be remembered that there are 10 turns of wire between each of the first 8 switch contacts and only 1 turn of wire between each 2 of the other contacts. The tuning of the receiving set is best accomplished by setting the right-hand switch arm on contact (1) and rotating the left-hand switch arm over all its contacts. If the desired signals are not heard, move the right-hand switch arm to contact (2) and again rotate the left-hand switch arm throughout its range. Proceed in this manner until the desired signals are heard.

It will be advantageous for the one using this radio receiving equipment to find out the wave frequencies (wave lengths) used by the several radio transmitting stations in his immediate vicinity.

The Test Buzzer (Z, Fig. 3).—As mentioned previously, it is easy to find the more sensitive spots on the crystal by using a test buzzer. The test buzzer is used as a miniature local transmitting set. When connected to the receiving set as shown at Z, Fig. 3, the current produced by the buzzer will be converted into sound by the telephone receivers and the crystal, the loudness of the sound depending on what part of the crystal is in contact with the fine wire. To find the most sensitive spot connect the test buzzer to the receiving set as directed, close the switch (5, Fig. 3) (and if necessary adjust the buzzer armature so that a clear note is emitted by the buzzer), set the right-hand switch arm on contact

point No. 8, fasten the telephone receivers to the binding posts marked "phones," loose the set screw of the binding post slightly and change the position of the fine wire (6, Fig. 3) to several positions of contact with the crystal until the loudest sound is heard in the phones, then tighten the binding post set screw (4) slightly.

APPROXIMATE COST OF PARTS

THE following list shows the approximate cost of the parts used in the construction of this radio receiving station. The total cost will depend largely on the kind of apparatus purchased and on the number of parts constructed at home.

Antenna		
Wire—Copper, bare or insulated, No. 14, 100 to 150 ft., about		0.75
Rope— $\frac{3}{8}$ or $\frac{1}{2}$ inch, 2 cents per foot		
2 Insulators, porcelain	0.20	
1 Pulley	0.15	
Lightning switch—30 ampere battery switch	0.30	
1 Porcelain tube	0.10	
Ground connections.		
Wire (same kind as antenna wire)		
1 Clamp	0.15	
1 Iron pipe or rod	0.15	
$\frac{1}{2}$ pound No. 24 copper wire double cotton covered	0.75	
1 Cardboard box		
2 Switch knobs and blades complete	1.00	
18 Switch contacts and nuts	0.75	
3 Binding posts—set-screw type	0.45	
2 Binding posts—any type	0.30	
1 Crystal—tested	0.25	
3 Wood screws, brass, $\frac{3}{4}$ inch long	0.03	
Wood for panels (from packing box)		
2 Pounds paraffin	0.30	
Lamp cord, 2 to 3 cents per foot		
Test buzzer	0.50	
Dry battery	0.30	
Telephone receivers	4.00 to 8.00	*
TOTAL	11.00	15.00

If nothing but the antenna wire, lightning switch, porcelain tube, crystal, telephone receiver, bolts and buzzer are purchased this total can be reduced to about \$6.00.

*Still more efficient and expensive telephone receivers are available at prices ranging to about \$20.00.

CONSTRUCTION AND USES OF A LOOP RADIOPHONE TRANSMITTER

BY ZEH BOUCK

THOUGH numerous articles have appeared extolling the advantages of the loop radiophone transmitter, to the knowledge of the present writer, no practical description of their construction and operation has been published. In discoursing on the subject many authors have emphasized (and not unduly) the directional effect of this type of transmitter and the resulting communicative possibilities due to the lessened QRM (interference). However, the radiation limitations necessarily

be easily transformed into a loop transmitter in either of two ways. The simplest, though probably less efficient method, is to substitute the loop in series with a variable capacity, for the ordinary aerial. In the second system the loop is used directly in place of the conventional inductance and where necessary, to sustain oscillations, a condenser (variable preferred) replaces the capacity afforded by the open antenna.

A glance at figure one will reveal that I have employed the second method wherein

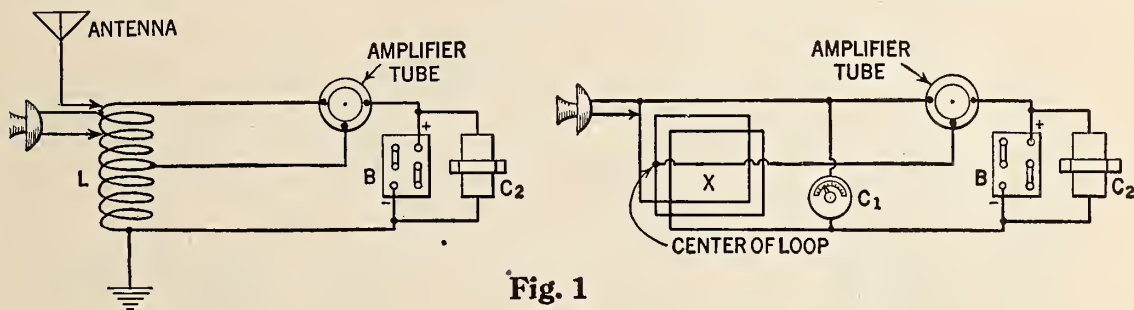

Fig. 1

imposed upon the loop by its electrical characteristics, make distances comparative with those secured with conventional antennas an impossibility except by a lavish expenditure of time and money upon ultra apparatus. For this reason, though I shall describe a transmitting loop capable of reliable communication over short distances, I shall rather emphasize the other adaptations of the loop as they appear under the general classifications of Novel Uses (magical illusions, etc.) and Laboratory Experiments.

For all three purposes the constructional details are identical, with the exception of the intercommunicative set, in which a slight elaboration of the basic type permits receiving and transmission with the same loop, tube, and tuning apparatus.

Before describing the set made and successfully experimented with by the author, it is well to mention that any wireless telephone at present radiating from an open antenna, can

the "Split filament circuit" has been superficially altered by the substitution of the loop X for inductance L and condenser C1 for the antenna and ground.

The loop was constructed on a twenty-inch square frame, and wound with seven turns of number twelve bare copper wire spaced three eighths of an inch. The variable condenser C1 is of .001 maximum capacity, and the fixed permittance C2 (a bypass condenser) is the size generally shunted across spark coil vibrators. However, if such is unobtainable, or the experimenter contemplates employing a plate potential in excess of two hundred volts, he is advised to build up a condenser of thirty plates of 2" by 2" tinfoil separated by mica sheets.

The high voltage, B, may be a convenient source of D. C. over one hundred volts which in the case of portable sets will probably be found in block B batteries or a small dynamotor operative from a six volt supply.

Almost any amplifier tube of sufficient hard-

ness will operate successfully, and exceptional results have been obtained with Western Electric Vt's one and two.

Modulation of extraordinary quality is secured by shunting a partial turn of the loop by a microphone, one terminal of which is connected on the grid side of the loop while the other is clipped over that fraction of a turn (usually about one half) which gives best speech, i. e., the loudest voice without distortion or blocking of the set.

Constructional details will be immediately comprehended by reference to figure two. The

phone and tune to a zero beat with the receiving set oscillating. The microaccuracy of this method is immediately apparent.

For intercommunicative work covering a distance which will vary directly with the applied plate potential from one to several blocks, the connections should be slightly altered so that they appear as in figure three. It will be observed in this circuit that a telephone headset and a high resistance potentiometer R, with the shunt push-button P, are placed in series with the high voltage. With the push-button released, the combined reactance and resistance of the phones and potentiometer should be of that critical value to just stop oscillations at any capacity of the tuning condenser C₁, a condition that is achieved by adjusting resistance R. At this point the loop will operate as a receiver for radiophone speech or spark signals. However, when the push-button is depressed, the full potential is again applied to the tube and

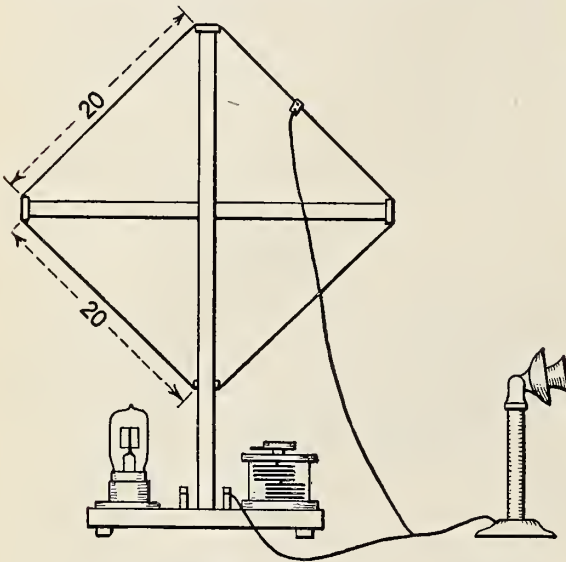

SIDE VIEW

Fig. 2

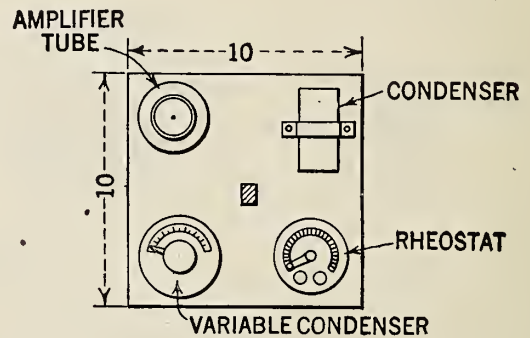

PLAN

instruments (socket, condensers, fixed and variable, and rheostat) are symmetrically arranged on a ten-inch square base about the upright pole which supports the loop. The weight and size of the complete equipment are such that the whole is easily revolved to secure directional transmission.

The experimenter will find many and varied uses for this apparatus in laboratory or research work, and I have used the set quite extensively as a calibrating wavemeter. To do this it is necessary to determine first the frequencies at which the transmitter oscillates at different capacities as indicated by the condenser scale. Employed in this manner, the set is extremely useful in calibrating other wavemeters and receiving sets. In the latter case it is advisable to dispense with the micro-

the set oscillates, i. e., transmits. When it is desired to establish communication between two such installations, the loops, in virtue of their directional transmission and reception, must be in the same plane, that is, pointing at each other. One station should be tuned (in receiving) to a wave at which there is no interference, and then, depressing the push-button, transmit and allow the other station to tune to resonance. Each station will now transmit and receive on the same wave. Boy Scout and similar organizations will doubtless find use for this set or those of like design.

By the addition of a set of the experimental type to his collection of props, the stage (or amateur) magician may add considerably to his repertoire of mind-reading mystifications. While it is obviously impossible to enumerate

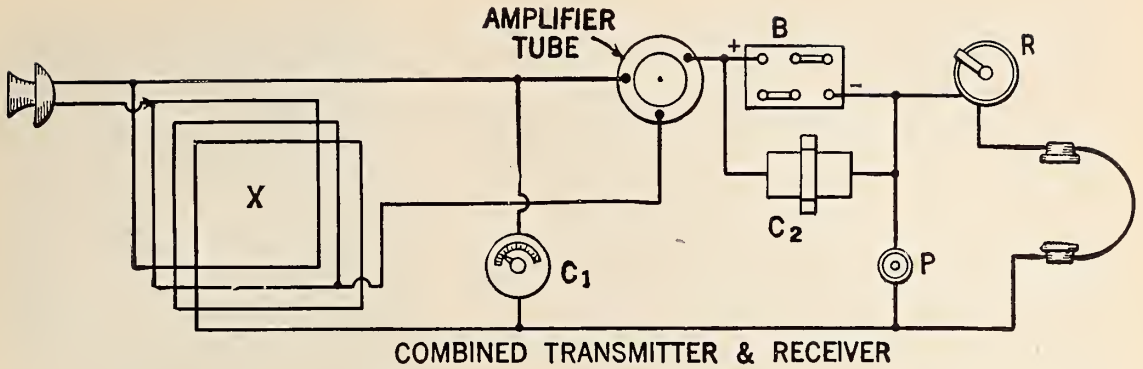

Fig. 3

or describe the legion adaptations in this line, I will mention one with which I have personally experimented.

The magician or mind-reader is consistently garbed in oriental attire, from his turbaned head which well conceals a pair of phones, to the flowing robes loosely enveloping him and a portable loop receiver of the design shown in figure four. The turns of wire, both the loop and single tickler turn (which should be separated by at least an inch), are easily interwoven through the thirty-six-inch circumference of the burlap band. The upper elastic belt serves to hold the loop in position about the performer's waist. The receiving bulb is preferably a tubular one which will slip easily into a pocket. The elastic belt will also support the filament flashlight batteries and two conventional .0005 condensers, the one in the grid circuit being supplied with a leak. As in the portable

transmitter-receiver, the potentiometer R must be varied until the bulb is just below the oscillation point. All tuning is of course accomplished by the variable condenser across the transmitting loop.

The illusion is perfect!

An assistant passes out slips of paper among the audience with the request that they write thereon any question they may desire answered. Upon collecting them he apparently turns the slips over to his *Blindfolded* master and exits. The magician holding each slip of paper before his bound eyes then gives relevant answers to every question! The secret is simple. The papers handed the magician are blanks, those upon which the questions are really written being retained by the assistant who, retiring to the wings (or even to the dressing room) reads them via radiophone, to the turbaned sorcerer!

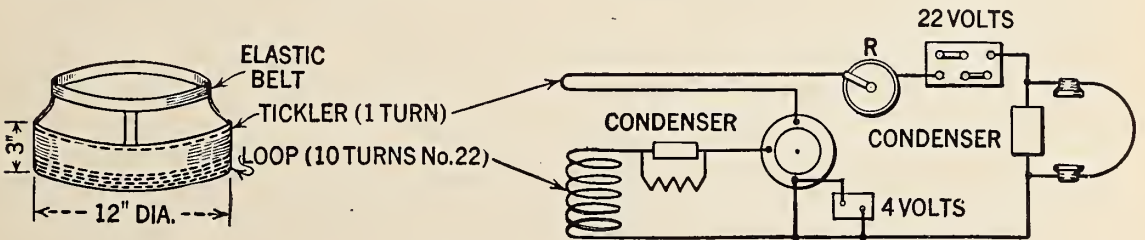

Fig. 4

A COMPACT PORTABLE WIRELESS SET

A Complete Wireless Telephone Transmitting and Receiving Station Which May Be Carried by a Single Boy Scout

By ARTHUR H. LYNCH

IT IS doubtful if any one subject studied by Boy Scouts is as popular as radio. This was true even before radio broadcasting was introduced, creating the nationwide interest it has. In the days when it was necessary to communicate by code, many instances arose which clearly demonstrated that Scouts were able to render great service to mankind not to mention the enjoyment they derived from the pursuit of this very attractive hobby.

In times of flood and other disaster, where the telephone and telegraph wires have been demolished, communication has been made possible and relief brought by radio outfits operated by Scouts. During the European War the work done by the Scouts is now a matter of history with which most folks are familiar, but the work of yesteryear is now being far outranked, and what is considered exceptional to-day is seemingly destined to be the commonplace of to-morrow.

For instance, who, a year ago, would have thought that a complete wireless telephone station, with its source of power, the necessary wire for the aerial and ground systems, transmitter and receiver, could be limited in weight to approximately fifteen pounds and could be conveniently carried in a single haversack? Surely there were few such folk.

It was but a few years ago, when the U. S. Army pack transmitter was introduced and caused a great furor in radio circles. It was made up in several units and could be carried from place to place by mules. There were collapsible masts and the spark transmitting unit and the generator unit and the receiving unit, each designed to fit snugly on the back of a mule. The generator was provided with two handles, somewhat similar to those on a coffee mill, and two husky men were kept quite busy cranking up enough "juice" to run the transmitter, which, by the way, had a very limited range. More recent models have been perfected by the Army and one set was made for use in France. However, there were no

complete stations in the war which could be counted upon to perform as the little complete station which is now available for Scout use.

THE "STATION" EQUIPMENT

IF THE apparatus in the accompanying illustrations is compared in size with the boys surrounding it, little need be said regarding its compactness, and misgivings are likely to present themselves as to the possible value of such a small outfit. In order to make this point very clear let us consider some past performances, just as soon as we have covered the parts which go to make up the "station."

First and foremost, there is a regenerative tuner, with a single wave length control and a tickler control. Wherever we find a regenerative circuit we must have vacuum tubes, and in this particular receiving set there is a tube of special construction, designed to operate from the power delivered by a single dry battery of the type ordinarily used for door bells. There is a rheostat, or regulating resistance, connected in this battery circuit, and adjusting it permits variation of the current flowing through the tube in order that any desired intensity may be secured.

Vacuum tube operation requires the use of a "B" or "plate" battery, which in this case is in the form of a block just about one third the size of a common red brick. This little battery is made up of a number of individual dry cells in series and is designed to supply a high voltage rather than much power. Such batteries may be counted upon to supply approximately twenty volts, which is sufficient for the plate circuit of the vacuum tube used in this outfit.

Of course it is necessary to employ telephone receivers, though this set may be used with amplifiers and a loud speaker when it is used in a permanent location rather than in field work. Except for the aerial and ground wires, which we will consider more thoroughly presently, there is nothing else needed for this transmitting and receiving station. Let us



THE PORTABLE RECEIVING OUTFIT

Which also can be used as a radio telephone transmitter. Current for the operation of the vacuum tube is supplied by a single dry cell

now consider its ability to receive, leaving the transmitting for consideration anon.

A PHENOMENAL RECEIVER

WE HAVE become so used to thinking of radio in terms of kilowatts, and towers and what-not, that the suggestion of a really compact receiving outfit, operating from a single dry cell being of much value does not seem very likely, but in this instance we have erred.

Many of these receiving outfits are now in use and there is nothing more interesting than putting one of them through its paces, for an agreeable surprise is generally the result. For instance, there is a gentleman in Jersey, who could not tell one letter of the code from another, were it to be transmitted to him at five words a minute, nor does he know the difference between a condenser and an inductance, and his ideas concerning wave length could never be found in any book on radio, for he hasn't any, but he has installed one of these receiving sets. The aerial this gentleman

boasts is a single copper wire, about eighty feet long and thirty or thirty five feet above the ground. Would it surprise you to know that he was able to receive wireless telephone speech very clearly from a vessel nearly a thousand miles at sea, during the day?

There are a number of similar installations in Brooklyn and it is quite a common thing for these stations to listen to the transmitting from the broadcasting station, located in East Pittsburgh, Pa., even though no effort is made to instal pretentious aerials. Most of those which have been observed are of the single or two-wire type, generally fifty to one hundred feet in length. With such a receiver is it strange that a new era has dawned in Scout communication?

AN EXCEPTIONAL TRANSMITTER

AFTER considering the wonderful improvement in radio receiving apparatus, which now makes it possible for us to listen to wireless telephone conversation over distances of many miles, with very simple equipment, it is even more astounding to learn that this same outfit may be converted into a transmitter by merely making an adjustment or two, removing the receivers from the head, and talking into one of them.

In order to transmit, it is necessary to have the bulb oscillating and this condition may be recognized by a mushy sound in the telephone receivers. When this occurs, it is merely necessary to talk into one of the telephone receivers and the speech, thus transmitted may be picked up over short distances. A low resistance microphone placed on the ground lead will give slightly better results.

It is not necessary to throw any switches in transferring from transmitting to receiving, but it is necessary to alter the "tickler" knob a little, in order to cut out the mushy sound when reception is being carried on. If this were not done, the incoming speech or telegraph waves would be distorted and in the case of the former, might be unintelligible.

FIELD OPERATIONS

SCOUTS on field manœuvres may conveniently carry one of these stations with them, and where several troupes are to be directed from a single headquarters, it is generally found advisable for the headquarters station to be equipped with a more powerful transmitting station, while the various troupes may

communicate between themselves by employing the small portable "stations" we are considering. Signals from headquarters may be received over rather long distances, depending, of course, upon the power at the transmitting station and such other variable factors as the size and height of the receiving antenna and the particular natural characteristics of the land over which the communication is carried on.

The most important consideration in field operations is the aerial, or "antenna" as it is sometimes called. There is a great deal of misunderstanding concerning this very important part of a radio station, so let us decide this case once and for all. Perhaps we may best know what to do by knowing what not to do.

For ordinary communication a wave length of two hundred meters should not be exceeded, therefore the best form of aerial is a single wire, having a total length, from the binding post on the set to its outer end, of about fifty feet.

This wire may be made of almost any metal and may be bare or insulated. For outdoor work, the best aerial wire is aluminum, because it is very light, but it is rather brittle and requires a little care in handling, which is not the case when copper or galvanized iron wire is employed. If the additional weight makes no difference, copper is most suitable.

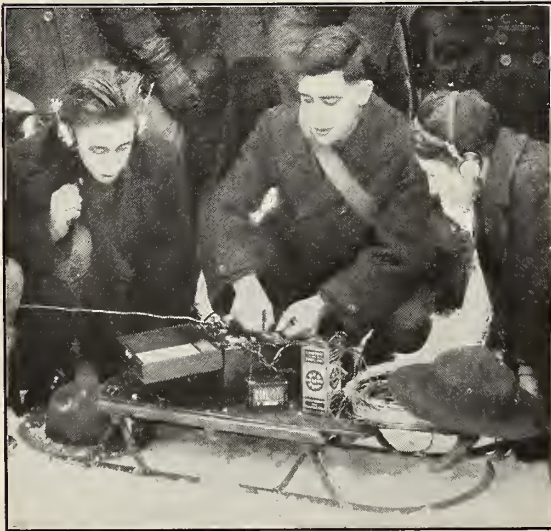

RECEIVING MESSAGES FROM TROOP HEADQUARTERS

The equipment shown in the previous picture in operation. No ground connection was possible so an insulated wire thrown on top of the snow was used as a counterpoise

Various locations require aerials of different classes, but no definite rules may be given, governing this phase of field radio communication and the following generalities may be followed, as nearly as is reasonably possible, with satisfaction.

Wherever possible, the aerial should be very well insulated and should be isolated from all possible surrounding objects. A very suitable aerial may be erected in a few minutes by attaching an insulator to a string and casting the insulator over a high tree, letting the string unravel as the insulator takes its course, in somewhat the same fashion as the gun used for life-saving purposes. A little practise is necessary for this work, but it is not a very difficult task for a boy to cast a line over the top branch of a fifty foot tree.

When the insulator comes down, on the opposite side of the tree, it is merely necessary to fasten one end of the wire to it, pull in on the string until the insulator is in a position approximately fifteen feet from the leaves, drive a stake in the ground and make the string fast to it. The remaining end of the aerial wire should then be connected to the outfit and drawn up taut. The ideal condition is found where there is a single tree without foliage, but if an effort is made to keep the aerial wire as far from other objects as possible, this ideal condition is not entirely necessary. In making the aerial do not make the very common mistake of using too long or too many wires. More than two should not be used, nor should the aerial be more than fifty feet in length, for this class of communication.

Wherever possible, advantage should be taken of a natural ground connection, that is, one in which it is possible to place a large sheet of metal directly into some body of water or soggy soil. If it is possible to locate a water pipe it is doubtful that a more suitable ground could be had. A water supply hydrant is frequently available along most of our highways.

Where use is to be made of the natural ground, a sheet of metal approximately one foot by three feet should be buried in moist earth after a wire is soldered to it or attached by a binding post. The latter method is frequently found more convenient. Where operation is to be carried on over a stretch of dry territory and it is impossible to locate a water pipe or some soggy ground, it is necessary to employ what is known as a counterpoise. A very con-



A BOY SCOUT TROOP EQUIPPED WITH RADIO

The scout with the knapsack has in it the complete wireless telephone transmitting and receiving station, including the necessary tuning apparatus, telephone receivers, batteries for power, aerial and ground wires

venient counterpoise may be made by a single piece of insulated copper wire 40 or 50 feet in length, laid directly above the earth in approximately the same direction the antenna extends. However, the direction of this wire is not of very great importance. Where possible a more suitable arrangement may be had by raising this counterpoise wire approximately one foot above the ground, by means of stays driven into the earth.

"THE STATION" IN OPERATION

THIS type of set is supplied with complete instructions for installing and operating, but since we have attempted using this outfit for transmitting as well as receiving, one or two points must be considered in order to have it operate satisfactorily.

Stations communicating back and forth by this simple method of wireless telephony should

operate on approximately the same wave length. By doing this the change from a suitable receiving condition to the proper transmitting condition is effected by merely rotating the tickler control knob. Best wireless telephone reception is accomplished when the receiving set is brought to a point just below oscillation, whereas transmitting may only be carried on satisfactorily where oscillation actually exists. The most convenient method for bringing about this change is, as we have said, rotation of the tickler control knob. Transferring back and forth may be done very freely after a little experience is had in connection with this outfit and very rapid transferring of thought between Scout Troops is now possible.

With the approach of good weather, Scout manœuvres will undoubtedly be increased and their scope made much broader by an intelligent application of radio telephony.

RADIO NOTES FROM HOME AND ABROAD

PUBLIC INTEREST IN RADIO

PROBABLY the sensation of the New York radio show in March, the second annual exhibition arranged by the Executive Radio Council of the Second District, was the interest of the public in the event. The show was housed on the roof of the Pennsylvania Hotel. After the first night it was decided that Madison Square Garden would have been hardly adequate. Thousands went to the show and more thousands were turned away, and those who got in were frequently as disappointed as those who failed, for the exhibition room was generally so crowded that the spectator couldn't see the exhibits and the exhibitor couldn't satisfactorily explain to the spectator.

All of which isn't exactly a criticism of the promoters of the show. Their past experiences had led them to believe that the exhibition would attract the amateur chiefly; they were unprepared, as all branches of the radio industry were unprepared, for the sudden great development of interest in the art.

Viewed as a whole, the show was noteworthy as indicating the belief of manufacturers in the permanency of broadcasting and the permanency of public interest. The tendency among producers of radio equipment is toward a compact receiving set in cabinet form which will take its place without criticism among the furnishings of the home. Loose ends, loose wires are steadily being eliminated. The loud speakers generally didn't make an entirely satisfactory impression. Some were good, but there was much evidence of throat trouble; one of them was usually yowling regularly. Before the next show the manufacturers should be able to exhibit reliable loud speakers. Otherwise they had better be left at home.

The Executive Radio Council, which arranged the show, is an organization of amateurs, and, notwithstanding their failure to gauge the extent and amount of public interest, they are to be congratulated for their efforts to make the exhibition representative and instructive. J. O. Smith, chairman, and the following members of the council comprised the exhibition

committee: Renville H. McMann, M. Blun, Carl E. Trube, C. B. Hobson, C. J. Goette, A. F. Clough, John D. Blasi, F. B. Ostman, W. J. Howell, H. Hertzberger, J. B. Ferguson, B. B. Jackson, F. L. McLaughlin, J. J. Kulick, C. E. Huffman.

A Giant Belgian Radio Station

A 500-kilowatt radio station is being erected at Ruysselede near Bruges, by the *Societe Independante Belge de Telegraphie Sans Fils*. It will be able to communicate with North and South America, as well as with the Congo in Africa. It will be possible to receive four messages simultaneously. Another big radio station is to be erected by the Government in the Congo.

Radio Broadcasting in Holland

THE broadcasting idea is steadily gaining ground in Europe, although it is well to point out that the service there is of a more commercial nature than its American counterpart. In Germany the radiophone has been in use for some time for the distribution of business reports. Now we learn from the *New York Times* that a radio-phone news service has been inaugurated in Holland, with excellent results. Fifty different newspaper subscribers of the Vasdiaz Agency at Amsterdam, equipped with a simple receiving apparatus, have been receiving the news reports.

This is considered only the commencement of wireless telephone for journalism in Europe. Although not yet extended abroad, this service will undoubtedly follow. International laws requiring special governmental permits for sending and receiving messages abroad are at present the only obstacles.

The Vasdiaz Agency received congratulatory messages from the Dutch Ministers and authorities and also from foreign government officials, including Premier Lloyd George. The Hague papers obtained excellent results in transmission by the new wireless telephone.



© Harris & Ewing

AN AMATEUR RADIO CONVENTION

The members of the first amateur radio convention from the states around the District of Columbia at the Arlington Station

Messages sent out from Amsterdam can be received by the whole of Holland.

Radio and Airways

RADIO and aviation go hand in hand. Certainly, aviation on anything like a practical scale needs radio, and needs it in the most emphatic sort of way. So it is not surprising to learn that the Army Air Service is now engaged in constructing and installing permanent radio stations at Mitchell Field, Long Island; Langley Field, Hampton, Va.; Langin Field, Moundville, W. Va.; and Wilbur Wright Field, Fair-field, O. Those at Moundville and Fairfield are to be spark sets of 5-kilowatt capacity, while those at Mitchell Field and Langley Field will be continuous wave tube sets of approximately 3-kilowatt capacity. The purpose of these stations will be to keep airmen posted as to weather conditions existing along their routes. According to Captain Oliver S. Ferson, it is hoped that the inauguration of this system of inter-communication between Air Service fields and stations will obviate the possibility of a recurrence of

accidents similar to that which occurred at Morganville, Va., when a number of lives were lost as a direct result of an airplane flying into a storm of which it had no previous knowledge. The Air Service contemplates the extension of this radio set to include eventually every Air Service field and station in the United States.

The Beginning of Radio Broadcasting in England

THE first of a series of regular wireless telephone transmissions, as radiophone broadcasting is called by our British cousins, took place recently, for the benefit of the English radio amateurs. The Marconi Scientific Instrument Company prepared a fifteen-minute musical programme for the occasion. The first telephone selection was radiated from the Marconi station at Writtle on a wave length of 700 meters. This was preceded by a series of radio telegraph signals for calibration purposes on 1,000 meters. The power employed for radio telephony is limited to 250 watts in accordance with the terms of the Post Office license.

Operating Vacuum Tubes on Alternating Current

SOONER or later the radio enthusiast who has a working acquaintance with vacuum tubes wonders why vacuum tubes cannot be operated on lighting current, thereby doing away with the necessity of storage batteries. The truth of the matter is that the slightest variation in the filament current makes a corresponding noise in the telephone receivers. Alternating current and direct current fluctuate, especially the former; hence their use results in noises in the telephone receivers. It has remained for Prof. Marcel Moye of the University of Montpellier, France, to conduct an investigation with vacuum tubes with a view to utilizing alternating or direct current. The problem is a difficult one, but this French investigator appears to have made some very substantial progress by way of ironing out the irregularities of the current, so to speak. Space does not permit us to state here just how Prof. Moye accomplishes the final result, but suffice it to state that he makes use of resistances, variable condensers, and a crystal detector, arranged in a very delicately

balanced circuit. Indeed, after considering the layout of equipment necessary to operate vacuum tubes on a lighting circuit, one comes to the conclusion that it is perhaps best, after all, to be satisfied with storage battery operation.

Britain's New Radio Station

FACTS are now available concerning the new British station at Leafield, England, located about 600 feet above sea level. The power plant consists of two 250-kilowatt arcs and auxiliaries. The main aerial system is supported on ten tubular steel masts, each 300 feet high. The ground wires are buried at a depth of about 9 inches. For reception a separate aerial, supported on 75-foot poles, is to be used. It is necessary for this aerial to be grounded and the receiving apparatus protected during transmission on the main aerial. This operation is performed by a remote-controlled switch, which is operated by the stop on the arc controller immediately preceding the stops operating the 1,000-volt contactors of the arc supply current.

GETTING BASEBALL RESULTS ABOARDSHIP IN THE GULF OF MEXICO

A combination of radio and a typewriter will soon spread the news to all the ship's company





© Underwood & Underwood

ONE OF THE ATTRACTIONS AT THE NEW YORK RADIO SHOW
E. R. Glavin with his wireless controlled wagon which ran about delivering mail and papers

Radio and the French Farmer

METEOROLOGICAL forecasts to twelve districts in France are now being sent daily from the Eiffel Tower for the benefit of farmers. They will indicate the weather for the following day, the direction of the wind, the state of the sky, and the possibilities of dangerous phenomena for agriculture, such as frost, storms, hail, and so on, and the variation of temperature. The messages will be transmitted at 4:30 p. m. daily, and in summer it is intended to send a second message at daybreak. This will contain the same information, only the minimum temperature of the night will be replaced by the maximum temperature of the day.

Atmospheric Conditions and Radio

METHODICAL experiments for discovering a relation between atmospheric conditions, particularly atmospheric pressure, temperature, dampness, wind, potential gradient, number of ions, atmospheric current in the antenna, and so

on, and the quantity and intensity of atmospherics, as well as fading of signals, were made by S. Wiedenhoff, a German investigator, and are reported in a recent issue of a German technical periodical. The chief conclusions are as follows: (1) The maximum variations in atmospherics are observed when the variations of the potential gradient are minimum and when the atmospheric current in the antenna and the number of ions in the air are maximum. (2) In general no atmospherics, or only a few, are experienced in conditions of dry fog, but they immediately appear so soon as fog is dissipated. (3) Rain, diminution of potential gradient and of the number of particles of dust produce great atmospheric disturbances. (4) Increase of atmospheric current in the antenna produces a sensible diminution of atmospheric disturbances.

So far as the regular and periodic variations in the intensity of atmospherics in day time (maximum in the afternoon, minimum in the morning), and during the year (maximum from June to September, minimum in February) are concerned, the following conclusions were arrived at: (1) The largest number of atmos-



© Underwood & Underwood

AN AMATEUR STUNT

A Match Box Receiver and Its Twelve Year Old Maker. A striking example of the interest of radio for boys

pherics is obtained when the vapor pressure is maximum at the earth's surface, when the conductivity of the air increases and when the velocity of the wind diminishes. (2) The num-

ber of atmospheric is minimum when the air conductivity is maximum at a certain height, when fog or great relative damp is present, when the temperature is minimum, and atmospheric pressure is maximum. (3) The number of atmospheric increases when the potential gradient increases.

As to the fading of signals, it was found that the intensity of signals increases when the atmospheric pressure and the wind increase, and when the temperature diminishes.

The Radio Cable and Airships

THE time may yet arrive when aircraft pilots will guide their ships of the air by means of their ears rather than their eyes. At least experiments have recently been conducted in France with the radio cable as a means of guiding aircraft, just as the same idea is now in use for the purpose of aiding steamship pilots in and out of narrow waterways such as harbors.

The recent experiments were conducted at the Villacoublay airdrome, and use was made of a discarded power line for the radio cable. Alternating current of 600-cycle frequency was sent through the transmission line so as to set up the desired magnetic field. On board the aircraft three simple loops of wire are employed, two of them placed vertically and one horizontally. In the cases of the usual

IN THE RADIO ROOM OF A DAILY NEWSPAPER

Getting news despatches direct from Europe. The codé messages are copied on the automatic recorder shown in the centre of the picture and later transcribed by operators by a method similar to that of a dictating machine

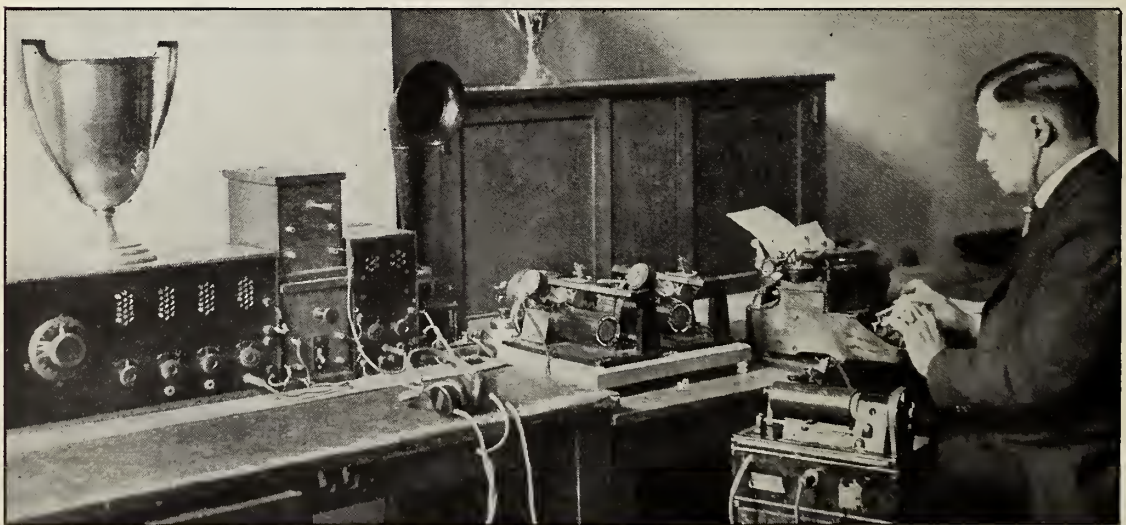



© Underwood & Underwood

A MINIATURE RECEIVING SET

Made in the shape of a ring. An ordinary umbrella is used as antenna—an interesting plaything for those versed in Radio

airplane, the loops are placed at the end of the machine and form part of the tail construction. The two vertical loops, one of which is placed longitudinally and the other right angled to the direction of flight, tell the direction of the cable. When the aircraft is moving directly over the charged cable, the humming of the alternating current is heard loudest in the telephone receivers worn by the pilot. The more the aircraft deviates from the path of the cable, the weaker becomes the hum. The other vertical loop, on the other hand, operates in just the opposite manner; the hum is loudest when the aircraft is at right angles to the cable. By switching from one to the other, the aviator can pick up the cable and follow it along by means of sound.

The horizontal loop is used at high altitudes to explore for the guiding charged wire. The cable can be picked up at 10,000 feet. However, the aircraft must be within 6,500 feet before the cable can be followed.

Ultimately, radio cables must come into

use for guiding aircraft, especially at night and during foggy weather. Cables leading in different directions can be supplied with alternating currents of varying frequencies in order to distinguish one route from another.

The Radio Telephone Where Wires Will Not Go

RADIO communication is being employed by a southern California light and power company between one of its power plants and the main office, a distance of 125 miles. Another light and power company is employing portable radio telephone sets for keeping in touch with camps in the mountain territory where extensions are in progress. Vacuum tube sets are employed in each case and the results are reported to be satisfactory under all conditions. Trials are in progress of portable sets with a 25-mile range for communication between the various construction camps.

LEAVING THEIR MONUMENTS IN THE ETERNAL ETHER

Stories of Radio Men at Sea

BY PARKHURST WHITNEY

SOMEWHERE in the Atlantic seven hundred miles off Cape Race lies the body of the wireless operator of the little Norwegian freighter *Grontoft*, lately bound from Norfolk to Esbjerg. With him lie the bodies of the other nineteen members of the crew. His name is unknown; but what he said while his wireless still crackled, the manner in which he met his fate, is bound to live in the annals of the sea. He was of the pure breed of men who take their chances with the gods of the storm.

One of the fiercest gales of a wild winter was turning the Atlantic on end one day last March as the Baltic liner *Esthonia* labored westward toward Cape Race. Great waves were burying liners under mountains of water. Two hundred miles westward from the *Esthonia*, the Cunarder *Cameronia* had just been raked fore and aft by the largest wave that Captain Blakie had seen in his thirty-five years at sea—a wave forty feet high and three hundred feet broad from trough to trough. It was that sort of day.

In the wireless room of the *Esthonia*, Edward Hanson, the operator, sat braced at his desk listening to the sputtering of other wireless operators as they retailed astounding details of the size and volume of the waves that were sweeping over their ships. At 10 o'clock in the morning Hanson picked up an SOS. It was from the freighter *Grontoft*. The call came in the usual form, giving, as regulations specify, the position of the ship, which was forty-eight miles northeast of the *Esthonia*. This done, the operator aboard the freighter added:

"God pity the boys at sea on such a night as this. The old man thinks it might breeze up by night."

There was a pause and Hanson's apparatus flashed back a response to the call. Then he dropped his receiver and notified Captain Hans Jorgenson, of the *Esthonia*. The *Cam-*

eronia had also picked up the appeal for help, but she was two hundred miles away. It was up to the *Esthonia* and Captain Jorgenson didn't falter, though his ship dropped sickeningly between two great walls of water as she put about. She trembled under the shock of a broadside of water and edged shivering into the wind as the screw raced and a huge comber heaved at her keel.

"Tell him," said Captain Jorgenson, "that we are on our way."

Hanson went back to the wireless room and sent the cheering message. The *Esthonia's* engines were put under forced draught, but such was the power of wind and wave on that day that she only made four miles in the first hour. At times her screw was hoisted clear of the water. Another SOS came from the *Grontoft*. At the end the operator tacked on his usual cheerful, ironic observations.

"Well," he said, "the steward is making sandwiches for the lifeboats. Looks like we were going on a picnic."

The picnic to which he referred was a gale in which no small boat could survive, even if it should happen to drop right side up from the davits. Hanson sent an encouraging message as the *Esthonia* drove on, picking up a little speed as she headed into the wind. Half an hour later the *Grontoft* operator sent out another of his cool comments. His ship was doomed, and so were the men aboard her, but he chose to jest about it as usual.

"The old wagon has a list like a run down heel," he said. "This is no weather to be out without an umbrella."

"Hold on, we'll be alongside soon," Hanson flashed back.

Then for a time there was silence while Hanson waited and other operators queried Hanson as to what he thought his ship could do even if she did come alongside the freighter. Hanson paid no attention to these messages; he was waiting for word from the gallant man in the wireless room of the *Grontoft*. It came

at noon, the first part of it dictated by the captain.

"We are sinking stern first," it said. "The decks are awash. The boats are smashed. Can't hold out any longer."

To this laconic farewell of another seafaring man, the operator added, as though he wished to assure Hanson that he wasn't unduly troubled: "The skipper dictated that. He ought to know. . . . Where did I put my hat? Sorry we couldn't wait for you. Pressing business elsewhere. *Skoal!*"

There was no more. Not so much as a bit of wreckage was visible at four o'clock in the afternoon when the *Esthonia* arrived on the scene. The *Grontoft* and her crew and her dauntless operator had indeed gone to pressing business—elsewhere.

Since that day in January, 1909, when Jack Binns used the wireless to save the passengers and crew of the White Star liner *Republic*, the world has come to expect great deeds of the men who ride the hurricane deck with receivers clamped to their ears. Nor has the world been disappointed. Sometimes they fail, as the operator of the *Grontoft* failed, because there are times when the elements are too much for man and his machines. More often they succeed. Their work is not always dramatic. The history of disasters at sea fortunately is not of a succession of *Republic* and *Titanic* affairs. It is the every-day routine duty of the radio that robs the sea of much of its terror. Radio frequently beats the heaviest storms of their toll of life; in fairer days it brings a sense of security and ease to all who travel on ships.

Sometimes the amateur takes a hand at rescue work. Three Brooklyn men went fishing one day last fall out in the Atlantic near the Ambrose lightship. When they started for home late in the afternoon they discovered that a leak in the gas feed pipe had nearly emptied the gas tank. They had oars, but the seas were rising and they could make little headway. Despite their combined efforts at the oars they drifted steadily toward the open sea in a twenty-six foot motor boat. They spliced two anchor lines together, but the line parted. Again they drifted seaward. Night came and they signalled the lightship with a lantern, but without success. Through the night they continued to drift with only a half filled water jug for nourishment. At two o'clock in the morning they saw a brightly

lighted passenger ship pass within two hundred yards without noticing them. Dawn came and they observed the *Hudson* of the United States lines and the *Lackawanna Valley*, a freighter, and hailed them without success. At noon another freighter came into view and seemed to head toward them. The men exhausted themselves trying to attract her attention, but she sheered off.

They were weak with hunger and exposure. Their motor boat was now about thirty miles southeast of the Ambrose light and far out of the lane of frequent travel. The boat was half full of water and her seams were beginning to open. They realized that their situation was desperate.

Then the steamer *Nantucket* came over the horizon, made for them, and picked them up. The night before a young brother of one of the men had become worried over their absence and had gone to a small wireless station operated by an amateur. A message sent out from that station was picked up by a wireless station operated by another amateur out on Rockaway Beach. From there it was relayed to the Atlantic and picked up by the *Nantucket*.

PRACTISING MEDICINE BY RADIO AT SEA

RADIO has brought a new idea into the practice of medicine—the long-range operation. Late one night the wireless operator at the Bush Terminal building in New York City sat at his desk and picked up a message from the captain of an oil tanker out in the Atlantic. One of the crew had cut his hand on a piece of wire a few days before; it had become infected and the man was suffering acutely. There was no surgeon aboard and an immediate operation seemed necessary. A heavy sea was running and it was impossible to transfer the man from the ship. The tanker's wireless was searching the ether for help.

The wireless operator at the Bush Terminal decided to take a hand. He telephoned to Dr. Raymond Barrett, of the Brooklyn Hospital, at his home and got his coöperation. Then he sat at his apparatus and transmitted directions between the physician at his home in Brooklyn and the tanker rolling in the Atlantic. There was a member of the crew who had had some experience as a nurse. To him the operator sent Dr. Barrett's directions about accessories for the operation, the making of bandages and drainage tubes. A herring

knife was sterilized, to be used as a scalpel. Drainage tubes were made from pieces of rubber. Then, while the doctor sent directions through the ether, the operation was performed, without anæsthetics, but nevertheless successfully.

On a recent voyage of the United States liner *America* a wireless message came from a Shipping Board freighter to the effect that nineteen members of the crew of thirty were suffering from a mysterious and painful malady. The vessels were three hundred miles apart, but from the information wirelessly to the *America*, Dr. C. F. Leidy and Dr. Hislop diagnosed the disease as ptomaine poisoning. For two days they treated the sick men by wireless and finally received this message from the freighter:

"Your directions followed. All but six now on duty. They are recovering fast. Thanks and God bless you. *Bon voyage.*"

On the heels of this message came another from a second freighter stating that a member of her crew was in agony. The doctors had only a layman's diagnosis on which to base their treatment, but they sent back instructions. The following morning they were surprised to receive a message from an Italian steamer three hundred miles in another direction. It read:

"Many thanks to the S. S. *America*. We had a sick member of crew suffering from similar ailment. Prescribed same as directed for other steamer. Our patient recovering. God bless you."

The operator of the S. S. *Ryndam* received a message one night which caused him to hurry to the quarters of Dr. William Ford. The message came from a freighter, and read:

"Captain's wife on board. Expects arrival of stork before we can reach port. Please assist."

The *Ryndam* was too far off to race with the stork, but Dr. Ford gave the operator directions which he thought a layman could follow. Two days later this news came.

"Now have a new son. Don't know your

name, doctor, but will call him Napoleon. A thousand thanks and God bless you."

It remained for the Seamen's Church Institute of New York City to establish a radio medical service for ships at sea. About a year ago the Institute realized the need for medical service on board ships that do not carry a physician and decided upon giving such service by radio. The matter was taken up with the Department of Commerce, which granted a special commercial license and the call letters KDKF. Ever since last April this station has been in operation. When a radiogram asking for medical assistance has been received, it has at once been telephoned to the Hudson Street Hospital in New York City. A physician there has telephoned back the necessary medical information, which has been sent by radio to the ship at sea. Great care has been exercised in order that the physician's precise instructions would be accurately transmitted. Indeed, the physician's instructions are received on a dictaphone by means of a special amplifier, which saves the physician from repeating them.

So valuable has been the medical service of the Seaman's Church Institute that the United States Public Health Service has undertaken to make the work national instead of purely local in scope. The Government has taken charge of this unique marine medical agency and is now coöperating with the Institute and with the Radio Corporation of America. The latter organization is going to coöperate with the Institute and the United States Public Health Service in the handling of free medical advice to ships at sea, through its stations at Chatham, Mass.; Siasconset, Mass.; Bush Terminal, Brooklyn, N. Y.; Cape May, N. J.; San Francisco, Calif. Hospitals designated to furnish information are: United States Marine Hospital, New York; alternates, Hospitals 38, 43, 61. United States Veterans' Hospital 49, Philadelphia; alternates, United States Veterans' Hospital 56, Fort McHenry, Baltimore, Md. United States Marine Hospital 19, San Francisco; alternate, United States Veterans' Hospital, Palo Alto, Calif.

RADIO FOR LIFEBOATS

HOW can radio telephone apparatus, for sending as well as receiving, be installed in a lifeboat?

The proper navigation of such a boat in a storm makes it necessary to reduce to a minimum any apparatus above the deck level. No loose wires above, in, or under the boat are permissible, since this would interfere with the proper handling of the boat and the throwing of lines. A small antenna of the ordinary elevated type would be highly undesirable from the navigating point of view.

Those were the obstacles that arose when the United States Coast Guard and officials of the Bureau of Standards considered the application of radio telephony to the problem of communication between a shore station and the life boat tossing out in the open sea. The importance of communication was obvious.

It was attacked diligently, and after tests it is believed that the question has been answered.

The boat selected for the test was a thirty-six foot, motor driven lifeboat, equipped with a heavy metal keel. The receiving and transmitting set was installed as far forward as possible. From the set a wire was run forward and connected to the metal keel. Two more wires, heavily insulated, were run aft from the set along the guards and connected with the keel. A particular kind of coil antenna was thus formed, of which the keel constituted a part. This arrangement was satisfactory from a navigating point of view.

The transmitting apparatus used at the shore station and on the boat were identical, and consisted of a five-watt radio telephone transmitting set. The wave length used for

RADIO ON A LIFE BOAT

The receiving and sending set installed well forward



THE LIFE BOAT AERIAL

Showing how the wires were arranged on the boat to form a kind of coil antenna

transmission from the boat was 380 metres; the shore station used a 675-metre wave length. The receiving equipment included an amplifier, using three stages of radio-frequency amplification, and two stages of audio frequency amplification, and was specially designed for the wave length used. The apparatus on the boat was particularly compact.

A demonstration was given at Atlantic

City. When the boat was six miles from shore, good communication was maintained with the shore station. This distance is considered sufficient for the ordinary needs of the Coast Guard. The test was regarded as very satisfactory, and as a result the Coast Guard is considering the installation of radio telephone equipment at a number of the more important stations.

A TROPICAL ISLAND RADIOPHONE

Radio Adventures Among the Bahama Islands

By CHARLES T. WHITEFIELD

LIKE most "fans," we hated to abandon our radio receiving telephone when we left home for some mild adventures among the Bahamas. So we packed it up with the idea that we could install it on the good ship *The Sea Scamp* a schooner of 70 feet which we had sent on to Nassau, New Providence, from Miami, where she had spent a comfortable summer getting a new coat of paint and all the troublesome expensive things that yachts require.

On the good ship *Munargo* coming south we had snatches of W J Z, Newark, but the air was jammed with local messages in short waves, and especially troublesome was the radio hog who amused himself by printing his alphabet, calling aloud to Heaven to hear his efforts, and completely blinding much better material.

When one leaves cold weather and New York, one's head is stuffed with plans of things to do among the Isles of June; but warm weather is very quieting to the ambitions of even the most energetic, and it seemed a big job to rig up the wires on the schooner; so we postponed this task until later.

Now along came Dan Smith, a full fledged radio bug. Radio was the very breath of his nostrils, and his conversation was so full of strange technical words that one felt instantly that here, indeed, was a man who could reach out into the ether and take from it what he willed. Newark, Washington, Pittsburgh, which had seemed to us so far away, he said would "come roaring in" if we gave them a chance, and, besides, he would do all the work.

Nassau, the metropolis of the Bahama Islands, is crowned by a hill, and on the top of it lives a very kind friend to whom we had talked much of radio, somewhat to his incredulity. Here was the ideal place to string the wires to Heaven, and the regulation that any one operating radio in these Islands must pay a fee of 5 shillings a year did not seem an insurmountable objection.

The idea that one could listen in Nassau to a concert being performed in Newark, N. J., and East Pittsburgh, Pa., seemed to our friends what they called a quaint piece of imagination. However, they put the island carpenters at work, and in a few hours the enterprising Dan Smith had the wires stretching over the roof of Government House.

In the daytime in Nassau one can do little with radio—the static is so bad—but the work was finished by evening and our friends sat about curious to see if this box of magic would do anything wonderful.

The final wires were connected—the anxious moment had arrived—and produced—not a sound. A heart-breaking pause. Perhaps the wires were on the wrong poles of the battery. They were. A violent hum developed, and in a minute a clear voice was heard talking at Miami, and then Newark and Pittsburgh. Our Nassau friends were now convinced that we were not liars, and so began our experiments in the Bahama Islands.

The natives here are soft-spoken, well ordered black people with some ambition and real charm. One quality which very much amused us in the Out Island was their implicit



THE "SEA SCAMP"

which carried the idea of listening in to the Bahamas

faith in everything you could tell 'em. We thought they might shy at a tale of what radio telephony could do, but all our stories were accepted at par. Had they not heard the words of living men and music come out of the black box wound up with the crank; had they not seen in the Sunday School building, men and women walking as shadows on the white wall? If this white stranger from the great world says he can pick out from the sky music, words, and the sound of the fiddle or the banjo, we know he can do it, and we ask him to put up the strings which connect with the sky and we will all keep quite still and listen.

All that the white man said came true, as they knew it would.

Of all our friends at Dunmore Town (on Harbour Island), none knew of the radio telephone. The mysterious machine which made dots and dashes, that but one man in the place understood, had no appliance for hearing the news and music in the ether by wireless telephone. The promise of bringing to earth opera singers from New York and Pittsburgh was much appreciated, as a child shows its pleasure for what it does not understand, but accepts as from the fairies. I am sure that all

the natives would answer to Barrie's "Do you believe in fairies?" a positive yes. Governor's Harbour, where they also have a more or less mute radio, is one of the other of the two or three places in all these islands that have even the beginnings of radio contact with the outer world. After leaving these centres of population, you find only little settlements of from 100 to as few as 10 inhabitants. At Watling Island, 300 miles south of Nassau, the first land Columbus touched, a Commissioner and a handful of natives make up the entire population—not even a school was here. But Watling Island light is important for the ships trading to Cuba and the West Indies, and here two lonely men live out a monotonous existence in a blistering sun the year round. Signing the visitors' book, we found that the last visitor had arrived involuntarily about two years before and his ship had been lost.

Another lighthouse not so far away has communication with the outer world only once every two months. One longed to give to each of these self-effacing but necessary workers the receiver off the boat and provide for them a touch with all mankind during their lonely vigils, four hours off, four hours on, never a full night's sleep.

At Bimini, the radio will soon take the place of the old Bahama "Welcome Tree."

COMING ABOARD TO HEAR THE RADIO

The *Sea Scamp* being visited by the police force of Harbour Island, the Bahamas

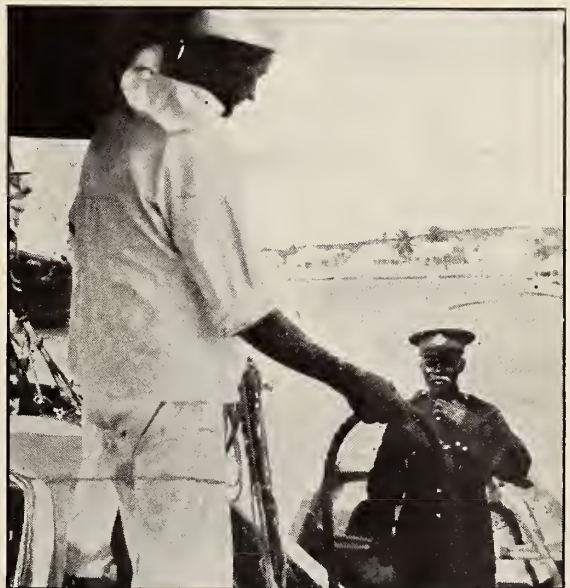

Bimini is now the famous "Booze Port." I well remember landing in the primitive days of 1917. Few yachts stopped at the Biminis, and it was a great day when a stranger came. The whole village (about twenty people) squatted under the "Welcome Tree" and the news of the world outside was revealed to the natives. Where this kindly "Welcome Tree" was, now is a huge club-house dedicated to rum in its various forms.

No more delightful experience could be found than introducing the radio telephone to these simple people. One evening we had a crowd listening to W J Z, the aerial being run from a flagstaff put up at almost a minute's notice. When we told them that W J Z meant Newark, N. J., they accepted it with entire trustfulness. If we had said that the people they heard talking and singing were in the moon, I have no doubt that that, too, would have been accepted.

One thinks of the tropical islands of the world as delightful places where the weather is always fine, food easy to come by, as it grows without attention, and occupied by a people of contented minds enjoying an easy life.

The real thing is quite different. These islands of the Atlantic, as well as the Pacific, are often stormbound for weeks and traveling in small boats, the only means available, is uncomfortable and dangerous. The number

LISTENING TO AMERICAN MUSIC

On board the *Sea Scamp* in Harbour Island, the Bahamas

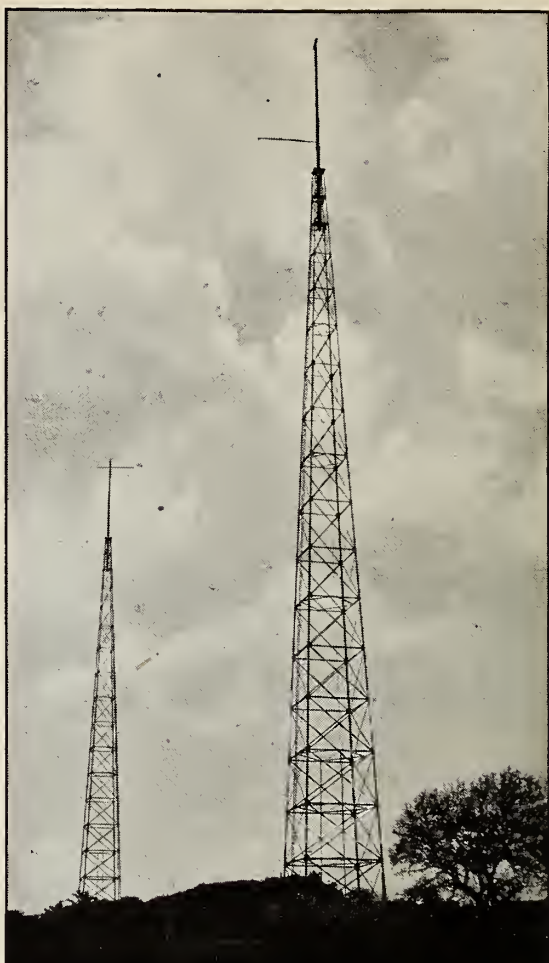

THE RADIO STATION AT NASSAU

Not equipped for radio telephone broadcasting which is practically unknown in the Bahamas

of lives lost among these island people is by no means small. Money, clothes, and food are for the most part scarce; and, almost worse than all, the pleasures of life, the occupations after the day's work is finished, are few and far between. To such people a simple and cheap radio telephone will revolutionize their life. From Nassau, where they have a good radio plant, they could broadcast to a thousand islands, giving not only amusement, but information of the utmost value, including, most important of all, storm signals which might easily save hundreds of lives.

To such a region as this—lonely, starved for a touch of the pulsing life of the great world—radio will come as more than a convenience or another form of pleasure. To the people here it will be literally a godsend.

THE ARMSTRONG PATENT

How an Undergraduate at Columbia University Discovered One of the Most Important Instrumentalities in the Radio World

MR. EDWIN H. ARMSTRONG has been confirmed by the United States District Court of Appeals as the inventor of an instrumentality which has been referred to as "one of the most important inventions, if not the most important, in the wireless art." By a striking coincidence the decision comes in the midst of the development of a great public interest in a service made possible by the invention.

Mr. Armstrong is a young man and was a student at Columbia while he was perfecting his revolutionary method. The instrumentality is the Armstrong feed-back circuit, the invention which makes possible the amplification of incoming radio waves, and lacking which neither long distance radio telephone communication nor radio telephone broadcasting would be possible.

The Court of Appeals thus upholds the de-

cision handed down a year ago by Federal Judge Julius Mayer in the long fight between young Armstrong and Dr. Lee de Forest and the De Forest Radio Telephone and Telegraph Company. The decision of the court, which is final, means that no long distance telephone communication, no nightly broadcasting programme can be carried out without using the Armstrong patent. Even the modern multiplex forms of wired telegraphy and telephony must use the methods.

The story of Armstrong's struggle for recognition has well been called one of the most romantic incidents of scientific achievement. He began his experiments with radio as a boy of fifteen. Before and during his student days at Columbia he became a close student of the fundamental action of the audion and read all the literature available on the subject.

THE ORIGINAL DRAWING OF THE FEED-BACK CIRCUIT WHICH LARGELY DETERMINED THE COURT IN ARMSTRONG'S FAVOR

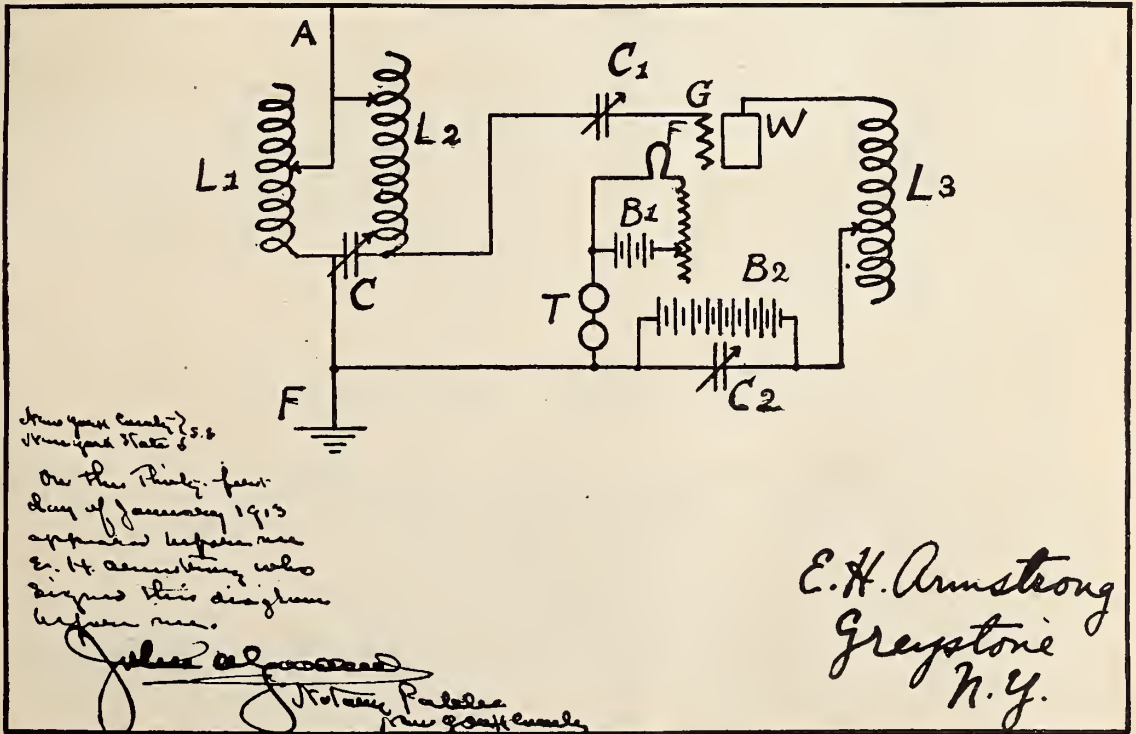

ARMSTRONG Committed suicide by leaping from 11th story of his hotel FEB 1, 1954, NEW YORK CITY.

Sometime during this period he connected a condenser across the telephone of a simple audion receiving system and noticed that on some bulbs an increase in signal strength would result.

He proceeded with his careful studies and experiments and obtained what he believed to be remarkable results. He showed the results to his father and asked for money with which to make application for a patent. His father refused, apparently not greatly impressed. Armstrong then applied to his uncle who also declined to finance him but suggested that the young man make a drawing of his principle and have it witnessed by a notary. Armstrong did so and it proved to be the most significant event of his life. The decision of the court was very materially influenced, it is apparent, by the fact that Armstrong had definite theories and beliefs about his invention and had carefully recorded them.

Armstrong failed to get the support of his family, but he did gain the attention of Professor Michael I. Pupin who took him into the Marcellus Hartley laboratories at Columbia University and enabled him to continue his researches. Litigation began in 1916 and continued until this country entered the war when a truce was signed. Armstrong was commissioned a major in the Signal Corps and was sitting in Hindenburg's former headquarters at Spa, Belgium, after the Armistice when a cablegram from his lawyer announced that Doctor de Forest was again pressing for action. The end has now been reached.

In the meanwhile Armstrong had issued licenses for the use of his patent in manufacturing receiving sets to seventeen different concerns, and then sold the patent itself to the



E. H. ARMSTRONG

The discoverer of the "feed-back" circuit, in the uniform of a major in the Signal Corps during the war

Westinghouse Company. Under the licensing agreement which the Westinghouse Company has with the other manufacturers which sell through the Radio Corporation, the Armstrong circuit will continue to be used by them. The decision will not affect these manufacturers nor the public. It will give credit and profit where both are due.

ADVENTURES IN RADIO

Perhaps no other branch of science enjoys the romance and the spirit of adventure ever present in Radio. It matters not whether it is the radio telegraph or the radio telephone, one has as many advantages as the other in this respect. Of course, radio telegraphy is the older of the two, and its exploits are more numerous; up to now, it covers a wider field of endeavor on both land and sea.

Aside from the everyday uses of radio, there are a great many instances in the history of the art which stand out as milestones in the march of progress; instances which few devotees of radio broadcasting know about. Many of these adventures were unique—not always possible or practicable to duplicate; on the other hand some were accidents, others mere incidents, still others great adventures; adventures never to be forgotten and which stand out as red letter days for the individuals concerned.

By adventures of radio we mean that which deviates radically from the commonplace. Radio has

Radio panels

HAVE your panels made to your own specifications. Celoron Radio Panel Service assures you the highest type, best serving, best looking radio panels made, machined and engraved to your own individual specifications.

Condensite Celoron Grade 10—the highest type of radio insulation that we produce—has a wide variety of uses in the radio field. It is extremely high in surface and volume resistivity, high in dielectric strength and low in dielectric losses. Particularly suited for panels because it machines easily, engraves beautifully and is extremely handsome in appearance. This is the grade we recommend. *It has been approved by the Navy Department Bureau of Engineering.

Where economy is a factor we can supply panels made of Vulcanized Fibre Veneer. This material is made of a center section of hard, grey vulcanized fibre veneered on both sides with a waterproof, phenolic condensation product. It has a fine, smooth, jet black surface, machines readily, engraves nicely and is applicable for use in the construction of radio equipment where very high voltages at radio frequencies are not involved.

Celoron Shielded Plates (patent applied for) are made with a concealed wire mesh imbedded directly under the back surface of the plate. This wire shield, when properly grounded, very effectively neutralizes all "howl" and detuning effects caused by body capacities. Made in both grade 10 and Vulcanized Fibre Veneer.

Send to-day for our Radio Panel Guide

Are you an enthusiast? Write to-day for our Radio Panel Guide that describes these panels in detail—quotes prices—and tells you just what the panel you want will cost.

Are you a Radio Dealer? Get in touch with us. Learn how easily Celoron Radio Panel Service enables you to sell panels completely machined and finished to your customer's specifications. No waste, no bother. Write for our special Dealer Proposition to-day.

DIAMOND STATE FIBRE COMPANY

Bridgeport (near Philadelphia) Penna.

Branch Factory and Warehouse, Chicago

Offices in principal cities

In Canada: Diamond State Fibre Co. of Canada, Ltd., Toronto

been responsible for many innovations—many new uses, some of which passed out of human ken, others were repeated again and again until to-day we have ceased to wonder and be thrilled when we chance to read newspaper accounts of such doings. Thus, we have the Radio Reporter, the first authentic, instances being that of reporter Sprague of the Los Angeles Examiner who, pressed for time and an urgent desire to "scoop" the other sheets, commandeered the radio telephone set of a local army officer in order to report an unusual sporting event. Then there is the Radio Detective who came into his own during the war and of whom more will be said in a future number. The Radio Doctor has again and again proved his worth at sea and many a sailor owes his life to a medical consultation held by radio from ship to ship or from ship to land. The initial success of the Radio Actor, or Actors, who have broadcasted an entire play over the radio telephone still rings in our ears. Then we have radio as the leading factor in the lives of the gunrunner, the smuggler, the arch criminal, the Central American revolutionist, the international spy, the cast-away sailor, and so we might go on indefinitely, for the exploits of radio are legion; some of which stand out as monuments of scientific achievements; others are ignominious ones to which this noble art has been unwittingly subjected. All of these nevertheless are intensely interesting, breathing of the very spirit of adventure and romance.

To this end, it will be the purpose of this department to report each month, radio adventures that actually took place, with real human beings as principals. The series will range over the entire world with incidents taking place in Sweden, Patagonia, and far-off Japan, as well as in the United States.

The editors would be glad to receive accounts of such radio adventures from readers of the magazine, either their own experiences in the first person or authentic experiences of others.

FOUND BY RADIO

By PIERRE BOUCHERON

ONE of the most romantic stories of the power of radio is the story of the finding of Cleo Archer. In January, 1920, Lester Archer was a young radio amateur living in Toledo, Ohio. This was before the day of widespread radio telephone broadcasting. With his radio set using the Continental Morse Code this young man accomplished in a short time what his mother, lawyer, and private detective agencies had been trying to do for thirteen years. At the age of five, Cleo Archer, Lester's sister, had been secretly placed in the Allen County Children's Home of Ohio by unfriendly relatives. To find Cleo became the life aim of young Archer and his mother, Mrs. Dorothy Archer, and to this end, they visited other cities and towns in a vain search, meanwhile conducting a legal battle to compel the home authorities to divulge Cleo's whereabouts.

In 1910, this young man, then but a boy in knee pants, became interested in amateur radio, and in a short time he had done what many thousand boys have since duplicated; erected a complete sending and receiving station enabling him to converse at ease with local enthusiasts.

For the next few years he spent a great deal of his spare time experimenting and improving his installation so that he was able in 1920 to send as far as 1,000 miles with his home-made transmitter, as well as to receive from the long distance high power stations at Nauen, Germany; Stavanger, Norway, and Lyons, France.

In talking, or rather telegraphing, through the ether, Archer's radio acquaintances reached considerable proportions, until they included many amateurs from neighboring states. The greater portion, of course, he had never seen, but they nevertheless all belonged to the great fraternity of the ether. One of these radio friends was Mrs. Charles Candler, of St. Marys, Ohio, who, with her husband, operates the powerful amateur station "8ZL" now well known throughout the United States for its long distance records.

One evening of January, 1920, young Archer was "talking" with Mrs. Candler in the comradery which radio boasts as its very own, when he conceived the idea of asking for her coöperation in broadcasting the "call" for his sister, Cleo. With the aid of the multitude of amateurs within the reach of "8ZL," Mrs.

Radio brings it
MAGNAVOX tells it



Without Magnavox Radio no wireless receiving set is complete.



Wireless Telephony

YESTERDAY a scientific marvel, today the most thrilling interest and enjoyment within reach of the average American home.

In the air, day and night, superb concert and dance music, important addresses, hilarious vaudeville, world weather reports; also correct time signals being broadcasted by radio transmitting stations in every part of the country.

Here is a new world of information, education and inspiration; an "Aladdin's" dream realized in actual fact when you install in your home any one of the many simple receiving sets with a *Magnavox Radio*.

The Magnavox Radio makes it possible for you to hear all that is in the air as if it were being played by your phonograph.

Any radio dealer will demonstrate for you, or write to us for descriptive booklet and name of nearest dealer.

THE MAGNAVOX COMPANY, Oakland, California
New York Office: 370 Seventh Avenue, Penn. Terminal Bldg.

Candler thereupon offered to transmit a general message bearing the girl's description and asking for information regarding her whereabouts. The first radiogram of this nature was sent late in January and was, of course, picked up and relayed by hundreds of other amateurs throughout the country who were only too willing to help in the search. Archer, meanwhile, sat night after night at his receiving set listening for a possible encouraging reply. Weeks passed and it began to look like a hopeless task when one evening, the faint call "8KV" (Archer's registered call signal) came from another amateur located at Van Wert, Ohio. Following this call, came some words hardly discernible, so faint were they, and in which young Archer was able to distinguish the words "your sister." Late at night of the same day, when most amateurs had closed for the night and local interference had subsided, Archer was again able to establish communication with the Van Wert station and was informed that a young girl answering the radioed description of

his sister was living at the home of a near-by farmer at Rockford, Mercer County, Ohio. Moreover, this amateur flashed back that he had been trying to reach Archer for the past two weeks but without success, owing to the limited range of his sending equipment.

Needless to add, it did not take long for Archer and his mother to investigate the radioed report. Much to their surprise and joy, the report proved correct and the girl was recognized instantly as the long lost one.

The story of Archer and his unique use of the ether is indeed an achievement to amateur radio of this country. To-day, with our great and far reaching radio telephone broadcasting stations throughout the country, we have at our disposal, probably, the most effective and inexpensive means of locating absent ones yet devised, and as the fame and worth of radio spreads far and wide it is quite reasonable to expect police officials to resort to its use for a multitude of purposes, whether for seeking the whereabouts of lost ones or for hunting criminals.

In the next number of the magazine this department will tell some adventures of radio in the police departments of our large cities, describing some actual instances which have occurred up to date and probable ones of the future.

THE GRID

Questions and Answers

The Grid is a Question and Answer Department maintained especially for the radio amateurs. Full answers will be given wherever possible. In answering questions those of a like nature will be grouped together and answered by one article. Every effort will be made to keep the answers simple and direct, yet fully self-explanatory. Questions should be addressed to Editor, "The Grid," Radio Broadcast, Garden City, N. Y. The letter containing the questions should have the full name and address of the writer and also his station call letter, if he has one. The questions and answers appearing in this issue are chosen from among many asked the editor in other capacities.

What is a loop antenna?

Will a coil antenna work if it is inside a house?

How does a radio compass work?

How many turns should be in a loop antenna to receive from a broadcasting station on 360 meters?

Loop or Coil Antenna

THE names loop antenna and coil antenna are used to designate the same kind of an antenna. This antenna is mainly used in the reception of radio waves. It consists of a boxlike frame upon which is wound turns of wire. The frames may be of

different sizes, but the usual sizes are 4, 6, or 8 feet square. They should be made so that they can be rotated around an axis, such as X-X¹ in figures 1, 2 and 3. (See page 78). Figures 1 and 2 show two different ways of winding the wire on the frame. In Figure 1 the wire has been wound on the outside of the frame. In Figure 2, the wire has been wound on the frame. Thus the wire lies in the same vertical plane. The distance between the turns of wire is called the spacing. This is represented at *a* in Figure 1. Figure 3 shows a good method of constructing the frame work for a loop antenna. The diagonal pieces *aa*¹ and *bb*¹ should be made wide enough at the ends to permit the proper spacing

TO GET the most pleasure out of wireless you will want a loud speaker. Then you can entertain a group of friends—hear the wireless telephone programs clearly all over the room—actually dance to wireless music—just like phonograph.

All loud speakers require vacuum tube amplification. The heart of the amplifier is the transformer.

ACME Transformers

have been brought to a high degree of efficiency through years of specialization on this one product. They amplify wireless telephone without detracting from the original tone value.

Acme transformers are for sale separately and also incorporated in complete Acme Instruments.

The ACMEFONE illustrated below, is a complete long range installation. It includes in one handsome cabinet, the tuner for selecting the particular station you want to hear, the equipment for three vacuum tubes to amplify (or magnify) the sounds, and a loud speaker which sends the voice and music clearly all over the room. The price is only \$80.00. The only additional equipment you will need is an aerial, three vacuum tubes, two "B" batteries and a storage battery. The work of installation has been reduced to the minimum. Just put up a simple aerial, insert tubes, hook on batteries and you are ready to listen.

Other Acme Apparatus includes vacuum tube detector and amplifier equipment, designed to hook on to your present receiving equipment and prepare the way for a loud speaker. Acme apparatus is backed by the reputation of the oldest manufacturer of transmitting apparatus in the country and is for sale at all radio dealers.

ACME APPARATUS CO.

*Transformer and Radio
Engineers and Manufacturers*

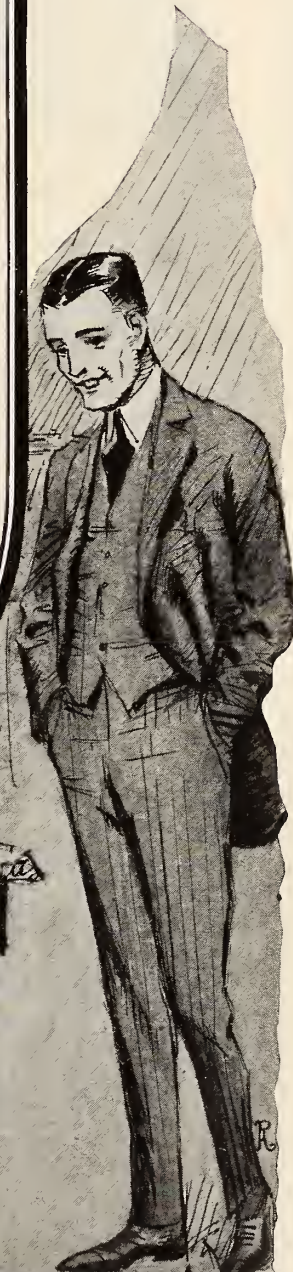
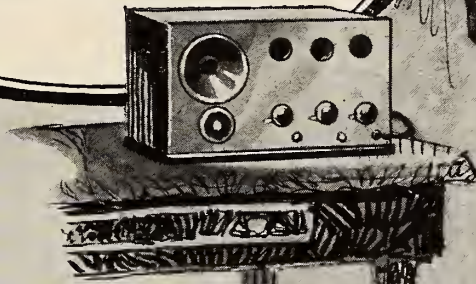

Acme
Radio Apparatus

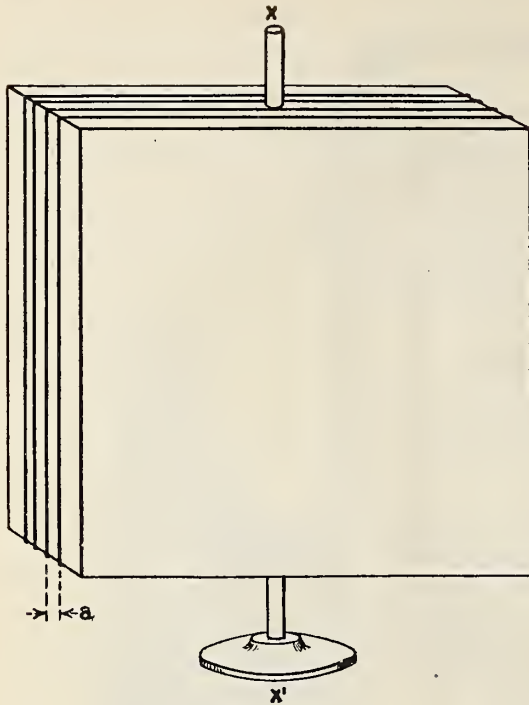

FIG. 1

of the wire. The figures are not drawn to scale so that they cannot be used as working drawings. Figure 2 for instance shows turns of wire near the centre of the frame. In reality

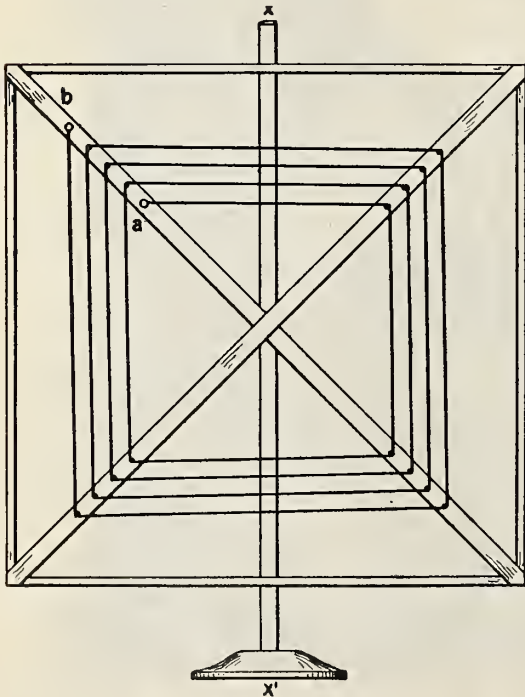

FIG. 2

the turns of wire are placed toward the outer edge of the frame. In general it will be found that a coil antenna such as shown in Figure 1 is the most satisfactory kind to use. In constructing the antenna, as little metal, as possible, should be used.

The antenna may be hooked up to the receiving set in a number of different ways. If it is desired to use a "tuner," the ends of the wire may be connected directly to the terminals to which the ground and the antenna lead-in wire would be connected if an ordinary type of antenna were used. This hook-up is shown in Figure 4. PC and PI represent the primary

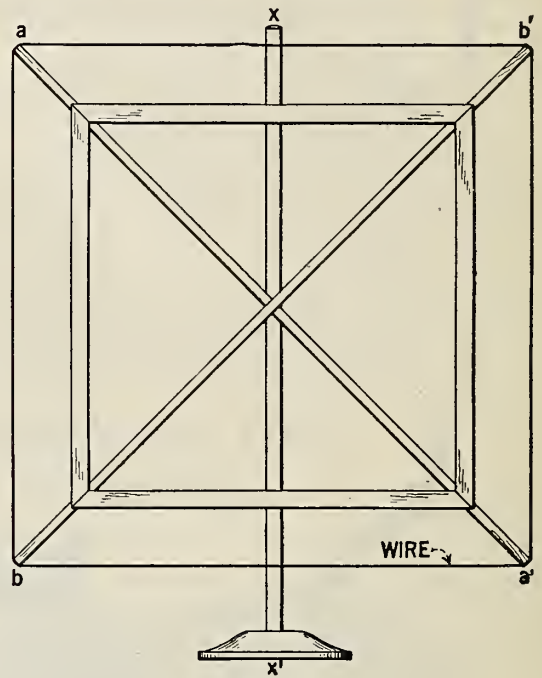

FIG. 3

condenser and inductance of the tuner, and SC and SI represent the secondary condenser and inductance. L represents the coil antenna. It is to be noted that no ground connection is necessary.

Although a tuner may be used, none is necessary, for the selectivity is sufficiently sharp to cut out all ordinary interference. The method of connection in this case is shown in Figure 5. There is a variable condenser shunted across the loop and leads from each side of this condenser go to the detector. No inductance is needed, as this is furnished by the loop. Again no ground connection is made. This method of connection allows much fainter signals to be

Announcing **WESTRAD** "WESTRAD"



Frost Fones

No. 162—2000 ohm..\$5.00
 No. 163—3000 ohm.. 6.00
 Undoubtedly the best phone on the market for the amateur's use. Approved by our Engineers.

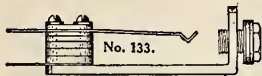

No. 133. Jack only.....\$0.65

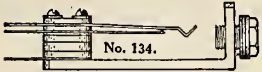

No. 134. Jack only.....\$0.75

Manufacturers and Jobbers of Quality Radio Apparatus Exclusively.

Our specialty is supplying the Radio needs of Amateurs.

TO AMATEURS

If your dealer does not have equipment shown on this page write us. You will find that every item represents the best of its kind.

TO JOBBERS AND DEALERS

The Amateur will ask for the equipment approved by Radio Engineers. We carry, manufacture and show in our ads nothing but Radio Apparatus which has been thoroughly tested and approved.

WATCH FOR NEW ITEMS!



PHONE PLUG No. 137

Takes the cord tips. Sliding sleeve permits tightening the set screws to hold the cords permanently.

Price\$1.25

FROST JACKS

Supplied with washers to fit any panel. Spring terminals spread to permit easy soldering. Pure silver contacts, nickel-silver springs. Interchangeable with other makes. Packed in individual containers. Prices listed under each style.



No. 131. Jack only.....\$0.90

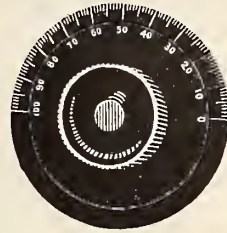

"WESTRAD" DIALS

Bakelite

3 inch.....\$1.00
 3/16" or 1/4" shaft.



Electrose Insulators

Midget No. 1061.....\$0.30
 Ball Type......45
 Strain Type No. 10..... .45

Aerial Wire

7 Strand No. 22 100 ft.
 Copper.....\$0.98
 Phosphor Bronze..... 2.45



No. 135. Jack only.....\$1.00

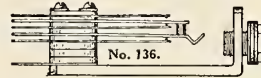

No. 136. Jack only.....\$1.25



\$5.75

"B" Storage Battery

This is a liquid storage battery made of only new materials; grids of the plates are moulded individually and are designed for radio work only (not old automobile battery plates cut up). The plates are pasted, given a forming charge; discharged and recharged in accordance with the best practice. They come to you charged. Rubber and wood separators used. Voltage variable on positive end; 18-20-22-24 volts. Price each...\$5.75

Frost Radio Plug No. 132

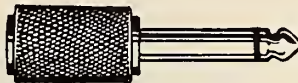

Specially designed for panel work. Standardized construction makes plugs interchangeable with other standard makes. Packed in individual containers.

Price, each.....\$1.00

Radio Hand Microphone No. 155

This hand microphone is designed especially for radio work. It is not suitable for wire telephone work.

Price, each **\$6.00**



WESTERN RADIO MFG. CO., INC.

154A Whiting St.

H. E. WILLMORE
 Vice-President and Gen. Mgr.

CHICAGO, ILL.

picked up than the first method. This is because the energy lost in the tuner in the first method is saved by the second method. One advantage of the first method, however, lies in the fact that, with the same capacity, a greater range of wave lengths can be received than by the second method.

The following data concerning coil antenna is given as a guide for making one. This data does not follow, in some respects, the formulæ that have been developed by radio engineers for the design of these antennæ. However,

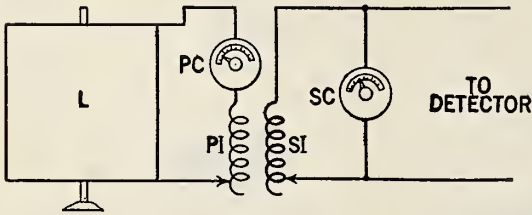

FIG. 4

coil antennæ made according to these descriptions have given good results.

To receive 360 meters. Coil made as in Figure 1. Frame four feet square. Ten turns of wire. Spacing 3 inches. Tuner to be shunted across the coil as shown in Figure 4.

To receive 600 meters. Coil made as in Figure 1. Frame four feet square. Ten turns of wire. Spacing one-fifth of an inch. Condenser only to be shunted across coil as in Figure 5.

To receive 3,000 meters. Coil made as in Figure 1. Frame six feet square. Fifty turns of wire. Spacing seven-sixteenths of an inch. Condenser to be shunted across the coil as in Figure 5.

These examples ought to enable one to make a coil antenna with some assurance of success. The following simple rules apply:

A longer wave length requires more turns if the size of loop and spacing is unchanged. Conversely shorter wave lengths require fewer turns.

For the same wave length and spacing, increasing the size of the loop diminishes the number of turns required. The converse of this is true.

For the same wave length and dimension of coil, decreasing the spacing decreases the number of turns required. This factor makes a very considerable difference in the number of turns. The converse of this is true.

Ordinary No. 18 bell wire is a satisfactory wire to use.

RADIO COMPASS

A RADIO wave consists of electromagnetic and electrostatic lines of force. These sweep the coil antenna and affect it. Considering only the electrostatic lines of force, it is seen that their effect upon the coil is as follows: (The effect of the electromagnetic lines of force is the same, as can be shown by a different process of reasoning). At any given instant the electrostatic lines of force have *different* intensities at *different* distances from the source of the waves. Also at any given instant the electrostatic lines of force have the same intensity at the *same* distance from the source of the waves. Electrostatic lines of force set up potentials in an object which they sweep. If in the same conductor one part is at one potential and another part at a different potential, a current will flow. Suppose the coil antenna is directed toward the sending station. One end of it is nearer that station than the other end. Hence the two ends are at different distances from the sending station, at any instant the two ends are swept by electrostatic lines of force of different intensity, which consequently sets up a different potential in the two ends of the coil. This difference of potential will cause a current to flow, thus enabling the signal to be heard. On the other

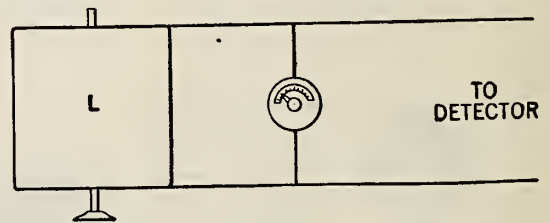

FIG. 5

hand if the coil is broad side to the sending station, the two ends are equidistant from it; they will be swept by electrostatic lines of force of the same intensity; there will be no difference of potential established; no current will flow and no signal will be heard.

Thus it is seen that when the coil is directed toward the sending station, full strength signals will be heard and when it is at right angles (broadside) to the sending station no signals will be heard. At intermediate positions the strength of the signals will vary from zero to



Listen to the world!

Anybody can set up and operate a
CROSLEY radio receiving station

No technical knowledge or wireless
experience necessary

COMPLETE RECEIVING STATION

HARKO Senior Audion Receiver

Combined tuner and audion detector. Picks up Pittsburg New-ark, N. J., Detroit, Chicago and ships at sea and other phones in Cincinnati, Ohio. Carefully tested. Results guaranteed. Without head phones, batteries and tubes **\$20.00**

CROSLEY 2 Step Amplifier

Matches Harko Senior in size and appearance. Amplifies 100 times. Will bring in voice and music with volume enough to fill the room. Complete except for tubes **\$25.00**

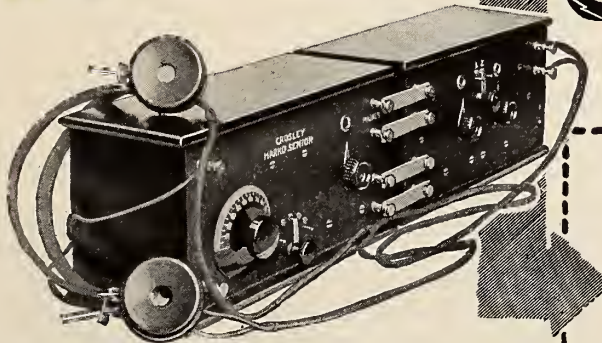

See this complete outfit at any dealers or send us this coupon for catalogue and we'll see that your dealer has one in a few days.

The technical side of "listening in" on radio messages, conversations, music, etc. has been so perfected and simplified by the Crosley Mfg. Co., that anybody can install a receiving set in his own room at little expense and labor. Non-regenerative feature eliminates carrier wave noise and simplifies tuning.

Broadcasting stations in all large cities are sending out concerts, lectures and news nightly. Prominent men talk every night to thousands by wireless. Artists are playing and singing to great invisible audiences. Are you enjoying this new entertainment?

No knowledge of electricity or previous wireless experience is necessary with the simplified Crosley outfits,—yet their efficiency is guaranteed and thousands of owners are getting wonderful results.

CROSLEY

MANUFACTURING CO.
RADIO DEPT
· CINCINNATI · O ·

CROSLEY MFG. CO., Radio Dept.

Gentlemen: RB-1
Send me your Radio apparatus catalogue and full details of outfit featured here.

Name _____

Address _____

The dealer I should like to see handle your products

is _____

full strength. It is the facts just stated that make a coil antenna a radio compass.

The method of using a coil antenna to determine direction is best described by an example. A coil antenna is set up free to rotate. It carries a pointer which passes over a circle graduated in degrees; the zero point of the circle being to the north. A signal is picked up after proper tuning. The coil is rotated until the signal is just about to become too faint to hear. The position of the pointer is then read. Say this is 164 degrees. The coil is again rotated in the same direction until the signal reappears with the same intensity at which the first reading is taken. Another reading is taken. Say this is 196 degrees. The average of these two readings $\frac{164 + 196}{2}$

gives you the position at which the coil is broadside to the station. In this case it is 180 degrees. This is the north and south line as 0 is at the north. The transmitting station then is at right angles to this direction. The transmitting station of the example lies in an east and west line. Whether it is east or west of the coil can not be told by any simple radio method, but this general direction is usually known.

For greater accuracy, four readings should be made and their average taken. The third and fourth readings are approximately 180 degrees from the first and second reading and are obtained by continuing to turn the coil around.

However, unless the coil has been specially designed for a radio compass, it is not worth while taking these extra readings as the first two will give as great an accuracy as the coil will allow. The cause of inaccuracy of an ordinary designed coil will not be discussed in this article.

A coil may be mounted inside a room and will receive signals as well as if mounted outside unless the room has a great deal of metal in it. However, if a coil is used as a compass inside a room, there is likely to be an error due to that fact. Thus a radiator in the room will pick up the radio waves and re-radiate them, thus becoming a secondary source of waves. This will affect the loop, causing it to show a direction wrong by as much as 10 degrees in some cases.

It has been found that coil antenna diminish the interference due to static. This is a great advantage in their use. In general, the smaller the loop, the more the static is diminished. Another advantage lies in the fact that, because of their directional characteristics they eliminate many interfering stations. Other advantages lie in their compactness and ease of construction. In conclusion, it is desired to point out that for any given condition, such as wave length and kind of apparatus to be used with it, there is a certain sized, spaced, etc., loop that will give better results than any other loop. With this article for a guide a few trials ought to produce this one best loop for you.

MERCHANDISING RADIO

A Discussion of Some Interesting Points
for the Retail Store to Stimulate Sales

By A. HENRY

TO-DAY we find radio apparatus upon the counters of the hardware store and even the corner drug store, but we wonder whether or not this condition will continue after the present rush for radio apparatus has subsided and the steady, normal demand for equipment again prevails. Many authorities on radio merchandising agree that the present demand will, in all likelihood, be supplied within the next few months, and that preparations for supplying

an even greater volume of business next year are to be arranged during this summer.

There are two distinct classes of radio dealers, but only one is to be a permanent feature in this merchandising field. First is the dealer who knows nothing whatever about radio other than that it is a very popular pastime and it offers him an opportunity to make a rapid turnover. The other and more stable radio dealer is the man who understands the radio business thoroughly and is not satisfied to limit his

AMRAD
RADIO RECEIVING SETS
may be hard to get but
purchasers, who have
them installed and reg-
ularly "listen in" to the
big broadcasting
stations, say the
equipment is well
worth waiting for.

AMERICAN RADIO AND RESEARCH CORPORATION

Medford Hillside, 57, Mass.

New York

Chicago

Place your order
with the nearest
Amrad Dealer.

Directory mailed
on request.

efforts to the mere making of sales to-day with no thought of the days to follow.

In order to make certain of a permanent standing in the radio business, it is necessary for the dealer to be able to discuss amateur radio conditions with his customers. He must understand their likes and dislikes and cater to them. There are many ways in which this may be accomplished, not the least of which is joining a local radio club.

have a striking picture of just where and how each unit is employed in the circuit.

LISTS OF PARTS

IN ADDITION to the display of a component part assembly, the dealer will find it advantageous to prepare a list of the elements included in the circuit. This list should also include such items as may be interchangeable and are carried in stock by him. For instance,



THE MODERN WAY OF SELLING RADIO APPARATUS
A club-room fitted with radio equipment in the rear of a dealer's store

A dealer should not only join a radio club, but he should be an active member. At the club meetings it is possible for him to be of great assistance by loaning apparatus for use in illustrating timely lectures. There is probably no better form of publicity than an illustrated lecture demonstrating the use of equipment which may be secured at the local dealer's.

SELLING UNITS

THE dealer may stimulate his sales very materially by having complete transmitting and receiving sets made from stock parts, completely wired on a single board conspicuously displayed on his counter or in the show-case. An arrangement of this character is shown in one of the accompanying illustrations, and it has been very effectively employed by one of the largest radio retail stores in the country. It is made up of stock parts and wired so that the experimenter coming into the store may

under the heading of condensers or inductances, the dealer may handle several, designed to accomplish the same purpose; where this is so his list should include all of them.

In building sets of this character, the dealer should provide two or three standard transmitting and receiving circuits, increasing this number when some new and particularly advantageous arrangement or instrument has been developed.

A CLUB ROOM FOR CUSTOMERS

WHERE space permits, the establishment of a club room for the use of customers is a highly desirable feature in a retail store. This is especially true in the business sections of large cities because it permits prominent radio amateur and professional men to get together for a short time during their lunch hour. One dealer has increased his business more than 500 per cent. in five months after the establish-



The CAPITAL Serves Indiana, Ohio and Kentucky



Interior of Salesroom

THE Capital Radio Supply Company, located at Indianapolis, was organized by prominent business men for the purpose of supplying this territory with the finest, most dependable and efficient radio equipment made.

Among the prominent manufacturers who are represented by this company are Grebe, Kennedy, Remler, King Ampli-tone, Hipco Batteries, Western Electric, Signal and Tuska.

Because of the financial strength, the experience and efficiency of the organization and the geographical location, the Capital Radio Supply Company is logically the distributor to *successfully* handle this rich territory.

CAPITAL RADIO SUPPLY COMPANY, Inc
Indianapolis, U. S. A.

ment of such a club room. The first room of this character was undoubtedly employed by a radio company in New Orleans several years ago, and its growing popularity proves that stimulation of sales has always resulted from its adoption.

Suitable transmitting and receiving apparatus should be permanently set up in the club room, a table and a number of chairs should be provided, as well as a fairly large blackboard. Patrons should be permitted to borrow equipment from stock for the purpose of making special tests or demonstrations. Wherever possible, sales folk should take an active interest in fostering this club room, helping to make prominent amateurs known to each other and settling some of the technical discussions which are bound to arise.

APPARATUS IN OPERATION

REGARDLESS of whether or not a club room is provided, the live radio dealer should not overlook the opportunity of installing a complete receiving outfit with a "loud speaker" in his store. There are so many broadcasting stations located throughout the country that but very few dealers will find it impossible to have such a receiving outfit provide the best kind of publicity for them. A "loud speaker" in operation is always an attraction, not only to radio folk but to the passerby. The receiving equipment should be accompanied by a number of descriptive placards suitably located, telling briefly the how's and why's of radio broadcasting.

In addition to this form of receiver it is sometimes found advisable to employ several complete demonstration outfits varying in price from the cheapest to the best, which may be connected or disconnected at will.

In this connection the dealer should be extremely careful to provide demonstration outfits only when they are found to operate satisfactorily, because a poor demonstration is a boomerang.

KEEPING PACE WITH THE FANS

A MODERN transmitting station should be installed in the dealer's home as well as his store, and he should avail himself of every opportunity to carry on communication with his customers. We have pre-supposed that the dealer understands radio. This is certainly the most satisfactory basis for the carrying on of a radio store, but where the dealer himself

is not intimately familiar with radio he should at least have in his employ men who are.

The value of keeping in touch with the radio fans in a dealer's territory is very completely demonstrated by the fact that a certain Southern dealer controls practically all the radio business in his city because he and every clerk in his store are expert radio men whose interest in the business does not cease with the closing of the store. They are actively engaged in amateur work and are known, if not personally, at least by radio acquaintance to a very great number of radio enthusiasts. This intimacy has resulted in amassing a business which was formerly controlled by a competitor who had little knowledge of radio, other than that there was a demand for the apparatus and it was possible for him to obtain a profit from its sale.

Radio has expanded so rapidly that there is now plenty of room for a vast number of retail dealers. However, when the stable business which is surely coming has arrived, the only dealers who will survive are those who have rendered service and satisfaction to their customers. To-day this is not so, for the demand is so great that consumers are almost forced to buy wherever equipment may be procured, but to-morrow is another day even though it does not dawn for several months.

AT THE PRESENT TIME

IN THE present emergency even the more forehanded dealers are out of stock of various parts. It is extremely short sighted, therefore, for the dealer to take advantage of a competitor because he happens to be in a position to do so by good luck rather than good management. By this is meant that reflections upon a competitive dealer on lack of stock should not be passed along to customers. Unfortunately, circumstances of this nature have arisen, and some dealers have not been able to overcome the temptation to cast a reflection upon their competitors. And while this was going on these very competitors had other equally important items of stock which the gossiping store had not. In the long run remarks to customers regarding other people's lack of stock strike home very severely when the customer realizes the general condition in the business at present, which most customers do.

There is not too much of the golden rule in business, but it is doubtful if a better rule can be devised for the guidance of any radio dealer who intends to go into the business to stay.

JUNE, 1922

PRICE 25 CENTS



RADIO BROADCAST

RADIO FOR EVERY PLACE AND PURPOSE

Keeping the Stars and
Stripes in the Ether

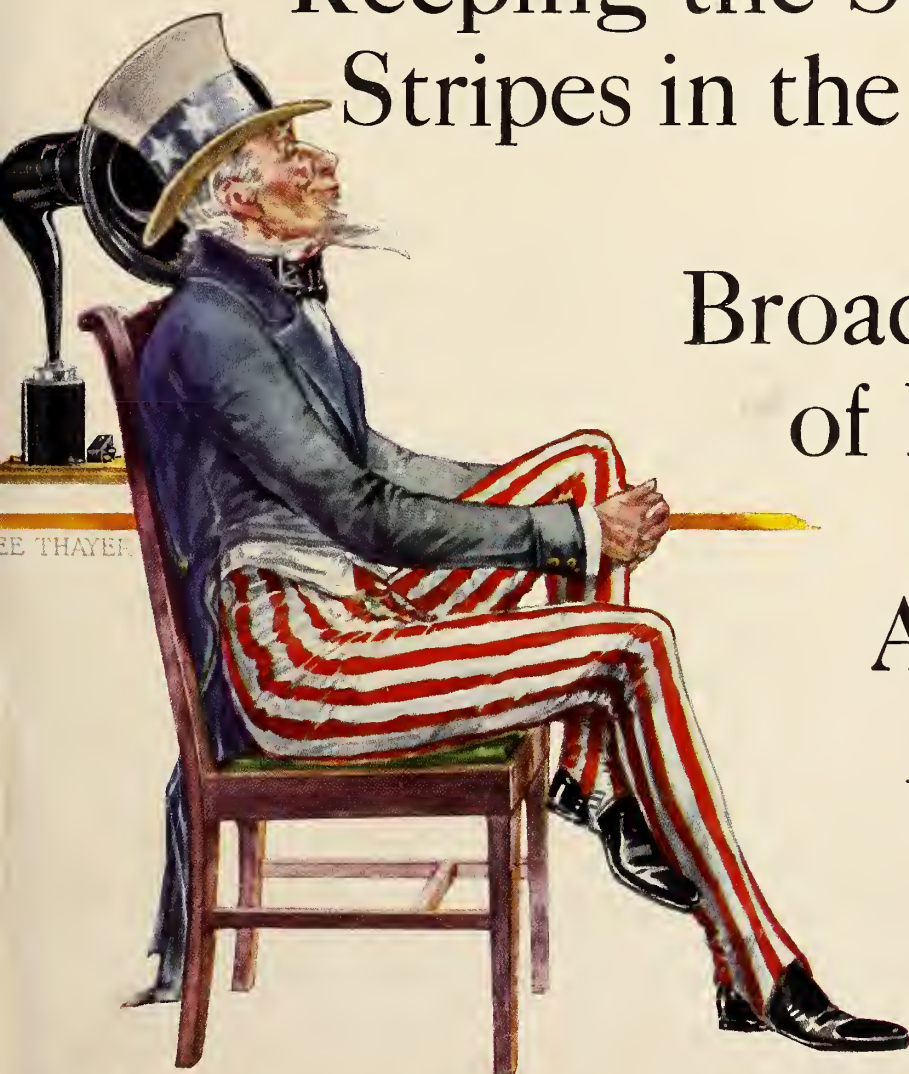

Broadcasting
of News



Amateur
Aerials

DOUBLEDAY, PAGE & COMPANY, Garden City, N. Y.

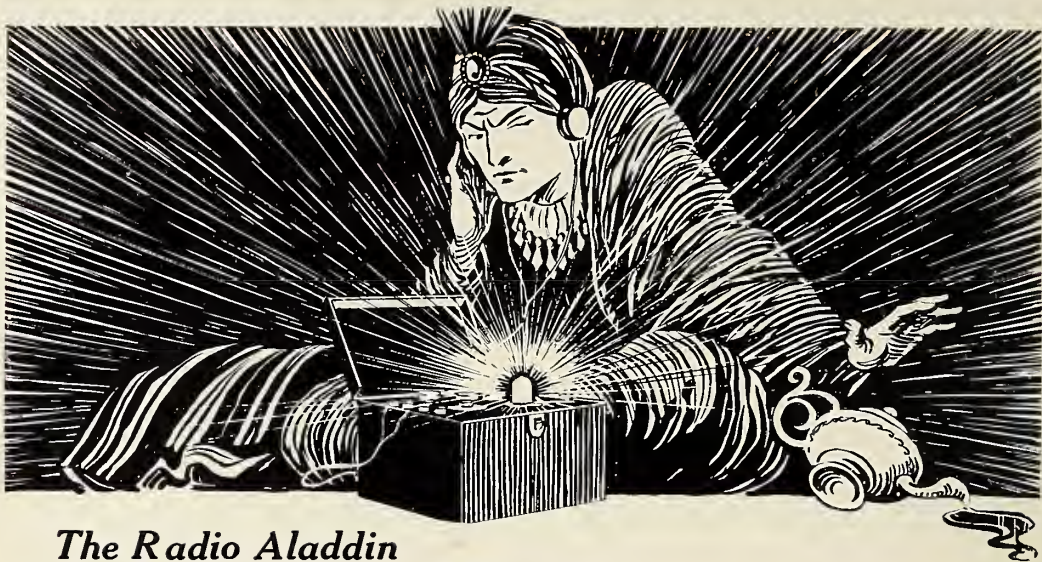

***The Radio Aladdin
Opens a New World of Magical
Fascinating Entertainment***

Our organization offers efficient service and quick deliveries, both at wholesale and retail, of The Radio products of the leading manufacturers, including

**Westinghouse
Radio Corporation
General Electric
Western Electric
Magnavox**

Send for descriptive pamphlets, advance weekly radio programs and full information concerning radio equipment of every description. Call at our nearest branch for a demonstration of receiving sets.

Telephone your order. Our automobile service enables us to guarantee immediate delivery to your home C. O. D. Phone to nearest branch store now!



Executive Offices, 565 Fifth Avenue, New York, N. Y.
Straus Building, Suite 710 Telephone: Murray Hill 654

BRANCHES

Detroit, Mich.
2311 Woodward Ave.
Main 7809

Norwalk, Conn.
17 High Street
Norwalk 675 Ring 4

Newark, N. J.
587 Broad Street
Market 3265

Brooklyn, N. Y.
102 Flatbush Ave.
Sterling 6349

White Plains, N. Y.
2-4 Mamaroneck Ave.
White Plains 2211

National Radio Distributors

DEALERS

May learn of our proposition by writing to the National Sales Department.

Radio Broadcast

ROY MASON, EDITOR



CONTENTS FOR JUNE, 1922

<i>Dr. Lee De Forest</i> - - - - -	<i>Frontispiece</i>
THE MARCH OF RADIO - - - - -	95
OBJECTS THAT DISTORT RADIO WAVES - - - - - L. E. WHITTEMORE	101
TUNING THE RADIO AERIAL SYSTEM - - - - - JOHN V. L. HOGAN	107
WHAT RECEIVING SET SHALL I BUY? - - - - - J. CONRAD FLEMMING	110
BROADCASTING ON POWER LINES - - - - -	115
WIRE BROADCASTING - - - - - JOHN F. DUNCAN	116
CARE AND OPERATION OF A CRYSTAL RECEIVING SET EDGAR H. FELIX	120
KEEPING THE STARS AND STRIPES IN THE ETHER COMMANDER STANFORD C. HOOPER, U. S. N.	125
RADIO PERSONALITIES - - - - -	132
R. A. HEISING - - - - - EDGAR H. FELIX	
PROMINENT RADIO EDITORS - - - - -	135
WHAT THE DETROIT "NEWS" HAS DONE IN BROADCASTING R. J. McLAUHLIN	136
THE AMATEUR RADIO LABORATORY - - - - - ZEH BOUCK	142
MISTAKES TO AVOID IN ERECTING ANTENNAS - - - - G. Y. ALLEN	145
HOW TO BEGIN TO ENJOY RADIO - - - CAPTAIN LEON H. RICHMOND, U. S. A.	151
THE PACIFIC COAST IS "ON THE AIR" - - - - - WILBUR HALL	157
ADVENTURES IN RADIO - - - - - PIERRE BOUCHERON	162
Married by Radio	
Sunk by Radio	
MAKING RADIO SALES PAY - - - - - ARTHUR H. LYNCH	166
THE GRID—QUESTIONS AND ANSWERS - - - - -	178
NEW EQUIPMENT - - - - -	180

Copyright, 1922, by Doubleday, Page & Co. All rights reserved
TERMS: \$3.00 a year; single copies 25 cents

F. N. DOUBLEDAY, Pres.
RUSSELL DOUBLEDAY, Sec'y.

ARTHUR W. PAGE, Vice-Pres.
S. A. EVERITT, Treas.

NELSON DOUBLEDAY, Vice-Pres.
JOHN J. HESSIAN, Asst. Treas.

DOUBLEDAY, PAGE & CO.

THE WORLD'S WORK COUNTRY LIFE THE GARDEN MAGAZINE SHORT STORIES EDUCATIONAL REVIEW
CHICAGO: People's Gas Bldg. GARDEN CITY, N. Y. NEW YORK: 120 W. 32nd Street
BOSTON: Tremont Bldg. LOS ANGELES: Van Nuys Bldg.

military training camps, sent out a stirring call for recruits from the United States Army Broadcasting station at Bedloe's Island, where the statue of Liberty stands. The possibilities of instant mobilization, in case of future wars, which this suggests, stagger the imagination.

The exploits of David W. Richardson and G. D. Murray, the two Princeton students who succeeded in sending and receiving radio messages from a Lackawanna railroad train while it was roaring through ravines and cuts at the rate of 65 miles an hour, and even passing

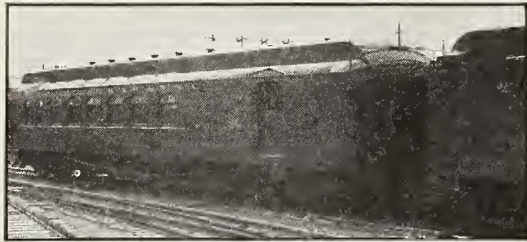

© Underwood & Underwood
Lackawanna Railroad coach specially fitted with aerial for radio tests

through long tunnels, have filled many columns in the press. Over in France the Compagnie du Nord has been making similar experiments under the direction of the French Ministry of Public Works near Bourget-Triage, but not while the train was running at great speed, nor over long distances.

Another important news item, if true, is to the effect that patrol automobiles of the New York Police Department are to be equipped with radiophone apparatus for the reception and transmission of wireless messages from and to Police Headquarters. The possibilities this suggests of throwing radio nets around automobile bandits and even speeders are interesting.

At this time when constant attempts are being made to fly across the ocean, it is good news that naval experts have perfected a method of keeping track of airplanes on overseas flights. Hereafter transoceanic planes are to fly in pairs, the leader to report their position every half hour, and in case of accident to either, the one in the air to report the circumstances, as the one on the water would be too low for satisfactory radio communication.

The Navy Radio Bill, which extends to June 30, 1925, the time during which Government owned radio will be allowed to handle press and commercial messages, except those

to China, has been adopted by the House and Senate and signed by President Harding. The service to Chinese stations will be terminated January 1, 1924, owing to international wireless agreements.

The Weather Bureau is promising more radio weather news, giving advance information of good and bad weather, and the Post Office Department is equipping its transcontinental and other airplanes with radiophone outfits with a radius of 200 miles.

The London *Daily Mail* accuses the "old fogies" of the army and navy air forces of hampering English amateurs. It is said that the United Kingdom has only 8,000 amateurs.

Captain Roald Amundsen, the explorer, who has started for the Arctic, is taking along radio outfits, not only for his ship, the *Maud*, but for two powerful airplanes which will form part of his equipment. As Captain Amundsen is said to estimate the duration of his voyage at from three to five years, it is safe to say that his radio equipment will be obsolete by the time he returns. In the meantime he and his crew will be able to find out the name of our next President, and we shall know if the brave Captain gets into any trouble and needs help.

Senator Harry S. New of Indiana made a political speech by navy radio to a meeting of women voters in Indianapolis and all other voters in Indiana who had receiving sets able to tune into the navy wave length, and thereby stirred up a tempest in a teapot. Once more the familiar cry is heard of using Government

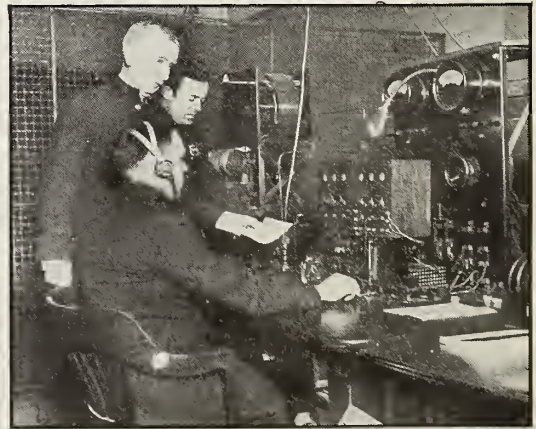

© Kadel & Herbert

New York's Police Department Radio System. This installation has been of great use in calling out the reserves, when needed, and relaying messages to the police boats in the running down of bootleggers smuggling liquor. It will shortly serve to keep Police Headquarters in touch with the Department's patrol automobiles



© Harris & Ewing

Senator Harry S. New of Indiana, to whom the distinction of making the first political speech by radio belongs

instrumentalities for political ends. It is safe to predict that men of all political parties will be accorded equal privileges, or that none at all will have them.

The American Telephone and Telegraph Company has disposed of its interest in the Radio Corporation of America.

Dr. Lee De Forest is reported to have invented a method of registering the action and voices of a photoplay in the same film.

Nearly two hundred daily newspapers in the United States are now maintaining radio news departments, and the number is constantly growing. The great majority of them are published on the Atlantic Coast. Nearly two score newspapers in New England maintain such departments, fifteen in the Southern states, and eleven enterprising newspapers on the Pacific Coast.

R. C. A. Annual Report

THE Transatlantic circuits of the Radio Corporation of America are now carrying 20 per cent. of the international message traffic between the United States and Europe, it is stated in the annual report of the corporation to the stockholders. Six direct international radio communication circuits are now in operation: Great Britain, opened March 1, 1920; Norway, opened May 17, 1920; Germany, two circuits, the first opened August 1, 1920, and the second May 19, 1921; France opened December 14, 1920; Hawaii and Japan, opened March 1, 1920.

"At the beginning of 1921," the report

states, "your corporation had in operation two Transatlantic high-power transmitting stations, one at New Brunswick, N. J., and the other at Marion, Mass. The station at Tuckerton, N. J. originally constructed by a German company, was of unsatisfactory design to meet the demands of Transatlantic service. The reconstruction of this station by the Radio Corporation of America made it ready for commercial traffic in January, 1921. The Tuckerton station now furnishes the transmitters for use on two distinct European circuits. At Radio Central, Rocky Point, L. I., construction work commenced during the previous year was completed to such a point that on November 5, 1921, the station was officially opened. When completed, this station will be a multiple station of twelve units, each consisting of a complete transmitter, and an antenna nearly one and a half miles long, supported by six steel towers, each 400 feet in height. The first unit of Radio Central was formally opened by President Harding. The message was acknowledged by 19 countries of the world, including Japan, Australia and New Zealand.

"The installation of high-power stations in South America has been inaugurated, by joint arrangement with the French, German and English companies, under which the interests of the four companies are trusted, with an American chairman chosen by the Radio Corporation of America. A station is now being erected in Argentine, and a concession has been



© Underwood & Underwood

Air Mail Plane Radiophone

obtained and financial commitments made in Brazil. At Warsaw, Poland, the Radio Corporation of America is now erecting a high-power station. One-half of the necessary radio equipment has been forwarded to Poland from the United States, and American engineers are making the installation."

Vacuum Tubes Promised

EVERY effort is being made by the manufacturers to meet the great demand for vacuum tubes—the very "heart of the radio." The Radio Corporation of America announces that the May production of vacuum tubes, used in radio transmitting and receiving sets, by the companies which it represents, will reach 175,000. The production scheduled for June calls for a total delivery of 200,000.

Crystal detectors formerly served the purposes of the larger number of amateurs, but the present popularity of broadcasting has created the demand for vacuum tubes. Although machines play a part in the major processes of manufacture, tubes are still largely made by

hand. Hand work plays a far more important part in making them than in the making of any other piece of electrical apparatus with which the public is familiar.

The manufacture of the delicate vacuum tubes used as detectors, transmitters, and amplifiers requires the building up of a force of technically trained men to work in the factories. That this is being rapidly done is proved by the fact that during the first eleven months of 1921 the average production of vacuum tubes by these companies was 5,000, in December the production schedule was increased to 40,000, in January to 60,000, and the production in April was expected to reach 150,000.

Russia and Radio

JUST to what extent Soviet Russia is making use of radio for external and internal communication remains to be heard when the truth once comes out of that dark country. At any rate, Russia is certainly exerting every effort to secure every possible

Spanish Royalty inspects new wireless. King Alphonso and Queen Victoria Eugenie of Spain are shown at the opening of the new wireless station in Madrid which has opened communication with Bilbao

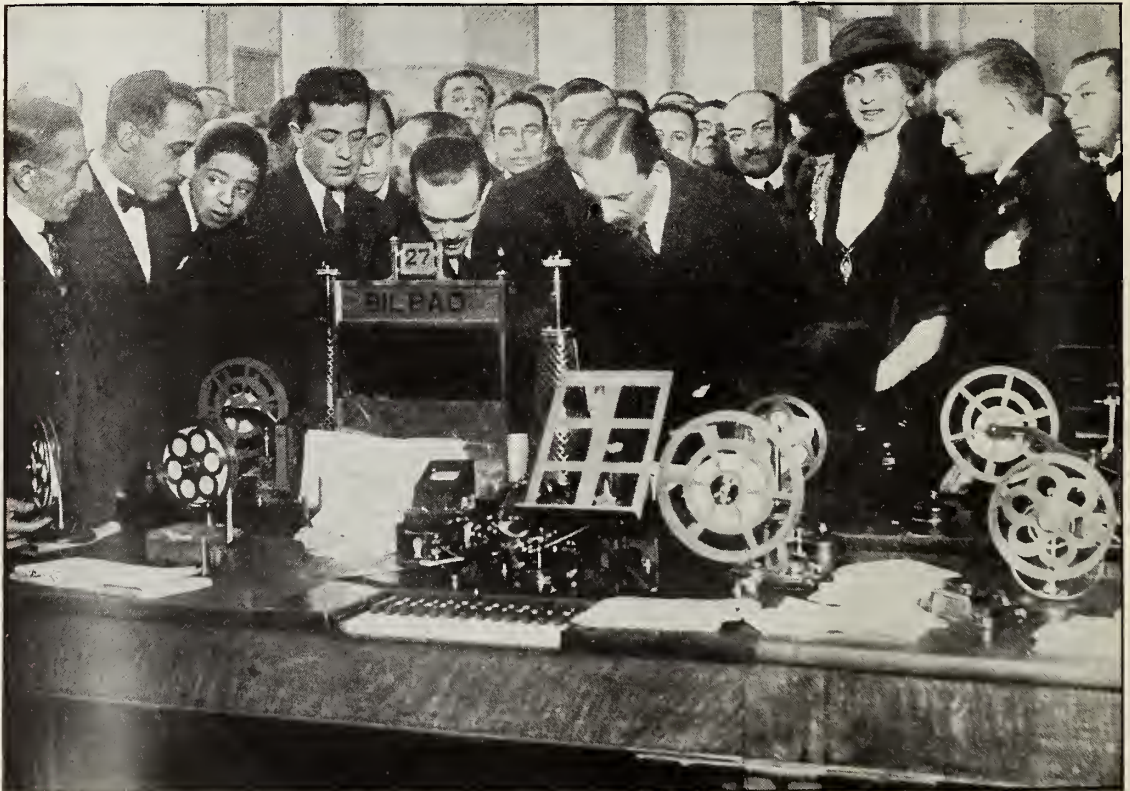

means of radio communication with the outside world. Now we learn that a radio service between Stockholm and Petrograd was inaugurated recently.

A New Russian Station

A *Central News* message states that a powerful radio station, capable of direct communication with Germany, England, Denmark, and Norway is nearing completion at Dietskoye Selo in Russia. It has been planned entirely by Russian engineers and erected by Russian labor.

Cable and Radio

AN interesting and convincing comparison as to the relative cost of operating a cable and a radio system may be gathered from the figures quoted by an Australian radio company, which plans to give a radio telegraph service between Australia and England, at one-third less than the cost of cable communication. The cost of establishing this service would be roughly \$5,000,000, of which the company already has about half that amount.

Radio Calling Apparatus

FROM France comes the news that L. Chauveau has developed a simple and reliable system whereby a radio operator may call up a certain person or station, in order to compete with ordinary wire telephony and telegraphy. This French inventor claims to have solved this problem and gives a description of his automatic radio calling apparatus in a recent issue of *Radioelectricite*. It consists of a combination of twenty magnetic relays—ten corresponding to "dot" and ten to "dash" calls, as well as a time relay. The apparatus can be set for any combination up to five letters or numerals, and if the call arrives in proper sequence and at proper time intervals, the last relay will close a signalling circuit, notifying the attendant of the receiving station. To ensure the essential accuracy of sequence and time, the sending station emits the call with a mechanical caller.

The Airplane and the Radio Beacon

WITH the rapid strides now being made in commercial aviation throughout Europe, the matter of radio beacons, as radio compass installations are called when employed to guide aircraft,

is an important one. It seems now that in the very near future there will be automatic radio telegraph transmitters located at regular intervals along air routes for the purpose of transmitting characteristic signals whereby any aircraft pilot can secure his bearings by checking up on two or more radio beacons. For the present, aircraft pilots depend on the usual radio stations, whom they ask for information concerning their bearings. In the future, the airships and airplanes will probably carry their own radio compass installations and will have to figure out their own bearings.

The British Mullard Tubes

IN THE United States we think of Radiotrons when we turn to vacuum tubes, not that there are no other tubes to be had, but because the Radiotrons are in such general use. In England, on the other hand, the amateurs think of Mullard radio valves. The British amateur makes use of the Mullard tubes made for receiving purposes. These tubes, or valves, as they are called, are made in a variety of types. The most common type is the type R, which has an overall length, including pin contact members, of $4\frac{1}{2}$ inches and a bulb diameter of $2\frac{1}{4}$ inches. It works best on a filament voltage of 4, and 60 to 80 volts between the plate and the filament. In the K type, which is somewhat more compact, about $3\frac{1}{2}$ volts is required for the filament, and 20 to 30 volts for the plate circuit. This particular type is suitable for use in radio frequency amplifiers. The D type is a slightly soft tube designed for use in detecting or rectifying signals prior to audio-frequency amplification. It operates best at about 5 volts filament current, and 20 to 30 volts for the plate circuit. The electrodes of the Mullard tubes are made from sheet nickel, and molybdenum and tungsten wire. The Mullard valves or tubes for transmitting purposes have bulbs made with silica, which not only reduces the danger of breakage but also permits of bringing the container nearer to the filament and grid so as to reduce the size of the tube.

The England-Egypt Radio Link

COMMUNICATION has been established between the Leafield (Oxfordshire, England) and the Abu Zabal (Cairo, Egypt) stations, but no commercial facilities are yet available, according to latest advices. In reply to a question in the

House of Commons recently, the Postmaster-General said that experimental transmission had been commenced between the two stations and as soon as the preliminary trials were completed a public service would be inaugurated. The Leaffield station had been working satisfactorily for some months, and its messages were regularly picked up practically all the way by liners on the Australian route. The total cost of these two stations was estimated at well over \$1,000,000. The cost of the remaining stations of the Imperial Chain is estimated at well over \$4,000,000, but without provision for patent royalties.

Some Applications of the Vacuum Tubes

PROBABLY no piece of electrical apparatus is so adaptable to a variety of purposes as the three electrode vacuum tube, and this with little or no modification of its construction. This wonderful adaptability is well illustrated in the high-speed transmitting and receiving equipment recently described by Lieut.-Colonel Cusins in his paper before the Wireless Section of the British Institution of Electrical Engineers. The transmitter and receiver contain together eleven tubes, which have, between them, eight different functions to perform. Of the two in the transmitter one is the main high-frequency generator while the other acts as a variable control resistance in its grid circuit. In the receiver, three serve as a radio-frequency amplifier, one as a tube relay, one as an audio-frequency generator, one as a tube-relay control valve, one as a direct-current amplifier, and two in conjunction as a double-current valve relay. Although the paper described the progress made in what the author called the mechanicalization of wireless telegraphy, this progress is only made possible by the elimination of mechanical links, except at the beginning and end of the chain, and their replacement by three-electrode vacuum tubes.

Radio Telephones on German Railroads

WHILE the idea of using radio telephones on railroads is not altogether new, all previous attempts along this line have not proved successful, for the simple reason that no suitable form of wave generator was available, and the receiving equipment was relatively crude. Now with the vacuum tube available for receiving and transmitting, it becomes possible to utilize

radio telephony for railroad purposes. It is reported that several German express trains are to be equipped with radio telephones to provide communication between the passengers and hotels and stations.

Radio Telephony in Sweden

THE telegraph authorities of Sweden are now conducting experiments for linking up the ordinary telephone with the wireless telephone so as to enable through calls to be effected. This scheme of using radio links, as radio telephony is called when employed in conjunction with regular telephone systems, has been tried out in the United States with promising results, and there is a radio link connecting up Santa Catalina Island with the California mainland in everyday operation.

Northern Africa Radio Station

THE building of the radio station at Ain-el-Hadjar, near Saida, on the railway line from Perregaux to Colomb-Bechar, has just been started by a detachment of military engineers. The station, which will be the most important in North Africa, is intended to form the radio link between France and her African colonies, and in case of a breakage of the submarine cables to undertake the forwarding of telephone messages between France and Algeria.

Radio Service for British Columbia

THERE has been established at Vancouver a radio telephone service for British Columbia, interior and coastwise, and for deep-sea ships as far as 2,500 miles at sea. It is planned to give the world news, concerts, and speeches to distant parts. The tests have been successful, and the station is now in regular operation.

When Wireless is Better than Wires

ESTABLISHMENT of radio stations at Stewart, Atlin, and Alice Arm, in British Columbia, and Dawson and White Horse, in the Yukon, will be urged upon the Canadian Government by Frederick Stork, member-elect for Skeena Riding. According to Mr. Stork, the cost of installing radio would be very small compared with the amount required to put the old telegraph line in shape, and would insure a service that would be in operation at all times.

Objects That Distort Radio Waves

Tests Show that Electric Wires or Cables, Steel Structures, Rivers, Trees, Trolleys, Tennis Backstops, Antennas, and Stone and Iron Monuments All Affect the Direction of Radio Waves

By L. E. WHITTEMORE

U. S. Bureau of Standards

ANY one who has thrown a stone into a pond of water knows how the waves spread in all directions from the spot which the stone strikes. The front of the wave moves along always remaining in the same position perpendicular to the line from the centre of the circle passing out in the direction of travel. This uniform position of the front of the water wave remains until the wave strikes a rock or a stick, or is led down a small channel or bay. Then the direction changes, and the wave takes a position which depends upon the size and nature of the obstacle which it encounters.

Similarly, radio waves spread out in all directions from the antenna of an ordinary radio transmitting station. The direction of the front of the wave is constant and is perpendicular to the line of advance of the wave unless some obstacle is encountered, or the wave strikes some new substance which causes it to change its speed or the velocity of transmission.

The things which may cause changes in the direction of radio waves are usually objects made of metal. Thus any electric wires or cables or any metallic structure, such as the steel frame of a large building, are likely to cause the direction of the radio waves to change as they travel along the surface of the earth. Even rivers and possibly trees during the spring when the sap is running may affect the direction of the passage of radio waves.

A comparison may be made with the waves of light which are transmitted from any object which we are able to see. The light waves ordinarily travel in a straight line, but when they strike some irregular piece of glass they are bent from this straight line. A familiar example is the bending of rays of light by the use of a glass prism or lens. Everyone is familiar with the distortion of light waves caused by a glass of water. A coin or other small object placed in the glass appears, when

seen through the water, to be in some position other than its real position.

If no objects are in the path of the waves to cause a change in the direction of the front of the wave, one can tell from the position of this wave front the direction from which the wave has come. In the case of the water waves this means the spot where the stone struck the water; in the case of the light waves the luminous object or source of light; and in the case of the radio waves the radio transmitting station.

If a small stick were thrown on the water in the region through which the water waves are traveling, this stick might happen to lie in a direction along the front of the wave. It would then move up and down as a whole, first riding on the crest of the wave and then riding in the trough of the wave. If the stick happened to be turned in the other direction, it would bob up and down, one end rising while the other end falls. In this case it would be lying across the line of the wave front, but exactly in line with the direction in which the waves are moving. It is conceivable that such a stick might be used by someone who could not see the water waves, but who could tell by means of his sense of touch by feeling the motion of the stick the direction in which the water waves were traveling.

If one cared to determine the direction from which light waves were coming, he could take a hollow tube and look through it as he turns it around. If the same amount of light were visible when one looked through either end of the tube, this tube would then be parallel to the front of the light wave. If as one looked through the tube he saw the light very brightly from one end, but saw no light from the other end, the tube would be across the line of the wave front and in line with the direction of transmission of the light waves. Thus the hollow tube could be used as a direction finder for sources of light. Actually we do not have



Radio direction finder frame on which telescope is mounted for use in sighting on the radio transmitting station. The scale of degrees is the circular disk just below the hand of the observer

to go through such a complicated procedure to learn the direction of sources of light waves because the human eye is itself an almost perfect direction finder for sources of light waves on account of its highly developed sense of sight.

We do not have physical senses which enable us to feel or see actually the direction from

which waves reach us from a radio transmitting station, so it is necessary to use a device which will give us some effect which can be observed through one of our senses, and this effect must be different when the device used is in the line of the front of the radio wave from what it must be when the device is perpendicular to the front of the wave or in line with the direction in which the wave is carried or transmitted along the surface of the earth. Such a device is found in one of the many types of antennas used for receiving radio signals.

When this type of antenna is used with the proper tuning and other receiving apparatus, it changes the energy carried by the radio waves into sound which can be heard by our ears. An antenna which is conveniently used in this way is made by winding a few turns of wire upon a frame a few feet square. The ends of this coil are connected to the rest of the receiving apparatus. When the coil is in the general vicinity of the radio transmitting station it is found that the signals which one hears are louder or weaker, depending upon the position of this coil antenna when turned about a vertical axis. When the coil is parallel to the front of the radio wave, there is little or no response, that is, one hears no radio signals. When the coil is perpendicular to the front of the radio wave, but is turned in the line of direction of transmission of this wave, there is a maximum response, that is, loud signals are heard. Therefore a coil antenna is a direction finder which will enable one to determine the direction of a radio transmitting station which is the source of radio waves. A common form of direction finder for use in receiving from the present day radio telephone broadcasting stations is a coil of about six turns of wire wound on a frame four feet square.

All practical uses of the radio direction finder require that it be connected to a sensitive detector and amplifier in order to secure reasonably loud signals. This is necessary because of the small size of antenna which can be conveniently turned around in one direction or another. The principal practical uses of the radio direction finder in radio communication are:

(1) Its use on shipboard as an aid to the navigation of the ship.* By its use the captain of the ship may tell the direction to a transmitting station located at a lighthouse.

(2) Its use at a radio station along the coast for determining the direction to a ship which

*See Bureau of Standards, Scientific Paper No. 428.

may be transmitting distress signals or which desires to learn its position.

(3) Its use on aircraft for enabling the pilot to tell the direction to a landing field. It is often impossible to see the ground from airplanes which are carrying mail or which are engaged in commercial business and must, therefore, fly under all weather conditions. The pilots of airplanes are always anxious to know the exact direction to the closest landing field in order that they may come safely to the ground in case of need.

(4) Its use on the ground at landing fields for aircraft to tell the direction of aircraft in flight which have on board radio transmitting equipment.

(5) Its use at a station engaged in ordinary radio communication. Such use takes advantage of the fact that transmitting stations

in one direction produce very weak signals, while transmitting stations in another direction may be heard very clearly.

(6) Its use as the antenna of a small portable receiving station, such as may be carried in an automobile or by hand.

For all of these uses it is important to know whether the direction finder is accurate in its indications. A calibration can be made which, when applied to the readings of the direction finder, makes its use entirely practical.

Such a study of the accuracy of a radio direction finder has been conducted by the United States Bureau of Standards of the Department of Commerce. The radio engineers connected with the radio laboratory of the Bureau of Standards have conducted a series of experiments to determine what kinds of objects cause serious change in the

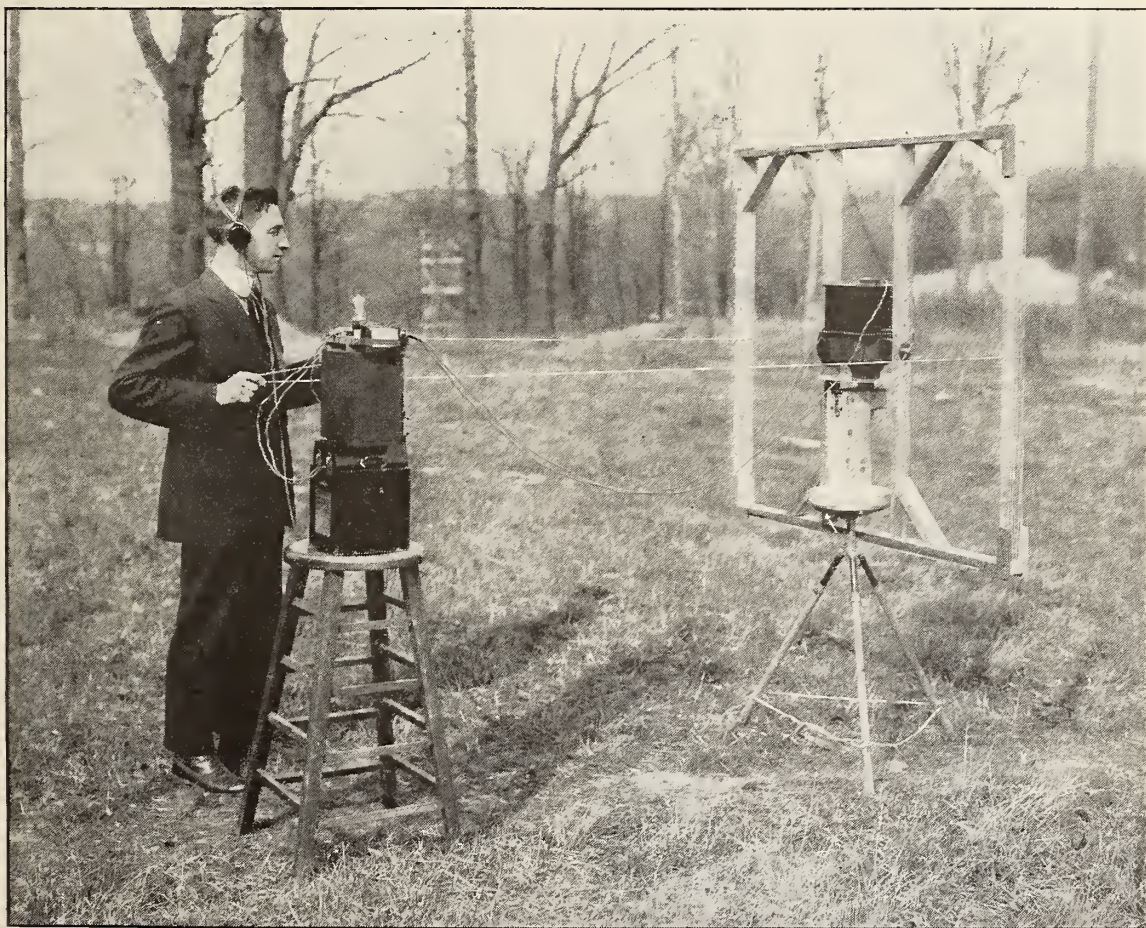

Radio direction finder in use in obtaining exact position of passing radio waves. The observer turns the frame by means of cords in order to be sure that his body has no effect on the direction of the waves. The detector and batteries are seen on the stool near the operator

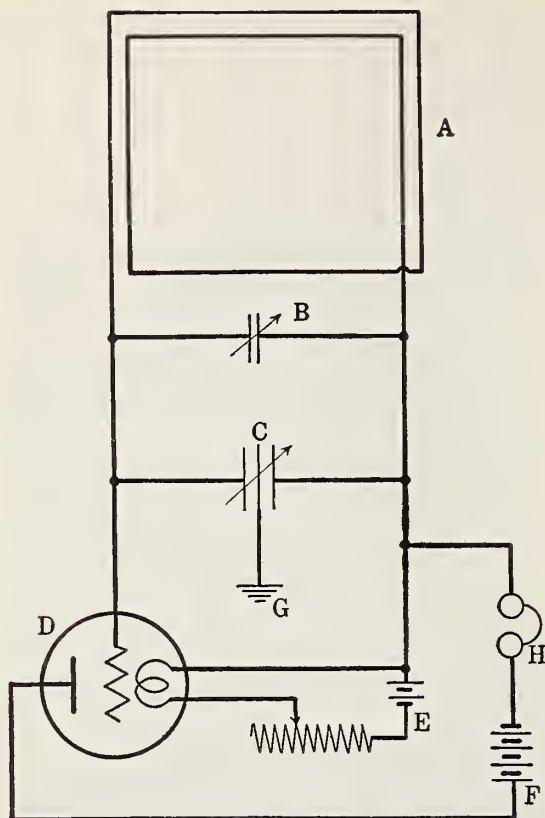

Circuit diagram of radio direction finder. A is the direction finder coil, B the tuning condenser, C the Mesny compensating condenser used for obtaining sharper indication of direction, D the electron tube detector, E the filament battery, F the plate battery, G the ground connection, H the telephone receiver

direction of radio waves and what precautions should be taken in using the radio direction finder in order to be as sure as possible that the direction obtained is the correct one. It was soon learned that the direction of the radio waves was noticeably different when the direction finder was placed near large metal bodies than when the direction finder was located in a large open space. But if this change in direction is once definitely determined for given conditions, it can be used in interpreting and making entirely correct the observations subsequently made in the use of the direction finder in practice. The most complete series of experiments was conducted on land with a portable direction finder and receiving set which could be taken to a large variety of places to determine the direction and amount of various individual cases of radio wave distortion.

The direction finder was fitted with a scale

for reading the angular position of the frame on which the coil was wound. This frame was also fitted with a telescope for use in securing a direct view of the radio transmitting station and thus determining visually the true direction. The coil wound on this frame was connected with the necessary tuning condenser, detector, amplifier, and telephone receivers for hearing the radio signals sent out from the radio transmitting station. A radio transmitting station was installed in one of the buildings of the Soldiers Home located in the northern part of the District of Columbia. This location was selected because the tower which supported one end of the transmitting antenna was visible from most points in the District of Columbia. The transmitting station was equipped with electron tube apparatus for sending out interrupted continuous waves. It was also arranged to transmit automatically a series of long dashes for use in making the tests of direction.

The receiving apparatus was so assembled as to be conveniently moved by motor truck to various points in Washington, D. C. The places selected were in open regions so far as possible with only one rather simple object near by which might cause the radio waves to change their direction in their passage through that vicinity. In taking readings, the direction finder frame was turned until the transmitting station was seen through the telescope. With the frame held in this position the scale was turned until the pointer read zero. The receiving operator then listened to the radio signals which were being transmitted at that time. He turned the direction finder frame until the signals were weaker than for any other position of the frame. The direction finder was then in the line of the wave front and the reading of the pointer on the scale was observed. If there were no objects causing any distortion or change in direction of the radio waves, this radio scale reading was zero, that is, the same as the scale reading found after the visual observation. If any difference was found between these two readings it showed a change in the direction of the radio wave from the true direction to the transmitting station. As the direction finder was moved nearer to or farther from the object being tested, the distortion or change in direction of the waves became greater or less.

Near the trolley wire of an electric interurban line the direction finder sometimes showed that

the waves were distorted as much as 50 degrees, while at greater distances from this same trolley line the distortion became less until at points about 2000 feet away the distortion was entirely gone. This means that after passing a distorting structure the waves straighten out again and are not erroneous in their direction until other obstructions are met. It was found that the amount of distortion produced varied sometimes as a trolley car passed along the line and thus changed the point at which the trolley wire was connected through its motor to the ground.

Near a large screen, such as is used as backstop for a tennis court, or near a large tree in an open field it is found that the distortion is in one direction when the direction finder is on one side of the object, while the distortion is in the other direction when the direction finder is on the other side. The distortion or bending of the waves is also found to differ when the transmitting station uses different frequencies or wave lengths. The wave length, which is subject to greater bending, depends upon the actual dimensions of the object which is causing this change in direction. When the direction finder was located on a large concrete bridge having steel reinforcement, a change in the direction of the radio waves amounting to as much as 14 degrees was observed. This bending of the waves became less as the direction finder was moved along the road away from the bridge in either direction. The distortion was found to be worse when the transmitting station was using a wave length of 400 meters than when it used longer waves. Similar results were obtained when the direction finder was placed in the vicinity of a telephone line or a low antenna of an ordinary radio receiving station. The distortion became greater as the direction finder was brought nearer to the wire. The distortion was in opposite directions as the radio direction finder was used at the two opposite sides of the wire, telephone line, or antenna. In the case of the antenna the distortion was found to be far greater when the antenna and receiving set system were tuned to the same wave length as that employed by the transmitting station whose signals were being observed.

Among the most interesting tests of this series were those made in the vicinity of the Washington monument. This monument is built of stone, but contains an iron stairway and an elevator cable which are conductors

of electric current. The Washington monument is 555 feet in height and is located in the centre of a large park which is comparatively free from other structures which might cause a change in the direction of the passing radio waves. By far the greater distortion of the waves was observed at points near the monument, changes of direction as large as 70 or 80 degrees being found at points as near as 150 feet to the base of the monument. When the direction finder was moved to a point 300 or 400 feet from the base of the monument the distortion was found to be only 5 or 10 degrees.

In order to determine the wave length at which the monument caused the greatest



Washington monument around which tests of the direction of radio waves were made. The natural wave length of the monument was found to be about 800 meters

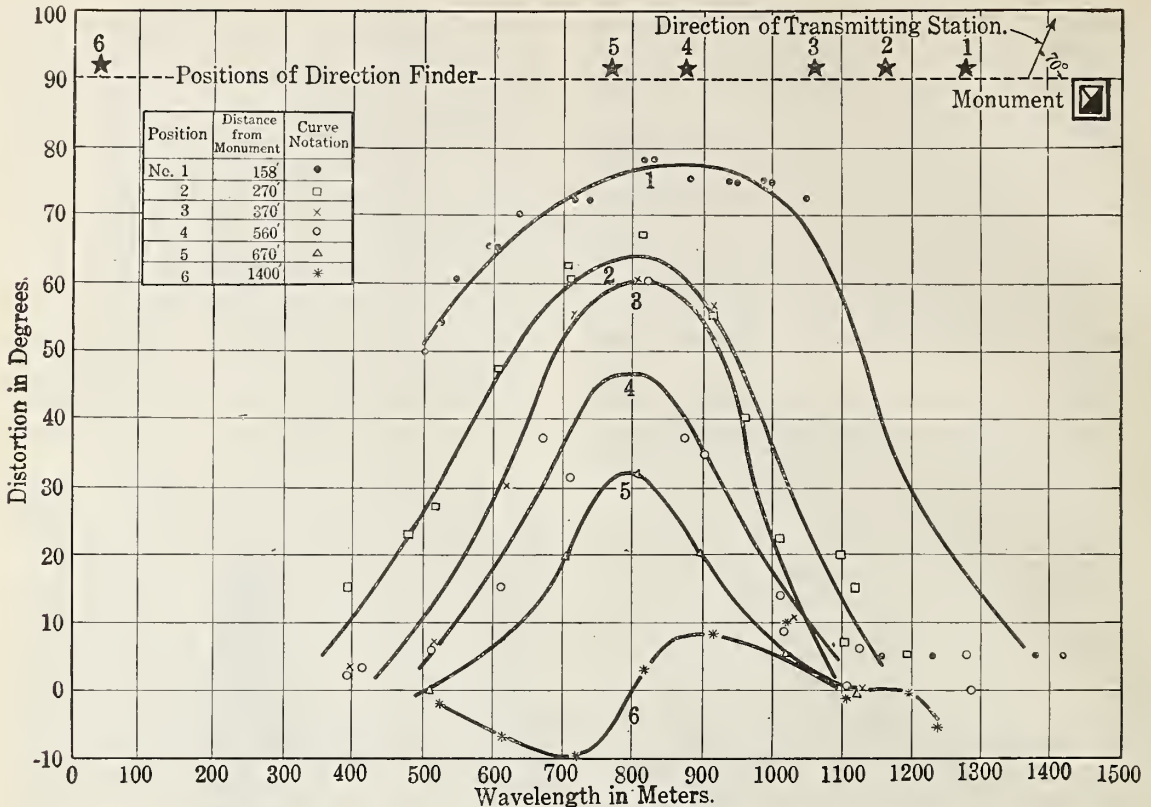

Distortion of radio waves of various lengths caused by the Washington monument. The closer the location of the direction finder to the monument, the greater the distortion at any point. The distortion was greatest when the transmitting station used a wave length of 800 meters

change in wave direction, signals were transmitted from the Bureau of Standards station at the Soldiers Home on a series of waves ranging from 400 to 1400 meters. The direction finder was placed successively at each of a number of positions at increasing distances from the monument. Measurements were made of the bending of the waves which was observed at each of these positions and for each of the wave lengths of transmission. It was found that while the bending of the waves was greater at the points nearer the monument, the distortion observed at a given location of the direction finder increased as the length of the transmitted wave was raised above 400 meters, until the wave length 800 meters was reached. At this wave length the angular distortion of the waves

was greatest, and when longer wave lengths were used by the transmitting station the distortion became very much less. It was therefore conclusively shown that the Washington monument was most effective in changing the direction of waves of 800 meters length. If the monument is considered as a simple radio antenna, it is found that the length of the waves which it would send out if it were used as the antenna of a transmitting station would be approximately 800 meters. Thus it may be seen that the distortion caused by a given object is greatest when the waves which are passing by it are of the same length as those which would naturally be sent out by that object if it were used as the antenna of a transmitting station.

Tuning the Radio Aerial System

By JOHN V. L. HOGAN

Consulting Engineer; Past President and Fellow, Institute of Radio Engineers

IT HAS been pointed out* that interference cannot be eliminated, even with the best radio receivers. Very intense interfering waves from powerful or nearby transmitters are likely to break through the barriers erected by the most highly selective receivers; if the interference is from a poorly designed or poorly adjusted sending plant, to exclude it from the receiver is found well-nigh impossible.

This situation does not argue against the adoption and use of sharply tuned receiving instruments, however. One would be greatly in error if he were to conclude that, since no known receiver (however nearly perfect) will prevent all interference difficulties, he might as well use a non-selective apparatus. A receiver which has the capability of close and exact adjustment to desired wave frequencies (or wave lengths) will invariably aid in minimizing interference effects; with it one will be able to receive clearly under many conditions where a broadly adjusted receiver would be helpless to discriminate between desired and undesired signals.

Now, what is it that makes one receiver "sharp tuned" and another "broad tuned?" How does it happen that a sharply adjusted or selective receiver will distinguish between arriving radio waves of only slightly different frequencies? Why does a broadly tuned instrument accept with almost equal ease signals whose frequencies are entirely different? The replies to these questions include nearly the whole subject of tuning at radio receiving stations. As a first step toward answering them, let us consider what happens when radio waves reach an intercepting aerial and the associated instruments.

Figure 1 is a diagram of a simple tuned receiving system. The aerial wires, which may be any of the familiar forms now seen throughout the country, are represented by the pitch-fork symbol at the top of the drawing; a connection leads from the aerial downward to the inductance or tuning coil within the radio station. As indicated, this coil may be wholly or partly connected into the circuit by means of

movable tap reaching successive turns. From this variable connection a wire extends farther downward through a sensitive current measuring instrument and thence to the ground connection.

When radio waves pass any receiving aerial wire system, they automatically and inevitably generate in that system a series of rapid alternating electric voltages (or electric pressures tending to cause a flow of electric current). If the aerial wire is connected to the ground, as in Fig. 1, the high frequency alternating voltages will produce a series of small but measurable

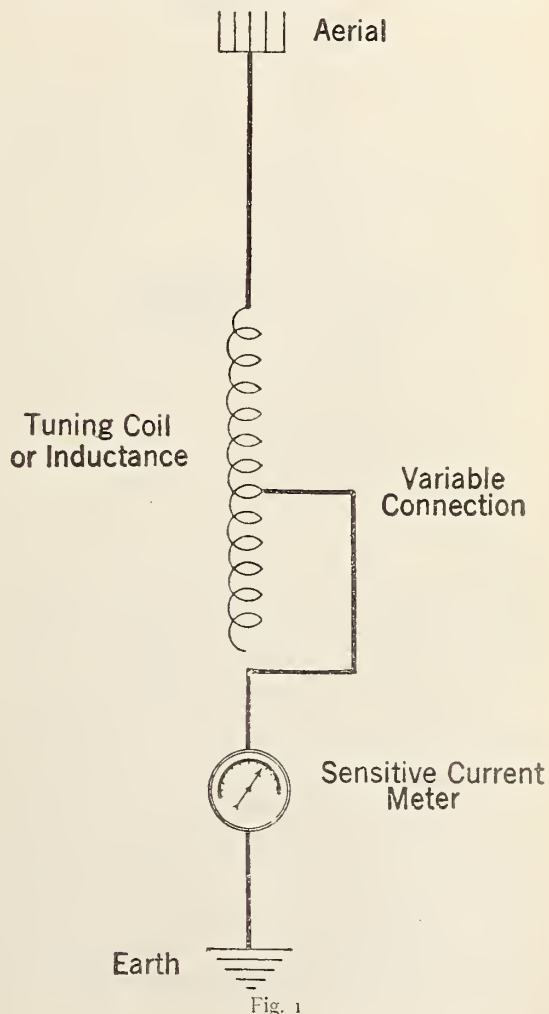

Fig. 1

*"Interference in Radio Signaling," by John V. L. Hogan, RADIO BROADCAST, May, 1922, p. 5.

electric currents flowing in the aerial-to-ground circuit. These currents will alternately flow up and down, the frequency of complete (double) reversal being identical with the frequency of the arriving radio wave. The currents will last as long as the radio waves continue to strike the aerial; when the wave ceases, the currents will rapidly die away.

It should thus be evident that if a stream of radio waves having a length of 360 meters, and

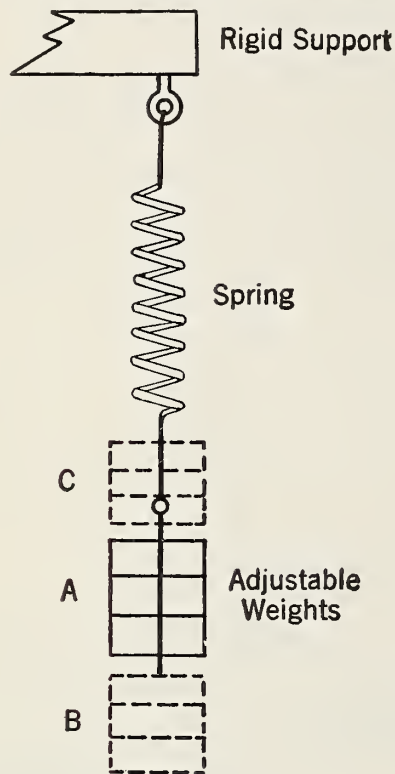

Fig. 2

therefore a frequency of 833,000 cycles per second, impinges upon the aerial of Fig. 1, there will be set up in the aerial wires an alternating current of the same frequency, viz. 833,000 cycles or complete reversals per second. This current will flow between aerial and ground through the tuning coil and meter shown, and, if the meter is of proper delicacy, will register its passage by moving the pointer. Similarly, if a 375 meter radio wave strikes the aerial, it will generate an 800,000 cycle current which will also flow through and be indicated by the meter. Supposing that we desire to receive the signals carried by the 833,000 cycle wave and current, and to exclude the signals of the 800,000 cycle interfering wave, it is clear that

we must find some method of augmenting the effects of one while reducing those of the other.

There is a practical scientific way of selecting electric currents of any one frequency at the expense of those having different frequencies. The method is based upon electrical resonance or tuning, and is analogous to the phenomenon of "sympathetic vibration" which is so well known in the field of music. It depends simply upon securing an agreement between the frequency of the driving forces (the radio waves, for instance) and the most-easily-assumed or "natural" frequency of the driven system (in our example, the antenna-to-ground circuit). When these frequencies are alike they are said to be tuned to or resonant with each other.

A digression will, perhaps, aid in securing a vivid idea of this natural or most-easily-assumed frequency of vibration. It is easy to grasp the thought of natural frequency of mechanical vibration in, for example, such an arrangement as is shown by Figure 2. Here a weight is supported by a coiled spring. At rest the weight takes the position A, where it is shown in full lines. If it is pulled down to position B and released, it will bob up and down between B and C, the path of travel gradually growing less and less until, finally, it will come to rest at the original position A. Perhaps the most interesting thing about such a system is that the number of times the weight will bob up and down again per second or per minute (in other words, its natural frequency of vibration) will be the same for every swing, regardless of the distance the weight moves in any one vibration. The most effective way to change this natural frequency of vibration is to change the stiffness of the spring or the mass of the weight. As can be easily seen, the greater the mass, the more slowly the system will oscillate; similarly, the greater the "flimsiness" of the spring, the more slowly will the weight move up and down. As these two factors (or either of them) increase, therefore, the frequency of natural vibration decreases. By changing either the weight or the spring one can make the frequency of the system anything he desires, within structural limits.

Suppose that when disturbed and left to oscillate the weight rose and fell, or executed a complete up and down movement, four times per second. The system would then have a natural frequency of four cycles per second.

This frequency is called "natural," because it is that of the system vibrating naturally or freely, without any external influence. If, now, one grasped the weight and used sufficient strength, it would of course be possible to force it to move up and down at a different rate, say once, or even ten times, per second. But this frequency would be *forced* frequency of movement, not a natural one. We may now consider the phrase "most-easily-attained" frequency used above. If one begins forcing the weight of this particular spring pendulum up and down at one cycle per second, and then gradually increases the rate of motion, he will find that as he approaches closer and closer to the natural frequency of four per second he will need to exert less and less effort to keep the weight swinging. At the exact natural frequency a mere touch for each vibration will maintain the oscillation; the spring and weight will seem to work together to keep on going at this particular rate. On the other hand, as it is attempted to move the pendulum faster and faster, at frequencies increasingly higher than four per second, the work required will be harder and harder. Thus, the natural frequency of four per second is the most easily attained frequency of vibration.

An entirely similar set of conditions holds for an electrical circuit containing elements such as coils and condensers, which possess the electrical properties of inductance and capacitance. We may set up such a circuit, as in Fig. 3, and charge the condenser (which need consist merely of two plates of metal hung face to face and close together in the air), by connecting to it a high potential battery. On removing the battery, the condenser will discharge through the coil, producing an alternating current which will swing back and forth at the natural frequency of the circuit. The frequency of this electrical oscillation can be changed at will by increasing the size of the condenser (i. e., its electrical capacitance) or the size of the coil (i. e., its electrical inductance). Varying these constants corresponds exactly to changing the flimsiness of the spring or the mass of the pendulum bob, in the analogous mechanical system previously described. So we have a way to control the natural or most easily attained electrical frequency of a condenser-coil circuit.

The condenser of such an electrical oscillatory circuit need not be of the ordinary plate-to-plate type. An aerial wire system acts,

opposite to the ground below it, like an electrical condenser. The elevated wires constitute one "plate" of such a condenser and the earth forms the other; the two possess electrical capacitance with respect to each other.

With the above in mind, and returning to the electrical system of Fig. 1, let us imagine that a stream of radio waves having 833,000

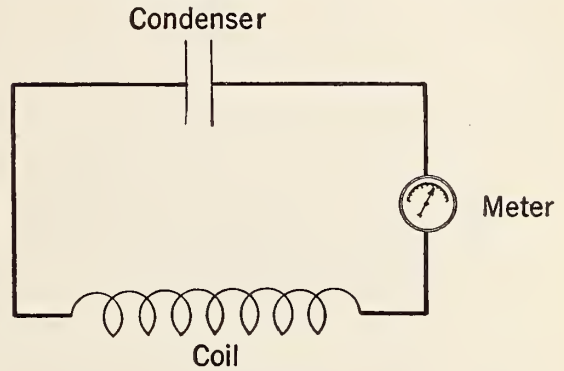

Fig. 3

cycles frequency strikes the aerial and induces corresponding voltages therein. Let us assume that the tuning coil has been adjusted so that its inductance, taken together with capacitance of the aerial system, gives to the circuit a natural frequency of the same value, 833,000 cycles per second. Reasoning that the induced voltages correspond to the hand driving the spring pendulum and that the resulting currents correspond to the motion of the pendulum weight, one would expect this agreement between arriving wave frequency and most-easily-attained circuit frequency to result in the largest possible radio current flowing in the aerial-to-ground system. This is the fact, as we may determine by a relatively simple test.

Consider that the frequency of the arriving waves falls slightly below 833,000 cycles per second, say to 831,000 cycles. The voltages in the aerial, and the currents produced thereby, will have this same lowered frequency of 831,000 cycles. But if the receiver is unchanged, this will no longer be the natural frequency, to which the system most easily vibrates; consequently not so much current can flow between aerial and ground. The same reduction in current would occur if the arriving wave frequency were slightly increased, say to 835,000 cycles per second. The greater the departure from the resonant condition attained at 833,000 cycles, when the arriving and natural fre-

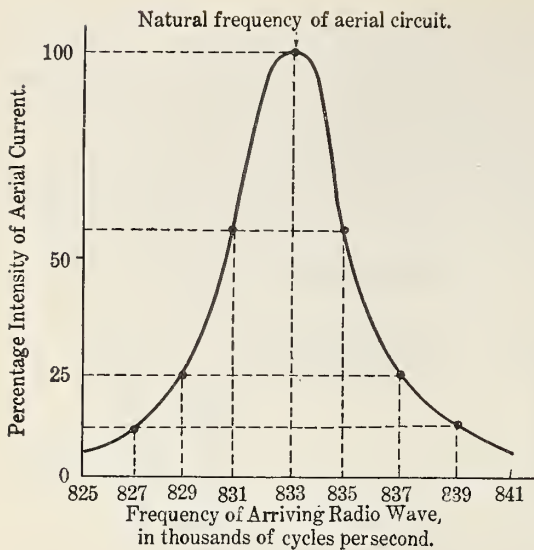

FIG. 4

quencies agree, the less the current which will be produced in the tuned aerial circuit. This is clearly shown in Fig. 4, where frequencies

differing by 4000 cycles above and below are seen to produce only about 25 per cent. of the maximum or resonant current value. A graph of the sort reproduced as Fig. 4 is called a resonance curve, since it shows how changes in frequency above and below the resonant value result in a diminution of the current to be indicated. A little study will make clear that the steeper the sides of such a resonance curve, or the sharper its peak, the greater will be the frequency-selecting power of the circuit it represents.

Evidently the adjustable resonant circuit gives us a powerful weapon against the evil of radio interference. By setting our receiver's natural frequency to agree with the frequency of the arriving wave to which we desire to listen, we automatically make our instruments less receptive to interfering waves of other frequencies. It is merely essential that we use circuits whose resonance curves are sharply peaked if we are to get the highest degree of resonant selection.

What Receiving Set Shall I Buy?

A Survey of the Current Offerings and When and How They Should be Employed to Receive the Radio-Phone Programmes

By J. CONRAD FLEMMING

THE selection of a radio receiving set should be quite as simple a matter as the selection of an automobile, piano, phonograph, furniture, suit, hat, or whatnot. The only reason why it appears more difficult is because the average layman knows less about radio than he does about other things—for the time being, at least. But if one becomes even superficially acquainted with radio and the requirements of radio reception, the selection of a radio receiving set for any given circumstances becomes just as simple and as positive as the selection of a rug to match the color scheme of a given room.

Behind all receiving sets there is one fundamental factor which affects the selection of the proper type for a given bit of work, and that is the distance between the receiving station and the transmitter which is to be heard.

The radio waves which travel out in all directions from the radio-phone broadcasting station become weaker and weaker as they reach farther and farther away from the transmitter, and in due course they become so weak that they no longer affect even our most sensitive receiving sets, so that to all intents and purposes they are non-existent. But in theory the waves go on for ever, becoming weaker and weaker and still weaker, but never reaching the zero beyond infinity.

Now receiving sets are of varying degrees of sensitiveness. Thus an inexpensive outfit must receive a certain amount of radio energy before it will respond and give satisfactory strength of music or speech in the telephone receivers. A more expensive outfit has a better means of using the intercepted wave energy to the utmost extent, so that it will respond satisfactorily with a far weaker wave

than is the case with the cheap outfits. A still more expensive outfit, provided with wave amplifying and sound amplifying accessories, responds to even weaker waves still, so that it operates at great distances when the waves have become so weak or attenuated that they are no longer detected by the cheaper outfits. So it is a case of using a receiving set that is sufficiently sensitive to make use of such radio waves as are intercepted in any given locality.

Thus it comes about that the person located in a city near a broadcasting station can employ a very inexpensive set with excellent results. On the other hand, the farmer, some 100 miles away, must employ a set costing ten times as much to receive the same broadcasting service. The cheap outfit does just as well as the expensive outfit under these circumstances; the farmer is simply paying for the distance which he has to span with his receiving set.

The usual method of intercepting radio waves is to use what is known as the antenna. This is simply one or two wires elevated a certain distance above the ground, and carefully insulated so that such wave energy as these wires intercept will not escape or leak before it can be brought to the receiving set.

The antenna should be at least 50 feet long, and for the best results, it should be at least 125 to 150 feet long. If the antenna is made longer than 150 feet, little is gained because it then becomes too long for the short wave length of radio broadcasting stations, and auxiliary apparatus must be employed to reduce the wave length of the antenna.

From the single- or double-wire antenna, a single- or double-wire arrangement is led down to the room containing the receiving instruments. This is known as the lead in. This wire is connected with the receiving set. Another connection is made between the receiving set and the ground, which may be a water pipe, a steam pipe, or a gas pipe, just so long as these pipes are known to be connected with the ground. In the country, where water pipes, gas pipes and steam pipes are not available, it is necessary to drive a length of iron pipe into damp soil, bury a copper or zinc plate in damp soil, or, again, to connect a wire to a pail which is lowered into a well or other body of water.

The antenna arrangement is mentioned in the foregoing only because it plays an important part in the selection of a receiving set. Other articles which are appearing in these

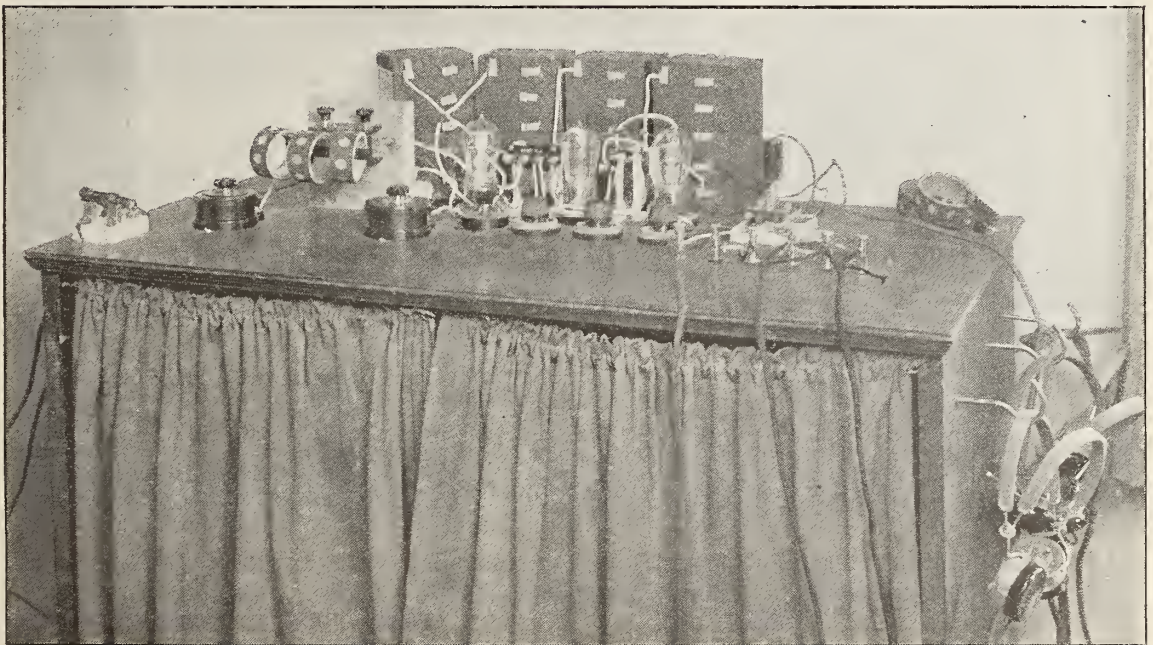

A receiving outfit of which the parts are screwed to a table top, and reduced to simple form. At the extreme left is the battery switch; then come the duo-lateral coils, the primary and secondary condensers, and the detector and amplifier bulbs with their accessories. The six binding posts on the right are so arranged that three head sets may be connected at one time. Behind them is a double-throw switch for cutting in the loud speaker



Although told that it could not be done, this radio enthusiast operates a loud speaker downstairs from his upstairs receiving set, the two being connected by seventy-five feet of flexible cord

columns have more to say regarding the erection of the antenna and the arrangement of the ground connection.

The first consideration in the purchasing of a receiving set is to decide just what broadcasting stations are to be intercepted and how far away they are located from the proposed receiving station. The second consideration is how big an antenna can be erected. Naturally, since the antenna decides how much radio energy is intercepted, the smaller the antenna the less the radio energy intercepted, and therefore the better the receiving set must be to operate over a given distance.

For receiving over distances of less than twenty-five miles, with a good antenna measuring 100 feet or more in length, elevated at least 20 feet above the ground or the roof of a house if it happens to be installed in a city apartment house, any one of the several inexpensive receiving sets, selling for about \$15.00 to \$25.00 will give satisfactory results. These sets generally consist of a simple tuning device, which permits of adjusting the set to any desired radio-phone station or radio telegraph transmitter within range, a simple crystal detector, and a pair of telephone receivers.

The crystal detector is the device which converts the intercepted radio energy into audible sounds in the telephone receivers. It is the simplest kind of radio detector, requiring no battery of any kind for its operation. However, its sensitiveness is rather limited, so that for distances greater than twenty-five miles it is of little value.

With inexpensive sets good results may be obtained from near by stations, but the impossible should not be expected. Thus it would be sheer nonsense to expect to operate a loud-speaking horn with a cheap outfit. Such loud-speaking devices, which make the radio receiving outfit somewhat akin to a phonograph in point of convenience and loudness, can only be used with the most expensive types of receiving set. Furthermore, only one pair of telephone receivers should be used with an inexpensive outfit, because the amount of converted energy is very small, and an additional pair of telephone receivers cuts down the sound strength. Still, two pairs of receivers may be used if necessary.

If louder music or speech is desired, even within a distance of twenty-five miles, it is necessary to turn to the more expensive offerings, in which the crystal detector is replaced by the vacuum tube. The vacuum tube detector resembles nothing so much as an electric lamp. It is provided with a filament, which glows like that of any electric lamp. However, it contains two other members, namely, a little helix or coil of wire which is known as the grid, and a cylindrical member known as the plate. The action of the vacuum tube is quite involved as far as the theory is concerned, but in practice it proves to be a far more sensitive device than the crystal detector.

The crystal detector, as already mentioned, requires no battery. The vacuum tube, on the other hand, requires two batteries, namely, a filament battery, and a high-voltage plate battery or "B" battery, as it is called. The filament battery must be capable of supplying current to the filament for a long period of time. Most vacuum tubes require a potential of five to six volts and a current of one ampere for the filament, so that this heavy drain necessitates the use of a storage battery. For that reason many persons hesitate to employ a vacuum tube set because of the expense of purchasing a storage battery, and also because the storage battery must be watched and tested at intervals to determine when it

is run down and when it requires recharging. However, there are now available on the market certain vacuum tube sets which make use of special vacuum tubes which operate on $1\frac{1}{4}$ volts and $\frac{1}{4}$ ampere of current. These tubes will operate satisfactorily on a single dry cell, which eliminates the troublesome storage battery. The "B" battery, on the other hand, lasts for months; after which it is renewed.

Once we have attained the vacuum tube category of receiving sets, the only difference in the various offerings is in the matter of elaborateness. The tuning facilities, which means the ease and the preciseness with which the set can be adjusted for any given wave length, are an important consideration. In radio-phone reception it is highly desirable to

be able to tune in a desired radio-phone programme and tune out undesirable programmes. This gives not only choice, but also gives a clear and pure rendition of the desired programme. Otherwise, muddled sounds are heard as though several persons were talking at one time or several orchestras or bands were playing different selections all at one time.

Speaking of tuning, it is well to bear in mind that some of the present offerings are designed with the layman very much in mind. These receiving sets have a simple tuner arrangement, because it is realized that the user does not want to master the handling of a number of controls to be found on the more professional sets. If the purchaser is of an adaptable turn of mind, it may be well to look



This Radio Regenerative Receiving Set, built by A. C. Philips, Hempstead, N. Y., has proved very effective. The antenna is composed of four strands of solid copper wire spaced two feet, eighty feet long, with a twenty-one foot lead-in. Height 51 feet. A home-made inductance wound on cardboard is used, with movable secondary, and taps on primary. A home-made variometer is used in the circuit as a tickler. The detector and two step amplification is made of standard parts. Double pole double throw switches connect to honey comb coils for long wave lengths. The following stations have been regularly and plainly heard. WJZ—WG1—WBZ—WGY—WWZ—KDKA—WDL—NOF—2XJ—IBKA—WYEB. The layout was arranged after a great deal of experimenting with different makes of standard parts, and left as shown owing to the fact that results were most satisfactory. Six sets of phones connected in series around the receiving room afford convenience and comfort to those who listen in.

into the sets with a number of tuning knobs, because good tuning does call for a number of tuning members. There is no such thing as simplicity combined with utmost efficiency in radio reception. Good tuning can only be obtained with a number of controls.

Another point to bear in mind is that the most important development in radio reception has been the introduction of the regenerative scheme invented by a radio engineer named E. H. Armstrong. To go into details concerning the Armstrong scheme is virtually impossible in this limited space, and a description of his invention was published in the last issue of RADIO BROADCAST; but suffice it to state that the Armstrong regenerative scheme simply converts part of the battery energy into oscillatory energy which is added to the incoming wave energy, giving greater strength to the ultimate sounds heard in the telephone receivers. Thus the detector is not only a detector but an amplifier as well.

So in purchasing a vacuum tube receiving set it is well to find out whether or not it is a regenerative set. Other vacuum tube sets will give good results, but the regenerative arrangement makes for greater range and louder signals with little more complication.

The simplest regenerative receiving set selling for \$75.00 will cover a distance of 75 to 100 miles under normal conditions, with a good antenna. For shorter distances it will give exceptionally loud signals, and will permit of using a number of pairs of telephone receivers. For distances above one hundred miles, it is necessary to use the more elaborate kinds of receiving sets of the regenerative design, together with what is known as the amplifier.

The amplifier may be included in a given receiving set, or it may be a separate piece of equipment. The amplifier increases the strength of the sounds heard in the telephone receivers, and thus brings up weak sounds, due to weak waves, to full audibility. It also makes possible the building up of weak sounds until they have attained sufficient volume to operate a loud-speaking horn, so that the music or speech can be thrown out in a large room and used for church, club, home entertainment or dance purposes.

Amplifiers come in the one-stage and two-stage models, and sometimes in the three-stage model, although the last-mentioned type becomes somewhat too complicated in its opera-

tion for the average amateur. The one-stage amplifier builds up the sounds to about four or five times their normal strength, while the second stage builds up this amplified energy four or five times more, or sixteen to twenty-five times the normal strength. Hence it will be noted that the amplifier not only gives louder sounds, but it also increases the range of the receiving set not a little by making what would hardly be audible sounds fully audible and even loud. So the amplifier is necessary when operating over a distance of more than 100 miles. For 200 miles or more a two-stage amplifier is absolutely necessary.

The usual type of amplifier is known as the audio-frequency type, because it handles the sounds or the currents of audible frequency which have come through from the detector of the receiving set. There is another type of amplifier known as the radio-frequency type, which is just coming into limited use. This type handles radio-frequency current, or current representing the radio wave energy, and builds up such current before passing it to the detector, which converts it into audio-frequency current. The radio-frequency amplifier, which comes in one-stage, two-stage, and even three-stage combinations, builds up the intercepted wave energy and not the sound strength. It makes for remarkable sensitiveness and for the covering of great distances, but it remains for the audio-frequency amplifier to give loud sounds. Often the two types of amplifier are included in one receiving outfit.

In cases where an antenna of the proper size cannot be used, then resort must be had to an improvised antenna. Anything will do to intercept radio waves at a reasonable distance. Thus a single piece of magnet wire, as insulated wire of small sizes is called, may be placed about a room behind a picture moulding. A piece of wire some forty feet long, concealed and out of the way, is sufficient to receive broadcasted programmes over a distance of 50 to 100 miles with a good receiving set with two-stage amplifier. The same set with a good antenna, however, would cover a distance of many hundred miles. Distance must be sacrificed with such improvisations.

It is only a matter of time when antennae will be done away with in most amateur radio reception, and the so-called loop will be employed. This consists of nothing more for-

midable than a number of turns of insulated wire wound on a wooden frame a few feet square. This frame takes the place of the usual antenna and the ground connection. Its two leads are brought to the antenna and the ground binding posts of the receiving set. The loop is used indoors, and must be so mounted that it can be turned about on its vertical axis. When the loop is facing end on toward the desired transmitting station, it receives the signals loudest. Indeed, the loop is the basis of the radio compass, which has proved such a boon to navigators, enabling them to take their bearings from shore stations. The loop is invaluable in radio-phone reception because aside from the sharp tuning qualities of the loop as compared with the usual antenna, it also enables an additional distinction to be made between the desired transmitter and the undesired transmitters by swinging the loop into the best position.

The best type of receiving set must be employed in connection with loop antennae. The crystal detector will not do. Unless a very short distance is to be covered, say twenty-five miles or less, a two-stage amplifier must be employed. For greater distances than seventy-five miles, a two-stage radio-frequency amplifier must be used to build up the intercepted wave energy, and a two-stage audio-frequency amplifier may be used in addition to build up the sound strength.

The efficiency of radio transmission varies from time to time. One evening a given receiving set will receive loud and clearly from a transmitter four hundred miles distant. Another evening, it will barely receive from a transmitter one hundred miles distant. Therefore, the effective range of a radio receiving set is always based on the distance which it will span under average conditions, and often this range is greatly exceeded for short periods.

Broadcasting on Power Lines

A DEMONSTRATION was recently given by General George O. Squier, Chief Signal Officer, U. S. A., of the application of his "wired wireless" or "line radio" system for broadcasting which is bound to have a far reaching effect on the future development of the broadcasting art. General Squier has demonstrated experimentally in his laboratories that it is entirely feasible and practical to transmit high frequency current telephony over power lines, electric light circuits, and for it to be received at any point on the line. A single transmitter connected to the power lines at some suitable point may broadcast over a considerable area and may be received by a large number of people by connecting receivers at various points on the line, the connection being made by a suitable plug in any light socket.

The transmitters or receivers are of the usual types now employed for radio telephony and may be connected to the power line in various ways; the preferred arrangement used at present is shown in the following diagram. In this method of connection, the danger of short circuiting the mains is entirely avoided, the condensers between the mains acting as a

by-pass for the high frequency currents only, permitting the power current, direct or alternating, but of low frequency, to flow along the

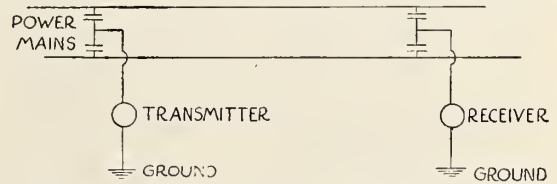

mains. For the radio currents the two mains are connected in parallel and used as one conductor, the ground being the return conductor. Good results are also obtained by connecting the transmitters and receivers between the mains, suitably protected by condensers to keep the large power current from passing through the radio apparatus, but the arrangement indicated above is more suitable.

The advantages of the line radio method of broadcasting as contrasted with space radio broadcasting are many. In the first place, the ether channels used for space radio broadcasting are limited, and even the few wave channels which are available for broadcasting can be more profitably employed for such radio activities where space radio is the only or best

method of communication. Also since there is no radio interference caused by broadcasting on power lines, any number of wave channels may be employed and therefore multiplying the number of stations that can be operated on the same line. It is conceivable that in every community we may have several transmitting stations operating at the same time, but each on a different wave length and supplying different services; one might be used exclusively for music, another for current news, and still another for educational information, etc. Also

by this means of broadcasting no antennae are required. A suitable plug connection in the light socket is all that will be required so that wherever the light circuits extend, which is nearly universal these days, radio broadcasting may be received.

It is hard to realize at this moment the vast possibilities of this method of broadcasting, but judging from the universal interest in the preliminary announcement in the press, it is a fair guess that the system will come into general use very quickly.

Wire Broadcasting

By JOHN F. DUNCAN

This article supplements the preceding one entitled "Broadcasting on Power Lines" by expanding still further the speculative possibilities suggested.—THE EDITOR.

WHEN a pleasant spring evening comes and you walk down to the public square to hear the first band concert of the season, probably you'll never think of broadcasting until the racket of some small boys makes you say under your breath, "Just like that — spark station when I'm trying for KDKA." And then you suddenly realize that you are listening to broadcasting of the oldest known form—one which has existed since man first knew how to make intelligible sounds.

For centuries sound waves in the air were the only means by which we could reach the ears of other people. Our message could be either person-to-person, or broadcasted to an audience, as we might choose. Then came the telephone, and one person could communicate with another, or with a selected few, even though they might be thousands of miles apart. Although the energies of telephone engineers were directed primarily toward *individual* communication, there have been several successful attempts at broadcasting by means of wire circuits. Two of these are interesting because they foreshadowed many of the radio developments of recent years.

In Budapest a system was operated successfully for several years prior to the war, the subscribers of which could listen in at any time

and hear a programme more or less appropriate to the time of day. Thus, current news would be "on tap" in the morning; market reports during the day; society news in the late afternoon; entertainment programmes in the evening. This service was furnished over copper wires tapped off for each subscriber's listening set, much like the long "party lines" in country districts. The expense was met by a monthly charge to each subscriber, and presumably the venture was profitable.

In Wilmington, Delaware, the local telephone company about twelve years ago operated a "music" exchange, to which a telephone subscriber could be switched on request. Here were a number of phonographs equipped with telephone transmitters. The subscribers would give the title of the piece he wanted, and an operator would put on the record and start the machine. A charge for each record was made. If the person had no preference for a particular record, he was put on a "general" circuit which had a varied programme. A loud-speaking receiver with a horn could be rented for use at home, and a number were installed on a "pay station" basis at ice-cream parlors, restaurants, etc. For a time the system paid well, but eventually the general use of phonographs killed its market, and it was abandoned.

With the addition of radio broadcasting we have examples of the three possible ways by

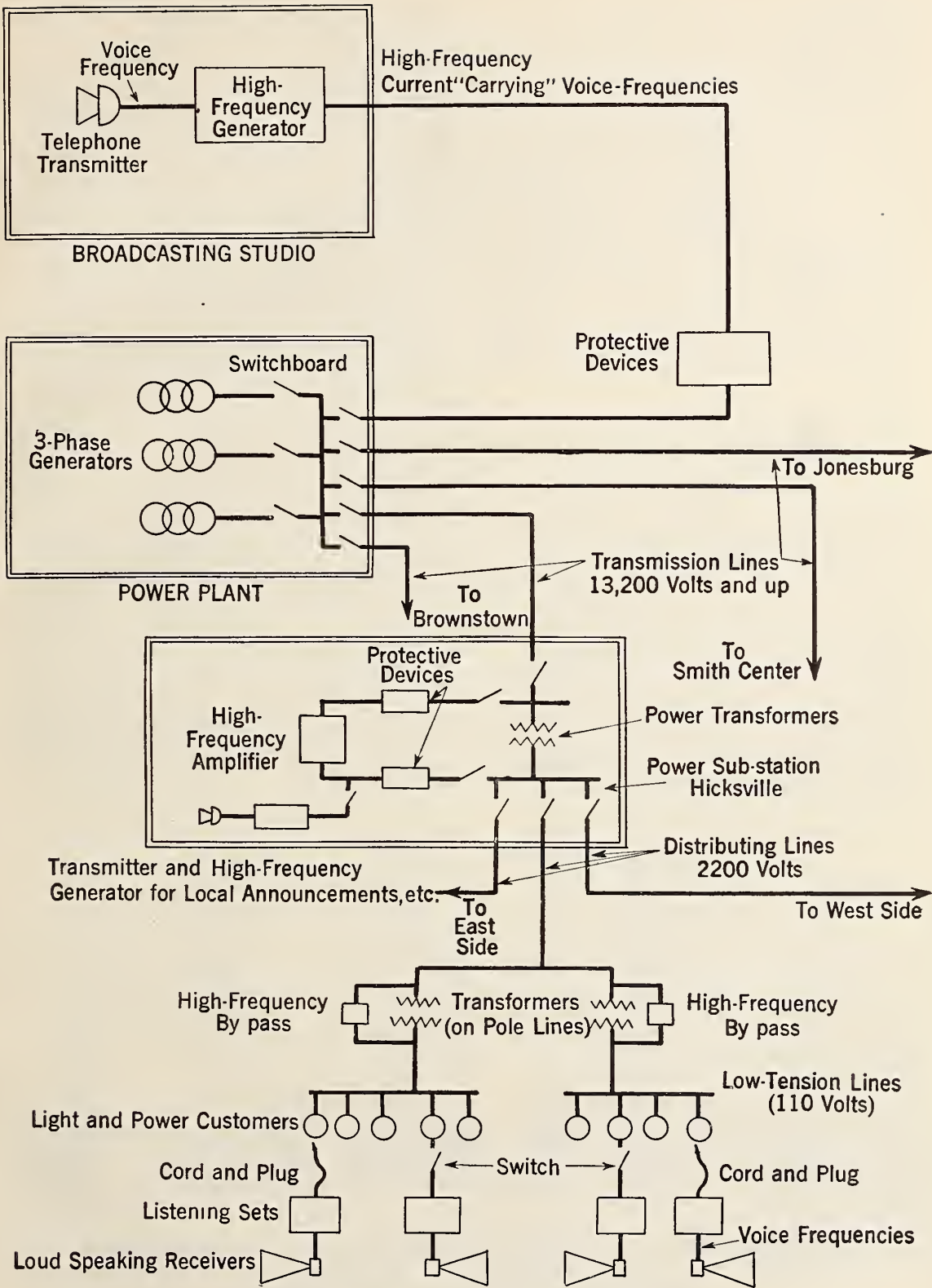

Fig. 1. Diagram of Carrier Broadcasting Set-up.

which voice or music can reach the ears of a large audience—by sound waves in the air, by electric currents on wires, and by radio. Each of these methods has its advantages and its defects, most of which are evident at first glance. Everybody knows, for example, that after the initial investment, a radio receiver costs little to operate, but its results are far from dependable at certain seasons, due to atmospheric conditions. The problem of paying for programmes sent out by radio is still unsolved. As broadcasting ceases to be a novelty, the publicity secured by an entertainer or lecturer through giving a "broadcast" performance will disappear, and these people will properly insist on payment for their services. But by whom?

If broadcasting is to become a permanent feature of our life, it is worth while to consider the real obstacles to its development, and examine wire broadcasting as a possible substitute for radio. The fact that the former system is limited to those persons who are "wired up" to it has certain decided advantages to its financial backers, and, paradoxical as it may seem, to its users. For a definite group of subscribers at so much a month is in a position to demand the sort of programmes it wants, and to insist on high-grade "transmission," free from noises and interruptions. The management of such a service is in the position of a theatre which will make money in direct proportion to its success in pleasing its patrons.

Such a sound economic foundation is indispensable for any permanent service.

It can safely be assumed that the cost of maintaining special wires to connect subscribers with broadcasting stations would be prohibitive—to say nothing of the difficulty of placing the wires in congested districts. This fact has been a stone wall which has blocked all attempts to develop this branch of the art. However, this particular wall has a gate whose key has been discovered within the last five or six years. Perhaps the analogy would be more accurate if we said that a ladder has been found by which we could climb up to a window and climb down again on the other side of the wall.

The gate or the window, as you prefer, is the use of existing wire plants, either of the electric light or telephone systems. There is nothing new in this idea; it occurred to many people years ago, yet the window was just out of reach. For instance, it was found that if telephone currents were passed through an electric arc, the original sound would be reproduced audibly, just as the old-fashioned alternating-current arc-lights would "hum" at the pitch of the circuit which supplied them. Some one proposed that a telephone transmitter should be connected to a city's arc-lighting system to broadcast police calls, news of robberies, etc. The difficulty, however, was that the arc-light was not a sufficiently "loud-speaking" receiver to be heard above street traffic, so nothing ever came of the idea.

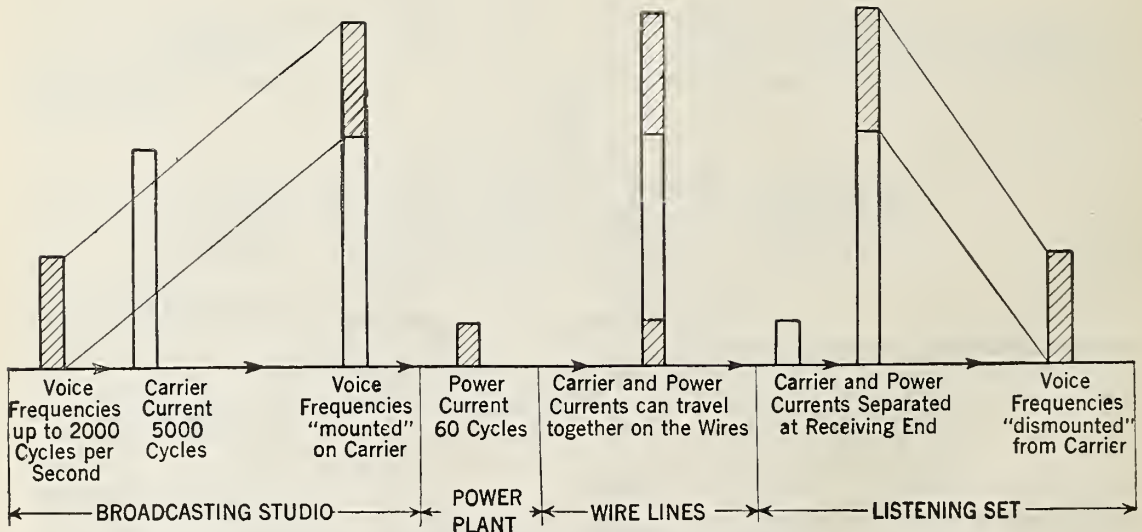

Fig. 2. How use of high and low frequencies allows wires to carry power and broadcasting at the same time

The principal difficulty in the use of electric and telephone wire lines is not in getting the "voice current" on to the wires but in getting it off. For electric light is usually alternating current, which at any commercial frequency is plainly and unpleasantly audible. And the telephone lines are built for the purpose of individual communication, which cannot be interfered with by "broadcasting." The problem of putting on another stream of "talk" without interference was only solved when a reliable method was found for using a high-frequency electric current as a "carrier."

This is where our analogy of the ladder comes in. The carrier in effect "lifts" the pitch of the intruding talk-stream to a point where it is inaudible, so that it does not interfere with the original use of the wires. At the receiving point it is then possible to separate the high-pitch (new) current from the low-pitch (original) current, and bring the high-pitch current down to its original (audible) pitch which may be heard in a telephone receiver or loud-speaker.

This explains in a rough manner what lies behind recent proposals to use electric light wires for broadcasting. We might have a central broadcasting station at the centre of a great power system, sending out its programmes over high-tension transmission lines to relay stations in each community. Here the "talk-stream" would be transferred to the distributing network reaching every house. Then by connecting a simple receiving set to any lamp-socket or wall-plug, we could "listen in" to news and music sent out hundreds of miles away.

Such a service offers attractive possibilities to electric service companies. Suppose such a company operates a system having one or more power plants connected with substations by high-tension lines. A broadcasting studio is built at any convenient central point and connected to the high-tension network through suitable protective devices. This studio might send out three or more programmes simultaneously—news and advertisements, popular and dance music, classical music, etc. Each of these programmes is carried by a different frequency, say 5000 cycles apart. By amplifiers at the substations, the losses in the transmission lines are made good, and the high frequencies transferred to the networks of distributing lines in each town. Where desired, a local programme can be sent out to the customers of a single substation. The apparatus used by the customers can be as simple to adjust as one of

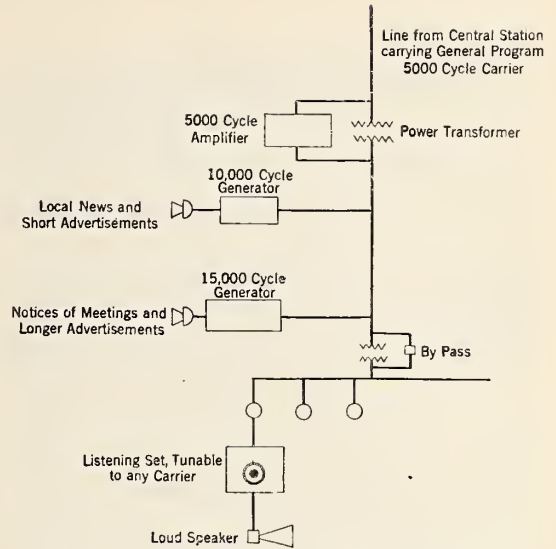

Fig. 3. Showing how three carriers can be used to give three programmes simultaneously

the radio sets now on the market which sells for \$65. Loud-speaking receivers can be supplied at varying rentals according to size, allowing their use in public places, such as hotels, restaurants, etc.

So much for the technical side of wire broadcasting. Commercially it offers several advantages to its users. The service would be furnished by a central organization fully responsible for the provision and upkeep of apparatus, just as are the telephone companies now. Users would have very little adjusting to do, and skilled assistance would always be available. With no static or fading to worry about, an evening's entertainment could be depended on at any season of the year.

All these advantages tend toward making broadcast receiving an exact science, instead of an art. To-day, skill and ingenuity count for a great deal. One reason why Jones builds a set is that his friend Smith has built one, and Jones isn't going to let Smith get ahead of him. Too, there is a powerful appeal to the imagination in tuning up a radio set and picking up stations all over the country. Perhaps it is the spirit of adventure that takes us on these journeys through the ether, rather than the absorbing interest of a lecture on ink or the charm of a church soprano's voice. If a large enough section of the public is interested in results, rather than in technical operation, then wire broadcasting offers a far better field for development than radio.

Care and Operation of a Crystal Receiving Set

By EDGAR H. FELIX, A. I. R. E.

A RADIO receiving set is an instrument to which alternating currents from an antenna system are supplied, and which converts these alternating currents into sound waves.

The chief advantage of a crystal receiving set over other types is the small investment involved and the fact that there is no up-keep cost after the initial investment has been made. The chief disadvantages are the comparatively short range, lack of selectivity and instability of crystal detectors.

A crystal receiving set, however, if it receives at all, receives perfect music without any distortion of sound quality. In this respect it is superior to a phonograph. The output of a crystal detector, however, cannot be amplified by vacuum tube amplifier, and, for this reason, head receivers are always necessary when using a crystal set.

To operate any mechanical device successfully we must not only know what the controls are, but also what they do, how they do it and why. For instance, you could start an automobile if you were told to depress a certain foot pedal and pull a certain lever toward you, and then release the depressed foot control. But you would certainly be a failure as a driver if you did not know the function of the clutch and the purpose of the transmission. For this reason, in describing to you the best way to operate a crystal receiving set, I shall tell you the function as well as the effect of each control.

A crystal receiving set performs three functions: first, it tunes the antenna system to resonance with incoming ether waves; second, it rectifies the incoming oscillating energy so that it can be converted to sound; third, it converts the rectified oscillations into sound waves by means of head telephone receivers. Each of these functions will be taken up in succession.

Resonance is a familiar term to you, but it is hard to understand its application in

radio without the recourse to analogies. If a tuning fork of a certain period of vibration is set into vibration it starts a series of sound waves. If a second tuning fork of the same period is held near the first, it is set into vibration by the sound waves sent out by the first tuning fork. When two vibratory systems of any type have the same period of vibration they are said to be in resonance. In the case of the tuning forks the period of vibration is determined by the material and dimensions of the tuning forks.

The period of vibration or frequency of an electrical circuit is determined by its inductance and its capacity.

Whenever there is a change in the quantity or direction of current flowing through a wire, a magnetic field is set up. On the other hand, a change in the strength of a magnetic field always causes an electric current to flow through any electrical circuit within its influence.

If current is passed through a length of wire, the magnetic field built up induces a current in the opposite direction from that which caused the magnetic field. In other words a magnetic field builds up a current opposing that which caused it. In this way magnetism in electricity corresponds exactly to inertia in mechanics.

If, instead of a straight piece of wire, a given length of wire is wound in the form of a cylindrical coil, the magnetic field of one turn unites with that of the next and so on, greatly intensifying the magnetic effect. The coil in this form is called a tuning coil.

The inductance of any electrical circuit or instrument is a measure of the facility with which magnetic fields are built up. A cylindrical coil, for instance, possesses considerably greater inductance than a straight piece of wire of the same length as that used upon the coil.

The greater the inductance of a circuit the longer the time required for the magnetic fields to build up and to get up the opposing



This is a new General Electric crystal receiving set complete with telephone receivers now being featured by the Radio Corporation of America. This little receiver has a wave length range of 180 to 700 meters, made in two steps 180 to 400 and 300 to 700 meters respectively, and tuning is accomplished by a single control to which a pointer is attached which moves over a graduated scale. When the set is not in use, the receivers may be placed inside the metal case by removing the front

current. Consequently, an alternating current of very high frequency cannot pass through a circuit possessing a very large inductive value, but it passes through a circuit of small inductive value with great ease. For, possessing a correct value of inductance to pass the high frequency current, each time the magnetic field has built up and the reverse current starts to flow, the high frequency current is itself reversing. The use of the correct inductive values thus aids the flow of an alternating current while too much inductive value greatly impedes or stops the current.

The meaning of the word capacity is ability to hold. The capacity of an electrical instrument or circuit is its ability to hold electrons. Free electrons held in suspense by any force are termed an electric charge. A device especially constructed to hold a charge is called a condenser. When a condenser is designed so that its capacity may be continuously varied over a wide scale, it is called a variable condenser.

The diagram shows an inductance and capacity connected in series. If we charge this capacity by means of a battery let us see what happens. There is a positive charge on one set of the condenser plates and a negative charge on the other. These opposite charges are connected by a good conducting circuit through the inductance. Consequently there is a flow of electrons through the inductance until the two charges are equalized.

In passing through the inductance, a magnetic field was built up which in turn caused a current to flow in the opposite direction. As a result the charges on the condenser plates are reversed; the plate that was first positive is now negative and vice versa. These charges again neutralize through the inductance. If there were no resistance or losses in the circuit, we would in this way have perpetual charges and reversals of charges. Such a circuit is called an oscillatory circuit, and the current flowing in it an oscillating current.

The larger the inductance the longer time it takes the magnetic field to build up, hence the slower the period of vibration of the circuit. The larger the capacity, the greater amount of current required to produce a charge of appreciable strength which will cause a current to flow through the inductance. So the larger the capacity of the circuit, the slower the period of vibration.

In radio reception wave lengths between 100 meters and 25,000 meters are used. A wave length of 100 meters consists of three million vibrations per second; one of 25,000 consists of 12,000 vibrations per second.

When receiving signals from the ether, the aerial and the ground form the two condenser

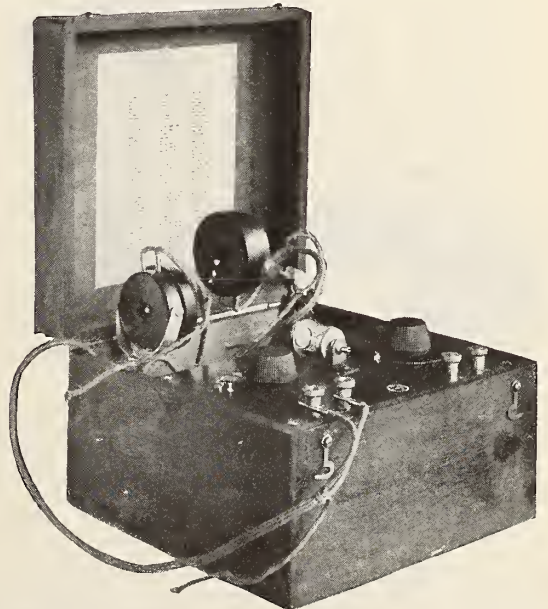

This is a complete crystal receiving set with two wave length controls, one of which acts as a fine adjustment on the other. This receiver is very useful for broadcasting reception. It may also be used to cover wave lengths up to 2,500 meters. It is marketed with a pair of sensitive telephone receivers

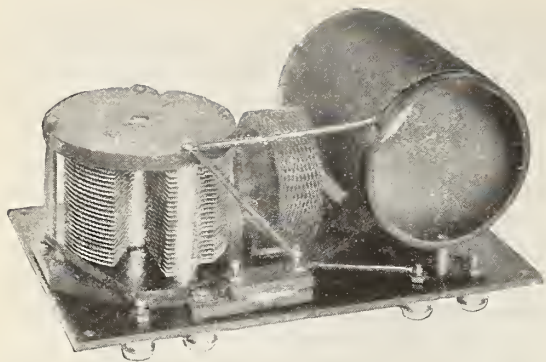

This is the interior of the crystal receiver previously described, and, as may be seen, the entire tuning equipment is mounted on a single Bakelite panel. A variable condenser is supplied for fine tuning and a lattice wound coil is used where wave lengths up to 2,500 meters are desired. This feature permits the reception of signals from the United States Government station at Arlington (Radio Va.)

plates of an oscillatory circuit. The inductance is the tuning coil or variometer used to vary the natural frequency of this circuit.

The first step in the operation of your set after your crystal is properly adjusted, consists of varying the inductance in the antenna circuit so that a current of the frequency set



This is the Aeriola Jr. Crystal Receiving Set manufactured by the Westinghouse Electric Manufacturing Company. Many of these sets have been sold on the strength of the company's broadcasting station WJZ at Newark, N. J., and these are used as receiving sets at that station. They are suitable for receiving waves of from 150 to 500 meters, and have an ordinary radius of 25 to 30 miles. They are sold completely equipped, except for the antenna. The cut in the next column shows the interior of this receiving set

up in your antenna by the transmitting station which you wish to hear, passes through the antenna system with the utmost ease.

The inductive value of the antenna system is in some receiving sets varied by means of a switch which cuts in or out small sections of a tuning inductance. Other sets use a variometer which is a special form of inductance so constructed that one half of the inductance opposes the other at minimum adjustment, and at maximum adjustment the two halves assist each other. In some sets the period of vibration of the antenna circuit is controlled by a variable capacity supplementary to the capacity of the antenna itself.

Now that we have our antenna circuit in

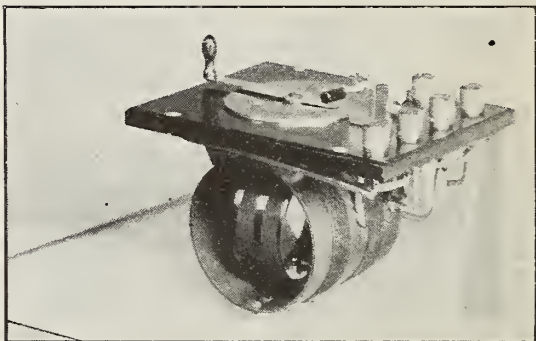

exact resonance with the transmitting station by proper adjustment of inductance and capacity, we must utilize the energy flowing in this circuit in order that it may be converted into sound waves. For this purpose a secondary circuit is used which obtains its energy from the antenna circuit. This secondary circuit should be in resonance with the antenna or primary circuit. When a two slide tuning coil is used, one slider varies the antenna wave length and the other the wave length of the secondary circuit. In such a set the same wire is used for both circuits and for this reason is called a direct coupled set.

Other types of receivers use separate windings for the antenna circuit and the secondary circuit. An instrument especially designed for this purpose, permitting adjustment of the distance between the primary and secondary circuit, is called a receiving transformer. The energy from the antenna circuit is transferred to the secondary by utilizing the magnetic field I have already described to you. The magnetic energy set up in the antenna inductance not only sets up a countercurrent in its own

circuit but also sets up a current in the secondary circuit which is within the magnetic field of the primary circuit.

The advantage of using two separate inductances for the primary and secondary circuits is that their physical relation or coupling may be adjusted. The looser the coupling—that is the further apart the two coils are held—the sharper and more exact the tuning of the two circuits. With a loose coupled set it is

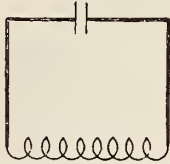

Fig. 1. An oscillatory circuit

usually possible to eliminate interference, which cannot be avoided with the single circuit set.

The tuning of an inductively coupled set is as follows: The coupling is first set at maximum; that is the primary and secondary inductances are placed in as close relation as possible. The antenna circuit is first tuned to the incoming wave; the secondary circuit is then adjusted to resonance.

Since the antenna circuit has the large capacity of the aerial and the inductive effects of the long wires, it usually requires comparatively few turns or little inductive value in the antenna circuit to place it in resonance with a much larger number of turns on the secondary inductance. A typical adjustment, for instance, is ten turns of antenna inductance to fifty turns of secondary inductance. Exact values cannot be given as this is determined by the size of your antenna, the length of the lead-in, the diameter of the coils used, and other conditions which are not standard.

Some sets are being manufactured which have but one control for wave length. In such sets close resonance is not always possible and for this reason they are not as selective as inductively coupled sets.

The result of placing the secondary circuit in resonance with the primary circuit through which a received signal is coming in is to have the secondary condenser charged and discharged millions of times per second. For instance, if you are listening to a 300 meter wave this condenser charges and discharges

one million times per second. This high rate cannot be converted into sound waves because no mechanical device can move so rapidly, nor would the ear respond to air waves of such rapid frequency. For this reason we use a crystal rectifier. A crystal rectifier allows current to flow through it in only one direction.

The function of the crystal detector, which is placed in series with the secondary inductance and capacity, is to allow an appreciable charge to accumulate on the plates of the condenser. It permits the plates to become charged in one direction, but prevents the discharge or equalization of the charges. When radio music is being transmitted on a 300 meter wave it is projected through the ether in vibrations of one million frequency. The voice or music is imposed upon this rapidly oscillating vibrating wave by means of modulation. Speech consists of intricate combinations of frequencies, ranging from 40 to 5,000 cycles per second. Modulation consists of changing the average intensity of the high frequency ether waves in accordance with the voice variations. Striking a second C above the middle C on the piano produces an air wave of 500 frequency. When this is sent over the radio telephone at 300 meters, modulation divides the one million frequency radio current into groups of 20,000 per second.

The crystal detector allows a charge to accumulate on the plates of the condenser. The modulation employed by the transmitter varies the amount of this average charge at voice frequencies. Head telephone receivers are connected across the condenser. The low frequency variations of the average charge pass through the telephones causing the diaphragms to vibrate. This in turn causes air waves which you hear.

Crystal detectors are of various types, but the process of adjustment in all cases is

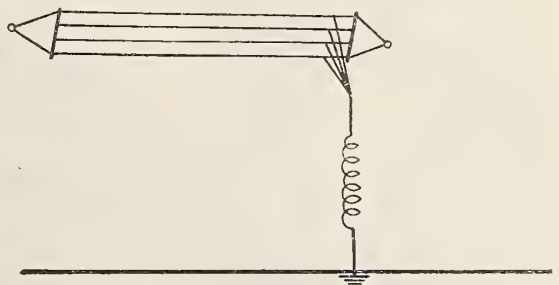

Fig. 2. The antenna circuit as an oscillatory circuit

approximately the same. Crystals are not sensitive at all points. The pressure of the contact on the crystal has an important bearing on its behavior. Sensitive points can only

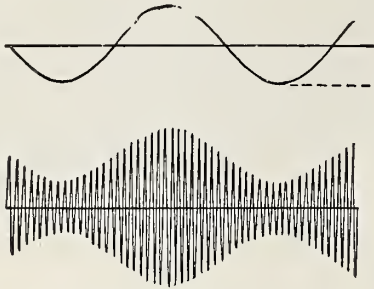

Fig. 3. Modulation of high frequency current. Upper curve represents voice wave; lower curve a high frequency current modulated by this voice current

be found by experiment, and the exact pressure to which the contact should be adjusted by experience.

A valuable aid in adjusting a crystal detector is the use of a test buzzer. A wire is connected from the terminal of the high pitched testing buzzer where contact is made with the vibrating arm. The tiny spark which you can see where the contact is made and broken serves to identify the correct terminal. This contact is connected with the secondary tuning inductance and causes a signal of standard strength to flow through the secondary circuit whenever the buzzer is put in operation. In

this way the most sensitive spot may be found without waiting for signals to come in.

The sensitive mineral should be protected from dirt and grease. An enclosed case is recommended.

All switch contacts should work smoothly and easily. They should occasionally be polished so that they do not become dull from corrosion. Sliders should make firm contact,

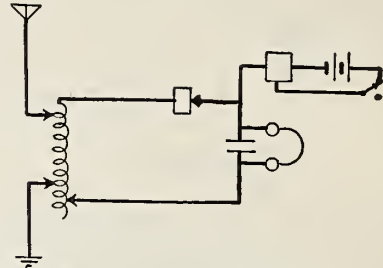
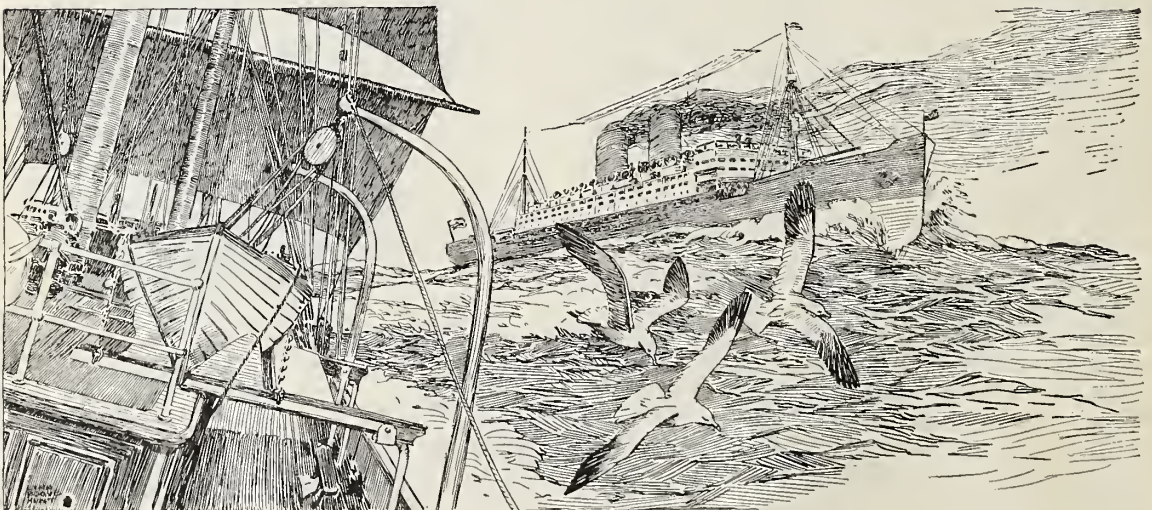

Fig. 4. Crystal receiver circuit showing test buzzer connections

yet not too firm to wear out the wire on the inductance.

The care and operation of a crystal set is a simple matter and brings its just reward.

The pleasure you obtain from a crystal receiver hinges largely upon your skill in adjusting the crystal detector. Transoceanic signals have been received on crystal sets, but it is more to the credit of the skill and patience of the operator than to the efficiency of the crystal receiver.



Keeping the Stars and Stripes in the Ether

By COMMANDER STANFORD C. HOOPER, U. S. N.

Head of the Radio Division in the Bureau of Engineering, Navy Department

IT CAN be stated without fear of contradiction that the very real importance of wireless, or radio, to the civilized world, and its almost limitless possibilities were not generally recognized prior to the outbreak of the war in Europe in August, 1914, except possibly by the military and naval officials of the leading powers who were intimately familiar with this branch of science, and by a few of the commercial concerns of the leading industrial nations engaged in world trade.

Any doubts which may have been entertained in the public mind of the practical utility of radio, must have been dispelled shortly after the outbreak of the war. These possible doubts were probably more quickly dispelled in Germany than elsewhere, because that country and its Allies were promptly isolated, so far as the exchanging of rapid communications with the North and South American Continents, Asia, Africa and the greater part of Europe was concerned, by the prompt cutting of all of her trans-ocean cables and the severing of other channels for exchanging rapid communications, except through her radio stations.

Upon the outbreak of the war in Europe, Germany was one of the two leading powers of Europe and one of the three leading powers of the world as regards the development and application of radio as a medium for exchanging rapid communications over both short and long distances, the other European power being Great Britain and the third power, although by no means third in rate of progress, being the United States of America.

The German Empire had already penetrated the United States in a radio sense by the establishment, in the year 1912, of the high power radio station located at Sayville, Long Island, New York, and a German firm was actively engaged in the construction of a second high power station at Tuckerton, New Jersey, when the war broke out, the latter named station ostensibly being established for a French concern.

An enormous volume of traffic, considering the limited normal traffic capacity of the station, was exchanged, subsequent to the outbreak of hostilities in Europe, between the Sayville station and a corresponding station situated at Nauen in Germany. In fact, this Sayville-Nauen circuit afforded the Central Powers the only channel for exchanging rapid communications with the outside world subsequent to the cutting of the German cables and the severing of the other channels of communication by the Allied Powers.

The British Marconi Company, a strictly commercial concern, with which the British Government was frequently rumored to be at odds, had also indirectly entrenched itself in the United States for communication purposes, by the formation of its affiliated company, the Marconi Wireless Telegraph Company of America. A considerable portion of the stock of this company was held by British subjects, and, as a natural consequence, the directing heads of the organization also were influenced largely by British subjects.

The operation of the German radio stations in the United States after the outbreak of hostilities, proved to be very embarrassing to our government, as the question of the maintenance of neutrality on our part was directly involved. Eventually it was found necessary to supplant the established censorship of the radio traffic passing through these stations by the replacement of the administration and operating personnel by radio personnel of the United States Navy.

The exchange of traffic between high power stations of the Marconi Wireless Telegraph Company of America located in the United States and corresponding stations of the British Marconi Company was prohibited by the British Government as a war measure, adequate facilities being available to the Allied Powers for the exchange of rapid communications by means of the transatlantic cable systems.



© Underwood & Underwood

OWEN D. YOUNG

Chief Counsel and Vice President of the General Electric Company, whose sense of patriotic duty, totally regardless of financial considerations, was the determining factor in the successful conclusion of the negotiations with the Navy



© Clinedinst

REAR-ADMIRAL WILLIAM H. G. BULLARD, U. S. N.

Who, as Director of Naval Communications in the Navy Department, so ably presented the Navy's point of view at the conference with the officials of the General Electric Company

The prediction enunciated in the following paragraph of the Government's radio policy, as established by President Roosevelt in the year 1904, may therefore be said to have been fulfilled:

"Because international questions may arise, due to the fact that the use of wireless-telegraph stations in our own possessions may affect the use of similar stations in foreign countries, it is desirable for the Congress to enact legislation which will enable the Government properly to handle such cases; failure to do so may seriously embarrass the Government at some future time."

These incidents served to emphasize the urgent necessity on the part of our government more clearly to establish its radio policy and to enact suitable legislation to effectually cope with abnormal conditions.

Upon our entrance into the World War the Sayville and Tuckerton stations were seized by the Alien Enemy Property Custodian, their operation, of course, being continued in the Government service by the Navy.

All non-government owned radio stations were promptly taken over by the Government and their maintenance, operation, protection, and administration entrusted by Presidential Proclamation to the care of the Navy.

Immediate steps were taken to improve not only the ex-German Sayville and Tuckerton stations but also the American Marconi's high-power stations to make trans-ocean communications by radio really effective and reliable and to meet the greatly increased requirements for trans-ocean communication as a result of our entrance into the war, and to provide an emergency means of trans-ocean communication in the event of the cutting of the cables by submarines, a contingency which was by no means regarded as remote.

Subsequently the Navy entered into negotiations with the American Marconi Company and also the Federal Telegraph Company, and, as a result, the Government purchased all of the Marconi Company's coastal medium and low power stations which included those situated in Alaska. It also purchased similar stations of the Federal Telegraph Company in the United States and the Hawaiian Islands.

As a consequence the Government obtained ownership of practically all shore radio stations situated within American territory, with the

exception of the Marconi Company's high power trans-ocean stations located at New Brunswick, New Jersey, Marion, Mass., Bolinas, California, and Kahuke in the Hawaiian Islands, thereby making our position as regards radio in connection with the national defense more secure, regardless of possible future legislation, as well as eliminating duplication of stations and ameliorating the exasperating problem of interference.

The only remaining feature of the situation which did not conform to the long established radio policy of the Government, especially as regards possible future embarrassments with respect to our status as a sovereign state, was the remaining practical ownership and direction, by other than United States citizens, of the American Marconi's high power stations situated within the United States and in the Hawaiian Islands in the Pacific.

It was obviously impracticable for our government to operate high power radio stations for exchanging communications with commercial stations situated in foreign countries, as a business venture, although the operation of such stations situated within the United States and in our outlying possessions for serving our Atlantic, Pacific and Asiatic Fleets had always been and is now, regarded as essential for military reasons.

The only logical solution of the problem therefore was to encourage the formation of a strictly American radio commercial company to take over the Marconi high power stations situated within American territory.

Negotiations were undertaken therefore with this end in view, and, on April 7, 1920, the Radio Corporation of America, a 100 per cent. American concern, came into existence, this corporation taking over the entire interests of the former Marconi Company, and incidentally assuring to our country, in conjunction with the existing extensive Naval radio stations, supremacy of the "ether" in other words, supremacy in the wireless service of the world.

The supremacy of America in this respect will be appreciated when it is understood that it has required more than twenty years of patient study, investigation, experimentation, and trial to develop the radio art to its present stage where not only ordinary radio communications between ship and shore can be reliably carried on, but where trans-ocean communica-

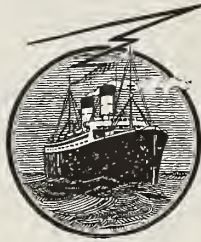

tions can also be reliably carried on in active competition with the ocean cable systems. When it is understood further that there are now ten super-high power radio stations in daily operation in the United States, five of the Radio Corporation of America, and five Naval, and seven similar stations in daily operation in our outlying possessions, one of the Radio Corporation of America, and six Naval, making a total of seventeen such American stations, one gets the picture. These stations are capable of spanning the Atlantic and Pacific Oceans, the Gulf of Mexico, the Caribbean Sea, the Gulf of Alaska, the Bering Sea, and reaching out into the Mediterranean, Black and Red Seas, the Indian Ocean and Asiatic waters.

The reliable effective transmitting ranges of each of these stations is from 3,500 to 6,000 miles, and, as the stations are located along our Atlantic and Pacific coasts, in the West Indies, in the Panama Canal Zone, in Hawaii, Guam, and the Philippines, it is obvious that their effective transmitting ranges cover the entire globe.

In addition to these, there are approximately 200 medium and low power stations having effective reliable communication ranges from 500 to 3,500 miles.

The number of American super-high power stations alone exceeds those of the rest of the world combined.

When the importance of radio is more fully realized by the general public, with the passing of time and the effecting of new developments in the radio art, the date of April 7, 1920, is likely to stand out more and more prominently in the history of radio signalling in its various forms and its relation to American interests and to the world.

Before that date, the birth-date of the Radio Corporation of America, there had been two or three attempts to form a large strictly American commercial radio company, but always without definite success. The Navy never had felt free to give full encouragement to the American Marconi Company because of its non-American character, as it was the established policy of the Government to encourage only companies controlled, at least largely, by American citizens.

The negotiations leading up to the formation of the Radio Corporation of America, and the decisions necessary to bring this about required

foresight and courage, and a high sense of patriotic duty on the part of those prominently engaged in its successful accomplishment.

The writer claims no credit for the result achieved, other than having made the original suggestion that the time seemed opportune to bring about its accomplishment.

After the negotiations were gotten under way the necessary details were handled by those within whose province those details came.

Special mention should be made however of the name of Admiral Bullard, who was detailed to the Department for duty as Director of Naval Communications and for carrying on the negotiations for the Navy; and particularly of the name of Mr. Owen D. Young, Chief Counsel and Vice President of the General Electric Company, whose sense of patriotic duty, totally regardless of financial considerations, was the determining factor in the successful conclusion of the negotiations.

The United States had not long been in the war when it became evident that the trans-Atlantic and trans-Pacific cables were loaded to their full traffic capacity, and it became obvious therefore that preparations would have to be made to handle large volumes of trans-ocean traffic by radio, thereby not only augmenting the cable service but providing emergency communication facilities should the cables be cut by submarines, especially the trans-Atlantic cables, the safety of which was by no means certain.

As Head of the Radio Division, the responsibility devolved on me to formulate plans, as far as the material matters were concerned, and consequently I arranged for conferences early in the fall of 1917 to decide definitely on plans for building up this service.

Representatives of the Army and of the Allied Powers were present at these conferences.

The requirements were placed before the conferees, and, as a result of the deliberations, definite plans were made, and the service was eventually built up to such a state of perfection that trans-ocean communications were made reliable and effective throughout the year.

This necessitated the replacement of the German transmitting apparatus by more modern and powerful equipment of American manufacture in the Sayville and Tuckerton stations; the replacement of the Marconi apparatus in the New Brunswick station by



Alexanderson alternators of the General Electric Company's manufacture, and the establishment of a 500-kilowatt power transmitting station at Annapolis, Maryland, and a corresponding station, but of twice this power, or 1,000 kilowatts, at Croix d'Hins near Bordeaux in France. Poulsen-Federal arc transmitters of the Federal Telegraph Company's manufacture were installed in the last named two stations, these two stations being the most powerful radio stations projected in the world at that time.

The Navy was charged with the full responsibility for all matters pertaining to radio after our entrance into the war, with the exception of strictly Army communication matters, and very close coöperation was maintained with the Army, as evidenced by the fact that the Navy took full charge of the construction of the 1,000-kilowatt station in France to insure the maintenance of rapid communication facilities for our Expeditionary Forces in France in the event of the cutting of the cables.

The Navy therefore had available to it the combined radio engineering talent of the entire United States, and too much praise cannot be given to the civilian radio engineers for the services rendered the Navy in this emergency.

As a result of the abnormally rapid advance brought about in the development of the radio art, as a consequence of the exigencies of war, and with the consequent production of new and improved apparatus and the inauguration of improved methods, the General Electric Company was found, upon the cessation of hostilities, to possess the ownership of a large number of the valuable patents covering modern radio apparatus, such as the Alexanderson alternator or transmitter, the vacuum tube transmitting and receiving equipment and the photographic recorder for automatic reception of radio traffic at high speed of say 200 words per minute as distinguished from the normal average hand sending speed of 20 words per minute.

The British Marconi Company, having previously enjoyed possession of ownership of the most valuable radio patents, were tardy in their research work, as they apparently felt that they enjoyed a monopoly in this respect, and need have no fear of a competitor.

It was apparent however that they suddenly became convinced that if they did not get hold

of certain General Electric patents, either the patents themselves or the license right of them, they would be unable to compete long in modern radio, because it was obvious that a company having the improved apparatus covered by these patents could cut in on them seriously, and perhaps drive them out of the field.

Negotiations were entered into with the General Electric Company by the British Marconi Company following the war with a view to effecting the purchase of several million dollars' worth of the improved apparatus, information to this effect becoming available to the Navy Department through the ordinary trade channels.

When I heard of this impending deal, I became convinced that the whole future of American radio communications was involved, and it was my conviction that the Government's established radio policy would fail utterly if any deal was

made which would give the British Marconi Company the sole rights to these patents or would give them a chance to get the first out-put of this modern apparatus from the General Electric Company's factories, because if they acquired the apparatus and had time to place it in service, no other radio company could catch up with them, and it would be impossible to interest American business men in the establishment of a strictly American commercial radio company, owing to the tremendous power which the British Marconi Company would have acquired.

The situation appeared to require immediate action, and, obviously, some degree of secrecy was essential.

On April 3, 1919, Admiral Bullard had but three days before arrived in Washington and taken up his new duties as Director of Naval Communications in the Navy Department, but as yet had had no opportunity to familiarize himself with the situation when the writer, accompanied by Commander George C. Sweet, United States Navy, now retired, went to him and laid the whole situation before him, with recommendations that a conference be held with the directors of the General Electric Company.

As a result of this conference, it was decided at once to get into touch with the General Electric Company by long distance phone with a view to arranging a conference in which the entire matter could be laid before the directors of the Company from the Navy's point of view.



I communicated with the General Electric Company and requested that we be given an opportunity to meet the directors on very important matters at the earliest possible date.

As a result, a conference was arranged with the General Electric officials, this conference taking place at 120 Broadway, New York, on April 7, 1919.

Admiral Bullard very ably presented the Navy's point of view to the conference and impressed the officials of the General Electric Company with the seriousness of the situation from a national point of view. After extensive questioning by Mr. Young of the General Electric Company he became convinced that it would be unpatriotic for the Company to continue its plans with the British Marconi Company, and that there was nothing for it to do but to cancel the proposed agreement with the British Marconi Company, and it was due to his courageous decision and able presentation of the situation that Mr. Coffin, Mr. Rice, Mr. Stone and Mr. A. G. Davis and others of the directors present were convinced that drastic action was essential, regardless of financial considerations, on the part of the Company.

After giving thorough consideration to the subject, the General Electric Company's representatives made the statement that they had not previously realized the importance of the matter from a national point of view, as they were a manufacturing concern and in the market for world trade, but that decidedly, they had no intention of subscribing to any plan which would prove inimical to the best interests of the United States.

The Navy representatives suggested that the Company should go into the radio operating business itself, or make some arrangements with existing American companies to handle the radio situation in a way that would guarantee American interests not only from a business point of view but also in the interests of the national defense.

The plan agreed upon by the Company in the conference of April 7, 1919, was that, if the General Electric Company obtained the British holdings in the American Company, they would absorb the Marconi Wireless Telegraph Company of America.

It was subsequently ascertained, however, that the American directors of the American

Marconi Company were in a receptive frame of mind as regards coming into the new company, as they themselves were aware of the fact that the major portion of the stock of the company was in British hands, and they frankly stated that the previous arrangement had never been quite satisfactory to them, that it had been looked upon with some anxiety and that therefore they welcomed some new arrangement such as the one proposed.

As a consequence the General Electric Company arranged that Mr. A. G. Davis and Mr. E. J. Nally (representing the American interests of the American Marconi Company) should go abroad for the purpose of terminating the pending deal for new apparatus, and also to negotiate with the British Marconi Company's officials for the purchase of their interest in the American Company, it being subsequently verified by their representative that the British interests were very large indeed.

At this time we were still using the service that we had built up during the war and were doing a tremendous amount of business across the Atlantic and Pacific oceans, but we were very desirous of transferring other than the Navy stations back to private ownership as soon as the deal could be accomplished.

Finally the General Electric Company was successful with the British Marconi officials and satisfactory arrangements were also made with the American officials of the American Marconi Company, and as a result the Radio Corporation of America was established.

With a view to making it possible to market the vacuum tube receiving equipment, the General Electric Company and the American Telephone and Telegraph Company exchanged licenses on their equipment, and the Radio Corporation of America came in on this exchange. In other words, the American Telephone and Telegraph Company with its subsidiary the Western Electric Company, the General Electric Company and the Radio Corporation of America all cross-licensed with one another in order to facilitate the sale of the American controlled equipment, this arrangement being due partly to the suggestion of the Radio Division of the Navy.

This arrangement was distinctly in the best interests of the public service, because it provided for the production and application in



service of this most important apparatus which otherwise would have been greatly retarded owing to the badly tangled patent situation among the American radio concerns themselves, and it resulted in the American radio services being freed from the handicaps which would otherwise have greatly retarded the forward march of progress in the development of the radio art in the United States.

The Navy in other ways gave its best advice and coöperation to the newly formed Radio Corporation of America for reasons which are obvious from the foregoing.

The cross-licensing on the part of the American Telegraph and Telephone Company, General Electric Company and Radio Corporation of America, together with our extensive and efficient manufacturing facilities for radio apparatus, and our extensive and widely separated chain of shore radio stations, has placed the United States in an unassailable position as regards all matters pertaining to radio, the immense value of which from the point of view of our humanitarian efforts, the national defense, our commercial interests and the nation's prestige throughout the world will undoubtedly be more fully realized as time goes on and further developments are made in the radio art.

Subsequent to the arrangements having been mutually made between the above companies, the Westinghouse Manufacturing and Electric Company and the Tropical Radio Company were also taken into the agreement.

It may be stated that, as a direct result of

the conference of April 7, 1919, American radio became the most powerful in the world, whereas prior to that time the British Marconi Company must have felt that their hold on the world in this respect was secure. The really important feature, however, is that, as a result of that conference, all of the radio interests of the United States were for the first time placed entirely in the hands of American citizens.

The Navy pointed out to the newly formed Radio Corporation that it should be to their interest to have connections with South America, in order to extend the all-American chain of high power stations, in the interest of the advance of trade and coöperation between North and South America.

The British, Germans, and French had secured concessions in South America which made this situation a very difficult one to handle, but through able management a compromise was effected, and, as a result, the Radio Corporation has entered into an arrangement with the British, Germans, and French in South America, while yet keeping control of the advantages already gained as outlined in this article.

We are now entering upon the era of radio-telephony, the future developments in which and the results therefrom no one can foresee.

The possibilities for good or for evil are so tremendous that it obviously is of primary importance that we guard our pre-eminent position in the radio world and maintain the lead which we now enjoy.



Radio Personalities

III

R. A. HEISING

The Man Who Solved the Problem of Sound Modulation by Radio

By EDGAR H. FELIX, A. I. R. E.

SELDOM does an inventor perfect his discovery and later realize its importance. The process is usually reversed and of four steps: first, the germ of an idea, second, a crude model; third, the acclamation of his discovery to the world; and fourth—if he ever reaches

that stage—the long and difficult process of perfecting the idea.

In this Reginald A. Heising, the inventor of the modulation system which makes broadcast music a practical possibility to-day, is the exception among a hundred great inventors. His discovery removed what had long been

the most baffling problem of radio telephonic communication. For some time prior to the development of the Heising system, methods of producing continuous waves, which are essential to radio telephone communication, were known to radio engineers. But the best, of the pre-Heising modulation systems failed in controlling any but the lowest power.

"By what process," I asked Mr. Heising at his New York laboratories of the Western Electric Company, "were you led to discover your system of modulation?"

"During my college days I realized that radio telephony would never come to its own until we were able to control high powers of continuous wave energy by means of the voice. All efforts had been concentrated on perfecting the microphone so that it could handle high powers and heavy currents flowing through it.

"Instead of aiming to solve the weaknesses of the microphone, I sought other means. This naturally led me to make the experiments resulting in the system of constant potential modulation."

This phrase, "my college days," may lead the reader to think of Mr. Heising as an old man. He is not; he is young, of quiet mien and deliberate manner. My conversation with him convinced me that Mr. Heising's inventive genius lies in his ability to visualize his problem graphically. His conception of electric circuits is so clear that he mentally sees the minute currents throbbing through the circuits. As a result, instead of attempting to scale insurmountable obstacles he quickly perceives the weak point, through which he can attain his objective.

Immediately after obtaining his Master of Science degree at Wisconsin in 1914, Mr. Heising joined the research forces of the Western Electric Company. His success in dealing with problems in modulation resulted in the award, in 1921, of the Morris Liebmann Memorial Prize by the Institute of Radio Engineers. This is the highest tribute which the radio fraternity can bestow upon a fellow scientist.

When I learned that his first patent, which established the basic principle of the Heising system, was applied for within six weeks after he began his experimental work with the Western Electric Company, I asked:

"How were you able to solve in so short a time this tremendously important problem on



REGINALD A. HEISING

which experienced engineers had been working so many years before you were out of your teens?"

"I did not realize I was working on an important problem," answered Mr. Heising. "My first step was to get a concrete idea of what was needed and to consider the various ways in which it could be met. By imagining the various possibilities in operation, I was able to eliminate most of the possibilities which occurred to my mind. So I very soon concentrated my efforts upon the control of the space current of the generating tubes, instead of, as had been the practice in the past, attempting to control the current by varying the resistance of the antenna circuit.

"It required but a few laboratory experiments to prove the correctness of the principle, and patents were quickly obtained. Later experiments proved that constant plate potential, with variation of the current in accordance with speech was not as effective as control of the plate potential by the voice, with constant current."

"You say you did not realize the importance of the problem? Had you realized it, do you believe you would have been as quick in your success?"

"I do not mean that I did not realize the

importance of the problem. What was uppermost in my mind was the problem itself. In fact, it was not until the patents had been obtained, that I considered their significance. One night, shortly after patents were filed, as I lay awake, the possibilities of the system flashed through my mind. The technical and scientific improvement, I must admit, was quickly overshadowed by the whole vision of what the radio telephone could accomplish; its possible effect upon our national life and welfare and the social and economic value of the transmission of speech so that it could be heard all over the country at the same time. It has taken time to see the realization of some of these dreams and even to-day we are only making a beginning."

Briefly, the Heising modulation system is as follows: words or music actuate a microphone through which the current from a battery is flowing. The sound variations cause the resistance of the microphone to change as the sound waves impinge upon it. The current in the microphone circuit thus varies with the speech. Hence it is called speech current. The speech current, in turn, is impressed on the grid of a vacuum tube, causing similar but greatly augmented variations in the output of the tube. If high powers are to be controlled, this speech current is magnified by additional modulator tubes, until the voltage variation is sufficiently large to modulate the power output of the oscillator or radio frequency generating tubes.

The output of the last modulator tube is impressed upon the source of plate potential of the power tubes so that their source of plate potential rises and falls in accordance with the sound waves of the speech or music to be transmitted. The space current in a vacuum tube rises and falls with each change of plate potential. As a consequence, when the plate potential rises and falls in accordance with the sound waves impressed upon the transmitting microphone, the radiated energy varies in the same way.

Amateurs, who are interested in the principles of modulation or who wish to construct radio telephone transmitters, will find Mr. Heising's paper, "The Audion Oscillator," appearing in the April and May, 1920, issues of the Journal of the American Institute of Electrical Engineers, and the paper on "Modulation in Radio Telephony", in the August, 1921, issue of the Proceedings of the Institute of Radio Engineers of great assistance in designing their apparatus. In these papers, Mr. Heising describes fully all circuits used and the advantages and disadvantages of each.

Recently Mr. Heising conducted a series of experiments in operating a printing telegraph by radio. Their success proves radio to be as flexible as wire communication. As many as 29,000 characters have been transmitted through two channels working simultaneously in one hour, with but fourteen mistakes attributable to radio shortcomings. The speed with which the printer could be operated was in no way limited by radio.

The career of Reginald Heising is remarkable for the extraordinary directness with which he has solved the most perplexing problems—the result of his remarkable and almost intuitional perception of the essential facts in radio. The important invention which led to Mr. Heising's recognition as one of the foremost radio engineers and discoverers of our time—the solution of the problem of modulation—was made within six weeks after he was graduated from college and started to work. Since that time he has greatly improved his system until it has become an essential factor in radio telephony. The many patents which have been granted over Mr. Heising's name and his important contributions to scientific literature are evidences of continued progress. Being still a young man, it is natural that more great things are expected from him. In the meantime, broadcast enthusiasts have much to be grateful for to Mr. Heising.

Here Are Four Well Known Radio Editors



Allen H. Wood, Jr., Technical Adviser
on Radio to the Boston Sunday *Herald*

Jack Binns, Radio Editor
of the New York *Tribune*

William F. B. McNeary, Radio Editor
of The Newark, N. J. *Call*. Known to
thousands of children as "The Man in
the Moon"



Milton Waldeman, Radio Editor of the New York *Globe*

What the Detroit "News" Has Done in Broadcasting

Being the Story of the First Local and National Election Returns, Music, World's Series Base Ball Results, Poetry, Theatrical Entertainments, Sermons and Speeches by Public Men Ever Broadcasted by a Newspaper

By R. J. McLAUHLIN

THE Detroit *News* was the first newspaper in the United States and, so far as is known, in the world, to perceive the possibilities of increasing its usefulness by furnishing the public with radio service. When the broadcasting was inaugurated nearly two years ago, wireless telephony, although it had reached a commercial stage and was already the hobby of a few enthusiastic experimenters, still remained a mystery to the community in general and was looked upon by many as possibly a familiar source of enjoyment to their grandchildren but of no particular interest or importance to the present generation. This

sentiment was changed virtually overnight when, in August, 1920, the Detroit *News* installed its first transmitting station and commenced its regular broadcasting.

The original apparatus consisted of a De Forest Type OT-TO transmitter, using a 200 meter wave length. Its range was limited, being, under the best of conditions, not more than 100 miles, and at this time there were approximately only 300 operators in the territory thus covered. The transmission set was in place ready for operation on Aug. 20, 1920, but no announcement was made to the public until a series of experimental concerts had been conducted over a period of ten days.



Detroit News Building



Chief Operator and part of Detroit *News* Radio Laboratory

These concerts were enjoyed by no one save such amateurs as happened to be listening in. Everything was found to be successful and satisfactory, and, on Aug. 31, which was the primary day, it was announced that returns from the local, state, and congressional primaries would be sent to the public by means of the radio.

The *News* of Sept. 1, carried the following announcement;

"The sending of the election returns by the Detroit *News* Radiophone Tuesday night was fraught with romance, and must go down in the history of man's conquest of the elements as a gigantic step in his progress. In the

four hours that the apparatus, set up in an out-of-the-way corner of the *News* building, was hissing and whirring its message into space, few realized that a dream and a prediction had come true. The news of the world was being given forth through this invisible trumpet to the waiting crowds in the unseen market place."

It was Aug. 31, then, which marked the beginning of wireless telephony as a social service. On that day the dream of actual vocal communication between points far distant and without any physical union came true on an astonishingly large scale. The public of Detroit and its environs was then made to



Robert W. Kelly, Radio Editor of the Detroit *News*

realize that what had been a laboratory curiosity had become a commonplace of everyday life, and that the future held extraordinary developments which would affect all society.

Every week-day since that date the *News* has broadcasted a programme to an ever-increasing audience. There has been no interruption in this service, and the programmes have constantly become more extensive and elaborate.

At first the concerts were confined entirely to phonograph music. Two programmes were broadcasted daily—one at 11:30 A. M. and the other at 7 P. M.—and, after a time, speakers and singers were occasionally secured to entertain the invisible audience.

Soon reports commenced coming in from outlying communities that the concerts were being successfully received and tremendously enjoyed. The radio has become such a familiar affair in so short a space of time that it seems odd to consider how remarkable this was regarded at the time. The thing held the

element of magic. The local receiving set became the centre of wondering interest in the little suburban town. The interest grew and dealers reported a demand for radio materials.

Then the steamer *W. A. Bradley* reported through the Marconi station at Ecorse—a little town west of Detroit—that the music of a *News* concert had been received where the vessel was steaming along through the night in the middle of Lake St. Clair. This, somehow, impressed the public as even more remarkable than sending the music over land, although, of course, it was not so. But the notion of a ship far off from land actually comprehending the words spoken and the music performed in a little room of a building in a great city seemed a peculiarly significant conquest over distance and darkness.

During the first week of broadcasting a party at the home of Mr. O. F. Hammond, 180 Parker Avenue, Detroit, danced to music sent out by the *News* apparatus and this was considered the local beginning of the social aspect of wireless telephony.

The man in the street, traditionally sceptical, was much impressed when, in October, 1920, the results of the World's Series contest between Cleveland and Brooklyn were instantly sent out to the waiting base-ball enthusiasts, and the first returns of a national election ever broadcasted were given by the *News* in November of the same year when hundreds of partisan voters held receivers to their ears and were informed by the voice through the ether that Harding had rolled up an enormous majority over Cox.

When the Christmas season came around, the number of radio amateurs had greatly increased in Detroit and the surrounding communities. Small boys were becoming great enthusiasts and Santa Claus remembered a great many with receiving sets. This added members to the *News* family of radio enthusiasts, and special holiday music, appropriate to the season, was broadcasted.

On New Year's Day of 1921 the *News* stated: "For the first time, as far as known, a human voice singing a New Year's melody of cheer went out across uncounted miles over the invisible ether that is the medium of the wireless telephone when Louis Colombo, Detroit attorney and famous baritone, sent his resonant tones into the mouthpiece at the office of the Detroit *News* at midnight, Friday."

And an astonishing achievement was con-

sidered to have been performed when those in attendance at a banquet at the Masonic Temple heard a concert received in the banquet hall by means of a three-wire aerial strung along the ceiling.

By this time the original transmitting set was found to be inadequate for the increasing requirements and it was almost entirely rebuilt. In the following June a two-wire antenna, 290 feet in length, was stretched between the *News* building and the Fort Shelby Hotel. Soon reports began to come in from distant points that the *News* concerts were being quite audibly received. Belleville, Ill., sent word that the concerts were enjoyed there and Atlanta, Ga., startled even the *News* operators by announcing that the broadcasting was carrying successfully to that distant place. Code messages came in from remote radio stations everywhere in the world, including the U. S. Navy station at Bordeaux, France, Nauen, Germany, and Hawaii.

The *News* now decided to organize its pro-

grammes on a more elaborate scale. They had previously been restricted, principally, to phonograph music and news bulletins, but now musicians were added and theatrical talent secured from Detroit playhouses to supplement this. The first noted literary man to send out his compositions through the ether to thousands of ear-pieces, was Edmund Vance Cook, the poet.

In December, 1921, the present ambitious programme was inaugurated. By this time the radio department occupied the entire time of a programme manager and two technical men, which staff has now grown to eight persons.

To-day phonograph music occupies an incidental place on the daily schedule, and the programmes are filled by stage celebrities, prominent clergymen, musicians and public figures of various sorts, many with national reputations. Among the noted stage persons who have made their radio debut in the *News* transmitting room are Frank Tinney, Van and Schenk, Percy Wenrich, and Lew Fields.



Detroit *News* Auditorium

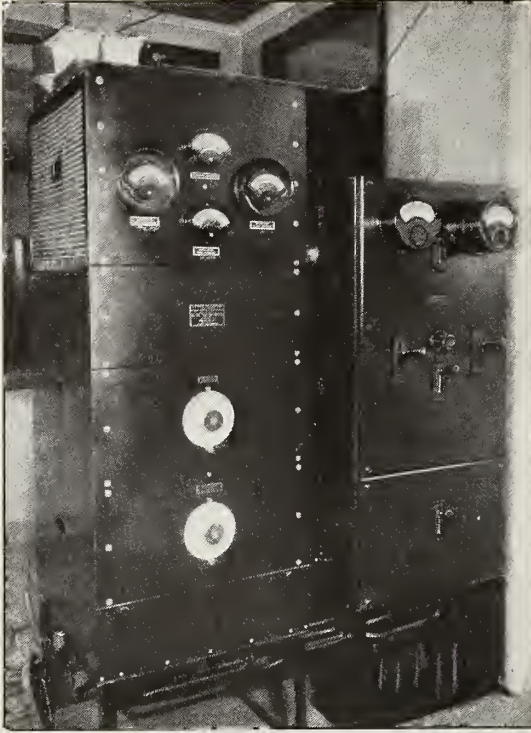

Detroit *News* Radio Broadcasting Installation. Transmitting panel at left. Control panel at right

Another point in last December's expansion of programmes was the securing of Finzel's Orchestra and other musical organizations with numerous members. These orchestras furnish music of various kinds, including dance music, and it is common for Detroit families to hold parties in their homes and dance to the music played by their favorite orchestra. The second Christmas concert presented by the *News* last year consisted of songs by carolers and addresses by Gov. Groesbeck of the State of Michigan, Mayor Couzens of Detroit and the Rt. Rev. Fr. John P. McNichols, president of the University of Detroit.

In February of this year the first concert by the Detroit Symphony Orchestra was broadcasted. Now every programme presented by that splendid organization is sent to music lovers not only in Detroit but over half of the United States. Expressions of enthusiastic appreciation from persons in all walks of life have followed this development of the *News* radio service. Contributions for the support of the orchestra have come from grateful people in a score of states who have thus been enabled to hear much finer music than could ever before be heard in the small towns

where they make their residence. The radio has opened new worlds of melody to music-hungry folk throughout the Middle West.

The *News* has received letters from Honduras, from Alaska, from Saskatchewan and Alberta, from Cuba, from officers on vessels on the Atlantic Ocean, from a ranchman in Wyoming, and from scores of other remote places, expressing thanks to the *News* for bringing across the great spaces such splendid music, such first-class theatrical entertainment and such rousing and stimulating messages from the leaders of the country's thought. All this has been extremely gratifying to those behind the project and has persuaded them that the great expenditure which the radio service has entailed has been amply rewarded in the consciousness of enhanced public usefulness.

A curious thing in connection with the broadcasting has been the reaction of stage artists to the undemonstrative little receiver into which they pour their songs and remarks. Frank Tinney refused to believe that he was not the victim of a hoax and that he was in reality not talking for the sole entertainment of the persons in the tiny auditorium where the transmitting apparatus is located. He was not convinced that a trick was not being played upon him until he heard music relayed back by telephone from Windsor across the river. This has been noticed in the case of almost every artist who is accustomed to applause as occasional motive power.

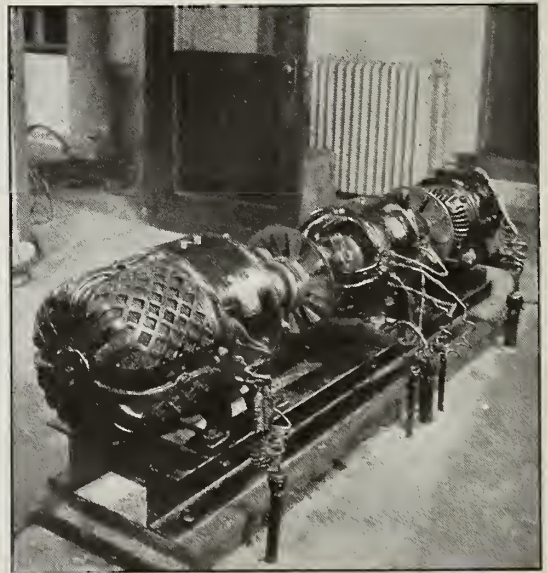

Detroit *News* Radio Laboratory Power Room

The *News* of Dec. 18, 1921, commented on this as follows:

"The receiver is not a very appreciative instrument, at least in appearance. One can't tell from the looks of the telephone whether his number is liked or not.

"This was quite baffling to Ernie Ball. He sang one or two of his most popular numbers, heard no applause and finally looked at the telephone in a manner that registered blind rage. And then he stuck out his tongue at the instrument which seemed to relieve his feelings a lot, for he swung immediately into another selection.

"In the case of Mr. Tinney, it was hard to convince that personage that this phenomenon was actually happening. Again and again he demanded to know if the thing were on the square, it was that uncanny. Of all the entertainers who appeared last week, Mr. Tinney probably suffered the most because of the absence of applause. The nature of his offering was such that it was almost necessary for him to have some demonstration of how folks liked what he was saying. This demonstration in all cases was not long in coming, for, at every concert, some of the appreciative listeners in flashed back their thanks and asked for more."

On the first of February of this year the installation was completed by the Western Electric Company of a 500 watt, 300 to 600 meter broadcasting set of the same type now being completed for the American Telephone and Telegraph Company on the roof of the Walker Lisenard Building, New York. Its power comes from two generators, one of 1400 and the other of 1500 volts, harnessed to a 5 H. P. DC motor. It is equipped with a specially high quality speech input arrangement, such as that used by President Harding at Arlington Cemetery last November, in which two No. 212-250 watt Western Electric vacuum tubes were used as oscillators and two more used as modulators.

One peculiarity about this set is the fact that, although it is only of 500 watt power when not in use, its power rises to 750 watts when

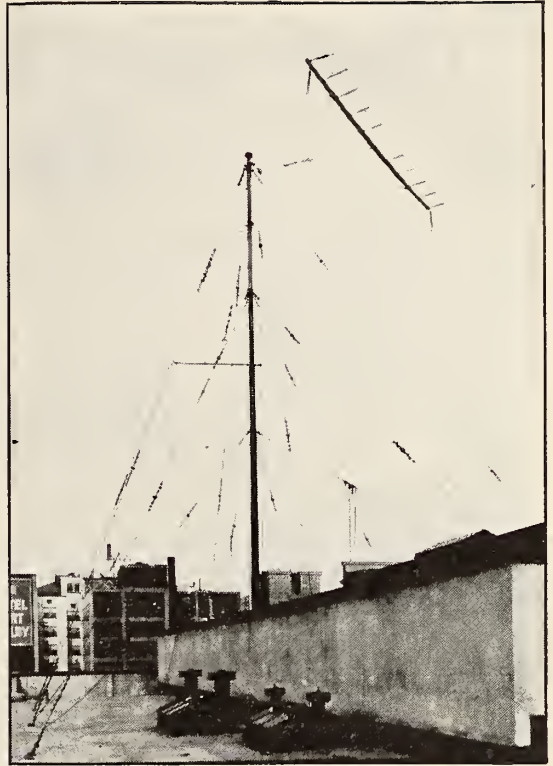

Aerial terminal on Detroit *News* Building

subject to conversation or music. Another feature is the fact that the power panel is entirely devoid of live points on its surface. All of the switches are concealed.

Since the transmitter used in the speech input section of the device is not as sensitive as the ordinary type, a Western Electric amplifier is used, which magnifies the voice about a hundred thousand times without producing any distortion.

This installation has an ordinary broadcasting radius of 1,500 miles, but reports have been received from points 2,300 miles away telling of successful receiving. The set was built to the special order of the *News* and is the only one of its kind thus far completed by the manufacturers. With this splendid equipment the *News* plans future radio activities on an even more elaborate scale than has thus far obtained.

The Amateur Radio Laboratory

Its Equipment and Uses

By ZEH BOUCK

IT WAS only in recent years that I was initiated into the delights and facilities of a well-equipped radio lab. Until then I had been content (where ignorance is bliss) to struggle along with brace and bit, borrowed for occasions, a soldering iron, a can of Nokorode and the kitchen tubs when available. Being anything but a mechanic, indeed I preferred designing unlimited transformers to cutting a single piece of core for one, I was almost entirely dependent on uncertain electrical supply stores for parts and sundries, bent and twisted to the proper shapes. Thus it was not remarkable that the game was seldom worth the candle, and my homemade apparatus, possibly well designed but poorly constructed, was often less efficient than manufactured instruments purchased at a saving in time if not of money.

My radio tests and experiments were always limited by our neighbors' sense of humor and the physical characteristics of a city apartment; they found a meagre expression in spark and Tesla coils.

About the time of honeycomb sets my radio common-sense, spurred by financial considerations, determined me to buy my apparatus only, and to table the experimental and constructional end until circumstances warranted a lavish layout. My determination was stimulated by a friend, an electro-chemical engineer, who desiring to take up radio, came to me for aid in selecting his original receiving set. His knowledge of the subject was then altogether theoretical (he knew high frequency A.C.), and so was willing to act on any advice I might offer. Realizing that he possessed an electrical laboratory with some constructional facilities, I suggested that we make the set (I had a pet design in mind) rather than purchase it outright. He welcomed the idea and promised to procure the necessary parts which I had enumerated in a long list. But alas! I failed to caution him on the correlation of sizes and similar details that my own experience had given me cause to respect, and his final conglomeration of radio in the making was one

that would have stumped a better mechanic than I to put together!

I remarked sarcastically that the three sixteenths variometer shafts were hardly good fits for knobs and dials drilled with a quarter-inch hole.

"Oh, that's all right," my friend was undaunted. "I've got some quarter-inch rod around here; I'll drill it out and make sleeves!"

I next complained of the inferior jacks he had bought, commenting on how poorly their brass ends would show up against the nickle-plating on the panel. He merely smiled quietly and a quarter of an hour later they were nickle-plated and buffed!

I then preserved peace until on hooking up I found that my friend had supplied me with number twelve hard-drawn wire, which, in its adamant quality, was as difficult to work as a high-tension bus-bar. I struck then and there, but the engineer, not perturbed in the least, made some reference to an electric furnace, and taking the wire with him, left the room. Before I had cleaned the soldering iron, he returned with the wire soft and pliable. He had annealed it!

We worked steadily but without rush or overexertion, and the afternoon of the second day saw the set complete and working! The apparatus combined long and short wave regenerative sets with a detector and two stage amplifier; an installation with a market value in excess of one hundred and fifty dollars, and which we had constructed for less than half that amount.

In the radio laboratory I would first emphasize the shop. While electrical equipment is also of primary importance, the apparatus itself more than justifies, indeed demands, a well-stocked workroom. In the average lab consisting of two rooms, the workshop is separate from the operating quarters. Of this type is the laboratory of Messrs. Howell and Woodrow whose call, 2AQQ, is familiar to New York operators. A section of the shop

is generally devoted to a testing table with outlets tapped to all wires running to the operating room. There is easy access to antenna and ground connections, A. C. and D. C. lines, and in the case of three wire systems both 110 and 220 volts are available. Wires are usually led from the A and B batteries in the shack so that all working conditions can be duplicated in the shop and apparatus given practical tryouts before being permanently installed.

The tool equipment of the shop varies proportionally to the owner's pocketbook, and paradoxically it is often an inverse proportion. It invariably includes the conventional carpenter's implements augmented by such drills, saws, etc., as facilitate working with bakelite, metal, and less ductile materials. An assortment of taps and dies is almost as essential as the soldering iron with its inevitable can of Nokorode. There, too, is the ubiquitous set of drawing instruments (the dividers gradually wearing away under the stress of many sharpenings) used in designing and laying out panels. In the more pretentious laboratories are found the bench lathe and drill press, tending through speed and accuracy to greater efficiency.

The accompanying photo shows the operat-

ing end of a radio laboratory in New York, owned by Mr. Henry Muller. This station, 2BH, stands an eloquent testimonial to the advantage of the well-equipped shop. The transmitting apparatus, a bulb set shown to the left, was designed electrically by the author, and constructed with meticulous attention to detail by Mr. Muller. All holes, with the exception of those inaccessible to the press, were drilled by machine. The large openings for the meters were cut by a power scroll-saw. The brackets were cut, drilled, and bent from massive strip brass, while the bushings and some back-of-the-panel construction are evidence of excellent lathe work. The core for chokes and the filament heating transformer were snipped from sheet iron and wound with commercial accuracy on a lathe. The tuning and amplifying cabinets show the intelligent use of good tools.

Indispensable to the radio lab are the raw materials with the almost infinite list of odds and ends. The miscellany of bakelite, hard rubber, brass and copper strips, nuts, bolts (six and eight thirty-two's predominating), glass, mica, "cabbages and kings" are of inestimable value when arranged in any semblance to system.

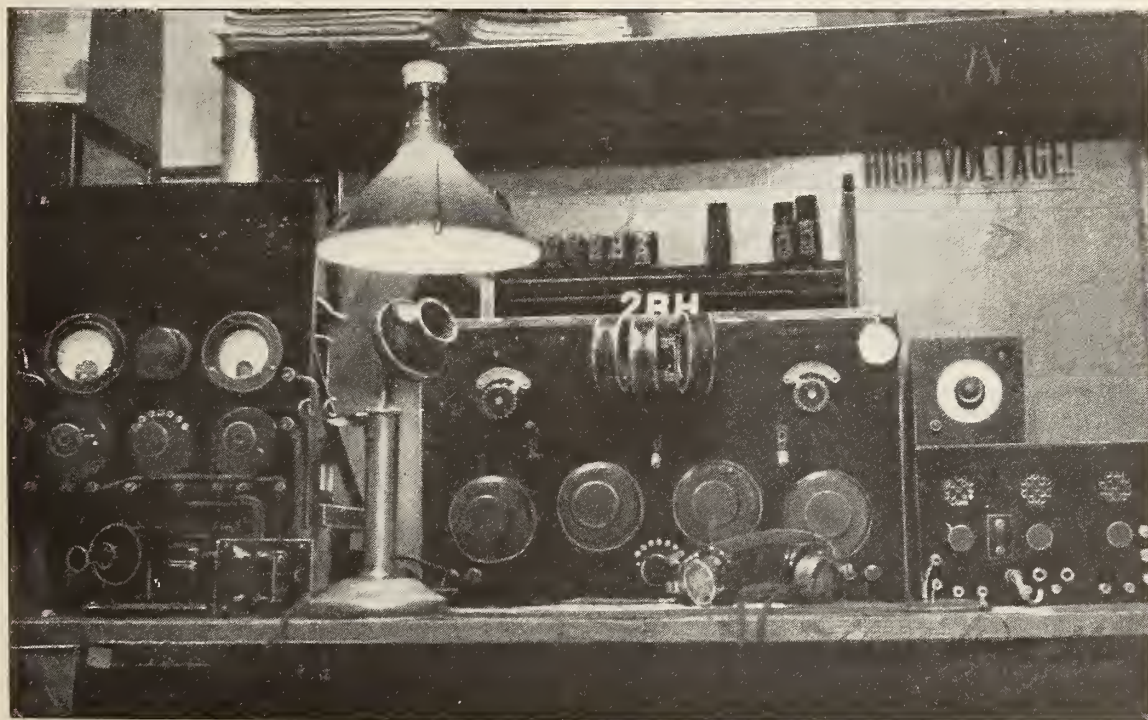

Operating table of an up-to-date amateur station (Radio 2BH)

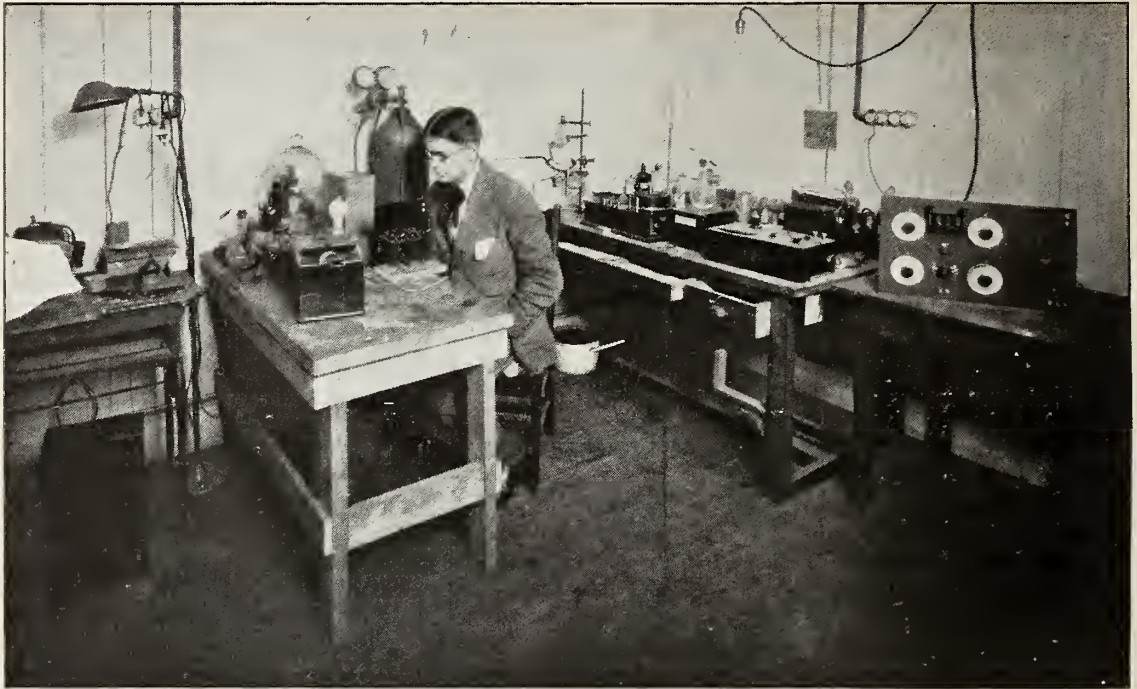

AMATEUR LABORATORY OF CHARLES P. MADSEN

Testing for faulty insulation. A partially completed receiving set is shown on the table to the right

The lab's electrical equipment is greatly dependent on the shop in which many of the instruments are designed and made. The actual transmitting and receiving apparatus is of first importance, and the photograph of 2BH gives an idea of the general trend in amateur shacks toward commercial lines. Mr. Muller's equipment, which has been partially described, is arranged similarly to a ship station which he operated for some time. The receiving set employs variometer regeneration on short waves, with honeycombs for six hundred meters and above, change from one to the other being effected by telephone switches in the centre panel. A loud-talker, operated from the second step, is not shown in the illustration. A possible and desirable addition to 2BH would be a spark transmitter, either 500 cycle quenched or 60 cycle rotary synchronous.

A charging system for storage batteries is another early consideration which, in the case of D. C., is easily installed by means of resistances or lampbank. If the station is wired only for A. C., some form of rectification must be employed; the most efficient methods being the two electrode valve (vacuum tube) and the motor-generator.

First among the radio frequency instruments is the wave-meter—in Mr. Muller's station, that prominent piece of apparatus resting on the detector cabinet. A dummy antenna, duplicating the capacity and inductance of the transmitting aerial, is indispensable for preliminary tuning without causing unnecessary QRM (interference). A small transmitting loop in conjunction with a single tube high frequency oscillator finds innumerable experimental adaptations. Nickle and copper plating equipment assures a uniform appearance to all parts without the irksome dependence on the electrical supply house.

A set of meters with auxiliary shunts and resistances is essential for electrical measurements. In delicate experiments the mil-amp and micro-volt meters are used in connection with a potentiometer, while in A. C. transformer work, such as the careful tuning of a spark transmitter, alternating current volt, amp and watt meters are required. For high frequency readings (radiation, etc.) a thermocouple meter is given preference over the hot-wire type. The direct reading ohm-meter (an English invention, known, I believe, as the Evershad Megger) is an instrument that is slowly finding its useful way into the amateur

laboratory. The invention, an ingenious arrangement, consists of a differential voltmeter actuated by a small hand-driven 250 volt dynamo. The device measures resistance with remarkable accuracy up to ten megohms (10,000,000 ohms)! The second illustration shows a testing table in the radio lab of Charles P. Madsen, New York City, with the author measuring the resistance between the blades of an amplifying jack by means of the ohm-meter. The radio apparatus, shown partially completed, was constructed in the lab by Mr. Madsen and myself. The result of the test indicated an unsteady resistance approximating ten thousand ohms (very low!) which was doubtless the cause of the microphonic rattling in the phones that we had been experiencing. When we wiped away a slight trace of soldering paste between the lugs, using a cloth moistened with methyl alcohol, the resistance rose to one megohm (1,000,000 ohms) with comparative quiet in the receivers and a noticeable increase in signal audibility.

A slide-rule and a dozen lengths of wire with test clips complete the equipment: this last, not a negligible item, but a most useful and integral part of the efficient whole.

III

A laboratory such as the one described is, of course, beyond the means of many amateurs, that is in the sense of being the individual

property of any one of them. But it is fully within the resources of a well-organized club. With voluntary contributions of tools and apparatus, the financial disbursement should not exceed a few hundred dollars, a sum well invested and bringing in untold dividends of better equipment and a more comprehensive insight into our art.

But the determined enthusiast intent upon his own lab will not be discouraged by the expense of the layout described. A radio laboratory is not a thing collected or built in a day. It is rather the result of an extended series of purchases, the more complicated tools and instruments arriving year by year, with experience. After all, the implements themselves are but a secondary consideration, the ability of the experimenter always coming first. In the hands of a deft mechanic, wonders have been accomplished with a small hand drill, a set of six and eight thirty-two taps and dies, a light soldering iron (electric preferred) and a few household tools. Add to these a wave-meter, and the whole, exclusive of transmitting and receiving apparatus, will amount to some twenty-five or thirty dollars, and the amateur will have laid the cornerstone to the laboratory of his dreams.

Above all, strive for neatness and orderliness in the lab. It is a virtue, and though consistent with many virtues in being often missing, it is also always its own reward!

Mistakes to Avoid in Erecting Antennas

By G. Y. ALLEN

J. B. WILSON of Reading, Pennsylvania, was visiting his friend Jim Black at Newark, New Jersey. That evening, at the dinner table, the conversation drifted to the wonders of radio, particularly to the latest achievements in broadcasting. Jim told how he and Mrs. Black scanned the programme as published in the daily papers, and how they "listened in" on evenings when they wanted some entertainment in much the same way as they would attend the theatre. He also went on to tell how the children liked

the "Man in the Moon" stories and as the company arose from the table, Mr. Black invited J. B. to come into the living room and "listen in" on the evening's entertainment.

"It's about eight o'clock now," said Jim, glancing at his watch. "They ought to be going. Here, put these on and see if I can tune him in," he continued, as he handed a spare head set to J. B.

Jim adjusted the crystal and moved the tuning handle over the scale, and soon J. B. heard Schubert's Ave Maria just as clearly as

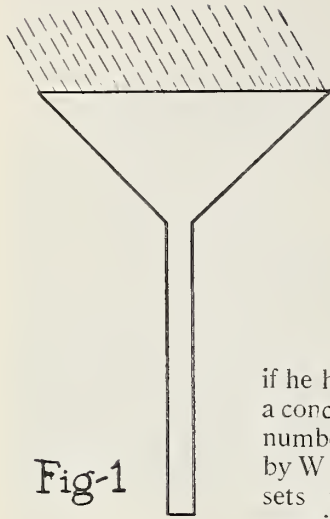

Fig-1

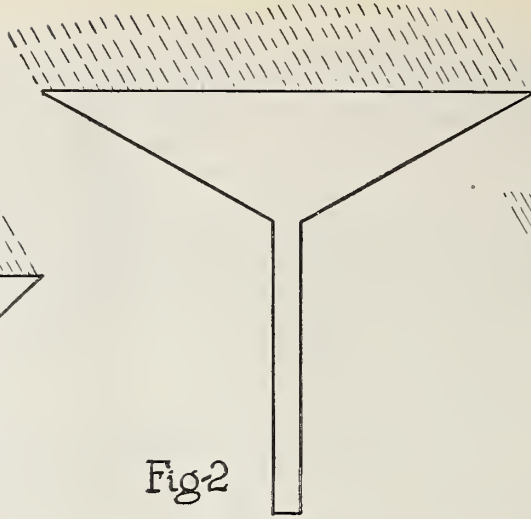

Fig-2

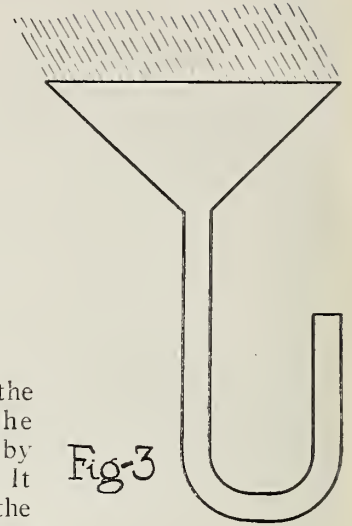

Fig-3

swering a number of questions that had come to the mind of J. B.

"The boy has been after me for some time to put in a set," said J. B., "but the landlord doesn't like the idea of a lot of wires strung on the roof of the apartment, and so I guess we'll have to wait until we move."

"Lot of wires?" said Jim. "Why, man, you don't need any wires. I'm getting this stuff on that bedspring in the next room. I just attach this wire to the spring and connect it to this terminal. You wouldn't want to hear that music better than I get it, would you?"

And so J. B. is finally convinced that a bedspring is all the antenna that is required under any and all conditions and he goes home, buys an Aeriola Jr., takes it up to his apartment in Reading, connects it to the bedspring—and hears nothing. The result is a very much dissatisfied customer and all on account of a little wrong information passed on by some one who was not wholly informed.

The antenna of a radio receiving set consists of the wire or wires

if he had been attending a concert. Several other numbers were rendered by W J Z before the head sets were removed to permit asking and an-

which collect the energy from the waves sent out by the transmitter. It is generally the most neglected part

of the set, and in the large majority of cases where satisfactory results are not obtained, assuming of course that the proper kind of a receiving set has been installed and that other fairly obvious conditions have been met, the trouble may be traced directly to a faulty antenna. Every one isn't as badly misinformed as J. B. was, of course, but there are other numerous pitfalls whose evil effects are not so obvious.

The strength of the sound that one hears from a radio set depends upon the voltage or electrical pressure created in the antenna by the waves from the transmitter and also upon the current, in the antenna wire.

A somewhat imperfect, but nevertheless helpful, analogy to an antenna wire is a large metal funnel supported above ground and connected to a rubber hose. Figure 1 shows a moderate size funnel corresponding to a small antenna. Suppose that a heavy shower is in progress. It will be easily seen that, if the rubber hose is not too large, the funnel will remain full and the water

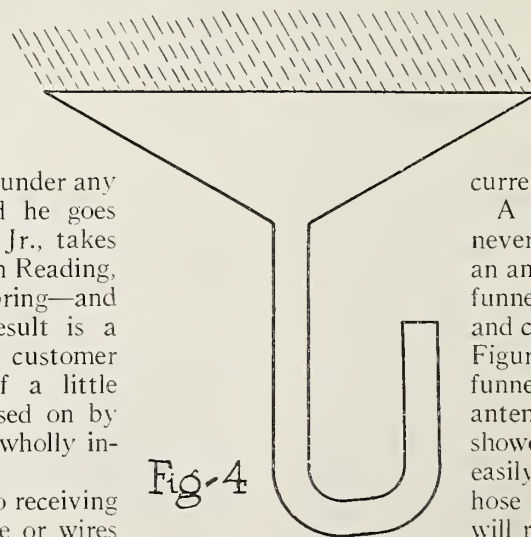

Fig-4

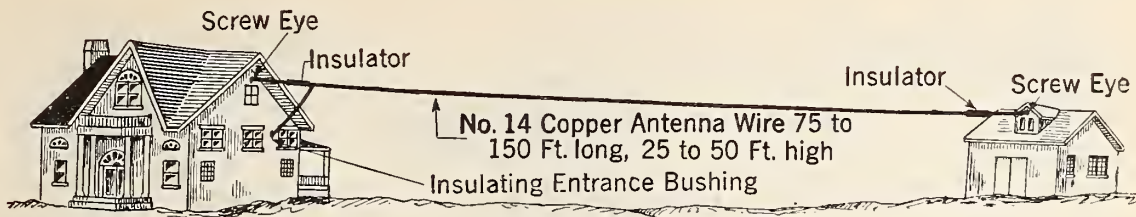

Fig. 5. Typical antenna for receiving from amateur and broadcasting stations

pressure at the lower end of the hose will be maintained constant. A smaller shower, however, will not keep the funnel full, and if the pipe pressure were to be maintained, a larger funnel, such as that shown in Figure 2 would be required.

When a radio antenna is located near to a radio transmitter, the waves striking it are comparatively strong. These strong waves will give good results on a small antenna. They correspond to the heavy shower maintaining the pipe pressure using a small funnel in the water analogy. However, when the radio receiving antenna is at considerable distance from the transmitter, the waves are relatively weak and they must be intercepted by a longer antenna to maintain the electrical voltage, just as it was found necessary to use a larger funnel to maintain pipe pressure in a light shower.

Another determining factor in the pressure at the bottom of the pipe in Figures 1 and 2, is the height of the funnel above the end of the hose. The higher the funnel, the greater the pressure. Similarly, the radio antenna should be placed high enough above the ground or the signal strength will be reduced.

A frequent mistake that is made in the erection of the antenna of a receiving station is in thinking that the only prerequisite is to get the wire or wires as high as possible regardless of any other conditions. In fact there is a tendency on the part of people living in tall apartment houses to feel that if they place their antenna on the roof, regardless of how close it comes to other objects it will function properly. The fallacy in this reasoning will be evident when it is realized that the electrical pressure on the antenna (one of the factors in determining the loudness of the signal) depends on how far the antenna is above grounded objects. The frame of apartment houses is generally of steel. This steel frame work

rests on the ground. Current is therefore free to flow up the steel frame and thus bring the ground pressure nearer to the antenna.

This can be better understood by referring to Figure 3 and 4. If the lower end of the rubber tube is made to approach the funnel, the water pressure at the end immediately decreases. Similarly when a radio receiving antenna is brought near to a steel frame apartment or to trees, or if the vertical wire connecting the antenna wire to the radio set (commonly called the lead-in) is run down an elevator shaft or through a conduit duct, the electrical pressure to ground is greatly diminished with a corresponding decrease in signal strength.

The erection of an antenna in such a way that wires come close to metallic objects resting on the ground is therefore equivalent to placing the antenna very close to the ground.

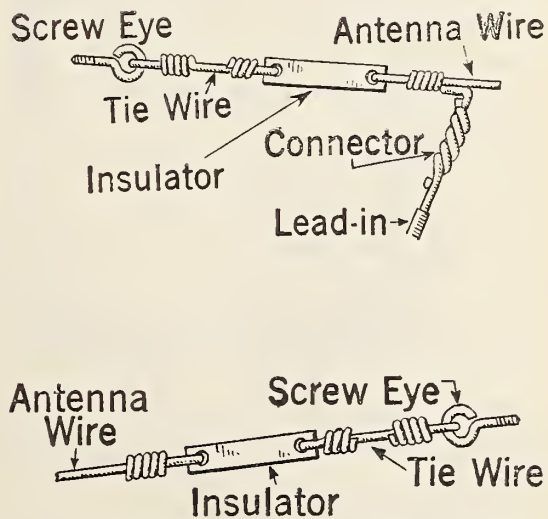

Fig. 6. Details of antenna construction

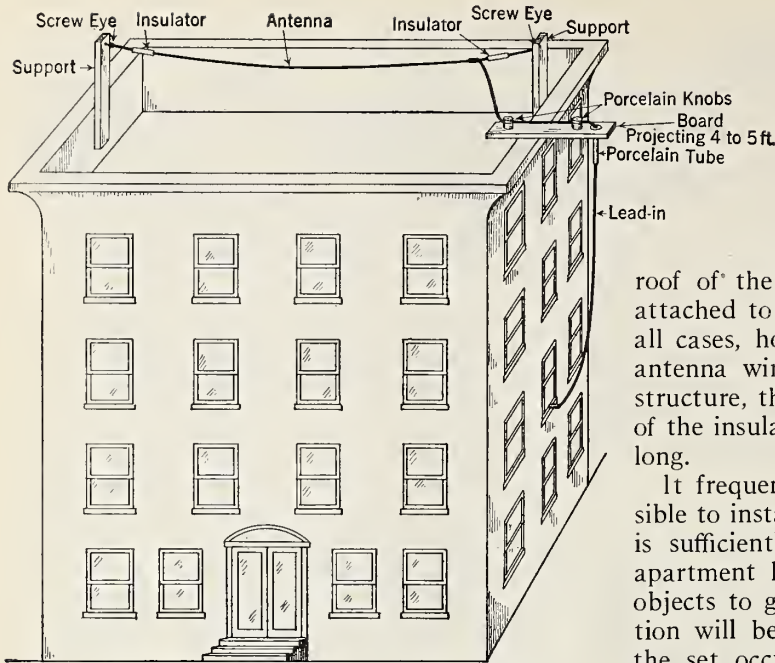

Fig. 7. ANTENNA ERECTED ON APARTMENT

In general the best form of an antenna for receiving from amateur and broadcasting stations is a single wire from 75 to 150 feet long and supported 25 to 50 feet high

Figure 5 illustrates an ideal antenna for use on a private estate. The wire should be not smaller than No. 14 B. & S. Gauge Copper or its equivalent. Any joints either in the antenna wire proper or in the lead-in should be as shown in Figure 6 or should be soldered. Twisted joints unless soldered are very unreliable, as they corrode. In fact, poor joints in the antenna wire frequently cause a falling off in signal strength as time goes on due to the corroding action.

If it is desired to install an antenna on the roof of an apartment house, the sketch shown in Figure 7 should be followed. The supporting posts should hold the antenna wire at least 15 to 20 feet above the roof of the apartment and the lead-in wire should be run over the side of the apartment as shown. In no case should the lead-in be run down an elevator shaft or through metal

conduit and it should be held from 2 to 5 feet away from the side of the apartment even if the wire be insulated.

If the apartment is so built that an elevator shaft or some other part of the structure rises above the roof of the house, the antenna may be attached to it as shown in Figure 8. In all cases, however, where the end of the antenna wire is attached to a grounded structure, the tie wire on the ground side of the insulator should be at least 2 feet long.

It frequently happens that it is impossible to install the lead-in wire so that it is sufficiently far from the side of the apartment house and all other grounded objects to give best results. This condition will be experienced if the owner of the set occupies a lower floor of a tall apartment that is located very closely to an adjacent building. In such cases, the owner of the set must realize that he will not obtain as good results as his neighbor on one of the top floors. The most ideal place for the receiving instruments located in a tall building is on the top floor. Good results can, however, be obtained on the lower floors if proper precautions are taken.

At times, proprietors of hotels or of restaurants located on the ground floor of tall buildings install receiving sets with loud speaking devices and they are frequently disappointed in the results obtained. Unless properly informed, they have the radio receiver installed in the room where the music is to be heard and the lead-in will probably be led down near to the side of the building and in some cases will

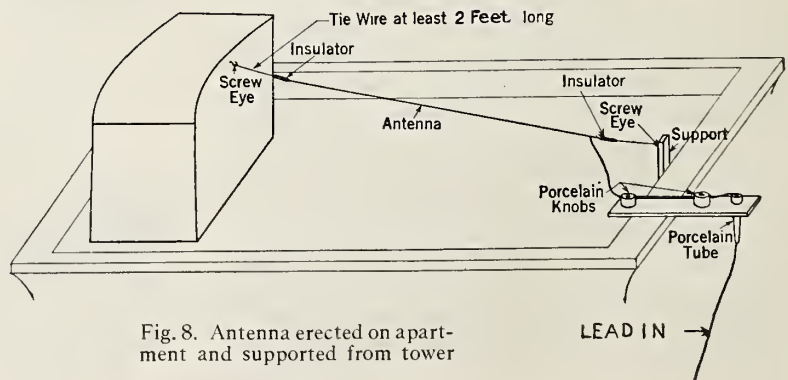

Fig. 8. Antenna erected on apartment and supported from tower

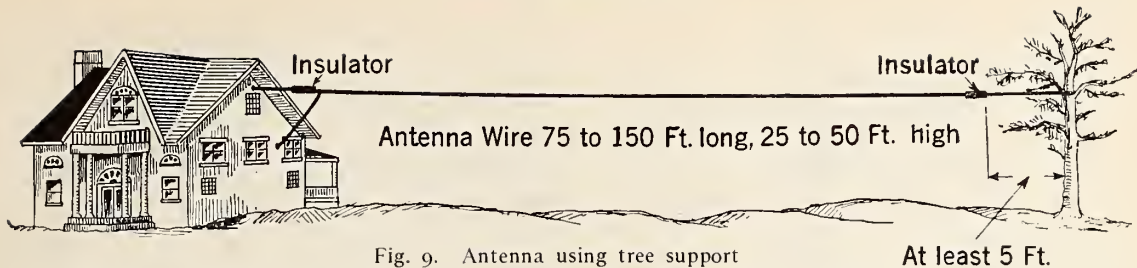

Fig. 9. Antenna using tree support

be brought several hundred feet through the building before it reaches the receiver. The abnormally long length of wire together with its proximity to grounded objects for a great distance will cause the set to give very poor results. The proper method of installing a receiver under such adverse conditions is to place the radio receiver on the top floor, if possible, running the leads from the amplifier to the loud speaker which may be located on the first floor.

If a tree is used to support one or both ends of the antenna, the tie wire should be long enough to permit the ends of the antenna wire to clear the tree branches by at least five feet. This is illustrated in Figure 9.

In the congested municipal districts and in certain localities less densely populated, considerable trouble may be experienced from noises caused in the radio set by near-by power lines. These power lines, particularly if they carry fairly high voltages, send out weak electrical waves of the same type as those sent out by a transmitter, and these waves may cause considerable annoyances on antennas in the vicinity. Contrary to the general impression, direct current lines cause more trouble in this direction than those carrying alternating current. The reason is that the frequency of the noise picked up from an alternating current line is so low that it causes comparatively little annoyance, whereas the variations in current occurring in a direct current line caused by the generators and motors connected to it is of such a high frequency as to be very troublesome at times.

If power wires are in the vicinity where it is desired to install an antenna, the antenna wire and lead-in should be placed as far as possible from the wires. The antenna should also be run at right angles, if possible, to the power wires. These precautions will reduce interference from power sources to the lowest point. In some cases where lines exist in more than one direction from the antenna location the antenna should be placed as nearly as possible

at right angles to both lines. In such cases the best location can only be determined by trial.

At times it happens that it is practically impossible to so place the conventional type of antenna that it is free from noises picked up from power wires. Or perhaps the owner of a broadcasting receiver is so unfortunately situated as to be located near to a radio telegraph station which cannot be "tuned out." Under such circumstances the most ready recourse is to a loop antenna.

The loop antenna consists of a wooden frame supporting a multi-turn rectangular loop of wire as shown in Figure 10. It is very directional in its properties, and by turning its plane toward the broadcasting station, all broadcasting is received with maximum loudness, and signals coming from other directions are reduced. Signals coming at right angles to the loop will not be heard at all. It is thus evident that if interfering noises come from a

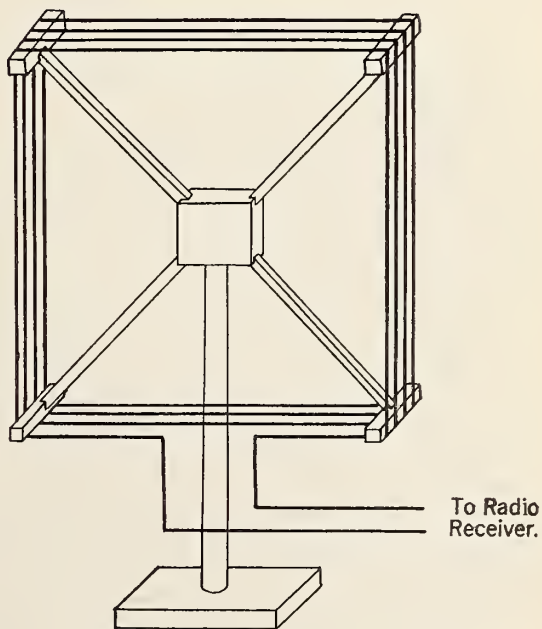

Fig. 10. Loop antenna

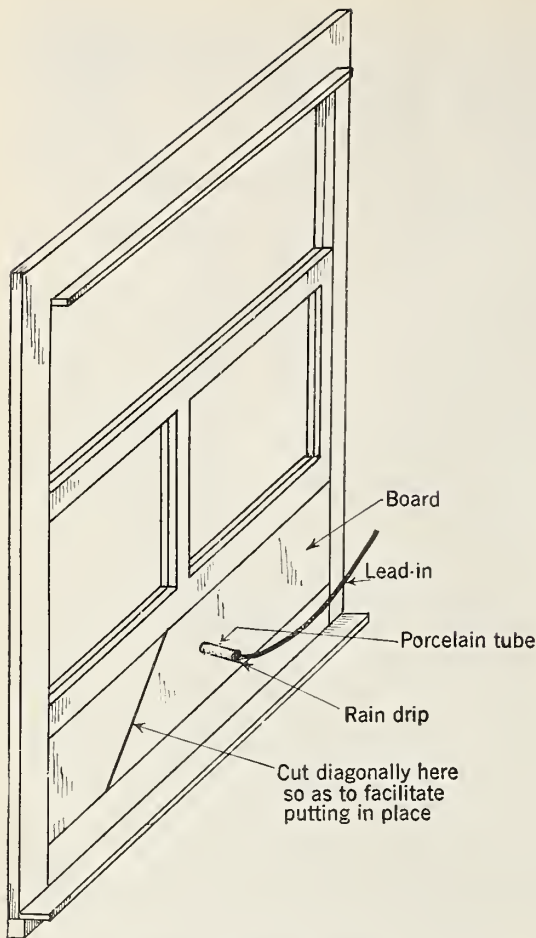

Fig. 11. Method of bringing lead-in into house

different direction to the broadcasting, their interference will be reduced.

The loop antenna does not pick up as much power as the conventional type of antenna, and unless the distance between the radio receiver and the broadcasting station is small, special apparatus involving high power radio frequency amplifiers is required.

In a frame house the lead-in may be brought into the room in which the receiver is placed by bringing it through a porcelain bushing in the wall of the house. In brick or concrete houses, the porcelain tube may be passed through a hole drilled in the window casing or a board may be placed under the window sash, and a hole drilled in it to take the porcelain tube. This latter method is shown in Figure 11.

The ground wire merits equal consideration

with the antenna. Although it is true that a ground on a water pipe in general cannot be bettered, yet in cases where it is necessary to run a long wire to a water pipe, better results may frequently be obtained in connecting to a steam or hot water radiator or even to a gas pipe. The ground wire should be as short as possible and should not be placed closely to the antenna wire. The antenna wire should never be taken into the building in the basement and brought to the radio set in close proximity to the ground wire. In fact the ground and antenna wires should be separated as widely as possible and both should be led in as direct a line as possible to their respective binding posts on the receiver.

This article on antennas would not be complete without some mention being made of lightning protection. Users of radio receiving sets and particularly landlords may rest assured that an antenna such as is erected for radio receiving is by no means as great a hazard as the telephone wires that can be seen running to any house. The radio antenna is hardly ever as long as the telephone connection between the house and the nearest pole and it is scarcely ever erected higher than a telephone line.

The Fire Underwriters Rules governing radio receiving antennas are now undergoing revision which will greatly simplify approval of small receiving installations by fire inspectors. Instead of the cumbersome knife switch that was formerly required, the use of a small enclosed gap in series with a wire to ground will be all that will be required, with the option of using a fuse to guard against possible contact between wires carrying high voltages and the antenna. There are now protective devices on the market which will doubtless be approved in the new revision of the code.

This article is not intended to create the impression that the installation of a radio receiving set is a difficult task. The thousands of successfully operating radio receivers bear evidence to the contrary. However, radio telephony reception like every other scientific phenomenon obeys certain laws. If these laws are not recognized, failure will result, but as long as they are appreciated and followed, radio telephony will be found to be one of man's most faithful servants.

How to Begin to Enjoy Radio

CAPTAIN LEON H. RICHMOND, SIGNAL CORPS, U. S. A.

Editor, Technical Training Literature, Office Chief Signal Officer

Captain Richmond, who was Professor of Physics at Western Maryland College before the war, was commissioned in the Signal Corps at the outbreak of the war. After passing through various instruction camps, he was assigned to the Royal Navy (British) Flying Field at Cranwall, England, where he worked with Lt. Commander J. M. Robinson (British Navy) in developing a radio direction finder and other radio apparatus for airplanes. Upon the completion of this duty, and after a short time at an American Flying Field, he was assigned to duty at the Army Signal School, Langres, France, where he was in charge of the Radio Department at the signing of the Armistice. For the past year and a half, Captain Richmond has been on duty in the Office of the Chief Signal Officer at Washington.—THE EDITOR.

THE main topic of discussion at the International Radio Convention at Paris was radio wave lengths. The main topic of discussion at the "Hoover Radio Convention" held recently in Washington was radio wave lengths. It is the purpose of this first of a series of elementary discussions on radio to explain what is meant by wave length and to show why the subject is such an important one in the radio world.

Every one is familiar with some kinds of waves, especially with those that appear on the surface of water. Let us study these water waves. We can represent them by a line as in figure 1, where the curving line represents

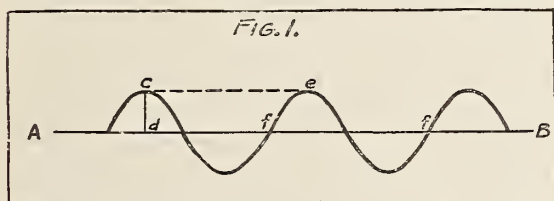

the surface of the water with waves on it and the straight line, AB, represents the surface of the water when there are no waves. The first thing we notice about a wave is its height. The stronger the breeze the higher the waves. The correct way to measure the height of a wave is to measure from the crest of the wave to the surface of the water when it is smooth. In figure 1 this would be represented by the line *cd*. A better term for this measurement is *amplitude* of the wave. Hereafter we will refer to the amplitude of the wave and not to the height. The reader should realize that in learning a new art, the learning of new words or new meaning of old words is probably the

most important factor. So through this series a term of particular application in radio will be italicized when it first appears.

If we have been in a boat or in swimming when there were waves, we are familiar with the fact that the waves have energy. In other words, they have power to move objects that are in the water or which they may strike. It is seen that the bigger the waves the more energy they have. Another way of saying this same thing is to say that the energy of a wave increases as its amplitude increases—a large amplitude gives a large amount of energy—a small amplitude gives a small amount of energy. In radio we use the energy of the radio wave.

If we watched water waves we would soon notice that besides height, the waves have length also. There would be a certain distance from one wave to the next. This distance can be measured from the highest part of one wave (called the crest) to the highest part of the next wave. This distance is the *length* of the wave. In figure 1 it is represented by the line *ce*. Also *ff* shows the length of the wave. The wave length, then, is the distance from any part of one wave to the *corresponding* part of the next wave. A short way of writing the word *wave length* is, " λ " pronounced "Lambda." This symbol means wave length. (Write several of these symbols so as to become familiar with them.)

If we stood on the shore and watched waves go by we would notice that waves, besides having amplitude and length, passed us at regular intervals of time. Count the number of waves passing per second. You have counted the *frequency* of the waves. Frequency, then, is the number of waves passing

any point in a *second*. It is represented by the letter "n."

Suppose now that we wished to know how fast the waves are traveling. We could find this out in different ways. The easiest way to find it out is to figure it out as follows: Suppose each wave is 10 feet long and there was one wave passing per second. The wave must be travelling 10 feet per second, then, in order to get by. If two waves per second passed, then the waves must be travelling 2×10 feet = 20 feet per second. If there were 12 waves per second ($n = 12$) and each wave was 10 feet long ($\lambda = 10$ feet) then the waves must be travelling $12 \times 10 = 120$ feet per second. But 12×10 is the same as $n \times \lambda$ so that the rate of travel (velocity) of a wave is $n \times \lambda$. Velocity is always represented by the letter "v" so that $v = n\lambda$.

Now we have a very good idea of what water waves are. We can sum it up by saying that water waves are RECURRING displacements of water, traveling at a definite velocity and having definite *amplitude*, *length*, and *frequency*. These waves carry energy. This is true of water waves, and if we say "disturbance" instead of "displacement of water" it would be true of any kind of a wave. Waves are a recurring disturbance, traveling at a definite velocity and having definite amplitude, length, and frequency. Waves carry energy.

Each different kind of wave has a definite velocity. All kinds of radio communication is carried on by waves, called radio waves. The velocity of a radio wave is so great that it would go around the earth seven times a second if it could keep on going. That is a great speed. It is 186,000 miles in a second. In radio we do not measure distances in miles—we use meters (a meter is a few inches longer than a yard). The velocity of radio waves is 300,000,000 meters per second.

This velocity is CONSTANT, so that in measuring radio waves, if we can find either the frequency or the length, we know the other. This is true because $v = n\lambda$ and v is always equal to 300,000,000 meters per second. So if we know either n or λ , the other one can always be obtained by dividing the known one into 300,000,000.

Examples: (1) What is the frequency if λ is 2,000? The frequency is 300,000,000 divided by 2,000 = 150,000 waves per second. (2) What is the wave length if the frequency is 50,000? $\lambda = 300,000,000 \div 50,000 = 6,000$ meters. Sometimes one is stated and sometimes

the other. Both are known when one is, as we have just shown.

In order to have a wave it is evident that there must be some material to carry the wave. This thing in which the wave travels is called the *medium*. The medium that carries water waves is water. Sound is carried by waves in air. Air is the medium for sound waves. So for radio waves there is a medium which carries them. This medium is called the ether. Not much is known about the ether except that it will carry certain waves very rapidly. Besides carrying radio waves, it carries light waves and also heat waves. Another fact that is known about the ether is the fact that it is *everywhere*. It is between you and every other object. It is between the earth and the sun, the moon, and the sun, etc. It is in everything, as well as in the space outside. It is in the magazine you are reading—it is in your body. It is *everywhere*. There is no exception to that. You cannot think of a place where there is no ether—for there is no such place.

Radio waves, then, are carried by this ether. In order to describe these radio waves it is necessary to recall and explain some simple facts that are familiar. In combing your hair, have you ever noticed that sometimes the hair will follow the comb as it passes back over the head, even though the hair and comb do not touch? This is explained by the fact that the comb has been electrified. The comb ATTRACTED the hair, causing it to move. How does one object move another when there is no apparent connection between them? The lack of connection in this case is only apparent and not real. There is a real connection between the comb and the hair which is not visible to the eye. A large number of invisible *lines of force* pass from the comb to the hair. These lines of force have a peculiarity in that they always try to become shorter. In trying to shorten they move the hair toward the comb. The complete name of these lines of force is *electrostatic lines of force*, the name coming from the fact that the lines have power and are caused by stationary (static) electricity (electro). Electrostatic lines of force are present in a radio wave.

No doubt you have often played with a magnet and noticed that the magnet will attract pieces of iron even though it does not touch them. Bring a magnet near a nail and suddenly the nail will jump to the magnet.

Here again one object causes another to move when there is no apparent physical connection between them. Again the lack of connection is not real. There is a connection. *Magnetic lines of force* pass from the magnet to the nail and cause the motion in a manner very similar to that caused by the electrostatic lines of force. Magnetic lines of force are also present in a radio wave.

A radio wave, then, is composed of magnetic lines of force and electrostatic lines of force. A radio wave is represented in figure 2. This

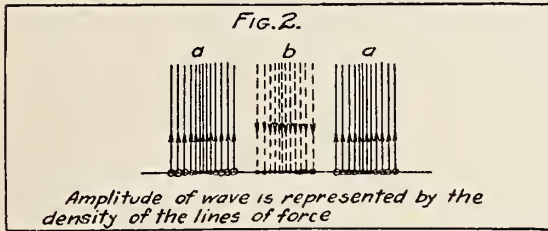

figure shows a radio wave moving from left to right. The electrostatic lines of force are represented by lines, the magnetic lines of force are represented by little circles at the end of the lines. It must be remembered that these are lines though they cannot be shown as such in a simple drawing. They extend at right angles to the electrostatic lines of force. In other words they extend away from you and into the paper as you look at the figure.

There is one other thing about a wave that we should observe. In a water wave we see that part of the water in the wave is above the level of the water when it is smooth and the other part of the wave is below the level. This is true of all kinds of waves—part of the wave disturbance is on one side of the usual (waveless) condition, and the other part of the wave disturbance is on the opposite side of the usual (waveless) condition. This is true of radio waves. Look at figure 2 and note that the arrows show that the electrostatic lines of force are directed upward in one part of the wave and downward in another part. This is also true of the electromagnetic lines of force. The open circles represent those that are directed toward you; the solid circles represent those that are directed away from you.

It must be clearly understood that this wave travels onward just as a water wave travels onward. This means that any point in the path of the wave is swept by lines of force, both magnetic and electrostatic, directed in one way and an instant later the same point is

swept by lines of force directed in the opposite way. Between each reversal of these lines of force there is a brief instant in which no lines of force sweep the point. As we already noted, the velocity of these waves is 300,000,000 meters per second. (They may be of any length; for example, as short as 50 meters or as long as 50,000 meters.)

An examination of figure 2 shows that the amplitude of the wave is shown by the density of the lines of force and that the wave length is shown by the distance between the densest part of the lines of force going in one direction to the densest part of the next series of the lines of force going in the same direction. All this can be very easily represented by a curved line as in figure 3, which is labeled the same as figure 2. Note how the curved line accurately represents the more complicated drawing of figure 2. The amplitude, which is represented in figure 2 by the density of the lines of force, is shown by the height of the wave in figure 3 (m). A radio wave is usually represented as shown in figure 3. It must always be borne in mind, however, that it is actually as shown in figure 2.

ENERGY OF RADIO WAVES

AS HAS been noted the density of the lines of force determines the amplitude, that is to say, the density of the lines of force determines the energy of the wave. Thus a very

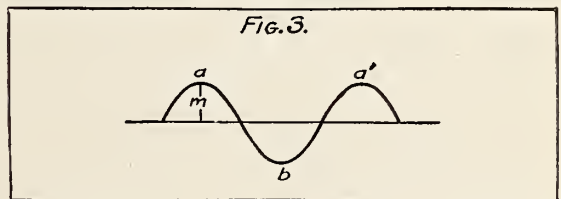

powerful radio transmitting station sets up radio waves having an enormous number of lines of force, a low-powered transmitting radio station sets up waves having only a comparatively few lines of force. As these lines of force sweep a receiving station they affect the instruments therein, the magnitude of their effect being determined by the amplitude of the wave. A radio wave spreads out from a transmitting station, the front of the wave spreading over a larger and larger area as it passes outward, in much the same way as ripples spread out from a stone thrown in a pool of water. As the number of lines of force in the radio wave does not vary, this means

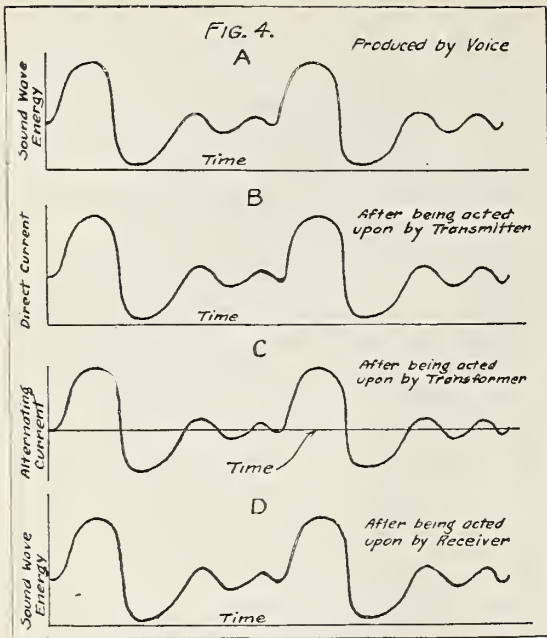

that the number present in any given area of the wave grows smaller as the distance from the sending station increases. Thus the farther a receiving station is from the sending station, the less energy it receives and the more difficult it becomes to pick up signals. The exact manner in which distance affects the energy in a wave may be expressed by a complicated equation. For our purpose it is sufficient to remember that the energy decreases much more rapidly than the distance increases. That is, a receiving station twice as far away from a transmitting station as another receives much less than one half as much energy as the nearer station; one three times as far away receives much less than one third as much energy. This is the usual thing but sometimes "freak" results that do not follow this rule occur. To sum up, the energy received by a station depends upon the energy sent out by the transmitting station and upon its distance from the transmitting station.

WAVE LENGTH SELECTION

A SENDING station transmits radio waves of a definite wave length. A receiving station is so arranged that it can pick up signals (energy) from a definite wave length. Of course the receiving station may be adjusted to many different wave lengths but when adjusted it picks up energy on one wave length

only. But it picks up ALL ENERGY on that wave length. It is the fact that receiving stations can so select energy from one wave length that allows more than one radio message to be sent through the ether at the same time. For example, suppose there were different stations transmitting, one on 300 meters, one on 400 meters, one on 500 meters, etc. Then a receiving station could be adjusted to select the 300-meter energy only and would not get any energy from the 400 or the 500-meter stations.

But if there were two stations in the same vicinity transmitting on the same wave length, say 300 meters, then the receiving station would pick up energy from BOTH transmitting stations. This would cause *interference*. This result would be very similar to that obtained when two people are talking at once on the same telephone line, or if you had two people talking to you through the same speaking tube at once.

There is, or was, in a certain city an amateur who had a radio telephone transmitter. Each night he turned on a phonograph and transmitted the whole evening. No one else in that vicinity could hold communication on that wave length because of the interference produced.

A definite wave length, then, must be thought of as a definite channel of communication through which one signal may pass but not two. If two signals are sent, the result is only confusing interference. Of course, if the transmitting stations are far apart, one signal may become so weak that there is no interference.

There are certain limitations in the radio transmitters and radio receivers which will not allow these wave-length channels to be too close together. That is, with ordinary apparatus, there cannot be one channel on 300 meters and another on 301 meters. This is because the apparatus is not perfect. This result may be approached however. The writer knows of one set which has been designed that allows nine channels of communication in a wave-length range of only two meters; from 74 to 76.

Here, then, lies the reason that wave lengths are the subject of discussion at the radio conventions. There are so many radio stations of different kinds that some control over their wave length must be exercised, otherwise a great many stations will be using the same wave length with consequent interference. Wave lengths must be controlled by someone

just as a telephone line is controlled by the telephone company. If there were no control, there would be no radio communication, for a great many people in the same vicinity would try to use the same wave length at the same time, with the same result, so to speak, that would occur if a great many people tried to use the same telephone line at the same time.

SOUND WAVES AND THE VOICE

SOUND waves are waves in air. The air is alternately compressed and rarefied; the compression corresponding to a crest of the wave, the rarefaction to the trough of the wave. A simple sound is made up of only one of these waves. More complex sounds are composed of a number of these waves. The voice, for instance, is a complex sound having, for a man, one wave whose frequency is about 250 per second, another of 500 per second, another of 750 per second, and so on. The wave of the lowest frequency is called the *fundamental*; the other waves are called *harmonics* or *overtones*. It is the number of harmonics present and their relative amplitude (strength) which make it possible to distinguish one voice from another.

WIRE TELEPHONY

IN ORDINARY wire telephony the sound waves produced by the voice are caused to produce, by means of a *transmitter*, a variation in a direct current; the variation in the current being identically similar in amplitude and frequency to the sound waves which produce it. This variation in direct current is usually converted, by means of a transformer, into a variation in alternating current which is similar to the variation in direct current. The variation in alternating current is then by means of a *receiver* converted into sound waves, the sound waves being identically similar in amplitude and frequency to the alternating current which causes them. As this identical similarity of amplitude and frequency has been maintained throughout the complete cycle, the sound waves produced by the receiver are identical with those originally produced by the voice. The series of events outlined above are represented by the curves of figure 4. The sound wave is represented in A of figure 4 in the same way as a radio wave is represented in figure 3. Each crest of the wavy line represents a compression of the air particles and each trough represents a rare-

faction of the air particles. It is noted that the sound wave is a complex one.

The instruments peculiar to wire telephony are the transmitter and the receiver. The transmitter, sometimes called a microphone, has two conductors separated by granules of carbon. The sound waves strike a flat piece of metal called a diaphragm and cause it to vibrate. The diaphragm acts upon the carbon granules, alternately increasing and decreasing the pressure of the granules upon one another, as it vibrates to and fro. This variation in pressure between the carbon granules varies the resistance of the granules. A direct current which is flowing through the granules is varied by this varying resistance. This varying direct current is changed into a varying alternating current by means of a step-up transformer. The alternating current acts upon the receiver. This receiver consists of an electromagnet through which the alternating current passes, and a permanent magnet which forms the core of the electromagnet. Mounted in front of the poles of this combination magnet is a flat piece of metal containing iron. This is also called a diaphragm. The alternating current causes the diaphragm to vibrate, thus producing the sound made at the transmitter.

(It is realized that the above paragraphs contain some electrical terms with which the reader may not be familiar. These will be explained in later articles.)

FUNDAMENTAL METHOD OF RADIO TELEPHONY

IN RADIO telephony methods are employed to produce at the transmitter and reproduce at the receiver a sound wave, that is, a

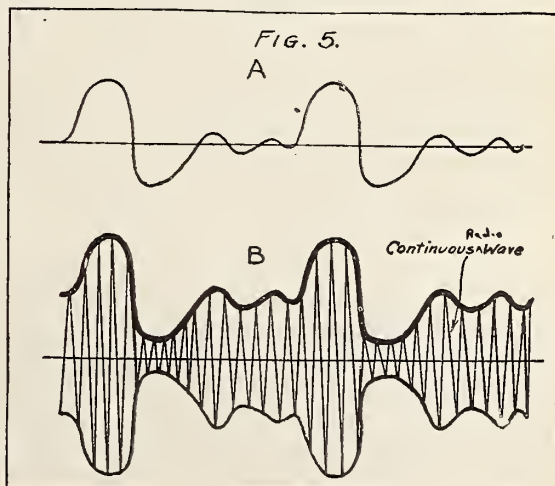

wave similar in character to that of figure 4. It has been found possible to do this by varying the amplitude of the radio waves so that this variation in amplitude follows in detail the wave variation produced by the sound. In figure 5, curve A represents a simple sound wave.

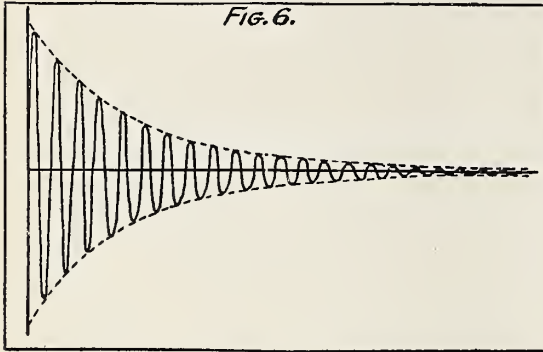

By means of methods to be described later the amplitude of a *continuous* radio wave is varied so that the variation in amplitude follows identically the amplitude and frequency of the sound wave. This is shown by the heavy line in B of figure 5. This line, together with the lower inclosing line, is called the envelope of the radio wave. Note that the upper and lower inclosing lines have the same shape. The radio wave is said to have been *modulated* when it was made to undergo the variations in amplitude. By means of the receiving apparatus, the heavy line shown in figure 5 B affects the receiving telephones. This causes the sound as explained in the previous paragraph.

To sum up, then, radio telephony is made possible by the fact that the radio waves are so modulated that their amplitude changes according to the voice waves. Figure 5 B represents very accurately what occurs. One may think of the whole process as a wave carrying a wave. The carrying wave being the radio wave, the carried wave being a wave which by means of the receiving apparatus is transformed into a sound.

KIND OF RADIO WAVES

RADIO waves can be classified into *damped waves*, *undamped waves*, and *continuous waves*. A damped wave is a wave in which the energy gradually decreases with each succeeding wave until it finally vanishes. In other words, the amplitude of the wave is first large then grows smaller and smaller until the wave

disappears. A damped radio wave is represented in figure 6. The heavy line is the wave and the dotted lines follow the diminishing amplitude. A damped wave is the easiest wave to produce and for years was the only kind of a wave used in radio communication. The series of waves shown in Figure 6 is called a *wave train*. Damped waves can be used in radio telegraphy only; that is they cannot be used in radio telephony. It will be shown later that even a single dot in the Morse code by telegraphy is composed of very many wave trains. It is to be realized, then, that in using damped-wave communication, the signals are composed of a great many wave trains and that between these wave trains there is a space in which there are no waves.

An undamped wave is a continuous wave, though a continuous wave is not always an undamped wave. This is like saying that a dog is an animal though an animal is not always a dog. The name continuous wave defines itself. It is a wave that does not die out; in other words, it is unbroken. The amplitude of the wave may vary but it never is zero. A very good example of a continuous wave is shown in figure 5, where it is so labeled.

An undamped wave is a continuous wave whose amplitude does not vary. The wave shown in figure 1 represents an undamped wave, for its amplitude is constant. The terms undamped wave and continuous wave are often used interchangeably. Continuous wave is the broader term. Accurately speaking, undamped waves cannot be used in radio telephony for, as we have shown, the method of radio telephony involves the changing of the amplitude of the radio waves.

Undamped waves have certain advantages over damped waves for use in radio communication. They carry much more energy in the same amount of time. For instance, suppose a dot used in radio telegraphy lasts one twentieth of a second. Using a wave length of 1,500 meters, there would be in undamped-wave transmission, 10,000 waves in this dot. If this dot was sent out by damped waves there would be, if a wave train occurred 1,000 times a second, 50 wave trains in the dot. If each wave train consists of 40 waves—a reasonable number—the total number of waves in a dot would be 2,000. Thus there are five times as many waves in the undamped-wave dot as in the damped-wave dot. But the damped wave has only one of its waves at maximum ampli-

tude and the rest gradually die away while the undamped waves have every wave at maximum value. For this reason, the energy of each undamped wave is in this case about five times the average energy of the damped wave, providing the maximum amplitude of the damped wave has the same value as the undamped wave's amplitude. Thus the energy in a dot carried by the undamped wave is 25 times the energy in a dot carried by the damped waves. This is a great advantage, especially as it does not take much more power

to generate the undamped waves than it does to generate the damped waves.

It is because of the above reason that practically all long-distance radio telegraphy is carried on by undamped waves. These waves also permit of a method of reception which greatly enhances their value over damped waves, though it is more difficult and requires more apparatus. There are other advantages of undamped waves which will be considered as more is learned about the radio art.

The Pacific Coast Is "On the Air!"

By WILBUR HALL

THIRTY years a Californian, I can remember three "crazes" that have swept the state and with it Oregon, Washington, and the contiguous mountain states, like measles in a boarding school.

Twenty years ago we went mad over Belgian hares. We paid as high as \$2,500 for a buck, and some of the gold cups presented to "best young does" and "best Imp. sires" were big enough to float a yacht in. To-day the Belgian hare is worth just what he'll bring for frying, and no more.

Ten years ago (or such a matter) we went dippy over roller skating. It was being done, and the liniment market was extremely bullish, while fortunes were made by the manufacturers of ball bearings, electric pianos, and court plaster. To-day roller skating is practised exclusively on the front sidewalk, and the only doctor's bills are paid by stout gentlemen who can't get out of the way quickly enough.

The third period or era of the Far West may come to be called the "loose coupler-detector-and-one-stage-of-amplification age." Instead of their symptoms, elderly women on our boats and trains and in our sewing societies discuss the number of stages of amplification necessary for DX reception. Women's clubs have abandoned the question of whether or not Bacon wrote Shakespeare, and are forming cliques over the dispute: "Who should be eliminated from the short wave-lengths?" Business men ruin their digestions at noon, not with politics

or financial rows, but with deep discussions involving the Heising constant current system of modulating the oscillator tube output. As for the boys (and a good many of the girls) their cry is: "Hey, Skin-nay; c'mon over! I'm getting the band concert at Catalina!"

Despite the fact that in the neighborhood of San Francisco there are located two or three of the earliest and most important radio telephony laboratories of the country, and the further fact that it was from here that several of the most vital improvements in the new service originally came, especially during the war, the average man on the street had never more than vaguely heard of radio until two months ago. Amateur operators, mostly boys, had been dabbling with wave-lengths and detectors and all the other mysterious factors and agencies; perhaps a hundred men were working at it—experimenting, testing, inventing, installing, improving, and looking forward to the big rush that was to come. But the layman gave it the same attention as he did the newspaper stories that the Akooned of Swat was to take unto himself another wife.

All of a sudden it hit us!

The first most of us saw of it, beyond random and rather dull newspaper and magazine accounts of developments, was in first-page, first-column headlines from New York, not over two months ago, proclaiming that the East had gone mad over radio.

Within twelve hours the interest swept the Coast.

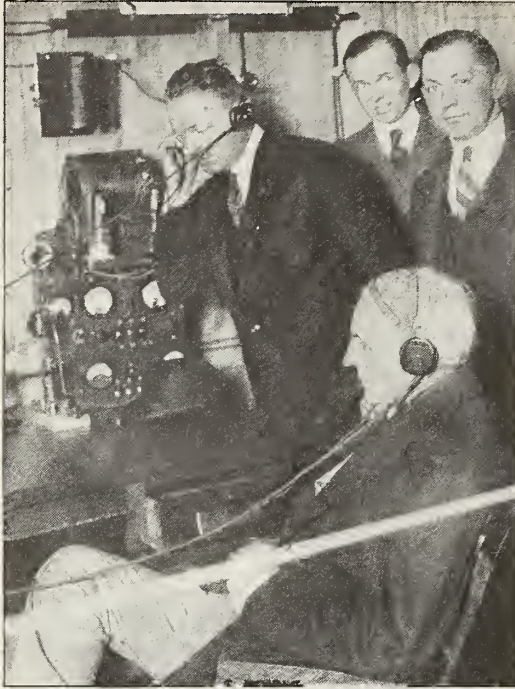

© Underwood & Underwood

Henry Ford listening to radio. He is reported to be a radio enthusiast and may well be thinking of a way to send crop reports to farmers with Ford tractors and "flivvers"

We found out at once that the new marvel had already established itself among us like the flu—quietly and insidiously. We found out that hundreds of our youths had been "on the air" for some time. We found out that engineers were ready to install any kind of plant we wanted, either for receiving or for broadcasting.

But what amazed and perplexed us, and still does, was that if we wanted anything in the radio line except copper wire and roofs to string our antennæ on, we would have to go down on a waiting list as long as that of the Bohemian Club, and that we would be lucky to get service inside of three months.

If we postponed action for three days, we went to find that the waiting list had quadrupled in length and that six months or maybe eight was the best we could hope for.

Naturally we thought someone was kidding us and we had to be shown that, for the better part of a year our local electricians, inventors, and manufacturers had been making radio stuff as fast as they could, working day and night, that they had enlarged their facilities twice, three times, ten times, and still were

swamped, and that every one of them was shipping sets East.

Perhaps this whetted our appetite for radio. At any rate, there isn't a complete receiving set of any sort to be had on the West coast to-day and there won't be for months, except for those who are on the list.

If it weren't tragic to them, it would be comic to see the bafflement in the eyes of local radio men.

"What's the present state of the radio business here?" they echo, vacantly. "You tell 'em! We don't know. We're out of our depth, and going down for the third time! We're working three shifts; we are fighting for raw materials; we are combing the country for men who know the business; and we are so far behind now that it doesn't look as though we'd ever catch up. Radio has caught on like grease in a Greek restaurant kitchen, and all we've got to fight it with is water in a teacup!"

The most amazing feature of it all to me is that, for the present at least, the only use for radio is "stunt" shooting. A few scattered receiving stations are making practical use of the radio in the matter of crop and weather reports and forecasts, the day's news, and so on. But practically all the activity now is about the dissemination of "concerts" played on the phonograph. The fact that every home that can have a radio receiving set can, and probably does, have a phonograph, seems to make no difference. People will sit for hours listening to Caruso sing or the Victor Band play through the air who wouldn't walk across a room and wind the old cabinet and get the same music home-grown. To this extent it is all a fad, and this phase of it will pass.

But the potentialities of the business are interesting. It is certain that, for one reason at least, the West will find greater use for radio than the East; said reason being that out here our distances are greater. What does that mean? Simply this: that radio annihilates distance, and the more distance there is to overcome the greater and more important the feat.

Concretely I mean something like the following:

Along the Atlantic Coast I suppose there are comparatively few homes of the middle or better class without a telephone. No one is more than a few miles from a telegraph station. Few live outside the delivery zones of daily newspapers. You can reach every human be-

ing in New York, for example, within eight hours, if you have to and hump yourself sufficiently.

On this Coast, to the contrary, four fifths of our area and probably two fifths of our people live beyond the range of easy communication. Mountain ranges, unfordable and unbridged rivers, and desert wastes intervene. You have to go around where you can't go across. If a political candidate, to take an example, wanted to communicate with every voter in the three Coast states, it would take him ten years to do it and by that time so many youngsters would have come to the voting age that some galoot in Woodland or Bellingham would probably have been elected by a plurality of thirty thousand and would have given away all the post-offices and made himself solid with the constituency and good for four terms.

Along comes radio. And I have made up my mind, since pursuing this elusive and mystic subject for the kind editor of this publication, that inside of a year there will not be a person in the Pacific Coast states who will not

have or be within easy reach of a receiving station that will give him the hot stuff just as it comes from the old griddle.

I mean that—no less.

Taking only the matter of our mines, oil fields, and scattered ranches. To-day the men on some of these properties and places are about three weeks behind the rest of civilization—and in that length of time, as life moves to-day, you could kill off a couple of foreign potentates, divorce the country's best-known actress and marry her again, drive copper up to twelve cents or wheat down to sixty, and develop nineteen brand-new movie colony scandals in Hollywood. To-morrow—or the next day, at latest—the mine owner can order a new tunnel driven or two hundred men fired in half an hour, from his city office or club; the petroleum operator can take options at the rate of one a minute or can receive hourly reports of progress on a deep hole; the commission man can buy eggs or barley or cotton at one and the same time in Astoria, the Walker Lake reservation in Nevada, or in the heart of the Colorado

Here's a boy who has done it. George Frost, 18 years old, president of the Lane High School Radio Club, Chicago, has equipped his Ford automobile with a radio receiving set





Not pretty, but it works. This radio installation put on his Ford by "Bud," Slocum, a 16-year-old sophomore in Ionia High School, Mich., is not as neat and compact as those to be installed on California's automobile stage lines—but it works

desert, and eat a sandwich at Fourth and Market streets, San Francisco, while he's so engaged.

Another instance (out of hundreds) is that, potentially, of the man operating a mountain resort. At present he and his guests are at one end of a tenuous telephone or telegraph wire, and between them and civilization are mountains, deserts, gulches, wastes, and unmapped wilderness, with nothing but the wire to depend on, and no assurance that a hawk pursuing a nimble English sparrow won't put that out of commission at any hour of the day. I make no doubt whatever that every resort and camp in the West will this summer be advertising daily news dispatches, concerts, fashion notes, and society items within an hour of the time that the man who stayed in the city gets them warm from the press. And the field is still left wide open for men who go into still more remote places, on business or

pleasure, and who to-day might slip over a cliff or break a rib and lie for days, weeks, or months, as the case might or might not be, before any one found him—or his body.

For once I think we are safe in asserting that the wild and woolly West is at least up with, and perhaps something ahead of, the East. Conservative estimates put the number of receiving sets operating on the Pacific Coast and adjacent states at 25,000. The estimates run as high as 50,000 and, counting home-made sets which are increasing at an unbelievable rate, this is probably more nearly correct. Some of our lads out here are receiving messages daily and taking in concerts that are dispatched from points as far distant as Japan and the Atlantic Ocean, and the excellent and lively radio magazine now published here and already in (I believe) its fourth year has a couple of pages of "Calls Heard" reports that will make any Easterner sit up and tune up.

They claim, I understand, that there is a scientific gentleman in Los Altos of Sunnyvale, just south of San Francisco, who has heard farther than any man in America with his extensive and elaborate set, and he is engaged now in experiments on improved devices that, he and his company say, will multiply the practical usefulness of radio ten-fold. And so on. The friendly rivalry that exists between operators of radio outfits has done more, as Mr. Herbert Hoover has observed, to hasten the perfecting of the new practice than fifty years of laboratory work would have done under normal and non-competitive conditions.

The first successful station on the Pacific Coast, both for broadcasting and receiving, was the army one, established at the Presidio, in San Francisco, at about the time of the close of the war. This is one of the best-equipped stations here still, and has done a lot for radio on the Coast. There are now at least two broadcasting stations in Seattle, one large one about to be completed in Portland, if not one in Reno, Nevada, and possibly scattering ones in the other states hereabouts. They go in so fast that no one pretends to be able to keep track of them and there is, of course, nothing as yet that is official. In California the bay region about San Francisco is far ahead, with approximately twenty broadcasting stations, several of them finely equipped and with a great range. Los Angeles has caught the craze now and several installations are being made.

One interesting possibility just hinted at to me may be unique. California has, I believe, more long-distance automobile stage lines than any other state. At present the State Railroad Commission is working very hard to make these lines a real public utility and as dependable as to running time, stops, number of cars operated, and routes followed as it has already made them standardized as to rates charged. The principal difficulty has been to maintain a fixed schedule or time-table. But already one of the largest of the companies operating in this field, itself new, is making plans to equip each of its stages with a small receiving set and to dispatch its drivers and keep in touch with them on the road by radio. Here, again, the West has a use for the radio that may never be so acutely felt, if felt at all, in the East.

All the San Francisco newspapers and sev-

eral in other cities are now publishing a radio page. This all in the last few weeks. The University of California has extension course lectures on practical radio-telephony and the classes are over-crowded. A tight organization, known as the Pacific Radio Trade Association, is functioning fully and trying intelligently, and already with some success, to bring order out of the present chaos of broadcasting. The Association has already issued a schedule of hours when the air can be grabbed by the many who want it, and its officers—sound men in the business—are now looking forward to the time when one central broadcasting station will be erected. If this is not done soon by the government or one of the powerful companies or combinations, the Trade Association will undoubtedly take the bull by the horns and do it itself. It means business.

Much of my information comes from an amiable young gentleman named Rathbun associated with the Colin B. Kennedy Laboratories, of San Francisco, and I want to quote him a little to make clear how radio has developed here.

"When I left the army," Mr. Rathbun said; "I had two or three business propositions made me, but I took the one that paid the least and, to my friends, seemed to have the poorest future—a position with this company. It was organized by Mr. Kennedy in June, 1919, and he had one office boy and a mechanic. I took the work up because I felt pretty certain that within ten years, and perhaps within five, there would be a general and widespread interest in radio telephony.

"I was mistaken. When the blaze flared up it took six months to reach greater proportions than I had ever dreamed it would reach under five years. Now the company employs sixty-five people and is putting on more every day. We are seven months behind our orders, which come from all over the world, but in a few weeks we hope to have our facilities increased to the point where we can catch up to within three months, at least.

"The growth of the business has not been even like a mushroom's development—it has been like the bursting of a shell."

It seems not too much to hope that, within a year or so, the Pacific Coast will hear faint rumblings of the news about radio. Not too much if you are a hopeful person.

Adventures in Radio

Perhaps no other branch of science enjoys the romance and the spirit of adventure ever present in radio. It matters not whether it is the radio telegraph or the radio telephone, one has as many advantages as the other in this respect. Of course, radio telegraphy is the older of the two, and its exploits are more numerous; up to now, it covers a wider field of endeavor on both land and sea.

Aside from the everyday uses of radio, there are a great many instances in the history of the art which stand out as milestones in the march of progress; instances which few devotees of radio broadcasting know about. Many of these adventures were unique—not always possible or practicable to duplicate; on the other hand, some were accidents, others mere incidents, still others great adventures; adventures never to be forgotten and which stand out as red-letter days for the individuals concerned.

By adventures in radio we mean that which deviates radically from the commonplace. Radio has been responsible for many innovations—many new uses, some of which passed out of human ken, others were repeated again and again until to-day we have ceased to wonder and be thrilled when we chance to read newspaper accounts of such doings. Thus, we have the Radio Reporter, the first authentic instances being that of reporter Sprague of the Los Angeles *Examiner* who, pressed for time and urgently desiring to “scoop” the other sheets, commandeered the radio telephone set of a local army officer in order to report an unusual sporting event. Then there is the Radio Detective who came into his own during the war and of whom more will be said in a future number. The Radio Doctor has again and again proved his worth at sea, and many a sailor owes his life to a medical consultation held by radio from ship to ship or from ship to land. The initial success of the Radio Actor, or Actors, who have broadcasted an entire play over the radio telephone still rings in our ears. Then we have radio as the leading factor in the lives of the gunrunner, the smuggler, the arch criminal, the Central American revolutionist, the international spy, the cast-away sailor, and so we might go on indefinitely, for the exploits of radio are legion; some of which stand out as monuments of scientific achievements; others are ignominious ones to which this noble art has been unwittingly subjected. All of these, nevertheless, are intensely interesting, breathing the very spirit of adventure and romance.

To this end, it will be the purpose of this department to report each month radio adventures that actually took place, with real human beings as principals. The series will range over the entire world, with incidents taking place in Sweden, Patagonia, and far-off Japan, as well as in the United States.

The editors would be glad to receive accounts of such radio adventures from readers of the magazine, either their own experiences in the first person or authentic experiences of others.

Married by Radio

By PIERRE BOUCHERON

THESE have been all sorts of marriages, happy, unhappy, and otherwise. There are conventional marriages taking place in the church, or at the court house, or at home, and the bride and bridegroom are face to face, or side by side when the union takes place. They can always take one long look at each other before the fateful step and call all bets off if either one changes his or her mind. There, at least, is one advantage of conventional marriages. But marriage by radio takes a certain amount of faith, hope, and charity as well as a strong belief in science.

There is the case, for instance, of Wakeman versus Ebert, who probably broke the world's record for long-distance marriages—long distance in the sense that when the event took place they were separated by a few odd thou-

sand miles and their “yes I do's” were carried to each other across this vast stretch by means of the etheric waves of radio.

This first long-range marriage by radio took place in May, 1920, the Girl, Miss Maybelle Ebert, being in Detroit, and the Boy, John R. Wakeman, somewhere on the Pacific Ocean on one of Uncle Sam's battle wagons, the cruiser *Birmingham*.

About 8:30 in the morning, while the *Birmingham* was in mid-Pacific, the radio operator called for Wakeman, one of the sailors, with an important radiogram. It was an unusual sort of message and lacked the usual naval lingo referring to orders, transfers, target practice, arrivals, departures, or provisioning.

When its nature was made known to the ship's captain and chaplain, the entire crew was mustered on the after-deck with sailor

Wakeman as the central figure. The ship's powerful 10 kilowatt transmitter was started and the entire ritual of the marriage ceremony was repeated slowly by first the three individuals on board—the minister, the sailor, and the operator—then through an etheric stretch of nearly 3,000 miles to the First Presbyterian Church of Detroit, Michigan, where were assembled the bride, her friends, and the minister. While Miss Ebert and her friends were grouped about the minister, the latter telephoned the bride's side of the ceremony to a near-by telegraph office from which it was wired to the powerful radio station at the Great Lakes Naval Training Station near Chicago. From there, the ritual messages were flashed to and from the ship in mid-Pacific.

While it is true that the messages had to pass through several intermediaries before reaching their respective destinations, not much more time was consumed than would

ordinarily occur at a conventional wedding. The above unique event required the combined use of the radio, the land line telegraph, and the land line telephone.

Since this incident, there have been all manner of radio weddings, short and long distance, by land, by sea, and by air. Some of our readers may recall the aerial wedding of Lieutenant Burgess and Miss Jones during the annual New York City Police Games of 1919. While this was a real honest-to-goodness wedding, it was more of a spectacular event than one of necessity. The bride and bridegroom flew in an army airplane over the huge crowds gathered below. Behind them in another airplane was the "flying parson" who performed the ceremony.

Below, near the grand stand, several loud speakers had been installed so that the crowd could hear the entire ceremony as carried on above by radio telephone between the two planes.

Here is how Uncle Sam keeps track of every ship in the United States Navy. Captain E. C. Kalbfus is on the ladder, and Assistant Secretary of the Navy Roosevelt (left), and Rear Admiral W. C. Cole, assistant chief of naval operations, are below. Each of the four walls of this room at the Navy Department is covered with a large blackboard devoted to a different fleet, and the ships' movements are reported by wireless

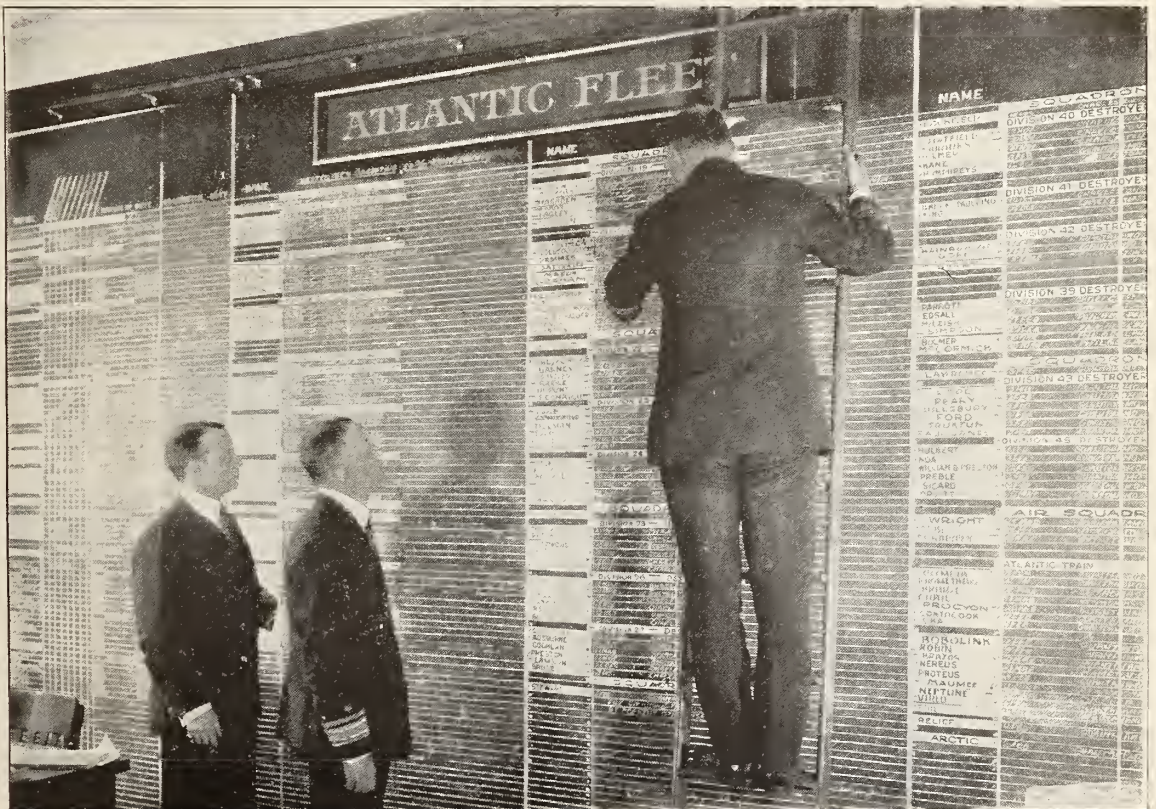

Sunk by Radio

NO, RADIOITE, it was not John Hays Hammond's radio torpedo in action, nor was it the German submarine *U-10* sent to the bottom by the duplicity and cunning of a British torpedo boat destroyer. It was a peace-time incident. It occurred off the semi-tropical and balmy coast of one of the Bahama Islands, and it was for the "movies" and in order that you, John, Maggie, and little Jimmie might be thrilled some evening while sitting in the little red "movie" house around the corner.

One morning of January, 1914, the tramp steamer *Camaguey* dropped anchor off Nassau, and the crew proceeded to the pleasant pastime of leaning over the rail while waiting for the local boarding authorities to come out from shore to pass inspection, preliminary to discharging a general cargo of merchandise. Close by lay a huge sailing boat painted the most vivid yellow imaginable, a yellow which covered sail, mast, body and all superstructure. What looked like lazy sailors were stationed here and there perfectly motionless and likewise clothed in the saffron scheme of the rest of the outfit. It was a strange sight this yellow "flying Dutchman" riding peacefully at anchor while the early sunlight played beams here and there on its vast expanse of yellow-hued sail.

The last rumble of the *Camaguey's* anchor chain had no sooner died down to respectable quietness when a speedy launch darted out from the other side of the yellow ship and

turned its bow toward the *Camaguey*, full speed ahead. In a short time the launch reached the side of the bigger craft and an excited individual jumped up from the stern end and yelled to the Captain to move the position of his ship to a point as distant as possible from the yellow craft as something drastic was about to happen. The e. i. being dressed in the office of a local authority, the Captain of the *Camaguey* accordingly picked up anchor again and moved to another point of the bay.

Meanwhile, the wireless operator had observed that the yellow craft was equipped with a radio antenna. Following the strong instincts of his kind and wondering what it was all about, he accordingly repaired to his "radio shack" and with his gaze centered on the strange craft began to call "CQ, CQ, CQ," which is the general call asking any one within hearing distance to reply.

For answer, he heard a loud, sonorous spark of close proximity telling him to please stop sending for at least 15 minutes. The operator continued to gaze out of the porthole across the calm surface of the lagoon at the yellow ship as if fascinated and with the head telephone receivers still on his ears.

Presently he heard a series of unintelligible dashes, sent slowly and perfectly timed, one following the other, then silence, then a few dots, then more dashes. It was all very strange, for they seemed to be so close that he reasoned they were being transmitted by the



Radio antenna among the palm trees in the Bahamas

Radio panels

HAVE your panels made to your own specifications. Celoron Radio Panel Service assures you the highest type, best serving, best looking radio panels made, machined and engraved to your own individual specifications.

Condensite Celoron Grade 10—the highest type of radio insulation that we produce—has a wide variety of uses in the radio field. It is extremely high in surface and volume resistivity, high in dielectric strength and low in dielectric losses. Particularly suited for panels because it machines easily, engraves beautifully and is extremely handsome in appearance. This is the grade we recommend. It has been approved by the Navy Department Bureau of Engineering.

Where economy is a factor we can supply panels made of Vulcanized Fibre Veneer. This material is made of a center section of hard, grey vulcanized fibre veneered on both sides with a waterproof, phenolic condensation product. It has a fine, smooth, jet black surface, machines readily, engraves nicely and is applicable for use in the construction of radio equipment where very high voltages at radio frequencies are not involved.

Celoron Shielded Plates (patent applied for) are made with a concealed wire mesh imbedded directly under the back surface of the plate. This wire shield, when properly grounded, very effectively neutralizes all "howl" and detuning effects caused by body capacities. Made in both grade 10 and Vulcanized Fibre Veneer.

Send to-day for our Radio Panel Guide

Are you an enthusiast? Write to-day for our Radio Panel Guide that describes these panels in detail—quotes prices—and tells you just what the panel you want will cost.

Are you a Radio Dealer? Get in touch with us. Learn how easily Celoron Radio Panel Service enables you to sell panels completely machined and finished to your customer's specifications. No waste, no bother. Write for our special Dealer Proposition to-day.

DIAMOND STATE FIBRE COMPANY

Bridgeport (near Philadelphia) Penna.

Branch Factory and Warehouse, Chicago

Offices in principal cities

In Canada: Diamond State Fibre Co. of Canada, Ltd., Toronto

yellow ship. Yet perfect stillness prevailed on board and even a pair of binoculars trained on the "lazy" crew failed to show the reason for the strange behavior of the craft.

Meanwhile the speedy launch had turned about and was making for a large float about a half mile in the offing where considerable paraphernalia seemed to be centred, with a group of men moving about from one instrument to another.

Slowly, the dashes were repeated, then the dots, then silence. Finally, a long dash was heard lasting fully a half minute, at the end of which the horror stricken operator saw a blinding flash dart from the centre of the yellow craft followed by a monster cloud of dense smoke, then a terrific explosion. The sails, mast, superstructure, sailors, and antenna were hurled high into the air and in a few minutes the smoke had cleared and the débris had settled near the spot where the doomed ship had been. It was indeed a horrible sight, a terrible tragedy. What had happened?

Just then it occurred to the operator to train his glasses on the distant barge. What he saw now was three perfectly collected and calm individuals gathered about a man who was *cranking away at a moving picture camera* "shooting" the last scene of the ill fated craft's end. Another movie tragedy with radio playing an unseen rôle had just been enacted.

Briefly, the yacht was painted yellow that it might better register on the film, the lazy sailors were dummies set up for local color, the barge held the directing party. A short distance away on shore was erected a portable spark transmitter which had sent the dashes and dots actuating a master relay and control drum on board the craft which in turn performed several functions, the final one that of igniting a powerful charge of explosive. The tramp steamer operator had witnessed a near drama assisted by radio, where the yellow craft had almost made its getaway with the millionaire pirate on board as part of the story's plot.

Making Radio Sales Pay

By ARTHUR H. LYNCH

RADIO broadcasting has proceeded at such a rapid pace that we now find haberdasheries and drug stores going into the radio retail business. This condition is not good for radio and it is doubtful that such stores will long continue to thrive as dispensers of radio products.

Even some of the largest department stores, in the cities where radio broadcasting is being carried on, are not suitably equipped with personnel to render the proper service to their radio customers. A few days ago, while making a small purchase in one of these establishments, a radio man overheard a clerk in the radio department explaining to a customer that a certain receiving set could be used with a loop antenna for the reception of broadcasted wireless telephone concerts over very great distances. The customer appeared sceptical, so the enthusiastic clerk plunged into a long story, using a lot of technical words which actually meant nothing to the customer, but which he thought would make a favorable im-

pression. Unfortunately, the customer believed the clerk and purchased the outfit.

Most of the technical language indulged in by the clerk was nothing more than hearsay, and his contention that the set would function satisfactorily over the long range he had mentioned was absolutely false.

Barnum said the public likes to be fooled; perhaps he is right, but it would be pretty safe to assume that after attempting to secure the wonderful results pointed out as possible by the clerk, the customer who purchased the radio outfit from a reputable department store would return the outfit to the store for credit and the store itself would be in a fair way to lose a good customer.

The importance of stopping such a course of procedure as this cannot be overestimated and those in charge of the radio merchandising departments, whether they be in department stores or electrical supply houses, should make every effort to be sure that the men behind the counter really know the possibilities of various

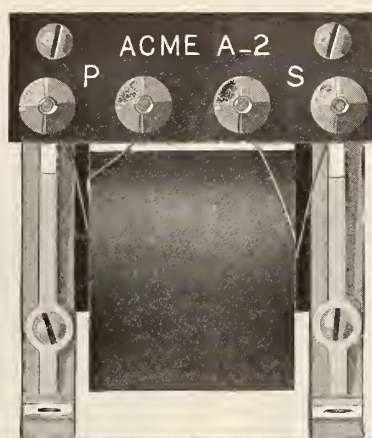

Model A-2S
Amplifying Transformer
Price \$5.

—and whispers become living voices

WHEN you add one stage of Acme Amplification to your receiving set, music and dialogue assume a depth and roundness totally lacking in the ordinary detector circuit.

Throw in two stages of Acme Amplification, and sounds come in volume so distinct that you can use a loud speaking device—the *real* way to hear broadcasting.

Acme Amplifying Transformers are built with specially designed closed iron cores which prevent howling and distortion. Why not buy the best, they cost no more.

For sale at good radio stores.

The Acme Apparatus Company

CAMBRIDGE, MASS.

*Transformer and Radio Engineers
and Manufacturers*

New York Sales Offices,

1270 Broadway

ACME

TRANSFORMERS

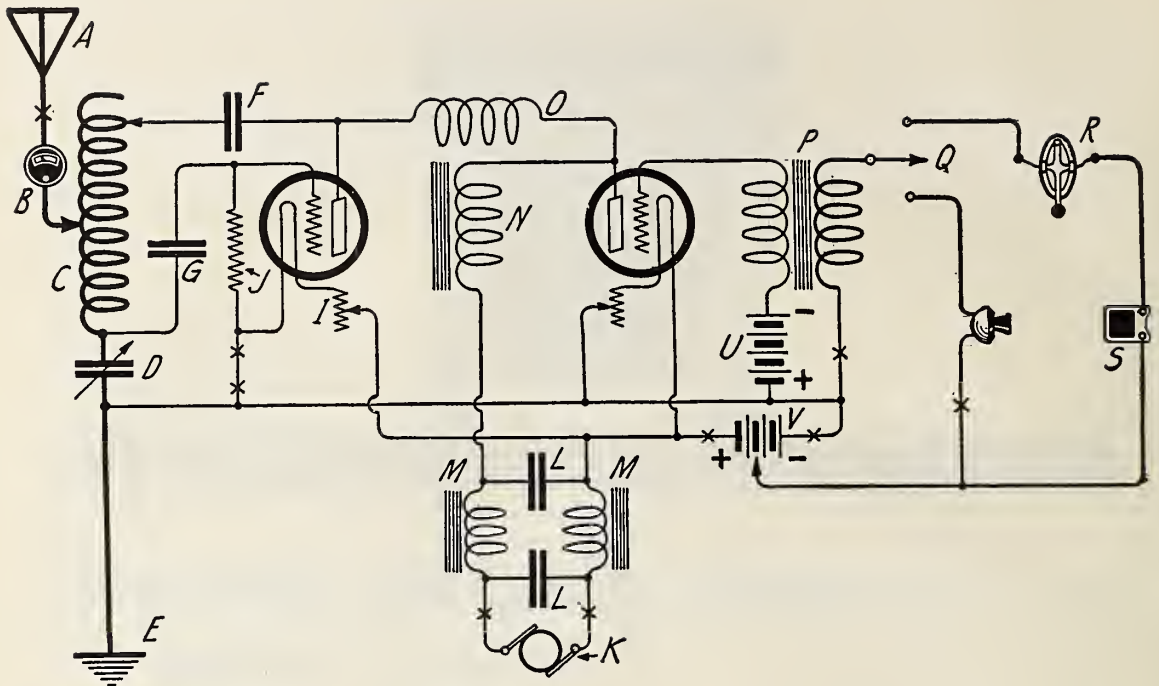

Fig. 1. Illustrates complete 5 watt radio telephone and buzzer-modulated radio telegraph transmitter. The assembly is entirely made up from stock parts and designed for use with direct current power supply. A motor-generator is employed for supplying the plate voltage.

types of equipment and in no case exaggerate the results which are likely to be obtained.

There is a growing tendency, even on the part of employees of the most representative radio companies in the country, to treat customers with little or no consideration. This is more or less natural, for the demand for radio apparatus is so great that if a sale is not made to Bill Jones, Dick Smith races in with a check in his hand all primed to relieve the radio dealer of any superfluous material he may have on hand.

Sales people in radio supply stores naturally become tired explaining to Tom, Dick, and Harry that their stock of What Nots is exhausted and that it is not likely to be replenished for a few days or a week, especially toward the end of the day after the same story has been told many many, times. However, the customer may also have put in a rather strenuous day in his office or at his bench, and is likely to resent the indifference on the part of the salesman.

Indifference of this sort grew during the boom time in business in the late war. The sales people in practically all the stores in the country became very independent, as did the

stores themselves. The natural reaction was that the public soon found that it was possible for them to do without some of the material they formerly considered necessary, and when the stores eventually secured quantities of the material, previously very scarce, the public had learned to do without it. This very same condition is rapidly growing in radio circles, and it is very regrettable. Can we not nip this tendency in the bud?

RADIO DISPLAYS

The accompanying illustrations serve very well to indicate the parts necessary for assembling a complete wireless telephone and telegraph transmitter for use with either alternating or direct current. Where direct current electric light systems are found, it is necessary for the amateur to use a motor generator for supplying the necessary plate voltage for the vacuum tubes. Where alternating current is available, however, a suitable method for transforming and rectifying the current is supplied by units now on the market which offer the dealer a very attractive source of revenue. By assembling a complete transmitter upon the base, having the wiring plainly

Crystal or Vacuum Tube Detection with the same set

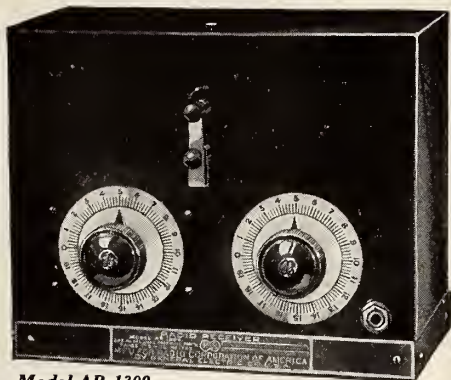

Model AR-1300

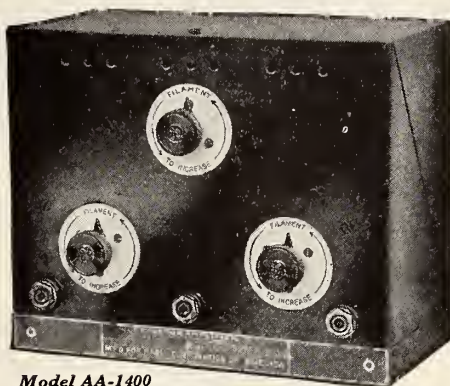

Model AA-1400

These two sets (radio receiver Model AR-1300 and Detector Amplifier Model AA-1400) meet the demand of the novice who wishes to start with a simple crystal detector and later to pass on to vacuum tube detection and amplification at minimum cost.

Radio receiver Model AR-1300 is a new tuner for the broadcast enthusiast. Used as a crystal detector it is a complete receiver. Used with Model AA-1400, here shown, the crystal detector is switched off and amplification is controlled by regeneration.

Detector Amplifier Model AA-1400 consists of a vacuum tube detector and two stages of audio-frequency amplification. It

is especially adapted for use with receiver Model AR-1300 to increase the strength of broadcasted concerts. The individual filament control permits close regulation of the received energy. Distortion of broadcasted music is avoided by a special high-frequency resistance across the secondaries. Three telephone jacks insure ideal selectiveness ranging from simple tube detection to two stages of amplification.

PRICES (NOT INCLUDING ANTENNA, TUBES, AND BATTERIES)

Radio receiver Model AR-1300 \$50.00
Detector Amplifier Model AA-1400 75.00
Total for Combination \$125.00

See these New G. E. Products at Your Nearest Dealer



Sales Department, Suite 1807
 233 Broadway, New York City

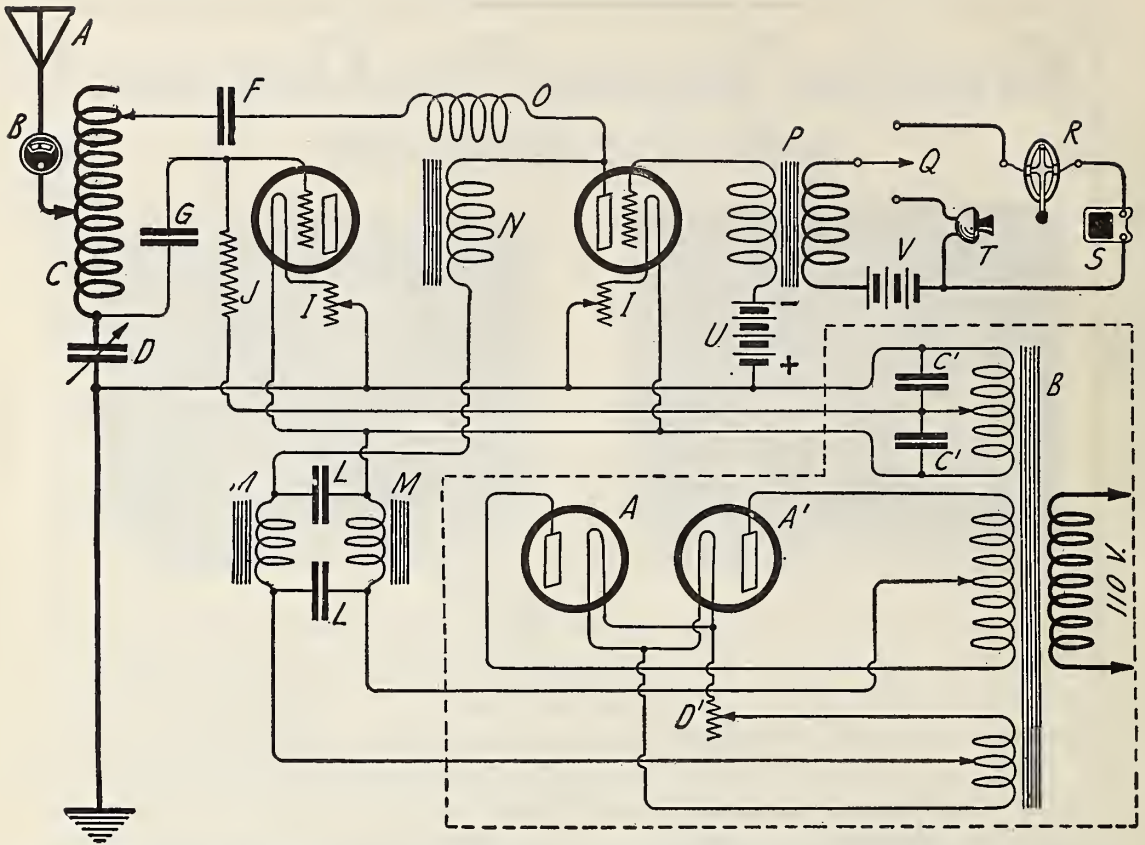

Fig. 2. In this circuit practically the same arrangement has been followed as in Fig. 1. However, this set is designed for use from an alternating power supply. The motor-generator is replaced in this instance by two rectifier tubes and a transformer made with three secondaries; one for lighting filaments of rectifiers; one for filaments of transmitter tubes, and one for the high voltage plate supply.

shown, and displaying it in the store, it is possible for the patrons to see at a glance how each unit is employed in the assembly.

LIST OF RADIO TELEPHONE OUTFIT PARTS

	Apparatus in Fig. 1	Approximate Price
A	Antenna	
B	1 Thermo-Ammeter, each.	\$18.25
C	1 Inductance	8.50
D	1 Variable Condenser	4.75
E	Ground Connection	
F	1 Condenser, .005 mfd., 1,000 volt	2.00
G	1 Grid Condenser	1.00
I	2 Rheostats.	1.20
J	1 10,000 ohm Grid Leak	1.25
K	1 Motor-Generator	99.00
L	1 No. 21A Fixed Condenser	2.55
M	1 Two-Coil, 150 milliampere choke	6.00
N	1 Single-Coil, 150 milliampere choke	4.00
O	1 No. US 100 Duo-lateral coil	1.30
P	1 No. 3 Acme Modulation Transformer	7.00
Q	1 S. P. D. T. Switch64
R	1 Telegraph Key	2.00
S	1 Buzzer	2.50
T	1 Microphone	2.65
U	1 Battery, 22½ volts	2.25

V	1, 6 V, 80 A Storage Battery	30.00
X	10, No. 3 Spring Connectors05

Fig. 2

All parts bearing the same markings as in Fig. 1 are duplicates. As previously mentioned, the motor-generator is done away with and the filament lighting battery may be put in the microphone circuit, as shown. The parts which differ from those in Fig. 1 are included by the dotted lines and follow:

A'	2 No. U. V. 216 20 watt, Rectifier Tubes	\$ 7.50
	2 Tube sockets	1.00
B'	1 200 Watt C. W. Transformer	20.00
C'	2 .001 Mfd. Condensers75
D'	1 5 ampere Rheostat	2.00

NOTE: The "x's" in the first diagram indicate the points at which alterations must be made in order to employ A. C. or D. C., as desired.

In addition to placing a demonstrating outfit of this character in the show case, it is essential that a list of the units employed, showing the price of each, be conspicuously displayed. Where the dealer's stock is made up of units designed for the same use manufactured by



Crosley Radio Apparatus

is proving to be the equal of any on the market regardless of price.

The Crosley non-regenerative circuit has so simplified the mechanical construction of Crosley Radio Apparatus that the low prices might be mistaken for an indication of cheap merchandise.

Crosley Radio goods are quality goods. Quantity production is also responsible for the reasonable prices at which they are sold.

Crosley Harko Senior Detector and Tuner

This highly efficient tuner and detector will of itself without amplifier bring in from hundreds of miles, concerts loud and clear with head phones alone. The hook-up is Crosley non-regenerative, efficient, yet simple. Detroit, Pittsburgh, Chicago, Newark, N. J., etc. are heard regularly in Cincinnati with this single instrument. Parts are substantial, well made and finely finished. The cabinet is mahogany finish, \$20, without batteries, head phones or tubes.

\$20

This Harko Senior receiver (pictured) in Denver, Colorado, without amplifier picked up Dr. Chas. Steinmetz's lecture in Schenectady, N. Y.



Other Crosley receiving apparatus, table and floor designs, completely illustrated in our catalogue. If dealers cannot supply you write us. Some distributing territory still open.

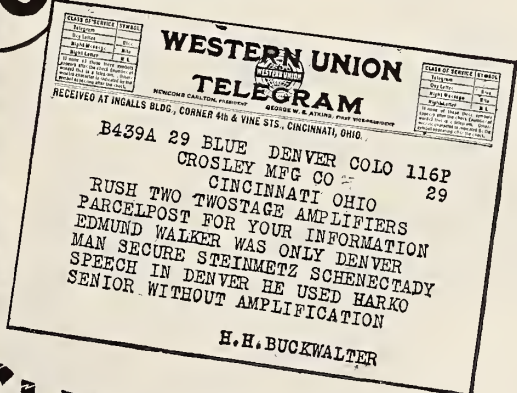

CROSLY
 Manufacturing Co.
 Dept. RB-622
 Cincinnati, Ohio

Write us for our Radio Parts Catalogue.

All radio accessories guaranteed tested and efficient. Low prices prove our slogan, "Better-costs less."



This is the complete layout for a 10 watt wireless telephone transmitter

several different companies, which can be employed in a circuit of this character, a circuit diagram should be shown with a symbol

for each unit indicated by a letter. The price list should carry not only the actual units in the assembly but also those the dealer has in

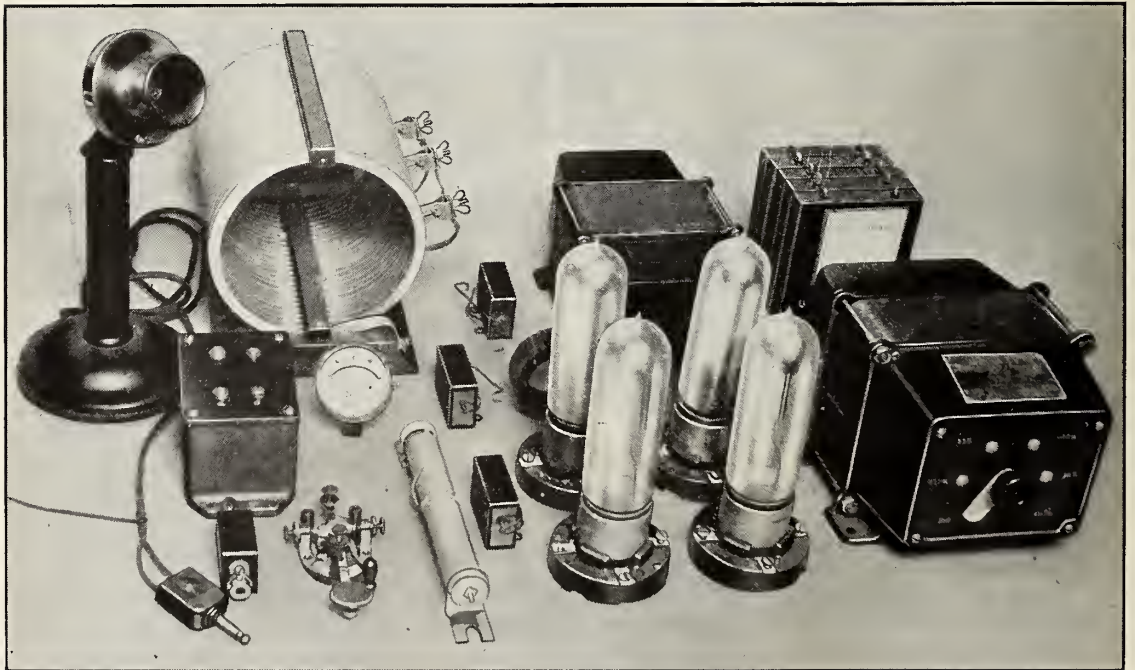

All the necessary parts for a complete 100 watt wireless telephone or telegraph transmitter are shown in this picture

A step ahead-

HESLAR RADIO

THE Heslar Radio Corporation, although new in organization, is old in experience. Headed by former Lieut. O. F. Heslar, U. S. N., who has had fourteen years of Radio experience with the government and has made many important improvements in Radio apparatus, this large organization is manufacturing Radio sets and equipment that will simplify the Radio art.



The Sign
of Superiority
*Know this sign
as your guide to
dependable Radio
equipment*

Into every Heslar product goes the highest standard of material, the finest craftsmanship and every HESLAR product features important improvements, that have immediately placed HESLAR equipment in great demand. We are already producing jacks, variable condensers, sockets and phones, that show marked advance over the present models. Ask for literature on these improved HESLAR creations.

Radio Equipment with Last Minute Improvements

Dealers—awake to the wonderful opportunities in radio and who realize the demand for superior quality and advanced apparatus will be quick to get in touch with this large organization.

Write for Territory at Once—NOW

"Heslar Radio-makes the World Your Neighbor"

HESLAR

RADIO CORPORATION
INDIANAPOLIS

Dept. A.

U. S. A

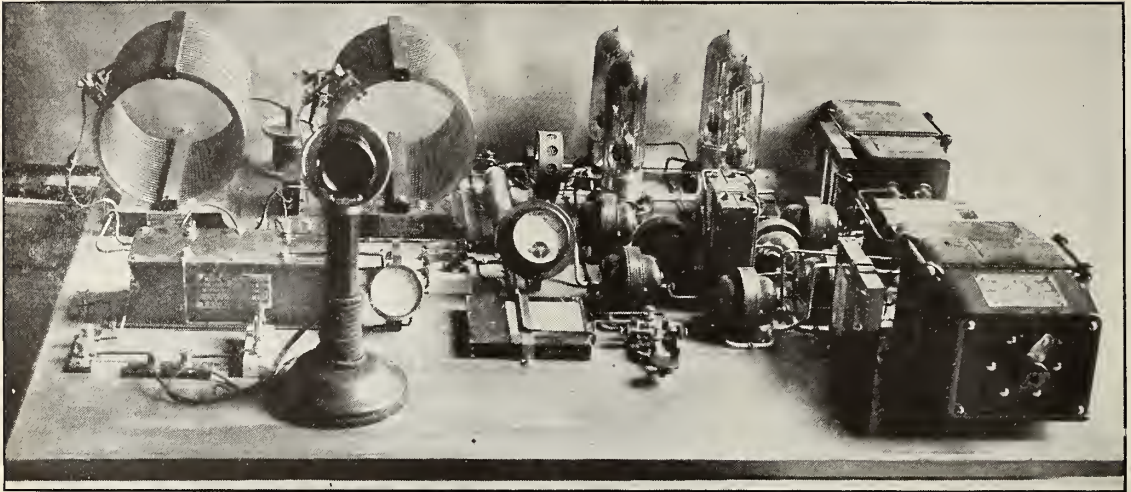

This is a highly refined vacuum tube transmitter circuit, such as is used for instructional and experimental purposes in colleges and laboratories. Completely wired, as this set is, it would be a valuable asset for any dealer, helping him to sell units

stock, which could be substituted for them. For instance, a dealer may handle four or five different types of telegraph keys or microphones, but only one of them appears in the assembly. Unless his list of parts includes the various types he has for sale, he is failing to take advantage of a good opportunity.

A short time ago, the following incident was brought to the attention of a salesman traveling through the South for a large corporation.

In one of the Southern States a man who ran a very flourishing electrical supply business, saw that radio was expanding very rapidly and decided to carry a line of radio equipment. He made rather extensive purchases which included not only small parts but complete transmitting and receiving outfits.

After the stock had remained on his shelves for some little while without showing any tendency to move, this dealer decided that it was a liability and took the necessary steps, as he thought, to wash his hands of it. He made one cut after another in the retail price, but his stock still remained.

In the meantime a competitor loomed up on the horizon in the form of an electrical dealer whose business was rather small and located almost directly across the street. This small dealer merely put in a few radio parts, but spent his evenings at a local radio school and attended the meetings of the local radio club religiously.

It was not long before he was able to talk

radio from the amateur's own viewpoint because he had become an enthusiastic amateur himself.

From his contact with the radio amateurs this man was able so to direct his purchases that a very limited investment followed by a rapid turn-over resulted in a rapid building up of a business which to-day is very substantial.

This story was told to the traveling salesman after he had observed an incident which must have been duplicated many times before by these two stores. A customer came into the store of the first dealer we have mentioned, desiring to purchase a certain unit which carried not only a designating name but a trade name. This particular unit is referred to by the experienced amateur by its trade name alone. The dealer advised this prospective customer that his stock of this class of equipment was exhausted, but he failed to take into account that a similar device made by a different manufacturer was to be found in rather large quantities upon his shelves. It happened that the salesman was in the store at the time and the incident interested him so much that he followed this customer to the competing store across the street. Here the same request was made and here, this dealer too, was compelled to advise this prospective customer that his stock of this type of unit was exhausted. However he did not fail to mention that he had another type which would serve the purpose just as well, if not better. Naturally the sale was made and the customer was

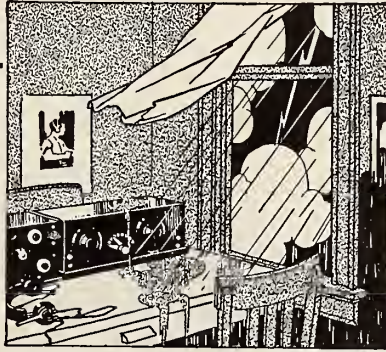

Rain Won't Injure Your Formica Panels

FORMICA does not absorb moisture so its insulating quality is never affected by weather or even by soaking in water. It does not swell or shrink and never warps. The handsome high gloss finish does not deteriorate. It looks good for years—and is good!

Formica has been approved as Radio Insulation by the navy and the signal corps. It is by far the most widely used Radio insulating material.

Formica is easy to machine and helps you do a workmanlike job on your panel. You can buy it cut to size for a standard Radio panel. All you need to do the work is a drill.

Dealers: We supply you with display cards for your store and Formica printed matter. We cut panels to size for you if you wish—and cooperate in every way possible. Extension to our plant will double capacity after July 1st.

The Formica Insulation Company
4628 Spring Grove Avenue, Cincinnati, Ohio

Sales Offices

50 Church Street, New York, N. Y.
9 South Clinton Street, Chicago, Ill.
414 Finance Building, Cleveland, Ohio
1042 Granite Building, Rochester, N. Y.

422 First Ave., Pittsburgh, Pa.
Sheldon Building, San Francisco, Cal.
932 Real Estate Trust Bldg., Philadelphia, Pa.
321 Title Building, Baltimore, Md.
415 Ohio Bldg., Toledo, Ohio

FORMICA

Made from Anhydrous Redmanol Resins

SHEETS TUBES RODS

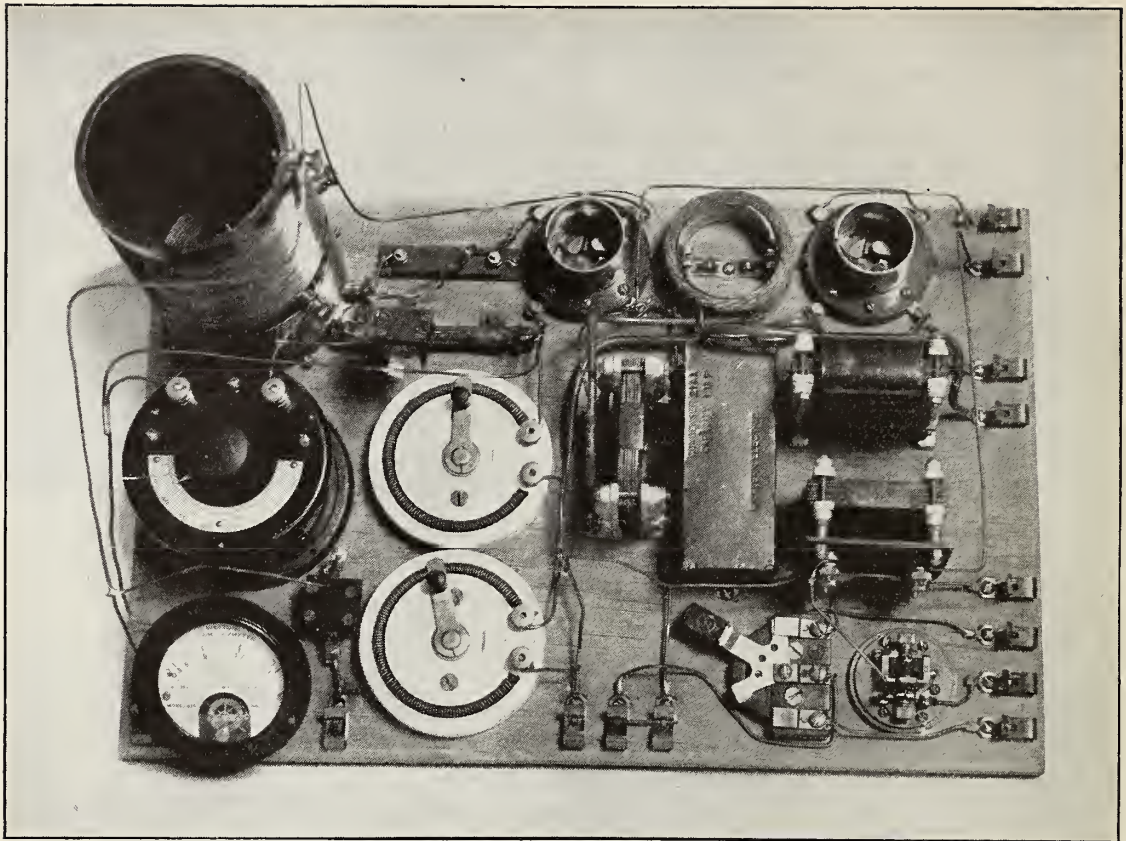

A DISPLAY OF STANDARD RADIO PARTS
Assembled, wired and displayed by a progressive
radio dealer—a great help to the buying public

entirely satisfied. Had the proprietor of the first store been sufficiently versed in radio to merchandise his stock properly, it would have been possible for him not only to make this particular sale but, in all likelihood, to secure for himself a steady customer, not only for his radio department, but for every other class of electrical goods he had for sale—and he had just about every kind.

The importance of highly trained personnel cannot be overestimated if the radio department of a general store or the strictly radio store itself is to survive. To-day, to-morrow, and next week, perhaps, the public will make

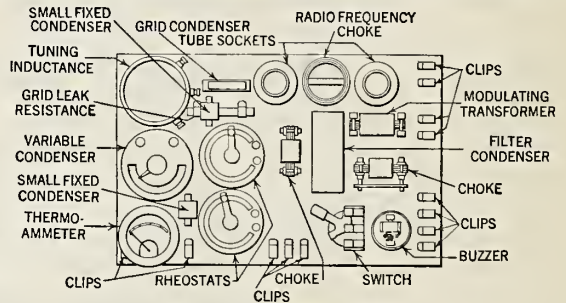

its purchases as best it can, but when the supply begins to equal the demand, it will again become necessary for us to "sell," which is going to be very difficult if the public to whom we seek to make sales has been abused by us.



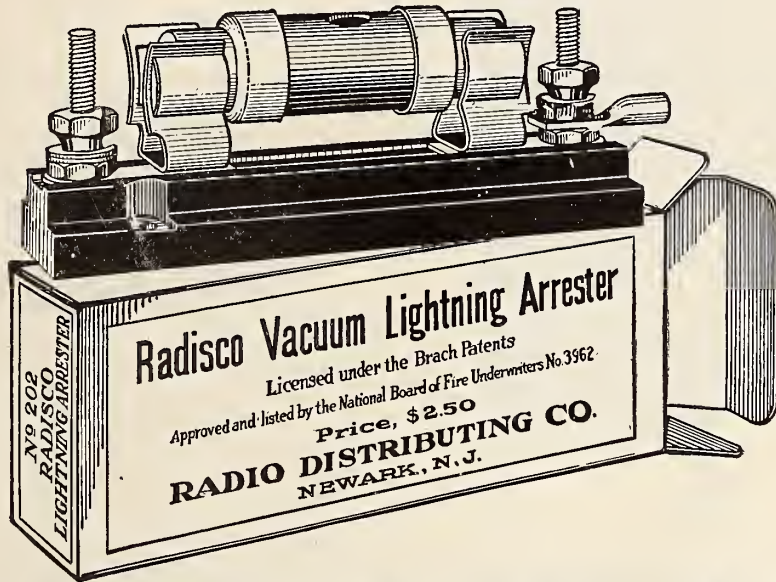

RADISCO PROTEC-TON

Automatic Lightning Arrester
DEFIES LIGHTNING

PROTECT your home and radio instruments from lightning with a Radisco PROTEC-TON. This "lightning defier" is approved by the National Board of Underwriters, Electrical, 3962. It eliminates the necessity of a lightning switch. It provides the assurance of absolute protection. Make your home safe. Get a PROTEC-TON at once. Price \$2.50.

This is only one of a line of "Radisco Recommended" Specialties carried by your dealer. Go to him and examine them at your leisure, he can make immediate delivery.

Look for the dealer who displays this sign

RADISCO

"Your Assurance of Satisfactory Performance"



Authentic information about how to install a Radisco PROTEC-TON to conform with Underwriters' requirements cheerfully given by RADISCO dealers. Go to the nearest RADISCO dealer and let him explain the necessity for this protection.

The Grid

QUESTIONS AND ANSWERS

The Grid is a Question and Answer Department maintained especially for the radio amateurs. Full answers will be given wherever possible. In answering questions, those of a like nature will be grouped together and answered by one article. Every effort will be made to keep the answers simple and direct, yet fully self-explanatory. Questions should be addressed to Editor, "The Grid," Radio Broadcast, Garden City, N. Y. The letter containing the questions should have the full name and address of the writer and also his station call letter, if he has one. Names, however, will not be published. The questions and answers appearing in this issue are chosen from among many asked the editor in other capacities.

What is an electron?

Why do hot metals throw off electrons?

Why will a current pass through a tube only when the filament is lighted?

How many electrons pass from the filament to plate in a detector tube?

Can an electron be seen with a magnifying glass?

Where do electrons come from?

Electrons

EVERY one is more or less familiar with the fact that ordinary matter can be broken up into very small particles. Sugar, for instance, is most commonly seen in the granulated form, which parts are visible to the naked eye. Powdered sugar is another familiar form. It takes a very keen eye to detect the particles of sugar in this form. Sugar may still further be divided by dissolving it in water, say a teaspoonful of sugar to a glass of water. No trace of the dissolved sugar can be seen. Its presence can be detected by tasting the water which is sweet. In dissolving the sugar, it has been broken up into the smallest possible particles. No matter what method is employed, the sugar could not be divided further. Similarly, other materials can be divided and subdivided until there comes a time when no further division is possible. These smallest particles of matter are known as molecules and atoms. An atom is the smallest division of matter. An electron is to electricity what an atom is to matter. An electron, therefore, is the smallest part into which electricity may be divided. It is negative electricity.

It has been shown beyond any possibility of doubt that electrons are present in all kinds of matter—in everything; metals, paper, wood, everything. In the usual state of matter, these electrons do not manifest themselves. But if a body has more than the usual number of electrons or less than the usual number, the body is said to be electrically charged; being charged negatively in the first case, and positively in the second case. As an electron is the smallest possible charge of negative electricity, a body is caused to have a negative charge by an excess of electrons and is caused to have a positive charge by a deficiency of electrons.

From theoretical consideration, it was long suspected that such a thing as the electron existed. Their presence was detected by the use of tubes similar to X-ray tubes. Having detected them, scientists were quick to go about making measurements of them. After a lapse of some time, and as a result of very careful and brilliant work, the mass, electrical charge, and dimension of an electron became known.

One very noteworthy experiment in measuring an elec-

tron was performed by an American, Prof. Millikan of Chicago. He introduced a minute drop of oil of about 1-10,000th inch in diameter in a chamber between two plates whose electrical charge was subject to control. The drop of oil was strongly illuminated and was viewed by a telescope. By controlling the potentials of the plates the oil drop could be made to fall or rise at will. The drop continually picked up and lost electrons. As it picked up an electron, it would move toward the positive plate (unlike charges attract); if it picked up two electrons it would move faster toward that plate. By carefully observing the action of the drop of oil, Millikan was able to determine very accurately the charge added to it by its picking up one electron.

The electron is inconceivably small in mass, in size, and in the charge it carries. It would take more than a million million of them laid side by side to make an inch. Thus it is seen that it is too small ever to be made visible by any means. When an ampere of current is passing through a wire, more than six million million million electrons pass any given point in the wire each second. A detector tube has a plate current of about 20 milliampères. As this is 1-50th of an ampere, then the number of electrons passing from the filament to plate is about one hundred and twenty thousand million million per second. This number is inconceivably large. Millikan says that the number of electrons which pass every second through a common 16-candle power lamp is so large that it would take two and a half million people, twenty thousand years of twenty-four hour working days to count the number if they all counted at the rate of 120 per minute.

It is seen from the above that a current of electricity is a flow of electrons. When man first commenced to study electricity he thought that there were two kinds, which he named positive and negative. As has been already noted this was an error, for there is only one kind and an excess or deficiency of this kind gives what was called negative and positive electricity. Soon man discovered that if a positively charged body and a negatively charged body were connected by a wire, electricity would flow along the wire. The direction of the flow of current was taken to be from positive to negative. This was also an error which has persisted to the present day. It is now known that nothing passes from the positive to the negative charge. On the contrary, the electrons pass from negative to positive and thus make the current. Ordinarily, however, we speak of the current as passing from positive to negative. The error is so deeply planted in all literature dealing with electricity and so many rules have been formulated upon it that it is too late to change it now. However, when one thinks about electrons, he must be aware of the fact

UNIVERSAL RADIO CABINET

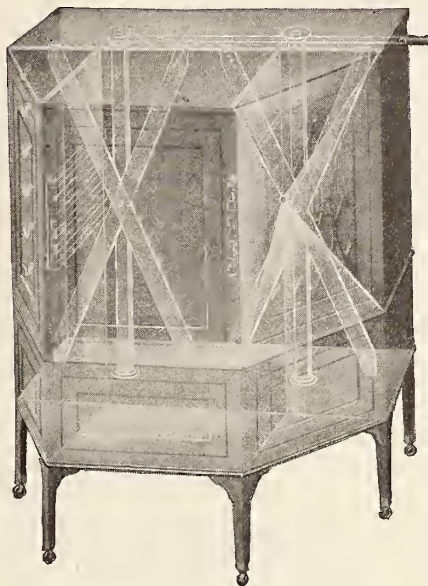

A Beautiful Piece of Furniture

You can put your own receiving set and batteries in this cabinet.

The horn is built in and is a part of the cabinet. The supports for a loop aerial and head phones are supplied, and adjustable shelves will accommodate every piece of apparatus.

Whatever the size of your instruments, they will fit these cabinets and you can install them yourself easily. We will gladly send you a descriptive circular telling how this is done.

Every owner of a radiophone wants one—it is just what you are looking for.

The apparatus will no longer prove a dust-collecting nuisance, scattered about the room—an unsightly obstacle wherever it is placed.

PRICES PREPAID

Size No. 1—To accommodate single units not exceeding 16" x 13" x 8"	Size No. 2—To accommodate units not exceeding in size 24" x 20" x 10"
Style A \$80.00 f. o. b. Grand Rapids	\$ 95.00 f. o. b. Grand Rapids
Style B 120.00 " " "	145.00 " " "
Style C 160.00 " " "	190.00 " " "

Ask your dealer for a Universal Radio Cabinet—or send your order direct to

FRANK LANE COMPANY

Woolworth Building, New York City

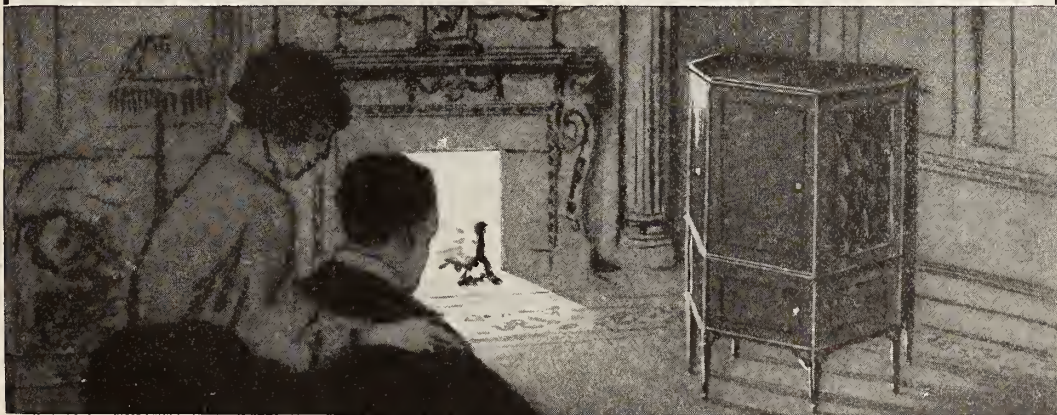

that they flow in the opposite direction from the direction of the current as it is commonly known. In the vacuum tube, for instance, the current is said to pass from the plate to the filament. In reality it is the electrons that pass from the filament to the plate.

As has been stated all matter contains electrons. These electrons are associated with the atoms of the matter. In some atoms the electrons are bound very firmly to the atom and cannot escape. In atoms of other materials, the electrons are held only loosely to the atom and very readily escape. Materials having electrons loosely bound to the atom are conductors of electricity. That is, if they are subject to an electromotive force (voltage) the electrons will move. One must not think that the same electrons pass all the way through the wire. The electrons are fed in at one end and other electrons escape at the other end. Thus in a battery with a completed circuit, it will take a long time for any particular electron to go completely around the circuit. But as soon as one electron leaves the battery another electron enters it.

The temperature of a body is caused by the motion of the atoms composing that body. If the motion of the atoms ceased, the body would have a temperature of absolute zero—that is, 461 degrees Fahrenheit below zero. As the rapidity of the motion of atoms increases, the temperature of the body increases, so that at very high temperature the motion of the atom is very rapid. The electrons are a part of the atom and hence share in its motion. In fact their velocity is much greater than the atom.

Water evaporates. Evaporation of water is caused by molecules of water (a molecule corresponds to an atom)

attaining such a high velocity that they escape from the rest of the water into the air, thus forming water vapor. Heat the water and the rate of evaporation increases. Heat it to the boiling point and the escape of the water molecules occurs not only at the surface of the water, but also within the water. Thus it is seen that an increase of temperature increases the velocity of the water molecules, which means that an increased number of them escape from the water.

At very high temperatures, under special conditions, metals can be made to evaporate. Thus it is possible to give the atoms of metals such a high velocity that some of them will escape from the rest of the metal. In the same way if the temperature is high enough (i. e., the velocity great enough) electrons will escape from a hot body. This evaporation of electrons will take place at a much lower temperature than would be required to evaporate the metal itself.

A hot body then emits electrons. It is this fact that is made use of in the vacuum tube. Heating the filament of a vacuum tube causes it to throw off electrons, which pass to the plate and thus make an electric current. If the filament is not heated, there are no electrons available and hence no current can pass.

In concluding it must be brought to the attention of the reader that some materials emit electrons more readily than others. The condition of the surface of a metal has an important effect upon the number of electrons emitted. Thus it happens that some vacuum tubes must have their filaments white hot, and other tubes must have their filaments only red hot for good results.

New Equipment

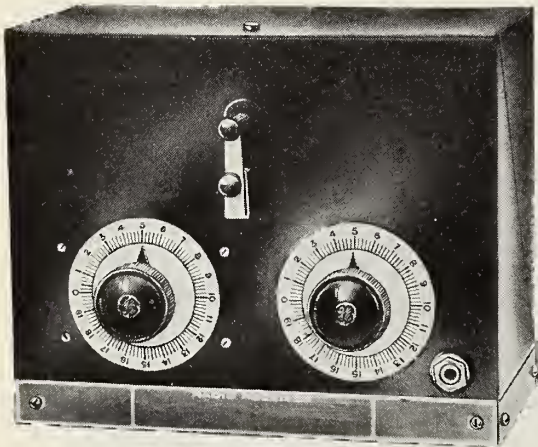

Exterior new General Electric short wave tuner embodying many new features. This tuner may be used with a crystal detector or vacuum tubes. An important feature is the metal case, used instead of the usual wood cabinet. This metal furnishes an effective "shield," preventing capacity effects between the receiver itself and the body of the operator

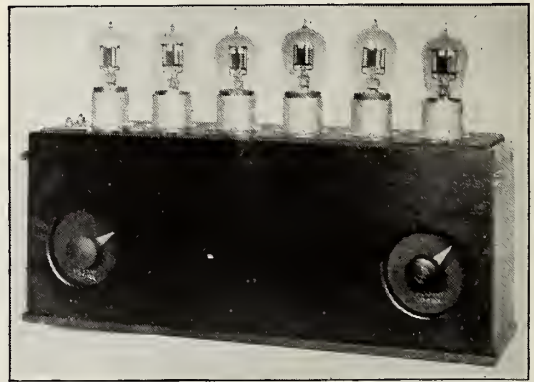

Exterior view of a new amplifying unit made by the Wireless Specialty Company for its use in conjunction with loop aerials and loud speaker. Six vacuum tubes are employed, but they function as eight, because two of the tubes are used twice. The complete unit operates as five stages of radio frequency, detector, and two stages of audio frequency. This unit has been built more for demonstration purposes than for general use.

Now Ready!

THE MARSHALL VARIABLE CONDENSER

designed by expert radio engineers of long standing and made of best materials throughout.

Front and back plates of selected hard rubber. Central mandrel turns in brass bushing and is adjusted through one or more cone bearings. Plates and separators, of especially prepared aluminum, cannot get out of true.

ASSEMBLED CONDENSERS

3 Plates, capacity .00014, \$2.50	9 Plates, capacity .00033, \$3.50	35 Plates, capacity .00121, \$ 6.00
5 " " " .00021, 2.75	17 " " " .00061, 4.25	67 " " " .0023, 12.00

—Here's A New Idea Build Your Own Condenser

SAVE money. No technical experience necessary. Lots of fun! You may now buy the Marshall Condenser in all standard capacities knocked down ready for assembling at prices materially lower. Complete instructions for assembling furnished with each outfit.

READY TO BUILD

3 Plates	capacity .00014	\$1.90
5 "	" .00021	2.10
9 "	" .00033	2.55
17 "	" .00061	3.35
35 "	" .00121	5.15
67 "	" .0023	9.40

Prices on other units on application, including non standard units to suit capacities needed to unify various non standard antennae and receiving outfit units.

Marshall Condensers are very ruggedly built for C.W. work either sending or receiving

Note:—If your dealer cannot supply you, write us direct enclosing remittance, together with dealer's name and address and the Marshall Condenser will be sent you anywhere in the United States parcels post paid. Order at once.

Live Wire Retailers—Our new selling plan will interest you. Write. We do not want cash from responsible parties. To such our terms are 30 days net, or we will ship C. O. D. when no credit or references are given. Discounts better than usual.

Radio Salesmen—Perhaps we have no representative in your locality. If you are a hustler let us hear from you. Several good men needed as district managers.

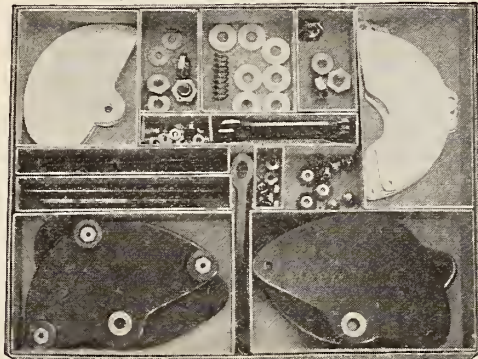

Special Outfit Containing 2 Marshall Variable Condensers Ready for Assembling

NEW HAVEN RADIO COMPANY MANUFACTURERS

61 Hamilton St.,

New Haven, Conn.

New Equipment



This is a very popular receiving set, covering a wave length range of 150 to 1,000 meters. The set itself is entirely mounted on a single Bakelite supporting panel and is encased by an attractively finished oak box having a hinged cover

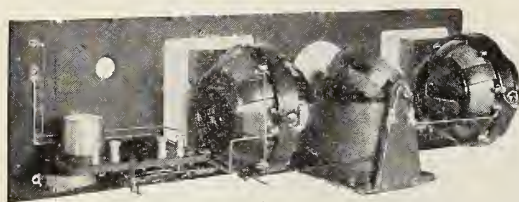

This is the interior of the 150 to 1,000 meter receiver, and, as may be seen, the vario coupler and variometers are of new design and are entirely shielded to prevent body capacity effects



This automatic triple jack is used where several pairs of telephone receivers are employed with a single receiving set. The telephone plugs may be inserted in the jacks at will and the proper arrangement of connections is automatically made

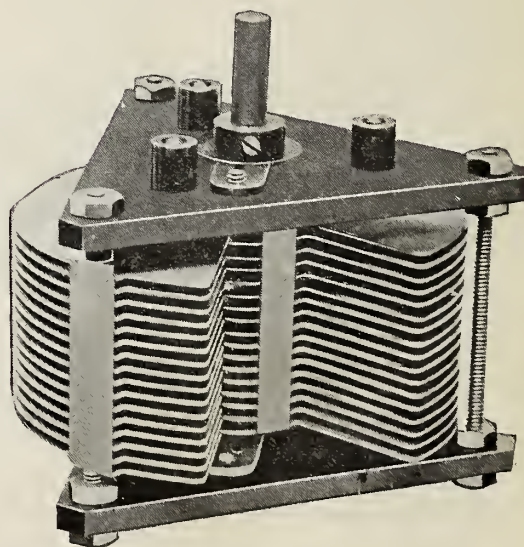

New variable air condenser of the General Radio Company, Cambridge, Mass.



No. T-100



No. T-101



No. T-106



No. T-105



No. T-102



No. T-103
No. T-104



N-S
NAA
CRYSTALS



N-S
"RED-HEAD" PHONES



Introducing Seven *Better* Radio Instruments

15 years of direct contact with the radio field has enabled us to develop these products. Each has new and unusual features that place it far ahead of common types—not one is a rushed-on-the-market experiment.

HERE THEY ARE

No. T-100 Reversible Rheostat—all metal type for table or panel mounting. For use with any detector or amplifier bulb—smooth action, perfect contact, substantial pointer with insulated knob.
—a *better* rheostat
Price \$1.00

No. T-101 V. T. Socket—Mechanical features that make it the only socket on the market that is genuinely rigid and strong when used for panel mounting and yet perfectly adapted to table or base mounting. All metal with Bakelite contact support.
—a *better* socket
Price 75c

No. T-106 Adaptaphone—Converts the sound chamber of phonograph into a loud speaker. Made of high-grade rubber. Will not scratch or mar parts of phonograph. Not necessary to remove cap from receiver. Will fit all phonographs except the Brunswick.
—a *better* adapter
Price \$1.00

No. T-105 Crystal Detector—New and ingenious design provides every adjustment to facilitate proper contact with the crystal. Contact wire can be moved to any point on crystal. Pressure can be easily regulated. Contact wire instantly renewable.
—a *better* crystal detector
Price \$1.00

No. T-102 Stopping Condenser—Heavy metal plates of novel design form substantial case for

condenser. Mica dielectric, capacity 0005 MF. Highly nickelled and polished, mounted on insulating base. Can be removed for panel mounting.
—a *better* stopping condenser
Price 75c

No. T-103 Grid Condenser, of similar design as above. Proper capacity for grid circuit in V. T. Hookups.
—a *better* grid condenser
Price 40c

No. T-104 Moisture-Proof Variable Grid Leak—arranged for front of panel mounting in connection with Grid Condenser. Nickelled and polished cover.
—a *better* grid leak
Price 60c

—and *better than ever*
the famous

N-S "Red-Head" Phones—3000 ohms. A triumph in Radio Receiver design. Beauty of design and ruggedness of construction coupled with a supreme sensitiveness are features that make "Red-Heads" the ideal telephone receivers for radio work.

Price with Cords \$8.00

—and
N-S NAA [Arlington Tested] Supersensitive Crystals, individually tested and packed in convenient metal boxes. Galena, Silicon or Goldite, price each 25c. Same mounted in cup, 40c each.

Number yourself among our thousands of friends and customers who know the reliability and accuracy of N-S Radio Products.

Send for Bulletin A which describes these products in detail

Dealers: Write for our very attractive proposition. IMMEDIATE DELIVERY

The **Newman-Stern** Co.
Teagle Radio Division
CLEVELAND, OHIO

New Equipment

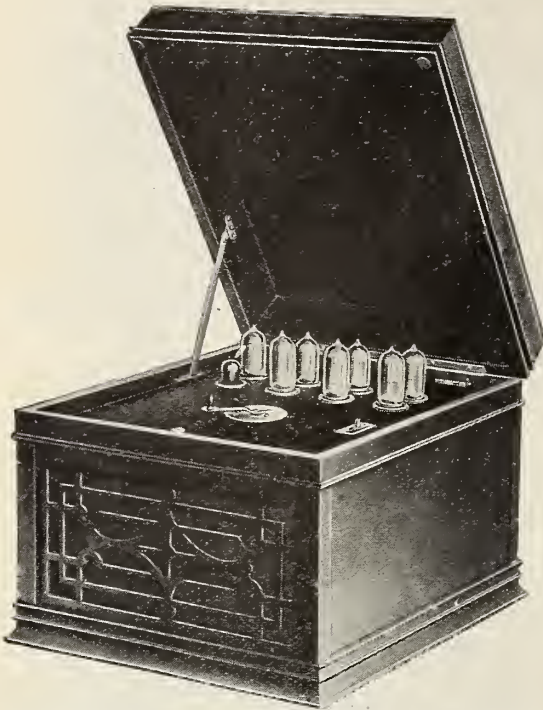

Aeriola Grand showing the vacuum tubes and ballast tubes in place, the switch which controls the entire current supply, and the single control lever used to tune in desired and tune out undesired broadcasting stations

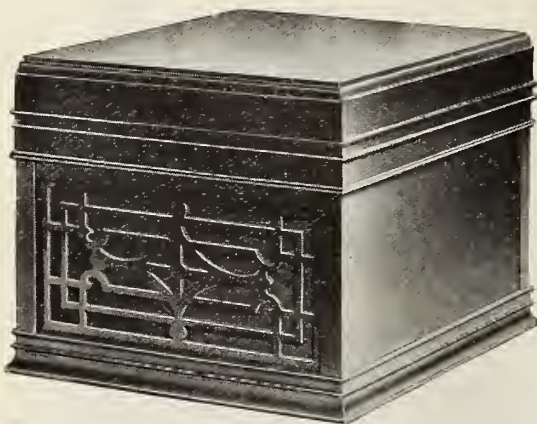

Aeriola Grand. The latest development of the Westinghouse Electric and Manufacturing Company is a complete broadcasting receiver equipped with a series of vacuum tubes, the necessary plate batteries, and a loud speaker, all mounted within the mahogany cabinet shown here. The operation of this set is so simple that it may be readily performed by a very young child



Westinghouse Vocarola. This is a complete loud speaker equipped with an especially designed reproducer having a corrugated metal diaphragm designed to produce music and speech without distortion. As may be seen, a telephone plug is provided for connecting the loud speaker to the receiving set

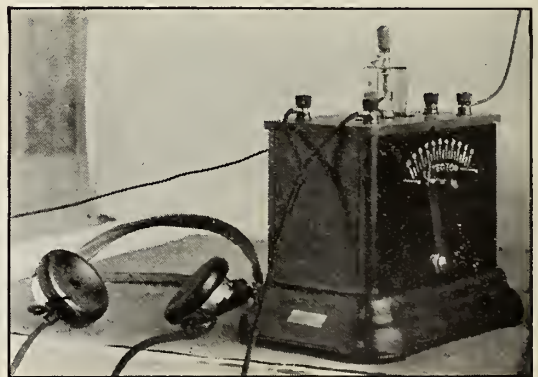

A new compact receiving set, the Federal, Jr., of the Federal Telephone & Telegraph Company

Give Your Radio Set the Advantage of

WESTINGHOUSE

RADIO

BATTERIES



Westinghouse "A" Batteries are especially built for the peculiar requirements of radio work. They deliver a constant, dependable flow of low voltage current. They are built to give long, low-cost service. They demand a minimum of attention.



In the Westinghouse "B" battery you have a *storage* battery for "B" work—the latest development in radio practice. It has all the reliability and dependable performance of a storage battery and none of the disadvantages of a dry cell. The Westinghouse "B" gives a steady, continuous, noiseless service. It lasts indefinitely. When exhausted it is easily recharged. The first cost is the last cost.

Don't lose the enjoyment of your Radio by operating under unsatisfactory conditions. Get Westinghouse "A" and "B" batteries from your radio dealer or the nearest Westinghouse Service Station.

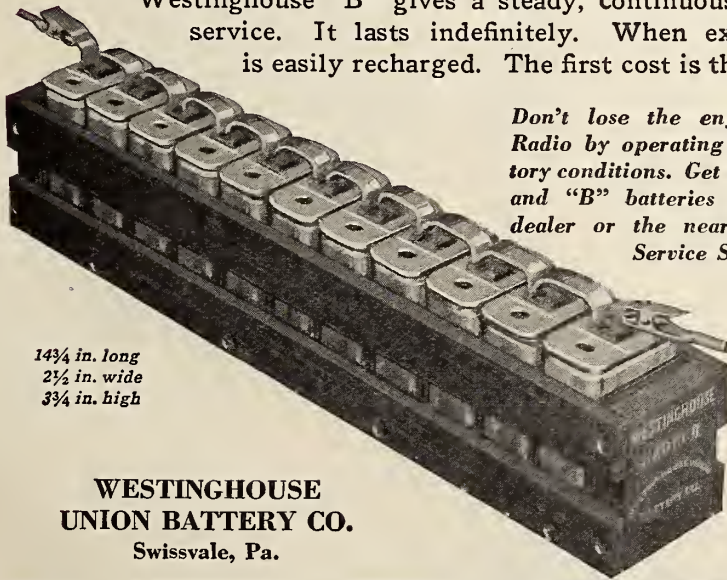

14¾ in. long
2½ in. wide
3¾ in. high

**WESTINGHOUSE
UNION BATTERY CO.**
Swissvale, Pa.

*"The best
Westinghouse
can build."*

New Equipment

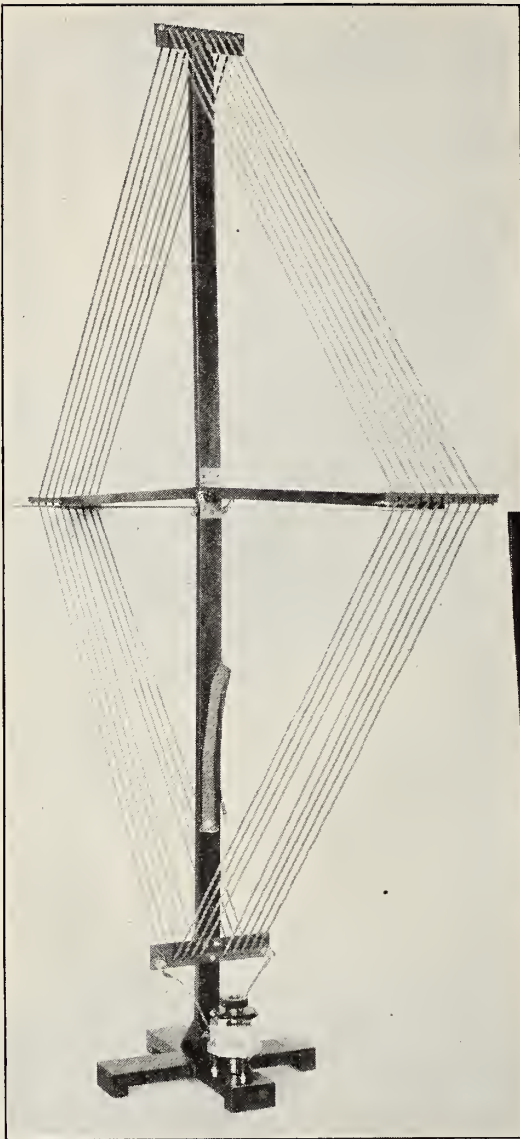

Collapsible loop antenna designed especially for broadcasting reception. This loop is made by the Wireless Specialty Company and the frame is of artistically finished mahogany, suitable for use in any living room. This loop has been designed for use in conjunction with several stages of radio and audio frequency amplification.

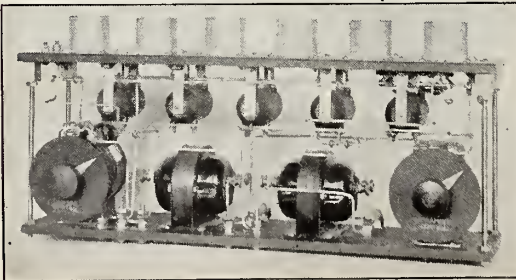

This is the same loop collapsed, showing its small size, making it readily portable. As may be seen, the wires are held in place by specially constructed bakelite frames. The variable condenser mounted on the leg of the stand is of entirely new design and is diecast throughout. This condenser is also manufactured by the Wireless Specialty Company.

This is the interior of the six tube amplifier shown on p. 180, and, as may be seen, the filaments of all six tubes are controlled by two switch arms. The workmanship in this unit is particularly striking, and, from an operating standpoint, the fact that six tubes function as eight, indicates that we may expect a great reduction in the cost of operation. Exceptional results have been secured with this unit and a loop antenna

JULY, 1922

PRICE 25 CENTS

RADIO BROADCAST

V. 1 #3

RADIO FOR EVERY PLACE AND PURPOSE

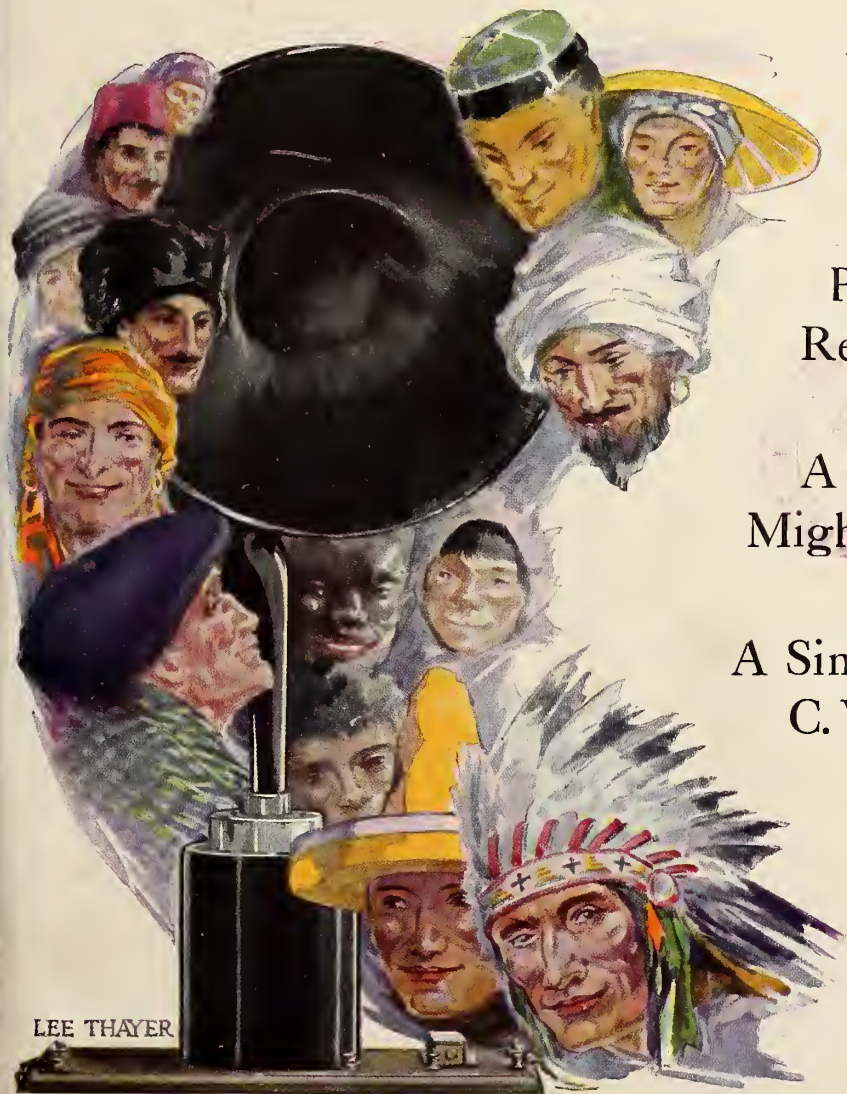

An Evening with
Dr. Alexander
Graham Bell

Protection of the
Receiving Antenna

A Church with a
Mighty Congregation

A Simply Constructed
C. W. Transmitter

Our Amateur
Radio Reserve

LEE THAYER

DOUBLEDAY, PAGE & COMPANY, Garden City, N. Y.

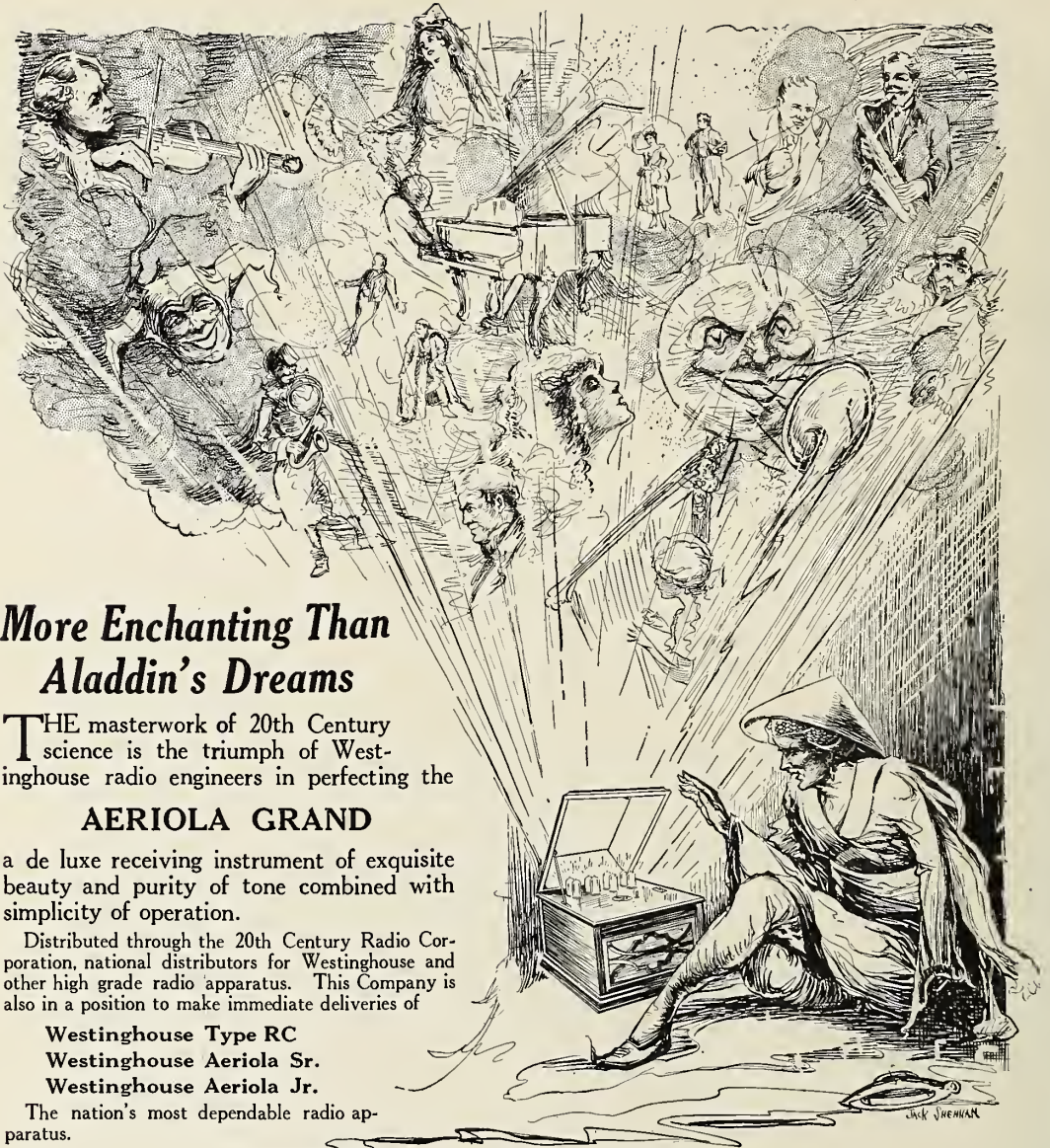

More Enchanting Than Aladdin's Dreams

THE masterwork of 20th Century science is the triumph of Westinghouse radio engineers in perfecting the

AERIOLA GRAND

a de luxe receiving instrument of exquisite beauty and purity of tone combined with simplicity of operation.

Distributed through the 20th Century Radio Corporation, national distributors for Westinghouse and other high grade radio apparatus. This Company is also in a position to make immediate deliveries of

Westinghouse Type RC
Westinghouse Aeriola Sr.
Westinghouse Aeriola Jr.

The nation's most dependable radio apparatus.

Write to us to-day for the name and address of your nearest dealer

20th Century Radio Corporation

Suite 710, Straus Building

Executive Offices

565 Fifth Avenue, New York

BRANCHES

Detroit, Mich.
2311 Woodward Ave.
Main 7809

Norwalk, Conn.
17 High Street
Norwalk 675 Ring 4

Newark, N. J.
587 Broad Street
Market 3265

Brooklyn, N. Y.
102 Flatbush Ave.
Sterling 6349

White Plains, N. Y.
2-4 Mamaroneck Ave.
White Plains 1030

National Radio Distributors

Radio Broadcast

ROY MASON, EDITOR

ARTHUR H. LYNCH, TECHNICAL EDITOR



CONTENTS FOR JULY, 1922

<i>Dr. Alexander Graham Bell</i> - - - - -	<i>Frontispiece</i>
THE MARCH OF RADIO - - - - -	191
WHEN DE WOLF HOPPER BROADCASTED TO HIS BIGGEST AUDIENCE -	198
WHAT EVERYONE SHOULD KNOW ABOUT RADIO HISTORY	
PROF. J. H. MORECROFT	199
AN EVENING WITH DR. ALEXANDER GRAHAM BELL - DONALD WILHELM	205
INCREASING THE SELECTION POWER OF A RADIO CIRCUIT	
JOHN V. L. HOGAN	211
PROTECTION OF THE RECEIVING ANTENNA - - - - -	G. Y. ALLEN 214
A CHURCH WITH A MIGHTY CONGREGATION - - -	ARCHIE RICHARDSON 218
RANDOM OBSERVATIONS ON RUNNING A BROADCASTING STATION	
H. M. TAYLOR	223
RADIO PERSONALITIES - - - - -	228
REGINALD AUBREY FESSENDEN - - - - -	LUCILLE JOYCE
NEW RADIO NET FOR ROGUES - - - - -	DONALD WILHELM 231
HOW RADIO CAME TO INDEPENDENCE, KANSAS - -	THOMAS M. GALEY 234
HOW TO BEGIN TO ENJOY RADIO - - -	CAPT. LEON H. RICHMOND, U. S. A. 236
A SIMPLY CONSTRUCTED AND OPERATED SHORT RANGE C. W. TRANSMITTER - - - - -	ZEH BOUCK 240
OUR AMATEUR RADIO RESERVE - - - -	MAJOR PAUL W. EVANS, U. S. A. 243
RADIO FOG SIGNALS AND THE RADIO COMPASS - - - - -	247
THE AUDIO PILOTING CABLE IN THE AMBROSE CHANNEL	
DONALD WILHELM	249
PROGRESS OF RADIO IN FOREIGN LANDS - - - - -	251
RADIO HELPING US ENJOY THE SUMMER - - - - -	ARTHUR H. LYNCH 255
RADIO IN REMOTE REGIONS - - - - -	262
THE GRID—QUESTIONS AND ANSWERS - - - - -	264
PRESENT RADIO BROADCASTING STATIONS IN THE UNITED STATES - -	270

Copyright, 1922, by Doubleday, Page & Co. All rights reserved
TERMS: \$3.00 a year; single copies 25 cents

F. N. DOUBLEDAY, Pres.

RUSSELL DOUBLEDAY, Sec'y.

ARTHUR W. PAGE, Vice-Pres.

S. A. EVERITT, Treas.

NELSON DOUBLEDAY, Vice-Pres.

JOHN J. HESSIAN, Asst. Treas.

DOUBLEDAY, PAGE & CO.

THE WORLD'S WORK COUNTRY LIFE THE GARDEN MAGAZINE SHORT STORIES EDUCATIONAL REVIEW
CHICAGO: People's Gas Bldg. GARDEN CITY, N. Y. NEW YORK: 120 W. 32nd Street
BOSTON: Tremont Bldg. LOS ANGELES: Van Nuys Bldg.

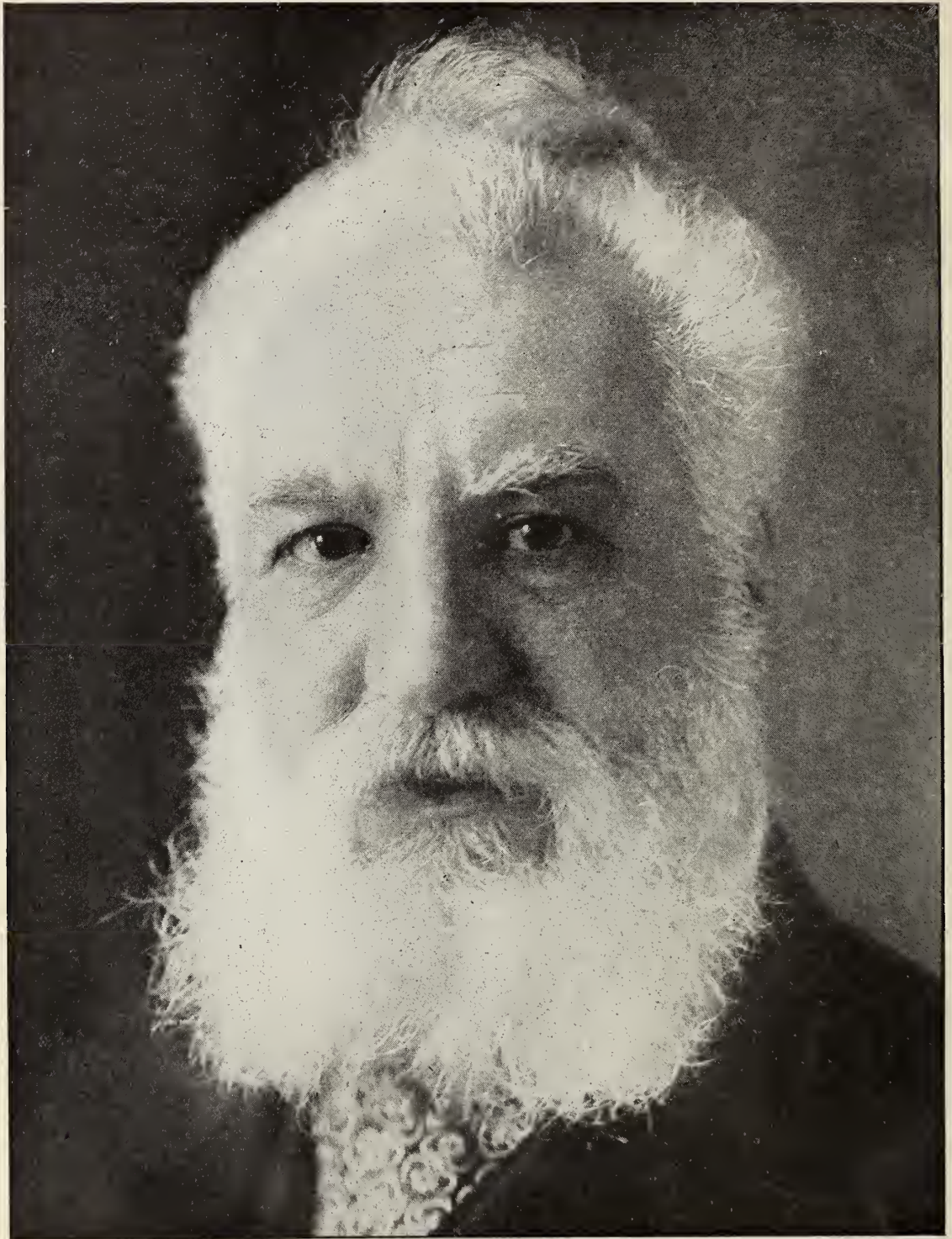

DR. ALEXANDER GRAHAM BELL
Inventor of the Telephone

JUL -7 1922

© Cl B 530865

RADIO BROADCAST

Vol. 1 No. 3



July, 1922

The March of Radio

REPORT OF THE RADIO TELEPHONE COMMITTEE

A VERY important step was taken in the progress of radio telephone development when the committee, called by Secretary Hoover, handed in their final report, containing recommendations as to the proper allocation of wave lengths for the different radio telephone services now existing, or anticipated. The committee, under the leadership of Dr. S. W. Stratton, the Director of the Bureau of Standards, was made up of experts from all branches of radio activity—the military and civil services of the Government, commercial radio engineers, college professors, and representatives of the amateurs, all combined to work out what seemed to be a reasonable division of the frequencies available for radio traffic.

The recommended assignment of wave lengths was as follows—Transoceanic experiments, non-exclusive, 5000-6000 meters; Fixed service, 2850-3300; Mobile service, non-exclusive, 2500-2650; Government broadcasting, non-exclusive, 1850-2050; Fixed station, non-exclusive, 1550-1650; Aircraft radio telephone and telegraph, exclusive, 1500-1550; Government and public broadcasting, non-exclusive, 1050-1500; Radio beacons, exclusive, 950-1050; Aircraft radio telephone and telegraph, exclusive, 850-950; Radio compass service, exclusive, 750-850; Government and public broadcasting, 200 miles or more from the sea coast, exclusive, 700-750; Government and

public broadcasting, 400 miles or more from the sea coast, exclusive, 650-700; Marine radio telephony, non-exclusive, 525-650; Marine telegraphy, exclusive, 525-650; Aircraft radio telephony and telegraphy, exclusive, 500-525; Government and public broadcasting, exclusive, 485-495; Private and toll broadcasting, 285-485; Restricted special amateur radio telegraphy, non-exclusive, 310; City and State public safety broadcasting, exclusive, 275-285; Technical and training schools (shared with amateurs) 200-275; Amateur telegraphy and telephony, exclusive, 150-200 meters (this makes the total wavelength range assigned to amateurs 150-275, part of it being shared with the technical schools); Private and toll broadcasting, exclusive, 100-150; Reserved, all below 100 meters.

Of course we are principally interested in the wavelengths to be used for broadcasting. Government broadcasting is defined as that done by departments of the Federal Government; public broadcasting as that carried on by public institutions, such as Universities; presumably church broadcasting will come under this classification. Private broadcasting signifies that carried on, without charge, by any communication company, newspaper, etc. Such broadcasting, if charge is made, comes under the classification of toll broadcasting.

In view of the interest of the public, as a whole, in broadcasting, it was strongly urged that point-to-point radio communication be

discouraged; it is quite evident to any one that the use of one "channel" in the ether for conversation between two individuals is entirely out of the question unless such communication is impossible by any other means. Thus point-to-point communication by radio must be allowed only for shore-to-ship, to light-ship, or to isolated islands, etc. The granting of licenses to companies organized for commercial radio traffic between cities should not be permitted. It is to be pointed out that if such procedure had been followed during the last few years, it would not have been necessary to get out injunctions to prevent such interference as was caused by the operation of the Intercity Radio station in New York City. Such unnecessary use of radio always impedes its progress for the financial benefit of a few men more interested in their own fortunes than in that of the radio art. Wire telegraphy and telephony furnish ample means of communication for commercial traffic, in fact, it seems likely that if inquiry were made it would be found that much of the "radio" traffic of such companies is sent over lines leased from the wire companies.

HOW MANY SIMULTANEOUS BROADCASTS ARE POSSIBLE?

IT WILL be seen that for private and public broadcasting the committee recommends three bands of frequencies, rather widely separated. Public broadcasting, such as might be done by a University carrying on extension work or the free lectures sent out by city departments, have wave lengths from 1050 meters to 1500 meters; this range should permit the simultaneous transmission of about eight messages without undue interference. In estimating how many simultaneous messages are possible (or how many "channels" are available) it is assumed that the receiving set is a good one of the type using vacuum tube and regenerative connection.

For private and toll broadcasting, the band from 285 meters to 485 meters is assigned; it will be remembered that at present all private broadcasting is done on a wavelength of 360 meters. The frequency range permitted for broadcasting of this kind in which we are especially interested is therefore from about 600,000 to about 1,000,000 cycles per second, a range of 400,000 cycles. How many separate channels are there available in this frequency range? It must depend very largely upon the quality

of the receiving set used and upon the skill of the operator in adjusting it, but with the average receiving set sold to-day it seems that there may be ten or fifteen channels; if all the receivers in use were of the better types and in the hands of skilled operators, probably twenty or thirty channels would be available, but of course, such is not the case. Probably there will be not more than eight useful channels in this range of frequencies.

The question must be indeterminate to a considerable degree because of the possibility of large differences in the various signal strengths. If, for example, two stations of equal power were transmitting from New York and were being received fifty miles away, both would be of equal strength, and it would be possible to adjust the receiving sets for no interference with two wavelengths as close together perhaps as 300 and 310 meters. But if one of the transmitting stations was within a few miles of the receiving set, and the other fifty miles away, then, in order to hear the distant station without interference from the nearby station a wavelength difference of 30 meters or more would be necessary.

Private and toll broadcasting are also allowed another frequency band from 100 meters to 150 meters; although this is a comparatively narrow band, there are several channels possible because of the large difference in frequency of the two limits, namely 1,000,000 cycles. It is quite likely that there are twenty more channels available here for good receiving sets and five to ten with ordinary sets. It must be pointed out, however, that practically none of the receiving sets which have been supplied to the public so far will be much good for receiving these low wavelength signals; most of them cannot tune for a signal of such low wavelength and those that can are very inefficient for such high frequencies.

WHAT KIND OF BROADCASTING IS COMING?

IN THE range of wavelengths, 285 to 485 meters there will be about eight channels available. For what are these eight channels going to be used? We do not need to consider the possibility of broadcasting lectures or other educational talks because for such work a special frequency band has been allowed, offering, for the present at least, plenty of channels for such traffic. It appears then, that for entertainment and toll purposes there are eight channels available. This seems a lot;

at present we have only one channel, and listeners in the vicinity of New York, for example, can hear nothing but WJZ when this station is in operation. KDKA and a few others can be heard only if WJZ stops sending. With eight channels open it seems as though we should have much better entertainment in the

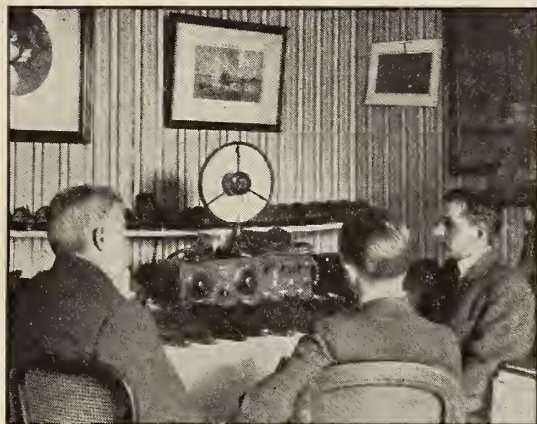

A progressive New York shoe salesman has installed a radio receiving set to entertain his customers. The large conical device is a loudspeaker made with a parchment diaphragm which reproduces music with little or no distortion

future than we have had in the past. Just what stations are going to furnish it is not yet evident, but the public may rest assured that the channels will all be spoken for soon after they are available.

Where does toll broadcasting come in? It is defined as broadcasting for which a charge is

made, and of course that means advertising. Yet direct advertising is not to be allowed, if the recommendations of the committee are followed, as they certainly should be, in this respect at least. The toll business will probably settle down into rather good entertainment, the only advertising the client receives directly being in the wording of the announcement of the selection. Much as we may frown on the idea of radio advertising, it must be appreciated that this is just the way WJZ's excellent programme is maintained to-day. The only pay the clients of the stations (in this case the artists) get is the advertising which the announcer gives them. Of course sometimes the performances of the artists also, are of advertising value to them, but if the tubes don't function properly, they are not.

RADIO IN THE LONELY PLACES

PROBABLY the million or more people who are listening every evening to the radio entertainment which various broadcasting stations offer, are unanimous in their appreciation of this latest contribution of applied science; judged by the methods of the statistician it must indeed be a wonderful art which contributes so much enjoyment to so many people. But there are much more important fields in which radio serves, fields in which the theatre, or movie, or dance hall can contribute nothing because they are not available. Of course the real field of radio will ever be that in which Jack Binns was the pioneer, the carrying of the

Even in Olongapo, P. I., the U. S. Navy carries on regular radio communication, and this little shack shelters the equipment



distress call of sinking vessels, or aeroplanes stalled in inaccessible places, or adventurous explorers who have encountered difficulties which make it imperative that they get help.

Besides these cases, in which the reception of perhaps one millionth of a watt of power from the distressed operator means the difference between life and death, there are other cases where radio means the bringing to life of some people leading an existence so lonely that they are dead in so far as contact with other human beings is concerned. To the dweller on a lonely isle, perhaps in connection with the rest of the world only once a year, to the lonely watchers on the light-

houses and light-ships, for weeks and months at a time abandoned to the wind and waves, radio telephony offers something of almost inestimable value. They can now hear the voice of their fellow man perhaps every evening, and the music which travels to them so silently and swiftly must

put new life into their monotonous existences. There must be many islands on our coast where the installation of a radio outfit will bring lonely people into immediate touch with the rest of the human race. In such places, and in the light-houses and ships, radio broadcast entertainment will bring cheer and enjoyment where nothing else avails. In a recent interview, George R. Putnam, Commissioner of Lighthouses, reported that many of the lighthouses in Alaska are being equipped with radio telephone apparatus. In some of these stations, he states, the keepers have been without mail from the outside world for as much as ten months.

In hospitals a receiving outfit should be a wonderful help in keeping patients interested and comfortable. Furnished with a series of head sets, so that any patient may listen in or not, as he desires, a good receiving outfit would prove a valuable adjunct to the cheerful nurse in keeping a ward filled with smiles and contentment.

Not all of us have the vision and imagination of a Faraday, so that there are still some details of radio theory which seem more or less obscure. One of the developments of radio, which seems always to attract much attention, is the reception of radio signals by a set on a moving object, such as train, bus, aeroplane, etc. Now there is really nothing strange about this at all; in fact, it would be much more strange if signals were not received on a moving car just as well as when it is stationary.

Radio communication is carried on by means of disturbances—wave motions—in the ether;

these waves travel with the speed of light (186,000 miles per second) for the very good reason that they are really the same thing as light. If we grant that a 100-meter radio wave is the same kind of a thing as a 10,000-meter wave, then radio and light are the same thing; because of the elec-



At the sea-shore or away in the mountains it is now possible to be in almost constant communication with the city. This portable radio set has a receiving range of several hundred miles and a transmitting range of four or five miles

tric and magnetic fields associated with them, they are called electromagnetic waves. When an electromagnetic wave travels by an antenna, it sets up alternating currents therein, which, acting on detector and telephones, give an audible signal. Now, will it make any difference whether the receiving station is moving or not? Radio waves being the same kind of disturbance as light waves, we may argue the question from the action of light. If a man in a passenger car, moving through a station, watches some one on the platform light a match, will the color and intensity of the flame be the same as if the car was not moving but was stationary at the platform? The flame corresponds to the transmitting station of a radio set and the observer's eye receiving the electromagnetic waves from the flame, corresponds to detector and telephone. The answer to the question is evidently—Yes, the motion of the observer does not in the least interfere with the observer's eye perceiving the

flame. Of course, if the passenger was carried past the station platform as fast, or faster, than the velocity of travel of the light wave he would never know whether the match was lighted or not; the light wave which started from the match when it was struck, would not be able to catch up with the observer, and so evidently could not affect the nerves of his eye. But trains and buses do not travel with such velocities, so we can eliminate that possibility from our discussion.

In so far as motion of the receiver is concerned, therefore, it is evident that there can be no effect on the action of radio waves; receiving a radio signal on a moving bus, or on a mile-a-minute train, is no more wonderful, from the standpoint of radio theory, than if the bus or train were stationary.

It is interesting to note that in some of the experiments in getting radio signals to moving trains, the signals were heard when the

train was in a tunnel, a hundred feet underground. Not very strong, to be sure, but still strong enough to be read. It might be said that the radio waves did not penetrate the ground so deeply but came in from the ends of the tunnel. But we also know that a submerging submarine, even after it has gone 60 feet below the surface still gets audible signals, and there are no tunnel ends for the signal to come through in such a case.

The ordinary theory of radio transmission shows that we can expect a certain amount of penetration of the radio waves into the earth or ocean; it can be predicted how far the waves will penetrate sea water, and the experiments with submarines check the theory. It's very much the same as light going through water; some will get through but most of it is absorbed before the light has penetrated the water very far; just so is the radio wave absorbed in the earth's surface.

Recent tests have proven that communication between moving trains and land stations along the route is now practical, and Edgar Sisson, Jr., is here shown operating the outfit on Lackawanna train Number 3



This absorption of radio waves gives rise to radio "shadows" such as are noticed if a high mountain intervenes between two stations. In such cases better communication is obtained if the distance between the two stations is increased, because the shadow becomes less definite, just as light shadows do in similar circumstances. An interesting case of this sort is noticed near the island of Cuba; there is a radio station on the south coast which cannot transmit reliably to ships on the north coast, there being a mountain range intervening; if, however, the vessel steams north for a hundred miles, thus getting out of the shadow, the communication is much better although the distance from the transmitting station has been more than doubled.

In a recent interview, Dr. Charles P. Steinmetz, the chief consulting engineer of the General Electric Co., is reported to have said that "under certain conditions it will be easier for wireless waves to pass through the ground than through the air. Submarines already have sent radio messages successfully while submerged, a primary substantiation of the theory, which looks to the conquering of another element in addition to the ether." If the noted engineer of Schenectady had ever listened to the signals received by a submarine as she submerges, as has the writer, and had listened to them fall off rapidly in intensity until at only a few fathoms depth they are entirely gone, only to reappear as the depth of the submarine is decreased, he would be convinced that it is much more difficult for the radio waves to travel through earth or water than through air. In fact, going through a few feet of water the signal decreases in intensity as much as it would in a hundred miles through air; this difference in behavior of air and water increases as the wavelength is made smaller.

A BETTER BROADCASTING STATION

BY THE time this is in press a new broadcasting station will be in operation, a station on the design of which probably more thought and talent has been expended than on any other in existence. It is on the top of one of New York's skyscrapers and is operated by the American Telephone and Telegraph Co.; its call will be WBAY. The actual transmitting set was designed and constructed by the engineers of the Western Electric Co., engineers who know not only engineering, theory, and practice, but who are especially trained in the

design and construction of communication apparatus.

The vacuum tubes used have oxide coated filaments, such as were employed in the detecting tubes used so extensively by the Signal Corps during the war. The larger tubes, of which there are four, are of 250 watt rating, using 1600 volts in the plate circuit. An interesting detail in the construction of these tubes is the blackening of the plates to increase the radiation of heat; a black plate will radiate much more heat, at a given temperature, than a shiny one.

A special type of microphone is to be used, the diaphragm of which is a tightly stretched, thin, steel membrane having a natural frequency far above voice frequencies. It is designed to give better reproduction of the consonant sounds than does the ordinary microphone transmitter. It is anticipated that only about 40 per cent. modulation will be employed, this comparatively weak modulation being used with the idea of keeping out the distortion of the voice sounds which occur if complete modulation is attempted.

The studio where the artists are to perform has been especially treated to reduce echoes to a minimum. The ceiling has been deadened by two inches of sound absorbing material; the floor is deadened with thick carpeting, and experiments are being made in padding the side walls with thick felt. It is the engineer's idea that practically no echo should strike the microphone; if it is actuated only by the original voice sounds, it seems that much clearer speech and music will be sent out than if echoes, from walls and ceiling, as well as the original voice, are allowed to fall on the microphone.

The absence of echoes in the room give one a strange feeling when talking; it seems as though one were talking into open space. It serves well to show how all of our senses combine to give us a certain total impression; the experience in this room convinces one at once that one's estimate of the size of the ordinary room is fixed not only by what the eye reports but also by the sound of one's voice, which, of course, will depend largely upon the echoes from walls and ceiling.

AN EXPERIMENT IN BROADCASTING

THIS A. T. and T. station is being constructed, and is to be operated, purely as an experiment. It had its inception in repeated demands upon the company for supply-

ing broadcasting transmitting sets, to be used by merchants, churches, philanthropic institutions, brokers, and what not. In all there were more than sixty such requests for apparatus, to be operated in New York City. And the Government restricts all broadcasting stations to 360 meters!

Evidently it would have been short-sighted policy to sell these equipments—the purchasers would soon find out they had white elephants on their hands. Such stations would evidently be installed for advertising, indirect, of course, but advertising nevertheless. And if a dozen of them were to operate at once they would so jam the air that none of them could be received. With the idea of avoiding this situation and further to get first hand information on the need and desirability of such broadcast advertising the A. T. and T. Co. decided to erect and operate themselves a first class sta-

tion, renting it to those firms and institutions which think they want such service; the station is to be a regular toll station where a merchant rents the privilege of using the ether for calling his wares.

Is there a demand for such a service, and, still more important, does the radio public want the ether used for such purposes? The operation of WBAY for a few months will probably furnish an answer to these questions. Whether the answer be Yes or No the operation of this station (which will have such a programme as to not interfere with WJZ) will be of benefit to the radio public because of the technical excellence of the station; the quality of transmission will probably be better than any other station now operating, so will serve as a stimulus to the others to improve the quality of their transmission to equal that of this new station.

H. M.

Submarine equipped by the Bureau of Standards, Department of Commerce, with special type of antenna for under-water radio reception and transmission

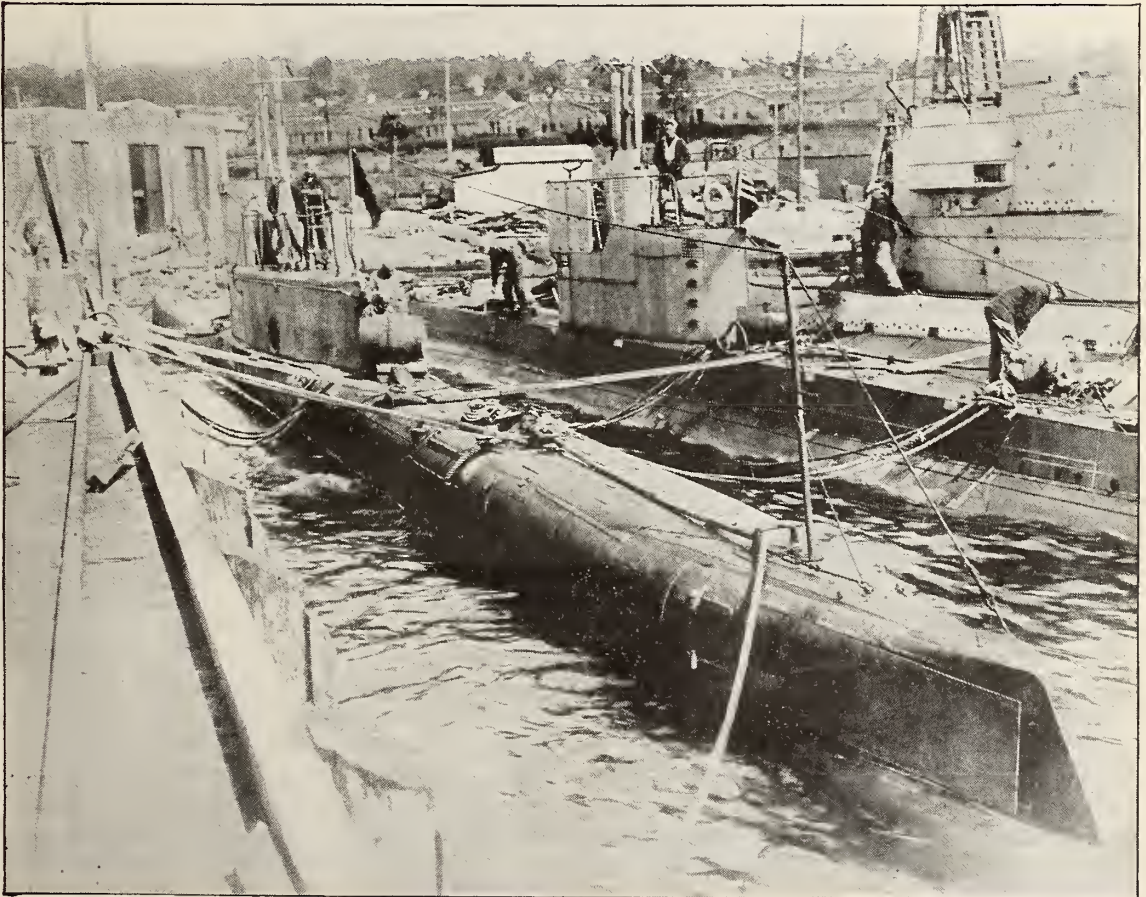

When De Wolf Hopper Broadcasted to His Biggest Audience

He Missed the Applause and Laughter and He Couldn't Gesticulate, but He Heard Later How Much He was Appreciated

SIX people had to do all the audible laughing for an audience optimistically estimated at three hundred thousand when De Wolf Hopper broadcasted his famous voice from

WJZ in Newark, N. J., recently. But the laughter proved a boon to the great comedian because he could judge by its duration just when the points of his jokes had sunk in, and it was time for him to resume his monologue.

"It was a peculiar and dramatic sensation," he said, "speaking to thousands upon thousands of people you couldn't see. I couldn't realize that so many people were hearing me. My performance lasted about twenty minutes, five and a half of which I devoted to reciting 'Casey at the Bat.' That was the hardest thing of all because I couldn't gesticulate. I had to keep my mouth about six inches from the little drum suspended in front of me."

Mr. Hopper's mobile voice sank to a sorrowful note as he spoke of the difficulty of delivering this famous baseball recitation without the emphatic gesticulations which have delighted his audiences for more than a quarter of a century. His fists involuntarily clenched themselves.

"I couldn't do this," he said mournfully, "when I came to the line 'Str-r-r-ike out!' It was a peculiar thing, however, that I think I never recited 'Casey' better. There I was in that long narrow room, with no way to

tell whether I was pleasing my audience or not. There were only six people in the room, a gentleman and lady who had accompanied me, my son, the soloist who was to follow me, and two operators. But they all laughed a lot, and that helped me to judge how long to pause to achieve my effects. I would wait until they stopped laughing and then begin to talk again.

"I told jokes, and talked about 'Some Party,' and greeted some old friends, who had told me they would be 'listening in,' but of course, I couldn't tell how they liked it. In the days after my initial performance, however, I got millions of

letters. I remember one in particular which appealed to me. It was from two baseball fans telling me how much they appreciated 'Casey.' They wrote that they had been baseball fans all their lives, and that one of them was eighty-two and the other one was eighty-four.

"It was a strange experience at first," he concluded, "but of course I'm used to it now."



Here is one of the famous gestures, the omission of which De Wolf Hopper lamented, when he recited "Casey at the Bat" by radiophone

What Everyone Should Know About Radio History

By Prof. J. H. MORECROFT

PART I

AT A recent dinner attended by the writer, the principal speakers of the evening both took as their theme the complacency with which we Americans take for granted the many conveniences and comforts surrounding us, which the application of modern science has made possible. They were both foreign born, both had come to America when young, and both had achieved remarkable success scientifically and financially after adopting the United States as their new home. Both of them are endowed with keen intellects and sound judgment of men and events, which attributes no doubt contributed largely to their success, but both of them expressed the opinion later that they really saw and appreciated the advantages and opportunities of America so much more than the average American that, in the race for achievement, the native born was actually much handicapped because he took so much for granted, without inquiring how wonderful the things about him really were and how they came to be developed.

WHAT AN IMMIGRANT BOY SAW

Professor Pupin, one of our best known and most successful scientists, is fond of relating his early impressions of America; the first walk he took after landing at Castle Garden was through the lower part of New York where the streets were lined with poles carrying hundreds of telephone and telegraph wires. Having been told that signals and speech were being conveyed over these wires from city to city, scores of miles, he was filled with awe and amazement; what an opportunity there must be, he thought, in a land where such things were a part of the every day life of the people! To the native New Yorker these wire-laden poles meant nothing; he had seen them gradually installed around him, and they incited in him neither awe nor inspiration. But to young Pupin, fresh from a land of no scientific develop-

ment, they spelled all kinds of possibility and opportunity; he didn't merely take them for granted, but inquired as to how and when and where and why these speech-carrying wires came about, how they operated, and later how their operation might be improved. The inspiration he received started him on that career which brought him fame and reward and made him finally the best known scientist in the field of telephone communication.

AFTER A CENTURY OF EFFORT

An art or science is of importance to mankind in direct proportion to the benefits men derive therefrom; the appreciation of radio, and to a certain extent the pleasure arising from it, will be greatly increased by a knowledge of its principles and development. The accomplishments of the early workers, marking out the trail which was to lead to the present state of the art, make interesting reading and serve well to lay the background for discussing the work of the later scientists and inventors whose contributions are directly incorporated in the radio receiving and transmitting equipments of to-day.

Every one is now becoming more or less familiar with radio communication, and it will soon be taken for granted as much as is the telephone; to the average person the radio entertainment every evening will soon cause no more wonder or interest than do the phonograph or movies. Actually, the simple receiving set of to-day, picking up music or speech from a transmitting station many miles distant, represents the result of nearly a century of effort and development by scores of scientists and inventors; before we become too complacent in the matter, and take the radio telephone in the same matter of fact way we do the rest of our applied science miracles, it is worth while to review their labors and progress, as a knowledge of their work will make the evening's radio concert the more pleasurable

and appreciated. It is with this idea in mind that the following brief story of the wireless telegraph has been written.

The earlier name for communication between two stations without the use of connecting wires was the wireless telegraph, but for reasons to be shortly pointed out the term radio telegraph or radio communication is now generally used and preferred. There are three closely allied developments in the growth of the radio of to-day, all of which contributed their share toward our knowledge of the art. The first has to do with the early attempts to carry on ordinary telegraph communication without wires, the earth's surface forming the conducting medium between the two stations. A great deal of work was done in this field by many workers; the reward for a successful solution would have been great as it might have made unnecessary, to some extent, the very expensive cables being installed for transoceanic telegraphy. This scheme of using the earth for conductor found application during the war just past for communication from the front line trenches and is well known to those acquainted with the work of the Signal Corps, where it goes by the abbreviation of its French name, T.P.S. (*Telegraphie Par Sol*).

THEN THE IDEA OF INDUCTION WAS TRIED

A second line of work used no conducting medium whatsoever between the two stations; comparatively slow change of current in one coil was used to induce currents in another coil in the vicinity and these induced currents, by some prearranged code, were used to convey information. This work was begun in England and the United States at about the same time, by independent workers; it did not apparently promise much success at the time, but with our present knowledge of the art it seems that some of the experimenters missed the real solution of the problem by a very narrow margin. This scheme has recently received much public notice because of its application to the guiding of vessels into a harbor during the night or in a fog, when ordinary methods of navigation are not available. In this method of navigation, a cable laid in the channel is traversed by alternating current and coils placed on the sides of the vessel's hull receive induced currents from the cable and the navigator can maneuver his vessel by the relative strengths of the signals received on the two sides.

The third line of work involved the same gen-

eral idea as the foregoing, but the changes of current were thousands of times as rapid as those formerly used; instead of using the ordinary phenomena of induction, as explained by Faraday and Henry, a new concept of *radiated power* was invoked and with this step taken, success was assured. As long as the communication between the two stations depended upon the induction ideas of Faraday and Henry the possible separation of the two stations was but a few times the dimensions of the coils used at the stations; when high frequency radiated power was utilized, the possible distance of communication was increased thousands of times and made feasible the transmission of signals between any two points located upon the surface of the earth.

THE FIRST EXPERIMENTS BY STEINHEIL

In 1837 Professor Steinheil, of Munich, while making some experiments with the telegraph apparatus ordinarily using two wires, one for the outgoing current and another for the return, found that it was possible to dispense with one of the two wires hitherto thought necessary, and use only one wire. This one wire was connected, at the transmitting end through battery and key, to large plates buried in the earth and at the receiving end it was similarly connected to ground through whatever type of receiving apparatus was used. He thus showed that the ordinary one wire telegraph system of to-day, using the earth as the return was possible. This experience evidently aroused Steinheil's imagination, as he suggested, in 1838, when discussing the results of his experiments, that it might be possible to carry on communication with no connecting wires at all between the two stations!

PROFESSOR MORSE'S WIRELESS

In 1842, Professor Morse in America, actually did establish telegraphic communication between two stations on the opposite banks of a river, there being no wires at all crossing the river. Along one bank of the river he laid a wire in which were contained his sending battery and key; this wire terminated in two metal plates placed in the river itself. These plates were separated from each other by a distance greater than the width of the river. A similar wire and set of plates was used on the opposite side of the river, the plates on one bank being opposite those on the other. The receiving galvanometer was inserted in series with this

second wire. When the sending switch was closed it sent current through the river water from one plate on the sending bank to the other. The current spread throughout the river and some of it strayed to the opposite bank, flowing through the opposite plates and wire and thus through the receiving instrument. Although but a small part of the current reached the opposite bank it was sufficient to actuate the galvanometer used for receiving, and thus *wireless telegraphy was an accomplished fact*. It may be noted that quite long wires were necessary on the two banks of the stream so it could not logically be called wireless communication, but it must be remembered that such is always the fact with our present radio stations. In a modern radio trans-Atlantic station the sending antenna may contain 50 miles of wire in the overhead net work and perhaps even more buried underground. The essential point in wireless communication is that there must be no wires connecting one station with the other.

BRITISH SCIENTISTS WHO CONTRIBUTED

In 1859, in Dundee, Lindsay was working along the same lines that Morse had followed, apparently unacquainted with Morse's experiments. He made many tests and endeavored to find the laws of transmission distance in terms of the size of plates used, length of land wires, size of galvanometer coil, etc. He came to the conclusion that if two plates were immersed in the ocean, one off the most northerly part of Scotland and the other off the southern coast of England, if a powerful set of batteries was used for sending, and if a galvanometer coil weighing two hundred pounds were used at the receiving station, it would be possible to send messages from England to America through the ocean water. We know now that the laws he deduced were not quite correct and that such a scheme is

not feasible. The idea of a receiving coil weighing two hundred pounds is interesting when we consider that the coil of the galvanometer actually used to-day weighs less than an ounce.

In 1845 Wilkins, in England, suggested that Morse's scheme be used in establishing wireless communication with France, across the English Channel, the same feat that was to make Marconi famous fifty years later, using a different and more effective form of transmission.

Many more experimenters than the few mentioned here worked in this field, endeavoring to eliminate the connecting wire between the two stations, among them Professor Trowbridge, of Harvard. He reached the conclusion that trans-Atlantic communication by Morse's scheme might be possible if the two plates to be submerged in the ocean were as far apart as are Nova Scotia and Florida. The wire thus required to connect the two plates would be as long as the distance to be traversed, a statement which gives the approximate range for this type of wireless transmission. The laws of the spreading of current were better known to Trowbridge than they were to Lind-



MICHAEL I. PUPIN

say when he first put out his project, and furthermore the telephone receiver had been invented in the mean time which gave to the scheme a receiver much more sensitive than anticipated by Lindsay.

Trowbridge also put forth the quite feasible scheme of fitting a ship with submerged plates in bow and stern (or bow plate and a trailing insulated wire astern, carrying the second plate at its end) and sending out into the ocean an interrupted current which would spread out all around the ship; another ship similarly equipped with plates and a telephone receiver for listening, would be able to detect the presence of the first ship, thus rendering collision in case of fog much less likely. If the

present scheme of radio communication had not come into the field, it seems likely that Trowbridge's scheme would have been universally adopted. If the trailing wire should be one quarter of a mile long, a second ship would be able to detect the presence of the first at a distance of about one half a mile and this would evidently give sufficient warning to prevent collision.

ALEXANDER GRAHAM BELL'S EXPERIMENTS

In 1882 Alexander Graham Bell tried out the scheme of using two charged metal plates immersed in water for communication. Using boats with a submerged plate at the bow and the second plate at the end of a trailing wire one hundred feet long, using interrupted current in one boat and the telephone receiver for the detector in the other, he was able to get signals when the boats were separated about one half a mile. This possible distance will be much less when the boats are in salt water than when in the fresh water of a river, however.

In the T. P. S. scheme of the army, two iron stakes are driven into the earth at a separation as great as feasible; a powerful buzzer, with battery and key, is placed in series with the wire which connects these two stakes. If two other stakes are driven into the ground some distance behind the front line trench where the first pair of stakes is driven, and this second pair of stakes is connected by a wire in series with which is a sensitive telephone receiver, the system forms a possible communication link from a position where other types of communication are impossible.

HOW MODERN RADIO DIFFERS

It is to be noticed that in the schemes of communication so far described the sending and receiving stations each connect two points on the earth's surface and the transmitting and receiving apparatus are connected between these two points; low frequency currents are caused to traverse the earth's surface and a small part of the transmitted current reaches the surface where the receiving points are located. This is true wireless telegraphy, as much so as the type used to-day for radio broadcasting, and the two methods have many points in common. The line connecting the two contact points at the receiving station should be essentially parallel to the similar line at the transmitting station; the transmitted power is sent in all directions in both schemes so that but a

very small fraction of the transmitted power is actually received. In the modern radio scheme each station uses two points in a similar manner, but one of them is on the earth's surface and the *other is up in the air*. The transmitting and receiving antennae should both be vertical, that is, parallel to each other as in the foregoing schemes. The essential difference of the two schemes lies in the frequency of current used in the transmitting antenna, and the factor of height of the two stations.

THE IDEA OF MUTUAL INDUCTION

A second possible method of wireless communication was opened up when the laws of electro-magnetic induction, discovered independently by Faraday in England and Henry in America, were made known. When a current flows through a coil, a magnetic field is set up in the space surrounding the coil. When the current in the coil is varied, the magnetic field will correspondingly vary, and if another coil is placed in proximity to the first, and so situated in the magnetic field, the changing magnetic field will set up a voltage in the second coil and if this is connected to some detecting device (such as a telephone or galvanometer) any change of current in the first will be recorded in the second. In this method real wireless communication is possible, there being no connection to the earth at either station. The amount of current which can be set up in the second coil by the changing current in the first decreases very rapidly with increasing distance between the two coils, so much so that the scheme is useful over only small distances. Thus if we have two coils say ten feet in diameter, the possible distance of communication would be probably less than two hundred feet.

Remarkable as was the discovery of electro-magnetic induction it contributed but little directly to the problem of wireless transmission of signals over appreciable distances; it is of course used throughout the transmitting and receiving sets wherever two circuits are coupled together magnetically, but in so far as the actual transmission of the power is concerned it gave but little promise. In 1891, however, Trowbridge suggested an interesting use of this principle, which, had it come about, would have much resembled a modern radio installation. His idea involved the installation of large coils in the rigging of a ship, these coils to be as large as could be carried from the ship's spars. If the current in the coil of one

ship should be interrupted many times a second, a telephone receiver connected to the coil of a neighboring ship would receive a signal and so permit the transmission of messages. Trowbridge further pointed out that such coils would permit the determination of the relative direction of the two ships from each other, a rôle filled to-day by the radio compass.

DOLBEAR, EDISON, AND STEVENSON

In 1883 Dolbear described his scheme for wireless signaling in which he used at each station an elevated wire, grounded on only one end; he was able to get communication over a distance of half a mile and some of his notes on the working of his scheme indicate that he was very close to a real solution of the problem.

In 1885 Edison and his associates devised a scheme for signaling to moving trains by induction from the telegraph wires running parallel to the railroad tracks. The currents induced in the train receiving apparatus were received with the train at high speed and the system had the advantage that the same wires could be used simultaneously for regular telegraph traffic. In Edison's apparatus the currents had to "jump" from the telegraph wires to the train, a distance of thirty to forty feet; it was evidently to this extent a system of wireless telegraphy.

The most remarkable achievement using the principle of magnetic induction was accomplished by Stevenson in England in 1892; he was able to establish reliable communication from the mainland to an island half a mile distant, using at his two stations large horizontal coils two hundred yards in diameter. In the transmitting coil the current from a few cells

was interrupted by scratching a contact on a file and in the receiving coil a telephone receiver was used for detecting the induced currents.

WHY "WIRELESS" CHANGED TO "RADIO"

We have now come to the point in the development of wireless communication where the really important work begins; it is worth while to review what had been done in the rather more than half century which had elapsed since Steinheil had used the earth for one of the conductors of his telegraph system

and had then put forth the proposition to do away completely with any wire connecting the two stations communicating with each other. A host of experimenters had worked on Steinheil's idea of using the earth or water as the only connection between the two stations, with some success, the most promising being the work of Bell; the feasible distance of communication by this scheme, however, seemed to be sharply limited to a few miles at most. Electrostatic as well as electromagnetic induction had both had their adherents, and considerable success had rewarded their efforts as evidenced by Edison's telegraphy with moving trains and Stevenson's transmission

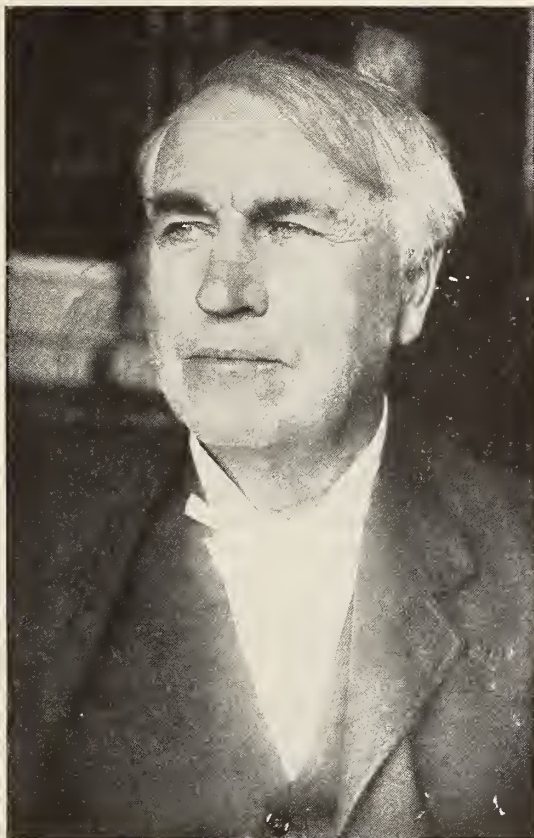

THOMAS A. EDISON

from mainland to island. The promise of much greater distance was rather slight with all of these schemes, however, and the time was ripe for the introduction of some new and radical step in the problem.

This new step was rapidly forthcoming; the energy radiated by very high frequency alternating currents and some simple scheme for detecting the high frequency currents, were the new concepts which were to give the development the wonderful progress which it

so soon showed. Incidentally, the new idea of using radiated energy, as contrasted to the previous schemes, gives us the reason for the change of name from *wireless* telegraphy, up to now a proper name for the art, to that of *radio* communication, indicating that the power used in carrying the message was not due to conduction through the earth's surface, or to magnetic induction, but to energy which was actually shaken free from the transmitting station antenna, and left to travel freely in all directions.

MAXWELL'S THEORY OF RADIATED POWER

The theoretical work of Clerk Maxwell carried out during the period from 1860 to 1870 and published in complete form in 1873 showed that energy may be radiated from an electric circuit and that this energy shaken free from the circuit follows the same laws as does ordinary light. In fact, Maxwell made light and radiated electric energy exactly the same kind of a disturbance in the universal ether, Maxwell had, of course, no idea of the usefulness of this startling concept; he was a scientist, of the pure kind as contrasted to the applied, and his work was done in the spirit of pure science. It was the truth regarding certain natural phenomena as he saw it, and it is in the pursuit of the truth about Nature's activities that men like Maxwell pass their lives. Their material reward is generally nil, but that matters to them not at all; the joy of finding out the secrets of nature is the only reward required to keep them stimulated for further work. We shall point out later the work of another pure scientist who predicted theoretically that the modern vacuum tube was possible; others made the tubes and reaped the financial reward. To those buying the tubes to-day it undoubtedly seems that they are still reaping their reward.

Maxwell's theory of radiated power was the subject of much scientific argument and discussion; for many years this theory lacked any experimental evidence, either for or against it. The English scientists in general adopted the theory, but those of the continent were against it as being more complex and difficult to understand than the older theories of light and electricity. At the suggestion of von Helmholtz, probably the best known of German physicists, Heinrich Hertz was persuaded to take up the problem of connecting experimentally the behavior of light and electromagnetic waves. Hertz had almost given up

the idea of carrying out this experiment when he noticed a peculiar event taking place in another experiment he was working on. He was discharging a condenser through a spiral inductance coil, when he noticed that another coil in the vicinity produced small sparks every time the discharge took place in the first circuit. This phenomenon is the same as takes place every time a spark transmitter is operated to-day; the current in the antenna of a spark set is excited by the oscillatory discharge in the so-called local circuit.

AN ACCIDENT STARTED HERTZ

The sparks in the second coil took place with such regularity that Hertz decided to investigate their action. It will be noticed that this beginning of Hertz's remarkable work was the result of accident; if the second coil had not been in the neighborhood of the first when the discharges were taking place, no spark would have been noticed in the second and probably nothing further on the problem would have been done by Hertz and some one else might have carried out his epoch-making work; in fact, Professor Oliver Lodge, in England, would have been almost sure to have carried out the work if Hertz had not started when he did.

Hertz's own report of his brilliant and important experiments is available, as the original papers of Hertz have been translated into English and published under the title of "Electric Waves"; for the most part the book is non-mathematical and makes very interesting reading. As Hertz felt his way in this new field his reports had all the fascination of those of the explorer of unknown lands. His various papers followed one another so rapidly that in the space of only two years, 1887-1889, he had covered practically the whole field and had established firmly the laws of electric wave propagation as we know them to-day. He showed that the waves sent off from an electric circuit carrying high frequency current traveled with the same velocity as does light, that these waves could be reflected by mirrors and refracted by prisms and lenses just the same as light. He measured the length of the waves with which he was experimenting, and found that his detecting circuit must be of the same natural frequency as the transmitter if the response was to be appreciable. As one reads the account of these experiments he feels that Hertz's laboratory was really the birthplace of

the radio art and cannot help feeling regret that this keen experimenter could not live long enough to see the wonderful practical benefits which mankind was to receive as the direct result of his work, carried out in the interest of pure science. It is because of the results following from the work of such men as Hertz that our most highly developed industries are to-day spending millions of dollars annually in the support of purely scientific research; the directors of these immense laboratories know too well that no real scientific truth can be discovered without bringing with it some application which will benefit the industry itself.

Very shortly after the death of Hertz in 1894 the world began to hear of the modest successes of Marconi, whose optimism and aggressiveness, combined with the wonderful foundation of knowledge which Hertz had given, soon showed that the possible reliable distance of radio communication was probably limited only by the extent of the earth's surface. In our next number will be taken up the work of the later and better known inventors and scientists, Marconi, Fleming, De Forest, Fessenden, Armstrong and others, who, building on the work of those earlier experimenters we have mentioned in this number, have given us the modern radio telephone.

An Evening with Dr. Alexander Graham Bell

By DONALD WILHELM

WE TELEPHONED to Dr. Bell shortly after dinner. We, the managing editor of the *World's Work* and I, wished, if possible, to see him, his secretary was told, if he felt physically able to see us.

Back came the inquiry a bit later "What time would you like to come, to-night?"

"To-night?"

"O yes. Doctor Bell often receives callers at night. He says that he will be glad to see you at any time up until two or three o'clock in the morning!"

At our end, we reckoned that there must be something wrong with the line! We considered that Doctor Bell was twenty-nine years of age when he invented the telephone in 1876, must therefore be in his seventy-fifth year! Being, ourselves, in the thirties, we felt that 9:30 would be late enough for us.

At 9:30 Doctor Bell arose from his family group, a figure as nearly majestic as the figure of a man ever comes to be; a veritable oak of a man; a tall man finely put together, in a light gray suit, with a skin tanned by the out-of-doors, and eye as clear and blue and rested as that of a young man. His white copious hair was flung back. A curved pipe hung in a per-

fectly steady hand. He wore neither glasses nor spectacles. I glanced at his hands. There was not a tell-tale mark of age on them. Later, when he snatched a paper pad from a handy table and with pipe dangling from his mouth and both hands and arms unsupported he drew a diagram, we could not discern the suggestion of a tremble. I confess that I wrote down in my notebook then and there just this: "Think what this man has done for the world! The hazards of Science are great enough, but where, except in the world of Science, can a man give his life for the millions yet conserve it still!"

"Light up," he laughed, settling himself in his chair. "Will you have a cigar or a cigarette—O you prefer your own brands? That's fine! I like to pull on this old pipe."

It was all like an idyl. Here was a man who, within the span of a lifetime, had seen his dreams come true; who had topped the mountain, held his ground, who says he never felt stronger intellectually. "My mind has a greater power of concentration," he observes when you ask him, "than it ever had. It seems to be quicker and it does not tire along the line in which I am interested. I sometimes work for eighteen hours at a stretch." And "by the by," to use his phrase, you are privileged to go along hand-in-hand with him down

through his long life, in turning the pages of his Recorder. There are whole volumes—a score of them, each of 500 pages or so—with records of his daily researches, experiments, speculations, all packed with the bounty of an intellectual life in a variety that is incredible. In these volumes, in fact, you find his tremendous energies devoted to the telephone, to kites and aircraft and the scientific breeding of sheep, to the utilization of waste heat, the need of a new acceptance of a metric system, experiments in preserving food, notes on eugenics and *The Biologic History of a Cat*; oral teaching, a paper on the utility of action and gesture, observations on lip reading, on Hertzian waves, and, among a hundred other subjects, not to mention many pages devoted to glorifying Life in general, his description of his early experiments in transmitting wireless signals through the earth's crust and through the waters of the Potomac. Also, most interestingly, you find his papers on the first of all wireless telephones—the photophone, the light phone.

About this first wireless telephone, which of course did not, like the modern radiophone, use a tuned circuit, we wished Doctor Bell to talk; also about his early experiments in detecting and transmitting signals, and the first use of the telephone therefor, without the use of wires. And of course we yearned to have him discuss his invention of the original telephone, and that momentous day, that birth-day of both wire and radio telephonic communication, March 10, 1876. For, clearly, without the use of some instrument as sensitive as the Bell telephone, even Marconi could not have revealed the enormous possibilities of the wireless.

The year 1871 found Doctor Bell, at the age of twenty-four, teaching vocal physiology in Boston University. By the by he established his own school, applied his own system of teaching the deaf, and went to live in the home of five-year-old George Sanders, one of his pupils, in Salem. In the Sanders cellar he set to work with tuning-forks, magnets, batteries. For three years he worked. In 1874 he had evolved what he called the harmonic telegraph—a device for sending a number of Morse messages over a single wire at the same time by utilizing the law of sympathetic vibration. That is important because, in seeking to develop it, and to perfect its transmitter and receiver,

electromagnet, and its flattened piece of steel clock spring, he met Thomas A. Watson, and on June 2, 1875, after months of countless experiments, profited by an accident, one of those accidents that have contributed a vast deal to Science. One of the transmitter springs stuck. The magnetized steel generated a current that sent a faint sound over the electric wire to his receiver. Then he knew that his supreme dream of telephonic speech was within the realm of possibility. So, with his principles established, he went to work on his telephone.



On March 10, 1876, the birth-date of the telephone, he applied these principles for the first time successfully. In that attic room of his, at the end of a hundred feet of wire, he put his mouth to his telephone and said, "Mr. Watson, come here, I want you." Watson came rushing through the intervening door shouting,

"I heard you; I could hear what you said!"

Doctor Bell likes to add, by the by, some of the singular incidents that followed. "The Japanese language was the first language, after the English, used over the telephone," he said. "I had two Japanese students. One of them asked me if the telephone would speak Japanese. I told them to try."

On October 9, 1876, over a telegraph line between Cambridge and Boston, Doctor Bell and Mr. Watson held the first telephone conversation over a considerable distance. Soon thereafter the *Boston Globe* transmitted the first press report, from Salem, Massachusetts, to Boston, by telephone. Still, people were incredulous. Thus Mr. Bell was invited to display his instrument at the Philadelphia Centennial. But there, in his remote corner, he attracted little attention until the Emperor of Brazil, Dom Pedro, took up the receiver to listen, at the far end of a large room, to the voice of the inventor. He exclaimed, dropping the receiver suddenly, "My God, it speaks!" That was an event which caught popular fancy; still, it was not until sixteen months after Doctor Bell had filed his patent, he says, when there were already 778 telephones in use, that, in August, 1877, The Bell Telephone Association, the first telephone company ever established, was formed. It had no capital at the outset. It had four members only—Doctor Bell, Gardiner G. Hubbard, Mr. Watson, and Thomas Sanders, Georgie's father, who furnished all the financial backing.

But Doctor Bell was not interested in business. "It has always been that way," he told me. "After I have made a discovery and got it under way my interest in it lessens." Hardly, in fact, had Theodore N. Vail and his associates set about to make the telephone a universal servant when the inventor himself struck off into new fields.

It was, as accurately as the date can at present be fixed, toward the end of the year, 1876, in which he invented the telephone, that Mr. Bell, for the first time, used the phone, instead of a galvanometer, to experiment with and to trace out the lines of the earth's potential. In these

experiments, incidentally, he used a steel-band telephone, as it was then called, to clasp the phone to his ears, leaving his hands free—the first time the helmet telephone receiver was ever used. "Using two metal exploring rods—they were really stove poker," he explained, "I set to work on Mr. Hubbard's place

on the outskirts of Cambridge. I drove the rods into the ground. At the receiving rod I found that upon listening with the telephone I could hear a clock ticking. I then noted that at periodic intervals the clock would miss a tick. By means of that irregularity I was able to identify the clock as the time clock of the Cambridge Observatory, a half mile away. There was, I knew, a telegraph line from the Observatory to Boston, to pass the time. Using ground that was charged, with the Observatory as the centre of an imaginary circle, I was able to define concentric circles that indicated much more accurately than had been possible with a galvanometer, the lines of potential. In other words, if both of the rods were in a part of the charged ground that was to be designated as concentric circle 9, closest to the Observatory, both ends of my earth telephone circuit had the same potential, but if one were in 9 and another in 8, there would be a residual effect and I would get a sound."

Later he carried these experiments on in a different direction. "First, in a vessel of water," he said, "I placed a sheet of paper. At two points of that paper were fastened two ordinary sewing needles, which were also connected with an interrupter that interrupted the circuit about 100 times a second. Then I had two needles connected with a telephone: one needle I fastened on the paper in the water, and the moment I placed the other needle in the water I heard a musical sound from the telephone. By moving the needle around in the water, I would strike a place where there would be no sound heard. This would be

where the electric tension was the same as in the needle; and by experimenting in the water you could trace out with perfect ease an equipotential line around one of the poles in the water."

In July, 1877, Mr. Bell married Miss Hubbard. They went to London on their honeymoon. In London he made



©Underwood & Underwood

Alexander Graham Bell, finding his own invention a source of annoyance, had it removed from his room in favor of a radio receiver. Mr. Bell is now 75 years old and an ardent radio enthusiast

the classic speech on the telephone and explained and demonstrated the experiments described above to William Preece, the head of the British Post Office system, who was vastly helpful to Marconi, and others. He also experimented across the Thames. "On one side," he said, "I placed two metal plates at a distance from each other, and on the other two terminals connected with the telephone. A current was established in the telephone each time a current was established through the galvanic circuit on the opposite side, and if that current was rapidly interrupted, you would get a musical tone."

On his return to America he discussed these experiments before the American Academy of Arts and Sciences in Boston, on December 11, 1878. He described his experiments, which he proceeded to develop on the Potomac.

"In the experiments on the Potomac," he said, "I had two boats. In one boat we had a Leclanché battery of six elements and an interrupter for interrupting the current very

rapidly. Over the bow of the boat we made water connection by a metallic plate, and behind the boat we trailed an insulated wire, with a float at the end carrying a metallic plate so as to bring these two terminals about 100 feet apart. I then took another boat and sailed off. In this boat we had the same arrangement, but with a telephone in the circuit. In the first boat, which was moored, I kept a man making signals; and when my boat was near his I would hear those signals very well—a musical tone, something of this kind: tum, tum, tum. I then rowed my boat down the river and at a distance of a mile and a quarter, which was the furthest distance I tried, I could still distinguish those signals.”

He added, in our discussion, that one of the boats that he used was near Chain Bridge while his own boat was, at the conclusion of the experiments, at the Washington Monument. And at the time of his experiments he pointed out the practicability, since “most of the passenger steamships have dynamo engines and are electrically lighted,” of each vessel trailing a wire a mile or so long duly charged, and attached to a telephone. “Then,” he said, “your dynamo or telephone end would be positive and the other end of the wire trailing behind would be negative. All of the water about the ship will be positive within a circle whose radius is one-half the length of the wire. All of the water about the trailing end will be negative within a circle whose radius is the other half of the wire. . . . It will be impossible for any ship or object to approach within the water so charged in relation to your ship without the telephone telling the whole story to the listening ear. Now, if a ship coming in this area also has a similar apparatus, the two vessels can communicate with each other by their telephone. If they are enveloped in a fog, they can keep out of each other’s way. The matter is so simple that I hope our ocean steamships will experiment with it.”

It is only to be added that these land and water experiments of Doctor Bell without question were factors in the success of Mr.—later Sir—William Preece in England. His first experiment was made in 1882. In that year in a public address, he said, “The discovery of the telephone has made us acquainted with many strange phenomena. It has enabled us, amongst other things, to establish beyond a

doubt the fact that electric currents actually traverse the earth’s crust. The theory that the earth acts as a great reservoir for electricity may be placed in the physicist’s wastebasket. . . . Telephones have been fixed upon a wire passing from the ground floor to the top of a large building (the gas pipes being used in place of a return wire), and Morse signals, sent from a telegraph office 250 yards distant, have been distinctly read. There are several cases on record of telephone circuits miles away from any telegraph wires, but in a line with the earth terminals, picking up telegraphic signals; and when an electric-light system uses the earth, it is stoppage to all telephonic communication in its neighborhood.” Mr. Preece then describes one of the first of all his experiments, which was made, it is to be noted, nearly five years after those described above of Doctor Bell. Sim-

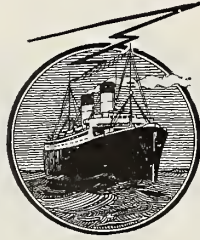

ply, this experiment, in March, 1882, successfully linked up the Isle of Wight with Southampton when the cable between that island and Southampton broke down. His complete circuit, including the water, started from Southampton, ran to Southsea Pier, 28 miles; across the sea, 6 miles; Ryde through Newport to Sconce Point, 20 miles; across the water again, $1\frac{1}{2}$ mile, thence from Hurst Castle back to Southampton, twenty-four miles. “With a buzzer, a Morse key, and 30 Leclanché cells at Southampton,” he says, “it was quite possible to hear the Morse signals in a telephone at Newport, and vice versa. Next day the cable was repaired, so that further experiment was unnecessary.”

Since those early days, while on one hand it becomes more and more apparent that the radio art would have been infinitely harassed in its origin and development without the telephone, it has also become apparent that the relationship of earth characteristics and those of the sea, must sooner or later have been given just such attention as Doctor Bell gave, and encouraged others to give, to them. There is good ground for saying that these experiments fathered many perfections in earth telegraphy, including the TPS work used in the main during the war by both the Allies and the Germans for intercepting messages, notably telephone messages. But, it is also to be noted that ground methods do not permit of the use of high frequencies, do not employ tuned cir-

cuits, and do not belong, in the view of many authorities, within the sphere of modern radio.

Nevertheless—the proof is in of Mr. Bell's amazing ingenuity and resourcefulness—it may well be that his experiments with ground and water telegraphy and telephony might long ago have given results that have not even now been attained if he had continued his experiments. But his fertile brain got to working in other directions, at aircraft, for instace.

We have seen how, on March 10, 1876, he spoke the first words ever sent over a telephone line.

Four years later, on Sunday, February 15, 1880—he remembers the date because on that day his daughter, now Mrs. Fairchild, was born—he received the first words ever spoken over a wireless phone. The words spoken and received were heralded by a flash of light through his laboratory window. Then he distinctly heard, he told me: "Mr. Bell, Mr. Bell, if you hear me, come to the window and wave your hat!"



The man who spoke these words was Charles Sumner Taintor. He was on the top of the Franklin School, 13th and K Streets, N.W., Washington. Mr. Bell was in his laboratory on L Street, between 13th and 14th, on the north side of the street. Curiously enough, it should also be added, though Maxwell and others abroad, in the years around 1880, were suggesting and even assuming a medium through which electromagnetic action could be propagated, Hertz, who demonstrated conclusively the existence of that medium and related electromagnetic or "Hertzian" waves and light waves, did not begin to produce his tremendous series of papers until 1888. Yet the instrument devised by Doctor Bell, by which for the first time in history words were transmitted beyond the power of the human voice and without the use of wires, might have been called a light-phone, was at both the Louisiana Purchase Exposition and the World's Fair displayed as the radiophone, and without question projected speech on electromagnetic waves, though not, of course, by means of high frequencies or a modern tuned circuit.

"For some time," Mr. Bell told me, "we had been carrying on experiments between the top of the Franklin School and the Virginia Hills, a mile and a half away. These experiments

had progressed until we succeeded with them that Sunday when my daughter was born."

He smiled. "Looking back," he considered, "I was very nearly not at home!"

He related, then, how, when his experiments had proven a success, he put all the records into a sealed envelope and deposited the envelope in the Smithsonian Institution, where, unopened, the envelope still remains. That fact leaked out. Shortly thereafter a gentleman named H. E. Lix, of Bethlehem, Pennsylvania, gave out the information that he had invented a method of seeing by telegraph. The two ideas of an invention by this unheard-of inventor and the mystery of the sealed envelope became confounded in public prints with the remarkable result that two English inventors assailed Doctor Bell for seizing upon their ideas concerning an instrument by which one could see by telegraph!

But Doctor Bell, himself, had nothing to say, for, by contract, all his inventions of that period automatically became the property of the American Bell Telephone Companies.

Briefly, Mr. Bell had noted the remarkable characteristics of selenium, which, Willoughby Smith in 1873 had demonstrated, would, if placed in an electric circuit, alter its resistance to the current under the influence of light of rapidly varying intensity. With this cue Mr. Bell developed a mirror in the shape of a telephone diaphragm—a mirror of minimum thickness. Fastened to this mirror was a mouthpiece. When one spoke through this mouthpiece the mirror vibrated. He then devised means to throw a beam of light against this mirror and, by reflection, to direct this beam to the receiving apparatus. Bit by bit he then developed improvements so that the mirror in its vibrations caused fluctuations (invisible fluctuations, of course) in the light rays and corresponding variations in the degree of heat in the amount of light thrown upon the substance designed to reproduce the sounds of the voice. For instance, the word "Hello," which makes changes in a modern electrical circuit distinctly different, after being spoken into a telephone, from those made by the word "good-by," caused certain vibrations in the mirror. These in turn caused fluctuations in the rays of light, and the receiving apparatus, under their influence, sent out sounds which reproduced the word, "Hello." For receiving, he

used selenium in an electric circuit with a telephone receiver, and, also vegetable fibre or lampblack placed in a glass bulb from which rubber tubes led to earpieces. On these substances (later it was demonstrated that many others could be used, such as a bit of black worsted cloth, of silk, or particles of rubber) the action of the rapidly varying degree of heat in the light rays caused the substances in the bulb to expel and absorb gases, alternately. These gases in turn produced vibrations in the air in the tubes and these vibrations made themselves felt in the eardrums of the person listening, causing an exact reproduction of the words spoken at the transmitter.

The instrument worked, and stood the test of many demonstrations. In the laboratories of the Bell Telephone Companies and later in those of the American Telephone & Telegraph Company, it was developed. There arc lights came to be used along with many other variations in Mr. Bell's original device. Thus in April, 1897, Hammond B. Hayes, one of the engineers of the American Telephone & Telegraph Company, noticed that a humming sound, audible in the receiver of the "radio-*phone*," corresponded in pitch with that produced by the generator supplying the current for the arc lamp used in the experiments. Starting with this discovery Mr. Hayes concluded that if the words spoken into a telephone were made to act directly upon the lighting circuit, it would not be necessary to use the mirror employed by Mr. Bell and the distance which speech could be transmitted would be greatly increased. In other words, the telephone current could be superimposed upon the lighting current. This was done by attaching the telephone wires to the wires in the arc light. The principles remained the same, but with the improved device, which was patented in June, 1897, the sound of the voice could be heard with distinctness at points several miles from the transmitter, and it was known that good results might have been had at much greater distance.

The instrument, as it now stands, is simple in appearance. The receiver used consists of a selenium cell enclosed in a glass bulb no bigger than that in which the homeopathic physician carries his pills. In making the cell, very fine brass wires are wound upon a bit of Indian pipe stone. The wires are then covered with

a thin layer of selenium and are attached to the wires which connect with the telephone receiver. The glass bulb is then placed in a reflector which concentrates the rays of the lamp upon the selenium.

At the sending end a searchlight such as is used on vessels is used. From the telephone transmitter, which is of special construction, wires lead to the lamp, and are attached to the wires which carry the lighting current. When words are spoken into the transmitter, the rays of the searchlight fluctuate. Standing by the lamp, however, an observer sees no change, of course. At the receiving end, which

may be miles beyond visual distance by the naked eye, the selenium responds to these fluctuations in the light rays and the current in the wires there increases and diminishes in thousands of infinitesimal changes which reproduce not only the spoken words but the very tones of the voice of the speaker.



The possibilities of the instrument, even though no results of its use with modern regenerators are available, are greater than may be supposed. Thus it had been found that an electric arc lamp is of itself a telephone receiver. The big light that hangs from a pole on the street corner may be made to talk! From the carbons in a lighted arc lamp there arises a column of vapor. If the lighting current is varied by superimposing upon it a telephone current, the column of vapor around the carbons in the lamp will fluctuate and sound waves corresponding to the words spoken into the telephone will be given out. Music can also be sent through the arc lamp—the notes of a bugle coming clear and distinct from an ordinary electric light when no bugler is in sight afford a striking illustration of things already done.

The application of the instrument to maritime use has also been developed, and it would be possible for one ship captain in his cabin to hear another in his cabin, or to hear from the shoreline, by means of this, the original radio-*phone*.

It can be used in the daytime as well as in the night time, but fog is its enemy.

It has been used by the German Government for lighthouse work, and by the U. S. Signal Corps.

It may yet be that the "talking arc," will come into its own, in spite of, or even in

conjunction with, the radio telegraph and the radio telephone.

And, at any rate, it will be just as well for Science, to add to its records of the original radio phone, which attracted scientific atten-

tion the world over long ago, those first words uttered on that eventful Sunday, February 15, 1880: "Mr. Bell, Mr. Bell, if you hear what I say come to the window and wave your hat!"

Increasing the Selection Power of a Radio Circuit

By JOHN V. L. HOGAN

Consulting Engineer, New York; Fellow and Past President, Institute of Radio Engineers;
Member, American Institute of Electrical Engineers

WE HAVE seen that by correctly coördinating the amount of capacitance and inductance in a freely vibrating radio circuit, we are able to secure an agreement between the most easily attained or natural vibration rate of the circuit and the received radio waves.* Each radio wave has a definite predominant frequency of vibration; the standard broadcasting wave oscillates at the rate of 833,000 cycles per second. By adjusting the capacitance of an intercepting or receiving aerial and the inductance of the tuning coil connected to it, we may make the natural oscillating frequency of the circuit from aerial wires to ground exactly the same as the frequency of the arriving wave; in this case there will be produced the greatest possible amount of current in the receiving aerial system, and consequently the loudest possible signals will be heard in an associated receiving telephone.

SOME LOGICAL CONCLUSIONS

A NATURAL conclusion to draw from the fact that agreement of natural and received wave frequencies results in maximum current is that disagreement between these frequencies would cause a reduced flow of current. That is, we would expect to hear weakened signals if we adjusted our antenna capacitance and tuning coil inductance to correspond to a circuit frequency differing from the received wave frequency. That is exactly what does happen when the experiment is tried.

*"Tuning the Radio Aerial System" by John V. L. Hogan. RADIO BROADCAST, June, 1922, p. 107

But when we change the circuit frequency to a value different from the tuned or resonant value, at which it is in harmony with the received wave, how much will our signal strength be reduced? For example, how far must we de-tune the circuit (or how great must be the disagreement in frequency) before the current is reduced to one-half its maximum or resonant value? This is the question whose answer explains the matter of *sharpness of tuning* or the selective power of radio receiving instruments.

To understand why one resonant circuit will tune more sharply than another, we must consider a little more closely what happens while such a circuit is oscillating. As we have seen, when a charged condenser is connected into a circuit including an inductance coil, the electrical energy stored in the condenser will discharge as an electric current through the coil and circuit. The current does not die away and vanish unless the circuit is poorly conductive; it "overshoots" and recharges the condenser in the opposite direction. Immediately thereafter, the condenser discharges backward through the coil and circuit, the electrical momentum or overshooting action of the coil causing a third recharge of the condenser. This time, however, the direction of the charge is necessarily as it was when the current oscillations were started. It is not hard to see that such successive reversing discharges of the condenser will generate an alternating current in the system, and that the frequency of this alternating current will depend upon the size of the condenser and the coil. The larger the capacitance of the condenser (just as the greater the flimsiness of the spring in a mechanical

vibrating system) the less will be the force tending to produce the electric oscillations, and consequently the slower their frequency will be. The greater the inductance of the coil (just as the larger the mass of the vibrating weight in a spring pendulum) the greater will be the electric inertia of the circuit, and consequently the lower will be the natural alternating current frequency.

REGARDING THE CONTINUITY OF OSCILLATIONS

HOW long will such a circuit continue to oscillate, once the electric vibration has been started? Will the condenser continue to discharge and recharge indefinitely, or will the electric energy originally stored all be used up after a certain number of oscillations have taken place? The fact is that each successive re-charge is a little less than the one preceding it, because some of the electric energy is lost in heating the wire of the coil and circuit during each oscillation. The amount of energy thus lost is proportional to the electrical *resistance* of the circuit, which is simply a measure of the opposition which exists to current flow in any conductor. Clearly, the greater the resistance of the oscillating circuit, the more energy will be lost at each swing, and consequently the fewer electric vibrations that can take place before the current dies away to an immeasurably small value.

Fig. 1 shows a simple oscillating circuit in which the resistance is small, being merely that of the wires and coil. In such a circuit the oscillations will continue for a comparatively large number of swings, and hence it is called a *persistent* oscillator. Fig. 2 represents a gradually reducing or persistent train of oscillations such as would exist in a persistently oscillating (or, as it is often called, feebly damped) circuit. On the other hand, we may increase the resistance of our circuit by inserting a resistor as in Fig. 3. This will make the circuit less persistent or more highly damped, and, since each condenser recharge will be considerably smaller than that which preceded it, the number of cycles of oscillation before the current dies away to a useless value will be much reduced. Fig. 4 indicates such a highly damped train of oscillations, the reduced number of vibrations resulting from an increase of the circuit resistance. If the resistance is made too large, the circuit will not develop any free electric oscillations whatever, for so much of the condenser energy will be used up in

the first discharge that no inertia or recharging effect will appear.

Now let us consider what this matter of cir-



Fig. 1: A persistently oscillating simple resonant circuit

cuit persistence, or the varying number of free oscillations, has to do with sharpness of tuning. We have seen that as the natural frequency of a receiving antenna is varied, from a value

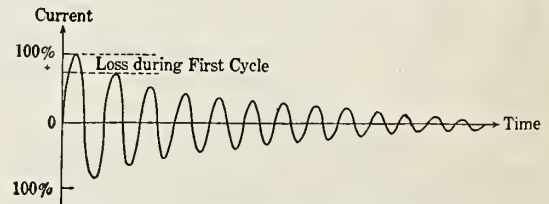

Fig. 2: A persistent train of oscillations such as would occur in the circuit of Fig. 1.

below the wave frequency of an arriving radio signal, upward to and then beyond that frequency, the current flowing in the antenna circuit increases to a maximum and then de-

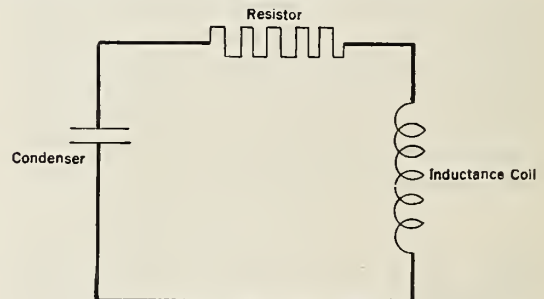

Fig. 3: A simple resonant circuit including a resistance unit which decreases its persistence

creases. The largest current value occurs at resonance, or when the frequencies are in agreement. The rapidity with which the current increases as the resonant point is approached is what determines the sharpness of tuning of the circuit.

The antenna-to-ground circuit of Fig. 5 behaves almost exactly as does the closed res-

onant circuit of Fig. 1. If the antenna itself were charged, like a condenser, by virtue of its capacitance, and allowed to discharge through the tuning coil to ground, it would vibrate

In other words, the higher the resistance effective in a tuned radio circuit, the less sharp its tuning will be. Since the selection power, by means of which the circuit discriminates be-

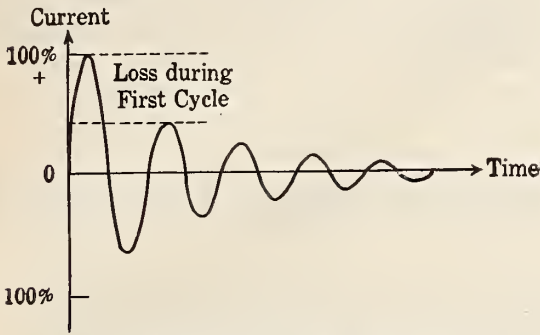

Fig. 4: A more highly damped oscillation train, characteristic of the non-persistent circuit of Fig. 3:

electrically at its natural frequency. The number of oscillation cycles before the current died away to negligible values would, as before, depend on the effective resistance of the circuit. Thus, if the switch were opened so as to put into the circuit the resistor shown in Fig. 5, the number of oscillations would be reduced just as in the case of the closed circuit.

If, now, we adjust the aerial circuit (by changing the inductance of the tuning coil) so that its resonant or natural frequency is 833,000 cycles per second, we will secure maximum antenna current from any station sending at that frequency. If the sending plant's wave is altered to a value above or below 833,000 cycles, the current in the receiving antenna will be reduced. We may plot, as in fig. 6, the amount of current which will be set up in the antenna as a sending station is adjusted to transmit successively all wave frequencies from 800,000 cycles to 875,000 cycles, both with and without the resistor in series.

The amount of resonant maximum current which will build up in any such circuit depends upon the degree with which the free or natural oscillations in that circuit cooperate with the arriving impulses to magnify their effects. Thus, the more persistent the natural oscillations are in the antenna, the greater and the sharper will be the rise of current as the resonant frequency is approached and reached. This is quite clearly shown by the curves of Fig. 6; when the resistance of the circuit is increased and consequently the persistence of its natural oscillations reduced, the resonant rise of current is neither so sharp nor so great.

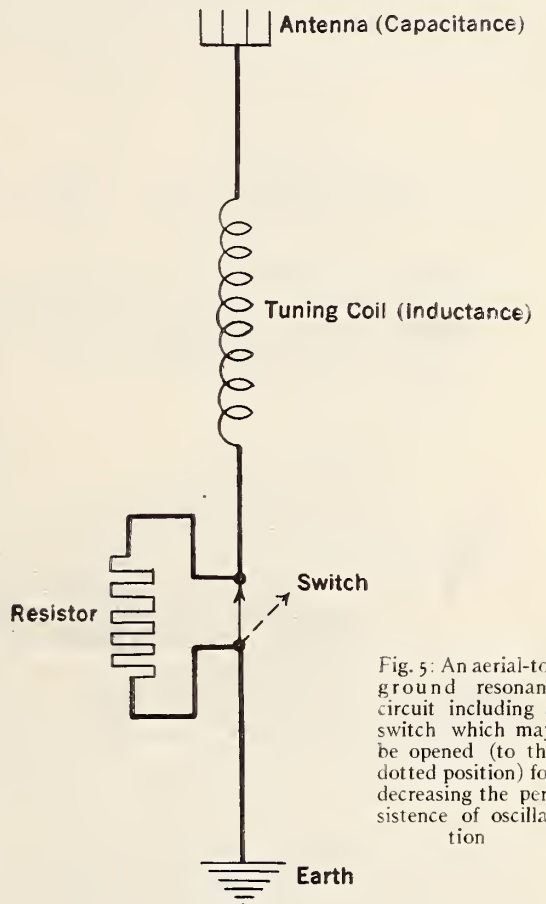

Fig. 5: An aerial-to-ground resonant circuit including a switch which may be opened (to the dotted position) for decreasing the persistence of oscillation

tween waves of different frequencies for the purpose of avoiding interference, depends directly upon the sharpness of tuning, it is obvi-

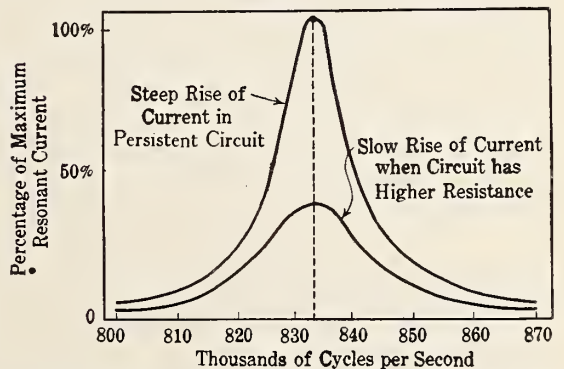

Fig. 6. Curves showing how the addition of resistance to the antenna circuit reduces the sharpness of tuning

ous that for best selectivity we must keep the wasteful resistances in our tuned radio circuits as small as possible.

The problem of building radio receivers which tune sharply and operate efficiently thus reduces itself to the provision of a way to abstract radio-frequency power from a tuned cir-

cuit, such as an antenna system, without unduly increasing its effective resistance. In general, the less opposition to current flow in the receiving circuits the greater will be their persistence, the sharper their selective adjustment to frequency, and the louder the received signals.

Protection of the Receiving Antenna

Many Radio Enthusiasts Have Been Worried About Their Antenna as a Lightning Hazard. The Following Description of Lightning Protection Includes the Much Desired Information Which Should Relieve This Apprehension. It Includes the Latest Recommendations of the National Board of Fire Underwriters

By G. Y. ALLEN

AS READERS of the June issue of "Radio Broadcast" will remember, Jim Black's initial radio set consisted of a small crystal receiver using a bed spring as an antenna. As was to be expected, however, Jim shortly outgrew such elementary equipment with its limited range, and experienced a desire to listen to stations farther away than was possible with a crystal detector. So one evening last week he carried home a small tube regenerative outfit.

In order to increase the possibilities of hearing distant stations, he erected a single wire antenna on the roof of the apartment house in which he lived. He hoped to hear Springfield and possibly Pittsburgh on this outdoor antenna.

He had given no immediate thought to the protection of his antenna until Mrs. Black raised the question one evening during an early summer thunder shower. No damage was done that evening, but the possibility of his antenna being a fire hazard worried Jim and he resolved to interview the dealer from whom he had purchased his set and find out what must be done to safeguard the apartment from damage.

Accordingly, the following noon found Jim at Gardiner's electrical store.

"Well, Mr. Black, how does the set work?" asked Mr. Gardiner.

"Slick as a whistle," said Jim. "We heard Detroit night before last, and Schenectady

comes in so loud that we can hear him in the next room."

"Fine work," said Mr. Gardiner. "You must have made a pretty good job of putting up that antenna. By the way, you didn't get a lightning ground switch when you were here last week. Thunder storms will be coming pretty frequently now and you'd better be prepared."

"That's just what I wanted to ask you about," Jim acknowledged. "The wife was a little scared last night during that shower, and I want to know what I must do to make the installation absolutely safe."

"That's easy," said Mr. Gardiner. "Just attach one of these hundred ampere double throw single pole switches outside of your house and run a number four copper wire down to a piece of pipe driven into the ground."

"Do you mean to say that I have to attach that thing to the outside of the house and run a piece of that heavy wire down the front of the building?"

"That is what the rules specify," said Mr. Gardiner.

"Well, I have a fine chance of getting away with that in our neighborhood," said Jim. "Guess that little old antenna comes down if that's the way it has to be protected."

Jim left the store in a very depressed state of mind. He did not want to remove the antenna because Mrs. Black took so much pleasure in listening to the concerts, and furthermore, he liked to fuss around with the set

himself. Yet he knew that it was an impossibility to disfigure the apartment house with a heavy switch and wire. It did not seem right to require a fifty-foot span only a few feet above the roof of the apartment to be protected by such a large switch when telephone wires of much greater length were protected only by a small fuse and protector attached to the window sill in the basement.

While thinking the matter over, Jim happened to remember an old friend who had recently become a fire insurance inspector and he decided to talk to him before removing the antenna from the roof.

The following day Jim called up his friend and went out to lunch with him. After the orders had been given Jim started immediately to question him on the protection of antennas. He told how he had installed the set without giving much thought to protection of any kind and of the information given him by Mr. Gardiner.

"Now, Bill, you know there isn't one chance in a thousand of my being able to put a heavy switch outside of the house, and as for running a heavy copper wire down the side of the house, that is certainly out of the question."

Bill looked at Jim's troubled face and smiled.

"Your friend Gardiner is surely a back number," he said. "The Fire Underwriters have recently revised the rules applying to the protection of receiving antennas and when the new simple specifications are followed, the antenna is a protection to the building on which it is erected instead of being a hazard.

"Instead of a heavy switch mounted outside of a building, which by the way you may forget to throw, you use a small gap permanently connected to a grounded wire. The gap is adjusted to operate at a voltage of five hundred or less. The protective device may be placed inside of the building and instead of a heavy and unsightly copper wire, you will need only a number fourteen wire connected to the nearest grounded water pipe or radiator."

As Bill talked he drew a sketch on the tablecloth similar to that shown in Fig. 1.

"Well, now you are talking," said Jim. "Where can I get one of these gaps?"

"You ought to be able to get one at any up-to-date dealer's," replied Bill.

And so, the lunch being over, Jim arose in a much better frame of mind than when he sat down, and immediately purchased a protec-

tive device which he took home and installed that night.

The latest revision of the Fire Underwriters code applying to receiving antennas has made possible the approval by fire insurance inspectors of installations that could not possibly be made acceptable under the old rulings. Manufacturers have been quick to recognize the value of the new requirements and there are now several protective devices on the market which meet these requirements.

The available types are divided into two classes, namely, the enclosed atmospheric type and the type in which the discharge takes place either in a vacuum or in some rare gas. This latter type is always sealed into a glass bulb.

Fig. 2 illustrates one of the vacuum type

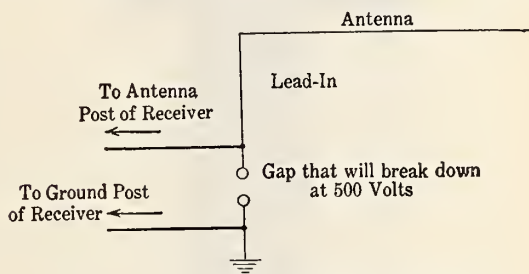

Fig. 1. Illustrating in a very simple manner the scheme for protection from lightning. When an electrical charge strikes the antenna, it jumps across the small gap and is carried to earth

protectors and figure 3 shows its construction. The distance between the spheres between which the discharge takes place is not critical and the adjustment for the proper voltage may be controlled by the quality of the vacuum.

Fig. 4 illustrates an enclosed atmospheric type of protector. It is similar to the lightning arrestors used for telephony with the exception that the blocks used are of special design. Telephone protection generally requires a permanent ground after the initial breakdown of the gap whereas this property is highly undesirable in radio protection. In fact, static, which is of frequent occurrence during warm weather, may discharge across the protector gap to ground many times a day and a satisfactory protector must be capable of withstanding such service.

Fig. 5 illustrates the construction of a gap of this kind. As can be seen, the gap consists of carbon blocks made of a special grade of carbon separated by a porcelain block. The quality of the carbon is such as to minimize the formation of carbon dust thus remov-

ing the possibility of short circuiting the gap. The protector has the further feature of permitting easy replacement of the carbon blocks should this be desirable.

The latest revision of the Underwriters code specifically rules against the exposure of a radio

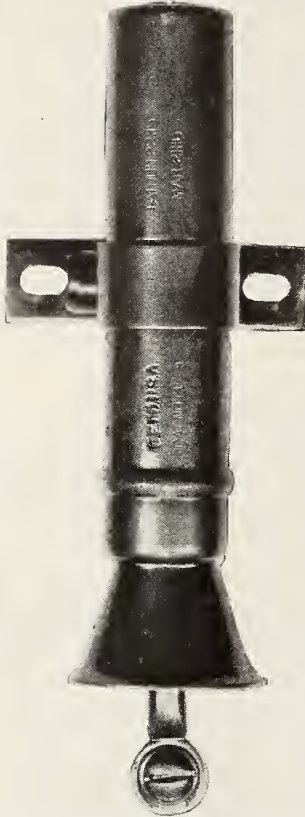

Fig. 2. One of the latest types of vacuum-gap lightning arresters is illustrated here. Its internal construction is shown in the accompanying sketch

receiving antenna to electric wires carrying voltages of six hundred or more. It can easily be appreciated, however, that installations initially free from such exposure may later become hazardous through no fault of the owner of the radio set. To protect the user fully under such conditions one of the manufacturers has designed the protector shown in Fig. 6. This protector is provided with a two-ampere fuse, and, should the antenna inadvertently become crossed with a power wire, the current to ground through the fuse will cause it to blow, protecting the radio apparatus and isolating the antenna. This makes all apparatus on the receiving side of the protector safe. The only

precaution the user of such a protector should take is to be careful not to come in contact with the antenna wire on the outside end of the fuse without having it first thoroughly inspected by a representative of the power company.

The construction of the protector is illustrated in Fig. 7. It will be noted that the gap is formed by two punched brass pieces separated by a mica washer approximately two thousandths of an inch thick. This gives a gap that will break down at approximately five hundred volts and which will stand repeated static discharges. The porcelain base provides excellent insulation.

The new regulations permit installation of the protector within the house, and allow the use of number fourteen B. & S. gauge wire or its equivalent for connecting the ground terminal of the protector to a grounded structure. A single throw single pole switch of small capacity may be used in addition to the pro-

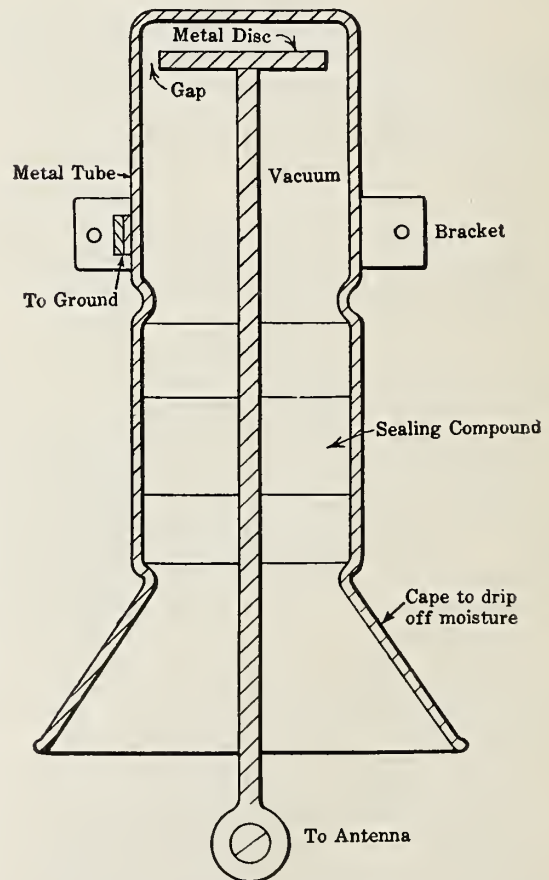

Fig. 3. The internal construction of the protective device shown above

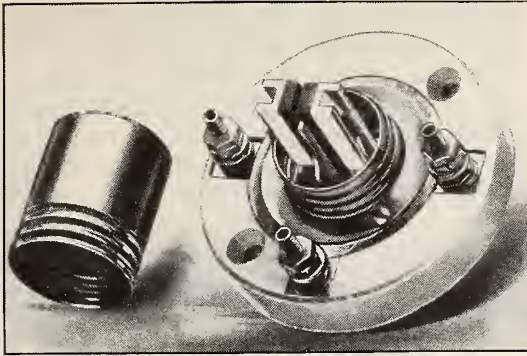

Fig. 4. Another type of protective device. The gap element may be replaced if necessary

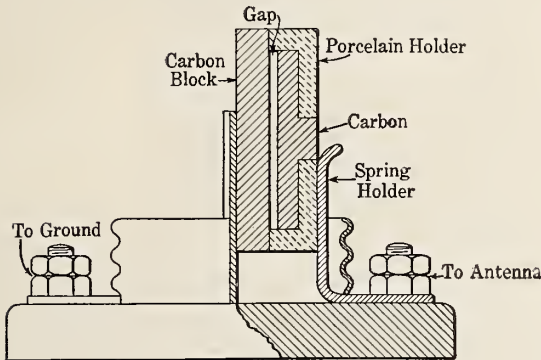

Fig. 5. The construction of the protective device shown above

ective gap if desired. This is shown in figure 8 on the next page.

The ground wire leading from the protector should be supported on porcelain knob insulators and may be connected to a water pipe or to a hot water or steam heating system that is electrically connected to ground. The pipe should first be carefully scraped or cleaned with sandpaper and an approved ground clamp placed around it. Installations in steel buildings may use the building frame as a ground.

If the installation is made in the suburbs where there is no city water supply, a piece of pipe seven or eight feet long may be driven into moist earth and the ground clamp attached to this.

ANTENNAS NEEDING NO PROTECTION

THE new regulations specify certain types of antennas which are exempt from any protection requirements whatsoever. Among these are the indoor antenna and the loop antenna.

For covering moderate distances a very

efficient antenna can frequently be erected wholly within the house. In individual houses, three or four wires supported on the rafters in the attic make a very desirable antenna, particularly in frame houses. In apartment houses good results can frequently be obtained by running one to four wires the length of the apartment just below the ceiling. If such a diminutive antenna produces sufficient signal

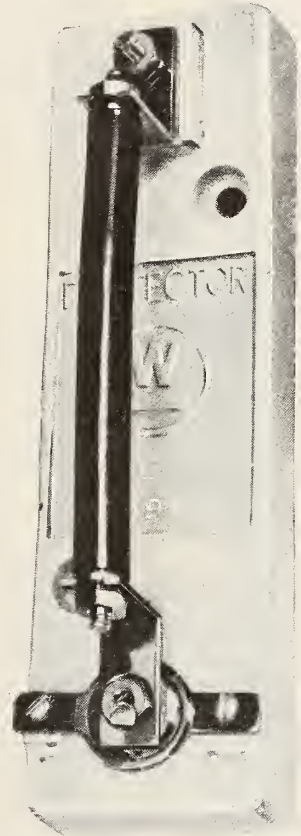

Fig. 6. A popular type of lightning arrester fitted with a fuse to protect the antenna in the event of its coming in contact with high voltage power lines

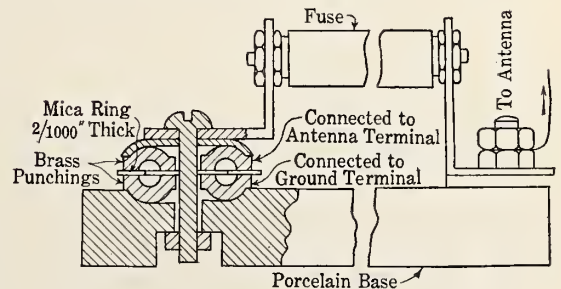

Fig. 7. The internal arrangement of the protector shown above

strength it has the advantage of reducing to a large degree undesirable noises such as static,

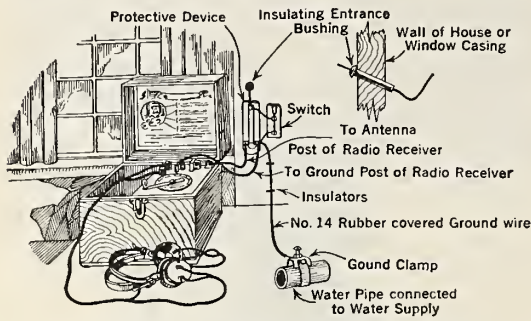

Fig. 8. The method for employing the lightning protective device installed within the building and connected to a suitable ground

and also cuts out a large amount of interference from spark telegraph stations.

The loop antenna is another type that requires no protection. The loop, however, does not collect as much energy as does the indoor antenna and so will not cover as great distances without the use of more sensitive receiving apparatus than that generally used. But the loop antenna has many desirable qualifications and gives promise of development in the future.

In general, the latest revision of the Fire Underwriters rules will make the advantages of broadcasting receivers available in many cases in which installations would have been impossible under the old regulations.

A Church With a Mighty Congregation

Pastor M. E. Dodd of the First Baptist Church, Shreveport, La., Who Installed a Radio Broadcasting Station so that His Aged Mother Four Hundred Miles Away Could Hear Him Preach, is Reaching Thousands of Radio Enthusiasts

By ARCHIE RICHARDSON

WHEN the first radio services were held one Sunday in May in the new half million dollar building of the First Baptist Church of Shreveport, Louisiana, but a small portion of the worshippers were found in the church auditorium.

The rest of the congregation were scattered throughout the United States, in portions of Mexico and upper South America, on the islands of the Gulf of Mexico and in ships at sea.

One of the country's most powerful radio broadcasting stations carried the pastor's voice through the hundreds of miles that lay between him and his hearers.

In hundreds of churches served by circuit riders, in hospital wards, in orphanages and old people's homes and in residences of those affiliated with this church, receiving sets are being installed to take advantage of the opportunities offered by the first powerful radio broadcasting station in this part of the country.

A 200 watt set, using a powerful motor

generator and operated by a licensed commercial operator, was used. The station sends out on a 360 meter wave length. The call number has not yet been assigned.

The station is located in the 10-story tower of the church. The antennas are suspended between the top of the tower and a 30 foot skeleton steel tower built on an office building across the street. They consist of four copper wires, 125 feet in length, 100 feet above the ground.

It was planned to broadcast the dedicatory services on Sunday, April 22, but part of the equipment failed to arrive in time to be installed before these services.

The normal radius of the station is 300 miles, but under favorable conditions it can be picked up from coast to coast, and is audible in portions of South America.

The broadcasting feature of the new church plans was arranged primarily in order that the aged and invalid mother of the pastor might hear the sermons of her son. At her home in Trenton, Tenn., nearly 400 miles away, a

receiving set has been installed in her bedroom, and daily it will bring to her the voice of her son.

Mrs. Lucy Williams Dodd, the mother of the pastor, Dr. M. E. Dodd, is nearly eighty years old, and for the last two years has grieved because she could not hear his sermons.

in late years has caused her to lose touch with many of the world's developments. But her son reminded her that when telephones first came into general use, she had said she would have none of them in her home.

She consented to a trial, and a radio set was installed in her home. Now she is an enthusias-



The pastor's mother, Mrs. Lucy Williams Dodd, eighty years old and an invalid, listening by radiophone at her home in Trenton, Tenn., to her son in Shreveport, La. The broadcasting station was installed in the church primarily so that she could hear her son's sermons

While Doctor Dodd was visiting her recently, she expressed the fear that she would never hear him preach again. That was the suggestion that led to the installation of the broadcasting station. He made her a promise that arrangements would be made so that she would hear every service he conducted as plainly as if she were sitting in a pew before him.

For a long time Mrs. Dodd was skeptical. The retired life her illness has forced her to lead

tic radio fan. Daily she listens to concerts and lectures sent out from broadcasting stations, and enthusiastically declares that the new-fangled ideas aren't so bad after all, especially for a woman of eighty who can scarcely leave her bed. And now the completion of the station in the Shreveport church has enabled her to listen to the voice of her own son.

Hundreds of churches that have no pastor or that are able to have a preacher only once or



First Baptist Church, Shreveport, La.

twice a month have installed or are planning to install receiving sets. Now that this church station has been completed, they will have services twice every Sunday and throughout the week as regularly as the city church. And they will have the same sermons and the same music that the people of the biggest Baptist church in the world enjoy.

It is stated that half of the Baptist churches of Louisiana are without pastors. The same is true of many other states. These churches are in small towns and in neighborhood settlements, in many cases off the railroads. Bad roads make many of them inaccessible through a large portion of the year.

That the church radio will be a boon to the isolated congregation is agreed by all religious workers. Many preachers declare that radio offers the church bigger opportunities than anything science has produced since the invention of the printing press. Some say that it ranks above the printing press in importance.

The rural church, long a neighborhood gathering place, will take on greater importance as a civic, educational and cultural centre, as a result of the installation of radio. People will gather at the church evenings throughout the week, as well as on Sunday, to hear the best

in music and lectures, to receive market reports, to get the day's news, and to hear the many other things offered by the country's broadcasting stations.

But radio will not take the place of the pastor of the small church, according to almost unanimous verdict of church leaders. They say the personal touch of the individual minister cannot be supplanted by the radio service. They regard it as supplementing his work, and offering him opportunities for bigger work, rather than substituting for him. Many a church has fallen apart through lack of a pastor, because there was no reason for the congregation to assemble. The radio is expected to remove this condition of affairs.

Aside from the religious services, many features will be broadcasted by the Shreveport church station. The auditorium, the largest in the city, has been offered as a civic and educational centre. The world's greatest singers and lecturers will be heard here, and their concerts and lectures will be available to all who have receiving sets. On the ninth floor of the church tower is a 13-bell chime, of which the largest bell weighs 3,000 pounds. Daily concerts are given by a trained chimer. A chime connection makes the broadcasting of

these concerts a simple matter. Recitals on the four-manual organ of the church, together with choir and congregational singing, will be features of the programme. A daily news service is being arranged for.

The pastor states that the performance of marriage ceremonies will be one of the tasks of his radio station. A marriage performed by radio is just as legal, and the ceremony can be as impressive as if the minister were present in person, he says. This, it is pointed out, will permit a couple to have their wedding solemnized by the minister of their choice who may be hundreds of miles away. The only thing in the way of a ceremony of this kind seen by Doctor Dodd is the tendency of the bridal couple to arrive late, but he thinks a way can be found to get around this.

The pastor expects to reach many of his flock who are addicted to Sunday morning automobile trips through his radio outfit. He will insist that when they go out Sunday morning they carry receiving sets in their cars.

There is only one fly in the ointment for the pastor. He is much concerned over the fact that a bed spring makes a splendid aerial. Much of his work, he says, is to get members of his flock out of bed in time for Sunday school or even the morning preaching service. When the people learn that they can listen to the services by attaching the receiving set to their bed springs, he fears there will be a growing tendency to lie abed Sunday mornings.

The matter of collections isn't worrying him, he says. While it is impossible to pass the collection plate around with his congregation scattered over forty-eight states, he says that just as effective means will be devised for financing the activities of the church.

The broadcasting station is but one of the unusual features found in this church, which is declared to be one of the most remarkable church plants in the world.

A 10-story tower, which furnishes quarters for a Sunday School of 3,000 and many young people's societies, has attracted much attention.

The upper portion of the 10-story tower of the First Baptist Church of Shreveport, La., is shown in the foreground; the dome over the main auditorium in the background, and the roof garden to the right of the tower



The four floors of the main building, together with the tower, have a total floor space of 51,500 square feet, and a combined seating capacity of 8,000 people.

The main auditorium will seat 3,000 people. It is equipped with a four-manual organ, and

toys, sand piles, and children's furniture, under the supervision of a nurse, cares for children of mothers attending services or working or shopping down town during the week.

The dining rooms furnish noon lunches daily to several hundred girls and women employed

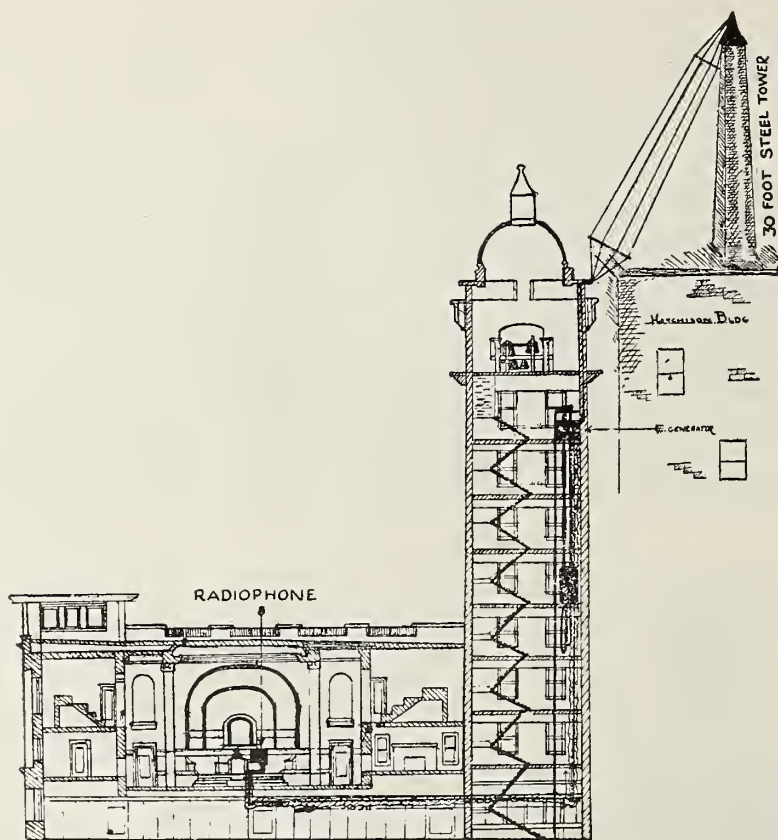

Drawing showing details of the radio installation

a chime connection. The transmitter of the broadcasting outfit is inconspicuously located in the pulpit, and connected with the generator by wires that run under the floor and up the elevator shaft.

Even the deaf will be provided for in this auditorium. An acousticon outfit has been installed with a transmitter in the pulpit, connecting by concealed wires with the pews. The roof garden provides accommodation for 1,000 people. During the summer, outdoor services, concerts, and socials will be held here. The nursery in the basement, fitted up with

downtown. Several banquets are served every week.

The banquet hall seats 500 people at two long tables.

A gymnasium is located in an upper room of the tower.

The congregation of this church numbers 2,200. Ten years ago its membership was 500. While the city has shown a growth of 43 per cent, the membership of the church has increased 400 per cent., while the contributions of the church to all causes has increased 3,000 per cent.

Random Observations on Running a Broadcasting Station

Success Demands a New Type of Impresario Who is a Sort of Combination Editor and Theatrical Manager

By H. M. TAYLOR

RUNNING a broadcasting station is a novel, not to say fascinating experience. There is no precedent to follow. There is no literature on the subject (that is, no literature in the usual sense; I do not refer to letters from the radio audience advising how the broadcasting station should be run). Each broadcaster, generally speaking, has to work out his own code of rules, use his own common sense, make his own formulæ, and profit by his own mistakes. Without doubt a broadcasting technique will soon be worked out. It is being done now—rapidly. But in the present state of the radio art, this technique is incomplete—embryonic.

There are two major problems to be encountered by those running a broadcasting station. One is the mechanical or technical side. The other, for want of a more descriptive characterization, may be termed the human side. Both are of the utmost importance. The public, which is the ultimate judge of the success of a broadcasting station, can never be satisfied if one side is defective. Good programmes count

for nothing if the technical mechanism does not put them out so that the average person can receive them clearly and fairly easily. And perfect reproduction and transmission of programmes avails little if the operator in charge does not possess a pleasing voice, speak

correctly, put on his numbers without long waits and possess a certain indescribable mental agility of his own. Then the artists who entertain play an important part, of course, in the success or failure of the broadcast. To find an operator who understands human nature so that he can be sympathetic and at the same time manage temperamental artists, successful business men and others who have attained prominence in world affairs, who can surmount the internal friction



Miss Eunice L. Randall telling a bedtime story in WGI, Medford Hillside, Mass.

ever present in all organizations, and who, in addition, thoroughly comprehends the scientific and mechanical operation of the broadcasting equipment, is difficult, to say the least. As the old farmer at the circus said, "There ain't no such animile."

Almost every large broadcasting station is operated by several men, with one man respons-

ible for its success. No one individual, at present at least, possesses all the qualifications necessary for running a broadcasting station. My own idea of the organization of a broadcasting department is to put a trained advertising man at its head and surround him with technical operators possessing as many of the so-called human virtues as possible. Tact, sincerity and unfailing good-nature are just as valuable as the possession of a first-class commercial license. A ready use of proper phonetics is as essential as a knowledge of atmospheric. The rise of radio broadcasting, besides opening up limitless commercial possibilities, and attendant problems, besides furnishing a new source of entertainment and inspiration to the general public, has produced a new type of impresario exemplified by him who runs the broadcasting station, and a new kind of vocation for a corps of assistants as well.

It is not my intention in this article to air my own personal views and activities in running a broadcasting station. I do not wish to pose as an expert, because I don't believe the expert has arrived. But I do believe the thousands and thousands of people "listening in" to radio programmes every night might be interested in the many difficulties, human as well as technical, which are encountered at the transmitting end. Moreover, an exchange of ideas among those struggling to put over programmes for the public interest, may help to improve those programmes for that same public.

I will never forget my first experience in putting out a high-class programme. It was in the early days of radio broadcasting. The main feature was a piano recital by a prominent concert artist. The possible audience was estimated at 25,000, an audience now tripled, and then some, for any large broadcasting station. I was to introduce the artist and had prepared a speech in carefully chosen words. Nonchalantly, I picked up the microphone to make the announcement on the evening which was quite an event for us in the annals of broadcasting. With perfect sangfroid I removed a cigar and started to open my mouth. All of a sudden, in such a rush, I saw before me 25,000 people, *strangers*—before me to whom a speech before a score of *friends* was enough to start the cold sweat and the knocking knees. Who was I to talk to such a vast assemblage!—such a throng as witnesses inaugurations, baseball games, and bull fights! For a moment I had radio stage fright in its

most acute form—but only for a moment. The attack passed as quickly as it had come. For I realized no one could see me, except the artist and my everyday associates.

To many, perhaps, this attack of radio stage fright may seem a bit incomprehensible. Yet, artists who entertain large concert audiences tell me they experience similar emotions, although very likely in much lesser degree. It is uncanny to sing one's best to a hundred thousand people—all unseen. Some artists unfamiliar with the extent that radio broadcasting has swept the country, frankly appear sceptical. Hardheaded business men often show by their expressions a certain doubt that their messages were actually heard by thousands. They have been *told* there is a large listening audience scattered over many states, but seeing is believing—except in radio. It is because of this uncertain feeling, this natural lack of complete faith on the part of the uninitiated, that broadcasting stations are continually asking those hearing their programmes to write in and let them know it. One of the most helpful ways in which an individual can assist the broadcasting station, now maintained at large expense to the operating company and giving programmes entirely free of charge, is to drop a card acknowledging receipt of the broadcast.

Constructive criticism from those hearing the broadcasting is of course always welcome to all stations. Even destructive criticism may be helpful. As for anonymous, destructive criticism, perhaps the least said the better. I suppose every broadcasting station occasionally receives anonymous communications, just as does every newspaper or magazine editor and man in public life. As long as there is darkness, there will no doubt be people who prefer to cloak their movements in deepest shadow.

The letters received in answer to requests for them, as well as unsolicited letters (of which there is a great number, showing that the spirit of the American public is right, as has always been maintained by those long in contact with it) run the gamut of personal opinion. Some would have all jazz music, others nothing but grand opera. Some like educational lectures and talks, others would have only music. Subdividing, some would have violin reproduction predominant, others would eliminate it entirely. (Any type of instrument may be substituted for "violin" in the above sentence.)

There are those who are "bored to death" with talks of interest to women, or market and stock reports, or code practice and instruction, or bedtime stories, or popular music or "highbrow" stuff. And then there are those who like these things, or some of them. Just as among a group of ten thousand newspaper readers there are comparatively few who read with equal interest the same page or article, so tastes vary in radio broadcasting programmes. The programmes are arranged to meet these divergent tastes as far as possible. Experience seems to indicate just now that musical features should predominate to a greater or lesser extent. The musical programme should be as varied as possible, giving the best, be it classical or popular in its nature.

I believe the tendency in the radio programme should be toward the classical, as people of taste and education, who can afford to own modern receiving apparatus, prefer this type of music. The balance of the programme may be filled with varied lectures, addresses by prominent men, readings, comedy sketches, and useful information. In all this, emphasis is put on variety. If broadcasting is to continue in popular esteem after the first novelty has worn off, then it is necessary, I believe, for the programme to be instructive and educational as well as interesting and entertaining. The man responsible for broadcasting programmes must have a rare sense of proportion, and be a fine judge of values. He must be a sort of combination editor and theatrical manager.

The first radio recital from WGI, Medford Hillside, Mass., was played by Miss Dai Buell. The concert was transmitted from an office temporarily made into a studio. The walls were hung with blankets and then covered with wrapping paper. The sound was caught by the large megaphone which at the time of the concert was at the extreme end of the sounding board of the piano. Although the broadcasting was rather crudely arranged, this music was heard in Ohio and Maryland, and other places between 500 and 1,000 miles



Almost as wide in variety as the suggestions about programmes are the requests regarding operating hours. A woman writes that her husband is a night watchman and does not wake up until 5 o'clock in the afternoon. He has a half hour to listen in at that time and two hours when he comes home in the morning between 8 and 10 o'clock. Couldn't we broadcast then? Dealers and merchants want broadcasting between 12 and one o'clock so that people can listen in on their noon hour, (a good idea). A young man wanted broadcasting after 11 p. m. because he didn't get home until that hour, as he attended night school three nights a week and worked evenings the rest of the time. The idea that still persists among some people concerning radio broadcasting is curious to say the least. The other night I was listening to one of our programmes in the reception room of the factory which is located a short distance from the broadcasting station. The night watchman came in wreathed in smiles and told me the following:

"A young lady just called me up," he said, "and said she would like to hear the radio. She said she did not hear anything. I asked her what kind of a set she was using and she replied—'I am just in a pay-station over in Boston. They told me to put a nickel in the slot and call you on the telephone and I would hear radio.'"

A woman who signed her name and address wrote in and said—"We enjoy your performance very much each evening and always have six or seven people listening. To keep husbands home at night 'Get a Radio,' says I. Be it said, friend husband even comes home in the middle of the afternoon now to hear your broadcasting."

Sometimes people make really alarming requests and are greatly incensed when we are unable to comply. A woman in New England wrote in recently that she wanted us to broadcast some dance music on Friday. "It must be next Friday," she said, "because I have got to be out both Wednesday and Thursday evenings." As my secretary says, "You'd almost think they were paying for it." Once

in awhile, after an unusually hectic day, I wonder if the radio public doesn't think companies who operate broadcasting stations are public philanthropists. A public servant is not a public philanthropist.

Another thing. There is a great difference in the report of a broadcast. A man in one town will say he "got the concert clearly and distinctly," while another man in the same town complains of a "hum," "a fuzzy rattle," or a noise "like unloading a tip-cart of bricks." Of course, reports regarding the concert itself vary with the taste of the individual.

I have been asked about the future of radio broadcasting. I am too busy with present details to have time to think much about its future. Then no one dares prophesy for fear of being reputed to-day a visionary and to-morrow exceedingly short-sighted. However, one thing, in my opinion, is certain besides "death and taxes," and that is some new method must be devised for financing radio broadcasting. Obviously, it is an enormous expense to the operating companies for which they are compensated by the sale of receiving equipment. But other companies can sell receiving equipment which will receive broadcasting programmes as well as those operating broadcasting stations. Far be it from me to mean by this statement that the sale of radio equipment should be limited to those at present operating broadcasting stations, but on the other hand the extra broadcasting expense, which benefits everyone in the business, cannot in fairness to all be borne by a few. Why can't there be a national broadcasting association, under government supervision, to the support of which every manufacturer of radio receiving equipment of a certain capitalization contributes? This is one suggestion. Another is that the government conduct and control broadcasting as it does the mails, or as cities do the water supply. These are merely suggestions and of course only a few of many possible ones. That radio broadcasting in some form will continue and improve and become more widespread is, to those close to this new, epochal industry, as certain as sunrise.



Radio Personalities

IV

REGINALD AUBREY FESSENDEN

By LUCILLE JOYCE

ALTHOUGH radio is but a side issue in the career of Reginald Aubrey Fessenden, inventor of the wireless telephone and radio compass, the smoke cloud for tanks, the electrically driven battleship, and the method of locating enemy guns by sound, and, as en-

six inches in outside diameter, giving a quarter horse power at 50,000 cycles and capable of being used as an amplifier with a ratio of 1-30 in current and 1-900 in energy of amplification; and a new type of radio telegraph receiver capable of recording each individual radio wave, thereby eliminating the troublesome static.

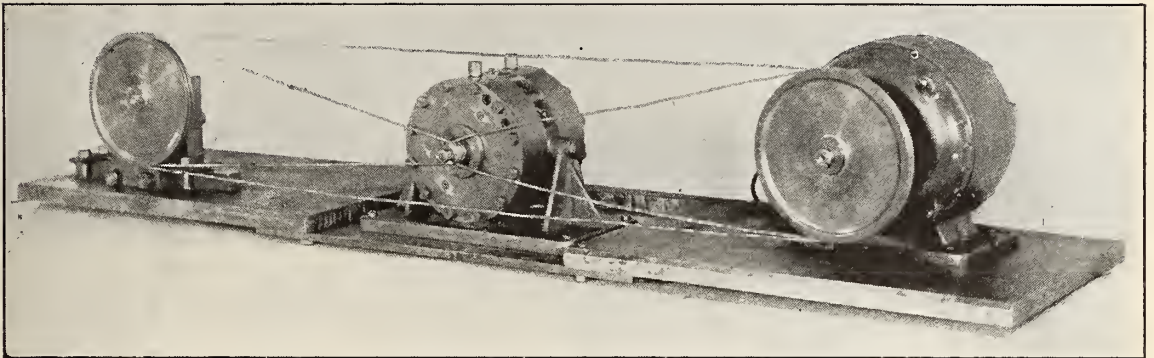

Professor Fessenden's radio frequency dynamo. The dynamo is in the centre and the machines each side of it are merely employed to drive it. Although it is but six inches in outside diameter, it is capable of delivering $\frac{1}{4}$ H. P. at 50,000 cycles. This machine is a forerunner of the present day high frequency alternators

gineering commissioner for the Ontario Power Commission, responsible for the mammoth power distribution from Niagara Falls, he has contributed to that science more perhaps than any other one man since the invention of wireless telegraphy.

Among his newest inventions which will soon be available to the average radio enthusiast, are a high frequency dynamo (Photograph D.), only

Photograph A shows such a receiver, and photograph B shows a record of dots made at a frequency of 50,000 cycles per second.

This photograph B is enlarged 2,000 times from the original record of the message, which is micro-photographed on a strip of photo film, moving 2 inches per second developed continuously, or on an 8 in. by 10 in. plate developed hourly. Each plate holds one hour's

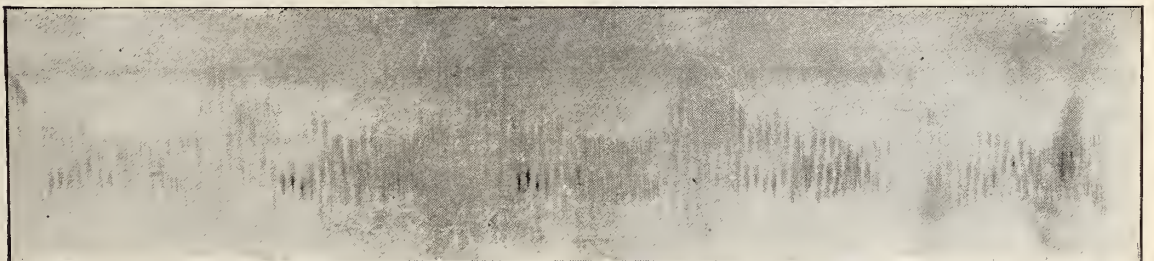

B. Record of dots made at a frequency of 50,000 cycles per second received by Professor Fessenden's new type of radio telegraph receiver

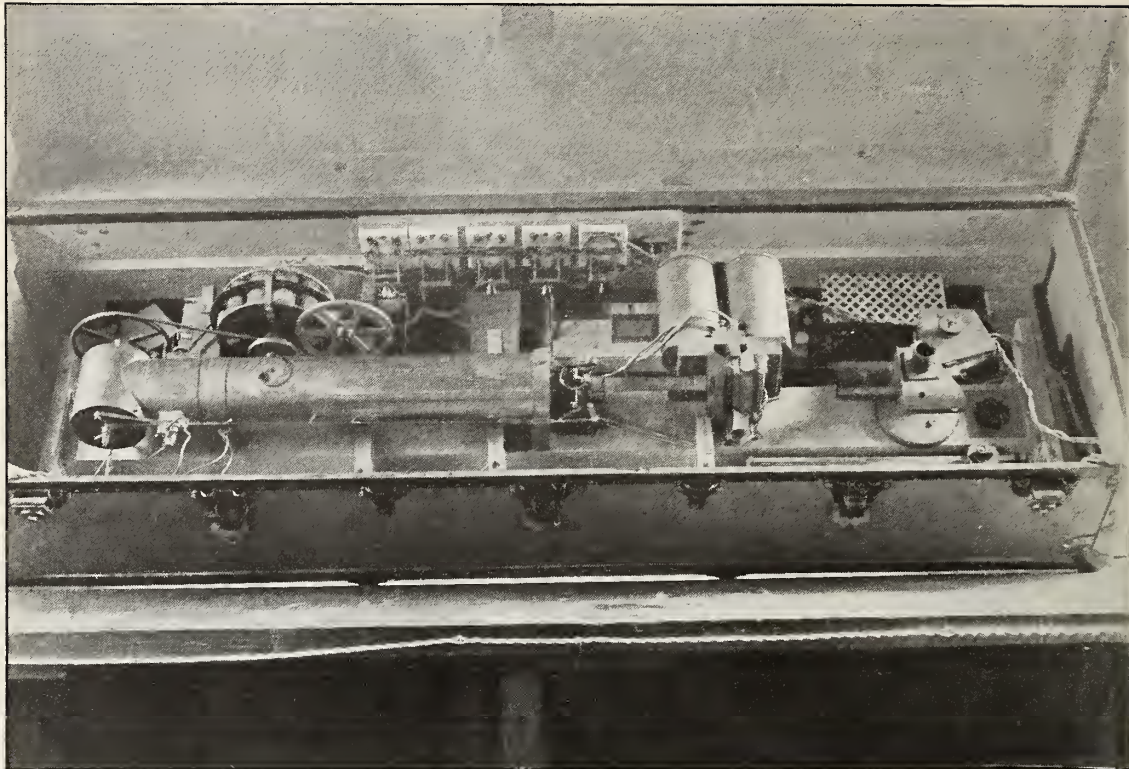

A. Professor Fessenden's new type of wireless receiver capable of recording each wireless wave, and used also in his radio camera

record of messages which may be transmitted at 500 words per minute or more. The film is used for periods of heavy static, and the plate for reference of the day's work. Two records are made simultaneously, one of the dots and dashes, and the other of the spaces, and with a highly damped aerial this gives reliable results.

A still more interesting development which Professor Fessenden already has in working order, and which will be demonstrated in the near future, is the transmission of moving pictures of scenes in distant cities. With the apparatus as he has developed it, it will be possible to point a radio camera, connected to a radio loop, at the steps of the Capitol in Washington, and by so doing enable every radio subscriber actually to see the President deliver his inaugural address and note every slight gesture he makes, as well as to hear his words by means of the radio telephone. Photograph A shows the receiving end of this radio camera.

The size of the picture, slightly limited at present, as it is received, is four feet by four feet on a screen twelve feet away, or four inches

by four inches on a screen twelve inches away. The coarse-graininess of the image at a distance of twelve inches corresponds to the 50 dot per inch process plate photo.

A method of overcoming cross talk, though of infinite importance in the transmission of speech, could not be published at the time of its discovery, because the publication, filed in 1915, was forbidden by the Government on account of the war, and was only recently released. The method consists of splitting speech up into a spectrum band and transmitting each element of the speech spectrum separately, then reassembling the elements at the receiving end. When it has been generally adopted, each subscriber will be given a number, with probably six figures, in the wireless telephone directory, and on turning the indicator to the six figures of the call of the person he wishes to talk to, and throwing the switch, he will find himself in direct communication with the person he called.

Not only is the brilliant professor interested in developing means of adequate communication between individuals, but his inventions



REGINALD AUBREY FESSENDEN

have been a remarkable boon to those who must trust their lives to the sea, especially the turbo-electric drive for battleships, and the iceberg detector. The oscillator shown in photograph C is now used on submarines for telegraphing under water, for detecting other submarines, and for telephoning between submarines submerged to a depth of 100 ft. at a distance apart of 10 miles, and for taking continuous soundings while steaming at full speed.

Professor Fessenden is at the present moment working not at some new radio improvement, but on a device by which one thousand pages of ordinary sized print can be reproduced in a space of a one inch square and read by means of projection on a 6" x 8" screen attached to the arm of a chair, the whole device is so small as to be carried about in an overcoat pocket. By photographing on and fusing into a kind of quartz by a method of his own invention, it is possible to preserve records in perpetuity upon a surface so minute as to be almost indiscernible to the naked eyes.

The man who is responsible for these remarkable inventions, as well as for a system of storing power at an annual cost of three cents per kilowatt hour in banks from which power can be withdrawn, and in which it may

be redeposited by the consumers at any time; and for the proposal in 1911 to make sun and wind provide all the power needed for mechanical use without dependence upon coal, is as remarkable in appearance and in personality as he is in intellect. He is a huge, bearded giant, well-built, genial, of stately bearing and impressive manners. In describing his discoveries he speaks without a great deal of enthusiasm, but with much precision and detail, in the manner of one describing the work of a third person. He rarely mentions himself in connection with his most remarkable inventions, but discusses them in the passive. Perhaps this reticence about himself and the fact that he is always willing to give credit to his assistants are reasons that he is not more widely known in this country.

In the combined study and laboratory of his beautiful home at Chestnut Hill, Brookline, overlooking the Reservoir, he spends many hours a day with his experiments, among his pieces of apparatus, his photographs, and his books. But he is not always working. He has two hobbies, golf and shooting. The wall in a corner of the big room is covered with

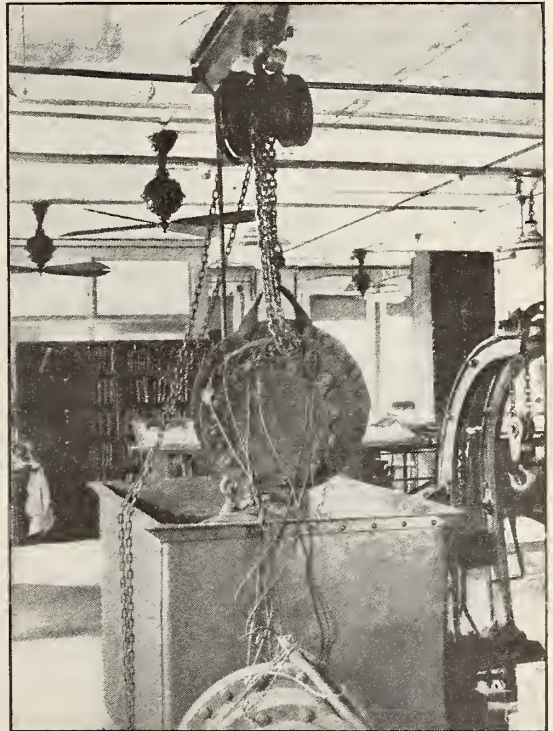

C. Oscillator used on submarines for telegraphing under water, and for telephoning between submarines submerged to a depth of 100 feet at a distance apart of 10 miles

action photographs of famous golfers, and near by stands a bag of golf clubs as though in readiness for a trip to the Country Club. Several guns which he delights to clean as well as shoot are a source of especial pride to him. In addition to out-of-door pursuits, he snatches moments of relaxation now and then, and often an upturned book shows that he has been interrupted in reading "Curiosities of Literature" by Disraeli, or other of his favorite authors.

Although born in Bolton, Canada, in the year 1866, and a volunteer with the First Canadian Contingent, and detailed to the War Office, London, by General Sam Hughes in 1914, he is proud to call himself a Yankee, and explains with pride that the first of his name to live in this country was John Fessenden, an original settler of Cambridge, Mass., whose tan yard was somewhere on the site of the present Harvard College Yard.

At the age of nineteen he was appointed inspecting engineer of the General Electric Company, and later was head chemist for Edison, to whose instructions he attributes whatever success he has had in inventing. He has been professor of physics and electrical engineering at Purdue University, later at Pittsburgh, special agent for the United States Weather Bureau, and consulting engineer for the Submarine Signal Company. Of recent years, however, he has felt it impossible to continue his more public work, and is devoting himself entirely to his inventions and experiments, all of which he realizes are of great practical value and of immense service to the world.

His seemingly superhuman accomplishments have been the result of a life-time of continuous and painstaking effort. As a child he was interested in mathematics. The banking profession, in which he was brought up, offered no incentive to his already inventive type of mind, and science, with its unceasing appeals to the imagination, excited him.

In 1892 he was giving a course in Hertzian waves at Purdue University, and from that time to the present has added one marvellous device after another to the development of wireless communication.

In endeavoring to transmit speech by wireless, he found it impossible with the old spark gap coherer system, because of the lack of two essential requirements, that the waves should be generated continuously and that the receiver should be capable of utilizing them

continuously. In 1899 he started four lines of work for producing continuous waves, first by commutating a continuous current, second by a continuous arc, third by a high frequency dynamo, and fourth by an unstable current. He succeeded in 1900 in first transmitting articulate speech by wireless over a distance of one mile at Cobb Point, Maryland, using a 10,000 cycle per second commutator. Though understandable, the articulation was not perfectly clear. With the development of the continuous arc generation method, he was able in 1902 to reach approximately 12 miles by using an arc frequency of 50,000 cycles per second, producing much clearer articulation. In 1903 in Washington he demonstrated before a number of prominent engineers an apparatus capable of working 25 miles, which was put on the market and tendered to the United States Navy in 1905.

In the mean time he had proceeded with the development of the high frequency alternator and finally constructed three dynamos at the Brant Rock, Mass., station, two of them operating at 50,000 cycles, by using the fields of a previous dynamo failure, and a third operating at 100,000 cycles.

For a continuous receiver, in place of the old coherer which had to be tapped back every time a signal was received, he invented a number of devices, the first of which was the ring receiver mounted on a sensitive microphonic contact, followed by the hot-wire barretter and the liquid barretter. About this time he devised an interesting type of receiver in which a small hot-wire barretter mounted on a small rubber holder fitted inside the ear, invisible wires ran to the hat-band and down the side of the body, permitting wireless telephone messages to be received by a person walking about in the fields several miles from a station.

After building various types of amplifiers, he was able to maintain regular wireless telephone communication between Brant Rock and Jamaica, L. I., with articulation clearer than over the wire telephone lines between the same places, using an apparatus in 1907 which permitted simultaneous talking and listening. In 1906 he had been able to demonstrate to a number of leading scientists the transmission of speech by wireless between Plymouth and Brant Rock, and the relaying of conversation over the regular wire lines.

As the result of tests made by the Bell Telephone Company, contracts were drawn up by

Mr. Fish in 1908 calling for the installation of wireless communication links between Martha's Vineyard and Boston, and for the construction of wireless long distance lines between Boston, New York, Buffalo, and Washington. The contracts were not carried out because the banking interests supplying money for the Bell Telephone Co. decided that the company was expanding too rapidly and revised their policy, in consequence of which wireless telephony for commercial use was delayed for about a dozen years.

Professor Fessenden describes the first transmission of articulate speech across the Atlantic,

which was accidentally accomplished in Nov. 1906. Operators telephoning between Brant Rock and Plymouth were overheard on several occasions by his operators at Machrihanish, Scotland, who identified the voices of the men speaking and sent back several reports giving the exact words of the conversations, which were subsequently verified by the log books of the station.

Since that time the inventor of the wireless telephone has been constantly improving upon it, developing and simplifying it so that it may be adopted for more general use.

New Radio Net for Rogues

William J. Burns Tells Some of the Plans of the Recently Established Bureau of Investigation of the Department of Justice. Radio to Play a Large Part

By DONALD WILHELM

TO BE recorded upon the all-pervading ether as a criminal, that," says William J. Burns, detective extraordinary and head of the Department of Justice Bureau of Investigation, "will be as good as landing behind the bars."

The old-style rogues' gallery is now out of date; we are, Mr. Burns says, on the threshold of a system incomparably more thorough, incomparably swifter, incomparably more discouraging to crime and criminals.

"The Department of Justice Bureau of Investigation," he told me, "is soon to begin using radio."

Radio, he explained, is to be used not only for the detection of criminals but for the prevention of crime. "We are trying to prevent crime," Mr. Burns said. "That will be our greater work."

He added: "We are trying to make this institution function in the interests of the people—for the first time."

He described how the Bureau of Investigation had been, in the main, a kind of service bureau for the Government, whereas now, in ways not heretofore revealed, its new aim is to serve the entire American public in its unprecedented battle against lawlessness—lawlessness, he points out, that is aided and abetted by new and swifter means of transportation, especially the automobile.

His Bureau is now setting up a kind of national and international switchboard. It is to be called a bureau of identification. Its handmaid will be radio. It will use radio, Mr. Burns says, to broadcast even fingerprints!

"We will have registered in the Bureau of Identification," he explained, "the fingerprints of any and every criminal, and of any other person who cares to put himself on record. We will have their photos and descriptions. We will be in touch with every police agency in the United States."

Many police departments are establishing the use of radio—they asked for, and were granted by the Radio Conference, the use of a separate band of waves, for their particular use, for city and state public safety broadcasting. Chicago has found radio useful in detecting stolen automobiles and automobile thieves. Philadelphia is coming into line. Berkeley, California, whose Police Chief, Vollmer, is matching science against crime, has every policeman provided with an automobile and virtually every auto equipped with radio. And other city police departments are equipping not only their motor boats, cycles and automobiles, and even in some instances their patrolmen, with radio but are using it to link up fire department apparatus. The writer's view is that this is only the very beginning; war against common

enemies of society will not stop with this. With apartment houses equipping their suites with radio extensions from a central receiving set; with thousands of city dwellers hitching themselves to radio waves; with virtually every farmhouse equipped with radio to meet the farmer's business needs as well as furnish him diversion; with the American radio chain reaching round the world, and the Signal Corps, Post Office, and other nets being developed to cover every inch of American soil, the future of crooks looks discouraging!

Still more intensive-ly, I believe, radio will be employed for police purposes. At sea we know that when the SOS jams the air, every neighboring ship stands by. On land when a similar SOS jams the air, in any emergency, every neighboring individual will stand by. At sea we have compass stations, a wonderful chain of them, brought into existence to combat submarines. Also we have radio beacons continuously emitting their warnings by radio. And on shore there is no reason why we should not have

Extract of a letter sent by William J. Burns, Director, Bureau of Investigation, Department of Justice, to all chiefs of police.

One of the first observations which Mr. Daugherty made, after assuming the duties of Attorney General, was to appreciate the need of establishing a Bureau of Investigation that would function promptly and effectively and at the same time have the confidence and coöperation of the forces of law and order in each town, city, and state. It is the desire of the Attorney General and myself to bring about this coöperation by a closer relationship between the local police forces of the country and the Bureau of Investigation of this department. In line with this desire, the Attorney General and myself have had several conferences with the representative of the International Association of Chiefs of Police, through the medium of the National Bureau of Criminal Identification, and have obtained suggestions for the effective inaugurating and carrying out of the plans for coöperation. These conferences have been most productive and have led now to the crystallizing of the plan for the establishment of a Central Bureau of Identification in the Department of Justice in which will be placed the fingerprints, photographs, and all detailed information available concerning criminals in this country. This it is hoped will not only be of material aid to the federal government but will be of invaluable assistance to the law-enforcing department of the cities and states.

radio beacons at every cross-roads. Even now these could be provided: If then a murderer—a John Wilkes Booth, let us say—were at large in Ohio or Maryland, say, that man could be caught by radio. His description could be put upon the all-pervading ether without his knowledge. Every apartment, every farmhouse, every gathering point of human beings, and mounted constabulary as well (the Canadian Mounted Police are now experimenting with radio) would have his description. Even now, with our present broadcasting system, any fugitive could be broadcasted pretty thoroughly. If, in addition, by the use of multiplex telephony, for instance, as General George O. Squier suggests, along every highway there were

alarm boxes, radio would indeed be the handmaid of the police and of all communities.

We have seen so many cases of fugitives overtaken by wireless on the sea—the first was that of Dr. Crippen, who was caught by wireless en route to Canada under an assumed name, arrested on landing, returned to



Motorcycle for police, equipped with the Thompson submachine gun and a radio outfit. This is the most modern of all police equipment and is rapidly being adopted by cities all over the country

England and hung—that we accept such events as a matter of course.

Again, it was only the other day that a banker in Dallas, Texas, who wasn't up on radio, walked out of the back door of his bank, a defaulter. He was reported by radio by the Dallas police to Post Field of the Army Air Service. At Lawton, Oklahoma, an amateur

caught the word. This amateur spotted his man, reported him. Before the end of the day the defaulter was lodged in the Lawton jail.

Mr. Burns, himself, told me of a case even more sensational.

Into the Westinghouse plant at Pittsburg came a young, well-dressed individual. He represented himself as a committee of one sent by a community organization to borrow a receiving set. He was loaned one of the very best and did not return it. The situation was reported to the local Burns detective agency. After an investigation this young man was broadcasted:

Twenty-four years of age or so, about five feet eight inches tall, blue eyes, a scar on his left cheek, etc. That evening, it so happened, this fugitive was entertaining his mother and some of his friends with his new receiving set. They were sitting by when out of the ether came a flash of the whole situation. The next morning his mother saved her son from arrest by appearing at the Westinghouse offices with saved-up earnings with which to buy the receiving set.

"Radio," Mr. Burns went on, "will be infinitely useful in crime work. Using it, we can add greatly to the strength of a central agency like ours. Criminals can be reported in the various ways heretofore used and also by radio. We can broadcast them. We can use radio to detect mere thieves"—the cry "Stop Thief!" must now have a far wider meaning—"for

notifying people to look out for forgers, so that merchants can be on their guard, and against other kinds of public enemies. We are going to be able to broadcast descriptions of fingerprints with sufficient accuracy to warrant the detention of any suspect until his identity is finally established."

It will be remembered that, abroad, the Belinograph—a Frenchman's invention by means of which photographs, signatures, and the like have been transmitted across the Atlantic—has been developed to transmit finger prints exactly. Mr. Burns' plan does not look



© Harris & Ewing
William J. Burns, Director of the Bureau of Investigation, Department of Justice

to using the Belinograph. Instead he is devising a new code that can be used more handily and will yet serve the main purpose. With the coöperation of such organizations as the International Society for Personal Identification, he is devising a code that classifies the varying whorls, arches, ridges, and loops in such ways that anyone familiar with the peculiar markings of each individual can tell at a glance whether a suspect belongs within a certain category.

How Radio Came to Independence Kansas

By THOMAS M. GALEY

This is a typical story of how the rage for radio is spreading, community by community, throughout the United States.—THE EDITORS.

MAR WIBLE brought it. At least it was Omar who opened the gates to it when, on the fifth of last December, he heard over his wireless telephone, the services at the Calvary Church in Pittsburgh, Pa., and the local newspaper printed an account of his experience. The curiosity of the public was instantly aroused, and many local telephone inquiries kept Omar Wible busy vindicating the veracity of the local press.

For about a dozen years before that, to be sure, Hubert Devore had been reading the big spark stations, and one evening about a year ago he was startled by the sound of a human voice in his receivers. It was the operator at the station on Catalina Island in California whom he heard talking, but that startling experience didn't get into the newspapers. So it was Omar Wible's hearing of the church services which gave the craze its first impetus.

Independence is a prosperous town in southeastern Kansas. Its twelve thousand inhabitants are of average intelligence and education, but only half a dozen boys who owned little home-made sparkers had ever heard, until then, that telephoning without wires was a practical reality. But soon, the word "broadcast" began to be heard, and then the fact became public property that the East was already started on a rampage of radio. Kansas is generally about two months behind the East in experiencing a business boom or depression. This seems to be equally the case with radio, but by the middle of last February it appeared that everyone wanted to "listen in," and by the end of that month the mysterious functions of a variometer or a grid-leak were becoming rather ordinary talk about town, especially where there was a small boy in the family.

Omar Wible had played with electrical apparatus ever since he had attended school in Chanute, Kansas, a dozen years ago. He had

constructed with his own hands, the receiving set with which he heard Pittsburgh, using jelly glasses, "Quaker Oats" cylinders, some wire, and an electric light bulb; at least, that is how the installation looked to a young business man who promptly called to see what sort of an apparatus could enable a man to hear church services 863 miles away.

Omar Wible, whose chief trouble at that time was that he had to make a living beating the drum in a moving picture show every evening during the very time when broadcasting fairly fills the air, went on and built himself a transmitter, using a generator from a junked automobile, so that the whole apparatus cost only about forty dollars. Then he broadcasted a concert by the Girls' Glee Club of Emporia College. Some of the members of the club slipped away to homes where friends, gathered around receiving sets, were eagerly awaiting the concert. The songs were pretty much garbled and the college cheer sounded like a dog fight, but everybody was delighted.

Omar Wible's aerial was tied to the top of a twenty-foot post, and stretched its crooked length from the front curb to the alley. Independence has seen many aerials since, but it hasn't been able to get rid of that feeling of the supernatural, the impossible, which Omar's aerial caused in those who gazed upon it. Even the detector tube, which, after all, only translates the faint impulses caught by the aerial cannot exceed the wonder of it.

About a dozen individuals promptly planned to put in transmitting sets, so they could keep in touch with relatives in Los Angeles or Cape Cod, but that wave of enthusiasm diminished as local knowledge progressed. It finally simmered down to the establishment of a real radio store and a rather costly 1 KW transmitter. To be sure, there is not much genius to transmit, but all the same it is planned to carry church services to every farmhouse within a reasonable radius and occasionally Schumann-



Omar Wible, who heard on his home-made receiving set the services at Calvary Church in Pittsburgh, Pa., 863 miles away, and thus started the craze

Heink or Al. G. Fields may provide the touch of genius. It is thought the local ministers must brace up to compete with the beautiful services from Pittsburgh and Detroit.

By the last of January it was possible to get KDKA in Pittsburgh and Fitzsimmons Hospital in Denver every night, at least when Bob Flint was not sending crashes of energy to Chester Pendarvis at Elk City eighteen miles distant.

A month later, "listeners-in" heard a new call and a voice announcing the *Detroit News*

Station. The service from this station came regularly with startling perfection. There were now three big stations which could be depended upon. Then Dallas came in, and, night after night, new ones appeared; notably Schenectady, Indianapolis, and Atlanta. So many attempted to use the narrow band, about 360 meters, that KDKA was crowded out.

For weather, market reports, and good music, the big cities are depended upon. Several fans even sent contributions to the *Detroit News* to help finance the Symphony Orchestra concerts so marvelously broadcasted.

The dramatic effect of the radiophone is far more profound in the rural districts of the West than in New York City, and the time will arrive with startling speed when every farmhouse will have a set.

Already one hears grumbling in the Eastern cities about the character of the programmes of certain of the big stations, so exacting and critical is the public mind in a big, conventional city. But our Western listeners are less critical of the programmes from the East, and the anticipation of marvelous broadcasting developments next winter is creating a rapidly growing interest. A sound that becomes each day more familiar in the Central West is: "Say, where can I get some bulbs?"

The sewing machine peddler who "sells" the farming districts in his little "whoopie" will be crowded off the road by the radio

peddler with most any sort of a set from a dollar up. It is on the farm where the best receiving success will prevail, being far from high tension lines, dirty street car commutators and power houses. It is to the lonely farms of the Central West that the radiophone will bring a new interest, an interest which



Home of Omar Wible whence he broadcasted the first concert and first sermon in Southeastern Kansas on a transmitting set that cost him only forty dollars

may hold the ambitious farm boys, and the farm girls as well, from flocking to the city.

How to Begin to Enjoy Radio

By CAPTAIN LEON H. RICHMOND, SIGNAL CORPS, U. S. A.

Editor, Technical Training Literature, Office Chief Signal Officer

Captain Richmond, who was Professor of Physics at Western Maryland College before the war, was commissioned in the Signal Corps at the outbreak of the war. After passing through various instruction camps, he was assigned to the Royal Navy (British) Flying Field at Cranwall, England, where he worked with Lt. Commander J. M. Robinson (British Navy) in developing a radio direction finder and other radio apparatus for airplanes. Upon the completion of this duty, and after a short time at an American flying field, he was assigned to duty at the Army Signal School, Langres, France, where he was in charge of the Radio Department at the signing of the Armistice. For the last year and a half, Captain Richmond has been on duty in the Office of the Chief Signal Officer at Washington.—THE EDITOR.

II

WHENEVER it is desired to receive a certain transmitting station, the radio receiving set must be *tuned* to that station. This is done by turning the knob or knobs on the receiving set. It is the purpose of this article to tell just what is done when these knobs are turned, i. e. why turning the knobs tunes the set.

OSCILLATING CURRENTS

A RADIO wave is produced by an electric current which moves first in one direction along a wire, then moves in the opposite direction. Such a current is called an *alternating* current, the word alternating describing the change in direction of the current. When the alternations of current (changes of direction) take place thousands of times per second, the term *oscillating* current is used to describe it. Radio waves used in present day radio communication are produced by electric currents which oscillate with a frequency of between 10,000 and 6,000,000 times per second. This oscillating current sets up radio waves of the same frequency. (See first article of this series for relation between frequency and wavelength.) The radio wave, coming to your receiving set, sets up in it oscillating currents, IF THE RECEIVING SET IS TUNED to that frequency (wavelength).

CONDITIONS FOR OSCILLATIONS (FREE)

A BETTER understanding of tuning can be had if we compare it with something with which we are all familiar. Let us first consider what happens when a weight is put

on a spring balance. If set in motion, the weight will move up and down, that is, it moves alternately in one direction and then in the other, without any outside aid. A little thought about it will show that there are two factors which cause this up and down motion. The weight is one factor, the spring is the other. When started in downward motion, the weight keeps moving beyond the position where the two will finally come to rest, but as soon as it gets beyond the point of rest, the spring begins pulling back. The further the motion from the point of rest, the more the spring pulls until finally the weight stops moving down and starts moving up, being pulled back by the spring.

We can get the same effect in another way. It would be well to do this experiment to fix the idea firmly in your mind. Take the blade of a hack saw or some similar object and fasten it in a vice allowing some of it to project. By some means fasten a weight to the projecting end. Pull the end to one side and let it go. It will vibrate back and forth. Again the weight keeps it moving beyond the point of rest and the springiness of the hack saw blade pulls it back toward the point of rest. Try this experiment with a hack saw blade, a kitchen steel knife, or a spatula.

The condition under which any system will oscillate is clearly set forth in the above experiment. To state it again, it is that there must be present something which will keep the system moving beyond the point of rest, and there must also be present something that will pull the system back toward the point of rest, the pull becoming stronger the farther the displacement from the point of rest. When

these two factors are present in a system, it is seen from the experiment that the system, when once set in motion, will vibrate or oscillate of its own accord.

It is evident then that if we wish an electric current to flow of its own accord to and fro (oscillate) in a circuit, there must be introduced into the circuit, each of these two factors. One of these factors is called *inductance*; the other factor is called *capacity* (sometimes called capacitance). The fundamental idea that I desire you to get now about inductance is this: When inductance is present in a circuit it tends to prevent any *change* in an electric current. Thus when a current tries to die away the inductance of a circuit will try to prevent it from dying away. Inductance acts like a weight in this respect. The fundamental idea I desire you to get about capacity is this: When capacity is present in a circuit it will store up electricity, but as soon as it begins to store some it tries to get rid of it. The more electricity that it stores, the harder it tries to get rid of it. Thus it is seen that capacity of a circuit corresponds to the springiness of the hack saw blade.

Let us represent, as in Fig. 1, a circuit having inductance and capacity and study it. Capacities A and B are equal to each other.

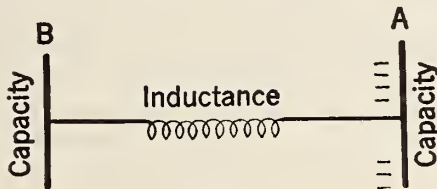

Fig. 1

By some means let us put a charge upon the capacity represented by A in the figure. This charge is shown by the minus signs, which represent the small particles of electricity called *electrons*. As has been noted, the capacity TRIES TO GET RID of its charge and is able to do so, as there is a circuit leading to the other capacity. The electrons pass along the wire to the capacity B thus making a current through the inductance. If it were not for the inductance, when the capacity B had received half of the electrons that were on capacity A, the electrons would stop moving, for capacities A and B would each be trying to get rid of their electrons with equal force. But the electrons are moving from A to B and hence there is a current flowing. The inductance now comes into play and PREVENTS THE CUR-

RENT FROM DYING AWAY, hence causing all the electrons on A to move over to B. The conditions are exactly the same as they were at first and exactly the same events take place with the exception that it is now capacity B which is charged and which gets rid of its electrons. This to and fro movement will continue until the energy dies away by wasteage. The to and fro movement of the electrons is an oscillating current.

Thus it happens that if a circuit contains inductance and capacity, an electric current will oscillate in the circuit when energy has been supplied. This is the exact counterpart of a mechanical system represented by the hack saw blade and weight which has elasticity (springiness) and mass (weight). The reader should compare step by step the action that takes place in the mechanical and the electrical systems. He will find that the action of one is similar to that of the other.

NATURAL FREQUENCY AND RESONANCE

NOW let us go back to the hack saw blade and weight experiment and notice another fact about it. Start it vibrating and notice the number of vibrations per second. Change the amount of weight on it and cause it to vibrate again. The number of vibrations per second is different from what it was. Change the stiffness of the blade (make it longer or shorter). Again the number of vibrations per second have been changed. What we have learned is this: that this mechanical system has a NATURAL FREQUENCY OF VIBRATION which may be changed by changing either the stiffness of the blade or the weight attached or both.

Electrical oscillations are exactly the same. In Fig. 1 the number of to and fro motions of the electrons (oscillations) depends upon the value of the inductance and capacity in the circuit. Changing either one or both of these will change the number of oscillations per second. This may be summed up by saying that an ELECTRICAL CIRCUIT CONTAINING AN INDUCTANCE AND CAPACITY HAS A NATURAL PERIOD OF OSCILLATION, DEPENDING ON THE VALUES OF THE INDUCTANCE AND CAPACITY. Every receiving set has inductance and capacity. What you do when you turn the knobs on the receiving set is to change either the amount of inductance or capacity in the circuit. (On some sets there are also knobs used to control the current supplied the vacuum tube or tubes.)

Thus the circuit can be adjusted so that its natural frequency is any value desired (within the limits of the set.)

TUNING then means that you adjust the natural frequency of your receiving circuit so that it is equal to the frequency of the radio waves you desire to receive.

Why must this be done? Because the amount of energy in the received radio wave is so small that, if the receiving circuits were not tuned, there would be no effect produced by the waves. It is a case of *resonance*. We are all familiar with resonance effects though we may not call them by that name. When you swung your playmate you used the principle of resonance. You timed your pushes so that they would come just at the right instant. By doing this you were able to make the swing go very high, using only slight pushes. The swing had a natural period of oscillation; by timing your pushes (tuning them, so to speak) you got a large effect from a small amount of energy.

Examples of resonance are numerous. The fool who rocked the boat knew about resonance. He timed the swaying of his body to the natural frequency of oscillation of the boat, thus overturning it. He secured a large effect from a small amount of energy. Have you noticed, very often when a piano is being played that, as a certain note is struck, the glass in a picture frame or some other object will rattle. This is because the object has a natural period of vibration equal to that of the note. The two are "in tune" and thus the small amount of energy in the sound wave produces a large effect.

Thus, then, when any system which has a natural period of oscillation or vibration of its own is acted upon by a very feeble force that has the same frequency, the effect produced by the feeble force is large. The radio wave from a distant station has only a feeble energy when it reaches your station. It has a certain definite frequency. If you desire that your receiving set be affected by the feeble energy in the radio wave, you must adjust your circuit or circuits so that their natural frequency is equal to that of the radio wave. The receiving circuit and the radio wave are then in resonance, hence the latter produces a comparatively large amount of energy in the receiver. This process of adjusting the natural frequency of the receiving set to equal that of the desired radio wave is called tuning.

Now we are ready to get a better understanding as to why we can have more than one radio message in the ether at the same time without interference. Suppose one station is transmitting on a wavelength of 300 meters and another on a wavelength of 600 meters. Their frequencies are then 1,000,000 and 500,000. Now if you adjust the natural frequency of your circuit to be 500,000, it will be in resonance with the 600 meter wave and out of resonance with the 300 meter wave. The 600 meter wave will affect your receiving apparatus; the 300 meter wave will not unless the latter is very close by. You are tuned to 600 meters. You did it by adjusting the values of the capacity or inductance in your receiving set.

From the above explanation it might be thought that your receiving set will respond to one frequency (wavelength) only. Unfortunately this is not the case. There is a *band of wavelengths* to which your receiving set will respond. The width of this band depends upon the receiving set. It may be that if you tune to 600 meters your set will respond almost equally well to any radio wave whose length is between 510 and 690 meters. This is a variation of 15 per cent. on either side of the 600 meters. This is not very *selective* tuning. It is to be noted that any station transmitting on a wavelength between 510 and 690 meters would cause interference if the waves had nearly the same amount of energy as the waves you were trying to receive. Some receiving sets are capable of better selection—sharper tuning. A set that will respond to wavelengths between 570 and 630 meters (5 per cent) when tuned to 600 meters is a fairly sharply tuned set. Such a set diminishes the possibility of interference.

This then is a limitation on the number of ether waves that can be utilized without interference. Another limitation lies in the fact that a transmitting station radiates an *impure* wave. That is, instead of radiating its energy at one wavelength, it radiates a band of wavelengths on either side of its main wavelength. Thus we have the transmitting station radiating a band of wavelengths and a receiving station responding to a band of wavelengths. This limitation upon a limitation greatly reduces the number of messages that can be in the ether without producing interference at the receiving station. Rapid progress is now being made in the reduction of the width of both

of these bands, thus increasing the number of wavelengths available for simultaneous communication.

In the receiving set the band can be greatly narrowed by the use of two selective circuits and this is a common arrangement. The first circuit selects a band of frequencies (wavelengths) from all the radio waves present in the ether. The second circuit selects a very narrow band of frequencies from those present in the first selective circuit. This double selection is very effective as the effect is cumulative.

A TYPICAL RECEIVING CIRCUIT

A TYPICAL receiving circuit is shown in Fig. 2. All the symbols used are those customarily employed. The reader should fix them firmly in mind, for they are not usually labeled in diagrams. Wherever an arrow appears it signifies that the quantity represented by the symbol through which it passes or to which it points is variable. Thus a coil represents an inductance; the arrow, A, pointing to the coil means that it is variable. Two straight lines of equal length near and parallel to each other represent a condenser, which is the name of the instrument that furnishes a capacity. An arrow through the lines means that the capacity is variable. The long arrow through the two inductances, one in either circuit, means that the strength with which the

contains an inductance and a capacity. It is only a tuner that is shown; the detector and phones not being included in the diagram. Note that there are five variable quantities represented in this tuner; that means that there are five knobs or handles to adjust. Your tuner may not be like this one, it may have fewer variables, but it will certainly have some of the features of this typical tuner. For instance, your tuner may have only one selective circuit and it may have only one variable quantity in this circuit. Again your tuner may have two selective circuits with only one variable in each and no means of adjusting the effect of the one circuit or the other. Other combinations are possible also.

INDUCTANCE AND CAPACITY

LET us conclude this article by describing how an inductance and capacity are made and how they are made variable. We will first consider capacity.

Capacity may be likened to a tire. Compare a bicycle tire and an automobile tire. Suppose we take 4 cubic feet of the air in a room and pump it into an automobile tire and also pump another 4 cubic feet into a bicycle tire. The same amount of air has been put into each tire but the results are different. The pressure in the bicycle tire is, say, 100 pounds per square inch. This means that the air inside the tire is trying to escape with a force of 100 pounds. It also means that, in order to blow up the tire, a force just greater than 100 pounds per square inch must be applied. But the same amount of air in the automobile tire causes a pressure of only, say, 20 pounds per square inch. The air inside is trying to escape with a force of only 20 pounds, and it required a force of only a little more than 20 pounds to put it in the tire. So in electrical capacity, the amount of capacity determines the force (electromotive) with which a certain quantity of electricity will try to escape and also the force needed to put that amount of electricity into the capacity. Using the same amount of electricity, the larger capacity requires less force to be charged and exerts less force trying to discharge itself.

In Fig. 3-A there are shown two conducting plates placed close together but separated by a nonconductor.

The plates may be of any metal and for the sake of compactness they are usually a number of small plates all joined together as shown in

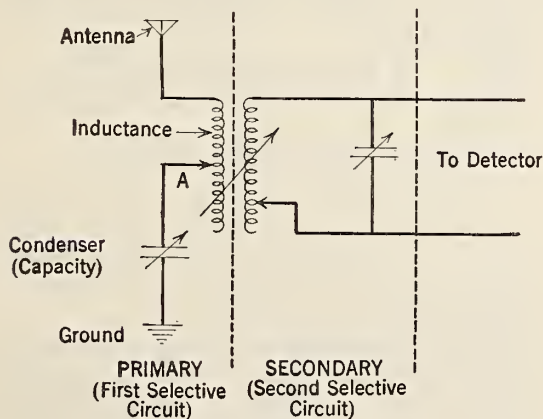

Fig. 2

primary circuit affects the *secondary circuit* may be varied at will. The method of doing this will be explained in a later article.

The dashed lines are not a part of the circuit but simply indicate its division into two selective circuits, each of which, you must notice

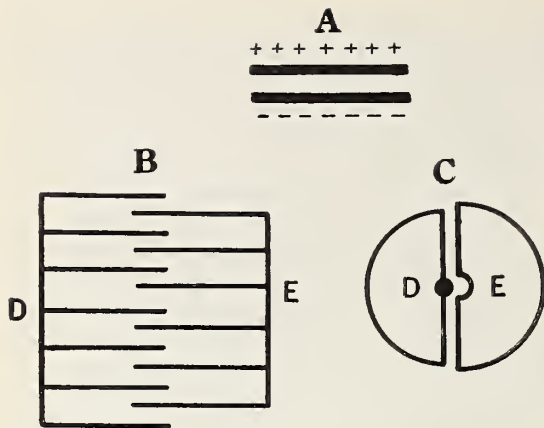

Fig. 3

Fig. 3-B. This is equivalent to one large plate. The material between the plates may be any nonconductor, but the most common materials used are oil, air, mica and paraffined paper. The whole apparatus is called a condenser. Fig. 3-B shows how a condenser may be made variable. The figure shows only a small portion of one set of plates opposite to the other set. This gives a small capacity. If the plates are moved toward each other, larger areas of the plates are opposite, thus increasing the capacity. In ordinary use each set of plates is

made semi-circular in shape. A shaft passing through the movable plates enables them to be rotated so that all or any part of the plates can be brought between the plates of the stationary set, thus varying the capacity. Such an arrangement is represented in Fig. 3-C.

An inductance is made by winding wire in a coil. The more turns of wire in the coil, the

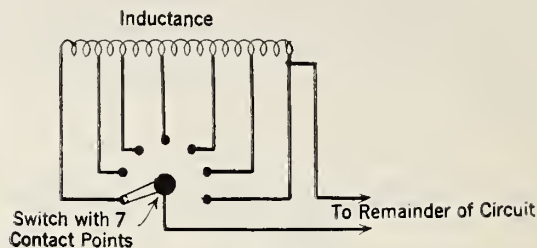

Fig. 4

greater the inductance. A variable inductance is made by winding a coil and connecting leads to it at every few turns. These leads or taps are run to studs, any of which may be used. In this way a variable number of turns and hence a variable inductance may be included in the circuit. Fig. 4 clearly shows the arrangement. A further discussion of inductance will be given in a later article.

A Simply Constructed and Operated Short Range C. W. Transmitter

By ZEH BOUCK

THE majority of battery phone sets are theoretically inefficient. The difficulty generally lies in dissipating a proportionately large amount of energy from the antenna without stopping oscillations. For this reason the Colpitts, a rather critical circuit at any time, is almost altogether inoperative from a low voltage supply except with an aerial of certain definite inductance and capacity. Many B battery phones employ an inductively coupled system to govern the transference of energy from what is often the split filament circuit. But here again if a relatively large antenna current be momentarily indicated the comparatively feeble oscillations will be smothered.

It was altogether by accident that I hit upon the following circuit which employs the antenna as an integral part of the oscillating system, and which radiates exceptional power in proportion to a low input.

The circuit is fundamentally that employed by the British Government during the war, and one that I have very successfully used in a five-watt set with an oscillator and modulator. While experimenting with the effect of different positive and negative grid potentials on the space current of the modulating tube, I accidentally clipped eighty volts in B battery (working blindly in the rear of the panel) to the plate of the oscillator. The current was choked through the modulation transformer,

and as I turned up the filaments, preparatory to throwing in the generator, I was surprised to see the radiation meter jump to slightly under one tenth of an ampere. A little investigation and experimenting resulted in the set I shall describe.

While I intend giving details of the electrical construction of the apparatus, the purely mechanical end, such as panel design and mounting, will be left to the taste and ingenuity of the experimenter. The set is in no way critical, and the builder need only approximate my directions with the single exception of tapping the grid coil.

C_1 is a variable condenser of a capacity no less than .001 and preferably a .0015. With some antennas and tubes it is possible to eliminate the grid condenser C_2 and the leak R_1 , merely shorting over; but in the majority of cases better results are obtained with them in the circuit. C_2 is a standard grid condenser, without leak, of the type sold by most dealers for thirty-five cents. I found the customary receiving grid leak of one or two megohms too high a resistance for transmitting purposes and I substituted a variable one of my own design that gave very satisfactory results. (Fig. 1.)

It is of the pencil mark type but the wide contacts and their proximity make very low resistances possible. Three-quarter inch brass

strips were used and bent as indicated, i.e., so that the separation between them was about one eighth inch and the machine screws passing through the ends would support and connect the grid condenser on the other side of the panel or base. A piece of very fine sandpaper, scraped so that it will take pencil lines without powdering, makes an excellent marking surface and is slipped under the blades. For the original adjustment the paper should be fairly well blackened.

The reactance or choke, X , may take almost any consistent form, from an L200 honeycomb coil to the bobbins of a telephone receiver. If desired it may be wound with two hundred turns of number thirty single cotton-covered wire on any convenient spool. As it is merely a high frequency choke, designed to prevent the high voltage battery from shorting the condenser C_1 , the core indicated in the diagram is not necessary.

L_1 , the main antenna inductance (Fig. 2), is wound on a four and a half inch (outside diameter) tube. Number twenty single or double cotton-covered wire may be used for all windings. The forty turns are tapped every fifth turn from the inside, and brought down to binding or clip posts on the lower periphery of the tube. The upper half of the winding is insulated with two layers of empire cloth or tape over which the grid inductance, L_2 , of twenty turns is wound. The taps, which are brought out directly in short lugs, begin at the tenth turn from the top and continue from there on with every alternate turn. In operation the upper end of the main inductance is connected to condenser C_1 so that the grid winding is always over the active part of L_1 . The modulating coil, L_3 of one, two, or three turns shunted by a microphone, is wound over the grid inductance, its ends twisted or taped together. The number of turns in this last inductance varies with power and transmitters, but generally a single turn will suffice, giving the best modulation without blocking the tube.

Any amplifying bulb of sufficient hardness may be used as an oscillator; a state of hardness being evidenced by a total absence of blue or purple haze when the filament is lighted and the plate potential applied. For the most consistent work the excellent results obtained from the Western Electric V. T. 1, commonly known as a "J" tube, will more than compensate for the expense and trouble of securing one.

The microphone is of the conventional type,

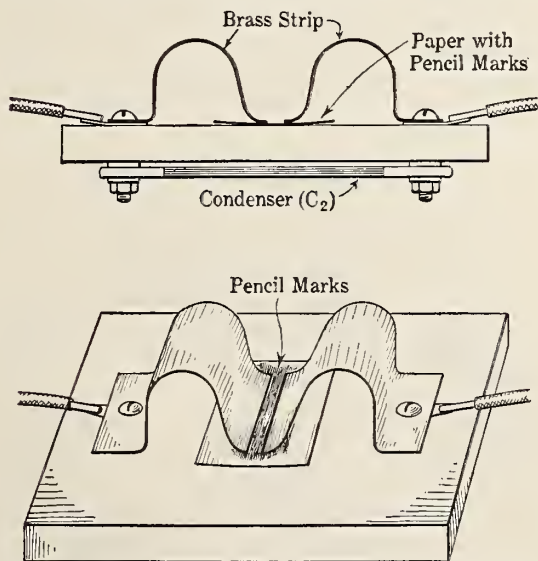

Fig. 1 illustrates the method used for making a variable grid-leak. By sliding the pencil-marked sandpaper under the brass clips different resistance values may be obtained. The upper illustration merely shows the location of the grid condenser

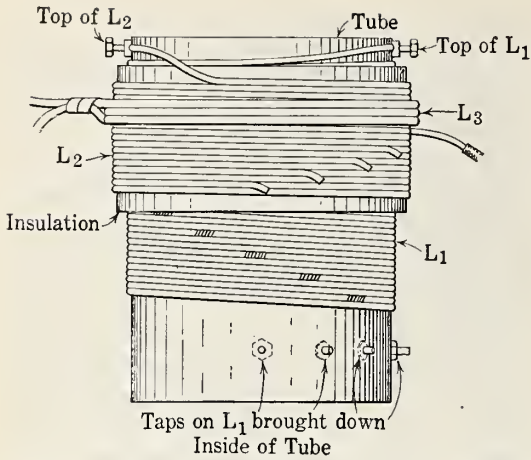

Fig. 2. The method of winding inductances is clearly illustrated here

generally, with the exception of nine points of the law, the property of the Bell Telephone Company. Trial will often show superior modulation with different transmitters of the same make.

The B battery is most conveniently built up of from five to ten twenty-two volt blocks, and it is a commendable precaution to disconnect them when not in use, thus preventing any possible short through condenser C_1 .

The system is principally a tickler one and a theoretical explanation of its functioning will be conducive to more intelligent operation.

As the A and B batteries are thrown in, the plate current rises (not instantly, as it is retarded by the reactance in L_1 through which it flows) from zero to maximum, and with it a magnetic field about L_1 , which, due to its proximity, cuts L_2 . If L_2 is connected in the correct direction (determined by experimentation) the current induced in it through the cutting of its turns by the lines of force from L_1 , will place a negative potential on the grid of the tube. This negative grid voltage repels the electrons (electrons being minus charges, and like charges repel each other) permitting fewer of them to complete their journey from the filament to plate. As the plate current (that current traveling through L_1 and which originally set up the magnetic field) is directly dependent on the intensity of the electron stream, it will decrease, with a corresponding fall of the magnetic flux. As the lines of force withdraw, L_2 is now cut in the opposite direction with a reversal of its current and the charge on the grid. The electrons are again permitted to pass, the plate current rises

(coincidentally the magnetic field) and the whole operation is repeated, in the case of a two-hundred meter wave, one and one half million times a second.

But this rise and fall of flux *also cuts L_1 itself*, inducing therein a high-frequency current which radiates energy from the antenna in the form of electro-magnetic and static fields.

For preliminary tuning the microphone is disconnected and a hot wire or thermo-couple meter (preferably the latter) reading from zero to two hundred and fifty milli-amperes is placed in series with the antenna.

The aerial and plate should be connected to the thirty-turn tap, and sixteen turns clipped in the grid circuit. If no radiation is indicated with the filament burning slightly above normal brilliancy (this is usually necessary when using amplifying tubes for transmitting) L_2 should be reversed. The plate and grid taps and condenser C_1 are then varied until the greatest radiation is secured. (From 50 to 200 milli-amperes.) The wave length may be altered by varying either the antenna tap or condenser C_1 without any alteration being made in the other adjustments, a wave meter being used at this stage of operations. With some tubes the grid potential as determined by the leak R_1 will be found critical.

Connections for buzzer modulation are shown in Fig. 3, and straight C. W. (continuous wave) may be employed by inserting a key in the positive or negative lead of the high-voltage battery. When transmitting with one of these two systems, the microphone circuit,

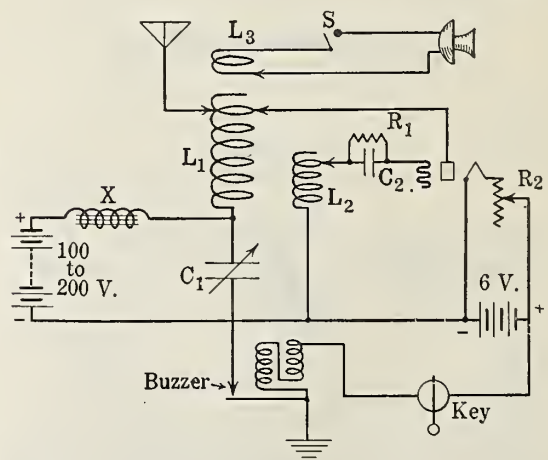

Fig. 3 is a schematic wiring diagram of the complete short range wireless telephone transmitter employing a receiving vacuum tube and B batteries

which absorbs considerable energy, should be opened at the switch S.

With the exception of the radiation meter and the microphone, the set is completely constructed of receiving parts and, including high-voltage batteries and tube, should not

cost more than thirty-five dollars. The range, is, of course, dependent on many factors, not the least of which is antenna and geographical location. But with two hundred volts on the plate, consistent communication of twenty miles on C. W. is not phenomenal.

Our Amateur Radio Reserve

MAJOR PAUL W. EVANS, Signal Corps

Chief of Training, Office Chief Signal Officer, U. S. Army

THE Signal Corps is that part of the United States Army whose duty it is to handle communications. It is a small corps, being only about two percent of the whole Army. Several books have already been written about the work of the Signal Corps during the war, but it is the object of this article to tell about the work of the Signal Corps in time of peace, and only that part of the work which deals with Radio.

One job of the corps is to keep up the communications for the Army, and another is to prepare for war. Keeping up the communications of the Army is no small task. Aside from the telephone service at all camps and posts, the Alaska cable between Seattle and Valdez, and the various telegraph lines, there is the radio communication between the various headquarters. The Army in the United States is grouped geographically into nine corps areas. Each corps area has a headquarters, and each one of these headquarters is under the direct control of the War Department in Washington. Hence the Signal Corps has a large station in Washington which communicates with a station at each corps area headquarters. These latter stations are at or near Boston, New York, Baltimore, Atlanta, Indianapolis, Chicago, Omaha, San Antonio, and San Francisco. They form what is known as the Army Net. All stations are continuous wave stations and operate on wave lengths between 1000 and 3000 meters. Each corps area headquarters has supervision over the various stations which are located at posts and camps within the corps area. This forms what is known as a Corps Area Net, of which there are nine. The stations, within the corps area nets are not all alike, due to the fact that the demands of

economy have retained in service many older type spark stations and also due to the fact that different sized camps, posts, or organizations each require their own particular type of station which is adapted to their needs. Thus, a long established army post may be found operating the same old spark set which has given good service for the last ten years, while a mounted organization in the field may be found equipped with the latest type of portable continuous wave set.

In preparation for war, the Signal Corps is of course constantly engaged in training its own men, sending them to the famous training school at Camp Alfred Vail, New Jersey, and fitting them in general to become better operators, better electricians, and better radio engineers. It also supervises the instruction of the Signal Corps Units of the National Guard and the Organized Reserve. These organizations go into camp every summer, where they receive special instructions in the field with the latest types of army signaling devices, demonstrated by picked troops from the Regular Army.

At eleven selected electrical engineering colleges in the United States, there is in existence what is known as a Signal Corps Unit of the Reserve Officers' Training Corps. Here electrical engineering students are given special training in army signal work, and when they are graduated by the university they are given commissions as second lieutenants in the Signal Officers' Reserve Corps. Each one of these Signal Corps Units is under the direct command of a selected Signal Corps officer from the Regular Army.

The Great War served to bring home to the people of the United States an important bit

of knowledge that has been known to military men for many years, namely, that success in a great war is dependent not only on training, military knowledge, and wealth, but on the *Man Power* of the nation. In a great war of



© Underwood & Underwood

Young America is learning to make its own radio equipment. School boys form a great percentage of the radio fans. The growth of this tendency means more and better Reservists—eventually, better citizens

to-day, the nation who is victorious must exert the last ounce of energy and must utilize the last available man.

If the United States were to go to war tomorrow, then what would be the work of the Signal Corps, and what part would Radio play in that work? In the first place, there would be needed many thousands of radio operators. The number of trained Signal Corps operators now enlisted in the Regular Army, National Guard, and the Organized Reserve would not be nearly enough. The number of operators now holding commercial licenses and jobs on commercial stations would not by any means make up the deficit. The country would have to depend upon the amateurs to fill the breach. Every available amateur would have to be considered as a potential operator for the Army of the United States or some other combatant force. Thus we see what *Man Power* means from the standpoint of radio work.

To try to select these men after the nation had been called to arms would result in considerable confusion and loss. The thousands of local draft boards would be so busily engaged in picking out experts of various trades for each of the various arms of the Service that many men, well qualified as radio operators, would become "lost in the shuffle," as the

saying goes. A large percentage of amateur operators would become impatient at the delays attendant to recruiting specialists and would rush off and enlist to carry a rifle or swing a pick.

In realization of this, the Chief Signal Officer, General George O. Squier, has directed that effort be made to bring the radio amateurs of the country into some sort of an organization so that their names and relative abilities may be known. The organization is known as the Amateur Radio Reserve, and the work is being carried out by the Signal Officer in each one of the corps areas. When an amateur joins this organization he does not enlist in the Army. His allegiance is taken for granted, and he is under no obligation to the United States other than that of the average citizen. He sends his name in to the Signal Officer of his corps area, signifying his interest in radio work and his desire to ally himself with the Signal Corps. The Signal Officer writes to him, informing him of the schedule and wave length of the broadcasting station at corps headquarters. In many corps areas the Amateur Radio Reserve have held regular meetings and have formed a permanent organization under their own elected officers. At each corps headquarters there is a radio expert who is able to answer questions, give instruc-



By means of this clock-work arrangement, a buzzer, key, a dry cell or two, and a pair of telephone receivers the youth of to-day learns the International (Continental Code). He not only fits himself for a place in the "Reserve" or a position in radio, but actually secures much enjoyment which others miss

tion, and assist the amateur operators in many ways. Sometimes these instructions are sent out by radic and sometimes by mail. Although this organization is only a few months old, it

has become surprisingly popular, and in one corps area alone, that around New York, the number of member stations has reached almost a hundred.

Many amateurs have written in to the Office of the Chief Signal Officer in Washington, or to their congressman, requesting that they be sent pamphlets on signal work. The economy of public money has forced the Signal Corps to curtail its printing bill, and no general distribution of these pamphlets can be made. They can be obtained by purchase, however, from the Superintendent of Documents, Government Printing Office, Washington, D. C., at a very small cost, usually about ten cents for each pamphlet. Among the pamphlets which will be of special interest to beginners are:

- Radio Communication Pamphlet No. 1, entitled "Elementary Principles of Radio Telegraphy and Telephony";
- Radio Communication Pamphlet No. 2, entitled "Antenna Systems";
- Radio Communication Pamphlet No. 20, entitled "Airplane Radio Telephone Sets";
- Radio Communication Pamphlet No. 28, entitled "Wavemeters and Decremeters";
- Training Pamphlet No. 1, entitled "Elementary Electricity" (15 cents).
- A larger book, Radio Communication Pamphlet No. 40, entitled "The Principles Underlying Radio Communication", came off the press about April 1, and is sold for \$1.00 by the Government Printing Office.

Since there are many amateurs who may desire to join the Amateur Radio Reserve, there is given below a list of the Signal Officers

GOOD MATERIAL FOR OUR "RADIO RESERVE"

Seventeen-year-old R. E. Leppert, Jr., of Harrison, N. Y. and his eleven-year-old sister, Vera, in a car that he designed, with a complete radio outfit designed and built with his own hands. He found the wreck of an old Ford in a ditch by the roadside and persuaded his father to buy it for the parts. Then he got new wheels and designed the body, which he had a tinsmith make. He began with radiotelephony three years ago, trying a simple crystal outfit first. Since then he has made many outfits, each an improvement over the previous one

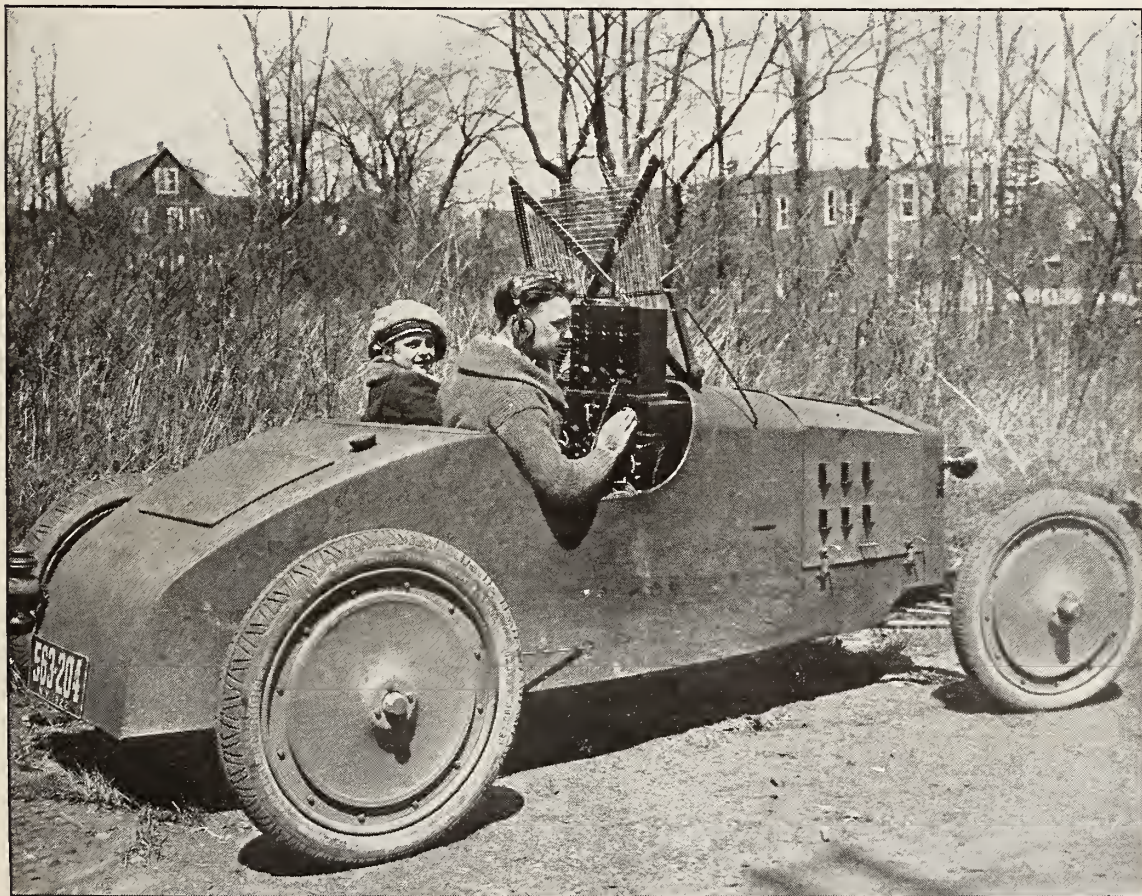

© Ewing Galloway

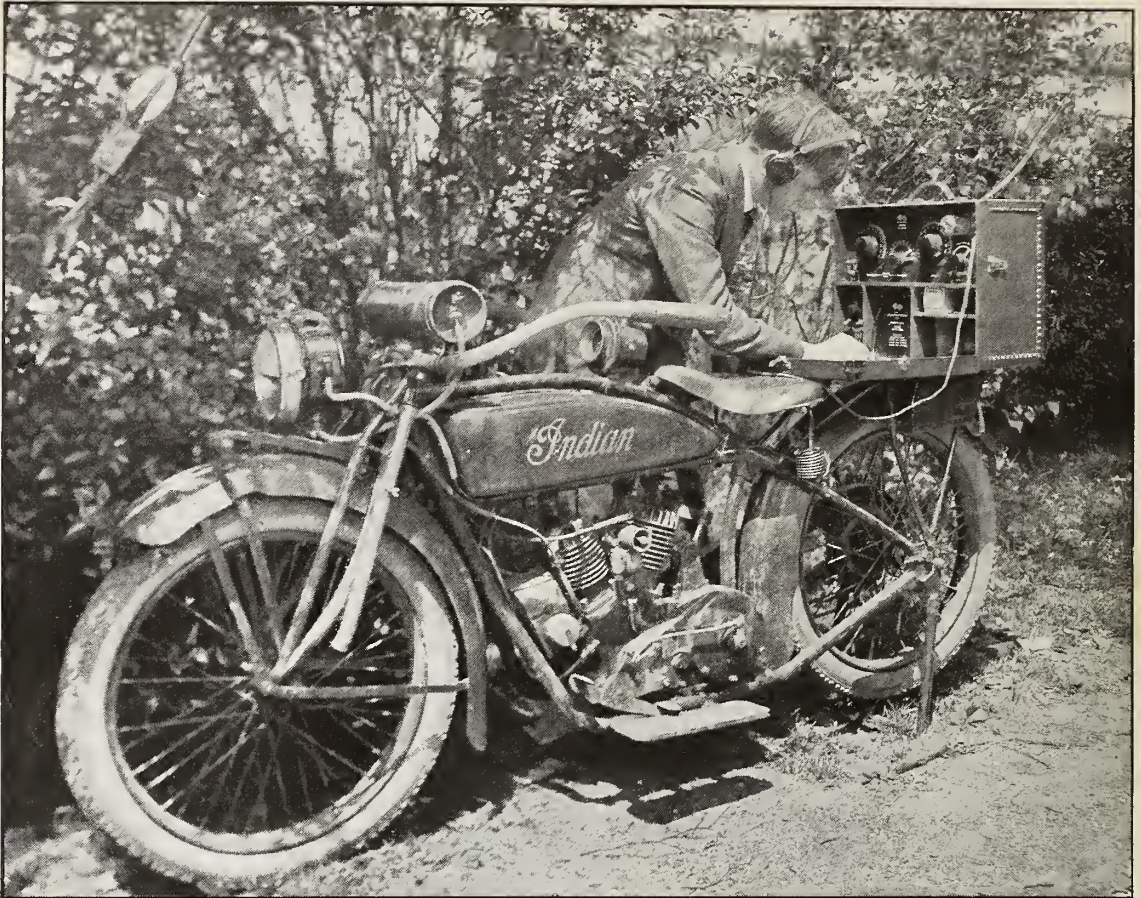

By means of this portable transmitting and receiving set, Radio reservists are able to communicate with each other and with headquarters while en route

of the various corps areas, with the states included in each area:

Signal Officer, 1st Corps Area, Army Base, Boston 9, Massachusetts. States of Maine, New Hampshire, Vermont, Massachusetts, Rhode Island, and Connecticut.

Signal Officer, 2nd Corps Area, 39 Whitehall St., New York City. States of New York, New Jersey, and Delaware.

Signal Officer, 3rd Corps Area, Fort Howard, Maryland. States of Pennsylvania, Maryland, Virginia, and the District of Columbia.

Signal Officer, 4th Corps Area, Fort McPherson, Georgia. States of North Carolina, South Carolina, Georgia, Florida, Alabama, Tennessee, Mississippi, and Louisiana.

Signal Officer, 5th Corps Area, Fort Benjamin Harrison, Indiana. States of Ohio, West Virginia, Indiana, and Kentucky.

Signal Officer, 6th Corps Area, 1819 West Pershing Road, Chicago, Illinois. States of Illinois, Michigan, and Wisconsin.

Signal Officer, 7th Corps Area, Fort Crook, Nebraska. States of Arkansas, Missouri, Kansas, Iowa, Nebraska, Minnesota, North Dakota, and South Dakota.

Signal Officer, 8th Corps Area, Fort Sam Houston, Texas. States of Texas, Oklahoma, Colorado, New Mexico, and Arizona.

Signal Officer, 9th Corps Area, Presidio of San Francisco, California. States of Washington, Oregon, Idaho, Montana, Wyoming, Utah, Nevada, and California.

Radio Fog Signals and the Radio Compass

IN THE radio fog signal station and its complement, the radio compass, the mariner has found a new and powerful weapon to use against his ancient enemies—fog and thick weather.

On May 1, 1921, the Bureau of Lighthouses placed in commission in the vicinity of the port of New York the first three radio fog signal stations installed in the United States. After observing their operation the lighthouse service proposes, as means are available and needs are developed, to establish similar stations near important ports on the seaboard, on the Great Lakes, and on some of the principal capes and lightships.

This newest ally of the seafarer enables him to guide his ship or determine its location, although sea and sky may be blotted out by fog at the time. The method is not at all complex. One or more lighthouses or light vessels are equipped with apparatus for sending radio signals of simple and definite characteristics.

The radio compass on shipboard responds to these signals and indicates the direction from which they come.

The navigator locates his position by the process of triangulation or cross bearings and steams through the fog free from fear of shoals or reefs. He may get his position from the signals of a single station, either by taking repeated bearings and logging the distance travelled between bearings or by a single bearing and dead reckoning. The method of cross bearings is, naturally, more convenient and more accurate.

When the system is more widely developed, when all ships are equipped with the radio compass as well as the customary radio apparatus, the danger of collision between ships will be greatly lessened and the rescue of disabled craft will be greatly facilitated. Two incidents will illustrate this point.

The Norwegian steamer *Onataneda* was in distress in a fog off Newfoundland, and gave

The Lighthouses are Miniature Transmitting Stations. Signals from them are picked up by the square coil in the foreground when it is pointed in their direction. The coil is mounted above a magnetic compass which always points north. The direction taken by the square coil when signals are heard loudest indicates the bearing of the lighthouse. Where two such bearings cross is the position of the ship



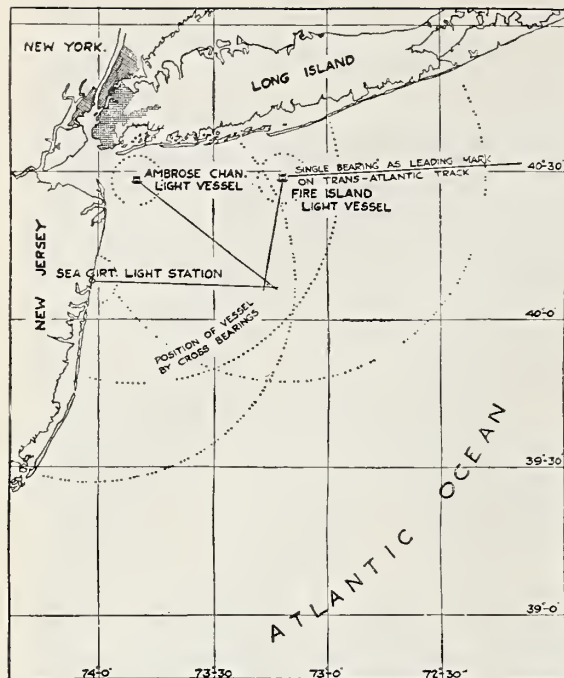

Chart, showing location of three radio fog signals in the vicinity of New York, with example illustrating the use of radio signal as leading mark for which a vessel may steer in approaching New York; also example of the obtaining of the position of a vessel by cross bearings on three radio stations. The distinctive characteristics of the signals from these three stations are indicated by dots on the circles; the larger circles are at the approximate useful limits of these signals

her position by dead reckoning ninety miles in error. The only ship able to discover her correct position and help her was the *Fanad Head*, equipped with a radio direction finder. The steamer *Wabkeena* was within fourteen miles of the steamer *Alaska*, lost off Cape Mendocino, Cal., when the latter was sending out distress signals. But the *Wabkeena* had no means of determining the direction of the signals and she steamed around in the fog for ten hours before she reached the scene of the wreck. Long before that time the *Alaska* had gone down.

The three stations established near the port of New York are the Ambrose Channel light ship, the Fire Island light ship, and the Sea Girt light station. A glance at the accompanying chart will show the reason for these designations; that is to say, they form a natural triangle.

Characteristic signals identify each station. Ambrose Channel sends one dash; Fire Island a group of two dashes; Sea Girt a group of

three dashes. The particular station is thereby as definitely located in a fog as a lighthouse in clear weather. The signals are operated continuously during foggy weather. To avoid interference the signals are sent on different time schedules, thus: Ambrose Channel sends for twenty seconds, silent twenty seconds; Fire Island sends 25 seconds, silent twenty-five seconds; Sea Girt sends sixty seconds, silent sixty seconds.

A special automatic, motor-driven timing switch produces the desired signal at regular intervals. A wave length of 1,000 metres is used and the range varies from thirty to one hundred miles, depending upon the sensitivity of the receiving apparatus.

The radio compass is a simple mechanism consisting of about ten turns of insulated copper wire upon a rotating wooden frame about four feet square. The frame or aerial is mounted on a spindle provided with a pointer. The aerial is usually mounted on the roof of the pilot house and the spindle terminates directly above the centre of a standard ship's binnacle. The pointer on the spindle, therefore, enables the navigator to read the direction of the fog signals directly upon the compass card.

The principle upon which the radio compass works, then, is this: When the plane of the coil on the pilot house is parallel to the direction from which the radio signal comes the signal reaches its maximum distinctness. As the coil is revolved the sound diminishes until it reaches a minimum, either side of the maximum point. Halving the difference between the two minimum points indicates the direction more accurately than the point of maximum intensity. As the coil rotates the pointer on the spindle accompanies it around the compass, so that the navigator can get the magnetic bearing of the radio signal station at a glance when the minimum point is reached.

During the war considerable use was made abroad of radio compass stations located on shore. After the war the Navy Department established similar stations on the coast of the United States and a number of these stations are now in active operation and furnishing bearings to ships asking for them. The system is the reverse of that adopted by the Bureau of Lighthouses, since the bureau system enables the navigator, if his ship is equipped with a radio compass, to take his own bearings.

The Audio Piloting Cable in the Ambrose Channel

By DONALD WILHELM

THERE are times when seamen yearn for a peep of the Ambrose lightship—times when fog hangs over them, the old man of the sea. There are times when, just short of New York Harbor, and hundreds of other harbors as well, they have to lay to and wait for hours or days.

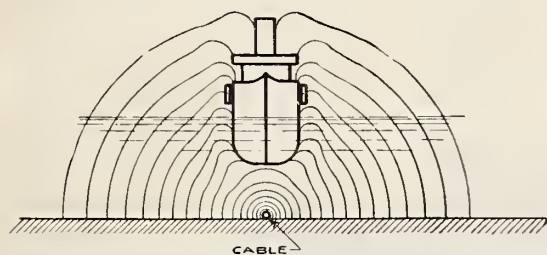

The manner in which a ship is guided by the "Audio Piloting Cable" is shown in this illustration. The collector coils on either side of the vessel are affected equally by the current in the cable when the vessel is directly above it. This results in the production of sounds of equal intensity in the telephones used by the pilot

It's depressing to passengers, to crews, to everyone on shipboard to be brought up short like that with their journey's end in view. And it's expensive—when a great liner has to wait on the weather the hourly maintenance cost per vessel ranges all the way from \$500 to \$4,000, the authoritative figures. But for \$50,000 initial cost, and as little as fifty cents an hour operating cost, an audio piloting cable has been laid and been operated through the Ambrose Channel, and can be laid at relative cost, and be operated through almost any channel in the world.

The Navy has demonstrated that. Figuring the cost of receiving equipment on each vessel at \$1,000, it has shown that the typical vessel might pay for its equipment with less than the cost of a few hours' delay off a typical port. And the cost of the cable itself, incidentally, is no more than any one of a number of individual buoys in and about New York or almost any large and typical harbor.

What's more, a blind man, properly equip-

ped, if he can but hear, can steer a ship accurately along such a cable.

The proof is in. Pilots, blindfolded, with only a bit of instruction, have publicly demonstrated just that. With only the first run of experimental coils, amplifiers, condensers, and switching devices, all of which the Navy is perfecting at the New York Navy Yard, novices, or old seafaring men new at the radio game, and other mere landlubbers, took the helm, and though blindfolded or with the bridge of the experimental ships closed in with canvas, followed the first major audio cable part or all the way from Fort Lafayette to hailing distance of the Ambrose Light or from the Light back the other way.

Clearly, such a device has a future in these days when some sailors have come to trust more and more to radio and when they have become accustomed, as many have, to the use

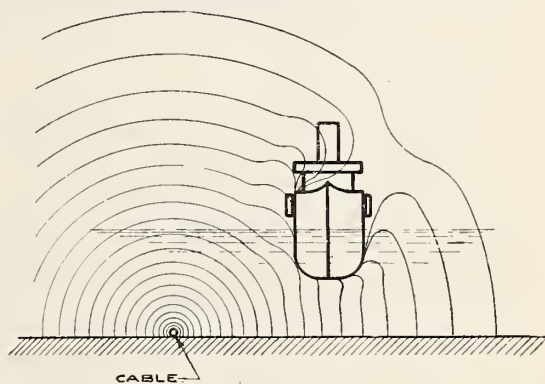

When a vessel leaves the direct path of the "Audio Piloting Cable" the collector coil nearest the cable is affected to a greater extent than the farther coil. This results in the production of unequal sounds in the pilot's telephones, and he then alters his course in the direction of the stronger signal until the strength of each is the same

of the radio compass to get them within automatic steering distance of the cable. Thus, it has been recommended to the Navy that the Ambrose audio cable be extended past the Light a mile or so, at which point it will divide and run northeasterly and southerly for five

miles or so. Then New York Harbor will lose its terrors even in the worst weather, to ships properly equipped with radio. It will, we can assume, be as safe for navigation during bad weather as the open sea. In other words, liners or other vessels properly equipped—and once the audio system is in vogue, legislation can be employed to make them carry equipment, exactly as legislation has required all vessels with more than fifty souls on board to carry distress wireless equipment—can race in toward the Lightship, pick up their bearings by radio compass, edge in and make contact with the audio cable, and make the harbor.

It was in October, 1919, when Commander Stanford C. Hooper, in charge of the radio division, Bureau of Engineering of the Navy, ordered A. Crossley, an expert radio aid, to proceed to New London and undertake the Navy's first major experiments with the audio cable, the promise of which has already been indicated by a long range of theoretical conclusions, along with the development of the equipment necessary, plus a few actual experiments, notably those of Expert Radio Aid R. H. Marriott, who made some experiments in Puget Sound and suggested their development to Commander Hooper.

At New London, first a wooden ship was used, a launch. And when it was discovered that there was no shielding effect from the launch's hull, it was found to be practicable to keep the launch within ten feet of the invisible cable, horizontally, and to steer it, of course, either way, to pick it up here or there and to use the device handily.

Then a metal ship, a submarine, was used, and the shielding effect of the metal hull was noted, on the action of the coils at either side

of the ship. The experiments conducted on the G-1 demonstrated that its commander could tell on which side of his vessel the cable lay. The strongest signal was always picked up by the coil nearest the cable while the minimum signal was received by the coil farther from the cable. And when the end of the cable was reached both signals eased off.

At once, then, the Navy proceeded to larger experiments in the Ambrose Channel. But

there was trouble when the longer cable laid there was tested out and investigation proved that the cable had parted, probably in the laying, at precisely fifty-two places! So the New York Navy Yard went at the business of developing and testing out a decidedly better cable, which, when duly laid and anchored, did all that was expected of it. For the U. S. S.



U. S. S. "ALGORMA"

Algorma, a large Navy sea-going tug, fitted with receiving equipment, steamed at her master's whim, almost exactly over the "audio."

The amplifier and switching device used on her were installed in the pilot house and the collector coils were rigged out from the opposite sides of the vessel on a level with the upper deck, about amidships, and about fifteen feet above the water-line. Steaming at right angles to the cable, she could pick up the signals 100 yards from it, and to follow it was like following a hand in the daylight. During the return trip to the city, in fact, the pilot house was blanked off with shutters so that the navigating officer could not see daylight yet he brought the *Algorma* through the Channel without aid of any sort, with the ship at no time more than fifty yards from the cable and most of the time squarely on top of it—this, though the navigating officer had received only three hours of training. And when the de-

stroyer, *Semmes*, was used later in public demonstrations, one of those who took charge, Captain Battle of the Cunard liner, *Virgilia*, though a total stranger to the system, by relying on a certain constant signal strength from the port coil, steered the *Semmes* along the twenty miles of the cable always within fifty yards of it, and always on the correct side of the channel.

The power used was supplied by commercial sources via Fort Lafayette. It was demonstrated that a current flow of three amperes was sufficient for all needs in water up to 200 feet. Other conclusions reached by the expert radio aid in charge, A. Crossley, pointed out that a collector coil having 800 turns of wire gave twice the audibility of the 400-turn coil; that the coils obviously must have identical electrical constants; that the use of tuned resonant receiving circuits increased the efficiency of the system 1,000 per cent., under which condition the cable can be picked up at

1,000 yards on either side of the cable, "which," he adds, "further increases the possibilities of the system for deep-water work." He remarks that very little difference was noted in the received signal strength when the coil was submerged or placed above the surface of the water, and that the use of the loudspeaker was found to be impracticable as the minute energy received from the cable at a distance will not actuate the diaphragm of a loudspeaker—only when the vessel was within forty yards of the cable would the loud speaker operate.

There are practicable refinements in the cable used and in the receiving equipment, which the Navy is developing.

And there is a future for the audio cable, the Navy officials are agreed. Its fullest usefulness at American ports and elsewhere, waits, however, on that larger appreciation of radio devices for sea as well as air navigation which pilots, both on the sea and in the air, expect, but do not as yet demand.

Progress of Radio in Foreign Lands

WORD has been received that the three daily newspapers in Vancouver, British Columbia, have each installed high-power radio sending equipment, by means of which isolated camps and farms are being brought into touch with the happenings of the outside world. Statistics recently published in the United States show that, whereas six months ago there were less than 50,000 receiving outfits in the whole of the country, and 40,000 of these within 100 miles of New York, to-day there are at least 800,000 of them, and the demand continues to be so great that the factories cannot cope with it. There are well over 200 radio-telephone broadcasting stations now in operation in the United States, and we can be certain that our neighbor to the north is becoming quite as enthusiastic about radio telephony as we are. In a short time we shall be listening in to Canadian broadcasting stations along with our own home stations.

At a conference recently held in France by the airway managers and pilots in order to draw up rules to prevent a recurrence of such an air collision as that which took place over

Northern France on April 7th, among other resolutions the following were passed: That all commercial airplanes must be equipped with radio telephones; that additional ground radio and weather reporting stations should be established at Poix and Noailles on the French section of the London-Paris airway; that the terminal air stations of Croyden and Le Bourget should now be in constant communication with each other by radio telephone as well as by ordinary radio; that the question of interference with radio telephony by the powerful Eiffel Tower radio station should now be investigated; that the ground radio station at St. Inglevert, on the French coast, which was destroyed by fire recently should now be replaced.

RADIO ON FISHING BOATS

ACCORDING to an article in a recent Bulletin of the Oceanographical Society of France, it appears that despite the interruption due to the war, considerable progress has evidently been made in the extension of radio communication to the French fishing fleet. In the space of ten years radio apparatus has been installed on some 200 vessels. In order

to have the messages from the fishing vessels transmitted as rapidly as possible, the French postal authorities, who are in control of communication systems in France, have them telephoned direct from the coast radio stations to the owners. La Rochelle is the only fishing port of importance which is not yet provided with a radio station, although some forty trawlers of that port are equipped with radio. At St. Pierre and Miquelon there is not as yet a sufficiently powerful coast station, but an up-to-date equipment with a radius of 600 miles is expected to be installed during the next season.

WHAT IS A RADIO OPERATOR?

FROM the London *Electrician* we learn of a dispute that has arisen between the Association of Wireless and Cable Telegraphists which has a membership of between 5,000 and 6,000 (95 per cent. of the total of British wireless operators), and the London District Association of Engineering Employers, representing the shipowners and the wireless companies. The men's secretary states that, in addition to a reduction of wages, the telegraphists were to be called upon to perform "other duties" besides telegraphic work. They had attempted to get a definition and a conference, but only a vague reply was given which would leave them entirely at the mercy of the shipowners and the captains. The question of wages alone could no doubt be satisfactorily settled. The men had been instructed to refuse to sign on any ships, and already 300 to 400 men were out. No doubt by the time this is read the trouble will be over, but the fact remains that a radio operator is often called upon to do work quite foreign to his duties as a radio operator. So the question: What is a radio operator?

THE INTERNATIONAL LOUD-SPEAKER

WHEN our loud-speaker enables us to hear radiophone broadcasting stations several hundred miles distant, we believe we are doing very nicely, do we not? Well, in Europe they are doing still better, and taking it more or less as a matter of course. While we have made remarkable progress in the transmitting end and in the introduction and working out of the radiophone broadcasting idea, it appears that the Europeans know a little more about radio-frequency amplification than we do—at least they make more use of it than we

do. For instance, it is reported that a loud-speaking radio telephone receiving set has just been completed at Lausanne, in Switzerland, which gives the radiophone concert sent out by the Eiffel Tower in Paris, a good 500 miles distant, as well as the stations in London and Berlin. The high-power radio telegraph stations of the United States are also being picked up by this receiving set and made audible throughout a large room.

EXPEDITING PORT BUSINESS WITH RADIO

THE radio telegraph stations which have been installed in the port office of the French inland city of Rouen and on certain pilot boats by the Rouen Chamber of Commerce have been officially put into service. These installations will be used exclusively for transmitting messages relative to maritime affairs, promotion of the port, and services for and of the port. The pilot boats equipped with radio will keep the port office informed of the arrival of vessels coming up the Seine River on every tide and will be instructed by the port office in regard thereto. Merchant vessels not equipped with radio and having urgent dispatches to transmit to local ship brokers before docking can do so through the port office, via the pilot boats. Other radio messages or dispatches not relating to navigation or the port of Rouen and its services must be sent through the public radio station at Bleville.

MAKING THE TELEPHONE RECEIVER MORE SENSITIVE

NO LESSER authority than G. Seibt of Germany has found it possible to increase the sound intensity of a telephone receiver by laminating or subdividing the pole pieces above the poles of the permanent magnet and by introducing a magnetic shunt or by-pass for the magnetic flux, just below the coils, according to *Elektrotechnische Zeitschrift*. The pole-piece divisions or laminations are made of 4 per cent. silicon steel. The magnetic shunt air gap was found to be most effective when set to about 2 millimeters. The diaphragm is made of the same steel as the pole-piece laminations instead of the previously used American ferro-type steel. Tests made with such receivers showed an increase of sound intensity of from two to two and four-tenths times that of the old model. The new receiver is already being made on a large scale.

IN RADIO, at least, Great Britain has much to learn from us, even if we are a much younger country. Until the present the British radio amateur has been operating under the most adverse and discouraging circumstances, and if his numbers have increased despite all the obstacles placed in his path, it is due to the attraction which radio holds for so many of us. The problem of licenses in Great Britain has become very acute. Just so long as the amateur was satisfied to receive and perhaps to send with extremely limited power, there was no objection to his activities. But now that the amateur is getting more ambitious, the problem is getting serious. Another thing is the lack of public broadcasting in Great Britain. The British amateur, as well as the clockmaker, receives his time signals from Paris, Moscow, and other centers—second-hand Greenwich time, to be sure; but since his country does not broadcast its own official time, he must get it from abroad. The British ether is filled with dots and dashes, but practically no radiophone broadcasting. The amateurs are now clamoring for a central broadcasting station like those operating in the Hague and in Paris, and it appears that their demands will be granted in the very near future.

GREAT BRITAIN'S WORLD-WIDE RADIO PLANS

THE publication of the report of the commission appointed to study the problem of world-wide radio communication for the British Empire discloses a number of interesting facts bearing on present-day radio. To begin with, the commission suggests that the communication should be effected in steps of about 2,000 miles, which is considerably less than the more ambitious jumps of a few years ago. Then the suggestion is made that vacuum tubes be employed to generate the radio energy used in transmitting. The excellent results obtained with a set of 48 vacuum tube oscillators used in the Carnarvon station with an input of 100 kilowatts, which was pushed up to 150 during the trial, are referred to. Messages were successfully transmitted to the United States, India, and Australia with this arrangement. It is stated that valve or tube renewals will be from 50 to 60 per cent heavier if alternating current is used instead of direct current, presumably due to the use of thermionic rectifiers. With regard to wavelength, it has been found by actual tests between Horsea and Egypt that

the best results over this distance can be obtained by the use of relatively short waves during the night and of a long wavelength during the day time. It is recommended that the masts be of steel, 800 feet high, insulated not only at the base but at intermediate points. Counterpoises are recommended instead of ground connections. With regard to duplex working, it is recommended that each receiving station should have a separate antenna and receiving apparatus for each distant station with which it may have to communicate, so as to allow of simultaneous reception from all. As a temporary expedient, it is suggested that

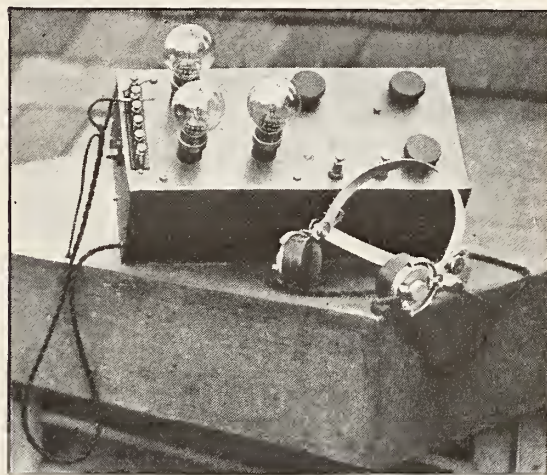

©Wide World Photos

The English Marconi Company has produced this broadcast receiver for home use. It may be installed and operated by the layman

arc generators be used. However, these are to be replaced as soon as possible with tube oscillators. It is interesting to note that no reference is made to high-frequency alternators.

FRENCH GOVERNMENT COMMUNICATION PERIODICAL

AMERICAN radio men will find much of interest in a French Government periodical called *Annales des Postes, Telegraphes, et Telephones*. This periodical is issued bi-monthly by the French Ministry of Posts and Telegraphs and each issue usually contains from 100 to 200 pages. It has been published for the last ten years. Telegraphy, telephony, radio communications, and the machines used in post offices are included in its field. In wire telegraphy, automatic high-speed systems, as

well as older systems, are covered. Communication by submarine cable also receives attention. In telephony, attention is given to the ordinary systems, and to automatic systems, repeating devices, traffic and operating problems, and the use of radio-frequency currents. In radio communication, attention is given to the principles, construction, and operation of a wide variety of devices and methods for transmission and reception. Results of researches conducted by the Ministry of Posts and Telegraphs are published in this periodical. Notices and abstracts are published of articles pertinent to the field of the *Annales* which appear in other French periodicals, and in foreign periodicals. The editorial staff of the *Annales* includes a number of prominent engineers, including Messrs. Denery, Blondel, Ferrie, Milon, Abraham, and Gutton. The annual subscription price is 27 francs, and orders may be addressed to the *Annales* at 3 Rue Thénard, Paris, France.

RADIOPHONE BROADCASTING IN PARIS

NOT slow to appreciate what broadcasting has meant to the American public, the French have gone in for the same thing. Just now the broadcasting centre of France is the Eiffel Tower station, operated by the French Army Signal Corps. The station has a radiophone range of 1500 miles and is transmitting radiophone programmes on a regular programme basis. In connection with their broadcasting activities, it appears that the French Army Signal Corps have been experimenting with the radio link idea—the insertion of a radio telephone section in regular telephonic communication. It is believed that at an early date it will be possible for a subscriber in Paris to speak, via his own telephone instrument, to a friend in London, using his own telephone instrument, the Eiffel Tower station being used for one end of the radio link. But for the time being the radiophone broadcasting is of prime importance and is pleasing the French public quite as much as our broadcasting activities have pleased us. It is also reported that the airplanes traveling over France and to England

pick up the radiophone concerts and enjoy them, high in the air.

A UNIVERSAL RADIO SIGN LANGUAGE

FROM various sources these days we hear requests to the effect that all radio diagrams be made in a uniform style. Since diagrams, as a rule, require no explanatory text, it is evident that they are one and the same for all languages. They are a universal language, to be sure. But due to the use of many different styles of symbols to mean one and the same thing, much confusion is encountered in using radio diagrams. It is now proposed that all diagrams be made with the same kind of symbols, which could be standardized with little trouble. In Germany the radio symbols have been practically standardized, so that all radio diagrams are more or less of the same general appearance.

THAT GERMAN INVASION

FROM time to time someone starts a rumor going the rounds of the radio fraternity, to the effect that Germany is soon to invade this country and flood it with wonderful radio apparatus. We have heard such rumors, one and all of us. We have heard of the remarkable vacuum tubes that are to be sold so cheaply that they will be virtually given away. We have heard of the remarkable receiving sets, costing so little that it will no longer pay to bother making a set, and so on without end. However, several months have gone by, and the German flood or invasion, whichever you wish to call it, has not materialized. And it is our firm belief that it is not likely to materialize in the near future. The patent situation, with regard to many features of radio equipment, is such that German products, many of which are not licensed or patented in this country, are not likely to find their way to our markets because of the danger of their being infringements of American patents and engendering expensive lawsuits. Especially is this true so far as tubes are concerned. All in all, the American radio industry has little to fear from German competition for a long time to come.

Radio Helping Us Enjoy the Summer

Our Vacations may be Better Spent if Radio is Taken with Us. In this Article Various Means are Suggested for Eliminating the Difficulty of Erecting the Summertime Antenna

By ARTHUR H. LYNCH

SUCH rapid strides have been made and so much good has come of boys and young men operating amateur wireless stations, that the U. S. Government has gone so far as to encourage its use, and Uncle Sam has not been satisfied merely to say, "That's a very instructive and helpful hobby you have taken up, my boy, keep at it and it will do you a lot of good." No, indeed; he has done much more than simply express his pleasure and give some verbal encouragement. He has actually instructed various government wireless stations to give the amateur a helping hand. And who is in a better position to help in that regard than our benevolent uncle?

For some time past, there have been men in the employ of the Government, who, either for selfish reasons or because they did not have vision enough to see that one day wireless would be of vast importance to our country, have endeavored to introduce and put into effect laws which would materially reduce the scope of amateur radio endeavor, if not prohibit it entirely. Such narrowness is to be regretted, and we must feel grateful to those who have overcome such attempts at legislation and have brought about a condition in which the amateur radio worker is not only encouraged but materially aided. Perhaps it will be of value to consider some of the reasons which would make such laws harmful not only to the worker himself but to the entire nation and possibly the world. It sometimes takes a war, or kindred upheaval, to make some men realize the value of things which seem useless or even an impediment to progress, and that is precisely the case with amateur radio.

But a few short years ago there was a flood in this country and the railroads were put out of business in the section which was flooded. The telegraph lines were also torn down, as were the telephone lines. The people within the stricken region would have been without communication with the rest of the country had it not been for the amateur wire-

less operators, who took it upon themselves to establish a reliable communication service and thus let the rest of the country know the needs of those who were suffering.

That was before the Government had taken such active part in the promotion of amateur wireless affairs, and there were many other similar instances of like importance which went to prove that the hobby was valuable, not only to the boy who enjoyed it himself, but to his fellows. It is interesting to observe a few things which have gone on since that time and see what effect they have had upon the country at large.

One of the most striking examples of the value of radio to the country is seen in the Great War. There are but few who will even attempt to claim that this country was in



This is an ex-service, man-carrying kite now used to carry an antenna. Some idea of its size may be had by comparing it to the men who are holding it. A suitable kite-string may be made from a stout clothes line

a state of preparedness, even though we should have learned a lesson about preparedness from our Mexican Border experience when the supplies for the National Guard were so insufficient as to hold up the movement of our troops in nearly every state of the Union for long periods. Even at the end of the Border Expedition, we could hardly claim to be prepared for any great emergency. But we went into the war with Germany unprepared, and the result of our unpreparedness is reflected in our having resorted to the floating of five loans, amounting to many billions of dollars, for the production of military supplies, to say nothing of food and ships. Unfortunately the ships, at least a very considerable part of them, were built at too great a cost and in a manner which would prevent them from being kept in service for any considerable period, and to-day the waste resulting from our unpreparedness may be indicated by the fleets of war time ships which have been lashed together and placed in harbors from which they will never again sail. They are a total loss, except for the purpose they served, which, though it was important was also extremely costly and would not have been necessary if we had been prepared.

And then there was the matter of training many thousands of men to take up various forms of military duty, and it is here that we may pause a moment and consider again how amateurs were able to help the Government. In any form of military training a certain amount of time must be spent in learning the ways of the army and the navy and the air forces in war time. There were but very few of our military units which could be filled by ordinary citizens and there were but few of our citizens capable of stepping into the stride of military affairs by reason of their experience in civilian life. In some instances, especially the professional branches of the service, which were capable of carrying on their work with little or no military training, we see just the opposite, for instance the Medical Corps, composed as it was of doctors and druggists and nurses, who did not have to be put through a long course of training before they were in a position to do good work. And this is exactly the case with radio.

Radio, in the war, was as necessary to our winning it as were our battleships, our troop ships, our guns or our men, for the reason that without its aid our army and navy would not have been able to keep such accurate check on

the workings of the enemy, and would not have been able to have military or naval maneuvers regulated with the precision which was found to be so necessary. But that is a long story, and we will not discuss it more. The point in mind is this; when the war broke out there were nearly 5,000 amateur radio operators in this country, who with little or no instruction were capable of entering upon a military career which was of great value and importance to the nation. Those fellows who had learned to send and receive rapidly, to build their own apparatus, to take reasonably good care of storage batteries, and especially those who had done any work with the latest forms of apparatus could step right into the breach and prove their worth by doing in a very short time what it would have taken them months to learn if they had not been allowed to carry on their pet hobby in times of peace.

There are instances without number which would go to prove these statements, but as interesting as they are, we can not consider everything at the same time, and they may furnish the fruit for interesting discussion later on. But we must say in passing that such instances as have been mentioned have gone far to establish a place in Uncle Sam's heart for the amateur radio fan and have helped to bring about some of these very encouraging conditions.

It is needless to mention that Uncle Sam has endorsed the activities of the Boy Scouts in this country and that he wants to do everything in his power to assist them. One of the greatest subjects in the Scout's course of study is signalling, and we must pause for a moment to consider it and how much Uncle Sam thinks of it—more, perhaps, than any other branch of Scoutwork. And there are many boys throughout the country who do not know how far our good uncle is going in his effort to help them to help themselves and help him, if he again needs their help, in this matter of signalling.

A FEW OF THE MORE IMPORTANT AIDS

FOR many years the U. S. Naval Radio Station at Arlington has sent out time signals and weather reports for the guidance of mariners, and this is also true of many of the other naval and other government stations throughout this country and its dominions. The value of these signals is very great, as it is through them that it is possible to keep ships' chronometers—which in plain American,



When the kite is near the ground it sometimes behaves badly and requires considerable attention, but once it has reached a height of 300 ft. or more, little difficulty is experienced with it.

merely means "clocks"—checked up and thereby navigate with more certainty. The weather reports are of similar importance and need no further mention. These signals, sent as they are on regular schedules, give the student of radio an opportunity to practice adjusting his apparatus as well as practice in receiving by the International, or as it is better known, the Continental Code. In addition to this time and weather reporting service, there are many stations throughout the country which send the news of the day to all stations which may desire to copy it, and the amateurs may well avail themselves of this opportunity.

In addition to these signals and those of the regular commercial and amateur stations, Uncle Sam has decided that every opportunity will be given the amateur to become proficient in receiving the code and has accordingly instructed certain of his naval and other stations to transmit certain amateur information upon well-regulated schedules and at a slow speed, so that the beginner will have an opportunity

to progress to a point where he will be able to receive the regular press and commercial messages without difficulty. The general plan followed is to have several of the stations, generally Navy stations, send out these amateur broadcasts each evening at a scheduled time. Where there are radio clubs, the value of these broadcasts is increased because the fellows can get together and compare the results of their receiving and locate their errors.

Another and just as important step has been taken by the Bureau of Markets, of the Department of Agriculture. In order to keep the farmers advised of market conditions as well as the weather, this department has undertaken to establish a *wireless telephone* service, which embodies several stations which send out the above information on certain schedules in such a way as to enable them to be received over distances of approximately two hundred miles without requiring any particular skill on the part of the operator.

All that is needed to secure the information which is thus sent out is a simple receiving set, such as may be found in many amateur stations. The value to the boys and the farmers of this information is very great. In towns where this information has not previously been received with regularity, it will be possible for the boys to rig up an outfit and invite their



Ashore, the kite-supported antenna materially increases the distance over which radio broadcasting may be received. The kite in this illustration is 7 ft. high

friends in to hear a representative of the U. S. Government *talking* to them over the wireless telephone. They will not even have to know the code. The value of the information may not be understood by the boys themselves for a time, but go and get the president of the chamber of commerce in your town and tell him that you can supply him with information about the weather and food market conditions, received right from Washington and you won't have to do any more worrying about where the money is coming from to buy new wireless apparatus. The information will be worth enough to the community for it to buy your apparatus for you. If you don't think so, take this with you and ask your local Chamber of Commerce or Board of Trade what they think of the plan. So that is what Uncle Sam is doing, and from now on we will consider the least expensive method for obtaining satisfactory results in availing ourselves of these very great aids to the study of wireless telegraphy.

OVERCOMING SOME OF THE DIFFICULTIES

ONE of the greatest difficulties in connection with a wireless station, especially where it is not to be a permanent installation, is the arranging of the overhead wires, generally known as "aerial" or "antenna." Now, for use in connection with communication in stations which are to be permanent, it is very desirable to refer to some good authority on such matters and not go into the thing in a haphazard fashion.*

But, where there is no possibility of planning the station beforehand, which is generally the case when it is desired to communicate between two Troops of Boy Scouts in different parts of some woods, it is necessary to do whatever is possible and more or less trust to luck. For this reason we will consider two methods which have been tried with very great success, especially with portable sets.

Of great importance is the erection of the aerial, so we will now consider it. The most suitable aerial for amateur portable field sets is, the single wire; that is, merely one wire in the air. There must also be a ground connection, but that is readily taken care of by driving a metal rod three or four feet into the ground or, better still, dropping it into water and attaching a wire to it, so we will confine ourselves to the aerial. On camping trips, it is generally advisable to be provided with plenty of copper

*See page 214, also RADIO BROADCAST for May and June.

wire for the making of several aerials, and it is also advisable to have several well-designed kites along, to be used as described later on. The first and most simple aerial is made in a few minutes and requires but one boy to get it in the air. If the troop is supplied with some stout twine and a few porcelain insulators, which may be had for a few cents, it is merely necessary to attach one insulator to the end of the string and then cast it, sling-fashion, over the top of any tree suitable for the purpose. When the insulator reaches the ground, on the opposite side of the tree, it is merely necessary to fasten a wire to it and pull in enough of the twine to raise the wire to a position about fifteen feet from the branches of the tree. The twine may then be fastened, and the wire may then be used for an aerial.

Another very satisfactory method for raising an aerial is to fly a kite or several kites and run a wire up on the string. By using a suitable kite, such as the one described, it is possible to substitute copper wire for the kite string and fly the kite directly on wire, as is shown in the accompanying photographs. The kite string (wire) should be brought to an insulator before being connected to the set and the insulator should be fastened to the ground by means of a piece of cord or another piece of wire.

MAKING THE KITE

DURING the writer's boyhood, he was fortunate enough to have made the acquaintance of a man who was an expert on kites and kite flying, and a few tips upon the selection of the proper sort of kite for use in conjunction with a radio set as well as further tips concerning the making of such a kite from the figures of the kite expert himself will prove helpful. The kite shown in the illustrations was made according to the directions here given and proved entirely satisfactory.

It is best to be sure that the wood used for the ticks is spruce. That both the upright and cross sticks are of the same length. That the cross stick crosses the upright stick at a point one-seventh the distance from top to bottom. That no nails be driven through or into either stick. That the proper method of holding the sticks in place is to wrap them securely together, so that they may be readily taken apart again and folded up for carrying purposes. That the vertical or upright stick be placed so as not to bend, but with its flat side at right angles to the kite cover. That

several sets of sticks should be provided for each cover so that it may be used for flying in different winds, the light sticks being used for the light wind and the heavier sticks for heavier winds. That the cross stick, in order to have the kite fly without a tail, must be bowed, and that the amount of bowing should be measured from the bowstring to the point where the sticks cross and should be equal to one-seventh the length of the stick. That the bowing on each side of the centre should be equal. This may be readily determined

by bowing the stick, placing it upon a flat board and following along the inside of the stick with a pencil, then reversing the position of the stick and comparing the second position of it with the lead pencil mark; wherever there is a variation it may be corrected by carefully sandpapering the stick until the desired result is obtained. This is very important.

In making the kite cover it is a very good idea to use four brass rings at the corners, connected together by picture wire, so that the cover may be removed easily, and it is also a good idea to use similar rings on each end of a piece of picture wire to form the desired bowstring, which, by the way, is always at the rear of the kite. It is not advisable to use paper for the kite covering because it will tear too readily and will not withstand water for very long. A

good, strong, light, and in every way suitable cover may be made from percaline, and if you are not very handy with the sewing machine it will be a good idea to get some female member of your family to make the cover for you.



With a portable radio outfit and a kite these two radio enthusiasts are about to step into their canoe from the pier of the Bayside Yacht Club

the bridle at a point found by bringing the bridle to the tip of the kite, for ordinary flying. If it is desired to make the kite fly on a greater angle, that is "higher," it may be done by moving the kite string further up the bridle. In

most cases this has been found to be bad practice because the kite does not fly steadily but rises to a high point and then falls back.

Several kites, constructed along these lines, may be taken apart and packed in a small space and weigh very little, so it will be seen that they form a very satisfactory means for



In the canoe the antenna is held in place by two small insulators and the kite is somewhere above. The "ground" connection is made by merely dropping a brass rod attached to the ground wire over the side of the canoe

making the aerial, where there are no trees available, such as is the case in the canoe, shown in one of the illustrations.

From these few facts about making kites very satisfactory results may be secured without much difficulty and for all around purposes

where a single kite is to be used the two sticks should measure five feet and their thickness depends upon the condition of the wind, though they never should measure less than one-half by nine-sixteenths inches. Where smaller kites are used it is advisable to fly two or more on the same string which they will carry without much sag. Box kites may be used, but it should be remembered that they do not fly on a very great angle and they require considerably more wind than the kites described. It should be further remembered that kites do not always behave as we would have them do, and it is not safe to fly them with wire for a kite string where they will be at all likely to drop over high tension wires and possibly cause trouble. It is well to be some distance from trolley or other exposed carriers of heavy current. If you use a kite in a canoe, as shown in the photos, be sure that there are a couple of paddles aboard, because the kite may pull you some distance unless you drop an anchor.

INTERCOMMUNICATION

Where two stations are equipped with the same kind of sets, it is a good idea to use the same length of antennae or aerials, and in order to prevent confliction with the law, which requires that amateurs work on a wavelength not to exceed 200 meters, it should be remembered that a single wire 100 feet long will have a wavelength of approximately 150 meters; 200 feet will produce a wave of 270 meters and 300 feet, 375 meters. As kites do not fly very well upon such short strings, it is a good idea to fly the kite on string till it reaches a height of several

hundred feet and then tie the end of the string to the end of the wire.

There are so many varying conditions which govern the amount of money a fellow may spend and the best type of set he can get for his particular purpose for that amount, that it is quite impossible to attempt a description of the most suitable radio equipment, here. If you are in doubt, go to your radio dealer, and if there is none in your town it will be well for you to write to some responsible manufacturer, who will be pleased to direct you in the matter of your purchase. Do not be afraid that he will rob you, because he is as anxious to satisfy you as you are to be satisfied; that is good business.

Once you become interested in radio you will find it very entertaining, especially if you are near some of the large cities, where manufacturers of radio telephone apparatus send out wireless telephone concerts. With a set, such as illustrated here it would be possible to receive music from such a station many miles distant, and by amplifying the received music it would be possible to have the entire summer colony hear the concert. By coöperating with the editor of a country newspaper it would be possible to issue daily the market reports previously described and last, to the author the use which appears of the greatest value is in connection with your Scout activities. Troops may well be several miles apart and communicate with each other by erecting radio stations which may be carried by a single Scout, or strapped to the baggage carrier of a motorcycle or bike, which may be set working within less time than it takes to tell it.

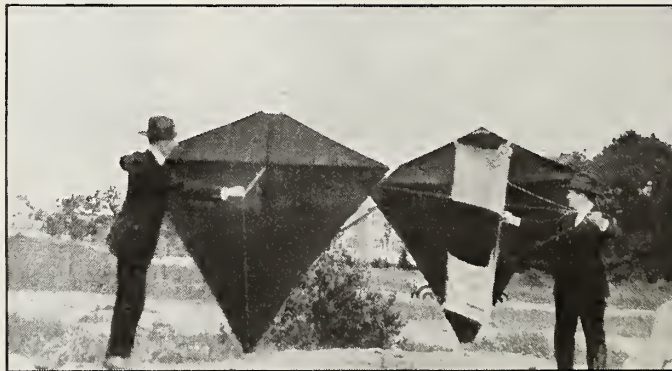

Here are two types of kites employed by the author in experimenting with the portable receiver. For all around use the left hand one is more suitable, but the right hand kite is better for an extremely high wind

Radio panels

and Radio Parts

START right. The panel is the very foundation of your set. High volume and surface resistance are essential factors. Make sure that you get them in both the panels and parts that you purchase. To make doubly certain look for the dealer displaying this sign

CONDENSITE **CELORON** Radio Panel Service

Condensite Celoron Grade 10—approved by the Navy Department Bureau of Engineering—is a strong, handsome, waterproof material, high in resistivity and dielectric strength. It machines easily, engraves without feathering and is particularly desirable for panels. It is also widely used for making many other important radio parts such as tube bases, platform mountings, variable condenser ends, tubes for coil winding, bases, dials, knobs, bushings, etc. We are prepared to make these various parts to your own specifications.

Where economy is a factor we can supply panels of Vulcanized Fibre Veneer made of hard grey fibre veneered, both sides with a waterproof, phenolic condensation product. This material has a hard, smooth, jet black surface, machines and engraves readily and will give excellent service where very high voltages at radio frequencies are not involved.

Shielded plates (patent applied for) are made with a concealed wire shield. This shield, when properly grounded, effectively neutralizes all howl and detuning effects caused by body capacities.

Send to-day for our Radio Panel Guide

Are you an enthusiast? This Guide describes our panels in detail—gives tests—and tells just how much the panel you want will cost.

Are you a Radio Dealer? Let us tell you how easily and profitably Celoron Radio Panel Service enables you to supply your customers with panels machined and engraved to their specifications. Write to-day for our Dealer's Proposition covering panels, dials, knobs and tubes.



Diamond State Fibre Company

Bridgeport (near Philadelphia) Pa.

BRANCH FACTORY AND WAREHOUSE, CHICAGO

Offices in principal cities

In Canada: Diamond State Fibre Co. of Canada, Ltd., Toronto.

Radio in Remote Regions

This department is devoted to stories of the use and benefits of radio communication in regions devoid of telephone and telegraph wires, and which are not reached by cable. Radio is proving a great boon, not only to explorers in the Arctic, the Tropics, and other distant places of the earth, but to mariners and lighthouse tenders on solitary islands, to distant army and trading posts, to hunters in the woods and ships at sea, to station agents at lonely junctions, and even to farmers dwelling in the midst of our country but separated by many days or hours from the news of the rest of mankind. RADIO BROADCAST will welcome any and all incidents which illustrate the value of radio in remote regions, and pay for those accepted at its regular rates.—THE EDITORS.

First Ship to Reach Island in a Year Gave Inhabitants News Three Minutes Old

IT WAS early in the summer of 1921 that the U.S.S. *Hannibal*, doing survey duty in and around Mosquito Cays, Nicaragua, Central America, steamed into the port of Georgetown, Grand Cayman, in the British West Indies south of Cuba. This was the first ship that had entered the harbor in a year, and, says Radioman W. D. Ross, U. S. N. "they sure were glad to see us."

This gladness changed to something akin

received at sea, and presented it to them when we reached port again."

The enthusiasm of the inhabitants of Georgetown, Grand Cayman, can be understood when it is realized that this little island, twenty miles long by five wide, has absolutely no means of communication with the outside world. No telephone, cable, or wireless connects it even to near-by Cuba. There is a small local telephone there, running from the Commissioner's



U. S. S. "HANNIBAL"

to rapture when they discovered that Ross could and would put them into almost instantaneous touch with the news of the outside world. Even stale news was more than welcome.

"They enjoyed the press that I gave them that was months old," says Ross, "and made special trips to the ship to get it. During the Dempsey-Carpentier fight we received the results three minutes after the knockout, picking up the high power station at Marion, Mass., which was sending to London. They were well pleased with the news. We always kept additional copies of our daily radio press

office to the post-office, a distance of one mile, but Radioman Ross was informed that his radiograms to the United States interrupted local telephone conversation. The mile of wire must have acted as a sort of antenna.

It takes months for a letter from the United States or England to reach this island. From the former it leaves Key West for Havana, Cuba, whence it proceeds to the Isle of Pines. Then it must go by steamer to Kingston, Jamaica, and from there by schooner to Georgetown, Grand Cayman. "And schooners," says Radioman Ross, "are scarce."



The end of a perfect howl—

THE squalls of a two year old are as music to the ear beside the howling demonstration put up by a fractious radio set. And how a set can howl unless one offers the soothing influence of the proper amplifying transformer.

Most any transformer can amplify sound, but it will also amplify the stray fields which produce howling and distortion. It takes the Acme Amplifying Transformer with its specially constructed iron core and coil to put an end to the howls and yowls. Only when you add the Acme do you get the realistic tone and volume so markedly absent in the ordinary radio receiving set.

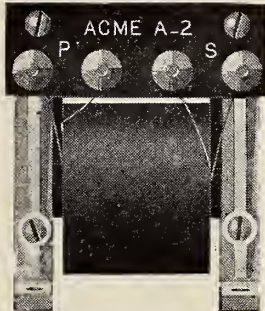

Type A-2 Acme Amplifying Transformer

Price \$5 (East of Rocky Mts.)

The Acme Radio Frequency Transformer greatly increases the range of any receiving set, either vacuum tube or crystal detector type. The Acme Audio Frequency Transformer produces not only volume, but reality of tone. It is indispensable to the satisfactory operation of loud speaking devices. The combination of one or more stages of Acme Radio and Audio Frequency Transformers assures the maximum of range, of volume and of reality in tone.

The Acme Apparatus Company, pioneer radio engineers and manufacturers have perfected not only Radio and Audio Frequency Transformers as well as other receiver units and sets, but are recognized as the foremost manufacturers of Transmitting Apparatus for amateur purposes. Sold only at the best radio stores. The Acme Apparatus Company, Cambridge, Mass., U. S. A., New York Sales Office, 1270 Broadway.

ACME

for amplification

The Grid

QUESTIONS AND ANSWERS

The Grid is a Question and Answer Department maintained especially for the radio amateurs. Full answers will be given wherever possible. In answering questions, those of a like nature will be grouped together and answered by one article. Every effort will be made to keep the answers simple and direct, yet fully self-explanatory. Questions should be addressed to Editor, "The Grid," Radio Broadcast, Garden City, N. Y. The letter containing the questions should have the full name and address of the writer and also his station call letter, if he has one. Names, however, will not be published. The questions and answers appearing in this issue are chosen from among many asked the editor in other capacities.

Care of Vacuum Tubes—Use of Rheostat

My vacuum tube lasted only two weeks. Can you tell me the reason for this?

Will a rheostat improve the action of an audion?

I wish to make a rheostat to use in the filament circuit of my detector tube. What resistance should I use?

How can I make a rheostat for my audion?

A VACUUM tube is a delicate piece of apparatus and must be handled with proper care. The designers have carefully planned the size, shape, and relative positions of its three elements (filament, grid, and plate) and have provided, in most cases, the strongest possible supports for these elements. However these supports are necessarily frail and the tube must not be roughly handled because one or more of the elements will break away from its support and thus the tube will be made useless.

Sometimes jarring a tube will simply loosen an element from its support and the tube will apparently be in perfect condition. Such a tube when used in a receiving set will cause it to "howl" whenever the set is subject to the slightest vibration, such as that caused by a person walking in the room, or a truck or trolley passing in the street. The howling is caused by the to and fro movement of the loose element, which, in turn, causes a variation in the current passing through the tube. This variation of current produces a noise in the telephone receivers which drowns out the desired signals.

As the name implies, the air has been exhausted from the inside of the vacuum tube. Extra special precautions have been taken to get a high vacuum—that is, to get out all the air. The tube is then sealed to its base. Hence no strain should ever be put between the tube and its base as this would be apt to loosen it and allow air to leak in. To sum up, then, a vacuum tube should be handled very carefully. It is as easy to damage as an egg is to break.

Many tubes are burned out by applying too high a voltage to the filament. Never use a voltage higher than that for which the tube is rated. A frequent cause of burning out a tube lies in faulty connections of the plate (B) battery. This battery, which always has a comparatively high potential, has its negative terminal connected to one side of the filament. It often happens that the insulation on the positive lead of the plate battery becomes worn out. Any movement of the receiving set is likely to cause the uninsulated part to come into contact with an uninsulated part of the filament lead. This throws a high potential across the filament and it immediately burns out. It is well to check over the wiring when a tube burns out to see that there is no fault or short circuit in it.

With ordinary care tubes should last a long time. Speaking only of tubes used in receivers or amplifiers, practically the only wear that takes place is in the filament. As is well known, the filament, when heated, emits electrons. Although new electrons take their place, the filament undergoes slow disintegration. Thus with perfect mechanical care a tube will in time become useless. However, much can be done to prolong the life of a tube.

The brighter the filament burns, the more rapidly it disintegrates and hence the filament should be lighted up just enough to give the desired result in the signals. The dimmer the filament is lighted the longer the tube will last. A curve showing how the current passing through a tube varies with the temperature of the filament is shown in Fig. 1. The curve gives a good indication of how a

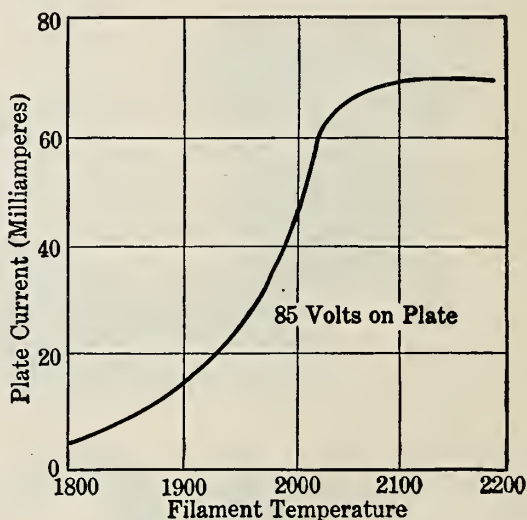

Fig. 1. Curve illustrating electronic flow for various filament temperatures

change in filament temperature changes the number of electrons which it emits. As it is the current passing through the filament which makes it hot, a method of controlling the current will also control the temperature of the filament. Control of the current is secured by the use of a rheostat. A rheostat is a resistance which may be varied at will.

A rheostat in addition to giving control over the brightness of the filament permits it to be heated up and cooled

The Book that brings Radio into the home -

What the Book Contains

Section 1. HOW RADIO ENTERS THE HOME. Contains just the information sought by the man who wants to buy a set. What set shall I buy? How much does it cost? What will it do? This section answers a hundred such questions. All types of sets are described from the least to the most expensive. Full installing and operating instructions.

Section 2. HOW TO RECEIVE MOST EFFICIENTLY. Important receiving accessories are described in language that the layman can understand. For the benefit of the amateur, technical data are given on audio and radio frequency amplification, erection of antennae, battery charging, regeneration, etc. Valuable receiving-circuit diagrams are published for the first time.

Section 3. VACUUM TUBE TRANSMISSION FOR THE AMATEUR AND EXPERIMENTER. Everything from A to Z about transmission with new, completely revised transmitting-diagram, incorporating radiotron transmission and kenotron rectification. Valuable operating instructions are given, and the use of mica condensers for transmission is emphasized.

Section 4. GENERAL INFORMATION - A VERIFIABLE GUIDE BOOK TO RADIO. Government laws, National Electric Code Radio Rules, vacuum-tube "Don'ts," list of broadcasting stations, radio glossary, specifications for a scientifically constructed amateur station, complete price list of all R C A equipment.



Price
35c

FOR the first time a book is published at a small price which gives the public all that it should know about radio. It is called "Radio Enters the Home," and it is written by experts. It tells how to enjoy popular radio broadcasting, and it gives complete descriptions of apparatus and installation instructions. No book so richly illustrated, so accurate, and yet so understandable has thus far been published.

The book is divided into sections. Over 200 illustrations, 112 pages, size 8" x 11". The technically un-informed man will find in sections written especially for him the simply presented facts that he seeks; in other sections are data and diagrams that appeal to the trained amateur.

PRICE, AT YOUR DEALER . . . 35 cents

If your dealer has exhausted his supply, send 35 cents to

Radio Corporation of America
WORLD WIDE WIRELESS

Sales Division, Suite 1807
233 Broadway, New York City

down gradually for it provides a means of gradually turning on, and off the current. This gradual change of temperature of the filament reduces to a minimum the danger of the filament breaking due to the expansion and contraction occurring when a change of temperature takes place. Still other advantages of a rheostat lie in the facts that it gives some control over a noisy amplifier; that it sometimes aids in eliminating interference; and that, by its use, any fluctuation in the filament battery potential may be equalized.

Many detectors and amplifiers are provided with a rheostat, but, in case yours is not, one can be easily made. Three different types are shown in figures 2, 3, and 4. The total amount of resistance should be about one ohm. Less than this may be used if the receiving set has been carefully designed. Bare resistance wire should be used. In figure 2 the resistance wire is wrapped spirally around

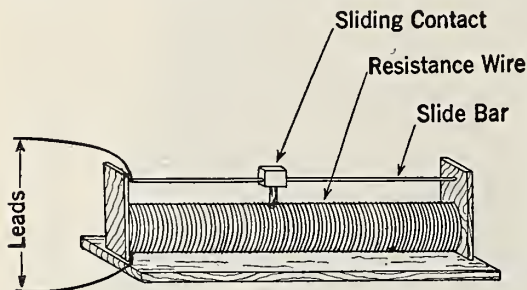

Fig. 2. A typical cylindrical rheostat provided with a slider for altering the number of turns of resistance wire in use

a form made of some insulating material. To one end of the resistance wire and also to the slide bar are spliced wires of negligible resistance to form the leads. The other end of the resistance wire is fastened to the form, but not connected electrically to any other wire. The slide bar is a conductor made of stiff material. The sliding contact should be wide enough to touch two turns of wire as it passes from one to another and narrow enough so that it

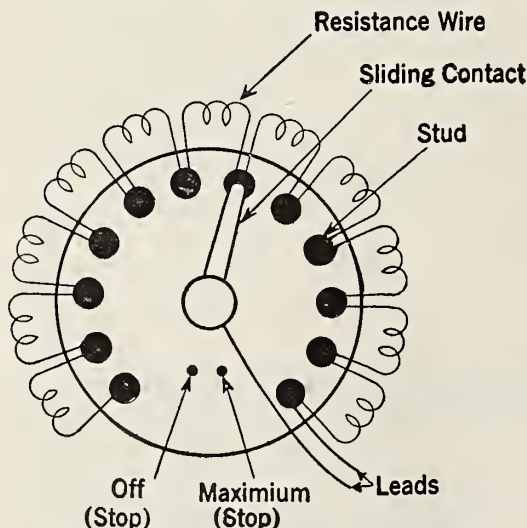

Fig. 3. One method of making a rheostat for front-of-panel mounting. The studs are mounted on the panel and are connected to the resistance coils in the rear

can be made to touch only one turn when it is centred. In winding the resistance wire leave enough space beyond its free end so that the sliding contact can be pushed beyond the wire thus breaking the circuit.

Figure 3 shows how to make a panel rheostat. The studs and the sliding contact are mounted on the face of the panel. The resistance wire, which is soldered to the studs as shown, is in the rear of the panel. Two small stops (Off and Maximum) prevent the contact from being moved too far. The sliding contact must be broad enough to touch both studs as it passes from one to the other and yet narrow enough to touch only one stud when it is centred over it. The leads should be made of wire of low resistance.

A very easily made rheostat is shown in Fig. 4. Resistance wire is wound spirally on a small cylinder ($\frac{1}{4}$ to

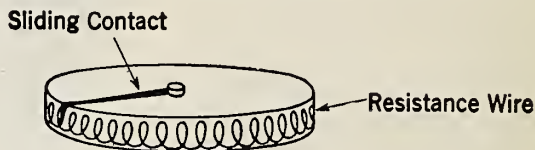

Fig. 4. This is a very popular form of rheostat. The shaft to which the sliding contact is connected is generally made long enough to carry the usual control knob as well as to permit either front or rear of panel mounting. A rheostat of this type permits accurate adjustment of the filament temperature

$\frac{1}{2}$ inch). It is then slipped off and put on the outside of a circular block of insulating material as shown in the figure. A groove must be made on the edge of the block to prevent the wire from slipping out of place. The spiral is stretched just enough to prevent adjacent turns of the wire from touching. As in the other rheostats the wire used for leads must be of low resistance.

The Three-Slide Tuner

Will you please inform me as to the advantage of the three slide type of tuning coil for radio receiving set over the two slide type?

—H. H., Chicago, Ill.

THE question asked will be answered by showing first the necessity of having a flexible coupling between the primary and secondary circuits in the receiving set and then by showing the advantage of the 3-slide tuner over the 2-slide tuner in this respect.

In the receiving set the antenna (primary) circuit is tuned to the frequency of the signals which it is desired to receive. The current in the antenna circuit from these signals becomes large while the current from signals of other frequencies remains small. This is due to the resonance effect obtained by tuning in. It is thus seen that the antenna circuit makes a selection from the radio waves that may be present at the antenna. The secondary, which is also tuned to the desired signals, is another resonant circuit and further eliminates any currents that may arise in the primary from signals which it is not desired to receive.

One of the important factors that necessitates two selective circuits in the receiving set lies in the fact that most of the detectors or rectifiers in use have a high resistance and, if included in the antenna circuit, will give that circuit a high resistance. This is fatal to good selectivity as a study of Fig. 1 will show. This figure shows the current established in a circuit tuned to 400 meters by radio waves of different wavelengths. Three different curves are shown.

WESTINGHOUSE

RADIO

BATTERIES

Eliminate all Battery Troubles from Radio Sets

The Westinghouse "A" Battery is a full capacity, low voltage, slow discharge, long-life storage battery built exclusively for radio work.

For "B" battery requirements Westinghouse has perfected a baby storage battery. No more throwing away exhausted cells. No more continuous "B" battery expense.

The Westinghouse "B" is a permanent battery. It never has to be replaced. It will discharge its load with constant, steady voltage. Then it can easily be recharged. It gives continuous service to the point of exhaustion without growing "scratchy." If your vacuum tube is inclined to be noisy you can adjust the contact on the Westinghouse "B" to take off the exact voltage the V. T. requires.

Get a Westinghouse "A" and "B" from your dealer or the nearest Westinghouse Battery Service Station and eliminate all your radio battery troubles.

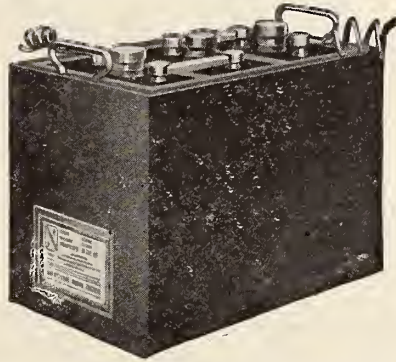

14¾ in. long
2¾ in. wide
3¾ in. high

WESTINGHOUSE
UNION BATTERY CO.
Swissvale, Pa.

*"The best
Westinghouse
can build."*

Curve A shows the response of a circuit of moderate resistance; Curve B shows the response of a circuit of very low resistance; and Curve C shows the response of a circuit

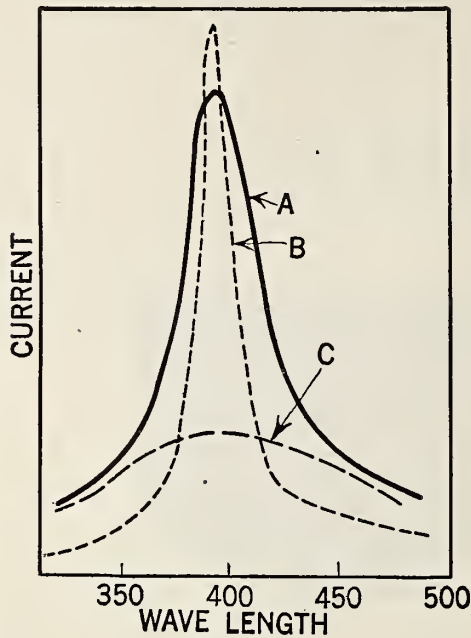

Fig. 1

of high resistance. The last-named circuit is not very selective for it responds almost equally well to many wavelengths. Such would be the response of an antenna circuit having in it a detector of high resistance.

The primary circuit picks up energy and transfers it to the secondary circuit. When two circuits are so arranged that there is a transfer of energy from one to another, the circuits are said to be coupled. Coupling may vary in degree, being "tight" if the effect of one circuit on the other is large; being "loose" if the effect is small. In Fig. 2 is shown how the current in one circuit varied with a change in coupling. The circuits were tuned to each other. Notice that there is a hump in the curve. This means that there is a certain degree for which the current generated in the secondary is greatest.

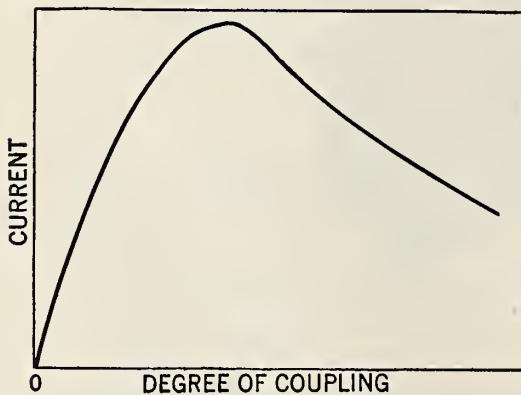

Fig. 2

Another fact about coupled circuits that should be known is that when two circuits are coupled, each circuit has two frequencies at which it will resonate. If the coupling is made loose these frequencies approach each other and may be considered to coincide. Fig. 3 shows the effect on a tuned circuit of coupling to it another circuit tuned to the same frequency. The effect of a tight coupling is shown by curve E. Note that there are two wavelengths to which the tuned circuit will respond well; i.e. there are two humps in the curve. The effect of a very loose coupling is shown by curve F. Here the two frequencies have been brought to coincide but the current produced is very small. Curve D illustrates the use of a correct coupling. There is practically

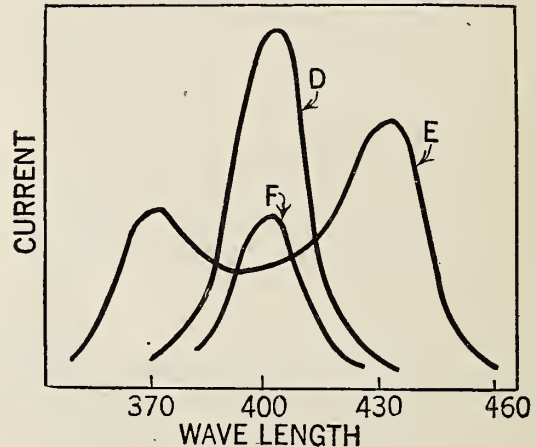

Fig. 3

only one wavelength at which resonance occurs and the current is comparatively large. Coupling adjustment is an important factor in clear reception as can be seen from the above discussion. The correct coupling for any signal is found by trial. In other words, the coupling is varied until the desired result in the signal is obtained.

There are various ways of coupling one circuit to another. The 3-slide tuner uses direct coupling. Part of the coil 1 (Fig. 4) is common to the primary circuit, A-I-G, and also to the secondary circuit, C2-K-I-N. The connection is thus a direct one. This coil is often called an auto-transformer because the coil transfers the oscillations of one circuit to another and is a part of each circuit. The degree of coupling between the two circuits depends upon the amount of inductance common to both circuits as compared to the amount of inductance in each of the two circuits. It is seen that the amount of inductance in the antenna circuit is governed by the position of the slider, S. The positions of the two sliders, K and N, govern the amount of inductance in the secondary circuit and also the amount of inductance common to both circuits.

In general, the advantage of the 3-slide tuner over the 2-slide tuner lies in the fact that the former is more flexible than the latter. (A 2-slide tuner would be one in which either one of the contacts, K or N, was immovably connected to its end of the coil.) This greater flexibility, gained by having the third contact movable, allows better tuning and coupler adjustments.

One particular advantage of the 3-slide over the 2-slide tuner lies in the fact that for any given degree of coupling,

HOMMEL

Radio Equipment Service For the Dealer

HOW much of an investment must I be prepared to make?

How much of this, that, and other things should I carry?

These are the most vital of the many questions which the prospective dealer must answer—

We can help you answer them, because we have a Dealer Service Department which is devoted to the study of markets, turn-over, the proper selection of radio equipment and other subjects that concern the dealer.

Furthermore, we are distributors for more than 40 of the most prominent manufacturers, and are usually in position to supply most of the dealer's needs from our large stocks.

Write us about your problems—our service will not obligate you in any way.

Catalogue No. 100 B sent upon request.

WHOLESALE ONLY

LUDWIG HOMMEL & CO

530-534 FERNANDO ST.



PITTSBURGH, PENNA

DISTRIBUTORS FOR

Radio Corporation of America	
Westinghouse	
General Electric	
Murdock	Acme
Fada	Rhamstine
Remler	Kellogg
Frost	Holtzer-Cabot
Brandes	Connecticut
Pacent	Burgess
General Radio	Hipco
Radio Service	Homcharger
De Forest	Brach
Baldwin	Chelsea
Signal	Arkay
	Clapp-Easthan

and other leading manufacturers

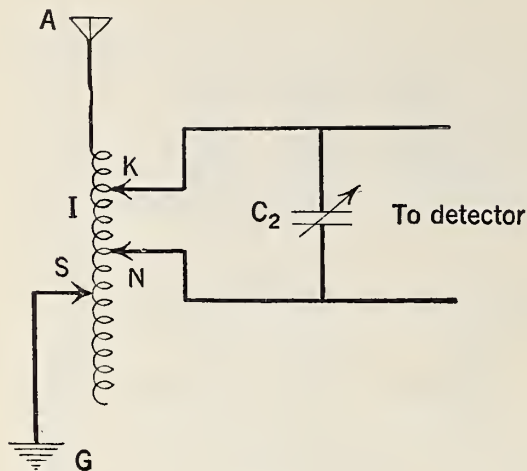

Fig. 4

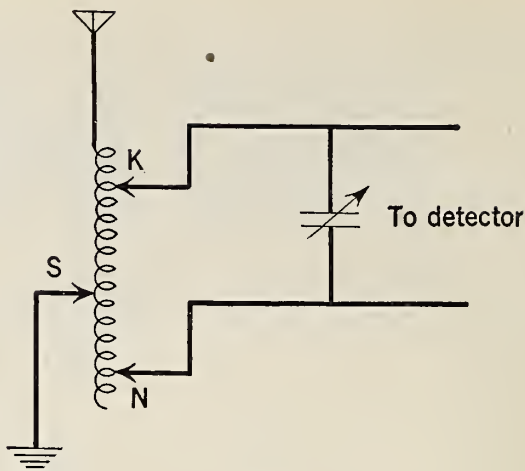

Fig. 5

there is allowed a wider range in the amount of inductance that may be used and hence a greater tuning range for the secondary circuit. A comparison of Fig. 4 and Fig. 5 will make this clear. The amount of inductance in the secondary circuit is greatly different yet the coupling is practically the same. In Fig. 4 the inductance common to both circuits (this is the greatest factor in determining degree of coupling) is that between K and N. In Figure 5 it is that between K and S. The latter is slightly larger than the former in order to compensate for the increase of inductance in the secondary circuit. This slight increase is necessary in order to keep the coupling the same. Of course the inductances between K and N and between K and S could have been made equal if desired.

This control over the amount of inductance in the secondary allows a wide variation in the relative values of the inductance and capacity in the secondary. Thus it permits their adjustment for the best efficiency of the detector. It makes possible the use of a "stiff" circuit, that is, one having a comparatively large inductance. It often happens that the relative resistances, due to faulty construction, etc., of the inductance and capacity vary greatly for their different values. The flexibility gained by the use of the 3-slide tuner enables a greater choice in the values of the capacity and inductance used in tuning in and thus permits one to get an adjustment at which the resistance is the minimum obtainable with that particular circuit.

Present Radio Broadcasting Stations in the United States

List of stations broadcasting market or weather reports (485 meters) and music, concerts, lectures, etc. (360 meters).

OWNER OF STATION	LOCATION OF STATION	WAVE LENGTHS	CALL SIGNAL
Alabama Power Co.	Birmingham, Ala.	360	WSY
Aldrich Marble & Granite Co. C. F.	Colorado Springs, Colo.	485	KHD
Allen, Preston, D.	Oakland, Calif.	360	KZM
Altadena Radio Laboratory	Altadena, Calif.	360	KGO
American Radio & Research Corporation	Medford Hillside, Mass.	360	WGI
Anthony, Earl C.	Los Angeles, Calif.	360	KFI
Arrow Radio Laboratories	Anderson, Ind.	360	WMA
Atlanta Constitution	Atlanta, Ga.	360, 485	WGM
Atlanta Journal	Atlanta, Ga.	360, 485	WSB
Atlantic-Pacific Radio Supplies Co.	Oakland, Calif.	360	KZY
Auburn Electrical Co.	Auburn, Me.	360	WMB
Bamberger & Co. L.,	Newark, N. J.	360	WOR
Beacon Light Co.	Los Angeles, Calif.	360	KNR
Benwood Co.	St. Louis, Mo.	360	WEB
Bible Institute of Los Angeles	Los Angeles, Calif.	360	KJS
Blue Diamond Electric Co.	Hood River, Ore.	360	KQP
Bradley Polytechnic Institute	Peoria, Ill.	360	WBAE
Braun Corporation	Los Angeles, Calif.	360	KXS



Stop Buzzing and Sizzling

FORMICA insulation for Radio use is perfect insulation! It prevents buzzing, sizzling and noise that makes it hard to hear over your radio telephone.

There are no weak places in Formica panels. They are not affected by moisture and weather conditions and do not deteriorate. They will give perfect service for years.

Formica is the most widely used radio insulation. It is approved by the Navy and the Signal Corps. It is a thoroughly high quality product—the finest possible insulating material all the way through! It contains no absorbent matter that will take up water and lose its insulating strength through humidity and moisture.

Formica panels have a handsome gloss or satin finish—black and natural brown.

Dealers: We have now in operation an addition to our plant which doubles our previous capacity. Back orders for Formica are being shipped rapidly. We always do our utmost to serve you promptly.

The Formica Insulation Company

4628 Spring Grove Avenue,

Cincinnati, Ohio

Sales Offices

50 Church Street, New York, N. Y.

9 South Clinton Street, Chicago, Ill.

414 Finance Building, Cleveland, Ohio

1042 Granite Building, Rochester, N. Y.

422 First Ave., Pittsburgh, Pa.

Sheldon Building, San Francisco, Cal.

932 Real Estate Trust Bldg., Philadelphia, Pa.

321 Title Building, Baltimore, Md.

415 Ohio Bldg., Toledo, Ohio

FORMICA

Made from Anhydrous Redmanol Resins

SHEETS TUBES RODS

PRESENT RADIO BROADCASTING STATIONS IN THE UNITED STATES—Continued

OWNER OF STATION	LOCATION OF STATION	WAVE LENGTHS	CALL SIGNAL
Buckeye Radio Service Co.	Akron, Ohio.	360	WOE
Bullock's	Los Angeles, Calif.	360	KNN
Bush, James L.	Tuscola, Ill.	360	WDZ
Central Radio Co.	Kansas City, Mo.	360	WPE
Church of the Covenant	Washington, D. C.	360	WDM
Chicago, City of	Chicago, Ill.	360	WBU
Cino Radio Mfg. Co.	Cincinnati, O.	360	WIZ
City Dye Works & Laundry Co.	Los Angeles, Calif.	360	KUS
Clark University	Worcester, Mass.	360,485	WCN
Coast Radio Company	El Monte, Calif.	360	KUY
Columbia Radio Co.	Youngstown, O.	360	WMC
Commonwealth Electric Co.	St. Paul, Minn.	360	WAAH
Continental Electric Supply Co.	Washington, D. C.	360	WIL
Cooper, Irving S.	Los Angeles, Calif.	360	KZI
Cosradio Co.	Wichita, Kansas.	360,485	WEY
Cox, Warren R.	Cleveland, O.	360	WHK
Crosley Manufacturing Co.	Cincinnati, O.	360	WLW
Daily News Printing Co.	Canton, O.	360	WWB
Dallas, City of	Dallas, Tex.	360,485	WRR
Dayton Co.	Minneapolis, Minn.	360	WBAH
DeForest Radio Telephone & Telegraph Co.	New York, N. Y.	360	WJX
Deseret News	Salt Lake City, Utah.	360	KZN
Detroit News	Detroit, Michigan	360,485	WWJ
Detroit Police Dept.	Detroit, Michigan	360	KOP
Diamond State Fibre Co.	Bridgeport, Pa.	360	WBAG
Doerr-Mitchell Electrical Co.	Spokane, Wash.	360	KFZ
Doran Brothers Electrical Co.	Hamilton, O.	360	WRK
Doubleday-Hill Electrical Co.	Pittsburgh, Pa.	360	KOV
Doubleday-Hill Electrical Co.	Washington, D. C.	360	WMU
Duck Co., William B.	Toledo, Ohio	360	WHU
Dunn & Co., J. J.	Pasadena, Calif.	360	KLB
Eastern Radio Institute	Boston, Mass.	360	WAAJ
Electric Equipment Co.	Erie, Pa.	360	WJT
Electric Lighting Supply Co.	Hollywood, Calif.	360	KGC
Electric Power & Appliance Co.	Yakima, Wash.	360	KQT
Electric Supply Co.	Clearfield, Pa.	360	WPI
Elliott Electric Co.	Shreveport, La.	360	WAAG
Emporium, The	San Francisco, Calif.	360	KSL
Erie Radio Co.	Erie, Pa.	360	WSX
Examiner Printing Co.,	San Francisco, Calif.	360	KUO
Fair, The	Chicago, Ill.	360	WGU
Federal Institute of Radio Telegraphy	Camden, N. J.	360	WRP
Federal Telephone & Telegraph Co.	Buffalo, N. Y.	360,485	WGR
Fergus Electric Co.	Zanesville, O.	360	WPL
Findley Electric Co.	Minneapolis, Minn.	360	WCE
First Presbyterian Church	Seattle, Wash.	360	KTW
Ford Motor Co.	Dearborn, Mich.	360	WWI
Fort Worth Record	Fort Worth, Tex.	360	WPA
Foster-Bradbury Radio Store	Yakima, Wash.	360	KFV
General Electric Co.	Schenectady, N. Y.	360	WGY
Gilbert Co., A. C.	New Haven, Conn.	360	WCJ
Gimbel Brothers	Milwaukee, Wisc.	360	WAAK
Gimbel Brothers	Philadelphia, Pa.	360	WIP
Gould, C. O.	Stockton, Calif.	360	KJQ
Groves-Thornnton Hardware Co.	Huntington, W. Va.	360	WAAR
Hale & Co.	San Jose, Calif.	360	KSC
Hallock & Watson Radio Service	Portland, Ore.	360	KGG
Hamilton Manufacturing Co.	Indianapolis, Ind.	360	WLK
Hatfield Electric Co.	Indianapolis, Ind.	360	WOH
Hawley, Willard P. Jr.	Portland, Ore.	360	KYG
Herald Publishing Co.	Modesto, Calif.	360	KXD
Herrold, Charles D.	San Jose, Calif.	360	KQW
Hobrecht, J. C.	Sacramento, Calif.	360	KVQ
Hollister-Miller Motor Co.	Emporia, Kansas	360	WAAZ
Holzwasser Inc.	San Diego, Calif.	360	KON
Howe, Richard H.	Granville, Ohio.	360	WJD
Howlett, Thomas. F. J.	Philadelphia, Pa.	360	WGL
Hunter, L. M. & G. L. Carrington	Little Rock, Ark.	360	WSV
Hurlburt-Still Electrical Co.	Houston, Tex.	360,485	WEV
Interstate Electric Co.	New Orleans, La.	360	WGV
Iowa Radio Corporation.	Des Moines, Iowa.	360	WHX

The Multiple Storage Battery Corporation Announces **RADIOBAT "B"**

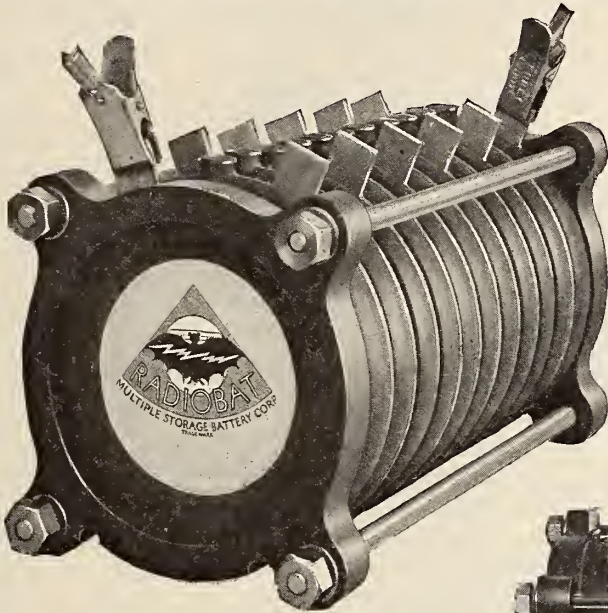

The Most Remarkable "B" Type Radio Battery. Revolutionary in Design and Construction.

Radiobat "B" is practically everlasting. It has no glass to break, no wooden case to rot, no separators of any kind.

Radiobat "B" is leak proof, it is free from acid fumes.

Any voltage desired can be obtained simply and easily.

Radiobat "B" will give a clearer tone to your Radio.

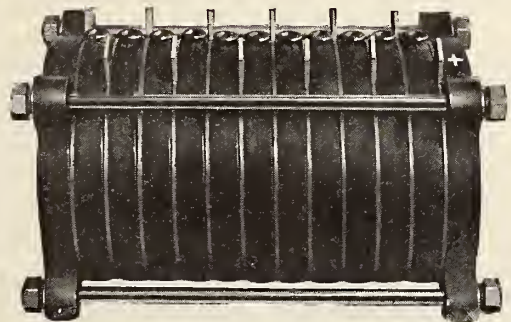

As Radiobat "B" has just been placed on the market, it is possible that your regular dealer will not be able to supply it. If this is the case, write us to-day enclosing \$12.00, the price of this extraordinary battery.

Also for Laboratories and Experimenters interested in high voltage with low amperage.

Dealers write at once for our proposition

**MULTIPLE
STORAGE BATTERY CORP.**



Established 1908

350 Madison Avenue

New York

PRESENT RADIO BROADCASTING STATIONS IN THE UNITED STATES—Continued

OWNER OF STATION	LOCATION OF STATION	WAVE LENGTHS	CALL SIGNAL
J. & M. Electric Co.	Utica, N. Y.	360	WSL
K. & L. Electric Co.	McKeesport, Pa.	360	WIK
Kansas State Agricultural College	Manhattan, Kansas	485	WTG
Karlowa Radio Co.	Rock Island, Ill.	360,485	WOC
Kennedy Co., Colin B.	Los Altos, Calif.	360	KLP
Kierulff & Co., C. R.	Los Angeles, Calif.	360	KHJ
Kluge, Arno A.	Los Angeles, Calif.	360	KQL
Kraft, Vincent I.	Seattle, Wash.	360,485	KJR
Lindsay, Weatherill & Co.	Reedley, Calif.	360	KMC
Los Angeles Examiner	Los Angeles, Calif.	360	KWH
Love Electric Co.	Tacoma, Wash.	360	KMO
Loyola University	New Orleans, La.	360	WWL
Marshall-Gerkin Co.	Toledo, Ohio.	360	WBA
Maxwell Electric Co.	Berkeley, Calif.	360	KRE
May (Inc.) D. W.	Newark, N. J.	360	WBS
McBride, George M.	Bay City, Mich.	360	WTP
McCarthy Bros. & Ford	Buffalo, N. Y.	360	WWT
Metropolitan Utilities District	Omaha, Nebraska	360,485	WOU
Meyberg Co., Leo J.	Los Angeles, Calif.	360,485	KYJ
Meyberg Co., Leo J.	San Francisco, Calif.	360,485	KDN
Middleton, Fred M.	Morestown, N. J.	360	WBAFG
Midland Refining Co.	El Dorado, Kansas	485	WAH
Midland Refining Co.	Tulsa, Okla.	485	WEH
Millikin University James,	Decatur, Ill.	360	WBAO
Minnesota Tribune Co. & Anderson Beamish Co.	Minneapolis, Minn.	360	WAAL
Missouri State Marketing Bureau.	Jefferson City, Mo.	485	WOS
Modesto Evening News	Modesto, Calif.	360	KOQ
Montgomery Light & Power Co.	Montgomery, Ala.	360,485	WGH
Mullins, Electric Co., Wm. A.	Tacoma, Wash.	360	KGB
Mulrony, Marion A.	Honolulu, Hawaii	360	KGU
Nelson Co. I. R.	Newark, N. J.	360	WAAM
New England Motor Sales Co.	Greenwich, Conn.	360	WAAG
New Mexico College of Agriculture and Mechanical Arts.	State College, N. Mex.	360,485	KOB
Newspaper Printing Co.	Pittsburgh, Pa.	360	WPB
Noggle Electric Works	Monterey, Calif.	360	KLN
North Coast Products Co.	Aberdeen, Wash.	360	KNT
Northern Radio & Electric Co.	Seattle, Wash.	360	KFC
Northwestern Radio Manufacturing Co.	Portland, Ore.	360	KGN
Nushawg Poultry Farm	New Lebanon, Ohio.	360	WPG
Oklahoma Radio Shop	Oklahoma City, Okla.	360,485	WKY
Oregonian Publishing Co.	Portland, Ore.	360	KGW
Palladium Printing Co.	Richmond, Ind.	360,485	WOZ
Paris Radio Electric Co.	Paris, Tex.	360	WTK
Pennsylvania State Police	Harrisburg, Pa.	360	WBAX
Pine Bluff Co.	Pine Bluff, Ark.	360	WOK
Pomona Fixture & Wiring Co.	Pomona, Calif.	360	KGF
Portable Wireless Telephone Co.	Stockton, Calif.	360	KWG
Post Dispatch.	St. Louis, Mo.	360	KSD
Precision Equipment Co.	Cincinnati, Ohio.	360,485	WMH
Precision Shop, The	Gridley, Calif.	360	KFU
Prest & Dean Radio Research Laboratory	Long Beach, Calif.	360	KSS
Public Market & Department Stores Co.	Seattle, Wash.	360	KZC
Purdue University	West Lafayette, Ind.	360	WBAA
Radio Construction & Electric Co.	Washington, D. C.	360	WDW
Radio Service Co.	Charleston, W. Va.	360	WAAO
Radio Shop, The	Sunnyvale, Calif.	360	KJJ
Radio Telephone Shop, The	San Francisco, Calif.	360	KYY
Radio Supply Co.	Los Angeles, Calif.	360	KNV
Register & Tribune, The	Des Moines, Iowa.	360	WGF
Rennysen, I. B.	New Orleans, La.	360	WBAM
Reynolds Radio Co.	Denver, Colorado	360,485	KLZ
Ridgewood Times Printing & Publishing Co.	Ridgewood, N. Y.	360	WHN
Riechman-Crosby Co.	Memphis, Tenn.	360,485	WKN
Rike-Kumler Co.	Dayton, Ohio.	360,485	WFO
Rochester Times Union	Rochester, N. Y.	360,485	WHQ
Roswell Public Service Co.	Roswell, N. Mex.	360	KNJ
St. Joseph's College	Philadelphia, Pa.	360	WPJ
St. Louis Chamber of Commerce	St. Louis, Mo.	360	WAAE
St. Louis University,	St. Louis, Mo.	485	WEW
St. Martins College (Rev. S. Ruth)	Lacey, Wash.	360	KGY
San Joaquin Light & Power Corporation.	Fresno, Calif.	360	KMJ

Exide

BATTERIES



For uniform filament current

To meet the requirements of radio service, the Exide Radio Battery was specially designed for the maintenance of a uniform voltage during a long period of discharge. You will take great satisfaction in a battery whose voltage does not drop quickly to a point where frequent adjustment of the apparatus is necessary.

Plates, separators, jars, terminals, every part and each detail of this battery is the result of the experience of the makers of Exide in building batteries for every purpose since the beginning of the storage battery industry.

Exide Batteries are used by governments and great industries all over the world. They propel mine locomotives and submerged submarines; they operate the fire alarm system and send your voice over the Bell telephone. Most of the government and Radio Corporation wireless plants are equipped with Exide Batteries.

You can get Exide Radio Batteries at every place where radio equipment is sold and also at all Exide Service Stations.

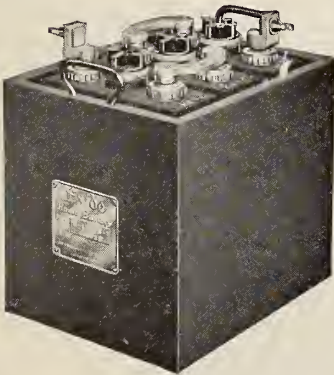

THE ELECTRIC STORAGE BATTERY CO.
Philadelphia

*Oldest and largest manufacturers in the world of
storage batteries for every purpose*

PRESENT RADIO BROADCASTING STATIONS IN THE UNITED STATES—Continued

OWNER OF STATION	LOCATION OF STATION	WAVE LENGTHS	CALL SIGNAL
Seeley, Stuart, W.	East Lansing, Mich.	485	WHW
Service Radio Equipment Co.	Toledo, Ohio.	360	WJK
Ship Owners Radio Service	New York, N. Y.	360	WDT
Snip Owners Radio Service	Norfolk, Va.	360	WSN
Shotton Radio Manufacturing Co.	Albany, N. Y.	360	WNJ
Southern Electrical Co.	San Diego, Calif.	360	KDPT
Southern Radio Corporation	Charlotte, N. C.	360	WBT
Spokane Chronicle	Spokane, Wash.	360	KOE
Standard Radio Co.	Los Angeles, Calif.	360	KJC
Sterling Electric Co. & Journal Printing Co.	Minneapolis, Minn.	360	WBAD
Stix-Baer-Fuller	St. Louis, Mo.	360	WCK
Strawbridge & Clothier	Philadelphia, Pa.	360	WFI
Stubbs Electric Co.	Portland, Ore.	360	KQY
T. & H. Radio Co.	Anthony, Kansas	360	WBL
Tarrytown Radio Research Laboratory	Tarrytown, N. Y.	360	WRW
Taylor, Otto W.	Wichita, Kansas.	360	WAAP
Thearle Music Co.	San Diego, Calif.	360	KYF
Tulane University of Louisiana.	New Orleans, La.	360	WAAC
Union College	Schenectady, N. Y.	360	WRL
Union Stock Yards & Transit Co.	Chicago, Illinois	360,485	WAAF
United Equipment Co.	Memphis, Tenn.	360	WPO
University of Illinois	Urbana, Illinois	360	WRM
University of Minnesota.	Minneapolis, Minn.	360,485	WLB
University of Missouri	Columbia, Mo.	360	WAAN
University of Texas	Austin, Texas	360,485	WCM
University of Wisconsin	Madison, Wisconsin	360,485	WHA
Wanamaker, John	Philadelphia, Pa.	360	WOO
Wanamaker, John	New York, N. Y.	360	WWZ
Warner Brothers	Oakland, Calif.	360	KLS
Wasmer, Louis	Seattle, Wash.	360	KHQ
West Virginia University	Morgantown, W. Va.	360	WHD
Western Radio Co.	Kansas City, Mo.	360,485	WOQ
Western Radio Electric Co.	Los Angeles, Calif.	360	KOG
Westinghouse Electric & Manufacturing Co.	East Pittsburgh, Pa.	360	KDKA
Westinghouse Electric & Manufacturing Co.	Chicago, Ill.	360,485	KYW
Westinghouse Electric & Manufacturing Co.	Newark, N. J.	360	WJZ
Westinghouse Electric & Manufacturing Co.	Springfield, Mass.	360	WBZ
White & Boyer Co.	Washington, D. C.	360	WJH
Williams, Thomas J.	Washington, D. C.	360	WPM
Wireless Phone Corporation	Paterson, N. J.	360	WBAN
Wireless Telephone Co. of Hudson County, N. J.	Jersey City, N. J.	360	WNO
Yeiser, John O. Jr.	Omaha, Nebraska	360	WDV
Young Men's Christian Association	Denver, Colo.	485	KOA
Zamoiski Co., Joseph M.	Baltimore, Md.	360	WKC

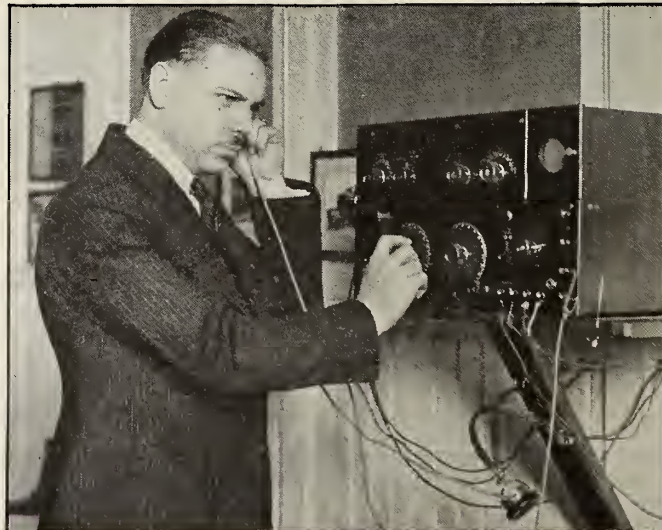

Radio Broadcasting has been perfected to a degree where the appearance of the Critic has become necessary. The public demands the highest class of entertainment, and large radio broadcasting stations check up their own work in this manner

AUGUST, 1922

PRICE 25 CENTS

RADIO BROADCAST

RADIO FOR EVERY PLACE AND PURPOSE



Will Antennas be Buried
in the Backyard

- The Storage
- Battery in Radio
- How Opera is Broadcast
- Marconi on
- Radio Telegraphy

DOUBLEDAY, PAGE & COMPANY, Garden City, N. Y.

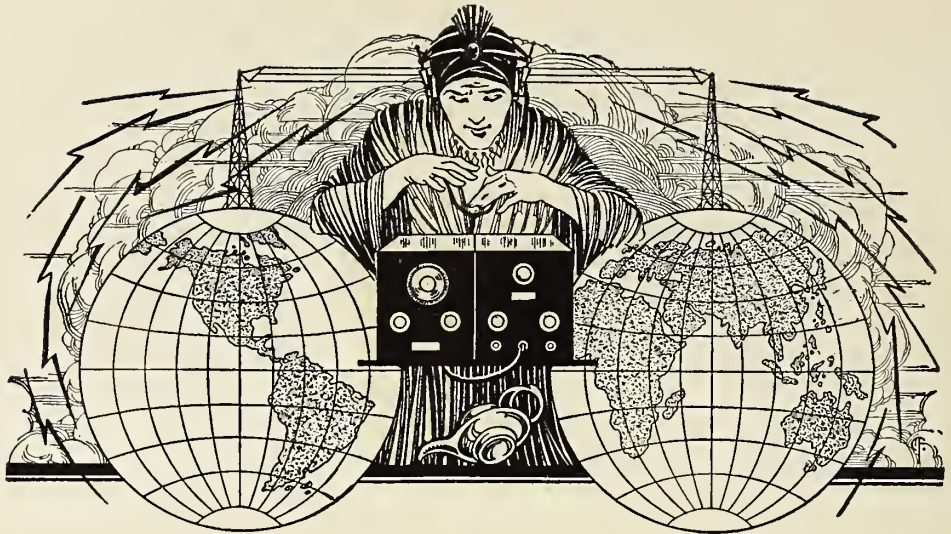

The Magic of Radio Brings Together the Ends of the World

Among the triumphs of inventive genius which have brought the miracles of radio into the lives and homes of millions of people, none so precisely meets the exacting requirements of this new science as the

Westinghouse Type RC Receiver

As national distributors of the products of leading manufacturers of radio equipment, we are at all times in position to make immediate quantity deliveries on this superior and popular instrument, as well as

Westinghouse Aeriola Grand Westinghouse Aeriola Sr. Westinghouse Aeriola Jr.

Write us to-day for descriptive pamphlets and full information concerning radio equipment of every kind

20th CENTURY RADIO CORP.

Executive Offices: 565 Fifth Ave., New York, N. Y.
Straus Building, Suite 710 Telephone: Murray Hill 6548

National Radio Distributors

Radio Broadcast

ROY MASON, EDITOR

ARTHUR H. LYNCH, TECHNICAL EDITOR



CONTENTS FOR AUGUST, 1922

<i>Prof. Michael I. Pupin</i> - - - - -	<i>Frontispiece</i>
THE MARCH OF RADIO - - - - -	279
BEWARE OF RADIO STOCK OFFERINGS - - - - -	284
HOW OPERA IS BROADCASTED - - - - -	C. E. LE MASSENA 285
ADDITIONAL BROADCASTING STATIONS IN THE UNITED STATES - - -	293
WHAT EVERYONE SHOULD KNOW ABOUT RADIO HISTORY, PART II	
PROF. J. H. MORECROFT	294
WILL ANTENNAS BE BURIED IN THE BACKYARD? - - - -	LEWIS WOOD 303
THE STORAGE BATTERY IN RADIO SERVICE - - - - -	JOHN GAREY 308
RADIO FREQUENCY AMPLIFICATION - - - - -	ZEH BOUCK 312
CLEARING UP THE ETHER - - - - -	PAUL F. GODLEY 316
BROADCASTING CHURCH SERVICES - - - - -	W. W. RODGERS 321
A FEW IDEAS ON RADIO - - - - -	W. D. TERRILL 330
A REVIEW OF RADIO - - - - -	LEE DE FOREST, PH.D., D.S.C. 332
RADIO TELEGRAPHY - - - - -	GUGLIELMO MARCONI 341
SHARPNESS OF TUNING IN A RADIO RECEIVER - - -	JOHN V. L. HOGAN 348
PROGRESS OF RADIO IN FOREIGN LANDS - - - - -	352
THE GRID—QUESTIONS AND ANSWERS - - - - -	358
NEW EQUIPMENT - - - - -	364

Copyright, 1922, by Doubleday, Page & Co. All rights reserved
 TERMS: \$3.00 a year; single copies 25 cents

F. N. DOUBLEDAY, Pres.

RUSSELL DOUBLEDAY, Sec'y.

ARTHUR W. PAGE, Vice-Pres.

S. A. EVERITT, Treas.

NELSON DOUBLEDAY, Vice-Pres.

JOHN J. HESSIAN, Asst. Treas.

DOUBLEDAY, PAGE & CO.

THE WORLD'S WORK

COUNTRY LIFE

THE GARDEN MAGAZINE

SHORT STORIES

EDUCATIONAL REVIEW

CHICAGO: People's Gas Bldg.

GARDEN CITY, N. Y.

NEW YORK: 120 W. 32nd Street

BOSTON: Tremont Bldg.

LOS ANGELES: Van Nuys Bldg.



© Underwood & Underwood

PROFESSOR MICHAEL I. PUPIN

Head of the Electro-mechanical Department of Columbia University, New York

AUG 11 1922

© Cl B 533241c

RADIO BROADCAST

Vol. 1 No. 4



August, 1922

The March of Radio

RADIO MIGHT HAVE PREVENTED THIS ACCIDENT

THESE are still definite, important, applications which we are slow to perceive and put into effect. Years ago Professor Trowbridge suggested the scheme of using loops of wire, strung in the rigging of a ship, for sending out and receiving messages over short distances, but in so far as we know his scheme was never actually installed. His idea of using audio frequency currents through the transmitting loops would have required quite powerful apparatus to make it sufficiently serviceable to warrant the expense of upkeep of the sets. The distance over which communication could have been carried out was rather small.

With the use of high frequency radio currents, however, the idea Trowbridge put forth is easy of accomplishment, and there is no good reason why it should not have been in operation while the *Egypt* was proceeding cautiously down the French coast, through a thick fog. We read: "For some time previous to the crash the vessel had been going very slow on account of the fog and *the usual fog precautions had been taken* (italics ours). Not until there was no possibility of avoiding the accident, it appears, did the watch officers on either vessel become conscious of the proximity of the other."

So we are evidently to conclude that this was an unavoidable accident, one to which each of us is exposed when afloat, even when all the usual fog precautions have been taken! Blow-

ing the fog whistle—and stationing extra lookouts at the bow—these were probably the usual precautions. Now it is evident to any one who has passed through fog banks that the extra lookouts are nothing but a form; they might tell the navigating officer that he was going to hit a vessel a few seconds before the crash occurred and that's about all the use they would be.

The fog whistle, with its penetrating roar, is probably the best protection we have to-day, but those who have made experiments on sound transmission know that there are silent spots, or zones, in which the sound of the fog whistle may not be heard even though the vessel may be close to the source of the sound. These silent zones occur because of the refractions and reflections of the sound waves by the dense fog banks and they shift around in haphazard fashion. And even though the fog whistle is heard, its direction is often problematical because of these same effects.

Now, a proper radio installation on board a ship would make practically impossible such an accident as that which caused the loss of a hundred lives on the *Egypt*. It will of course be said that there was undoubtedly radio apparatus on board. Of course there was, but this apparatus was also undoubtedly being used at the time of the collision, to listen on the 600-meter wavelength—to listen for distress signals from other possible collisions!

How should this possibility of collision in

fog be avoided? It seems that an extremely simple and feasible expedient would be to have an extra radio set on board, which would be used when passing through a fog, this extra set to be manned in addition to the regular set. The transmitter should be a non-directional, low-powered, set to send at perhaps 100 meters, to send sufficient power to be heard a mile or so. The transmitter would be kept in operation automatically, sending out a dash perhaps every five seconds, and the special fog operator would be listening on a 100-meter wavelength by means of a rotatable loop, or radio compass. This listening loop could be kept rotating automatically until a signal was picked up, and then the operator could stop its motion and at once locate the direction of the source of the special wavelength signal.

Just as the ordinary radio set has decreased tremendously the dangers from collisions at sea (after they have happened) so this fog radio would tremendously decrease the possibility of collision, that is, it is a preventive measure rather than a remedial measure. The apparatus being low powered and of such short wavelength, would cause no interference at all with regular traffic, and the outfit could be manned without any extra number of operators, in fact, as it would not be necessary for this operator to read Morse, he might be one of the ship's crew, working under the ship's regular operator. In the future the putting into operation of this special fog radio should form a part of the "usual fog precautions," which, in the case of the *Egypt*, proved so inadequate.

THE PASSING OF THE "RADIO REVIEW"

SHORTLY after the close of the war there was projected in England a high class, scientific journal on Radio; tentative subscriptions having warranted a start, it began publication in October, 1919. Its first editorial, by G. W. O. Howe, sounded its policy. "The sole aim of the *Radio Review* will be to record the scientific developments of radio telegraphy and of those branches of allied sciences which are related to that subject." True to this aim, its standards were held high, meaning by high, such treatment of the subject matter as would appeal to the specially trained radio engineer. Its appeal was necessarily to a rather narrow field of subscribers, and like all such truly scientific journals, its publication costs exceeded the income from subscribers and advertisers; the subscription rates were raised

to the rather excessive amount of about \$14 (five pounds) per year, but the high cost of paper and printing have forced its suspension.

It is intended by the editors to continue the publication of scientific articles in connection with the *Wireless World*, which has been renamed *The Wireless World and Radio Review*. We regret exceedingly the suspension of the *Radio Review*; during its short life, the radio engineers have received from its columns a great deal of valuable and much appreciated information. It is to be hoped that the section of the new magazine can keep the quality of its scientific section up to the excellent standard set by its suspended predecessor.

UNDERWRITER'S REQUIREMENTS

THE National Board of Fire Underwriters apparently believe in playing safe in their bets against fires. The apparently harmless receiving antenna at first received rather strenuous treatment at their hands and if any one, dwelling, let us say, on the tenth floor of an apartment house in New York City, had complied with their requirements of a few months ago, the antenna installation, instead of being a rather small part of the cost of an installation would have cost as much as the whole receiving set, even including the tubes!

The requirements of the Underwriters are gradually becoming more sane; their latest modifications seem eminently reasonable and easy to comply with. A few months ago a No. 4 wire was required for the ground connection, installed in a very particular fashion; later a No. 8 wire was acceptable, and now a No. 14 copper wire or a No. 17 copper-clad steel is allowed for the ground connection, and this same ground connection may be used as the ground wire of the set. A lightning discharger, or protective device, is still required, but the types allowed are comparatively cheap and easily installed.

Evidently feeling that inside antennas do not cause an extra fire risk, no provisions are given regarding their installation. It is to be pointed out, however, that an antenna located in the attic of a wooden house is probably a greater fire hazard than one of equal height installed outside, by the side of the house. If we accept the general assumption that such antennas "attract" lightning, it is a fact that both antennas do it equally well, and so are equally likely to be struck. The fact that one is inside the house and the other outside does not in-

fluence the lightening bolt when it is making its choice. However, the inside antenna can only be struck after the bolt has passed through the roof of the house! Evidently its damage, as far as fire risk is concerned, has been accomplished even before it gets to the antenna. The outside antenna might be struck many times without much likelihood of fire, if it is properly grounded.

As we see the problem, the increased likelihood of being struck by lightning is directly proportional to the receiving efficiency of the antenna. The higher the antenna the more likely to be struck and also the better a receiver it is. The only antenna which is free from the possibility of being struck is one located beneath a grounded metal roof; this is an extremely poor receiving antenna, as many enthusiasts know too well.

THE FRANCIS BACON CROCKER FOUNDATION

AT A recent meeting of the New York Electrical Society, Professor M. I. Pupin made announcement of the donation of \$10,000 by the Marcellus-Hartley Corporation to establish the Francis Bacon Crocker foundation. The Marcellus-Hartley Corporation was organized by Mrs. Helen Hartley Jenkins to give support to various institutions doing useful work in the arts and sciences; evidently the New York Electrical Society falls into this category.

It offers to its members about ten lectures a year on various electrical topics of general interest; having a rather small membership and low dues, it has recently been in financial difficulties. The income from the Crocker fund will be used to defray current running expenses.

Professor Crocker was one of the electrical pioneers of this country; he was intimately

associated with many of the important activities of the electrical industry during his lifetime. He was one of the founders of the C and C Electrical Co., and was later vice-president of the Crocker-Wheeler Co. of Ampere, N. J. As head of the department of Electrical Engineering at Columbia University he made a reputation as an educator and teacher of electrical science and was warmly esteemed by the many students coming in contact with him during his long term of service with the University.

The Francis Bacon Crocker foundation will do a doubly useful service in helping to support the activities of the Electrical Society and in helping to keep alive the memory of Professor Crocker.

THE AMATEUR RADIO RESERVE

IN OUR last number there appeared a short article telling of the work carried out by the special branch of the Signal Corps which goes by the above title. Developed and encouraged by the Chief Signal Officer of the Army, this work of banding together the

enthusiastic group of radio amateurs who would jump to the aid of the country in the event of another war, seems like an excellent work to carry on. There is no waste of time in what we ordinarily think of when military training is mentioned, but the activities consist largely in keeping the amateur in touch with the local Signal Officer and other amateurs in his district, with whom he would very likely have to work in case of need.

Radio instruction in general, and specifically in the operation of Signal Corps outfits, is carried on under a Signal Corps expert, so that the amateur would be fitted to join at once that service where he would undoubtedly count the most, the radio section of the Signal Corps. Although but little money is needed for the activities of the Amateur Radio Reserve, we

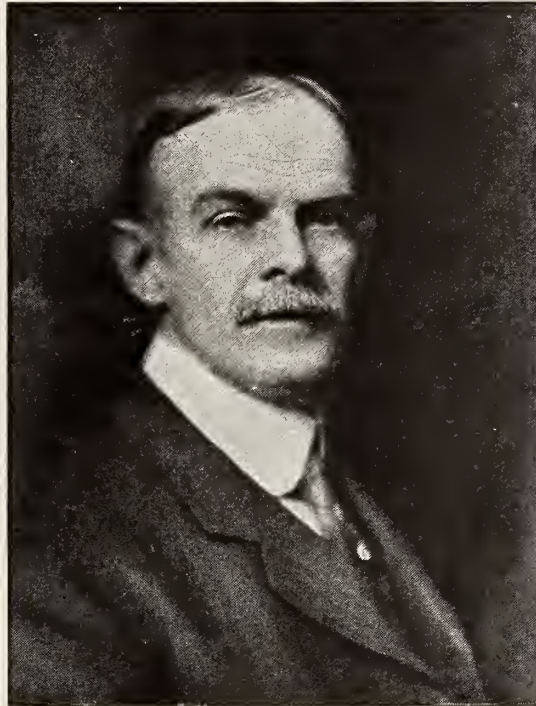

PROF. FRANCIS BACON CROCKER

understand that, the appropriation having failed to pass, they must soon cease. It seems that this very peaceful "preparation" well deserved the necessary appropriation to continue its existence, and we hope means will be found to permit it to do so.

DANGER FROM STATIC

FROM what we have recently heard discussed by the hosts of new radio enthusiasts, it seems that between the publications of such organizations as the National Board of Fire Underwriters, talks by many radio men who should know better, and the rattling, hissing, crackling of the loud speaker during the last month, the radio public is pretty well scared of the phenomenon which goes by the name of static.

To be sure, when one is listening with head sets, at the output end of a two step audio frequency amplifier and one of those whip-crack atmospheric disturbances comes in, the listener is well prepared to believe that there must be some danger associated with such a vicious sounding discharge. As a matter of fact it is our opinion that there is no fire risk at all due to ordinary static; with a small antenna such as the average receiving station uses it seems that the voltage of one of these heavy static disturbances is comparatively small, certainly not more than ten volts for the average "crack". The amount of current associated with this voltage is not more than a small fraction of one ampere, so that the actual electrical energy in the antenna which gives the rattling of the telephone receivers is probably much less than that required to ring the door bell! And no one has ever entertained the idea that his house was going to be burned down because of the electrical power flowing over his bell wires.

Whatever extra risk a house is subjected to when a receiving antenna is installed is not due to static at all but due to the remote possibility that the chance of the house being struck by lightning is increased by the presence of the antenna. It is embarrassing to put forth theorems as to how lightning behaves, because probably the first case under observation after the theory has been expounded will happen in exactly the way the theory says it will not. It seems as though the answer as to whether or not the presence of antennas do increase the fire risk will have to wait on the statistics of the next year or two; with the number of antennas

in operation increasing by the hundreds of thousands, any real risk associated with the antenna must certainly show itself in the form of a greatly increased number of fires attributable to lightning strokes. In other words, if you wonder if the antenna does increase your fire risk, join the ranks of statistic providers, put up the antenna, and wait for a year or two. In the mean time enjoy the radio news and concerts without worry.

The electrical theorist can argue quite soundly, on either side of the question, as to whether or not the fire risk is increased, but it seems most likely to the writer that in the average well installed antenna station it has been decreased. Undoubtedly the chance of lightning landing in the neighborhood of the house has been increased, but the likelihood of damage therefrom has just as probably, perhaps more so, been decreased.

STATIC ELIMINATORS

AS THE number of radio listeners increases, so does the chance of profit for the dispenser of patent devices to improve radio reception. By this time the radio public knows much more about static and its interfering effects than it did in April. And after having an interesting lecture or well-executed musical selection spoiled by the cracks and hisses of the atmosphere, the radio enthusiast is psychologically in the proper status for the operations of the vendor of a static eliminator. At the time of this writing such a thing does not exist, nor is there any immediate promise of such a device; there has not yet been put forth anything of the kind which is worth the trouble of installation. The U. S. Patent Office is full of descriptions of hopes and aspirations along this line, but none of the patented projects does what the inventor hoped it would do. So unless you have some money you want to lose, it will be wise not to invest it in some cartridge shaped affair (or any other shape) which draws static out of your receiving set and disposes of it in a way you don't understand.

The best attempt at static elimination is the employing of the loop antenna; for two reasons the loop antenna compared to the ordinary overhead antenna gives a greater ratio of signal strength to static disturbance. Static comes from all directions and the signal comes from only one; the loop is very selective as regards picking up signals from different directions so that when oriented toward the

desired station it receives full signal strength and comparatively little static because only those static waves which are travelling in the same line as the signal will be received with full strength. Also as the waves of static are generally long compared with the waves used for broadcasting, and as the loop is a very poor receiver for long waves, here again static is discriminated against, in favor of the signal.

If the static eliminators are no good, it seems likely that the stock of companies formed to manufacture and dispose of these devices (or any other of similar import) is not a very attractive investment in spite of the large returns promised. Not all of the fake radio schemes have yet been floated!

The radio novice must frequently be puzzled in trying to make sense out of the radio articles he may read. In the same magazine we read in one place that "all broad-

casting stations are transmitting on the same wavelength, namely 360 meters"; in another part we read that two signals of the same wavelength cannot be separated by any known scheme, and in a third section we read how so-and-so, by a slight turn of a handle tunes out W J Z and receives either K D K A or W G Y.

If such is possible, then one of the previous statements made must be inaccurate. As a matter of fact it *is* generally possible to tune out one broadcasting station and get another if the set used is well designed for selectivity and if the receiver is not too close to any one of the stations. This is because, in the first case, a good receiving set can successfully separate two signals of very nearly the same wavelength and in the second, the different broadcasting stations *do not* send on the same wavelength,

but only approximately so; if they lived up to the letter of the law it would be impossible to ever separate one from the other.

DISTANT CONTROL OF APPARATUS BY RADIO

THE remote control of different devices by the use of radio waves has frequently brought forth spectacular articles in the press; the explanations given are generally entirely inadequate and worded in such a way that the action is made to appear much more mysterious than it really is. A technical description

of the schemes customarily used in controlling torpedoes, vessels, free automobiles, etc. is well outlined in a short article by F. W. Dunmore of the Bureau of Standards, published in the Proceedings of the spring convention of the American Institute of Electrical Engineers. Circuit diagrams as well as illustrations of actual distant control



© Underwood & Underwood

One of Uncle Sam's agents broadcasting weather, crop, and market reports for the benefit of our farmers. Thousands listen to this service

relays are given, together with an easily understood explanation of the operation of the apparatus for cases where batteries only are available and when alternating current supply is the source from which the tube circuit must be actuated.

Using just the schemes described here, it would evidently be possible to accomplish almost any reasonable operation by the use of radio waves; the distant control of a warship under way, being used for target fire, or the gyrations of the driverless automobile become easy to understand. Wireless transmission of pictures or simultaneity of several distant and apparently unrelated events are not only possible but are comparatively easy of accomplishment with apparatus such as described in this paper.

J. H. M.

Beware of Radio Stock Offerings

THE return postcard of W. A. Ferguson & Co., of 19 West 44th Street, New York, reproduced below came to the attention of the editors of RADIO BROADCAST because it bears on its face a copy of the design showing a father and son enjoying radio which appeared on the May issue of RADIO BROADCAST. W. A. Ferguson & Co. reproduced this

to get capital by soliciting funds from the public by extravagant promises.

Broadcasting does not reach 75,000,000 people, or 15,000,000 homes, as stated on the reverse of this card. The statement that profits on radio equipment run from 100 to 1,000 per cent. is calculated to mislead, because, if there were any such profits, the public



PRIVATE MAILING CARD

PLACE
ONE
CENT
STAMP
HERE

W. A. FERGUSON & CO.
SUITE 509, BERKELEY BLDG.
19 West 44th Street
New York, N. Y.

WE BELIEVE
THIS CARD
WILL BRING
YOU FACE
TO FACE
WITH THEM.
BEST
STARTLING
INVESTMENT
OPPORTUNITY

PH

W. A. FERGUSON & CO.
Suite 509, Berkeley Bldg.
19 West 44th Street
New York, N. Y.

Gentlemen:

Without obligation or cost to me, mail at once, full information regarding Wireless Telephone, Business Organization, Plant, etc.

Name
Write Plainly

Address

City

NOT TO BE MAILED BY CHILDREN

without permission. They reproduced it upon a type of literature with which RADIO BROADCAST does not desire to be associated in any way, and the object of this notice is to make it clear to all readers of RADIO BROADCAST that the use of its cover design by W. A. Ferguson & Co., does not imply the endorsement or approval of W. A. Ferguson's offer in any way, shape, or form. On the contrary, we think it proper to warn our readers against new stock offers of radio manufacturing companies. Radio is not producing millionaires daily as is stated on the face of this card. It is a rapidly expanding business, but the expansion is of a solid nature and in the hands of men who have been devoting their energies to this field for some time, and their businesses do not need



HUNDREDS OF MILLIONS OF DOLLARS will be MADE IN RADIO TELEPHONE EQUIPMENT

Opportunity used to be the telegraph—the telephone—the wireless. The WIRELESS TELEPHONE is 1922's most startling business opportunity. It opens up the fastest money-making investment opportunity the world has yet seen. It is producing millionaires daily and this is YOUR opportunity. Hundreds are investing and hundreds will invest in the WIRELESS TELEPHONE and that will mean the fortunes that are to be made.

A little self-confidence and the courage to investigate are all the price that you are asked, to have the greatest opportunity given you ever offered the investing public.

START YOUR FORTUNE BY WIRELESS TODAY

LEARN THE KNACK OF MAKING MONEY

If these facts won't prove mighty?
money makers for you—what will?

ON December 20th, 1920 the first broadcasting station was placed in operation in Pittsburgh. Since then some fifty-two stations, reaching 75,000,000 people or 15,000,000 homes, have been constructed.

SINCE 1901 the annual average of gross business done in the sale of Radiophone apparatus has been \$50,000. Based on the business done by the manufacturers since the first of the year, gross sales for 1922 will amount to \$50,000,000, an increase of one thousand fold. And this is but the beginning.

THE profits in the manufacture of radio equipment run from 100 to 1000%. The most fascinating invention of modern times opens up investment opportunities unexcelled since the Telegraph, Telephone, Eastman Kodak, Victor Phonograph and Ford Motors were in their infancy.

RADIOPHONE securities are the opportunity of to-day. Millions have been made and are being made. The men with vision and courage, who invested their small savings with Mr. Morse and his "toy", are as independent to-day as those who invested with Mr. Bell and his "toy". Exactly the same opportunity may be yours to-day with the RADIO TELEPHONE.

NOW - MAIL THIS CARD TODAY AND GET DETAILS OF OUR SPECIAL - NOW OFFERING - TOMORROW MAY BE TOO LATE

need not think that men who had the foresight and ingenuity to be in the radio business successfully in this boom time would need to give away to the public the profits which long investment, effort, and foresight have brought them. These misleading statements are followed by the time-worn get-rich-quick device of comparing the present investment opportunities in radio with those which existed when the Telegraph, Telephone, Eastman Kodak, Victor Phonograph, and Ford Motor companies were in their infancy.

RADIO BROADCAST objects most strenuously to being associated, even by implication, with this enterprise, and we wish to state that its reproduction of the copyrighted drawing on our May cover is a plain case of theft.

How Opera Is Broadcasted

Difficulties That Must Be Overcome in Order to Obtain the Best Results. How Singers Must Be Especially Drilled and Grouped, and How the Opera Must Be Revised, Interpreted, and Visualized to Make Up for the Lack of Action, Costumes, and Scenery. Artists Are Put in a Musical Straitjacket. Moving, Whispering, Even Deep Breathing a Crime

By C. E. LE MASSENA

IF THERE be a sixth sense, it must be that undefinable thing called *sensation* for which the modern public seeks in every department of daily life, and its latest form is radio. The present tremendous popularity of radio is due to its uncanny character, the unbelievable things which it accomplishes. It is, in truth, a novelty sensation. "The Choir Invisible," "In Tune with the Infinite," "The Voice of Nature," "There's Music in the Air"—all heretofore poetic fancies—are now real factors in our existence. If the world has gone daft over radio, it is because radio has brought us into closer relationship with one of nature's great mysteries—Ethereal Communication.

With a multitude of listeners, the radio broadcasting stations have had, of late, to provide increasingly adequate programmes. At first, talks, phonograph music, and news reports sufficed, but, like the proverbial snowball, radio broadcasting gathered volume as it moved, and a larger scheme had to be devised which to-day includes recitals by artists, concerts by bands and instrumentalists, lectures, sermons, and finally opera—and all within the space of a year. Naturally, such a schedule offered some problems and difficulties, all of which have been overcome successfully, but there is still room for improvement, especially in the realm of opera, the broadcasting of which is a problem quite different from anything else. Here we have to deal not with a single voice or instrument or with a unit, such as a band or orchestra or chorus, but with a combination of several such elements—solos, ensembles, choruses, instrumental numbers, dialogue,—and all must be rendered in such a manner as to provide a finished result. How to manipulate these forces quietly, without interruption or stop, or the introduction of sounds other than those desired, offers some food for thought.

There are certain mechanical limitations associated with this new instrument of com-

munication. Talking machine companies solved their problems by recognizing these limitations both as to sound volume and frequency of vibration, and accordingly they evolved a recording technique which is almost perfect. The radio has just begun to feel its way, and no such technique has been developed but it is only a question of time before it will be perfected. The conspicuous facts are these: Radio fans who "listen in" know that phonograph records broadcast well, also solos, both vocal and instrumental. Duets, trios, quartets, choruses and operas reproduce less perfectly, owing to the fact that radio recording technique is in the experimental stage. Orchestras, bands, and large vocal bodies lose much of their detail in the ether. Volume is imperceptibly decreased, and words emitted by more than a single person are apt to become blurred and muffled. Yet, every problem has a solution, and one for this will undoubtedly emerge at a not too distant date.

Performances of opera have been transmitted from the Berlin Opera House and the Chicago Opera House and heard at long distances, but the actual broadcasting of a complete opera was not undertaken until March 15th last when Mozart's "The Impresario" was presented at the WJZ station at Newark, N. J. The writer had the honor of being associated with this enterprise. As soon as the date had been fixed, William Wade Hinshaw, manager of the company and president of the Society of American Singers, assembled his forces, and, with a dummy microphone, practised broadcasting the opera in his New York studio.

NO SCENERY, NO ACTING—JUST SONG AND SPEECH

THE company had just returned from a twenty-five weeks tour. They were familiar with every detail, line, phrase, and position, but these had to be set aside for the nonce and a new version prepared. Action, costumes,

facial expression, entrances, exits—all had to be abandoned. The music and the dialogue alone could be retained. The opera must be done with just these two factors. No scenery, no acting—just song and speech.

That was a job in itself, but the end justified the means. After the concrete materials had been properly adjusted to circumstances, another problem loomed up—that of arranging the producing elements so as to secure the maximum tonal effect. This was accomplished by introducing a shifting process, each singer having a fixed position from which he moved forward, backward, and sidewise according to a prearranged scheme, precisely like a football line that opens and shuts and moves by a code of signals. This opera, having to deal with principals only and a pianist, presented no difficulties as to chorus or orchestra; therefore, as soon as the singers understood how and when to move, the hard work was done. As a preliminary measure, however, Mr. Hinshaw journeyed to Newark several days in advance of the performance and delivered a lecture by radio on "Opera Comique," thereby preparing his invisible audience for the novelty in store for them. He explained the meaning of this kind of entertainment, recited the plot, told about the artists who would sing the various rôles, and made a strong plea for better music and a deeper appreciation of good music such as Mozart composed. He decried jazz and the modern dance music as unhealthy and immoral, and asserted that pure, wholesome opera comique would do much to turn the world of music back to normalcy.

THE BROADCASTING STATION AT WJZ

AT NEWARK, the recording took place in a small room, about 10 x 40 feet, on the second floor of the Westinghouse plant. At one end is a grand piano. On one side is the electrical apparatus which conveys the message to the amplifying station on the roof. On the opposite side is the switch and a set of headphones, also a phonograph and an orchestrelle. In the centre is the portable microphone into which the sound waves are directed. At the back of the room are chairs and tables for auditors and reporters. There have been several kinds of microphones employed—a platter disc, a cup and a cylindrical tube. The last named was in use at this time. It is about six inches in diameter, lined with felt, and is suspended from an adjustable tripod.

Obviously a double operation is necessary in broadcasting music by radio-telephone. The singer or player produces a series of tones, each of which proceeds, not of itself, but via a sound wave. This wave enters the cup, is transferred to the station on the roof over a telephone wire and then broadcasted through the ether by means of electromagnetic waves.

THE ACTUAL BROADCASTING OF OPERA

THE programme for the evening has been announced through the press and by bulletin, and the thousands of radio fans are adjusting their headpieces at the scheduled hour. Of course, they do not hear the voices of the singers or the tones of the instruments any more than they do over the ordinary telephone. They hear a reincarnation, a recreated voice and tone, because the original tones are not conveyed but first transformed into ethereal waves and then transformed back again by means of the many receiving outfits within range of the broadcasting stations. This is what makes the whole thing so uncanny, mysterious, and sensational. It is the thrill of thrills. Not only do the listeners experience a new sensation, but the performers also. To talk or sing or play to an invisible audience of unknown proportions is sufficient to make the most seasoned opera star or concert artist quake. A new experience—a novel sensation, even to those who knew nought of awe or fear.

The company arrives and is shown into the *sanctum sanctorum*. They take their places. The announcer explains that they are subject to certain radio traffic regulations, as other broadcasting stations are also operating and it would be discourteous to begin until the exact hour announced, when the air lanes are free. Now the usual running time for "The Impresario" is an hour and forty minutes, but in the tabloid version for broadcasting twenty-five minutes have been eliminated. Even an hour and a quarter in this musical straitjacket is enough to tire any artist. Movement is prohibited, whispering is little short of criminal, and even too deep breathing is forbidden. The announcer cautions all regarding these details and asks if they are ready. With a final admonition of "Sh-h," he closes the switch and then speaks into the microphone, while the members of the company stand silently by, with eyes dilated, enwrapped in a new experience. "This is the WJZ station at Newark, N. J." he begins, "broadcasting Mozart's opera com-

William Wade Hinshaw
(Manager) introducing
Percy Hemus (Star)
to the radio audience

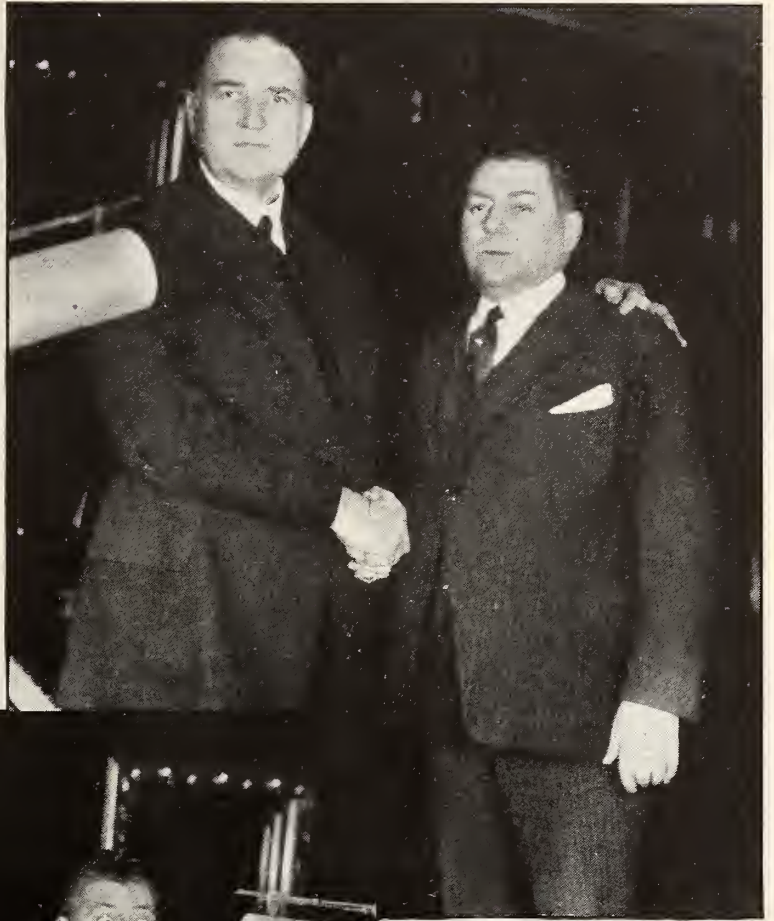

Thomas McGranahan,
Regina Vicarino, and
Percy Hemus singing
"The Impresario" for the
invisible audience

ique 'The Impresario' under the direction of William Wade Hinshaw. Announcer ACN. I take pleasure in introducing Mr. Hinshaw." Mr. Hinshaw silently slides into the position promptly vacated by ACN and addresses his audience. Anxiety! Suspense! Yes, 100 percent! The nervous strain is intense, and all are glad when he concludes and they can do something. This tension acts as a stimulant. In most cases, radio singing and playing inspires the artists to do even better than their best. That is why the radio concerts are of such excellence.

HOW "THE IMPRESARIO" WAS BROADCASTED

MR. HINSHAW proceeds to introduce the several artists by name, requesting them to speak and tell who they are and what characters they impersonate. This done, the signal is given to the pianist to proceed, and the opera is on.

As each character appears, the singer steps forward, delivers his lines or sings, as the case may be, then retires to make way for the next, who takes up the thread immediately. When two or more are engaged in dialogue or ensemble musical numbers, the heads come together so that everything may be recorded and no one be more prominent than another. At the end of the hour and a quarter, the company is ready to draw a long breath and a handkerchief and relax. It is fun, but it is hard work, too.

Having no chorus or orchestra to handle, "The Impresario" was an admirable composition with which to initiate the broadcasting of opera. It was the first work of its kind ever sent out on the air, and proved a great success. Mr. Hinshaw received numerous letters from many sections of the country, some from far distant points, expressing the pleasure and satisfaction of the hearers.

HOW "PANDORA" WAS PREPARED

HAVING made close observations, during the presentation of "The Impresario" and having carefully noted the conditions under which the music is recorded, I was able to conduct the rehearsals of "Pandora" with some degree of certainty as to the arrangement of the forces employed. Compactness was the first consideration, and this meant curtailment to the last degree. I judged that eight voices—all of good quality and power and all using the same vocal method—would serve better than

twice or thrice the number chosen at random. To this end, I enlisted the coöperation of Mme. Minna Kaufmann, the well-known vocal teacher and coach, who selected the required number of singers from among her best pupils and taught them the choruses with the most gratifying results. Those who heard the rehearsals and later the radio performance said that the volume of sound was like that emitted by a large chorus.

Then I arranged the music so that it would be sung in unison or in two-part harmony, as a more involved harmonic structure would only weaken the effect due to the inner voices being lost in the volume of sound while, on the other hand, with the simple harmony arrangement, each voice was reinforced and the waves made that much stronger. I had the four solo voices sing along with the chorus, thereby increasing its power. My method of grouping was entirely new to the operator who at first wanted to employ the usual method with the singers in front and the instruments further back, but I prevailed upon him to try my arrangement.

Every instrument, every voice, every phrase, and most of the words came through the air distinctly and clearly and there were no discordant elements noted. One more detail. I instructed the instruments to play with gusto and the chorus to sing with vim. The soloists could enjoy a little more freedom, but precision and dynamic force were necessary as a first consideration. My contention proved correct. Except in some of the very loud choruses, wherein the words were lost in the mass of tone, our efforts met with surprisingly good results.

While vocal music carries better than instrumental music by radiophone, there is no occasion for dissonance, if the forces are properly adjusted, selected, and placed. But if the same grouping employed in concert and stage performances is adhered to, trouble is sure to follow. Adequately to broadcast an opera employing an orchestra, soloists, and chorus means a lot of hard thinking and much preliminary practice. With the present method, only a limited number of the sound waves from so large an assemblage will find their way into the microphone. Therefore we should retain only such a force as will meet the demands and eliminate the rest. The quandary then is how to ascertain which record and which do not. This problem can be solved only through experiment and practice.

With a score like my "Pandora," several



Below: "The Impresario" company at the broadcasting station and above: the same company on the stage. The artists in both pictures are in the same positions and include, Thomas McGranahan (Mozart), Gladys Craven (pianist), Regina Vicarino (Mme. Hofer), Percy Hemus (Schickaneder), Hazel Huntington (Mlle. Uhlic), Francis Tyler (Phillip)



new elements were introduced. In presenting this, I undertook to broadcast a work requiring the services of principals, chorus, and instruments, so April 6, 1922, marks the date of the first complete operetta ever given in this manner. That it proved successful was due to the care and thought bestowed upon the preliminary rehearsals, and to the selection of the participants. The first problem was how to

place the forces to best advantage. There was no precedent to follow, and therefore experiment was the only avenue open. An arrangement had to be devised so that none of the music would be lost and none be too loud or too soft. A dummy microphone was secured, and the chorus was grouped compactly in front of the piano with lid raised. The four solo singers were placed in front of the chorus

and the two stringed instruments at either side near the microphone. In this way a good ensemble was secured with the weaker close to and the stronger forces back from the recorder. The same plan of movement as to positions was carried out as in "The Impresario," except that I explained the plot between the musical numbers, omitting the dialogue, and in this way made a condensation that occupied just an hour in delivery.

"Well, your company certainly sang their heads off," was the pleased comment after the performance. Why? Because they were singing under the influence of a new sensation which gave an added stimulus to their efforts and lent zest to their work. Both productions were broadcasted without a hitch or slip, and the results justify more entertainments of like character. Two other operas—"Martha" and "La Traviata"—were given in radio form with piano during the interim between the broadcasting of "The Impresario" and "Pandora," but I am not in a position to discuss them, not having heard or seen the presentations. However, as a result of these experiments, it is evident that not every form of opera can be presented by radio successfully. Mr. Hinshaw asserts that "the ultra-modern opera is an impossibility . . . that one must choose a work that is melodious and in which solo voices do the greater part of the singing." I am not convinced as to the last statement. I think duets, trios, quartets, and other combinations, even choruses, are capable of being successfully broadcasted, just as they are successfully reproduced on the phonograph. It all depends upon how thoroughly the problem is studied and how well it is solved. Mr. Hinshaw says further that a Wagner opera could not be produced successfully, and that the best of all for radio are those of the classic style, and particularly the works of Mozart.

WHAT THE FUTURE HOLDS

TO-DAY, that is true; to-morrow, it may not be true. I would not go so far as to assert that all modern opera is impossible for radio presentation. Anyone who has been associated with broadcasting music readily realizes that such an enterprise requires much more careful preparation and training than do concert and stage productions. The singers have only their voices with which to convey the tonal message; therefore they have to sing well and invest their song with all that the eye

can not see. That is the huge and difficult task that makes radio opera such a hazardous and precarious undertaking under present conditions.

Stringed instruments, by reason of their inferior potency as wave generators, must always be close to the microphone, just as they are placed closest to the horn during the process of making a phonograph record. Before it was possible to obtain a good tonal balance of orchestral instruments for phonograph records, much experimenting had to be done. The



"PANDORA" PRINCIPALS REHEARSING
Philip Spooner (Epimetheus), Mrs. C. E. Le Massena
(Pandora), Marion Heim (Hope), William H. Henningsen (Quicksilver)

same thing is true of radio broadcasting. A brass band where all the instruments are of the same timbre will sound very well via radio, likewise a chorus, but when two or more dissimilar elements are broadcasted simultaneously, it is highly important that they be placed in the most advantageous positions. Violin and piano, voice and piano, two voices, an instrumental trio or quartet, an accompanied chorus, an orchestra—all these offer problems which must be solved before such combinations can be broadcasted in a manner to give complete satisfaction to the listener. A violin string is rubbed with a bow, while the piano's strings are struck by hammers. The tones are different and so are the sound waves produced—both as to strength and character. The



A rehearsal in Mme. Kaufmann's studio, Carnegie Hall, New York. C. E. Le Massena, composer and director, at extreme right

weaker ones must be closer and the stronger farther from the recorder. Moreover, as men's voices carry better than women's—because they are deeper and consequently have fewer vibrations per second—it is advisable to place the women nearer the microphone in ensembles. Just how far from the recorder each should be placed is a matter of careful experiment. The same rule holds good for the voice and piano and all other dissimilar combinations.

BROADCASTING SHOULD BE ON A COMMERCIAL BASIS

WHEN the programmes announcing celebrated artists were first made public, they created a widespread demand for receiving sets, for there were thousands who had never heard these artists and others who wanted to hear fine voices and players by radio. There was a rush for bookings and talent from which to choose was plentiful. But now the novelty has worn off. The best artists refuse to appear or to repeat; managers and associations are inserting a clause in their contracts prohibiting artists from giving radio recitals without remuneration. That is right. Why should artists give their services for this kind of work, which is not charitable, but solely for the benefit of the companies who sell radio receiving

sets? Artists get some publicity, naturally, but it soon expires in the rush of events.

What is the future of radio opera, and indeed of radio music in general? It all depends upon how far the broadcasting companies are willing to coöperate with artists and musical organizations. So long as the programmes were good, and so long as leading artists were willing to appear thereon, the sale of sets mounted enormously. But what about the present situation? It is evident that unless the former high standards of excellence are maintained, radio fans will register a vociferous protest.

Mme. Galli-Curci, one of the most celebrated singers in the world, was invited to sing via radio, and promised big advertising. She was also guaranteed an audience of a million and an orchestra to assist her. Of course the lady's managers declined the invitation. As she can earn \$4000 to \$5000 a night, why should she waive this sum in order to sing for thousands who already know her, and the majority of whom have probably heard her? The commercial profit to the company would have been enormous, but wherein could it benefit her?

The whole trouble at present is that the manufacturers are lacking in foresight. The time is coming, and soon, when they will have

to engage such artists as they require, or resort to cheap musical programmes. For example, when Mr. Hinshaw took his opera company to Newark, the expense to him was considerable. This production sells for \$1000 with piano and \$1500 with orchestra. Taking into consideration the rehearsals and the time expended in traveling, the loss was probably not less than the latter amount. As an advertising proposition, there was a certain value received, but nowhere in proportion to the service rendered. Broadcasting should be put on a commercial basis. Companies are making big money out of this novelty and can afford to engage artists and pay them for their services.

One of the officials of a prominent manufacturing company, when confronted with this argument, stated that if the artists refuse to sing gratis, they may force a discontinuance of concerts and drive the broadcasting stations into another avenue of activity. This is a very commercial way of looking at so important a phase of a wonderful industry, and obviously is the wrong attitude. Moreover, the programmes are not arranged at present with a view to the best results. There is too

much variety, good and bad all jumbled together, in an effort to fill out the broadcasting time. Artists realize that it is detrimental to appear on a jazz programme, or to be sandwiched in between a comic singer and an amateur band. The time is coming soon when programmes will have to be planned with more skill. There must be an "opera" night, a "popular" night, a "band" night, a "jazz" night, an "artist" night, a "juvenile" night, etc. The time is hastening when it will be necessary to engage artists and organizations precisely as is done in the regular concert field. A laborer is worthy of his hire, and as soon as programmes are made up with a view to their artistic value, and not with a view to securing something for nothing, then there will be proper coöperation and a mutual benefit for all participants.

All the world wants music. The easiest and cheapest way to get it is by means of the radio telephone which affords opportunities to a vast multitude of persons who otherwise would be unable to hear any. The man in the lighthouse, the farmer in his kitchen, the lumberman in his shack, the traveler at sea, literally thousands of persons hitherto isolated,

JUST A SMALL PART OF THE AUDIENCE





HEARING HIS FIRST OPERA

are now able to relieve the monotony of their existence by introducing culture and entertainment into it by means of radio-telephony. Music is no longer confined within the four

walls of concert halls and opera houses. Radio-telephony has freed the captive bird from its prison, and it is now at liberty to soar and to sing for all who may care to hear.

ADDITIONS TO LIST OF PRESENT RADIO BROADCASTING STATIONS IN THE UNITED STATES PUBLISHED IN THE JULY ISSUE OF RADIO BROADCAST

CALL SIGNAL	OWNER OF STATION	LOCATION OF STATION	WAVE LENGTHS
KDYL	Telegram Publishing Co.	Salt Lake City, Utah	360
KDYM	Savoy Theatre	San Diego, Calif.	360
KDYN	Great Western Radio Corp	Redwood City, Calif.	360
KDYO	Carlson & Simpson	San Diego, Calif.	360
KDYQ	Oregon Institute of Technology	Portland, Oreg.	485
KDYR	Pasadena Star-News Publishing Co.	Pasadena, Calif.	360
KLX	Tribune Publishing Co.	Oakland, Calif.	360
KNX	Electric Lighting Supply Co.	Los Angeles, Calif.	360
KQI	University of California.	Berkeley, Calif.	360
KYI	Alfred Harrell	Bakersfield, Calif.	360
KZV	Wenatchee Battery & Motor Co.	Wenatchee, Wash.	360
WAAD	Ohio Mechanics Institute	Cincinnati, Ohio	360
WCAB	Newburgh News Printing & Publishing Co.	Newburgh, N. Y.	360
WCAC	John Fink Jewelry Co.	Fort Smith, Ark.	360
WCAD	St. Lawrence University	Canton, Ohio.	360
WCAE	Kaufman & Baer Co.	Pittsburgh, Pa.	360
WCAG	Daily States Publishing Co.	New Orleans, La.	360
WCAJ	Nebraska Wesleyan University	University Place, Nebr.	360,485
WCAK	Alfred P. Daniel	Houston, Tex.	360
WCAL	St. Olaf College	Northfield, Minn.	360
WCAM	Villanova College	Villanova, Pa.	360
WCAN	Southeastern Radio Telephone Co.	Jacksonville, Fla.	360
WCAO	Sanders & Stayman Co.	Baltimore, Md.	360
WCAP	Central Radio Service	Decatur, Ill.	360
WCAQ	Tri-State Radio Manufacturing & Supply Co.	Defiance, Ohio	360
WCAR	Alamo Radio Electric Co.	San Antonio, Tex.	360
WCAS	William Hood Dunwoody Industrial Institute	Minneapolis, Minn.	360
WCAT	South Dakota State School of Mines	Rapid City, S. Dak.	485
WCAU	Philadelphia Radiophone Co.	Philadelphia, Pa.	360
WCX	Detroit Free Press	Detroit, Mich.	360,485
WHB	Sweeney School Co.	Kansas City, Mo.	360,485

What Everyone Should Know About Radio History

By PROF. J. H. MORECROFT

PART II

A FEW years after the publication of Hertz's work in 1888 the scientific world heard rumors of the experiments of Guglielmo Marconi, then about 20 years old. He had been a student of Physics under Professor Rosa, at the Leghorn Technical School, and had especially made himself acquainted with the work of Professor Righi, who had been making experiments similar to those of Hertz, extending Hertz's work into the region of very short electric waves, about one centimeter long.

MARCONI'S METHODS

MANY contributions to scientific development have been the result of accident; something strange and unexpected has happened in the course of an experiment and has thus started a keen mind in search of its significance. But not so with Marconi; it is evident in reading of his early experiments and progress that he had set out, intentionally and with premeditation, to develop the laboratory work of Hertz into a successful scheme of communication. And once having started on the problem he stuck to it with a persistence seldom seen in a scientific worker. His progress was methodical, and followed the line suggested by his experimentation; there are no wonderful jumps in the methods of attacking the problem or in the results achieved. The development brought out by Marconi from 1895 to 1902 is an excellent example of scientific attack and accomplishment; with keen insight as to what was happening, Marconi took the logical steps to increase the distance over which he could carry on signalling and also the certainty of the communication.

His enthusiasm and ability steered him clear of the thorny and tedious path which must be trod by many inventors; the British Post Office Department and many prominent scientists gave him assistance and encouragement in carrying out his tests. It was in England that Marconi found the conditions best suited to the

development of his new scheme of telegraphy; the British Empire has always been foremost in the development of communications as it is evidently of utmost importance for the close coöperation of its component parts. Until the United States entered the field of world-wide radio the British cables practically controlled the field of international communication. This of course gave to her traders a great advantage over others and enabled them nearly to control world trading. It is no wonder therefore that Marconi was so ably assisted in his development work in England. Its success would give the British Dominions still better control over the world's trade routes.

As everyone at all acquainted with radio knows, it involves the generation and radiation of high frequency waves at the transmitting station and some means of detecting them at the receiving station. Marconi started by using at his transmitting station radiators similar to Hertz's, but used at his receiving station a more sensitive indicator than was used by Hertz—a device known as the Branly coherer. The coherer, in the form first used by Marconi, was a small piece of glass tubing with metal terminals in each end, the space between these ends being filled with metallic filings, loosely in contact. It possessed a remarkable property by virtue of which if high frequency voltages were impressed on its terminals the contacts between its particles of metal dust became much more intimate so that the electrical resistance of the device became much less. This effect could be taken advantage of in the scheme of Marconi very well; a battery connected through the coherer could ordinarily force but little current through it because of its high resistance, but when it was affected by the high frequency waves sent out by the transmitting station its resistance fell to a low value and thus the battery could send much more current through it and so ring a bell or operate a printing telegraph, etc. This coherer of Branly, which was considerably im-

proved by Marconi, was probably the most important single factor in Marconi's early work, it so far exceeded in sensitiveness Hertz's spark-gap receiver that it increased the possible distance of communication hundreds of times.

EFFECT OF HEIGHT AND SIZE OF ANTENNA

EARLY in his work Marconi got the idea of using at his transmitter and receiver a vertical wire, to the upper end of which was connected some large metallic body (such as a tin-covered cubical frame) and the lower end of which was connected to metal plates laid on the ground. He found that with his vertical wires six feet high he could communicate one hundred feet and with them twelve feet high he could get the same amount of signal at a distance of three hundred feet, and when they were twenty-four feet high he got the same signal strength at twelve hundred feet. Furthermore with his twenty-four foot wires—, if he increased the size of the metal bodies connected to the upper end, the possible distance was very much increased; thus with metal cubes about three feet on a side his transmission distance was three times as much as when they were only one foot on a side. These experiments, which were carried out in 1895, it will be noted, gave to Marconi ideas regarding the efficiency of an antenna as a radiator or receiver which we accept as correct to-day after much more refined measurements of the quantities involved. If an antenna is to send out much power, it must be high, and, further, it must have a large spread of wires at the top and be suitably connected to good earth plates, or ground, as we call it.

In 1896 Marconi went to England with his apparatus and there took out his first patent on wireless telegraphy in that year. His work interested Sir William Preece, of the

British Government telegraph service; this eminent engineer at once realized the wonderful advance Marconi had made over previous attempts along this line, and gave to the young inventor his hearty support and approval. Although Marconi made no startling new invention he had availed himself of the known possibilities of Hertzian waves and had improved the Branly coherer and had made a combination which worked. When the validity of Marconi's claim to an invention was questioned Sir William Preece made the following comment:

"He has not discovered any new rays; his receiver is based on Branly's coherer. Columbus did not invent the egg but he showed how to make it stand on end, and Marconi has produced from known means a new electric eye more delicate than any known electrical instrument and a new system of telegraphy that will reach places hitherto inaccessible. Enough has been done to prove and show that for shipping and lighthouse purposes it will be a great and valuable acquisition."

Sir William's belief in the usefulness of the young inventor's

scheme has been amply justified, as we now know; in fact, his estimate of the value of Marconi's work was all too small.

From 1896 on Marconi gave many demonstrations, gradually increasing the size of his apparatus and correspondingly the distance over which he could communicate. In 1898 a set was in actual operation connecting the Goodwin Sands lightship with the shore; with the success thus far reached it was evidently only a matter of perseverance and material resources to accomplish transoceanic communication, the goal towards which many of the earlier experimenters, dealing with currents in the ocean water, had striven with no success.

In 1899 he had in operation two stations

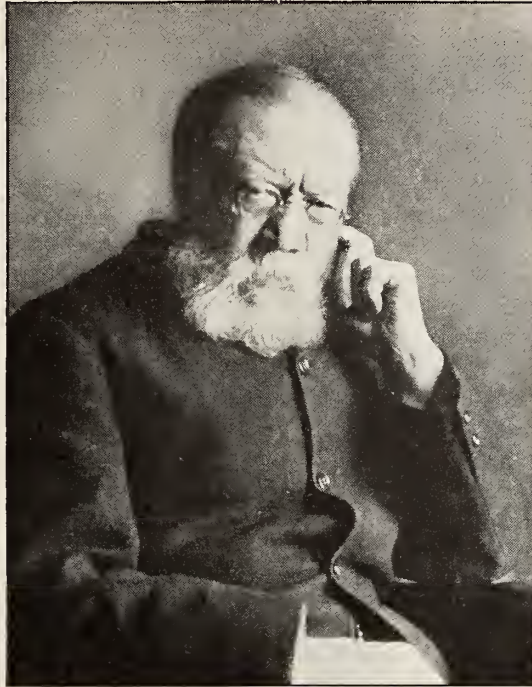

© Underwood & Underwood

SIR WILLIAM H. PREECE

bridging the English Channel, and during the month of December, 1901, the first transatlantic signals were received by him in Newfoundland. For these first transoceanic tests his receiving aerial in Newfoundland was a wire supported by a kite, and the transmitting aerial, in Cornwall, on the west coast of England, was two hundred feet long and one hundred and sixty feet high. The spark transmitter used in Cornwall had an electrical capacity of only about 10 kilowatts and its efficiency must have been extremely low. In judging the ability required of Marconi in getting these first messages it must be remembered that to-day, with much more efficient transmitting sets, and receiving circuits thousands of times as sensitive as was Marconi's coherer, we use hundreds of kilowatts of power to get reliable transoceanic communication. The success of Marconi's first transoceanic tests speaks volumes therefore for his experimental ability. Bold indeed would be the experimenter to-day who would attempt transoceanic signalling with an inefficient spark coil transmitter, and a coherer for a receiver!

TUNING OF TRANSMITTER AND RECEIVER

THE waves used in the early experiments were not much more than "splashes" in the ether (whatever that mysterious substance may be); the receiving apparatus could not be tuned, and the great gain in loudness of signals which tuning makes possible could not be obtained. Pupin, in America, had pointed out the possibility of using tuned circuits at low frequency, and from 1899 to 1901 Marconi did much experimental work in trying to use tuning (or syntonizing, as it was then called) and took out several British patents on the application of tuned circuits to wireless communication.

He accomplished a great deal, using two tuned circuits, loosely coupled at the transmitting station and two similarly arranged circuits at the receiving station. The arrangement of circuits he used in 1900 was as good as that we use to-day in a modern spark transmitting set; of course there are certain features which have been improved since then, such as the quenched spark gap, and the crystal detector or vacuum tube detector, at the receiving station. We must remember that in all this important development work of Marconi's he was using as detector the coherer, which, although Preece regarded it as the most sensitive electrical eye possible, was but a very crude and

insensitive piece of apparatus compared to that we use at present. It had to be continually tapped by a buzzer attachment to maintain it in a sensitive condition; after a signal had been received through the coherer the dust particles were cohered, and had to be shaken apart by the taps of the buzzer before they could again function to receive another signal.

PRACTICAL TRANS-ATLANTIC COMMUNICATION

IN 1907 the company developing Marconi's work opened the well known stations at Clifden, in Ireland, and Glace Bay, in Nova Scotia. Regular commercial business was carried on at the rate of ten cents a word. This Clifden-Glace Bay service was the pioneer radio link between America and Europe and much very valuable data was gained during the first few years of its operation. In spite of its novelty and isolation in the technical field (for years no other radio transmission rivalled it), the service was surprisingly uniform and reliable. It was in the study of the operation of this service that Marconi first found out that it was very difficult for a radio signal to cross the sunrise or sunset line; when the sun had risen in Ireland but had not yet come up in Glace Bay the sunrise line was somewhere in the Atlantic and the signals had to cross this line. A remarkable fading effect in the strength of signals was noted; in fact transmission across the line was practically impossible. We still have to contend with strange fading phenomena in radio transmission, but this special sunrise seems to occur to an appreciable extent only for the comparatively short waves used in the early days. Now, with waves 20,000 meters long, the effect is of much less importance. It was in the operation of this Clifden-Glace Bay service that the tremendous difference between transmission in the summer and that in the winter was forcibly brought out. The interference by atmospheric disturbances is thousands of times as troublesome during the summer as in the winter months, so that the amount of power required for summer traffic must be many times as great to get the same reliability in transmission as in the winter months.

Many of the amateurs will recall the consistent transmission of the low pitched musical note of Glace Bay; it used to be the station by which we could test the condition of our sets, regularly sending its dots and dashes across the ocean. The Clifden station was not as easy

to "get," of course, as was Glace Bay but many of the good amateur experimenters used to do it, nevertheless.

OTHER EARLY WORKERS IN THE FIELD

OF COURSE, work as remarkable as was that of young Marconi excited the interest of every scientific and technical man of the day and many of them contributed valuable ideas to the rapid development of the new art. In England Fleming was closely associated with Marconi, and was undoubtedly of great assistance in the early experiments helping to design properly the circuits and apparatus. Later he contributed the Fleming valve about which more is said later on. Lodge and Muirhead made important contributions and were granted various patents, particularly with regard to the coherer, which was unquestionably the weakest point in Marconi's whole scheme. This coherer, which occupied the same position in the receiving circuit as does the crystal or tube detector of to-day, with its buzzer for de-cohering after every dot, was rather complicated and unsatisfactory in its performance, and many of the workers endeavored to modify it so as to improve its performance. With the simple crystal detector of to-day, or the vacuum tube, the work of the early experimenters would have progressed much faster and farther.

MARCONI'S WORK TAKEN UP IN GERMANY

WORD of Marconi's work having reached Germany, Professor A. Slaby came to England in 1897 to see the experiments. He himself had been trying to use the ideas of his illustrious countryman, Hertz, to obtain communication over appreciable distances, and had met with but meager success. Slaby was quick to recognize the superiority of Marconi's work over his own and gave him generous praise after seeing but a few of his experiments. In analyz-

ing Marconi's work, Slaby (who afterwards became one of the foremost wireless inventors of Germany) replied to some of the criticism which had been raised against the novelty of Marconi's work in the following words: "It was urged that the production of Hertz rays, their radiation through space, the construction of the electrical eye*—all this was known before. True; all this had been known to me also, and yet I was never able to exceed one hundred meters.

"In the first place Marconi has worked out a clever arrangement for his apparatus which by the use of the simplest means produces a sure technical result. Then he has shown that such telegraphy (writing from afar) was to be made possible only through, on the one hand, earth connection between the apparatus, and, on the other hand, the use of long extended upright wires. By this simple, but extraordinarily effective, method he raised the power of radiation in the electric forces a hundred fold."



© Paul Thompson

JOHN STONE STONE

After witnessing Marconi's experiments and returning to Germany, Slaby began active development of wireless along the lines already taken by Marconi, and, associated with Count von Arco, developed the well known Slaby-Arco wireless apparatus. Professors Braun and Zenneck made valuable contributions also to the German wireless development. In 1903 Slaby and von Arco and Braun joined interests with the *Allgemeine Electricitäts Gesellschaft* and Siemens and Halske to found the *Gesellschaft für Drahtlose Telegraphie*, which firm put out the excellent wireless apparatus used in the "Telefunken" system.

To the scientific and theoretical side of radio Drude, Abraham, Wien, and Seibt, in Germany contributed; in France Poincaré, Branly, and Ferrie; in Italy, besides Righi there were Belini and Tosi (who did the pioneer work in the

*By which was meant the coherer.

radio compass); in America, Pupin, Trowbridge, Pierce, Fessenden, and Stone helped in the early developments.

WORK OF FLEMING

ALTHOUGH there were many engineers and scientists of valuable assistance to Marconi in his early work, of these J. A. Fleming was by far the most important, judging by the contributions he made. Fleming assisted in making the generating apparatus at the transmitting stations more powerful and reliable, using an alternating current generator and transformer in place of the spark coil used earlier by Marconi. His great contribution to the art was not along these lines, however, but in furnishing a more reliable and sensitive detector of the high frequency radio currents set up in the receiving aerial. The coherer, and later the magnetic detector, had been used by Marconi; the magnetic detector was more reliable than the coherer but even this was far less useful than the Fleming valve, the forerunner of the wonderful vacuum tube used to-day in all good sets.

In 1883 Thomas A. Edison had noticed a peculiar action taking place in some of the special incandescent lamps with which he was working at the time. Experiments carried out with a bulb in which there had been sealed a metal plate close by the filament but insulated therefrom, showed that if the metal plate was made electrically positive with respect to the filament, current could pass through the vacuous space between the filament and plate, but if the plate was made negative with respect to the filament no current could flow. Here there was evidently a kind of electrical gate, or one-way valve, and the idea was patented by Edison in 1884. The phenomenon was given the name "Edison effect."

Fleming had used some of these bulbs having the extra electrode inside and when working with Marconi he got the idea of using this effect to permit the detection of the high frequency currents in a receiving aerial. Using a coil for transmitter and another for receiver, the same as Hertz had done, he utilized one of these bulbs with a direct current galvanometer in series to see if the direct current instrument would indicate. His first tests were successful and indicated that such a type of rectifier would probably be much more useful than the coherer.

Fleming took out a patent in Great Britain in

1904 and in America in 1905, the patent covering the idea of using the Edison effect in detecting high frequency signals. It has been frequently stated that Fleming did not invent this device, the well-known Fleming valve,—that his accomplishment was merely the application of an old idea in a new field. This is undoubtedly true, but such application has repeatedly been rated as invention and it has been judicially confirmed that Fleming's work did constitute an invention. The life of this patent is, of course, now expired, so that the construction of a two electrode tube for detecting radio signals is now permissible for anyone.

Marconi used some of the early Fleming oscillation valves (as Fleming called them), and found them much more satisfactory than the coherer then used. The ordinary crystal detector had not yet been discovered, so the production of the oscillation valve by Fleming constituted a real advance in the art. In sensitiveness those valves which have been tested by the writer are about equal to an ordinary crystal, but they have the advantage, of course, compared to the crystal that it is not necessary to hunt for a "good point." As long as the batteries are not run down, and the filament is hot, a valve will always function properly, whereas it cannot similarly be known for a crystal that it is operative or not, but recourse must be had to testing with locally produced signals.

Fleming apparently made a quite thorough investigation of his valves, and it is worth while noting some of his remarks regarding their behavior. He had noticed that the current flowing across the vacuous space in the valve was strongly affected by the action of either an electric or a magnetic field. The control of the electron stream by the magnetic field is the basis of the action of the "magnetron," a device developed in the General Electric Laboratory during the last year or two. The action of an electric field on the electron flow to the plate of course foreshadows the control of the plate current by an electric field applied either internally (the De Forest audion) or externally, as done in the Marconi audion, with external grid, a type of tube known to but few radio experimenters. It seems strange that Fleming did not at once jump to the idea of the audion, but the history of science is full of just such occurrences—a worker on the point of making an important discovery, yet missing it by the merest chance.

In recent years developments have been carried out and patents have been granted for Fleming valves which have been more thoroughly evacuated than were Fleming's valves. It scarcely seems that these devices (styled "kenotrons") are inventions; they employ no action unknown to Fleming, even though they do permit the use of much higher plate voltages than was possible with Fleming's original tubes. It seems, however, that Fleming appreciated the significance of a good vacuum for the proper operation of his valves. In one of the specifications of his 1904 patent he states: "As a very high vacuum should be obtained in the bulb, and a considerable quantity of air is contained in the conductors, these should be heated when the bulb is being exhausted. The filament can be conveniently heated by passing a current through it while the cylinder* can be heated by surrounding the bulb with a resistance coil through which a current is passed, the whole being enclosed in a box lined with asbestos, or the like.

When the cylinder is replaced by any form of conductor which can be heated by passing a current through it, this method is usually more convenient than that just described."

It is evident from this, to anyone, that Fleming did appreciate the importance of high vacua in electron tubes and it therefore seems that later tubes, which are much more completely exhausted than were Fleming's, do not constitute an invention, but are merely the embodiment of Fleming's ideas, carried out to a higher degree than was possible for him with the then rather imperfect and difficult methods of evacuation available to him.

In 1911 Willows and Hill developed a Fleming valve in which the hot filament was a lime-coated strip of platinum, a so-called Wehnelt cathode, because Wehnelt was the first to point out the advantage of using such a

*Fleming's plate.

cathode. If the hot filament is covered with certain oxides the electrons are emitted at a much lower temperature than if a pure metal is used, and thus less filament current is required to get a certain number of electrons. This type of oxide coated filament has been developed by the Western Electric Company for its long distance telephone repeaters.

In 1904 Dr. Lee De Forest was working in America on the use of the flame as a rectifier for high frequency radio currents. He took out a patent in 1905 on a bulb having two

hot filaments connected in a peculiar manner, the intended functioning of which is not at all apparent to one comprehending the radio art. The wording of the patent claims is not that of a scientist but that of a shrewd patent attorney trying to hide some mysterious secrets in a superfluity of high sounding terms, instead of giving the exposition of a fact or operation discovered by the inventor. This is the trouble with too many of our patents, from the standpoint of one



© Underwood & Underwood

DR. LEE DE FOREST

trying to understand what the inventor has done; the patent attorney tries to put the wording in as indefinite a form as possible so that, no matter what may happen in the future, the wording of the patent, it may be argued, anticipates just that development.

De Forest's claims were gradually changed until they finally described a device identical with Fleming's valve, which he styled the "audion". In the published accounts of the action of the audion De Forest seems to have thought the action very mysterious although Fleming had explained the action apparently quite satisfactorily some time before. During his early work it seems as though De Forest were deliberately trying to avoid giving Fleming credit for the work done in developing the oscillating valve. Had De Forest studied Fleming's writings at all, he would not have thought the action of the valve so mysterious.

In 1907 De Forest made his real contribution to the radio art; he somehow conceived the idea of interposing a metallic mesh, or grid, between the two elements of a Fleming valve and thus gave us that wonderful piece of apparatus, the three electrode tube. Much litigation ensued because of De Forest's claims that his device did not embody the principles of the Fleming valve. De Forest's claims and explanations were extremely dubious; it was about this time that the writer asked De Forest, at a public scientific meeting, a simple question as to how the audion functioned and to which answer was made that "his patent attorneys had told him to say nothing as to how the audion functioned." What patent attorneys can do for a scientist! Had it not been for experimenters like Armstrong of Columbia University, Langmuir of the General Electric Company, and van der Bijl of the Western Electric Company, we should know but little to-day of the action of the three electrode tube.

It is to be pointed out, however, that little as De Forest contributed to an explanation of his device, the thing which he actually did, namely the insertion of the third electrode into a Fleming valve, was a most wonderful contribution to the radio art. As a matter of fact, in the opinion of the writer, this was the most important single step taken in the whole development of radio communication. Let us give De Forest credit for this wonderful achievement, even though he was so reluctant to give credit to the other workers in the field, principally Fleming, on whose work the possibility of the audion depended.

R. A. FESSENDEN

FROM 1900 to 1907 Professor R. A. Fessenden was extremely active in the development of various phases of radio. The files of the Patent Office at Washington pay tribute to his activities during this period—his patents are counted by the dozen. Besides several patents on rectifiers, to compete with the coherer and the magnetic detector, he devoted himself among other things to radio-telephony; as early as 1901 he had laid down the essential principles of the art. The high frequency alternator which was later taken up by the General Electric Company, and further developed by their staff of engineers, and given the name Alexanderson alternator, was first conceived, patented, and built by Fessenden. The compressed air condenser, a very efficient form of

condenser for large transmitting stations, is an invention of Fessenden; many of these are used to-day in the U. S. Government station at Arlington from which the standard time signals are sent out.

The most important of Fessenden's contributions to present day radio, however, is probably that by which he showed possible the reception of continuous wave telegraph signals by the so-called "beat method," or heterodyne reception. He first mentioned this scheme in 1902, but did not apparently use it much until 1907 when he described the method and gave several schemes for using it, among others the electrostatic and electrodynamic telephones. The heterodyne method of reception is not only a very ingenious scheme for overcoming a difficulty (absence of wave train frequency in continuous wave transmission), but it is an extremely sensitive method and it made feasible most of the early long distance radio transmission. The importance of the heterodyne scheme was increased tremendously when Armstrong discovered that the vacuum tube detector itself could be used for generating the required local high frequency currents.

WORK OF ARMSTRONG

DURING 1911 and 1912 E. H. Armstrong was studying for the degree of Electrical Engineer at Columbia University; he was not an especially brilliant student, in fact in many of his courses he did rather poorly. The writer knows because Armstrong was one of his students. The characteristics of alternating current machinery in general, did not prove very enticing to the young student, not because he was lazy or indifferent but because he had a hobby—and a vision. He was experimenting at his home with wireless apparatus and trying to find out how the three electrode audion of De Forest worked. If De Forest confessed in public that the action was too mysterious for him to explain, then Armstrong would explain it for him! Which he promised to do, and did very shortly.

After graduating, Armstrong continued at Columbia as assistant to the writer in the radio laboratory; later he worked with Prof. M. I. Pupin, continuing his study of the three electrode tube. As the writer looks back to those days it seems undoubtedly true that Armstrong understood the action of the audion better than anyone else in the world. Day and night he thought and talked of nothing but the audion;

his devotion to this study, and perseverance therein finally brought rich reward—he was granted a patent, the validity of which was recently confirmed, which gives to him credit for being the first really to understand the action of the three electrode tube.

In using the audion as a detector of wireless signals certain coils were required, and Armstrong accidentally placed two of these coils much nearer to each other than they should normally be and lo—a strange noise was heard in the telephones. This strange noise started Armstrong to work on his wonderful discoveries.

It was noted in the first part of this history that the more or less accidental occurrence of a small spark started Hertz on his epoch making discoveries, and certainly it was as much an accident that led to Armstrong's work. But by those who may, at this point, think that an accident may some day make them also famous, let it be remembered that after the accidental noting of something unusual it was a long and difficult road which led to the complete explanation and utilization of the phenomenon involved.

The noise which Armstrong heard was the beat note between the oscillation being set up by the De Forest audion he was using and a signal being sent out from some continuous wave station. He found that the pitch of the note varied with the adjustment of his circuit, and by keen intuition he came to the conclusion that the tube he was using was oscillating at a high frequency. He pursued the study of the action until it became very clear to him and he made patent application for his idea—which is fundamentally this: If the plate circuit of a three electrode tube and grid circuit are suitably connected (by magnetic induction or otherwise) the reactions occurring between the two circuits tend to set up alternating current in that circuit which has a condenser and

coil connected together, the value of inductance and capacity determining the frequency of the alternating current generated.

He found out that even if the adjustment was not sufficiently carried out to make the tube oscillate, still the interconnection of the plate and grid circuits might cause a tremendous increase in signal strength. This is the "feed-back" or regenerative idea for which Armstrong's work is known.

Since Armstrong's first work appeared, innumerable circuits, with fancy names sometimes attached, have been published, the "inventor" probably thinking many times that the idea was entirely new. They are all embraced by Armstrong's patent, however, if they function by the interaction of the plate and grid circuits of the tube which can be brought about by the use of

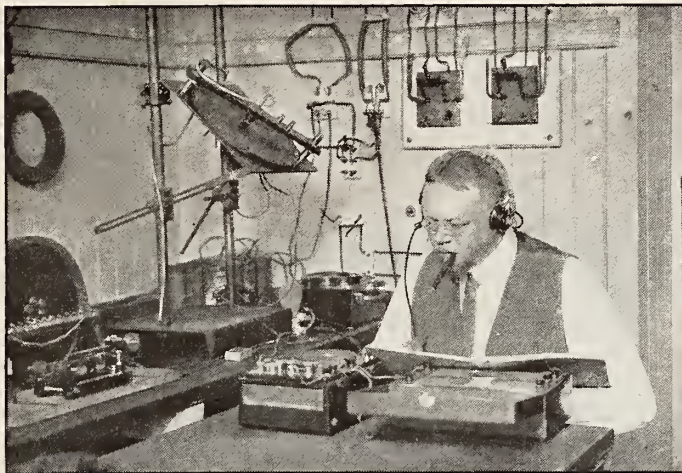

© Paul Thompson

R. A. FESSENDEN AT WORK IN HIS LABORATORY

various connections of condensers and coils. In general there must be made provision for the energy which is resident in the plate circuit battery to get into the grid circuit if oscillations are to be maintained; if this provision involves the electrical or magnetic interconnection of the plate and grid circuits by use of condensers and coils suitably arranged, the idea comes under Armstrong's feedback claims. It is of course possible, that some other action may be found by which case the present monopoly on the use of regeneration would be temporarily broken.

WHAT ARMSTRONG'S CIRCUIT MAKES POSSIBLE

IT SEEMS a simple thing to couple together the plate and grid circuits of a vacuum tube and one would scarcely believe the importance of such an evident possibility. The results of the coupling are however very important. When a continuous wave signal is received the ordinary crystal detector or vacuum tube detector does not yield a signal because there is no variation in the amplitude of the high fre-

quency current, a variation with a frequency in the audible range. If, however, the local circuit is continually excited by a high frequency current, when the high frequency signal is received the two high frequencies will act together and produce "beats", and the frequency of these beats is the same as the difference in frequency of the two different currents. This method, as mentioned previously, is the result of Fessenden's work.

Armstrong's idea evidently enables the vacuum tube which is being used as detector to act also as a generator of the high frequency currents which serve to produce the beats when the continuous wave signals arrive. Not only does the simple coupling idea of Armstrong thus permit the audion to act as a receiver of continuous wave signals, but it also makes it an extremely sensitive receiver at the same time, if the adjustments are carefully carried out. The writer well remembers one night, before Armstrong had published his explanation of the action of the oscillating tube, spent at the Marconi's then new station at Belmar, N. J. Mr. Weagant, the chief engineer of the American Marconi Company, and Mr. Sarnoff, at present manager of the Radio Corporation, were also witnesses of those early tests when Armstrong showed us how his circuits could "pick up" the continuous wave stations on the Pacific coast—stations with only a few kilowatts of power. To hear the note of the station changed at will, by a turn of a handle on one of the boxes, was a severe puzzle for the Marconi engineer, especially as Armstrong, like a proper inventor, had everything completely hidden in boxes, with the lids securely screwed down. And nary a chance did the chief engineer have to peep inside! He would surely have been surprised had he seen how simple the whole thing was.

As another illustration of the remarkable advance in sensitiveness made possible by Armstrong's invention, the writer recalls hearing in his laboratory at Columbia, on several occasions, a station on our west coast in communication with one at Honolulu, and the two stations were continually calling for "repeats". They were only 2,000 miles apart, over the ocean, and the laboratory was 3,000 miles over land from the nearer one and 5,000 miles from the farther. Both stations were

received at the laboratory clearly by using Armstrong's apparatus, yet they could not understand each other, using the receiving apparatus then in general use.

Besides the wonderful amplification of signal obtainable by the feed-back principle, the selectivity of a circuit is greatly improved so that stations sending on nearly the same wave length cause no interference. This idea is of more value in telegraphy than in telephony; in the latter the receiving circuit must not be too selective or else the speech will not be clear but will be drummy in quality, and indistinct.

Armstrong has also given to us a valuable idea in his special short wave amplifier, and has just startled the radio world with what he has named his "super-regenerative" scheme whereby the present amplifying power of his circuit is greatly increased.

OTHER WORKERS IN THE FIELD

IN THIS brief history of the art many names have necessarily been omitted. Pupin, in his early work on tuning alternating current circuits, did much to show how to make radio signals more free from interference; Lowenstein showed the importance of properly adjusting the potential of the grid of the three electrode tube if it is to operate efficiently as an amplifier; Pickard and others discovered the utility of the various crystal detectors used in the cheaper radio sets of to-day. Round, in England, and Meissner, in Germany, both were on the track of the regenerative action of the tube when Armstrong found it, and they were not far behind Armstrong. Poulsen and Pederson, in Denmark have been responsible for the development of the tremendous arc generators used in long distance transmitting stations, such as that erected at Lyons, France, by the American engineers during the war. Alexander, in America, and Goldschmidt, in Germany, have perfected wonderful high frequency generators. General Squiers has shown possible the transmission of radio frequency currents over ordinary telephone wires resulting in our present "wired wireless". And the great research laboratories of the General Electric and Western Electric companies, with such men as Hull, White, Heising, and others, have contributed tremendously to bringing the art of radio to its present high state of development.

Will Antennas be Buried in the Back Yard?

By LEWIS WOOD

The first successful long-distance underground reception was effected in 1916 by Dr. J. H. Rogers who passed his ideas on the subject over to the Government when we were at war. By his system static, which usually occurs in the air strata above the earth, is considerably reduced because the energy collectors for the receiver are kept away from these strata. The use of the Rogers system was looked upon with favor during the war and is now in use in various Naval Stations. The Navy spent thousands of dollars experimenting with this receiving system, much of the work being done at Belmar, N. J., Bar Harbor, Me., and New Orleans, La. In addition to reducing static, this character of receiving station has the property of being very directional, which also reduces interference from undesired stations. Long waves are received much more satisfactorily than short waves, and for this reason it would seem as though the system is better adapted to commercial and government radio than for use by the man-in-the-street. No towers are required, but these qualities are limited to receiving only, for the present system does not function satisfactorily as a transmitter.—THE EDITORS.

IS THE day coming when aerials will be buried in the back yard instead of running across the roof or sticking up on high poles as at present? Dr. J. Harris Rogers of Hyattsville, Md., thinks so, and he has given such an emphatic demonstration of his theory that scientists and navy and army experts who have witnessed his tests believe it will not be long before the tall towers that have cost so much money will be unnecessary.

As far back as 1908, in experiments whose subsequent developments proved of incalculable benefit to the American Army and Navy during the World War, Dr. Rogers, a scientist of reputation, conceived the idea that the earth instead of the ether furnished the real medium for transmitting radio waves. This premise will come as a jolt to the poetic

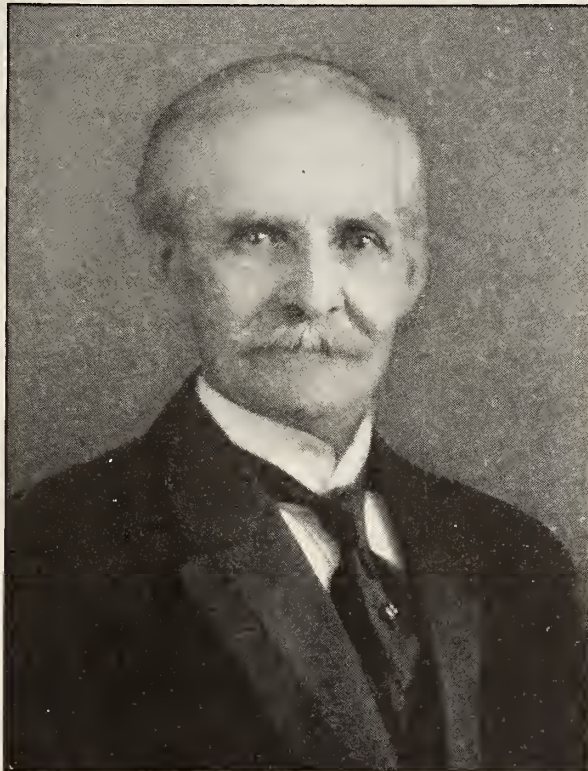

© Harris & Ewing

Dr. J. Harris Rogers of Hyattsville, Md., discoverer of the underground and undersea system of radio communication

Perish the thought that Galli-Curci's voice comes in via the sink-pipe instead of out of the broad sky. Yet Dr. Rogers has no less an authority to reinforce him than the great Charles P. Steinmetz who lately declared that under certain circumstances it would be easier for wireless waves to course through the ground than through the air.

DR. ROGERS' METHOD HELPS ELIMINATE STATIC

ONE of the most startling and interesting features of the Rogers discovery is the practical elimination of static through the underground aerial. The writer knows that during a heavy electrical storm when the ether was enormously disturbed, Dr. Rogers, using a loop aerial suspended in a brick-walled well, heard KDKA and WJZ with absolute dis-

tinctness, and no interference to speak of. The contrast has been illustrated many times, and in the most dramatic fashion, for Dr. Rogers, by manipulating a switch, throws his receiving set first in on an outdoor aerial and then on his underground loop. The difference in effect is always marked.

Recent experiments in Dr. Rogers's laboratory brought in vocal and instrumental music on a 360 meter wave length over a distance of 220 miles. The instruments used were three stages of radio-frequency, a detector, two stages of audio-frequency amplification and the underground loop. For a long time, Dr. Rogers has been receiving radio telegraph waves by this underground method, but the new experiments concerned themselves not with the long wave lengths but with

the short lengths which to-day make up the chief percentage of radio traffic. There was strong static in the air at this time and street cars and passenger and freight trains were speeding to and fro not 200 yards away from the laboratory, but none of these disturbances interfered with the reception of the concerts.

RECEIVES THROUGH WATER AS WELL AS EARTH

DR. ROGERS has worked for years on his discovery and against the utter skepticism of some of the most eminent radio engineers and experts in the world, he has turned their opposition topsy turvy. When with a 4,000 foot wire buried three feet in the earth inside a tile pipe and leading in a westerly direction, he clearly heard communications between German army units on the European battlefield, he amazed naval and army officers. Then he set out to prove that water as well as earth was a communicating medium for electro-magnetic waves. Naval officers, Marconi and Dr. G. W. Pierce, radio

expert of Haryard University, all said this was impossible, but Dr. Rogers the dreamer promptly invented the method of communicating with submerged submarines.

Coming from patriotic and fighting stock, for his grandfather was an American naval lieutenant and his father a Confederate soldier, Dr. Rogers was intensely anxious to aid his country during the World War, and it is notable that although he naturally applied

for letters patent he gave the benefit of his discoveries to his government without compensation. At the age of sixty-seven, he bent every energy to his task. In 1916 in an obscure piece of land he owned not a great distance from "The Parthenon" where his fathers had lived before him, he reproduced a dug-out on the Western front



The field laboratory built by Dr. Rogers, where a secret delegation of Naval Officers first heard German Army communications by means of an underground antenna

and from this central receiving station he ran scores of subterranean wires. They were laid like the spokes of a wheel, buried at various depths in the ground and of numerous lengths. The inventor worked with the most intensive application using combination after combination of the wires, in the main, however, obtaining his best results with his "ground" and "antenna" either set at right angles to each other or in opposite directions.

A SECRET SESSION

TO THIS little field laboratory, which he afterwards named "Mount Hooper" in honor of Commander Stanford C. Hooper, then in charge of the navy's radio division, Dr. Rogers invited the officers. They doffed their uniforms and came inconspicuously in citizens' clothes, to Hyattsville which is seven miles from Washington. Like Dr. Rogers, they listened clearly to German official reports, and daily heard Nauen, the Eiffel Tower, and many American stations on long waves, including

Darien, and all without the annoyance of static, strays, or other ethereal clashes. In this experiment Dr. Rogers used a large tuning coil, a variable condenser, a one-step amplifier and a pair of telephone receivers. The antenna was formed by a rubber-covered cable. It was only a little while then before the Rogers system was installed in the government naval station at New Orleans where astonishing results were secured. Not long afterwards, Lieut-Commander A. Hoyt Taylor was ordered to install the system at the Great Lakes naval station.

The next and most important step came when the underground aerial was placed in operation at Belmar, N. J., for trans-ocean work. Six wires were laid under the ground at that point, and six operators were able to hear as many different European stations at the same time. So absolutely perfect was the scheme

that all communications from the Allies to the United States were received through the underground antenna, and messages came in with great distinctness and with regularity even on days when the overhead towers would have been useless because of storms and when the lives of operators might have been in danger. The system was used in the American trenches in France, and many times it supplied the only instrumentality of communication.

COMMUNICATION BETWEEN SUBMARINES

THIS achievement did not content Dr. Rogers, for he was even then working diligently on his supposition that water provided a medium of communication. At the same time he was experimenting at "Mount Hooper" he was making tests below the surface of a little pond near by. He met success

almost immediately in this undertaking for from a small boat he transmitted messages with underwater wires to his home two miles away. But submarines operate not in fresh water but in the salt sea, so he transferred his operations to Piney Point a promontory in Chesapeake Bay. Here the naval experts cooperated fully and perfect communication was established between two submerged submarines.

The wildest dreams of fancy seemed to have been realized for a submarine beneath the sea, a battleship on the surface, an airplane hovering in the sky and an army base employing the Rogers underground system all talked to each other. A submarine submerged eight feet off the Atlantic coast heard Nauen, Germany; twenty-one feet submerged it heard distant stations on 12,000 meters wavelength. A transmitting station operating with forty-eight

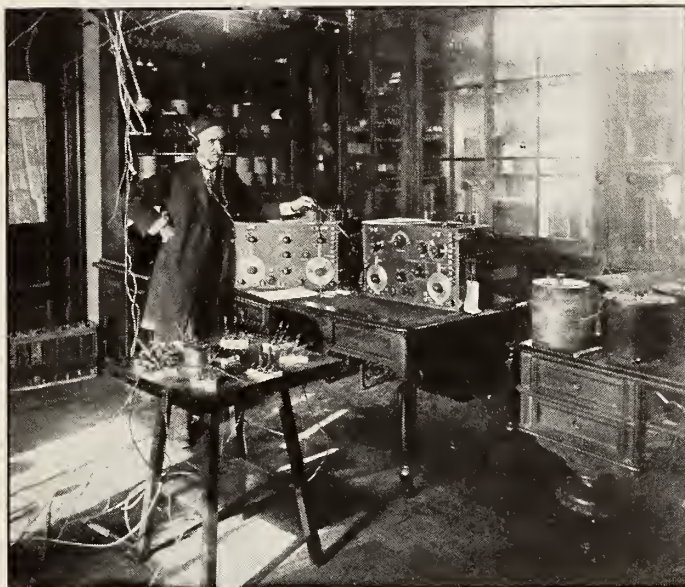

Dr. Rogers using an underground loop antenna receiving a radio concert 220 miles. On the table in the foreground a group of switches, connected to various underground antennas, serve to alter the direction of reception and the wave length

amperes antenna current 600 feet away from a receiving station, using the Rogers underground aerial system, did not interfere with Nauen being picked up on 12,600 meters and New Orleans on 5,000 meters. No interference and no static. Aerials far under water were used to receive Cavite, Philippine Islands, 8,100 miles distant, on its regular 11 a. m. and 5 p. m. schedules.

THE ROGERS THEORY

THE basis of the Rogers theory is a complete upset to accepted theories. Ever since the days of Hertz, scientists have believed that electro-magnetic impulses pass through the space above the earth's surface. But Dr. Rogers, who had already secured fifty electrical patents in 1908 formulated another hypothesis.

"The energy liberated at the base of the aerial is propagated through the earth as well as through the ether above," he said. "An elevated aerial at a great distance would be actuated by these earth waves just as effectually as if the waves reached the same point through the ether. When these earth waves reached the base of the aerial the potential of the plate (earth) would be raised and lowered and the aerial energized accordingly."

This did not make any hit with the hard and fast scientists. In answer to Dr. Rogers' question, "if fifty units of power go into an aerial, what becomes of the equal amount of energy that goes into the ground?" they replied that this was dissipated in the form of heat. The scientists held that ether was the only conducting medium through which the electro-magnetic waves could be sent. But in contra-distinction Dr. Rogers says: "Electric energy liberated at the base of an antenna will be propagated through the earth even in the absence of the space above, were this condition possible. The earth and water waves are not dependent on each other, except when first propagated. Both the earth and the air waves are propagated at the same time, one above and the other below the surface of the earth."

It must not be held that Dr. Rogers believes that no ether waves travel through the air. He admits the presence of the air waves, but nevertheless he holds that because of the earth's curve, they die out in strength as they proceed. In fact he asserts that at great distances many of these waves transmitted through the ether never reach their destination, the result being really achieved through the earth-medium.

It was on the theory that the electro-static waves pass perpendicularly over the earth's surface that high towers were first erected. Great height of the antenna and great length were always thought to be an advantage. But if Dr. Rogers is right in saying that the ether waves fade out in intensity, then there is no necessity for this enormous capacity for reception. "Ether waves die out eventually in proportion to the earth's curvature and the distance over which they are propagated," Dr. Rogers says in explaining this particular theory. "At great distances ether space waves have no appreciable effect on receiving apparatus. The apparatus is energized by energy transmitted through the earth. Ground cur-

rents travel with the speed of light and are picked up at the receiving station. The space waves persist for an appreciable distance, which accounts for airplane to airplane and earth to airplane communication. Long transmissions such as 12,000 miles never reach the receiving station due to the high resistance of the atmospheric envelope."

TRANSMITTING RANGE LIMITED

TRANSMISSION by means of Dr. Rogers' invention has not been developed as fully yet as has been the receiving of messages. While transmission has been accomplished over a distance of seven miles, it has not been possible to send to greater lengths because insulating material that will stand the heavy current used in sending has not been found. Radio telegraphy is received over long distances regularly, and Stavanger and Nauen come in easily. The most recent experiments seem to show that short wave messages and radiophone communication of all kinds will have no limits eventually, and so in time it may be possible to abandon all the expensive, unsightly, and undesirable towers and overhead aerials.

The towers have always been a nuisance. Those used in transatlantic work and even in the high-power stations of this country are costly, require time to build, are magnets for all atmospheric disturbances, are not directional and are menacing targets in time of war. Even though many experts consider towers necessary for transmission and for short wavelength work, Dr. Rogers believes they will be done away with. He urges that his system is far ahead of the towers because it eliminates static, and expense, is very directional, is safe for operators, is secret in time of war, is unimpaired by storms, and is economical to maintain.

A SCEPTIC CONVINCED

MOST of Dr. Rogers' experiments are now conducted in a well covered by a building insulated against the ether. He has suspended in the well a loop aerial, which he can turn at will. Not long ago an experimenter who turned out to be a "doubting Thomas" visited the Rogers laboratory. He praised the doctor's work but it turned out later that when he left Hyattsville he conducted some experiments of his own to see how the Rogers system worked. Evidently he was satisfied, for he said that tests in a concrete lined cellar with a

galvanized iron housing brought him fine results. He said he employed a magnavox which made signals audible for a distance of several hundred feet, and that during one rainy evening the presence of considerable water in the bottom of his pit did not affect the outcome.

Signals and voice received over the underground antennae do not come in as strongly as through the overhead aerial, but this is entirely compensated for by the fact that the absence of static renders the communication clear. During the war Lieutenant-Commander Taylor reported this condition and added that signals received at the Great Lakes station from both Arlington and San Diego could be copied with much more accuracy than when received via the overhead antenna. While Dr. Rogers has used various lengths of antennas, he finds that he obtains best results through a 2,000-foot wire insulated from the ground throughout its length. Although his first trials were with straightaway antennas, he early became convinced of the efficacy of the loop aerial, telling Lieutenant-Commander Taylor in 1916 that this would be better than the former method.

OFFICIAL RECOGNITION

OFFICIAL recognition of his work for the American cause was early accorded to Dr. Rogers. After the confidential investigation by naval officers in 1916, Josephus Dan-

iels then Secretary of the Navy asked the patent office to expedite action on the scientist's application. Captain S. S. Robison a distinguished naval expert and author of the "Manual of Radio Telegraphy and Telephony," Admiral William Strother Smith and many other notable experts complimented Dr. Rogers highly and Commander Hooper

wrote in Nov. 1917, "Your invention is the one above all which has been of greatest interest to me and the one which I consider of greatest value, especially during the present crisis." Georgetown University and the University of Maryland both conferred the degree of Doctor of Science upon the inventor, while the General Assembly of Maryland extended a vote of thanks in a joint resolution. The Maryland Academy of Sciences, in addition to bestowing a gold medal, recommended Dr. Rogers for the Nobel prize. Admiral R. S. Griffin chief of the Bureau of Steam Engineering, wrote: "There have been other claimants to methods of underground signaling, but none was useful, within



Upon the huge tables Dr. Rogers tries out various circuit arrangements, and he has all the necessary instruments handy for making accurate comparisons of results obtained by various methods—nothing is taken for granted or "judged"; if it can not be observed by employing his delicate meters, it is not passed

the Navy Department's knowledge, to the extent of being a valuable asset to the general scheme of radio communication. The introduction of Dr. Rogers's receiving system marked the beginning of the use of underground aerials for receiving to great advantage over raised aerials, and has been valuable to the navy during the war."

GAS PIPE GROUNDS AND THE FIRE LAWS

In an article entitled "Mistakes to Avoid in Erecting Antennas," by G. Y. Allen published in the June issue of Radio Broadcast, the author stated that the ground connection could be made to a water, steam, or even a gas pipe. Since the publication of that article the National Board of Fire Underwriters has drawn up some new rules. The use of gas pipes for ground connections is now forbidden. The reason for this rule is that some gas systems in the house are electrically insulated from the ground, and would therefore resist the flow of current to the ground and a high potential surge might cause a fire.—THE EDITORS.

The Storage Battery in Radio Service

How to Select a Battery of the Right Capacity, Where to Install It, What Care Must Be Given It, and How It Is Charged

By JOHN GAREY

The Electric Storage Battery Company

WHERE vacuum tubes are used with radio receiving equipment a small current of electricity at a constant voltage is required to heat the filament in the vacuum tubes in order to make it sensitive for receiving. A great deal of experimenting and investigating has been done to determine the best means of supplying a current which will be suitable for this purpose, but so far the only really practicable method which has been found is the use of a storage battery

It might seem offhand that the ordinary lighting current from the city supply after it had been properly reduced through resistance would be ideal for this purpose, but the fact of the matter is that this current is not at all suitable as there is a humming noise which accompanies it which is distinctly audible in the head phones and which therefore seriously interferes with the receiving of music, speech, or other broadcast messages. It is possible to eliminate these noises to a large extent by means of complicated tuning processes but one must be an experienced radio engineer in order to obtain satisfactory results by this method.

A storage battery is, therefore, the most practicable source of current for the filament circuit as a storage battery will supply a noiseless current at an approximately constant voltage and it can be connected up and operated by any one by merely following a few simple rules. The battery used to heat the filament in a vacuum tube is known as the "A" battery.

DETERMINING THE PROPER SIZE OF BATTERY TO USE

THE capacity of a storage battery is measured in ampere hours or the ability of the battery to give a discharge of a certain number of amperes for a given number of hours. Thus a battery which will give a discharge of 1 ampere for 80 hours has a capacity of 80 ampere

hours, which is the product of the discharge rate in amperes multiplied by the time in hours for which the battery will give this discharge.

In determining the proper size of battery for use with your radio set, there are two factors to be considered. The first is the number of vacuum tubes which are to be used, and the second is the facilities which are available for recharging the battery when its charge has been used up.

Most receiving vacuum tubes now on the market each require a current of approximately 1 ampere. The current required by two tubes is thus about 2 amperes and by three tubes 3 amperes, etc. These tubes also require a voltage of approximately 5 volts and this means that a 6-volt, 3-cell storage battery must be used. Each cell of a lead type storage battery delivers approximately 2 volts. Suppose, for instance, that your radio set uses two vacuum tubes and that the set will be in operation on an average of 2 hours per day, the discharge current required will then be 2 amperes and this discharge over a period of 2 hours will take 4 ampere hours per day out of the battery. A 40 ampere hour battery would carry this discharge for about ten days before recharging, and an 80 ampere hour battery would carry this discharge for about twenty days.

If there is either alternating or direct current available in the home, the storage battery will need to have only sufficient ampere hour capacity to take care of the discharge to the vacuum tubes over a period of about a week as it is always a simple matter to recharge the battery by the methods which are outlined below. In general either a 40 or an 80 ampere hour battery is used under these circumstances.

If, however, there is no current available in the home and it will be necessary to transport the battery to a charging station every time it requires recharging, it will be well to obtain a storage battery of sufficient capacity to take care of the required

discharge for a considerable period to avoid the inconvenience of this transportation at short intervals. It is generally best to use an 80 or a 120 ampere hour battery in this case.

WHERE TO INSTALL THE BATTERY

IN INSTALLING the battery, choose a place where it will be readily accessible for the addition of water to replace evaporation of the electrolyte and also where it will neither be cut off entirely from all ventilation nor will be near any exposed flame.

The solution or electrolyte in the battery is a dilute solution of sulphuric acid and it will be wise to install the battery in such a place that no harm will be done to expensive rugs or hardwood floors in case any of this electrolyte is accidentally spilled. If by chance any of the solution is spilled, the effect of the acid can be counteracted by the prompt use of a dilute solution of ammonia.

The best practice when installing a storage battery is to place it in a closet or in a covered box where it will be out of the way but readily accessible. In some cases the storage battery can be installed on a shelf in the cellar and the lead wires brought up through the floor to the radio set.

A number of the more expensive cabinet radio receiving sets have a space provided at the base of the cabinet so that both the storage battery for the filament circuit and the dry cell battery for the plate circuit can be installed in a convenient but out of the way position.

In some cases ingenious amateurs have built a small box or cabinet divided into sections to hold both filament and plate batteries and also the rectifier or battery charger. The outside of this box may be given a stained finish in

order to match the finish of the remainder of the apparatus.

Although a well-built storage battery has a neat and well-finished appearance, it is not ornamental and there is really no more reason why it should be installed in the parlor than there is, for instance, that the battery which rings the front door bell should be placed in a similar position.

The first step which any one should take

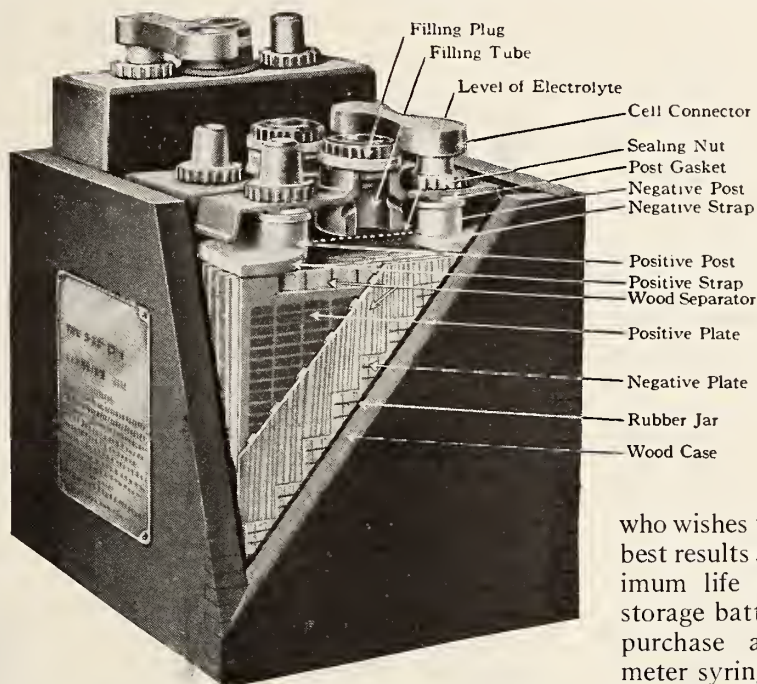

This is a sectional view of a six-volt lead plate storage battery such as is commonly employed in radio circuits. There are three individual cells, each having its own composition case, as may be observed in the picture. The rear cell has been raised to show its appearance. The centre cell is in normal position and the front cell is cut away to show its parts

who wishes to get the best results and maximum life from his storage battery is to purchase a hydrometer syringe. This instrument consists of a glass barrel with a rubber tube on one end and a rubber bulb on the other, as shown in an accom-

panying illustration. Inside the glass barrel there is a hydrometer float with a graduated scale.

Due to the chemical reaction which goes on in a storage battery during charge or discharge, the specific gravity or density of the solution varies from a maximum at full charge to a minimum when the battery is completely discharged. The gauging of the specific gravity of this solution is the only reliable means of determining the state of charge or discharge of the battery.

In batteries used for radio service, the specific gravity of the solution ranges from about 1.275 at full charge to 1.175 at complete dis-

charge. The scale of the hydrometer float is graduated from about 1.300 to 1.100.

The procedure to follow in taking a specific gravity reading is as follows:

Remove the vent cap from one of the cells, gently squeeze the rubber bulb of the hydrometer syringe expelling the air and insert the rubber tube through the opening, down into the solution. Then allow the bulb to expand, thus drawing some of the solution up into the glass barrel. A little practice will show how much the bulb must be squeezed in order to draw sufficient solution up into the glass barrel to float the hydrometer but still not have it in contact with the top of the glass barrel.

With the hydrometer floating freely, the next step is to find where the top level of the solution in the glass barrel comes on the graduated scale of the hydrometer float. The reading of the scale at this point is the specific gravity of the solution.

If the reading is 1.275 the battery is fully charged. If it is 1.225 the battery has practically half of its capacity remaining, but if the reading is as low as

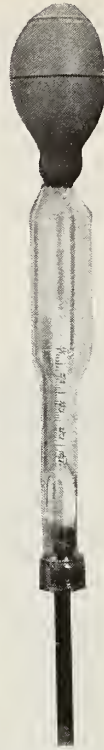

This is a hydrometer syringe, used for determining the condition of storage batteries. The tip is placed in the cell to be tested and by merely pressing and releasing the rubber bulb some of the battery liquid is brought up into the syringe barrel which is of glass. The position on the hydrometer scale to which the surface of the liquid rises is the value of the specific gravity. The hydrometer must float free of the glass barrel

1.175 the battery is in a discharged condition and should be recharged as soon as possible. When the reading is completed, care should be taken to return the solution in the glass barrel to the same cell of the battery from which it was withdrawn.

The taking of hydrometer readings is really a very simple process which can easily be learned by any one after a little practice.

In order to obtain satisfactory results from a storage battery in radio service the following few simple rules should be followed:

1.—Keep the level of the solution in all cells above the top of the plates by replacing evaporation with pure distilled water only, as required. (About once per month.) The best time to add the distilled water is just before the battery is to be charged.

2.—Keep the tops of the cells wiped clean and dry.

3.—Never let the battery stand in a completely discharged condition any longer than is absolutely necessary.

4.—Never add acid to the solution. The

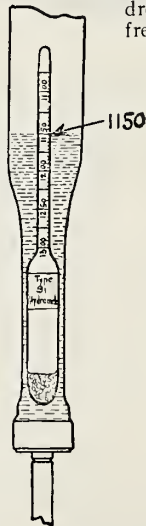
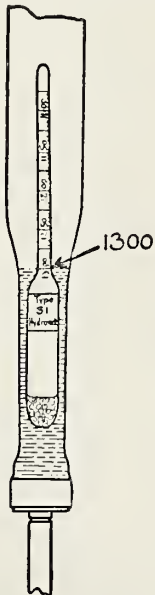

The figure to the left illustrates the position the hydrometer will take in the syringe when the battery is fully charged—it shows that the specific gravity of the electrolyte, or liquid, is 1300. When the electrolyte forces the hydrometer to only 1175, it is time to recharge the battery

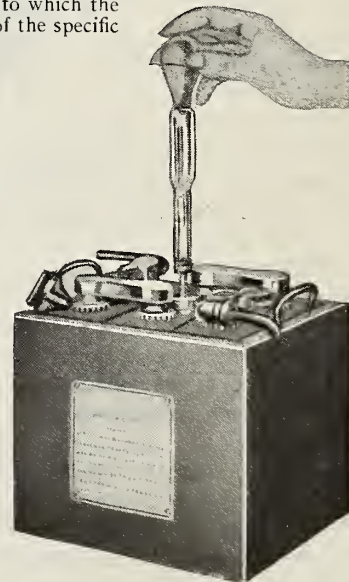

The vent-cap has been removed from the centre cell of this battery—there are three cells in a six-volt storage battery of the lead type—with the cap removed the tip of the syringe may be inserted and the electrolyte tested

original acid is all that is ever needed in the battery unless it has been spilled—in this event have new acid added at a service station.

CHARGING THE BATTERY

IF THERE is lighting current available, the first step to be taken is to find out from the lighting company the voltage of this current and whether it is a direct or an alternating current.

If the current is found to be direct, the battery can be charged either through a battery charging resistance which can be readily obtained or through a combination of lamps of the proper size and rating. An accompanying diagram shows the arrangement for charging a 6-volt battery from a 110-volt, D. C. circuit, the lamps being carbon filament lamps rated at 110 volts and 32 candle power. As shown, they are arranged in parallel with each other and the combination is in series with the battery. With this arrangement, each

lamp will allow 1 ampere of charging current to pass through the battery, so that the number of lamps to be used will depend upon the charging rate of the battery, which is generally stamped on the battery name plate. The diagram shows six lamps which will allow 6 amperes to flow and is therefore suitable for use with a battery having a charging rate of 6 amperes.

It is very important that a storage battery should not be charged at a rate higher than the charging rate given on the battery name plate.

Care should be taken to see that the positive terminal of the battery is connected to the positive lead of the lighting circuit. If the battery is charged in a reverse direction for any period of time it will be ruined.

A simple method of determining which is the positive or negative lead from the lighting circuit is to dip the ends of the two wires, one from each side of the lighting circuit, into a glass of water in which a teaspoonful of salt has been dissolved, taking care not to allow the ends of the wire to touch. Fine bubbles of gas will be given off from the *negative* wire. After

this has once been determined, it will be a good plan to so mark the positive wire that it may always be distinguished from the negative one.

In the event that the lighting current is found to be alternating, a suitable rectifier must be obtained to convert this current to direct current before it can be used for charging the battery. With a rectifier the use of resistance, as given above, is not required as the current is automatically reduced by the rectifier. The only precaution to be taken is to be sure that the charging rate of the rectifier does not exceed the proper charging rate of the battery as given on the battery name plate.

In either of the above cases the battery may be considered to be completely charged when, with the charging current flowing, all cells are gasing (bubbling) freely and the specific gravity of the solution, as read by the hydrometer, has reached a maximum and shows no further rise over a period of 5 hours.

Provided the charging rate used does not exceed the proper charging rate of the battery, no serious harm can come from continuing the charge for a number of hours after the battery has reached a fully charged condition. It will therefore be possible to leave the battery on charge over night without risk of damaging it.

The storage battery in radio service is by no means an experiment but is a dependable source of power which will give better results for use with the filament circuit than any other method that has been found.

Storage batteries have been in very general use in the electrical industry for many years. Wherever an absolutely dependable source of non-fluctuating current has been required. They have been used universally in wireless telegraph service ever since that method of communication came into commercial use. Every time you telephone or send a telegram a storage battery is used.

In obtaining a radio storage battery just as in making any other purchase it is the best economy to buy one of the highest quality.

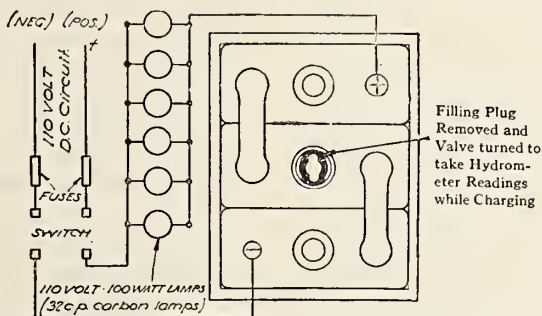

By employing a lamp bank in series-parallel as shown here, a storage battery may be charged from a direct current (D. C.) supply. Where lamps of the size indicated are employed, each permits a current flow of approximately one ampere. With six lamps burning, the charging rate would be about six amperes. Almost any desired charging rate may be obtained by using lamps of suitable values

Radio Frequency Amplification

Its Problems and Possibilities

By ZEH BOUCK

THE advantages of *radio* over *audio* frequency amplification are many, but its general use in amateur installations has been retarded by attendant complications which radio science is to-day just overcoming.

Audio and radio frequencies refer to frequencies or vibrations as divided into bands, one (audio) affecting the human ear as sound, and the other (radio) of a pitch above that to which the ear responds. An interesting experiment that will clarify and illustrate the difference between audio and radio frequencies is unconsciously performed by the operator in searching out bulb or arc stations with his receiving tube oscillating. At certain variations of the series or shunt condenser the howl of the transmitting station is audible, the note becoming lower and lower as the variation is continued. At the resonance point the sound disappears to be heard again on the other side, rising in tone until it leaves the audio range at approximately ten thousand cycles, and vibrates at radio frequencies that cannot be heard.

Throughout this article, and in similar papers, it is well to bear in mind the relation of frequency to wavelength, understanding that they vary inversely: the higher the frequency, the lower the wavelength. The layman can easily comprehend this relationship by visualizing the analogy of a piece of string equal in length to the distance radio waves travel in one second; imagining the string "chopped" into homologous parts. It is obvious that the more sections (higher frequency) into which the string is clipped, the smaller will be each individual piece, (wavelength) or vice versa.

The principal advantage of radio frequency amplification is that it makes audible signals that were originally too weak for detection and which, therefore, unlimited stages of conventional amplification would not have affected. Ordinarily, to receive radio signals, phone or spark, the potential applied to the grid of the first tube must be of sufficient in-

tensity to vary the plate current at *audio frequency*. However, if the original current induced from the antenna circuit is not of the requisite strength, it can be augmented by successive steps of radio frequency amplification to that point where it can be detected or transformed into sound impulses. From there on, if desired, it may be amplified further by audio frequency methods.

Thus radio frequency intensification makes practicable reception on loops, small indoor and ground antennas, in which only a comparatively small amount of current is induced and picked up.

Radio frequency amplification is also opening up unthought-of possibilities in the field of static elimination: first, by permitting, as explained in the preceding paragraph, the use of underground antennas, and loops located in cellars, with which atmospheric disturbances are almost nil, reception being often possible in the midst of an electrical storm; and secondly, on short waves by a tendency to amplify signals in greater proportion than static due to the fact that QRN (*static*) is more prevalent at lower frequencies (higher waves). Listening in alternately on long and short wave sets of a summer evening will demonstrate this.

Another advantage of this system of intensification is the discrimination against extraneous noises, amplifying only the signals which come through loud and clear, free from rattle and scratching so characteristic of present day amplifiers. Such sounds are practically unavoidable and are due to one or all of the following causes:

1. Noisy batteries and poor connections.
2. Mechanical vibration of the tubes.
3. Induction from telephone, electric light and bell wiring.

To acquire a knowledge of radio frequency amplification applicable to everyday receiving problems, it is necessary to grasp the fundamentals of bulb operation, particularly the significance of the characteristic curve; and the phenomenon of resonance with the difficulties imposed on radio frequency currents by reactance.

It is fairly well understood that the plate current through a vacuum tube is directly dependent on the electrification of the grid, and that any change in the grid charge will cause a similar but greater variation in the plate current. Thus when a high frequency current, such as exists in the secondary circuit during reception, is impressed on the grid, the plate current will fluctuate with each alternation; in other words it will vary at a radio frequency equal to that of the original current. But the plate current also fluctuates at audio frequencies, owing partly to what is known as the asymmetrical action of the valve, and partly to the periodic discharges from the grid condenser. In this manner the space or plate current of a receiving tube is divided into two parts, the radio frequency and audio frequency components, a phenomenon that is shown diagrammatically in Fig. 1.

In radio frequency intensification it is of course the radio frequency component in which we are interested and which is passed on to the succeeding tubes for amplification. But the comparative values of the two components vary

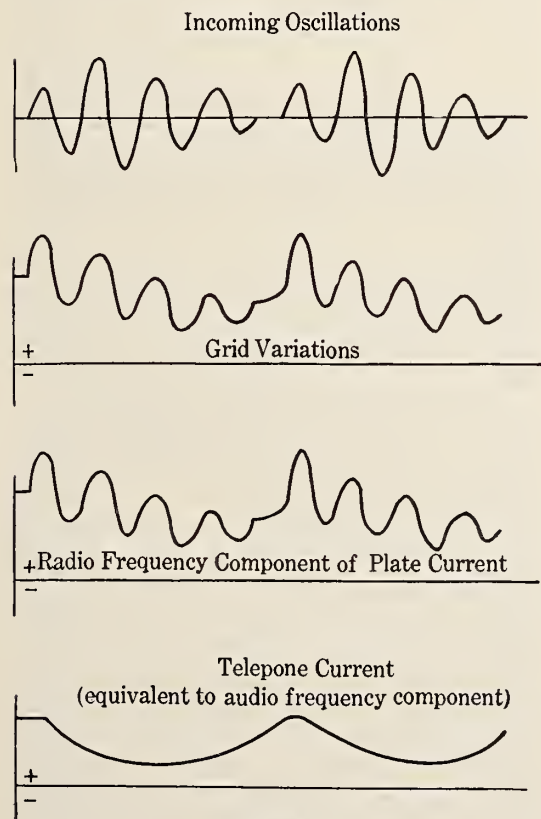

Fig. 1.

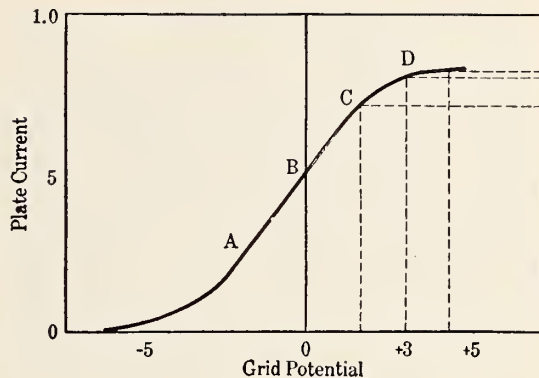

Fig. 2.

with the average grid potential as determined by the grid condenser and leak.

The characteristic curve of the three element tube is shown in Fig. 2, and it perfectly illustrates how grid variation at different potentials will have certain effects on the radio frequency and audio frequency components. If an alternating e. m. f. is applied to the grid, on one half cycle it will augment the grid potential, while the other half alternation will decrease it, with corresponding changes in the plate current. But if the original grid potential is plus three volts, i. e. the tube is being operated at point D of the characteristic curve, study of the diagram will show that the change in grid potential toward zero will cause the plate current to drop in greater proportion than an equal change away from zero will increase it! This is called the asymmetrical action of the tube, and in virtue of this lack of uniformity each group of incoming oscillations will cause an average drop in the plate current (always providing the bulb is operated at point D), a drop that occurs at audio frequency. If, on the other hand, the audion is operated somewhere on the straight portion of the curve, from A to C, such as at point B, the alternating potential on the grid will cause an equal rise and fall of the plate current, thereby decreasing the audio frequency component, but strengthening the radio frequency component. Therefore, in order to secure the best results with radio frequency amplification, some method of determining the grid potential should be employed. In hookups calling for neither the grid condenser nor leak, the same effect can be partially secured by a careful adjustment of the filament and plate batteries. In some cases the condenser and leak will be found necessary to control oscillations as the radio frequency

amplifier is, *per se*, a tuned plate circuit and at times will oscillate.

Having determined a method of taking the fullest advantage of the radio frequency component, it now remains to pass it on to similar stages for amplification, and finally to a detector. The plate current of the detector tube is caused, by grid adjustment, to vary powerfully at audio frequency and is passed either through the phones or the primary of an audio amplifying transformer. Where leaks and condenser are used in each step of amplification, the last tube is generally a soft bulb, which, with a different grid adjustment, functions as the detector.

Any system that will impress the radio frequency output of one tube on the grid of a succeeding one, while discriminating against audio frequency vibrations, will act as an amplifier. Two methods, the resistance coupled (Fig. 3), and the inductive or transformer type (Fig. 4) have been popular on low frequencies, but until recently neither had been very successfully adapted to short waves. Previous to the perfection of the present day amateur tube, the high internal capacity of the available bulbs, acting partly as a shunt condenser across any added inductance in the plate circuit, made tuning down to two hundred meters very difficult. Also the adjustments in the inductively coupled amplifier are extremely critical at the higher frequencies. Each successive step of radio frequency amplification must be in resonance with the preceding one (in tune with it) just as the set itself is in resonance with the transmitting station. Resonance is a condition in radio frequency circuits in which an alternating current of a certain period will pass through it with the least loss, and it is determined by the balancing effect of inductance and capacity. Hence, as resonance is dependent on these two qualities, a change in either inductance or capacity will shift the resonance point to another wave. And the reverse of this is a corollary, i. e. that a shift in wave will necessitate a corresponding change in either

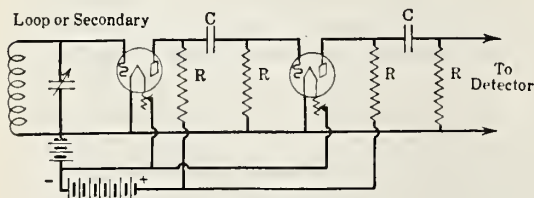

Fig. 3.

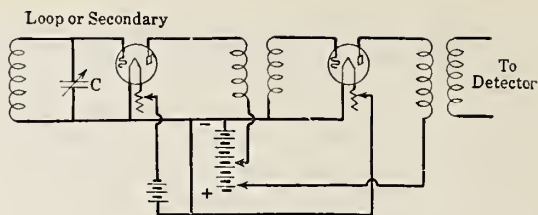

Fig. 4.

inductance or capacity or both to regain resonance. But this phenomenon is much more apparent at higher frequencies where a minute change in the values of L and C will shift the wave several meters, while on a higher wave it would have little effect.

Thus every change in wavelength on a short wave radio frequency amplifying set made necessary, and to an extent still does, a complete retuning of each step of amplification. However, the modern vacuum tube with its low internal capacity, and transformers designed to be operative over a band of high frequencies, have done much toward solving the problem. Some attempts have been made to broaden the range of operative waves in radio frequency transformers by the introduction of an iron core, but this, as a rule, is very inefficient owing to hysteresis loss. Hysteresis loss is a diminution of power occasioned by the utilization of energy to reverse the magnetic field of the iron core. When the current, and with it the magnetic poles, fluctuate a million or more times per second (on low waves) the loss is comparatively large.

The condensers C , in the third diagram, are placed between the successive steps of amplification. This capacity offers a low reactance to radio frequencies, passing them on for amplification, but impedes audio variations.

The inductively coupled system in Fig. 4 employs radio frequency transformers such as have been placed on the market by several manufacturers, and which are operative with fair efficiency from two hundred to five hundred meters. The primaries and secondaries are tuned broadly to the same wave and freely pass the radio frequency components through each bulb, but due to their low inductance there is little transference of audio frequency energy. The circuit in Fig. 4 was designed for broadcast reception on three hundred and sixty meters. The loop is wound on a frame, twenty-four inches square with six turns of wire spaced one inch. Condenser C has a capacity of .0015 mf.

with an almost indispensable vernier adjustment. With two steps of radio, a detector and one step of audio frequency amplification, signals from WJZ received in Jersey City, comfortably actuated a loud talker. The speech was of unusual clarity, unmarred by distortion, microphonics or scratching sounds.

Loops have been indicated in Figures 3 and 4, but in each case the secondary of a tuning transformer or variocoupler may be substituted and the set operated from an open antenna.

One of the most ingenious circuits for radio frequency amplification,—one that completely eliminates the undesirable features of other systems, which are low efficiency and critical adjustments on short waves, and the tuning of each step for different frequencies—is the external heterodyne or (later) the super-heterodyne system of Major Armstrong.

The phenomenon of beats caused by heterodyning, is fairly well understood, but for the benefit of the new enthusiast it might be well to mention

that the beat is a wave or frequency resulting from the superimposition of one frequency on another, or, still more clearly, the difference between them. In the experiment mentioned before as an illustration of audio and radio frequencies by tuning in a continuous wave station with the receiving set oscillating, the sound or squeal was the beat set up by two frequencies (those of the transmitting and receiving bulbs) whose differences were less than ten thousand, or within the audio range.

A fundamental idea of the functioning of the Armstrong circuit can be had from Fig. 5 without recourse to a complicated diagrammatic dissertation. A is the heterodyne bulb in a circuit designed to set up oscillations of any desired frequency. Cabinet B encloses five steps of radio frequency amplification, with the final detecting tube, each step tuned sharply to a predetermined frequency, for example, 500,000 cycles (600 meters). Cabinet C is an audio frequency amplifier of one, two or three stages. An incoming signal is heterodyned by the local oscillations so that the resulting beat frequency (or the difference between the incoming and the

local oscillations) is equivalent to a six hundred meter wave to which the amplifier is tuned! If the desired station is an amateur working on two hundred meters (1,500,000 cycles), the heterodyne will be adjusted to one million cycles (1,500,000 minus 1,000,000 equals 500,000). In three hundred meter reception (1,000,000 cycles) the local oscillations would be tuned to the frequency of five hundred thousand, etc., always bearing in mind that the beat frequency must be that to which the amplifier is tuned.

An efficient two step radio frequency amplifier can be made of honeycomb coils,—a set that will prove not merely an interesting experiment, but a desirable addition to any station. Two-coil mounts are used and wired in place of the radio frequency transformers in

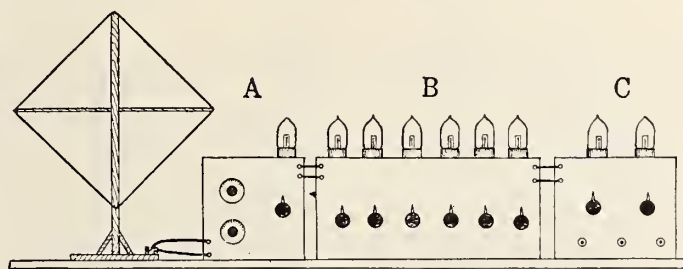

Fig. 5.

Fig. 4. In making large wave shifts, different coils are plugged in (the same size throughout) permitting reception on any wave, while very fine tuning is accomplished by coupling variation. Strange to

say, the circuit seems to give better amplification on loop than on a conventional antenna.

Special care should be taken in wiring up radio frequency amplifiers. Bare wire is preferable, well spaced, and run as much as feasible at right angles. Leads must be short, and every precaution taken to avoid adding either capacity or inductance to the circuit.

It is difficult to make comparisons between regenerative sets and straight hookups with radio frequency amplification, because, as explained before, the radio frequency set is virtually a tuned plate circuit and regenerates to a certain extent. However, one step of radio frequency intensification, in an ordinarily non-oscillating circuit, will give louder and clearer signals than the average short wave receiver with a single bulb.

To sum up: Radio frequency amplification consists of taking full advantage of even the almost infinitely weak radio wave in nearly its original form, and strengthening it through cascade amplification. In this manner it differs from the audio systems which only amplify, along with other noises, a sound wave

corresponding roughly to a radio wave of sufficient strength to cause it. Radio frequency is the more difficult to handle, but improve-

ments that are steadily simplifying the system will soon place its advantages at the disposal of the layman.

Clearing Up the Ether

What the Conference Called by Secretary Hoover Did to Find a Satisfactory Basis on Which to Build Stable Radio Development for the Best Interests of All Who Would Use This Means of Communication

By PAUL F. GODLEY

This is a thoroughly comprehensive discussion in everyday "American" of the most important radio question of the day. The author of this article is recognized internationally as an authority on the subject, and represented American amateurs at the conference, called by Secretary Hoover in Washington.—THE EDITORS.

ALL this discussion about wavelength—what does it mean? What is the great significance which attaches to the discussion? Why the need for a national conference on the subject, and what has been the outcome? Will the wavelengths of existing stations be changed? If so, why? Will many thousands of receivers be scrapped as a result, and would such scrapping of receivers, if found necessary, be justified?

Questions such as these have been uppermost in the minds of radio fans for many weeks, and few there are who seem to have been able to get to the bottom of the whys and wherefores of the recent radio conference to which so much space was given but a short time ago in our daily press. To close students of the Art it became apparent many months ago that some radical changes in the methods of apportioning wavelengths for transmitting stations must be made at once if the rapid development of the radiophone were not to be choked at its birth. Interests of all sorts have been clamoring for licenses to broadcast: concerts, news, sports events, advertising, whatnot,—everything was to be thrown pellmell into the air. In order that the air might be kept as free as possible from the "squatters," the Department of Commerce, which has it within its power to license radio stations of all classes, has made it a policy to place all broadcasting stations on one wavelength—360 meters. That is now to be changed.

Thousands of newcomers have entered radio

fandom. Nearly all of these have little knowledge of radio—either its limitations or its possibilities. A great percentage of these in some fashion gained the idea that all interference was of "amateur" origin. Seasoned radio men knew better, of course, but the demands of these newcomers, fortunately, hastened a conference which came none too soon.

In order that you may understand something as to the nature of the situation as it exists at the time this is written, it would be well for you to get some idea (1) as to what electric waves are and something concerning their length and the number which are useful in radio communication, (2) the different classes of service which are demanding accommodation and their degree of importance, (3) the number of stations which can be operated in a given community within a certain band of wavelengths, and (4) what steps have been taken by the committee of experts called to Washington by Secretary Hoover to utilize most economically those wavelengths available for radio communication. An understanding of these things should give you a clear picture of what the situation is and what future developments should promise.

THE ETHER

SCIENTISTS have formed a theory which assumes that our universe floats in and is pervaded with an invisible, *extremely* elastic fluid. We do not know its nature. This sea of elastic fluid is not quiescent, it is troubled

at all times by vibratory disturbances. These disturbances vary in characteristics. Some recur at inconceivably short intervals, others recur at longer intervals. We are able to both create and detect some of them. Our eye detects a few of these vibratory disturbances and we have classified those as "light." Our bodies detect others of these ether disturbances and we have classified them as "heat." A camera will detect still others

which neither the body nor the eye will indicate, such as X-rays, etc. There are many groups of disturbances in this elastic fluid—it has been named the ether—which we have not "discovered," but many years ago, a German scientist, Hertz by name, discovered disturbances which produced electrical effects and which could be reproduced by electrical effects. These have been called Hertzian, or electric waves. In reality they are the same sort of disturbances and, generally, exhibit the same characteristics as all ether disturbances. It is this group of electrical disturbances which is used in radio communication. The intervals between these electrical disturbances in the ether vary as does also their magnitude. Both the magnitude and their intervals are determined by certain factors. For example, the greater the force used in creating the electric disturbances in the ether, the greater the magnitude of the disturbances, and the greater the electrical dimensions of the machine or system used in the creation of the disturbances, the greater the interval of time between their recurrence.

All of these disturbances travel through the elastic conveying medium at the same rate of speed, which is 300,000,000 meters per second. (which equals 186,000 miles, or approximately $7\frac{1}{2}$ times around the world). Knowing that these disturbances travel at a certain rate and knowing that they reach

a given point at certain fixed intervals, it is seen at once that in their travels they are spaced a certain distance apart. Therefore, we may find the distance of spacing by dividing their rate of speed by the frequency of their recurrence. The result will be an expression in meters and this is what is termed, "wave-length," for the disturbances are undulatory in form like a wave disturbance on water.

Electrical disturbances in the ether which are of use in radio communication vary in frequency between about 3,000,000 per second and 12,000 per second, or, converting frequency to wave-length, from 100 meters in length to 25,000 meters in length. We know of certainty that there are disturbances in the ether of

RAY OR WAVE	FREQUENCY PER SECOND	WAVE LENGTH, METERS	RECEIVER
GAMMA RAYS Given off by Radium and radioactive substances .	30,000,000,000,000,000.	.000,000,000,01	Photographic plate or fluorescent screen.
X-RAYS Used for medical purposes.	4,700,000,000,000,000.	.000,000,638.	
SHORTEST ULTRA-VIOLET RAYS .	3,000,000,000,000,000.	.000,000,1.	The eye
Violet Light .	830,000,000,000,000.	.000,000,36	
Blue " .		.000,000,454	
Green " .	down to	.000,000,49	
Yellow " .		.000,000,588	
Orange " .		.000,000,652	The skin
Red " .	270,000,000,000,000.	.000,000,8	
INFRA-RED RAYS which include what we know as heat. . .		down to .001.	The aerial with suitable detector circuits.
ELECTRIC WAVES used in radio .	6,000,000 down to 12,500	50 to 25,000	

This table is a word picture of the various movements in the "ether" which register upon our senses in the form of heat, light, and color; and vibrations which may only be detected by scientific processes. Radio waves are at the base of the table and vibrate at a very much slower rate—though even these waves are too rapid in their alternations for the human ear to detect.

much higher frequency as well as much lower frequency, but we have not yet learned how to use them in radio communication and we cannot say that they will ever prove useful unless our present limitations are somehow swept away.

THE CAUSE OF INTERFERENCE

IT MIGHT seem to the uninitiated that even with this great number of different frequencies from which to choose it should be possible to erect and operate an unlimited number of electric wave (radio) transmitting stations without their interfering with each other. Some day this may be possible. At the present time, however, the machinery used for the generation of these electric waves as well as those machines used for detecting them at distant points, is in a state of development which by no means permits this. Although we desire to create a disturbance of a very definite frequency, we find that in using the means now available, we also create disturbances of slightly greater frequency and slightly lesser frequency. And, too, although we may wish at the distant receiving stations

to register the effects of disturbances of but one definite frequency, the lack of perfection of our receiving equipment as yet makes this impossible. To avoid interference between transmitting stations it is obvious, then, that the frequency of the disturbances which they create must differ to a sufficient extent to offset the shortcomings of the available apparatus and methods. The *very best* that we are able to hope for now is a difference in frequency, for adjacent transmitting stations, of at least 10,000 cycles. This means that within a given small area it would only be possible to erect a comparatively small number of stations, and at the same time avoid interference. But, if stations are *separated* sufficiently, and if they are *limited* in their range of transmission, two or several may operate on the *same* wave length without producing interference at the receiving station.

These things have all been taken into consideration in the division of available wavelength bands among the various classes of service.

RADIO'S MOST IMPORTANT SERVICE

RADIO telegraphy quite naturally found its first application in providing communication between points excluded from the use of other methods. First of all came communication between ships at sea and between ships and shore. Communication of this class is a very important one, since it insures the safety of both life and property at sea. Communication of this class is still considered as the most important use to which radio telegraphy and telephony may be put, and now that we have discovered the wonderful potentialities in connection with the broadcasting of vital news information, educational matter, entertainment, etc., it is the consensus of opinion, of American radio men at least, that radio broadcasting ranks second in order of importance. Perhaps that class which ranks third in this list is intercommunication among amateurs, for neither our Army or our Navy can forget the importance of a personnel trained in modern signal methods during wartime. It is doubtful whether enough money could be appropriated by our Government to train such a vast body of communication men as those amateurs who train themselves in their fascinating pursuit of radio telegraphy. It has been recommended by this Conference of experts that the status of amateurs be es-

tablished by law, and that certain wave bands be allotted to them and specified in the law. And, so good has been the impression which amateurs and amateur organizations have made upon this committee that it has also been recommended that amateurs "police" themselves,—that they be a self-governing body with regard to operation, violations, etc.

HOW THE ETHER IS DIVIDED

THERE are many other classes of service, too, and they all have been given proper consideration. Intercontinental radio telegraphy service has been allotted its band of waves; naval service, army service, aircraft service, radio compass service, radio beacons, city and state public safety service, technical and training schools, and, in certain cases, private radio stations have all been taken care of.

Most of the intercontinental service requires the use of very high power. High power stations best fit themselves to the lower frequencies, i. e., long wavelengths. Low power transmitters such as those used by amateurs, and such as those used in broadcasting and for ship to shore work, adapt themselves to the shorter wave length. Some idea as to how these wavelengths have been divided is given in the table showing allocation of wave bands for radio telephony.

WHAT THE TECHNICAL TERMS MEAN

FOR an understanding of this table, some of the terms used in it are defined.

"Broadcasting" is that type of transmission which is intended for consumption by an unlimited number of receiving stations, no charge being made for the service. This includes service broadcasted by departments of the Federal Government (Government broadcasting); the dissemination by radio of educational and informational service by public and state institutions, universities, etc. (public broadcasting); the broadcasting without charge of news, entertainment, and other service by the owner of a station, such as a newspaper, or other private or public organization (private broadcasting); and broadcasting by a transmitting station of a public service corporation where a charge is made for the use of the station (toll broadcasting).

By "fixed" service radio telephony is meant radio telephone service between two fixed points.

“Radio beacons” are radio transmitting stations which transmit signals by means of which a mobile direction-finding station may determine its bearing or position.

HOW THE ETHER IS DIVIDED

USE	WAVE LENGTH	WAVE FREQUENCY
	METERS	KILOCYCLES PER SEC.
(1) Transoceanic radio telephone experiments, non-exclusive	6,000	50.
	5,000	60.
(2) Fixed service radio telephony, non-exclusive	3,300	90.9
	2,850	105.2
(3) Mobile service radio telephony, non-exclusive	2,650	113.2
	2,500	120.
(4) Government broadcasting, non-exclusive	2,050	146.
	1,850	162
(5) Fixed station radio telephony, non-exclusive	1,650	181.8
	1,550	193.5
(6) Aircraft radio telephony and telegraphy, exclusive	1,550	193.6
	1,500	200.
(7) Government and public broadcasting, non-exclusive	1,500	200.
	1,050	285.7
(8) Radio beacons, exclusive	1,050	285.7
	950	316.
(9) Aircraft radio telephony and telegraphy, exclusive	950	316
	850	353
(10) Radio compass service, exclusive	850	353
	750	400
(11) Government and public broadcasting, 200 miles or more from the seacoast, exclusive	750	400
	700	428
(12) Government and public broadcasting, 400 miles or more from the seacoast, exclusive	700	428
	650	462
(13) Marine radio telephony, non-exclusive	750	400
	650	462
(14) Aircraft radio telephony and telegraphy, exclusive	525	572
	500	600
(15) Government and public broadcasting, exclusive	495	606
	485	618
(16) Private and toll broadcasting	485	618
	285	1052
(17) Restricted special amateur radio telegraphy, non-exclusive	310	968
(18) City and state public safety broadcasting, exclusive	285	1052
	275	1091
(19) Technical and training schools (shared with amateur)	275	1091
	200	1500
(20) Amateur telegraphy and telephony (exclusive, 150 to 200 meters) (Shared with technical and training schools, 200 to 275 meters.)	275	1091
	150	2000
(21) Private and toll broadcasting, exclusive	150	2000
	100	3000
(22) Reserved	100	above 3000

"Radio compass service" consists of a direction-finding service to which a mobile station transmits, and which in turn transmits back to the mobile station its bearing or position.

Marine radio telegraphy includes all radio service between ships at sea and between ship and shore.

By "technical and training school" is meant a school which carries on instruction for the training of men for the radio service.

"Amateur" is defined as one who operates a radio station either transmitting, receiving, or both, without commercial gain, merely for personal interest, or in connection with an organization of like interest.

It is also of interest to note that public safety broadcasting on the part of city and state organizations, in small cities especially, is expected to be conducted by the interruption of other types of broadcasting service in case of emergency. In the larger cities, however, this service is quite apt, ordinarily, to employ its own stations, under which circumstances it will be confined to the use of the wave band 275 to 285 meters. A coöperation of private detective agencies with municipal or state services in the use of this wave band is recommended.

HOW AMATEURS ARE AFFECTED

OTHER provisions which have been recommended have to do with that band of wave lengths allotted to amateur radio work, for it would seem best that this band be divided into smaller bands of different types of transmitters. The lowest wave lengths within this band would naturally fall to that type of station which creates disturbances over the broadest band of wavelengths, while the higher wavelengths (those nearest the waves assigned for private broadcasting) are available only to that type of transmitter which uses the most advanced methods,—continuous wave transmitters. Between these, in the order of their merit, fall radio telephone stations and interrupted continuous wave stations, and any radiophone broadcasting carried on by amateurs must be done within this wavelength band.

Further recommendations have to do with the limitation of power, the geographical distribution, and the hours of operation of broadcasting stations. Thus all present broadcasting needs may be taken care of for the time at least, while it is expected that greater freedom

will follow the expected rapid advancement of the radio art.

In considering the causes for interference and some unnecessary sources of interference, it is expected, of course, that effort be made to utilize the most improved types of transmitting and receiving machines. Certain classes of transmitters cause far greater percentages of unnecessary disturbance than others. Time will eliminate those in favor of the improved types.

REGARDING RECEIVERS

WITH regard to receivers, some types reject a great portion of any disturbing influence while others do not. Here, too, it is to be expected that the most efficient types will survive.

What may seem rather surprising is that certain types of receiving instruments, because of the methods which are employed in them to build up the strength of the signal, also act as miniature transmitters. That is to say, some of the energy which is supplied locally for the reinforcement of the feeble incoming signal gets on to the antenna of the receiving station and escapes, creating disturbances in the ether of exactly the same character as would be created by a small transmitting station. Under certain conditions, even though there may be several hundred receivers of this character within a small area, the disturbances which they created would be of no moment (where the signal from the station which it is desired to receive is strong). On the other hand, where a number of such "transmitting" receivers are within a small area and this area is located at a point remote from the broadcasting station, considerable interference results, and it is common knowledge that in certain communities great difficulty is frequently found in receiving the broadcast programmes satisfactorily. All of these receivers are attempting reception at the same time. They all are adjusted approximately to the same wavelength. Under these circumstances, and, as indicated above, when the broadcasted signal is weak, considerable interference results.

Development will, in a great measure, take care of these things and it is entirely reasonable to assume that within a comparatively short time radio broadcasting will have become stabilized, and as much a part of our daily life as our newspaper, our telephone, or even our meals.

Broadcasting Church Services

By W. W. RODGERS

NO ONE thing broadcasted by radiophone has caused so much discussion or brought about so general an interest in radio as has the broadcasting of church services. Probably because of the fact that sending out broadcast an entire church service was iconoclastic—in the nature of breaking a few idols of very ancient standing—and because it seemed to oppose a movement of the church to get members into the edifices, there has been some question raised as to the propriety of this sort of broadcasting. Of course, its value to the shut-in, the sick or the feeble, or even the people not within reasonable traveling distance of a church, has never been questioned.

But, does sending out these church services over immense areas increase or decrease attendance at the churches? Is it doing a service or harm to the church? Is it a fad, and will it last? What is the effect upon the hearer? Really, is it worth while as something more than an entertainment?

These questions are continually asked of radio broadcasters, and of the ministers themselves who have the services of their churches broadcasted. These ministers, truly "Sky Pilots," have various answers, but a history of church service broadcasting and a review of the details of its growth will naturally give the reader an opportunity to decide for himself.

The first church services ever broadcasted by radiophone were sent out from the Calvary

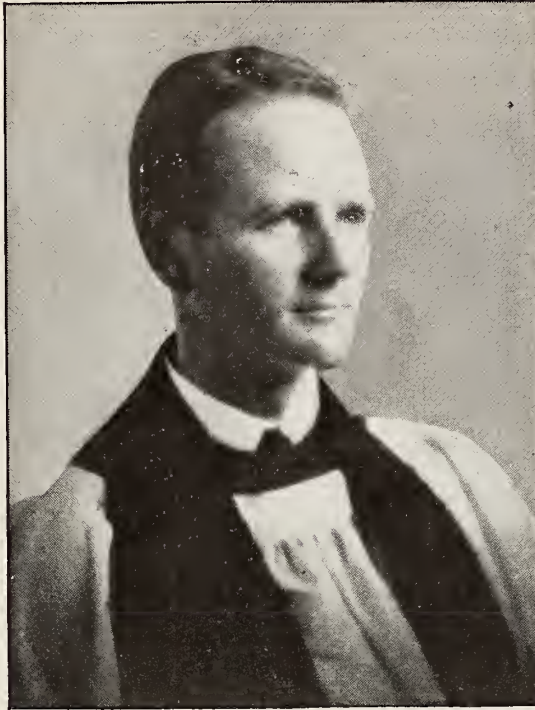

The Rev. Edwin J. Van Etten, rector of Calvary Church, Pittsburgh, Pa., the first minister ever to have his sermons and church services broadcasted. They have been sent out from radiophone station KDKA, East Pittsburgh, Pa., almost every Sunday evening since January 2, 1921

Episcopal Church, Shady Avenue, Pittsburgh, Pa., Sunday evening, January 2, 1921, from Station KDKA located in the East Pittsburgh Works of the Westinghouse Electric & Manufacturing Company, about nine miles distant from the church. The connection between these two points was, of course, a telephone line.

Those who arranged to have the services broadcasted can now look back at this first service with some amusement, but it was serious business then, for the radiophone had not come into such great popularity as it now enjoys. Strangely enough, obtaining the consent of the minister to broadcast the services from the church

was comparatively easy, as the Rev. Edwin J. Van Etten happens to be a very progressive minister and the radio idea appealed to him from the start.

It was not easy to get a good test from the church. The first services were sent out through a phonograph horn placed in the chancel. One end of the horn was attached to a telephone receiver, and, with this crude device, such sounds as were picked up by the horn were sent along the wire to East Pittsburgh and from there out into the ether.

It may seem odd to radio engineers, but the radio church services were picked up clearly by local receiving sets. In fact, so well did the signals come in, that the church was the recipient of many congratulatory letters on the installation of a radio transmitter. During

the next week, many people called at the minister's home for the purpose of seeing the antenna and sending set. When they saw the large horn, their disappointment was manifest. Most of them could not imagine the idea of sending through such an apparatus.

The horn was merely tied in place with stout cord high up in the chancel, out of sight of the congregation. Situated as it was, the vibra-

his explanation was accepted. There was no ground left for more queries by the interested one who simply had to look at the horn situated "there," so prominently, to know where the services went.

However satisfactory the horn was for the purposes of demonstrating to skeptics the ability to catch church services, it left much to be desired when it came to catching sound.



Calvary Church, Pittsburgh, Pa., the first church in the world to have its services broadcasted by radio

tion of passing street cars or the reverberations of the organ set up a rattling that was easily distinguishable.

The next week the horn was placed in the same place, but in order to guard against vibration, it was hung on rubber bands. In addition it was placed in full view of the congregation, to eliminate any skepticism regarding the method of sending out the services. Any member of the church questioned as to the manner in which the services were being broadcasted, had only to point to the horn and say "The music and the voices go out there," and

Telephone transmitters were next resorted to, and these were placed in various positions about the choir. One of these transmitters was placed in front of the minister, another over the choir, another near the chimes, etc.

The telephone transmitters worked fairly well, but still were not entirely satisfactory, so some amplification was placed in the line to boost the sound on its way to the station. This was a decided improvement. And when microphones were substituted for the telephone receivers, still more improvement was noted.

So, as the situation now stands in Calvary Church, there are eight microphones placed about the church. The chimes, the pulpit, the chancel, the organ, each has a microphone, while the others are placed advantageously above the choir. These microphones were tried in more than a hundred and fifty different places in the church before the results were entirely satisfactory.

though now in operation more than a year, has never been more than a week old at any time. This is due to the fact that constant changes are made in the broadcasting apparatus. The KDKA of December 23, 1920 and the KDKA of May 3, 1922, which was heard in Iquique, Chile, 4200 miles away, are two very different stations.

With the improvement in their broadcasting,

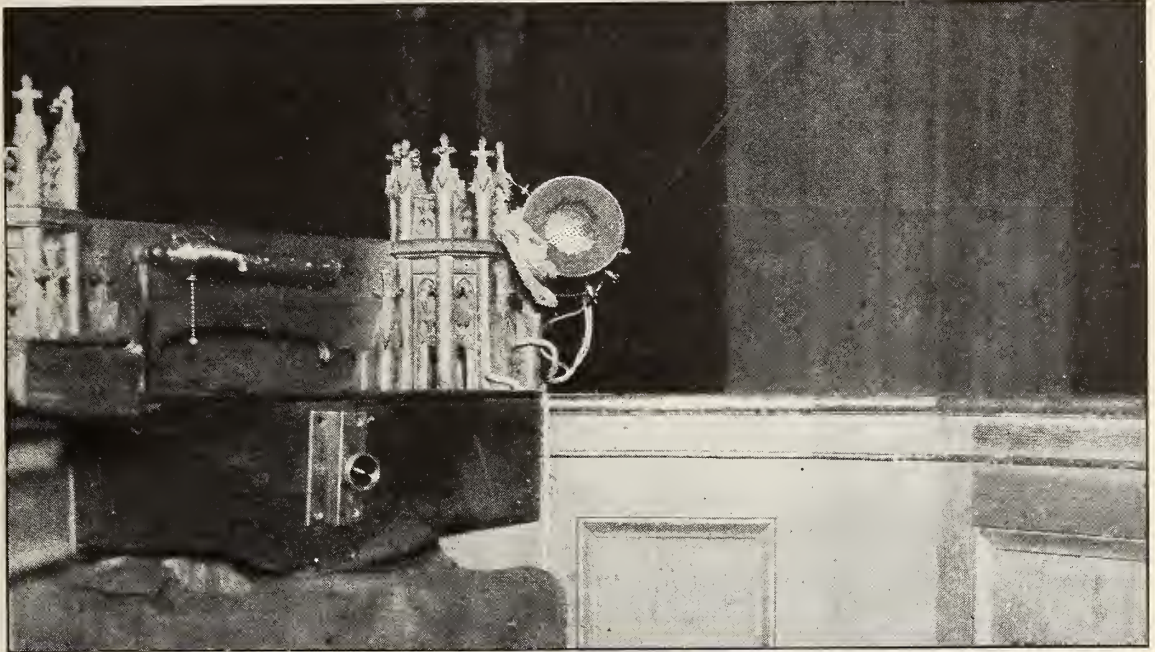

The microphone in the pulpit of Calvary Church, Pittsburgh, Pa.
Note its location and the felt padding used to guard it against vibration

All these microphones lead to a switch box which also contains tube amplifiers. An operator sits up with the choir and throws the switches for the different microphones. When the choir sings, a switch connected to the microphones in the choir loft is thrown so that these particular microphones are open. When the minister speaks, the microphone in the pulpit is thrown open. When the chimes are played the switch for them is thrown.

As a matter of fact, experimenting is still going on to perfect the telephone line system in order to get the voices to the broadcasting station as clearly as possible.

Remember that, in addition to experimenting with the microphone system at the church, tests were being continually made from the station. The equipment was changed almost as much as the microphones, for KDKA, al-

increasing interest was manifest in the church services. Letters began to stream in every Sunday from every part of the country and from all classes and conditions of people. The old lady in Maine enjoyed the sermons as much as the lady in Pittsburgh who was ill and in bed. In fact, popular sentiment seemed to be decidedly in favor of the church services being broadcasted.

After a few months of broadcasting from Calvary Church, an event happened which seemed to open the columns of all the newspapers to radio. The Herron Avenue Presbyterian Church lost its pastor, and one of the trustees, himself interested in radio, suggested the idea of installing a loud speaker and loop antenna in the church to receive the services from Calvary. This was done, and, after a few tests which were pronounced satisfactory,



Amplifying box and switches leading to the various microphones located in different parts of Calvary Church: An operator (in this photograph, W. W. Rodgers, author of this article) sits up with the choir, and throws the switches to open the proper microphones at the right times

the Herron Avenue Church actually went through the Episcopal service received from Calvary. The congregation even contributed to the collection. News of this event was published in newspapers throughout the country, from Maine to California, and it seemed to open the minds of thinking people to the great possibilities of the radiophone. At least an impetus was given radio which lifted it beyond the playtoy stage. Serious business men began to take it up, and the radiophone really entered the home as a serviceable equipment.

Some people may take exception to the statement that church services are really the backbone of the radiophone broadcasting programmes. But they are. The church is the most powerful factor in America. It wields a tremendous influence on the individual citizens. And the mere fact that church services are being broadcasted is proof enough that radio broadcasting is not merely a means of amusement for idle hours, but is also a mes-

senger of hope and uplift for serious minded men and women.

The broadcasting of church services is practically the history of radio broadcasting. It was started with almost the first of the regular concerts sent out by KDKA, a pioneer radiophone station, and these services are the only part of the programme which has survived the first year and a half of broadcasting. All the other things tried on the radiophone in those first few months have made way for something better.

The morning services of Calvary Episcopal Church were eliminated from the programme after a time, to give way to those of other churches. The idea, which had at first been viewed with distrust by other ministers, had by now been demonstrated to hold wonderful possibilities for sending out the Gospel. So, when it was decided to give these other churches an opportunity to have their services broadcasted, there was no opposition to meet,

only whole-souled coöperation on the part of the clergy.

The microphones and apparatus with their telephone line to KDKA have at various times been installed in the Point Breeze Presbyterian Church, where the Rev. Percival H. Barker is minister; the Emory Methodist Episcopal Church where the Rev. W. Wofford T. Duncan is pastor; the First Presbyterian Church, where the Rev. Maitland Alexander is in charge, and the Trinity Episcopal Church where the Rev. Edward Scofield Travers, formerly a chaplain at West Point, is rector. All these churches are in Pittsburgh. At the present time, the morning services of the Point Breeze Presbyterian and those of the Emory Methodist Episcopal churches are broadcasted alternating weeks. The Calvary Episcopal Church service is sent out every Sunday evening, as it has been, with but few exceptions, every Sunday since January 2, 1921.

The story of church service broadcasting can all be told from KDKA, for this station was

first in the field and made all the innovations in this form of broadcasting. Take, for instance, radio chapel, now a feature of nearly all radio broadcasting programmes.

These chapel services were started in order to give ministers of denominations other than those whose services were regularly broadcasted an opportunity to use the air. Many ministers in Pittsburgh have taken advantage of this opportunity to address the "invisible radio audience" and as many more are anxious to embrace it. Each is given a Sunday afternoon, in his turn.

No better idea of the effect of the minister's voice on his radio flock can be given than by relating the recent experience of William Jennings Bryan. Mr. Bryan had accepted an invitation to address the congregation of the Point Breeze Presbyterian Church from the pulpit regularly occupied by Dr. Percival H. Barker. Owing to the fact that no word could be sent to Mr. Bryan previous to the date on which he was to come to the Point Breeze

William Jennings Bryan as he looked preaching his famous sermon "All" to the congregation of the Point Breeze Presbyterian Church, Pittsburgh, Pa., and by radio to unseen thousands. Note the microphone just under the pulpit lamp. Mr. Bryan received more than 5000 letters about this, his first sermon by radio



church, the radio department took it for granted that the Great Commoner's sermon would go out from the broadcasting station.

The same day that Mr. Bryan came to Pittsburgh, his manager was approached regarding the broadcasting of the sermon. The request, supposedly a mere matter of form, was at once refused. This refusal was quite unexpected, but, as the manager explained, he was unfamiliar with radio demonstrations and did not care to risk the consequences, whatever they might be.

The difficulty of finding a substitute was explained, as it had been announced in the newspapers and over the radiophone that Mr. Bryan would be certain to deliver his famous sermon "All" from Dr. Barker's pulpit that Sunday evening, but the manager was obdurate.

Meanwhile Dr. Barker and Mr. Bryan were together at the Hotel Schenley. Neither one knew of the decision of the manager, and, as they were discussing the coming sermon, Dr. Barker said:

"Do you know, Mr. Bryan, that you are going to have the largest audience of your career this evening?"

"That's interesting," said the Great Commoner, "Do you expect your church to be crowded?"

"Crowded! Indeed, yes," was the answer, "but my congregation will not comprise the whole of your audience. Most of it, you'll never see."

"How's that?"

"Why, don't you know, the pulpit is connected to a radiophone broadcasting station and your sermon will be sent out into the ether over a radius of several thousand miles."

"Well, that's fine. I shall be glad to speak by radio," said Mr. Bryan.

He did speak by radio, and his audience, as Dr. Barker assured him, did number many thousands scattered over nearly all portions of the United States. Mr. Bryan delivered his sermon on Sunday evening, and by Tuesday evening more than 1500 letters had been received either at East Pittsburgh or at the Point Breeze church from interested radio listeners. The statesman was greatly astounded at the size of an audience which would write a minister or public speaker 1500 letters. He had occasion to leave the city for two weeks, and, when he again returned, he found more than 5,000 letters addressed to him. This

completely convinced him of the sincerity and interest of his radio congregation, as indeed it would convince even the most skeptical of the size, intelligence and interest of this wonderful "invisible audience." It is safe to say that the letters almost convinced the manager of the benefits to be derived from a radio lecture, or, as in this particular case, a radio sermon. There should be little difficulty in getting Mr. Bryan to speak by radio in future.

This little incident in which a sermon brought forth 5,000 letters is proof that a minister using the radiophone as a winged messenger for his teachings, will wield a powerful influence over an immense territory. The radio minister reaches people he could not get in touch with otherwise. Radio carries the Gospel right into the home, there to sow its seed and bear Christian fruit.

All manner of people are reached by these radio sermons. This fact is clearly shown in the following typical letters to Dr. Van Etten. These letters were picked at random from a collection of several thousand received by this minister, and are quoted verbatim. The names and addresses are omitted for obvious reasons.

Heard in Ohio

Columbus, Ohio,
March 27, 1922.

DEAR SIR:

I heard your entire service, from the ringing of the church bells to your closing hymn over the radiophone at my home last evening. It came through so loudly that I had to cut out some of the amplification. Your enunciation was perfect. I did not miss a word of your sermon and was only sorry that I could not join you at the gathering at the Parish House after the services.

Yours very truly,

From Illinois

Joliet, Ill.,
Jan. 24, 1922.

MY DEAR, DEAR FATHER:

You will be surprised to receive this letter and I know you will excuse me for taking the liberty of addressing you, but last Sunday night, January 22, I heard every word you uttered about Bishop Whitehead and his forty years of service in your diocese, the prayer which you delivered, together with other prayers that I have often read in our prayer

book, as I belong to the Christ Episcopal Church, Joliet, Illinois, Father Tanner, rector.

To further acquaint you with the matter, I live in a little five room bungalow. . . . The thrill that came over my wife and myself when we heard your voice in our radio set, brought the tears, it was so wonderful, and, as we heard the soloist sing during the offertory

of your Sunday evening service has put Pittsburgh and your church on our map.

Last evening four of us "listened-in" to your services and occasionally tuned in to jazz music. My son said "Let's go back to the Minister, I like that better." Seriously my family looks forward to your Sunday evening service with anticipation. I wonder about

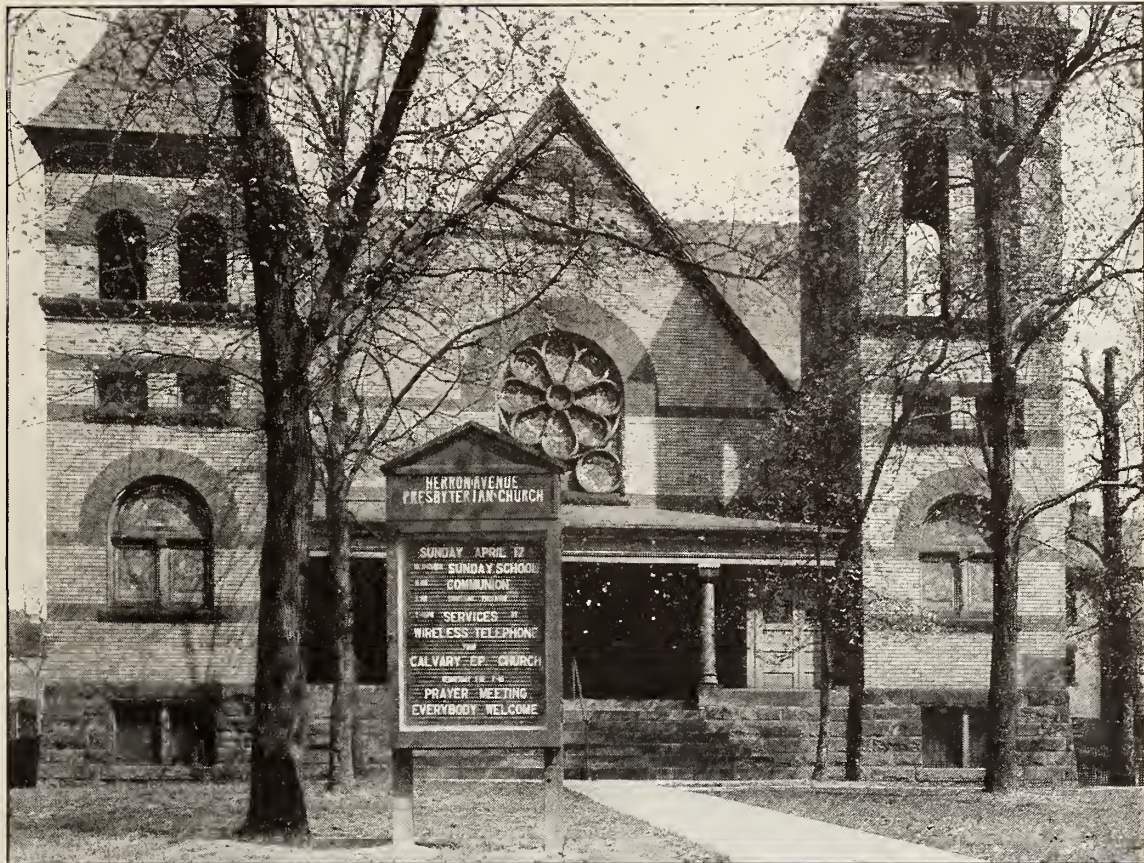

Herron Avenue Presbyterian Church, Pittsburgh, Pa., the first church to receive by radio the services of the Calvary Episcopal Church miles away. The Herron Avenue Church had lost its pastor, and one of its trustees brought about this innovation. The congregation even contributed to the collection

and the pipe organ play, we really forgot where we were, for the time being.

Thanking you and trusting and hoping that I may be with you again next Sunday over the wireless, I am, with kind regards

Yours truly,

From Connecticut

Rockville, Conn.

DEAR SIR:

The distance in a direct line from your pulpit to my receiving set is, as near as I can determine, four hundred miles, so the broadcasting

of the size of your wireless audience. It is difficult to estimate. Allow me to congratulate you upon being a pioneer in the broadcasting of church services by wireless.

Yours truly,

This man has decided to go to church, at least once.

Pittsburgh, Pa.,

February 2, 1922.

DEAR SIR:

Just a few words to say how much we enjoyed your services Sunday evening, February 26, via radio,

My father-in-law has not been inside a church for almost fifty years but has not missed a sermon broadcast from Calvary since last April.

Our home is in Mt. Oliver. Am going to sneak in the side door of your church some evening.

Yours truly,

From Vermont

Enosburg Falls, Vermont,
January 23, 1922.

REVEREND SIR:

I think you will be interested to know that your service last night was very plainly and clearly heard by me and the members of my family and this, in spite of the fact that a gale was blowing at the time. That you may know the extent of the gale, would say that some of the local churches cancelled their evening services on account of it.

We are located in Franklin County, Vermont, in the very northern part and within six miles of the Canadian Boundary.

Yours truly,

"Or Those on the Sea"

S. S. City of Alameda,
Sunday Night at Sea,
January 15, 1922.

DEAR SIR:

Imagine several old, profane, sailor-men, sitting around a table with receivers clamped closely to their heads, listening to the word of God as spoken by you, and you will know what took place aboard our ship to-night. I enjoy your services each Sunday night. To-night I called in the other men. We all extend to your church hearty good wishes, and may your services continue being transmitted. We are just off the coast of Florida.

Respectfully,

From Massachusetts

Worcester, Mass.
Feb. 27, 1922.

DEAR SIR:

One of the finest sermons I ever heard came over the wireless last night from your tongue.

I could hear you distinctly, even hear you breathe and clear your throat. Surely the work is wonderful. I am a new man at the business and am free to confess it is the most interesting and entertaining pleasure I ever took up.

I could hear you better than stations nearer home, either Newark, N. J. or Medford, Mass.

Very truly yours,

A Philosophical Amateur

DEAR SIR:

Three neighbors joined us last evening in attending your services via "Radiophone."

The first time you shouted your name and address (evidently in an endeavor to reach the Pacific Coast or perhaps Japan and the Philippines) we heard you and the very walls vibrated—then that long deep breath—and you charged again—we never heard the rest—one of the bulbs blew out.

My set has three bulbs, two at \$6.50 and one at \$5.00. The one you blew out was of the \$5.00 variety, when in another second it might have cost me \$6.50, therefore I figure I owe the Calvary Episcopal Church \$1.50, which I cheerfully enclose for your next Sunday collection.

Keep on shouting the Gospel you are doing a great work. I don't care if you blow out all the lights.

With kindest wishes,

Very truly yours,

From Georgia

Macon, Georgia,
Jan. 23, 1922.

DEAR BROTHER:

At 7:45 Sunday night the service from your Church by the Assistant Pastor was all heard in our room, we certainly enjoyed the sermon. We heard distinctly the first and second lesson read from the Bible also the appeal from the Minister in behalf of a Memorial Window and we listened with a great deal of interest to the sermon.

With best wishes and success in the winning of many souls to Christ, we are

Yours truly,

Heard in Germanton, N. C.

Germanton, N. C.,
April 24, 1922.

Rev. L. B. Whittmore,
Pittsburgh, Pa.

MY DEAR SIR:

A gentleman here has the "radio" and I take this liberty to thank you for your "congregation" here for your sermon last night (Sunday).

Every word was as plainly audible with few exceptions as if we were in your own church listening to you.

Your sermon was a winner and the music and singing simply glorious and the writer of the uncomplimentary letter should listen in on every one of these sermons and get some *Christian religion*, or else he has no feeling for the finer things that are.

We certainly enjoyed the sermon, the music and singing more than I can express and we hope to have the pleasure of hearing you again.

Again thanking you and with kindest regards, I remain

Yours very truly,

These letters, the ones quoted above, and the others that have been received come from people living all over the United States, are *bona fide* evidence that wireless church services are not a fad and that they are not merely an entertainment but are a help and benefit to all who hear them. They are convincing proof of the spiritual value of radio sermons as well as interesting information upon the manner in which these services affect different hearers. And there are literally thousands of similar letters now on file in the studies of the Rev.

Van Etten, Dr. Barker and the Westinghouse radio division.

Only passing mention has been made in this article of the benefits of the radio services to the sick, or shut-in.

The great help the radiophone has been to the unfortunate who for some reason is prevented from attending church when he desires is so self-evident as to need no explanation. Possibly radio services are doing their greatest work in bringing comfort and cheer to the lonely sick or invalid.

There is just one more question to be answered. "Will radio services have a detrimental effect on church attendance?"

Dr. van Etten can answer this from his experience.

He states, "It will greatly increase the church attendance. It is the greatest advertisement the church has ever had. Every Sunday, I meet new people drawn here because they know me over the wireless.

"Every week letters say: When we are in Pittsburgh, we shall surely come to Calvary Church. The radio will increase church attendance as the phonograph has increased interest in musical concerts. It is not, after all, a satisfactory substitute for the real thing, but advertises the church services far and near."

The Rev. Daniel L. Marsh of the Smithfield Street Methodist Episcopal Church, with his choir and the operators and announcers of KDKA in the broadcasting studio just before a Radio Chapel Service on Sunday afternoon



A Few Ideas on Radio

By W. D. TERRILL

Chief Radio Inspector, U. S. Department of Commerce

IT WILL be remembered that Edward Bellamy published a book entitled "Looking Backward" in 1887. This book created a great sensation. One passage of it deals with the hero's experience in a home in which he woke after a kind of Rip Van Winkle slumber of many years. On answering "yes" when asked if he would like to hear some music, he was led into a room where, strangely enough, he saw no musical instruments. He asked his hostess where and how the music was to be played. She smiled and asked him to sit down.

She then crossed the room and so far as he could see merely touched one or two screws. At once the room was filled—but not flooded—with the music of a grand organ anthem, with the volume of melody perfectly graduated to the size of the room. Scarcely breathing, he listened to music such as he had never expected to hear.

On asking his hostess when such concerts were available, the hostess replied, "Oh, our people keep all hours; but if music were provided from midnight to morning for no other purpose, it still would be sent for the sleepless and sick. All of our bedchambers have a telephone attachment at the head of the bed by which any person who may be sleepless can command music at pleasure."

The hero was even more surprised when on Sunday the family, after consulting the newspaper to see who was going to preach in the various churches, assembled in the music room, where, while seated comfortably in their own easy chairs, they heard an excellent sermon.

Now, only about thirty-five years of Mr Bellamy's estimated one hundred and thirty have passed. His only mistake was that he thought it would take us longer to accomplish these things.

I must leave it to another Edward Bellamy to predict the future possibilities of radio. It is only in its experimental stage and we shall no doubt see great improvements in the art before next winter, in point of the results we are able to get through broadcasting.

On June 1st there were 301 licensed radio

telephone broadcasting stations in the United States. On that date there were only seven states without radio telephone broadcasting stations—New Hampshire, Delaware, South Carolina, Mississippi, Kentucky, Wyoming and Idaho. California has the largest number—59. Ohio has 23; Pennsylvania, 20; New York, 18.

Los Angeles, California, has the largest number of radio telephone broadcasting stations licensed in any city of the United States—18.

There are now forty-three newspapers broadcasting in the United States. Of these the *Detroit News* was the first.

One can only approximate the number of receiving stations in use in the United States.

On June 1st it was reported by the National Radio Chamber of Commerce that a careful survey of the entire country had been made relative to radio developments and that there were approximately 1,500,000 radio receiving sets in homes in this country.

It was also reported to the Department of Commerce that a small group of manufacturers in New York City had unfilled orders on June 1st amounting to \$30,000,000.

The same report reveals the fact that at present there are in use in the United States approximately ten million automobiles, six million phonographs, and that, according to present indications, there will be approximately six million radio receiving sets in use within five years.

Since the estimated value of the average receiving set is placed at fifty dollars, on the basis of receiving sets alone, it is estimated that approximately fifty million dollars will be spent annually for new installations in the United States. Five million pounds of brass and copper alone, it is estimated, are required for every million instruments.

The National Retail Dry Goods Association estimates the annual volume of radio business open for exploitation at \$70,000,000. It points out that in New York City, Chicago, and Pittsburgh there are department stores handling radio equipment at the rate of from \$5,000 to \$6,000 weekly.

The Bureau of Foreign and Domestic Commerce reports that in one of the early months of the present year the Westinghouse Company sold, at jobbers' figures, \$2,000,000 worth of equipment. The General Electric Company reports that it will soon be manufacturing from 8,000 to 10,000 complete receiving sets a month. Another indication of the demand for radio equipment is the fact that between January 1st and May 1st of the present year the Secretary of State of New York issued charters to 1,800 corporations having something to do with radio. The Bureau of Foreign and Domestic Commerce estimates that there are now at least 300 "real" corporations manufacturing radio equipment exclusively, in addition to hundreds manufacturing parts as a side line along with amateurs and others such as electricians. Yet, according to figures compiled no longer ago than 1919 the total radio business for the entire country for a year was estimated at \$7,000,000.

It has been estimated that Washington, D. C., has 1,800 private receiving sets; that in Detroit there are between 40,000 and 60,000; and that one home in every six in Pittsburg is equipped with a receiving set.

There is no way in which the Bureau of Navigation, which licenses all broadcasting stations and operators except governmental stations and army and navy operators, can determine the exact number of receiving sets in the United States, because no license is required for the operation of a receiving set.

The Radio Service of the Bureau of Navigation, which is able to function more or less judicially because it is not operating stations of its own, was created July 1, 1911 by Act of Congress passed in June, 1910. That Act provided that no ship of any nationality should leave an American port with fifty or more souls on board without radio equipment to permit it to send distress signals in an emergency for

four hours. Ship inspection was the beginning of the radio work of the Bureau of Navigation, which, by law, was extended, so that the Bureau, with its nine established inspection offices, was in position to meet the enormous expansion of radio activities that has come during the past two years. It feels that its ship inspection work has proven invaluable in saving lives and property. To quote only one incident, a few years ago a British ship about to put out from Baltimore with a cargo of horses and with more than fifty persons on board, was held up by the local radio inspector. The master of this ship resented the authority of the United States requiring him to have radio equipment and an operator on board. In mid-ocean the ship caught fire. She burned to the water's edge. Her radio equipment was the means of saving everyone on board, a fact that the master of the ship himself, on his return to Baltimore some months later, acknowledged, going to the office of the radio inspector personally to thank him.

Without some regulation of sending stations, anarchy in the ether would be the inevitable result. But those who are regularly listening in realize that there is still a large necessity for better control of radio which cannot be accomplished, as the Radio Conference pointed out, without new legislation. It is therefore hoped that new legislation will be enacted during the present session of Congress which will improve radio conditions, particularly broadcasting, by making available for this purpose several bands of waves in addition to those now used so that one can more effectively tune in the station desired and tune out those not desired.

In the present rapidly developing situation there is, in fact, no more imperative need—a need that the Department of Commerce can properly advance because its interest in the situation is solely in behalf of those who are served by the art.



A Review of Radio

By LEE DE FOREST, Ph.D., D.S.C.

In this interesting article Dr. De Forest not only relates the steps in radio which led up to his invention of the Audion, or vacuum tube, but dips into the realm of prophecy and tells vividly and convincingly what he believes the immediate future of radio will be.—THE EDITORS.

AND while I thus spoke, did there not cross your mind some thought of the physical power of words? Is not every word an impulse on the air?"

Poe, in his mystically suggestive dialogue of Onios and Agathos, tells of the birth of a wild star, brought into existence by a few sentences, spoken on the distant earth.

That which was in his time a vague dream assumes to-day a guise of reality. Earthly sounds, spoken words, air waves, limited hitherto to the confines of our atmosphere, have now been transmuted into ether vibrations, and, in theory at least, pass outward to the uttermost limits of space.

It is a pleasing, if perhaps an idle, thought that at last, after these million years of silence, human words, mortal music (and some of it most sweet, "even to other ears, than ours") can be heard, however attenuated and dim, in the wilderness of stars. Let not some cynical physicist point out that the rarefied and electrically conducting regions of our upper atmosphere offer an impenetrable barrier to all Hertzian oscillations. Until such a one has been beyond, and returned with proof, let us pin our faith to Poe's fable.

The acceleration of progress in these latter years is perhaps the most striking phase of man's advancement in physical science. Thirty years ago the existence of Hertzian, or electrical waves, was theory alone. That great searcher, Heinrich Hertz, discovered for us an empire vaster than Columbus', wider than any land or sea. To-day the ether waves he taught us how to find are of more utility than those of all our oceans.

Twenty-five years ago wireless telegraphy was hardly a word in our vocabulary. To-day scarcely a ship bearing passengers, or a vessel of war, but is able to telegraph to its mates lost below many horizons, through night or storm—to summon help in danger, or to exchange the news of the world. And undoubtedly "To-morrow" the commander of

every vessel that floats will converse, voice to voice, with other captains, near or far, and with friends in port, a hundred, five hundred, then thousands of miles away.

This latest Hertzian offspring, the wireless or radio telephone, is a child already outstripping in speed of growth its elder brother. Not two decades have passed since the press heralded the first experiments in voice transmissions without wires, by electrical waves. Yet already the navies of many nations now have ships equipped with radio telephones, and their introduction to the merchant marine has begun.

It was five years after Marconi's first demonstration of "spark" telegraphy in England before an authentic distance record was established in telegraphy; the same distance record was established by the radiophone in less than two years!

This startling progress is, however, largely due to the similarity in methods employed in telegraphy and telephony. Many a knotty problem, wrought out at the cost of toil and error in the telegraph, was found ready solved for the younger art. Intricate though the way may be, delicate of handling, and difficult of solution the puzzles, I doubt if even the developers of the radio telephone will ever meet with as great discouragements as they overcame in the "good old early days" of the wireless telegraph.

ODDITIES IN EARLY VENTURES

THE earliest attempts at telephony without wires employed entirely different methods from those in use to-day. Thirty years ago Sir William Preece established such communication between the Skeeries Islands and the English mainland.

Long wires were strung on telephone poles parallel to the coast line, and connected to earth plates at either end of the line. A similar stretch of wire on the Skeeries ran parallel to those on the mainland, and were similarly

earthed at either end. A battery and telephone transmitter were connected in one line, and an ordinary telephone receiver in the other. Telephonic currents passing through the first line and into the earth spread out as "leakage" currents in the earth. A few of these weak "strays" found their way into the earth plates of the distant wire, and, traversing this latter, produced faint words in the receiver, but the transmission distance possible by this means is little greater than the length of the wire lines involved.

Another early attempt to solve the problem was by low frequency "magnetic induction," as it is called. This method, depending upon the electro-magnetic induction between parallel loops of wire, is also extremely limited in range and utility.

Professor Bell, at the Columbian Exposition in Chicago, in 1893, talked over a beam of light. In Germany, Ruhmer, using Simon's "Talking Arc" lamp in a powerful parabolic projector, detected light fluctuations on a selenium cell, which translated them into telephonic currents. The maximum distance thus attainable was only five miles; and the slightest barrier in the path of the light beam cut off all communication.

FOLLOWING THE OLDER BROTHER

TC-DAY the principles employed in the methods of telephoning without wires are in many ways analogous with those of the wireless telegraph, by which transmission over great distances is a matter of every-day occurrence. These principles are, moreover, in a way similar to those employed in the line telephone.

In the simplest form of wire telephone circuit, electric current from the battery passes through a microphone transmitter, out over the line, through the distant telephone receiver to the earth, and through the earth back to the battery.

The intensity of the continuous current here employed is controlled by the resistance of the carbon granules in the microphone transmitter. With each vibration in the speaker's voice against the transmitter diaphragm this resistance is made greater or less, and the flow of current is thus controlled. These changes in the current produce corresponding vibrations in the iron diaphragm of the telephone receiver, which is attracted more or less strongly by the small electro-magnet around which the wire is wound.



Mme. Mazarin, noted French soprano singing a selection from "Carmen" over the De Forest wireless telephone in New York City in 1909

In the wireless system, alternating currents of very high frequency, generated by the electric arc, replace the continuous current. These currents surge up and down in the vertical wires of the station and excite in the space surrounding it electric, or "Hertzian" waves, which radiate outwardly from the station in all directions, in everwidening circles.

A portion of these radiated waves cuts the other wires at the receiving station, and generates high-frequency currents in that conductor, which are exactly similar to, but very much weaker than, the currents surging up and down at the sending station.

The voice, by means of the microphone transmitter inserted in the wire of the sending station, controls the strength of these high-frequency currents, exactly as it controls the continuous current in the wire telephone.

At the receiving station, the "wireless detector," is influenced by the received high-frequency currents, and translates these into telephonic currents which operate the telephone receiver exactly as in the case of the "wire" telephone receiver. In this way the voice vibrations are reproduced, although no wire connects the two stations.

It was therefore only after the advent of wireless telegraphy by means of "detached," or "radiated," electric waves that one saw the possibility of voice transmission over considerable distances without wires. Not for several years after the first wireless telegraph message had stolen its silent way over English waters was it plausible to suppose that spoken words could be similarly transmitted. The earliest form of detector, the "filings" coherer, certainly gave no indication of such things in store.

The coherer device consisted of a small mass of metallic filings, placed loosely between two silver electrodes, contained in a small glass tube and connected, one end to the vertical wire, the other to a plate buried in the earth. When an electrical wave passing through the ether cut this elevated wire, a minute electric current was generated therein. This current, traversing the loose-lying filings on its way to earth, caused them to cohere. Thereupon a current from a local battery was enabled to pass through the coherer, following the wave current, and this local current was used to ring an electric bell or operate a Morse "ticker." But the filings remained cohered until an automatic tapper, by agitating the glass tube, again interrupted the passage of the current.

Not until the first "anti-coherer" or "auto-coherer" was discovered (a detector not re-

quiring the slow "decohering" operation) was it possible to detect continuously the rapid succession of electric waves, which were sent out from the transmitting station while the sending "key" was held down.

With these new forms of detectors it was possible to use an ordinary telephone receiver in place of the Morse ticker, and therein to hear a sound which actually reproduced the sound of the spark at the transmitting station. It was now noticed that every acoustic property of the spark was faithfully transmitted, its change in "pitch," which depends on the number of sparks per second and all its variations in intensity and sound quality.

"If one can only teach the spark to talk, we will have wireless telephony," was remarked.

Various methods for making the sparks talk at once suggested themselves. The simplest and the crudest of these was to talk through a megaphone directly into a long or flaming spark. This was as inefficient as it was simple! In the ordinary wireless telegraph transmitter the number of sparks per second or "spark frequency," is very low compared to the vibrations of the human voice, and very little influenced by any such means.

Hence methods were investigated for increasing this spark frequency beyond that which the human ear can detect, to 50,000 per second. In 1900 the investigations of Duddell, coupled with those earlier, but less heralded, of John Stone Stone brought attention again to methods for producing enormously rapid electrical pulsations from direct instead of alternating currents.

The remarkable work of Nikola Tesla in this particular branch, as first described by him before the Franklin Institute in 1893, never commanded the attention it deserved.

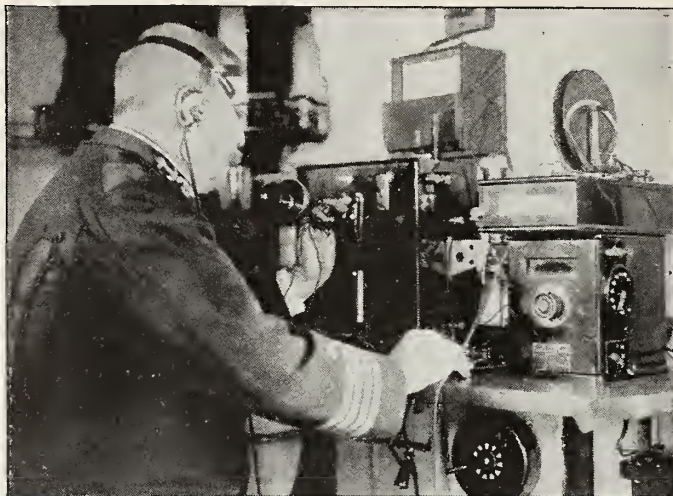

Capt. Ingersoll, Chief of Staff to Admiral Evans using a radiophone on the U. S. S. *Connecticut* at Hampton Roads in 1907. In the upper right hand corner of the picture may be seen what was termed a pancake receiving oscillation transformer, the number of turns on either coil being regulated by the movement of a slider arm

It was found by these investigations that if across the wires leading to an electrical arc a small coil of wire and a condenser were connected, then this arc would under certain conditions emit a musical note. This indicated that the arc was in some manner acting rapidly to interrupt or disturb, the electric current flowing through it; and the frequency of these fluctuations, as indicated by the pitch of the note emitted, depended upon the size of the coil of wire and on the capacity of the condenser, which were connected across the arc.

It was found that the pulsating or alternating currents thus generated in the branch or condenser circuit possessed many of the properties of the high-frequency alternating currents generated by the spark discharge in wireless telegraphy. They were, however, small in intensity compared with those used in wireless, and generally of much lower rates of vibration. However, they possessed the very desirable quality of persistence and regularity; each alternation was exactly equal in strength to those preceding and following it. The oscillations, in other words, were not "damped."

Various ways were next devised for making these arc oscillations more rapid and more intense. The former object was attained by placing the arc itself in a partially exhausted vessel; or in the chimney of a lamp, where it was exposed to hydro-carbon vapors; or later, by Poulsen, in an atmosphere of pure oxygen, or of ordinary illuminating gas.

Earlier investigations had shown that by keeping the arc electrodes artificially cooled, by making them hollow and circulating water through them, it was possible to cause the arc to oscillate at very high frequencies, even in the open air. In very early experiments I found that placing the arc in steam is a particularly effective method.

THE TUNE OF THE WAVE

IT MUST be remembered that in all these arrangements of the arc the actual rate of electrical vibration is determined largely by the amount of capacity and the dimensions of the inductance coil which are connected across it. By these two adjuncts the "tune" of the electrical waves which are being generated is determined.

The smaller these elements, the higher the electrical "tune," which may vary from 100,000 vibrations per second to 1,000,000 or

more. The radiated waves travel outward from the antenna with the velocity of light—186,000 miles per second. Their "wave lengths" therefore at these frequencies range from about 3000 meters down to 300 meters.

The radio telephone apparatus employing such an arc oscillation is, as we say, very "sharply tuned." For the reason that each wave is exactly similar in length and intensity to every other one of the wave train which a certain transmitter sends out, it is necessary that the distant receiving apparatus should be very accurately attuned to these particular waves in order to respond to them at all.

These periodically received impulses, each weak in itself, may represent in their aggregate

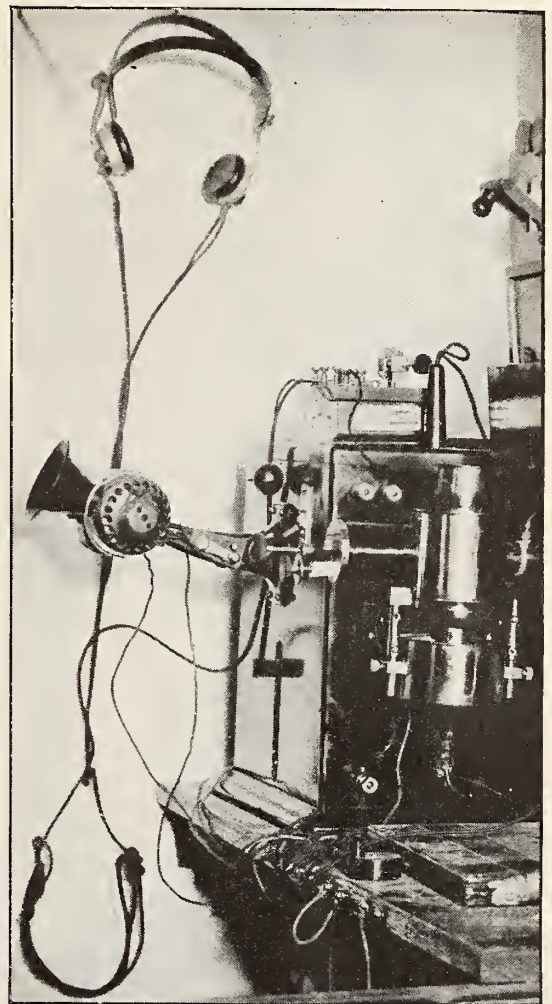

De Forest radiophone installed in Metropolitan Tower for New York to Paris tests. This transmitter was of the arc type and the arc chamber may be seen to the right. Parallel microphones were employed to modulate the antenna current

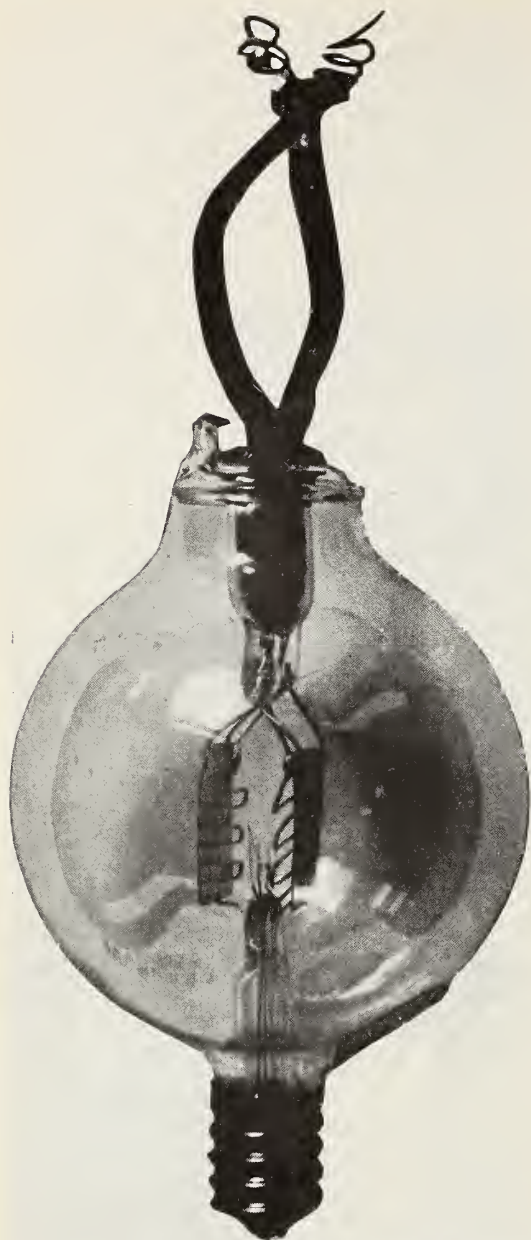

© Paul Thompson
This is a real old De Forest audion. Several years ago radio amateurs saved for long periods to procure one of these magic bulbs. As may be observed, two filaments, two plates, and two grids were employed. The stability of this type tube was anything but constant due to imperfect evacuation

a great amount of energy (as energies go in wireless!), but unless the receiver system is so tuned that each little surge set up in it by an incoming wave occurs at exactly the right instant to fit in, or harmonize with, the succeeding wave, interference will occur in the wires, and the surgings, instead of gradually

becoming stronger, will be completely or partially nullified.

It is exactly as one sets a pendulum in vibration by slight successive taps properly timed. Let these taps vary from the proper interval ever so little, and the pendulum almost immediately comes to rest.

So with our sustained oscillations in the radio telephone receiver. The electrical circuit there is essentially the same as at the arc transmitter. It is built-up "capacity" and "self-inductance," but with a detector, or responder, substituted in the place of the transmitter arc.

Now if this capacity and inductance are the same as in a certain transmitter, that and no other transmitter can awaken a response in this particular detector circuit.

TRANSFORMING THE VIBRATIONS

HOW have we "taught the spark to talk"? As so often in the history of invention—by not doing it—by suppressing the spark!

By the little silent arc, or by very high-frequency alternator (which later accomplishes at great expense and complication only what Nature is willing to do for us, simply and automatically), we first secured our sustained electrical oscillations, smooth and continuous radiations from the aerial wires.

Their frequency, as we have seen, is far beyond the range of the ear, so that although each wave gives a little kick to the distant detector, the ear listening in at the telephone hears not a sound.

But the intensity of these rapidly succeeding impulses we can vary by the voice, exactly as the voice in the ordinary telephone transmitter controls the momentary strength of the current therein flowing. We also employ the microphone, only instead of connecting it in the "line" it is inserted in the lead which runs from the oscillating system to the earth-plate.

Every inflection, every shade of articulation, the timbre of each instrument of an orchestra will be instantly carried and reproduced with surprising fidelity, notwithstanding all the strange transformations through which the original vibrations have passed.

THE LIGHT THAT DID NOT FAIL

THE radio telephone transmitter of 1907-12 employed the electric arc very similar to the arc light. But the wonderful sensitiveness and adaptability of the little audion incandes-

cent lamp, first as a wireless detector, then as an amplifier for weak wireless telegraph or wire telephone currents, kept haunting me. I was finally convinced that it contained the possibilities of a transmitter, of a generator (as well as a detector) of alternating currents. I reasoned that if, as a detector, it transmuted alternating into direct currents, this process could be reversed; that it could equally well transform direct into alternating currents.

In 1912 I determined this to be a fact. I found then that I had in the simple incandescent audion lamp with its filament, and plate and grid elements, a marvelous little generator of alternating currents, set up in the proper circuits connected to its elements and containing capacity and inductance.

A large number of circuit arrangements permit the audion thus to oscillate and transform the energy supplied from the battery or dynamo into alternating currents of low or high frequency, as desired.

The audion itself is a small incandescent lamp containing, besides its filament, two metallic plates or wires, one of which is connected to the telephone receiver and local battery, the other to the wires which carry the high frequency oscillations. The conducting medium inside the audion bulb is exceedingly sensitive to the minutest electrical effects, and serves as a medium by which the incoming electric waves can control the local telephone currents. The one most essential and completely novel element in the whole strange device is the "grid" member, interposed across the path of the traveling ions ("wanderers" as their Greek name implies). Try to imagine one of these ionic carriers of the voice currents of electric charges, and contrast it with a carbon granule of a microphone transmitter of the early "telephone relays." Compare a soap bubble with a load of coal, and you will have some relative idea of the sensitiveness of the audion and that of the old microphone relay.

Here we have, then, light speaking unto light—an arc lamp to an incandescent, over miles of city or wastes of sea, through the walls of hundred of buildings—and by means of other light waves—invisible because so long, yet still light waves in their nature!

In appearance the radio-telephone transmitter is not very unlike the old style "wall-set" telephone. An instrument having a range of seventy-five miles occupies only

about a square foot of table space, exclusive of course of the small dynamo required.

UNCLE SAM AN EARLY CONVERT

IN NOVEMBER, 1907, the United States Navy installed twenty-six sets of radio telephones upon as many battleships, torpedo-boat destroyers, and auxiliaries, prior to their famous round-the-world cruise. The specifications at that time called for five-mile transmission for inter-fleet work! Some of those instruments, crude though they were compared with the present type, maintained communications for forty and fifty miles. To-day—such is the progress in this new art—the Navy calls for instruments capable of a hundred mile conversation between warships and nearly as many miles between seaplanes and ship stations. In another year, it is safe to forecast, the requirements will be twice as rigorous as these, but the development of the science will keep pace.

In the spring of 1908 a first demonstration of the early American arc transmitter system was made in Paris, before representatives of the Government of France. The tall aerial

Dr. De Forest trying out one of his more recent inventions, a portable wireless telephone operated entirely by current from a lamp socket.

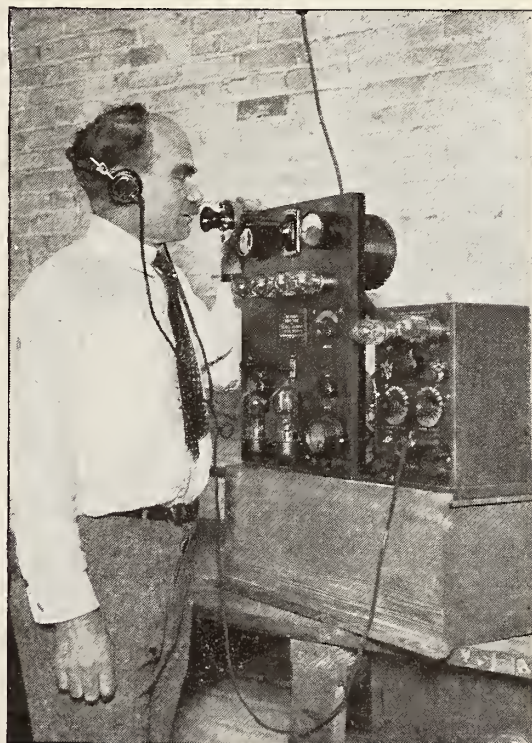

at the Eiffel Tower wireless telegraph station was not then used, as it was desired to approximate conditions obtaining on shipboard. From a small antenna communication was demonstrated to a government station at Melun, sixty kilometres distant.

The Italian Navy, following the examples of our own, decided then to install the radio telephone on several war vessels at Spezia. Between the arsenal wireless station, at San Vito, and the little scout vessel *Partenope*, conversations were maintained up to eighteen miles, notwithstanding that the scout's aerial was only thirty-five feet high.

Skirting in close under the lee of Palmuria's Isle, a rocky cliff and mountain 1500 feet in height separated the two stations, and yet the distant voices came in clear and distinct. Through the port-hole of the little cabin I could look straight into the black entrance of Byron's Cave, where it is said the poet has written some of his best lines. As I repeated to the hidden listener those first lines from the Corsair:

"O'er the glad waters of the deep blue sea,
Our thoughts as boundless and our souls as free,"

I wondered if ever in that rocky cliff Byron's vivid imagination had fared so far as to picture this strange reality!

The growing realities of the possibilities of the radio telephone for naval purposes was shown when the British Admiralty next expressed a desire to witness its operation. In September, 1908, an elaborate demonstration was made at Portsmouth, between H. M. S. *Furious* and H. M. S. *Vernon*. Here was established the longest range record up to that time in an official test—over fifty sea miles, although the limit of the apparatus was by no means reached. As proof of accuracy, and significant of what the "sea-phone" could accomplish merely as long range, day or night, substitute for flag-signalling, lists of numerals were read off on the *Furious* and copied on board the *Vernon*. Lists of figures read at fifty miles were received without an error.

Then came 1914, and the swift development of radio communication through the needs of war. In the light of what the Oscillion radio telephone accomplished for the Allies during the war, these bits of ancient history in this new young art (already "old" after ten years) now take on a new interest, for, thanks to this

new young art, we had the voice-commanded squadron, airplane artillery fire control, and immediate communication at sea between ships, and between ships and shore stations, all of which is now taken as an ordinary matter of course.

Obviously the prime field for the radio telephone is to furnish communication where it is impossible or inexpedient to stretch or maintain wires or cables, and yet let us not forget also that one of the big advances in wire telephony to-day, the recently heralded multiplex telephone, whereby several distinct, individual telephone conversations may be held over one wire at one time, is in truth nothing more or less than the practical use of a telephone wire in serving as a guide to a number of wireless waves of varying length, each wavelength in turn acting as the unseen messenger of the individual wire "telephone" conversation. Here, too, it is pleasing to note the results of pioneer work done by an American inventor; on this occasion, an expert who has long used his efforts in behalf of the advancement of the radio art, Major General George O. Squier.

BROADCASTING

IT IS in the field of Broadcasting, however, that I personally find an especial interest, no doubt through the fact that for many years, indeed since my first experience with the transmission of news and music by radiophone, in 1907, I have taken an eager part in dreaming of what was to come on this particular side of radio development. At no time throughout those many years, when so many of our foremost citizens refused to pay heed to the art of the radiophone, could I see anything but the practical service to be rendered by it. Failure to convince men of standing in the world of public interest, as well as in the commercial field, led to numerous disappointments, and further delays. The endless number of demonstrations we arranged with a view to convincing the public that the day of radio was here, were seemingly of no avail.

To-day I would not, in dwelling on this almost uncanny Radio Renaissance which the broadcasting idea has brought upon us, overlook the all-important part therein which the newspapers have played. Without the discerning vision of certain of our more progressive editors, the already immense success of our radio broadcasting idea could never have

been realized. Possibly their change of attitude during the last three years has been even more surprising than that of the Government and radio company officials in general.

In 1919, when I began a quiet little campaign of education and persuasion with certain editors, I sought to show what unlimited possibilities for the education and amusement of all America, and particularly of the dweller on farms and in

isolated districts, the radio telephone possessed. By the very nature of its propagation, the medium it employed, by the astonishingly simple and inexpensive receiving apparatus required, should it not have been clear to anyone giving the matter a little thought, that a few powerful, well-located radiophone transmitters could afford a

means for nation-wide announcement for one-way communication, which was absolutely new in man's experience? Yet while this technical phase of the situation was (perhaps doubtfully) admitted, yet none of those newspaper men with whom I came in contact seemed at that epoch to realize the possibilities for genuine good to the public of this proposed service.

Yet, let it be known, the managers of the *Detroit Daily News* grasped the germ of the idea as soon as it was presented. A small transmitter was installed on the roof of their building shortly thereafter by the Radio News and Music Inc., a company which at that time sought but failed to interest the other newspapers of the country; and to that newspaper belongs (as told in *Radio Broadcast* for June) the honor of establishing the first "radiophone newspaper service," interesting and up-to-the-minute news bulletins, interspersed with music or monologue to make the service doubly attractive.

Then, not many months later, the Westing-

house Company, whose progressive directors had long before determined to break into radio regardless of what millions this might involve, took up the possibilities of the broadcasting idea. Backing faith with works, they opened up their regular station at Pittsburg, then one at Newark. So at last Broadcasting began to come into its own.

Now that a few years will see every fair-sized vessel, on ocean or lake, equipped with this safeguard for the mariner, is, I take it, as certain as progress. Then, fog-bound, or lost near shore, unacquainted with his bearings, knowing nothing of the telegraph code, every skipper can call to some listener at the nearest life-savers' station, or lighthouse, and hear in a still small voice his vessel's name re-

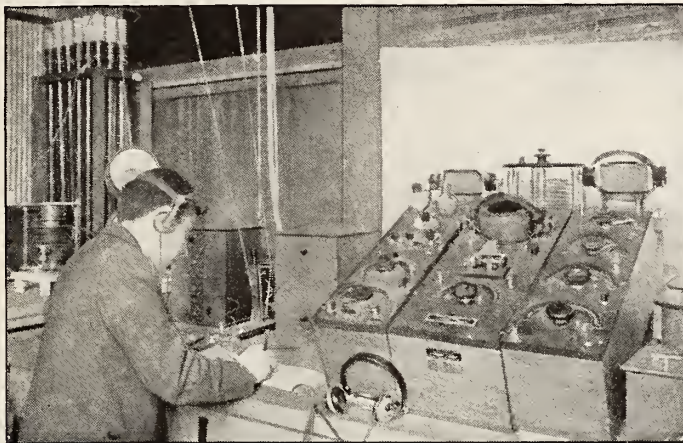

In 1908 messages were sent from the Metropolitan Tower, New York, to Milwaukee and Key West by the "Sparkless" radio telegraph. The arc chamber employed for this transmission may be seen at the extreme left over the operator's shoulder. The huge boxes before the operator constitute the receiving equipment. The radio amateur of yesteryear will recognize the old fashioned variometers, variable condensers, audion detectors, and adjustable pillar inductances

peated and its whereabouts revealed. Or, he will hear an answering "Ahoy," and be told that another craft, steering a certain course, is close upon him. The tug captain will be in telephonic touch with his barge office, miles distant, or with the steersman of his tows, even if the hawser has parted. A yacht-owner, without the luxury of a Morse operator in his crew, can already call up his club miles away over the waters. Cities separated by a hundred, a thousand miles of gulf are to be connected by telephone over the water, although the distortion and alternation of currents in a submarine cable of such length render voice transmission utterly impracticable.

It is of course no longer necessary that the speakers themselves be at the radio telephone stations in order to use them. Wire telephone instruments are directly connected to the wireless at terminal stations, thus giving all the elasticity of the present telephone exchange, yet employing the radio telephone as the "trunk line" or connecting-link.

Ranchers in sparsely settled districts will subscribe to a radio-telephone, and be in close contact with distant neighbors. Mining camps, mushrooming on a mountain-side, will have their radio telephone with town long before a telegraph company feels justified in stringing wires. And when snowslides or storm have felled all wire lines, the radio telephone will be unhampered; for the medium it employs lets the avalanche slip under it, and the snowflakes sift unhindered through it.

In great cities, also, as well as in far-off villages, and farm lands, we already see at hand the sweet music of opera, or orchestra; or the lines of a play, sent over the wire telephone from microphones on the stage to a central radio telephone plant, and there translated into ether vibrations,

to be absorbed by the wires of a thousand new aeolian harps, and carried down thence to a tiny receiver in each home.

Plans for distributing such eternal music from some lofty tower in New York, I understand, are already under way, and on a not far distant Christmas dawn, the wireless operators and cabin listeners on steamers far out on the Atlantic may hear carols and glad tidings from the home city, far down in the West.

And what more does the future hold for the newest, farthest-reaching art? Ask of the Sphinx of Science, who ever remains silent in the shadow of dawn. Could Poe, the dreamer, the idealist, live again to-day, he might not call as he did, to science:

"Vulture, whose wings are dull realities!"

Dr. De Forest measuring the current in various circuits employing a large sized vacuum tube for wireless telephone transmitting

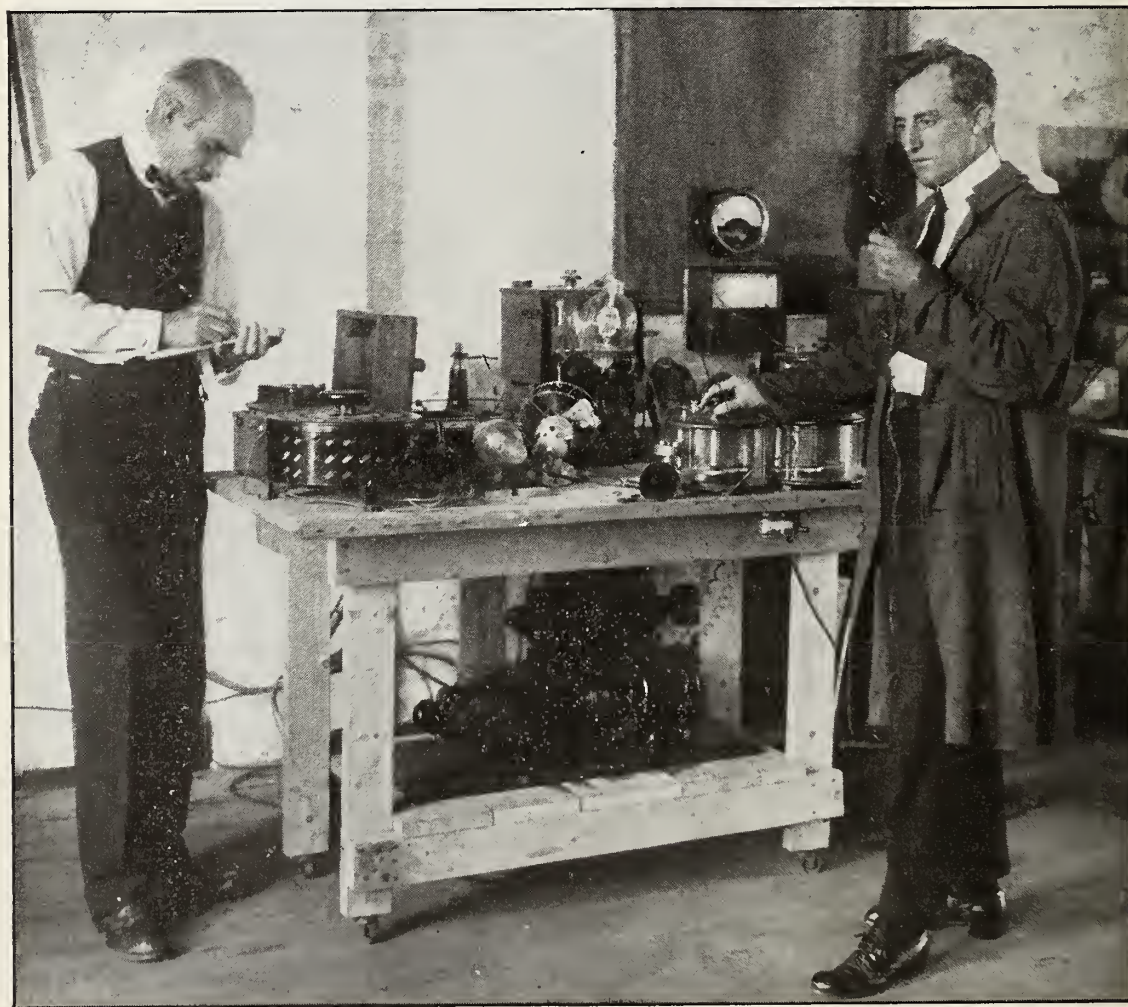

Radio Telegraphy

By GUGLIELMO MARCONI

The most striking point in Senator Marconi's lecture before a joint meeting of the American Institute of Electrical Engineers and the Institute of Radio Engineers, held in New York City on June 20th, was the suggestion that the shorter wavelengths have been practically abandoned by experimenters and commercial interests. Due to recent advances in the radio art, especially the development of the vacuum tube, effective signalling on short waves is now possible. Mr. Marconi suggested that this will undoubtedly stimulate a great interest in American amateur radio circles which should result in further radio success. In speaking of his parabolic reflector system, he mentioned wavelengths of 15 to 20 meters, which, it would seem, are hardly possible for the average amateur worker, for the erection of a reflector 15 meters high covering an area 15 or 20 meters in diameter would involve a considerable expenditure. For the most part, American amateurs will have to devote their efforts to short wave propagation without the use of the reflector, and it is interesting to note that, even prior to Mr. Marconi's lecture, American amateurs have made some very successful attempts to communicate by this method. Space does not permit us to reproduce Senator Marconi's entire lecture, but the following material covers the most salient points he made about radio telegraphy's past, present and future.—THE EDITORS.

THE first occasion on which I had the honor of speaking before the members of the American Institute of Electrical Engineers was of a very festive nature.

It is more than twenty years ago, to be exact, on January 13, 1902; (there was not then any Radio Institute in existence) and on that date, memorable for me, I was entertained by more than 300 members of your Institute at a dinner at the Waldorf-Astoria in this City. I was offered that dinner following my announcement of the fact that I had succeeded in getting the first radio signal across the Atlantic Ocean.

Many men whose names are household words in electrical science were present, men such as Dr. Alexander Graham Bell, Professor Elihu Thompson, Dr. Steinmetz, Dr. Pupin, Mr. Frank Sprague, and many others.

The function was one I shall never forget, and displayed to the full American resource and originality, as only 'forty-eight hours' notice of the dinner had been given, but what has left the greatest impression on my mind during all the long twenty years that have passed is the fact that you believed in me and in what I told you about having got the simple letter "S" for the first time across the ocean from England to Newfoundland without the aid of cables or conductors.

It gives me now the greatest possible satisfaction to say that, in some measure, perhaps, your confidence in my statement was not misplaced, for those first feeble signals which I received at St. John's, Newfoundland, on the

12th of December, 1901, had proved once and for all that electric waves could be transmitted and received across the ocean, and that long distance radio telegraphy, about which so many doubts were then entertained, was really going to become an established fact.

I propose to-night to bring to your notice some of the recent results attained in Europe and elsewhere and to call your attention particularly to what I consider a somewhat neglected branch of the art; and which is the study of the characteristics and properties of very short electrical waves. My belief is always that, only by the careful study and analysis of the greatest possible number of well authenticated facts and results, will it be possible to overcome the difficulties that still lie in the way of the practical application of radio in the broadest possible sense.

A very great impulse has been given to radio telegraphy and telephony by the discovery and utilization of the oscillating electron tube or triode valve based on the observations and discoveries of Edison and Fleming, of those of De Forest and of those of Messiner in Germany, Langmuir and Armstrong in America, and H. W. Round in England, who have also brought it to a practical form as a most reliable generator of continuous electric waves.

THE VACUUM TUBE

AS THE electron tube, or triode valve, or valve, as it is now generally called in England, is able, not only to act as a detector, but also to generate oscillations, it has sup-

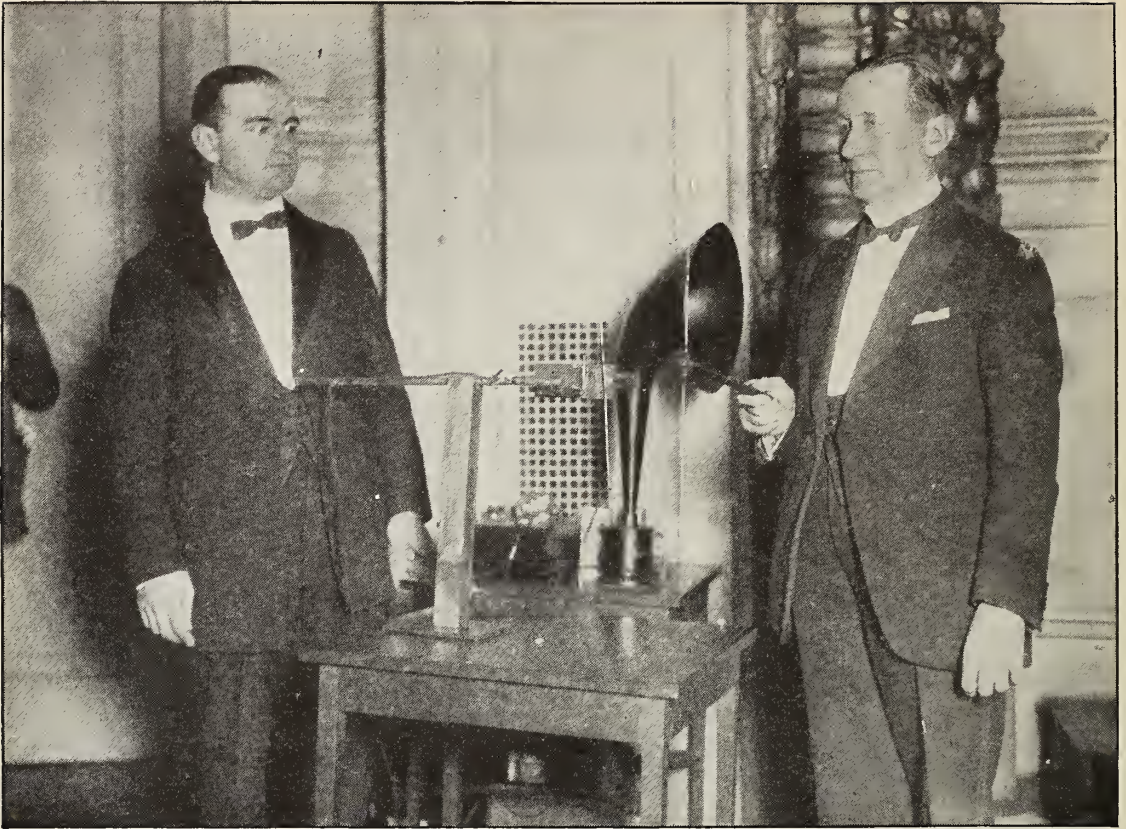

© Kadel & Herbert

Marconi demonstrating the effect of placing a tuned inductance between the transmitter and receiver of a short wave directive system. Where the inductance is of the same wavelength as the wave of the transmitter, the signals at the receiver are entirely cut out when the shield is between the two stations. The signals are considerably augmented, however, if the tuned inductance is placed behind the receiving antenna. Where reflectors are employed at the receiving station, the signal intensity is increased approximately five times. The gentleman at the left is Dr. Alfred Goldsmith, President of the Institute of Radio Engineers

plied us with an arrangement which is fundamentally similar for both transmitter and receiver, providing us also by a simple and practical method with the means for obtaining beat reception and an almost unlimited magnification of the strength of signals.

A result of the introduction of the triode valve has been that the basic inventions which made long distance radio telegraphy possible have become more and more valuable.

It has been so far our practice to use a plurality of tubes in parallel at our long distance stations. High power has been obtained in practice up to 100 kilowatts in the antenna by means of a number of glass tubes in parallel, and for the present we are standardizing units capable of supplying 4 kilowatts to the antenna, in the numbers required and sufficient for each particular case.

Some difficulty was at first experienced in

paralleling large tubes in considerable numbers, but no difficulties now occur with groups of sixty bulbs working on voltages of 12,000 on the plate.

I am told that no insurmountable difficulty would be encountered if it were desired to supply 500 kilowatts to the antenna from a number of these bulbs. The life of the bulbs has been very materially increased and the 4-kilowatt units are expected to have a life, which, based on a great number of tests carried out both in the laboratory and at our Clifton station, should be well in excess of 5,000 hours.

The development of single unit tubes of considerable power is also progressing. We have lately concentrated on the production of high power tubes made of quartz, and two sizes of each bulb are now being made, one for 25 kilowatt to the antenna, and another for 75 kilowattss but it is not expected that the

efficiency of the high power single units will be as good as that of the multiple units, and the work on the large tubes is being considered so far as experimental.

EFFICIENCY OF TRANSMITTERS

IN transmission work, a large amount of investigation has been carried out during the last two years on the efficiency of the circuits and in regard to the best way of utilizing the available energy.

Considerable increases in efficiency have been obtained in the aerial or antenna circuits and also in minimizing the losses in the attendant loading coils, and the latest results indicate that it is possible to obtain efficiency of radiation into space as high as fifty per cent. on wavelengths as long as 20,000 meters, when, in this particular case, towers of a height of 250 meters would, of course, have to be used, owing to the length of the wave.

Very careful investigations have been carried out by Mr. H. W. Round of all the losses in the loading coils and other parts of the tube circuits, and actual measurements on considerable power have shown that an over-all efficiency from the input power on the plates of the tubes to the aerial of seventy per cent. is possible with a complete avoidance of harmonics, that is, an efficiency from the power input to the plates of the tubes to actual radiation into space of about thirty-five per cent.

On shorter wave stations it is quite practicable still further to increase this efficiency

although possibly it is hardly worth the extra expense involved. We have at present one station in England working on a 3,000 meter wave length with a height of mast of 100 meters which has an efficiency from plates to radiation into space of 40 per cent.

In high speed transmission, we are maintaining public services at 100 words per minute to two places in Europe, namely, Paris and Berne, using a single aerial transmitter with two wavelengths on the same aerial, and although the operation of utilizing a single aerial for two wave lengths is not an advisable one for high power work, it has certain points to recommend it in medium power work, where the consequent loss of efficiency can be made up for by a slight increase of power.

These two waves are working duplex to both Paris and Berne and practically all traffic is taken on printing machinery, although there are occasions when, because of static, reception has to be done on undulator tape, and, in some rare cases, on the telephones, by sound.

The reception at these shorter distance stations is carried out by means of a cascade arrangement of high and low frequency tuned amplifier circuits attached to the directional aerial system of the Bellini type, arranged for unidirectional reception when necessary. Very great care is taken in the receiving circuits to shield them so that the tuned circuits come well into action and to prevent any direct effect or influence of the aerial on circuits other than those intended to be acted upon. The char-

Marconi's yacht, the *Elettra*, which is fitted with a very complete radio laboratory. While the yacht was in the Hudson River Mr. G. Mathieu, who accompanied Marconi, received signals from Europe with remarkable intensity, by a system of amplification he has perfected, using a loop antenna

© Kadel & Herbert



acteristics of all these circuits have been very accurately measured so as to give filter curves suitable to the required speeds of working, and the adjustments are easily performed by the operators. Aside from the protection from interference given by directional reception, a close filtering, and an element of saturation, no particularly sensational methods or ideas in regard to static elimination have been so far introduced into practice.

WHERE STATIC COMES FROM

DURING my present journey across the Atlantic on board the Yacht *Elettra*, we noticed that up to about half way across (apart from the effects of local storms, static interference appeared to be coming mainly from the

European and African continents, while at more than half way across they were coming from westerly directions, that is, from the American continent.

The changing over of the direction of origin of these disturbances has also been noted under similar circumstances by Mr. Tremellen in crossing the Pacific.

The protection of receivers against the troubles of atmospherics or static can only be, and is likely to continue to be, a relative matter, as it is quite obvious that a static eliminator under certain conditions will cease to be effective, where the static arrives with much greater intensity than had been anticipated, and will also frequently fail when, in consequence of the weakness of the received signals, amplification

A very good idea of the receiving antenna may be had from this photo. The young man is demonstrating the effect of placing a tuned inductance between the transmitter and receiver. A slight movement to one side or the other permits the signal to be received, but when it is placed directly before the receiving antenna, signals are entirely cut off. If we are to have directional, short wave transmission it would seem as though both sending and receiving stations would have to be high enough to offset the possibility of any shielding objects coming between them. Operation in large cities would be quite difficult. The receiving rod is slightly shorter than the reflector rod because the former is connected to a circuit having a certain amount of inductance

Courtesy Radio Corporation of America

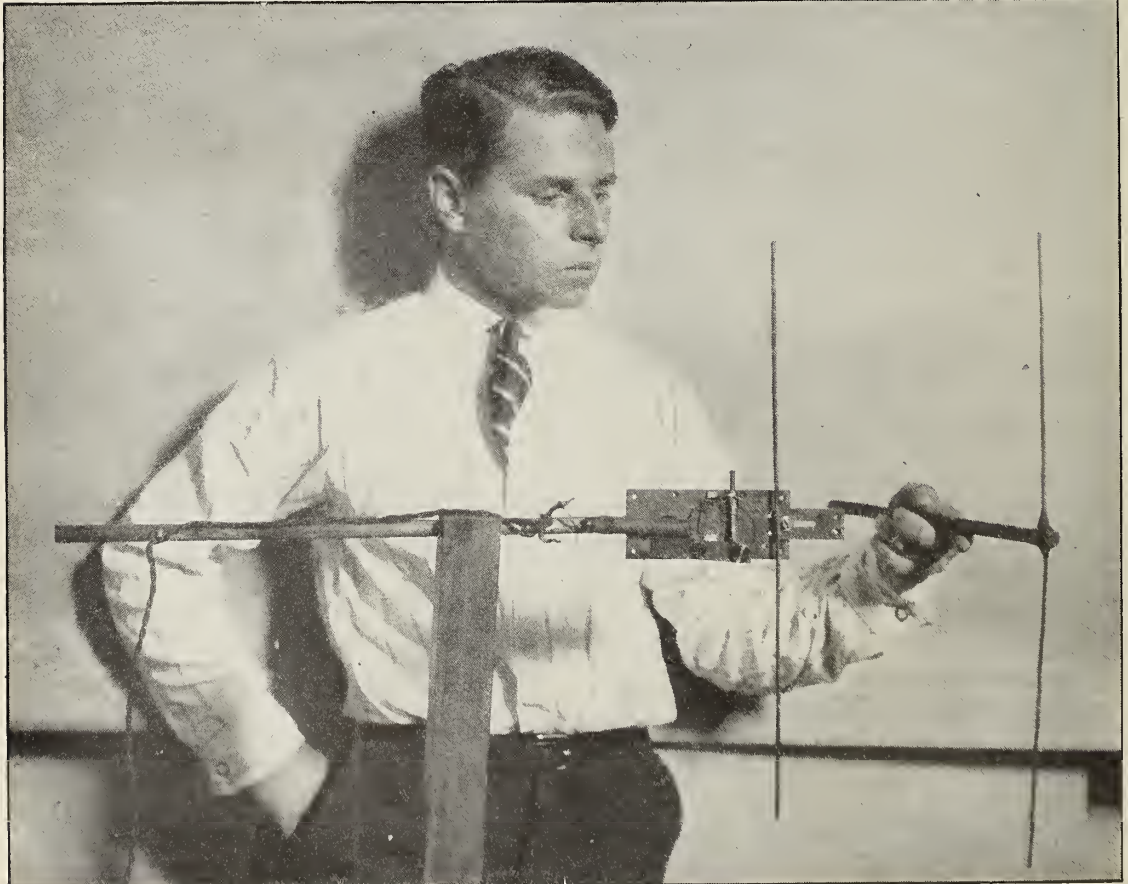

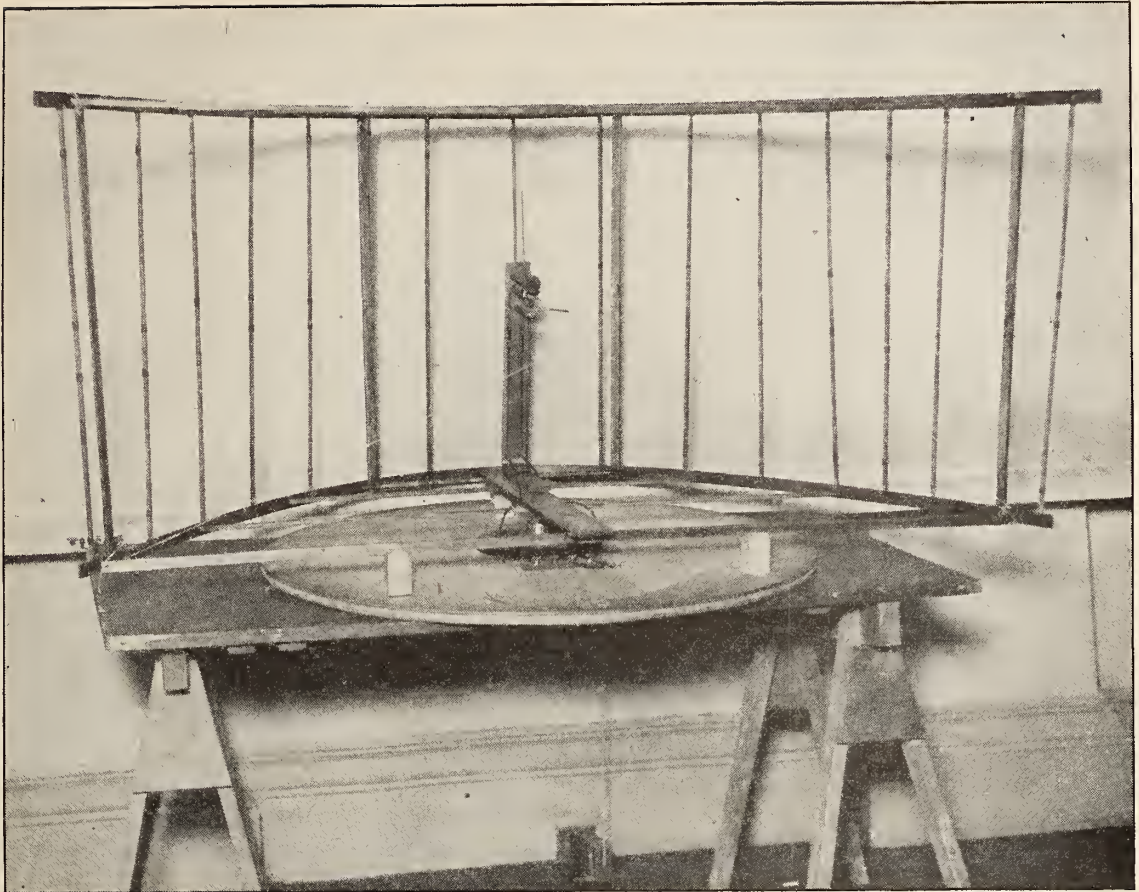

The transmitter Marconi used to demonstrate his directive transmission system for extremely short wave work. The table supports a pivoted disc which carries the transmitting antenna and the parabolic reflector. The direction of transmission is altered by orientating the reflector. The upright rods in the reflector are insulated from each other and are of one and one half the transmitting wavelength. Directional transmitting of this nature on 15 or 20 meters would present great difficulties for the amateur to overcome due to the complexity of building the reflecting system.. However, where the transmitter could be installed on the roof of a building and a higher building was adjacent to it, the reflecting wires could be suspended and insulated from the latter

has to be increased to any considerable extent.

RECENT DEVELOPMENTS

IT WOULD be really interesting to know how much the increased number of C. W. transmitters, the development in directional reception, and the improvements in tuning that has taken place during the last few years have really increased our speed of readability and reliability over given distances.

As the development has been gradual, the tendency is toward pessimism, but I think we are now able at the same expense to work at about 8 to 10 times the effective speed that we were able to work at in 1912 under the same atmospheric conditions.

Interference from other stations has, of course, enormously increased, and this has perhaps somewhat checked the increase of speed, but fortunately prevention of interference from other radio stations is a very much easier problem than the prevention of the disturbances caused by natural electric waves, or static.

Amongst the different types of tube amplifiers used in modern radio receiving stations, the tuned high frequency and audio frequency amplifier is probably the one which excites the greatest technical interest. In fact, its selective qualities, combined with the comparatively better ratio of signal strength to interference which it secures, justifies such interest.

If those researches were generally not quite successful in regard to preparing or fixing the

design of practical apparatus, they however indicated that the main difficulty to be overcome was to combine considerable amplification with stability and that the solution of the problem became rapidly more difficult with the increase of the number of tubes used in cascade.

By stability, in this case, I mean the freedom from any sudden generation of oscillations in any part of the circuits of the amplifier.

RECEIVING DEVELOPMENTS

IN 1920, however, an important step was made by Mr. G. Mathieu, as to the path to be followed out in order to obtain a practical solution of the problem. This consisted in the design of a new type of air-core tuned intervalve transformer arranged in such a manner as to possess only an extremely electrostatic capacity between the windings, and having its effective primary impedance about equal to the effective internal plate to filament resistance of the tube in use when the secondary circuit was brought into resonance with the frequency of the oscillations to be amplified.

The results to be achieved during the first tests of these new transformers appeared to be quite amazing, the amplification factor for one tube having passed suddenly from 5 to about 15 for the particular tube tested, whilst the stability proved incomparably better than what had been obtained previously, even when the grid of the tube was kept to a negative potential of 1 or 2 volts.

The same principle has proved quite as successful when applied to the design of iron-core low frequency transformers. In this case, however, it was found necessary to adopt an iron magnetic shunt between the windings so as to provide a sufficiently loose coupling between the primary and secondary circuits of the transformer. Recently, Mr. Mathieu has further improved the design of his high frequency transformer by making it astatic.

THE IMPORTANCE OF SHORT WAVES

I SHALL now deal with another and most important branch of the science of radio telegraphy; a branch which I might say has been a long time most sadly neglected. It concerns the use that can be made of very short waves, especially in regard to their application to directional radio telegraphy and radio telephony.

The study of short waves dates from the time of the discovery of electric waves them-

selves, that is, from the time of the classical experiments of Hertz and his contemporaries, for Hertz used short electric waves in all his experiments, and also made use of reflectors to prove their characteristics and to show, among many other things that the waves, which he had discovered, obeyed the ordinary optical laws of reflection.

As I have already stated, short electric waves were also the first with which I experimented in the very early stages of wireless history, and I might perhaps recall the fact that when, more than 26 years ago, I first went to England, I was able to show to the late Sir William Preece, then Engineer in Chief of the British Post Office, the transmission and reception of intelligible signals over a distance of $1\frac{3}{4}$ miles by means of short waves and reflectors, whilst, curiously enough, by means of the antenna or elevated wire system, I could only get, at that time, signals over a distance of half a mile.

The progress made with the long wave or antenna system, was so rapid, so comparatively easy, and so spectacular, that it distracted practically all attention and research from the short waves, and this I think was regrettable, for there are very many problems that can be solved, and numerous most useful results to be obtained by, and only by, the use of the short wave system.

Sir William Preece described my early tests at a meeting of the British Association for the Advancement of Science, in September, 1896, and also at a lecture he delivered before the Royal Institution in London on the 4th of June, 1897.

On the 3rd of March, 1899, I went into the matter more fully in a paper I read before the Institute of Electrical Engineers in London, to which paper I would recall your attention as being of some historical interest.

DIRECTIONAL TRANSMISSION

AT THAT lecture I showed how it was possible, by means of short waves and reflectors, to project the rays in a beam in one direction only, instead of allowing them to spread all around, in such a way that they could not affect any receiver which happened to be out of the angle of propagation of the beam.

I also described tests carried out in transmitting a beam of reflected waves across country over Salisbury Plain in England, and

pointed out the possible utility of such a system if applied to lighthouses and lightships, so as to enable vessels in foggy weather to locate dangerous points around the coasts.

I also showed results obtained by a reflected beam of waves projected across the lecture rooms, and how a receiver could be actuated and a bell rung only when the aperture of the sending reflector was directed toward the receiver.

Since these tests of more than twenty years ago, practically no research work was carried out or published in regard to short waves, so far as I can ascertain, for a very long period of years.

The investigation of the subject was again taken up by me in Italy early in 1916 with the idea of utilizing very short waves combined with reflectors for certain war purposes, and at subsequent tests during that year, and afterward, I was most valuably assisted by Mr. C. S. Franklin, of the British Marconi Company.

Mr. Franklin has followed up the subject with thoroughness, and the results obtained have been described by him in a paper read before the Institution of Electrical Engineers in London on the 3rd of April, 1922.

Most of the facts and results which I propose to bring to your notice are taken from Mr. Franklin's paper.

The waves used had a length of 2 meters and 3 meters. With these waves, disturbances caused by static can be said to be almost nonexistent, and the only interference experienced came from the ignition apparatus of automobiles and motor boats.

The receiver at first used was a crystal receiver, whilst the reflectors employed were made of a number of strips of wires tuned to the wave used, arranged on a cylindrical parabolic curve with the aerial in the focal line.

The tests were continued in England at Carnarvon during 1917. With an improved compressed air spark gap transmitter, a 3-meter wave, and a reflector having an aperture of 2 wavelengths and a height of 1.5 wavelength, a range of more than 20 miles was readily obtained with a receiver used without a reflector.

In 1919 further experiments were commenced by Mr. Franklin at Carnarvon for which electron tubes or valves were used to generate these very short waves, the object being to evolve a directional radio telephonic system.

A 15-meter wave was chosen, which could quite easily be generated by the type of electron tube employed.

As a result of the success of these experiments it was decided to carry out further tests over land across a distance of 97 miles between Hendon (London) and Birmingham.

The power supplied to the tubes employed is usually 700 watts. The aerial is rather

longer than half a wavelength and has a radiation resistance which is exceedingly high. The efficiency input to the tubes to aerial power is between 50 and 60%, and about 300 watts are actually radiated into space.

With the reflectors in use at both ends, speech is usually strong enough to be just audible with a $\frac{1}{4}$ to $\frac{1}{2}$ ohm shunt across a 60-ohm telephone.

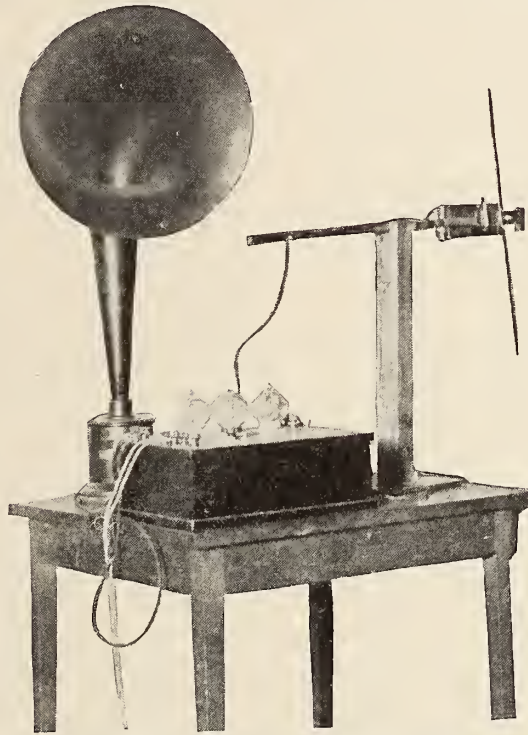

The receiving outfit used by Marconi to demonstrate the reception of extremely short waves sent out by a directive antenna. For the demonstration, he used a loud speaker of American make so that the audience could observe the effect of his directional antenna. The signals of extremely short waves are picked up and then pass through a circuit similar to the superheterodyne and thus changed to a wavelength of six hundred meters. Although six hundred meters is the wavelength for ship use no interference is experienced from this source because only those waves which influence the detector circuit are passed on. This feature of the receiver was not pointed out by Marconi and is therefore not generally realized

With both reflectors down and out of use, speech is only just audible with no shunt.

By means of suitable electron tubes or valves, it is now quite practicable to produce waves from about 12 meters and upward utilizing a power of several kilowatts, and it is also practicable to utilize valves in parallel.

Reflectors besides giving directional working, and economizing power, are showing another unexpected advantage, which is probably common to all sharply directional systems. It has been noted that practically no distortion of speech takes place, such as is often noticed with non-directional transmitters and receivers, even when using short waves.

It has thus been shown for the first time that electric waves of the order of 15 to 20 meters in length, are quite capable of providing a good and reliable point to point directional service over quite considerable ranges.

I have brought these results and ideas to your notice as I feel—and perhaps you will agree with me—that the study of short electric waves, although sadly neglected practically all through the history of wireless, is still likely to

develop in many unexpected directions, and open up new fields of profitable research.

BROADCASTING

NO REMARKS from me or from any one else are required to tell you what has already been done with radio in America, as a means of broadcasting human speech, and other kinds of sound which may also be entertaining if not always instructing.

In thousands of homes in this country there are radiotelephonic receivers, and intelligent people, young and old, well able to use them—often able to make them—and in many instances contributing valuable information to the general body of knowledge concerning the problems, great and small, of radio telegraphy and radio telephony.

But I think I am safe in saying that if radio has already done so much for the safety of life at sea, for commerce, and for commercial and military communications, it is also destined to bring new and, until recently, unforeseen opportunities for healthful recreation and instruction into the lives of millions of human beings.

Sharpness of Tuning in a Radio Receiver

By JOHN V. L. HOGAN

Consulting Engineer, New York; Fellow and Past President, Institute of Radio Engineers;
Member, American Institute of Electrical Engineers

IF WE set up a simple radio receiver as shown in Fig. 1, connecting a sensitive direct-current meter in the place usually assigned to the telephones, we will be able to determine approximately the strength of the radio-frequency alternating current which any arriving wireless wave may set up in the antenna to ground system. As has been pointed out in an earlier article,* the natural frequency of the aerial system may be altered within wide limits simply by changing its effective capacity or its effective inductance. Further, it has been shown that the greatest amount of current will be induced in any antenna-to-earth circuit when its natural frequency agrees exactly with the frequency of the arriving radio wave. Still further, we

have seen that the aerial current for this harmonious or tuned condition will be the larger, and will depend the more critically upon care in adjustment, when the electrical resistance of the circuit is made as small as may be feasible. Thus it becomes evident that a good radio receiver, one which is both efficient and selective, will need to have convenient instruments for the control and adjustment of its natural frequency as well as a minimum of resistance or opposition to the flow of electric current.

THE TUNING CIRCUITS

IN THE arrangement of Fig. 1, there are two tuning coils A and B, and a tuning condenser. The coils may be assumed to be of the well-known variometer type, although similar effects would be had if other forms of adjustable coils

* "Increasing the Selection Power of a Radio Circuit," by John V. L. Hogan. *Radio Broadcast*, July, 1922, page 211.

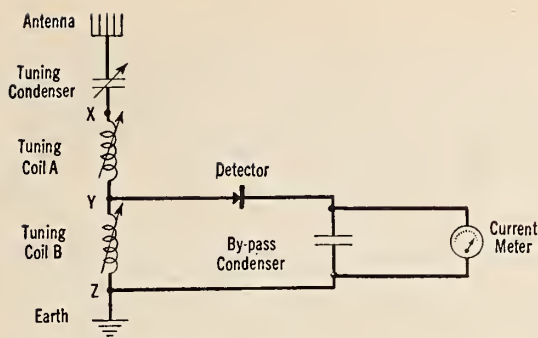

Fig. 1: A conductively coupled radio receiver arranged to permit variation of the detector voltage by tuning the detector circuit

were used. The condenser should be closely adjustable as to capacitance, as is the usual interleaved segmental-plate arrangement. Increasing the inductance of either coil or increasing the capacitance of the condenser will lower the natural frequency of the circuit, thus making it resonant to a longer wavelength. From the point of view of tuning, it is immaterial whether we increase the inductance of coil A or of coil B, for the two are connected in series and the effective inductance of the circuit (which controls its free or natural oscillation frequency) depends upon the total value of both.

However, it will be noted that the detector and current-meter branch of the receiving circuit is connected across only the lower of the two coils, that is, across coil B. To understand the effect of this, we must appreciate that for any particular amount of current which any one series of radio waves may generate in the antenna-to-ground circuit, there will be produced a certain definite quantity of electric pressure or voltage between the points X and Z marking the outside terminals of the pair of inductance coils. We must realize, beyond this, that the voltage so produced will be divided between the points X and Z and the points Y and Z (or between the terminals of the two individual coils), in proportion to the relative amount of inductance in each tuning coil. Thus, if coil A is equal to coil B in size, the total voltage will be divided equally across each. If coil A is twice as large as coil B (in inductance), two thirds the total voltage will appear across X-Y and one third across Y-Z. Consequently it becomes evident that by dividing between the two coils in various ratios the total amount of inductance required to tune the receiving antenna circuit, we may alter the

proportion of the total voltage which is applied (across the points Y-Z) to the part of the receiver containing the detector and current-meter.

Clearly, it would not be necessary or even desirable to provide two separate inductors or tuning coils if we were concerned merely with adjusting the natural frequency of the antenna system. In a radio receiver, however, we wish to provide not merely a resonant condition but also a *sharp* resonant condition, or one in which all resistance effects are minimized. In this way we secure not merely loud signals from the station to which we desire to listen, but also the least amount of interfering signal intensity from disturbing stations which may be transmitting simultaneously with neighboring wave frequencies.

RESISTANCE OF THE RADIO RECEIVER

THE total resistance of a radio receiver, which we desire to keep as small as possible, may be divided into four portions. The first of these, and usually the smallest, is simply the electrical resistance of the wires in the aerial, the tuning coils and connections. In well-designed instruments this amount is too little to require much consideration. The second portion is the so-called ground resistance, which includes the opposition to current flow existing in the connection to earth and, near the receiving station, in the earth itself. This part may be kept small by using firmly made and well-distributed ground connections, or, where that condition is difficult to secure, an artificial ground or counterpoise. The third part of the total is not a true or simple resistance, but represents the losses in the receiver due to re-radiation from the aerial of high-frequency current energy set up in it by arriving waves. The proportion of this third part is not easily controllable, for it depends mainly upon the size and form of the receiving antenna; in any event, it is not a resistance to worry about, for the general conception is that the higher the re-radiation loss the better is the antenna for intercepting wave-energy and therefore the better one can afford such losses.

The fourth portion of the total resistance is the one with which we are mainly concerned, for it may be controlled by the design or adjustment of our receiving outfit. It represents the part of the total received energy which goes into the detector and in part performs useful work by producing signals. At first

sight one would be inclined to say: "Let us make this fourth or useful part of the resistance as high as possible, for the greater it is the more energy will pass to the detector and the louder will be our signals." A little study will make clear the fallacy of this idea, however. It is true that the higher this useful resistance (in proportion to the other three parts) the greater the percentage of the whole received energy which will be impressed upon the detector. But is it true that the signals will be louder, or that the amount of energy thus put into the detecting system will be greater? Beyond rather low limits the answer is emphatically no, for the increase in total resistance will reduce the total energy set up in the antenna system by the received waves and there will be less power available to produce signal effects.

SIGNAL STRENGTH AND SELECTIVITY

THUS it appears that in such a receiver there exist two effects working against each other, either of which alone would tend to improve the strength of the signals heard. We desire to make our detector resistance effect as great as is feasible, since a substantial part of it represents work done in producing what we want, i. e., radio signals (which term, of course, includes speech or music received by radiophone). On the other hand, if we increase the resistance effect too greatly the resonance in our receiving aerial circuit will be spoiled; signals from waves to which we are tuned will not build up to so strong an intensity, and interfering waves will cause disproportionately loud disturbances. Evidently, we must strike a happy medium, a satisfactory balance between loss of signal energy and loss of selectivity.

By dividing the tuning inductance into two parts connected as in Fig. 1 we are enabled to strike this balance. The resistance effect of the detector is proportional to the amount of electrical power delivered to it from the antenna circuit. The power applied to the detector depends upon the radio-frequency voltage impressed upon it. In Fig. 1 the detector is connected to the points Y and Z; the voltage across these points is controlled by the amount of inductance in tuning coil B. Thus by changing the proportion of the total requisite tuning inductance in coil A as compared to coil B, we can vary the voltage affecting the detector and can control its resistance effect in the antenna circuit. The smaller the per-

centage of the total inductance allotted to coil B, the lower will be the voltage on the detector, and the less the resistance effect. The less this resistance, the weaker will be the signals, but the sharper the tuning.

HOW DETECTORS VARY

WHERE the detector has the capability of absorbing a good deal of energy, as when a crystal rectifier is used, this adjustment is of great importance. Many of the crystal receivers now on the market are very poor from the point of view of tuning because in them the detector voltage is made too great a percentage of the available total. Where the audion vacuum tube detector is used, the grid or input circuit (to which the detector oscillation voltage is applied) refuses to take a great deal of power, and consequently the careful division of the total inductance is not ordinarily necessary. The principle, however, should be understood and kept in mind, for it explains many tuning difficulties experienced by novice users and designers of radio apparatus.

There is another exceedingly useful way in which the proportion of detector resistance in the tuned antenna circuit may be controlled. If instead of the conductive or wire detector connection of Fig. 1 we substitute a magnetic coupling as in Fig. 2, we may vary the voltage impressed upon the detector by changing the position of the secondary coil B with respect to tuning or primary coil A. The nearer the two coils are together, the closer their coupling is said to be and the higher will be the radio-frequency voltage impressed upon the detector. As before, the higher detector voltage causes the abstraction of a greater part of the antenna power and produces the effect of larger detector resistance, which will reduce sharpness of tuning but, up to a certain point, will increase signal strength. In this simple coupled circuit of Fig. 2 the natural frequency of the antenna system is controlled almost exclusively by the tuning condenser and the primary coil A; the position of the second coil B does not greatly affect the resonant frequency unless the coupling is quite close. Changes in the coil A, however, do alter the coupling to the detector circuit, since as the inductance of A is reduced the strength of the magnetic field about it (which is what induces the secondary coil voltages applied to the detector) will ordinarily be weakened; and the secondary coil will need to be moved closer to the primary if the same

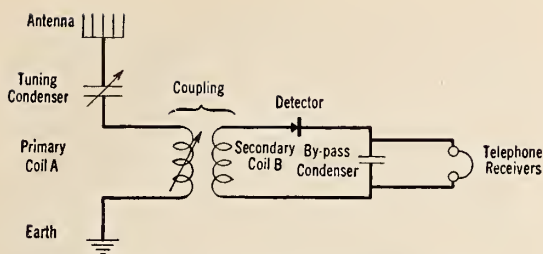

Fig. 2: The inductively coupled receiver with broadly-tuned secondary circuit

coupling is to be maintained. Probably the most convenient way to adjust the circuits natural frequency to resonance with an arriving radio wave is by using the tuning condenser shown, since the coupling is not appreciably changed by the variations of capacitance of this instrument. It is entirely feasible to use the arrangement of Fig. 2 with a non-adjustable primary coil, the tuning being then entirely dependent upon the variable condenser.

CONCERNING DETECTOR VOLTAGE

HOW will changing the detector voltage or coupling affect the practical operation of the two circuits shown? If the circuit of Fig. 1. is arranged so that with the tuning condenser at a mid-scale setting and each of the two inductors A and B at one half its maximum value, the natural frequency of the antenna agrees with the frequency of an arriving stream of radio waves, the receiver will have the capability of tuning considerably above or below this frequency. When such a stream of waves arrives, it will generate radio-frequency currents in the antenna-to-ground circuit. Corresponding voltage impulses at the points Y and Z will be impressed upon the detector; by its characteristic rectifying action the voltages which occur in one direction will produce a larger current through the detector circuit than will those in the opposite direction; thus a rectified or direct current will flow through the meter and cause a deflection of the indicating needle, the scale reading of course being larger as the applied voltage is increased. Let us suppose that with the inductance evenly divided between the two coils A and B and with the condenser scale at 90° , the receiver is tuned to 360 meters wavelength (833,000 cycles per second). Let us further assume that some near-by station is transmitting a constant, unmodulated (or unvarying) stream of waves at this resonant frequency, of

such intensity as will cause the current meter to show a deflection of 50 milliamperes. If now the tuning condenser is altered to a scale reading of 100° , the natural frequency of the antenna will no longer be 833,000 cycles, but something less; the antenna current will no longer attain its resonant maximum, the detector voltage will fall, and the meter reading will drop off to, perhaps, 10 milliamperes of current. The same reduction of current may be secured if the tuning condenser is turned away from the resonant point in the opposite direction, say to 80° on the scale, since the natural frequency will then be higher than the frequency of the arriving wave.

WHY VARIABLE UNITS ARE VALUABLE

NOW suppose that instead of dividing the total inductance equally between coils A and B, we put one quarter of it in A and the remaining three quarters in coil B. Since the total inductance remains as before, the resonant setting of the condenser will again fall at 90° . However, we may expect to find that the increased resistance effect of the detector will decrease the antenna current so much that the meter reading even at resonance will be less than before, or, say, 40 milliamperes. Moreover, the sharpness of tuning will be decreased, so that when the condenser is moved off resonance to either 80° or 100° the current indicated by the meter will not fall so greatly but may remain as large as 25 milliamperes.

For the opposite case, in which coil A is given three quarters of the inductance and only one quarter placed in coil B, the resonant antenna current will be greater than before. The part of the total voltage applied to the detector may be less, however, so that the meter reading will reach only 45 milliamperes as a tuned maximum. Nevertheless, reduction of the resistance effect will sharpen the tuning very greatly, so that even if the condenser is moved only 5° on either side of the resonant point (i. e., to 85° or to 95°), the current reading may drop as low as only one or two milliamperes.

An entirely similar set of effects will be found with the arrangement of Fig. 2. The signals and tuning will both be bad if the coupling between primary and secondary is too close; loosening the coupling somewhat will improve both signal strength and sharpness of tuning; further separation of the coils will cause some weakening of signals but will allow still sharper tuning. The inductively coupled circuit in

Fig. 2 is a little more flexible in adjustment than the directly connected system of Fig. 1, and somewhat more free from interference pro-

duced by near-by stations. It is, however, usually considered harder to adjust for equivalent signal strength.

Progress of Radio in Foreign Lands

SEVERAL more or less common applications of the vacuum tube are described in a recent issue of the British periodical *Nature*, but the author, M. Joseph, tells of its use for the testing of hearing capacity, which is certainly an unusual application. In this connection the usual three-element vacuum tube is employed in a heterodyne circuit. This means that it is employed as an oscillator or generator of current of any frequency from one to several million alternations per second, while a second current, generated by another oscillator, is introduced so as to set up the well-known phenomenon of "beats" or pulses set up by the difference between the two rates of oscillation. The "beats" cause audible sounds in a telephone receiver connected with the oscillating circuit. This method is employed in the reception of continuous wave signals, the frequency of which is such that they are by themselves absolutely silent when intercepted with the usual receiving set. The heterodyne action, however, causes the "beat" effect to actuate the telephone receiver so that the signals can be heard. Now M. Joseph comes forward with the suggestion that this principle be applied to the testing of hearing capacity. Never before has there been such a simple and accurate device for determining the audibility range of the human ear. Ordinarily, the human ear responds to sounds the frequency of which does not exceed 3,000, although in certain instances some sounds of the frequency of 18,000 and even 30,000 and 40,000 have been heard. On the other hand, some ears are deaf to sounds of 500 cycles frequency, while others find it impossible to distinguish between different frequencies or notes, just as some eyes cannot distinguish between shades and even colors. The heterodyne device now enables us to produce the full range of sound frequencies accurately and simply and in any desired volume. Thus we

have an extremely valuable method of testing human hearing capabilities.

GERMANY'S DISTRIBUTION OF RADIO NEWS

FROM long and systematic experiments the German Post Office has come to the conclusion that radio telephony is the simplest and cheapest means of distributing news from a central point. The Post Office administration has entered into an agreement with a news distributing agency for the circulation of market prices of stocks, prices of material, and so on, according to the *Elektrotechnische Zeitschrift*. Subscribers to the service pay 4,000 marks per annum to the Post Office for installation and maintenance and a subscription for the news service to the Press Agency. Reception of news service which is not subscribed for is partially prevented by changing the figures, which have to be decoded by the subscriber entitled to the particular service. The apparatus employed in Germany for the reception of the Post Office broadcasting service consists of a single-wire antenna. A loop antenna is not employed since it involves expensive amplifying devices. A single-tube receiving set is regularly supplied, but in special instances where the distance is greater than usual, a two-stage audio-frequency amplifier is also supplied. The filaments and the plate circuits are supplied with current taken from the ordinary electric light socket through suitable resistances. This is an interesting fact, in view of the Bureau of Standards experiments which have been under way for some time in Washington, D. C., and the report on which has been promised for some time past. This practice eliminates the troublesome storage battery and the expensive B battery of the usual vacuum tube apparatus. All the German apparatus is sealed in neat cases, but inspection windows are provided so that the condition of the vacuum tubes may be studied.

THE Imperial Wireless Telegraphy Committee of 1920, which is the British organization charged with Great Britain's world-wide radio plans, described the arc as "pre-eminent at the present moment among methods of long-range wireless transmission." Whether we agree with this conclusion or not, the fact remains that the Leaffield station, the first station of the Imperial Chain, has now been equipped with Elwell-Poulsen arcs similar to those at Lyons, Rome, Nantes, and so on. Transmitting press messages at low power preparatory to the opening of the similar station in Egypt, Leaffield's signals were regularly received in Australia, India, and other distant points, as well as by British shipping throughout the routes to America, South Africa, and Australia. Our British friends claim that arcs handle traffic with certainty and at low cost. Arcs are particularly suited for use in districts remote

from the great industrial centres. Arcs are recommended by the Wireless Telegraphy Commission of 1921 for installation in East Africa, Hong Kong, and Singapore.

THE "ALL RED" RADIO AND WORLD COMMUNICATION

THE name "All Red" Radio no doubt suggests the Soviet rule of Russia, but as a matter of fact it is the name adopted for Great Britain's world-wide radio plan. According to a report to the Department of Commerce from Consul General Sammons of Melbourne, Australia, direct radio communication between Australia, Canada, and Great Britain, supplementing the "All Red" cable line of the Pacific Cable Board, is likely to be established within two years as a result of a contract just concluded between the Australian Government and the Amalgamated Wireless Company, Ltd.

The main Australian station will probably be located in New South Wales. According to the Melbourne *Argus*, the power used will be about 3,000 kilowatts, and the combined cost of the central station and of a feeder station in each of the six states will be about £1,000,000. The plant for the central station will be manufactured in England, but those for the smaller stations will be made in Australia. The controlling interest in the Amalgamated Wireless is vested in the Commonwealth Government of Australia, and of the seven directors, the Govern-

ment and the minority stockholders will each have three, the seventh being chosen by vote of the first six. An important clause is that prohibiting the Amalgamated Wireless from combining with any other commercial interest and requiring it to remain always "an independent British concern." The company is also to develop, manufacture, and sell radio

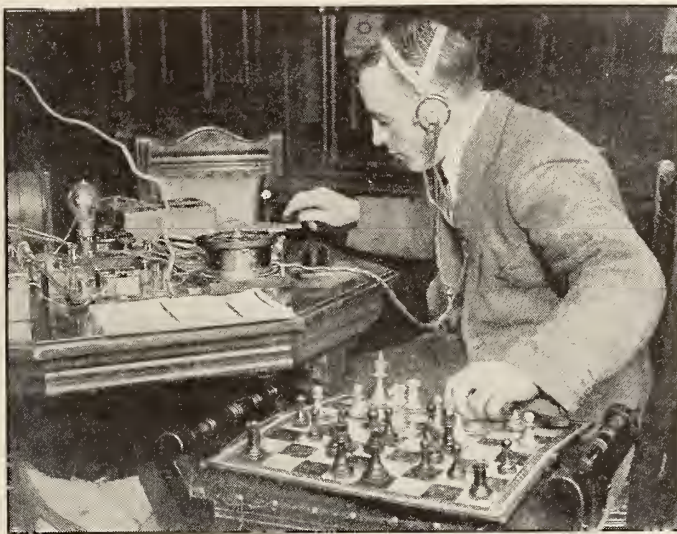

©Kadel & Herbert

Frank Walsh, an inventor of Brighton, England, playing a game of chess by radio with his brother who is in Paris

apparatus and to furnish service to ships and aircraft. It has been made a party to the general agreement for the interchange of wireless patents entered into by the principal radio equipment companies of the world. New high power radio stations to communicate with Australia are planned for Great Britain and Canada. The proposed rates for radio service are about two-thirds of the present cable rates.

THE INTERNATIONAL WIRELESS CONFERENCE

COMPOSED of representatives of the Radio Corporation of America, Compagnie Generale de Telegraphie sans Fil, Gesellschaft fur Drahtlose Telegraphie m. b. h., and Marconi's Wireless Telegraph Company, the International Wireless Conference recently completed its deliberations. A number of important questions dealing with the development in different parts of the world of

radio telegraph and telephone communication have been considered and satisfactorily settled. As a result of the agreement between the four companies, a number of new international radio telegraph services are to be opened in the early future. In order that commercial wireless telegraphy and telephony should be developed to the best advantage in the interests of the public and of international commerce, it has been decided that the companies should not erect any stations which would entail the harmful radiation outside an agreed radius of harmonics or secondary waves which are beyond the definite wave bands allotted to each particular station.

JOHN BULL CONSIDERS BROADCASTING

OUR British cousins have been casting inquisitive and even longing eyes across the big pond ever since they received word concerning our wonderful radiophone broadcasting activities, and now they are anxious to do a little broadcasting on their own account. And we do not blame them; they have been missing the fun long enough. At any rate, an English authority on radio, Mr. Kellaway, has given considerable study to broadcasting and has now formulated certain plans which tend to give the maximum service to the British public with the least interference to commercial and Government radio traffic. He would allow a limited number of radiophone broadcasting stations. The country would be divided roughly into areas centring upon London, Cardiff, Plymouth, Birmingham, Manchester, Newcastle, Glasgow or Edinburgh (or both), and Aberdeen, and one or more broadcasting stations would be allowed in each of those areas. Permission for those stations would only be granted to British firms who were *bona fide* manufacturers of radio equipment. If too many applications for broadcasting privileges were received, then he would ask the various firms to come together at the Post Office—this department has charge of communications in Great Britain, following the practice prevalent in European countries—so that an efficient service might be rendered, that there might be no danger of monopoly, and that each service should not be interfering with the efficient operation of the other. The stations would be limited to a power of $1\frac{1}{2}$ kilowatts, and furnished with wavelengths which should not interfere with other services. The normal hours for broadcasting would be from 5 p. m.

to 11 p. m., except on Sundays, when there would be no limit. There would be certain regulations in regard to the character and class of news which these agencies could transmit. And, most important of all, we might add, incidentally, that Mr. F. G. Kellaway, aside from being very well posted on radio matters, is Postmaster General of Great Britain.

THE LONG ARM OF SOVIET RUSSIA

PERHAPS Soviet Russia is decadent in transportation, industry, and other features of present-day life, but so far as communication is concerned, the mysterious republic, if it can be called such, is certainly quite up to date. It is reported from Moscow that the Council of People's Commissaries have granted a concession for telegraphic and radio communication between India and Europe. Communication will be through Russian territory, and there will be connection with Turkey, Egypt, Persia, and the Mediterranean countries.

GREAT BRITAIN'S WEATHER BROADCASTS

OWING to numerous requests from amateur users of radio receiving sets, according to the London *Electrician*, the two daily weather messages sent out from the Air Ministry are now being distributed or broadcasted at a slightly lower rate than previously. Investigation of the requests showed that a number of amateur radio users, situated in remote rural localities, are carefully picking up the Air Ministry weather forecasts, and are handing them on at once to neighboring farmers.

THE INAUGURATION OF THE ANGLO-EGYPTIAN SERVICE

SOME time ago the Anglo-Egyptian radio service, via the Imperial radio stations at Leafield and Cairo, was inaugurated. Telegrams are accepted at any post office in Great Britain for Egypt, Palestine, and Syria for transmission, and a corresponding service is available in the opposite direction. The rates of charge are 3d. a word less than the corresponding cable rates for full-rate traffic and $1\frac{1}{2}$ d. a word less than the corresponding cable rates for deferred traffic. Press messages may be sent to and from Egypt and Palestine at $2\frac{1}{2}$ d. and $3\frac{1}{2}$ d. a word respectively. Telegrams intended for transmission by this route should be marked "via wireless." In



©Kadel & Herbert

Paris has inaugurated the first wireless telephone police patrol. A radio outfit has been installed on a truck to keep in touch with headquarters while in pursuit of criminals

addition, arrangements have been made, pending the provision of further stations of the Imperial wireless chain, for telegrams addressed to places beyond Egypt, served by the system of the Eastern Telegraph Company, to be forwarded by wireless to Cairo and thence by the company's service to their destination at the normal through rates of charge.

CHINA'S RADIO TELEPHONE SERVICE

A RADIOPHONE service, claimed to be the longest span of its kind in the world open to public use, was inaugurated recently between Peking and Tientsin. The equipment was supplied by the China Electric Company and was manufactured exclusively by the International Western Electric Company of New York. The system as perfected in the Peking-Tientsin service insures transmission when connected with telephone central offices. The tests that were applied at the opening ceremony were entirely successful. The distances between Peking and Tientsin is 80 miles.

WHEN MEXICO REFUSED RADIO STATIONS

FROM good British sources it is learned that the Marconi Company has proposed to the Mexican Government a scheme whereby the company would control for fifty years all radio stations built or to be built on Mexican territory. After the expiration of the fifty years the radio stations would be turned over to the Government or the concession renewed. The Government is reported to regard the offer in its present form as unacceptable, but it is believed would be prepared to give it favorable consideration if modified. To which we ourselves can add, truthfully and unflinchingly, that fifty years is a long, long time in

radio development. Perhaps that is the impression of the Mexican Government, too.

RADIO EQUIPMENT OF ATLANTIC LINERS

A RECENT issue of *Radioelectricité* contains a description of the radio equipment aboard the steamships *Paris* and *Lafayette* of the French Line. On both steamers a 5-kilowatt vacuum tube transmitter has been installed with a wave range of between 2,000 and 9,000 meters. A 5-kilowatt motor-generator set is employed to produce the plate high-tension current for four oscillating tubes, while the low-voltage current for the filaments of these tubes is obtained from the same machine. Both vessels are equipped with radio compasses or radiogoniometers. A distance of over 2,000 miles has been covered by the transmitter of the *Paris*.

THE RADIO STATION ON RUNDEMANDEN MOUNTAIN

THE radio station on the Rundemanden, a mountain towering 2,500 feet over the city of Bergen, Norway, is being modernized and equipped with more powerful equipment as well as radio telephone apparatus. As the new equipment has a radius of 1,800 miles, it is believed that direct communication with American radio stations will be possible under good conditions. Radio telephones with a 500-mile radius are also to be installed and communication established with England and continental Europe. These improvements, estimated to cost about \$25,000, are to be completed by the time this is read. The work will be carried out for the A. S. Telefunken Com-



©Kadel & Herbert

This is a receiving and transmitting station in the French police truck. Note that the operator is wearing an American made head set

pany, a Norwegian corporation, by the German company, of that name.

AMATEUR STATIONS IN FRANCE

AN AMATEUR transmitter is such an unusual thing in France, because of the strict radio laws applying in that Republic, that considerable honor attaches to any amateur transmitter as is evident from the following notices, appearing in *La Nature*: "A certain number of transmitting stations of amateurs, intended for the study of radio and for experimental purposes, are operating at present, viz.: M. L. Deloy, at Nice—Call letters, 8AB, continuous wave at 525 meters; works every day at 21 to 22:30 hours. (In France the twenty-four hours of the day are not divided into two periods of twelve hours each, with the A. M. and P. M. designation. Instead, the day begins at midnight and continues for twenty-four hours until the following midnight. Therefore, 21st hour would be eight o'clock.) M. J. Roussel, at Juvisy-sur-Orge—Call letters 8AD, damped wave, 600-cycle alternator, at 200 to 400 meters. Works every evening except Saturday, at 20:30 hour (summer time), and Sunday at 15 hour. Transmitter employs tubes as definite installation . . . 8AE, experimental station in the district west of Paris . . . 8AH M. M. Coze, 8, rue Lalo, at Paris, station for experimental work, with irregular transmitting periods."

THE TRANSATLANTIC STATION AT EILVESE

ALTHOUGH not as well known as the Nauen station, the Eilvese station is by no means unknown to ambitious American amateurs who can receive its signals providing their sets tune up to extreme wavelengths and they make use of good amplifying equipment. The Eilvese station in Germany obtains its

power supply from the Weser power station as three-phase, 15,000-volt current, and transforms it into 5,000 volts before it is rectified in a 600-horsepower motor-generator set consisting of one alternating-current motor and two direct-current dynamos, one for 220 volts and the other 440 volts. The 440-volt generator feeds the Goldschmidt high-frequency machines. To be assured of continuity of service there are also installed five Diesel oil engines of 200-horsepower each. For the regular telegraph service, 400 horsepower to 600

horsepower is needed. There are two aerials, one of the umbrella type for waves of 7,000 meters, to 12,000 meters and a ring type for longer waves. The main tower is 800 feet high, and the six smaller towers are 340 feet high. Six weights of 3,200 pounds each keep the wire network under proper tension mechanically.

The receiving station is at Hager, three miles from Eilvese, and is connected to two 3-mile straight-line antennas, laid out and built like a double high-tension line on poles with disk-type insulators, with two wires 30 feet above the ground and two wires 60 feet above the ground, both lines on the same poles, one above the other. Eilvese works with the Goldschmidt station at Tuckerton, N. J.

INTERESTING FACTS ABOUT TELEPHONE RECEIVERS

THE telephone receiver, which is used in radio work to convert the oscillatory electric energy of the detecting circuit into acoustic vibrations or sound, has been studied by J. Brun of France, who tells of his findings in *Radioelectricité*. For the efficiency of conversion to be a maximum, states the author, it is advisable to make the diaphragm resonant to the pulse frequency of the receiving circuit. Under the best conditions, the transformation

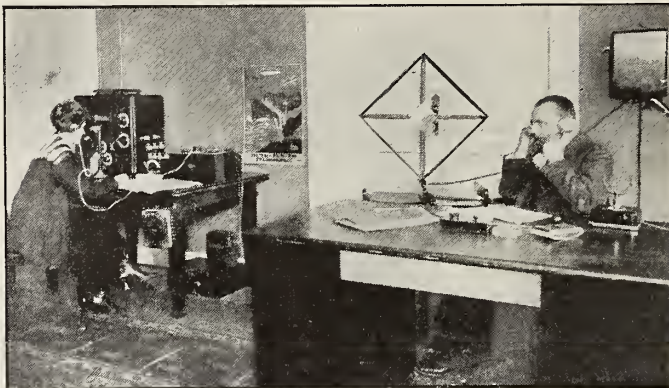

©Kadel & Herbert

Through an arrangement with Huth Funken Company, the Berlin stock exchange has installed radio in its office for supplementing the ticker. The operator on the left is transmitting reports. The man at the right is receiving reports by radio and forwarding them to an associate over an ordinary land line telephone

Radio panels *and Radio Parts*

START right. The panel is the very foundation of your set. High volume and surface resistance are essential factors. Make sure that you get them in both the panels and parts that you purchase. To make doubly certain look for the dealer displaying this sign

CONDENSITE
CELORON

Radio Panel Service

Condensite Celoron Grade 10—approved by the Navy Department Bureau of Engineering—is a strong, handsome, waterproof material, high in resistivity and dielectric strength. It machines easily, engraves without “feathering” and is particularly desirable for panels. It is also widely used for making many other important radio parts such as tube bases, platform mountings, variable condenser ends, tubes for coil winding, bases, dials, knobs, bushings, etc. We are prepared to make these various parts to your own specifications.

Where economy is a factor we can supply panels of Vulcanized Fibre Veneer made of hard grey fibre veneered, both sides, with a waterproof, phenolic condensation product. This material has a hard, smooth, jet-black surface, machines and engraves readily and will give excellent service where very high voltages at radio frequencies are not involved.

Shielded plates (patent applied for) are made with a concealed wire shield. This shield, when properly grounded, effectively neutralizes all howl and detuning effects caused by body capacities.

Send to-day for our Radio Panel Guide

Are you an enthusiast? This Guide describes our panels in detail—gives tests—and tells just how much the panel you want will cost.

Are you a Radio Dealer? Let us tell you how easily and profitably Celoron Radio Panel Service enables you to supply your customers with panels machined and engraved to their specifications. Write to-day for our Dealer's Proposition covering panels, dials, knobs and tubes.



CONDENSITE
CELORON

Diamond State Fibre Company

Bridgeport (near Philadelphia) Pa.

BRANCH FACTORY AND WAREHOUSE, CHICAGO

Offices in principal cities

In Canada: Diamond State Fibre Co. of Canada, Ltd., Toronto.

of energy is accomplished with an efficiency of not more than $\frac{1}{700}$, owing to hysteresis and eddy currents. (These scientific terms apply to magnetic losses which occur in all electromagnetic devices). Telephone receivers used for radio purposes give an audible signal with a minimum current of from 1 to 10 thousandths of a micro-ampere at a frequency of 1,000 cycles per second. The relative sensitiveness of different types of telephone receivers is characterized practically by their ohmic resistance. In practice, however, it is not always advantageous to employ receivers of high resistance, according to this authority, since extreme sensitiveness is a defect if selectivity with signals of varying intensity and notes is desired. Efficiency in reception depends in part on the employment of telephones of resistance appropriate to the detector used. For the same amount of received energy, a crystal de-

detector (average resistance 8,000 ohms) produces in the receiver a current of low intensity at a high voltage, while a magnetic detector (resistance 140 ohms) gives, on the contrary, a current of low voltage and of high intensity. In the case of high-resistance receivers, the best results will be obtained when working with crystal detectors or vacuum tubes, and with low-resistance receivers, the best results will be obtained with magnetic detectors and other low-resistance detectors. (The magnetic detector, which makes use of a soft iron core wire band, passing continuously through the magnetic field of a pair of permanent magnets and a winding connected with the telephone receivers, was employed several years ago in radio communication, prior to the introduction of crystal detectors and vacuum tubes which are simpler, yet more sensitive to signals.)

The Grid

QUESTIONS AND ANSWERS

The Grid is a Question and Answer Department maintained especially for the radio amateurs. Full answers will be given wherever possible. In answering questions, those of a like nature will be grouped together and answered by one article. Every effort will be made to keep the answers simple and direct, yet fully self-explanatory. Questions should be addressed to Editor, "The Grid," Radio Broadcast, Garden City, N. Y. The letter containing the questions should have the full name and address of the writer and also his station call letter, if he has one. Names, however, will not be published.

VARIABLE CONDENSERS

I have a 43-plate variable condenser and a receiver with two variometers. May the condenser be employed to advantage with this receiver?

—M.M., Detroit, Mich.

A 43-PLATE condenser of the commercial type ordinarily approaches .001 mfd capacity. A capacity as high as this is rather difficult to employ in short wave work, although it is very satisfactory for use in conjunction with long wave reception. However, where a large antenna is employed for short wave reception, a condenser of this character connected between the antenna and tuner or the tuner and the ground reduces the natural period of this circuit and permits the use of more turns in the antenna circuit. The increased number of turns in this circuit is frequently accompanied by a greater transfer of energy to the secondary tuning circuit resulting in louder signals.

A 43-plate condenser causes a material change in the wave lengths for a very slight change in the position of its plates and is, therefore, rather critical. As a general rule

any well-made variable condenser in the antenna circuit permits more selective tuning and better all-around results, though it is sometimes accompanied by a slight reduction in signal strength where a small antenna is used.

Is it possible to secure better results by using a variable grid condenser and what size should such a condenser be? Should a grid leak be employed with it? If so, what resistance should it be?

—D.B., Trenton, N. J.

AS A general rule variable units in all radio circuits aid in obtaining better results because they afford a ready means for bringing the circuits into the most suitable balance; that is, for a given frequency or wave length best results may be obtained by employing a certain amount of inductance and capacity. Changing the inductance or the capacity may result in bringing the circuit in tune with a given wave length but its power of selection as well as its energy-absorbing values are found to exist in the greatest degree when a suitable balance of inductance and capacity is found. A variable grid condenser helps to make this balance possible in the grid circuit and it offers a convenient method for making up the differences found to exist in

Radio brings it MAGNAVOX tells it



TO make your receiving set really complete, equip it with a Magnavox Radio—the Reproducer Supreme.

The electrodynamic principle involved in its construction, makes the Magnavox Radio a most efficient converter of electrical energy into sound waves.

With either type Magnavox Radio the hook-up is as simple as connecting the ordinary head receivers.

R-2—Magnavox Radio with 18-inch horn, for those who wish the utmost in amplifying power: for large audiences, dance halls, etc.

R-3—Magnavox Radio with 14-inch horn, ideal for homes, amateur stations, offices, etc.

Model C—Magnavox Power Amplifier insures largest possible power input for Magnavox Radio.

Any radio dealer will demonstrate the Magnavox for you.

The Magnavox Co.
Oakland, California
N. Y. Office: 370 Seventh Ave.

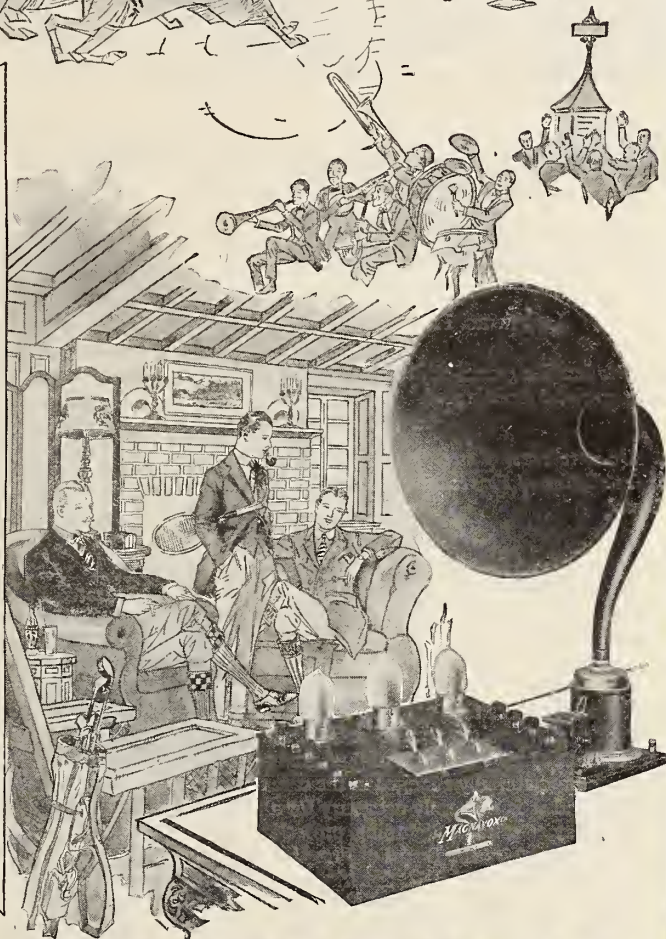

MAGNAVOX

Radio

The Reproducer Supreme

vacuum tubes. In the same circuit one vacuum tube may require a very small grid capacity for its best operation while another tube may require comparatively more capacity. With a variable grid condenser the most suitable capacity may be had instantly. The same thing applies to a given circuit and a given tube receiving from several stations. A variable grid condenser aids materially in building up desired signals and eliminating undesired signals. A variable grid condenser should be of comparatively low capacity; that is, it should have a maximum of approximately .0006 mfd.

It is rather difficult to determine without actual experiment whether or not a grid leak is required in a given circuit or with a given tube. Vacuum tubes vary greatly and the function of the grid leak is to keep a constant potential on the grid of the vacuum tube in order that the electronic flow may be thoroughly controlled. Some vacuum tubes operate most satisfactorily without a grid leak. It is also significant that a tube of this character employed in one circuit would give results without the grid leak, while in another circuit, the grid leak would have to be used in order to obtain the best results. The resistance value of a grid leak is also a matter of experiment. As a general rule a grid leak resistance of 2 megohms will suffice. It is generally a safe practice to employ a grid condenser and grid leak unit of the character now on the market having a capacity of .0005 mfd and a resistance of 2 megohms.

LIGHTNING PROTECTION

Do I need to install a ground switch for lightning protection? I am using a crystal receiving set.

—N. M., Topeka, Kansas.

What size wire must I use for grounding my receiver? Does the installation of the receiving set cut off the insurance on my home?

—K. P., New York City.

My receiving set is on the tenth floor of a city apartment. Is it necessary for me to run a heavy copper wire to an outside ground connection keeping the wire seven inches from the building wall?

—J. D., Brooklyn, N. Y.

UNTIL a very short time ago, the National Board of Fire Underwriters required all radio stations to be fitted with a heavy current carrying ground switch. This rule has been materially changed in the case of receiving apparatus and it is now only necessary for a receiving station to employ a suitable lightning protective device which has been passed by the Board of Fire Underwriters.

According to the new Fire Underwriters' regulations recently proposed receiving sets may be grounded by any copper wire not smaller than No. 14 B & S gauge. The installation of a radio receiving set, when the provisions of the National Board of Fire Underwriters have been lived up to, should not interfere in any way with the insurance on a house. The regulations are quite easily lived up to and if you entertain any doubt as to the wiring of your receiver, it might be well to have the installation passed on by some representative of the Board. It is possible, however, that such a representative might not be informed of the recent alterations in the code of regulations and it may be necessary for you to communicate with the headquarters of the underwriters' organization. The new regulations make it unnecessary for any one installing a receiving set to employ a heavy lightning switch and heavy wire running to the

outside ground connection separated from the building by insulators several inches long. It is now merely necessary for you to employ an approved lightning protective device connected to some permanently grounded metal system in the house or apartment, by a No. 14, or larger, B & S gauge copper wire.

By a permanently grounded system is meant the steel frame of the building; the pipes of the water supply system pipes of a steam or hot heating system, but *not the gas pipes*. Where a connection is made to the grounded metal system, the copper wire should be attached by soldering or by an approved ground clamp after the building frame or piping has been thoroughly scraped with a coarse file or sandpaper.

LAMP-SOCKET ANTENNAS

There are several devices on the market for use in a lamp socket to replace the outside antenna. Will they really work or are they fakes?

—F. S., Long Branch, N. J.

THE devices you refer to have been rather thoroughly tried out and in most instances have proven almost as satisfactory as the average outdoor antenna. These devices are designed to cut out the noise in the telephone receivers which would be caused by low-frequency electric charges such as exist in electric light wires, while permitting the high-frequency radio charges to pass through; they are actually filters.

Where the electric light wires are run under ground the results obtained are not as good as where these wires are carried on poles such as is the case in the country. Devices of this character made by reputable manufacturers should give satisfaction, but it is quite possible that the demand for them will be so great that many irresponsible makers will exploit these machines shortly. This is likely to be disastrous to many receiving sets.

The device includes a condenser made in a similar manner to most other condensers where metallic plates are separated by some insulating substance such as mica, but of different capacity. Where these units are employed there is no ready means of determining which side of the lamp socket in the house is connected to the line side and which is connected to the ground side of the electric light circuit. Where a connection is made to the ground side of the lighting system, no danger exists. However, if the device is connected to the line side of the electric light circuit and for any reason the plates of the opposite sides of the condenser should come in contact with each other or the insulation between them should break down, it would be possible for a short circuit to take place, because the line wire would then be connected through the device and your receiving set to the ground. In all likelihood this would blow out the fuse in the lighting circuit but, before the fuse was blown, it is almost certain that some of the wire on your receiving set would be pretty badly burned up. For this reason care should be used in determining upon the purchase of this device, and manufacturers should subject these units to a severe test before offering them for sale, in fact, they should be passed upon by the National Board of Fire Underwriters.

RADIO AND AUDIO AMPLIFICATION

What is the difference between radio and audio frequency amplification? Can the former be used with a loud speaker?



“Stop those back fence concerts”

THE yowls of a prowling Tommy are as mere love-songs beside the ear-splitting howls of a perturbed radio set (and you'll be surprised how often one gets perturbed without the calming influence of the proper Amplifying Transformer).

Most any transformer can amplify sound, but it will also amplify the stray fields which produce howling and distortion. It takes the Acme Amplifying Transformer with its specially constructed iron core and coil to put an end to the “back=fence” concerts. Only when you add the Acme do you get the realistic tone and volume so markedly absent in the ordinary radio receiving set.

The Acme Radio Frequency Transformer greatly increases the range of any receiving set, either vacuum

tube or crystal detector type. The Acme Audio Frequency Transformer produces not only volume, but reality of tone. It is indispensable to the satisfactory operation of loud speaking devices. The combination of one or more stages of Acme Radio and Audio Frequency Transformers assures the maximum of range, of volume and of reality in tone.

The Acme Apparatus Company, pioneer radio engineers and manufacturers have perfected not only Radio and Audio Frequency Transformers as well as other receiver units and sets, but are recognized as the foremost manufacturers of Transmitting Apparatus for Amateur purposes. Sold only at the best radio stores. The Acme Apparatus Company, Cambridge, Mass., U. S. A. New York Sales Office, 1270 Broadway.

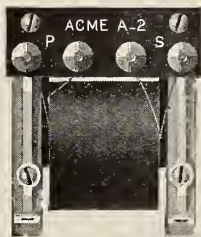

Type A-2 Acme Amplifying Transformer
Price \$5 (East of Rocky Mts.)

ACME

for amplification

Must different transformers be employed for various wave lengths?

—J.B.W., Oakland, California.

THE essential difference between radio and audio frequency amplification is this: With radio frequency, the very slight current produced in the receiving antenna system by passing waves from a transmitting system are caught and passed through amplifying devices designed to permit this current to oscillate—that is, to flow back and forth at the same frequency it passes through the ether. With audio frequency the current from the detector tube is passed through successive amplifying stages, not at the natural frequency of the signal as it passes through the ether, but at a frequency very much lower, which is within the range of audibility. In the case of radio frequency amplification, the incoming signals are amplified by means of a local source of energy before they reach the detector tube, while audio frequency amplification takes place after detection.

Detection requires a certain amount of energy for its proper functioning and it is obvious that several stages of audio frequency amplification would be valueless where the strength of the incoming signal was insufficient to produce detection. It is here that radio frequency is valuable for it builds up the infinitely weak signal to a point where proper detection may take place, and from this point on it is possible to increase the signal audibility by the audio frequency amplification method.

Radio frequency amplification alone will not operate a loud speaker over any material distance. In fact, the general rule may be laid down that loud speakers may only be employed where at least one or two stages of audio frequency amplification are employed. Radio frequency amplification has not been very popular in amateur circles until recently for the reason that different transformers were required for the various wave length ranges and the range of any one transformer usually covered but a few hundred meters. This difficulty has been materially reduced by the introduction of a new radio frequency transformer designed to function satisfactorily over a particularly broad range of wave lengths. This broad range is made possible by taking advantage of the balancing effect

found to exist when an iron core radio frequency transformer is employed. A transformer of this character having a wave length range of 200-5,000 meters may now be had and another transformer having a range of 5,000-25,000 may also be procured. For all practical purposes, the wave length ranges covered by these two transformers permit the operator to receive on practically all of the wave lengths now in use.

A very significant fact regarding radio frequency amplifiers is that the results obtained by a single stage of radio frequency amplification and a vacuum tube detector non-regenerative circuit are approximately the same as those obtained by a vacuum tube detector alone, employed in a regenerative circuit of proper design.

Will you please furnish me with a suitable circuit diagram for employing radio frequency amplification with a regenerative receiver and two steps of audio frequency amplification?

—O. H., Brooklyn, N. Y.

THE accompanying diagram illustrates a suitable method for employing radio frequency with a regenerative receiver and two stages of audio frequency amplification. As will be observed, a tuning coil and variable condenser are connected in series with the aerial and ground. An energy-absorbing circuit is thus formed, which feeds into the first radio-frequency amplifier tube. The second tube also acts as a radio-frequency amplifier and its transformer is of the tuned variety made by shunting a variable condenser across what would ordinarily be the antenna and ground connections of a vario-coupler or loose coupler, for the primary and the usual secondary circuit for the tuned secondary.

Two potentiometers are used in this circuit; one to supply the correct plate potential for the detector tube and the other as a stabilizer for the radio-frequency amplifier tube. The transformer between the first and second stages of radio frequency is of the laminated iron core type having a wavelength range of 200 to 5,000 meters. When audio frequency is not desired, it is merely necessary to connect the telephones between the variometer in the plate circuit and the negative side of the "A" battery.

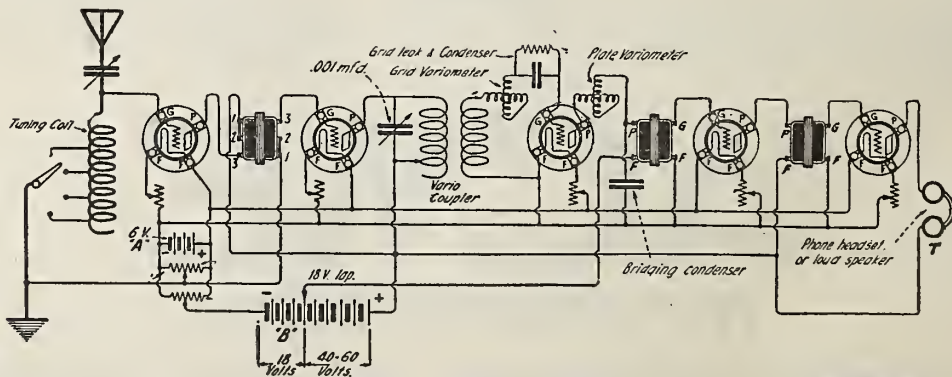

SEPTEMBER, 1922

PRICE 25 CENTS

RADIO BROADCAST

RADIO FOR EVERY PLACE AND PURPOSE

The
United Fruit Company's
Radio System

Developments in
High Power
Radio

Shall
We Have Music
or Noise?

Armstrong's
Super-Regenerative
Circuit



DOUBLEDAY, PAGE & COMPANY, Garden City, N. Y.



"All the World and His Wife"—



to say nothing of the children—are enthralled by the magic spell of Radio. And as Radio takes its place among the essential conveniences and accepted methods of entertainment of modern life, the demand for apparatus of high efficiency and dependability increases. This demand is most satisfactorily met by the



Westinghouse Type RC Receiver



As national distributors of the products of leading manufacturers of radio equipment, we are at all times in position to make immediate quantity deliveries on this superior and popular instrument, as well as



Westinghouse Aeriola Grand Westinghouse Aeriola Sr. Westinghouse Aeriola Jr.



An American sugar planter in Tuintiqua, Cuba, gets perfect reception on Westinghouse RC from Newark, Pittsburg, and Chicago, 1400 miles away

Write us to-day for descriptive pamphlets and full information concerning radio equipment of every kind.



20th CENTURY RADIO CORPORATION

National Distributors



Executive Offices, 565 Fifth Avenue, New York, N. Y.

Straus Building, Suite 710

Telephone Murray Hill 6548



Radio Broadcast

ROY MASON, EDITOR

ARTHUR H. LYNCH, TECHNICAL EDITOR



CONTENTS FOR SEPTEMBER, 1922

<i>Edwin H. Armstrong</i> - - - - -	<i>Frontispiece</i>
THE MARCH OF RADIO - - - - -	367
THE HISTORY OF THE DEVELOPMENT OF THE UNITED FRUIT COMPANY'S RADIO TELEGRAPH SYSTEM - - - - -	ROY MASON 377
DEVELOPMENTS IN HIGH POWER RADIO COMMANDER STANFORD C. HOOPER, U. S. N.	399
RADIO IN THE FOREST SERVICE - - - - -	DONALD WILHELM 407
CHARGING THE "B" STORAGE BATTERY - - - - -	G. Y. ALLEN 413
KING ELECTRON - - - - -	R. H. RANGER 421
ARMSTRONG'S SUPER-REGENERATIVE CIRCUIT - - - - -	PAUL F. GODLEY 426
RADIO'S GREAT FUTURE - - - - -	HERBERT C. HOOVER 433
SHALL WE HAVE MUSIC OR NOISE? - - - - -	PERCE B. COLLISON 434
ADDITIONAL BROADCASTING STATIONS IN THE UNITED STATES - - -	438
BOOKS ABOUT RADIO - - - - -	JOHN V. L. HOGAN 439
PROGRESS OF RADIO IN FOREIGN LANDS - - - - -	442
U. S. WEATHER REPORTS FOR SHIPS WITHOUT RADIO - - -	S. R. WINTERS 446
THE GRID—QUESTIONS AND ANSWERS - - - - -	448
WHAT RADIO IS DOING FOR ME - - - - -	A. J. DeLONG 452

Copyright, 1922, by Doubleday, Page & Co. All rights reserved
TERMS: \$3.00 a year; single copies 25 cents

F. N. DOUBLEDAY, Pres.

RUSSELL DOUBLEDAY, Sec'y.

ARTHUR W. PAGE, Vice-Pres.

S. A. EVERITT, Treas.

NELSON DOUBLEDAY, Vice-Pres.

JOHN J. HESSIAN, Asst. Treas.

DOUBLEDAY, PAGE & CO.

THE WORLD'S WORK COUNTRY LIFE THE GARDEN MAGAZINE SHORT STORIES EDUCATIONAL REVIEW

CHICAGO: People's Gas Bldg.

GARDEN CITY, N. Y.

NEW YORK: 120 W. 32nd Street

BOSTON: Tremont Bldg.

LOS ANGELES: Van Nuys Bldg.



EDWIN H. ARMSTRONG
Inventor of the regenerative and super-regenerative circuits

RADIO BROADCAST

Vol. 1 No. 5



September, 1922

The March of Radio

MARCONI'S VISIT

ON MANY other occasions we have unmistakably shown our appreciation of the inventor of radio, but never before have he and his work been of such widespread interest. Technical societies have, in the past, showered upon him tokens of their appreciation, universities have bestowed honorary degrees upon him in acknowledgement of his scientific achievements, but on this occasion a million radio enthusiasts from all over the country were directly interested in his comings and goings.

The outcome of his pioneer wireless work was of everyday interest to them. Tuning—static—wavelength—interference—words which on Marconi's previous visits had been meaningless terms to all but a few of the technical men, are terms which we use as glibly as we do spark plug and carbureter.

Probably no other inventor has seen the results of his early endeavors so rapidly become a part of the life of the people, or has seen himself so suddenly become a public figure. Of course a Babe Ruth can climb to popularity with even greater speed than has Marconi, but the reason for the popularity is hardly on the same plane with that which accounts for the reception Marconi has just received. The education which comes from seeing the ball fly out of bounds into the bleachers and that which one acquires in investigating and studying the action of a radio receiving set, are

hardly to be compared. Marconi's contribution to our lives is of lasting and growing importance; his work has probably stimulated popular interest in science more than the efforts of a hundred teachers of Physics and Electricity.

If we inquire as to just what specific contribution to the radio art of to-day is responsible for the bestowal of the much-coveted medals of the Institute of Radio Engineers and the American Institute of Electrical Engineers, which Marconi has just received, the answer is not apparent. His improved coherer and magnetic detector have long been relegated to the museum, and his spark transmitting sets will soon rapidly disappear. It seems, after reading over his early experiments and efforts, that the most important of his contributions, which still dominates the radio art, is the grounded, vertical antenna.

Hertz, of course, had not found it necessary to ground either his transmitting sets or his receiving loops for getting his wireless signals; because of the short distance between his receiving and transmitting apparatus, the scheme worked perfectly well with ungrounded apparatus. Marconi, however, soon found out that to communicate over greater distances, a high vertical antenna was all important, and that, further, its transmitting and receiving action were both much improved if the antenna was suitably connected to moist earth at its lower end. This grounding of the antenna

seems to be the one important contribution which still persists. It was not many years ago, at a meeting of the A.I.E.E. that Professor Pupin, in reviewing the work of Marconi, said that the line of demarcation between the work of Hertz and that of Marconi was that fixed by the grounding of the antenna—that Hertz's electric waves were free to spread out in space untrammelled by connection to the earth, whereas Marconi waves had their "feet" fastened to the earth. This fastening of the feet of the waves to the earth's surface was what resulted from the grounding of the antenna.

So it seems that the grounded antenna may be regarded as Marconi's principal contribution to the art as we know it to-day. How long the grounding of the antenna will be regarded as important is problematical—many of the best stations, when using short waves, do not ground their antennas at all. Instead of connecting the antenna to a water pipe, or to iron stakes driven into moist earth, as is the custom, the "ground" wire of the set is connected to a network of wires suspended several feet above the earth, and carefully insulated therefrom. In many cases it is found that the use of this network, or counterpoise, as it is called, makes the antenna much more effective than if it were actually grounded. The large station at Sayville, which, during the early part of the war, was the principal connecting link between Germany and America, does not ground its antenna, but uses such a counterpoise, the network of wires being many acres in extent. For receiving antennas we are inclining more and more to the coil aerial; practically the same thing as used by Hertz.

In the experiments which Marconi showed to his audience on one occasion he used a simple Hertzian oscillator for a transmitter and a similar device for a receiving antenna. To be sure, they were excited by waves generated in a modern vacuum tube instead of by the sparks of Hertz, but in so far as the structure of the sending and receiving aerials was concerned they were Hertzian rather than Marconian. For this backsliding from grounded Marconi waves to the ungrounded waves of Hertz Professor Pupin facetiously chided Marconi; he (Pupin) had previously shown that Marconi had made tremendous progress over the work of Hertz by using the grounded antenna, and now Marconi had deserted his child, the grounded antenna, and gone to tread in the footsteps of Hertz.

But even though all of Marconi's specific contributions to radio are supplanted by something better (which must necessarily soon be the case with such a rapidly advancing art) Marconi will still be the creator of radio; its apparatus may be much changed in appearance and action from that which he first used to span the Atlantic—others may have appeared in the radio field who understand the action of modern apparatus better than does Marconi—apparatus and methods may be worked out which are millions of times as sensitive as anything Marconi was able to devise—in spite of all this Marconi is the one to whom all credit is due for the present status of Radio. He it was who conceived the idea of radio communication—he it was whose judgment and perseverance accounted for the initial successes which made the future of radio so promising and certain, and it is for these qualities and accomplishments that we now do him honor, giving him our medals and crowding his meeting places to overflowing.

REFLECTION AND ABSORPTION OF RADIO WAVES

ALTHOUGH the fact may have been stated many times, it is apparently rather difficult for one to comprehend that radio waves and light waves are essentially the same in that they are governed by exactly the same laws. On the occasion of his talk before the Institute of Radio Engineers, Marconi showed an experiment on the reflection of waves and, from the admiration and applause which the success of the demonstration elicited, it was evident that even this audience, largely composed of technically trained men, had not yet really accepted as true the fact stated above, that light waves and radio waves act alike.

In the demonstration there was used as a transmitting antenna a simple vertical copper rod about 18 inches long, excited by a vacuum tube at the proper frequency so that radio waves about one meter long were sent off; possibly one watt of power was radiated. Suspended from a wooden framework built about the transmitting antenna, were other copper rods, hung vertically, of exactly the same length as the first, these other rods being completely insulated from everything. These additional rods were arranged about the antenna in the form of a parabola; a view of these additional rods from straight above would have shown them arranged in a curved line of the same form as the cross-section of an

AN IMPORTANT ADVANCE
IN RADIO TRANSMISSION

Drs. W. R. Whitney and Irving Langmuir showing Mr. Marconi their new vacuum tube which it is thought will revolutionize long distance radio communication, eventually supplanting the high frequency alternators

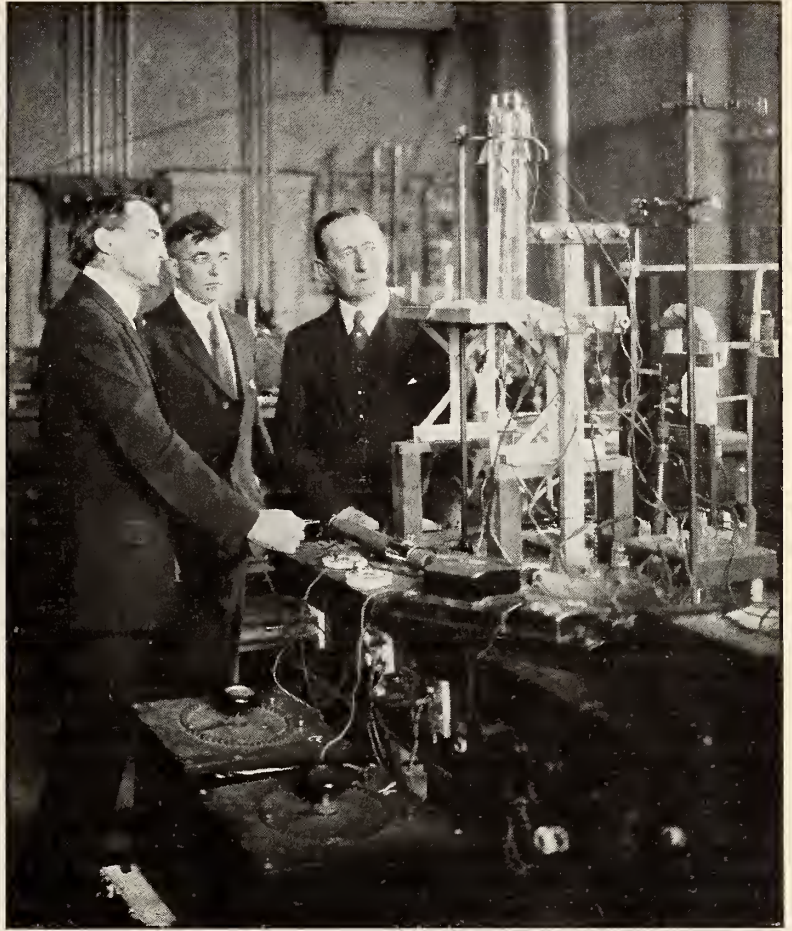

automobile headlight mirror, the transmitting antenna having the same position with respect to the curved line of the others as the filament of the headlight has to the curve of the headlight mirror. The transmitting antenna was at the focus of the parabolic curve formed by the other rods.

The action of the parabolic headlight mirror is to send all the electromagnetic light rays, coming from the filament, straight forward, in an approximately parallel beam. In Marconi's experiment the electromagnetic radio waves, coming from the antenna, were similarly reflected and sent forward from the mirror-like arrangement in a nearly parallel beam, and, by rotating the mirror about its axis, the beam could be sent in any direction desired. That the beam of radio waves was thus rotated was readily shown by having a stationary receiving antenna (another copper rod of the same length as the others) suitably connected to an amplifier and loud speaking horn. As

the transmitting mirror was rotated, the beam of radio waves could be made to impinge or not on the receiving antenna, as evidenced by the loud speaker.

It undoubtedly occurred to many of the observers that this scheme should be used in ordinary radio communication, but it is to be remembered that a mirror, to be effective in reflecting light, must have dimensions several wavelengths long. To get good reflection of light for example, the mirror must be not less than about one-hundredth of an inch square. The same considerations hold for the reflection of radio waves; the mirror must be commensurate in size with the wave length used. Marconi's mirror to reflect waves a meter long, was about a meter on a side and of course gave very poor reflection compared to the straight line reflection of light given by the ordinary mirror because it was so small compared to the radio wavelength. Evidently to construct a mirror to reflect an ordinary

360-meter wave would be prohibitively difficult.

The shielding effect of a single wire, of the same length as the transmitting and receiving antennas (so as to be in tune with them), was shown remarkably well by interposing such a wire between the transmitter and receiver, rather close to the receiver. This extra antenna, tuned to the oncoming waves, is set into electrical vibration, and will itself radiate so that in the neighborhood of the extra antenna the actual radiation will be the summation effect of the original waves and those sent out by the extra antenna.

An accurate analysis shows that there will result in the space between the extra antenna and the original transmitter more radiated energy than would exist if the extra antenna were not there; the extra energy we say is due to the reflected energy from the extra antenna. Behind this antenna, however, that is, in the space between the extra antenna and the receiver, the summation of radiated energy is less than if the extra antenna had not been put there, in fact close to the extra antenna the radiation is nearly zero; we say there is a radio shadow in this region. The intensity of this radio shadow, *i. e.* how nearly the actual radiation is reduced to zero, decreases at greater distances, just the same as the shadow thrown by a tree trunk becomes less and less definite with increasing distance from the tree.

The intensity of the radio shadow also depends upon how well the extra antenna is tuned to the oncoming waves and how low its resistance is; Marconi showed, in his experiments, that if the extra antenna was 16 inches long instead of 18 inches, it threw scarcely any shadow at all. It is to be noticed that a low-resistance, tuned antenna throws a definite shadow, because it reflects the oncoming wave, and the lower the resistance and better the tuning, the better the reflection. If a high resistance antenna is interposed between a transmitter and receiver, the shadow would be noticed, as before. However there would be but little reflected energy; the extra antenna absorbs the oncoming radio wave, thus producing the shadow, but instead of reflecting the original beam, it uses it up in producing heat. This absorption effect is the one noticed by dwellers in steel structure buildings who try to receive radio signals from a broadcast station with steel buildings intervening. A vertical antenna run up the side of a steel frame

building will give fair reception if not placed too close to the building and if it is on that side of the building facing in the direction from which the signals are coming. If the antenna is located on the opposite side of the building almost nothing will be received; in this case the receiving antenna is in the radio shadow of the building. Although the steel frame of the building is not tuned to the signal wave, it has a sufficiently high resistance to absorb nearly completely the energy of the signal wave.

These ideas of reflection and absorption deserve the attention of every one interested in radio; they frequently account for the exceptionally good reception obtained in one locality and exceptionally poor reception at another.

It is not necessary to have metallic conductors to bring about reflection and absorption; any partially conducting medium will accomplish the same thing to an extent depending upon how good a conductor the medium is. The rarified air and partially conducting clouds in the upper regions of our atmosphere are just such conducting bodies, and they bring about reflection and bending of the radio waves to a remarkable degree. Just as the peculiar formation of reflecting surfaces in "whispering galleries" permit a whispered sound to be heard at a point hundreds of feet distant, so the reflection of radio waves from clouds, etc. occasionally permit the normally infinitesimal power from a distant low-powered transmitting station to focus and concentrate at some points of the earth's surface and so permit the exceptionally long distance records for communication to be established. These effects, it must be remembered, are generally rare in their occurrence; it seems however, from reliable data, that in certain localities this concentrating effect occurs more or less consistently. It seems likely that the structure of the earth's crust may very likely bring about bending and focusing of radio waves; certain stations consistently report satisfactory communication with a distant station while others, much closer, are able to communicate only occasionally and this in spite of the fact that the receiving apparatus is equally good at all these receiving stations.

It is to be noted that these ideas of reflection and absorption shown by Marconi are by no means original with him; the wonderfully keen mind of the real pioneer, Hertz, saw all these phenomena with remarkable clarity. In his book, "Electric Waves," prin-



THE INTEREST IN RADIO

May be judged by this photograph, taken after a meeting of The Radio Club of America, at which E. H. Armstrong revealed the secrets of his super-regenerative circuit

cipally a compilation of the results of his experiments, there appears a paper entitled "On Electric Radiation." This paper was published in 1888 and in it are given all the effects shown by Marconi and others. For example, besides the reflection effects with mirrors, it is shown how a large prism of pitch enabled Hertz to actually bend his narrow beam of radio waves, just as a glass prism bends light waves. Those whose interest in radio has carried them past the "turn the knob and listen" stage will find Hertz's reports of his experiments interesting and entertaining reading.

ARMSTRONG'S SUPER-REGENERATION

AFTER waiting eagerly for some months for the disclosure of the much heralded discovery of Armstrong by which he made two tubes do the work ordinarily accomplished by eight or ten, the radio public in the neighborhood of New York had two opportunities recently of hearing the circuits explained and demonstrated by the inventor himself. He first presented this new scheme before the Institute of Radio Engineers; in the proceedings of that body the first reliable, printed analysis of the scheme will soon appear. The auditorium was filled to overflowing at this session, but the jam at the meeting of the Radio Club of

America, at which he spoke shortly after, was much worse. Although held in one of the largest assembly rooms of Columbia University, there were hundreds who could not fight their way to within hearing distance of the speaker. The enthusiasm displayed at these meetings shows that the public interest in radio has by no means begun to wane, as some jobbers in radio supplies seem to think.

From the experimental demonstrations, it is evident that the amplification of signals is surely as much as the inventor claims for it; the results were simply astounding to those who have done much work with triodes, and so are fairly familiar with their ordinary possibilities. In both cases the demonstration was given in rooms inside buildings with heavy steel frames and covered with grounded copper roofs. One could almost call such places Faraday cages—electric "holes" where radio waves do not penetrate. In both cases Armstrong was able, with two tubes (of considerably more power than the ordinary tube, however) to receive signals from a broadcast station, about fifteen miles distant, on a two-foot loop, and to receive them sufficiently loud to be heard throughout the auditorium. Such amplification almost passes one's comprehension.

On neither occasion was the quality of re-

ceived speech as good as we get by the more prosaic schemes of amplification; this, however, may have nothing to do with the operation of the circuits themselves, but may have been due to the action of the loud speaking horn used. Judgment as to quality of received speech (by which any scheme of amplification must stand or fall) must be reserved until more people have tried it out with various types of loud speakers. The inventor himself says the quality is as good as can be obtained by any other scheme of amplification.

By the time this is in print there will probably be many of these super-regenerative sets in use and we shall know whether the scheme is as good as it looks—whether it is a scheme the average skilled amateur can successfully manipulate. Of course on this point we recollect that many said the ordinary regenerative scheme was too ticklish a circuit for the average amateur to handle, but development seems to have shown otherwise. Undoubtedly, this new circuit of Armstrong's requires more manipulative skill, to get much out of it, than does the ordinary regenerative circuit, but perhaps it will not be beyond our ability.

The inventor estimates that his new scheme gives amplification thousands of times as great as his ordinary regenerative connection; as an instance of what it may be expected to do, he states that at his home, a three-tube combination arranged for the super-regenerative action, working into a loud speaking horn, gave a signal on a three-foot loop loud enough to be heard 1,000 feet away, the signal coming from a 500-watt broadcast station 25 miles away.

The action of the new arrangement can be understood only by one familiar with the ordinary regenerative circuit. The simplest form of the regenerative circuit uses a tickler coil in the plate circuit, which is coupled to the grid circuit. As the tickler coupling is increased, the grid and antenna circuits being continually kept tuned, the signal strength increases gradually at first and then very rapidly. Just as it seems as though the amplification is going to be extremely large the tube starts to oscillate and the expected increase in signal is never reached.

Evidently (at least, evidently to one familiar with the action of the circuit) if the tickler coupling could be increased past the critical value at which oscillations start, and still oscillations be prevented, the anticipated amplification might be obtained. This, Armstrong

himself had frequently said was quite impossible, but then he found out he was mistaken. It was possible, and he found out how to do it in a most ingenious way.

It takes time for a tube to set itself into the oscillating state, an appreciable fraction of a second. If the tickler coil coupling is suddenly increased, very large amplification can be obtained while the tube is getting itself into the oscillatory state, but the duration of this condition is extremely short, perhaps one ten-thousandth of a second; this time depends upon the relative values of inductance and capacity used in tuning the circuit. What Armstrong's new idea amounts to is this—by excessive tickler coupling he makes the tube give excessive amplification as it is getting itself into the oscillating state, and then, before the tube actually reaches its steady oscillating state he has a second circuit act on the tube to stop completely the oscillations which have started. In a brief fraction of a second this second circuit stops its action and the first tube again gives excessive amplification as it again endeavors to get itself into the oscillating state.

If these periods of excessive amplification follow one another with great rapidity, the signal is given excessive amplification in pulses, with the same rapidity; if the frequency of these pulses of excessive signal is above audible range, the ear interprets the received signal as a continuous one. The ingenuity of the scheme is now apparent; let the tube amplify while it is in a changing state, in which super-amplification can be obtained, and then bring it back again and make it start over again to go through this critical condition repeatedly. And make it go through this critical condition with sufficiently high frequency so that the ear interprets the signal as a continuous one, it actually being a series of pulses. The scheme involves ear deception in the same way that the moving-picture, by changing with sufficient rapidity, makes the eye perceive a continuous impression.

Although by a very delicate arrangement of doubly tuned circuits it is possible to carry out the scheme with only one tube, the scheme generally requires two tubes, and the inventor recommends the use of three tubes by those attempting to use the idea. The three-tube arrangement is better than the two in that it is possible to make the various required adjustments independent of one another.

A 200 K.W. HIGH-FREQUENCY ALTERNATOR

Of the type used for trans-oceanic communication. Recent developments indicate that these huge machines may be supplanted by vacuum tubes

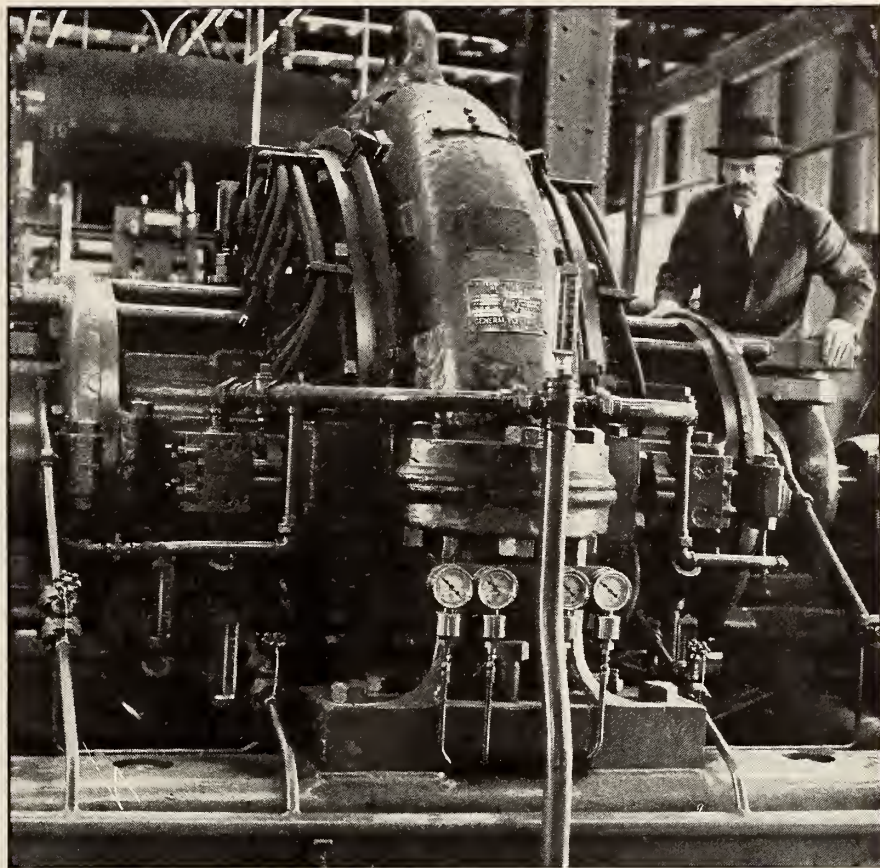

As it is essentially an improvement on his older scheme, the new idea is commercially useful only to those who control his earlier patent; of course this phase of the subject doesn't interest the real amateur as he "builds his own" anyway and so is not bothered by patents. For the benefit of these enthusiasts Armstrong, in his last talk, gave the complete circuit arrangement for his new scheme, giving the proper values of coils, condensers, resistances, etc. which he regards as most suitable for getting the best results.

One of our contemporaries recently gave out the statement that the use of coil aerials "virtually eliminates static." If this were so (which it isn't) Armstrong's super-regenerator brings static back again; although he used coil aerials in his demonstrations, the static disturbance was frequently much stronger than the voice, making it unintelligible part of the time. The coil aerial by no means eliminates static; it should normally increase the ratio of signal strength to static over that obtained with the ordinary antenna, but it is not im-

possible that some of the sets using excessive amplification offset this advantage by amplifying static more than they do the signal.

RADIO CURRENT GENERATORS

IN A radio transmitting set the electrons in the conductors must be made to oscillate back and forth with inconceivable rapidity from 20,000 times per second to several million, depending upon the wavelength it is desired to radiate.

In the early days of wireless, the only feasible scheme for bringing this about was to charge a condenser to a high voltage and let it discharge through a spark gap and inductance; under such conditions the discharge is oscillatory. Such high-frequency currents rapidly die away, as the original energy of the condenser is used up in the form of heat and radiation.

It was early realized that if the high-frequency currents could be maintained of constant amplitude as long as the sending key was held down, the power radiated from a given antenna could be greatly increased and the

receiving apparatus could be made much more sensitive and more free from interference. So we have the development of Dudell's singing arc. This was improved sufficiently by Poulsen and Pederson so that it was for a time the best type of high-frequency generator for large transmitting stations—in fact it is a question even to-day as to whether or not it isn't the best generator for the largest stations. Our large naval stations, and the large station in France which our engineers constructed during the war, use Poulsen arc generators.

Naturally an engineer wants to use a rotating machine for a generator, rather than such a device as an arc, so we have to-day the wonderfully designed, and wonderfully built machines which are the outcome of the work of Fessenden, Alexanderson, Goldschmidt, and Latour. In these revolving generators, electrical and mechanical design have been carried to the limit. Iron of the best electrical and magnetic properties, in sheets about one-thousandth of an inch thick, finely stranded wires for the conductors, best dielectrics for insulation to keep losses low, air gaps between stationary and revolving parts dangerously small, speeds on the edge of the rotating members which approach the speed of a cannon ball—these are a few of the special features involved in the construction of a high frequency alternator.

In one case, due to the expansion of the parts of the machine as it warmed up in operation, the air gap, which was very small to begin with, disappeared altogether and the stationary and moving parts came together, resulting in the complete wreckage of the machine! On the other hand, some of these high-frequency alternators have given satisfactory service for years, apparently requiring but little more attention than the normal generator for low frequency currents.

All of these high-frequency generators have rather low efficiency; the Poulsen arc delivers to the antenna, as high frequency power, less than one half of the power supplied to it by the continuous current machine from which it draws its energy; the rotating machines are better than this, but even they have excessive losses, except at the very lowest radio frequencies.

To take advantage of one of the most important features of continuous-wave radio it is essential that the frequency of current supplied to the antenna must be exceptionally constant; this means that the speed of the

rotating machines must be held constant to a degree undreamt of in ordinary engineering work. The speed must not vary more than about one hundredth of one per cent. even when full load is suddenly applied or taken off. Most ingenious and intricate schemes have been devised which do hold the speed constant to this degree.

During the last ten years the size of the electron tube, or triode, designed for the generation of high-frequency power has been gradually increased until to-day it seems to be steadily advancing into the field at present held by the Poulsen arc and the high-frequency alternators. In a broadcast lecture on the triode, a few months ago, it was predicted that before the last Alexanderson alternator was installed in the great Radio Central building on Long Island, the triode would have advanced to such a stage that it would be advisable to take out the generators and put in tubes in their place.

We remember that only four years ago Alexanderson, the designer of the 200-KW machines used in this station, conceded that for one KW of high frequency power, the tube was a potential competitor of the alternator; to-day his company presents Marconi with 20-KW tubes and we have reliable reports that 100-KW tubes are well along the stages of development and that much greater ones are being planned.

Of course, in comparing the size and cost of the triode and the Alexanderson alternator, it must be remembered that a high-voltage, continuous-current machine is required to furnish power to the tube and that the present cost of upkeep on tubes is rather high. The filaments of triodes burn out after a life very short compared to the life of an alternator, and the present cost of replacement is high. However there is no reason why the tubes should not last much longer than they now do. The high electron current should be emitted from a heavy tungsten target instead of from the thin filament, which by its evaporation, causes the tube to fail. The heavy target, heated by electron bombardment from a comparatively cool filament, would last years without appreciably evaporating. With this, and with the water cooling which is required in the larger tubes, and better knowledge regarding the making of air-tight joints between metals and such insulators as silica or glass, the possible size of triodes seems to be unlimited.

With high voltage supplied to the plate cir-

cuit, the tube may have an efficiency well over 90 per cent. and as the high-voltage generator may have an equal efficiency, the triode may deliver to the antenna over 80 per cent. of the energy supplied to the set.

The one feature of the triode oscillator which makes it so much superior to a machine is the constancy of the frequency it may be made to generate, and the consequent very fine adjustment it is possible to carry out at the receiving station amplifiers. After a triode has been operating some time, so that its parts have reached a fairly constant temperature, the frequency may remain, for long periods of time, constant to within one-thousandth of one per cent. Besides this constancy of frequency to recommend it, another feature which makes it so flexible compared to the generators is the ease with which its frequency may be changed if desired, and also the ease with which its output can be controlled, by means of the grid potential.

CHURCH SERVICE BY RADIO

WE HAD outlined in our last number a typical radio installation in a Southern church, and it was evident from the story that the broadcasting of church services might well be one of the legitimate fields in which radio may be expected to expand. Now we have a report from Atlanta, Ga. that there has been launched by the Wesley Memorial Church a campaign to devote \$1,000,000 of the Methodist Church's educational fund for the establishment of radio receiving sets in the several thousand small churches in the South where services are held only when the itinerant pastor finds time to pay a visit.

In these small churches, where a regular pastor could not be supported, it seems as though the radio service from the metropolitan church with its inspiring music, the like of which is never available to the country church congregations, will serve well as an adjunct to the itinerant preacher. It will never displace him—because religion is essentially personal. It would be difficult for us to conceive of our early religious impressions having come from a Magnavox, or a Western Electric horn, wouldn't it? But then, times change.

RADIO AT THE POLE

THE day has gone when explorers set out on a voyage of discovery and were lost to civilization until their return, or perhaps forever, or when, on their return, they had to

rely on speech and notes to describe their adventures. Amundsen, starting on a North Polar expedition which he anticipates will take four years to carry out, expects to be in constant communication with the world he has left behind. He will have with him moving-picture machines, aeroplanes, and radio apparatus for both transmitting and receiving. What data is available on the transmission of radio waves over frozen wastes indicates that there is a very much greater absorption there than exists in the temperate zones. That radio can however travel through the polar regions is evidenced by the recent announcements of Marconi that many times radio signals have been observed at the antipodes after having travelled completely over one polar region or the other. Amundsen's wireless reception in the frozen north will add to our knowledge of transmission, besides being of immediate importance to him in keeping touch with his base.

RADIO VS CABLES

WHEN the wireless telegraph was first shown practicable it was frequently stated that the wire telegraph was doomed—that it could not possibly compete commercially with a system which did not need to carry the overhead charges necessitated by the expensive wire system and right of way. Evidently radio has not encroached upon the territory of the ordinary telegraph at all, but, on the contrary, has brought it additional business.

The competition between land wires and radio really never could be regarded as serious by one understanding the possibilities of the two methods. But in the field of trans-oceanic communication it might well be argued that radio would hurt the other schemes of communication, namely, the cables. Cabling is slow compared to the possible speed of radio transmission, and cannot be speeded up with our present equipment, as the cable itself carries the electric signalling current rather slowly compared to the 186,000 miles per second of radio.

But evidently, even in this field, radio is to prove an adjunct, rather than a competitor. In a recent interview President Carlton, of the Western Union Telegraph Co., stated that the Radio Corporation was carrying only twelve to fourteen per cent. of the trans-oceanic business, in spite of the fact that the radio rates are appreciably lower than the cable rates. He feels

that whatever growth there comes to the radio traffic will come from part of the new business created—that cables will always carry the larger part, and will not suffer from the competition.

It seems strange that the cable companies should be worried so little by radio competition; to be sure they have the element of secrecy which radio lacks, but the speed of signalling by radio is increasing so rapidly that it seems as though their rates could soon be lowered to such an extent that the cable rates, which probably cannot be materially reduced, will be prohibitively high. Mr. Carlton speaks however of a new type of cable being developed which will increase the speed of cabling perhaps ten times. Should this prove to be a fact, the cables would probably be able to carry on traffic at a greater speed even than radio. We have often heard boasts as to how fast traffic can be carried on by radio, but every amateur knows that the present average rate of radio transmission across the ocean is probably not more than ten words a minute, when the number of "repeats" required is taken into account.

Static disturbances, which so seriously limit the speed of radio transmission have but little effect on the cables; they do have their sources of trouble, principally in the earth currents, but they are not as bad as the trouble caused to radio by static. In ending his interview, Mr. Carlton said: "It (radio) is not yet an equal rival of the cables and probably never will be. It is, and probably will continue to be, a valuable adjunct to the cables."

STANDARD TESTS FOR RADIO RECEIVERS

THE members of the National Retail Dry Goods Association are evidently worried over the quality of the radio outfits they have been selling. Apparently at their request, the

Bureau of Standards, in coöperation with the Electrical Testing Laboratories of New York, has arranged a tentative schedule of inspection and performance that completed sets are to be subjected to before the dry goods dealers will handle them. The bulletin of the Association, from which we have our information, announces that it is hoped the scheme will be in operation in time to supply the fall trade with "certified" sets.

The schedule of tests and inspection to be carried out seems rather extensive and much more elaborate than the situation demands. Such elaborate data is obtained on no other goods sold by the retailers, we surmise. Among other things which the dry goods people will learn as a result of the tests are whether or not washers are used, size of wire used for connections, the size of the cabinet, type, size, and construction of binding posts, finish of the edge of the panel, and many similar important features! It is stated that the schedule will be expanded as occasion requires.

Radio sets will eventually be sold the same as practically any other commodity, on the reputation of the manufacturer. For a short time the retail dry goods dealers may need the information which these elaborate tests will give them; when their managers and clerks know a little more about this type of goods, the tests will not be required to the same extent. In one way the tests may be of much value to the radio public: they may prevent some of the dealers making such exorbitant claims for their apparatus as they did last spring; we recall distinctly one advertisement in which it was claimed that apparatus which could be purchased for \$35 was good for reception from any station within 500 miles! Reliable tests will prevent such unreasonable claims and thereby the public will be benefited.

J. H. M.





SWAN ISLAND IN THE CARIBBEAN SEA

The History of the Development of the United Fruit Company's Radio Telegraph System

By ROY MASON

The story of how the United Fruit Company built up its big radio telegraph system has never before been told. Through the courtesy of the Company's officials, RADIO BROADCAST is enabled to give it to the public for the first time.—THE EDITORS.

THE story of what the United Fruit Company has accomplished in developing its system of radio communication, the installation of which was begun in 1904, is the history of the development of the radio art in the United States since that date. This American company, which is the greatest agricultural, as well as one of the largest steamship enterprises in the world, has shown an initiative and progressiveness in developing this system which is unparalleled in the commercial radio art.

Its steamships, comprising the "Great White Fleet," are built especially for service in tropical waters, and furnish regular passenger, mail, and freight service between the Atlantic and Gulf ports of the United States and Cuba, Jamaica and the Atlantic ports of Central America and Colombia, and, through the connecting lines at the Panama Canal, with the west coast ports of Central and South America.

In 1904, the entire eastern coast of Central America and the northern coast of Colombia, South America, were without any direct means of communication with the United

States, with the single exception of a cable station at Colon, Panama. The route which messages from the United States for Central America had to follow up to that time, was by cable through Galveston, Texas, across Mexico and down the west coast of Central America to San Juan del Sur, Nicaragua, and thence via government owned and operated land wires to points of destination. These land lines—traversing as they did swamps and jungles, and being subject to the usual adverse conditions encountered in certain parts of this tropical section, with its torrential downpours and consequent washouts and floods,—made it extremely difficult, and in a great many cases impossible, to maintain a constant and thoroughly reliable telegraphic service. As a consequence, messages to some parts of this territory were subject to delays of hours and often days.

Dealing as it does in such a perishable product as the banana, and directing the movement of a large number of steamships at tropical ports, the United Fruit Company has always been dependent upon quick, reliable telegraphic

and telephonic communication, not only between its offices in the United States and Central America, but between its various banana plantations and division headquarters in the tropics. Therefore, delays to its messages, or inability to send them at all, were of most serious consequence.

In 1904 the Company had already established its own telegraph and telephone lines between its banana plantations and division headquarters in the individual countries of Central America, and was expanding this system to connect the division headquarters of each country.

That year the late Mr. Mack Musgrave, who was in charge of the Company's telegraph and telephone service in Costa Rica, was instructed to make a trip overland between Port Limon and Bocas del Toro, to report on the practicability of constructing a telegraph and telephone line between the headquarters of its Costa Rica Division at Port Limon and the headquarters of its Panama Division at Bocas del Toro, a distance overland of about 150 miles and by sea of about 75 miles. At this time the only means of "quick" (?) communication with Bocas del Toro was by means of canoe from Port Limon. Messages from the Company's offices in the United States for Bocas del Toro were telegraphed to Galveston, Texas, and then cabled to San Juan del Sur, Nicaragua, where they were given to the Nicaraguan Government land lines, which in turn transferred them at the border to the Costa Rican Government land lines for transmission to the Company's office at Port Limon. These messages were then entrusted to natives, who would make the trip in a canoe on the open sea between Port Limon and Bocas del Toro in from 30 to 60 hours, depending upon weather conditions. This canoe service, although it served a purpose, was not only expensive (\$25.00 gold for the trip) but was unsatisfactory, as in many instances messages sent to advise the manager at Bocas del Toro of the expected time of arrival of a steamship, or of delays to steamships en route to that port, would not be received until after the bananas had been cut, and in many cases not until after the arrival of the steamship to which the message referred. As a result, whole trainloads of bananas, cut and transported to the seaboard on the assumption that a steamship would arrive at least within twelve hours of scheduled time, would necessarily be left

on sidings or in the freight yards, where they would soon spoil.

Or again, a steamship would arrive without the Company's manager having received the message apprising him of her expected arrival, and it would then be necessary to hold her in port until the bananas could be cut and transported to seaboard. These same conditions were true to a greater or less extent at other of the Company's tropical division points.

The establishment of a means of quick communication with the Company's tropical divisions, and particularly with the rapidly growing Panama division, was, therefore, of paramount importance, and the Company was prepared to go to almost any expense to insure against undue delays to its messages, which so seriously affected its principal business of growing and transporting bananas to the United States and Europe.

After making the overland trip from Port Limon to Bocas del Toro, Mr. Musgrave reported that, on account of the numerous rivers and swamps to be crossed and the character of the country in general, it was his judgment that wire telegraph or telephone lines could be constructed only with great difficulty and that on account of floods and washouts, the service which could be maintained over such a line, were it established, would be subject to frequent interruption. He therefore suggested the establishment of radio stations at Port Limon and Bocas del Toro, which recommendation was adopted, and he was instructed to proceed to the United States and purchase the necessary equipment.

This was shortly after the International Yacht Races off Sandy Hook between the *Reliance* and the *Shamrock III* had been successfully reported by radio by the original American De Forest Wireless Company, later known as the United Wireless Telegraph Company. Mr. Musgrave purchased from the former company the transmitting and receiving sets for the stations at Port Limon and Bocas del Toro. The apparatus purchased for the latter station was the selfsame set used in reporting the International Yacht Races. It was installed at Bocas del Toro in 1904, and the transmitter continued in operation as a "standby" until 1921, the engine and generator of this set being still in service at Almirante, Panama, as auxiliaries to other power equipment.

The radio service between Port Limon and



RADIO STATION AT PORT LIMON
Headquarters of the United Fruit Company's Costa Rican Division

Bocas del Toro was inaugurated early in 1905, and was the first to be established in Central or South America. There being no other means of telegraphic communication with Bocas del Toro, that station handled not only all telegraphic business of the United Fruit Company, but that of the general public as well, until 1921, when the station was moved to Almirante, Panama, a few miles away, where the Company had established its new divisional headquarters. Messages for the general public at Bocas del Toro are now handled via Almirante, and thence by telephone.

The original Bocas del Toro station consisted of one 200-foot self-supporting steel tower and umbrella antenna, and a combined dwelling and operating house, all situated on a hill overlooking Almirante Bay.

The Port Limon station comprised two 200-foot self-supporting steel towers having a span of 200 feet, an inverted L antenna, a power house and an operating house, all erected on the seaboard. The towers and engines are still in use, but in 1912 the original transmitting apparatus was replaced by a Fessenden 5 K. W. 500 cycle rotary synchronous spark transmitter. Steel towers 200 feet in height were a distinct departure from the wooden masts of from 125 feet to 185 feet in height, which carried the antenna at the majority of coast stations in those days.

The receiving apparatus at both stations has been changed from time to time as the radio art advanced. The original receivers were of the De Forest two and three slide tuner types, having as detectors the old "goo" responder, and later the electrolytic of both the Fessenden and Shoemaker types, which were subsequently replaced by the Pickard crystal detectors.

These first radio stations of the United Fruit Company were installed under the direct supervision of Mr. Henry O. Easton, who will be remembered by the pioneers in radio as one of the first installers and operators employed by the old American De Forest Wireless Company. Mr. Easton is still with the Company as Superintendent of its tropical stations, and is also Division Superintendent at New Orleans of the Tropical Radio Telegraph Company.

The operation of these two stations convinced the Directors of the United Fruit Company that, regardless of the many imperfections in radio apparatus, and notwithstanding the static and other conditions, which made the operation of radio stations in the tropics in those days extremely difficult, radio communication would be practicable and would ultimately prove extremely valuable in the handling of such a highly perishable product as the banana.

BOCAS DEL TORO, PANAMA

Where the United Fruit Company established the first radio station in Central America. Until 1904 all messages for this point had to be carried by canoe on the open sea from Port Limon. The trip took from 30 to 60 hours



These two stations, while representing the best in radio equipment at that time, were far from perfect. Static, always much more severe in the tropics than elsewhere in the world, caused untold annoyance and often heart-breaking delays. However, the directors of the United Fruit Company did not lose their confidence in the commercial application of this new science, and, a year later, in 1906, authorized the construction of radio stations at Bluefields and Rama, Nicaragua, neither of which had telegraphic service sufficiently reliable to serve the purpose of the Company. These stations were erected and placed in operation that year, and handled not only all of the Company's telegraphic business but also approximately 90% of that of the

THE RADIO STATION AT BLUEFIELDS, NICARAGUA

Erected in 1906, and still handling the bulk of the telegraphic business of the general public between that point and the United States and Europe



general public between those places and the United States and Europe.

The Bluefields station is still in operation, and is handling the bulk of the telegraphic business of the general public between Bluefields, the United States and Europe. Bluefields is also now connected by government operated land wires with Managua, the capital of Nicaragua, which gives it a cable outlet to the outside world. The Rama station, situated on the Escondido River, about forty miles above Bluefields, was abandoned when the Company discontinued its banana producing and exporting activities in Nicaragua.

Up to 1907 all of the United Fruit Company's radio communication had been confined to these four original stations at Port Limon, Bocas del Toro, Bluefields and Rama. However, as a result of the experience with these stations and the need for quicker and better communication facilities between the United States and the east coast of Central America, Mr. Andrew W. Preston, President and Mr. Minor C. Keith, Vice President of the Company, decided that not only the interests of the Company but those of the United States demanded that improved communication facilities be established, and that radio should be the means. Their ambition, voiced at that time and now all but accomplished, was to connect all the republics of Central America and Colombia, South America, by radio communication with the United States, either direct or by relay, so as to give hourly communication. The Company had demonstrated that radio communication was not only a useful adjunct to its tropical divisions, but to its steamship service as well. The Board of Directors accordingly authorized the equipment of the Company's steamships with radio apparatus of the very latest type.

It was planned that the United States terminal of this radio system should be at New Orleans and that a relay station be established on Swan Island. Accordingly, in 1907, the Company purchased from the United Wireless Telegraph Company their station at New Orleans, which was to be enlarged, and also their station at Burrwood, La., at the mouth (southwest pass) of the Mississippi River, about ninety miles south of New Orleans. This latter station was to be used principally for communicating with ships at sea, leaving the New Orleans station free for long distance work.

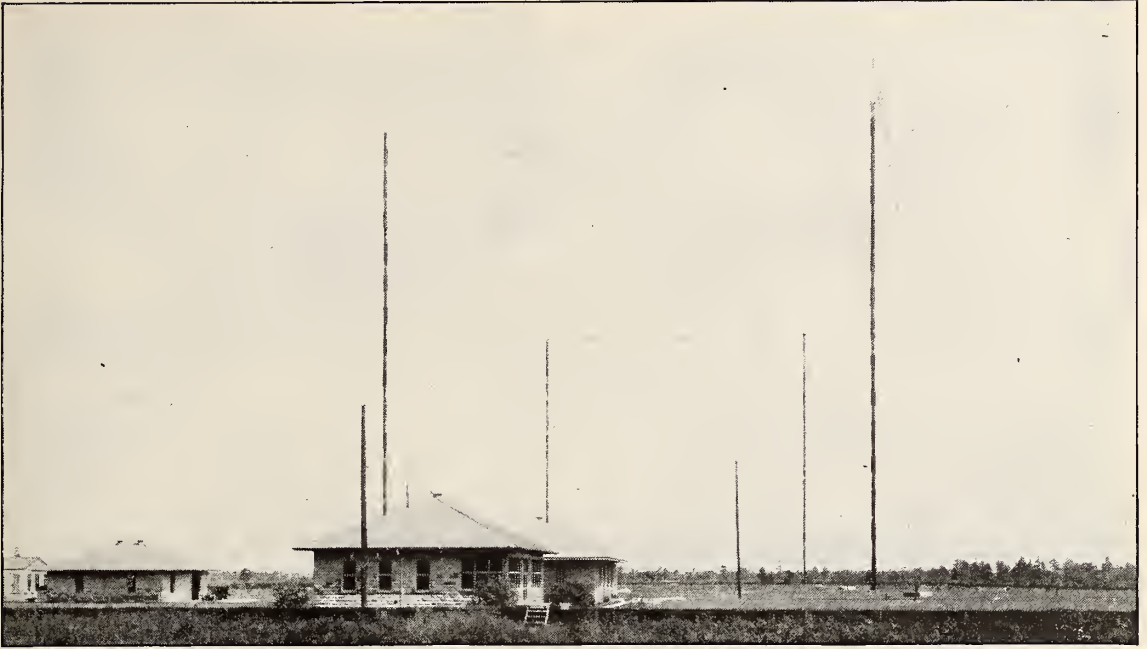

THE NEW ORLEANS RADIO STATION

Showing its store house, operating house, generator house, and four 320-foot tubular steel masts

In 1907 Mr. Musgrave again came to New York, and got in touch with Mr. Harry Shoemaker, then Chief Engineer of the International Telegraph Construction Company, and purchased from him a 10 K. W., 60-cycle

spark apparatus for installation at Swan Island. Only a few stations were equipped at that time with transmitting apparatus of more than 5 K. W. power, and the design and manufacture of a 10 K. W. set was therefore a special

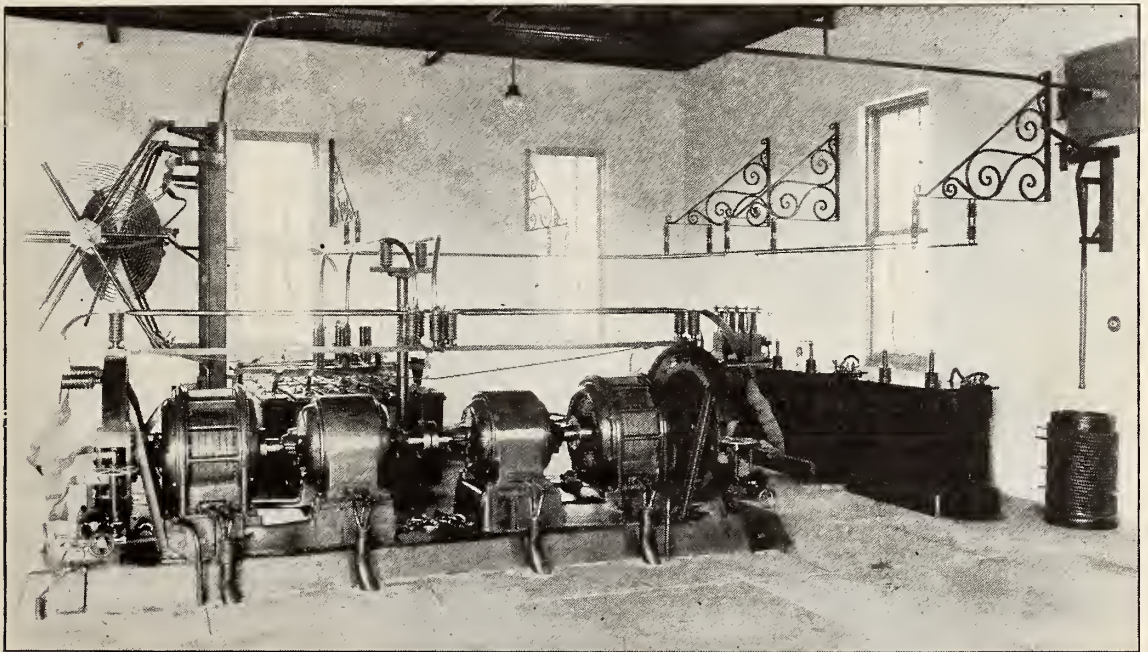

The generator room of the New Orleans Radio Station, showing two 40 K. W. units

undertaking. Mr. Musgrave also purchased additional equipment for the Port Limon station to increase its power. Two 200-foot self-supporting steel towers were also purchased for Swan Island and likewise for New Orleans.

Swan Island, which had been selected as the relay point, is an island about one mile wide and two miles long in the Caribbean Sea about nine hundred miles south of New Orleans and ninety miles northwest of Honduras. It has no harbor, and the average ship cannot come closer than within one-half mile of the beach, while the larger ships must lay off nearly a mile. In the days of the Spanish Main, it was the headquarters of a group of buccaneers who ravaged the Central American coast, and there are yet evidences of their occupation of the Island. At the time of the establishment of the Company's radio station there, its only inhabitants were a Captain Adams and a few Grand Cayman laborers, who were shipping phosphate and growing coconuts for the Swan Island Commercial Company, an American company which owned the island. It is one of the most beautiful little spots in the Caribbean Sea, enjoying an even temperature the year round.

As ships stopped at Swan Island only at irregular intervals, several months apart, and as everything had to be transported in row-boats on the open sea between the ship and the beach, the construction of the radio station presented many difficulties, particularly in the handling of the tower steel, oil storage tanks and the heavy engines and generators. It was therefore impracticable to ship materials piecemeal. A ship was accordingly chartered and everything necessary for the construction of the station was loaded and shipped at one time, accompanied by a construction gang. The erection of the plant required about eight months and it was placed in operation during the latter part of 1907. Only one man was stationed there at this time.

In those days radio communication was largely a matter of cut and try. Radio engineers and scientists, of whom there were then only a very few, had not yet acquired the experience nor worked out the formulæ under which modern radio stations are constructed. They knew something of static, but had only a more or less vague idea of its tremendous volume and long duration in the tropics.

It was found that, while under favorable atmospheric conditions, the Swan Island sta-

tion could communicate with both New Orleans and Port Limon, at certain seasons of the year, during the period of static (which prevails nine months out of the year and which is particularly strong on the longer wave lengths in the tropics) spark apparatus of the only type then available of 10 K. W. power was insufficient to maintain communication with New Orleans. The Swan Island station, however, was worth the effort and proved its value on many occasions.

Radical improvements came almost overnight in those days, and it was realized that the spark apparatus of the type so recently installed at both Swan Island and New Orleans would soon be obsolete. While the Company's ambition for uninterrupted and reliable communication between the United States and Central America had not yet been realized, the tests then being conducted by Professor Reginald A. Fessenden between Brant Rock, Massachusetts, and Machrihanish, Scotland, with his 500-cycle rotary synchronous spark sets, lent every encouragement. The 500-cycle note of the Fessenden transmitters came through the static much more readily than the 60-cycle note of the apparatus then installed at the Company's stations. Signals received at Swan Island and Port Limon from Brant Rock were of such a fine tonal quality and were so strong that it was apparent to the Company that a decided improvement could be made in their radio service by installing similar apparatus.

Accordingly, Mr. Musgrave in the latter part of 1907 again visited the United States and got in touch with Col. John Firth, who was at that time the selling agent for the newly invented crystal detectors of Professor Greenleaf W. Pickard, and for other radio specialties. Through Col. Firth Mr. Musgrave met Mr. George Schley Davis, who was then in charge of the United States Naval Radio station at the Brooklyn Navy Yard. Mr. Davis, both in his capacity as instructor in the Naval Radio School and as manager of the Navy Yard Radio Station, had been testing and reporting on all the various types of radio apparatus submitted to the Navy Department for test. Mr. Musgrave explained to him the communication problems of the United Fruit Company and requested his advice. The successful tests between the Fessenden stations at Brant Rock, Massachusetts, and Machrihanish, Scotland, and of other Fessenden apparatus coming



Above. The Radio Station at Almirante, Panama, as it looked on April 1st of this year



To the right. A tower of the Almirante Radio Station seen through tropical foliage

under Mr. Davis's observation, led him to recommend that system.

As a result, Mr. Musgrave promptly communicated with Professor Fessenden, and, in conjunction with him, mapped out a comprehensive plan for installing his latest inventions in the United Fruit Company's stations. It was also determined to erect a second relaying station at Cape San Antonio, Cuba. Accordingly the Company ordered from Professor Fessenden's company two 25 K. W. 500 cycle rotary synchronous spark transmitters, one to be installed at New Orleans and the other at Cape San Antonio, Cuba, which would give the Company a relay connection between New Orleans and Swan Island. If these two sets proved successful, similar sets were to be installed at Port Limon, Costa Rica, Santa Marta, Colombia, and Colon, Panama.

The Company at this time also ordered for each of its ships the Fessenden 2 K. W. 500-cycle rotary synchronous spark transmitters, which were the last word in radio transmitters. The Company was the first to put them into commercial operation on shipboard and they soon became known the world over, not only for the high-pitched tone of their sparks, but for the distances at which they were heard. Signals from the Company ships, while in the Caribbean Sea, were heard both in Port Said, Egypt, and by ships in the vicinity of Honolulu—a remarkable achievement in those days. The performance of these ship sets had a marked influence on ship installations in general, and other companies were soon installing ship sets having similar characteristics.

It is worthy of note and an index of the progress of the radio art that the Company paid from \$6,000 to \$8,000 each for these ship transmitting sets now costing \$4,000, and \$50 each for crystal detectors, selling to-day for \$2.50. The crystal detector receiving sets for which the Company paid \$500. each sell to-day for \$100.

The tube, as a detector and amplifier, had not yet come into use, and Dr. Lee De Forest was still experimenting at his New York laboratories in Park Avenue, with the "third element" of the present-day tube. At about this time also, Dr. De Forest was working in cooperation with Professor Thaddeus Cahill, who had established "Telharmonium Hall" at Thirty-second Street and Broadway, New York City, from which they were broadcasting music generated by Professor Cahill's tel-

harmonium machine. This was probably the first time in history that music was broadcasted by radio for entertainment purposes, and it naturally attracted a great deal of attention. According to Mr. Davis, this music was successfully transmitted by radio from "Telharmonium Hall" to the New York Navy Yard Radio Station, and there transferred to the wire telephone and thus distributed to the various offices of the Navy Yard.

While the construction of a radio station in such an isolated place as Swan Island was very difficult, it was infinitely more so at Cape San Antonio, located at the extreme western end of Cuba. The only site available for the radio station was fifteen miles from the nearest native habitation and fifty miles from the nearest railroad. The Cape was infested with mosquitoes, sand flies, chiggers and almost all other known pests, and construction facilities were wholly lacking. Even the rock for concrete had to be hauled and then broken by hand, and sea sand had to be dug from the beach and the salt washed out of it before it could be used.

The Cape San Antonio station was planned for only one tower 250 feet high with an umbrella type antenna, an operating house and residence and a power and store house. All of the radio apparatus, tower steel, kerosene oil engines and building materials (except sand and rock) were loaded on a steamship at Baltimore and shipped to Havana, where they were transferred to a chartered schooner and transported to their destination. Cape San Antonio resembles Swan Island in only one respect, *i. e.*, it has no harbor or wharf facilities and everything must be unloaded on the beach from rowboats and small lighters in the open sea. The apparatus and materials were shipped the latter part of 1908 and the station erected during the summer of 1909. The new Fessenden apparatus had in the meantime been installed at New Orleans, and communication between Cape San Antonio and New Orleans was established during this same summer.

Even with a 25 K. W. 500-cycle spark set, communication between New Orleans and Cape San Antonio, a distance of only 600 miles, suffered at times from delays due to the severe static, although, during perhaps six months of the year, good service could be maintained at night or in the early morning hours.

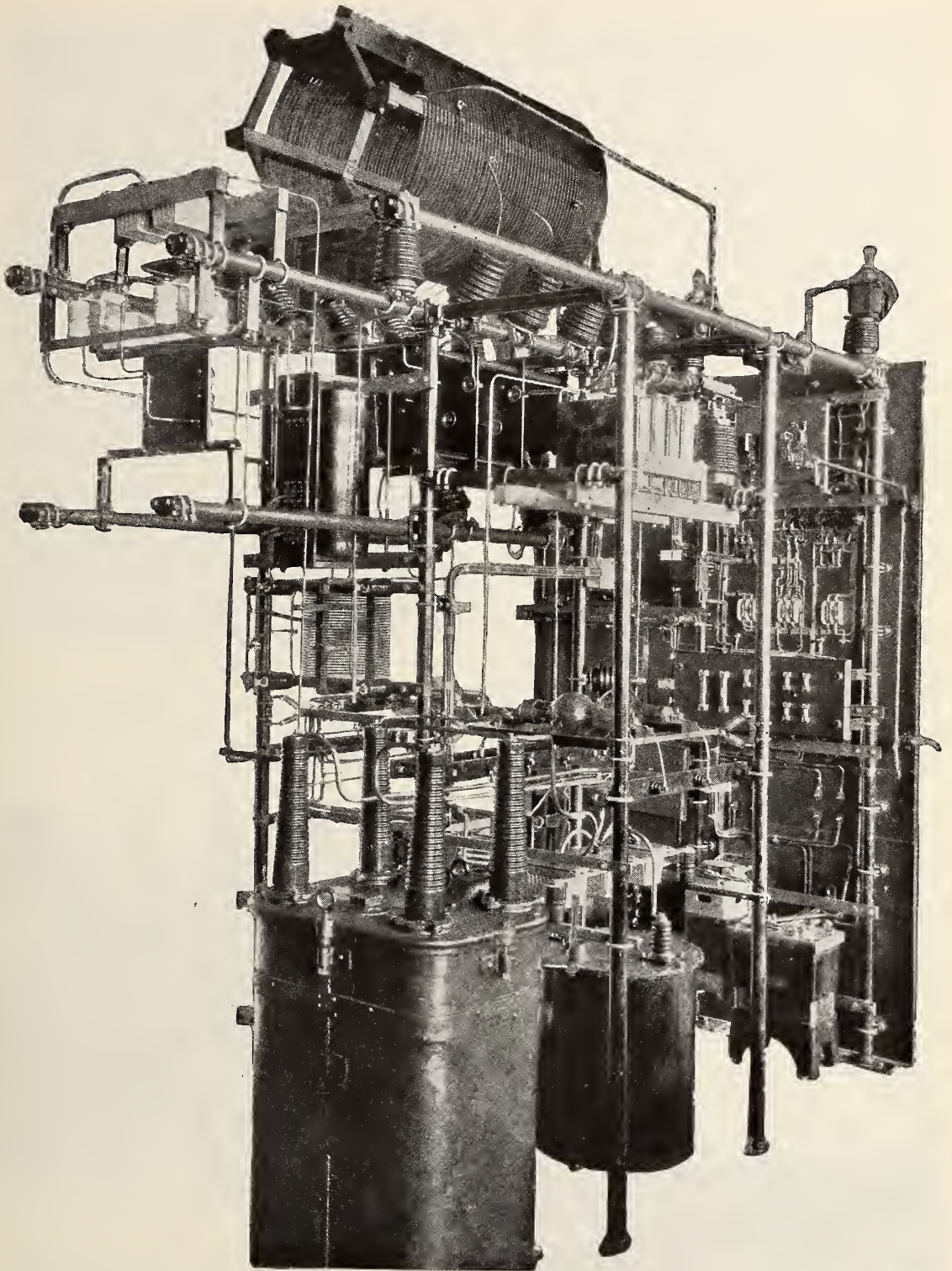

THE ALMIRANTE TRANSMITTER

The Company had not yet, even with the new Cape San Antonio and New Orleans stations in operation, attained uninterrupted hourly communication between the United States and Central America. It was during this period that the Company conceived the idea of a part cable and part radio connection between the United States and Central America to tide over the time until new and better radio apparatus could be developed and installed at its stations. The schedules of their steamships, equipped with 2 K. W. Fessenden radio sets, were so arranged that one of these vessels was in Colon harbor six days out of each week. These ships, while lying at the dock in Colon, could communicate with Port Limon and thus came into being the telegraphic route to Central America known as "Via Colon Radio." Messages over this route were sent by direct cable from New York to Colon, where they were delivered to the United Fruit Company offices and then to their ships in port for transmission to points in Costa Rica, Nicaragua and to Bocas del Toro via Port Limon radio. Service over this route was first established in 1909, and it materially decreased the time required for telegraph service between the United States and Costa Rica and Nicaragua, as well as materially increasing the efficiency of telegraph communication between these coun-

tries. This Colon radio service via United Fruit Company ships continued without interruption until the passage of the law prohibiting the use of radio transmitters on ships in Colon harbor. Since that time messages over this route have been handled through the United States Government Radio Station at Cristobal and thence via Port Limon.

It is interesting to note in connection with the "Via Colon Radio" route that during the Nicaraguan revolution against President Zelaya in 1909, when cable communication between the United States and Europe with Nicaragua and Costa Rica was interrupted at San Juan del Sur, Nicaragua, it was only by means of the Company's radio service, through its ships at Colon, that telegraphic communication was possible with those countries. This service, during the Nicaraguan revolution, was so important both to the Government and to the commercial interests of the United States that the Company exerted every effort to keep it going and secured for its ships the best land wire and cable operators in New York. This was prior to the passage of the law prohibiting the use of the American Morse code and requiring operators to be licensed, so that it was possible in those days to procure operators from a wire or cable office and place them on board ship, without previous radio training. Operating, while at the dock in

Below. View of the Radio Station at Swan Island, once the haunt of buccaneers in the days of the Spanish Main



Above. In spite of its loneliness and perils, the Swan Island radio men are not always depressed



GEORGE SCHLEY DAVIS

In charge of the United Fruit Company's Radio Activities. Mr. Davis is General Manager of the Radio Telegraph Department, General Manager of the Tropical Radio Telegraph Company, and President of the Wireless Specialty Apparatus Company, and is a Director of the Radio Corporation of America and of the Wireless Specialty Apparatus Company

Colon, was no sinecure; the noise from deck winches and the static made the work of these operators exceedingly difficult. However, during the period of the Nicaraguan revolution and for a considerable time thereafter, the Colon-Port Limon radio route was one of the fastest and most accurate telegraphic routes in the world.

It was during this period that the Company made it a standard requirement of its service for all receiving operators to transcribe radio messages directly on the typewriter. Although used in wire telegraph offices for a long time previous, typewriters had not up to this time been considered essential as a time-saving factor in the receipt and delivery of radio messages. So far as is known, this is the earliest adoption of typewriters as standard equipment for a ship or shore radio station, and the United Fruit Company was the first to make compulsory the use of the typewriter by radio operators.

During the hurricane season of 1909, the Cape San Antonio station was partially blown away. It was rebuilt but again seriously damaged by a hurricane the following year. It was again rebuilt, but in August, 1915, an unusually severe hurricane swept the western end of Cuba, completely demolishing the station. It was not again restored because of the refusal of the Cuban Government to permit the Company to move the station about fifty miles inland, out of the centre of the hurricane zone.

Early in 1909, it had become obvious to the Company officials that radio communication was of such permanent importance and their radio-construction programme had assumed such proportions that it required additional trained radio personnel. Mr. Musgrave therefore invited Mr. George S. Davis to join the Company's organization as his assistant. Mr. Davis secured his release from the Navy Department, and joined the Company in Sep-

CAPE SAN ANTONIO, CUBA

The Radio Station, photographed after a hurricane in 1915

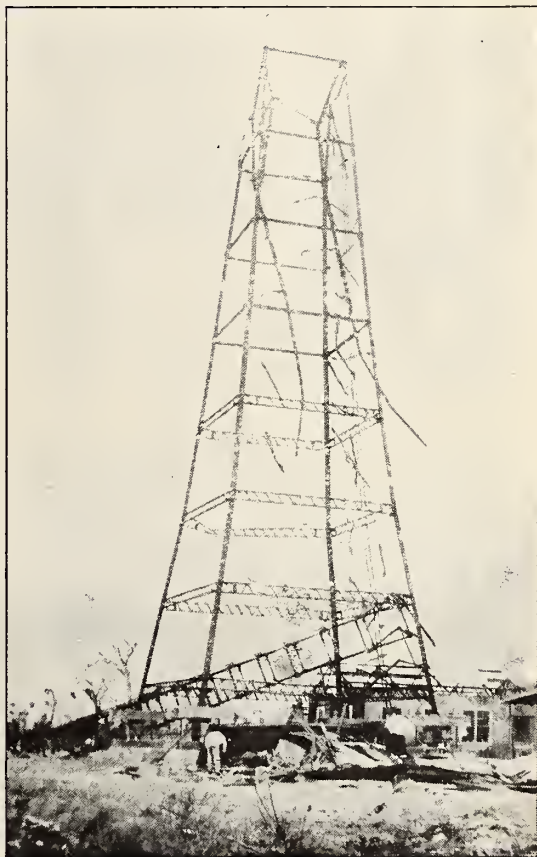

tember, 1909. His first work was to organize the radio department as distinct and separate from the electrical department, and to rebuild the Cape San Antonio station, to complete the installation of the Fessenden radio sets on all of the Company ships and to supervise the experimental work and tests being conducted at the New Orleans station. What is believed to be the first commercial use of the famous Fessenden heterodyne invention was between Cape San Antonio and New Orleans during 1910 and 1911. New and improved receiving apparatus was installed at all stations at about this period, and additional transmitting apparatus installed at both Port Limon and Bocas del Toro.

In the latter part of 1911, Mr. Musgrave resigned from the Company and went to Alaska, returning about two years later to Seattle, where he died. To his persistence, in the face of discouragements and construction difficulties always encountered by the pioneer, is largely due what is to-day a very important link in commercial communication facilities between the United States and Central America. Upon the resignation of Mr. Musgrave, Mr. Davis was appointed General Superintendent of the Radio Department, the headquarters of which were moved from New Orleans to New York.

Also in this year the United Fruit Company acquired an interest in the Wireless Specialty Apparatus Company, established in 1907 for the purpose of exploiting the radio inventions of Professor Pickard. The Company had been paying high prices for its radio equipment, and its activities had grown to a point where radio laboratory facilities became essential for developing the ideas of its own personnel and

particularly so that it could, in a measure, control the design of radio apparatus particularly fitted to withstand tropical conditions. Since 1911 the Wireless Specialty Apparatus Company has supplied all of the United Fruit Company's transmitting apparatus up to 5 K. W. power and all of its receiving equipment. The United Fruit Company is now purchasing its high powered transmitting apparatus from the Radio Corporation of America. The General Electric Company later became associated with it in the Wireless Specialty Apparatus Company.

By 1911 certain parts of the New Orleans and Cape San Antonio stations had become more or less obsolete, and, as they did not fulfil all of the exacting requirements of the Company, it was decided to select a new and permanent station site at New Orleans where a more modern and powerful station could be erected, to rebuild and re-equip Swan Island in its entirety, and to establish a new high-powered station at Santa Marta, Colombia. Accordingly, a contract was made with the Marconi Wireless Company of America to furnish for each of these stations 50 K. W. 500-cycle rotary synchronous spark transmitting apparatus.

At New Orleans the site selected occupies twenty acres of ground upon which were erected four steel masts of the guyed Marconi type, 320 feet in height which permitted of the erection of a directional antenna measuring 300 feet by 600 feet, with an effective height of approximately 275 feet. The station buildings were of concrete and consisted of operating house, power house and machine shop.

At Swan Island the original site was en-

THE RADIO STATION AT SANTA MARTA, COLOMBIA
Showing the power house, operating house, and residence for employees



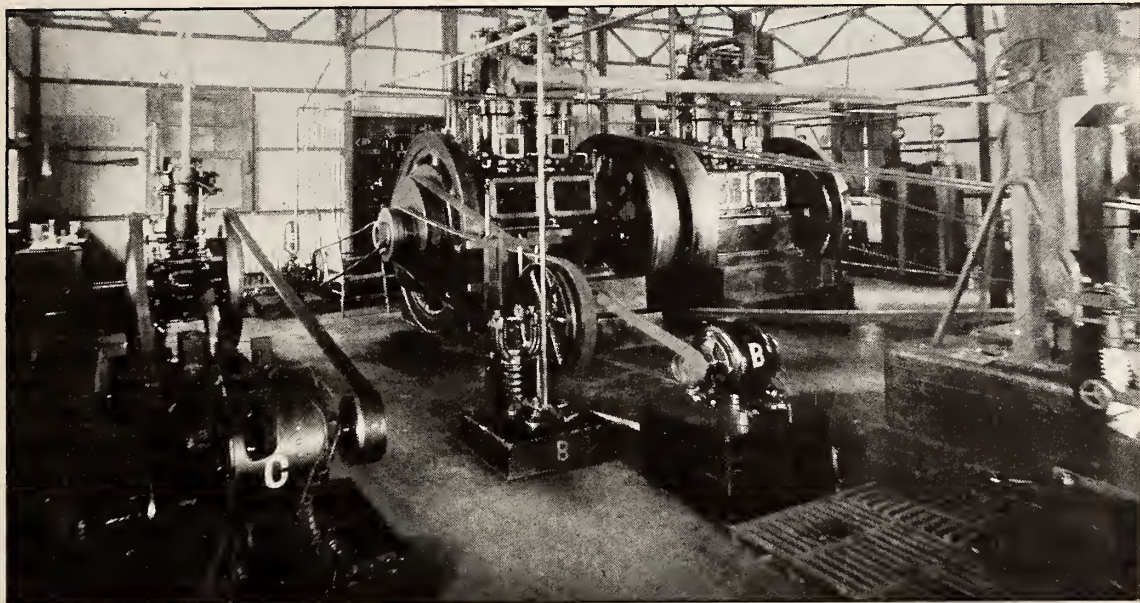

THE 100 H. P. RADIO STATION AT SANTA MARTA, COLOMBIA
This view of the power house shows two 50-H. P. kerosene oil engines, air compressor, exciter, a small radio set for ship work, and other machinery

larged to permit the erection of two additional 250-foot towers and an antenna similar to that at New Orleans. The height of the two original towers was increased to 250 feet. The construction of the new Swan Island station, on account of its location and lack of facilities, was no small undertaking. It was necessary to provide two 75 H. P. kerosene oil engines, and also auxiliary engines and generators for operating the small power radio set, as well as to provide electric current for the refrigerating plant, machine shop and also the beacon light which the Company maintains for shipping. It required approximately two years to complete the new station.

The Santa Marta station was identical in every respect to that of New Orleans, but here the construction difficulties were no greater than are usually encountered in tropical countries.

The three new stations—New Orleans, Swan Island and Santa Marta—were placed in commission during 1912 and 1913 and are still in operation. Direct communication is maintained between New Orleans and Swan Island, the latter station acting as a relay point for stations in Colombia, Costa Rica and Honduras, as well as a relay point between Jamaica, Cuba and Central America.

In 1914 the transmitting apparatus of the New Orleans station and the interior of the

power house were damaged by fire. No time was lost by the Company in restoring this station and putting it on the most modern basis possible, which included the installation of 60 K. V. A. 500-cycle rotary synchronous spark transmitters.

It was during this same year that a hurricane swept over Swan Island and blew down one of the towers, which was immediately rebuilt. In the following year a hurricane, which reached a velocity estimated at 130 miles per hour, blew down three of the Swan Island towers. Although the buildings, due to their steel, concrete and asbestos construction, were not seriously damaged, it was several days before the apparatus could be placed in commission and work resumed, using an antenna strung from the stubs of the towers. An idea of the unusual force of this hurricane may be gained from the fact that it blew down practically all of the coconut trees on the island, some of which had withstood the hurricanes and high winds of twenty years or more.

As a result of experience, it is the Company's idea that its radio stations should be so constructed that they will function at all times regardless of hurricanes, floods and earthquakes and can be relied upon when all other means of communication fail. Although the towers

and buildings at both Cape San Antonio and Swan Island, as well as New Orleans, were designed to withstand the average hurricane, the experience with hurricanes at those places indicated that a much heavier construction and a different design should be used. They therefore called in Mr. A. W. Buel, consulting engineer, of New York, who had been associated with the design and construction of the Company's railway bridges in Central America. In cooperation with Mr. Davis, he has designed and the Company is now erecting, towers which will withstand wind forces up to 140 miles per hour. These latest towers, which the Company has adopted as standard, are 420 feet in height, are self supporting and triangular in shape, and have at the top a bridge arm 150 feet across. The towers are designed to be installed with a span of 1,100 feet and to carry an antenna of 20 wires, each 1,000 feet long.

It is hardly surprising to find that all steamships of the "Great White Fleet," in addition to providing for the special comfort of passengers, have been equipped with the most modern safety devices and are prepared to meet almost any emergency. One of the precautions thus taken was to install on each steamship storage batteries as an emergency power source for operating the radio transmitter, and for an emergency lighting system to be used in case of failure of the main dynamos. With characteristic thoroughness, Mr. Davis selected this equipment by a process of elimination, the main considerations of which were reliability of operation under adverse conditions, and the fact that emergency power should be such as would enable the radio operator to obtain it instantaneously for the radio equip-

ment as well as for the emergency lighting system.

Mr. Davis states that storage batteries seemed to come nearer these requirements (for auxiliary power purposes) than either steam or internal combustion engines, in that they could be brought into use by merely throwing a switch on a switch-board.

The installation of such an elaborate equipment is not compulsory but was made possible by the broad policy of the Company to leave nothing undone, regardless of the expense involved, for the safety and convenience of its passengers and crews. It was the first company to recognize the value of complete storage battery equipment in connection with the operation of the main radio apparatus on board ship, and to install on its ships a complete emergency lighting system operated from storage batteries. All of its steamships will finally be equipped with the Pickard radio Pelorus, which will enable the captains to determine their bearings from the radio beacon stations now being established by the U. S. Department of Commerce.

In 1914, the Company abandoned the old Burrwood, La., station and erected a new plant at a point nearer the mouth of the Mississippi River. The Burrwood station was originally intended for marine work, but, on account of its ideal location—from a radio receiving standpoint—in the marshes bordering on the Gulf Coast, the Company contemplates making it its principal radio receiving terminus in the

United States, and from here remotely controlling the high-powered transmitter in New Orleans.

At the present Burrwood station there are two 250-foot towers set on a span of 650 feet,

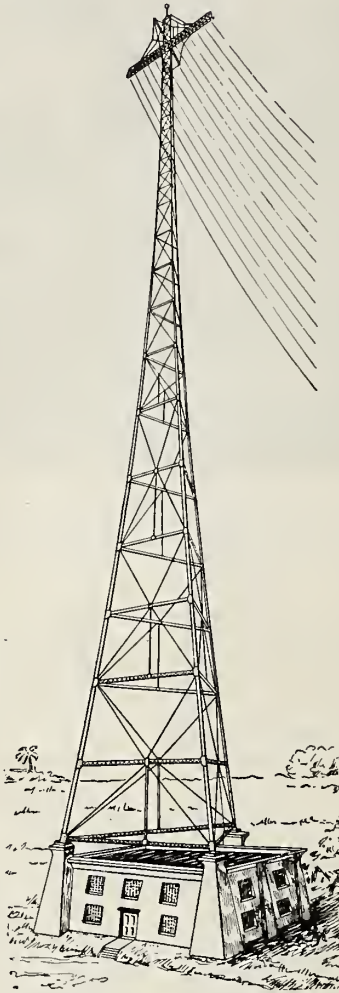

THE "EGYPTIAN MONOLITH"
TYPE OF TOWER

Especially designed for the United Fruit Company to withstand wind forces up to 140 miles an hour, and now adopted as standard. These triangular towers, 420 feet in height, are self-supporting and have a bridge arm 150 feet across. They are designed to be installed with a span of 1,100 feet and to carry an antenna of 20 wires, each 1000 feet long

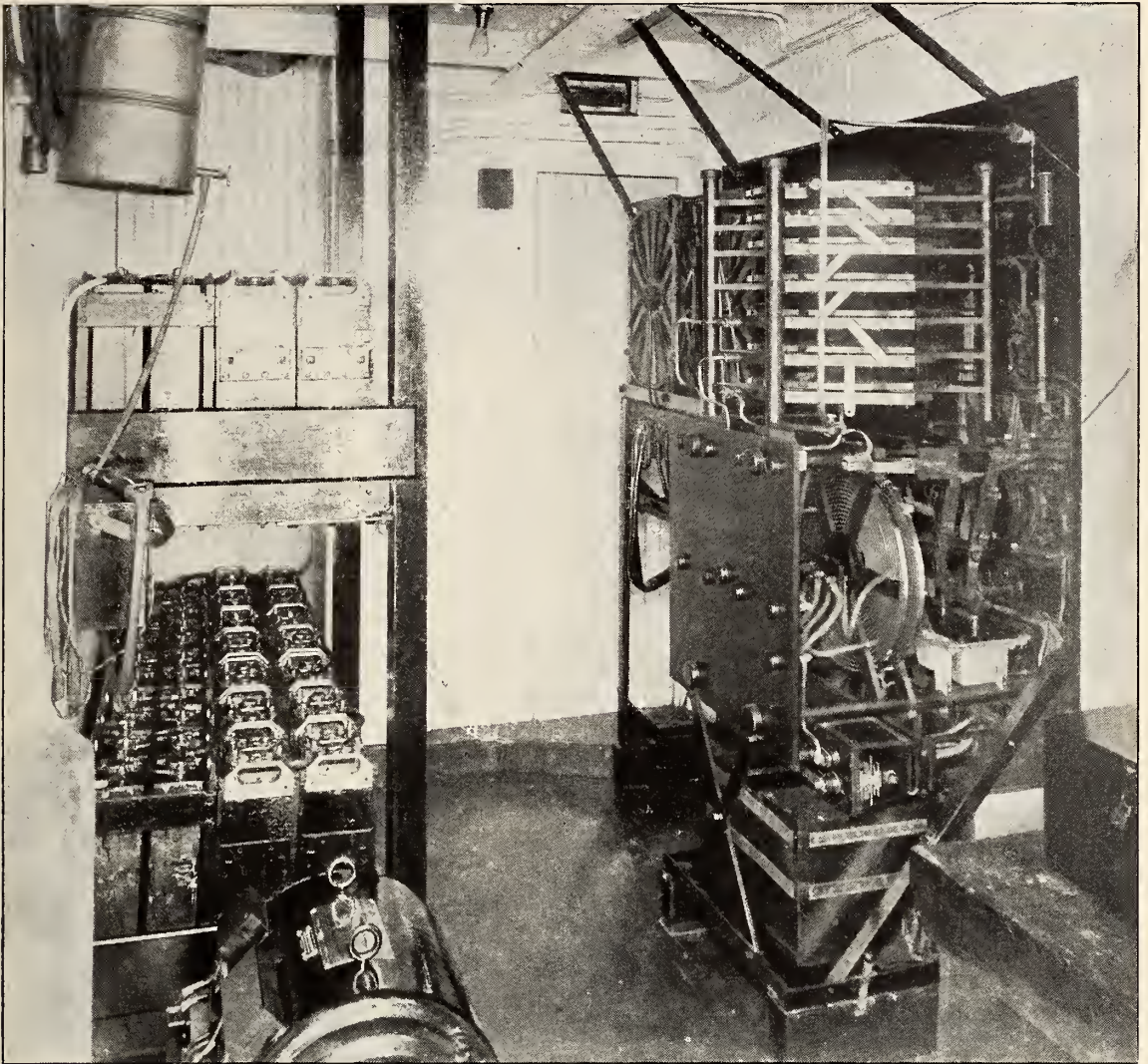

GENERATOR ROOM ON THE S. S. "ULUA"

The motor-generator may be seen in the foreground to the left. Directly behind it are the two banks of Edison storage batteries used for radio as well as lighting in emergency. To the right is the 2 K.W. transmitting outfit which is automatically controlled by switches located in the operating room

a combined operating house and residence, and a power house. The only site available for this station, or in fact for any station near the mouth of the Mississippi River, is in the swamps extending for miles back. The towers rest on piles, as do the buildings and sidewalks. This station has thus far withstood the high winds encountered during the hurricane season in the Gulf. It offers the most direct means of communication between the Southwest Pass of the Mississippi River and New Orleans.

In 1913 the Tropical Radio Telegraph Company was organized as a subsidiary of the United Fruit Company to handle the radio

business of its steamships and of its stations in the United States. The activities of this subsidiary company have since been extended to cover Honduras and Nicaragua.

In 1914 the Tela Railroad Company (a subsidiary of the United Fruit Company) opened up the banana district around Tela, Honduras, and a radio station for communication with Swan Island was constructed for that company. A year or two later a similar station was built for the Truxillo Railroad Company (also a subsidiary of the United Fruit Company) at Puerto Castella, Honduras. Both of these stations, communicating as they do exclusively with



THE RADIO STATION AT TELA, HONDURAS

United Fruit Company stations, are part of this company's radio system.

The partial destruction by hurricanes of the Swan Island station and the total destruction of the Cape San Antonio station was enough to discourage the average company from attempting to build against them, but these difficulties were finally overcome and the Company now has stations which it believes are hurricane proof in every sense of the word.

The report of the final destruction of the Cape San Antonio station by the 1915 hurricane is illustrative of the type of men employed by the United Fruit Company at its stations, and of the force of these storms. The following are extracts from the report made by John A. (Jack) Cole, one of the old-time radio operators who was at that time in charge of the Cape San Antonio station.

About 3:00 P. M. on September 13th, I took a barometer reading and noted that it was unusually low, about 29.60. At 4:00 P. M. I was in communication with Swan Island and ascertained that his barometer was also low, and suggested to him that we get special weather observations off to the Weather Bureau at once. I immediately sent these messages to the Weather Bureau via New Orleans, repeating them again on the night schedule. Everything was made in readiness to withstand a storm and I also made up monthly reports together with the Weather Bureau report in order to have them ready if anything happened. These were fortunately saved and were later forwarded from Havana.

On the morning of the 14th the barometer was still dropping and I got in touch with the ships who gave me their reports and observer messages. The barometer was falling and the wind increasing and a few minutes after communicating with Swan Island, the wind increased in velocity and blew down a portion of the aerial. In the meantime, repairs having been made, storm warnings had been sent to all ships and were being repeated at intervals. About 9:00 A. M. the entire aerial was blown away

and from that time on the wind blew stronger and stronger and about 11:00 A. M. was blowing with hurricane force. The Cuban Government wind gauge had by this time been blown away, but I judged the velocity of the wind was not less than 100 miles an hour and the barometer still falling.

Our kitchen was the first to go, then the gas plant, warehouse and roof of water storage plant were blown down, and some of the iron roofing carried for miles into the woods.

Next the tower, which had been guyed with four 1" steel cables, broke in two about half way up, breaking the guys which blew straight out with the force of the wind.

The roof of the operating house was next blown off and the windows and doors blown in. Myself, the cook and engineer were inside at the time and we then took shelter in the engine house. The operating house, although of steel construction on concrete foundation, was moved about 8 feet off of its foundation. The roof and floor of the veranda were wrenched from the house, but the house itself stood, although badly damaged.

The engine house, where we went for shelter, stood only about twenty minutes after we got there. This being the last house, we started for the woods.

The radio log entry of Mr. Cole at this juncture tells perhaps more vividly than anything else could what happened.

"Part of antenna blown away," reads one entry; "made repairs". A little later another entry reads: "Antenna gone." "Storehouse gone." "Operating house gone." Then a fourth entry records a similar catastrophe to the engine house.

The final climactic summary reads:

"Everything gone, we are going to the woods."

Then he buried the station records and the radio log, and, with R. C. Attaway, the engineer, started for the woods about 400 yards distant. Continuing, Mr. Cole says:

We got a little protection behind some large

stumps. After being there for about an hour, there was a lull. The wind subsided and we returned to the station. We found that the Cuban Government barometer (the United States Government barometer was destroyed early in the storm) which has a scale graduated to read from 27.5 to 32.00, was down to the lowest mark; in fact, the indicator was against the pin at 27.6. I do not know how much farther it would have gone if the pin had not been there.

When I found that the barometer was as low as it would go, and the wind again increasing, we decided to go to the lighthouse, three miles away. This is a stone structure and we thought it would stand. In the meantime the wind had gotten stronger than ever. It took us about four hours to reach the lighthouse, which we did at 7:00 P. M., having had to crawl most of the way amidst flying sand, timbers, falling trees, etc. On our arrival at the lighthouse we found that the prisms had been blown in, putting the light out of commission. We found there the wreck of a Honduranian schooner. The captain had come in as close as he could get, but before he could get a boat out, the anchor chain parted and the vessel started out to sea. All hands jumped overboard and somehow got ashore.

The vessel was blown to sea and disappeared in less than 30 minutes.

We spent the night at the lighthouse and returned to the station on the 15th, finding that all provisions, furniture and kitchen utensils had been destroyed or buried under the sand. About 10:00 A.M. a native family, carrying five dead bodies, arrived at the station on their way to the lighthouse. This family, named Soto, who had lived in this locality for three generations, lost five of their number during this storm.

We endeavored to clean up a bit and get a place to sleep, but the mosquitoes, gnats and crabs which invaded the house, would not permit.

On the 18th I hired a small sailboat and started for Arroyos, 50 miles distant, but a few miles out sighted a Cuban revenue cutter, which took me on board and landed me at La Fe at night, from which place I proceeded to Havana.

Until some ten years ago, the United States Weather Bureau had been without adequate weather reports from the Gulf of Mexico and the Caribbean Sea, and, during the hurricane season, August 15th to September 15th particularly, the lack of such facilities was a



RADIO OPERATOR'S ROOM
On the "Great White Fleet" S. S. *Tolosa*



THE S. S. "ULUA"
Of the "Great White Fleet." The radio equipment on this vessel duplicates that on the *Tolosa*

great handicap to merchant shipping in those waters. The United Fruit Company had inaugurated, as a part of its own radio service, a system whereby its ship captains kept each other advised as to weather conditions encountered. With the coöperation of the United Fruit Company, the U. S. Government was enabled to extend its Weather Bureau Observation Service to all the Company ships and shore radio stations. All the ship captains of the "Great White Fleet" were appointed special deputy weather observers, as were the chief radio operators at Burrwood, La., Cape San Antonio, Cuba, Swan Island, and Bluefields, Nicaragua. Weather observations from the Company ships and from these shore stations are made twice daily, and relayed through Swan Island and New Orleans and thence by wire to the Weather Bureau in Washington. These weather observations, in addition to those received by cable from the Windward and Leeward Islands by the Weather Bureau at Washington, enable it to report accurately the occurrence of hurricanes, plot their tracks and determine their force, and thus to issue reliable storm warnings for the information of all shipping and for the Gulf Coast of the United States and for Cuba, which has resulted in the saving of millions of dollars in property and of many lives. These storm warnings are broadcasted in the Gulf and the Carribean Sea by the United Fruit Company radio stations for the benefit of all shipping, and it not infrequently occurs that, through information thus disseminated, ships are enabled to steer clear of hurricanes or can be held in port until the storm has passed.

While the Company's project for direct radio communication with Central America has been attained, owing to the recent marked improvements in radio apparatus it now plans further to improve its service by completely rehabilitating all of its ship and shore radio stations, with the end in view of ultimately establishing radiotelephonic communication with Central America. All of its Central American stations will be open to the public as soon as the necessary permits are granted by the respective governments.

Its radio building programme contemplates the installation of tube transmitters for both radiotelegraphic and radiotelephonic purposes on its ships, enabling passengers to talk with the shore from their staterooms at any time during the voyage.

The Tropical Radio Telegraph Company is now erecting in Tegucigalpa, the capital of Honduras, one of the most powerful tube transmitting stations on this continent, which it is expected will be in operation by December of this year. It is interesting to note in connection with this station that the 420-foot steel towers, radio apparatus, oil engines and building materials must be shipped to Amapala, Honduras, on the Pacific coast, where they are lightered ashore and then hauled over an 80-mile mountain trail to Tegucigalpa. Steel gangs and installing engineers have been sent from the United States.

Powerful tube transmitting apparatus will also be installed at New Orleans and at a new station which the Tropical Radio Telegraph Company proposes to erect in the vicinity of Miami, Florida.

The Tropical Radio Telegraph Company plans to have in operation in 1924 a tube transmitting station at Managua, the capital of Nicaragua, which will give direct communication with the United States through Miami and New Orleans.

Later, similar equipment will be installed in Colombia, Costa Rica, and Swan Island, and possible in Cuba, so that probably by 1925 this great radio system will have been completed and the plan of the United Fruit Company to provide the general public as well as itself with a fast, reliable and instantaneous means of communication between the United States and Central America and Colombia will be complete. Further, what is perhaps of more importance to those countries, it will bring together out-of-the-way places and thus pave the way for closer commercial and political relations between the Americas.

The United Fruit Company has spent more than \$3,000,000 in the development of its radio system, and upon the completion of its projected radio building programme its investment in radio will probably exceed \$4,000,000.

Radio operators in the service of the Fruit Company are all carefully selected men trained to meet its special requirements and to uphold the high standards of the Company. On its ships the radio operators rank with the pursers and have excellent cabin accommodations. The salaries paid to ship operators are based both on their ability and on length of service with the Company; chief operators receive from \$105 to \$140 per month and second operators from \$85 to \$105 per month, and found.

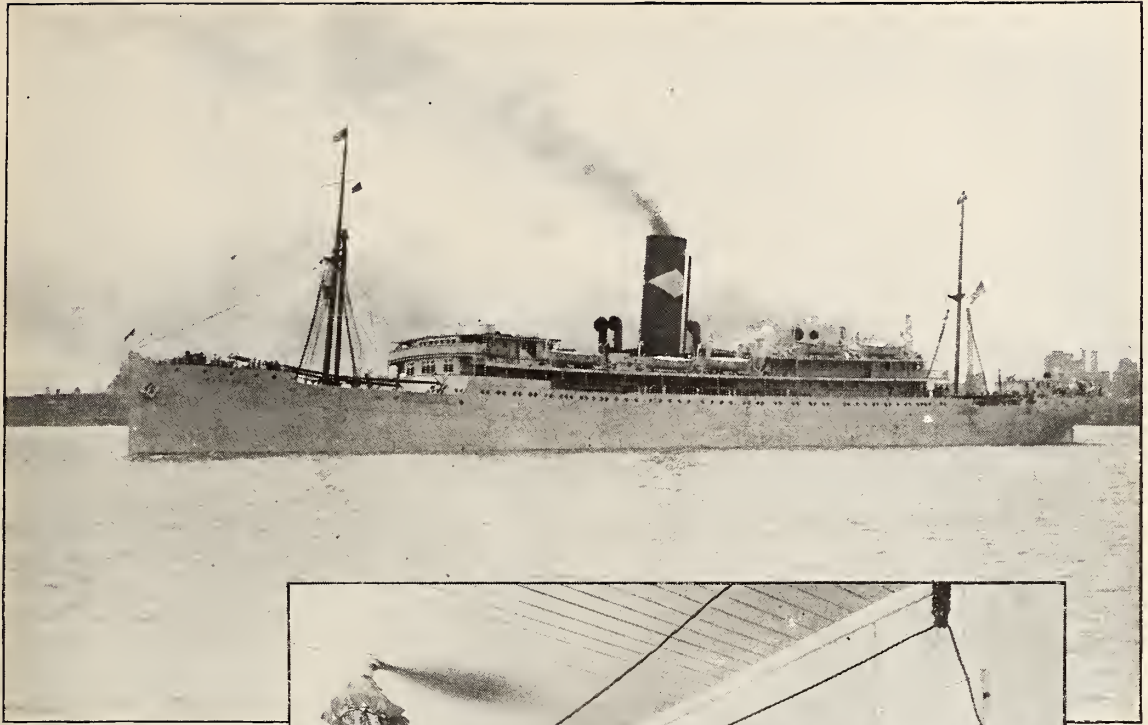

THE "S. S. PASTORES"
OF THE "GREAT WHITE
FLEET"

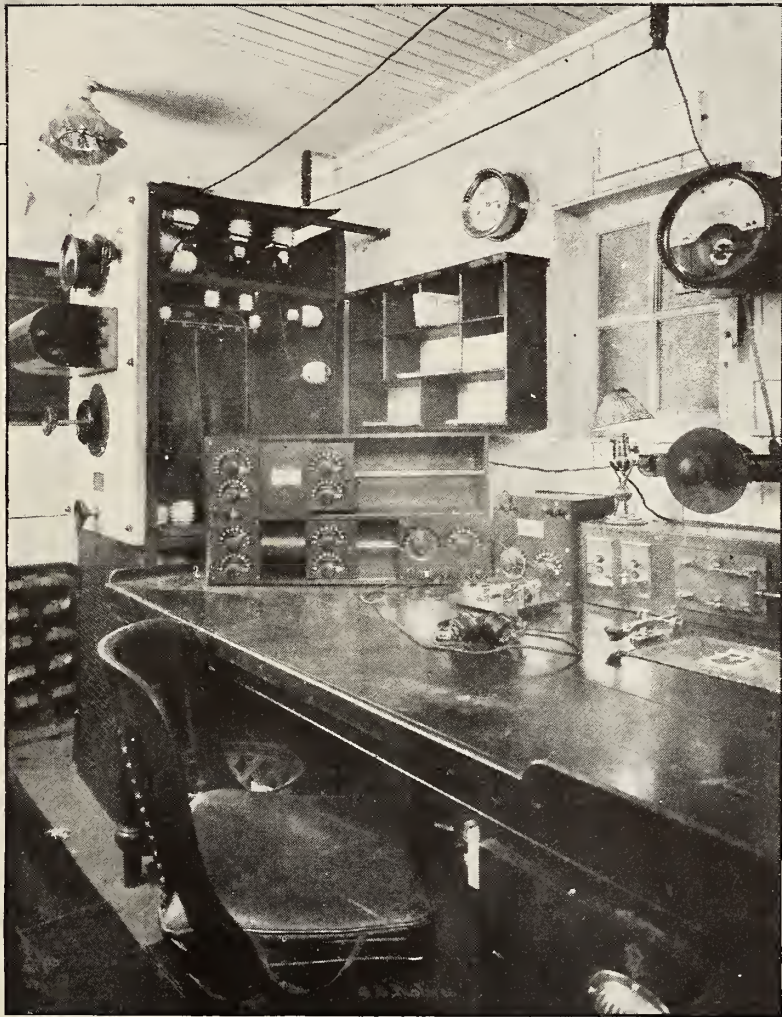

RADIO OPERATOR'S
ROOM ON THE "S. S.
PASTORES"

In the tropics the company provides living quarters for the operators, and for their families in localities where it is possible for an operator to have his family. The salaries paid to chief operators in the tropics range from \$150 to \$250 per month, depending upon the length of service and assignment. At Swan Island the company also maintains the mess and furnishes a cook and mess attendant.

Operators in the tropics are given an opportunity to learn the banana business from the ground up. One of the Company's former operators is now a banana farm superintendent in Honduras; one is the president of a well known radio manufacturing company; another is secretary of a steamship company and others have been promoted to other responsible positions on shore and to pursers and engineers on shipboard.

It is no exaggeration to say that today the United Fruit Company is organized around its ability to communicate quickly by means of its own communication system, without which the conduct of its shipping, but more especially the banana business, would be seriously interfered with, since it enables the management to keep in close touch with its outlying divisions and thus to advise them instantly on the conditioning, cutting and shipping of bananas. Through the use of radio the cutting and moving of bananas to seaboard in the tropics can be timed to coincide with the arrival of steamships at the loading ports, and thus the losses which would result from cutting this perishable fruit too soon are reduced to a negligible sum.

The conception and carrying out of its radio policy was a big thing not only for the United Fruit Company but for the commercial interests of both the United States and Central America, and great credit is due Mr. Preston, Mr. Keith and the Board of Directors for their foresight and courage which enabled the Company to complete, in the face of tremendous discouragements and adversity, a construction and operating programme of such far-reaching importance. It is characteristic of the true American spirit of initiative, and indicates what can be accomplished by American enterprise abroad. It also demonstrates the mutually beneficial results which can be secured through the development of a great public utility by private initiative under wise government regulation rather than under government ownership and operation.

Since 1911 the radio activities of the United Fruit Company in all its branches have been under the immediate direction of Mr. George S. Davis, who is General Manager of their Radio Telegraph Department. He is also President of the Wireless Specialty Apparatus Company, General Manager of the Tropical Radio Telegraph Company and a Director of the Radio Corporation of America. He is a Fellow of the Institute of Radio Engineers and a member of various other scientific organizations.

While in the United States Navy, Mr. Davis became interested in electric propulsion for steamships, and, largely as a result of his initiative, the United Fruit Company decided to give electric ship propulsion a trial. Their newest steamship, the *San Benito*, was accordingly equipped with electric drive by the General Electric Company, and has proven so satisfactory that additional ship tonnage when built will probably be propelled by electric machinery.

Assisting Mr. Davis in the Company's radio engineering and construction work is Mr. William E. Beakes, Chief Engineer of the Radio Telegraph Department and of the Tropical Radio Telegraph Company. Mr. Beakes was with Professor Fessenden's company from 1904 until 1912 and participated in the early work at both the Brant Rock, Massachusetts, and Machrihanish, Scotland, stations. He represented the Fessenden Company in the installation of the United Fruit Company stations at Cape San Antonio, Cuba, and New Orleans, entering the service of that company in 1912.

Colonel W. P. Rothrock, formerly Chief Designing Engineer of the Fort Pitt Bridge Works and well known among structural steel builders as having supervised the third tracking of a large section of the New York Elevated system, and the construction of some of the largest war material plants, is superintendent of tower and building construction for the Radio Department of the Fruit Company. He erected the new 350-foot towers at Almirante, and is now in Honduras, erecting the 420-foot towers at Tegucigalpa.

This article would hardly be complete without a few words concerning the United Fruit Company's activities—what it is and does. It was incorporated on May 30, 1899, and is engaged primarily in the production and transportation of tropical products, principally

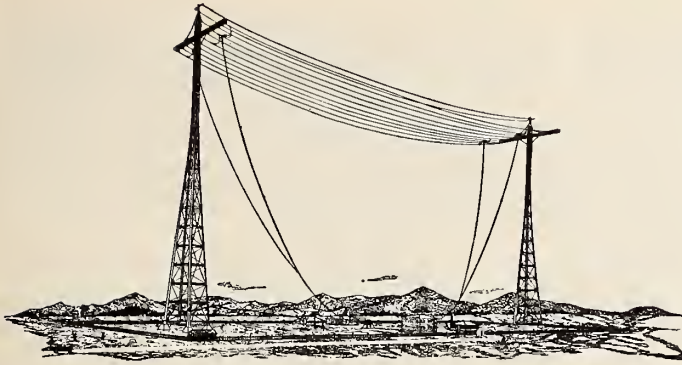

NEW STATION AT TEGUCIGALPA, HONDURAS
Now being built by the Tropical Radio Telegraph Company

bananas, sugar, cacao and coconuts. It also conducts an extensive freight and passenger business.

Its tropical divisions are located in Colombia, Costa Rica, Cuba, Guatemala, Honduras, Jamaica, Panama and the Canary Islands. During the past ten years it has shipped from the tropics 284,000,000 bunches of bananas.

It has on its payrolls, including those of its subsidiaries, approximately 67,000 employees. It owns 1,536,000 acres of land of which more than 365,000 are cultivated. In addition it leases 125,000 acres of land of which 30,000 are cultivated.

It operates more than 1,300 miles of railways, 500 miles of tramways and over 3,500 miles of telephone and telegraph lines, in addition to its radio system.

In Latin America it does a mercantile business amounting to more than \$10,000,000 a year.

The United Fruit Company is one of the most complete and best equipped organizations devoted to the production of sugar. This fact is not generally known by the public, which regards it solely as a banana and steamship enterprise. It has in Cuba 87,000 acres of cane and two large sugar mills located at the seaboard, and owns the Revere Sugar Refinery at Boston, which is one of the most modern plants of its kind in the world.

Before closing the story of this remarkable company and its achievements, mention should be made of its medical service in the tropics. Probably few realize the magnitude of this service including, as it does, not only

the care of the sick, but preventive medicine and supervision of sanitation. Yet on the preservation of health and improved conditions which make living in the tropics safe and enjoyable has depended in a large measure the success of all that the United Fruit Company has attempted and achieved.

An annual medical service, which is expressed in six figures, commands attention. During 1921 the number of patients cared for in the tropics by the Company's medical department was 208,000, of whom 33,000 were non-employees.

A large personnel of experienced executives, doctors and nurses, recruited from all over the world, is carrying on the work of this department of the United Fruit Company's activities.

The cost last year of operating hospitals and dispensaries was \$240,000 in excess of receipts. Through other departments directly associated with but not included in its medical service, the company spends annually in sanitation \$275,000; for parks and street cleaning \$200,000; and \$300,000 in excess of receipts for electric light plants and waterworks.

The Company has expended more than \$200,000,000 toward the development of the Latin American countries where it does business and is the most potent factor in the extensive commercial relations of the United States with these countries.

These few salient facts concerning the United Fruit Company and its operations clearly indicate the varied interests served by its ex-

OPERATING HOUSE UNDER CONSTRUCTION

At the new Tegucigalpa station of the Tropical Radio Telegraph Company. All the buildings at this station will be made of stone



tensive and rapidly growing radio system. Radio—a dream of the scientists two decades ago—has firmly established its place in the commercial and political life of the world. Too much credit cannot be given the inventors and pioneers for their courage and perseverance in accomplishing this result.

The United Fruit Company has just announced the inauguration of a free medical radio service from its hospitals in the various countries of Central America and from its passenger steamships to all ships at sea. This service is available without charge so far as the United Fruit Company and subsidiary companies are concerned to ships of all nationalities through the following radio stations operated by the United Fruit Company or the Tropical Radio Telegraph Company:

<i>Radio Stations</i>	<i>Radio Call Letters</i>
New Orleans, Louisiana	WNU
Burrwood, Louisiana	WBW
Fort Morgan, Alabama	WIO
Sea	US
Tela, Honduras	UC
Puerto Castilla, Honduras	UA
Tegucigalpa, Honduras (Open Nov. 1922)	UG
Port Limon, Costa Rica	UX
Almirante, Panama	UB
Santa Marta, Colombia	UJ
All passenger steamships of the United Fruit Company	For ships' call letters see International Radio Call Letter List

Radiograms requesting medical advice should be signed by the captain of the ship and should state briefly, but clearly, the symptoms of the person afflicted. Such radiograms should be addressed "UNIFRUITCO" (name of place) and may be sent to any of the United Fruit Company's hospitals listed below:

Santa Marta, Colombia
Port Limon, Costa Rica
Almirante, Panama
Tela, Honduras
Puerto Castilla, Honduras
Puerto Barrios, Guatemala

All United Fruit Company passenger ships carry doctors, and free medical service may be secured by radio from any of them by a radiogram addressed "Ship's Doctor" followed by the name of the steamship.

This free medical service is established primarily for the benefit of ships not carrying doctors; however, should occasion require, ships' doctors may hold consultation by radio with the United Fruit Company ships' doctors and hospital staffs.

It is requested that when sending medical advice radiograms, radio operators check them "(number of words) DH Medico."

"DH Medico" radiograms will be given preference over all other radiograms, excepting SOS calls, throughout the radio service of the United Fruit Company and subsidiary companies.

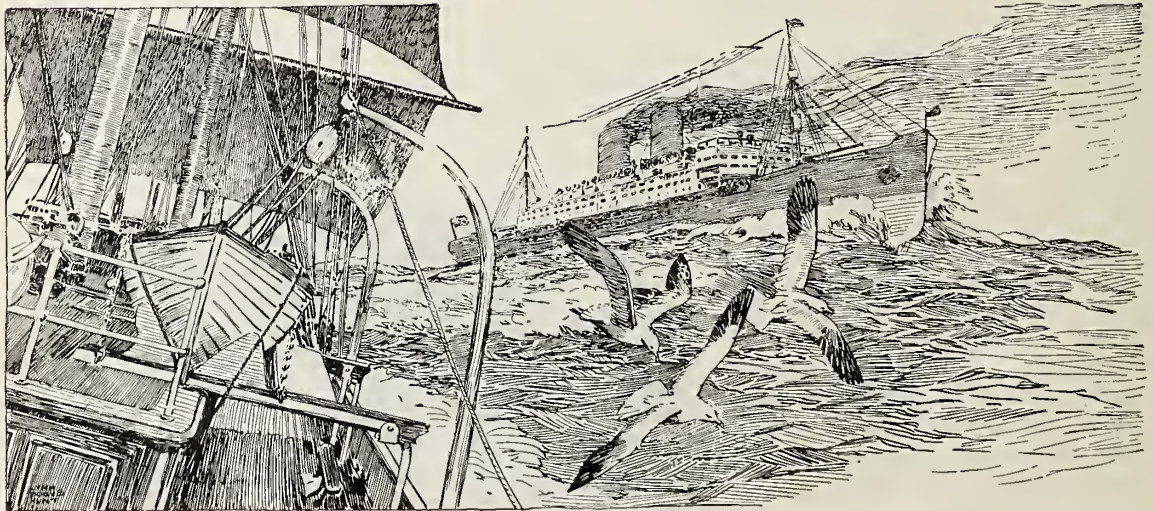

Developments in High-Power Radio

And Its Practical Application in the Services of the United States Navy

By COMMANDER STANFORD C. HOOPER, U. S. N.

Head of the Radio Division in the Bureau of Engineering, Navy Department

APPROXIMATELY twenty-five years ago, or to be exact, in February of the year 1896, a young scientist of Italian and Irish parentage journeyed from Italy to England in the hope of interesting the British Government in an invention by the use of which the claim was made that communications could be exchanged between distant points without utilizing the ordinary connecting wires or other visible connecting medium.

Doubtless he experienced some difficulty in getting in touch with the government officials in London, and, presumably, when he did, his claims were listened to with a degree of skepticism comparable to that which would probably now confront a man who suddenly claimed to have exchanged communications with inhabitants on the Moon. It would be only natural that such an attitude would prevail because the only method then known for exchanging rapid communications between points separated by distances considerably beyond the range of visibility was to utilize the land line wire telegraph, telephone, or ocean cable systems, and it was generally believed to be impossible to exchange rapid communications over great distances without utilizing connecting wires.

However, the expression "wireless telegraphy" or communications without wires, naturally envisaged communications with ships at sea and between ships separated by great distances at sea, and doubtless the authorities of the leading maritime power of the world would not let pass any proposition, however fantastic, that might possibly bring this about.

Needless to say, the young inventor to whom reference has been made was Marconi.

We learn that six months after Marconi arrived in England he conducted a series of trials before the British Post Office officials and navy and military officers on Salisbury Plain, and succeeded in establishing communication over a distance of one and three quarter miles. About one year later Marconi increased this

distance to four miles, and a few months later he increased the distance to eight miles.

Thereupon news of the performances of the young inventor began traversing the ocean cable systems of the world radiating from London (the cable systems themselves having been in successful operation only about twenty-five years) and a skeptical world was apprised of the remarkable new invention of "wireless telegraphy."

Thus we see introduced into the world within a generation two remarkable inventions enabling the exchange of rapid communications over long distances, namely, the ocean cable and wireless, or radio telegraphy.

Now, after these systems have been developed and largely perfected, we find ourselves on the threshold of another remarkable development in connection with the exchange of rapid communications over long distances, namely, wireless telephony or the radiophone, about the future possibilities of which it is difficult to hazard even a conservative prediction.

Obviously the world is advancing rapidly and with great strides in the development and inauguration of new means for exchanging rapid communications over long distances, thereby linking the remote regions of the world together with the less remote regions, bringing the more backward peoples into close contact with the less backward; in fact, gradually consolidating all the peoples of the world into one great human family by providing channels for readily exchanging rapid communications.

As a matter of fact, the shortening, in effect, of the vast intervening distances separating the different principal parts of the world, and the opening up of regions hitherto regarded as more or less inaccessible, as a result of the inauguration of the new methods of exchanging rapid communications, has already come to be regarded as so commonplace as not to excite unusual interest or comment.

During the interval of time from the year 1897 to 1912, developments took place in wireless or radio telegraphy so rapidly that the



Riggers replacing a defective insulator in the Navy's Pearl Harbor high power radio station antenna

range of communication increased from eight miles to as much as three thousand miles under the most favorable conditions, and the application of this method of communication to practical uses, particularly in connection with sea-going ships, especially as regards the preservation of life at sea had been amply demonstrated by the rescue of the passengers and crew of the ill-fated American passenger steamship *Republic* on January 23, 1909, before that vessel went down, assistance having been summoned by the stricken vessel by wireless.

About three years later, or on April 15, 1912, the lamentable *Titanic* disaster occurred. It will be recalled that the one radio operator carried by the steamship *Carpathia*, while he was preparing to retire for the night, but while still wearing his radio headphones, almost accidentally overheard the radio distress calls, or S. O. S. signals, of the *Titanic*, and as a result, the *Carpathia*, after steaming at full speed throughout the night, arrived in the early morning hours at the position previously given by the *Titanic* and rescued the occupants of the *Titanic's* boats after the great vessel had gone down in mid-Atlantic carrying with her a large number of her passengers and crew. The *Titanic* disaster convinced the world of the

inestimable value of radio as an agency to safeguard life and property at sea, and it resulted in much beneficial legislation being enacted by the various governments of the world, especially as regards the equipping of sea-going passenger-carrying vessels with reliable radio outfits and also the carrying of more than one radio operator. The very great value of radio in naval and military tactics and as an agency to influence world trade was also coming to be generally recognized, and plans began to be formulated by the various leading powers of the world, notably by Great Britain, Germany, and the United States, with a view to establishing chains of high-power radio stations on shore to meet the national and trade requirements.

Germany undertook the establishment of a high-power station in the United States to work with a similar station near Berlin. Great Britain contemplated an "Imperial Wireless Chain" designed to connect all of her outlying possessions with England by radio.

The United States Navy established its first high-power station at Arlington just outside of Washington as the terminus of a projected trans-Continental trans-Pacific High Power Circuit to connect the Navy Depart-

ment by radio with our Atlantic, Pacific, and Asiatic Fleets and to afford our government a means of communicating with our outlying possessions in the West Indies, the Panama Canal Zone, Alaska, the Hawaiian Islands, Samoa, Guam, and the Philippines, either directly or through intermediate radio relay stations, and entirely independent of cable facilities.

The Navy's main high-power circuit was to comprise, in addition to the Arlington station, primary high-power stations at points on the California coast, in the Hawaiian Islands, and in the Philippines. It was hoped that reliable trans-Continental service could be maintained between the Arlington station and a primary station on the California coast, thence with Hawaii and thence with the Philippines.

Secondary high-power stations in the primary chain were planned, one for the Canal Zone, one for the West Indies, one for Alaska, one for Samoa, and one for Guam, to work with Arlington direct or through one or more of the primary stations. Other stations of medium power were planned, but these nine stations were to be the principal reliances or key stations for exchanging communication with our three Fleets and with our outlying possessions.

Work was gotten under way without delay, and within five years all of the eight remaining stations were completed and placed in operation as were also several less important stations.

These nine key stations are located at Arlington in Virginia, Darien in the Panama Canal Zone, El Cayey in Porto Rico, San Diego in California, Pearl Harbor in the Hawaiian Islands, Cordova in Alaska, Tutuila in American Samoa, Guam in the Mariana Islands, and Cavite in the Philippine Islands.

These stations, extending nearly halfway around the world, have been maintained in daily operation since their establishment and they have rendered the service originally expected and required of them, with the exception of the Arlington station, this station having been supplanted as the terminus of the high-power circuit by the more powerful station subsequently established at Annapolis, Maryland.

Thus it will be seen that within an interval of about twenty-five years after Marconi's epoch-making demonstrations when he signalled, without utilizing connecting wires, over distances of from one to eight miles, the United States Navy had in daily operation in the

services of its Fleets and the Government in general, a chain of radio stations whose signals constantly were encompassing the globe, this chain of stations being the most widely extended, most effective and reliable, and comprising the greatest number of high-power radio stations of any country in the world.

The effective working ranges of these stations throughout all periods of the day and night and all seasons of the year is from 2,000 miles for the less powerful stations to 6,000 miles for the most powerful stations, such as the Cavite station in the Philippines; and these effective ranges, together with the widely separated locations of the stations and the fact that they are operated practically continuously, results in electrical impulses corresponding to the "dots" and "dashes" of the radio code com-

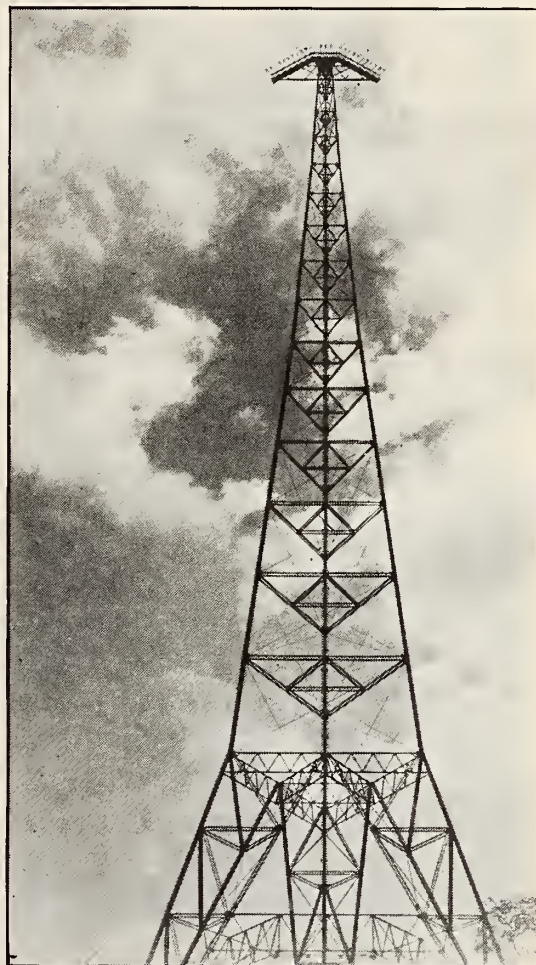

Upper section of one of the Navy's standard 600-foot self-supporting towers extending high up into the clouds. Note that the large antenna insulators are barely visible

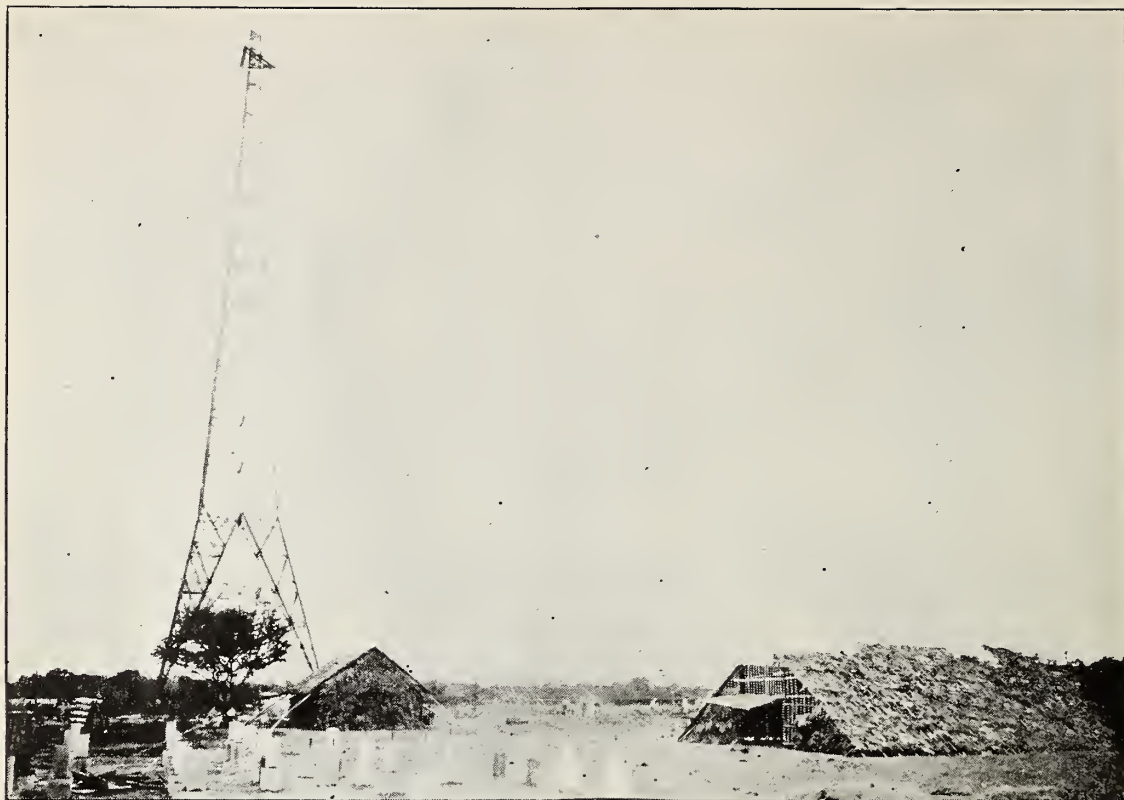

The application of science in the forward march of civilization. View of 600-foot self-supporting steel tower being erected among the native huts at Cavite, Philippine Islands

prising messages in the English language constantly spreading over the entire Earth.

Obviously the establishment and successful operation of this widely extended chain of high-power radio stations involved very great difficulties, not only from the constructional point of view but also the technical aspects of the situation.

In a pioneer undertaking of this kind when dealing with a new art whose development was then and is now rightly regarded as being only in its infancy, especially as regards the use of high power, very little authentic information was available as a guide as to what results could actually be expected in service, and the question of the most suitable type of antenna supports, antenna and ground systems, antenna insulators, types of transmitter, power supply, etc., were matters of theoretical contention based largely on personal opinions.

Time has proven that experience, and successful experience alone, is the only true guide in designing a radio system. This experience was not then available to the Navy. Nothing

is easier than to take a map, mark out radio station sites, connect them by straight lines and call the arrangement a radio system; but nothing is more fallacious in radio. The type of transmitter to be adopted was, of course, of very great importance, as was also the type, height, and location of antenna supports. Other important features could be modified, if required, after the stations were placed in service without involving excessive interruption to service; but it would be an extremely difficult and costly matter to replace transmitters or to rearrange the antenna supports.

One of the fundamentals in radio technique is that the strength of signals at a distant receiving station is dependent upon the effective height at which the overhead wires of the antenna system are suspended above the earth, and the value of the current delivered to the antenna without causing brushing or corona formation at the transmitting station.

Obviously, therefore, regardless of all other considerations, it is always desirable to suspend the transmitting antenna the greatest distance

that is possible above the earth, to insulate effectively the antenna from its supports, and to deliver the greatest possible current value from the transmitter into the antenna for communicating over long distances such as distances of 2,000 to 6,000 miles.

Three types of antenna supports were available from which a selection could be made, namely guyed wooden lattice masts, guyed steel pipe or steel lattice masts, and self-supporting steel towers.

A variety of factors must be considered in the selection of the type of antenna supports to be used, particularly at high-power stations, where the initial cost and subsequent upkeep must be given careful consideration, such as the area of the ground available for the station site and the cost required to purchase, if not already available, the availability, locally or otherwise, of suitable timber, in the case of wood masts, transportation facilities and labor costs, intensity of prevailing winds, nature of soil in connection with foundations, etc.

The Navy decided on self-supporting steel towers as antenna supports in preference to steel or guyed wood lattice masts in the interests of permanency, dependability, and comparative low cost of upkeep, notwithstanding the fact that the effective antenna height would be reduced thereby in the order of 15 per cent. as compared with guyed wood masts.

The tower height was fixed at 600 feet and to be of sufficient strength to withstand a hori-

zontal antenna pull at the top of 20,000 pounds. Three towers were decided upon for each station, the towers to be erected at the apices of a triangle 1,000 feet on a side.

Broadly speaking, there were only two classes of radio transmitters available for selection, one the damped wave system, and the other, the undamped or continuous wave system. The first question to be decided was which of the two systems should be adopted, whether the system of damped waves, or the system of undamped or continuous wave transmission, and the second question was the selection of a type of transmitter of the system decided upon.

The damped wave system as originally used by Marconi, based on the earlier experiments of Hertz, had been in general use in the radio services of Great Britain, the British Marconi Company and its various affiliated companies, including the Marconi Wireless Telegraph Company of America, for low power and medium power stations but it had not been successfully demonstrated for use in high power stations to work reliably over long distances.

In the damped or spark system of radio telegraphy the antenna is given a series of electrical impulses of considerable intensity but of very short duration at comparatively infrequent intervals, and the average power is thus a very small fraction of the maximum. If communications are to be exchanged over extremely long distances, the energy to be handled during one of these impulses becomes

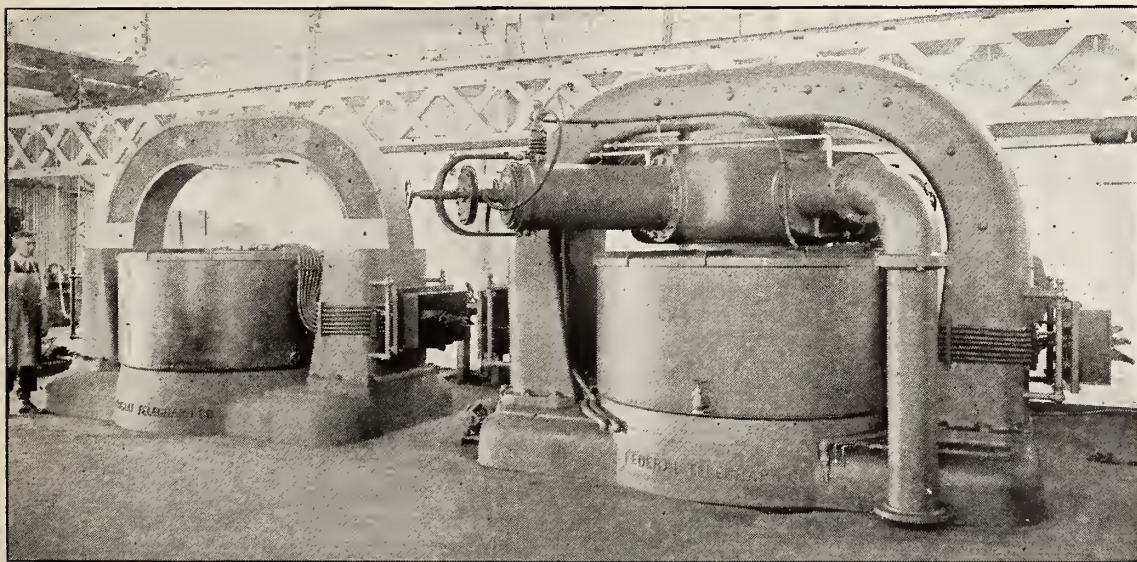

View of the Cavite and Pearl Harbor arc converters under manufacture and assembly at the Federal Telegraph Company's factory at Palo Alto, California

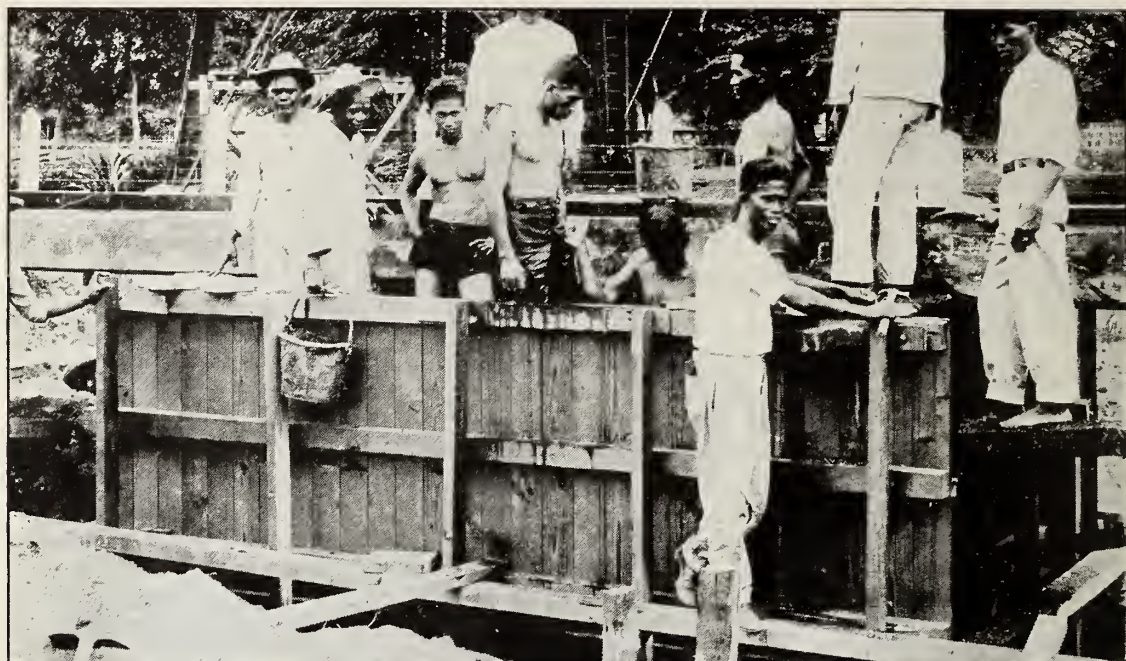

Native Filipinos working on the construction of the Navy's high power radio station at Cavite, Philippine Islands

so large as to be impracticable. Moreover, as a result of the increment and decrement of the oscillations, the effect of the method is to produce the simultaneous radiation of a wide range of wavelengths, or very "broad" waves, which seriously interfere with receiving stations which may be attempting to copy the signals of other stations. These facts were not generally recognized as early as the year 1912, but they are undisputed at this time.

About this time the Navy found itself in a most fortunate position, principally as a result of the early start it had obtained in the establishment of the high-power 100-kilowatt station at Arlington, and also two medium 25-kilowatt stations, one at Key West, Florida, and one at Colon in the Canal Zone. These stations, together with various other receiving stations, provided facilities by the use of which the relative efficiencies of transmitters of the damped and undamped systems could be tested under actual service conditions, and the results of these tests, when undertaken, proved conclusively that the undamped wave system was far superior for long-distance work.

Spark or damped wave transmitters had been installed in the Arlington, Key West, and Colon stations, a Fessenden synchronous spark set at Arlington, and similar, but smaller sets, at Key West and Colon. The various stations

were operated daily in service and the reliability and quality of the service under regular operating conditions and varying atmospheric and seasonal conditions had been determined.

Spark sets of from one half to five kilowatts power had also been installed in many other stations ashore and on shipboard, but these three stations represented what were then considered to be high-power stations.

THE ARC SYSTEM

IN ADDITION to the damped, or spark system, there became available, about this time, the undamped arc system as invented by Dr. Valdemar Poulsen and Prof. P. O. Pedersen of Copenhagen, Denmark, in 1902. This type of transmitter was just emerging from the elementary stages, and had not yet been developed for powers greater than thirty kilowatts.

An American radio company, the Federal Telegraph Company which had recently been formed, had purchased the exclusive rights in the Poulsen arc system for the United States and had also purchased two arc sets from the Danish Company, one set rated at five kilowatts and one at twelve kilowatts. The Federal Telegraph Company established a laboratory and factory at Palo Alto, California, for the purpose of developing and manufacturing arc radio transmitters, and undertook the establishment

of a few low-power stations along the Pacific Coast of the United States.

The Federal Company also established a 30-kilowatt station at San Francisco and a similar station at Heliia in the Hawaiian Islands, for trans-Pacific service. Fairly reliable service was established between the United States and Hawaii through these stations, the distance being approximately 2,500 miles.

The Navy's station at Arlington constituted at this time the most pretentious high-power radio station in the world, and while its signals could be heard over distances of 5,000 miles under the most favorable conditions, that is, at night during the winter months, the service was far from satisfactory during all periods of the day and night, and during all seasons of the year for distances of 2,000 miles.

The Arlington station, in which a 100-kilowatt damped wave set was in operation, and whose antenna was supported by one 600-foot and two 450-foot towers, made available most excellent facilities for a test of the spark or damped wave system of radio telegraphy as compared to the arc or undamped wave system.

COMPARISON OF SPARK AND C. W. TELEGRAPHY

ARRANGEMENTS were therefore made with the Federal Telegraph Company for the installation of one of their most powerful

transmitters, a 30-kilowatt set, in the Arlington station for comparative tests. In addition to the comparative audibility of the signals from the 100-kilowatt spark and 30-kilowatt arc Arlington installations at Key West and Colon and various other distant receiving stations, comparisons could also be had of the 25-kilowatt spark signals from Key West and Colon at the Arlington station.

Upon completion of the arc installation at Arlington, an antenna current of slightly more than 50 amperes was obtained, as compared to slightly more than 100 amperes obtained with the spark set. Notwithstanding this difference in antenna current in favor of the spark set, the average received signal strength of the arc set at Key West, Colon, and other distant stations exceeded that of the 100-kilowatt spark set under the varying conditions imposed during the observations.

The signals of the arc were audible at San Francisco and even at Pearl Harbor under most favorable conditions, the distance between Arlington and Pearl Harbor being approximately 5,000 miles. This demonstration clearly indicated the superiority of the undamped wave system of radio telegraphy over the damped wave system, particularly for use over long distances, and it proved to be the determining factor which influenced the Navy

Naval radio operators on duty in the receiving "hut" of the Navy's trans-Pacific high power station at Cavite, Philippine Islands



in the selection of the type of equipment to be employed in its high-power stations. As a further check and assurance as to the superiority of the arc, the cruiser *Salem* was dispatched on duty in the Atlantic Ocean, and exhaustive receiving tests were made on this vessel comparing the signal strength and quality of the Arlington spark and arc installations. The results of these receiving tests at sea confirmed, without the shadow of a doubt, the results of the previous tests made by distant stations on land. During the cruise of the *Salem*, the signals from the Arlington arc set were of readable audibility all the way to Gibraltar, whereas the signals emitted by the spark set were not at all times readable and at times were so extremely weak as to be scarcely audible, although the spark set employed more than three times the energy of the arc set.

The arc set was purchased from the Federal Telegraph Company and allowed to remain in the Arlington station. Shortly afterward a contract was awarded to that company for a 100-kilowatt arc transmitter, for installation

in the projected high-power station for the Canal Zone to be established at Darien midway between Colon and Panama City, this action being taken in spite of powerful opposition by commercial radio interests which were interested in the manufacture of the damped wave or spark transmitting equipment. The Darien set was the result of developments carried on in the United States in connection with the production of arc radio transmitters for high power, and further developments were undertaken resulting in the gradual production of 200 kilowatt sets for the San Diego station, 350 kilowatts for the Pearl Harbor station, 500 kilowatts for the Cavite station and the Annapolis station, and finally 1,000 kilowatt sets for the Lafayette station, the establishment of which the Navy undertook at Croix d' Hens near Bordeaux, France, during the war, as a precaution to insure the maintenance of uninterrupted communications with our Expeditionary Forces in the event of the cutting of the transatlantic cables by submarines.

(To be Continued)

1000-Kilowatt super high-power radio transmitting station erected by the U. S. Navy at Croix d'Hens, near Bordeaux, France, during the war to insure facilities for rapid communication between the U. S. Government and our Expeditionary Forces in France in the event of the expected cutting of the transatlantic cables by submarines. Eight 820-foot self-supporting steel towers as radio antenna supports, each tower weighing 550 tons or a total of 4,400 tons of fabricator steel support aloft an antenna weighing $3\frac{1}{2}$ tons. Will this station eventually be developed into a world wide radio telephone station?

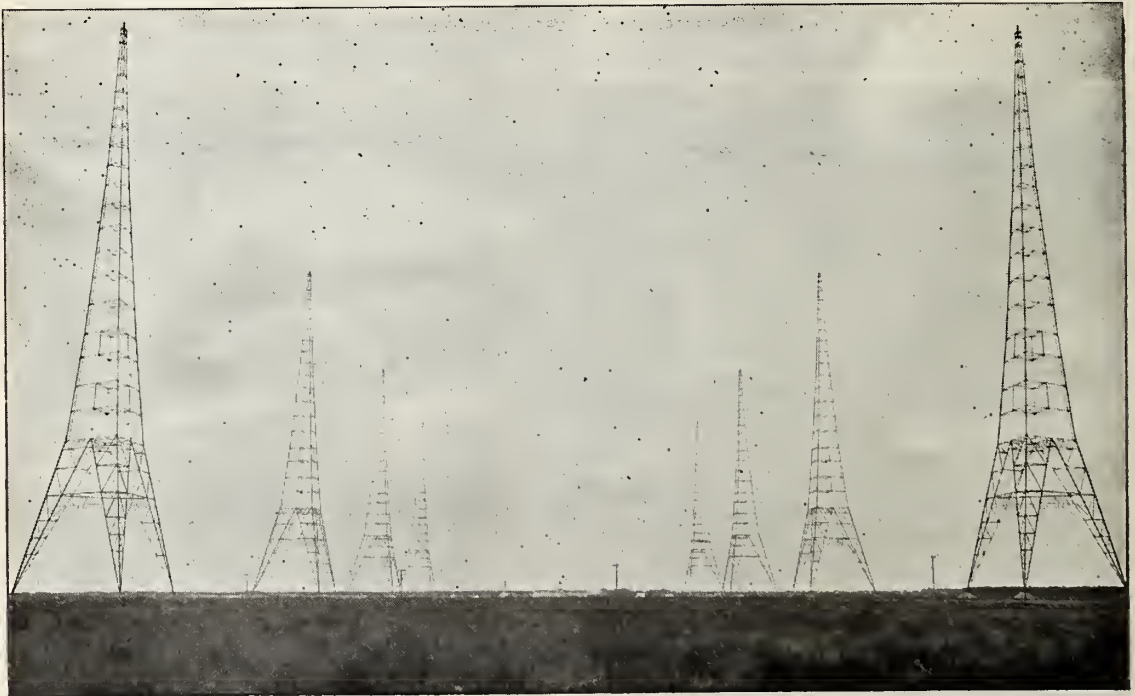

Radio in the Forest Service

How Electric Waves are Used to Fight the Timber-Devouring Fire God

By DONALD WILHELM

THE worst blow-down in the history of the Forest Service occurred on the Olympic Peninsula in Washington in the winter of 1920-21. There, in an impenetrable tangle of fallen trees, lay a huge potential pyre covering a thousand square miles, a nature-built bonfire ready for a match. Near the heart of that jungle, one day, appeared a settler with the match. Up above droned an Air Service airplane. Its observer, an "air ranger" assigned by the Forest Service, saw the settler apply the match and start to burn brush. He wirelessed down. A forest ranger five miles away got the message, relayed to him by land phone, and pounced on the settler in less than half an hour. That's one way in which radio has become useful to the Forest Service.

Without question, forest fires afford a distinctive opportunity as well as a unique problem to radio. What holocausts are to large cities; what mine disasters, summoning whole countrysides to mine entries where the instinct of every man is to rescue, are to mining communities; what war is, in fact, to whole nations, that, conflagrations are to great forests. They duplicate all the fires of war. They defy distance, once they get under way, and travel with terrific speed, roaring like the thunder of a thousand approaching guns. They strike terror to all the creatures of the forest: birds, snakes, animals, large and small, even insects, flee pell mell, before them. They seem to rise on their toes and topple forward to grab whole mountainsides and gorge themselves with huge mouthfuls of our remaining timber.

To stop such fires before they get under way—that is the only hope of the Forest Service. "To catch them quickly and catch them small," Chief Forester William B. Greeley told me, "that is the problem. The passage of time—the shortest possible lapse of time between the detection of a forest fire and reaching it—that is what tells the tale. Ordinarily the lapsed time is less than three or four hours, and then it is generally possible to get the situation under control. But it is often next to impossible to

reach the fire after it has been observed. When roads or trails have to be made, as in Idaho in 1920, for instance, when fires started one hundred miles from a railroad, you are apt to find an uncontrollable conflagration—frequently several in different spots."

HOW FAST FOREST FIRES TRAVEL

DURING dry seasons fire alarms are sometimes reported in a given area every few minutes, and the speed of the fire's spread is amazing. In one instance a fire galloped up a slope eight hundred feet high and more than a mile long in twenty minutes. In one of the forests in Idaho a fire traveled twenty miles in the course of a single afternoon. Another fire, near Missoula, Montana, devoured 24,000 acres of timberland in a day, racing over a distance of fifteen miles in five hours. In a National forest in California, the Klamath, a series of lightning storms started forty-eight fires in six days, while in the Trinity Forest a single disturbance in one day started seventy fires, also causing a number of others in neighboring areas.

And when the forest fire-fighting crews reach the scene of a fire, they find none of the facilities afforded by a city fire department. There are no high pressure mains, no fire-boats, no hose, no handy assistance in the shape of second, third, and fourth alarms bringing fresh men and equipment; there is generally no water. There is smoke. There is danger. There are frequently no roads or trails, and usually no fire-fighting apparatus except shovels and saws, picks and axes, dynamite, and the human ingenuity of volunteers in fighting fire with fire—that is, by means of backfires.

This is obviously a situation where your means of communication tell the tale. Without adequate means of communication, i. e. without hope of prompt assistance, an individual confronting a great forest fire covering whole square miles could expect to do nothing except join the creatures of its animal world and flee. But, with adequate means of communication, an individual has a chance of



THE FOREST PATROLMAN

Often finds himself above snow-capped peaks or rugged valleys, trusting in his machine. A forced landing here would mean disaster . .

holding his ground and staying the flames by rallying everyone available to his assistance.

OUR STAGGERING FOREST FIRE LOSSES

THERE are, in the 156,000,000 acres of our National Forests alone, approximately 6000 fires each season; there will probably be even more in the present season because the number of man-made fires increases steadily with the number of visitors using the National Forests. In 1921, the Chief Forester says, there were, in the National Forests alone, 3,000 man-made fires—fewer than usual because of favorable climatic conditions. From 1914 to 1917 there were from 4,300 to 5,600 each year. In the last 11 years there have been 42,000. "If, now," Colonel Greeley insists, "the number of man-made fires increases hand in hand with the increasing number of campers and hunters using the National Forests, the problem of fire control is wellnigh hopeless." The stake at issue, moreover, is not only material wealth, but human lives. The populace of Oregon, for instance, is in nearly all ways dependent upon forest fire control. The lumber industry is our second largest industry. It's annual production varies from \$35,000,000 to \$40,000,000 a year, and dependent upon the industry as a whole, the head of the Lumber Division of the Department of Commerce estimates, are about 700,000 Amer-

icans. And this industry looks to our National Forests as its last reserve!

These additional facts should also be kept in mind: in a few more decades, Colonel Greeley points out, if we continue our present rate of timber and lumber consumption, we shall reach the beginning of the predictable end of our lumber supply, which, even now, must be transported enormous distances at high freight rates, over single-track railways for the most part, when needed in most sections of the United States. Forest fires are thus more than sheer waste; they constitute a huge menace to our existing stands of virgin timber, to the young growth beneath it, to watersheds feeding some of our most prolific valleys, to one of our major "key" industries, to products that are used in virtually every unit, large and small, from the chair in which we sit to the home in which we live, of building and manufacture.

Now, in grappling with the fire god in those five states—Idaho, Washington, Montana, Oregon, and California—which hold eighty per cent. of our government timber, the forest fire departments include, in a volunteer sense, every man jack for miles around. The regular fire fighters, previous to 1919, consisted principally of lookouts on peaks or plateaus, and rangers on horse, on foot, or in automobiles where roads were practicable.

In 1909 a new factor came into play—the airplane, the lookout above the mountain. This new factor caught the popular fancy. In the two years following its advent the people of Washington and Oregon alone subscribed \$75,000 of their own funds, and in many cases much of their own volunteer labor, to provide adequate flying fields. Cities, counties, states, the Forest Service, and the U. S. Army Service did the rest. The Air Service established airplane routes over thousands of miles of mountains and valleys which the Forest Service observers could now read for signs of fire as one reads an open book.

In 1919, and in 1920 too, the airplanes did really wonderful work, not only in establishing a highly creditable record in reporting fires, for the most part without the use of radio, but also in reconnaissance and other work such as the incident related at the outset of this article.

AND NOW THE RADIO NET

THE tremendous value of the airplane not only in mapping areas like that of the great blow-down on the Olympic Peninsula, but also in directing the attack against widespread and treacherous fires, emphasized the value to the

Forest Service of aircraft, and, by the same token, the value of radio in order to make their observations almost instantaneously available. So in the season of 1921 an unprecedented use of radio as regular airplane equipment was expected.

It is not in point here to detail the disappointments that came with interruptions to the air patrols on account of the decrease in the size of the Army and the shortage in its supply of oil and gasoline—a shortage that public and private contributions, along with an unexpected expenditure by the Forest Service of \$7,500, rather tardily but for the most part remedied. The point is that, during that year, radio was for the first time used in a large way to supplement the system of land wires developed by the Forest Service.

Recognizing the fact that radio communication is the most important factor in the success of airplane Forest Patrol, the Radio Department of the Air Service interviewed the Forest Service relative to the employment of qualified licensed amateur radio operators to be stationed at the latter's headquarters in each National Forest. This plan provided for continuous contact with the airplanes, and also for



A FOREST FIRE

Filmed from the air by the Oregon Patrol

communication by radio between headquarters to supplement the land lines—one-party lines, in most cases, which often took from two to three hours to get a message through to the forester interested.

Then, preparatory to making this plan most effective, the Air Service established at Mather Field in California a radio school for sixty men, along with a liaison officers' school to

but the range obtained on the forest patrols in 1921 averaged one hundred miles, and in several instances two hundred miles. This is remarkable, and is due principally to the location of the receiving antenna, receiving apparatus, ability of the operators, and the altitude at which the patrol was flying."

This type of sending apparatus made it possible for the ground stations to keep in

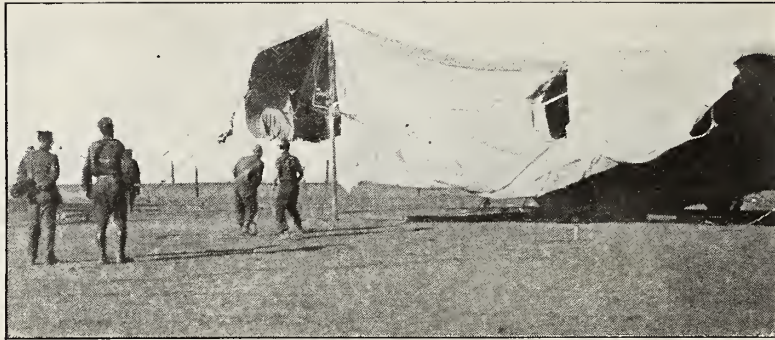

A TENT HANGAR IN A WIND STORM.
Which causes a temporary activity rivalled only by fire

quality officers to use the radiophone and telegraph from airplanes in directing fire fighting on the ground. Next, ample supplies were requisitioned and tested. Then the radio net, including the four airplane bases and fifteen other stations, was set up. Finally, in the opinion of both the Air Service and the Forest Service, it worked!

TYPE OF EQUIPMENT USED

THE regular Signal Corps set, type S C R-73, was used exclusively for radio telegraph transmission from the airplanes of both the Ninth and Ninety-first squadrons, employed in this work. The Ninety-first Squadron, patrolling the Oregon and Washington forests, equipped its airplanes with two complete sets and two antennas, one to be held in reserve. The Ninth Squadron, on the other hand, equipped its airplanes with only one antenna but two keys, one in each cockpit, so that either the pilot or observer could telegraph.

The Air Service officer in charge reported about this set that, "if properly installed and taken care of, this equipment is an efficient and reliable airplane damped-wave transmitter. The S C R-73 set was originally intended to have a range of approximately forty miles,

touch with the airplanes and even to maintain a considerable "overlap" while the planes were in transit between main station and sub-bases. The period allotted each observer to transmit his messages was so arranged that no two airplanes within the same range of reception of either radio station transmitted at the same time. As a result of this arrangement both stations could copy the airplane's messages. Each main and sub-base operates on a different wave length.

AIRPLANE SETS CAN TRANSMIT FROM GROUND

ANOTHER interesting fact about this transmitting set is that the patrol airplanes are equipped with the F-5 fairleads of the Air Service Radio Department, which are the insulating tubes passing through the fuselage of the airplanes for the antennas to be passed through, and they could transmit, when on the ground, by using the high-power tap of the set, signals that were audible at their home stations. This ability to transmit while on the ground was particularly useful when these airplanes were required to fly long patrols, or landed at outlying gas supply stations, none of which were equipped with transmitting sets.



THE FIELD AT COLLEGE PARK, WASHINGTON

THE RADIO TELEPHONE TRIED ALOFT

THE S C R-68 and-68A airplane telephone transmitting sets were installed on two airplanes at each of the main and sub-bases to be used for direct communication from the airplane to the ground and vice versa in combatting large fires. The plan was to have the airplane fly directly over the fire areas carrying a Forestry Liaison Officer to direct the fire fighters. However, the loud speaker used with the receiving set on the ground for this purpose during large fires proved of no value in some instances because the noise of falling timber, wind, etc., drowned it out, although communication by this means from the airplanes to the lookouts proved fairly successful. Accordingly,

the Air Service Radio Department immediately started experimenting at Crissey Field, San Francisco, with the power amplifier to adapt that instrument successfully to all emergency use.

The receiving sets used were also of standard Signal Corps design, with crystal detector sets as part of the equipment of all the amateur radio stations for use in the reception of signals from airplanes on patrol over immediate areas, and as a practical measure, since almost all of the amateur stations were a long way from the battery charging stations. Amplifiers formed part of all the main, sub-base and amateur stations, and battery charging apparatus was installed at all the main and sub-base stations for keeping airplane, radio and automobile batteries in good condition.



TAKING IT EASY AT BEAR MOUNTAIN CAMP

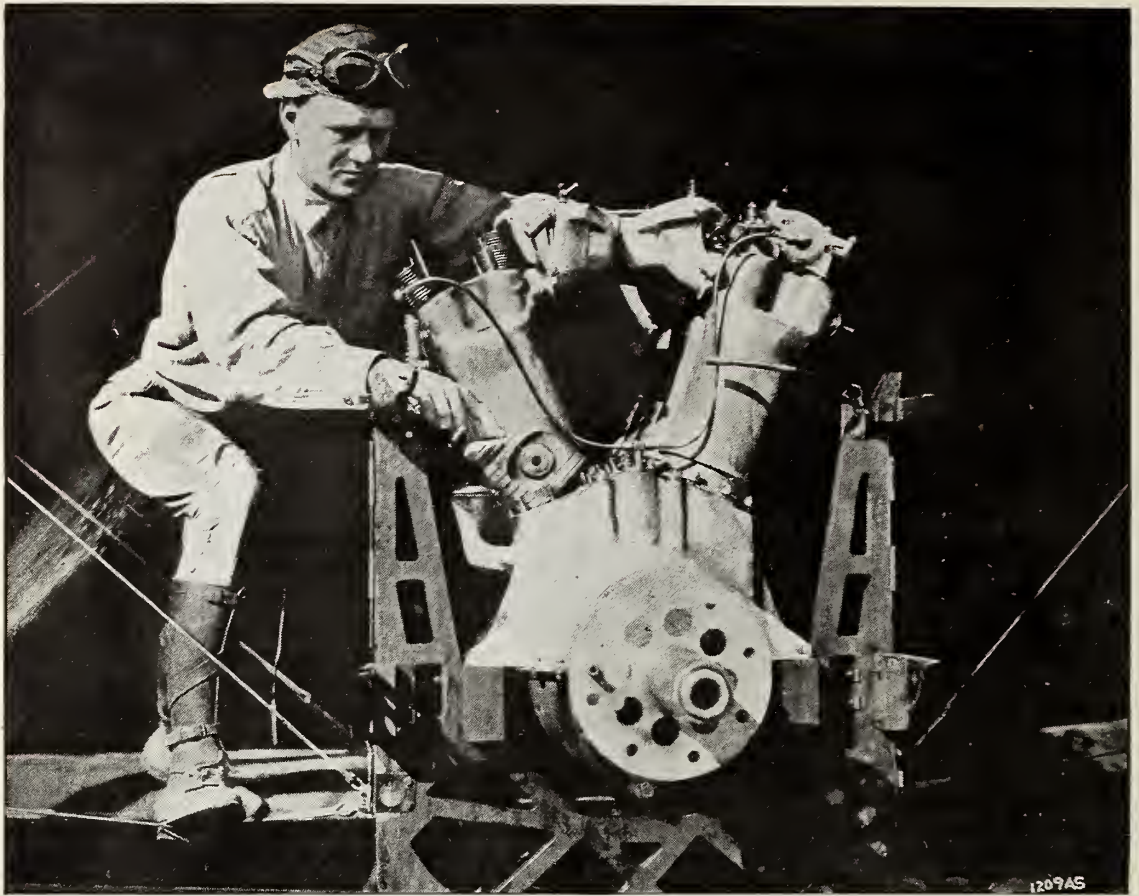

THIS FOREST PATROLMAN'S PISTON GAVE WAY

While in the air near Eugene. Broken crank shafts or other mechanical ills necessitating a forced landing on the side of a rocky mountain are part of the airman's daily life

The antenna installed at the main and sub-bases that were equipped with two-way (ground) radio communication consisted of the "T-type," the directional effect being used to favor the routes of the airplane patrol. The masts used were eighty-foot trees, felled, hewed, and transported from the forests by the Air Service personnel. The umbrella type of antenna was used at the sub-bases that had no transmitting sets, with the legs of the umbrella spaced so as to provide the directional effect desired on the patrol routes.

MODERN APPARATUS

FOR inter-field work the patrol net was equipped with three 1-kilowatt De Forest transmitting sets located at Mather Field and Corning, in California, and Eugene, Oregon,

as well as with two radio tractors, at Camp Lewis and March Field, in California; and an S C R-67A set improvised to use continuous wave telegraphy on occasions when it was not possible, because of interference, to use the voice, at Crissey Field, San Francisco. In addition, the two-control, free net system was used from Eugene, Oregon, and Mather Field—the control stations for Washington and Oregon on the one hand and for California on the other. The two-control stations had three closed periods each day to conduct their administrative business and transmit reports, weather news, etc. These periods were from 7 to 8 A. M., from 12 noon to 1 P. M., and from 6 to 8 P. M. At other times than these the net was free for each control station to use as its operator desired.

The Air Service officers in charge also pointed out in their recommendations the advantage of equipping all airplanes with continuous wave transmitting sets, and recommended the use of three powerful S C R-108 sets, the use of two 80-foot steel towers, and, besides these the employment of radio direction finding apparatus. "This system," their recommendations pointed out, "would greatly increase efficiency in locating fires, enabling the airplane to send the fire signal when directly over the fire, and the ground station or receiving station to determine the exact location of the conflagration, thus doing away with the necessity for an observer on forest patrol."

With such recommendations as these carried out, and with the steady increase in amateur stations, radio, one can readily see, has a promise—when Congress shall have forgotten its present passion for saving pennies while throwing caution, in some directions, to the winds—of serving, as no other means of communication can, in battling conclusively with the fire menace. The Forest Patrol net has proved its worth. The Forest Service has it down in black and white that, "radio was tried out last year on an extensive scale, and was a decided success."

There remains now only to point out that, thanks in part, of course, to the careful

personal selection of amateur operators by the Air Service Radio Officer who made the recommendations to the Forest Service, the radio amateur phase of the project was a success. Indeed, at the close of the 1921 season, no thought of giving up amateur service was even entertained.

Not much more needs to be added to the Forest Patrol radio net. It is pointed out that, in general, it can be used or readily developed to supplement the existing wire facilities and to consolidate the entire area of the National Forests in a communication scheme that will link together every lookout on the mountain and every airplane above the mountain with the main bases and sub-bases whence the rangers go forth on foot, on horseback, or in automobiles.

Yet, at the time this is written (late in June), this opportunity, this challenge to the fire god, seems destined for the present to go by default, unless you and I and all the rest of us who help to make up public opinion raise our voices in remonstrance, because the Forest Service cannot carry on the Air Patrol and hasn't radio equipment; because the War Department argues that it cannot afford the enterprise this year; because Congress told the War Department, "We're saving money this session."

Charging the "B" Storage Battery

By G. Y. ALLEN

In this article the author has covered in a most comprehensive manner various types of storage "B" batteries and methods for charging them from both alternating and direct current sources. Although this article deals primarily with "B" batteries, the principles involved are identical with those where the "A" battery is cared for with the exception that lower voltages are dealt with in the latter instance. A thorough study of this article should enable our readers to secure better results from their receiving apparatus.—THE EDITORS.

COINCIDENT with the advent of the vacuum tube there appeared the necessity of a source of high voltage direct current to supply the plate circuit of the tube. Before the days of high amplification, small flash-light dry cells connected in series in sufficient number to give the proper voltages were used

with success. With the coming of high amplification, however, and particularly with the invention of the regenerative circuit, the old type of dry cell was found to create considerable noise. Dry Battery Companies have improved their product, but there seems to be an inherent variation in voltage in any dry cell, due to the internal chemical action that has defied the

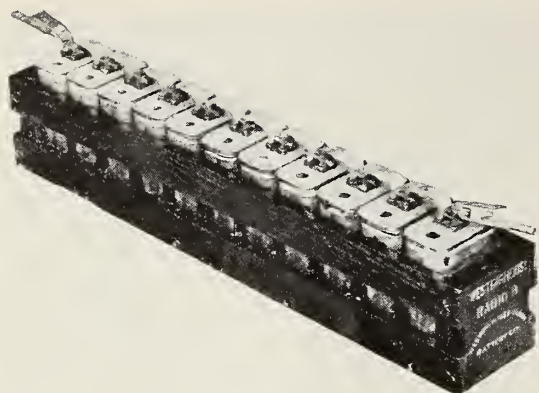

FIG. 1
A storage "B" battery of 11 cells

attempts of inventors to remove, and even the best dry batteries are guilty of producing many of the frying noises that are heard in most amplifying radio sets.

When radio traffic was limited to telegraph signals, no great objections were raised by the operating personnel to these battery noises. In fact they were considered a good omen as they indicated that the receiver was "alive." The telegraph signals could easily be read through the "hissing" sound and manufacturers concentrated in improving the quality of their batteries. It is true that during the war substitutes were sought for the plate dry battery or "B" battery as it is commonly known, but this was not done as a remedy for the noise created by the battery but due to the perishable factor in any dry battery and to the consequent difficulty of shipping batteries from this country and having them arrive in France in a usable condition.

Among other things, radio broadcasting has brought with it a demand for quality of reception. Music that may be perfectly pleasing to the experimenting amateur may be extremely irritating to the ear of the trained musician. The people who are now interested in radio are demanding perfect undistorted music from their radio receivers. It is with the thought of eliminating the inherent noise of dry batteries that storage battery manufacturers have developed a storage battery of size and capacity suitable for supplying the high voltage direct current needed by all vacuum tubes now on the market.

The action of the storage battery gives a very uniform discharge and it is practically free from any noise-creating action. Until

recently the design of a storage battery in small units has been impracticable. Within recent months, however, several reputable battery manufacturers have placed on the market batteries ideally designed for any radio receiver.

As the current consumed by the plate of the average radio receiving tube is but a few thousandths of an ampere, and as the plate area of a storage battery is proportional to the current it must supply, the plate area of a battery needed for the plate supply of vacuum tubes is very small. The height and width of the batteries now on the market varies from two to six inches.

Regardless of the size, each storage cell furnishes about two volts. The average vacuum tube is designed to employ from 20 to 100 volts in the plate circuit. Batteries are therefore made up in most cases of 11 or 12 cells arranged in some form of tray and delivering an average of about 20 to 25 volts. By connecting batteries in series, any voltage may be obtained.

Typical storage batteries are shown in Figs. 1, 2, 3 and 4. Figs. 1 and 2 show batteries of conventional design using heavy glass jars, lead plates, and dilute sulphuric acid electrolyte. Fig. 3 shows a somewhat radical departure from usual design in that there are in reality no jars for containing the acid, but it is held within moulded material pressed into intimate contact with lead discs which also hold the active elements of the battery.



FIG. 2
A lead type storage "B" battery

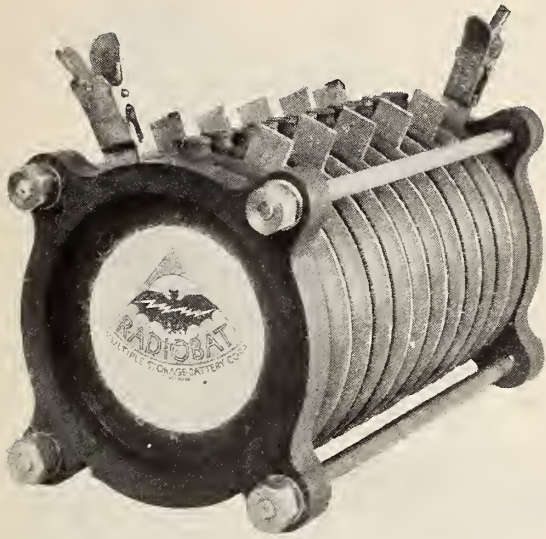

FIG. 3
A Storage "B" Battery of 11
cells utilizing gelatinous electrolyte

The one objection to any storage battery is that it must be kept charged. This means it must be connected to a source of direct current every two to four weeks and the energy consumed by the radio set must be replenished. Furthermore, even if the radio set has been idle for a considerable period, the battery must still receive its periodic charge to keep it in proper condition.

CHARGING FROM DIRECT CURRENT SOURCE

FOR those fortunate enough to live where they are supplied with direct lighting current, the matter of charging is extremely simple. It resolves itself into merely connecting the battery to the lighting system. Care should be used to see that the positive side of the electric power line is connected to the positive side of the battery or the battery will be further discharged and ruined instead of receiving a replenishing charge.

As the average direct current lighting current is 120 or 230 volts, and as the voltage of the plate batteries that the average radio set requires will total around 45 to 60 volts, the battery should not be connected directly to the line, but a voltage-reducing resistance should be interposed. This may consist of a 25- to 40-watt lamp of the voltage rating used for lighting, or a charging resistance may be used such as is shown in Fig. 5. If the electric bulb is used, the proper polarity may be

ascertained by noting the brilliance with which the lamp burns. The circuit should be connected momentarily first in one direction and then in the other. *It should be left in the direction which produces the dimmer light condition.*

When using the charging resistance shown in Fig. 5, the proper direction of the current may be noted by watching a milliammeter connected in the circuit. The ammeter is also helpful in showing how rapidly the battery is charging. The manufacturer always specifies the most desirable rate at which to charge the battery. Higher rates are detrimental and lower rates take more time than necessary.

Figs. 6 and 7 illustrate the proper connections for charging the plate battery from a direct current supply.

CHARGING FROM ALTERNATING CURRENT SOURCE

THE homes of the majority of buyers of radio receivers are supplied with alternating electric lighting current. The reason for this is that alternating current can most economically be sent over great distances and it is just as good for lighting as is direct current. It is, however, totally unsuited for charging storage batteries.

A better understanding of why this is will be gained from Fig. 8. The curve conventionally illustrates an alternating current. The horizontal line indicates equal time units and the vertical line indicates the instantaneous voltage. When the curve is above the horizontal line, the current is assumed to be going in what we will call the positive direction, and when it is below the line the current will flow in the opposite or negative direction. It will

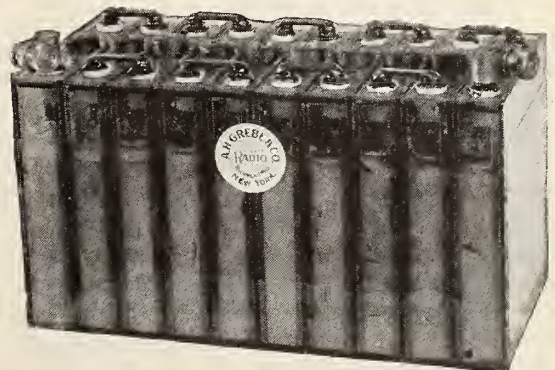

FIG. 4
A 20-volt, 3-ampere-hour storage battery of the unspillable type. Each cell is made up in a transparent compartment



FIG. 5
Charging Resistance

be seen from this curve that one half of the time the alternating current flows in one direction therefore, and during the other half of the time it flows in the reverse direction. Furthermore, these reversals of flow occur at the rate of from 50 to 120 per second.

Now a storage battery must receive a current in one direction only if it is to be recharged. If a storage battery should be connected to an alternating current line directly, it would perhaps receive a slight charge during, we will say, the positive half of the current, but it would receive an equal discharge during the reversal of the current. The result would be that the battery would probably slowly discharge instead of charge.

To charge a storage battery successfully from an alternating current line, therefore, something must be interposed between the line and the

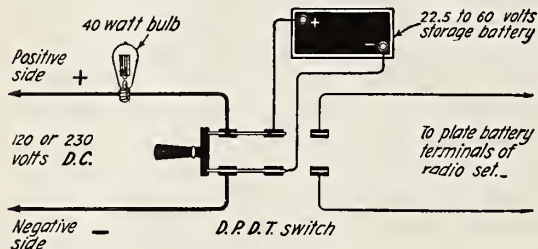

FIG. 6
Charging from a direct current supply

battery to insure the battery receiving current in one direction only.

This device may take the form of a kind of check valve that permits current to flow in one direction only or it may take the form of a motor generator, the motor being suitable for operation from the alternating current supply and the generator delivering a current suitable for charging the battery. In general, the former method is to be preferred as the apparatus costs less and is usually somewhat more efficient.

There are three standard principles on which these valves or rectifiers, as they are generally

called, are built. These are known as the chemical rectifier, the gas rectifier, and the mechanical vibrating rectifier.

CHEMICAL RECTIFIERS

THE chemical rectifier depends for its action on the fact that a current will flow in one direction only between a piece of metallic aluminum and certain kinds of electrolyte in which it may be immersed. If an aluminum rod is therefore immersed in a solution of ammonium phosphate, and if another electrode of some metal such as lead is also immersed in the solution, current will flow from the lead to

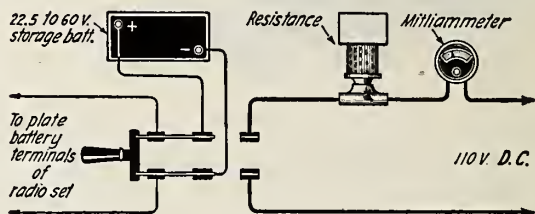

FIG. 7
The voltage varies with the time as shown here

the aluminum rod, but will be prevented from passing in the opposite direction. The reason for this is that on attempting to pass current from the aluminum rod to the lead, a large number of minute bubbles of gas are immediately generated around the aluminum, effectively insulating it from the solution and thus preventing current flow. In this analysis, the current is assumed to flow from the positive side of a battery toward the negative side. Most recent scientific investigations indicate that the current actually "flows" in the opposite direction, but the actual direction of current flow is unimportant as long as it is remembered that the chemical rectifier allows current to pass through in one direction only.

Fig. 9 shows a chemical rectifier now on the market, and Fig. 10 shows the most simple method of connecting it so that it will charge a "B" battery.

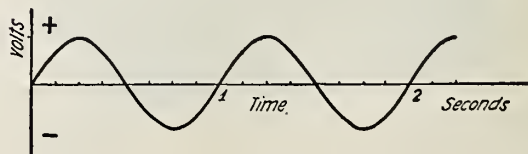

FIG. 8

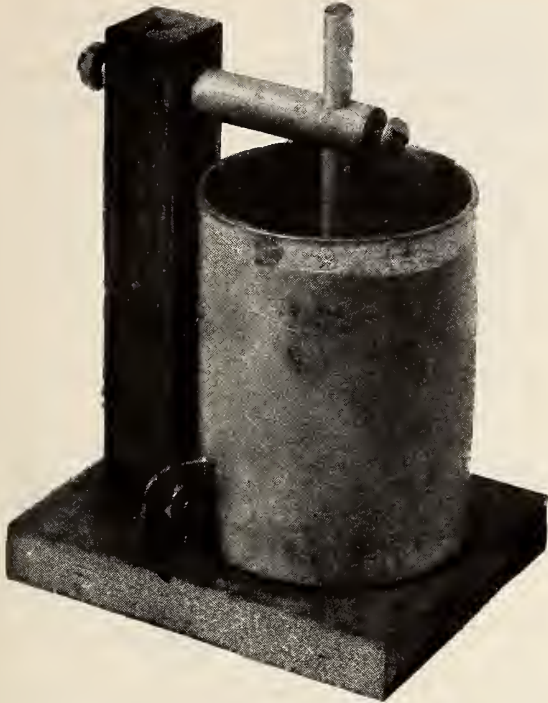

FIG. 9

Electrolytic rectifier suitable for charging 20 to 60 volt B battery from alternating current

Fig. 11 shows the kind of current the battery receives. It will be noted that this current takes the form of a series of periodic impulses, all of which, however, are in the same direction. The battery is being charged but half of the time it is connected to the line, but this does not indicate necessarily a low efficiency as there is no current flowing during the other half of the time and so no power is consumed.

If it is desired to charge the battery in a shorter time without damage, four rectifiers may be used as shown in Fig. 12. The battery will now receive a charge continuously.

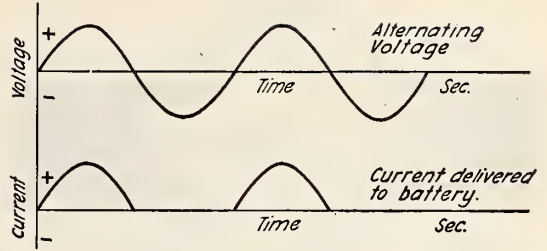

FIG. 11

Where a single rectifier is used the resultant current flows into the battery in the manner depicted in the lower graph

THE GAS-TYPE RECTIFIER

THE second type of rectifier, namely, the gas type, depends for its action upon the phenomenon of current passing in one way only through a tube filled with an inert gas when one of the terminals is comparatively cold and the other is composed of proper material and is heated.

A cross section of such a tube is shown in Fig.

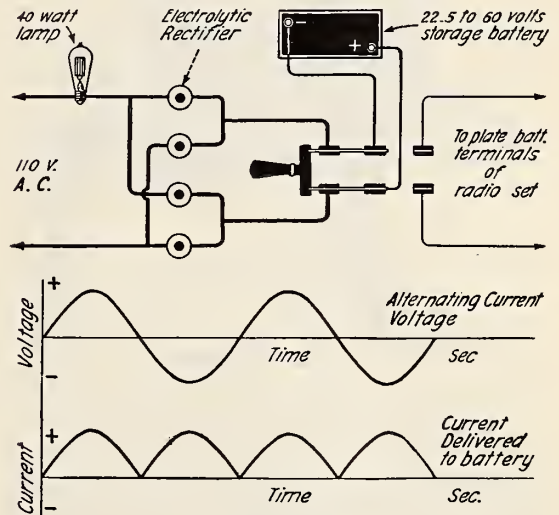

FIG. 12

The method of connecting electrolytic rectifiers and a lamp in circuit. The curves illustrate the resultant currents. The switching arrangement makes it easy to throw the batteries either "on charge," or into operation

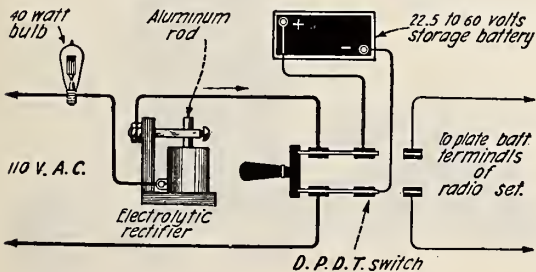

FIG. 10

An electrolytic rectifier and ordinary lamp in series combined with a D.P.D.T. switch is a good arrangement

13, and its action, briefly stated, is as follows:

The filament is heated to incandescence by some independent source of current. The filament, being of tungsten, gives off little particles known as electrons. These electrons are really negative charges of electricity, and if a positive charge is placed on the anode, they

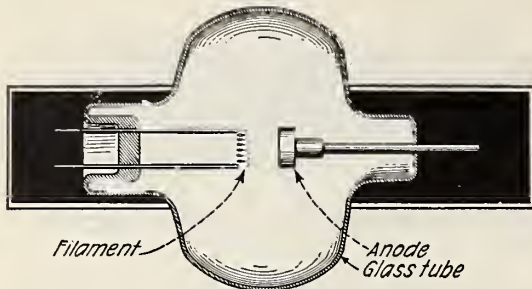

FIG. 13
Gas tube rectifier

are attracted in this direction. They attain such a speed that, in passing through the gas with which the tube is filled, they collide with its molecules, actually breaking them apart and setting free additional electrons. The final result is the existence of a large number of electrons, all of which will be attracted to the anode of the tube. Now these electrons really are electricity in motion and they thus serve to carry current across the space in the tube. As the conventional way of assuming the current flow is from the positive to the negative side of a battery, and as these electrons travel

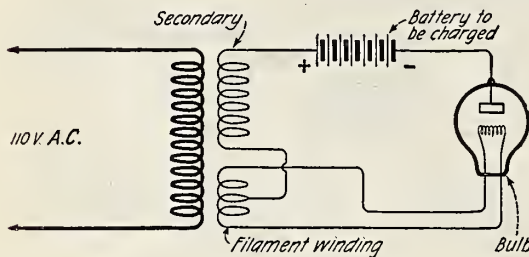

FIG. 14
A schematic diagram of a gas-filled charger

from the negative to the positive electrode of the tube, it is customary to say that the current flows in opposite direction to that of the electron flow.

If an attempt should be made to reverse the current flow by making the cold electrode negative and the filament positive, none of the negative electrons can leave the filament because they are highly attracted to the filament by virtue of the positive charge and are furthermore repelled by the cold electrode on account of its negative charge.

It at once becomes apparent, therefore, that current will pass in one direction only through a tube of this form, and it becomes worthy of

consideration in charging a storage battery from alternating current.

The schematic connections of a rectifier using a gas tube is shown in Fig. 14. As the voltage of the supply is generally considerably above even the voltage of the plate battery, a transformer is used to reduce the voltage economically. Two secondary windings are placed on the transformer, one carrying the actual battery charging current, and one simply for heating the filament.

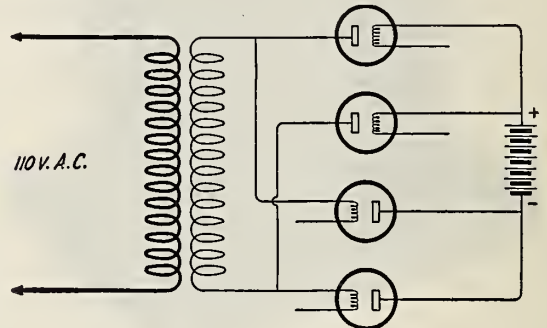

FIG. 15
Using both sides of the A.C. is made possible with this arrangement

With the connections shown, the filament will burn to incandescence as soon as the current is turned on. Now, if the battery to be charged is connected as shown, it will receive a pulsating charge every time the secondary alternating current is in a direction in which the tube will allow it to pass. On the reversal, the tube will not allow passage of current. The graph of the charging current will be practically identical with that shown in Fig. 11.

Rectifier tubes can also be arranged for charging from both halves of the cycle as shown in Fig. 15. The filament heating connections

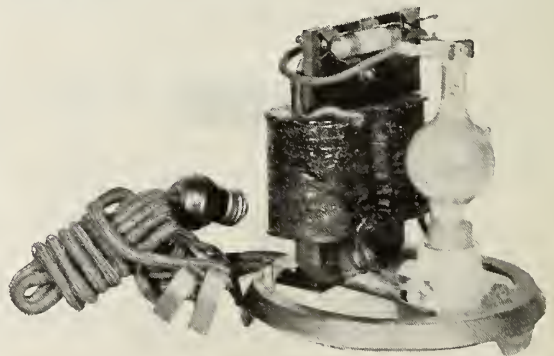

FIG. 16
Gas tube rectifier with cover removed

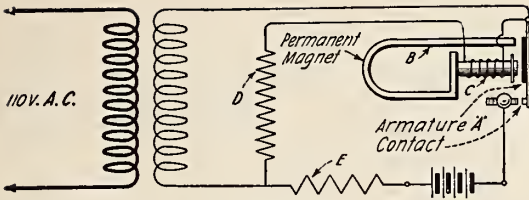

FIG. 17
Another form of vibrating charger

are not here shown, but they would be similar to Fig. 14.

One form of gas rectifier on the market is shown in Fig. 16. On examining the illustration carefully, it will be noted that there are two possible positions for the fuse. By placing it in one set of clips, the voltage is suitable for charging 6-volt filament battery, whereas the alternate position supplies a voltage suitable for the "B" battery.

MECHANICAL RECTIFIERS

THE vibrating rectifier differs from the above two types by depending on mechanical means for its action. It is simply an automatic scheme for mechanically connecting the battery to the line at each cycle when the current is flowing in the proper direction and disconnecting it when the current reverses.

A typical rectifier of this type is diagrammatically shown in Fig. 17.

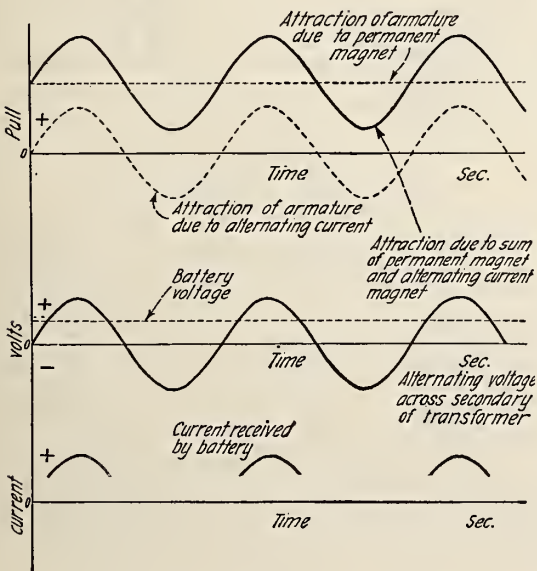

FIG. 18
This is what happens when the charger shown in Fig. 17 is in action

As in the case of the gas rectifier, it is customary to step the alternating current voltage down to a value suitable for the battery by use of a transformer.

In the diagram, "A" is an armature supported at one end and free to vibrate. Its mechanical natural period is adjusted to that of the alternating current on which the rectifier is to be used. "B" is a permanent magnet with one pole placed near to the vibrator. The other pole is in the form of a spool on which is wound a coil. Contacts are mounted on the vibrator which make contact with the stationary part as the vibrator operates. "D" and "E" are resistances to limit the flow of current.

As the vibrating magnet is wound on the

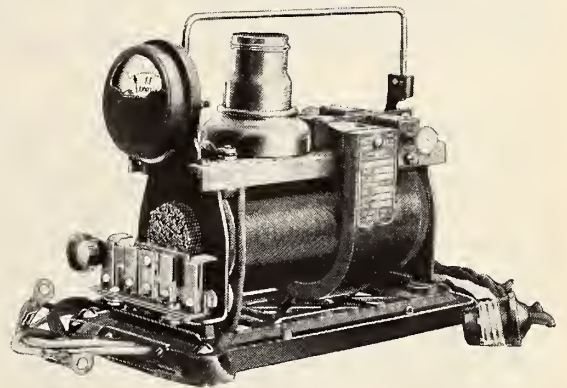

FIG. 19
A vibrating rectifier with switch for charging at different rates

pole of a permanent magnet, the attraction for the armature will decrease when current through the coil is in one direction and will increase when it is in the other. If the armature is mechanically tuned to the frequency of the current, and if it is provided with proper resisting springs, it will vibrate in synchronism with the alternating current.

If contacts are placed as shown, they will close when the current is in one direction and open when the current reverses. If the battery is placed in the circuit as shown, the vibrator may be adjusted to give the battery a charge in one direction only.

A better understanding of just what occurs can be gained by referring to Fig. 18. The first graph shows two curves, one indicating the constant attraction of the permanent magnet and one showing the variable attraction due to the alternating current. These attractions



FIG. 20

Another charger made on the vibrating principle

add to each other, giving the effect shown by the heavy line. It will be seen that the attraction for the armature increases and decreases once during each cycle. This will tend to make the armature vibrate back and forth once per cycle, which will close the contacts at the same rate. Using proper polarities, therefore, the battery will be connected to the secondary of the transformer every time the current flows in the proper direction.

There is one point of difference between this form of rectifier and the electrolytic and gas types. These two types inherently prevent the possibility of current flowing in the wrong direction and so discharging the battery. In the vibrating form of rectifier, on the other hand, this feature must be obtained by proper adjustment. This will be understood by reference to the second curve in Fig. 18. The dotted line represents the battery voltage, and the solid curve indicates the alternating voltage. If the contacts should be allowed to remain closed until the alternating voltage is less than the battery voltage, the battery would discharge, and the time of charging would be greatly increased. The third curve in Fig. 18 shows the battery charging current with proper adjustment. In this ideal case, the vibrator is assumed to make contact at the instant that the alternating voltage equals the battery

voltage and to break contact when they are again equal.

Figs. 19 and 20 illustrate typical types of vibrating rectifiers. These are both provided with ammeters so as to show the proper direction of the current.

There is one type of rectifier on the market that automatically takes care of the proper polarity and thus prevents improperly connecting the battery to the line. A schematic diagram of this charge, is shown in Fig. 21. It will be seen that there are two coils used, one being connected directly across the battery to be charged. This coil is used instead of the permanent magnet and its polarity, of course, depends upon which way the battery terminals are connected to the charger terminals. As the armature of the vibrator always closes the circuit between the line and the battery when the sum of the attractions due to the constant pull (in this case caused by the coil connected to the battery) and the alternating pull is greatest, the battery will always be charged regardless of which terminals of the charger it is connected to. With this type of rectifier, therefore, it is impossible to connect the battery improperly.

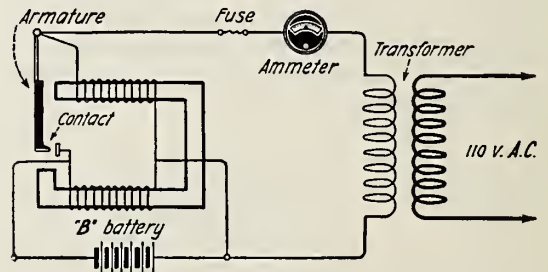

FIG. 21

A typical circuit arrangement of the vibrating type of battery charger

The only disadvantage of this type of charger is that low battery voltages will evidently cause a small amount of attraction due to the battery magnet, and if the battery is very badly discharged, it is possible that the rectifier will not function. If the battery is kept charged, however, this trouble should not occur.

From the above, it will be readily appreciated that the advantages of a "B" storage battery can be enjoyed by all, even those located in districts served with alternating current.



KING ELECTRON

Tells About Radio Regeneration

By R. H. RANGER

Engineer, Radio Corporation of America.

Trade Mark "King Electron" for illustrations registration pending. R. H. Ranger

THERE is a squeaking and squawking in the radio receiver. The expressive word "birdies" has been used to describe them. But it is certain that everyone has noted them, particularly one who has a tube set. They are caused by false oscillations either in the home set or in a neighbor's set. A better understanding of the actions involved may reduce this nuisance.

Regeneration does not mean getting something for nothing; it does mean making the most use out of the incoming signal to release the power of the batteries in the receiving set to give out sound. With the vacuum tubes as detectors or amplifiers, the receiving set may be considered as a trap ready to be sprung by the received signals.

Electrons. The little particles of negative electricity called electrons are everywhere as well as in the vacuum tubes. They are running around in any receiving set trying their best to follow the adjustments of the radio fan. In wires their paths are rather confined, but in the vacuum tubes they have considerable freedom, and as a result they can produce five or more times as much effect in a vacuum tube as they can in other ways.

When a Radio Wave Arrives. For this par-

ticular consideration, suppose a radio receiving aerial is set up connected through the condenser and coil of a tuning set to ground. On the reception of a radio signal, little electrons are sent scurrying down the aerial and the connected tuner to ground.

Of course, there may be many millions of these electrons concerned in any particular episode of radio action. But it may be just as well to represent the relative motions by only a few. In the drawings, consider that each electron represents a million million or so.

In the Tuner. Now the purpose of the tuner is to make a low resistance path for the travel of these electrons, such that with the continued waves coming from the transmitting station, they will develop quite a swinging motion, the sum total effect of which will be imposed upon the detector and telephone receivers.

If, due to the wave action, the electrons have rushed away from the top of the coil in the tuner, down toward the ground, the electrons from the vacuum tube will try to make up for the deficiency by going to the left from the grid of the vacuum tube through the grid-leak condenser to the top of the coil.

Grid Action. Now, one electron removed

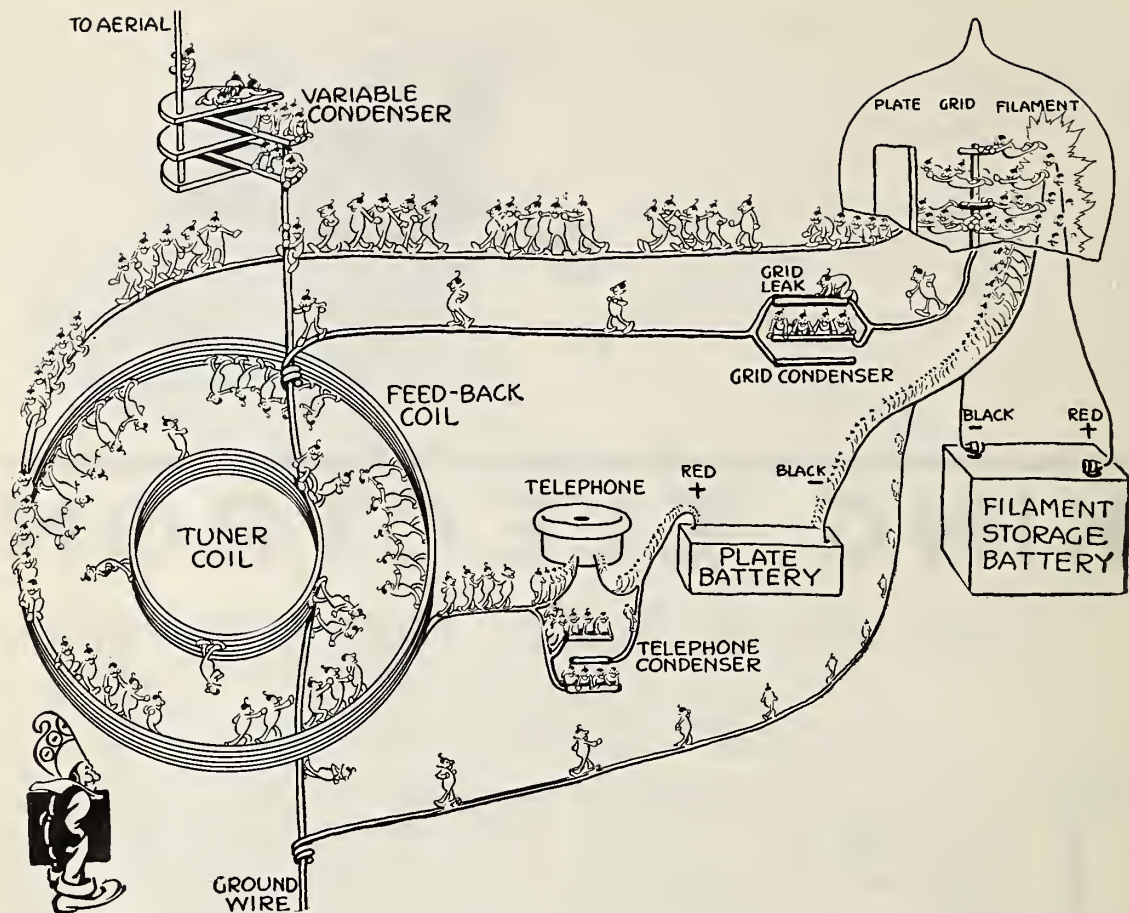

KING ELECTRON'S PICTURE OF THE RADIO RECEIVER AT REST

That is, before the radio signal puts in its appearance. The electrons in the antenna circuit, which comprises the antenna, variable condenser, tuner coil and ground are just waiting for something to happen. Because the storage battery is heating the filament of the vacuum tube, at the right, the electrons are leaving for the grid. In their flight they are attracted by the positive charge on the plate where they end their trip through space—although only about one of every six actually does land on the grid. The electrons which land on the plate continue their voyage by wire, moving through the feed-back coil and the telephone with its by-pass condenser, to the plate battery which supplies the driving force, eventually returning to the filament. The electrons which landed on the grid pass over the grid leak and its by-pass condenser to the tuner coil, through the ground lead, and back to the filament. "There are, then," says the King, "two circuits in action, waiting for their comrade, the antenna circuit, to join in the frolic"

from the grid may mean that six more will try to make up the deficiency in the tube and rush from the filament toward the grid. But only one will hit the grid and the rest will speed to the plate. This means that the plate current of the vacuum tube may be increased five times as much as the original current which caused the effect.

On the next swing of the ether wave coming from the transmitting station, the electrons will surge up in the aerial. These will become concentrated on the bottom plate of the tuning condenser. As this is directly connected to the grid of the tube, the grid will also have more than the usual number of electrons on it. This

will cut off the flow of the electrons through the vacuum tube. As before, the effect will be much greater in the plate circuit of the tube than the original current. So each swing of the grid will cause a much greater swing of the plate current. This is called amplification. As it is occurring in this case as fast as the radiowaves come through space, it is called radio frequency amplification. Although, with the regenerative connection, the vacuum tube is normally connected as a detector, to the extent just described, it is also a radio frequency amplifier.

Feed-Back Coil. To take advantage of this amplification, it is necessary to feed-back the amplified plate current into the grid of the

tube. This is done with the feed-back coil. The feed-back coil is connected directly in the plate circuit of the tube and is brought close to the aerial tuning coil. If a direct connection was taken from the plate circuit of the vacuum tube back to the grid circuit, the battery forces used to work the tube would get all mixed up. That is why this device of using a separate coil is used.

Transformer Action. Now, if the current in the feed-back changes, a new situation develops. Whenever electrons speed up or slow down, they react back on any other electrons that happen to be around. In other words, if for some reason electrons decide to rush

along a wire, the electrons in a separate wire near them will try to make up for this activity by running in just the opposite direction. They are just like a lot of people that always want to force themselves against any change, forward as well as backward. This is just the situation between the tuner coil electrons and the feed-back coil electrons. But the feed-back electrons have the best of it as there are more of them, and they have a greater driving force behind them. So when they start to rush around the feed-back coil, the electrons in the tuner coil rush the other way. This is the basis of the "transformer" action used in all electrical work.

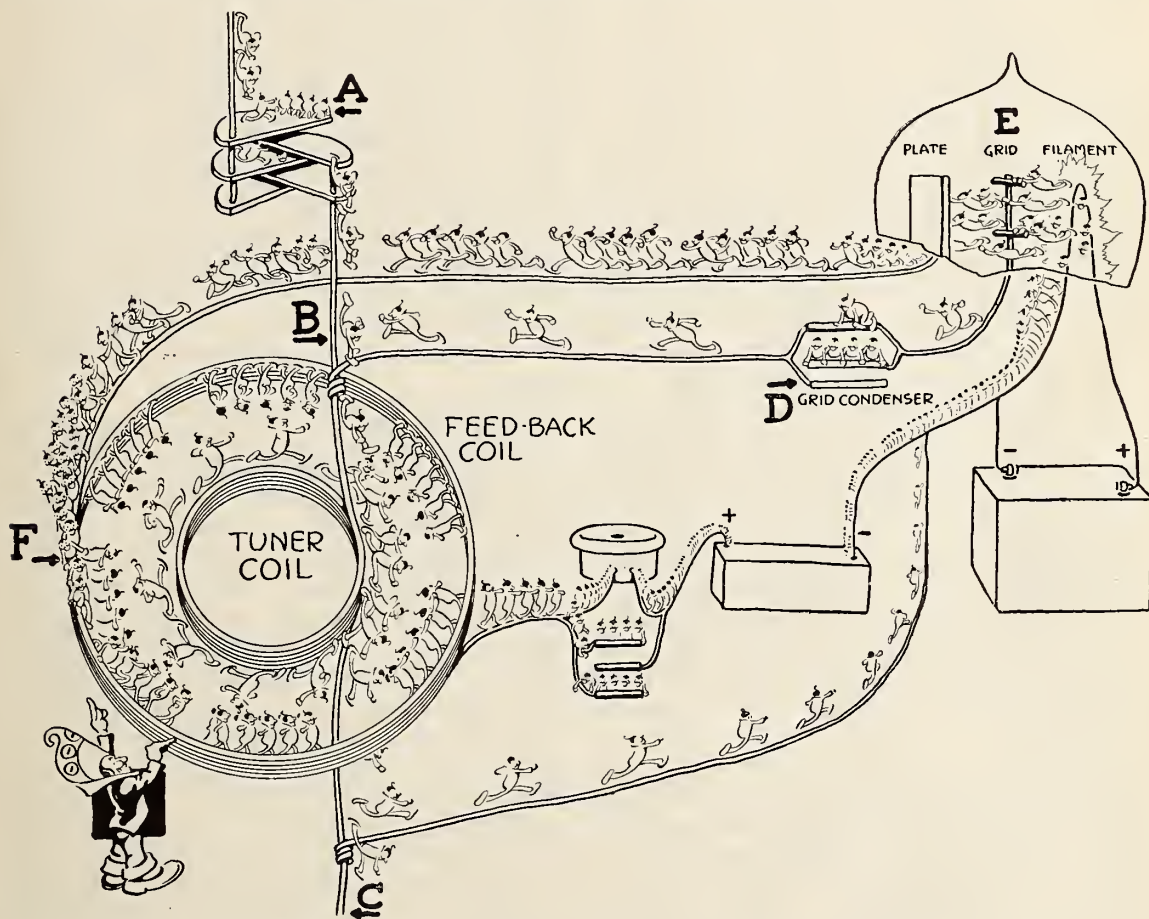

"BEHOLD!" SAYS KING ELECTRON, "A RADIO WAVE HAS ARRIVED ON THE ANTENNA

And has put new life into my lazy boys."

The wave forces the electrons down the antenna lead-in wire to the variable condenser, A. The electrons which were on the lower plates rush down through the tuner coil to the ground. While they hasten away they are joined by the grid circuit electrons, racing from the grid. This group only joins the fun while passing through the coil, for their home is in the filament and they return by branching off at C. Their departure from D, meanwhile, causes more to run down from E. So many come that they pile up and force their way across the grid-leak resistance. As the electrons leave the grid, E, their place is immediately taken by others, from the filament. Most of those leaving for the grid are attracted by the plate and finding that they can not return, race through the feed-back coil at F. The electrons have not noticed all that is happening and King Electron warns them

Feed-Back Connection. Now, the progressive radio-fan takes full advantage of this reactionary movement. The feed-back coil is so placed with respect to the tuner coil that the kick-back produced in the tuner coil by the feed-back or "tickler" electrons will force even more electrons to run down the tuning coil. This in turn takes more electrons away from the grid as before. At the grid, this speeds up the plate electrons again and the feed-back principle is carried as far as wise. From this it would seem as though the electrons were lifting themselves by their boot straps in this quickly rising process, and, with the batteries supplying the necessary power, that is exactly the case. The electrons are merely the agents and the radio-fan is the director.

Naturally this process must not be carried too far. If it were, the reaction would carry the rise to the limits of the number of electrons given off by the filament in the vacuum tube, irrespective of the strength of the received signals. It is absolutely essential that the output of the vacuum tube should be proportional to the strength of the incoming signals, in order that they may represent the variations which constitute speech and music at the transmitter. So the feed-back must only be carried to a point just below the complete swing.

Continuous Oscillations. When this critical position is reached, the electrons will act as though they were swinging to the limits of the pendulum-like action. When the limit is reached, the pendulum begins its return and makes a vigorous swing in the reverse direction, aided again by the feed-back principle which forces a swing started in the downward direction just as well as it forces one upward. As a result, the receiver will continue to oscillate electrically, even though no signals may be coming in.

As the set is connected to an aerial, these oscillations will be sent out exactly as radio transmission. They will cause interference on all the receivers in the neighborhood that are trying to receive signals near the same frequency as the oscillations. The result is the familiar squeak. For his own sake as well as his neighbor's, the radio fan will do well to promote "courtesy of the-ether" by keeping his set from reaching this oscillating stage which may be recognized by the mushy noise in the telephone receivers when oscillating occurs.

Feed-Back Design. As a matter of design, the radio fan will have two ways of controlling

the amount of feed-back. One consists in having a fixed number of turns in the feed-back coil (their number depending upon the wavelength to be received), and in adjusting its position with respect to the tuning coil. If the feed-back coil is directly inside or next to the tuner coil with the turns in the same direction in both coils, the effect will be at a maximum. If the feed-back coil is moved away from the tuner coil or turned with respect to it, the effect will be decreased accordingly.

Another way is to have the feed-back coil sectionalized with taps so that more or less turns may be used. With more turns, the feed-back will naturally be greater. It is also to be observed that more "tickler" action, as this feeding back is frequently called, is necessary for the longer wavelengths than for the shorter. The feed-back may also be accomplished by a condenser connection from the plate, back to the grid. Still another way is to allow the condenser action of the plate of this tube to react back on the grid inside the tube. In the latter case, it is necessary to put a tuning coil called a "variometer" in the plate circuit of the tube, so that it will tune this circuit of the tube to the frequency of the desired signals. These methods of course require more adjustment.

Operation. The radio fan should tune his set and adjust the feed-back or "tickler" at the same time. When the desired signals are heard, the tuner should be carefully adjusted for maximum signal strength and then the "tickler" should be carefully brought up to the point just below which "howling" occurs. If the howling starts, the "tickler" should be reduced rapidly and then brought up to a position just below the critical point.

Distant Signals. It is possible to find distant weak signals by using a little more "tickler" than usual. This will produce a singing note when the set is nearly tuned to the desired signal. By careful tuning, this note will be made to decrease in pitch to a vanishing point or "zero beat" position as it is called. The "tickler" action should then be reduced until articulate speech is heard. It must be remembered, however, that all the stations in the vicinity will receive the benefit of this experiment in the form of the squealing above referred to, so it should not be done when they may be listening to broadcasting on nearly the same wavelength.

Major Armstrong. Two little points of his-

tory are interesting in Major Armstrong's first work with regeneration.

While he was making his first tests, he said to one of his friends, "I have got something but I haven't quite figured it all out." That he did have something has certainly been amply sustained by science and the law.

At about that time tests were being made at Belmar, N. J., at the new receiving station of the Marconi Wireless Telegraph Company of America on the reception of signals from England. A series of 400-foot high towers extended for more than a mile from the receiving station. Engineers had been working for a considerable period trying to get worth while signals when

Mr. E. H. Armstrong came down from New York with a black box carefully painted to conceal its contents. With this device, readable signals were received from England by Mr. David Sarnoff, now General Manager of the Radio Corporation. A modest consideration would have obtained the full rights to the regenerative receiver inside the box, but the engineers stated that it was the mile of towers that did the trick. As a result, Major Armstrong had a long tussle ahead in getting the merited recognition for regeneration which proved such a valuable adjunct to radio reception during the World War, and which has now come to mean so much in broadcast reception.

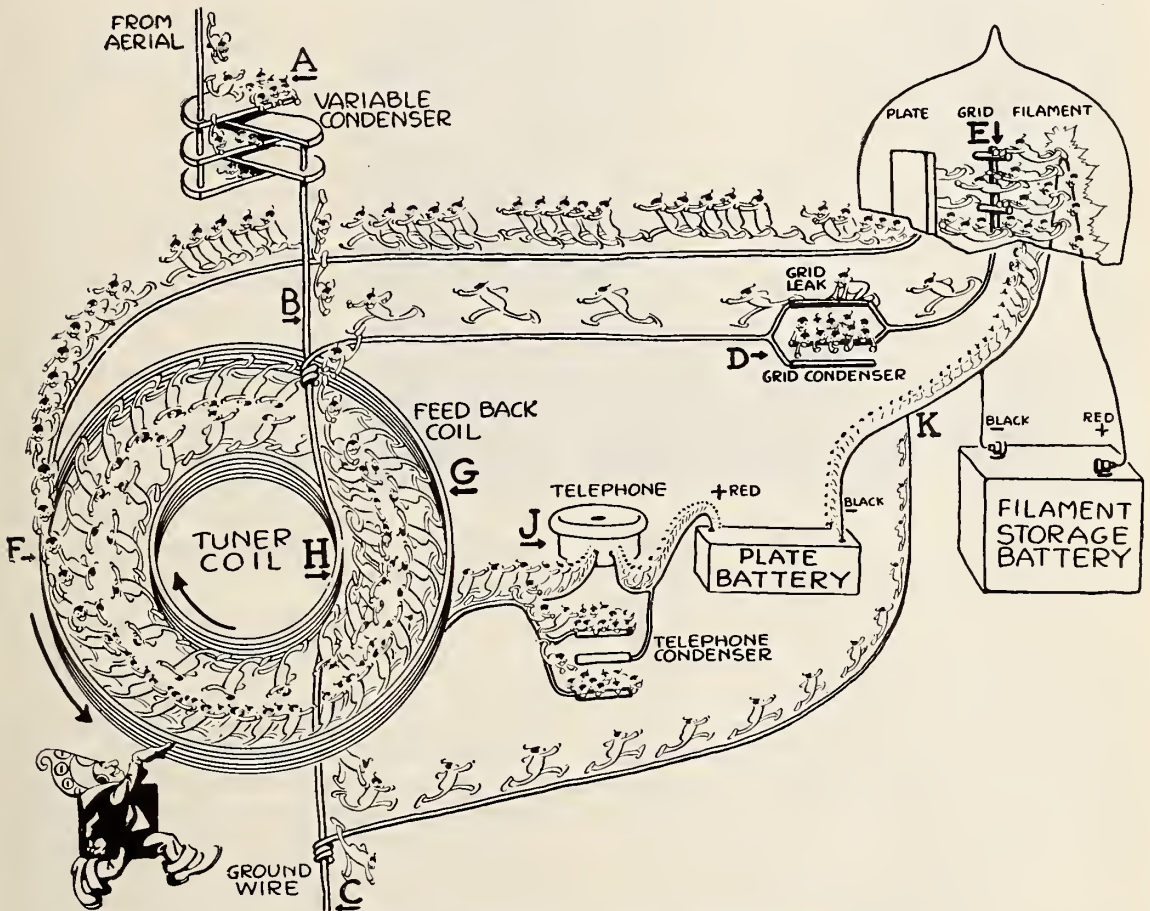

"KEEP THE POT A-BOILING," SAYS KING ELECTRON

As all the little electrons are on the go, around the feed-back coil and up to the telephone receiver at J. Here is a "house of too much trouble:" some of the electrons become disgusted, and pile up on the by-pass condenser to wait their turn to enter. From the receiver and condenser they rush on through the plate battery and back to the filament, K. The electrons in the feed-back coil have so much fun that those in the tuner coil become jealous and rush even faster in the opposite direction in an attempt to bring the average motion back to zero. They have been travelling in the opposite direction, but now there is actually a stampede. This action causes excitement among the electrons on the grid. The movement of the plate electrons is then at its height. With the repeated arrival of radio waves, the grid condenser, at D, tends to keep the grid negative, resulting in an increased average passage of electrons through the telephone receiver, making its diaphragm move back and forth in synchronism with the changes of the broadcasting transmitter

Armstrong's Super-Regenerative Circuit

A Discussion of its Advantages, Limitations and Some of its Variations, from the Standpoint of Assembly and Operation

By PAUL F. GODLEY

The author of this comprehensive article tells in a very concise way just what he has learned of the new circuit which, after it has been somewhat refined, is likely to revolutionize our system of reception. Mr. Godley has employed various forms of this circuit for several months and his observations should greatly assist experimenters in finding the right road.—THE EDITOR.

WHAT is super-regeneration? It is a remarkably clever combination of electrical phenomena which will relentlessly grip the thoughts and imaginations of radio folks everywhere. There is no doubt about that. At the time this is written but a few days have elapsed since Armstrong's disclosure of the new method of radio reception yet literally tens of thousands of folks are wrestling with the super-regenerative circuit in an effort to master it and learn its limitations. Oh yes—it has limitations. But what great steps forward do not have?

To the city dweller—the man who finds himself hedged in on every side by steel and stone, or to the man who is harassed by someone who is lightning-shy, super-regeneration will prove a boon. To the radio fan with experimental leanings it will come as a heaven-sent gift, for the combinations of the circuits it is possible to employ are extremely numerous, and in them lies endless fascination. But there seems to be some doubt whether the circuit is of great advantage to those who are able to erect an antenna, or to those who find themselves upwards of 75 miles from a broadcasting station. Commercial application alone can fully show its usefulness.

THE ACTION IS COMPLEX

THE actions within a super-regenerative circuit are manifold, and, given the equipment ready for operation, the large percentage of those who will attempt its use in experimental form are quite sure to experience difficulty in getting the circuit into proper operation, and many will find themselves completely discouraged by mysterious whist-

lings and hissings and squawkings. But, the objectionable sounds have each a meaning, and a very interesting one. Knowing something of their language, they serve well as a guide to successful operation.

The super-regenerative receiver is based upon the regenerative receiver shown in Figure 1, while both depend for their operation upon that property of the audion—the three-element vacuum tube—which enables it to reproduce very faithfully in greatly amplified form any feeble pulse of electrical energy which is fed into it. Thus, if an electrical pulse be induced in the grid circuit (see Fig. 1) it will appear in greatly magnified form in the plate circuit. The oscillatory pulse in the grid circuit will die very shortly in its effort to overcome the resistance of the grid circuit. Likewise that magnified oscillatory pulse in the plate circuit for the same reasons.

AMPLIFICATION LIMITED ONLY BY TUBE AND BATTERY CAPACITIES

BUT, if the plate circuit be "coupled" to the grid circuit in such way that its magnified energy reinforces the decaying pulse of the grid circuit, the effects of the resistance of the circuits upon the pulse may be either partially or wholly offset. That is, the initial pulse may be propagated for a short time or over an infinite period. The batteries supply the energy necessary for this action. If the regenerative action of the plate circuit upon the grid circuit is less than sufficient to offset inroads which circuit resistance makes upon it, the death of the energy pulse is but postponed. If the regenerative action of the plate circuit upon the grid is more than enough to offset resistance loss, the pulse grows rapidly

larger and larger due to the magnifying characteristics of the vacuum tube. This amplifying action is limited only by the carrying capacity of the tube and the ability of the batteries to supply energy. When the capacity of either one or the other is reached the growth of the pulse stops, but it continues its unceasing oscillatory movement through the circuits.

Suppose then, that our circuit is so adjusted as to make an energy pulse grow as it passes through the tube recurrently. A pulse acts upon the tube, increasing very rapidly in size until it taxes the full capacity of the tube, and continues thus indefinitely leaving no opportunity for subsequent incoming pulses of energy to affect the action of the circuits in any way. In this condition the circuits are of no value for reception. They must act on each of a long chain of pulses in exactly the same manner to be of service.

THE "CONSERVATIVE" RECEIVER

WHAT we have previously used and termed a regenerative receiver is not, strictly speaking, regenerative in its action. It is but conservative, and might now better be termed "the conservative receiver," for, to be of value the simple regenerative action may be carried only to that point where the energy fed back into the grid circuit by the plate circuit is somewhat less than that lost through toll taken by the circuit resistance. It is necessary that the first pulse be allowed to die out in order that the track may be cleared for its successor, and so on, and on. No true regeneration there; only conservation—though the energy conserved is quite large indeed and results in signals 100 to 200 times greater than had been previously possible.



©Kadel & Herbert

A THREE-TUBE SUPER-REGENERATIVE RECEIVING OUTFIT

Used by E. H. Armstrong at the Radio Club of America's meeting held in Columbia University. Signals from a loud speaker were clearly heard over the entire auditorium

To reach the capacity of the tube and supply battery, the average feeble signal energies must complete the circuit through the tube perhaps fifty times. If at the end of that time it were possible to kill the oscillation, amplification would have been accomplished and the path would be clear for subsequent pulses. On broadcasting waves (400 meters) fifty oscillations occur in approximately one sixteen-thousandth part of a second. It would then be necessary to stop the amplifying action sixteen thousand times per second approximately. The action may be stopped by throwing a high resistance into the circuit.

Armstrong does this in effect by throwing positive charges upon the grid of the tube—one every sixteen-thousandth of a

second, approximately. The instrument for accomplishing this remarkable feat comprises a second regenerative vacuum-tube circuit which perpetually oscillates at a frequency of say, 16,000 cycles (equivalent to a wavelength of approximately 20,000 meters), and which is

cation is enormous, being equal to the twenty fifth power of 2. During the positive half of the oscillator cycle, the grid of the oscillator tube is positively charged. This being true currents will flow by conduction from the filament of the oscillator tube to the grid.

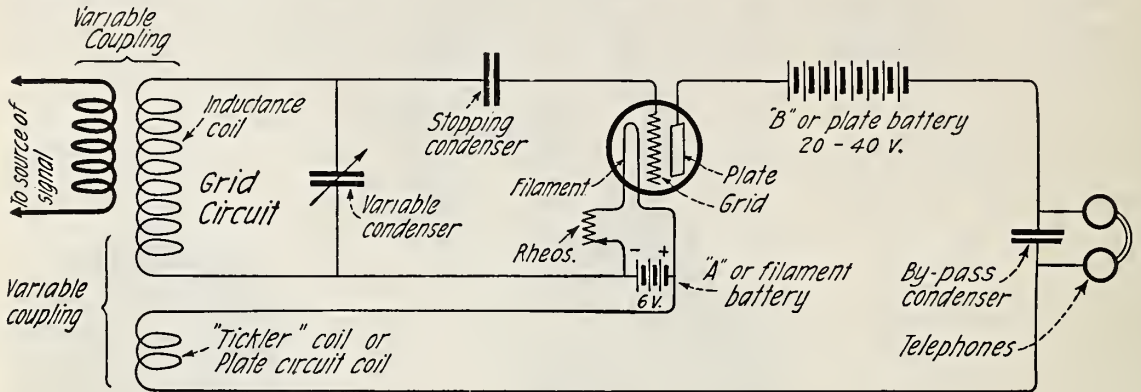

FIG. 1

properly associated with or coupled to the grid of the receiver tube, which thus receives, alternately, 16,000 each of positive and negative charges per second (Fig. 2). While the negative charge is upon the grid of the receiver tube it will function. While the positive charge exists it cannot function. While the oscillator tube is in the negative half of its cycle, the receiver (regenerative) tube is amplifying. While the oscillator tube is in the positive half of its cycle the regenerative tube is, for all practical purposes, doing nothing.

Thus energy is actually withdrawn from across the terminals of the regenerator inductance L 1 by the tube O, the path of this conduction current being from L 1 to filament, to grid, through C3 and back to L 1. The effect of this action is the same as though a considerable resistance had been placed in the regenerator circuits, sufficient energy being dissipated to stop the action of the regenerator. Thus the arrangement is highly effective.

That which will be of interest to most is an analysis of and details concerning the most likely of the several methods which Armstrong has devised for accomplishing super-regeneration.

Figure 4 shows the arrangement of the circuit of Figure 3 in such way as to call for but one set of batteries. By rearrangement of the oscillator circuit and the addition of an air core choke to confine properly the regenerated signal currents, preparation is made for further

THE MOST SUITABLE CIRCUIT

FIGURE 3 shows the schematic arrangement of the two tubes. The action in this circuit is as follows: assume the oscillator tube to be undergoing the negative half of its cycle (duration approximately one thirty-thousandth part of a second.) During this period the regenerative circuits are amplifying the signal pulse received by it from the antenna, and at a wavelength of approximately 400 meters the signal pulse would have made approximately 25 round trips through the regenerator tube. Assuming that each passage through the tube resulted in a magnification of 2 times, it is apparent that the total amplifi-

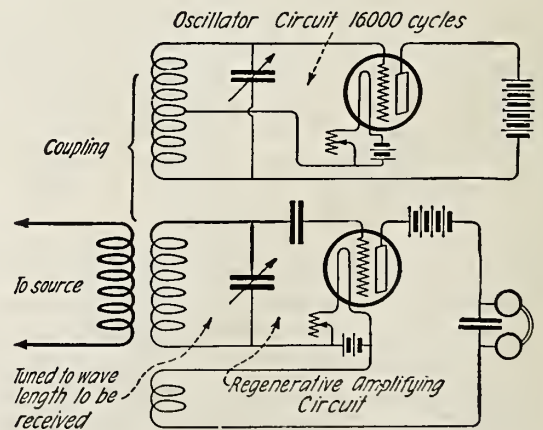

FIG. 2

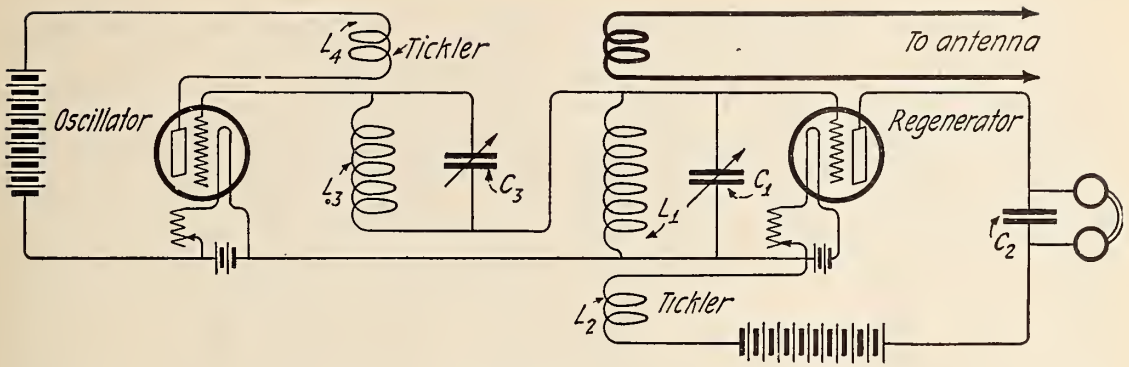

FIG. 3

improvement. The same method for controlling the action of the regenerator is still used however.

A list of materials necessary to put this circuit into operation is as follows:

- 1 Variocoupler of special design (see Fig. 5 and text.) This coupler comprises L1 and L2.
- 1 Loop antenna having 12 turns each 3½ feet on a side.
- 1 6-volt storage battery.
- 4 to 6 22½-volt blocks of "B" battery.
- 2 1500 turn honeycomb coils: (L3 and L4).
- 1 air core choke (L5). May be made by winding 300 turns of #28 insulated magnet wire on a form 4 inches in diameter.
- 3 Variable air condensers having a maximum capacity not less than .001 MF. (C1, C3, and C4.)
- 1 Fixed condenser, capacity .005 MF (C2).
- 2 Filament current rheostats.
- 2 Vacuum tube sockets.
- 1 Pair phones.
- 2 Amplifier vacuum tubes. These tubes must be of the hard variety. Soft, or gassy tubes will not function satisfactorily. The regenerator

tube may be a Moorehead, Radiotron UV-202 or any one of the Western Electric tubes such as Types E, J, V, or L. The oscillator tube should preferably be one of the latter, though either Radiotron UV-202 or UV-203 may be used, preference being given the latter.

The inductive coupler shown in Figure 5 may be made according to that sketch. Care should be taken to see that the windings of the "regenerator inductance coil" run in the same direction as those of the stationary coil of the tickler if the device is to be connected into the circuit as indicated in the sketch. In case this is not done, the terminals of the tickler may be reversed.

With reference to Fig. 4, it will be seen that the condenser C4 is connected through the inductance L5 to the grid of the regenerator tube on the one side, and through the "B" battery to the filament circuit of this same tube on the other. The inductance L5 is interposed in this circuit to choke back the high-frequency currents of the regenerative circuit. Without this, these currents would pass through the

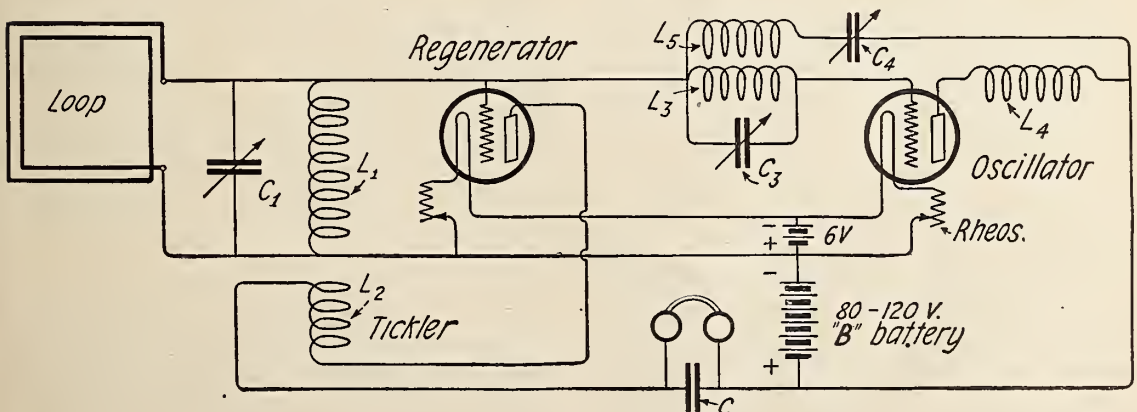

FIG. 4

condenser C₄ and very effectually prevent operation.

The action which takes place in this circuit has already been explained. However, it would appear from operation of the circuit as shown in Fig. 4 that in addition to acting as oscillator the second tube is also effecting some amplification, and this is quite possible. Full advantage of this possibility is to be taken in a later circuit.

HOW TO OPERATE THIS CIRCUIT

TO PLACE this circuit in operation, insert a pair of telephone receivers between the "B" battery and the inductance L₄. After lighting the oscillator tube, set the condenser C₃ at a point near its full value. Follow this by adjustment of the filament current, plate battery, and condenser C₄ until a high pitched audible note is heard in the telephones. If this is not forthcoming, look over connections. If it is forthcoming, the tube is oscillating at an

audible frequency. This is as it should be. Remove the telephones from the plate circuit of the oscillator tube and close the circuit. Oscillations will continue. An easy way of doing this is by employing a telephone jack and plug, which will make a complete circuit even when the plug is withdrawn.

To get final adjustments it will now be necessary to light the regenerator tube. The filament current and plate battery of this tube are also adjusted so that by advancing the tickler from a minimum toward a maximum value oscillations may be started. The presence of oscillations may be determined by placing the finger upon the grid terminal of the regenerator tube. If a decidedly pronounced click is heard, both when the finger touches

and leaves the grid terminal, oscillations are in process.

If a wavemeter is available it will come in handy at this time to those who are strangers to the circuit. Set it at the wavelength at which reception is to be effected and start the buzzer. Condenser C₁ may then be adjusted for the approximate proper value, and the tickler brought into play for the amplification. If no wavemeter is available a given station may not be picked up so readily. Suffice it to say that when the condenser is set at about half its value, the circuits will be tuned to approximately 350 meters, providing directions

as to construction have been followed. Attention is called to the fact that for regenerative action of the proper sort with this circuit much closer coupling between the plate and grid circuits of the tube is required than when the simple regenerative circuit is employed.

In advancing the tickler from minimum toward maximum a point will be reached where a

great hissing is heard in the telephones. Regenerative action is setting in at that point. Continue the advance of the tickler. The hissing noises will cease, or nearly cease, and it is at this time that the tickler coupling is adjusted to approximately the correct value. If this is borne in mind, the loop circuit may be varied over fairly wide limits in wavelength and the circuits at the same time kept in a fairly sensitive condition

WHEN THE SIGNAL ARRIVES

WHEN a signal is heard the best obtainable settings for strength should be made at C₁ and with the tickler. All adjustments should then be gone over. Vary the filament brilliancy of the two tubes for maxi-

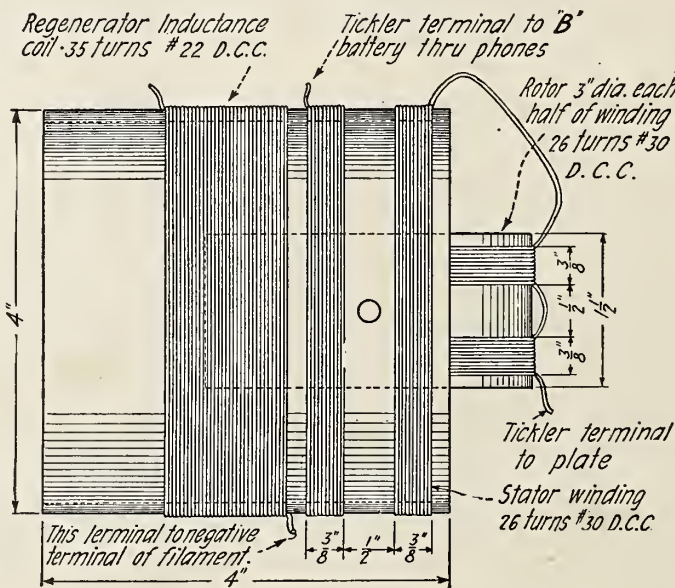

FIG. 5

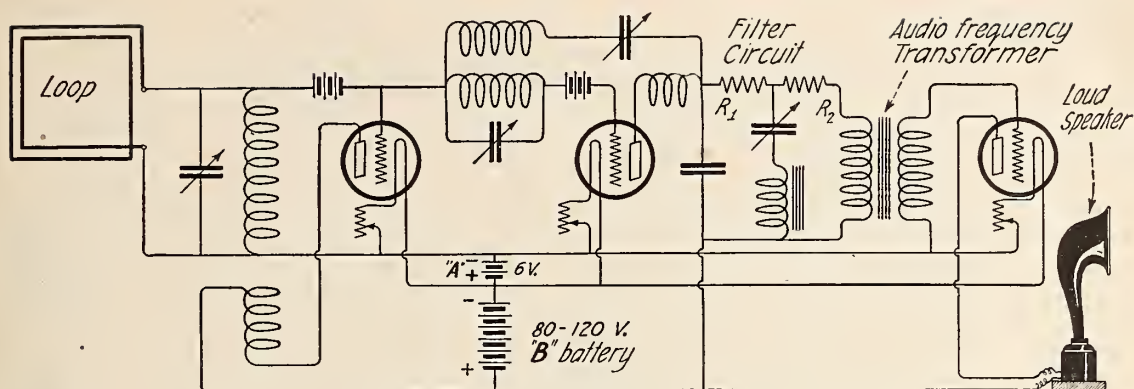

FIG. 6

imum signal strength. Likewise, search for the best value of plate battery for each tube, and swing the loop into that position where signal is loudest. For, it must be remembered a loop receives best only those signals which advance in a direction parallel to its plane. Do not, however, expect too great directionality from the loop. The wires and coils in the circuits themselves, as set up on the table will pick up some energy. The energy picked up by the circuits on the table will not usually add to those picked up in the loop. Use of the circuit will soon indicate this fact. When this is taken into consideration the loop may always be swung through an arc of 180 degrees to ascertain in which position greatest signal is to be had.

With further reference to Figure 4, this variocoupler may be assembled by setting a variometer of standard construction alongside and quite close to a coil similar to the regenerator inductance coil of the figure. For the standard variometer it will probably be necessary to use a 5-inch tube. In this case about twenty-eight turns of wire will suffice.

A MORE COMPLICATED CIRCUIT

FIGURE 6 shows a further step toward increasing the effectiveness of the circuit. It consists in taking the signal out of the oscillator circuit instead of the regenerative circuit. In addition to its previous functions, the oscillator tube now acts as rectifier and amplifier. The potentials generated across the terminals of the inductance L_1 modulate a resultant of the oscillations of the oscillator tube. This is rectified, amplified regeneratively by the oscillator tube circuits, and again rectified with a considerable additional amplification as the result.

The difficulties with this circuit are somewhat greater, the principal one being that, unless careful adjustment is made, beats occur between harmonics of the oscillator circuits and those energies which exist in the regenerative circuits. Also, since the telephones are in the oscillator circuit, the audible tone of the oscillator is heard at all times. The first is perhaps the most objectionable of the two from the experimenter's standpoint, for, if the pitch of the oscillator frequency is sufficiently high the ear will soon become deadened to it. But, from the standpoint of good quality of tone where voice or music is to be received, the latter is by far more objectionable, particularly where the third tube is added for the addition of a loud-speaking telephone.

If an inaudible frequency is used in the oscillator circuit, amplification will be less, for the lower the frequency of this oscillation, the greater the amplification. A compromise must therefore be made between amplification and quality where it is desired to receive broadcast programmes. This compromise is somewhat mitigated by the use of a filter system which is interposed between the oscillator circuit and the telephones or amplifying tube, and so constructed and adjusted as to bar all tones above 3,000 cycles which is the upper limit of tone frequencies of the voice and of musical instruments.

The construction of such a filter is not easy for the average experimenter, although the parts which it calls for may be purchased with little difficulty. The resistances R_1 and R_2 should be non-inductive and have a value of between 10,000 and 15,000 ohms. The inductance is made with an iron core and has a value of approximately 1 henry. The variable condenser has a maximum value of .005 MF.

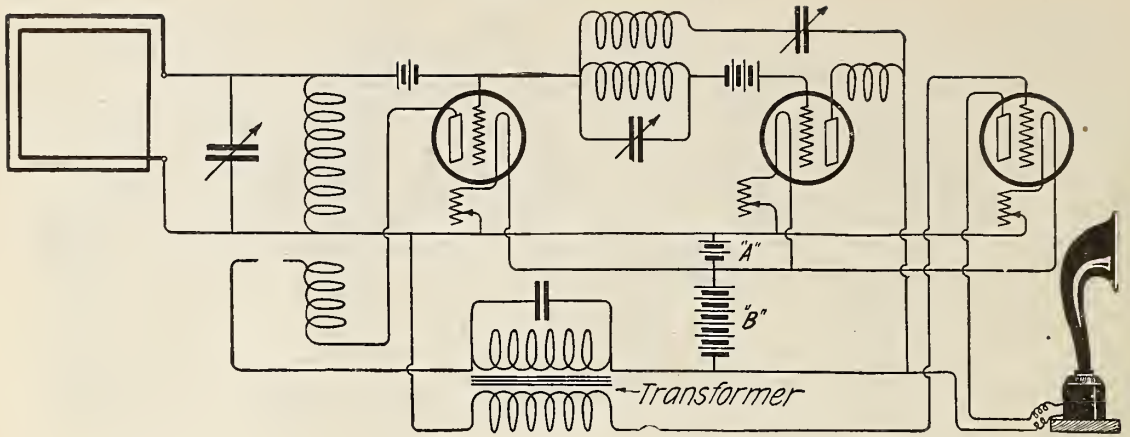

FIG. 7

The circuit comprised by the variable condenser and inductance of the filter is adjusted for minimum oscillator tone in the telephones or loud-speaker.

A COMPROMISE FOR BETTER TONE QUALITY

FIGURE 7 shows an arrangement for three tubes which is a compromise, the audio frequency amplifier tube being coupled into the regenerative circuit. This circuit will prove easier of operation, and, without the greater difficulties encountered in the circuit of Fig. 6, give good volume and quality.

FOUR FUNCTIONS WITH A SINGLE TUBE

ATTENTION is called to the biasing batteries in the grid circuits of the tubes in the last mentioned figures. This battery needs to be variable in $1\frac{1}{2}$ volt steps and to have a range up to about 6 volts. The use of these batteries gives considerable additional stability

to the circuits and thus enables greater amplification.

Figure 8 shows an extremely interesting application of the circuit. Here, one tube performs all functions,—regeneration, amplification, oscillation, rectification. Here one tube is used with very great effectiveness. The circuits are not particularly easy of adjustment but are recommended for trial to those who have found it possible to master the previous circuits.

A careful study of the actions which take place in the super-regenerative circuit and a little patience will be rewarded. The combinations of the circuit which will be suggested to those who do understand the principles of action are unlimited. Only a few have been pointed out here, and it is to be expected that for months to come a great deal will be heard as to what has been done by countless amateurs with this new method.

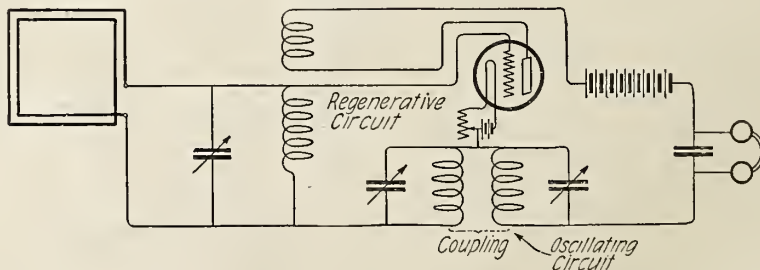

FIG. 8

Radio's Great Future

By Herbert C. Hoover

Secretary of Commerce

RADIO implies the extension and betterment of means of communication everywhere. It is incredible that the new science will, therefore, prove to be a fad of merely passing importance. For, clearly, from the very beginnings of recorded history, man has struggled against the barriers of distance in his effort to impart and to receive information, to discover and to afford diversion, to develop transportation and trade.

Before the advent of the wireless, although we had the telephone and telegraph for inter-point communication on land and via sea cable, there was no way by which we could communicate with moving bodies either on land, in the air, on or under the surface of the sea. Now radio serves such carriers. Again, before the advent of the radio telephone, there was no instantaneous means of communication for use in broadcasting information and entertainment to tens of thousands of listeners simultaneously.

Now, because radio bridges these and similar gaps, the ideal of universal communication, which has long aimed to inter-relate everyone possessing the necessary equipment anywhere on this earth, is in its realization predictable and must be accepted as an augury of better understanding and of swifter means of accomplishment throughout the world.

Fortunately, too, as a result of the Radio Conference called by this Department early in the present year, bills are now before Congress which promise to provide order instead of anarchy in the ether. The new radio industry is unique in that everyone is unanimous in the common desire for legislation and regulation that will make the new science of the greatest possible good to the greatest possible number of Americans.

The accomplishment of this legislation may, accordingly, be considered as the next important step in the progress of radio and in the extension of its use throughout the United States.

© Underwood & Underwood



Shall We Have Music or Noise?

PERCE B. COLLISON

THE facts brought out in this article will interest the three groups most interested in radio-telephone broadcasting. First, the broadcaster, then the merchant who is entering upon an entirely new field, that of demonstrating and selling radio apparatus, and last but not at all the least, the general public—the consumer.

Radio-telephone broadcasting is epochal and is here to stay, but we must concede that much must be done to bring it to a point where it will approach perfection.

Our congratulations and thanks to “KDKA”, “WJZ” and those other splendid pioneers, but unfortunately there are many individuals operating inefficient and poorly designed equipment, more or less conglomerate collections of miscellaneous parts assembled by persons with a rudimentary knowledge of radio-telephony.

For example,—the writer has been listening to a certain broadcasting station for a couple of months and was thoroughly disgusted with the quality of their signals and their programmes. The operators of this station frequently ask for comments on their signals and usually at the close of their evening programme acknowledge with thanks the many “complimentary” letters and telephone communications they have received. But their efforts do not deserve such praise and it is suspected that they receive no such compliments, or that if they do, they come from poor judges.

On a certain evening a piano selection was being “rended” in a wretched style and I was goaded into calling these people by telephone and protesting. A young man answered the phone and in response to my unwelcome criticism he stated that he was surprised to learn that their signals were poor and asked for suggestions. I explained what I thought was wrong and to demonstrate what I meant I placed the transmitter of the telephone a few feet from my “loud speaker” and let him drink his own poison. He was inclined to believe that my receiver was at fault so I picked up another better station and let him listen to

some good signals. This finally convinced him that his station was greatly at fault and he promised to do better. But did he? He did not. Night after night they continue to flood the ether with squawkings that bring unpleasant remembrances of the old tin-horned gramophones. This stuff, for that is all the title it merits, will discourage thousands of prospective purchasers of radio-telephone receiving apparatus and should be ruled out of the ether.

These and other malefactors, even though they may be operating with the best of intentions, are arousing a storm of protest and harsh criticism that will react against every broadcasting station in the country unless something is done to improve their programmes. Their main fault lies in imperfect modulation and wrong methods of recording. As a general rule a single voice singing gives much better results than a chorus. Likewise a few stringed instruments sound better than an entire symphony orchestra. Jazz bands are an abomination and should be absolutely eliminated, not because the public does not like jazz but because the scrambled mess of disjointed harmony that is jazz just cannot crowd into a telephone transmitter, with the result that all the public hears is a babel that bears no resemblance to music. What the public wants is music, not excitement!

Piano music, if used at all, should be carefully chosen and then played by an artist. Canned music is not wanted, that of phonographs or any other instrument. We all have our share of good phonographs and player-pianos and they give us much better music than has ever been broadcasted by radio-telephone. The writer has listened to a score of piano concerts and has noticed one particular fault. In many compositions certain softly played portions are hardly audible and then when the artist crashes into a grand finale the telephone diaphragms go crazy. Something should be done to keep the volume more even, if necessary instruct the recording artists not to play either too softly or too loudly. Impress upon them that there are certain limitations to a radio-telephone transmitter and let them keep within

those limits. Artists when making phonograph records must observe certain rules, and radio-telephone broadcasting should be governed by similar rules.

Speeches! Unless the speaker has a message to deliver that is of great importance or of assured public interest he or she should neither be asked nor permitted to bore several hundred thousand people with some lengthy discourse on abstract subjects. Propagandists, politicians blowing their own horns, well meaning but terribly uninteresting welfare workers, rabid attacks on city or state governments,—these and others of the same type,—please stop them. Give us authentic briefs of the day's news, crop reports, information regarding the science of agriculture, fashion and house-keeping hints for the women-folks, sporting news for the young folks, perhaps a bed-time story for the children once in a while, and then only in fifteen-minute doses. Every programme, every day, should be planned to be of some interest to every member of the family, else interest will lag. The present rush to buy radio-telephone apparatus is the result of clever press agent work and its decided novelty. If this interest becomes dulled because of uninteresting broadcasted programmes the industry will suffer throughout.

The general public has purchased receiving apparatus to be amused and interested, and if the broadcasting stations do not maintain a

high standard they will defeat their own purposes.

So much for the broadcaster.

Now I am going after the merchant.

Just recently the writer was walking along a busy street and observing a crowd in front of a building a few blocks away, and, being possessed of the usual amount of metropolitan inquisitiveness, he decided to investigate. Upon approaching the crowd he was greeted with a babel of noise that sounded like the wild whoops that are showered upon Babe Ruth when he swats another ball into "the great beyond." The cause of all this commotion was a "loud speaker" connected to a radio-telephone receiver. The assemblage was not at all impressed with this free "concert", but, on the contrary, there were many murmurings and quite a few loud spoken comments to the effect that "If that's this here radio that the papers are talking about I don't want none of it."

And right at this minute there are hundreds of such unconvincing demonstrations of radio-telephone broadcasting being perpetrated upon the suffering public, and I say it's a doggone shame. Not one person in that large crowd would offer anything but a cold response to any attempt to sell them a radio-telephone receiver; indeed, any such attempt would have met with instant ridicule.

Being an enthusiastic radio bug and having several friends in the business of manufacturing



and marketing radio-telephone apparatus, the writer decided to remedy this deplorable condition and to do so at once. Elbowing his way through the crowd he bravely walked into the store and politely asked for the proprietor. A precocious youngster in his late 'teens said that the "boss" was out, and volunteered the information that he did not want to buy anything as business was rotten. It sure was. He was then asked if the "concert" which he was thrusting upon a wholly disgusted but unmistakably curious crowd was bringing in any results. To this he replied in perfect metropolitan slang, "Naw, those eggs are just stickin' around for the base-ball scores and as soon as I cut this stuff they will all beat it." It was a wonder to me that those "eggs" would stick around at all. But it was a true demonstration that the public *is* interested in radio, and it will take a whole lot of abuse to drive them away from it. Surely we do not intend to make any great effort to drive them away, do we?

Standing upon the counter was a radio-telephone receiver, of honest parentage, connected to a well known "loud speaker". The writer knew that these two units could give considerably better results and thereupon decided that, come what may, he was going to adjust that receiver so that it would no longer defame the good name of its creator. While the youngster stared and protested, the proper adjustments were made, and, as if by magic, the blare disappeared and in its stead there came from the horn of the "loud speaker" a decidedly good reproduction of violin music played by an artist of no mean ability. The signals were coming from one of the best broadcasting stations in the country, and, with a little finer adjustment, the music cleared into an almost perfect reproduction. The crowd was visibly impressed and crushed closer to the store in order that they might not miss any of this musical treat. Three or four serious-minded individuals separated from the crowd and came into the store in order that they might get even closer to the instrument, and they were just bubbling over with enthusiasm and questions,—and more kept coming. But alas, the clerk was no nimble wit, and failed to grasp a golden opportunity. He was more frightened than anything else. And his "boss" was probably wandering around trying to sell out the business and cussing at himself for having ever entered the radio game. Having no further

interest, I sneaked out, leaving the store and its prospects to fate.

When will the newcomers into radio merchandising realize that the selling of radio-telephone apparatus requires at least as much knowledge of the business as that usually at the command of a live-wire automobile salesman? Or are they relying upon the present "craze" to offset their shortcomings? And coupled with this rudimentary technical knowledge should be a real ability to "tune" in stations and thereby give a creditable demonstration. I have had several of these merchants try to sell me apparatus, and they all go through the same performance. After making a few introductory remarks intended to impress upon the prospective purchaser that the particular piece of apparatus they are selling is so superior to anything else on the market that they are inclined to pity their competitors, they point out a few of the "points of superiority." These usually are unimportant details such as the finish of an adjustment handle, the finish of the panel, but never do they go into the technical design of the instrument. Why? Because they don't know anything about it, or if they should happen really to understand something about the goods they offer they do not know how to explain these things. With the proper use of analogies I can explain the operation of a radio-telephone receiver to an intelligent boy twelve years old. If he does not understand me, I stop trying to sell him anything because he is going to be a perpetual source of annoyance to me after he buys. Then comes the "demonstration," the execution and torture, I should say. These people seem to think that the public wants quantity and not quality even in music,—they are all wrong. We have been well educated to good music by our phonographs and the excellent symphony orchestras at the leading motion-picture houses, and are not going to be impressed with anything less satisfying. They sizzle the filaments of vacuum tubes, jam in the tickler coupling until the telephones howl with rage and then beam upon you, expecting to see you become joyfully enthusiastic and buy the whole store. Do you do it? Well, hardly.

A well known radio engineer recently remarked that by careful compilation of the reports he had received he had concluded that there were eleven radio engineers in this country and no less than 350,000 "radio experts." I say to you, beware the "radio experts."

Whence came they? Are they the aftermath of those hurriedly and half trained radio operators that were pressed into emergency service during the late war? Every store selling radio supplies now has its "radio expert." The newcomers into radio merchandising are too quickly falling prey to these "experts." Perhaps, if radio apparatus were not being offered for sale by haberdashers, stationers, drug stores, etc., these "experts" would not find so many soft berths where they can prey upon a credulous and mystified public. If manufacturers were not so anxious to flood the country with apparatus and make a quick profit (and perhaps an equally quick getaway), and restricted their agencies to electrical dealers, *bona fide* radio supply houses, and other agencies equipped by training and personnel to distribute technical apparatus, this evil would be automatically corrected.

Automobile manufacturers demand that their distributors maintain a "service and repair station." The general public has a great deal to learn about radio apparatus, and, unless helped along by intelligent "service", there will be a reaction more violent than the original "boom."

Now for our friends, the general public, without whose support and good will we cannot maintain anything. I suggest that you purchase only that apparatus that is "trade-marked" by reliable and well known manufacturers. Avoid the "unknown" outfits. Perhaps they may appear to be cheaper at first, but the usual thing is that the purchaser is either disgusted with the results or decides to replace them with proper equipment. In any case the original purchases represent financial loss. Having acquired a standardized well-engineered piece of apparatus, follow the installation instructions and operating suggestions usually given by the manufacturer. Take no advice from any other person unless you have learned by previous experience to respect his judgment. The manufacturers will gladly answer questions, and it naturally follows that they are the best source of information for their own products.

Regarding "accessories." Do not purchase any additional equipment that may be suggested by a zealous salesman until you are sure that you understand its proper application and that you really need it. Many a well



conceived piece of apparatus has been either ruined or rendered ineffectual by an attempt to "improve" it. The manufacturing engineers usually design each and every element for a particular purpose and to work best only in conjunction with certain other elements. Substitution for any of these parts usually results in a loss of efficiency. Wait until you are thoroughly familiar with the apparatus you have and are certain that it is not operating to best advantage before you begin to tear it apart. There are many really excellent pieces of standardized apparatus now on the market, and it is always safe and sure to buy equipment

identified by the trademark of a well known manufacturer.

In conclusion let me assure you that I have not intended to appear pessimistic or unreasonably critical but just brave enough to state frankly what hundreds of us are murmuring to ourselves and to our immediate friends.

This radio-broadcast proposition requires the closest kind of helpful and friendly coöperation during this trying period of its development, and, if we all honestly endeavor to do our share it will be quickly brought to a high degree of perfection, and then, surely, we shall have Music and not Noise.

SUPPLEMENTAL LIST OF BROADCASTING STATIONS IN THE UNITED STATES FROM JUNE 1 TO JUNE 15 INCLUSIVE

CALL SIGNAL	OWNER OF STATION	LOCATION OF STATION	WAVE LENGTH
KDZU	Western Radio Corporation	Denver, Colo.	360
KDZW	Claude W. Gerdes	San Francisco, Calif.	360
KDZX	Glad Tidings Tabernacle	San Francisco, Calif.	360
KDZZ	Kinney Bros. & Sipprell	Everett, Wash.	360
KFAB	Pacific Radiofone Co.	Portland, Oreg.	360
WEAN	Shepard Co.	Providence, R. I.	360
WEAO	Ohio State University	Columbus, Ohio	360,485
WEAP	Mobile Radio Co.	Mobile, Ala.	360
WEAQ	Young Men's Christian Association	Berlin, N. H.	360
WEAR	Baltimore American & News Publishing Co.	Baltimore, Md.	360
WEAS	Hecht Co.	Washington, D. C.	360
WEAT	John J. Fogarty	Tampa, Fla.	360
WEAU	Davidson Bros. Co.	Sioux City, Iowa	360
WEAV	Sheridan Electric Service Co.	Rushville, Nebr.	360
WEAX	T. J. M. Daly	Little Rock, Ark.	360,485
WEAY	Will Horwitz, Jr.	Houston, Tex.	360
WEAZ	Donald Redmond	Waterloo, Iowa	360
WFAA	A. H. Belo & Co.	Dallas, Tex.	360,485
WFAB	Carl F. Woese	Syracuse, N. Y.	360
WFAC	Superior Radio Co.	Superior, Wis.	360
WFAD	Watson Weldon Motor Supply Co.	Salina, Kan.	360
WFAF	H. C. Spratley Co.	Poughkeepsie, N. Y.	360
WFAQ	Radio Engineering Laboratory	Waterford, N. Y.	360
WFAH	Electric Supply Co.	Port Arthur, Tex.	360
WFAJ	Hi-Grade Wireless Instrument Co.	Asheville, N. C.	360
WFAK	Domestic Electric Co.	Brentwood, Mo.	360
WFAL	Houston Chronical Publishing Co.	Houston, Tex.	360,485
WFAM	Times Publishing Co.	St. Cloud, Minn.	360
WFAN	Hutchinson Electric Service Co.	Hutchinson, Minn.	360,485
WFAP	Brown's Business College	Peoria, Ill.	360
WFAQ	Missouri Wesleyan College & Cameron Radio Co.	Cameron, Mo.	360
WFAU	Hall & Stubbs	Stanford, Me.	360
WFAS	United Radio Corporation	Fort Wayne, Ind.	360
WFAT	Daily Argus Leader	Sioux Falls, S. Dak.	360
WGAB	QRV Radio Co.	Houston, Tex.	360



Books About Radio

By John V. L. Hogan

Consulting Engineer, New York; Past President, Institute of Radio Engineers

ONE of the constantly recurring and seldom answered questions of the day is "What is a good book on radio?" There are several reasons why it is not easy to reply to this query; chief among them is that radio signaling is already so huge a topic that no one book can cover it accurately and completely. Again, the written treatment which one person requires will be utterly unsuited to the needs of other readers; there must be provided both the detailed technical descriptions of single branches of the art to suit the demands of engineer-students, and the simplified (sometimes obviously sugar-coated) expositions intended for beginners. Between these extremes one finds a host of radio publications, some good and many unutterably bad, each attempting to cater to some group of persons interested in radio either as an art, a science, a service, or an amusement.

There lie before me as I write (to quote Captain Fitzurse) more than eighty books on radio. Some of these are old standbys; some are worthy newcomers into the field of radio literature; and some are apparently written solely because their authors or their publishers thought that there was a good market for any book with "radio" or "wireless" in its title. It will not be possible for me to review all of these in the space of this article, nor even to describe all the good ones. However, I can perhaps select a number which can be depended upon in the main and which will appeal to each of the groups which wants to read about radio.

Let us take up first those intended for the beginner, who has possibly been attracted by the broadcast services and who desires to learn something about radio in general. Readable and clear presentations of radio principles and their earlier applications will be found in Professor Kennelly's "Wireless Telegraphy and Telephony"¹ and Professor Fleming's "The Wonders of Wireless Telegraphy"²; although both were printed a decade ago, their interest and accuracy make them valuable to-

day. Another well prepared book of the same period is "Wireless Telegraphy"³ by Professor C. L. Fortescue. A more recently revised book is "Wireless Telegraphy and Telephony"⁴ by Alfred P. Morgan; this volume is neither so closely confined to radio principles nor so exhaustive in its explanations of them as those above mentioned, and it takes space to describe many obsolete instruments, but it aids in giving a newcomer something of a general view of the radio field. Recent books which treat the uses of radio in a broad way, outlining for the reader a picture of the applications beyond radiophone broadcasting, are "Radio for Everybody"⁵ by A. C. Lescarbours and "The Complete Radio Book"⁶ by R. F. Yates and L. G. Pacent.

For readers who desire to learn about the transmission of speech and music by wireless, several books can be recommended. An interesting historical treatment of the earlier years is given in "Wireless Telephony"⁷ by Ernst Ruhmer. This is brought down to 1918 in a volume which is more logically arranged and in which the author discusses the mode of operation of many types of apparatus, "Radio Telephony"⁸ by Dr. A. N. Goldsmith. A simplified discussion of the present-day radiophone, with emphasis on the vacuum tube but little historical matter, is contained in "Elements of Radio Telephony"⁹, by W. C. Ballard, Jr. One of the newest books, which gives an exceedingly clear presentation of radiotelephonic principles and authoritative descriptions of the operation of modern sending and receiving apparatus, is "Radio Phone Receiving,"¹⁰ edited by Dr. Erich Hausmann and written jointly by a number of well-known radio engineers.

Another extensive group of radio readers includes those who want information on how to make their own instruments. There have been many articles, pamphlets, and books printed for amateur apparatus builders, but it is a sad fact that the great majority of the designs presented are either impractical or inefficient, if not both. Many radio writers

have given explicit directions for constructing transmitters and receivers which (so far as one can judge from the almost obvious faults in the suggested instruments) they have probably never tried to build and certainly never succeeded in working. In contrast to this sort of thing are two helpful books by M. B. Sleeper, entitled "Construction of Radio Phone and Telegraph Receivers for Beginners"¹¹, and "Design Data for Radio Transmitters and Receivers"¹²; full working details for building a modern variometer type receiver (together with some interesting comments on radio telephony) will be found in "The How and Why of Radio Broadcasting"¹³ by Arthur H. Lynch; and much information of utility is given by E. E. Bucher in "The Wireless Experimenter's Manual"¹⁴.

A number of special subjects in the application of radio have been treated individually. "Radiodynamics"¹⁵ by B. F. Miessner tells an interesting story of the control of distant mechanisms by means of wireless waves; "Wireless Transmission of Photographs"¹⁶ by M. J. Martin describes many unusual experiments along the line which the title indicates; and "The Alexanderson System for Radio Telegraph and Radio Telephone Transmission"¹⁷ by E. E. Bucher will interest any one who would enjoy exploring a modern high-powered trans-oceanic wireless station. Another special subject, which on account of its importance has received much attention by authors, is the vacuum tube now in such wide use. Elementary books describing its action as detector, amplifier, and oscillator are "The Oscillation Valve"¹⁸ by R. D. Bangay, and "The ABC of Vacuum Tubes in Radio Reception"¹⁹ by E. H. Lewis, both of which are clear and generally accurate. A somewhat less recent book on the same subject, which, however, gives an easily understood graphical description of the working of the device, is Bucher's "Vacuum Tubes in Wireless Communication".²⁰ For the advanced or scientifically trained student "The Thermionic Vacuum Tube and its Applications"²¹ by H. J. Van der Bijl will be found a splendid treatise. Two other highly technical books on tubes are "The Thermionic Valve and its Developments in Radio Telegraphy and Telephony"²² by J. A. Fleming, and "Thermionic Tubes in Radio Telegraphy and Telephony"²³ by John Scott-Taggart. The former gives much historical matter of interest and value, as well as Professor Fleming's mathematical analyses of

tube action; the latter is a very recent publication which describes present day British practice in the design and construction of valve outfits.

Two other rather specialized books which will be of greatest use only to the technical student are "Telephony without Wires"²⁴ by P. R. Coursey and "Continuous Wave Wireless Telegraphy"²⁵ by W. H. Eccles. The first of these is quite different from the purely popular accounts of wireless telephony; it treats the radiotelephone technically as a division of radio signaling and assumes that the reader is fairly well familiar with wireless telegraphy. The second book is a full engineering development of the electrical theory of continuous-wave circuits and instruments, including vacuum tubes.

Having passed to the technical publications in radio, we must now consider those which go into the subject in a general but somewhat advanced way. The non-technical reader will have difficulty in getting very much from most of these books, but any one with even a small mechanical or electrical aptitude or education will be able to dig out a good deal of immense value. F. K. Vreeland's book called "Maxwell's Theory and Wireless Telegraphy"²⁶, containing a translation of the famous paper by Poincaré, is not abstruse; the presentation of the principles underlying modern radio is vivid and easily read, so that the book, though nearly twenty years old, is interesting to-day. Another of the older books which still is attractive is the "Principles of Wireless Telegraphy"²⁷ by Dr. G. W. Pierce; here the emphasis is placed upon the action of resonant circuits and receiving instruments. A somewhat later publication is Zenneck's "Wireless Telegraphy,"²⁸ translated by A. E. Seelig, which is a classical work on the fundamentals of radio design and practice. Another radio classic is Professor J. A. Fleming's "Principles of Electric Wave Telegraphy and Telephony"²⁹, which first appeared in 1906 but which has been brought up to 1919 in a revised fourth edition; this volume is an exhaustive historical, theoretical and descriptive treatment of the development of radio signaling.

In the past year or two there have appeared three other general radio books, each of which is noteworthy in its particular classification. "Electric Oscillations and Electric Waves"³⁰ by Professor G. W. Pierce is a highly technical discussion of the theories and operations under-

lying the whole science of radio; here engineering students well accustomed to handling the tool of mathematics will find much to clarify and reduce to quantitative relations the ideas which are generally considered only qualitatively. The second book, "Principles of Radio Communication"³¹ by Professor J. H. Morecroft, is much more understandable to the average technical man, for although mathematical analyses and developments are not slighted they are supplemented with abundant graphical illustrative data. Moreover, this volume does not stop with abstract considerations, but goes into the basic detail of modern radio instruments. It is valuable both as a course of study and as a reference book. The third of this recent group is the U. S. Army Radio Pamphlet (something of a misnomer) No. 40, named "The Principles Underlying Radio Communication" (Second Edition)³² which is intended for students with comparatively little mathematical training but who desire a quite comprehensive presentation of electromagnetism and its applications in radio.

Although a good many of the books mentioned above contain material the most important use of which is for reference, there are certain others whose greatest value appears when one has before him some particular problem for the solution of which certain quantitative data are required. Among these are "Wireless Telegraphy and Telephony; a Handbook of Formulae, Data and Information"³³ by W. H. Eccles, "Standard Tables and Equations in Radio Telegraphy"³⁴ by Bertram Hoyle, and "The Wireless Telegraphist's Pocket Book of Notes, Formulae and Calculations"³⁵ by J. A. Fleming. The U. S. Bureau of Standards has issued as its Circular No. 74, under the title "Radio Instruments and Measurements"³⁶ a valuable collection of radio data. In this connection, special mention must be made of Ralph Batcher's "Prepared Radio Measurements"³⁷ which contains some sixty self-computing or alignment charts designed to obviate much numerical work in simple radio computations.

Another useful reference work is the "Yearbook of Wireless Telegraphy"³⁸, which comes out annually and contains the radio laws of various countries, a five-language radio glossary, a list of the land stations throughout the world, and much other information. Finally, every radio station should have the U.S. Department of Commerce radio pamphlets

"Radio Communication Laws of the U. S."³⁹, "Amateur Radio Stations of the U. S."⁴⁰ and "Commercial and Government Radio Stations of the U.S."⁴¹ which contain essential data as to license requirements, the call letters and locations of important radio stations, etc.

So brief a description as I have given of each book will hardly suffice to bring out its real value to the reader. Nevertheless, by arranging the volumes in a rough classification and by mentioning only a few of the leading books in each class, I trust that I have succeeded in indicating which (of the many publications now available) are most likely to fill certain needs in a reasonably satisfactory way.

* * *

Books noted in the above article, in the order of reference to them:

- 1: "Wireless Telegraphy and Telephony"; A. E. Kennelly; Moffat, Yard & Co., New York, 1910; 279 pages; (out of print).
- 2: "The Wonders of Wireless Telegraphy"; J. A. Fleming; Society for Promoting Christian Knowledge, London, 1913; 279 pages; price \$1.40.
- 3: "Wireless Telegraphy"; C. L. Fortescue; G. P. Putnam's Sons, New York, 1913; 143 pages.
- 4: "Wireless Telegraphy and Telephony"; Alfred P. Morgan; Norman W. Henley Pub. Co., New York, 1922; 154 pages; price \$1.50.
- 5: "Radio for Everybody"; A. C. Lescarbours; Scientific American Pub. Co., New York, 1922; 334 pages; price \$1.50.
- 6: "The Complete Radio Book"; R. F. Yates and L. G. Pacent; The Century Co., New York, 1922; 330 pages; price \$2.00.
- 7: "Wireless Telephony"; Ernst Ruhmer; Crosby Lockwood & Son, London, 1908; 224 pages; price . . .
- 8: "Radio Telephony"; A. N. Goldsmith; The Wireless Press, New York, 1918; 247 pages; price \$2.50.
- 9: "Elements of Radio Telephony"; W. C. Ballard, Jr.; McGraw-Hill Book Co., New York, 1922; 132 pages; price \$1.50.
- 10: "Radio Phone Receiving"; E. Hausmann, A. N. Goldsmith, L. A. Hazeltine, J. V. L. Hogan, J. H. Morecroft, F. E. Carnavacioli, R. D. Gibson, and P. C. Hoernel; D. Van Nostrand Co., New York, 1922; 183 pages; price \$1.50.
- 11: "Construction of Radio Phone and Telegraph Receivers for Beginners"; M. B. Sleeper; Norman W. Henley Pub. Co., New York, 1922; 142 pages; price 75 cents.
- 12: "Design Data for Radio Transmitters and Receivers"; M. B. Sleeper; Norman W. Henley Pub. Co., New York, 1922; 85 pages; price 75 cents.
- 13: "The How and Why of Radio Broadcasting"; Arthur H. Lynch; Doubleday Page & Co.,

- New York, 1922; 32 pages and 4 charts; price 50 cents.
- 14: "The Wireless Experimenter's Manual"; E. E. Bucher; The Wireless Press, New York, 1920; 340 pages; price \$2.25.
 - 15: "Radiodynamics"; B. F. Miessner; D. Van Nostrand Co., New York, 1916; 206 pages; price \$2.00.
 - 16: "Wireless Transmission of Photographs"; M. J. Martin; The Wireless Press, Ltd., London, 1916; 114 pages; price \$2.00.
 - 17: "The Alexanderson System"; E. E. Bucher; The Wireless Press, New York 1920; 55 pages; price \$1.25.
 - 18: "The Oscillation Valve"; R. D. Bangay; The Wireless Press, Ltd., London, 1920; 215 pages; price \$2.75.
 - 19: "The ABC of Vacuum Tubes"; E. H. Lewis; Norman W. Henley Pub. Co., New York, 1922; 132 pages; price \$1.00.
 - 20: "Vacuum Tubes in Wireless Communication"; E. E. Bucher; The Wireless Press, New York, 1918; 174 pages; price \$2.25.
 - 21: "The Thermionic Vacuum Tube"; H. J. Van der Bijl; McGraw-Hill Book Co., New York, 1920; 391 pages; price \$5.00.
 - 22: "The Thermionic Valve and its Developments in Radio Telegraphy and Telephony"; J. A. Fleming; The Wireless Press, Ltd., London, 1919; 279 pages; price \$5.00.
 - 23: "Thermionic Tubes in Radio Telegraphy and Telephony"; John Scott-Taggart; The Wireless Press, Ltd., London, 1921; 424 pages; price \$8.00.
 - 24: "Telephony without Wires"; P. R. Coursey; The Wireless Press, Ltd., London, 1919; 414 pages; price \$5.00.
 - 25: "Continuous Wave Wireless Telegraphy"; W. H. Eccles; The Wireless Press, Ltd., London, 1921; 407 pages; price \$8.00.
 - 26: "Maxwell's Theory and Wireless Telegraphy"; H. Poincaré and F. K. Vreeland; McGraw Pub. Co., New York, 1904; 255 pages; (out of print).
 - 27: "Principles of Wireless Telegraphy"; G. W. Pierce; McGraw-Hill Book Co., New York, 1910; 350 pages; price \$3.00.
 - 28: "Wireless Telegraphy"; J. Zenneck, translated by A. E. Seelig; McGraw-Hill Book Co., New York, 1915; 442 pages; price \$5.00.
 - 29: "The Principles of Electric Wave Telegraphy and Telephony"; J. A. Fleming; Longmans, Green & Co., London, 1919; 707 pages; price \$14.00.
 - 30: "Electric Oscillations and Electric Waves"; G. W. Pierce; McGraw-Hill Book Co., New York, 1920; 517 pages; price \$5.00.
 - 31: "Principles of Radio Communication"; J. H. Morecroft; John Wiley & Sons, New York, 1921; 935 pages; price \$7.50.
 - 32: "The Principles Underlying Radio Communication"; Signal Corps, U. S. Army; Government Printing Office, Washington, 1922; 619 pages; price \$1.00.
 - 33: "Wireless Telegraphy and Telephony"; W. H. Eccles; D. Van Nostrand Co., New York, 1918; 514 pages; (temporarily out of print).
 - 34: "Standard Tables and Equations in Radio Telegraphy"; Bertram Hoyle; The Wireless Press, Ltd., London, 1919; 159 pages; price \$3.25.
 - 35: "The Wireless Telegraphist's Pocket Book of Notes, Formulae and Calculations"; J. A. Fleming; The Wireless Press, Ltd., London, 1915; 347 pages; price \$3.50.
 - 36: "Radio Instruments and Measurements"; Bureau of Standards; Government Printing Office, Washington, 1918; 329 pages; price 60 cents. Reprinted by The Wireless Press, New York, and bound in cloth; Price \$1.75.
 - 37: "Prepared Radio Measurements"; Ralph Batcher; The Wireless Press, New York, 1921; 132 pages; price \$2.00.
 - 38: "The Yearbook of Wireless Telegraphy and Telephony"; The Wireless Press, Ltd., London; issued annually; about 1200 pages; price \$6.00.
 - 39: "Radio Communication Laws of the U. S."; Department of Commerce; Government Printing Office, Washington; price 15 cents.
 - 40: "Amateur Radio Stations of the U. S."; Department of Commerce; Government Printing Office, Washington; price 15 cents.
 - 41: "Commercial and Government Radio Stations of the U. S."; Department of Commerce; Government Printing Office, Washington; price 15 cents.
- Note: The books published by The Wireless Press, Ltd., London, may be obtained from The Wireless Press, New York, at the prices given.

Progress of Radio in Foreign Lands

ENGLAND'S BROADCASTING PROBLEM

ENGLAND is still discussing radio-
phone broadcasting, while numerous
English radio amateurs storm and
fume as they read our American
radio periodicals. Now we learn that
Postmaster General Kelleway of Great Brit-
tain, in a recent speech, announced the com-

pletion of plans for radiophone broadcasting
by the General Post Office at a nominal sum to
patrons for a permit, which will be the only
expense involved. The normal hours for
broadcasting will be from 5 P.M. to 11 P.M.
except on Sundays, when there will be no limit.
Certain regulations are to be issued later with

regard to the character and class of news which the authorized agencies will be allowed to transmit. Until last September the manufacture, sale, or possession of radio apparatus was greatly restricted by the General Post Office, under the provisions of the Defense of the Realm Act (regulation No. 22). With the lapse of that war-time regulation, the authority of the Post Office is limited to that conferred by the Wireless Telegraphy Act of 1904, which requires the possession of a license before any radio apparatus can be installed or worked. For these reasons, radio telephone broadcasting in Great Britain has heretofore been limited to occasional demonstrations by the General Post Office and Marconi's Wireless Telegraph Company; as late as last October, the *Wireless World*, of London, was receiving subscriptions from radio amateurs in England to insure the continuance of the radio concerts conducted by the Nederlandsche Radio Industrie at The Hague, in Holland. The Marconi Company has recently announced its intention to broadcast radio telephone news and concerts. The general development of the field by the Post Office will be far reaching

in its effects in establishing a new industry that will give employment to large numbers of people, as it has done here.

BRITISH VALVES AND OUR VACUUM TUBES

FOR a long while back our British friends have been using "valves," as they call vacuum tubes, for their high-power radio telegraphic communication. For this purpose the British Admiralty has developed a special type of glass with a high silica content, which stands considerably more heat than ordinary glass. The silica valves, as the tubes employing the special silica walls are called, are covered by the Admiralty Patents and the sole licensees and manufacturers are the Mullard Radio Valve Company. At present, the Mullard organization makes a Mullard audio-frequency tube with a continuous anode consumption of 15 milliwatts and a filament consumption of 150 milliwatts—a "dry cell" proposition, at the lower end of the scale, and a high-power silica valve with a continuous anode consumption of 2.5 kilowatts and a filament of 0.25 kilowatts at the upper end of the scale. The power tubes are mounted in neat cartridge-like

A SCOUT TROOP IN AN ENGLISH SCHOOL

Being taught the construction and use of the radiophone. There are very few scout troops in America as well supplied with radio equipment as these boys are



holders which may be handled with a minimum danger of breakage.

INCREASING THE RANGE OF NAUEN

THAT famous long-distance radio station, Nauen, in Germany, is to be altered so as to increase its range and to meet the increasing traffic in the United States and Argentine Republic. Twenty-five million marks additional capital is being raised by the Trans-Radio Company, and a beginning has already been made with the constructive work. The plans include the erection of seven new masts, each 689 feet high, and the dismantling of four of the existing masts. Until now the Nauen signals have been picked up in the United States by amateurs possessing tuners of extreme wave length range, as well as vacuum tube detectors and two-stage audio-frequency amplifiers. With the increased power of Nauen after the alterations, the signals should be picked up even more readily.

LONG-DISTANCE BROADCASTING OF NEWS

THE Central Telegraph Office of England is now carrying on wireless services to Berlin, Cologne, Posen, Rome, and Egypt. News handed in at that office is broadcasted from the Post Office radio station at Leafield, near Oxford, and is picked up in India and

RADIO BROADCASTING IS FINDING ITS WAY INTO INDIA

Where, it is thought, the new science will materially reduce the tendency toward revolt



Australia, except when atmospheric conditions are unfavorable, while a regular radio news service is carried on with Halifax in Nova Scotia.

THE FRENCH MILITARY CHAIN AND OTHERS

THE French Military Chain, is now nearly completed, much of it having been planned since the Armistice. Paris is, or shortly will be, linked by first-class stations with the Soudan, the Congo, Antananarivo, Pondicherry and Cochin China. All these steps are of the 2,000-mile order or less, except that from Antananarivo to Pondicherry, which is 3,100 miles. Besides the Military Chain, France possesses a first-class Naval station at Nantes, and two magnificent stations at Bordeaux and Lyons. The Italian state-owned scheme, on the other hand, embraces two modern stations in Italy, and two spark stations in North East Africa. The Rome station was built by the British radio engineer, Mr. Elweel, during the war, and the Coltano station is being equipped by the Marconi Company. The longest distance between the Italian stations is about 2,500 miles. Still another scheme was the German Chain, which contemplated three stations in Africa, one in the Java Seas, and one in Yap. Those which were erected were lost during the war. The distance from the Nauen station to the

Kamina station is 3,400 miles, and proved too great for real work. Windhuk is nearly 2,000 miles south of Kamina, and is believed to have exchanged scarcely any signals successfully during its short active life.

BELGIUM'S EXPANDED RADIO SERVICE

THE Belgian merchant service, which before the war included ten radio units, now possesses more than 120, which are controlled by the Administration des Télégraphes. Belgium is building a high-power radio station which will insure communication with her colonies and with distant countries, and make her independent of the cables, if need be.

Radio panels and Radio Parts

START right. The panel is the very foundation of your set. High volume and surface resistance are essential factors. Make sure that you get them in both the panels and parts that you purchase. To make doubly certain look for the dealer displaying this sign

CONDENSITE
CELORON

Radio Panel Service

Condensite Celoron Grade 10—approved by the Navy Department, Bureau of Engineering—is a strong, handsome, waterproof material, high in resistivity and dielectric strength. It machines easily, engraves without “feathering”, and is particularly desirable for panels. It is also widely used for making many other important radio parts such as tube bases, platform mountings, variable condenser ends, tubes for coil winding, bases, dials, knobs, bushings, etc. We are prepared to make these various parts to your own specifications.

Where economy is a factor we can supply panels of Vulcanized Fibre Veneer made of hard grey fibre veneered, both sides, with a waterproof, phenolic condensation product. This material has a hard, smooth, jet-black surface, machines and engraves readily and will give excellent service where very high voltages at radio frequencies are not involved.

Shielded plates (patent applied for) are made with a concealed wire shield. This shield, when properly grounded, effectively neutralizes all howl and detuning effects caused by body capacities.

Send to-day for our Radio Panel Guide

Are you an enthusiast? This Guide describes our panels in detail—gives tests—and tells just how much the panel you want will cost.

Are you a Radio Dealer? Let us tell you how easily and profitably Celoron Radio Panel Service enables you to supply your customers with panels machined and engraved to their specifications. Write to-day for our Dealer's Proposition covering panels, dials, knobs and tubes.



Diamond State Fibre Company

Bridgeport (near Philadelphia) Pa.

BRANCH FACTORY AND WAREHOUSE, CHICAGO
Offices in principal cities

In Canada: Diamond State Fibre Co. of Canada, Ltd., Toronto.

U. S. Weather Reports for Ships Without Radio

By S. R. WINTERS

ORDERS have been promulgated and recently issued to managing agents and masters of the vessels of the United States Shipping Board to signal by international code or other methods storm warnings picked up by radio to ships devoid of wireless facilities. Described as a courtesy of the seas, this departure in the constantly expanding uses of radio communication is made possible by arrangements with about twenty high-powered stations of the world to broadcast storm warnings on schedules furnished wireless operators on board government-operated ships.

The safeguarding of life and property is the objective of the government instructions, which are mindful of all vessels not equipped with radio, irrespective of the nationality of the ship. The innovation recognizes the fact that many vessels are cruising along the coast without these facilities. Whenever any such ship is met on the high seas by a vessel of Uncle Sam, storm warnings picked up during the preceding twelve hours will be made available to it. This friendly service includes weather reports intercepted through foreign as well as domestic radio stations.

Stations coöperating in the world-wide service which brings weather forecasts to vessels on the high seas with quite the effect and frequency that the approach of storms is foretold to farmer and city dweller on land include: Poldhu, 2,700 meters; Malta, 2,700 meters; Eiffel Tower, 2,500 meters—stations located in Europe; Melbourne, 600 meters, and Sidney, 600 meters, in Australia; Shanghai Zi Sapawei; Papeete and Ile Tahite, 600 meters, in French Oceania; Pearl Harbor, 600 meters, in Calcutta, 200 meters, in India; in Hawaiian Islands; Choshi, 600 meters, in Japan; Campeche, 600 meters, in Mexico; Capetown and Durban, 600 meters, in South Africa; and the

following stations in the United States—Arlington, 2,500 meters; Annapolis, 1,700 meters; Key West, 1,500 meters; Santiago, 600 and 950 meters; San Francisco, 600 and 950 meters.

The vessels of the United States Shipping Board are equipped with radio apparatus of the latest type. Transmitters, receivers, and auxiliary storage batteries for emergencies are included in the outfits. Recently Uncle Sam adopted the policy of providing all new ships with continuous-wave transmitting sets of the Poulsen 2-kilowatt type. Likewise vacuum tube detectors are in service. By the method of relaying used between Shipping Board vessels messages filed on ships plying on usual passenger routes can be transmitted to any point in the universe. Special effort is being made by the Shipping Board to so-develop its communication system in conjunction with that of the United States Navy Department and high-powered commercial stations located in this country that its vessels will be within receiving distance of one of these stations regardless of their location on the high seas.

Creditable records in radio communication have been established recently by cargo-and-passenger-carrying agencies of the Shipping Board. The *S. S. Aeolus* on an errand from New York City to South America communicated with *S. S. Venezuela* near the Hawaiian Islands. On passenger vessels plying between New York and Montevideo, in South America, passengers were supplied current news and reports from stock markets at home daily throughout the trip, unless severe static conditions in southern waters interfered.

The broadcasting of storm warnings, it would seem is a courtesy of the seas that will not only render a practical service but stimulate friendly relations between passengers on vessels of all nationalities.



*"Listening in"
with the Magnavox
Radio, the repro-
ducer supreme—*



Essential to the full enjoyment of your wireless receiving set is the MAGNAVOX RADIO

A FEW months ago the Magnavox Radio occupied a relatively unimportant position in the list of Magnavox products—today even our greatly increased production facilities are taxed to supply the demand for Magnavox Radio, the reproducer supreme.

It is the Magnavox Radio which gives every receiving set its greatest enjoyment and use—doing away with the restrictions

and limitations of the *individual headset*. The receiving set only *brings* the message, while Magnavox Radio *tells* it clearly and in full volume to all within reach of its voice.

The Magnavox Radio operates with any good type of receiving apparatus, and was not designed for any one particular make. Without the Magnavox Radio no receiving set is complete.

*Any radio dealer will demonstrate; or write us
for descriptive booklet and name of nearest dealer.*

THE MAGNAVOX CO. Home Office and Factory:
OAKLAND · CALIFORNIA

New York Office: 370 Seventh Avenue

The Grid

QUESTIONS AND ANSWERS

The Grid is a Question and Answer Department maintained especially for the radio amateur. Full answers will be given wherever possible. In answering questions, those of a like nature will be grouped together and answered by one article. Every effort will be made to keep the answers simple and direct, yet fully self-explanatory. Questions should be addressed to Editor, "The Grid," Radio Broadcast, Garden City, N. Y. The letter containing the questions should have the full name and address of the writer and also his station call letter, if he has one. Names, however, will not be published.

Will a loop aerial work as well, or nearly as well, as a single wire antenna 100 feet long?

D. C.

Gloucester, Mass.

IF THE single wire is outside and isolated from surrounding objects and is 25 feet or more above the ground, it is doubtful that any loop will function as well, unless the deficiency in signal strength obtained is compensated for by the use of radio frequency amplification. Armstrong's latest circuits work very satisfactorily with a loop but they are very critical in their operation. In any event the energy picked up by an outside wire is generally greater than that picked up by a loop.

I am enclosing a photograph of a receiving set published in Radio Broadcast. Will you kindly send me the general requirements for this set and how to construct it?

E. H. C.

Brooklyn, N. Y.

YOUR letter is typical of a great number requesting detailed information on equipment illustrated in RADIO BROADCAST. It is impossible to comply with such requests for the reason that the photographs in many instances are supplied by manufacturers and it would be unfair to them for the details which they have spent considerable time and money in perfecting to be made general information. However, from time to time, the details for the construction of equipment designed by individuals appear in the text of the magazine.

Can you tell me where I can find diagrams of radio hook-ups by Armstrong?

LIBRARIAN

Bridgehampton, N. Y.

MANY of the fundamental circuits for the Armstrong regenerative system are included in the copy of Patent No. 1,113,149 which may be had upon application to the Patent Office, for five cents. This patent contains some very useful information. Among other things, various circuit arrangements are shown in which the wavelength is regulated by varying the inductance, capacity, or both. As the wave length of any circuit depends upon the aggregate values of inductance and capacity it contains, variation of either, or both results in a change of wavelength. In order to accomplish various results, it is advisable to make the changes in various ways. For instance a tickler or regenerative coil provided with a slider for regulating the number of turns in the coil may well be substituted by a variometer. The design and action of Armstrong's latest invention, the super-regenerative circuit, is rather completely covered in an article by Mr. Paul Godley appearing in this issue. Circuit diagrams and the values of the various elements necessary for their arrangement are given.

Is it possible to establish a broadcasting station which would give satisfactory results in an outdoor delivery, especially where there are many trees, etc? What does a broadcasting station consist of and approximately what would such a station cost to install?

H. H. S.

Miami, Florida

THERE would be very little difficulty in broadcasting from out-of-doors. The microphone into which the artist or lecturer speaks at most broadcasting stations is located some distance from the transmitting apparatus itself. For outdoor delivery, the microphone might well be placed on the speaker's platform beside the customary pitcher of water.

A broadcasting station comprises a group of vacuum tubes along with the necessary generators for supplying the comparatively high voltage used in connection with the tube plates. In some broadcasting stations alternating current from an ordinary 60-cycle supply line is stepped up by transformers and then passed through rectifiers which convert it into direct current, following which it is smoothed out by a combination of condensers and choke coils. In this instance the high voltage generators are not necessary.

The price of a good broadcasting station suitable for transmitting over distances in excess of one hundred miles is several thousand dollars. Further information regarding stations of this character may be had by addressing the American Telephone & Telegraph Company, New York City or the Western Electric Company, New York City.

In contemplating a broadcasting station you should be certain that its operation is not going to render you liable to damage suit for patent infringement. As broadcasting is considered in the sense of commercial radio, the operation of a station for broadcasting is placed in the commercial category and equipment sold for amateur or experimental use only, when used in a broadcasting station makes the owner of that station liable to suit.

Can a person equip a truck and travel from city to city giving radio concerts? What would such a station cost including the license?

W. H. S.

Cleveland, O.

UNDOUBTEDLY a good radio receiving set could be installed on a truck and used as you suggest provided the distance from the broadcasting stations did not become too great. It is doubtful that an antenna permanently attached to a motor truck would be large enough to receive from more than forty or fifty miles with intensity enough to be heard by an audience of any size.

An outfit of this character would cost at least \$500. If you contemplate this project as a commercial enterprise, the receiving equipment will cost a great deal more because



Putting the "howler" to sleep

THERE'S more than one "howler" to put to sleep these days. Your radio set can put on the greatest squalling and howling demonstration you ever dreamed of. The surest way to stop this howling and keep it peaceful is to add an Acme *Audio* Frequency Amplifying Transformer.

Most any amplifying transformer can magnify the incoming sounds but it also amplifies the howling and distortion of stray fields in the circuit. Acme Transformers with their specially constructed iron cores and coils eliminate this disagreeable feature—and it only takes five dollars to buy one.

Acme assures your receiving a large volume of sound that possesses the

natural tones so lacking in the ordinary receiving set. Then, too, you will want the Acme *Radio* Frequency Transformer which costs the same as the Acme *Audio* Frequency Transformer. It can be used on both crystal detector and vacuum tube sets. It greatly increases the range of either.

You can buy either transformer at your nearest radio store or write the Acme Apparatus Company (pioneer transformer and radio engineers and manufacturers), Cambridge, Massachusetts, U. S. A. (New York Sales Office, 1270 Broadway.) Ask also for interesting and instructive booklet on the use and operation of amplifying transformers.

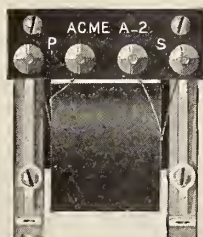

Type A-2 Acme Amplifying Transformer
Price \$5 (East of Rocky Mts.)

ACME

for amplification

it will have to be licensed for commercial use. Otherwise you are likely to infringe on patents. A better arrangement might be to install a complete station on the truck but make arrangements in the towns visited for the erection of a temporary outdoor antenna.

Will you please publish a wiring diagram of the Armstrong super-regenerative circuit indicating the values of the various elements?

N. M.

New York City.

YOU will find the answer to this question very completely covered in Mr. Godley's article, "The Armstrong Super-regenerative Circuit", appearing in this number.

We have a large factory which, we believe, could be turned over to the manufacture of receiving sets. Of course, we cannot manufacture Armstrong regenerative sets but contemplate an inexpensive crystal receiver which, we understand, infringes no patents. Are there any objections to this procedure?

J. D.

Brookfield, Mass.

THE manufacture of crystal receiving outfits has been indulged in quite generally for the reason that manufacturers considered that there were no restrictions on such devices. However, The Wireless Specialty Apparatus Company which is associated with the General Electric Company and the Radio Corporation of America, controls the Pickard patents on crystal detectors and receiving

circuits employing crystals. They have advertised the fact that crystal receiving outfits infringe these patents in an open letter to the public and trade.

The Freed-Eisemann Radio Corporation has entered suit against The Wireless Specialty Apparatus Company alleging that the latter's advertising has seriously damaged the former's business and that the crystal receiving sets manufactured by the Freed-Eisemann Corporation do not infringe the patents referred to. The Freed-Eisemann Corporation is a member of The Independent Radio Manufacturers, Inc. and the association is to defray the cost for the suit which the company is pressing. The outcome of this and other suits dealing with crystal receivers, which are to receive court attention shortly, will probably clear up one of the most serious situations in radio. Further information regarding this situation may be had from The Independent Radio Manufacturers Association, Inc., 165 Broadway, New York City.

Many companies have been able to manufacture and sell units which infringed patents which they honestly did not know existed. This condition has been the result of the unprecedented demand for radio equipment and the effort being made by large manufacturers who held the patents to supply the demand. Due to the temporary let-up in radio during July and August these patent holders have been able to devote their attention to this part of their business and it is advisable for any company contemplating the manufacture of any type of radio equipment to have as its first requisite a thorough assurance that the devices they are to make are not patent infringing.

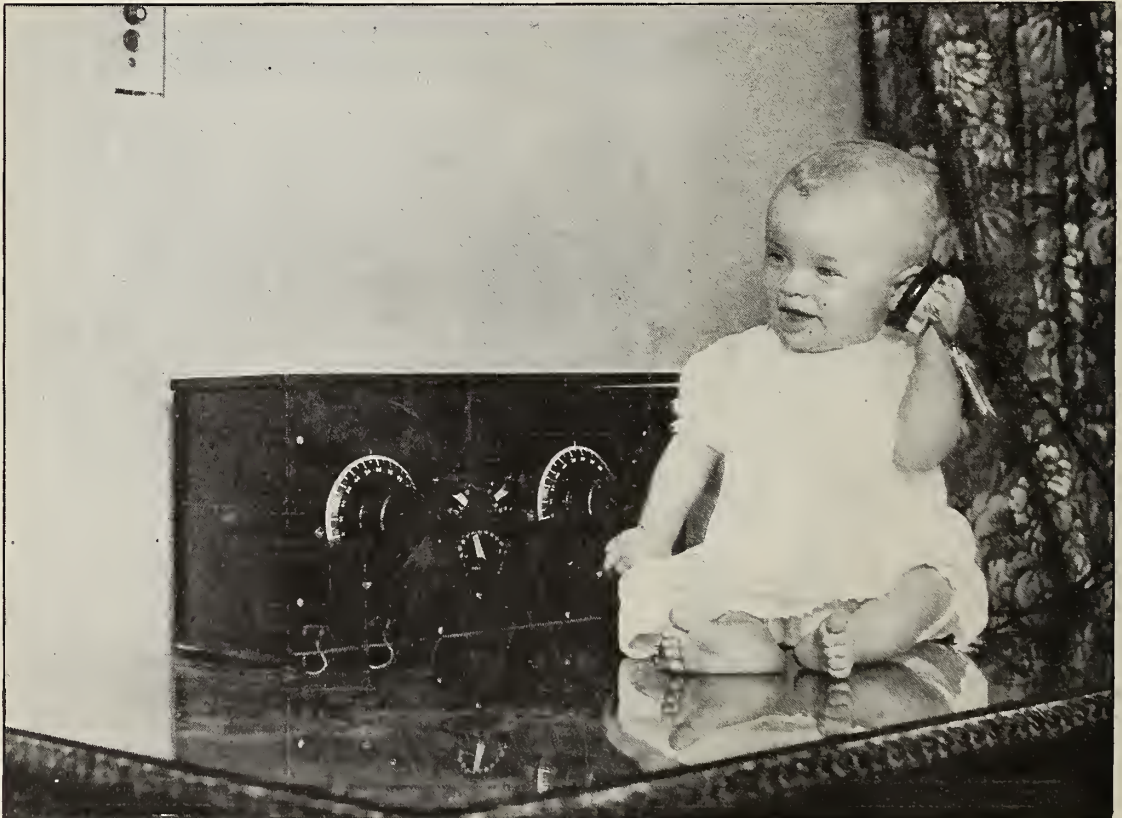

ROY YATES SANDERS, JR.
A Radio-mite listening to the birdie

RADIO BROADCAST

RADIO FOR EVERY PLACE AND PURPOSE



25
Making Life Safe
at Sea



Radio Has
Gripped Chicago



King Electron
Tells About
Detection



Choosing a
Radio School



One Vessel Radio
Might Have Saved

Super-Sales and Service

Super-sales are to the radio industry what super-regeneration is to the radio experimenter. During the broadcasting year just closing, the 20th Century Radio Corporation sold more Westinghouse equipment than any other radio distributor in the United States.

Super-Service made these super-sales, and to-day the 20th Century Radio Corporation supplies more successful dealers with radio equipment than any other distributor, because skilled organization and strategic location of distributing depots make for super-service.

In accordance with the policy of this corporation to handle the output of only reliable and responsible manufacturers whose products are of unquestioned quality and merit, we announce that we have accepted distributorship for the complete line of Paragon Products manufactured by the Adams-Morgan Company. America and England know these products for their unparalleled performance on both distance and selectivity.

Complete literature and prices on the Paragon line together with delivery schedule has been included in our extensive list which is now available to dealers.

20th Century Radio Corporation

6548 Murray Hill

565 Fifth Avenue

New York, N. Y.

BRANCHES

Detroit, Mich.
2311 Woodward Ave
Main 7809

Norwalk, Conn.
17 High St.
Norwalk 675 Ring 4

Newark, N. J.
587 Broad St.
Market 3265

Brooklyn, N. Y.
102 Flatbush Ave.
Sterling 6349

White Plains, N. Y.
2-4 Mamaroneck Ave.
White Plains 1030



PAUL F. GODLEY
One of America's foremost radio experimenters

RADIO BROADCAST

Vol. 1 No. 6



October, 1922

The March of Radio

THE DANGERS IN UNRELIABLE BROADCAST LECTURES

TO SPEAK of censorship to a "free" people is generally like waving a red flag at a bull. The mere fact that some one is going to censor something before letting it be publicly disseminated arouses at once a violent antagonism to the movement. But if the censorship be a wise one, evidently administered for the public good, we should support and welcome it. We are constantly subject to such censorship in the United States mail service, for example, and only those who would make themselves rich at the expense of the gullible part of the public by floating some fake stock scheme, or dispensing obscene literature, really object to it.

Recently, a lecture was delivered from WJZ by a Mrs. Hale on the subject of cancer treatment. This lecture should never have been permitted. As the lecturer proceeded, it was evident that instead of benefiting the public, here was a case where the broadcasting service was being used—no doubt unintentionally—with positively harmful effects.

With increased power must always come increased responsibility. Thus a broadcast lecture, with its possibly hundred thousand listeners, must be examined for false statement and dangerous advice much more thoroughly than when the lecture is delivered in a hall to a few dozen people. This examination is still more necessary in the case of the radio lecture because the use of the station

itself vests the lecturer with a certain authority and furthermore the audience does not have the face-to-face contact with the speaker by which can be judged, to some extent at least, the reliability of the statements made.

The message this particular lecturer had to offer was contained in the advice to treat cancer by a dietary régime. From the manner in which the speaker proceeded it might be concluded that the medical profession had recently adduced proof from experimentation to the effect that cancer was a blood disease and could be controlled or eliminated by certain dietary precautions. If such were the case no greater benefit could be conferred on the human race than the rapid dissemination of such information, but any one with common sense knows that this would not have been left for a lecturer who was evidently not even familiar with the well-known sources of information on cancer treatment, and whose knowledge of the subject has been recently gleaned from a superficial reading course not properly absorbed because of lack of scientific training and ability.

As counter-evidence to the so-called authorities which the lecturer quoted, we learn by interview with Dr. Francis C. Wood, one of the acknowledged eminent specialists on cancer and its treatment, that "we can safely say that 90,000 physicians in the United States do not believe what this woman says."

For the information of those who may have been influenced by this talk on cancer, we note in passing that the diet treatment for cancer was advocated and practised by the old Roman and Arabian physicians and that the records show that one of the Roman Emperors died from cancer after having been subjected to a strictly controlled diet; that some of the sources quoted gave out over fifty years ago the ideas presented by the lecturer; that one of the better known physicians quoted has because of his unbalanced views, been publicly repudiated by the hospital on the staff of which he formerly served; that the dog experiments referred to as proving that cancer was a blood disease involved the treatment of a growth the nature of which was not even identified with that of cancer; and that since 1875 active work has been carried on by well trained, disinterested observers to find any relation between diet and cancer growth *and none has been found!*

A fact often cited by diet enthusiasts to support their theories is the comparative absence of cancer among prisoners, due presumably to the simple diet of prison life. The real reason for this is found to have nothing whatever to do with the diet. Statistics give the average age of the inhabitants of our prisons as about twenty-four and statistics further show that the average age at which cancer shows itself is forty-five!

In addition, we were offered the advice of some physician advocating a theory of "electronic vibration rates." Now it so happens that we are well enough schooled in the activities of electrons to know that this combination of words is a camouflage for a woeful "electronic" ignorance, calculated to impress a susceptible clientèle. We have been able to find no evidence connecting electrons with cancer and believe the whole idea nothing but pure "bunk."

If any one hearing this lecture was influenced by it in such a way as to put off immediate consultation with a reputable physician in a suspected case of cancer, then instead of having dispensed a truth which "may reach and help save some life," the lecturer has jeopardized some life which by prompt measures might have been saved. The next time a broadcast lecture on health topics is to be given let us hope those in charge of the station will get the best information they can as to the harm or

good likely to result, before permitting its presentation.

INTER-DEPARTMENTAL ADVISORY COMMITTEE TO HELP REGULATE ALL GOVERNMENT RADIO

A FEW years ago government officials cared but little which of them assumed authority over the growth and application of radio communication. With the recent tremendous growth, however, it was inevitable that some dispute should arise between different departments as to whose traffic was the more important and so should have "the right of way." It is evident that there must be much difference of opinion in such matters and that some super-departmental control is necessary to harmonize the various requirements.

The supervision of radio has long belonged to the Department of Commerce, it having been primarily a ship service. The Navy is of course vitally interested, as radio communication probably trebles the fighting efficiency of the fleet. The Signal Corps must be continually developing radio as it will often be the most valuable means of communication available on a battle front. We understand that even in peace times the Signal Corps operates 58 traffic stations and that somewhat over 200 official messages are transmitted from Washington daily by Army radio. The Post Office, with its airplane service now well under way, is naturally much interested in radio regulations because of the relation they bear to air navigation. The Department of Agriculture is awaking to the fact that radio service for the farmers is an important field for its activity.

Because of these varied interests and their conflicts, there has been recently organized an inter-departmental committee, the business of which is to advise Secretary Hoover regarding priority of material and schedules for stations disseminating government information. The activity of the committee will be advisory only; its first recommendation will undoubtedly be to have the different departments cease using radio channels for traffic which can just as well be carried over land wires. There are at present eight primary government broadcasting stations sending out news and information. This number will undoubtedly increase so that the advice of the committee will soon be needed by Secretary Hoover in allotting channels, time schedules and material.



The personnel of the committee, headed by Dr. S. W. Stratton, includes representatives from the departments of Agriculture, Interior, Justice, Labor, Navy, Army, Post Office, State,

at Newark, has been using the 360-meter ether channel, during what seems to certain other stations a disproportionately large share of the time, and has refused to agree with these



© Harris & Ewing

THE INTERDEPARTMENTAL ADVISORY COMMITTEE ON GOVERNMENT BROADCASTING

From left to right: James C. Edgerton, Post Office Department; F. P. Guthrie, Shipping Board; Capt. H. P. Perrill, Chief Coördinator's Office; Dr. S. W. Stratton, Bureau of Standards; J. C. Gilbert and W. A. Wheeler, Department of Agriculture; A. E. Cook, Department of Labor and L. J. Heath of the Treasury Department. Dr. Stratton has been made chairman of the board

Treasury, Budget, Shipping Board, and the Bureau of Standards.

WAR BETWEEN BROADCASTING STATIONS

IT WAS a foreordained fact that there would eventually be conflicts between various broadcasting stations, especially in the neighborhood of New York, where a large number of them have been installed. This has recently come to pass. We have had the experience of listening to a jumble of signals of just the kind anticipated—dance music competing with a lecturer for the ear of the radio audience.

From the press notices it seems that WJZ, the Radio Corporation—Westinghouse station

other stations on what they think a reasonable division of hours. It is probably because of this attitude on the part of the Radio Corporation station that the Radio Broadcasting Society has been organized recently, banding together broadcasting stations for the purpose of allotting them hours in what they regard a reasonable division, with the idea of averting the kind of interference to which we have recently been treated. It seems that WJZ felt itself above such a conference—that its right to the ether should be unchallenged by later comers and it was not until the counsel for the Broadcasting Society had started action to have the license of WJZ revoked by the federal

authorities, that a temporary peace and agreement were made possible.

It seems to us that here a most critical situation has been reached. We believe that the activities of such a society as the one projecting itself into this situation may result in very serious harm to radio. It is natural that the policy of such a body should demand what they regard as a legitimate division of the time to be determined largely by the society's members. With the interests of no particular station at heart, but with the primary idea of furthering the progress of radio, we should regret exceedingly and condemn vehemently any allocation of hours based upon the investment and advertising desires of the various companies operating these stations. This is settling the question in the interest of the companies rather than in the interest of the radio public.

It is of no concern to us how much money has been invested by any company in their station, nor how much the company expects to increase their sales from the advertising value of their programmes. Broadcasting from the station *should not be allowed unless the station is operated in the most excellent manner possible.* By the best manner possible we mean that not only should the technical action of the station be as good as the present state of the art will permit, but also that the character of the programme sent out shall be the equal of that offered by other stations. It would be sheer nonsense to stop the operation of WJZ for one minute, so that some dry goods store might send out a scratchy fox-trot phonograph record which is mixed up with a loud commutator hum and "blocking" or over-modulation of tubes. The time has gone by when the public should have to listen to such stuff, because there are stations which have been properly designed and to which it is a pleasure to listen.

We think that just as the Department of Commerce refuses to license a ship or shore station operating with spark telegraphy, unless the technical characteristics of the apparatus pass certain requirements, so broadcasting licenses should be refused unless the radio inspector is convinced that the messages will be transmitted with the best possible articulation and constancy of frequency. As soon as the quality of transmission deteriorates to such an extent that people say of radio "it isn't as

good as a phonograph"—which could have been truthfully said on several recent occasions—the license to operate should be revoked.

In the meantime we wish to asseverate, as strongly as possible, that the proper allocation of broadcasting hours must be settled entirely in the interest of the listening public; the selfish interests of grocery and department stores should not count one iota. If, in the interests of the listeners, it is advisable to let WJZ operate all the time, to the complete exclusion of all others, then let it be settled that way. The only criterion which must serve to guide in the allocation of hours is excellence of programme excellently produced.



REGENERATIVE RECEIVERS MUST BE CONTROLLED

AS ONE listens nowadays for the evening concert he is continually bothered by whistling noises coming from his receiver, generally, it seems, at a critical point in the programme. Just as the singer endeavors to show the radio audience how well her voice can execute a pianissimo passage, a series of peeps (of which fortunately, she is not aware), spoils the whole effect.

These whistling interruptions are due to some regenerative receiving circuit in the neighborhood of the listener, radiating from its antenna continuous-wave power which, combined with the power sent out from the broadcast station, produces a disagreeable beat note in other receiving sets in the vicinity. When a regenerative set is made to oscillate it really becomes a miniature continuous-wave transmitting station, sending out perhaps one hundredth of a watt of power. It might seem that such a small amount of power could do no harm but it is to be remembered that the amount of power picked up by an antenna from the distant broadcasting station is only a very small fraction of this. In fact, if the oscillating receiving set is within a mile or so of the listening station being disturbed, the amount of power received from the broadcasting station may be only a small fraction of the amount received from the interfering oscillating receiver.

As more receiving sets are installed, the nuisance from this source continually increases at a much faster rate than does the number of receiving stations. This trouble must be controlled and stopped in some way, either by the good sense of the operators or by requiring that

receiving sets shall not be allowed which are capable of oscillating at the frequencies used for broadcasting. If Armstrong's super-regenerative idea is used by an appreciable

showed it to be an attempt of the "independent" radio manufacturers to gain strength by combination; it evidently did not anticipate including the Radio Corporation of America.



FORMING THE NATIONAL RADIO CHAMBER OF COMMERCE

Among those who attended the convention, were; Maj. L. B. Bender, S. C., U.S.A., Harry L. Bradley and F. F. Look, Allen-Bradley Co.; S. F. Briggs, Briggs & Stratton; Dr. L. Clement; C. B. Cooper, Ship Owners' Radio Service, Inc.; Powell Crosley, Jr., Crosley Mfg. Co.; W. L. Y. Davis, Eastern Radio Corp.; Dr. J. H. Dellinger and R. S. Ould, Bureau of Standards; A. A. Danda, Fahnestock Elect. Co.; Wm. Dubulier and W. A. Eaton, Dubilier Condenser and Radio Corp.; Alex Eisemann and J. D. R. Freed, Freed-Eisemann Radio Corp.; M. Glacer, Editor, *Masonic Review*; F. P. Guthrie, U. S. Shipping Board; W. F. Hurlburt, Wireless Improvement Co.; H. Hyams, Radio Service & Mfg. Co.; A. M. Joralemon, National Carbon Co., Inc.; Abraham Kutner; Arthur H. Lynch, Editor, *Radio Broadcast*; Byron L. Moore, Federal Tel. & Tel. Co.; Wm. B. Nevin, Radio Distributing Co.; F. W. Magin, Industrial Controller Co.; H. J. Power, American Radio & Research Corp.; G. C. Sleeper, Sleeper Radio Corp.; I. P. Rodman, Gardner-Rodman Corp.; W. C. Russ; Charles E. Stahl, Conn. Tel. & Elec. Co.; E. Steinberger, Electrose Mfg. Co.; P. G. Weiller, Gregg & Co.; C. T. Maloney, Cutler-Hammer Co.; Wm. C. Hill, Formica Insulation Co.; and C. D. Lefevre, Westinghouse Union Battery Co.

number of receivers, on elevated antennas, the trouble will be immeasurably worse and some regulation should be at once put into effect to prohibit the use of these sets except on loop aeriels, which radiate comparatively little power. A regenerative, oscillating set may be used without causing this trouble if it is preceded in the receiving circuit by a radio-frequency, non-oscillating amplifier, a scheme not yet used to any great extent.

REGULATION AND STANDARDIZATION BY THE NATIONAL RADIO CHAMBER OF COMMERCE

THERE has recently been organized an association of manufacturers of radio apparatus, "banded together for the purpose of creating a favorable public opinion towards the radio industry by maintaining a high standard of quality and dependability in the manufacture of radio apparatus." The original outline of activity of the association

The anticipated activities of the association are classified as manufacturing, marketing, technical, government, patents, educational, and employment. Information on materials entering into the manufacture of radio sets; standardization of nomenclature, marking, etc.; factory costs, methods of packing and marketing apparatus, and similar items are to come under the supervision of the association, according to the prospectus. Although price fixing will not be directly attempted, we learn from the same outline that agents will make studies of prices "with the view towards regulation of overcharging for apparatus of inferior quality." It seems, then, that we should be happy to have the amount of overcharge for inferior goods "regulated," but should not a society with such an imposing name prevent overcharging altogether instead of merely regulating it? In fact, why should such an association, with the avowed

intention of getting the good will of the public, countenance the marketing of inferior apparatus at any price?

A laboratory for testing radio apparatus and material is planned; a member firm may submit any of its technical problems to the laboratory staff for solution. It will be remembered that last month we mentioned the fact that the National Retail Dry Goods Association had requested the Bureau of Standards to formulate tests of radio receivers, which tests were to be carried out by the Electrical Testing Laboratories, so it seems that very soon the public should be getting receiving sets that are tested and guaranteed.

A reorganization of the society was effected in Washington on July 26 resulting in a change of officers. The first president, Mr. Alexander Eisemann, a well known radio manufacturer, was replaced by Mr. W. H. Davis, of Pennie, Davis, Marvin and Edmonds, probably the most capable attorney engaged in radio litigation. The other new officers include Harold Powers, of the American Radio and Research Corporation, Cloyd Marshall of the Dubilier Condenser Company, and George Lewis of New York. It is to be hoped that with the change of officers there will be formulated a policy promising more to the radio public than did that contained in the original prospectus.

At the meeting when the reorganization took place, army representatives urged upon the members the advisability of standardizing the smaller parts of radio equipment so that, in case of necessity, the tremendous amount of apparatus scattered throughout the country could at once be applied to outfitting the Army and Navy.

We believe that the Chamber will do well to proceed cautiously on this standardization programme. In such a rapidly growing art, little standardization of parts can be effected without seriously hampering further development. Tubes, for example, have already been standardized too much; the present type of tube with its four terminals coming through close together and having the four-terminal base is acknowledged to be of poor design. Its electrical characteristics could be greatly improved by a different arrangement, but a change of construction now would result in the scrapping of much of the apparatus in

use to-day. If an independent company were free to manufacture tubes to-day, they would by no means follow the present standardized form; a different construction, with different base, would greatly improve the action of the tube at high frequencies, so much so that the present standardized type would probably soon be discarded.

As we see it, there is no likelihood of the military branches of the Government requiring our receiving sets during the next few years. The possibility is so remote that the development of radio equipment should be controlled by this consideration only in such matters as screw sizes and like details, and the sizes of units might be standardized without altering their electrical characteristics. Sets are changing so rapidly that before the next war our present equipment will be completely antiquated. Standardization should be applied only

to those details in which nothing is to be gained by change.

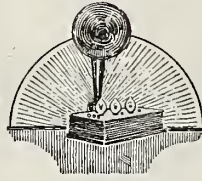

DID PETER COOPER HEWITT DISCOVER THE GRID?

IN A recent annual report of Cooper Union there appeared a tribute to the late Peter Cooper Hewitt from his friend and fellow scientist, Professor M. I. Pupin. It is evident that Pupin thought very highly of the inventive and scientific ability of Hewitt, almost as much as he did of the more human traits of his character.

A visit to the Hewitt laboratory, which was dismantled shortly after the inventor's death, showed that he had been intensely interested in radio development; much of the apparatus installed in the laboratory had evidently been used in high-frequency experiments, especially in the phenomena occurring in vacuum tubes of various kinds. A pair of huge Tesla coils, which he had used at the two ends of his laboratory, as transmitter and receiver, showed that Hewitt had been interested in radiation phenomena since the early days of its demonstration by Hertz; recent vacuum tube appliances showed that his interest in this line of work had been carried into the most recent developments.

An extremely interesting note in Pupin's eulogy of the inventor of the mercury vapor lamp is that in which he states that Hewitt was the real discoverer of the grid and its functioning in a three-electrode tube. Pupin evidently had personal knowledge of this dis-

covery of Hewitt's as he makes this statement unequivocally. Evidently Hewitt did not appreciate the importance of his discovery or he would have covered his priority with letters patent, as he did so many other ideas arising from his experimental work.

On this basis, then, it appears that De Forest gets credit for an idea really first discovered by Hewitt and it seems strange that, in a similar way, Armstrong gets credit for discovering that an audion would oscillate, as it undoubtedly had done for De Forest many times, without his realization of the importance of the action.

We remember some early experiments of De Forest's in which

he was trying to show the applicability of his audion as a telephone repeater, and some of the audions *squealed* when connected to the repeating circuits. Undoubtedly the squealing tubes, which were classed at the time as defective, were oscillating. The inventor of the audion had brought about the proper conditions for setting the tube into oscillation and had produced the oscillations, but without realizing it. So as Hewitt approached the discovery of the three-electrode tube, and as De Forest approached the discovery of the oscillating tube, so many times may we be close to an important discovery, yet fate lets us pass it by and we go on to oblivion instead of fame.

THE LIGHTING WIRE AS AN ANTENNA

MUCH has been said lately about the bother of the outdoor antenna, and many owners of radio receivers, especially those in apartment

houses where landlords' rules are obstacles to be overcome, have been only too ready to grasp at a more easily installed substitute. The coil aerial is a *bona fide* substitute but of course it

requires several stages of amplification before it becomes electrically the equal of the ordinary elevated antenna. When the idea of using the ordinary lighting wires as an antenna was suggested, many were ready to give this new antenna a trial—and a number of these have been sadly disappointed. In many cases not only is the lighting system not so good as an outdoor antenna but it refuses to work at all.

The reason is more or less evident to any one

who has an elementary knowledge of radio transmission and when it is noted how lighting wires are installed in a house. In practically no apartment house can the lighting wires be a very efficient antenna, because throughout their whole length, from the lighting company's sub-station to the lamp socket, they are either actually underground or else installed in a grounded iron pipe or metallic casing. Such a wiring system can take comparatively little energy from the advancing radio wave and so can give but little signal. On the other hand dwellers in the suburbs, where the electric wires are installed overhead on poles, may possibly get very strong signals from their lighting system, depending somewhat upon the style of wiring used in the house. If the house wiring is carried in iron pipes or conduits grounded to the water pipes, poor results will generally be obtained. If armored wire is used, such as BX cable, somewhat better signals may be

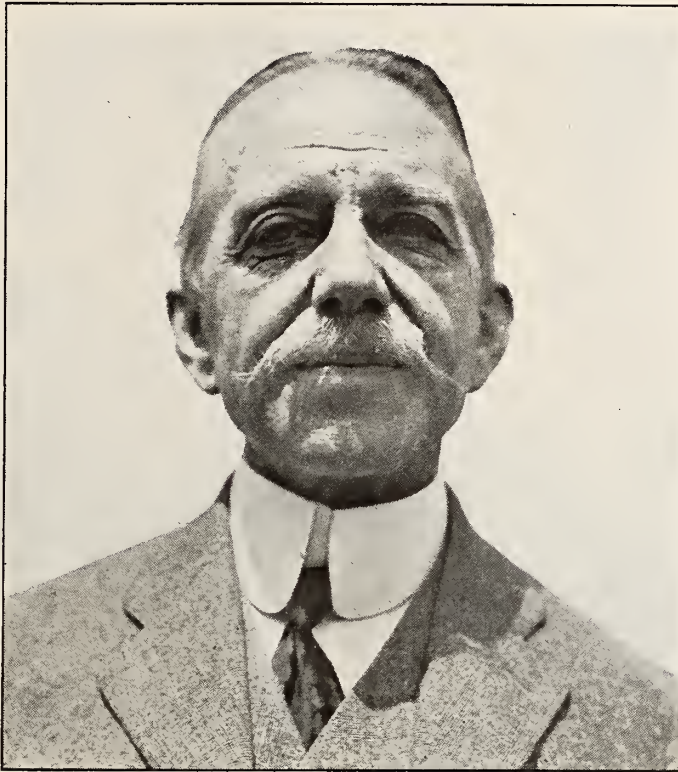

THE LATE PETER COOPER HEWITT

expected, and probably the best results are obtained when the old-fashioned "tube-and-knob" wiring has been installed.

One side of the house wiring system is generally grounded to the water pipe where the wires come into the house; evidently using such a wire for an antenna will prove rather futile. The ungrounded side of the wiring system is the one which should be used to pick up the radio signal, but this wire must not be connected directly to the receiving set as a short circuit is almost sure to result, burning out house fuses and quite likely damaging the radio set. The special plugs sold for the purpose of using the lighting wires for antennas are fitted with condensers which will let through whatever radio currents there may be on the wires and still prevent the lighting current from leaking to ground and damaging the apparatus. The plugs sometimes used for this purpose have cheap paper condensers in them, which may or may not give sufficient protection from the lighting current; only those plugs which have been subjected to a high voltage test should be used.

In tests recently conducted in New York City, where the wiring was all underground, the signal received was poor, and much disturbing noise, evidently originating in the motors used in neighboring factories, was encountered. But the same power system gave fairly good results, fair signal and but little disturbing noises, in the outlying parts of the system, where the wiring was overhead and there was no machinery operating in the vicinity. When a signal *is* received from an underground system the effect is due to the fact that radio waves do penetrate a conducting medium to a certain extent; this penetration of the waves into the earth is not mysterious but might be calculated if the local conditions were exactly known. It is this earth penetration which accounts for the success of the Rogers underground antennas as described in our August number.

ELIMINATING "A" AND "B" BATTERIES BY GETTING POWER FROM THE LAMP SOCKET

SOME months ago there appeared a notice that the physicists of the Bureau of Standards were ready to hand over to the radio public a wonderful boon in the shape of a triode amplifier which required no batteries of

any kind for its operation. To many of us whose enjoyment of a concert has been spoiled by the sudden giving out of the filament storage battery, or who have been bothered by noisy, loose connections or bad cells in the plate battery, this announcement was indeed welcome. The interest of the public in the new device was so great that the Bureau had to get out a form reply to the numerous inquiries as to how soon the description of this battery-less amplifier would be ready.

In the July number of the Journal of the A.I.E.E. there is an interesting description of this amplifier by Physicist Lowell, of the

Bureau, who has done the major part of the development work in the perfection of the new apparatus. The article shows the growth of the idea from a simple three-tube arrangement to the final product, which has the Bureau's seal of approval, an amplifier and rectifier outfit using altogether seven tubes and a crystal rectifier. Three

tubes are used to make a radio-frequency amplifier feeding into a crystal detector circuit, which changes the modulated high-frequency current into an audio frequency current; from this crystal circuit the current passes through two stages of low-frequency amplification into a loud speaker.

The filaments of all tubes are supplied with power from the secondary of a specially wound transformer, the primary of which draws its power from the ordinary sixty-cycle alternating current supply available in the average home. One rectifier tube, in combination with choke coils and condensers suitably connected supplies plate current for all the tubes and the other rectifier tube supplies the current used to excite the magnetic field of the loud speaker used. The latter tube is of the gas-filled variety, the Tungar tube used in small storage battery charging outfits. This type of tube, by the way, is a direct outgrowth of the Hewitt mercury arc rectifier, the source of electrons being a hot filament instead of the hot spot in the pool of mercury as used in Hewitt's rectifier.

The transformer and rectifier tubes are conveniently mounted in one box and the five-tube amplifier unit is compactly arranged in another; in order to make the amplifier operate it is necessary only to connect the flexible cord in the ordinary lamp socket. The amount of power drawn from the house circuit is about



the same that is used by an ordinary fifty-watt lamp.

It seems incongruous to incorporate a crystal rectifier in a modern receiving set; we have

facturer will probably see their sales fall away to some extent, but the radio public—at least that part of the public which can afford to maintain a seven-tube receiving

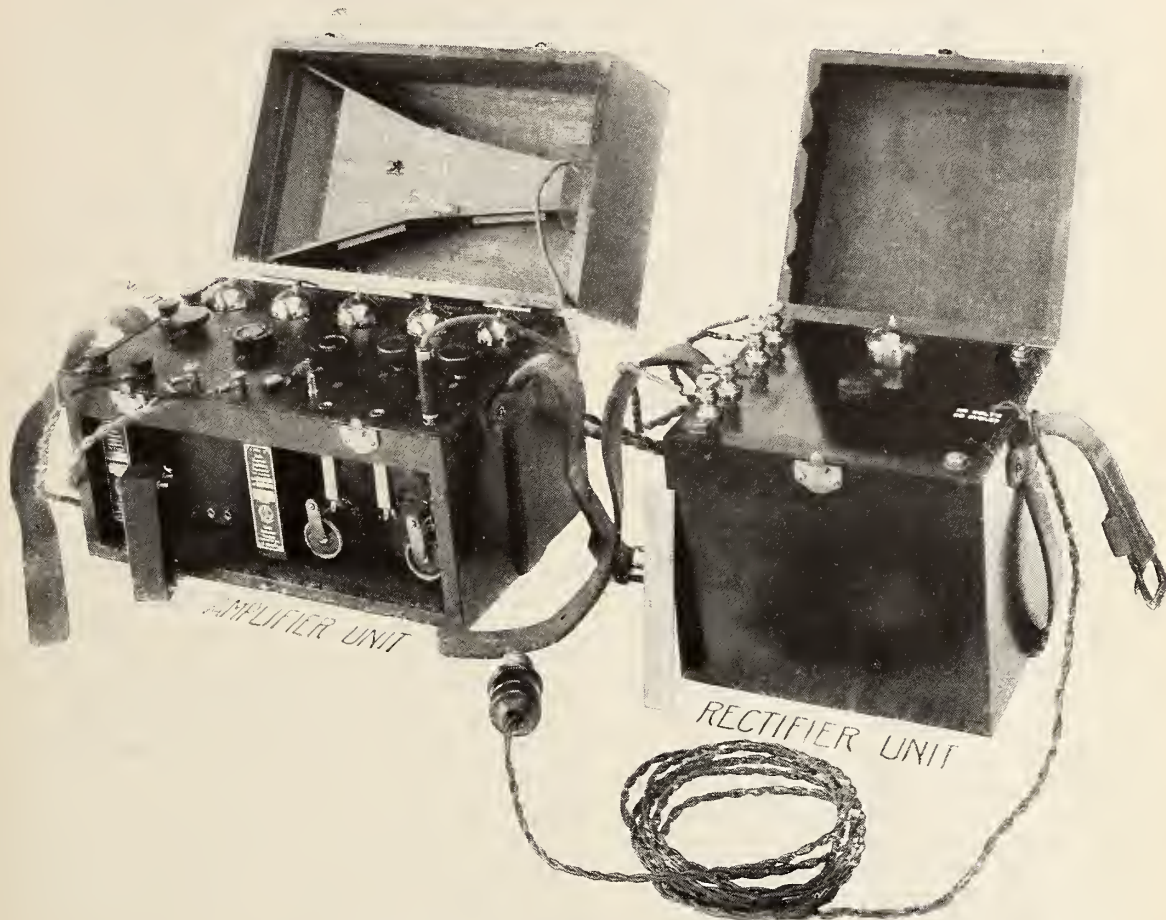

Courtesy A. I. E. E. Journal

REPLACING "A" AND "B" BATTERIES

This equipment, developed by the Bureau of Standards, does away with batteries for reception. Six tubes are employed in addition to a crystal detector. The Bureau is working on a device which will make use of a vacuum tube in place of the crystal

thought that crystals were due to go into the discard, but this apparatus apparently gives them a new lease on life. Developments are being carried out in the tube laboratories, however, which will soon give us a tube of peculiar construction such that it may fill the place occupied by the crystal in this latest amplifier circuit.

With this new tube available, the bureau will undoubtedly substitute it for the crystal rectifier and this amplifier of Lowell's will then be the most convenient outfit we have seen. The dry cell and storage battery manu-

set—will be greatly benefited by this new apparatus.

ARBITRATION SOCIETY OF AMERICA MAY END RADIO DISPUTES

ALTHOUGH the founding of this society has nothing directly to do with the present progress of radio, it is not at all impossible that some of the wrangles, necessarily occurring in an art going forward at such a rapid rate as is radio, may find their way into the court of the Arbitration Society and thus be settled much more expeditiously and fairly than is the

case with most of the radio patent suits; the action may also be settled at much less cost to the litigants.

It appears that there exists, in New York State, an Arbitration Law, amended in 1920, which makes possible and advisable such an association as this newly formed Arbitration Society. The law is probably known to-day to only a few outside the legal profession but if the Society functions as we anticipate and hope, in a few years more cases will be settled under this law than in the ordinary courts of justice. In brief, this law provides that two parties involved in an actionable difference may have this difference settled, legally, by arbitration. If both parties have agreed, in writing, to have the action settled in this manner, the award of the arbitrator is binding and irrevocable. The authority of the arbitrator is the same as that of a judge of a court, in fact his award will be confirmed by the court, if necessary, and it is as final as though the case had been settled by regular trial procedure.

The cost of carrying a case through the Arbitration Court will be negligible; there will be no red tape or peculiar legal technicalities to observe as in present trials; each party may tell his side of the story completely without being subjected to a bull-doing cross examination by a legally trained ignoramus as is frequently the case in present methods. No expensive expert witnesses will be required by either side. Practically the whole cost will be that entailed for the rent of the rooms used and a nominal fee for the arbitrator, who is selected by the disputants themselves.

The movement owes its origin to the vision of a prominent New York lawyer and former judge, Moses H. Grossman: on the present Board of Governors are deans of law schools bankers, business and professional men. Its start has been most propitious and augurs well for a career of increasing usefulness to the American public. It has received unanimous commendation from the legal fraternity and the press throughout the country, largely because it provides relief from the long and expensive process by which difficulties are at present legally settled, a process which, as the Society's outline announces, constitutes in

many cases a denial of justice rather than an administration of it.

There is practically no limit to the scope of its services, any action other than criminal or divorce cases being within its jurisdiction. It is not impossible that in a short time the record of the Society will be such that its services will be at once invoked for the settlement of those complicated trade questions which are at present fomenting so much trouble and loss in our industrial life.

In a typical case already settled by this method the taking of evidence for both sides lasted an hour and fifteen minutes and on the following day the arbitrator's award was made; it was evidently fairly satisfactory to both parties. The movement surely has our best wishes and its founders our respect and congratulations for a service so highly conceived, so intelligently planned, and so propitiously started.

SHIPS AND AIRPLANES SHOULD CARRY EMERGENCY ANTENNAS

WE HAVE passed legal enactment which requires that all vessels, falling within a certain classification as regards passenger traffic, shall have in addition to the regular radio equipment a complete emergency outfit, so that in case of need, with the regular apparatus out of commission, the emergency outfit can be used for sending out a call for help.

Now, it seems not at all impossible that an accident bringing disaster to a vessel may also carry away her antenna, without which the emergency equipment is of little avail. It seems that in such cases a kite-supported antenna might prove of the utmost importance; there is nearly always sufficient wind at sea to support a kite and it seems as though in the provision for emergency equipment we might well require that proper apparatus for sending up one of these emergency antennas be included. Such a kite-flown antenna, or possibly a small balloon-supported antenna might also be a very valuable adjunct to the radio equipment of an airplane. In case of a forced landing in some remote spot, it might well make the difference between death and rescue.

Making Life Safe at Sea

A Discussion of Some of the Scientific Aids to Navigation Which Will Go a Long Way Toward Promoting Our Ocean Commerce and Reducing the Hazard of Sea Travel

By ARTHUR H. LYNCH

NOT many of us do a great deal of sea traveling, and those of us who do frequently board our marine carrier with perfect confidence in the line, the captain, the "wireless" and good luck. Little, if any thought is given to the danger—and there is danger every time we go up the gang-plank, whether it be for a trip of a hundred or many thousand miles.

Radio telegraphy has undeniably reduced the danger factor of yesteryear, but even that great instrument for safety has its limitations. Systems are available, however, which can make navigation practically safe from a standpoint of collision or running aground in an effort to pick up a lighthouse or vessel in thick weather.

Unfortunately, these scientific achievements are not in general use. There seems to be a cycle of time necessary before any new marine aid is applied. To those who have followed the trend of progress, it must be apparent that instances are few in number of a new scientific achievement being put to practical use soon after its discovery. In the words of a man who has ardently devoted himself to the safety of life at sea, "Only a terrible disaster wakes the people to a realization of the possibilities of sea safety devices. Prompted, perhaps, by the immensity of the loss of life and property, and its attendant publicity, the layman asks, 'Couldn't something have been done to prevent it?' After every great marine disaster investigations take place and the public seeks to avoid a similar catastrophe."

Does it not seem strange that the makers of our marine laws, in whose trust is left the safety of life and property on the high seas, do not concern themselves more quickly and more intelligently with man-made devices which can accomplish this result? Is it because they are hampered by insufficient funds to carry on their work? If so, let us all do what we can to see that the necessary appropriations are

made. If it is simply the fact that they need a little pushing, let us all push together.

In bringing this matter to general consideration, and in pointing out a most valuable marine safety system, it is, perhaps, advisable to consider the details of some marine tragedies which in all likelihood could have been avoided. It is remotely possible that such consideration may lead, directly or indirectly, to safer sea travel.

CONCERNING THE "REPUBLIC" AND "TITANIC"

THE much-heralded story of the saving of the steamer *Republic* by radio, and the averting of a disaster which would doubtless have taken place without it, greatly stimulated the framing of laws requiring vessels, which carry a certain number of people, and travel a certain distance, to be provided with radio equipment.

Regarding this particular collision, which occurred on January 23rd, 1909, it is significant that even with her radio the lives on this vessel might not have been saved had it not been for a certain device we are to consider further along which is not in universal use to-day, and for which there is no compulsory legislation.

The value of radio to the safety of life at sea found little support or interest among maritime legislators until after the sinking of the *Titanic*, on April 15th, 1912. Radio saved more than seven hundred lives in this most terrible of marine tragedies, but the loss was so great that it set the world to thinking—for a little while.

Marconi had proven in 1899 that radio was a valuable aid to safe navigation, after having brought his equipment to a point of practicability. However, little consideration was given to his conclusive evidence until 1910, and it was not until 1913 that radio even began to receive the attention it deserved! Since that time, it has gone through a series of rapid changes, and improved equipment is continually finding its way from the factories.

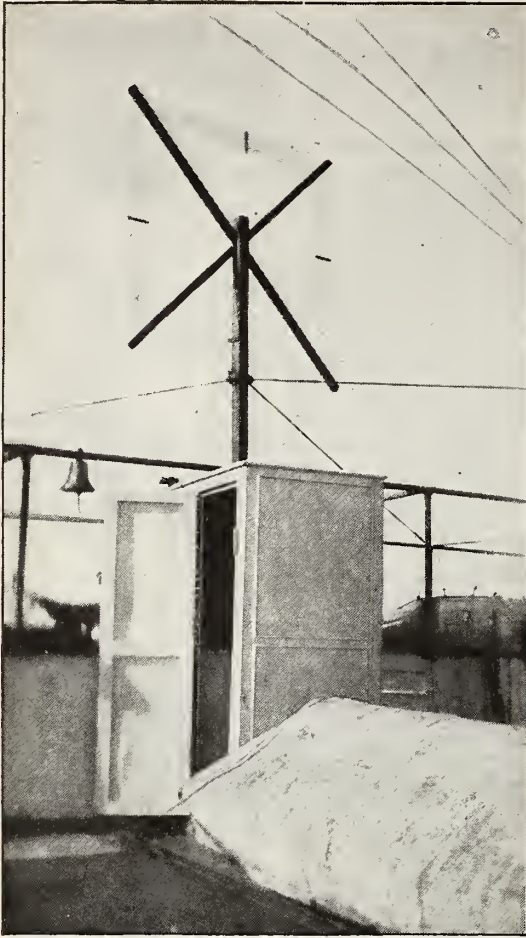

CAPTAIN MAXSON'S LOOP

Before the use of the radio compass became general, Capt. Maxson of the S. S. *Momus* built his own radio compass with which he made many interesting observations

Although the radio direction finder was given some scientific consideration before the war and did manage to find itself on one or two vessels, it was thought to be a refinement more costly than valuable. Little attention was paid to it in other than government shipping circles and the only improvements made were of a scientific rather than a practical nature. When the war god drew his sabre and the brains of the world concentrated upon the means to win back peace, it was natural that scientific devices which could be used would be immediately developed. Radio engineers, here and abroad, strove to perfect the radio compass, because it assisted them in locating enemy troops by determining the direction of signals coming from the latter's radio stations. Many other applications of the compass were

evolved and put into practice, especially in connection with the guiding of bombing airplanes on night errands.

The radio compass was also used on some of our transports and other fighting craft for locating hostile submarines, as well as for general navigation.

It was developed to a point of comparative practicability before the end of the war, and since that time it has been the direct means of averting many marine disasters. Much of the work done in perfecting the radio compass could not have been successful without the development of the vacuum tube, which it made possible more accurate observation over greatly increased distances, than was possible with the older types of equipment.

RADIO COMPASSES AND BEACONS

THERE are two distinct methods for the application of the radio compass idea, for guiding vessels in foggy weather or for any of the other maritime uses to which it may be put. Our Navy Department and our Bureau of Lighthouses have contributed much to the perfecting of a system for guiding ships when all other forms of navigation would be valueless.

The radio compass, in the form most common in this country, consists of several turns of wire wound on some sort of a frame which may be orientated by a handle or other device, coupled to the proper tuning apparatus. As the coil is rotated, the operator can notice a marked increase in the signal strength from a given station, at a given point on the scale mounted below the handle of an indicating device. Where a magnetic compass is used in conjunction with this device it is possible to determine with only a slight error the direction from which the signals emanate. By employing this system, vessels at sea can determine their bearing or direction from some receiving station on the coast whose latitude and longitude is known. It is not necessary for the ship itself to be equipped with a radio compass for the direction is determined at the shore station, where a compass coil is in operation, and the result is then sent by radio to the vessel. It is possible for a vessel to secure a very definite idea of its position, as well as its bearing from a given point. In this case, however, it is necessary to receive bearings from two shore stations located at different points. The point at which the bearings cross indicates the position of the vessel. Stations of this char-

acter are called radio compass stations and are located along our coast line and at the entrance to many of our larger harbors. Within the past few years they have rendered a remarkable service.¹

Professor J. H. Morecroft of Columbia University in an editorial in the August RADIO BROADCAST, has made the very practical suggestion that radio compasses operating on short wavelengths could be manned by any member of a ship's crew with very little instruction. By a

signals and report them to the navigating officer.

An arrangement of this character would in no wise interfere with existing services. It could be made a very simply operated device, and infinitely more worth while than the present practice of employing a bow watchman even though the latter is supplied with a powerful glass.

There is another type of station used for marine work, based on the same principle but



DIAMOND SHOALS LIGHTSHIP

This modern light vessel is located off Cape Hatteras and is equipped with submarine signaling equipment radio beacon, and other modern appliances for the guidance of navigators

timing arrangement, it would be possible to have signals automatically transmitted by a special, low-power, short-wave outfit, and during the periods of silence a receiving compass coil, tuned to the wavelength employed could be automatically rotated. The observer would merely have to note the direction of incoming

¹Much valuable work in this application of radio may justly be credited to Frederick A. Kolster, formerly Physicist of the Bureau of Standards and now with the Federal Telegraph Company, as well as to Francis W. Dunmore, Associate Physicist of the Bureau of Standards. "The Direction Finder and its Application to Navigation" which was prepared jointly by these two men, is a comprehensive booklet thoroughly describing and illustrating the principles involved. It is listed under "Scientific Papers of the Bureau of Standards" as No. 428.

using a method which is exactly the reverse of the one we have just considered. This type is known as the radio beacon. In the same manner as a lighthouse employing a flashing light may be distinguished by the length of the flash or the number of flashes, the radio beacon may be recognized by the signals it is made to transmit. In heavy weather these stations send signals at regular intervals, in all directions, which may be picked up by any ship within their range.

In this instance it is necessary for the ship desiring to know her direction from a beacon station to be equipped with a radio compass of the type we have just considered for shore

observation. The ship then makes an observation of the direction of the signals coming from the beacon station, and, if there are two beacon stations, can determine her position.

LIMITATIONS OF THE RADIO COMPASS

Granting that the error of the average ship radio compass does not exceed two degrees of arc, which is a very generous concession, it is readily appreciated that it is subject to some rather serious drawbacks from this consideration, as well as from some others which are even more important, especially in the open sea. Principal among these limitations, is the fact that it offers no method whereby distances may be measured, unless it is possible to make simultaneous observations from two beacon stations or secure reports from two shore compass stations.

The measuring of sea distances in foggy weather is very important, for upon it depends the safety of many lives. An experienced radio compass operator can estimate fairly accurately the distance between his compass and the station he is receiving from, if he is familiar with the power employed at the transmitting station, but his estimate at best is only a guess, and guesswork in navigation is to be avoided.

THE NEED FOR ACCURATE SEA MEASUREMENT

It would seem as though the determining of the distance a vessel would have to run in a certain direction, in order to pick up a lightvessel or lighthouse in foggy weather, would be of value in entering a harbor. As two vessels approach each other, their distance apart taken at intervals would indicate the time at which they would pass and enable their

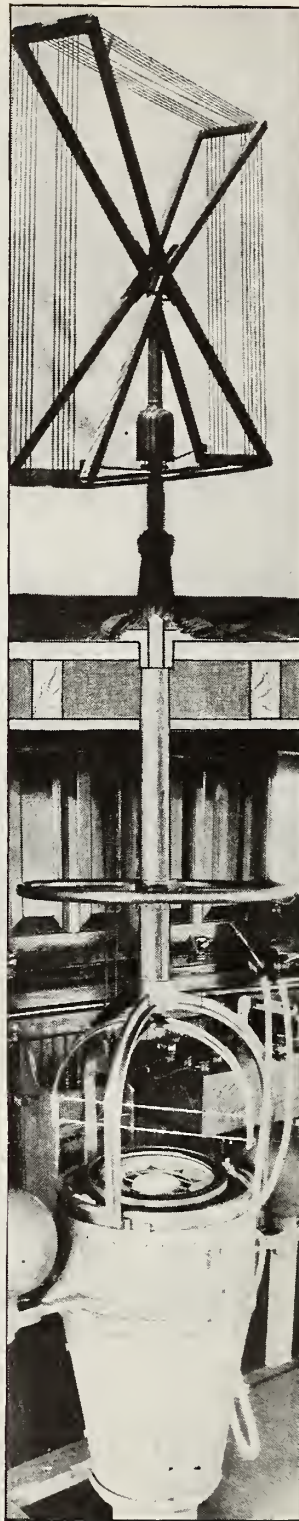

A MODERN SHIP'S COMPASS

Combining the magnetic needle and the loop antenna

navigators to avoid each other with greater certainty and less anxiety than is possible to-day.

Unfortunately, the value of modern marine appliances has not been thoroughly appreciated in shipping circles; there is a tendency to oppose any expenditure, regardless of its value to ships and shipping. Perhaps a reason for this is that shipowners are charged a rate of insurance for their vessels, dependent to a great extent upon the record of their line and the record of casualties on the route in which the steamer is engaged, rather than upon the efforts of the owners to make the individual vessel safe. The law of averages seems to remain, regardless of the efforts made in individual cases. There is no such thing as a reduction in the insurance premium for the installing of safety devices, such as is the case in automobile insurance or in insuring buildings. There are many fire-detecting and extinguishing devices made for marine use, but their adoption does not alter the premium rate one iota, directly. If a steamship line happens to run all its vessels safely for a number of years, and keeps them on routes where marine disasters have never, or infrequently, occurred, a slightly better premium rate may be obtained. An officer in one of our largest companies once remarked before a meeting at which this subject was brought up, "If, by the grace of God and a fair wind a line manages to fight shy of accidents, it is quite likely to be able to secure a comparatively low rate or premium."

There is all manner of loose talk about a merchant marine and a subsidy—or some other form of government backing for steamship lines which is a subsidy when the war paint is removed—but there is very little common-sense legislation dealing with the protection of property at sea and

making it attractive for owners to provide ships with safety devices which are practical.

FOG—THE GREATEST MENACE

WE HAVE made great progress in marine engineering, and storms no longer hold the danger they formerly did. Derelicts are systematically sought and removed. Icebergs are located and their positions broadcasted to mariners by radio. Careful charting of the Seven Seas, accomplished at great cost by the various countries, and the establishment of lights on dangerous shoals and promontories have stripped the sea of much of its former risk, but one great hazard remains—the one mariners fear most—fog!

Millions have been spent for fog-horns and other sound-producing devices but they are all subject to error, due to variations in atmospheric density which prevent the sound waves from traveling in a given direction. Sound waves may be refracted from side to side or up and down, resulting in certain areas where the sound is not heard at all.

VESSELS LED TO DISASTER BY REFLECTED SIGNALS

IN a paper presented at the 29th Annual Convention of the American Institute of Electrical Engineers in Boston, June 27, 1912, Mr. H. J. W. Fay pointed out that from 1893 to 1902 between 900 and 1000 vessels were wrecked by aberrations of sound or by being drawn on a false course by echo. The approximate loss in property amounted to \$57,500,000 and no less than 530 human beings were sacrificed.

These statistics became an appeal for the mariner, and encouraged inventors to renewed efforts which were at last realized in a successful system of submarine signaling.

SUBMARINE SIGNALING: ITS ORIGIN

THE system which has been perfected for sea warnings is based upon the fact that sound travels through water without the distortion, reflection and refraction which obtains where air is the carrying medium. Sound under water has another advantage: it travels faster than in air.

It is impossible to determine with accuracy the originator of this form of communication, and, were the truth known, it is quite likely that primitive man made use of some form of under water signaling, however crude his instruments

may have been. It is said that the natives of Ceylon used this knowledge many years ago to signal each other when at sea in their fishing boats. They used an earthen "chatty" which was submerged and struck with some hard object. A sharp percussive clink was thus produced which could be heard by placing the ear against the bottom of a boat many miles distant.

In 1826 we find that two scientists, Messrs. Colladon and Sturm, sought to measure the velocity of sound in water. They struck a submerged bell with a hammer and listened for the sound by submerging one end of a common ear trumpet and holding the other end to the ear. It is quite likely that they were aware of the experiments made in 1767 by a Scotch scientist who managed to hear a large hand bell at a distance of 1200 feet by the simple expedient of submerging his head.



It would seem, therefore, that there is nothing very new about submarine signaling—at least in theory. It was known long before anyone thought of securing patents on it or putting it to any practical use.

EARLY DEVELOPMENT OF UNDERSEA SIGNALING

THE first published record of any attempt to apply the principles of under-water signaling to some useful purpose is found in an English patent issued in 1878 to Henry Edmunds. This patent describes a system for ringing a submarine bell by electricity: for attaching a bell to a buoy and taking advantage of the wave motion to supply power for operating the bell, as well as the suggestion that sounds could be created under water by submerging and energizing an ordinary telephone receiver.

The underlying principles of this patent are quite like those in use to-day, though they have been greatly refined.

For a receiver, Mr. Edmunds suggested the use of an oar with its blade under water and

the handle end pressed against the ear. He also suggested the use of an ordinary telephone microphone which could be submerged to pick up the sound, but he gave no details of its construction.

In 1887, W. G. Spiegel obtained a U. S. patent for a submarine sending and receiving system which was found to be of little practical value.

The next year, 1888, Neale and Smallpage, in England, applied for a patent pertaining to microphonic and acoustic receiving devices, but they seem never to have passed the patent stage.

In 1889, Professor Lucien I. Blake was granted a patent for a receiving device of similar design to that described by Neal and Smallpage. Professor Blake also proposed the use of the under-water siren, which has since been developed practicably.

Apparently the invention of the telephone in 1876 urged a number of inventors to re-attack the subject of submarine signaling, for between 1876 and 1891 we find independent effort bent in this direction in many quarters of the globe. Among these are A. Benari of France; Mario Russo d' Assar of Italy; Thomas A. Edison, William G. Spiegel, John M. Batchelder, Lucien I. Blake, E. Huber, and F. J. Kneuper of the United States; Henry Edmunds, F. N. Boyer, N. T. Neale, J. H. Smallpage, Walter Walker, and others in England.

Following the exhaustion of the ingenuity or the resources of these inventors, very little was accomplished and nothing of a commercially practical nature was produced until May, 1898, when Arthur J. Mundy of Boston took up the task and succeeded in developing a practical

system of undersea sound propagation and reception.

Professor Elisha Gray joined Mr. Mundy in the experimental work, and before his death in 1901, the project had reached a stage where a submerged bell could be heard a considerable distance by means of a microphonic receiver, also submerged.

DETERMINING THE DIRECTION OF SOUND

THERE was one great drawback to this system: the receiving microphones would function satisfactorily at sea only when they were cast overboard from a vessel in a calm sea with the vessel motionless and noiseless. This meant tedious work and many mariners would not bother with it, regardless of fog or other hazard.

Then, too, it was impossible to determine the direction from which the sound arrived, although it was early realized that a device which would accomplish this would help shipping tremendously. Ships approaching each other in fog could avoid collision if they knew the direction they bore from one another. It rested with Mr. Mundy to solve this problem. He did it in the manner shown in an accompanying sketch.

A microphone is suspended in a water-filled tank on each side of the vessel, below the water-line and far enough from the bow to be free from the noise caused by the cutting of the water as the ship is under way. In present-day systems, two microphones are placed in each tank to make certain that the signaling system is not entirely crippled if one of them fails to function.

In this diagram three methods of operating submarine bells are indicated. The bell at the left is operated entirely by the motion of the waves, and it is interesting to note that one such bell during eleven months' service struck over four million times without any indication of wear on the moving parts. The centre bell is controlled by an electric cable operated from the lighthouse. The bell at the right is operated by a pneumatic pump on board the light vessel



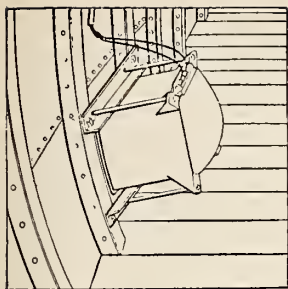

RECEIVING TANK

This is a receiving tank, two of which are employed for submarine signal receiving; one on either side of the forward part of the vessel. The receiving microphones are suspended in water in this tank

This method of receiving obviated the necessity for "heaving to" to make observations, as well as eliminating the disturbing noises caused by machinery aboard the vessel.

By a system patented by Mundy and Millet in August, 1894, it was possible to determine the direction sound was coming from, applying the method shown in an accompanying diagram.

THE SENDING APPARATUS

THE first sound producers were 120-pound bells of the ordinary locomotive type with a rate of 320 vibrations per second. 300-pound bells with a rate of about 400 were also tried. Some were made of bell metal and others of steel, and some were excited electromagnetically by alternating current.

The final choice was a 220-pound bell having a vibration rate of 1215 per second—the type now in general use.

FIRST MARINE INSTALLATIONS

THE first vessel on which submarine signal-receiving apparatus was installed was the U. S. Revenue Cutter *Seminole*. Tests carried on in Boston Harbor resulted in hearing an 800-pound church bell with rate of 450 vibrations a distance of about half a mile.

The next boat so equipped was

a steel passenger vessel plying between Boston and Gloucester, Mass. This, by the way, was the first vessel on which tests were made while under way. Running at half speed the ship heard signals from a bell at Egg Rock at a distance of three-quarters of a mile. Then came the *Chippeta*, a wooden ship, used for experimenting.

All manner of receiving schemes were tried, including the use of a microphone diaphragm as part of the ship's skin, below the water line. Microphones were attached directly to the ship's skin, but this location proved undesirable because noises were produced in the receivers by the ship's machinery and by the impact of rushing water when the vessel was under way.

Then wooden tanks were constructed in the fore-peak of the *James S. Whitney* using the outer skin of the vessel for one side of the tank. They were filled with 64 cubic feet of water and it was found that by their use, signals could be heard from ten to fifteen miles while steaming at fifteen miles an hour.

Followed much experimental work resulting in the development of a cast iron tank 16 inches square and 18 inches deep with a rubber gasket to make it watertight, while also serving as a sound insulator, preventing noises on the vessel from reaching the microphone.

The *Metropolitan* fleet was then equipped, and the Allan Liner *Tunisian* was the first

transatlantic vessel to be fitted with this apparatus.

IS THE GAME WORTH THE CANDLE?

IT WOULD seem logical from an economic standpoint that, unless any system of safety devices resulted in a saving greater than the cost of its installation, operation and maintenance, we might well do without it. But when we think of marine

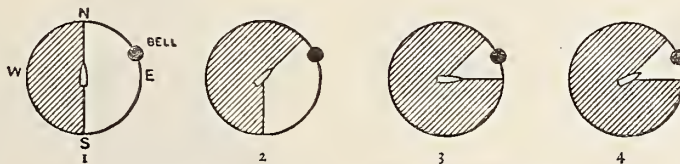

SUBMARINE SIGNAL DIRECTION FINDING

By the Mundy and Millet method

- These diagrams show how the direction of the bell or oscillator may be determined on board ship by using the submarine signal receiving apparatus. Starting with ship heading north, with bell E. N. E.
1. Shows the ship headed north when the first observation is made. With the semaphore switch set to starboard the bell sound is heard, but with the semaphore switch set to port no bell sound is heard, showing that the bell is located in the unshaded portion of the circle. (At distances less than one mile the sound may be heard faintly on the opposite side of the ship from the bell.)
 2. Shows the ship swung to starboard four points, heading northeast, and the louder bell sound still being heard on the starboard side; the shading is extended, leaving only the small, unshaded portion of the arc to be explored. A faint sound may now be heard on the port side.
 3. Shows the ship swung to starboard four points more, heading east, but in this position the louder bell sound is heard on the port side and the weaker bell sound on the starboard side, and the shading is again extended, showing that the ship has been swung past the bell, which now bears on the port bow.
 4. Shows the ship swung two points to port, heading on the bell, in which position the volume, quality and tone of the bell will be equal on both port and starboard sides, showing that the bell is located dead ahead.

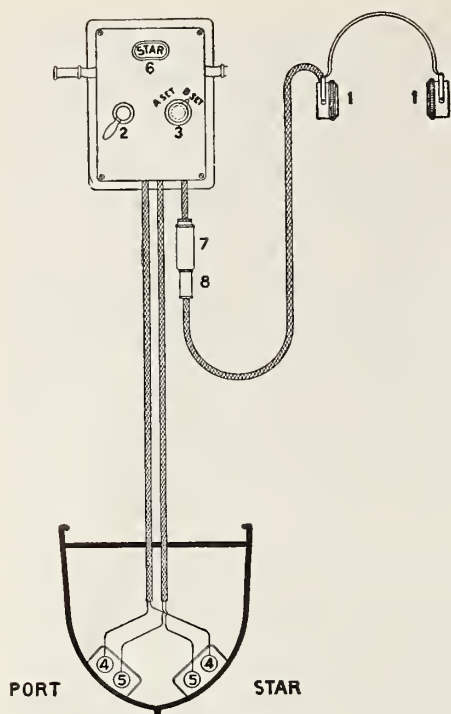

1. EAR PIECES
2. HANDLE
3. KNOB
4. A MICROPHONES
5. B MICROPHONES
6. SEMAPHORE
7. SOCKET
8. PLUG

THE ULTIMATE
RESULT OF
MUNDY'S WORK

This diagram illustrates the standard type of submarine signal equipment. By manipulating the switch on the receiving box, the operator is able to tell whether signals are coming from his port or starboard side. Each receiving tank is fitted with two microphones so that the possibility of the apparatus becoming inoperative is quite remote.

safety devices, we must forget dollars and cents and consider the value of human life.

Who knows but there may have been a man on the French submarine *Pluaise*, which was sunk with all hands, who would have perfected some devices for the betterment of mankind? The *Pluaise* met the uncommon fate of rising to the surface and striking the cross-Channel boat *Pas de Calais*. Had the *Pluaise* been equipped with submarine signal-receiving gear she could have heard the noise made by the approaching steamer and avoided the collision.

THE REPUBLIC DISASTER

THE sinking of the American S. S. *Republic* on January 23, 1909 is the first marine disaster in which radio played a significant part. Coupled with the sinking of the *Titanic*, this

tragedy stirred up enough interest and action to have radio equipment made compulsory on certain classes of vessels.

Had it not been for the timely application of submarine signaling and the resourcefulness of an officer of the S. S. *Baltic*, the historic rescue of the *Republic's* passengers and crew might not have been effected. Little has been said about this in the stories told of this great radio achievement.

The *Republic* was reported in distress, by radio, but was located by submarine signals. When Jack Binns sent out his history-making CQD (now SOS). It was received by Jack Irwin who was on duty at the Marconi station at Siasconsett. Irwin eventually got in touch with the *Baltic* and made known the condition and position of the *Republic* and the *Florida* which had collided. The accompanying sketch was made by an officer of the *Baltic* and indicates the method employed.

The *Baltic*, bound from Europe had picked up the submarine bell of the Nantucket Shoals light vessel and had laid her course for New York. She had proceeded eighty miles when Irwin informed her that the *Republic* was in distress.

Captain Sealby of the *Republic* informed the *Baltic* that he was in range of the Nantucket Shoals bell and gave his bearing as determined by the Mundy & Millet method. In seeking the *Republic*, the *Baltic's* first move was to get back in range of the Nantucket bell.

By learning the bearing of the distressed vessel from the lightship it was possible to seek her intelligently, but much time was lost, even when this method was employed. Had the *Republic* been equipped with a submarine bell or some other form of sound producer, she could have been located much more rapidly.

After taking the passengers of the *Florida* and the *Republic* aboard, the *Baltic* proceeded to New York in a dense fog, making Fire Island and Ambrose Channel lights by the submarine signal method.

THE FESSENDEN OSCILLATOR

A GREAT advance in submarine signaling is credited to Reginald A. Fessenden* a noted American inventor. A device called an oscillator, shown in an accompanying illustration has been perfected by him. A section of the ship's skin is cut away below the water line, and the surface of the oscillator takes its

*See RADIO BROADCAST for July, page 227.

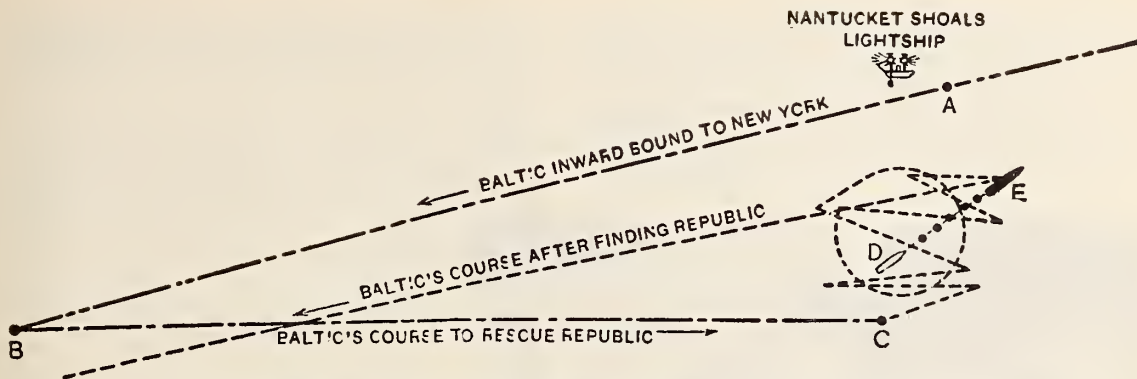

CHART MADE BY AN OFFICER ON THE S. S. "BALTIC"

Shows how the disabled *Republic* was finally located by means of submarine signals and illustrates how much more rapidly the rescue could have been effected had she been equipped with some sort of sub-sea signaling device

place. An alternating current, vibrating at about one thousand cycles causes the steel diaphragm to vibrate, thus producing a shrill note, somewhat similar to the note produced in a radio receiver by a spark transmitter fed by a 1000-cycle generator.

Although the diaphragm of the oscillator is of steel about three-quarters of an inch thick, it was found that, used as a receiver, sounds could be received many miles when it was connected with vacuum tube amplifiers. In an

address delivered August 30, 1920, Mr. Hammond V. Hayes, Chief Engineer of the Submarine Signal Company, said of this phase of the business, "Not only were such sounds audible in telephones, but phonograph records were made of them and, possibly even more remarkable, photographs of the sounds produced by invisible ships were taken."

These under-water sounds are produced by the movements of propeller blades in the water and by ships' auxiliary machinery. Most ships, it was found, had their own distinguishing noises, and it became possible later for men expert in listening, not only to report the type of



FESSENDEN OSCILLATOR

Used for producing and receiving submarine signals. The note produced by this oscillator is quite similar to the 500-cycle quenched spark radio transmitter

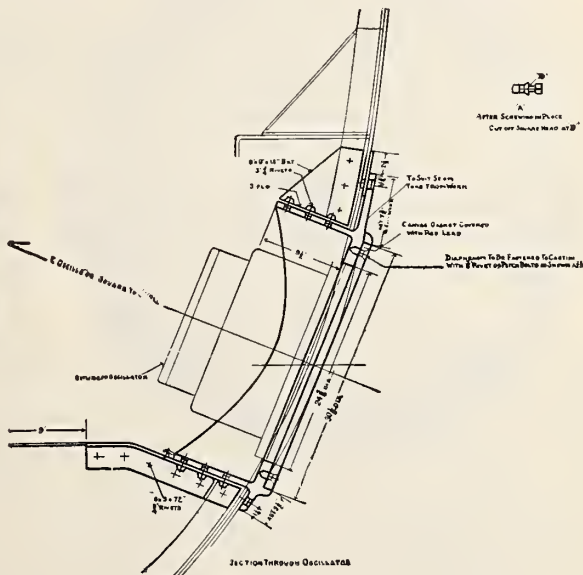

METHOD OF INSTALLING

The Fessenden oscillator on shipboard. Part of the vessel's skin is cut away and the hole is filled up by the front surface of the oscillator

ship, but the individual ship, by recognizing some characteristic of the sounds heard. Moreover, it was found that even a submarine, lying at the bottom of the ocean, gave sufficient noises to indicate its presence, unless extraordinary precautions were taken on board it

us the sound reaches both ears simultaneously, and we can then determine its direction without seeing it.

By a scientific application of this principle, employing microphones under water for electric ears and an acoustic balance or compensator, it is possible to determine quite accurately the source of under-water sounds.



THE SUBMARINE DETECTOR

Used extensively during the war to locate enemy submarines. Men in the U. S. Navy became so skillful in the operation of this device that they could recognize vessels by certain characteristic sounds made by their main or auxiliary engine. The device at the lower right is an acoustic compensator—a mechanical substitute for the human "binaural sense of direction"

against the movement of men and machinery. The detection of submarines, as developed during the war, was confined almost entirely to undersea sound receiving.

OUR BINAURAL SENSE

MR. RICHARD FAY has developed a receiving device which takes advantage of the principle by which the human ear distinguishes the direction of the source of any sound. If, for instance a cannon is fired at a distance to our left, we know more or less accurately its direction. Although few of us know what makes this possible, the reason is a simple one—the sound from the cannon reaches our left before it does our right ear and the difference in time is unconsciously converted into direction. When the cannon is directly in front of

MEASURING SEA DISTANCES BY SYNCHRONOUS SIGNALING.

WE HAVE seen that vessels can not only communicate with one another and learn of each other's existence by submarine signaling and by radio, but that they can determine to a nicety the direction they bear from one another. We have seen, also, that vessels approaching a port or a light may do so with some certainty, regardless of weather conditions. But there still remains a problem of the greatest importance: how to determine with precision the distance from the source of sound to the point where it is received. This problem has been solved by an ingenious system of synchronous signaling.

Briefly, radio and submarine signals are sent out simultaneously; when the difference in time between the arrival of the radio and the submarine signals—due to the difference in speed of propagation of radio and sound waves—is determined, and

given the speed at which the waves travel, it is a simple matter to compute the distance between the transmitter and receiver.

The computations are made as follows: We know that the signals from a radio transmitter travel with the speed of light—186,000 *miles* in a single second. And we know that the signal from a submarine-signaling device travels approximately 4,800 *feet* per second, depending upon the water. Observations of the latter have resulted in the following table:

TEMPERATURE	DISTANCE PER SECOND	
	FRESH WATER	*SALT WATER
50 degrees F.	4,719	4,836
59 "	4,783	4,901
68 "	4,849	4,970

*3% salinity. This table does not apply in measuring depth.

For all practical purposes, therefore, it is possible to consider the radio signal as instantaneous and the speed of the submarine signal as 4800 feet per second. By arranging a synchronous transmission system and employing a stop watch at the receiving station, the elapsed time between the arrival of the two signals may be measured in seconds. Multiplying the number of seconds by the 4,800 feet for each second, we have the distance of the receiving station from the source of the signals.

THE RESULTS OF TWO TRIALS

AS FAR back as 1911, the U. S. Government made tests to determine the value of synchronous signaling. The chart on page 476 shows graphically the results obtained. It should be borne in mind that at the time this test was made, vacuum tubes were not in use, nor were radio compasses. It is quite likely that these would greatly increase the accuracy, and extend the range over which signals could be heard.

The morning of September 10, 1911, during which the experiments were made, was very hazy, but the Nantucket Shoals Lightship could be seen from a distance of about 5 miles. There were light airs from the west-northwestward. The barometer stood at 30.11 inches of mercury. The sea was calm.

Starting near the lightship, a course was steered to the westward for a distance of 8 miles, and then, turning to the southward and proceeding east-southeastwardly, the lightship was passed on the port beam at a distance of 3,450 yards. Standing on for 8 miles more and then turning to the northward, a northwesterly course was pursued, passing the lightship on the port beam at a distance of 4,600 yards, and thence turning to the southward and approaching and passing near the lightship on a southwesterly course at the close of the observations.

The track of the *Washington* in relation to the lightship is shown on the accompanying chart in a continuous black line, which was determined by range-finder readings, compass bearings, and distances run, after making careful allowance for the tidal currents that were found setting generally to the northward during the course of the experiments.

The preconcerted signals from the lightship consisted of simultaneous signals from the wireless-telegraph apparatus and the submarine-bell at the instants when the steam fog-whistle gave a blast.

The sound blast from the fog-whistle was blown at intervals of one minute—the maximum interval at which the timing device attached to the whistle permitted it to act. At the instant the whistle blew, the wireless-telegraph operator gave a tick of two or three seconds in duration and the valve of the striking mechanism of the submarine-bell was tripped and gave a stroke of the bell. This was accomplished accurately, as could be tested by the coincidence of all three signals when the observers were close to the lightship.

The results of the experiments, are best shown graphically,

two loci have been laid down on the chart of the track pursued during the experiments representing in red and black, respectively, the locus of the distance of the observing vessel from the lightship, as determined by the distance traveled by sound in water, between the time of arrival of the Hertzian waves and the signals from the submarine signal-bell and the locus of the distance of the observing vessel from the lightship, as determined by the distance traveled by sound in air, between the time of arrival of the Hertzian waves and the signals from the steam fog whistle.

A remarkable feature, which will be noticed on the chart, is that the sounds from the steam fog-whistle were lost after steaming half a mile to the westward of the lightship at the beginning of the experiments, whereas, in proceeding to the eastward, they were carried throughout the run. The times of losing the bell and the whistle are marked along the charted track of the *Washington*. The wireless-telegraphic signals were of course carried all the way through.

The times of arrival of the wireless-telegraphic signals and the fog-whistle signals were noted by means of a Hack chronometer, and the times of arrival of those from the submarine bell by a stop watch. The same observer noted both the wireless tick and the submarine-bell signal.

The following temperatures of the air and the water were recorded in the course of the experiments:

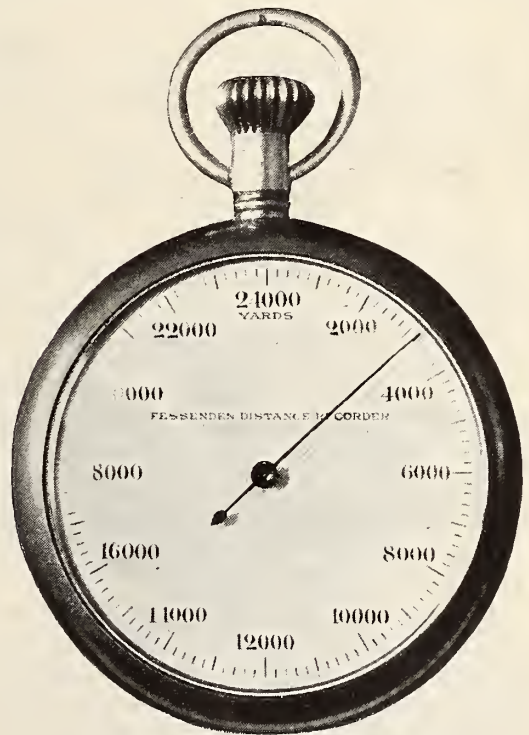

FESSENDEN DISTANCE RECORDER

As the radio signal is heard, the watch stem is depressed which sets the indicator in motion. When the submarine signal is heard, the stem is depressed a second time, stopping the movement of the indicator. The distance from the source of the submarine signal may then be read from the dial in yards. More elaborate indicators are available and are generally mounted on the wall and controlled by an electric switch

TIME	ON BOARD THE WASHINGTON		TIME	ON BOARD THE LIGHTSHIP	
	Tem- pera- ture— air Fabr.	Tem- pera- ture— water Fabr.		Tem- pera- ture— air Fabr.	Tem- pera- ture— water Fabr.
7 a. m. .	67°	66°	7 a. m. .	67°	59°
8 a. m. .	67	67			
9 a. m. .	67	67			
10 a. m. .	66	65			
11 a. m. .	69	65	1 p. m. .	71	59

For the purpose of computing, from the observed intervals of time, the distances which are recorded in the table and graphically shown in the loci on the chart, the velocity of sound in air at a temperature of 68½° Fahrenheit was deduced as 1,132 feet per second, and Dorsing's determination of the velocity of sound in water as 4,794 feet per second at 19° centigrade or 66° Fahrenheit was adopted, both values being derived from the fifth revised edition of the Smithsonian Physical Tables.*

miles with good results. On the day of the official trials, all observations were made with the *Patricia* (engines stopped) close to the *Shipwash* Lightvessel, a distance of about 11 miles.

"The actual distance determined by sights was found to be 23,000 yards, assuming that the charted position of the *Sunk* and *Shipwash* lightvessels are correct.

"Thirty synchronous signaling observations were made, the maximum and minimum figures being 23,600 and 22,500 yards respectively and the mean 22,900 yards. The mean error, 100 yards, is negligible, and is doubtless partly due to errors in the positions of the two lightvessels concerned, whilst the errors in the individual observations are so small as to be of practically no importance.

"As was to be expected, it was found that the

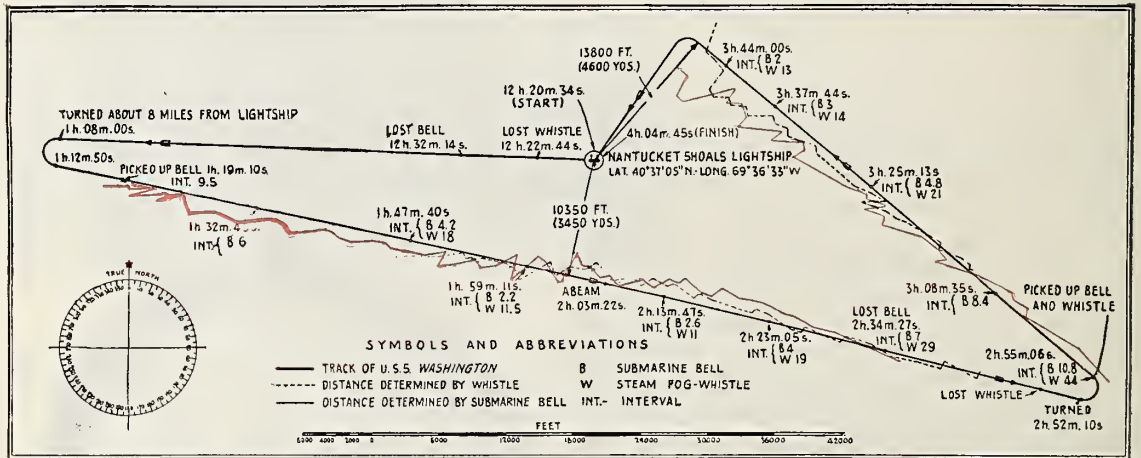

BLACK TRACK OF U.S.S. WASHINGTON BLACK DISTANCE DETERMINED BY WHISTLE RED DISTANCE DETERMINED BY SUBMARINE BELL

SYNCHRONOUS SIGNALING

As carried on between *Scotland Lightship* and the U. S. S. *Washington* produced the results shown on this chart. Radio, a submarine bell and a steam whistle were employed

On a test carried on between the Steam Yacht *Patricia* and *Sunk* Lightvessel by the London office of the submarine Signal Company on August 26, 1921, witnessed by a committee of Elder Brethren of Trinity House, both the oscillator and the submarine bell being used for submarine sound transmitting, the following report was made:

"Preliminary observations were made with bell and oscillator at distances up to about 17

*From the Hydrographic Office, Washington. Supplement to the Pilot Chart of the North Atlantic Ocean, 1911.

bell and oscillator gave equally accurate results although the latter gave louder signals."

Unfortunately this system, invaluable as it will unquestionably prove to be during the next few years, is not yet in general use. To be sure, it is scarcely out of the experimental stage; but when manufacturers and ship-owners do take it up, it should be easily developed or adapted from existing equipment; for many ships are now supplied with both radio and sound-wave reception apparatus. No changes would be required, except that the in-

stallations would have to be arranged so that one observer could employ both. The observer would wear a head-set of the type employed at present, but one receiver would be connected to the submarine signal receiver and the other to the radio receiver.

THE COLLISION PREDICTOR

DESCRIBING the application of synchronous signaling to navigation, Mr. J. Joly, Professor of Mineralogy in the University of Dublin and a Commissioner of Irish Lights,

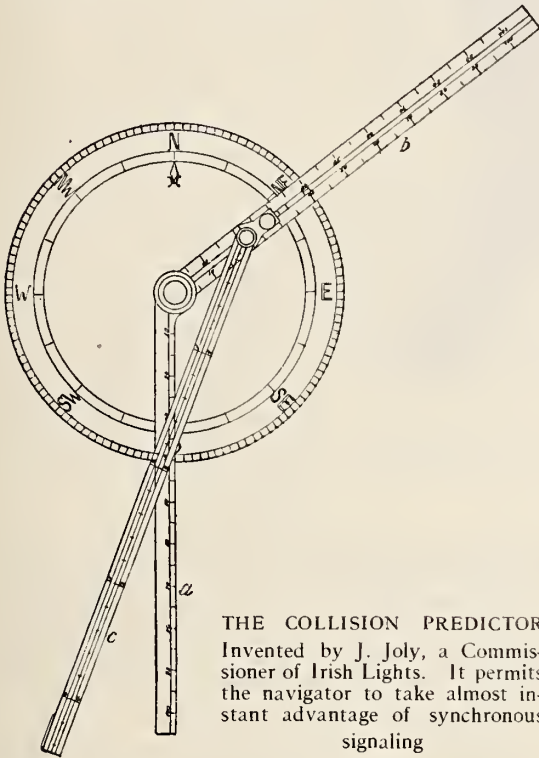

THE COLLISION PREDICTOR
Invented by J. Joly, a Commissioner of Irish Lights. It permits the navigator to take almost instant advantage of synchronous signaling

tells of an invention he has named the "Collision Predictor." This, a comparatively simple device, enables the navigating officer to take advantage of synchronous signaling in a rapid, reliable manner. The device itself and the theory on which it is based are shown in accompanying illustrations.

"The theory of the Collision Predictor is simple enough," writes Professor Joly. "In the diagram we suppose A., sailing due south, has started at the point O and will reach the positions 1,2,3, etc., in successive intervals of two minutes. B is at the distance d_0 when A is at O. If a circle is drawn with O as centre and d_0 as radius, B must be on this circle. B is moving in a NE $\frac{3}{4}$ E direction. We lay off the

course of B from O accordingly, and along the line O-B we lay out points corresponding to the travel of B in successive intervals of two minutes (the interval of time between each group of synchronous signals). This gives the points 1',2',3', etc.

"Now, if keeping the distance d_0 as radius we strike circles from the points 1', 2', 3', etc., the ship B must be transferred from one of these circles to the next every two minutes. In the figure only portions of the circles are shown, marked I, II, III, etc.,

"When the second signal arrives at A, A is at I and B somewhere on the circle I. The distance is now d_1 . With I as centre we describe a circle to this radius. B must be on this circle, and as we know that she is also on circle I she can only be at one or the other of the points of

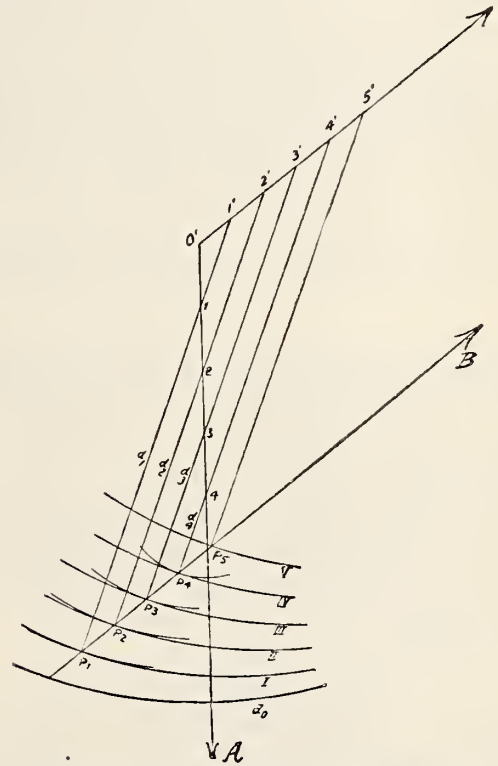

THE THEORY OF THE COLLISION PREDICTOR
Is graphically illustrated in this diagram. The method of calculation is explained in the text

intersection of these circles. Or, if the circles do not intersect but touch on a point of tangency, she must be at that point. We can at this stage predict risk of collision or safety. If the circles intersect, there is safety. If they merely touch, there is going to be a collision.

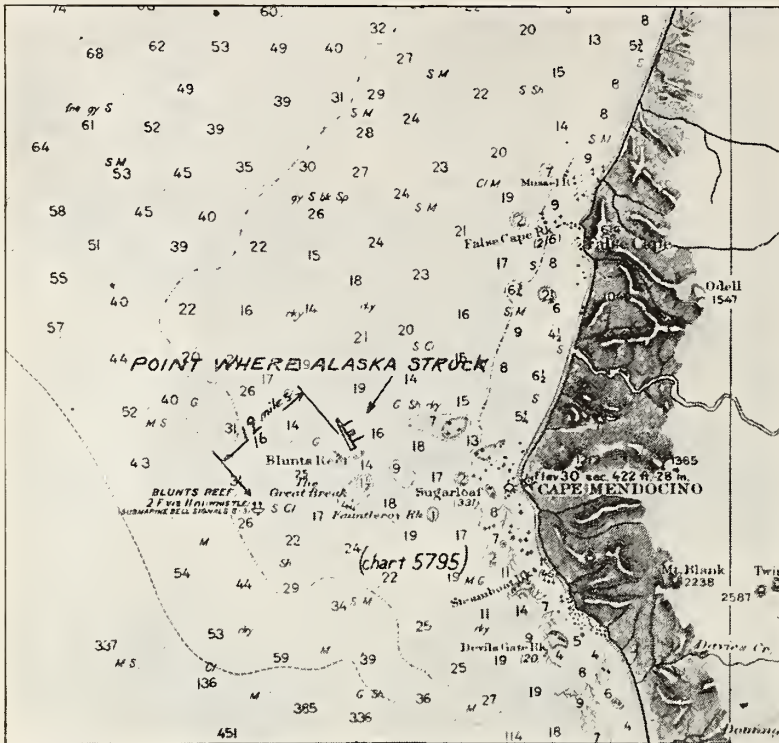

WHERE THE S. S. "ALASKA" SANK

Is shown on this map. Thirty-nine lives were lost. A submarine bell was operating 1 $\frac{1}{2}$ miles away and this disaster might have been avoided had the vessel been equipped with submarine signal receiving equipment

Before proceeding we can see in a general way the truth of this deduction. For if B may be either of two points and all the conditions of course and speed be satisfied, there cannot be collision. Obviously, there cannot be two possible lines leading to collision; it can only occur if both vessels are making for a common point, and, as two parallel lines cannot pass through the same point the two possible N.E. $\frac{3}{4}$ E. lines cannot conform to the conditions of collision.*"

FINDING THE OCEAN'S DEPTH

UNTIL recently there have been sections of the ocean which were never "sounded," but it is now possible not only to ascertain depth, but also to make topographical maps of the ocean bed—thanks to another application of submarine signaling.

The U. S. S. *Stewart* has recently completed a series of tests, employing the submarine oscillator and microphone receivers to determine depth. The oscillator is mounted near

*"Synchronous Signaling in Navigation," page 41, by J. Joly, T. Fisher Unwin, Ltd., London, 1916.

the stern of the vessel with its diaphragm pointing downward. A key closes a circuit which sets the diaphragm in vibration and thus causes sound to be sent out under water. The sound waves travel to the bottom and are reflected back, in echo fashion, and the time period is measured in seconds. Dividing the time period by two (for the sound travels both ways before it is received) and multiplying this result by the distance sound travels in water per second, indicates the depth. The speed of sound in this instance varies with the depth and tables are being prepared by the U.S. Navy to show this speed.

A system of this nature is liable to some error where the surface of the bottom is particularly irregular, due to refraction and reflection, but it is

infinitely more reliable than the time-honored practice of heaving a lead sinker having a hole in its bottom filled with soap to which some of the ocean bed clings. It is quite unlikely that the latter system is of much use except to the men who have sounded the bottom enough in the same place to know its appearance.

This new sounding system should prove valuable to cable companies because it enables them to determine with accuracy the location of the valleys in the ocean bed which may be followed with a great saving of cable.

By this system it is also possible to locate icebergs, derelicts, or other hazards in the path of a vessel.

LESSONS FROM THE "EGYPT" AND THE "ALASKA"

IT DOES not take long for the terror of a marine accident to pass away, and the outcome of investigation can never replace a single life lost at sea. For instance, no effort made now can avail any of those 102 lost when the British steamer *Egypt* collided with the French steamer

Seine and was sunk 15 miles off Armen Light, Island of Ushant, on May 27th.

Nor can the coroner's jury or others do more than fix the blame for the sinking of the American steamer *Alaska*, which ran ashore off Cape Mendocino, 17 $\frac{3}{8}$ miles from Blunt's Reef Lightship. This occurred during a heavy fog on August 6th, last year. Thirty-nine lives were lost.

The coroner's jury, after several weeks of testimony taking, recommended that more general use be made of radio compass bearings furnished by the U. S. Radio Service, and that owners of passenger vessels be required to equip their vessels with a listening device for the detection of submarine signals, and commented upon the fact that the bell on the Blunt's Reef Lightship was ringing when the *Alaska* sunk less than two miles away.

The Neptune Association, which is composed of Merchant Marine Officers, wrote the Board of Supervising Inspectors at Washington, following the sinking of the *Alaska*, and expressed the belief that, had the *Alaska* been equipped with apparatus for receiving submarine signals, the wreck would probably have been avoided. In addition to wishing to make navigation safer, the Neptune Association stated that they desired that masters be exempt

from responsibility of loss when all necessary equipment had not been provided for the proper operation of vessels.

BUT LIFE CAN BE SAFE AT SEA

REGARDLESS of the catastrophes which have occurred in the past, it is possible to reduce them greatly in the future, by employing the electrical aids to navigation now available.

For direction finding, and for navigation at long distances from shore, the radio compass is sufficiently accurate to guide us to a point in range of a submarine signal station.

Then, reaching the lightship by submarine signaling makes it possible to pick up a submarine cable and follow it, even in the thickest fog, directly into port.

Distances may be accurately determined by synchronous signaling, depth need no longer be a matter of guess-work, and the berg of the frozen seas can now be detected and avoided by application of the same device which tells the depth.

With these scientific advantages at our disposal, are we going to continue to have *Republics* and *Titanics* and *Egyptis*, pointing with scorn at our civilization?

SUBMARINE BELL INSTALLATION ON OUR COASTLINES



The Selective Double-Circuit Receiver

BY JOHN V. L. HOGAN

Consulting Engineer, New York; Fellow and Past President, Institute of Radio Engineers;
Member, American Institute of Electrical Engineers

WHEN we use a receiver embodying a type of detector such as that including the crystal variety, which is capable of absorbing a relatively large amount of electrical energy, it is necessary to arrange some way of controlling and restricting the voltage applied to the detector system if sharp tuning is to be secured.* As the proportion of voltage applied to the detector (in comparison with the total voltage developed in the tuning system) is reduced, less energy is drawn from the persistently oscillating circuits and the anti-resonating resistance effect of the detector assembly is made smaller. To secure maximum selectivity by radio-frequency tuning, we must provide condenser and coil circuits which can oscillate freely and in which resistance is minimized.

The receiving circuits illustrated in the earlier articles of this series contained only a single tuned or resonating circuit, i. e., that which included the aerial itself. By coupling the detector system somewhat loosely to this tuned antenna circuit it is possible to sharpen its resonant selection considerably, as has been explained. But the aerial and ground resistances, as well as the re-radiation resistance effect, remain in the circuit and put a limit to the improvement in tuning sharpness which can be secured by reducing the detector voltage; even under the best conditions of adjustment this single circuit tuner is hardly selective enough for working through severe interference.

It is entirely feasible to add to the receiver a second tuned circuit in which resistance or damping effects are further reduced, and which consequently adds materially to the sharpness of tuning in the system. Fig. 1 shows the simplest way in which this tuned secondary circuit may be arranged with a crystal detector. The usual antenna circuit

contains the primary tuning condenser and the primary coil; inductively coupled to this latter is the secondary tuning coil, and across its terminals is directly connected the new element, a secondary tuning condenser. Suitable choice of the sizes of secondary coil and secondary condenser (which should be variable) produces a closed resonating circuit in which the antenna and ground resistances appear only to the small degree reflected through the inductive transformer. Thus the sharpness of tuning in this secondary circuit, and its resonant selectivity, will be very high. The only serious limitation to the selection power of the simple two-circuit receiver of Fig. 1 is the effect of detector resistance; as may easily be seen, the entire secondary voltage is applied to the crystal branch and hence damping due to the detector will be a maximum. However, if the by-pass or telephone-shunting condenser is made of moderately small capacitance (say 0.005 microfarad) fairly sharp tuning will be had.

The selectivity of the double-circuit tuner may be greatly increased by reducing the proportion of the secondary voltage applied to the detector. A simple way to do this is

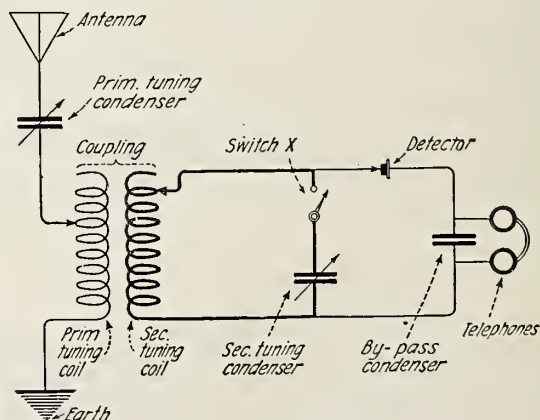

FIG. 1

The Double-circuit Tuner with Crystal Detector: the tuned secondary is shown in heavy lines

*See "Sharpness of Tuning in a Radio Receiver," by John V. L. Hogan, RADIO BROADCAST for August, 1922, pp. 348.

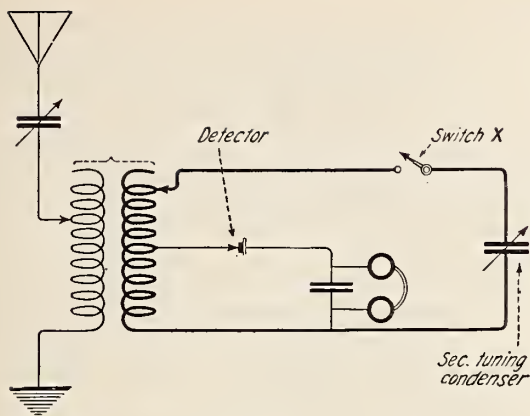

FIG. 2

In this form of double-circuit tuner the damping produced by the detector is reduced

shown in Fig. 2, which differs from Fig. 1 only in the connection of the detector and telephone circuit across a part (instead of the whole) of the secondary tuning coil. In this manner the effect of detector resistance upon the secondary tuning may be cut down substantially, with a corresponding gain in resonant discrimination between arriving waves of slightly different frequencies. Another method, which has the additional advantage of providing easy variation in the detector coupling, is to use a second oscillation transformer as shown in Fig. 3. The less the inductive coupling between the coils of this second transformer, the smaller will be the damping introduced into the tuned secondary circuit on account of detector resistance. In both these circuits (Figs. 2 and 3) the telephone shunting condenser may well be of rather large capacitance; instead of the value 0.005 microfarad suggested for Fig. 1, a condenser of 0.02 microfarad may be used with some improvement in signal strength.

The operation of any one of these three circuits, but perhaps particularly of that shown in Fig. 2, will be a pleasant surprise to anyone who has come to believe that receivers using crystal detectors are necessarily poor in tuning or selective qualities. For best results it is of course necessary to adjust carefully, and the apparatus itself must be well made in order that losses of received energy in conductor resistance, condenser leakage, poor connections, etc., will not overshadow the gains to be secured through the secondary tuned circuit with reduced detector coupling. A properly built crystal receiver of this type,

accurately adjusted, will give signals as loud as or louder than those from ordinary single-circuit crystal sets and, in addition, a degree of selectivity which can be surpassed only by the best vacuum tube outfits. Moreover, the absence of batteries and the freedom from tone distortion which are characteristic of crystal receivers may be taken together with the selectivity obtainable in the manner just described to recommend such arrangements for most reception over short or medium distances (up to about 25 or 30 miles from broadcasting stations or 100 miles from radiotelegraph plants) where good receiving aerials may be erected and when ordinary head-telephone listening is satisfactory.

When it is desired to receive over longer distances, one should take advantage of the greater sensitiveness inherent in the three-electrode vacuum-tube detector. As has been pointed out, this instrument draws very little power from the tuned receiving circuit to which it is connected, and, consequently, modern audion receivers are generally more highly selective than those using crystal detectors. The vacuum tube of course requires a battery for lighting its filament and for supplying telephone-circuit current; on the other hand it is at least several times as sensitive as the crystal (a critically adjusted "gassy" or soft detector tube may give responses some fifteen times as loud as would a crystal, to the same weak signal) and so may be used with smaller receiving aerials or for working over longer distances.

The vacuum tube detector will give fairly good resonant selection in a single circuit re-

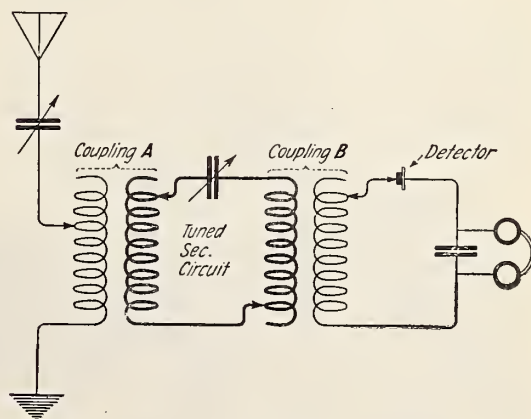

FIG. 3

The detector may be placed in a third circuit inductively coupled to the tuned secondary

ceiver even when coupled quite closely to the antenna, or, in other words, when the detector voltage is a large proportion of the total. A great improvement may be made, however, by using a double-circuit tuner similar to that of Fig. 1. Such an arrangement, adapted to the most sensitive detector tubes of the soft variety, is drawn in Fig. 4; here the full secondary potential is applied to the grid circuit of the detector, but since so little power is drawn by the audion not much selectivity is lost because of this connection. Where the secondary circuit is of unusually low resistance it is possible to gain something in sharpness of tuning by using the tapped coil plan of Fig. 2 with the tube detector, but this is not ordinarily of much value in short-wave reception.

The great gains in freedom from interference which may be secured through the use of the double-circuit tuner, as compared to the simple resonant aerial circuit type, must be paid for by increased care in adjustment. To tune an ordinary double-circuit receiver properly is an operation which may require several minutes, since (starting from a condition of complete de-tuning) the following steps are necessary for most satisfactory adjustment of the arrangements of Figs. 1, 2, and 4:

A: Be certain that the detector is in sensitive condition. When using a crystal this should be determined by means of a test buzzer; a "gassy" tube detector is adjusted by noting the beginning of the soft hissing in the telephones when filament current or plate potential is increased.

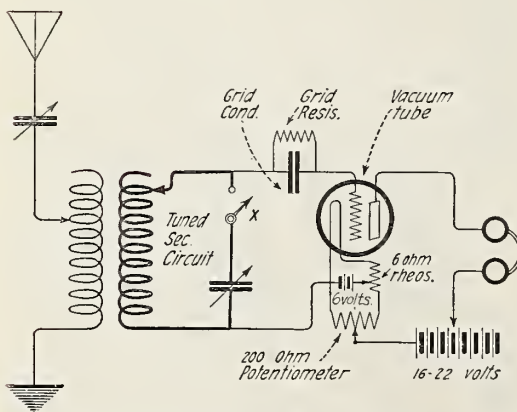

FIG. 4

The double-circuit tuner with accessories for using a "soft" vacuum tube detector.

B: Disconnect the secondary condenser (by opening switch X) and move the primary and secondary coils near together or to practically maximum coupling.

C: Adjust the primary tuning condenser and, if necessary, the primary tuning coil until the loudest signals are heard from the desired station.

D: Weaken the primary-secondary coupling somewhat, close switch X and adjust the secondary tuning condenser until the desired signals are again heard at a maximum strength.

E: Move the primary condenser setting slightly to increase signal intensity still further.

F: Having secured approximate adjustment as above, find by experiment the best coupling value for the signal-intensity and interference-freedom desired, remembering that for every change in coupling it may be necessary to retune slightly on both primary and secondary condensers in order to retain the greatest signal strength.

After once having learned the rough settings for any given wavelength, the tuning operation may of course be limited to the final step given above. It will be found that careful tuning will give results well worth the effort.

Since the tuned condition of either primary or secondary circuit represents agreement between the frequency of the arriving waves and the natural or free oscillation frequency of the circuit, longer wavelengths will always be received with greater values of tuning inductance and capacitance than will shorter waves. Nevertheless, the same wavelength will produce resonant maxima of response at many values of inductance, the corresponding condenser being reset to compensate for the change. Thus, when a desired signal has been picked up, it is a good plan to try reducing the inductance of the primary tuning coil, of course increasing the primary condenser by a corresponding amount each time. Some particular ratio of primary inductance to capacitance will ordinarily be found to give the strongest signals; the coupling and the secondary condenser should be slightly readjusted as each change is made in order to maintain complete resonance. In the same way, for a given wavelength it is desirable to try various ratios of secondary capacitance to secondary in-

ductance; with the vacuum tube detector, best results will ordinarily be had with relatively small condenser values in the secondary.

When a vacuum tube detector is used, it is feasible to utilize its radio-frequency amplifying power so as to neutralize a substantial portion of the receiving antenna resistance. This resistance-reducing property is one of the most valuable features of vacuum tube operation, and is obtained by means of the feed-back or regenerative action discovered by Armstrong. To use the tube detector for this purpose it is not necessary to rely upon the double tuned circuit receiver; regeneration applied directly to the aerial-to-ground circuit will give excellent results in selecting sharply between signals from moderately distant stations on slightly different wavelengths.

The feed-back circuit is based upon the discovery that the audion detector repeats into its plate circuit, in amplified form, the radio-frequency currents applied to its grid. In other words, the tube not only converts the arriving signal energy into an audible current form suitable for operation of the telephones, but at the same time transfers to the telephone circuit an enlarged copy of the radio signal impulses. If we place a condenser of moderate size across the telephone terminals so as to shunt these repeated radio-frequency currents across its winding (without disturbing the lower-frequency currents which are to act on the diaphragm), the amplified oscillations will pass freely through the entire plate circuit. By inserting a radio-frequency coil in this circuit, next to the plate connection, where the potential variations are greatest, we may set up a strong high-frequency magnetic field produced by the amplified oscillations. If, as indicated in Fig. 5, this coil is placed near to the antenna tuning coil it will act inductively upon the aerial circuit; by selecting the direction of current flow correctly, part of the plate-circuit oscillations may be caused to add their effects

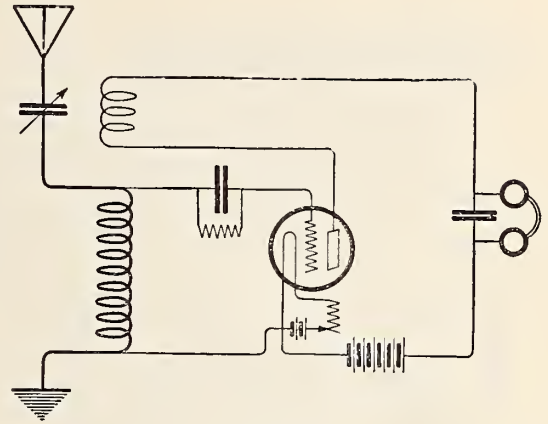
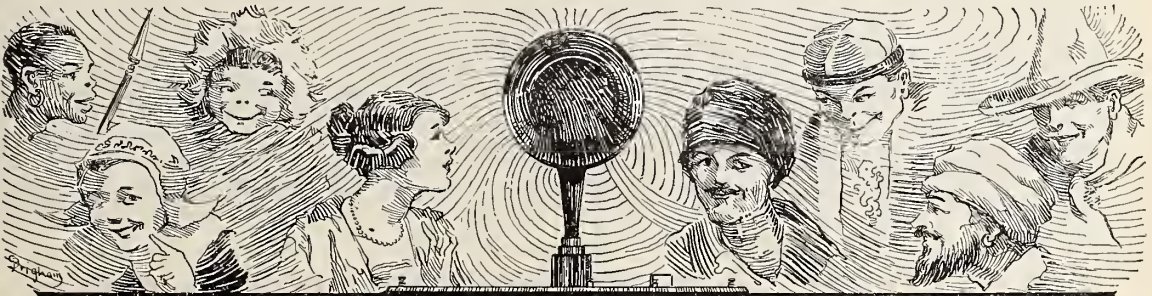

FIG. 5

A so-called single circuit receiver employing a tickler or feed-back coil for regeneration

to those of the oscillations already flowing in the antenna, so as to produce a great increase in the total current strength. This is equivalent to reducing the antenna resistance, in its final effect, for, with no increase in the voltage which the arriving electromagnetic waves impress upon the aerial, there is produced a much greater flow of current of radio frequency.

Perhaps the most interesting feature of this regenerative effect is that it amplifies to a maximum only the signals to whose frequency the circuit is tuned: thus the behavior of the system is as though the aerial-to-ground resistance were greatly reduced for a single comparatively narrow band of wave frequencies. Sharpness of selection is therefore a prominent characteristic of the properly adjusted feed-back receiver, just as of any other low-resistance resonant circuit. The arrangement of Fig. 5, however, is subject to some disturbance from powerful near-by transmitters operating at wavelengths sometimes widely different from that being received. The cure for these transient interference effects is to use a combination of Figs. 4 and 5.



Developments in High-Power Radio

And Its Practical Application in the Services of the United States Navy

By COMMANDER STANFORD C. HOOPER, U. S. N.

Head of the Radio Division in the Bureau of Engineering, Navy Department

PART II

THE passage by Congress of the Naval Appropriation Act of August 22, 1912, contributed greatly to the advancement of the radio art as regards the development of high-power radio, not only in the United States but throughout the world. It gave to the Naval radio service a great opportunity, but it also placed a heavy responsibility on those entrusted with the direction and administration of the service.

This Act appropriated \$1,500,000 for the establishment of six of the Navy's projected high-power stations, those to be located in the Isthmian Canal Zone, on the California Coast, in the Hawaiian Islands, in American Samoa, at Guam and in the Philippines. This constituted a programme of great magnitude in high-power radio construction and one which obviously was difficult of accomplishment at that period. The trail had not yet been blazed in this direction and little information of a practical nature was available. The Arlington station was under construction but had not yet been finished; so that definite information was not available as to what could be expected from a station of this type.

The plans for the six new stations therefore must necessarily be held in abeyance pending the completion and testing of the pioneer high-power Arlington station. Being a pioneer in substantial high-power radio construction, this station must be regarded in the light of an experiment. Because of insufficient scientific knowledge at that time, mistakes were made in the establishment of the Arlington station, principal among which were locating the station on high ground and placing the steel towers too close together, but nevertheless this station has rendered most valuable service to the Government ever since it was placed in commission, and moreover it served as a guide by which similar mistakes on a larger scale were avoided. It also made

available a high-power station for testing different types and makes of apparatus in actual service, thereby enabling the selection of the most efficient type of equipment available for service at that time. It was, in short, the agency by which delay was avoided in establishing the extensive radio system required to meet the needs of our Atlantic, Pacific, and Asiatic Fleets and other government agencies.

The Arlington station may justly be regarded as the pioneer development in high-power radio in the world, as well as the fountain head of the Navy's existing radio service, a service of which the stations on shore extend more than one quarter the distance around the world and whose signals are constantly encompassing the globe. The true significance of the Arlington station will not be fully appreciated until the history of radio is finally written.

THE POULSEN ARC TRANSMITTER

UNDOUBTEDLY the second feature of importance in connection with the development of radio in the United States, especially as regards high power, is the Poulsen-Federal arc converter. This type of transmitter, successfully developed by the ingenuity of American radio engineers from powers of 30 KW to 1,000 KW within a brief interval of ten years, and manufactured in the United States, is the outstanding unit of apparatus in the Naval radio service. Arc transmitters have given satisfaction in the services where they have been employed for powers from 2 KW to 1,000 KW. The Navy has used this type of apparatus in its high-power stations continuously since the first 30-KW arc transmitter was tested out in the Arlington station ten years ago. Arc transmitters produce harmonics as do other types of transmitters. They also produce a form of interference called "mush," the cause of which is not yet thoroughly understood. Two waves were also radiated, instead of one, in the system of signaling

originally employed. All three undesirable features are gradually being eliminated, however, and it is expected that the arc will then radiate as pure a wave as any of the other existing transmitters.

By originally adopting the arc transmitter for its high-power stations, the Navy has obtained satisfactory service from the beginning and it has not yet become necessary to replace the original installation in order to keep abreast of the progress in radio. It

thereby avoided the expense which the Marconi Wireless Telegraph Company of America (now the Radio Corporation of America) found it necessary to assume when that company was obliged to scrap practically new spark transmitters and install alternators in all its high-power stations in order to carry on transoceanic traffic satisfactorily. It also avoided long delay in establishing its transcontinental, trans-pacific chain of high-power stations such as has been experienced by the British in establish-

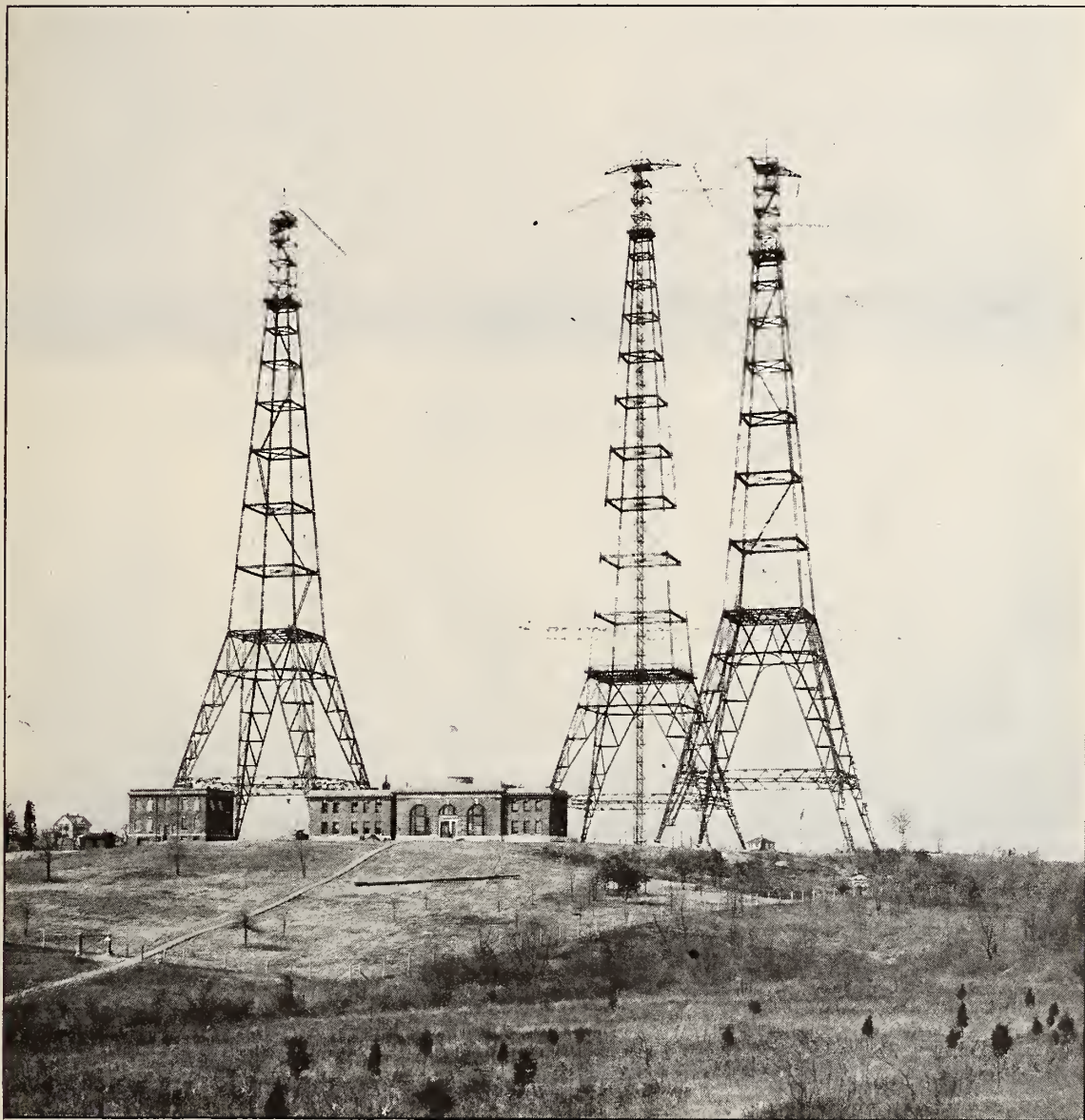

ARLINGTON

Probably the best known radio station in the world. All manner of new developments are tried out by the Navy at this station. Mariners listen for its time signals and weather reports the world over

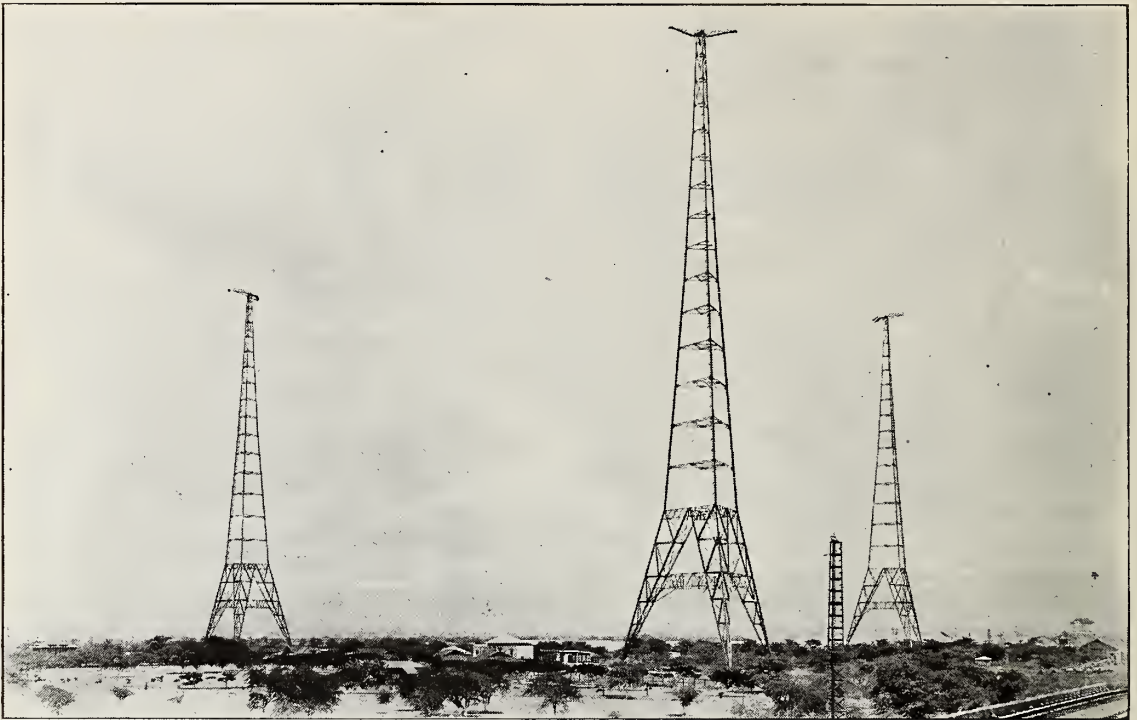

PEARL HARBOR, HAWAII

The U. S. Navy high-power station in mid-Pacific. It is not uncommon for experienced amateurs as far away as our eastern seaboard to copy messages from this giant

ing the Imperial Wireless Chain, this delay being reflected by the fact that one of the first of this chain of outlying stations, that at Cairo, Egypt, has only recently been completed, although the Navy's stations have all been in daily operation for several years. The Navy's stations were ready and rendered most important services after our entrance into the war.

It is worthy of note, in this connection, that a commission appointed by the British Government made a study of the arc type of transmitter with a view to its possible adoption for use in the stations of the Imperial Wireless Chain, about the same time the Navy was investigating it for use in its high-power stations. The British Commission's report, which was promulgated after the Navy had definitely decided to adopt the arc, was to the effect that this type of apparatus was unsatisfactory for the purpose intended and it was therefore not recommended for use. Notwithstanding this fact, the arc transmitter is now being installed in stations in the Imperial Wireless Chain.

Vested with the authority granted by Congress in 1912 and being satisfied with the

performance of the arc type of transmitter as a result of the Arlington tests and further extensive tests carried on subsequently with the 100-KW arc converter installed in the new Canal Zone station at Darien, the Navy, in 1914-15 went ahead with the project of establishing the five additional high-power stations. Sites for these stations were selected about five miles from San Diego, California, within the Naval Station at Pearl Harbor in the Hawaiian Islands, within the Naval Station at Tutuila, American Samoa, at a point about five miles from Agana on the Island of Guam, and within the Naval station at Cavite about twelve miles from Manila.

Three-legged, self-supporting steel towers, similar to those designed for the Arlington station, were erected at all of the stations with the exception of Tutuila where 300-foot wood, guyed, lattice masts were used, owing to insufficient funds for steel ones. Three 600-foot towers were erected at the San Diego, Pearl Harbor, and Cavite stations. Two 450-foot towers were erected at Guam. Two 300-foot wood masts were erected at Tutuila.

A 200-KW arc converter was installed at Challas Heights, 350-KW at Pearl Harbor, 500-KW at Cavite and 30-KW at Tutuila and Guam.

All five stations were completed and in commission within two years thereby linking our most distant possessions, the Philippines and other islands in the Pacific with Washington by radio. As a result of the establishment of this chain of high-power stations and with the stations at Cordova, Alaska and Cayey, Porto Rico, subsequently established, and the replacement of the Arlington station by the more powerful Annapolis plant, the Navy Department is enabled to keep in constant touch with our three fleets, with their auxiliaries and with their bases. The Government now has a system of communication radiating from Washington and covering our entire coasts and our outlying possessions, a system entirely independent of the land lines and the meagre cable facilities in the Pacific.

The Naval radio service is used by all the government departments and agencies. It serves the Army for communicating with its forces in the Philippines and our other possessions in the Pacific, with the Canal Zone and the West Indies. It serves the Weather Bureau, the Bureau of Lighthouses, the Bureau of

Fisheries, the Coast Guard and similar government agencies. It provides channels of communication with our outlying possessions which make them entirely free of foreign-owned or controlled cables and therefore it is a potential asset for the development and fostering of our trade.

The Naval radio service normally handles approximately 20,000 words per day across the Pacific, this volume of traffic being greatly increased during cable breaks. About 5,000 words are normally handled between Puget Sound, Washington, and Cordova, Alaska, and when breaks occur in the Army's cable between Seattle, Washington, and Valdez, Alaska, the number of words averages between 30,000 and 35,000 per day. About 8,000 words are exchanged daily through the Darien station in the Canal Zone and about 5,000 words through the Cayey station in the West Indies.

Messages are constantly passing between the various coastal stations on shore and naval and merchant vessels at sea. Government messages are sent daily from the Annapolis high-power station to corresponding stations in Europe and are received at the special receiving station at Bar Harbor, Maine, and relayed over leased land wires to Washington.

All of the Navy's high-power stations are

CAYEY, PORTO RICO

The Insular outpost of the Navy's high-power system

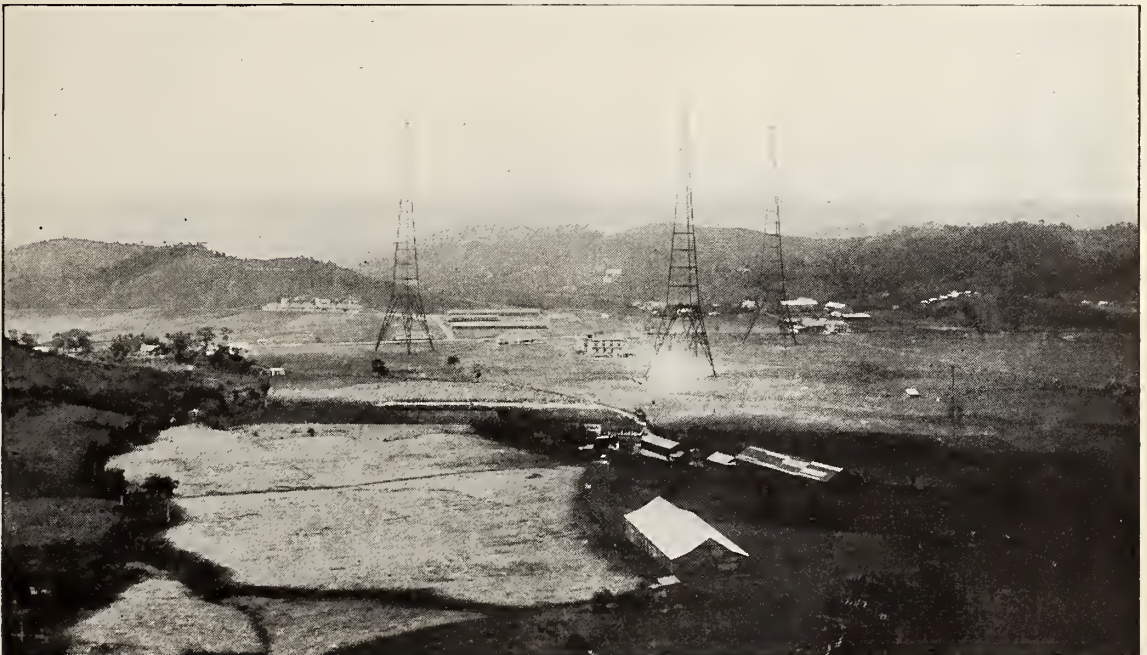

operated duplex to enable messages to be received at the same time other messages are being sent from the same station or unit. This is accomplished by establishing a control and receiving station at a distance of about ten or twelve miles from the transmitting stations and connecting the two stations by land wire telegraph. Radio men are posted at the transmitting stations to start and stop the machinery and to regulate the apparatus, the functioning of which for transmitting messages, however, is controlled by the operator at the central and receiving station. In practically all the Navy's high-power stations there are installed a medium-power and a low-power transmitter in addition to the high-power set. Operators at the central and receiving station may be sending out messages with the three transmitters simultaneously and other operators may receive from distant stations at the same time.

The naval stations in the Pacific and in Alaska would be almost completely isolated from the United States were it not for the Army's cable and the Navy's radio service. The Army's cable has deteriorated considerably with age and consequently is frequently broken. At such times the radio service takes over all cable traffic in addition to its normal traffic and passes it on to stations situated along our Pacific Coast. In the Pacific, reliance is also placed on a single cable and when this fails, the only remaining medium of communication is radio. There is no connection with American Samoa except by radio but entirely satisfactory service is maintained between Tutuila and Pearl Harbor over the Navy's radio circuit, about 2,000 words being exchanged daily.

The Navy's transpacific high-power radio circuit may be said to extend into China and temporarily at least, into Siberia. A station of 30-KW power has been established within the Peking Legation Compound, surrounded by the 40-foot-high Tartar Wall, which encloses the American Legation, to prevent the American Minister from becoming isolated from the outside world when internal disorders are in progress in China. The ordinary communication facilities in China are unreliable under normal conditions and the service is frequently interrupted altogether when disorders are in progress. The Navy's radio station at Peking has afforded the only medium of communication on more than one occasion, not only for the American Minister, but also for the other foreign diplomats in Peking. The Peking station is operated by members of the Marine detachment guarding the American Legation. This station exchanges communications with the high-power station at Cavite, with the flagship of the Asiatic Fleet, with vessels of the Yang Tse Patrol and with the station at Vladivostok.

The Navy took over from the Russian Government the then in-completed radio station at Vladivostok as a result of the dispatch of American troops to Siberia during the war. This station has since been

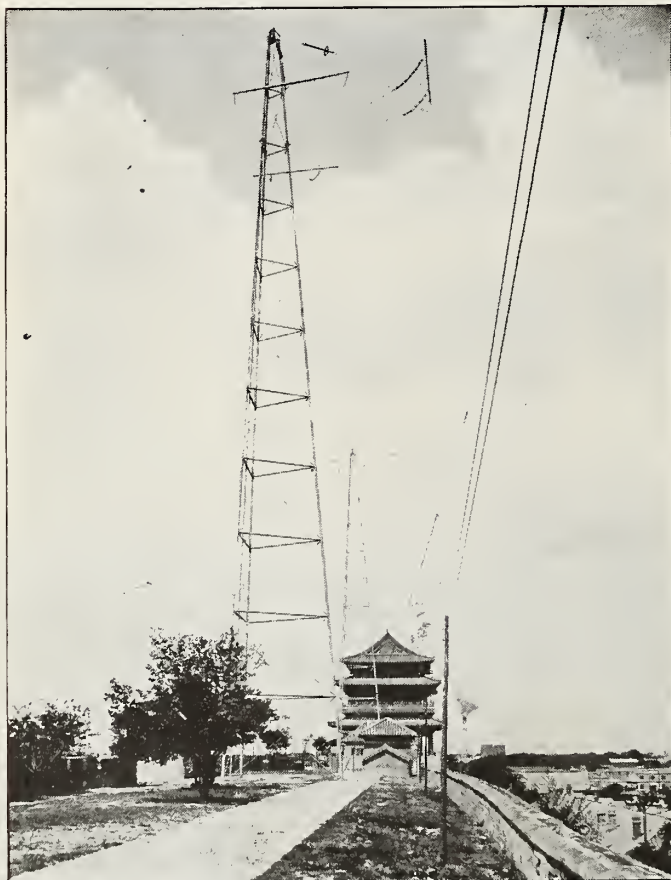

THE U. S. NAVY STATION AT PEKING, CHINA

Operated by the U. S. Marines located at the American Legation Compound which is within the famous 40-foot Tartar Wall. Two of the towers are atop the wall

operated by Naval radio operators under the direction of the Commander-in-Chief of the Asiatic Fleet, and communicates with Cavite, Peking, and Naval and merchant vessels in Asiatic waters. The existing naval radio circuit extends eastward from Vladivostok and Peking through the Philippines, Guam, the Hawaiian Islands, American Samoa, to San Francisco, thence northward along the Pacific Coast to Puget Sound, Washington, and to Alaska; from San Francisco, southward to the Isthmian Canal Zone; from San Francisco through San Diego and across the continent to Washington; from Washington along the Atlantic Coast, the Gulf of Mexico and along the Great Lakes; from Washington southward to the Isthmian Canal Zone and the West Indies; and again from Washington across the Atlantic where contact is made with stations in European countries

including the 1,000-KW station established by the Navy at Croix d' Hens, near Bordeaux, France to insure contact with our Expeditionary Forces in the event of the cutting of the transatlantic cables by submarines during the war.

The fact that the aggregate cost of the six successful naval high-power stations was within \$1,500,000 is worthy of considerable reflection on the part of commercial companies engaged in building radio stations during the period 1914 to 1917.

The development of the Navy's high-power radio system cannot fairly be reviewed without paying tribute to Rear-Admiral R. S. Griffin, U. S. Navy, now retired, who, as engineer-in-chief of the Navy, was responsible for the building up of the naval radio service during his term as chief of the Bureau of Engineering from 1913 to 1921.

One Vessel that Radio Might Have Saved

By ORTHERUS GORDON

HOW long will it be before small ship owners will realize that a wireless outfit placed on their sloops and schooners may pay for itself hundreds of times over, on the first voyage? Day after day they are confronted with evidence that ought to convince them of its value, yet they continue to send their barges, their tugs, and their sailing craft down coast without proper means of calling for help should they suddenly need it.

A striking example of what radio might have done toward the saving of property for at least one merchant came to my attention with the sinking of the three-masted schooner *Tarok*, a year and a half ago. At that time, I was on board a large oil tanker going south in ballast. We had experienced rough weather from Cape Hatteras down and learned from passing ships that conditions farther south had been rough and unsettled for some days. The second morning below Hatteras we sighted a small black object one point off the port bow and

soon made it out to be a small boat. As we approached it, we saw that there were five people aboard, and that one of them was waving a red tablecloth from the end of a spar. Coming alongside, we hauled them aboard—they were too weak to climb—hoisted their boat clear of the water, and made it fast alongside our port lifeboat. Then, while we continued our journey, we heard the story of the *Tarok*.

Her captain was as bitter as he was weary. He had recommended a thorough overhauling and a spell in dry-dock for his vessel. He had also wanted radio, if nothing more than a small spark transmitter to be run from a storage battery, and a crystal receiving set with which to set his chronometers occasionally, from the Arlington or Key West time signals. He had tried for these, but without success. The owners said the ship didn't need the first thing, and that he didn't need the second. They had told him it was absurd to equip with wireless a vessel that didn't go more than one hundred

miles outside of land and that didn't leave a beaten steamship track for more than twelve hours. The captain answered that there were days and days, even in the most crowded waters, in which he hadn't seen a ship of any kind, yet he knew there were scores of them within radio call—just beyond the horizon. Wouldn't it be wise to be able to summon help if help was needed? They laughed at the captain. He was getting old, they said, and was losing his skill.

The truth of the matter was that he had only wished to reinforce his skill; and that very trip was to show the owners how easily a vessel might fill with water and sink, within the very sight of land, for all that the "skill" of an old seaman could do to prevent it.

The *Tarok* with her crew of captain, mate, steward, and two sailors, left Atlanta, Georgia, on February twenty-sixth, 1921, and turned her nose toward Porto Rico. She had as a cargo, fifty-two thousand feet of finished lumber—all ready to transform into native houses upon arrival at its island destination. Her holds were full and her deck was full—for her owners were the kind that under-manned and under-supplied their vessels, but overloaded them—and she struggled along under full canvas with as little life as if she were towing lead.

Six hours out and barely in the Gulf Stream, when they were descended upon by a furious storm. They bared their masts and pounded into it, each hour carrying them farther from their course and bringing them north with the sweep of the Stream. All night they were in the thick of it, and next morning discovered that they had sprung a leak. It was not a fast leak, but a slow, insistent one somewhere in the depths of the lumber-piled hold. They could not locate it, try as they would, and the water was steadily rising in the bilges. Inch by inch, it crept up the side of the hold, and inch by inch, the *Tarok* settled down. She labored heavily now and wouldn't answer her helm. As much canvas as possible was carried, but to no avail; the good old ship was caught and would have to stay that way until someone came along and rescued her.

Think of it! In this day and age, a vessel with a ten thousand dollar cargo forced to depend on chance for the saving of her cargo and the lives of her crew!

When the crew were flooded out of their quarters forward, and the captain and mate out of their quarters aft, the entire outfit gathered on the roof of the after deck-house to talk the situation over. As long as the weather



HER HOLDS WERE FULL AND HER DECK WAS FULL

For her owners were the kind that undermanned and undersupplied their vessels but overloaded them



IT WAS NOT A FAST LEAK

But a slow, insistent one, somewhere in the depths of the lumber-piled hold

held, they were all right. But the least blow, and over she'd flop, and that would be the last of her. Before that happened, perhaps help would come—some passing ship, some north-bound tanker or freighter. But the *Tarok* was in the Gulf Stream being carried rapidly away from any ship that might be behind her, yet without sufficient speed to catch up with any ship that might be ahead. So for twenty-four hours they watched—and saw nothing. They were low, and the visibility was poor; their horizon could not have been more than four miles away. Now, on the chart of the Atlantic Ocean, a circle eight miles in diameter is no larger than a pin prick, and the chances of a vessel entering the area in which the *Tarok* was sinking were few indeed.

Here is where radio would have brought them vital help. If they had a set that could send only ten miles, it might reach out beyond the horizon and bring some ship with a tow-line and a lift into the nearest port. But the captain didn't even have that—so he did what he could, and then sat disconsolately on the roof of the deck-house with the remainder of his crew.

On the morning of the twenty-ninth, the situation hadn't improved a bit—they were still scanning the horizon for a ship. At ten

o'clock they saw one—a tramp freighter, crossing the Stream and heading in for a coast port. She was about four miles away, and the men on the raft that had once been a ship could see her plainly. But would she see them? They did what shipwrecked sailors always do. They shouted, they waved things, they danced. The mate climbed the rigging with a white cloth. All to no avail. The ship went unseeingly on its way, and hope left the hearts of the captain of the *Tarok* and his crew.

That night, there was a recurrent storm—and the *Tarok* turned turtle. The men managed to pile into the lifeboat and cast loose in time to avoid going over with it; but in the lifeboat their condition was none too enviable. The seas rose to tremendous heights; it rained, and the wind blew harder.

How they lived through the night, and until we found them two hundred and ten miles away from the spot where the *Tarok* had first run into the storm, is a mystery to them all.

The *Tarok*, of course, was a total loss. She was reported as a derelict by our ship and in the course of events was probably located by one of the Coast Guard cutters and blown to bits by powerful charges of well-placed dynamite.



THINK OF IT!

In this day and age, a vessel with a ten thousand dollar cargo forced to depend on chance for the saving of her cargo and the lives of her crew

“Here ends the first scripture lesson.” I know I am not alone in hoping that it will prove to be a lesson and that it will lead to a radical change in the attitude of small-ship owners who still belong, serene in their antiquity, back in the Middle Ages.



THAT NIGHT SHE TURNED TURTLE

And it was only by good luck and good seamanship that the men managed to pile into the lifeboat and cast loose in time to avoid going over with her

Choosing a Radio School

By HOWARD S. PYLE

YESTERDAY, imaginative and adventuresome young people were known to run away to sea, eager to try the sailor's rough and varied life in all corners of the globe.

Times may have changed, but human nature hasn't: to-day also, there are those who long to sail the seven seas; hundreds of would-be sailors, likewise imaginative, likewise adventuresome. But how different, in many cases, is their picture of sea life from that which fired the enthusiasm of their predecessors! The job of cabin-boy gives way to the position of radio operator; the work is concerned less with coils of tarred rope than with coils of fine wire; less with activity in which physical strength is demanded, than in which technical knowledge is of supreme importance.

Particularly among young men of high school and college age will be found the desire to try this modern game, to taste the life of the searover, even if only for a trip or two, or long enough to see some of the far places of the world, before passing up the carefree life of marine operator for a more prosaic application of the scientific side of radio in some factory or laboratory.

And in radio, as in all worth while fields of endeavor, we may learn much from others. For this reason we have schools, colleges, trade schools, and the modern correspondence methods of supplying information. Electricity, chemistry, medicine, all the most important sciences have been brought within the understanding of the American public through institutions of learning, which have provided the keys with which to open the doors of the minds best informed in these classes of learning. The result has been scientific specialists of world renown. Should we not then expect as great things from our radio schools, teaching exclusively, as they do, this new science?

THE FIRST WARNING

BUT—there seems to be a certain amount of bad in all good things. As soon as the question of money is involved, we find persons who live by preying on those who are too easily

persuaded. Hence we have numerous small schools of the fly-by-night variety, who advertise "in a loud voice" for a short while, take our money, promise much—and give precious little in return. This, unfortunately, hurts our many conscientious and excellently conducted schools of good standing.

Now, radio, as applied commercially, is a very new art, and like all infant enterprises, is sometimes beset with unscrupulous methods. In choosing a radio school, therefore, we must be on our guard. Let us consider, to begin with, the matter of advertising. It is the attractive presentation of the opportunities in radio that first catches the eye of the layman, through the advertisements in popular trade magazines.

Let us suppose that you are one of those who have a keen desire for knowledge of radio, but know nothing more about it than what you may have gleaned from the daily paper. Or perhaps you have been interested enough occasionally to purchase a copy of a radio periodical. You glance through its pages, and while much of the matter therein is in terms unintelligible to you, merely to read some of the less technical items, describing the marvels accomplished by radio, fills you with a desire to know more clearly and more thoroughly how all these things are brought about. More particularly, if you are a student, or perhaps a dissatisfied office worker, and of a mechanical turn of mind, it will not be long before your fingers will itch to grasp the subject and have a hand in the molding of its future applications. At about this time, you turn a page and come face to face with a large ad, fairly radiating opportunity (and consequent life of ease and plenty to be yours in a few short months), if you will only "sign and mail the coupon to-day". Please note that such advertising is seldom found at the front of the magazine, but generally toward the end, where the reader will find it after being warmed to his subject by a perusal of the text. This is good business. I do not disparage the advertising efforts; advertising is the real foundation of any business. What I want to drive forcibly into your mind is a caution not to allow the glamor of the ad-

vertising, with its carefully cloaked phrases, to cause you to make too hasty a decision as to choosing a school. How then to proceed?

READ THE ADVERTISEMENTS CAREFULLY

LET us first read carefully all the statements contained in the advertisements of the various radio schools. Consider them particularly with regard to what reference they make to wage scales for radio operators. The writer has taken note of the fact that at the present time, while the salaries paid marine operators have taken a drop, some schools still advertise—"a position which pays you \$125 monthly and expenses, to start." Beware of this. The condition does not now exist. \$125 and expenses *was* the wage scale until recently, for *chief operators*. \$110 was paid to juniors. Seldom does a radio school graduate receive, as his first assignment, the berth of chief operator. Even so, it would pay, at this writing, only \$90 or \$105 at most, depending upon the class of ship. This is but one point which you must watch for yourself. The trade journals do not knowingly accept misleading ads. containing false statements, but sometimes they do slip through.

THE TRUE EMPLOYMENT SITUATION

NOW let us consider another point brought out prominently in radio school ads.—that of employment. Practically all radio schools conduct an employment service, and the majority do conscientiously endeavor to place you after you have completed their course. The radio game, however, as far as the operating field is concerned, depends greatly upon shipping, which is dependent upon foreign commerce. Consequently, shipping is more or less spasmodic, based on the law of production and demand. It naturally follows that if shipping is irregular, the demand for radio operators is, also. This is not mere in-

ference, it is fact. At this moment, the writer is 500 miles south of New York, northbound from Haiti, on a sugar-laden vessel. Three weeks ago, at the time of signing on for this voyage, operators were scarce around Norfolk, from which port we sailed. One month ago, in Seattle, there were three operators for every vacancy on west coast vessels. A few years ago, from the same Puget Sound port, an operator could pick his vessel; he was almost

begged to take a trip. Supply and demand again, you see, with the unsettled condition of shipping naturally occurring.

Another point to be considered while on the employment subject: There are, at present, a large number of the "old timers" in the game who are idle; men who have thousands

of miles and many ships to their credit. The radio operating companies are making every effort to place these men—giving them preference, naturally, over newcomers. Then where will the green school-graduate stand? Let me tell you what each of six different employers of marine operators recently told me. I questioned them as to the prospect of employment for graduates of radio schools. The replies were alike, in effect: "we accept their applications, smile at the proudly displayed diploma done in gold and seals, and give the jobs to the old-timers. If we need a man in a hurry, or for an unimportant job, these lists of school graduates prove useful at times." There you are.

NOW, in talking to some who have aspired to be radio operators, I have been told, "But I do not intend to go to sea, I expect to go to work in a shore station." But a shore station wireless telegrapher must of necessity be an *operator*, and a radio school graduate is *not* an operator—*yet*. True, he has a Department of Commerce license, but radio operating in a shore station, or on the high seas, is a far cry from your theory classes or code work. Take



A BEAUTIFUL HOTEL FOR RADIO MEN

Turning a page you meet an "ad" fairly radiating opportunity and consequent life of ease and plenty for you if you will but "sign and mail the coupon to-day"

the man who wants the shore job. Can he sit down before a tuner and vacuum tube detector with multi-stage amplifier, skillfully eliminate all interference, pick out a particular spark note or style of sending through bad interference, and put the signals down in good readable copy on a typewriter as they come in? I've never yet seen the green man do it! Or, take a high-power circuit ashore; can he sit down to a typewriter, listen to a perfect, clear-cut "bug" sending at 30 or 35 words a minute, translate the characters into combinations of the Philips code, further translating them into readable English, and turning out perfect, deliverable copy from his typewriter, without a falter? So much for your shore positions.

There is one other phase of the game, other than operating. A radio school course, and a first class license will probably enable you to secure a position as clerk in a radio store, or radio department, or to become associated with a radio manufacturing company in a small position. All of this will give you valuable experience, but a position as manager of a radio store, or radio inspector, specialist or other high sounding title, will distinctly *not* follow immediately upon the heels of your graduation. There is always a place for you, as is true in any line, *after* you have proved your worth—but in no line will you be led into a general manager's office and given the chair of authority with no more than a school diploma for experience. You must earn your job. So much for the employment question.

Let us suppose you have given the foregoing careful thought, and are still determined to enter the radio field and blaze your own trail. In that case, take a course in a good radio school by all means. It can be either a resident or correspondence school—more on this later—but be sure it is good. And don't stop there;

study, study, study, and subscribe to the leading radio periodicals, make apparatus for yourself, put yourself into it heart and soul!

YOUR SCHOOL MUST GIVE PRACTICAL TRAINING

I WARN you to pick a *good* radio school. You say, "how shall I know it is good?" Here's how: no subject can be taught well from books alone. It must be supported and clarified with actual practice. For instance,

take languages. The writer has been in many foreign ports, and has been much amused at the conversational efforts of some of the members of ship's crews. Men who were excellent, A1 Spanish students in college had a terrible time in Chile, a Spanish-speaking country! They knew Spanish, pure Spanish, but not the ver-



LIFE AT SOME OF THE HIGH-POWER STATIONS TRULY HAS ITS SOCIAL ADVANTAGES

And sight of them is never lost by the advertising men of the radio correspondence schools. Mention is not generally made of the fact that a job at such a station means copying trans-ocean signals at high speed on a typewriter eight hours a day, seven days a week

sion that the Chileans use. The same applies to radio. You may have a perfect theoretical understanding of the "hows and whys," but would be in an awkward position were you confronted with the necessity of repairing a burned out generator at sea.

The value of experience shows itself particularly in cases where the apparatus breaks down in an emergency. The operator who can send out messages in the face of apparently insurmountable difficulties is worth his weight in gold. The following incident is taken from an operator's log:

"I was sent home on another vessel, signing on as a wiper. The vessel ran out of fuel. No response being received to our S O S, I was called up from the engine room to see if I could assist the operator in establishing communication.

Investigation showed that all units of the transmitting condensers were broken down. This was overcome by using in their place the series condensers in the short-wave circuit. An improvised radiation ammeter had to be

constructed, and the antenna circuit direct coupled and retuned. Communication was then established with a vessel which relayed our message to Havana, but soon the motor generator burned out beyond repair.

To rig a transmitter again we had to change the power transformer from closed-core to open-core type, and to construct an electrolytic interrupter. Having no gasoline for a blow-torch, we had great difficulty in shaping in the galley fire, heavy gauge glasses for the interrupter, while the ship was rolling heavily, but we managed to get it working well enough to reestablish communication.

Before assistance reached us we were out of glass tubes for the interrupter and had to close down until we rigged up one of the ship's large alarm buzzers for a transmitter. This worked well up to a distance of seventeen miles, daylight, and communication was handled by relay.

Two days later we were picked up and towed into port."

Choose a school that is fully equipped with modern apparatus covering all that you are likely to encounter at sea. This should comprise a complete arc transmitter, quenched spark panel transmitter, tube transmitter, storage batteries, generators, and a goodly number of receiving sets, both of the crystal and vacuum tube varieties. Above all, the school should offer unlimited opportunity to the student to dig down into the heart of the apparatus and see what makes it work and why. A complete station should be in constant operation, with advanced students as operators.

CORRESPONDENCE COURSES

NO CORRESPONDENCE course in radio is of the highest practical value *in itself*. You can learn theory from it, but if, after completing the course in a way satisfactory to

the school, you were to be confronted with various parts of a standard installation, it is doubtful if you could distinguish between them. If, however, you have access to a radio factory, or can visit a radio station ashore or aboard ship frequently, enlisting the services of the operator to explain the apparatus to you, in connection with your correspondence course, you should gain a good foundation upon which to build a practical radio education.

I do not wish to discourage aspirants to the radio operating field, but merely wish to point out that all is not music that makes a loud noise. We don't want to see the radio field filled up in a year or so with a group of disillusioned young people, who blithesomely followed their courses, with fond hopes of taking the radio world by storm, only to find that there were many others ahead of them.

The writer has recently completed a three months' investigation of radio oppor-

tunities, and knows that they exist for the trained man. He has also visited many radio schools, taught in a number, and been closely allied with such institutions for some years past. Therefore, he knows whereof he speaks. The facts are here.

If you have the determination and the stuff in you to follow it up, the radio field will welcome you. If you are fired with the idea of being a radio operator in four months, traveling the world over at \$125 a month and expenses, to start with, sheer off. It's a man's game, and as such takes a solid foundation. Don't be fooled by glaring promises of high-salaried, big-titled jobs at the end of a few months' training. In radio, as in any line, you *must* earn your place. There is just as big a position for you in the radio field as anywhere—perhaps bigger—if you'll work for it and earn it.

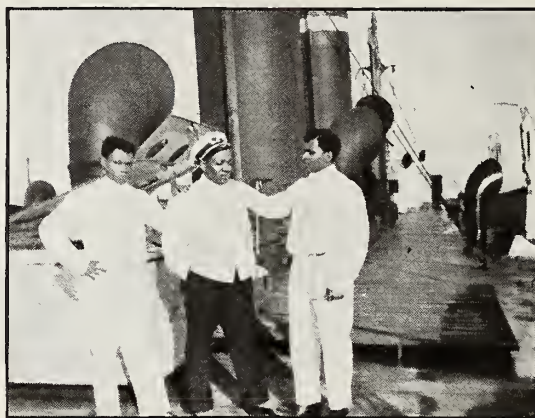

ON THE LARGER LINERS BELL BOYS DELIVER THE MESSAGES

For the radio man, and a steward caters to his every need—on some freight ships the radio man delivers the messages himself and has to scrap with the oilers for a place at the mess table where he receives cold "slum gullion" and other similar delicacies of the sea-going variety

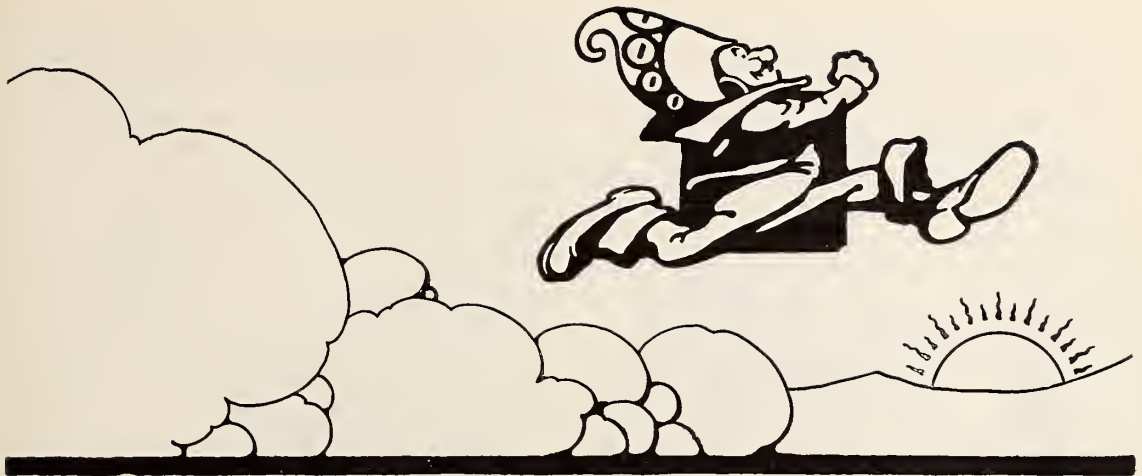

KING ELECTRON

Tells About Detection

By R. H. RANGER

Engineer, Radio Corporation of America.

Author of "The Radio Pathfinder."

Trade Mark "King Electron" for illustrations registration pending, R. H. Ranger.

Illustrated by TOM MONROE

WILL it ever be possible to hear radio signals directly without the need of receiving sets?"

Maybe, — provided broadcasting keeps up for the several thousand years sufficient to develop in successive generations of radio enthusiasts an ear attuned to the new waves in space. But let us hope not, as one of the chief advantages of radio broadcasting is that the receiving set may be shut off when not desired.

The ears we have are attuned to air waves. The air waves in which we are interested are those caused by the vibrations of our vocal organs or musical instruments. Unfortunately, many other happenings in every day life always give rise to sound waves which we usually characterize as noise.

The piano scale affords a fair idea of the useful range of sound vibration. The lowest note vibrates back and forth at a frequency of some twenty-seven times a second; the highest note at some 4,200 vibrations a second. To produce sounds by the ordinary telephone, electric cur-

rents vibrate back and forth in the telephone wires at the same frequency or time of vibration as the corresponding sound. But it has not proved practical to send out radio waves in space at these low rates of vibration. Vibrations of the order of a million per second are necessary in order to broadcast in an economical manner from the transmitting station to many receivers, and this is much too fast for the ear to hear. So for the next few thousand years it would seem to be necessary to have radio-receiver ears.

These radio ears consist of receiving apparatus which will translate the radio vibrations of about a million cycles a second in ether into sound waves in air. This explains the need of a "detector", to detect the changes in these radio waves which correspond to the sound frequencies.

King Electron and his band of many million runners are at the service of the radio man. At each receiving station they stand ready to rush around in the approved manner to produce music out of the fast-vibrating radio waves coming through the ether.

An aerial wire connected to a receiving set constitutes an electric path of definite length for these electrons to move back and forth upon. It takes them a certain time to rush from one end of this path to the other and back again. If the surges are coming through the ether from the transmitting station at just the proper frequency to push these electrons on their happy way back and forth on the rises and falls of the radio waves, the maximum commotion will be produced in the receiving set. The process of tuning adjusts the length of this path to make the time of travel just right for the particular radio waves desired. So, when the tuning is correct, the electrons will rush back and forth with the incoming waves.

PRODUCING SOUND BY ELECTRICITY

AT THE sending station, sounds in the air are controlling the output of the radio transmitter. A mouthpiece is arranged to pick up the sound waves. These waves are much slower in their number of vibrations per second than radio-frequency waves which are being sent out into space. But the mouthpiece is connected to the radio transmitter in such a manner that the air pressures of the sound waves striking the mouthpiece will con-

trol the intensity of the radio waves transmitted. As a result the million or so radio waves per second will leave the transmitting station, but their intensity or power will vary up and down in step with the sound waves which strike the mouthpiece.

In consequence, the electrons in each of the receiving stations will move back and forth most rapidly in step with the incoming radio waves, but the intensity or force of their motion will vary depending upon the variable intensity of the incoming radio waves. As a result of this, the intensity of their motion will correspond to the sound vibrations at the transmitting station. To discover these changes in intensity and translate them into sound is the function of the receiving set.

HOW THE TELEPHONE RECEIVER WORKS

THE most practical device so far developed for changing electric effects into sound is the telephone receiver invented by the late Alexander Graham Bell. In this, electric currents of the same frequency as the desired sound, vibrate in the electric coils and in so doing pull the thin iron diaphragm of the receiver back and forth, pushing and pulling the air around the receiver to correspond, and in consequence

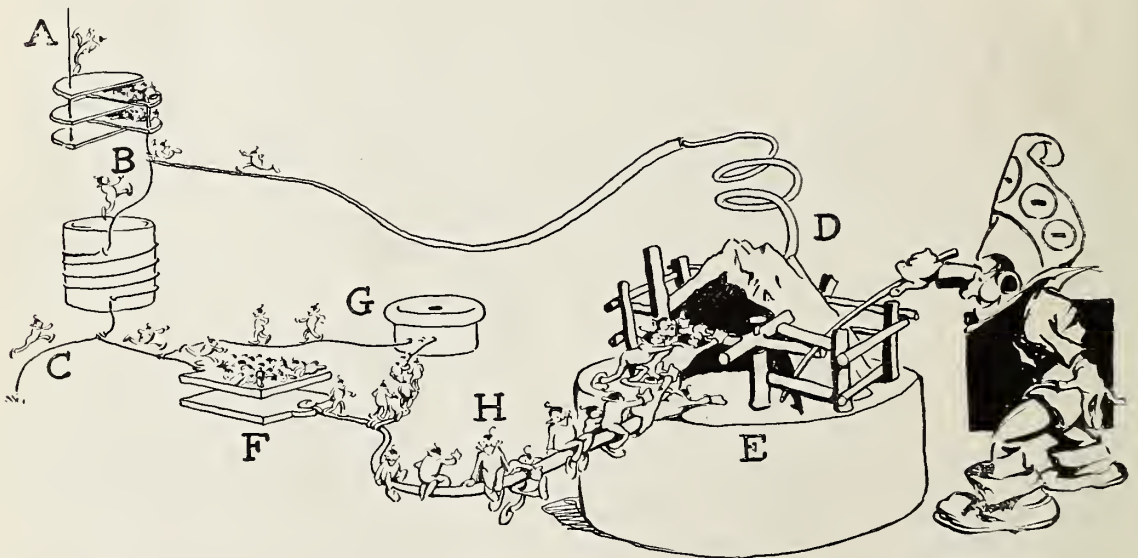

KING ELECTRON HOLDS THE TURNSTILE

On the dip in the radio-wave, the accommodating electrons rush back from the ground at C, through the tuner coil to B, to the tuning condenser and out to the antenna at A. This change of affairs makes those in the alternate crystal-detector route around through F, H, E, and D to B want to return; but the turnstile action of the crystal detector prevents them, and the trapped electrons at H have nothing left to do but continue around through the telephone receiver and out through G. The result is that the activity of the electrons urged on by the radio waves shows itself by a continued action in *one direction* through the telephone receiver, moving the receiver diaphragm and making sound.

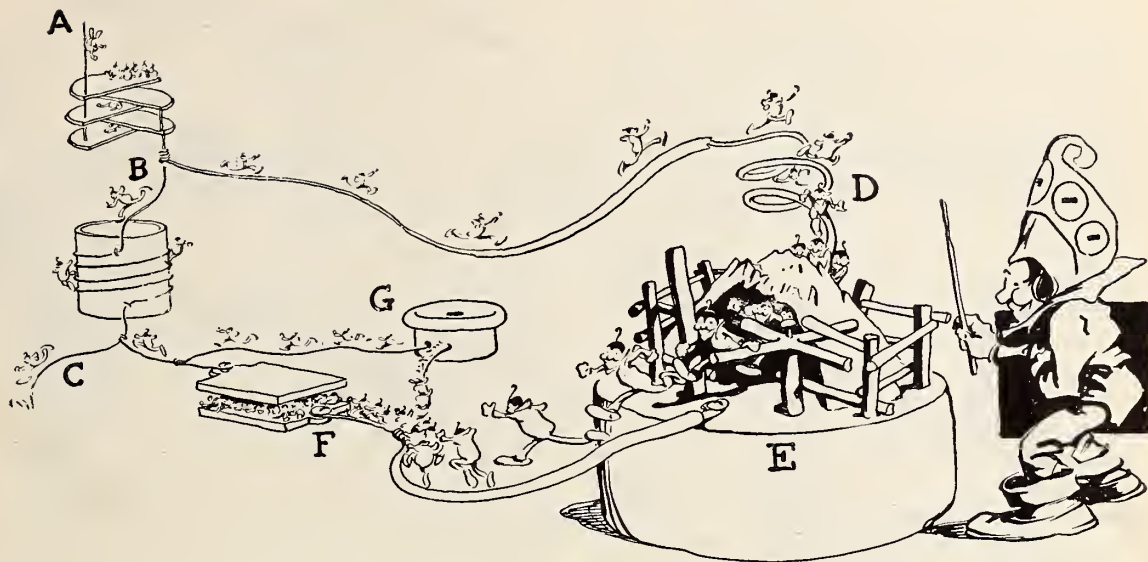

KING ELECTRON TELLS HIS BOYS TO WATCH THEIR STEP

Down from the antenna they come, urged on by a radio wave coming through space. At A they come to the variable condenser where they crowd on one side. Off their mates rush from the other side of the condenser. At B these divide, some rushing down through the tuning coil to the ground at C; the others take the right-hand path to the steel wire "cat whisker" at D. These continue on through the one-way crystal detector at E which acting as a turnstile, will let them through. On they go to F where they pile up on the by-pass condenser. They begin to go through the slower acting telephone receiver at G and around to the ground at C.

producing sound waves. Where the telephone receiver is used for radio the detector comes between it and the fast-moving electrons in the tuned aerial circuit.

If a one-way turnstile could be set up so that electrons could pass only in one direction through it, the perfect detector would be found. Such a turnstile would be placed in a wire leading from one side of the tuning coil in the receiving set. From this turnstile a wire path would lead on to the telephone receiver, and from there to ground. Whenever there was a rush of electrons down from the aerial, some would take this path through the turnstile and rush down through the telephone receiver. With the return swing of the electrons, back into the aerial, none of them could get back through the telephone receiver because the turnstile would be set against them. With the million vibrations per second, there would be a million rushes of the electrons in one direction through the turnstile and through the telephone receiver. If the ether waves were steady in value, this would mean that all of the little impulses through the telephone receiver would have the same value. The telephone receiver iron diaphragm is too slow moving to respond to each of the million impulses, but it will take

up an average position pulled by the impulses in one direction in the coils.

As long as the waves keep up their steady vibration, the telephone diaphragm will hold this position, but if the radio waves change in strength, the strength of the little impulses rushing in one direction through the receiver will change also, and the receiver diaphragm will move to correspond. As the changes in the intensity of the radio waves are caused at the transmitting station by sound vibrations, the changes will be passed along into the receiver diaphragm and corresponding sound will be given out by the telephone receiver, and the complete process of broadcasting will be realized.

THE USE OF A CRYSTAL DETECTOR

NO PERFECT turnstile for electrons has been invented yet, but there are many partial solutions. The Crystal Detector is the simplest. This consists of two dissimilar substances which have different electric characteristics at their surfaces. When they are placed in contact with each other this difference makes it easier for electrons to go through the combination in one direction than it is for them to go through in the other direction.

One of the most common forms of crystal detector is a piece of galena and a steel point just touching it. The steel point is adjusted until signals are heard best in the receivers. When this is done, the perfect turnstile is more nearly realized. How near this is will be understood when tests have shown that none of the known detectors has an efficiency over 15 per cent. (This is eliminating any amplification or regenerative effects accomplished with vacuum tubes.)

Just how the turnstile effect is produced in a crystal detector has never been clearly shown. If it were, it might be possible to raise this percentage for detectors. The fact that many investigators have spent years of study on the problem, and the fact that many thousands of conceivable combinations have been tried would seem to indicate that new investigators would have a rather difficult job improving on the work that has already been done. Late experiments indicate that the crystal detector action is caused by the thin film of moisture present on the crystal surface which makes a small battery cell out of the combination of the two dissimilar substances. This small cell has, of course, very small capacity, and the electron current in one direction will aid this cell action, and in the other direction the electrons will practically stop the cell action. As a result, they work on together in one direction and they practically stop in the other.

Other investigators consider the effect to be one of heat. The rushing electrons heat the small contact which gives rise to "thermal electricity." Thermal electricity is caused by heating the contact of two dissimilar substances. This thermal current is in one direction only so that the rapid variations across the contact will heat it; and this heat will develop the thermal current which going in one direction will work around through the telephone receiver and give a reproduction of the changes in intensity.

CARE OF CRYSTAL DETECTORS

SOME practical points may be mentioned in the care of crystal detectors. The first and most important is that the crystal be kept clean. Fingers are the worst offenders. Do not touch the crystal surface. A crystal may be washed with alcohol, or even soap and water. The soap should be thoroughly washed off.

The steel point or "cat whisker" should always be clean and fairly sharp. It must not

be too sharp, however, as this will cause it to "burn" off too quickly.

THE "BY-PASS" CONDENSER

MUCH unnecessary mystery surrounds the use of the by-pass condenser used to improve the efficiency of detectors, connected around the telephone receiver.

A condenser consists of two conducting metal plates pressed close together with an insulating substance between them. The metal plates will allow electrons to gather on them, but the insulation will keep the electrons from crossing from one plate to the other.

There are electrons everywhere. Therefore, in what might be called the state of rest, or "zero" electric pressure, there are still a large number of electrons present on everything, including the two sides of a condenser. Electrons are quite human in not liking to be crowded too much. If more electrons are then forced upon one side, the density of the electrons will, of course, be increased on that side, which means more electric pressure, and there will be a rush of the electrons off the other metal side. For very rapid movements back and forth of electrons, the condenser will therefore act exactly like a straight wire connection, as there will be a motion of electrons into it on one side and out of it on the other. So such a condenser will let such electron vibrations pass through it easily. A good value for a by-pass condenser is one or two one-thousandths of a microfarad. This condenser is connected across the telephone receiver, making it possible for the rapid electron impulses to pass through the turnstile detector quickly and on through the by-pass condenser to ground. They would have much more difficulty in getting through the telephone receiver at this rapid rate, due to the many turns of fine wire of which it is made.

"But doesn't this lose all the benefit of the electron action as fall as the telephone receiver is concerned?"

No, because although the effect is such as to have a quick motion of electrons along this path through the by-pass condenser, there is no actual motion of electrons from one side of the condenser to the other across the insulation put there to keep them from crossing. So they will pile up on one side. When the impulse has reversed, the trapped electrons cannot return through the turnstile set against them. So, this extra number of electrons has but one

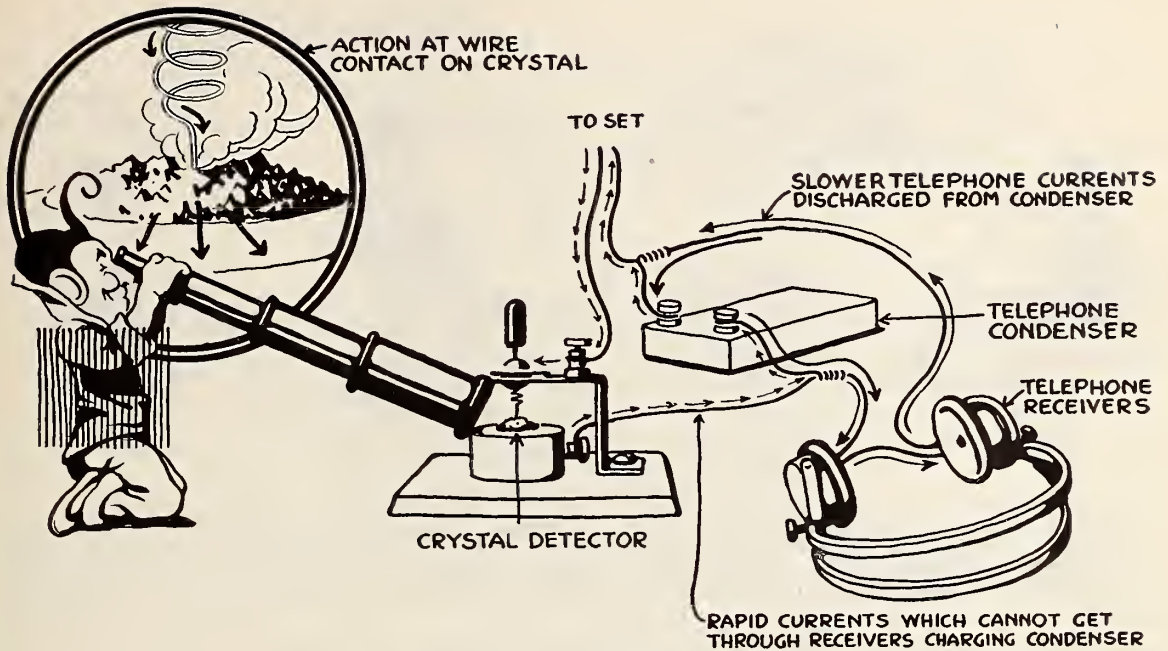

KING ELECTRON STUDIES THE CRYSTAL ACTION

This may be a "heat" effect, where the small contact between the "cat-whisker" steel and the crystal is heated by the rapid rush of electrons. This heat means high vibration of the particles of the wire and crystal at the point of contact. The result of this rapid vibration is to make the electrons move in one direction only across the point of contact. This motion of electrons is called "thermal electric current." As it is in one direction, it will work through the telephone receiver and produce a motion of the receiver diaphragm, causing sound.

choice, and that is to go through the telephone receivers. What it means is that the electrons on these rapid pulses will pile up on one side of the by-pass condenser, and then they will slowly work their way around to the other side of the condenser to ground by passing through the telephone receiver. When the word "slowly" is used, it is meant slowly with respect to the million frequency of radio waves, because the action through the telephone receiver will still be quite fast enough to correspond to the sound vibrations of the order of some one thousand vibrations a second. Thus the action of a by-pass condenser is to improve the efficiency of the detector-telephone receiver combination first, by giving the radio electrons a quick path to move along; and second, by acting as a storage tank to take these electrons and then allow them to pass off through the telephone receiver.

As a matter of fact, any two metal surfaces separated by an insulator act as a condenser. Two such metal surfaces are the two wires leading to the telephone receivers in the telephone cord. So the cord acts as a by-pass condenser itself. This makes it necessary only

to add a rather small capacity to give the best efficiency for the detector action.

THE BUZZER TEST

NOWADAYS, as there are so many signals in the ether all the time, there is less need of a testing outfit for the crystal detector adjustment. Still, for receivers at a distance from the transmitting stations, such a device may be a great help.

In its simplest form it consists of an ordinary electric buzzer, which as it buzzes constitutes a small radio transmitter, and will therefore act on a receiving set which is properly adjusted. It is necessary only to connect a buzzer with a dry battery and a push button in series. Every time the button is pushed the buzzer will send out the small radio signals on the sparking at the contact. These will be sufficient to work the receiving set. If the buzzer is not quite strong enough, the effect may be increased by adding one extra insulated wire attached to one of the buzzer binding posts. The insulation of the extra wire is taken off only at the buzzer end. The other end of the wire is wrapped around one of the crystal detector

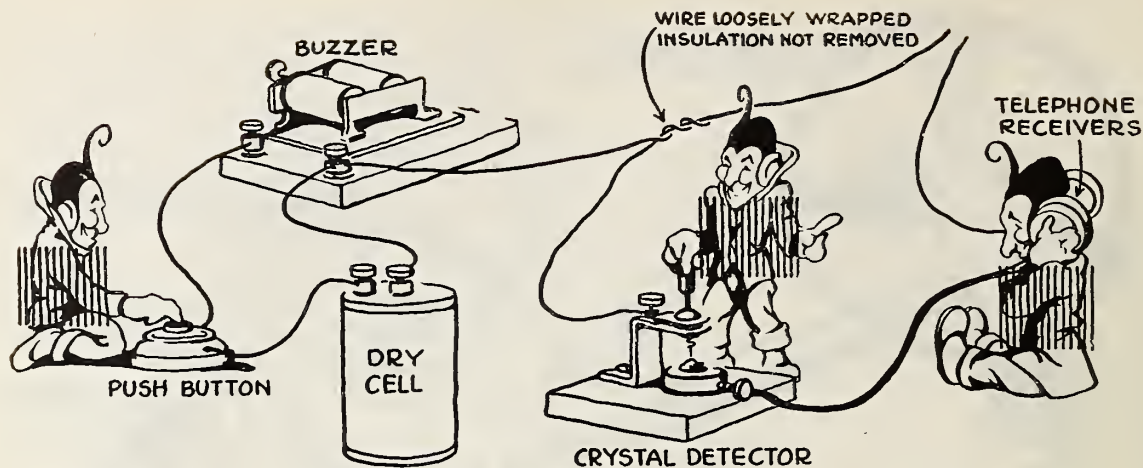

TESTING OUT THE CRYSTAL DETECTOR

An ordinary buzzer is requisitioned by King Electron. This acts as a small radio transmitting set. Its transmitting antenna is a short length of wire attached to one binding post of the buzzer and brought near the receiving set. A dry battery and a push button in series with the buzzer complete this test transmitter. As it buzzes, the cat-whisker is adjusted until the signals are heard nicely, when the tester is shut off and the tuner is adjusted for distant radio waves.

wires loosely, or it may be wrapped around the aerial wire. Usually it is sufficient just to bring the wire near the aerial or antenna.

With the buzzer working, the crystal detector is adjusted until the signals are heard best. It does not pay to find the ultra-sensitive point, as it will be found that such a point will only last for a little while until a crash of static "burns" it up.

When the detector has been adjusted for good average results with the buzzer, the buzzer is shut off, and any signals that are passing through the ether should be heard nicely.

In all work with radio, it is a very good plan to start with something known, and then work for the more difficult and more sensitive results. The buzzer tester falls into the first class, as

by its use the receiving set detector may be well adjusted, which indicates that the detector and the telephone receiver with the by-pass condenser are all working well. With continued practice, it may be possible to remove the buzzer to quite a distance from the receiving set and still get the test. Under these conditions it is certain that the receiving set is in the most sensitive condition.

The action of the crystal detector is fundamental, as the action of the other detectors is better understood from this viewpoint. So next month the much greater activity of King Electron in the Grid Leak-Detector connection with the vacuum tube will be taken up, together with the action of the Heterodyne.



Radio Has Gripped Chicago

The Ears of the Entire Middle West Were in the Auditorium Opera House Last Winter, and Boys are Building Thousands of Sets

By GEORGE P. STONE

FEW landscapes in all the world are more depressing than the barrens of Chicago's great west side. The scene consists of a seemingly endless succession of mean streets, across which dispirited tenements and glum "workmen's cottages" glare grumpily one at another. Soot is on everything—the buildings, the sky, the infrequent and listless trees, and the swarms of children. It is a desert scene, more disheartening than the Sahara because it is wrapped perpetually in gloom and crowded with thwarted human lives.

But since winter, a queer blooming has occurred in the desert. The elevated railways' intrusions upon the backyard life of the region reveal a strange vegetation on the housetops. The vegetation is not heavy, it casts no shade, it does not even comfort the casual eye; but to the imaginative beholder it is tremendous with promise. Ugly as it is in outward form, the vegetation lets down beauty and pleasure and a new interest in life into hundreds and hundreds of gloomy tenements.

Each of the numerous shoots of wire intimately connects some desert dweller and his family with such luxury as used to belong only to the wealthy few. Grand opera, news expensively and quickly gathered, the words of political and religious leaders, instrumental music by great artists—all these are carried by the house-top antennas down into dingy rooms for the comfort of persons for whom such things simply did not exist a year ago.

The alacrity with which antennas have appeared on the skyline of the west side is the most dramatic and most hopeful phase of the development of radio broadcasting in Chicago. Crude homemade aerials are on one roof in ten along all the miles of bleak streets in the city's industrial zones. For thousands of families, life has acquired new savor through radio.

It is hard to imagine the splendor of the vistas which radio must have opened to many of these people. Picture, if you can, John Taplowski, foundry helper, listening to Mary

Garden and Lucien Muratore in "The Love of Three Kings" over little John's school-made radio set! Then reckon on several thousand John Taplowskis in the grim back streets along the muddy Chicago River and the wastes of frame shacks out "back o' the yards," feasting on an inexhaustible variety of radio entertainment! Staggering, isn't it? And it indicates the folly of saying that "the public will soon tire of this fad."

For some the radio is indeed only a new toy, soon to be dropped, but for the owners of the clumsy antennas on the tenement roofs of the west side, wireless telephony is a miracle which cannot stale. It is making life over.

Chicago has another radio audience for whom the daily broadcasts are more than a temporary palliative of boredom. On the prairies of all the Middle West, from the Alleghanies to the Rockies and the northern border to the Gulf, the broadcasters have a farmer clientele which gets not only excellent entertainment but also vastly helpful news of prices and weather and current events from the air.

These—the humbler folk of the city and the farmers with few other social contacts—are more than "fans." Their interest in radio is genuine. It will last. It is the dependable factor on which plans for the future are being based.

Chicago caught the radio fever in earnest last fall, when the Westinghouse Company established Station KYW on the roof of a downtown skyscraper. Its KDKA station, in East Pittsburgh, had then been broadcasting for nearly a year, and stations had been created or were being built at Newark, N. J., and Springfield, Mass. The Chicago staff of the company wanted to get abreast of the others. The approaching season of the Chicago Opera Company seemed an opportunity.

Now the Westinghouse people do not pretend to be philanthropists. Their broadcasting service is business, and they admit it. They manufacture radio sets. They want a market for those radio sets. To create a market they

must make the sets valuable to purchasers. Hence the broadcasting. Hence, too, the excellence of the broadcasted programmes, for the better the entertainment the larger the audience.

In arranging for the opening of their Chicago station the Westinghouse radio men found a willing ally in Miss Mary Garden, then director general of the Chicago Opera Company. Efforts were being made to enlist the public generally in support of opera. Wealthy guarantors were wearying of paying the bills. Miss Garden and her associates in the management of the company were appealing to all Chicago to back the enterprise out of civic pride.

The suggestion that opera be broadcasted by radio was welcomed. Grand opera is an exotic dish. Taste for it is not instinctive, but acquired. Miss Garden saw in the broadcasting plan a chance to instill a liking for good music in thousands of minds outside the range of any other appeal, and so the plan was adopted.

The story of the amazing manner in which the Chicago Opera Company obtained a nightly audience hundreds of times greater than the capacity of any theater in the world has been told so often that to repeat it here would be useless. It is enough to say that every opera given by the company in the winter season was broadcasted by Station KYW so that the ears, at least, of all the Middle West were in the Auditorium Opera House six nights a week.

The consequences were amazing. In Chicago at the opening of the opera season were approximately 1,300 radio sets. Announcement of the fact that opera was to be broadcasted started a clamor for equipment. As the season advanced and professional critics added their praises of radio transmission to the ecstatic comments of radio enthusiasts the clamor in-

creased. To "listen in" on the opera became the most fashionable and popular of winter sports. Home, it seemed, couldn't be home without a radio set.

But no radio sets were on the market!

Manufacturers and dealers had not foreseen such a demand. Who could have foreseen it? Until the fall of 1920, radio sets were not very saleable. Only industrial users and a comparatively few "experimenters" wanted them. As well have tried putting turbine engines in the household furnishing field. After the first rush nothing was left for the hundreds of frantic radio customers save "bootleg stuff"—sets rebuilt or manufactured in defiance of patent restrictions. And all the while the finest opera in America literally was wasting its fragrance on the desert air.

Came then the small boy to the rescue. He is the hero of Chicago's radio drama, the small boy is. Frank Conrad, who began the broad-

casting, and H. P. Davis, who established the "granddaddy station" at East Pittsburgh, and Miss Mary Garden, who made broadcasting of opera possible, have their places in the cast, but the fellow in the spotlight is the American boy.

The normal Yankee youngster's insatiable desire to "see what makes it go" always has been a stimulant to mechanical progress. Every American invention from the cotton gin to the airplane has felt the boy's influence. Tinkering in their impromptu backyard workshops, young Whitneys and Edisons and Wrights have done important things in mechanics, simply out of boyish curiosity about what's inside the darn thing.

Just as their grandfathers fiddled with bicycles and their fathers with automobiles, the young Chicagoans of 1921 began fiddling with the radiophone. And presently the number of radio sets in KYW's field had tripled, although the dealers in electrical supplies had only one



A FAMILY PARTY

Some boys get the radio fever when very young

answer for customers: "We haven't a thing; perhaps next month. . . ."

Families were compelled sometimes to sacrifice physical comfort for the sake of having a radio set in the house. One young genius appeared in his high school physics class with a home-made set neatly housed in a mahogany silver chest, for which his mother doubtless was searching at that very moment. Another lad dared the parental thunderbolts by snatching springs off his father's bed. Whole platoons of zealots discovered simultaneously the peculiar fitness of rolled oat containers and appropriated them as material for "tuning coils" sometimes without regard for the breakfasts stored away inside.

In one way or another radio sets were contrived out of the amazing collections of junk always to be found in the woodsheds and cellars of families with boys. And they worked! And the opera got new hearers.

The tremendous enthusiasm of the youngsters threw an embarrassing burden on the public schools. Boys who had been yawning through their physics and manual training classes came suddenly to life as the enthusiasm for radio spread. They demanded that their teachers

unfold without delay the secrets of wireless telephony. They wanted an explanation of the phenomenon and instruction in radiophone construction. And with a few exceptions the teachers were caught off base.

For six months a breathless teaching staff was hard put to keep the necessary one jump ahead of its hungry charges. Instructors found themselves compelled to outstrip their classes in study. To their credit be it said that they stood to their guns. As soon as it became apparent that radio broadcasting was to be an institution, special classes in radio were organized, materials for set construction were put at the disposal of manual training groups, and students were encouraged to build and practise with radiophones of their own.

At the close of the opera season the number of sets in use in the city of Chicago had increased from 1,300 to something like 20,000. And you have the word of experts for it that boys of high school age were responsible for at least 75 per cent. of the increase. Grown-ups occasionally took flyers in the new game, but those who made the home sets work, who contrived makeshifts to take the place of unavailable gear, were mechanics in short trousers.



GEORGE FROST

© Underwood & Underwood

The 18-year old president of the Lane Technical Club with a cup which he recently won at an exhibition

The departure of the opera company left the Westinghouse company in a quandary. By broadcasting the music of Miss Garden's organization, KYW had established a radio audience of thousands. That audience wasn't going to wait ten months for another opera season; it wanted entertainment without delay. Undeniably it was KYW's move.

A musical director and a staff of performers were engaged. The newspapers, by now awake to the fact that radio was claiming as much public interest as baseball and divorce, offered coöperation. And when the curtain fell on the last operatic performance of the winter, KYW was ready with an all-day broadcasting programme. Twelve-hour service has been given daily ever since, and will be maintained.

The beginning is at 9:25 A.M., Chicago daylight saving time, when the opening market quotations of the Chicago Board of Trade are broadcasted by means of a straight connection between a phone booth in the pit and the KYW set. At half-hour intervals thereafter the fluctu-

ations of the market are reported to radio users until, at 1:20 P.M., the closing report is available.

This grain market service has proved itself of the greatest value to farmers throughout the Middle West. It has done much to bring the grower and the dealer into harmony. Thanks to his radiophone, the wheat grower in the remotest prairie is on an equal footing with the speculator in Chicago. He would be in no better position were he at La Salle street and Jackson Boulevard, watching the bidding and selling in the world's greatest grain market. He is enabled by radio to sell at the most opportune moment, and his suspicion of grain dealers is abating as his confidence grows.

Livestock quotations are broadcasted, too, through an arrangement with the stockyards. Stockmen all through the West get news of receipts and sales and prospects immediately.

The first general news report of the day goes out at 2:15 P.M., with the livestock market reports. Important happenings the world over



TRANSMITTING MARKET QUOTATIONS

From the Chicago Board of Trade through a microphone to Westinghouse station KYW, operating the latter automatically

The image shows a large blackboard with handwritten market quotations. The board is divided into several sections for different commodities:

- OATS:** Columns for APR, MAY, JULY, SEPT. Prices range from 31.5 to 41.5.
- CORN:** Columns for APR, MAY, JULY, SEPT. Prices range from 60 to 68.
- WHEAT:** Columns for MAY, JULY, SEPT. Prices range from 123 to 134.
- RYE:** Columns for MAY, JULY. Prices range from 96 to 108.
- PORK:** Columns for MAY, APR, MAY, JULY, SEPT. Prices range from 2100 to 1090.
- LARD:** Columns for MAY, APR, MAY, JULY, SEPT. Prices range from 107.5 to 109.0.
- SHORT RIBS:** Columns for MAY, JULY, SEPT. Prices range from 11.25 to 16.50.

A radio operator's hand is visible in the center, pointing to a price of 107.5 under the LARD section. Below the board, there are rows of letters: K N U J K N U K N K N U K J K N U K.

TICKER QUOTATIONS OF THE CHICAGO BOARD OF TRADE

Posted here, and the radio operator is in a position to note every price change promptly

are bulletined, often before they are in print. Forty-five minutes later the lineups for every American and National league baseball game are sent into the air, to be followed at intervals of thirty minutes by bulletins of the progress of each game. If Babe Ruth or Ken Williams slams out a home run in New York or St. Louis, the radio bleachers get the word in less than half an hour. And the wallop which gave Georges Carpentier his recent victory over Kid Lewis in London was reported in Chicago homes and on Oklahoma farms almost before the cheering had stopped around the ring.

At 4:15 KYW's huge audience gets another batch of news about happenings generally, the grain and livestock markets, and the stock quotations. This report is followed at 6:30 by financial and baseball finals, and the radiophoners can knock off for chow.

The children come in for their share of the programme at 7:15, when a bedtime story is sent out. Just as soon as the story has been told and the children have been tucked into bed, father and the boys are given a concise summary of the sports news of the day, with particular emphasis on baseball.

Then the real entertainment begins. KYW has tried to keep its evening musical programmes up to the standard set by the opera company

in the first months of Chicago broadcasting. To do so is good business. Audiences can't be held with second-rate stuff. Not all of the entertainment is on the artistic level of the opera of course. The radio audience is heterogeneous. To send out nothing but highbrow music would be to discourage many listeners. But nothing amateurish is permitted. Jazz is mixed with the classic, but it must be accomplished jazz, and there must not be too much of it.

A programme chosen at random from the summer schedule of KYW will indicate the sort of entertainment given to the station's clientele.

This is what radio fans in the Chicago broadcast zone heard on August 15th:

8:00 P. M.—Musical by Ethel S. Wilson, soprano; Herman Salzman, baritone; Rosalyn Salzman, accompanist; Bernard W. Wienbroer, 'cellist; Isadore Witte, pianist. "Pale Moon." Logan, and "Rose in Bud," Forster; "Berceuse," from "Jocelyn," Godard, and "Romance," Kronold; "Toreador Song" from "Carmen," Bizet, and "The Little Irish Girl," Lohr; "Sonata Pathetique," Beethoven, and "Prelude in B Minor," Chopin; "Sunrise and You," Penn, and "One Fine Day," from "Madama Butterfly," Puccini; "Traumerei," Schumann,



DURING TERM TIME

Such groups as this are not uncommon in the high schools of Chicago

and "Ave Maria," Schubert; "On the Road to Mandalay," Speaks, and "Rose of My Heart," Moret; "Polonaise Militaire," Chopin, and "Moths," by Phillipp, "Prelude in A Major," Chopin.

Every Sunday afternoon chapel services are held by radio, with some distinguished Chicago preacher speaking at the KYW studio. And on Mondays, Wednesday and Fridays KYW gives an hour in the afternoon and an hour in the evening to WBU, the Chicago city hall station, which offers special features.

No one has been brash enough to attempt a reckoning of KYW's daily audience, but it is tremendous. New towers just installed, 495 feet above the street, give the station a normal range of 2,000 miles and an occasional range of 3,500 miles. Letters of praise or censure have come to the musicians of the station from auditors as far away as Catalina Island, Cal., Medbury, Mass., and San Francisco. Indeed, Miss Evelyn Goshnell, who came to Chicago early in the spring with a play, brought commendation for a KYW concert she heard in mid-Atlantic.

The letters which come daily to the station reflect the genuine interest of the farflung radio audience. A Nebraska farmer asks for "less of that highbrow piano playing." A critic in Montana notes that "Miss So-and-so's songs were just fine, but don't ever let that Mr.

Whosis play again." The applause and the booing are as frank and emphatic as the demonstrations of a gallery crowd in a theater. They keep the performers on their toes.

Naturally the pleased interest of all these radio users has been contagious. In spite of the shortage of supplies, the number of sets in operation has increased steadily from month to month. No searching census has been made, but the broadcasters know of 30,000 radio sets in the metropolitan district to-day.

The summer has brought a lull in the radio demand. Talk of "summer static" has spread as talk of German spies and enemy airplanes spread during the war, so that the hundreds of shops which flaunt hastily painted "Radio Supplies" signs over their doors are less busy than they were four months ago. Prospective radio fans are awaiting the coming of more favorable weather. The midsummer apathy distresses no one, except perhaps the apathetic themselves. Manufacturers are from three to four months behind their orders now, and the dealers simply can't see daylight. An idle summer will restore something like a balance between supply and demand, and all signs point toward a vigorous revival of radio interest in the fall.

In the middle of June the public schools turned loose several thousand young manufacturers of radio sets. These boys (and girls,

too) have spent much of their vacation time in practising the radio craft they learned in school last winter and spring. Those who are watching the radio field closely expect Chicago to have 75,000 sets in use by fall.

That the youngsters learned the craft and learned it well is to their own and the city schools' credit. They furnished the impetus, and the schools supplied the instruction. Chicago's public school system always has been wide awake in technical matters. The four great technical high schools—Crane, Lane, Harrison, and Washburn—are admittedly without superiors in the country, and the vocational training departments of the grade schools and general high schools have served as models for other communities. This flair for technical training was directed radio-ward as soon as it became evident that broadcasting was going to make wireless telephony interesting.

A. G. Bauersfeld, supervisor of technical work in all the Chicago schools, had been

encouraging interest in radio before the present era began. Lane Tech had a radio club as early as 1904, and instruction in wireless transmission is not a new thing in that or other city high schools. When interest began to widen, Mr. Bauersfeld prodded his instructional corps into action. Teachers were urged to encourage students who seemed interested and to study the subject themselves.

Every school in the city soon began to feel the effects of the radio fever. Classes in electrical theory doubled and redoubled. Shop classes came suddenly to life as boys who had refused to become interested in the manufacture of furniture awoke to realization of the fact that by becoming proficient in furniture-making they would learn to make good radio cabinets.

The students' interest in radio was helpful generally. Boys aren't content with knowing that by turning a dial this way or that they can evoke sounds from a radiophone. They



© Underwood & Underwood

RADIO SETS MADE IN MANUAL TRAINING CLASSES

Radio fans from twenty-four Chicago high school clubs met early in June in the office of Albert C. Bauersfeld, supervisor of technical education in the public schools, to listen to talks by prominent electricians and display some of their handi-craft. In the picture, from left to right, are William Helm, Clarence De Butts, Milo E. Westbrooke, W. J. Bogan, Sup't. Peter A. Morterson, and Corwin Eckel

must know the why and wherefore. So they didn't rest with instruction in the building of sets, but quit their afternoon ball games to study theory.

Boys began besieging the KYW station, the Chicago *Tribune's* wireless plant, and WBU. They were at the doors early and late.

"And of all the visitors we have," a KYW guide said, in talking of the younger generation's passion for radio, "we get the most fun out of the boys. Grown men simply 'Ah!' and 'Oh!' or ask silly questions. The boys get right down to brass tacks. I've seen kids in short pants stagger our radio men with questions that went straight to the heart of things."

School teachers had similar experiences. "For a while I was almost ashamed to go to school in the morning," one high school instructor confessed, "because the boys were shooting over my head. I had to do the hardest sort of grinding before I could face them. They took to the business like ducks, and were speaking the lingo with the fluency of experts before the radio fever was a month old."

Radio clubs in the schools are supplementing the work in the classroom. Lane Tech's pioneer club served as a model and has, in fact, been instrumental in organizing the radio interest of other schools. George Frost, the 18-year-old president of the Lane club, has been indefatigable. Unaided he produced the first radio-equipped automobile in Chicago and he serves at schools as a sort of unofficial instructor.

Through the efforts of young Frost and others of the Lane club, radio clubs have been formed in most of the schools, until now the organizations include thousands of young wireless experimenters. The growth of Marshall High School's club illustrates the speed with which these organizations develop interest in their hobby. This club was formed in May, with a membership of 100. By June 1 the secretary had 400 names on his book. A set is now being built at the school. When it has been finished the club will have 750 members, the officers say. And before a year is out most of the 750 will have put radio sets into their own homes. Thus the wireless audience grows.

The Chicago Association of Commerce has contributed fuel to the boys' enthusiasm. For several years the association has fostered civic-industrial clubs in the high schools. The

clubs devote their energies to neighborhood work in Americanization, study of social and political problems and first-hand observation of Chicago industry, business, and government. Because the backers of these clubs foresee that the interested boys of to-day will be the informed men of to-morrow they are encouraging the radio hobby. The Association of Commerce wants to make Chicago the radio centre of America. To that end it is helping the high school enthusiasts by opening for them the doors to great electrical plants and laboratories.

The boys' clubs are not the only ones. Although the popular excitement over radio is less than a year old in Chicago, a Chicago Radio Club already has been organized. It has a clubhouse near the lake shore and is bringing together men interested in wireless, not for technical purposes only, but for social ends as well. It uses radio just as the large athletic clubs use sports, that is, as a binder.

But the sandlots have turned out more big leaguers than all the athletic clubs combined, and the radio experts of to-morrow are more likely to come from the high school groups than from the elaborate clubhouse on the lake front.

Chicago's two great universities—Northwestern and Chicago—have been pretty well immune from the radio fever, probably because neither is a technical school and the students' ambitions and interests already were fixed in other directions. Armour Institute, Lewis Institute and the many lesser technical institutions in Chicago have noticed some increase in the demand for instruction in wireless, but there, as in the cultural universities, previous fixation of undergraduates' interest has had a restraining influence. The real fever will not reach the colleges until the high school enthusiasts begin graduating.

None of the colleges has availed itself of the opportunity to broadcast helpful lectures. WBU, the city hall station, is the only broadcasting agency which has attempted education in anything except music, and WBU's efforts have had a political tinge. City officials lecture by radiophone six times a week on matters of importance to Chicagoans as citizens, explaining the work of the police department, the manner in which the streets are kept clean, ways of avoiding disease and accident, and so forth.



The city has in mind a far more important radio experiment. George E. Carlson, commissioner of gas and electricity, and Chief of Police Fitzmorris are seeking from the city council an appropriation of \$68,000 for radio-equipped automobiles. In its fight to prevent crime the police department sends out daily fleets of automobile patrols, each assigned to a definite area, so that the pursuit of robbers may be delayed as little as possible. Commissioner Carlson and Chief Fitzmorris want to equip these patrols with radiophones, in order that they may be kept constantly in touch with headquarters.

Experiments with a model patrol have been successful, but as yet the council has withheld the money needed for equipment of a fleet.

If the radio patrols live up to expectations, an effort will be made to equip every roundsman with a radiophone. Next fall may find the city hall radio operator in touch at all times with every policeman in the city, so that cordons can be thrown about the scene of a crime

before the criminals have had time to get away.

City officials, newspapers, manufacturers, dealers and schools are accepting the general interest in radio at its face value. They are convinced that every American home will some day be radio-equipped; that in the near future the wireless telephone will be considered as necessary as the commercial telephone is considered now.

Most of our social troubles, it is pretty generally agreed, grow out of misunderstanding. We base our hopes and prejudices and faiths on widely different sets of facts, variously interpreted. Democracy, they say, whose business it is to spread intelligence, cannot flourish until knowledge of events reaches the masses quickly, clearly, and wholly.

If that be true, what present-day phenomenon is more encouraging than the new look of the dingy skyline of Chicago's hinterlands, fringed with radio antennas thrust up for long-denied draughts of sweetness and light.

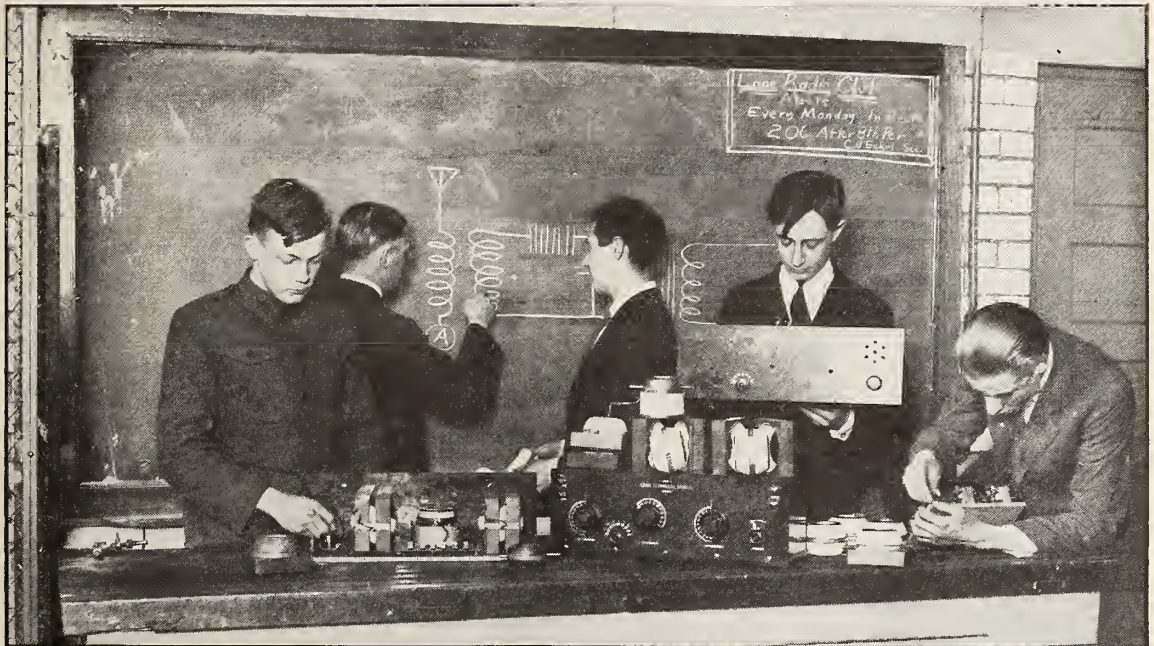

© Underwood & Underwood

A CLASS AT LANE TECHNICAL HIGH SCHOOL STUDYING RADIO

This school not only teaches radio, but instructs pupils in how to manufacture their own instruments, and boasts the pioneer boys' radio club

“With the Night Mail”

By DONALD WILHELM

BECAUSE of its great distances, favorable topography, willingness to try out new devices, and characteristic appetite for speed in travel and communication, America is the natural habitat of both radio man and flyer. The plane and the electromagnetic wave—these two annihilators of time and space—came into being almost simultaneously. Their secrets Man discovered and applied within the span of one generation. Now the Twin Sciences, both coming of age, must grow together, for even if radio can do without the plane, the plane cannot do without radio. Soon, too, federal regulation of commercial aeronautics, which is quite as necessary to the development of aviation in America as was federal regulation of radio, is to be lodged under Secretary Hoover—either cop extraordinary—in the Department of Commerce.

Order in the air, settlement of questions of liability in case of accident, practicable insurance rates and extremely large capital for investment in commercial aviation await this event. Pending it, moreover, and all propaganda to the contrary notwithstanding, in aviation as in radio, America is leading the way. Thus—for one thing—our Air Mail Service is without question the largest and most successful achievement in regular, commercial flying in the world to-day.

During the next six months or so, the Air Mail will attempt something extremely significant in the history of the Twin Sciences. It will attempt regular night flying, by using radio direction finders, radio field localizers and the radiophone to guide the mail pilots all the way

from hop-off to landing. With these aids, it expects to be able to fly mail across the continent daily, both ways, in somewhere around twenty-four hours.

THE TEST TRANSCONTINENTAL FLIGHT

ONLY once has mail been carried from Coast to Coast so fast—about 125 times as fast as the Forty-niners crept across the endless plains, and five times as fast as the fastest express train. On February 22, 1921, on a test transcontinental flight without the aid of radio, and at the cost of one pilot's life, the mail plane covered the long trip of 2,650 air miles (you add a third usually in calculating railway distance), in twenty-five hours. Then Pilot Nutter hopped from the San Francisco field before dawn and, mostly in the dark, and partly at a height of 18,000 feet, crossed the Sierras and ran

Some years ago, Rudyard Kipling wrote a fanciful story called “With the Night Mail,” describing an imaginary air mail service in the year 2000 A. D. between London and Quebec. We still have seventy-eight years in which to realize his prophecies, but can we doubt, when we consider the advances made in only eighteen years, that in *less* than that time there actually will be an airplane mail service from Europe to America? Not equipped with the huge and clumsy dirigibles of Kipling's fertile imagination, perhaps, but with trim, swift planes of an improved type, as to which, even in 1922, we can only make guesses.

Meantime, our own Government is perfecting an airplane night mail service between the Atlantic and Pacific seaboard. Its beginnings, struggles, successes, and hopes for the future are dealt with in this article.—THE EDITORS.

on to Reno, 187 miles, in two hours. Pilot Eaton ran the mail on to Elko, Nevada, and thence to Salt Lake City, 437 miles. Murray reached Cheyenne, 381 miles, and there Yager carried the mail on into the night, reaching North Platte at 7:48, Middle Time, 110 miles. Then it was Jack Knight who flew the 248 miles to Omaha, and, because no other plane or pilot was available, in the middle of the night, with nothing to guide him except the instincts of a homing pigeon and a few farmers' bonfires at long intervals, he continued till dawn and landed safely on Checkerboard Field, near Chicago, 424 miles away. From there, other pilots flashed in relay on to New York.

These distances and details are important; for, until planes fly at twice their present speed,

if the mail is to be carried from coast to coast in twenty-four hours, *a gap of a thousand miles or so must be flown at night*, and, the Air Mail insists, such routine night flying is clearly out of the question without radio. But with radio the project is thought to be entirely practicable. It has no terror for most of the postal pilots. There are some who have said to the writer that they would rather fly at night if they have the guidance of radio than in the daytime when, on some of the runs, fog often lies in wait for them and forces them to fly very low, dodging all manner of obstacles. “But,” said one, “give me radio direction-finding apparatus that really works and I’d a lot rather fly at night, way up, than take a chance in the daytime in thick weather with the best compasses, turn indicators, distance recorders and drift indicators I’ve ever seen in a plane. Our compasses

spin, and most of these other instruments are as good as a pile of junk when you get twisting around in a tight corner at a hundred miles an hour.”

So the Radio Division of the Air Mail, after years of experimentation with radio in coöperation with other Federal agencies, and years of yearning for sufficient funds, is making ready to use radio to guide its pilots, and is having a survey made of the transcontinental route. The man at the head of the Post Office Radio Division is, you may take it, qualified to judge of the difficulties. For long before the war he was an ardent amateur, then a teacher of physics and radio, then a war pilot—one of the few trained at Ellington Field for night flying—and, when the war was over, the first man successfully to fly the mail both ways between New York and Washington, over the initial Air Mail run.

THE AIR MAIL RADIO STATION IN WASHINGTON

© Harris & Ewing



"The problem of night flying and of using radio to assist the Air Mail to cross the Continent in a day," he explained in the authorized interview following, "boils down to three major questions:

(1) Which stages of the long trip shall be flown at night?

(2) What kind of radio equipment shall be used on the planes and on the ground?

(3) What types of field and between-field lighting shall be employed?"

The third question, he says, is already settled: so-called gas accumulating searchlights, which operate automatically for months at a time without attention, have obvious advantages. Pointed skyward, placed conspicuously at the fields and at intervals of fifty miles or so between fields, such lights, both in point of effectiveness and simplicity, are the best answer to the least difficult of the three major problems.

Which gaps between New York and San Francisco shall best be covered at night is a larger problem. It may be, Mr. Edgerton explains, because of the enormous demand—notably by banks—for the swiftest possible service between New York and Chicago, that the entire run of 753 miles between these cities will be covered, eventually, at night. Yet this great distance includes the New York to Bellefonte, Pa., run, the worst run of all heretofore, mainly because of its fogs and mountains. Certainly, he adds, the Reno-San Francisco gap, to cover which a pilot must fly higher than in crossing the Alps, is out of the question both as a matter of safety and of Post Office strategy in expediting the mails across the continent.

But the remaining question, concerning radio equipment, will be to most of us the most interesting aspect of the Air Mail's ambitious plan.

Here the problem is twofold.

One phase of it has to do with supplying means by which the pilot, high up, clipping the welkin in the middle of the night, can keep in continuous touch with ground stations, and possibly with amateurs now and then.

The other phase has to do with providing what Mr. Edgerton calls navigation aids—radio direction finders and radio field localizers.

"These things," Mr. Edgerton believes, "are possible of accomplishment. Ideally, the pilot simply wears a special radio telephone helmet, designed to exclude motor noise. On

his plane a coil of wire is wound—about the struts for instance—and is connected to a receiving set on board. Then, as when a direction finder is mounted on a ship, and is oriented, the signals from a given transmitting station, or radio beacon, are loudest when the coil is pointed directly at the station. Moreover, if such a coil is mounted rigidly on a plane so that it points in the same direction as the plane, it can readily be seen that if the pilot pivots the plane so as to keep a maximum signal in his ears, he is bound to fly, as on an imaginary line, straight toward the beacon. Then, flying high, he can evade or fly through fog, his worst enemy, instead of having to fly low where he must dodge physical obstacles. But if the beacon is at the point of destination, the pilot will still be unable to locate the field exactly in thick weather because there is apparently a blind spot around each regular transmitting station, or beacon, which increases in size with the length of waves used. On a clear night, if he is careful not to level out to land too soon, and if the field is properly lighted, he can usually land all right. But if the night is not clear he will lose his direction, experiments show, just when he needs it most.

"It was to help him land that the radio field localizer was developed in 1918 and 1919 with the assistance of the Bureau of Standards radio section and the Navy. Various designs were tried out. One consisted of an insulated wire laid on the ground round the edges of the field, charged with low-frequency current and intended to operate like an audio cable such as the Ambrose Light cable, perfected by the Navy. But the device that we expect to use—experiments to develop which were begun at the Bureau of Standards in August, 1918, and then carried on at our former field at College Park, Maryland—is a peculiar kind of radio transmission aerial which transmits vertically in the form of a cone that gains diameter with increased altitude. At a height of about 3,000 feet above the field such a cone can, we believe, be made to have a diameter of nearly a mile. Distinguishing between the direction finding and landing signals, and spiraling down inside this theoretical cone, the pilot can, as he approaches the field, approximate its centre and his own altitude and effect a landing."

Experiments to apply the principles of radio direction finding to postal airplanes were begun, in coöperation with the Navy, in February, 1919. At that time a direction finder was

installed on a Curtiss R4L mail plane powered with a Liberty motor; so that the findings made (which had to be extensively altered to be satisfactorily applied to twin-engine planes), are applicable to the present postal planes which are practically all DH4B's, having single Liberty motors. This type was adapted first by the Post Office itself from the well-known DH4's—"coffin-boxes," they were called, because the gasoline tank was lodged between the seats. The principles of the "Robinson method," explained below, were utilized in the Post-Office-Navy experiments. Two definite problems were found: one, eliminating ignition disturbances of a severe nature, the other, providing a circuit reliable and simple enough to be used by a pilot unskilled in radio.

The ignition disturbances were caused by the low- and high-tension sides of the ignition circuit, which causes produced two separate and characteristic sounds. At first an attempt was made to shield the entire ignition circuit by means of metallic sheathing, but difficulty was experienced in securing adequate and frequent grounds. Next, an attempt was made to get results by sheathing only the direction-finding circuit, but here again, when the apparatus and batteries were sheathed with metal, although not of course the loops themselves, the weight was excessive and there was little improvement in the diminution of the disturbances. Finally a successful attempt was made by placing the direction-finding loops at the most distant point from the motor that the plane afforded. The Robinson method called for fixed "A" and "B" coils wound at right angles to each other, with the planes vertical. Both coils were constructed with rubber-covered aircraft wire and, at variance with accepted policy, were bunched together, since this materially aided in shortening the installation time and increased the wavelength of a given number of turns. The "A" plane of the coil, parallel to the longitudinal axis, was wound between the extreme entering and trailing edge struts. All loops were wound on a form placed on the side of a building, taped, then transferred to their permanent positions where they were again taped into place on the struts and wing surfaces with airplane linen, which was then "doped." The two leads from each coil were carried in a taping on the trailing edge of each lower wing to the fuselage. The "B" coil, at right angles to the "A" coil, was wound between the second and third rear struts



THE AIR MAIL MAN

Carries emergency rations in tin cans and bottles

away from the fuselage and on the opposite side from the "A" coil.

The second plane problem, that of providing a circuit reliable and simple enough for a pilot untrained in radio, was solved by mounting the instruments, including "B" batteries, six-stage amplifier, variable condenser and one double-pole double-throw switch, in one unit, on detachable brackets carrying elastic cord supports. These brackets were located beneath the pilot's seat along with the filament storage battery, which was also mounted on a bracket.

With the plane equipment, including an improved helmet with close-fitting receivers, rubber ear cushions and an outer hood over all working satisfactorily, the problem of developing field localizers was then continued, with the coöperation of the radio section of the Bureau of Standards. The Army and Navy were much interested in all this, for they had used radio direction finders for planes during the war, but neither had developed satisfactory radio field localizers. Since a plane approaching a field while receiving direction-finding signals from a station on the field can come safely within half a mile, the problem was to obtain a means of supplying a localized signal, intelli-

gible to the pilot and strong in the immediate vicinity of the field, but decreasing very rapidly with distance from the field. The experiments extended from various applications of alternating current with relatively low frequency to the use of radio transmitting and relatively high frequencies. This latter method made it possible for the pilot to use the same helmet. Moreover, when a very quiet engine was used, and using 20 amperes of 1,000-cycle current in the transmitting circuit, signals were heard when the plane was at a height of 6,000 feet, and there were indications of faulty tuning in the receiving circuit, at that.

The proposed set-up of radio beacons and localizers offers some practical difficulties, especially while Congress holds the Post Office Radio Division down to \$87,000 a year, as at present. The present Post Office radio chain used for administering the Air Mail consists of only twelve stations (Washington, Hazelhurst, L. I.; Bellefonte, Pa; Cleveland and Bryan, O; Chicago, Iowa City, Omaha, Cheyenne, Wyo.; Salt Lake City, Utah; Reno, Nev.; and San Francisco). Three of these are Navy stations (Cleveland, Chicago and San Francisco). Since radio beacons and localizers, to be adequate, must be actually on the postal fields, and these three are not on the postal fields, new ones must be provided. Again, some of the postal stations are too far apart, as indicated above, to keep a plane in communication with one station or another. And, once more, since the power of receiving beacon signals is limited, and since a plane steers toward

them, not away from them, provision must be made accordingly. However, if field stations are provided at Chicago and Cleveland, the distances between Chicago and New York are not large: from Chicago to Bryan by air is 178 miles, from Bryan to Cleveland 152 miles, from Cleveland to Bellefonte 206 miles and from Bellefonte to Hazelhurst 217 miles.

The transcontinental chain of stations of the Air Mail used for administrative purposes, incidentally, are not identical with the postal stations used for broadcasting agricultural information. There are eight now broadcasting: Washington (the only one using the radio-phone); Bellefonte, Omaha; North Platte, Neb.; Rock Springs, Salt Lake City, Elko, and Reno.¹

It is to be noted that in no instance is the broadcasting equipment identical with that required for serving planes en route. So the problems confronting the Radio Division of the Air Mail must comprehend broadcasting administration, communication with planes, interpoint communication and radio beacon and field localization, along with radio equipment of the planes themselves.

Clearly, if the Air Mail, solving these problems, can develop and perfect night flying, it will have done much to advance the cause of aviation in America. And, further than this, it will have contributed a great deal toward demonstrating radio as the super-messenger that neither under the sea, upon the land, nor in the clouds, knows any limitation.

¹The Air Mail expects, by the way, to use the wavebands 1050-1500 for broadcasting, 950-1050 for its beacons and localizers, and 850-950 and 500-525 for its aircraft.

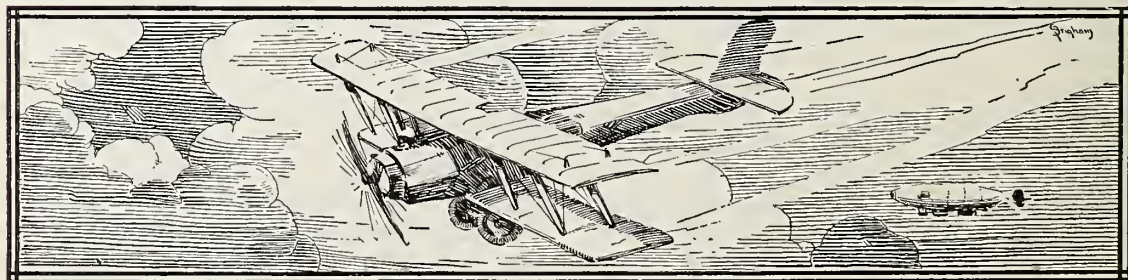

Shielded Receivers

By THOMAS C. TIBBEY

UNTIL the advent of the modern regenerative receiver, the term "shielding," as applied to radio apparatus, was quite unknown.

The regenerative receiver, however, being super-sensitive to all electrical influences, has been found to require protection against external electrical disturbances. Shielding accomplishes this. It is the process of surrounding the entire receiver, and sometimes even the individual circuits therein, by a metallic surface. This usually takes the form of a copper lining in the receiver cabinet and on the rear of the panel itself. This shielding absorbs any electrical influence which would normally find its way to the windings of the receiver, and induce in them an electric current, in the same manner that radio waves induce electric currents in a receiving antenna. In this instance the windings of the receiver virtually act as an antenna, absorbing energy from the ether. This energy may be radio telegraph or radio telephone signals, "induction" from electric light or power lines, or the summer pest of Radio—Static.

SHIELDING IN RADIO COMPASS WORK

THE Radio Compass, or as it is sometimes called, the Direction Finder, has been rendered accurate only by effective shielding of the apparatus.

The heart of the Radio Compass is the "Compass Loop" which is a square coil of wire about two feet on a side and wound with six to twelve turns of insulated wire. These turns are spaced about one inch apart and held in this position by means of notched bakelite strips on the edges of the square frame of the coil. This coil is usually mounted above the operating room and arranged so as to be revolved by a shaft which passes through the roof into the room to be operated by means of a hand wheel. Wires leading from the terminals of the coil are likewise brought into the room and connected to the tuning apparatus.

When the coil is revolved so that its edge is pointing toward a transmitting station, the signals are received with maximum intensity, decreasing as the coil is revolved, until the point

is reached where the coil is broadside to the station. At this point no energy is induced in the coil, and no signals are heard.

It follows, therefore, that when using the compass coil or "loop antenna"—a name probably more familiar to most of us—only those stations are heard which lie along the line in which the coil points. Under ordinary conditions this is not absolutely true, and here is where shielding plays an important rôle.

As we have seen, the leads from the coil extend to the apparatus. These leads, together with the windings in the receiver and the wiring of the entire set, comprise an antenna, of no mean proportions. It may be readily understood, that when the coil is pointing so that no signals are being received from a certain station on the Compass Loop, they are being received on the wiring of the set. This wiring, acting as an antenna, has no directional properties and therefore seriously interferes with accurate determination of direction, or elimination of unwanted signals.

The entire apparatus and leads, are therefore enclosed in a copper shield. This usually takes the form of a very fine mesh copper screen which surrounds the room, covering all windows and doors. This shielding effectually prevents the effect we have spoken of, and renders the Radio Compass an accurate and valuable agent for the guidance of ships at sea.

AN IMPORTANT ADJUNCT IN BROADCAST RECEPTION

FIGURE 1 illustrates what is probably the most highly developed receiver available to-day. This receiver is entirely shielded. The receiver cabinet is lined with copper, as well as the rear of the panel. Openings are provided in the panel shielding, in order that no part of the receiver wiring come in contact with the shield. A further refinement is effected by separating the primary, or antenna circuit, from the secondary, or detector circuit, except through such coupling as is controlled by a coupling coil. This type of shielding is valuable for preventing undesired reactions between the circuits of the receiver. A schematic wiring diagram of this receiver is shown in Figure 3.

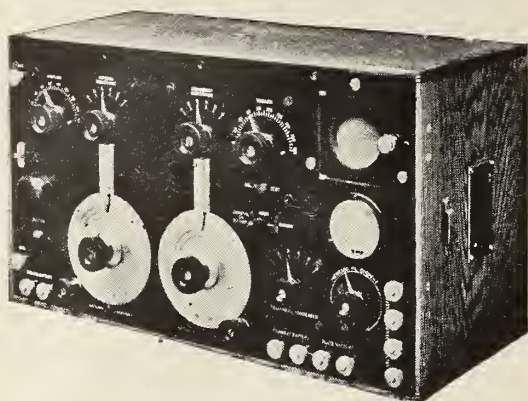
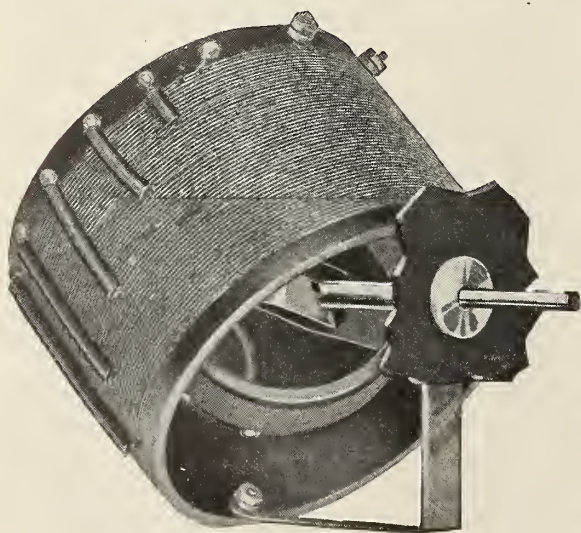

FIG. 1
A highly developed shielded receiver

It has recently been brought to the writer's attention that there is now available for amateur use a novel coupler employing a separate secondary load coil, which may be applied to this circuit. If the circuit is employed and the apparatus shielded, an extremely sensitive and selective receiver is available for long distance Radiophone reception, which should enable us to enjoy broadcasting without undue interference from nearby radio telegraph stations.

With the apparatus generally in use, a great many of us are bothered by interference from nearby commercial and amateur stations while receiving Radiophone broadcasts. In cases where the interfering stations are located close to the receiving station the antenna effect of



THE "ULTIMATE" COUPLER

the receiver wiring is very marked. Upon first thought one would think this phenomenon helpful, whereas in truth it is really detrimental.

Let us consider the case of the receiving set acting as an antenna. Unless the receiver, especially one having a large wavelength range, is equipped with "dead-ending" devices on the windings, the adjustment of the inductances, more particularly the primary, will have very little effect upon the intensity of the incoming signals.

Assuming the normal intensity of a near-by spark station when tuned in to have a value of 100, if we disconnect our antenna, it will be found that we can receive the station over a comparatively wide range of adjustments with

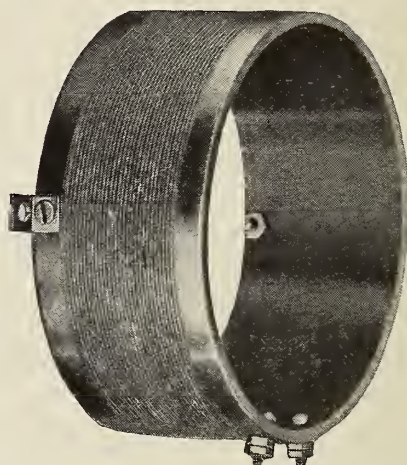

THE SEPARATE SECONDARY LOAD COIL

an intensity of perhaps 10. This would be sufficient to interfere seriously with broadcast reception. In the case of the usual commercial spark station at a distance of 5 miles, and on a wavelength of 600 meters, and a broadcasting station at a distance of 10 or 15 miles on 360 meters, the above example is a fair estimate of the relative intensities.

Thus we see that the least intensity with which we can normally receive the commercial station even without the antenna, is 10 when we are tuned to the broadcasting station on 360 meters. It follows that we shall be unable to tune the spark station out entirely no matter how selective the receiver.

Now, if we can prevent the receiver itself from "picking up" any signals, we shall at once greatly reduce the intensity of the interference and the selectivity will depend entirely upon the inherent characteristics of the antenna

and receiver. This may be accomplished by "shielding" the receiver.

SHIELDING THE RECEIVER

IN SETTING about to shield the apparatus, the entire interior of the receiver cabinet should be covered with copper foil which must be connected to the ground post of the receiver, great care being taken to have all pieces in perfect electrical contact. This can only be done by lapping and soldering the joints. Before the foil is put in place, the interior surfaces of the cabinet should be given a coat of shellac or varnish, allowing it to become very "tacky." This will render it easy to smooth out the foil and hold it so. As each side is laid in, the foil should be further secured by $\frac{1}{4}$ inch brass brads driven through the foil into the wood. The nailing should be done through the lapped seams near the edges, after a row of brads has been placed lengthwise along the centre line of the sides.

Cutting the foil in such shape that the entire box may be lined with a single piece of metal will remove the necessity of soldering any joints. The shape of the metal is shown in Figure 2. Copper foil, however, is not readily obtainable in widths greater than 8 inches, and in case it cannot be obtained sheet copper known as "twelve pound" should be employed.

The shielding of the cabinet should project sufficiently to enable connection to be made with the shielded rear surface of the panel. If the panel is set in a rabbet, the foil should project over the face of the rabbet and be secured by brass brads which should be sunken flush

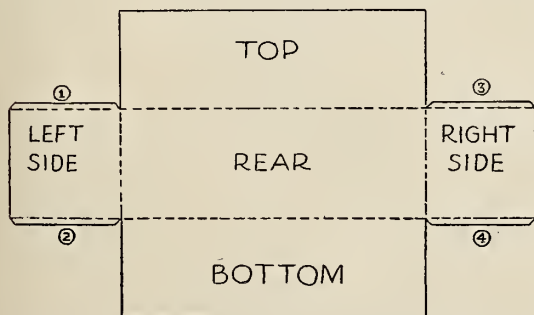

FIG. 2

with the surface by means of a nail set, so that the shielding of the panel will make good contact with it when the panel occupies its position in the box.

It is most important that the panel be shielded, as this serves the dual purpose of preventing the effect explained above, and also preventing "detuning" due to the presence of the hand or body near the receiver. No doubt all who use unshielded regenerative receivers have had this annoying experience.

The shield for the rear of the panel should

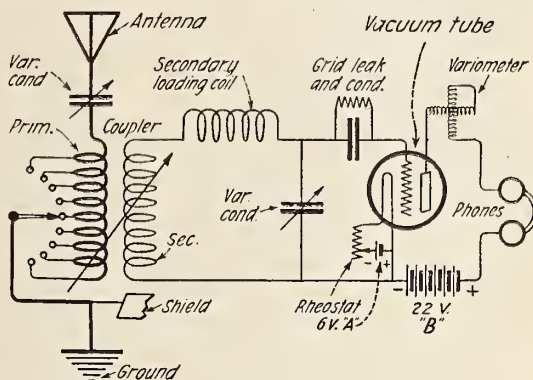

FIG. 3

be cut to size, and openings provided with $\frac{3}{8}$ inch clearance around all projecting switch points and terminals, with the exception of the "ground" binding post, to which it should be soldered.

After cutting the required openings in the foil, the rear of the panel should be coated with shellac or varnish and allowed to become very tacky. The copper foil is then warmed, laid in position on the rear of the panel, rubbed smooth, and dried under a slight pressure such as may be provided by placing a perfectly flat piece of wood—previously oiled to prevent its sticking—on the shielded side of the panel, and resting a weight upon it. Unless great temperature changes are experienced, the foil applied in this manner will retain its close contact with the panel. However, to make certain, thin strips or discs of bakelite may be placed under any nuts on the rear of the panel, projecting over the cut out space on to the foil, thus securing it. With panels of $\frac{1}{16}$ inch in thickness or more, "blind" holes may be drilled in the panel from the rear to within not less than $\frac{1}{16}$ inch from the face of the panel. These holes should be tapped for a suitable thread with a bottoming tap, or an ordinary tap with the point ground off, to accommodate round head machine screws, the heads of which will secure the shield. This is an operation which requires considerable skill in order not to have the panel bulge where the drill almost

penetrates, and is only recommended on the heavier panels.

The shielded receiver as it now stands, will prevent any undesired effects due to the coils picking up energy but we may still further utilize shielding to prevent undesired coupling between circuits, which often causes erratic performance of the receiver.

To shield a receiver internally it is necessary to cut a piece of wood to form a partition, and covering one side and the rear edge with copper foil in the manner described. This should be placed in the proper position and secured to the rear and sides with flat head wood screws countersunk flush with the surface. This shield should then be soldered to the shielding in the rear of the cabinet.

The internal shield should be so placed as to separate the coupler from the plate variometer,

and should be equidistant from both if possible. The front edge of the internal shield should extend not quite to the front of the box, a space of approximately one inch from the rear of the panel being allowed for the necessary wiring to connect the apparatus in the two sections. All wiring should be covered with varnished tubing and kept as far away from the shielding as possible.

It will of course be necessary to modify the above directions somewhat to suit conditions, especially if the shielding is going to be applied to a receiver which is already constructed, but if the general scheme is followed out, the operator will have a receiver which tunes sharply, which is unaffected by induction noises of any kind, other than those picked up by the antenna, and which performs in a consistent and efficient manner.

Radio Personalities

V

COMMANDER STANFORD C. HOOPER, U. S. N.

By DONALD WILHELM

Commenting on Commander Stanford C. Hooper's article "Keeping the Stars and Stripes in the Ether," which appeared in the June number of RADIO BROADCAST, Mr. Owen D. Young, Chairman of the Board of Directors of the General Electric Company, said: "Commander Hooper did not do himself justice, as, indeed, it would be impossible for any modest man to do himself justice under similar circumstances. The facts are that the initiative which brought into being our American radio policy and resulted in preventing us from being outdistanced by other nations started with Hooper. It was he who spurred on Admiral Bullard in his negotiations with the General Electric Company, and he was always ready to help overcome every kind of difficulty. I don't want to detract in any way from the able work of Admiral Bullard. Commander Hooper could not have accomplished what he did without the Admiral's assistance. But the original thought, the initiative and the persistent pushing were Hooper's, and he should have full credit for them." We are therefore publishing the following personality sketch of the naval officer whom Mr. Young esteems so highly, and who has been a valued contributor to this magazine.—THE EDITORS.

COMMANDER Stanford C. Hooper cannot remember the time when communication by means of electricity did not hold a fascination for him. When he was only eight years old, he knew the Morse code. When he was ten he was nosing out more of the secrets of signal strength and dots and dashes. When he was twelve he was an office messenger with an eye and an ear cocked at his main chance at a telegraph key. When he was fourteen he had qualified himself as a telegrapher. Then, with such an education as he had pieced out in San

Bernardino while spending his summers working independently for the Southern Pacific, substituting for professional telegraphers during their vacations, he made plans to enter the Naval Academy, at Annapolis.

Young Mr. Hooper, aged seventeen, with the unusual distinction of having been a telegraph messenger and operator, entered the Naval Academy on September 6, 1901, three years after the Signal Corps successfully demonstrated wireless phenomena for the first time in the United States, and two years after Marconi provided facilities, at the expense of



© Harris & Ewing

COMMANDER STANFORD C. HOOPER
Head of the Radio Division in the Bureau of Engineering, Navy Department

the New York *Herald*, for reporting the international yacht race between the *Shamrock* and *Columbia*. With such a background of practical experience as the young midshipman had, it is no wonder that some of his classmates have said that he was even then a "bug" on wireless. Actually, it may be imagined, he had some clear ideas on the future of radio before the Navy saw anything in it. It may even be that he had dreamed that it would sometime bind the remote places of the world together and reach clear across from Wrangel to Casablanca, from Colombo to Penang, from Zanzibar to Togoland and Heart's Content. At any rate, after being graduated on January 31, 1905, serving as midshipman on the *Chicago*, the destroyer *Perry*, the monitor *Wyoming*, and later on various ships as an ensign—still tinkering with radio apparatus at every opportunity—1910 found him, a lieutenant-commander, back at the Academy as an instructor of electrical engineering, physics and chemistry, there to preach his favorite doctrine that there should be a navy man assigned as a radio officer with the Atlantic Fleet. So the Navy came right back at him and made him the first fleet radio officer, which work brought him down, not only through the incidental business of being present at the capture of Vera Cruz, but to the brewing and spilling of war in Europe.

At this point, it is worth remembering that Naval officers are not usually what any one would call effusive in publicly describing one another. So it behooves one to read what Lieutenant-Commander C. N. Ingraham solemnly recorded in the Annals of nothing less than the proceedings of the United States Naval Institute:

"The first fleet radio officer under whom I served, then Lieutenant-Commander S. C. Hooper, could operate faster and with a greater degree of accuracy than any man under him. He was the fleet radio officer in the days when, if ship operators were kept out of port unexpectedly, they might ask one of the shore operators, 'Say, old man, how is it to call Gertrude and say I can't get in to-day'; when Morse and Continental were mixed according to the desire of the sender, and when no regard was given to any form. By continual practice he learned to tell each vessel in the fleet by her spark, almost unerringly, and to distinguish, by certain peculiarities, the sending of each man under him. He was not the only competent officer in the fleet, but in being one, and

realizing its importance, he was able to take the necessary steps to see that all radio officers be detailed for radio duty alone, and that they give to their work a certain number of hours each day including one watch. Though all of these did not take advantage of the opportunity to become proficient operators, a certain percentage took enough interest in the work to master operating. I know that some of those who made good disliked the assignment at first as much as, or more than, those who did not make good, but later became interested through the determination to do their best in any position assigned. For it is interesting after the long and tedious practice necessary to acquire proficiency is finished. It is as much a real game as auction bridge, and requires infinitely more finesse.



"When this officer left the fleet, he had brought it to the highest state of efficiency possible at that time with the apparatus provided. Every operator in the fleet wanted, above all else, to 'burn up' the fleet radio officer, and at the same time send 'good stuff.' They could not do this, but they kept trying. Each operator hated to be obliged to ask for a repetition of any part of a message because the fleet radio officer never did. Mr. Hooper would tell them he had transmitted so many miles, or had received such and such a distance with a stated apparatus, and they would endeavor to beat that record. At one time, in Vera Cruz, at a conference, he said he had copied a message from Nauen, Germany, where a new spark station had just been installed. One operator, I know, sat up all night the following night with a radio room completely shut up—not even a fan going, for fear of induction—and copied a complete message from the same station, on a crystal detector where the fleet radio officer had used an audion. You may say that such things as this officer was able to do are not possible with the fleet at its present proportions. No, not as a whole, but distinctly YES, if all forces, squadrons, and divisions, had officers well versed in operating and in procedure."

Next, the Navy sent Commander Hooper abroad as an observer, with "a receiving set in his pocket," to listen in on radio abroad and learn whether the European countries were using new and better methods than those used by the Navy. Thus he listened in and heard the Germans entering Brussels, at the very outset of the war.

After that duty, the Commander reported back to the Department in Washington to take part in the first thorough reorganization of the Navy's radio. After this, from 1915 to 1917, he served as the head of the Radio Division in the

Bureau of Engineering, which has charge of the Navy's radio research, construction, and material (whereas the Naval Communications Service, whose radio section was formerly under Engineering, handles the radio and other communication traffic). Except for one short interval, through the eventful years when it may be said Navy radio and all radio with it was coming of age, he has held this office. That interval, in the year of 1917 to 1918, saw him do what any Commander yearns to do in an emergency—it saw him bolt for the bridge of the destroyer *Fairfax*, doing convoy duty across the Atlantic. But the Navy called him ashore again: it may be presumed that he was needed.

He has the insignia of the French Legion of Honor, and more such, home in his trunk. He served on the Advisory Committee of the Arms Conference, had a consulting part in the recent Radio Conference, and has had other incidental honors and functions.

But the thing that the Navy will remember him for will be his skill as an executive, and his technical skill. As the Navy puts it, "He is a practical radio man." And that, in the Navy, means a lot. In this instance at least it means that Commander Hooper started very young, stuck at it, and has been able to put to good ends the understanding of men and the skill he began to pile up when a boy messenger and telegrapher in San Bernardino, California.

As a result of his practical, direct, alert, and canny make-up, it is understandable that he was the initiating force in seeking the Conference between himself and Admiral Bullard on the one hand, and the officers and directors of the General Electric Company on the other hand. This latter conference was described in detail in the June issue of *RADIO BROADCAST*—that conference, on April 7, 1920, which was the birthplace of the Radio Corporation of America and of America's world-wide radio chain.

For the sake of finding out who really made the first recommendations for this all-important conference, I have turned to the authorities—to various Naval officials then high in office, to letters from officials of the General Electric Company, and in direct touch with the subject. I have had letters and verdicts by officers in interviews that establish the fact that it was Commander Hooper who saw the drift of the American chain into the hands of the Marconi Companies, saw the opportunity for the General Electric to refrain from giving over their patents or patent rights to any one other than Americans, and accordingly, in the nick of time, took the initiative. One of the officers with whom I conferred and with whom I correspond is Commander George C. Sweet, now a consulting radio engineer in New York City, who was present at the meeting at which Commander Hooper put the situation up to his ranking officer in Naval

Communications, Admiral Bullard, has stated that "Hooper was responsible for the scheme to confer with the General Electric Company."

We now know the important results that have come from his initiative. One can trace, too, his effective work as an executive in dozens of spots in the history of radio development in the Navy, all of which would constitute too long a tale here. For there is hardly a phase of development of radio in which the Navy has not had a part, and the records show that many of the Navy's supreme achievements in radio came while Hooper was head of the Radio Division, and are still coming.

To many of us, after all, the most interesting fact is that he started as a boy-of-all-work in a telegraph office of the Southern Pacific, tried out the Postal Company as well, then, after having started out, as we have seen, from San Bernardino, California, progressed successfully all the way to the post he now occupies.



Radio in Remote Regions

This department is devoted to stories of the use and benefits of radio communication in regions devoid of telephone and telegraph wires, and which are not reached by cable. Radio is proving a great boon, not only to explorers in the Arctic, the Tropics, and other distant places of the earth, but to mariners and lighthouse tenders on solitary islands, to distant army and trading posts, to hunters in the woods and ships at sea, to station agents at lonely junctions, and even to farmers dwelling in the midst of our country but separated by many days or hours from news of the rest of mankind. RADIO BROADCAST will welcome incidents and photographs which illustrate the value of radio in remote regions, and will pay for those accepted at its regular rates.—THE EDITORS.

A Sign in the Wilderness

By SUE M. HARRISON

The story of an extraordinary sign and an extraordinary sort of wilderness. The author writes: "This narrative, while not dealing with far-off countries, does deal with the most remote region, right in our midst, that one could find in the United States. Where but in these Carolina mountains can you find seventy-five American men and women who have never used a telephone?"—THE EDITORS.

I HAD been visiting in Ashville, North Carolina for about a week, when my hostess suggested a trip through the mountains for the coming Sunday. About four o'clock in the afternoon we passed a little school house, deserted as far as school teaching was concerned, but far from deserted as we saw it. About sixty mountaineers were studying this sign on the front of the building:

"Preaching Here Tonite By Radiophone
Mountaineers All Welcome Free"

Radiophone—the latest and most wonderful product of science—here in a desolate place where there had been no school for years, where even the telephone was a mysterious thing—often unknown.

We found our way down a narrow path and came to a little spot of green, a cosy tent, and—the Moores. Mr. and Mrs. Moore are two young people of Chicago, Illinois, who are making an extensive tour of the United States. And on their way they are shedding joy and making hosts of friends, from the Atlantic to the Pacific, because they are sharing with everyone they can find, at every stop, a certain little black box. For the magic thing is equally wonderful on prairie or mountain top. The little black box is the specially-designed container for the latest addition to their complete camp outfit—the Radiophone. It is a remarkably sensitive set: they are able to hear concerts

over a thousand miles, and the telegraph reaches them from twice that distance.

Such a set is unheard of in many places, and in many others it is an impossible luxury. So the Moores are trying to shed a little of the unmatched pleasure that radio can bring. The mountains particularly appeal to them, for there they find a lack of other amusements, and of other means for education and information that makes the radiophone a greater blessing. Toward evening they inquire for a deserted school—the more secluded the better—and they are easily found, for there are many deserted schools in these mountains.

A short time after their camp is up, there are generally half a dozen mountain men about the school. And of course they see the sign "Preaching Tonite—." When they find that the strangers are glad to have them at the camp, one or two will slip away and return in a short time with several others. The mountains, apparently so desolate, are in reality alive with human beings, all trying to live and learn under conditions that are most pitiful. Many get to town only once a year; many of the women never leave the mountains from the day they enter them as brides to the day they are "toted" out to be laid to rest. Imagine what the little sign on the side of the deserted school house means to such as these!

Men who live within themselves, drawn by a curiosity they cannot resist, talk as they talk

few times in their lives. For these men know life from living; they know nature from contact; and religion from faith. And so they talk, not as scholars, but as men who sense the deep truths of life and who strive to express the feeling, with a simplicity that is stunning.

Women whose children can scarcely read or write, who know neither history nor promise of the future, women who have been deep within the mountain for years, come out with eyes as timid as a wild deer, with hands as calloused as a boy's bare feet.

What does the little sign mean to them?

To answer this question, our little party decided to wait until seven-thirty, when the service would begin. Early that evening the mountain folk began to gather about the camp. I was most surprised to note the number of women. It must have been an effort for them to come out to meet utter strangers. But their men had told them of a strange, wonderful thing, a thing that would bring them "preachin" from the great churches in the city, that would bring them music from a massive organ such as none of them had ever seen—music with swells and tremolo as perfect as the sigh of the wind in the high pine-tops. So whatever timidity they felt, they conquered, for they were there, all that could come.

Mr. Moore tuned in KDKA (Westinghouse Electric Co. of East Pittsburgh). The service was coming to their broadcasting rooms from one of the churches in Pittsburgh. After the regular service they broadcasted a twenty-minute musical programme. The sweet strains of a violin came over the mountain tops, down the slopes, over the hundred feet of antenna, through the mysteries of the little black box to our eager ears. One lad listened with a tragic expression on his face. The music ceased. His expression did not change. Awe, wonder, joy, and fear struggled for control. Then the announcement—and music. He leaned forward and closed his eyes. It was the music he dreamed of, it was the reality of those sobbing symphonies he heard in the moaning pines of his own mountains. It was expression, that vital thing that few mountaineers know.

More than seventy-five men and women listened to the evening service and to the music. Only three had ever used the ordinary telephone. Many, indeed the majority, could not write, and could read but very little. Yet these men and women are close to us, they are our own blood, they are in our own country, they are in



the heart of the most famous range of mountains in Eastern America. And the sad part is, that these people do not realize what to do with the help often kindly offered them: they are so ignorant of civilization, yet possess the inert refinement and deep-rooted pride of their forefathers—America's founders and defenders.

To these, the Moores are bringing the greatest wonder of the modern age, they are showing the boys how to make or obtain a thing that will mean more to them than anything else they could possibly have. For the Radiophone brings them religion, education, music, and news of events, from all over the world.

What greater thing can the Radiophone do than this? I doubt if radio ever brought a church service to a more intense audience than that grouped about the Moore camp. I know that radio never brought a message more gratefully received and more *thoroughly appreciated* than that sermon from hundreds of miles away. I know that radio never made a sign—in the wilderness of any country—a sign of progress and of hope—that could kindle interest in life and in the world more than the sign that will live in the memory of every one of those sturdy mountaineers.

Radio on Robinson Crusoe's Isle

IF ROBINSON CRUSOE, upon his first reconnoitering party after landing on the island, had been greeted with the menacing, whining, snapping voice of a $1\frac{1}{2}$ -KW spark transmitter, he would undoubtedly have run back to the beach and swum out to sea again. He would never have found "the print of a man's naked foot . . . which was very plain to be seen in the sand." In due time he would have succumbed to the undertow, and later on, poor Friday would have been served up as fricassee by his cannibal captors. In short, we would have been done out of one of the finest adventure stories ever written. Fortunately, however, this did not occur and could not have occurred until some two hundred years after the events of which Daniel Defoe wrote.

What put the whole idea into Defoe's head,

CUMBERLAND BAY, JUAN FERNANDEZ



Courtesy of Houghton, Mifflin & Co.

THE FOOTPRINT IN THE SAND

you will remember, was the account of the exile of Alexander Selkirk on the island of Juan Fernandez. For four years and four months (1704-1709), Selkirk had lived there in solitude. The island where this took place, and which became in Defoe's story Robinson Crusoe's isle, lies about 360 miles out in the sea, west of Valparaiso. It is at present owned by the Chilean Government, which maintains a radio station there, of sufficient power to communicate with Valparaiso.

Between Selkirk's time and the present, the island of Juan Fernandez has been the scene of many strange doings. In the eighteenth century,

it was a favorite rendezvous of pirates and of the French and British sea rovers. More recently—in 1915—the hunted German commerce raider *Dresden* was sunk by British warships there, in Cumberland Bay. The accompanying photograph, taken from the rugged mountains that surround this bay, shows the small fishing village of San Juan Bautista.

The radio station is situated on one of the high points some 1000 feet above the sea. It is operated by the Chilean Navy, which expects soon to replace the $1\frac{1}{2}$ -KW "chispa" (spark) transmitter with more modern and more powerful apparatus.

What Would You Like to Have in Radio Broadcast?

The editors would be pleased to hear from readers of the magazine on the following (or other) topics:

1. The kind of article, or diagram, or explanation, or improvement you would like to see in RADIO BROADCAST.
2. What has interested you most, and what least, in the numbers you have read so far?

Broadcasting Nearly to the Arctic Circle

The Edmonton Journal Has Established a Station in Alberta, Canada, and Prophecies that the Hudson's Bay Company Will Do Likewise

By FRASER M. GERRIE

EDMONTON, Alberta, boasts the world's farthest north radio broadcasting station.

Hunt up the family atlas, O ye blasé New Yorkers who nightly tune up your instruments and "listen in" on whatever may be winging its way through the ether in your immediate vicinity, and who imagine perhaps that this modern miracle has not extended to the uttermost parts of this terrestrial sphere. Not that Edmonton can exactly be classed in the "uttermost parts," but just thumb over the pages of your atlas and appreciate how the great world-wide radio audience is extending in an ever-widening circle. That this radio circle has already extended fully a thousand miles north of Edmonton, and not such a great leap from the arctic circle, is already a matter of common knowledge. "Carpentier knocked out in the fourth round" was the message flashed through thousands of miles of air from Jersey City July 2, 1921, and almost ere the fatal word "ten" had died away the news that Jack Dempsey had retained his fistic crown was known at Fort Norman, a thousand miles and more north of Edmonton.

But it is only within the last four months that radio broadcasting on a commercial scale has been started in Alberta. The "farthest north" broadcasting station is located in the office of *The Edmonton Journal*, and every afternoon and evening since May 1st, residents of Alberta within a radius of five hundred miles of the city have been delighted with these nightly entertainments. The pioneer Marconi set installed last

May has given splendid satisfaction, and the entertainments have been heard as far away as Victoria, B. C., and in practically every part of the province.

Lest a wrong impression be gathered, it should be stated that radio in the far North, a thousand and more miles from Edmonton, is far from being at the stage where lonely trappers, and prospectors gather in some



THE ANTENNA ABOVE THE EDMONTON JOURNAL BUILDING IN EDMONTON, ALBERTA, CANADA

frontier dwelling and "listen in" on messages and concerts from a long distance. The Jersey City message already referred to was received over a high-power Dominion Government receiving set taken in by a survey party. J. B. Henderson, the Ottawa expert in charge of this set, arrived in Edmonton one day this spring on his way north for the summer. Before leaving he set up his apparatus, connected it with the largest aerial in the city, and picked up time signals from the Lyons, France, the Annapolis, and the Darien, Panama stations.

The possibilities of radio in the far North country, which stretches all the way to the Arctic circle, are tremendous. That radio stations will soon be scattered all over that

territory at outposts and forts on the fringe of civilization seems to be a certainty. *The Journal* has received applications and requests for information from points as far north as Fort Chipewyan and Finley Forks at the junction of the Peace River and Athabasca.

That the big northern trading and transportation companies, such as the Hudson's Bay Company, will soon be availing themselves of the wonderful possibilities, is a foregone conclusion. Officials of the Imperial Oil company are considering radio, and have cited the trip of Ronald McKinnon where two months were required to bring word of the far north wells, whereas by radio this information would have been available in a few seconds.



THE INTERIOR OF THE EDMONTON JOURNAL'S BROADCASTING STATION

Most of the transmitting and receiving equipment is of English manufacture. The receiving tubes, located on the panel at the right are quite different in form from the American tubes, and the receiving set above them is also quite different from those we use

Progress of Radio in Foreign Lands

REVENUE FOR THE BROADCASTING ORGANIZATIONS

FOR the time being, at least, we are fortunate as regards our radiophone programmes. The broadcasting stations maintain a high standard and their services are free. Furthermore, there is nothing to prevent anyone from listening in, and small but adequate receivers can be made without great difficulty or expense. In Great Britain, however, no one is willing to do the broadcasting unless assured of some definite return. Consequently it is not surprising to learn that the British radio organizations which are to do the broadcasting have asked the Postmaster-General not to license a receiving set unless made by a member of one of the broadcasting organizations. In this way, the profits derived from the sale of radio receiving equipment would go to those who maintain the broadcasting services. Still another plan is to have the Postmaster-General exact a modest fee for each receiving license, and then turn over a part of the receipts to the broadcasting organization. Already the British radio enthusiasts have been asked for voluntary contributions toward the maintenance of the station in Holland which is providing entertainment for so many of them.

POWERFUL FRENCH STATION EXCELLENT IN TESTS WITH NEW YORK

ACCORDING to a Reuter news dispatch, the radio station of Sainte Assise in France, which has been under construction for the past two years, has unofficially opened communication with New York. The American technicians in communication with the French station, which is the most powerful so far constructed, state that they consider it gives the clearest signals they have ever received from France. The new station will be placed at the disposal of the general public as soon as the authorization of the French Government has been given.

BELGIAN AMATEURS SERIOUSLY RESTRICTED

RADIO TELEPHONY, which is now becoming popular in England and France, evokes comparatively little interest in Belgium. The reason seems to lie in the rigid restric-

tions placed on radio stations by the decree of August 7, 1920, which prohibits radio broadcasting and limits receiving stations to time signals and meteorological messages. Detailed regulations prohibit the use of vacuum tubes unless specially authorized, require secrecy in regard to all messages which are not public property, forbid receiving stations to accept any remuneration in connection with their work, and provide for cancellation of the license and other penalties in case of violation of the regulations.

VIENNA WILL HAVE MARCONI COMPANY RADIO CENTRAL

THE Austrian Government has granted a charter to Marconi's Wireless Telegraph Company for the establishment of a central radio station in Vienna, in coöperation with an Austrian company. It is stated that the Austrian Government will participate to the extent of 30 per cent. of the capital, and a group of Austrian banks will assist the Marconi Company in founding the Austrian Company. This concession is said to have been obtained in spite of strong competition on the part of the Telefunken interests of Berlin.

GREAT PROGRESS IN RADIO IN ITALY SINCE THE WAR

THE war was the cause of a very rapid development in radio telegraphy in Italy. Figures before and after the war show that the number of ship stations has increased from 54 to over 400, that the number of words per year between ships and coast stations has increased from 80,000 to about 1,000,000, and that traffic between Italy and her colonies has risen from 150,000 to 900,000 words per annum. From *Elettrotecnica*, we learn that international traffic is carried on by two sending stations, San Paolo and Centocelle, and three receiving stations, Monterotondo, Taranto, and Covitavecchia, all controlled by the Rome telegraphic central. The operating is duplex. Arcs, alternators, and musical sparks are employed for transmission, vertical and loop antennas, amplifiers, and Wheatstone apparatus for reception. The Coltano station

is being altered to render it capable of working with North America. The San Paolo station is capable of sending 30 words per minute, but with a transmitter which is now being built, it will be able to send 50 words per minute.

BRITISH ARMY OPINIONS ON RADIO IN THE NEXT WAR

ADDRESSING the cadets of the Royal Military Academy, Woolwich, at the semi-annual inspection recently, the Earl of Cavan, who did such remarkable work during the war, particularly in Italy, and who is now Chief of the Imperial General Staff, said that he had learned with regret that for financial reasons instruction in radio at the Academy had been dropped. He hoped that the courses might soon be restored. During the war he was horrified at the number of casualties among men engaged in burying telephone wires, and with the advance of radio the question arose, "Why not abolish telephone wires?" In this connection, the Army Council had decided that from division headquarters to the front line there would be no telephone wires in the future. Therefore the Earl of Cavan looked to all young officers to obtain a practical knowledge of radio.



IMPROVING THE SOUTH AFRICAN RADIO SERVICE BEATING THE STATIC AT PORT ELIZABETH

THE British Imperial Government plans to connect Great Britain with South Africa via Cairo and Nairobi, by a series of short-range stations. The South African station of this chain is to have a range of from 2,000 to 2,500 miles. The present radio equipment in South Africa, operated by the Post Office Department, consists of three stations—one at Slangkop on the Atlantic coast, near Cape Town, one at Durban, and one at Port Elizabeth, opened about a year ago. This latter station is of $1\frac{1}{2}$ -kilowatt power and is designed to cover the coastal area between Cape Hermes and Cape Agulhas, hitherto screened from or out of range of the Slangkop and Durban radio stations for vessels sailing close to the coast. The new station is fitted with a spark transmitter having a musical note and provides satisfactory communication for the whole of this area, even under the worst daytime conditions. In addition, this station is of considerable value to

the commercial community of Port Elizabeth, affording it a ready means of communicating with vessels approaching Algoa Bay.

RESEARCH CONDUCTED BY THE INTERNATIONAL UNION OF SCIENTIFIC RADIO TELEGRAPHY

THE International Union of Scientific Radio Telegraphy was organized two years ago for the purpose of furthering the study of fundamental problems of radio communication. Separate branches have been formed in a number of different countries, and the work of the American section has been in progress for over a year. Recently, according to *Radio Service Bulletin*, measurements have been made at stations in the United States of the intensity of signals received from various French stations, and by a continuance of these measurements it is expected that more compre-

hensive knowledge will be obtained of the phenomena attending transatlantic transmission. At a recent meeting of the American section, various committees reported on their study of wave intensity, atmospheric disturbances, variations of wave direction, measurements of radiations which cause interference, and electron tubes. Particularly in the case of measurements of the intensity of radio waves, is it important that international co-operation be promoted, since it is only by frequent simultaneous measurements made by widely separated sending and receiving stations, that accurate and valuable data may be obtained.

INTERESTING NEW EQUIPMENT FROM ENGLAND— A DIRECTION-FINDER OF GREAT ACCURACY

THE Annual Inspection of the National Physical Laboratory, which recently took place in England, disclosed a number of interesting radio devices. Among the exhibits in the wireless hut were inductance coils suitable for use on a 2,000-volt circuit. All live parts are carefully protected, and where it is necessary to see the interior of the instrument, windows are used made of non-inflammable transparent material. *The Electrician* states that the self-capacity, in inductances of this kind, must be very small. Consequently, copper strip spirals are used for inductances up to 300 microhenries, and multi-stranded wire, wound in basket form, for capacities from 0.3 up to 3 millihenries. In the latter case

the conductors are made of 80 strands of No. 40 wire, all separately insulated. A modified frame or loop antenna was shown for obtaining bearings by radio. For this purpose a single loop is commonly used; but in this instance a smaller loop has been fixed at right angles to the first and on the same axis with it. The object of this is to avoid complete silence in the direction of the signals, as the bearings are thus more easily obtained. A commutator is also fitted, so that the winding of the main loop can be reversed at any moment; the reversal shows at once whether any local c. m. f. is affecting the signals. It is said that bearings can be taken to an accuracy of one degree or less.

COLLECTIVE EUROPEAN WEATHER REPORT FROM THE EIFFEL TOWER

AMERICAN data is now added to the collective European radio report which is transmitted daily at 11:30 A. M. (Greenwich Mean Time) from the Eiffel Tower in Paris. The observations broadcast consist of the barometer reading and the direction and force of the wind at 1 A. M. (G. M. T.) on the day of issue, at about 30 places scattered over the Continent, now including Bermuda, Chicago, Cleveland, Denver, Cape Hatteras, Salt Lake City, San Francisco, Washington, and Winnipeg. Approximate positions of the centres of cyclones and anti-cyclones are also indicated.

RADIOPHONE RECEPTION AS A SIDE SHOW

THE public radio station which has been established at Southport, England, is claimed to be the largest of its kind in the world. It is built like a small entertainment hall. On the "platform" a large receiving set has been installed, from which 60 distributing wires radiate. These are suspended, at well-spaced intervals, from the ceiling, and to the end of each is attached a hand phone, suspended within easy reach of the seated patron. Arrangements are made with certain broadcasting stations to send out music between specified hours.

BETTER EQUIPMENT FOR SHIP STATIONS

IT IS a well-known fact that aside from the real greyhounds of the ocean, most ships are provided with a rather poor and antiquated

lot of radio instruments. In fact, the average radio amateur has a far better receiving set than the average ship station; yet it is surprising what the skilled ship operators accomplish with crystal detectors and old spark transmitters. Nevertheless, F. J. Chambers, writing in a recent issue of *The Electrician*, of London, points out the necessity of employing better instruments on shipboard. He pleads for the installation of better detectors and for amplifiers, as well as for continuous-wave vacuum-tube transmitters, as a relief from confusion and interference in the ether, as well as for greater range. Already we learn that the Marconi Company has installed 3-kilowatt vacuum-tube transmitters on board the principal liners. Heretofore, range has been obtained by the simple but inefficient expedient of piling on power. Now the tide has set in the opposite direction. Simple but inefficient spark transmitters of $1\frac{1}{2}$ -kilowatt rating are being replaced with quenched spark transmitters of $\frac{1}{2}$ -kilowatt rating on board small ships. Ultimately, it is safe to presume that vacuum-tube continuous-wave transmitters will be employed.

In the same article the author makes a plea for the ending of the monopoly which has been legitimately built up as the result of radio development and radio patents, and for the introduction of competition so that ship installations may be made up of the best equipment available.

RADIO AND AVIATION

A RECENT issue of *Radioélectricité* contains an interesting historic account by P. Brenot, describing the gradual development of radio telegraphy and telephony aboard aircraft from the beginning of this phase of the art, in 1910, to the present day. It seems that the builders of aircraft and the manufacturers of radio equipment have not collaborated any too well. As a result, extensive alterations costing a great deal and resulting in serious time losses have to be made in aircraft in order to accommodate radio installations. The author makes a plea for closer coöperation between aeronautical constructor and radio engineer, with a view to securing the best results with a minimum of alteration.



The Grid

QUESTIONS AND ANSWERS

The Grid is a Question and Answer Department maintained especially for the radio amateurs. Full answers will be given wherever possible. In answering questions, those of a like nature will be grouped together and answered by one article. Every effort will be made to keep the answers simple and direct, yet fully self-explanatory. Questions should be addressed to Editor, "The Grid," Radio Broadcast, Garden City, N. Y. The letter containing the questions should have the full name and address of the writer and also his station call letter, if he has one. Names, however, will not be published.

Some receiving sets are provided with dials, marked from 0 to 100 and others are marked from 0 to 180. How is it possible to determine the wavelength for a given setting of the dials?

B. T. H. Los Angeles, Cal.

THE marking on most receiving sets can not be used as a direct method of determining the wavelength of received signals and is provided so as you may have some definite idea of where to look for certain stations, *after you have once been able to tune them in.* After a station has been heard, you may make a record of the position of the dial or dials and it is quite likely that the same station may again be heard by making the same adjustment. There are some sets, which are used extensively, such as the Westinghouse and the Grebe, which are provided with dials which do not indicate wavelengths directly, but we have become accustomed to using them and know about where to find stations operating on given wavelengths. Provided the antenna is of the dimensions recommended, it is found that most broadcasting stations may be picked up by the Westinghouse "RC" receiver with the dial indicating approximately 30. The Grebe receivers of the variocoupler and twin variometer type are provided with a wavelength chart which indicates the wavelength for dial settings in the secondary circuit. By this method, stations of known wavelength may be picked up by setting the proper dial and then adjusting the others. The wavelength of any station within range of the set may be measured by first properly tuning the receiver and then reading the wavelength from the chart for the particular setting of the secondary tuning dial. In instances of this sort the wavelengths are not very accurate but serve quite well for all practical purposes, and where accurate measurements are required a wavemeter should be employed.

What is the best crystal for a receiving set and how far should it be possible to receive from a broadcasting station with a well-designed crystal set?

A. B. K. Galveston, Tex.

FOR all around reception, it is doubtful that any crystal will give better results than may be had from galena. Merely procuring a piece of galena and putting it in your set, however, will not do. It is necessary to procure a large-sized piece and break it up into smaller pieces, testing each piece. It may be necessary for you to try a great many pieces before you find one which is truly sensitive, but the task is entirely worth while.

A very good method of testing crystals is to have a double detector stand or two detectors which may be thrown into the same receiving circuit at will; one is used with any crystal and the other is used as the test stand by placing var-

ious crystals in it. As soon as one crystal is found which gives satisfactory results it may be used as the standard and others may be compared to it. In making the comparison, some single transmitting station should be picked out and the strength of its signals used as the determining factor.

The crystal is the heart of the crystal receiving set and some of the sets which have been thrown back on the hands of their manufacturers by dissatisfied purchasers would have given satisfaction if a little more care had been exercised in selecting the crystals with which they were equipped.

It comes more or less as a shock to most new radio enthusiasts to learn that the commercial operators on ship-board have received signals with crystal sets, without any amplification whatever, over distances in excess of eight thousand miles. One operator, in making a trip from New York to San Francisco by way of the Straits of Magellan, received press dispatches from the old Telefunken Station, located at Sayville, Long Island, nearly every night of his voyage. Another operator, on a trip from an East Coast port, through the Panama Canal, to Corral, Chile, which is some two hundred miles south of Valparaiso, received press, weather reports, and time signals from the U.S. Naval Station at Arlington over his entire trip with the exception of four days, and these four days were spent in the Torrid Zone where the static was extremely severe. No amplifiers were used and the results obtained are not at all uncommon.

No such results as these may be expected from a broadcasting receiver, but you may be sure that the range over which your set will operate depends to a very great degree upon the sensitivity of the crystal you employ and the skill with which you are able to locate its most sensitive points, and this skill comes with continued use.

How is the regeneration accomplished with the standard variocoupler and two-variometer hook-up, when there is no inductive relationship between the placement of these three units?

L. P. New York City

YOUR question is quite like many others we have received, and the following explanation may be helpful, though it is truly a repetition of material already published in articles appearing in Radio Broadcast.

To begin with, you are not quite correct in the assumption that there is no inductive relation between the elements for the primary and secondary of the variocoupler are in inductive relation to each other. The grid variometer is usually connected in series with the secondary of the variocoupler and thus becomes a part of the same circuit and, though it is not in direct inductive relation to the pri-

When Marconi heard the AERIOLA GRAND



© UNDERWOOD & UNDERWOOD



Look for this trademark
at your dealer's.

"IT comes closest to the dream I had when I first caught the vision of radio's vast possibilities. It brings the world of music, news and education into the home, fresh from the human voice. It solves the problem of loneliness and isolation.

"The Aeriola Grand is at present the supreme achievement in designing and constructing receiving sets for the home—a product of the research systematically conducted by scientists in the laboratories that constitute part of the R C A organization."

G. Marconi

The Importance of the Symbol R C A

Crude Radio apparatus of a kind can be made even by embryonic organizations. But the vitally important inventions that have made radio the possession of every man, woman and child are those protected by patents owned by the Radio Corporation of America and developed as the result of costly research conducted in the engineering laboratories of the Radio Corporation of America.

The name-plate of a Radio Set is all-important in the purchase of radio apparatus. If it bears the letters "R C A" the public and the dealer are assured that at the time of its introduction it is the highest expression of the advancing art of radio.

In tone quality, in simplicity of manipulation the Aeriola Grand is unrivalled. A child can snap the switch and move the single lever that tunes the Aeriola Grand and floods a room with song and speech from the broadcasting station.

Any R C A dealer will be pleased to show you the Aeriola Grand and to let you judge its wonderful tone quality for yourself.

There is an R C A set for every purse—Prices range from \$18 to \$350.

Aeriola Grand
with stand
\$350

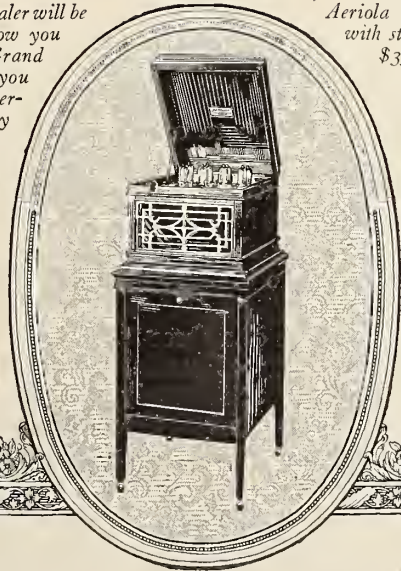

Radio Corporation
WORLD WIDE WIRELESS
of America

Sales Dept., Suite 2066
133 Broadway
New York City

District Office
10 South La Salle St.
Chicago, Ill.



What Radio Is Doing For Me

LaFayette, Ind.
April 26th, 1922.

EDITOR,
Radio Broadcast,
New York City.

DEAR SIR:

I am enclosing a photo of myself using a radio receiving set.

By way of introduction wish to say that I am a bedfast shut-in whose life has been greatly brightened by the wireless. From the leading stations I am able to bring to my bedside the best of talent.

My outfit consists of a three-tube set and a loud speaker. Chicago, Detroit, Indianapolis, Pittsburg, Newark, Schenectady, and many other places I hear regularly. Often the sounds are so loud as to flood the room with music and voice.

I have purchased my radio with my own earnings. In 1918 I opened a magazine subscription business in this city. In four years I have built a good business. Last December I handled twelve thousand letters.

I declare that my radio is an investment! As a means of creating a wide circle of friends it is invaluable. My room is the most popular place in the community. I have used it as an excuse to invite in folks with whom I have long wanted to get better acquainted. The new friends I have enlisted by use of my radio mean more business for me.

In a very short time I honestly believe that a wireless telephone will be as common in the home, and especially in any room where there is sickness, as the electric fan and other conveniences.

Hospitals are installing radio to facilitate recovery among the sick. Having listened in to daily entertainments, I declare myself less susceptible to fatigue, more alive to everything, and a more contented person. Radio has done for me what medical science failed to do.

Very Sincerely,

A. J. DELONG.

A. J. DELONG,
LaFayette, Indiana.

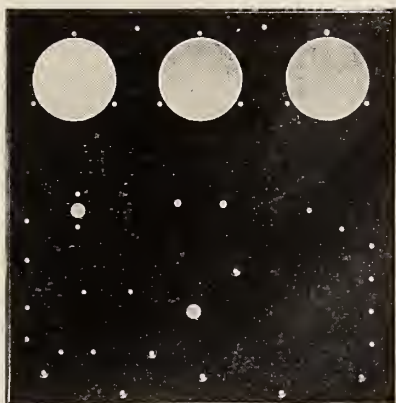

CONDENSITE CELORON

Sets a New Standard in Radio Panels and Parts

This strong, handsome, jet black, insulating material gives you a surface and volume resistivity greater than you will ever need and a beauty that will make your set the envy of your friends. It is the ideal material for making radio panels because it machines readily—engraves with clean cut characters and can be finished with a high natural polish or a rich dull mat surface.

If you want the highest type panel you can obtain—a panel made from a material approved by the Navy Department Bureau of Engineering—a panel that will give you continued satisfactory service—insist upon a Condensite Celoron Panel.

Make Your Next Panel of Condensite Celoron

If your local radio dealer cannot supply you with a genuine Condensite Celoron Panel get in touch with us direct. We'll see that you are supplied.

An Opportunity for Radio Dealers

Condensite Celoron Radio Panels offer a sales opportunity unequalled to the live wire dealer who is keen on building business on a quality basis. Write us to-day for our special Dealer's Proposition and let us give you all of the facts.

Diamond State Fibre Company

**Bridgeport (near Philadelphia), Pa.
Branch Factory and Warehouse, Chicago.**

Offices in principal cities

In Canada: Diamond State Fibre Co. of Canada, Ltd., Toronto.

mary, changes in the variometer cause changes in the wavelength of the entire grid circuit of which the secondary of the variocoupler forms a part and the inductive relation between the primary and secondary is therefore altered.

The major adjustment of the "coupling," as it is called, is generally accomplished by changing the position of the secondary with relation to the primary. This may be done by rotating the secondary, which changes the plane of its winding with relation to that of the primary, or by moving the secondary away from the primary, which has the same effect, that is, reducing the coupling or the influence of one winding on the other.

When the secondary winding lies in the same plane as the primary winding, the transfer of energy from one to the other is most pronounced and the coupling is "tight," and the same holds true when the secondary is brought close to the primary, provided the planes of the two windings coincide.

The relation of the primary to secondary—in this case, the grid circuit—changes with the number of active turns in each, as well as with the placement of their windings with relation to each other. Most circuits of the character you refer to are provided with variocouplers having a secondary winding which is "fixed," that is, the number of turns can not be changed, and the wavelength of the grid circuit is regulated by adjusting the variometer. However, the primary of the vario-coupler is generally provided with taps to permit the use of any number of turns, and the turns actually in use are termed the "active turns." Although the relation of the two windings may not be altered, there is a change in coupling with every change in the number of active turns in the primary winding.

Having disposed of this relationship, we come to the explanation of the regeneration or feed-back, as it is commonly called here, or reaction, as it is termed in England. Here the relationship between the circuits is of a different nature and one is affected by the other through the vacuum tube and there is no direct inductive relationship between the variometer in the plate circuit and the elements which comprise the grid or secondary circuit. The term, reaction, used by the English, by the way, is much less a misnomer than either of our names and smacks less of mystery.

It has been found—and there are many, many claimants to the finding—that a receiver employing a vacuum-tube detector will produce a greatly augmented signal when the electrical period of the wiring in the plate circuit is identical to that in the grid circuit, and a correct voltage is supplied the plate.

The variometer in the plate circuit is merely a simple means for altering the electrical length of the circuit at will, to compensate for wavelength adjustments in the primary and secondary, for all three must be identical if the maximum signal is to be had.

When the current passing through the turns of the rotary element of the variometer opposes the current in the stationary winding, the wavelength of this unit is shortest, but when the current in each half of the unit is flowing in the same directions, the wavelength is longest. The range of a given variometer depends upon the number of turns in the elements as well as the distance between the rotary and stationary elements and the distance between the turns in the windings of each, as well as the particular kind of wire employed and the insulating material or varnish used.

Some forms of regenerative circuits are made with a fixed inductance—the number of turns can not be altered—mounted so that its position with relation to the secondary circuit may be altered. In this instance the coil takes the place of the variometer and the reaction effect is obtained by altering the position of the feed-back or "tickler" coil, as it is commonly called. In this case there is, of course, and inductive relation between the secondary and plate circuits, whereas in the variometer-tuned arrangement this indicative relation does not exist and the reaction occurs directly through the vacuum tube when the current in the plate and grid circuits is in phase, that is, when it is passing through the same electrical length in each circuit and when the rising and falling of current in each circuit occurs simultaneously.

Perhaps the case may be better understood from consideration of the action of the vacuum tube functions for this particular purpose. We know that the greatest energy transfer, from the antenna to ground circuit, which includes the primary of the variocoupler, occurs when the secondary or grid circuit is of the same wavelength and the coupling between the two circuits is properly adjusted. We also know, from a study of what happens when the vacuum tube is used as a detector, that the current imposed on the grid controls the current flowing in the plate circuit, but the current in the latter is greatly increased because it is drawn from a local reservoir, the "B" battery. By adjusting the wavelength of the plate circuit, it is possible to have the current flowing in the grid circuit and that in the plate circuit in step with each other. By doing this, we find that a greater current finds its way to the grid, and as the current in the plate circuit depends upon the variations in the grid current, a greatly augmented signal results.

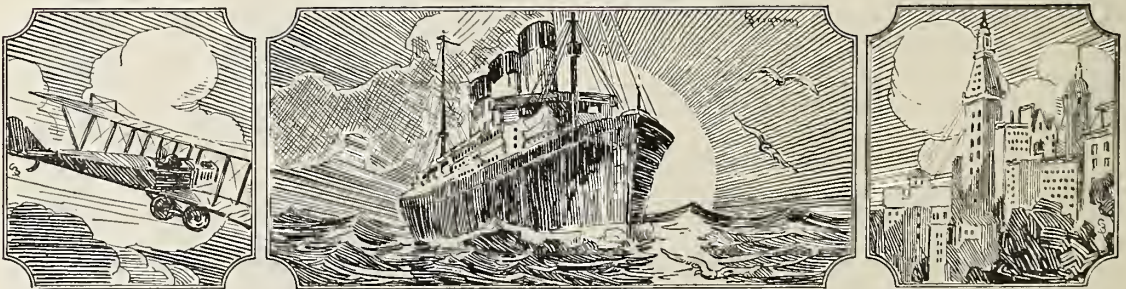



Unlimited resources of entertainment with the Magnavox Radio

IT is the Magnavox Radio which is invariably selected for demonstrations of technical or public interest. The two sizes of Magnavox Radio meet every requirement of volume and range—from the home gathering to the largest public audience.

R-2 Magnavox Radio with 18-inch horn . . .	\$85.00	Model C Magnavox Power Amplifier	
R-3 Magnavox Radio with 14-inch horn . . .	45.00	2 Stage—AC-2-C	\$ 80.00
		3 “ —AC-3-C	110.00

*The Magnavox products may be had of good dealers everywhere.
Our interesting new booklet (illustrated in 3 colors) sent on request.*

THE MAGNAVOX COMPANY, Oakland, California; N.Y. Office, 370 Seventh Ave.

MAGNAVOX RADIO

The Reproducer Supreme

John Bull's World-Wide Radio

Interesting Facts from the Technical Report of
the Imperial Wireless Telegraphy Commission

By J. CONRAD FLEMMING

IF JOHN BULL did not have a world-wide radio scheme on his mind, he would not rank among the leading nations of the world. Uncle Sam has his own extensive radio system pretty well under way, with the partial completion of the Radio Central at Rocky Point, Long Island, while France is rushing the work on the huge Sainte Assise station, which will be the largest in existence. Germany has, or rather had, an ambitious world-wide radio system, with the powerful Nauen and Eilvese stations as the starting point.

But we are primarily interested in John Bull's world-wide radio scheme in this case, because of a report of the Wireless Telegraphy Commission which, in accordance with the suggestion of the Imperial Wireless Telegraphy Committee, was appointed in 1920 to make recommendations regarding the sites and apparatus for the stations of the Imperial Wireless Chain. The Commission comprises such eminent men as Lord Milner, Dr. W. H. Eccles, the well-known authority on radio communication, L. B. Turner, E. H. Shaughnessy, and Lt. Col. C. G. Crawley. So the report, as might well be expected, is replete with interesting facts concerning long-distance radio communication, incorporating, as it does, the best existing practice as well as the revelations of the radio laboratory.

The report starts out by pointing to the fact that the Imperial Wireless Telegraphy Committee recommended that the vacuum tube transmitters should be capable of delivering at least 120 kilowatts to the aerial and that double this power may be within the range of possibility in the near future. Mention is made of the excellent results obtained with large silica vacuum tubes. To-day, four or five $2\frac{1}{2}$ -kilowatt vacuum tubes of the silica type are being produced every week for the British Admiralty. It is estimated that twenty-four large tubes would be required to deliver 120 kilowatts to the aerial. If a vacuum tube transmitter were operated 24 hours per day,

without rest, it would require between 36 and 108 tubes per year for renewals. If glass tubes were employed instead of silica, then about four times as many would be required for equipment and for renewals. So for the present the problem is to key up the vacuum tube industry in order to turn out the requisite number of tubes.

The Report goes into a discussion of costs for vacuum tubes and replacements. It is claimed that the filaments of burnt-out tubes can be renewed, thus reducing replacement costs materially. It is hoped to realize a filament life of 2,000 to even 6,000 hours, eventually.

That vacuum tubes are not altogether an experiment in long-distance communication is evident from the report's mention of the Marconi Company's experiments with this type of transmitter. Commercial traffic has been established across the Atlantic by means of vacuum tubes, so we are told, using less than 30-kilowatt input at Clifden, Ireland. The German Telefunken Company has also had good results with vacuum tubes. The Commission visited the Carnarvon station and witnessed the trials with the largest vacuum tube set yet constructed. Forty-eight glass vacuum tubes were assembled, with an input of about 100 kilowatts. By overloading the tubes it was possible to employ an input of 150 kilowatts. The signals were intercepted in India and Australia.

The matter of wavelengths is an important one. Extensive experiments have been conducted by the Wireless Telegraphy Commission between the Admiralty station at Horsea and Egypt. The conclusion is that the best signals are those obtained at night by the use of relatively short waves, while the best day signals are those using long waves.

Then there is the question of transmitting aerials and masts and towers. In connection with vacuum tube transmitters, it is held that the high aerial with relatively small area is preferable to the low aerial with a large area.



“Why the menagerie?”

YOU wouldn't stand for a young menagerie howling around the house. Why permit your radio set to act that way? It's unnecessary. For just five dollars you can add an Acme *Audio* Frequency Transformer to your set. This ends the howling and distortion so prevalent in the ordinary detector unit and at the same time it greatly increases the volume of incoming sound. Music and the human voice assume their natural tones. No more thin, squeaky voices and tiny elfin wails.

You will also want the Acme *Radio* Frequency Amplifying Transformer. You can use it with either a vacuum tube or a crystal detector set. It greatly increases the distance over which you can receive broadcasting programs. Just the same price as the Acme *Audio* Frequency

Transformer. Two stages of Acme *Audio* Frequency Amplification with two stages of Acme *Radio* Frequency Amplification will give you maximum range, volume and certainty of natural tone. Your set is incomplete without them.

The Acme Apparatus Company (pioneer transformer and radio engineers and manufacturers) also make detector units, detector and two stage amplifying units, the Acme Clear Speaker, the Acmehone, also C. W. and spark transmitting apparatus. Acme Apparatus is for sale at radio, electrical and department stores. If one is not close at hand, send money direct. Ask also for interesting and instructive book on Transformers. The Acme Apparatus Company, Cambridge, Mass., U. S. A. New York Sales Office, 1270 Broadway.



Type A-2 Acme Amplifying Transformer
Price \$5 (East of Rocky Mts.)

ACME

for amplification

When it comes to the supports for the aerial, the ideal mast is one made of insulating material. Wooden structures are an approximation of the ideal, although they are unsatisfactory for use in the tropics. Steel structures, on the other hand, are parasitic—they take away from the useful radiation of the station, although much of the parasitic loss can be overcome by insulating various portions of the mast and placing the mast on an insulating base.

The conditions for receiving have also received considerable study, and experiments have been conducted with a view to developing suitable directive systems which would reduce interference to a minimum. It is suggested that each station should have as many receiving units as the number of stations with which it is to communicate. The receiving units should be grouped together at a distance of 20 to 40 miles from the transmitting station.

Static—that bugbear of long-distance radio communication—comes in for its share of attention. Experience recently gained in England and Egypt is reported to indicate that atmospheric interference may be appreciably reduced by each of three distinct methods as follows: (1) Atmospheric balancing, in which an ingenious system of tuning causes the more or less complete cancellation of the undesired static. (2) Limiting the strength of the received signals, and therefore the strength of the atmospheric disturbances at the same time, since increasing the sensitiveness of the detector and the degree of amplification generally increases the static noises to such a degree that even the amplified signals are not clearly heard. It is better to receive weaker signals through very slight static. (3) Barraging, which is an elaborate tuning system for reducing static.

All of which gives John Bull's radio men plenty to do, for the present.

SUPPLEMENTAL LIST OF BROADCASTING STATIONS IN THE UNITED STATES FROM JUNE 16 TO AUGUST 10 INCLUSIVE

CALL SIGNAL	OWNER OF STATION	LOCATION OF STATION	WAVE LENGTH
AGI	Signal Corps School	San Francisco, Calif.	360
KDPM	Westinghouse Elect. & Mfg. Co.	Cleveland, Ohio.	360
KDZT	Seattle Radio Assn.	Seattle, Wash.	360
KFAC	Glendale <i>Daily Press</i>	Glendale, Calif.	360
KFAD	McArthur Bros. Mercantile Co.	Phoenix, Ariz.	360
KFAE	State College of Washington	Pullman, Washington	360
KFAJ	University of Colorado	Boulder, Colorado	360
KFAN	Electric Shop.	Moscow, Idaho	360
KFAP	Standard Publishing Co.	Butte, Montana.	360
KFAQ	City of San Jose	San Jose, Calif.	360
KFAR	Olesen, O. K.	Hollywood, Calif.	360
KFAS	Reno Motor Supply Co.	Reno, Nevada	360
KFAT	Donohue, Dr. S. T.	Eugene, Oregon.	360
KFAU	Independent School District of Boise City	Boise, Idaho.	360
KFAV	Cooke & Chapman	Venice, Calif.	360
KFAW	Radio Den, The	Santa Ana, Calif.	360
KFBA	Ramey & Bryant Radio Co.	Lewiston, Idaho	360
KFBB	Buttrey & Co., F. A.	Havre, Mont.	360
KFBC	Azbill, W. K.	San Diego, Calif.	360
KFBD	Welsh, Clarence V.	Hanford, Calif.	360
KFBE	Horn, Reuben H.	San Luis Obispo, Calif.	360
KFBF	Smith, F. H.	Butte, Mont.	360
KFBG	First Presbyterian Church	Tacoma, Wash.	360
WAAB	Jensen, Valdemar	New Orleans, La.	360
WFAU	Lewis, Edwin C. Inc.	Boston, Mass.	360
WFAV	University of Nebraska	Lincoln, Nebr.	360,485
WFAW	Miami <i>Daily Metropolis</i>	Miami, Fla.	360
WFAQ	Kent, Arthur L.	Binghamton, N. Y.	360
WFAY	Daniels Radio Supply Co.	Independence, Kansas	360
WFAZ	South Carolina Radio Shop.	Charleston, S. C.	360
WGAC	Orpheum Radio Stores Co.	Brooklyn, N. Y.	360
WGAD	Spanish American School of Radio Telegraphy	Ensenada, Porto Rico	360
WGAH	Goller Radio Service.	Tulsa, Okla.	360
WGAJ	New Haven Elect. Co.	New Haven, Conn.	360
WGAJ	Gass, W. H.	Shenandoah, Iowa	360
WGAJ	Lancaster Electric Supply & Const. Co.	Lancaster, Pa.	360
WGAM	Orangeburg Radio Equipment Co.	Orangeburg, S. C.	360
WGAN	Lloyd, Cecil E.	Pensacola, Fla.	360

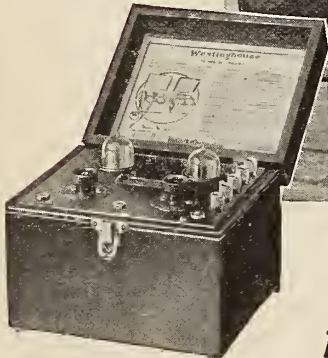
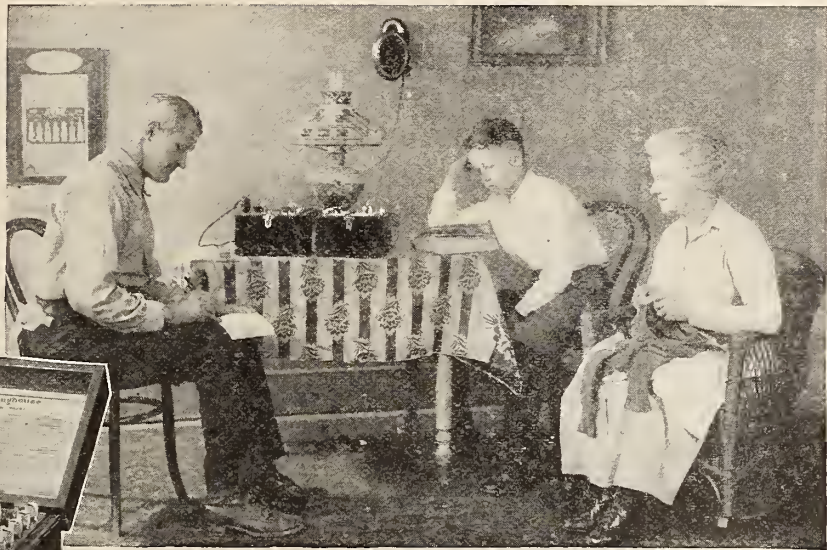

AERIOLA AMPLIFIER
Model A C
 Complete with two WD II-A
 dry battery tubes
 without batteries - \$68.00

Vacarola Loud-speaker
Model L V - - - - \$30.00



*This symbol of quality is
 your protection*

*Before buying radio apparatus,
 always consult the book "Radio Enters
 the Home." Price 35 cents
 by mail.*

The AC AMPLIFIER for the AERIOLA SR.

THE Aeriola Sr., simplest and most efficient of all single-tube receiving sets, becomes still more efficient with the new model A C amplifier.

No storage battery is required. With only two dry cells, two tubes, and a 45-volt plate battery the model A C amplifier greatly increases the Aeriola Sr.'s range of reception. Used with the Vocarola loud-speaker, the amplifier connected with an Aeriola Sr. fills a whole room with concerts received over distances of ten to thirty miles.

Anybody can make the simple connections required, including mother and the girls.

Because there are no storage batteries to charge, because both the Aeriola Sr. and this new model A C amplifier are so light and handy, the combination is ideal for the broadcasting enthusiast who has no storage battery charging facilities. Ready at your Dealer's October 1st.

Radio  **Corporation**
of America

Sales Dept., Suite 2066, 233 Broadway, New York City
 District Office, 10 South La Salle Street, Chicago, Ill.

WGAO	Patterson, W. G.	Shreveport, La.	360
WGAR	Southern American	Fort Smith, Ark.	360
WGAS	Ray—Di—Co. Organization	Chicago, Illinois	360
WGAT	American Legion, Dept. of Nebraska	Lincoln, Nebraska	360
WGAU	Limb, Marcus G.	Wooster, Ohio	360
WGAV	B. H. Radio Co.	Savannah, Ga.	360
WGAW	Albright, Ernest C.	Philadelphia, Pa.	360
WGAY	North Western Radio Co. Inc.	Madison, Wisconsin	360
WGAZ	South Bend <i>Tribune</i>	South Bend, Ind.	360
WHAA	State University of Iowa	Iowa City, Iowa	360
WHAB	Thompson, Clark W.	Galveston, Texas	360
WHAC	Cole Bros. Electric Co.	Waterloo, Iowa	360
WHAD	Marquette University	Milwaukee, Wisconsin	360
WHAE	Automotive Electric Serv. Co.	Sioux City, Iowa	360
WHAF	Radio Electric Co.	Pittsburgh, Pa.	360
WHAG	University of Cincinnati	Cincinnati, Ohio	360
WHAH	Griffin, John T.	Joplin, Mo.	360
WHAI	Radio Equipment & Mfg. Co.	Davenport, Iowa	360
WHAJ	Bluefield <i>Daily Telegraph</i>	Bluefield, W. Va.	360
WHAK	Roberts Hardware Co.	Clarksburg, W. Va.	360
WHAL	Phillips Jeffery & Derby	Lansing, Michigan	360
WHAM	University of Rochester	Rochester, N. Y.	360
WHAN	Southwestern Radio Co.	Wichita, Kansas	360
WHAO	Hill, F. A.	Savannah, Ga.	360
WHAP	Otta, Dewey L.	Decatur, Ill.	360
WHAQ	Semmes Motor Co.	Washington, D. C.	360
WHAR	Paramount Radio & Electric Co.	Atlantic City, N. J.	360
WHAS	<i>Courier Journal & Louisville Times</i>	Louisville, Ky.	360,485
WHAT	Yale <i>Democrat & Yale Telephone Co.</i>	Yale, Okla.	360
WHAU	Corinth Radio Supply Co.	Corinth, Mississippi	360
WHAV	Wilmington Electrical Specialty Co.	Wilmington, Del.	360
WHAW	Pierce Elect. Co.	Tampa, Florida	360
WHAX	Holyoke Street Ry. Co.	Holyoke, Mass.	360
WHAY	Huntington <i>Press</i>	Huntington, Indiana	360
WHAZ	Rensselaer Polytechnic Institute	Troy, N. Y.	360
WIAA	Waupaca Civic & Commerce Assn.	Waupaca, Wisconsin	360
WIAB	Joslyn Automobile Co.	Rockford, Illinois	360
WIAC	Galveston <i>Tribune</i>	Galveston, Texas	360
WIAD	Ocean City Yacht Club	Ocean City, N. J.	360
WIAE	Zimmerman, Mrs. Robert E.	Venton, Iowa	360
WIAF	De Cortin, Gustav A.	New Orleans, La.	360
WIAG	Matthews Elect. Supply Co.	Birmingham, Ala.	360
WIAH	Continental Radio Mfg. Co.	Newton, Iowa	360
WIAI	Heers Stores Co.	Springfield, Mo.	360
WIAJ	Fox River Valley Radio Supply Co.	Neenah, Wisconsin	360
WIAK	<i>Journal Stockman</i> , The	Omaha, Nebraska	360,485
WIAL	Standard Radio Service Co.	Norwood, Ohio	360
WIAN	<i>Chronicle & News Pub. Co.</i>	Allentown, Pa.	360
WIAO	School of Engineering of <i>Milwaukee & Wisconsin News</i>	Milwaukee, Wisconsin	360
WIAP	Radio Development Corp.	Springfield, Mass.	360
WIAQ	<i>Chronicle Publishing Co.</i>	Marion, Indiana	360
WIAR	Rudy & Sons, J. A.	Paducah, Ky.	360
WIAS	Burlington <i>Hawk Eye</i> —Home Electric Co.	Burlington, Iowa	360
WIAT	Noel, Leon T.	Tarkio, Mo.	360
WIAU	American Trust & Savings Bank	Le Mars, Iowa	360
WIAV	New York Radio Laboratories	Binghamton, N. Y.	360
WIAW	Saginaw Radio & Elect. Co.	Saginaw, Michigan	360
WIAX	Capital Radio Co.	Lincoln, Nebr.	360
WIAY	Woodward & Lothrop	Washington, D. C.	360
WIAZ	Electric Supply Sales Co.	Miami, Fla.	360
WJAB	American Radio Co.	Lincoln, Nebraska	360
WJAC	Redell Co., The	Joplin, Mo.	360
WJAD	Jackson's Radio Eng. Lab.	Waco, Texas	360
WJAE	Texas Radio Syndicate	San Antonio, Texas	360
WJAG	Huse Publishing Co.	Norfolk, Nebraska	360
WJAJ	Y. M. C. A.	Dayton, Ohio	360
WJAK	White Radio Laboratory	Stockdale, Ohio	360
WJAL	Victor Radio Corp.	Portland, Me.	360
WJAN	Peoria <i>Star & Peoria Radio Sales Co.</i>	Peoria, Ill.	360
WJAP	Kelly Duluth Co.	Duluth, Minn.	360
WJAR	Outlet Co., The	Providence, R. I.	360
WKAA	Paar, H. F. & <i>Republican Times</i>	Cedar Rapids, Iowa	360
WKAC	<i>Star Publishing Co.</i>	Lincoln, Nebr.	360
WKAD	Looff, Charles	East Providence, R. I.	360
WKAF	W. S. Radio Supply Co.	Wichita Falls, Texas	360

For this Broadcasting Receiver thousands have been waiting

EVER since broadcasting became the vogue, there has been a demand for a receiver which would fill a whole room with music of perfect tone quality but which would be so simple that anyone could tune in by moving a single lever.

This ideal has at last been realized in the Aeriola Grand—the supreme achievement of present-day radio.

When you hear the voice and the music that comes from the Aeriola Grand it is as if the lecturer or singer at the broadcasting station were in your presence. The whole family listens and marvels.

The Aeriola Grand stands unrivaled not only as a radio receiver but as a piece of cabinet work.

PRICES

- Complete with mahogany stand, storage battery, battery charger, antenna equipment and all accessories.....\$409.50
- Without stand, storage battery, charger and receiving antenna equipment.....\$325.00
- With stand, but without storage battery, charger and antenna.....\$350.00
- Mahogany stand only.....\$35.00

See the Aeriola Grand at your nearest dealer
Before you buy any receiver, secure a copy of the book "Radio Enters the Home." It tells the real story of radio and will help you to get the most out of this new art. 128 pages—over 200 illustrations—35c. a copy. At your dealer or write direct to

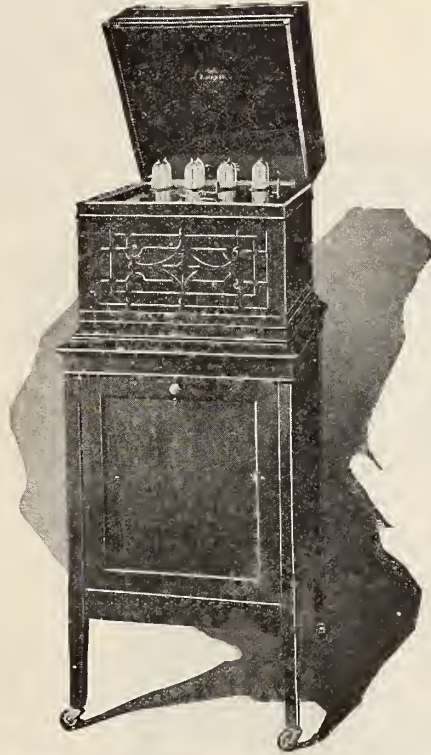

What the Guests Heard at the Jacksons' Aeriola Grand Party

- Baseball Scores
- Dance Music
- Songs by a great ballad singer
- Lecture on the "Wedding Ring, Past and Present"
- A story by a famous author
- Chamber music by a noted string quartet
- The whole opera "Cavalleria Rusticana" with explanations.
- News of the day
- Weather forecast for the following day

Radio Corporation
of America

Sales Dept., Suite 2066
233 Broadway New York, N. Y.

District Office
10 So. La Salle St. Chicago, Ill.

New Equipment



The latest type receiving set is here illustrated, and were the doors closed it might well be taken for a phonograph. All the necessary equipment, including the tuning elements, the storage battery, and plate batteries, is within the cabinet. The reproducing element is directly connected to the horn in the same manner as in phonographs. The receiver is of the vacuum tube regenerator type employing detector and three stages of audio frequency amplification and has a wave length range of 150-3000 meters. This elaborate machine is known as "Radiotone" and is manufactured by A. H. Grebe & Company.

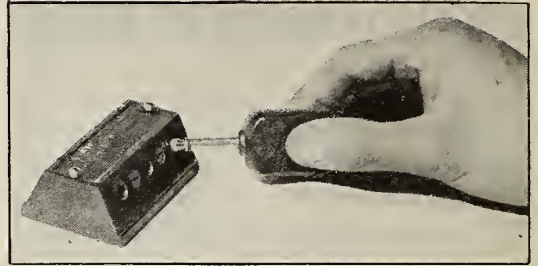

By means of the clever arrangement shown above, one, two, or three telephone plugs may be connected in the circuit without making any change in the wiring. This device is made by Pacent Electric Co.

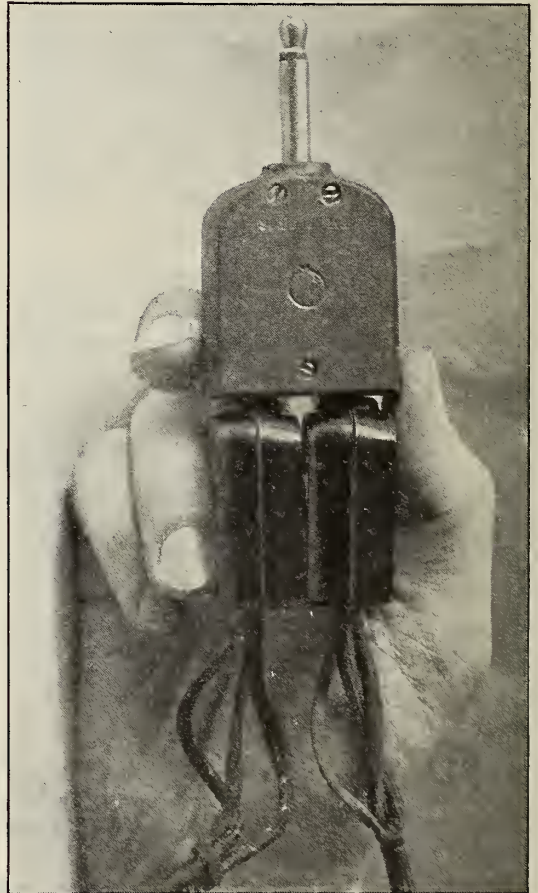

A double telephone plug has been devised by the Pacent Electric Co., permitting the use of two pairs of telephone receivers connected in circuit as illustrated above

Use Kennedy Receivers for Effective Reception You can't go wrong—Quality always counts

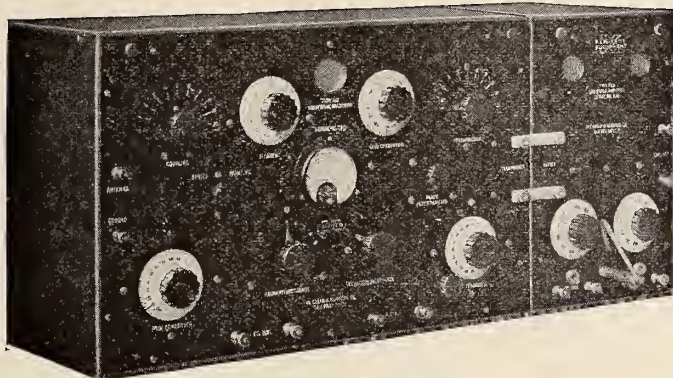

KENNEDY
EQUIPMENT Look for the Trade Mark

TYPE 110 UNIVERSAL REGENERATIVE RECEIVER, WITH TYPE 525 TWO STAGE AMPLIFIER. WRITE FOR BULLETINS.

All Kennedy Regenerative Receivers are licensed under Armstrong U. S. Patent No. 1,113,149.

A UNIVERSAL RADIO RECEIVER, in fact, as well as in name, the Kennedy Receiver Type 110 can be made to detect, regenerate or oscillate at will, over its entire range of 175 to 25,000 meters. Cabinet is of solid walnut, hand rubbed finish—Kennedy Quality and Workmanship evident throughout.

Like the Universal Receiver, Type 525, two-stage amplifier is built for dependable service. It matches the receiver in height, depth and general finish.

THE COLIN B. KENNEDY COMPANY
INCORPORATED

RIALTO BUILDING

SAN FRANCISCO

HOME-O-FONE

Radio Telephone Receiving Set

LISTEN IN with a sturdy, practical radio set that you can be proud of—not a toy or a makeshift. You will not know what a crystal set can do unless you get a Home-O-Fone, the quality package outfit. You are sure of satisfying results with a HOME-O-FONE because it is scientifically correct. But in addition, this De Luxe Package set is constructed of only the highest grade materials and designed to retain its handsome finish as well as its efficiency. An addition to the appearance of any room. Tuned with one simple adjustment—no extra parts required. Guaranteed to hear the broadcasts in your own or nearby city.

Complete Outfit Includes:—

HOME-O-FONE No. 2 RECEIVER with prevision tune adjustment, in handsome cabinet-finish case with cover and compartment for headset, etc.—**DOUBLE HEADSET**, with two special "RR" concert 'phones, 2200 ohms, headband and long telephone cord—**ANTENNA WIRE**—150 feet.—**GROUND CLAMP**.—**HIGH INSULATION RADIO RECEIVER CABLE** for room connection—25 feet. **SPECIAL PORCELAIN INSULATORS** for antenna—4.—**"ANCHOR" AUTOMATIC RADIO LIGHTNING PROTECTOR** as required by National Underwriters' Rules.—**INSTRUCTION FOLDER**.

IMMEDIATE DELIVERIES

Send for folder containing Antenna drawing. A few select territories still open for live dealers.

RADIO RECEPTOR COMPANY, INC.
No. 1 Madison Avenue New York, N. Y.

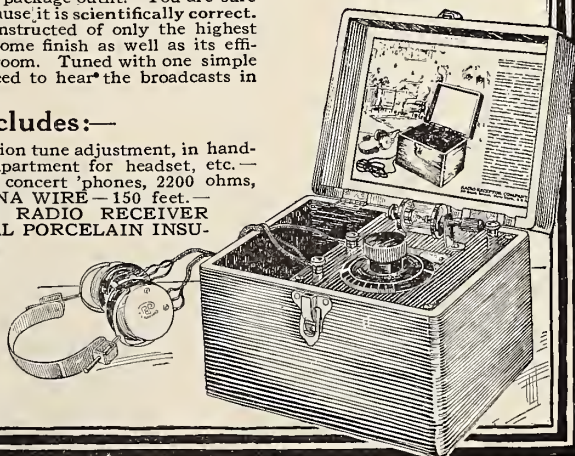

\$24
COMPLETE
including Antenna, etc.
No batteries or tubes needed
Every Set **GUARANTEED**



What to Call Them

THE recommendations of the Committee on Nomenclature of the Radio Telephone Conference called by Secretary Hoover of the Department of Commerce in Washington were as follows:

1. In place of the word "Wireless" and names derived from it, use the prefix "Radio"; Radio Telegraphy, Radio Telephony.

2. Instead of "Statics" or "X's," use "Atmospheric Disturbances" or "Atmospherics."

3. Disturbances produced by other stations to be designated as "Interference."

4. For the title of a triode employed in one of its regular modes, use "Rectifier triode," "Amplifier triode," "Generator triode."

5. In describing coupling of high frequency circuits, use "Resistance Coupling," "Inductive Coupling" (by self-inductance or mutual inductance), "Capacity Coupling."

6. For the generic title for a system of conductors for radiating or absorbing radio waves, use "Aerial."

For an open circuit aerial use "Antenna."

For a closed circuit aerial use "Coil."

7. For a receiving arrangement in which beats are produced by a separate local oscillator, use "Heterodyne."

For a receiving arrangement in which the same electron tube is used for generating oscillations and detecting, use "Self-heterodyne."

8. Classification of waves emitted by radio transmitters.

Type A—Continuous Waves.

Waves that in the permanent state are periodic and such that their successive amplitudes of oscillations are identical.

Type A₁—Manipulated Continuous Waves.

Continuous waves of which the amplitude or frequency vary under the action of hand telegraphic manipulation.

Type A₂—Continuous Waves with audible frequency modulation.

Continuous waves of which the amplitude or the frequency vary according to a periodic law of audible frequency. This is commonly referred to as ICW method of transmission.

Type A₃—Continuous waves with speech modulation.

Continuous waves of which the amplitude or the frequency vary in accordance with speech vibrations (radio telephony.)

Type B—Damped Waves:

Waves composed of successive trains in which the amplitude of the oscillations after having reached a maximum decreases gradually. This refers to waves from spark transmitters or other types of transmitters having a characteristic decrement similar to spark transmitters.

NOTE 1. If in continuous wave transmitters the rectified plate voltage is not substantially constant direct voltage, the station should be classed under Type A₂.

NOTE 2. In ICW transmitting stations if the variation in the wave length or frequency of the transmitted wave is effected in a gradual way (sinusoidally) the station should be classed under Type A₂. If the variation in frequency or amplitude is abrupt (chopper method) it should be classed in Type B.

In order to differentiate between the amateur and the experimenter, the following definitions are suggested for consideration:

The amateur is one who operates a radio station transmitting, receiving, or both, in a non-professional way, merely for personal interest or in connection with an organization of like interest.

An experimenter is one who operates a transmitting or receiving station, or both, for exclusively technical or scientific investigations.

NOTE. Further recommendations or nomenclature to be added later.



This is station K.S.&S.Co.

ANNOUNCING Better Radio Equipment Kellogg Built Throughout



No. 69A Head Set



No. 2. Tube Socket



Iron Core Choke Coil



Air Choke Coil



No. 501. Plug

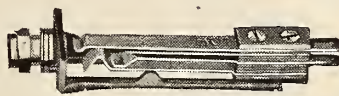

No. 501. Jack



No. 502. Grid Condenser on Single Mounting

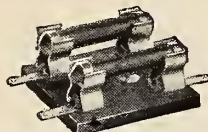

No. 503. Grid Leak and Condenser on Double Mounting



No. 21. Microphone



Strain Insulator



No. 501. Dial

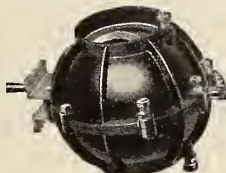

No. 501. Variometer



No. 505. Variable Condenser

KELLOGG STANDARD RADIO APPARATUS is made in standard resistances and ratings. Only the highest grade material is used, and first-class workmanship assures a product that guarantees high efficiency and durability.

Send for our latest radio Bulletin

Kellogg Switchboard & Supply Co., Chicago

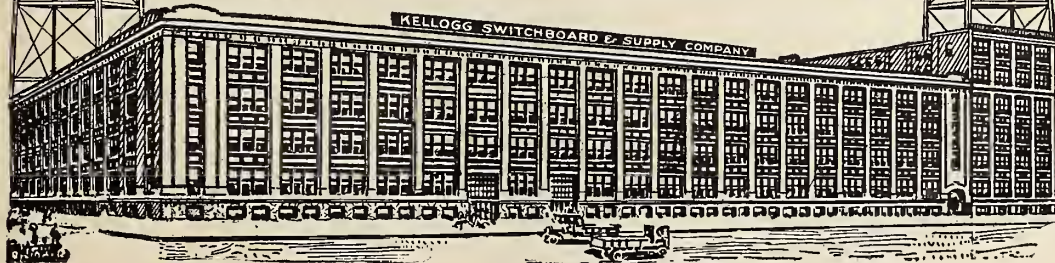

HOMMEL

Order NOW for Fall

WHEN vacation time is over and the days get shorter, Radio is going to take its place again in filling up the long chilly evenings both in the city and on the farm. There will be big demand for both parts and complete sets. Will your stocks be up to date and able to take care of all this trade?

DISTRIBUTORS FOR
 Radio Corp. of Amer.
 Westinghouse
 General Electric

Frost	Kellogg
Remler	Acme
Fada	Brach
Murdock	Homcharger
General Radio	Signal
Brandes	Pacent
Baldwin	Rhamstine
Burgess	Connecticut
Hipco	Arkay
Chelsea	Radio Service
Holtzer-Cabot	Tuska

Clapp-Eastham
 and other leading
 manufacturers



Now is the time to put your stock in order for Fall, not at the last moment, when we are rushed with orders and deliveries may not be so prompt.

Order Now. To-day. Our new, illustrated catalog No. 200 B will help you.

Send for it.

WHOLESALE ONLY

LUDWIG HOMMEL & CO
 530-534 FERNANDO ST.  PITTSBURGH, PENNA

Burgess, the *Radio Battery* — construction fully patented

When you buy a Burgess "B" Battery you get more than long life, noiselessness, high capacity, and moderate price. You get also Burgess special radio construction, perfected by wireless specialists and fully patented! This exclusive *radio* construction is found in no other battery on the market today.

What does this mean to users of radio batteries? It means clear receiving. It means lowest cost per hour of service. It means long shelf life and highest current capacity. It means that Burgess "B" Batteries are the best *radio* batteries it is possible to produce. Don't take our word for it—ask any radio engineer.

Leading manufacturers of radio equipment specify "Burgess." Burgess "B" Batteries are handled by all progressive jobbers and dealers. "Look for the Black and White Stripes." If your dealer doesn't handle Burgess "B," just address:

BURGESS BATTERY COMPANY Engineers — Dry Batteries — Manufacturers

Offices and Warehouses at:

CHICAGO, ILL., 111 W. Monroe St. NEW YORK, N. Y., 50 Church St. BOSTON, MASS., 136 Federal St.
ST. PAUL, MINN., 2362 University Ave. KANSAS CITY, MO., 2109 Grand Ave. MADISON, WIS., Main & Brearly Sts.

In Canada: BURGESS BATTERIES, Ltd.
Winnipeg, Toronto, Montreal

BURGESS "B" BATTERIES

"ASK ANY RADIO ENGINEER"

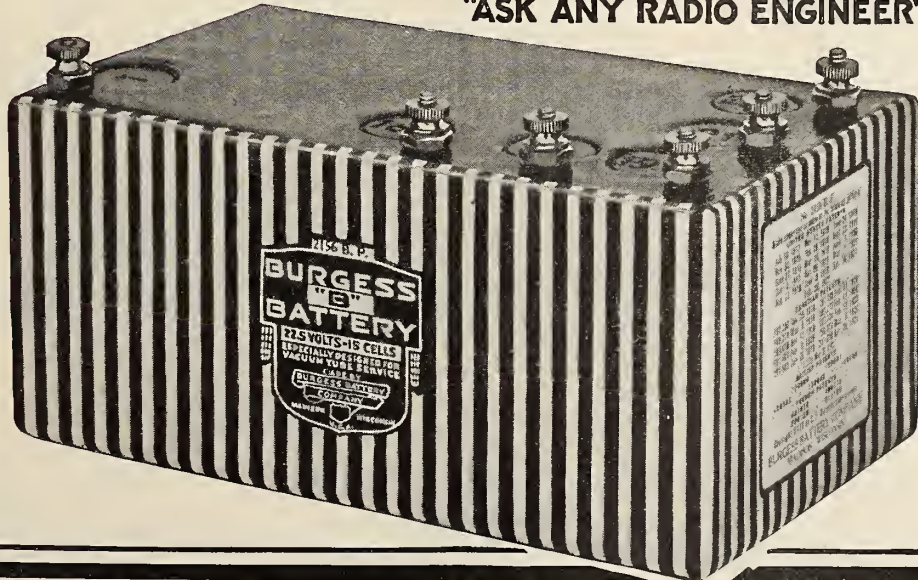



Cunningham tubes

*The Heart of
Your Home Receiving Set*

**AMPLIFIES AS
IT DETECTS**



**TYPE C-300
GAS CONTENT
DETECTOR
\$5.00**

**TYPE C-301
HIGH VACUUM
AMPLIFIER
\$6.50**

PATENT NOTICE

Cunningham tubes are covered by patents dated 11-7-05, 1-15-07, 2-18-08 and others issued and pending. Licensed only for amateur or experimental uses in radio communication. Any other use will be an infringement.

*—enjoy clear reception by
using Cunningham Tubes*

Cunningham Detector Tube known as type C-300 insures clearest reception for all radio messages, concerts, press and weather reports.

The rigid specifications to which these tubes are built in the General Electric Laboratories determine their uniform operation and perfect clearness.

Cunningham Amplifying Tube known as type C-301 is conceded to be the most efficient amplifier ever produced. For complex and multi-stage circuits, freedom from distortion and absence of all tube noises as well as for the operation of loud speaking telephones and devices requiring considerable power, this tube has no equal.

If your dealer cannot supply you write us direct for the name of a Radio Dealer who can.



Trading as
AUDIOTRON MFG. COMPANY

248 First Street, San Francisco, California
154 West Lake Street, Chicago, Illinois

The trade mark GE is the guarantee of these quality tubes. Each tube is built to most rigid specifications.

REMLER *Cunningham*

Giblin-Remler COILS INDUCTANCE

**APPARATUS
THAT
RADIATES
QUALITY**

Type and Number of Turns, Mounted	Price, Mounted	Type and Number of Turns, Unmounted	Price, Unmounted	Inductance in Milli-henrys at 1000 cycles Accuracy 3/4 %	Natural Wave Length in Meters, Accuracy 3/4 %	Distributed Capacity in micro-microfarads, Accuracy 1/4 %	Wave Length Range in Meters using Condenser of .001 max. and .0004 mfd. min.		High Frequency Resistance in Ohms at Wave Length Show				
							Min.	Max.	200	500	1000	2000	
RG 20M	1.50	RG 20U	.70	.030	39	14.3	63	334					
RG 25M	1.50	RG 25U	.70	.041	47	15.2	75	389		1.1			
RG 35M	1.50	RG 35U	.70	.083	87	25.4	128	550		1.5			
RG 50M	1.60	RG 50U	.80	.169	114	21.6	185	785		3.5			
RG 75M	1.65	RG 75U	.85	.377	163	19.8	266	1170		8.8	4.4		
RG 109M	1.70	RG 100U	.90	.666	217	19.9	358	1550		28.3	12.1	6.2	
										80.3	26.8	12.6	
RG 150M	1.75	PG 150U	.95	1.503	281	14.8	512	2320	1000	2000	5000	10000	
RG 200M	1.80	RG 200U	1.00	2.68	374	14.7	690	3110	69.8	23.8	7.1		
RG 250M	1.90	RG 250U	1.10	4.20	424	12.1	860	3880		50.6	12.5		
RG 300M	2.00	RG 300U	1.20	6.11	494	11.2	1030	4680		87.5	19.9		
RG 400M	2.10	RG 400U	1.30	11.04	618	9.7	1380	6300		141	29.3	13.8	
RG 500M	2.30	RG 500U	1.50	17.50	747	9.0	1730	7900			54.6	22.3	
											93.1	34.9	
RG 600M	2.40	RG 600U	1.60	29.2	1024	10.1	2260	10250	2000	5000	10000	20000	
RG 750M	2.65	RG 750U	1.85	39.0	1249	11.3	2660	11850		111	43.8		
RG 1000M	3.40	RG 1000U	2.50	71.6	1620	10.3	3570	16000			64		
RG 1250M	3.89	RG 1250U	2.90	108.0	1930	9.7	4380	19700			123		
RG 1500M	4.40	RG 1500U	3.70	159.8	2390	9.3	5300	23800					

This table compiled by Robert F. Field of Cruft High Tension Electrical Laboratory, Harvard University, Cambridge, Mass.

The Ideal Loading Coil

These new inductance coils will increase the wavelength range of your short wave receiving set.

There is nothing more fascinating than the reception of radio messages from high-power stations located thousands of miles away.

These stations use wavelengths between 1000 and 25,000 meters. This is far above the receiving range of the average receiver designed for amateur broadcast reception.

Inserting Giblin-Remler Coils of the proper values (determined from the table shown on this page) and shunted by a variable condenser, in series with the antenna circuit and the secondary circuit of your receiver, will increase its wavelength range any desired amount.

The Giblin-Remler Coil makes possible the reception of high-power, long wave foreign stations, as well as time signals, press and weather reports from various naval stations throughout the United States.

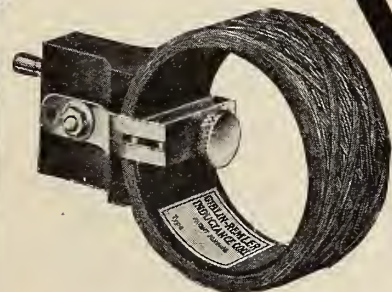

Maximum Inductance and Minimum Distributed Capacity

Remler Radio Mfg. Co.

E. T. CUNNINGHAM, General Manager
248 First Street, San Francisco, Calif.
154 W. Lake Street, Chicago, Ill.



Just Off the Press

The Radio Experimenter's Handbook

By M. B. SLEEPER

Gives wiring diagrams and hookups, explains the theory and operation of damped and undamped transmitting sets, and receiving equipment. The book is profusely illustrated. Tells you the things you want to know about wireless in simple, untechnical language. In this respect, it differs from most radio books in that it tells you what you want to know, and not what the author thinks you ought to know. 16 chapters. Fully illustrated. Price \$1.00.

Other Popular Radio Books

Radio Hook-Ups, by M. B. Sleeper . . . \$.75
Indispensable to the radio amateur who designs or builds his own receiving apparatus.

Radio Design Data, by M. B. Sleeper75
Gives tables and data for designing, receiving and transmitting apparatus.

Construction of New Types Trans-Atlantic Receiving Set, by M. B. Sleeper75
Tells how to listen to the high-power telegraph stations of foreign countries.

Construction of Radiophone and telegraph Receivers for Beginners, by M. B. Sleeper75
Tells in detail the building of radio apparatus.

How to Make Commercial Type Radio Apparatus, by M. B. Sleeper75
Describes in detail many commercial types of transmitting spark and vacuum tube sets, both telephore and telegraph and receiving equipment of all kinds.

A B C of Vacuum Tubes Used in Radio Reception, by E. H. Lewis . . . 1.00
A book explaining in detail all about vacuum tubes.

Experimental Wireless Stations, by P. E. Edelman 3.00
A book describing all modern improvements.

Wireless Telegraphy and Telephony Simply Explained, by A. P. Morgan 1.50
A book the radio experimenter cannot afford to be without.

FREE! Catalogue of Wireless, Automobile and Other Books Sent Free on Request.

SUPPLY DEALERS. Write for special terms.

The Norman W. Henley Publishing Co.
2 West 45th Street, New York

"East and West, the Globe is Best"

GLOBE RADIO HEAD PHONES



Highly sensitive
Matched receivers
Natural in tone
Each receiver tested by radio
Light weight (11 oz.)
Comfortable to wear
Will not distort signals, when amplified
Articulation perfect

2200 ohms List price only \$9.00

There are many types of head sets on the market but not too many good ones. The GLOBE RADIO HEAD SET incorporates a knowledge of acoustics based on nearly fifteen years of experience in making high grade sound producing and receiving instruments. It embodies correct design with the best of materials. The Globe Phones are for those who discriminate.

Ask about the Globe Antenna Attachment Plug for connecting your radio set to your electric light circuit. Buy from your local dealer, or write us direct.

GLOBE PHONE MFG. COMPANY
READING, MASSACHUSETTS, U. S. A.

"United" Radio Products

"United" Audio Frequency Transformers



Two finishes: Black Enamel or Buffed Nickel Plated, \$4.50

The beauty of the outside of this transformer is but a reflection of the superb workmanship under the shell—no howling—no distortion—clear amplification for one or more stages.

United Mfg. & Distributing Co.

536 Lake Shore Drive
Chicago Illinois

"United" Variable Condensers

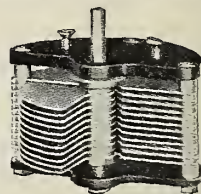

Prices

43 plate, \$4.50; 23 plate, \$1.00; 11 plate, \$3.50; 5 plate, \$2.75; 3 plate, \$2.25, without dial or knob.

That "United" Condensers have become the standard with manufacturers of radio sets, by which all others are judged, is, in itself, the strongest endorsement of their superior construction and effectiveness.

Ask your dealer to show you this condenser. Then, you, too, will appreciate why it has been accepted as the standard.

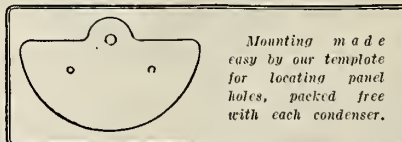

Mounting made easy by our template for locating panel holes, packed free with each condenser.

NOTE: Any advertised claim of having an arrangement with us to sell our products at special prices, is fraudulent.

Finest Filament Control

We Have Ever Used, *Says Radio Guild, Inc.*

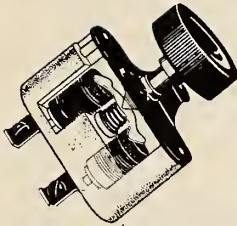

How It Works!

Graphite discs (not loose carbon grains) provide the delicate control for vacuum tubes. A single knob, without vernier, gradually applies or removes pressure from the discs, thereby changing the filament current more smoothly and noiselessly than any vernier rheostat.

Louder reproduction, quicker tuning, and a greater receiving range follow the installation of Bradleystats in your radio set. Twenty years of experience in precision control, and a one-year guarantee protect you.

Allen-Bradley Co.
Electric Controlling Apparatus
278 Greenfield Ave. Milwaukee, Wis.



RETAIL PRICE
\$185 P.P. 10¢
Extra.

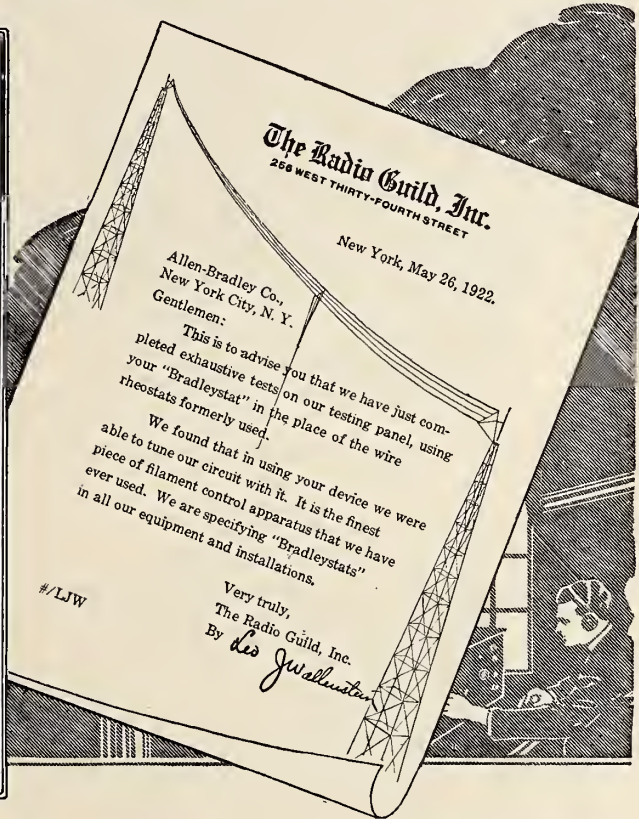

Bradleystat

REGISTERED U. S. PAT. OFF.

PERFECT FILAMENT CONTROL

RADIO HEADQUARTERS QUALITY---PRICE PROMPT SERVICE

We list below a few popular items from our large stock of standard Radio Supplies. Play Safe—buy standard equipment. Order from this list.

Westinghouse RC Receiver.....	\$132.50	Murdock No. 3660 43-plate Var. Condenser, no case.....	4.00	Baldwin Type F Phones.....	\$ 16.00
Westinghouse RA 2-Tuner.....	68.00	Murdock No. 3680 23-plate Var. Condenser, no case.....	3.25	Western Electric Phones.....	15.00
Clapp-Eastham IZ Revr-Amplifier	100.00	ABC No. 650-11 11-plate Var. Condenser.....	3.00	Westinghouse Vocarola.....	30.00
Clapp-Eastham HR Regenerative Receiver.....	40.00	ABC No. 650-3 3-plate Var. Con. Ration 3-inch Dial.....	2.25	Magnavox R-3, 14 inch Horn.....	45.00
Clapp-Eastham HZ 2-Stage Amplifier.....	40.00	Ration 4-inch Dial.....	.75	Acme A-2 Amplifying Transformer.....	7.00
Grebe CR-9 Receiver-Amplifier.....	130.00	Moulded Bakelite 3-inch Dial.....	1.00	Acme A-2 Amplifying Transformer former, semi-mounted.....	5.00
Grebe CR-5 Receiver.....	80.00	Cunningham C-301, Radiotron UV201 Amplif. Tube.....	.75	Jefferson No. 41 Amplifying Transformer.....	4.25
Grebe RORK 2-Stage Amplifier.....	55.00	Cunningham C-302, Radiotron VY202 Power Tube.....	6.50	Jefferson No. 45 Amplifying Transformer.....	7.00
Remler No. 330 Detector Panel.....	8.50	Jefferson No. 48 Tube Socket.....	8.00	R. C. UV-712 Amplifying Transformer.....	7.00
Remler No. 331 Amplifier Panel.....	6.00	R.C. UT-541 Porcelain Tube Socket.....	1.00	Murdock No. 358 .0007 Mfd. Fixed Cond.....	7.00
Remler No. 333 Same with Cam Switch.....	9.00	Signal R-75 Tube Socket.....	2.50	Federal No. 15 Universal Plug.....	.70
Remler No. 505 Panel-mounted Variocoupler.....	12.00	Clapp-Eastham HT Bakelite Panel Socket.....	1.40	Frost No. 132 Plug.....	1.75
Remler No. 502 Panel-mounted Variometer.....	9.75	Remler No. 810 Jr. Filament Rheostat.....	1.00	Frost No. 131 Jack.....	1.00
Remler No. 500 Moulded Variometer.....	6.50	Remler 1 1/2-Amp. Panel Rheostat No. 811.....	1.00	Frost No. 133 Jack.....	.90
Remler No. 501 Same with No. 100 Knob and Dial.....	7.50	Remler 3-Amp Panel Rheostat No. 813.....	1.75	Frost No. 134 Jack.....	.85
Remler No. 503 Variocoupler.....	5.40	Paragon No. 1023 Panel Rheostat.....	1.75	Frost No. 135 Jack.....	1.00
Remler No. 504 Same with No. 100 Knob and Dial.....	6.40	Bradleystat Filament Controller.....	1.50	Frost No. 136 Jack.....	1.25
Clapp-Eastham F-735 43-plate Var. Condenser.....	4.75	R. C. PR-535 Rheostat.....	3.00	Rotary Lever Switches. See our catalogue	
Clapp-Eastham F-774 17-plate Var. Condenser.....	4.25	Cutler-Hammer H-1 Vernier Rheostat.....	1.50	Remler Standardized Switch Parts Cabinets and Panels. See our catalogue	
Chelsea No. 1 43-plate Var. Condenser, mounted.....	5.00	Cutler-Hammer H-2 Plain Rheostat.....	1.50	Brach No. 223 Outdoor Vacuum Gap Protector.....	3.00
Chelsea No. 2 23-plate Var. Condenser, mounted.....	4.50	R. C. PR-536 "A" Battery Potentiometer.....	1.00	Brach No. 290 Indoor Vacuum Gap Protector.....	2.50
Chelsea No. 3 43-plate Var. Condenser, with Dial.....	4.75	Batteries.....	2.00	Keystone Radio Lightning Arrester.....	2.00
Chelsea No. 4 23-plate Var. Condenser, with Dial.....	4.25	Frost Fones No. 162, 2000 ohms.....	5.00	Antenna Insulators, Magnet Wire, Cardboard Tubing, Bakelite Tubing, Fiber Tubing, Spaggetti, Radio Books, Crystal Detector Supplies, Battery Chargers, Loading Coils, etc.	
Murdock No. 367 43-plate Var. Condenser in case.....	4.50	Frost Fones No. 163, 3000 ohms.....	6.00		
Murdock No. 368 23-plate Var. Condenser, in case.....	4.00	Murdock No. 56 Phones, 2000 ohms.....	5.00		
		Murdock No. 56 Phones 3000 ohms.....	6.00		
		Baldwin Type C Phones.....	16.00		
		Baldwin Type E Phones.....	16.00		

Free Catalogue illustrated, sent on request

In business since 1860

Julius Andrae & Sons Co.

354 Broadway, Milwaukee, Wis.

Dealers—Buy reliable equipment from a house of established reputation. Send for catalogue of tested and approved apparatus and our discount sheet.

THE Supercouple "A" BATTERY

FOR RADIO

NEEDS WATER ONLY ONCE A YEAR

Entirely different from the modified vehicle batteries sold for this purpose. No leakage or seepage of battery acid, no fumes or spray, no corrosion of connecting wires, no separators. Write for illustrations.

80 AMPERE HOURS \$18.00.

J. A. RITTER

LANSDOWNE, PA.

BUILD YOUR OWN



Special offer, complete 50c text book for only 20c postpaid. Wonderful information makes you understand radio. Tells how radio messages are received. Tells how to make eight different classes of crystal and vacuum tube receiving sets with range of 25 to 2000 miles. Detail drawings and complete bills of material given for each set. We enclose our price list of parts. Buy direct from factory and save many dollars. Nothing else like this book on the market. Money back if not satisfied. Desk 22, RADIO PARTS MANUFACTURING CO., PARK PLACE, DETROIT, MICHIGAN

20c

PATENTS

PROTECT YOUR INVENTION TO-DAY

Write for 1922 Illustrated Book, Free

Radio-Electrical, chemical, and mechanical experts; over 20 years experience.

A. M. WILSON, Inc. (Radio 3 ARH)

311-19 Victor Building Washington, D. C.

(Successors to business established 1891 by A. M. Wilson.)

WESTINGHOUSE AND OTHER STANDARD

RADIO SETS AND PARTS

Liberal commissions paid for interesting others which enables you easily to

EARN YOUR SET AND MAKE MONEY

Write for Price List and Proposition

WHEELER-THOMAS RADIO CO., Dept. 27, Holland, N. Y.



MARSHALL VARIABLE CONDENSERS

Precision Instruments, which are built from outfits of finest quality parts, to the exact capacity of the experimenter's own set. 3, 5, 9, 17, 23, 35, 43, and 67 plate sizes. For further information write

NEW HAVEN RADIO COMPANY

61 Hamilton Street,

New Haven, Conn.

Pacific Coast Representative:

H. SALMON, Berkeley Inn, Berkeley, Cal.

Here's the Fada Receiver!

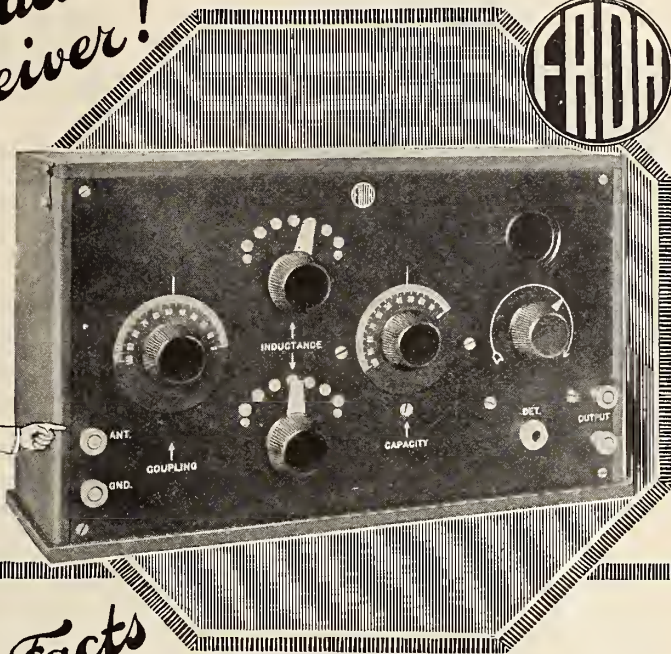

and There's the Facts about it.

An Ideal Home Entertainer

THE Fada receiver, a result of the same perfection in design and construction that distinguishes all Fada products, is gaining popularity as an ideal home entertainer.

When it's radio time in your home you can sit back in your favorite chair among the family circle, and command at your fingers touch such noted artists as May Petreson, Percy Grainger, Mme. Margaret Namara, Lydia Lipkowska—the Russian Coloratura soprano of the Imperial Opera of Petrograd.

You marvel that their voices come into your home with such depth of emotion and true personality. Such music is an inspiration to everyone, it goes to the very soul of things and brings joy to all.

With a Fada receiver this is all possible in your own home.

The new Fada handbook will be sent you upon receipt of 5c to cover postage. It's a How-To-Do-It book and you should have it.

THE FADA HANDBOOK
of
FADA - FACTS



FRANK A. D. ANDREA

1581-B Jerome Ave.

New York City

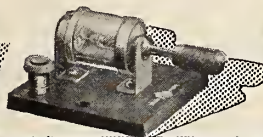
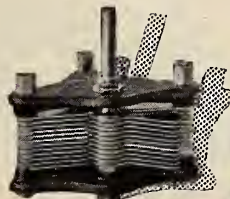

Cleveland Dulce-Tone Junior.

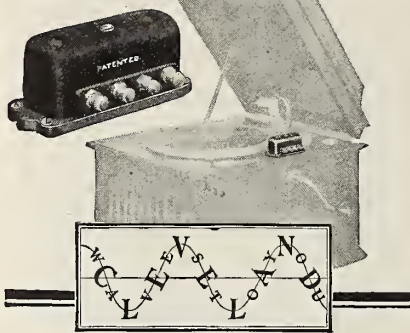

**Radio Music Perfectly Reproduced
Through Your Phonograph**

The Dulce-Tone Junior converts your phonograph into the finest of loud talkers without detracting in the least from its power to play phonograph records.

The radio music comes to you with cello-like sweetness, even more clearly than that reproduced from your records.

The Dulce-Tone Junior is adaptable to any phonographic instrument. When you consider that you are using the wonderful sound-box, tone-arm and even the needle which has been perfected only after years of experimenting, you can realize the **QUALITY** and **SWEETNESS** of the tone which is so faithfully reproduced through the Dulce-Tone Junior.

Any one can attach the Dulce-Tone Junior in a few minutes. To operate, simply swing the tone arm allowing the needle to rest on the small center element of the Dulce-Tone Junior. This ingenious instrument eliminates the necessity of numerous expensive headphones when entertaining a room full of people—is a true economy.

The Dulce-Tone Junior is the instrument of the century—an instrument that will improve any radio set. Put one on your phonograph to-day and realize the possibilities of radio music for quality of tone.

Retail Price Only \$15.00
(\$17.50 West of the Rockies)

If your dealer does not handle the Dulce-Tone Junior fill out the coupon below, mail it with one dollar and we will forward this wonder instrument to you C. O. D. at \$14.00.

THE CLEVELAND RADIO MFG. CO.
238 St. Claire Ave., N. E., Cleveland, Ohio
Sole Licensees under KAEHNI Circuit Inventions and Patent Applications.

THE CLEVELAND RADIO MFG. CO.
238 St. Claire Ave., N. E., Cleveland, Ohio

Enclosed find one dollar for which send me a Dulce-Tone Junior (\$14.00, balance due C. O. D.).
Send me your folder entitled "Waves to You Through Your Phonograph."

Name

Address

Town & State.....

**NOVO
"B"
BATTERIES
FOR RADIO**

22½-45 & 105 VOLTS

**NOISELESS
DEPENDABLE
GUARANTEED**

ASK YOUR DEALER

NOVO MANUFACTURING CO.

424-438 W. 33rd ST.
NEW YORK

531 SO. DEARBORN ST., CHICAGO.

Vacuum Tube Detector, \$5.50

Including complete cabinet with all instruments wired ready for use.

**Detector and Two Stage
Amplifier, \$22.50**



With transformers and all other instruments in cabinet, ready for operation. This equipment is of high quality, and distances of as high as 3000 miles have been obtained with ease.

**BATTERIES AND
TUBES EXTRA**

"Superior" Receiving Set, \$4.75



**In Cabinet, complete,
as shown**

Guaranteed to bring concerts louder than any other crystal set made regardless of price. We will prove this to your satisfaction or refund your money.

Parts for "SUPERIOR" set ready for assembling, \$3.25. Variometers, \$4.25
2000 Ohm Head Phones, \$5.00

SOUTH HILLS WIRELESS SHOP
411 Charles St., Knoxville, Pittsburgh, Pa.

Which Will You
Judge By—
Results or
Unproved Claims?

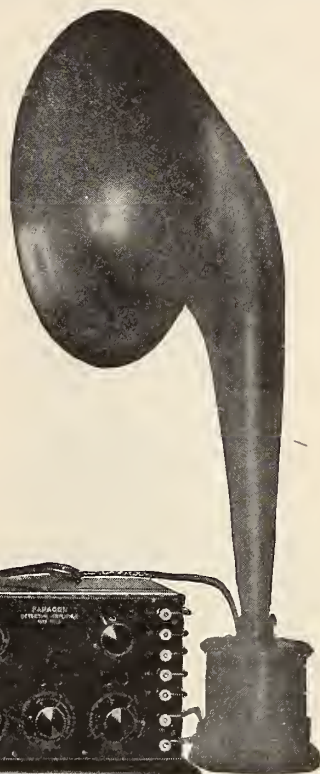

Type R-A-10 Receiver

Licensed Under Armstrong Patents

D-A-2 Detector-Amplifier

Also Manufacturers
of

- PARAGON
- Radio Telephone
- Transmitters
- V. T. Control Units
- Rheostats
- Potentiometers
- V. T. Sockets
- Amplifier
- Transformers
- Detectors
- Control Dials
- Amplifiers
- Receivers
- Switches
- Variometers

Paragon Stands on its Record

In 1915 Paragon was the *first* regenerative receiver manufactured.

In 1916 Paragon effected the *first* transcontinental reception (not prearranged) from New York to California.

In 1917-18 Paragon receivers, due to better sensitivity and selectivity, proved superior to all others in interception of enemy signals by the U. S. Army and Navy.

In 1921 Paragon effected the *first* transatlantic amateur reception, registering American amateur signals at Ardrossan, Scotland, a distance of 3500 miles.

In 1922 Paragon Products are a safe investment in a market in which it is difficult to judge values.

Paragon needs no extravagant claims; but we guarantee our customers this:—that Paragon Products are reasonable in price, sound in design and thorough in workmanship.

If your dealer does not sell Paragon Products, send for catalogue (free) and we will supply you promptly.

ADAMS-MORGAN CO., 10 Alvin Ave., Upper Montclair, N. J.

PARAGON

Reg. U. S. Pat. Off.

RADIO PRODUCTS

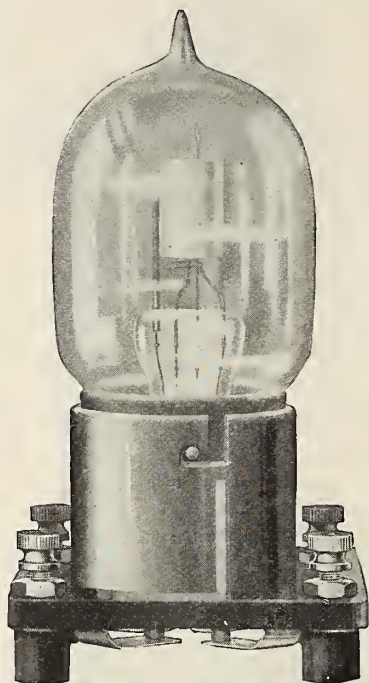

Pickles and Warts SOUND FUNNY

But did you ever stop to think that you always find them together? Wherever you find a "live" radio dealer, there you will find

THE ALAMO SOCKET

Specifications:

Insulated Feet; Nickel Plated Barrel; Barrel Reamed to size insuring no vibration of vacuum tube; Large Phosphor Bronze Springs; Base Polished Finished Formica Properly Labeled.

LIST PRICE \$1.00

—BRACKETS—

Nickel Plated for Single Panel Mounting 16c
Double Mounting 40c, Triple Mounting 50c

UNUSUALLY ATTRACTIVE DISCOUNTS
WRITE OR WIRE FOR PROPOSITION

THE ALAMO SALES CORP.

National Distributors

812 Peoples Bank Bldg., Indianapolis, Indiana

PACIFIC COAST REPRESENTATIVES:

TILTZ ENGINEERING AND EQUIPMENT CO.

LOS ANGELES

SAN FRANCISCO

WRIGHT-COLLENDER BLDG.

MONADNOCK BLDG.

PATENT APPLIED FOR



Radio Telephone Headsets

DON'T let them substitute any other make of Headset for your Radio Outfit. The tonal quality of what you hear is vitally important. Holtzer-Cabot Headsets are the result of many years' experience and skill in making Telephone Headsets.

Insist Upon

Holtzer-Cabot

Telephone Headsets

Sold by all responsible dealers

THE HOLTZER-CABOT ELECTRIC CO.

Boston, Mass.

Chicago
Philadelphia

New York
Cleveland

Baltimore
San Francisco

States Radio Receiving Equipment



Its outward beauty puts the States Receiving Set in a class by itself; and on top of this, its mechanical perfection is as "beautiful" to the radio engineer as its fine appearance to the layman.

The receiver section contains one Radio Frequency—one detector—one audio frequency amplifying tube. The amplifier unit has two stages of audio amplification. Both cabinets are solid mahogany with a piano finish. The panel has a highly polished, lustrous black finish with silver plated letters and dials.

Simple to operate—it is offered to you only after exhaustive tests have satisfied this company that this receiving set will give you the best results it is possible to obtain with any equipment.

Write for illustrated folder

STATES RADIO CORPORATION

501 South Jefferson Street

Chicago

Illinois

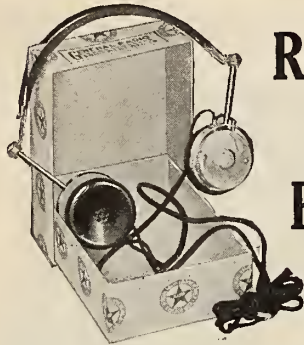

Red Star Head Phones

Why take a chance with your receiving set by using poor head phones, for after all your radio receiver set is no better than your head phones.

Red Star head phones speak up sharp and clear. Light in weight, they fit the head

comfortably and do not tire, they are easily adjusted over the ears.

Protect your receiving set, by buying good head phones—ask your dealer to show you Red Star phones. You will be surprised at the results you will attain.

Monocoil 2000 ohms—\$5.00
Long-distance 3200 ohms—\$6.00
Including head band and 6ft. cord

GENERAL RADIO EQUIPMENT CO.
1139 Diversey Pkwy. Chicago

TUSKA

Market
Reports



RADIO



Tuska Variometer Type 200

The Tuska Variometer was the first moulded Variometer on the market; not only first to arrive, but first in quality.

All TUSKA RADIO follows this example. The name Tuska is a standard. Insist on Tuska Sets and Tuska Parts.

Send 5c for Tuska Catalog No. 3

The C. D. Tuska Company

Bartholomew Ave., Hartford, Conn.

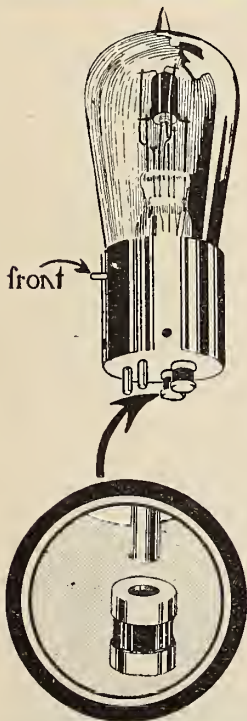

Saves Tubes--

Attached right where all "juice" going into the filament must pass, the

RADECO Safety Fuse

makes it impossible for you to "burn out" a bulb-filament from any excessive amperage whatever, even an accidental short. Good on any standard tube used in any standard socket.

4 for \$1

Buy from your dealer or direct by mail.

When ordering, specify exactly what make and number tube fuses are wanted for.

RADIO
EQUIPMENT CO.
630 Washington St.
Boston, Mass.



Every
Radio "Bug" needs
a **HANDY ANDY**
SOLDERING SET

INCLUDES two specially designed, high grade, copper irons, large coil of resin-centered solder and liberal quantity of Sal Ammoniac. The small iron for all intricate work, the large one for outside work. Handy Andy is ideal for radio amateurs and manufacturers, plumbers, garage men, and radiator shops, tin shops and battery service stations. Sent postpaid on receipt of

ONLY \$1.00

With
HESLARADIO

The World is Your Neighbor

- Heslar Equa-Tone Phones \$10.00
- Heslar improved sockets \$ 1.25
- Heslar Var. Condensers
- 23 Plate \$ 3.60
- 43 Plate \$ 4.50



HESLAR
RADIO CORPORATION
INDIANAPOLIS-USA

Dealers! Write today for attractive dealer offer on Heslar Radio Parts and Complete Sets

BELL V. T. SOCKET

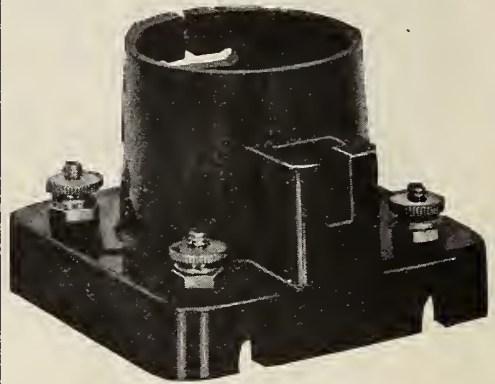

Price \$1.25

Genuine Bakelite. Heavily nickelled phosphor bronze springs, making double electrical contact. Adapted for panel or base mounting.

Reinforced T slot, allowing use of both sending and receiving tubes without adjustments.

Manufacturers of moulded insulation since 1911

BELL MANUFACTURING CO.
13 Elkins Street Boston, Mass.

This Is How
RADIO BROADCAST

Supplements the Easy Course in Home Radio this month

"A Guide for Listeners In" is supplemented this month by "The March of Radio" by Professor J. H. Morecroft.

"Radio Simply Explained" finds its continuance in "King Electron Tells About Detection"—the second of R. H. Ranger's uniquely illustrated articles.

"Tuning and What it Means" is carried on by our article titled "The Selective Double Circuit Receiver" by John V. L. Hogan.

"Installing the Home Set" is dealt with in a very comprehensive article on "Shielded Receivers," by Thomas C. Tibbey.

And the "Additional List of of Broadcasting Stations" makes "Bringing Music to the Ear" a simpler undertaking.

If you do not own the Easy Course in Home Radio, you will find it advertised in this issue. The regular price for the course is \$3.00. The regular price of Radio Broadcast is \$3.00. Our price for both \$5.00. Send your order direct to us.

RADIO BROADCAST
GARDEN CITY, NEW YORK

For Charging Radiophone and Automobile
Batteries at Home, use



The Sterling

Portable Rectifier

It is not necessary to lug your battery to a service station. Rectifier charges your battery without its being disconnected from radio outfit.

Mechanism simple, effective and durable.

One thumbscrew does all adjusting. Either clip can be attached to positive terminal. No danger of injuring battery.

Initial charging rate 6 volt battery either 5 or 10 amps.

Price complete, \$16.00. (West of the Rocky Mts.) \$17.00

We also manufacture: Radio Frequency Transformers, \$6.00; Audio Frequency Transformers, \$4.00; Filament Rheostats, \$1.25; Filament D. C. Ammeters and Voltmeters, \$4.00.

Sterling Pocket Voltmeters for testing Type "B" Batteries: 34-B (0-30volts) \$2.25; 34-C (0-50 volts) \$2.75.

Write for Booklet giving full information

THE STERLING MFG. CO.
2833 Prospect Ave., Cleveland, Ohio

Over two and one-half million Sterling Electrical Devices in use to-day

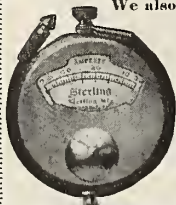



MURDOCK RADIO

WHEN men everywhere *insist* on Murdock apparatus, we realize that *quality* manufacture has imposed on us a *quantity* obligation, sometimes hard to meet.

Examine Murdock apparatus at your dealers.

There are no other phones so good at so low a price. *After* you *have* bought, a 14 day trial privilege assures satisfaction with your purchase.

WM. J. MURDOCK COMPANY

Washington Avenue
1270 Broadway, New York City
509 Mission Street
Chelsea, Mass.
San Francisco, Cal.

No. 56—2000 Ohm—\$5.00
No. 56—3000 Ohm—\$6.00





True Gold,
said Confucius,
'does not fear the fire'
— and
"Grebe Radio
survives the most
exacting tests."

Doctor Wu.

MAKE your radio con-
certs a source of never-
ending entertainment and
delight for yourself and friends.
Tiresome experiments and ad-
justments—unpleasant interrup-
tions and noises are eliminated
in the famous Grebe CR-5.

Correctly designed for thoroughly
satisfactory service on all radio
telephone work. Its range em-
braces all wave lengths from the
amateur to the Arlington time
signal.

A complete regenerative receiver
in which but two simple tuning
adjustments are used.

ASK your dealer to
demonstrate—If he
is unable to do so, send
us his name for inter-
esting circular.

A. H. GREBE & CO., Inc.
Richmond Hill, N. Y.

Grebe Radio Apparatus
is
Licensed under
Armstrong U. S. Patent
No. 1,113,149





The Recognized Symbol of Superior Performance



Amrad Radio Frequency Broadcast Receiver

RADIO FOR THE HOME

OWNERS of Amrad Short Wave Sets are bringing in broadcasting programs from even greater distances by adding the new Amrad 2-Stage Radio Frequency Amplifier to their equipment.

This new Amrad development may be added to any short wave or regenerative receiver. It makes audible many distant stations ordinarily never heard. It does not amplify static or local stations as much as audio-frequency amplification. Connections are easily and quickly made.

If you have an Amrad or other standard short wave set send for Bulletin R describing this 2-Stage Radio Frequency Amplifier. If you have no Set send for Bulletins R and L describing the combination illustrated above.

Complete Amrad Catalogue 10c stamps

AMERICAN RADIO AND RESEARCH CORPORATION

Sales Division

Department 20

MEDFORD HILLSIDE, MASS.

(4 miles north of Boston)

NEW YORK

CHICAGO



Scene from the Opera "Faust"



The New
Star in
the Radio
World

***M**OMENTOUS events in the arts and sciences are the result of rising above out-worn principles, independent of the tools of mediocrity. Beginning where others have been content to finish, a forward-looking group of radio engineers, comprising the Mu-Rad Laboratories, have designed and successfully constructed radio apparatus which is as advanced as the twenty-one-jewel watch is over the key-winder. Prices of this apparatus insure that great numbers will benefit from their achievements. Descriptive literature upon request.*



MU-RAD
LABORATORIES
INCORPORATED
ASBURY PARK
NEW JERSEY

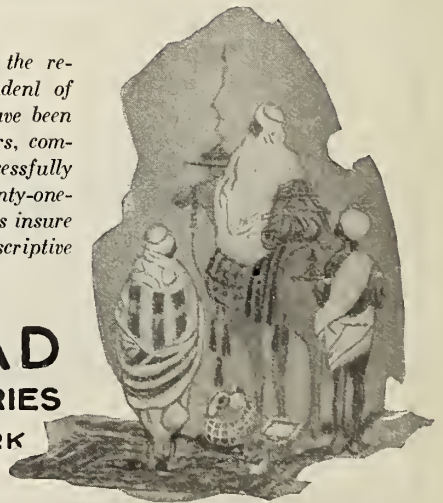

“What’s new in Radio, Mr. Jones?”

Everything’s new in radio, of course, but the newest, most-complete-in-itself device to-day is the



“SOCOSTAT”

(Socket-rheostat)

How Would a “Socostat” Improve My Radio Set?

The “Socostat” saves money, time and material, eliminates the wiring of two separate parts and has no exposed parts. It’s simple to install adds to the appearance of your set to say nothing about the extra efficiency of your receiving apparatus.

You have heard propaganda about the static conditions of the atmosphere during the warm months. With up-to-date radio equipment good results can be obtained under any weather conditions. Try a “Socostat” and you will be convinced of this fact. The static and tube noises will be reduced to a minimum.

I’ll certainly give it a fair trial. If it does all you say I know it will be worth a great many times the initial cost to me. And I am taking no chances as the “Socostat” is guaranteed.

The “Socostat” has a bakelite base and cover. The nickel plated receptacle takes any standard detector and amplifier tube. Rings and screws all nickel plated. The internal rheostat permits

very sensitive filament adjustment by turning the knurled cover. If your dealer can’t supply you, write direct to us. \$2.50 post-paid. Descriptive literature upon request.

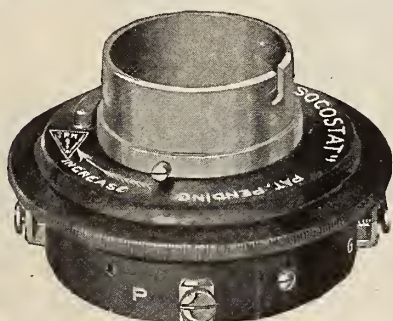

Single-Unit Socket and Rheostat for Table or Panel Mounting

Jobbers and dealers write
Automotive Electric Service Corp.
206 Amsterdam Ave., New York City

Manufactured by

FEDDERS MFG. CO., Inc.

57 Tonawanda St. Buffalo, N. Y.

Radio



The Greatest Radio Offer of the Year—Absolutely Complete, \$49.50

This special receiving outfit will give as good results as any outfit of this improved type on the market. It is absolutely complete, there is nothing extra to buy. We include everything—you simply put up the aerial, connect the instruments, which is easy to do, and in less than half an hour you can be receiving signals, radio music, lectures, stock reports, market reports, or any other radio program sent out.

In making tests with this set in Chicago we regularly heard Detroit, Pittsburgh and other stations were often tuned in. Of course, atmospheric conditions affect the range of this or any other receiving set made.

Highest Development in Radio Receiving

This outfit will equal in results any outfit of this type regardless of price. It is especially made for us and has behind it the fifty year old guarantee of Montgomery Ward & Co.: "Satisfaction guaranteed or your money back." You take no risk whatever in ordering this set.

Long Distance Vacuum Tube Receiving Set

The complete outfit includes our special Combined Tuner and Detector; Special 2000 ohm Double Head Set; Radio Storage Battery; one Detector Tube, one "B" Battery; and complete antenna and connecting equipment including 150 feet bare copper wire and 25 feet insulated wire, porcelain tube; double throw switch; 2 antenna insulators; lightning protector; ground clamp, 2 screw eyes and 25 feet of wire for instrument connections.

Order this set at our risk. It will be packed carefully and shipped immediately from our nearest house. Shipping weight 40 pounds. 563Z599—Complete Outfit..... **\$49.50**

Order this outfit today and start at once enjoying in your home the most marvelous invention of the age.

Price of receiving Set without batteries, head piece, switch and aerial, shipping weight 8 pounds: 563Z598 — \$27.50. Send money order or check to the one of our five houses that is nearest to you.

MONTGOMERY WARD & CO., Dept. 27-R
Chicago Kansas City Saint Paul Fort Worth Portland, Ore.



RADIO CATALOG

FREE

This FREE catalog tells you the kind of Wireless Equipment to own, so that you receive in your own home all the latest news, music, Church services, lectures, —everything that is broadcasted.

Every home should have a wireless telephone outfit. We now offer complete outfits from \$12.95 up.

Everyone interested in radio should see our low prices on parts and accessories. Write for this book. Learn about the miracle invention of the age. Easy to install, simple to operate.

One copy of this booklet is yours FREE. Write for your copy.

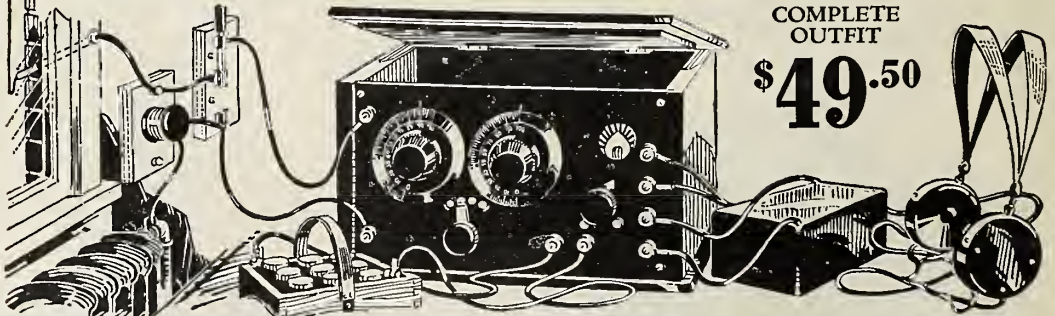

COMPLETE
OUTFIT
\$49.50

Montgomery Ward & Co.

≡ The Oldest Mail Order House is Today the Most Progressive ≡

CROSLEY

Better—Costs Less

Two Outfits That Are Taking the Country by Storm



CROSLEY RECEIVER MODEL VI. This set consists of one stage of Tuned Radio Frequency Amplification and Audion Detector. It is normally for use with head phones, but is especially recommended to be used with any type of loud speaker. Additional amplification is unnecessary if head phones and horn are used in receiving local stations. Price without phones, batteries or tubes.....\$30.00

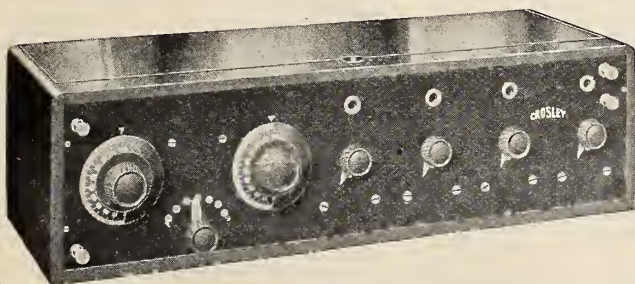

CROSLEY RECEIVER MODEL X. Is the same as MODEL VI with two stages of Audio Frequency Amplification added. In placing this receiver on the market we are offering you a unit whose range, volume and selectivity is remarkable. Nothing can compare with it at twice the price. Developed in the CROSLEY laboratories, this unit is absolutely the last word in long range Radio Receiving Apparatus. Used with head phones and loud speaker it will bring in distant stations all over the house. Price without phones, batteries or tubes, \$55.00

A REVELATION to those who have had the opportunity to try them out, the Tuned Radio Frequency Amplification feature of the CROSLEY MODEL VI and MODEL X and other larger models have met with universal success.

BY PLACING one stage of Tuned Radio Frequency Amplification before the detector tube we not only amplify the signals before they reach the detector, enabling it to work more efficiently, but also make sharper tuning possible and eliminate interference and static to a wonderful degree. These sets are especially designed for broadcast reception, covering a range of from 200 to 600 meters and we believe they cannot be equaled at any price.

WE HAVE not only incorporated every refinement of detail in the mechanical features of our sets, but are offering you a beautiful piece of furniture with highly polished cabinet and neatly engraved formica panels as well. The knobs and dials are of solid moulded composition and of excellent design, making an outfit that will compare with anything on the market.

We also manufacture Receivers for from \$25. up and all kinds of Radio parts.

Write for our new illustrated and descriptive catalogue.

Sold through dealers and jobbers everywhere. If your dealer does not handle CROSLEY instruments write us direct.

CROSLEY MANUFACTURING COMPANY
DEPT. RB 10 CINCINNATI, OHIO



A Word About Price!

*Something that everyone interested
in Radio should know*

THE Automatic Electric Head Set has been developed and completed to give a maximum loudness and clearness under all conditions.

Some of the outstanding features have been discussed in these pages. Price has been quoted at \$10.00, with plug attached \$11.50. This is a fair price. It covers development and manufacturing costs plus a reasonable profit.

On account of the widespread demand for Radio equipment, it is difficult to judge real values by the various prices you see quoted. High price may not necessarily mean commensurate quality. That is why it is safer to buy a product whose origin you know.

Automatic Electric Company has been making high class telephone apparatus for over thirty years. This perfected Radio Head Set is the result of years of experience and technical knowledge, backed by the reputation of this house. And it is our aim to give you the best Head Set ever produced, to fit all requirements.

Some of the Important Points of Superiority of the Automatic Electric Head Sets are:

Single pole construction — (a single powerful electro-magnet which takes effect at the exact center of the diaphragm).

The soft iron magnetic path assures minimum loss of strength and character to the diaphragm vibrations.

The coil design — a single coil wound on a cylindrical core. No sharp corners. The core of the coil is very small and the electric resistance per average turn is correspondingly low.

High resistance, as you know, sounds impressive but means practically nothing. The thing that counts most is PROPER effective impedance. This is governed chiefly by the number of turns of wire, amount of iron in the magnetic circuit, and its construction.

If your dealer sells high class Radio apparatus, he can tell you all about Automatic Electric Head Sets. Ask him. If he cannot supply you, order from us direct. Price is \$10.00, postpaid — with plug attached \$11.50.



Automatic Electric Company

ENGINEERS, DESIGNERS & MANUFACTURERS OF THE AUTOMATIC TELEPHONE IN USE THE WORLD OVER
HOME OFFICE AND FACTORY: CHICAGO, U. S. A.

This is the high grade plug that comes attached, when desired, to Automatic Electric Head Sets. It will take care of any kind of cord terminals, will fit any kind of jack and will accommodate two head sets. With this plug attached to our head set you can be sure the head set is properly "poled."



Ask Uncle Sam He knows!

BY FAR THE BEST FOR RADIO PANELS

Uncle Sam has used Bakelite-Dilecto X. X. on electrical and wireless equipment in the Navy and Signal Corps for over *eight years*.

That's proof this unique material outdoes hard rubber, wood or marble. Uncle Sam does not adopt anything until he has tested everything!

Bakelite-dilecto!!

Amazingly adaptable for RADIO panelling and insulation. Gives positive and permanent insulation and utterly eliminates vibration. Imparts a professional finish to any home-made set.

Tests highest in every particular. Unheard-of dielectric strength (proved constant 5.2). Resists water, heat and milder acids. Cannot warp or swell. Finished a sleek, everlasting black. Tough and hard; yet *easily machined*.

Tell us who your electrical supply man is and we will write you where to get Bakelite-Dilecto X. X. cut to your exact requirements.

THE CONTINENTAL FIBRE COMPANY Factory, Newark, Delaware

Dealer service from

NEW YORK	233 Broadway
ROCHESTER	85 Plymouth Av., S.
CHICAGO	332 S. Michigan Av.
PITTSBURGH	301 Fifth Av.
SAN FRANCISCO	75 Fremont St.
LOS ANGELES	411 S. Main St.
SEATTLE	1927 First Av., S.

bakelite dilecto

GRADE XX

Broadcasting a Message of Radio Reliability

Cotoco

TRADE MARK REG. U. S. PAT. OFF.

Buy by this Name and You Buy Right

COTO-COIL CO. is not a mushroom growth in the Radio Field. We were winding electrical coils long before the radio boom. We are here to stay. Our products are right to hold their own in any comparison for quality. Electrically correct and mechanically accurate. Even the Cotoco Dial is a better product—practically unbreakable, with metal insert to assure smooth action.

**COTOCO AMPLIFYING
TRANSFORMER FOR
AUDIO FREQUENCY**

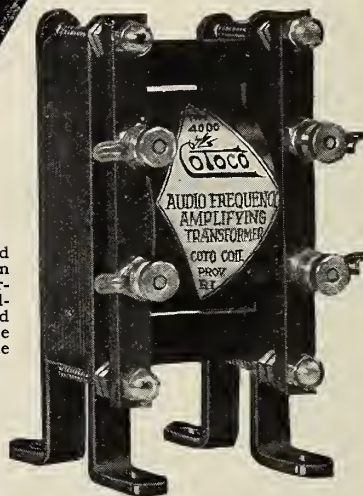

**COTOCO VARIABLE
AIR CONDENSER**

Scientifically correct for minimum of electrical losses. A fine machine product that is as superior as it looks.

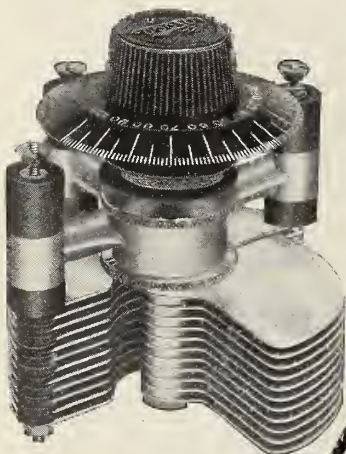

The perfected protection against distortion in headphones or loud speaker. Stable audibility over a wide range of frequencies.

**COTOCO HONEYCOMB
INDUCTANCE COIL**

Yet to find its equal as a compact, neat and remarkably efficient inductance unit. The original. Still the best.

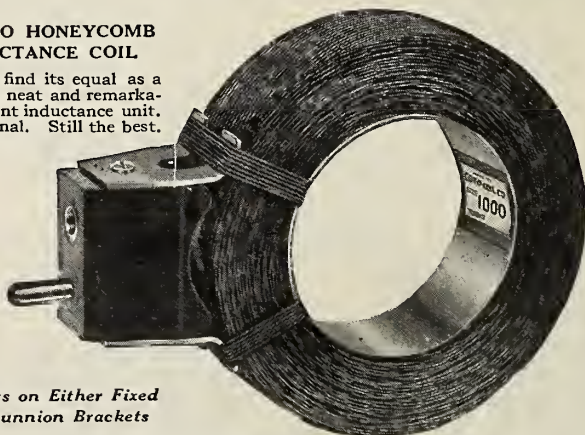

*Send Us Your
Dealer's Name*

if he does not carry Cotoco Products. We will mail you **FREE** Connection Diagrams for Loop Aerial set and see that he can supply you.

**COTO-COIL CO.
87 Willard Ave.
Providence, R. I.**

*Mounts on Either Fixed
or Trunnion Brackets*

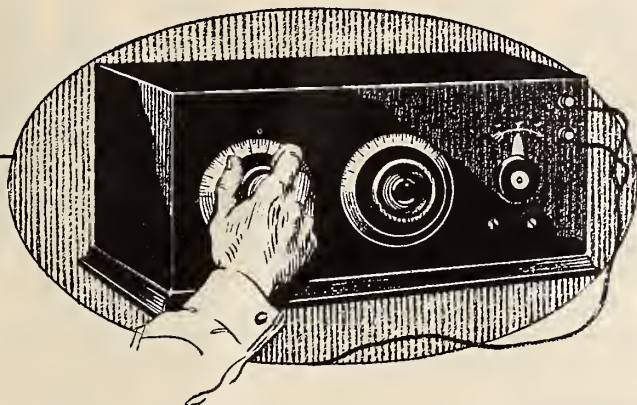

You Can get the best insulation *now!*

ANY dealer can get Formica quickly now so there is no longer any need to use an insulation in which you have less confidence.

Our large capacity makes it possible for us to keep fully abreast of the large radio demand—and to serve all of our customers promptly.

When you insist on Formica you get an insulation that is approved by the navy and signal corps—and one that is known by the makers of the finest radio apparatus as being leak-proof, warp-proof, and remarkably uniform in insulating quality.

Formica works well with ordinary tools. You can produce a perfect panel, and all you need is a drill. It has a wonderfully attractive finish and holds it during a long life. Dampness, fumes, chemicals, do not injure Formica. It is almost immune to conditions.

That is why it is the most popular of all radio insulating materials.

*DEALERS: We have many valuable dealer helps.
Store cards, folders, plates for advertising. Call on
us for coöperation.*

THE FORMICA INSULATION COMPANY

4628 Spring Grove Ave.
Cincinnati, Ohio

SALES OFFICES

50 Church Street... New York, N. Y. 414 Finance Bldg... Cleveland, Ohio 422 First Avenue... Pittsburg, Pa.
9 South Clinton Street... Chicago, Ill. 1042 Granite Bldg... Rochester, N. Y. 1210 Arch Street... Philadelphia, Pa.
415 Ohio Building... Toledo, Ohio 313 Title Building... Baltimore, Md. Sheldon Building San Francisco, Cal.

FORMICA

A Laminated Phenolic Condensation Product
SHEETS TUBES RODS

BRACH vacuum LIGHTNING ARRESTER

The Highest Development in Radio Protection

Ordinary common sense will lead the average radio user not only to comply with the rules of municipal authorities to insure the safety of his radio equipment, but he will do it to make possible clear signals and enjoyable entertainment.

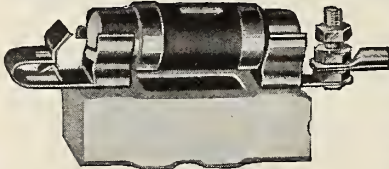

Indoor Type, \$2.50

Unless static interference is nullified there is bound to be disappointment no matter how well planned the concerts and lectures at the broadcasting stations.

The Brach Vacuum Lightning Arrester has demonstrated its superiority through over 16 years of service to the big railroad and telegraph companies, large fire alarm systems and the U. S. Army. It is built up to a standard; not down to a price.



Outdoor Type, \$3.00

Listed by the Underwriters' Laboratories.

Sold by Leading Radio and Electrical Dealers

L. S. BRACH MFG. CO. Newark, N. J.

16 Years' Specialists in Lightning Protective Apparatus
Makers of Solderall—Mends Metals; Connects Wires

Coast Representatives—Pacific States Electric Co.
San Francisco, Los Angeles, Oakland, Seattle, Portland, Spokane

BUS-BAR JACKS

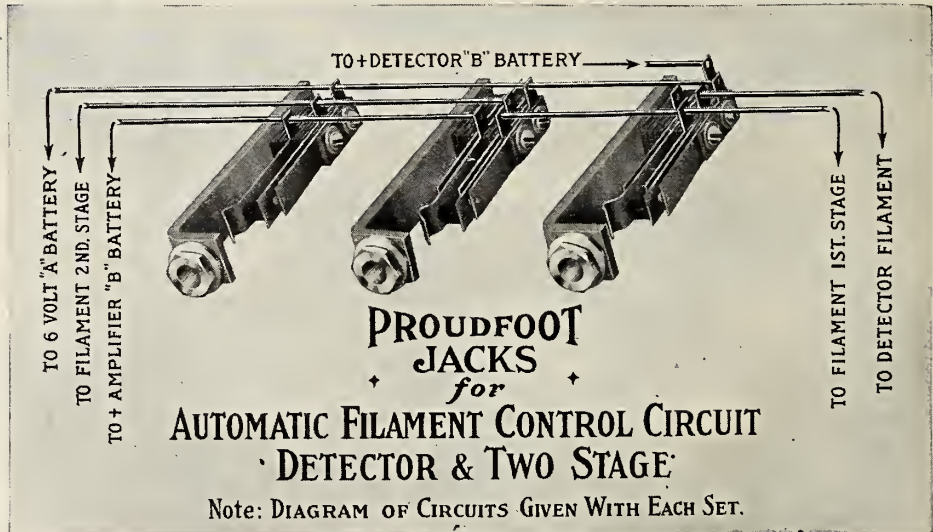

Price Per Set \$3.00

CRUVER MFG. CO., 2456 W. Jackson Blvd., Chicago, Ill.

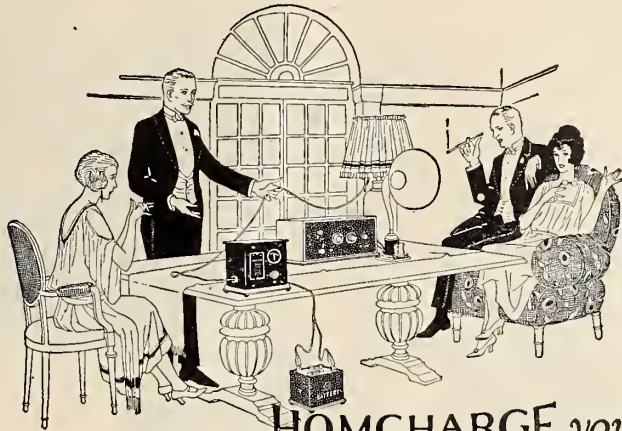

HOMCHARGE your Radio Battery for a nickel!

Enjoyable Radio Concerts and maximum receiving range are obtained only when your battery is fully charged. Don't be bothered with the inconvenience and expense of taking your battery to a service station every few days for recharging.

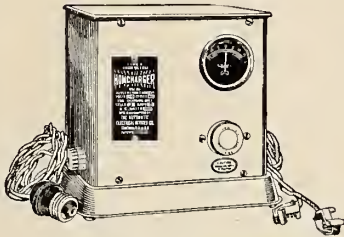

Type "R" (Portable)
Radio Homcharger De Luxe

RADIO HOMCHARGER DE LUXE

has been designed especially for this purpose. It charges your "A" or "B" battery over night without removing it from your living room. The Homcharger is silent and clean in operation—no muss—no trouble—no dirt—requires no watching.

Simplicity itself. Attach to any lamp socket and connect to battery. Fully automatic in operation—cannot overcharge or injure the battery. Constructed of the best materials—moulded Bakelite Base—Jewell Ammeter—Oversize Silicon Steel Transformer. No castings to break—only the finest stampings used thruout.

SAFE—all parts entirely enclosed—no danger from fire—approved by Fire Insurance Underwriters everywhere. Unconditionally guaranteed—lasts a lifetime.

An Ornament For Your Living Room

Beauty has been combined with utility in the NEW RADIO HOMCHARGER DE LUXE. The body is beautifully finished in rich Antique Mahogany—the base and fittings in a handsome dull gold. Equipped with rubber feet, it cannot mar polished surfaces. It harmonizes with the finest living room.

Over 50,000 HOMCHARGERS IN USE

50,000 users have heartily endorsed the HOMCHARGER. Beware of imitations when buying as *there is only one HOMCHARGER. Insist on the genuine which bears our registered trade name, HOMCHARGER.*

Furnished complete with attachment cord and plug, charging cable and battery clips. No extras to buy. Price at all good radio, accessory and electrical dealers, \$18.50, or shipped prepaid upon receipt of purchase price, if your dealer does not carry it.

Booklet illustrating the NEW RADIO HOMCHARGER DE LUXE in actual colors is FREE for the asking. Send for your copy today.

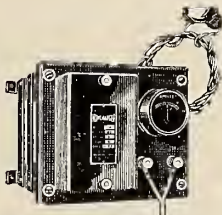

Type "W" Homcharger for
Wall Mounting
Over 50,000 in Use

The Automatic Electrical Devices Co.
128 West Third Street Cincinnati, Ohio

Largest Manufacturers of Vibrating Rectifiers in the World

*BRANCH OFFICES: New York - Chicago - Pittsburgh - Detroit - Dallas - Philadelphia
Los Angeles - Baltimore - Minneapolis - Kansas City - St. Louis - Atlanta.*

KENNEDY EQUIPMENT

*The Standard by which
to judge Radio Equipment*

SO careful has been the manufacture of Kennedy Equipment since its inception that radio enthusiasts everywhere proclaim it the standard by which to measure all radio receiving apparatus.



Kennedy Regenerative Receivers are licensed under Armstrong U. S. Pat. No. 1,113,149, and are sold by good dealers everywhere.

KENNEDY

*Short-Wave
Regenerative Receiver
Type 281*

is a sturdy example of the quality which has made the name Kennedy synonymous with good radio equipment everywhere. Type 281 possesses selectivity and efficiency to a high degree, these features being insured by the correct use of inductively coupled circuits.

WRITE FOR LATEST BULLETIN C-3
Address our nearest office

The COLIN B.

KENNEDY

COMPANY

INCORPORATED

SAN FRANCISCO U. S. A. SAINT LOUIS

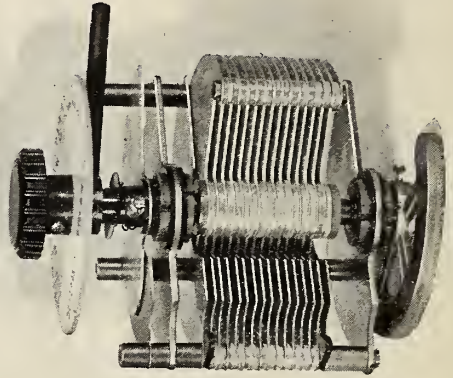

Thanks For Your Patience!

THE radio public was very patient when we were unable to supply De Forest Vernier Condensers, because they knew that all we could make were going into the famous De Forest MR-6 Receiving Sets.

Now, however, you can have the satisfaction of putting genuine De Forest Condensers on that special set you are building. The CV-1003 and CV-1503 Vernier Condensers are now again available. Production has been increased as fast as was possible—always remembering the maintenance of De Forest quality.

It is only necessary to remind you of some of the reasons why these Condensers have been declared perfection by radio experts. The movable plates are heavier than those in any other. The separately controlled Vernier plate gets you "in on the peak" and gives you 20 per cent. louder signals. The securely fastened counterweight acts as a balance and permits smooth, accurate operation in any position. Each Condenser is individually tested at 500 volts. The whole construction is a fine example of scientific precision laboratory equipment.

Used with De Forest Honeycomb Duo-Lateral Coils these Condensers provide tuning equipment unsurpassed for selectivity, sharpness, and all-round efficiency.

De Forest Radio Tel. & Tel. Co.
Jersey City, N. J.



Exide

BATTERIES



How will you choose your battery?

If you are technically inclined, you will be much interested in the construction of the Exide Battery designed especially for radio. From plates to connector terminals, each detail is the result of experience gained in every field by the oldest and largest manufacturers of storage batteries in the world.

If you buy a battery on reputation, consider these facts: Exide was the pioneer battery not only in the automobile but long before the days of automobiles. Great industries of all kinds rely on the Exide's ungrudging power. Every time you use the Bell telephone an Exide Battery sends your voice over the wire. Most of the government and commercial wireless plants are Exide-equipped.

The Exide Radio Battery gives uniform filament current for all types of vacuum tubes. It is rugged and long-lasting.

You can get an Exide Radio Battery at every place where radio equipment is sold and at all Exide Service Stations.

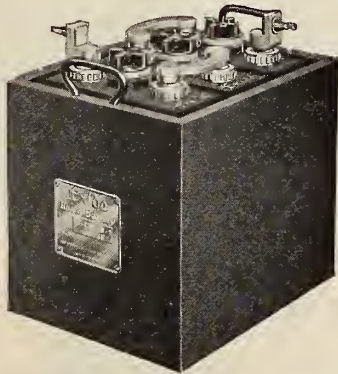

THE ELECTRIC STORAGE BATTERY CO.
Philadelphia

*Oldest and largest manufacturers in the world of
storage batteries for every purpose*

You Get Better Results With Erla Radio Frequency



Voice and music a thousand miles distant are heard perfectly through a loud speaker, using only one stage of ERLA radio frequency amplification. And this result is accomplished with complete absence of tube noises and distortion. Furthermore, tuning is extremely simple and non-critical, so that even the most inexperienced amateur has no difficulty in getting perfect results. Write for free diagrams of hook-ups. Address Dept. B

Electrical Research Laboratories, Chicago

On sale by first class dealers.
Or send us your order direct,
with your dealer's name.
Special proposition to jobbers.

Price: Types AB1, AB2, AB3,
\$6.00 each

Write for literature and prices
on bezels, phone plugs, tube
sockets, grid leaks, grid con-
densers, and other standard
ERLA products.

ERLA

TRADE MARK REGISTERED

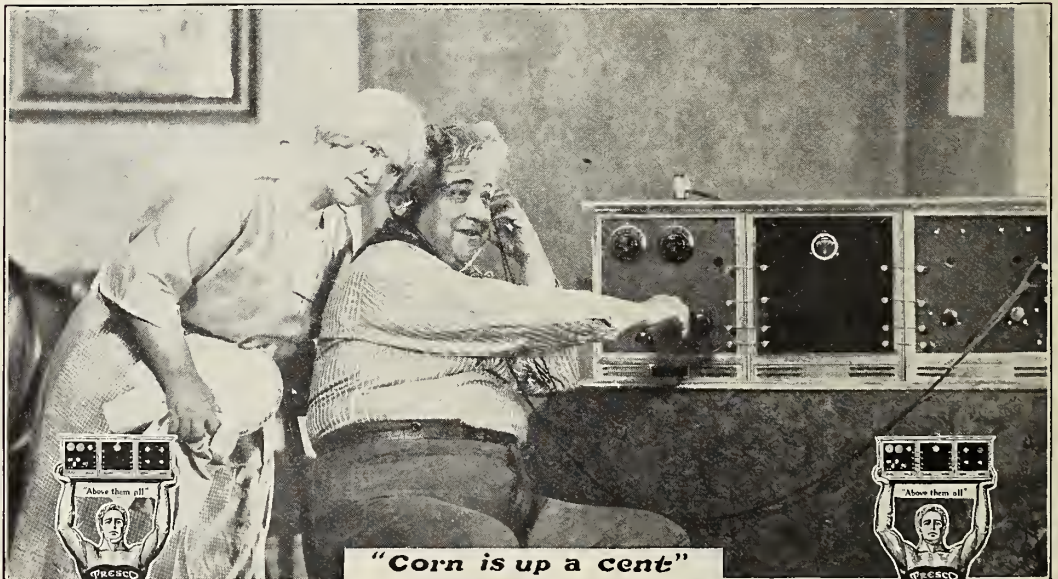

"Corn is up a cent"

Lic. Under Armstrong U.S. Pat. 1,113,149



PRESCO

J. Matheson Bell, Sales Mgr.

Davenport, Iowa, U.S.A.





“How to make your radio set work best”

IN ORDER to make your radio set work, let's briefly consider the requisites necessary and then apply a definite method to achieve this end.

To receive signals of maximum intensity, the open and closed circuits of the receiver *must be accurately tuned to each other and to the frequency of the incoming wave.* Tuning in the circuits of a radio receiver is accomplished by means of the variable elements of inductance and capacity.

The best results in tuning to a wave length are obtainable by means of a variable condenser, always providing that this instrument has been constructed with *micrometer exactness* as is the Westwyre Variable Condenser.

Not only does this instru-

ment enable you to more readily *select the station you desire* where two or more are broadcasting at approximately the same wave length, but *it tends to increase the strength of incoming signals* and *eliminate interferences* from near-by stations which ordinarily drown out those farther off.

In a weighing operation, weights of several pounds are first placed on the scales, while the delicate balancing is accomplished by a sliding beam-weight. So in a radio set the inductance may be varied in rather large steps while the finishing off is left to one or more Westwyre Variable Condensers which are capable of exceedingly fine wave length adjustment.



43 plate, .001 mfd with dial - - - \$5.00
23 plate, .0005 mfd with dial - - - 4.00

11 plate, .00025 mfd with dial - - - 3.50
3 plate, vernier with dial - - - 3.00

Westwyre Variable Condensers



THE WESTWYRE RADIO CO., Westfield, Mass., U. S. A.

I am attaching money order check forPlate, Westwyre Condenser, shipped by parcel post.

Please send radio catalogue.

Name
Street.....
City



**"As good
as Brandes"**

ONLY if a headset bears the name Brandes can it be "as good as Brandes." And genuine Brandes *Matched Tone* headsets cost no more than less sensitive and less rugged imitations.

Send ten cents in stamps for the "Beginner's Book of Radio," which explains radio in terms that anyone can understand.

Distributors and District Offices:

Munsey Bldg., Washington, D. C. 76 Pearl St., Boston, Mass. 33 S. Clinton St., Chicago, Ill. 709 Mission Street, San Francisco, Cal. International Electric Company, Wellington, N. Z.

C. Brandes, INC.
"Matched Tone" Headsets
TRADE-MARK REG. U.S. PAT. OFF.
237 Lafayette St., New York

Made in Canada by Canadian Brandes, Ltd., Toronto
Distributed by Perkins Electric, Ltd., Montreal

Result of 14 Years' Experience

Making the Most of Radio with DUBILIER Products



No antenna, no loop — just the Ducon in a lamp socket.

SCREW the Dubilier Ducon into any lamp-socket. No antenna or loop is required.

The Dubilier Ducon is a perfect safety device. It prevents the lighting current from reaching the set and permits only the feeble radio oscillations to pass.

Price, at your dealer, \$1.50.

Dubilier Micadons Reduce Tube Noises

Tubes howl partly because condensers fluctuate in capacity. Dubilier Micadons are *mica* condensers *permanent in capacity*. Hence they reduce tube noises and greatly improve the reception of broadcasted concerts and lectures.

Dubilier Micadons, made in several types, meet every radio need. The price varies from 35 cents to \$1.00 each, depending on type and capacity.



Micadon type 600. Molded case. With and without grid-leak mounting. Price 75c to \$1.00 each, depending on capacity.



Micadon type 601. Made with eyelet terminals. Price 35c to 40c each, depending on capacity.

BRANCH OFFICES:

San Francisco, Cal. 709 Mission Street, Suite 701-704
St. Louis, Mo. Syndicate Trust Building, Suite 1409
Washington, D. C. Munsey Building
Chicago, Ill. 15 E. Monroe Street

DUBILIER
Condenser & Radio Corp.
48-50 West 4th St. N.Y.

Jobber and Dealer orders now being filled

Canadian Distributors: Canadian General Electric Co., Toronto, Canada

AMPLIFICATION

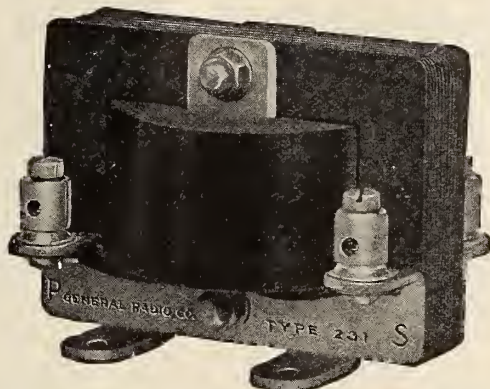

Amplification was first made practicable by the use of the three electrode tube. To take full advantage of the amplifying feature of the vacuum tube, the impedance of the grid circuit of the amplifier tube must be adapted to the impedance of the plate circuit of the detector, or preceding amplifier tube. This correct arrangement of impedance values can best be accomplished by a transformer. The primary and secondary windings, as well as the magnetic circuit can then be designed so as to give the maximum change of potential on the grid of the amplifier tube.

Amplification in this manner is only about a decade old. One of the first companies to design amplifying transformers was the General Radio Company. This Company has, furthermore, the distinction of being the first in this country to supply the experimenter with a closed core amplifying transformer.

Since the introduction of the first transformer, the subject of amplification has received much attention in our research laboratory and new improvements have been developed from time to time. Our Type 231-A amplifying transformer represents a six-year study of the problems of amplification. It embodies the best features in amplifier design.

There are several transformers on the market to-day having as high an amplification factor as the Type 231-A transformer. At certain resonant points, some are even higher. Extraordinary amplification at a single frequency is seldom to be desired. High amplification over a wide band of frequencies is the true measure of a satisfactory amplifying transformer. With the increase in radio telephony, this feature is not only to be desired but is essential. It is in this feature that the Type 231-A amplifying transformer excels. It is designed to give the maximum amplification possible without distortion when used with a Radiotron UV-201 vacuum tube.

The core construction is such that there is little tendency for the setting up of external fields with the resultant howling in the audio frequency circuit. The distributed capacity of the secondary is low so that the maximum potential is obtained on the grid of the tube.

The constants of the transformers are as follows:

	Primary	Secondary
Direct current resistance.....	1,100 ohms	5,500 ohms
A. C. resistance @ 1,000 cycles.....	11,000 ohms	130,000 ohms
Reactance @ 1,000 cycles.....	66,000 ohms	700,000 ohms

PRICE, COMPLETELY MOUNTED, \$5.00

Send for Free Radio Bulletin 911-B

GENERAL RADIO COMPANY

Massachusetts Avenue and Windsor Street

CAMBRIDGE, 39

MASSACHUSETTS

Standardize on General Radio Equipment Throughout

Federal RADIO APPARATUS

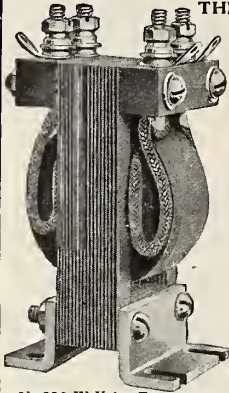

No. 226-W Voice Frequency
Amplifying Transformer

THE RECOGNIZED STANDARD
YOU WILL BE REPAID IN SATISFACTORY
RESULTS if you equip your set with

Federal PARTS

We illustrate here two articles that were in general use throughout the WORLD WAR in Army and Navy equipment and have met with the hearty endorsement of the Radio Fan ever since. They represent the highest degree of perfection yet attained in Radio Apparatus and are typical of the complete line we manufacture.

FOR SATISFACTORY RESULTS
INSIST THAT YOUR DEALER SUPPLY GENUINE FEDERAL EQUIPMENT

**Federal Telephone and
Telegraph Company**
BUFFALO, N. Y.



CHELSEA Variable Condensers (Die-Cast Type)



No. 1. Price \$5.00

Amplifying Transformer No. 50

The Chelsea Amplifying Transformer gives the highest amplification possible and at the same time will not squeal, howl, or in any way cause noisy circuits. It is beautiful in design and embodies electrical characteristics unequalled by any. Guaranteed for all circuits up to 500 volts with a high safety factor. It will not fail in service.

Purchase Chelsea Radio Equipment from your dealer. If he does not carry it send to us. Write for our new No. 6 catalogue.

CHELSEA RADIO CO., 150 Fifth Street, Chelsea, Mass.

Manufacturers of Radio Apparatus and Moulders of Bakelite and Condensite.

No. 1—	.0011 m.f. mounted	\$5.00
No. 2—	.0006 m.f. mounted	4.50
No. 3—	.0011 m.f. unmounted	4.75
No. 3—	.0011 m.f. unmounted, without dial	4.35
No. 4—	.0006 m.f. unmounted	4.25
No. 4—	.0006 m.f. unmounted, without dial	3.85

Top, bottom and knob are genuine bakelite, shaft of steel running in bronze bearings, adjustable tension on moveable plates, large bakelite dial reading in hundredths, high capacity, amply separated and accurately spaced plates.

Unmounted types will fit any panel and are equipped with counterweight.

Guaranteed for circuits up to 1,000 volts.

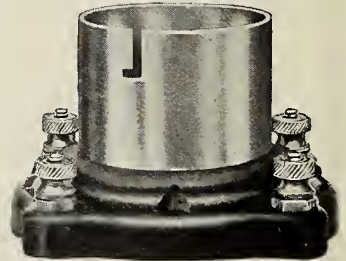

Price \$1 00

Bakelite Socket No. 60

This socket includes a bakelite base supporting four external readily accessible binding posts. The tube receptacle is highly polished nickel and will take any standard detector or amplifying tube as well as the smaller size power tubes. Although primarily intended for receiving circuits it will operate satisfactorily on any circuit up to 1,000 volts. It may be mounted either on table or panel. Positive contact springs.

An added beauty to any radio station.

Price \$4.50





"Comin' In Great!"

At Last! —

High Efficiency Receivers at a Down-to-Earth Price

ELEVEN years in the manufacture of delicate electrical units and apparatus—eleven years concentrated in the production of one line of equipment—all electrical, *means* something in accumulated experience and facilities.

That's the answer to how we have been able to place on the market this super-sensitive radio head set for \$6.00.



All the high-priced qualities. Sensitiveness—balance—natural voice pitch—no scratching. Light weight, aluminum case—solid horse shoe magnet—no laminations—bus-bar connections, no loose wires.

Light diaphragm, set to thousandths-of-an-inch accuracy from magnet poles. Clean cut, rugged design throughout. Comfortable on the head—good to look at. Compare them with other makes irrespective of price and you'll be convinced they're quick sellers.

Write for exceptional dealer proposition and name of our local factory representative nearest you.

Briggs & Stratton Co.
Milwaukee  Wisconsin



Put up in attractive orange-colored cartons

2000 Ohm.....\$6.00
3000 Ohm.....\$7.50



Tune 20 times faster

The "Amplitrol" controls the amplifier tube circuit without the use of jacks, plugs or any additional switches. No necessity of plugging in from one stage to the next—simply attach phones or loud speaker to binding posts and turn on any stage at will.

The "Amplitrol" not only adjusts the filament to its maximum efficiency, but it automatically controls the plate circuit at the same time, thus eliminating an extra operation. Unlike an automatic filament control, the "Amplitrol" does not put a sudden strain on the filament. A real necessity for amplifier tubes. **Price \$4.00.**

The Amplitrol
PAT. PEND.

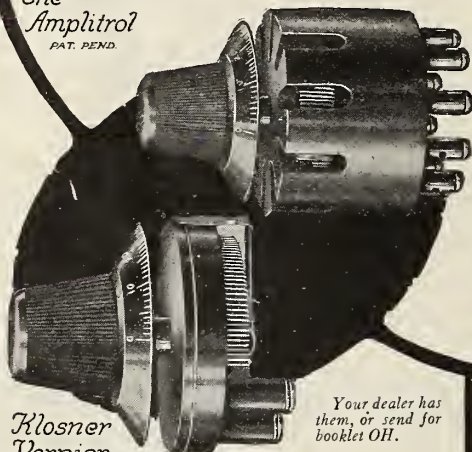

Klosner Vernier Rheostat Model 200
PAT. PEND.

Your dealer has them, or send for booklet OH.

What the "Amplitrol" is to the amplifying tube, so the Klosner Rheostat is to the detector tube. The new improved Rheostat Model 200 embodies some vast changes and improvements.

These are too numerous to list, but your inspection will immediately win your approval. **Price \$1.80.**

The "Amplitrol" and the Klosner Rheostat are the ideal combination for vacuum tube control. They do not employ the graphite-disc principle, but that of wire wound. This feature insures perfect contact at all times, making tuning 20 times quicker and louder and giving greater range.

Klosner Improved Apparatus Company
2024 Boston Road ~ ~ New York



for **SATISFACTION**
demand these high quality radio parts

Bethlehem Variable Condensers

Capacities .001, .0005, .00025 M.F. and Vernier. \$2.50 to \$4.00

Bethlehem Radio Plugs

Type AX1, standard; and AX2, universal. \$1 each.

Bethlehem Radio Jacks

Type BX1, open circuit, 60c. BX2 closed circuit, 75c. BX3, double circuit, 90c. BX4, single filament control, \$1.10 each.

Bethlehem Radio Tool

Invaluable for many assembly operations. 75c. each.

Bethlehem Radio Dials

70c. each.

Every BETHLEHEM product is GUARANTEED to be exactly as described and free from all defects in materials and workmanship

Write for full descriptions. Ask for dealers' names.

Bethlehem Spark Plug Company, Inc.
Bethlehem, Pennsylvania

bethlehem

1898---1923---25 Years Experience in Head Phone Equipment *Your Guarantee*



YOU will be surprised at the clear, distinct ring of the message received over the Leich Radio head phones. This company began making head sets in 1898—thus the refinements and improvements of years of actual service tests are incorporated into the Leich head phones.

The head band is light—both ear phones fit evenly and firmly, and can be worn for hours without discomfort—the band can be adjusted by the thumb nut, and remains fixed—no readjustment is necessary.

No. 1-D.	1500 ohms	- - -	\$ 7.00
No. 1-B.	2000 ohms	- - -	7.50
No. 1-C.	3000 ohms	- - -	10.00

Equipped complete with head band and 6 ft. cord
Ask your dealer—if he cannot supply write us

Leich Electric Company
Genoa, Ill.

no ground aerial

The A-P Special Receiving Set

One of the most important, most revolutionary developments since the discovery of radio. The receiving set thousands have been waiting for. A set that requires no ground, no aerial. For general use a single wire not exceeding 15 feet in length, concealed in the picture moulding, laid on the floor, or, if out-of-doors, placed on the ground, is all that is necessary. Stations 400 miles distant have been heard under these conditions. For distant service a wire not over 50 feet long will produce better results than can be obtained with the elaborate 150 to 200 feet aerial and ground, or loop system required by other types of receivers.

The A-P Special has the apparent advantages of radio frequency amplification without its delicate and complicated adjustments. It is remarkable for its simplicity of control and marked selectivity, and ideal both as a home set and for use as a portable in camping or outing.

Bulletin B contains complete information on this wonderful set. Write for it and name of our nearest dealer. We are now in position to make prompt shipments.

The Oard PHANTOM
no ground circuit

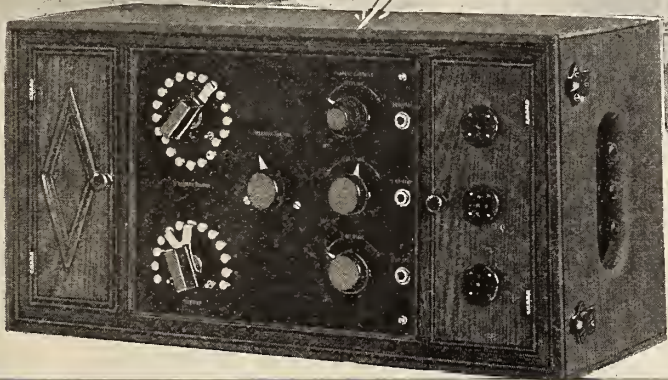
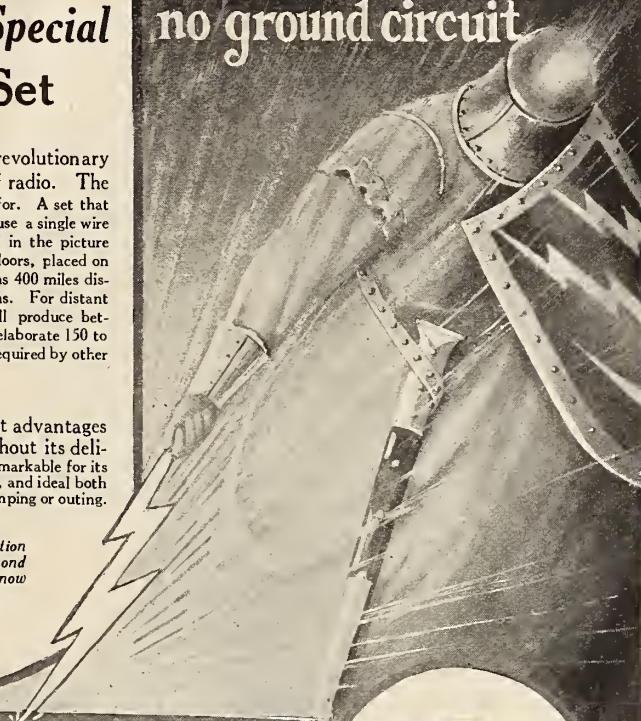

Set closed with cover
for use as portable

U.S. AND FOREIGN
PATENTS PENDING

Atlantic-Pacific Radio Supplies Co.
 Operating K.Z.Y. 646-650 Mission St. Radio
 Broadcasting Station San Francisco, Cal. Supplies

ELIMINATE OUTSIDE AERIAL USE LIGHT CIRCUIT

No longer is it necessary to contend with the dangers incident to stringing antenna wires. You can now listen to the world by just inserting "Super-Antenna" plug in any electric light socket. This unit has been designed by one of the country's foremost Radio Engineers. *Gives perfect results—Saves expense.* Operates on any electrical circuit D. C. or A. C. with switch "ON" or "OFF."

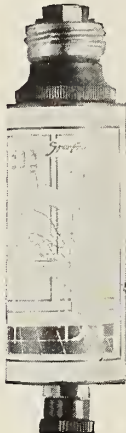

MAKES YOUR RADIO SET PORTABLE

By using the "SUPER-ANTENNA" unit you can move your set from room to room, or house to house. *Entertain your friends anywhere.* This wonderful unit safeguards your set. Eliminates A. C. hum—is shockproof—will not blow fuses and reduces static effect. Has 8 different hook-ups that give good results on any circuit. **ORDER TO-DAY. Price \$2.80** If your dealer cannot supply you send us his name enclosing check or money order. West of Rockies \$3.00. Canada \$3.70.

F.R.L. Super-Receiver—Radio Frequency

This set is months ahead of any other unit offered the Radio Public. Made of best materials obtainable—tested by skilled engineers and gives perfect modulation of music, speech, and signals without distortion.

30 Mile Range without Antenna or Ground

This unit has 1,000 mile receiving radius and a range of 150 to 600 meters. Has no equal for sensitiveness and efficiency. **Price including tubes \$240.00.**

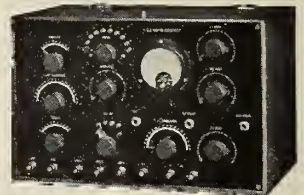

DEALERS and JOBBERS—Wire or Write for Discounts and Special Territory.

SUPER-ANTENNA COMPANY

Dept. 910

Quincy, Ill.



FROST-RADIO PROTECTOR

Listed by Underwriters' Laboratories under April, 1922, regulations. No interference with clear Radio receiving.

**Never Grounds
Mounts Indoors**

Price \$1.50

Good deliveries on
this approved device.





FROST-RADIO Extension Cord and Plug

Comes in lengths from 10 to 100 ft. Loud speaker can be placed anywhere and connected with Radio set with FROST-RADIO Extension Cord.

OTHER FROST-RADIO LEADERS

Frost-Fones Frost-Radio Improved Plugs and Jacks
Frost-Radio Receiving Transformers Cunningham Vacuum Tubes
Remler Radio Apparatus

Inquire of your Local Dealer.

HERBERT H. FROST

NATIONAL FACTORY DISTRIBUTORS
TO THE ELECTRICAL-RADIO JOBBER
154 W. LAKE ST. CHICAGO, ILL.



The Mark of the Quality Radio Store—



WHEN you see this sign on the clean plate-glass window of a radio shop *you may enter*—assured that the apparatus and prices are right; the stock complete; a competent radio expert in charge;—and the Golden Rule in force.

"It pays to buy at the Sorsinc Store"

Mr. Dealer:—If you are a progressive merchant, you may display the Sorsinc sign. Let us tell you how.

Ship Owners Radio Service, Inc., 80 Washington Street, New York
Wholesale Distributors

EISEMANN

WITHIN the last few months many concerns have engaged in the manufacture of radio parts, and the market has become flooded with apparatus of varied design and wide price range.

Obviously, greater discrimination must be practised by the buyer of radio materials.

Is not the guarantee of a responsible Corporation a factor to be considered? For twelve years the Eisemann trademark has been recognized in the automotive industry, as an assurance of quality and dependability. The same high standards are maintained in the manufacture of radio parts.



**Audio Frequency
Amplifying
Transformer**

This part used as an intervalve unit in a cascade amplifying outfit, utilizes to the highest degree amplifying properties of all makes of vacuum tubes. Maximum amplification within the tube limits is made possible and distortion of the signal is eliminated. The ratio is nine to one.

Highest degree of insulation of the primary and secondary windings is assured by the vacuum impregnating process in manufacture.

Price each \$6.00



Head Set

The Eisemann Head Phone will faithfully reproduce all broadcasted musical and spoken sounds. It is of simple design, yet rugged and sturdy of construction. The set is unequalled for quality of tone and balance of the receivers.

Specifications:

- Receiver case—aluminum.
- Coils—wound with highest grade enamelled insulated copper wire.
- Resistance—2,200 Ohms.
- Magnets—High percentage tungsten steel—permanent.
- Diaphragm—Rust-proof.
- Cord—Six foot.
- Head Band—Approved spring wire—self-adjusting sliding rod type.

Price complete—\$8.00



**Vacuum Tube
Socket**

The contact points or fingers are supported by a single piece, tempered steel spring of proper tension. The four terminals are insulated from this spring by Bakelite insulation.

The socket is an all-metal, non-breakable type with provisions for table or panel mountings.

Price each 50c

Send for Folders describing Eisemann Radio Equipment.

RADIO DIVISION
EISEMANN MAGNETO CORPORATION

William N. Shaw, President

32 - 33rd Street, Brooklyn, N. Y.

DETROIT

CHICAGO

The radio industry is still young. The manufacturers who are looking to the future are building for permanence. That is why we put every ounce of our ability into the making of

UNION RADIO Apparatus and Accessories

That we are justified in this endeavor is attested to by the popularity Union Radio equipment has attained in the eyes of radio fans who are demanding quality and "best result" performance.

Our expert engineers are constantly at work on new improvements. Pictured below is the new (patent applied for) Union Radio Filament Rheostat.

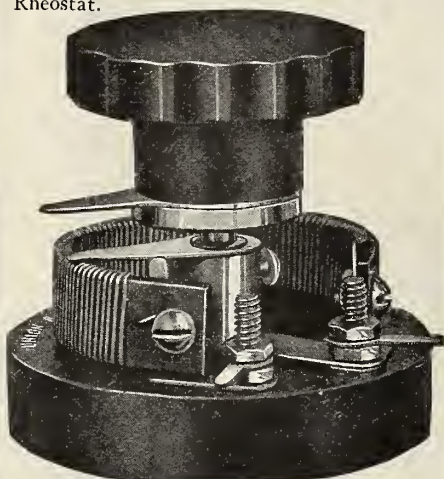

Price with Knob (as shown above) \$1.20
Price with 2 1/2 in. Condensite Dial \$1.50

Base Knob and Dial Genuine Moulded Condensite

This Rheostat, our Vacuum Tube Receptacle and our Phone Tip Jacks (all patents applied for) are only three of the new developments that are making Union Radio apparatus and accessories such favorites.

We guarantee without reservation all Union Radio apparatus and accessories as to workmanship and materials.

Union Radio products include complete receiving sets, 2 step amplifiers, variable condensers, condensite dials, filament rheostats, receiving vacuum tube receptacles and telephone Tip Jacks.

Write now for your copy of our catalogue, "Radio Apparatus B."

Retailers and Wholesalers

Samples of our guaranteed, reasonably priced "Quality Products," sent on request. Our terms and trade discounts are liberal. Write for our proposition.

UNION RADIO CORPORATION
200-MT PLEASANT AVENUE, NEWARK, N.J.
NEW YORK OFFICE 116-WEST 32ND-STREET

AUDIOLA

CHICAGO

GET acquainted with Radio by buying an Audiola Crystal Receiving Set.

The 23-plate variable condenser insures sharp and accurate tuning. It is a complete unit, in a rich mahogany finished case, with nickel plated fittings.

Needs no batteries, no tubes, no fussing. Just connect it with aerial, ground and head phones, and "listen in."

Price \$10 Complete

(without headphones)
At your dealer or write direct for illustrated booklet.

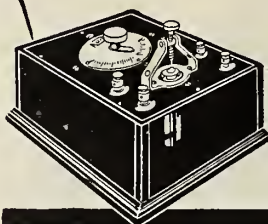

Audiola Radio Co.
430 S. Green St., Chicago

We can use a few high-class representatives for exclusive territory.



Our Radio Department is conducted by electrical engineers, which assures you dependable and highly efficient Radio equipment, either in complete sets or separate units, such as Head Receivers, Variocouplers, Variometers, Cabinets, Detectors, Antennas, Rotary Spark Gaps, Sliders, Panels, Dials, Knobs, Condensers, Grid Leaks, Contacts, Galena Crystals, etc.

We especially recommend our popular Receiving Set, RESODON, which is one of the most desirable outfits for the home, club, etc. This set comes in a beautiful mahogany finished cabinet. Write for literature.

PAUL G. NIEHOFF & CO., Inc.

Electrical Laboratories and Manufacturers

240 E. Ohio Street

Chicago, Illinois



Na-ald Small-Space V. T. Socket

35c Each; 3 for \$1.00

Moulded genuine Condensite. Requires but small space for mounting. Readily accessible binding posts. No excess metal to interfere with efficiency. Unaffected by heat of bulbs or soldering iron. Phosphor bronze contacts; nickel plated brass binding screws. Slash-cut slot. Prices possible only because of enormous production.

Special proposition for dealers and jobbers

Alden-Napier Co.

52 Willow St., Dept. B.

Springfield, Mass.

Gilbert Radio Apparatus



No. 4084
Variometer



No. 4082. Variable Condenser

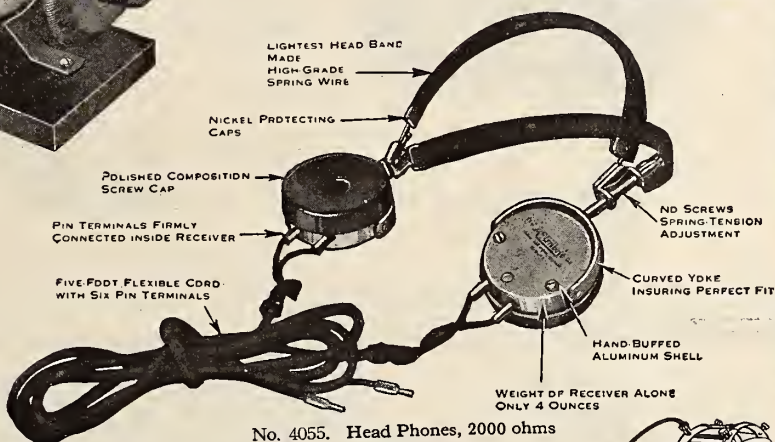

No. 4055. Head Phones, 2000 ohms

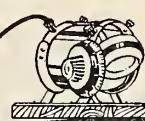

Quality Radio Parts at Popular Prices

From the very beginning of Radio, Gilbert Radio Apparatus has kept pace with the times. As new developments were found to have merit, we were among the first to put them on the market.

Our engineering department is constantly in touch with Radio improvements; therefore when you buy Gilbert Radio Apparatus you can be sure it is not only the best but the latest in its field.

Gilbert Radio Parts are scientifically constructed instruments, carefully and sturdily built, and so designed that anyone can build a Radio Receiver second to none. All of the most necessary and advanced parts are included in the Gilbert Line, some of which are illustrated above.

Write for Catalogue No. 55, just off the press

THE A. C. GILBERT COMPANY
Dept. H, New Haven, Conn.





RADIO HEAD PHONES "MELLOTON"

Are highly sensitive and will register weakest messages, and faithfully reproduce speech and true tone of music.

Twenty-eight years' experience in phone manufacture insures perfect design, best materials and workmanship.

Have matched receivers, carefully tested, weighs only 11 ounces, is very comfortable and may be adjusted without removing. Moderate price.

Attractive Offer to Dealers

S. H. **Couch** Co., Inc.
TELEPHONES
TRADE MARK

Norfolk Downs, Massachusetts



3000 OHMS

List Price
\$8.00

BE A RADIO WIZARD

Get the best results from your set by knowing radio. Know the answers to radio questions. Substitute knowledge for guess work by reading the Standard Radio Encyclopedia—a practical guide to radio by A. Howland Wood, formerly an Instructor and Radio Engineer in the U. S. Navy. From this book you can get new knowledge of just how and why radio works.

EASY ORDER BLANK

PERRY & ELLIOTT CO.,
146c Summer St., Boston, Mass.

Enclosed is \$2.00 for which send me the Standard Radio Encyclopedia with the understanding my money will be returned if the book is not satisfactory.

Name.....

Address.....

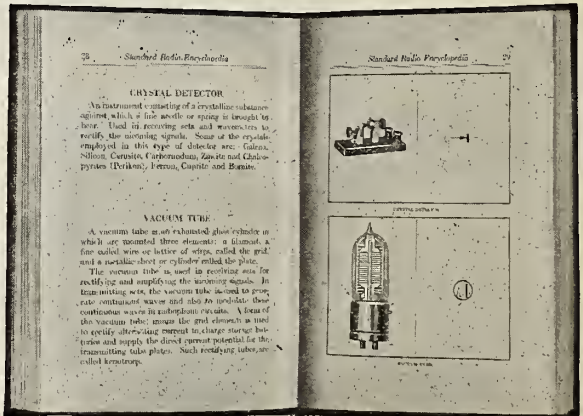

Helps Expert or Beginner

Easy to read and easy to understand. Every instrument and part clearly explained. Makes technical books simple. Over 100 attractive illustrations and wiring diagrams. You will enjoy your set more when you have the clear understanding of radio which you will get from this complete guide book. The price is only \$2.00 and will be gladly refunded if you are not entirely satisfied. Just pin the bills to the order blank and mail to

PERRY & ELLIOTT COMPANY
146c Summer Street BOSTON, MASS.

Let Your Apparatus Speak for Itself

AMERICAN RADIO EXPOSITION

A national exposition for radio manufacturers, dealers, inventors, and amateurs, covering the entire field of radio.

A complete exhibition of apparatus, accessories, and materials.

Daily demonstrations, broadcasting, lectures, orchestral concerts, Grand Opera artists in person—motion pictures illustrating practical uses of radio and the principles of its operation.

TO BE HELD AT

GRAND CENTRAL PALACE

46th St. to 47th St. and Lexington Avenue

The heart of the great terminal zone, close to the busiest shopping districts,

NEW YORK CITY

December 21st to 31st, 1922

Schools and colleges will be closed, making it convenient for young folks to attend. To these young people the magic of radio makes a specially strong appeal.

Manufacturers and Dealers should contract for space now

Address inquiries as to rates, etc., to

AMERICAN RADIO EXPOSITION COMPANY

Telephone: John 0009

120 Broadway, New York

EDUCATIONAL AND INTERESTING

THIS IS A "REGAL" YEAR

Five Big Reasons for the Enormous Sale of "Regal" Receiver and "Regal" Amplifier

1. Designed by our own radio engineers and a scientific precision instrument, simple and easy to operate.
2. Has wave length range from 150 to 1800 meters—guaranteed.
3. Built entirely in our own factory with all "REGAL" parts.
4. Backed by our thirty years experience of precision manufacturing.
5. Priced at \$40.00 instead of \$100.00. Reason—we build it ourselves.

"REGAL" VACUUM TUBE RECEIVER

"REGAL" TWO STAGE AMPLIFIER



Price \$40.00

To triple range and increase audibility Price \$35.00

Some Excellent Features of the "Regal"

Minimum number of controls, all clearly marked, with taper knobs and etched silver dials. Unique "REGAL" Telephone Connector, permitting use of three pair of head phones (doing away with all jacks and plugs). Fine potentiometer plate control—so necessary to efficient tuning of modern vacuum tube detector. New "REGAL" Rheostat (6 ohms—2.2 amperes). New "REGAL" Inductance Switch, doing away with all unsightly switch points and insuring fine electrical connections. "REGAL" 23-Plate Condenser. "REGAL" TUBE SOCKET. Mahogany piano finished cabinet. Rear Panel Connector for all wires—no wires in front of cabinet.

"REGAL" INDUCTANCE SWITCH..	\$2.50	"REGAL" TELEPHONE CONNECTOR...	\$1.50
"REGAL" RHEOSTAT.....	1.25	"REGAL" CONDENSERS, 43-Plate.....	4.50
"REGAL" VARIO-COUPLER.....	5.00	23-Plate.....	3.50
"REGAL" TUBE SOCKET.....	.75	11-Plate.....	3.00

Dealers and Jobbers—Send for our handsome new catalogue No. 10.

THE AMERICAN SPECIALTY MFG. COMPANY

BRIDGEPORT, CONN.

COILS

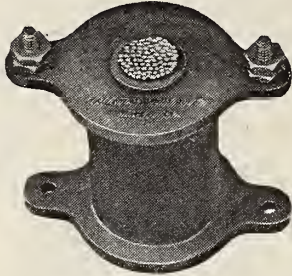

These are needed for the

Armstrong Super- Regenerative Circuit

5-Millihenrie Choke Coils	\$2.50
100-Millihenrie Choke Coils	3.00
12000-Ohm Non-inductive Resistances - - - - -	3.00
1250-Turn Honeycomb Coils	2.00
1500-Turn Honeycomb Coils	2.50
.005 Micon fixed Cond. - - -	.75
.0025 " " " "	.50

Attractive discounts to dealers and jobbers and immediate shipments.

These coils are guaranteed correct to within 2% and may be returned within six days if found unsatisfactory.

DURHAM & COMPANY
Radio Engineers

1936 Market St. Philadelphia, Pa.



LIST
\$ **8.50**

EVERETT DOUBLE RADIO PHONES

*"Not the loudest but
the clearest"*

Light in weight, withstand
amplification without distortion.

AT ALL DEALERS

Everett Electric Corp.

320 Broadway New York



35c Each; 3 for \$1.00

Na-ald Genuine Condensite Dial

The dial that runs true

Numerals engraved on bevel and knob so shaped that fingers do not hide them. Thin edge with clear graduation to make reading easy. Concealed set screw in metal insert. Will not warp or chip. Finish and enamel permanent.
Low price with this quality possible only through automatic production methods.

Special dealer and jobber proposition—on opportunity!

Alden-Napier Co.

52 Willow St., Dept B. Springfield, Mass.



"All-American" Audio Frequency Amplifying Transformers

Two Types—Ratio 10 to 1.
(Type R3) Designed for 1st stage. Ratio 3 to 1 (Type R2) for 2nd and 3rd stages.

Type R2—\$4.25
Type R3—\$4.50

Send for Bulletin describing Radio and Audio Frequency Transformers.

RAULAND MFG. CO.
35 So. Dearborn St. Chicago, Ill.

MIRACO Radio Frequency Broadcast Receiver

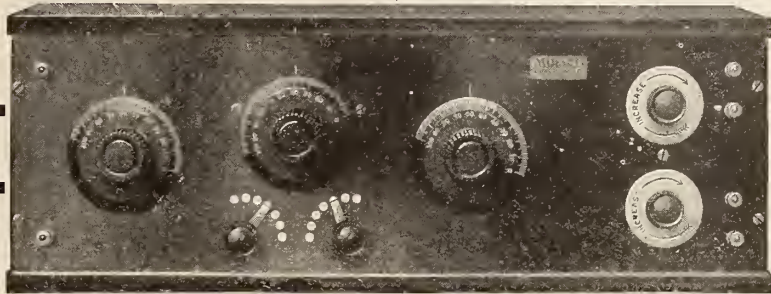

REPRESENTING THE LATEST DEVELOPMENT IN LONG DISTANCE RADIO RECEIVING SETS

Provides sharper tuning, with less controls, eliminates interference and reduces static to a minimum.

AMPLIFIES BEFORE IT DETECTS which makes it capable of bringing in concerts and signals from extremely long distances.

Dealers write now. Send for literature descriptive of this and other "MIRACO" Products.

\$45.00 Prepaid: less tubes, phones, and batteries

MIDWEST RADIO COMPANY

806 MAIN STREET
CINCINNATI, OHIO

Transcontinental Reception

By using three stages of DX RADIO FREQUENCY TRANSFORMERS, one radio amateur listens to Hawaii, California, Colorado, Texas, Georgia, Massachusetts and New York broadcasting stations.

Manufacturers are standardizing their sets using DX TRANSFORMERS.

Use the Best

Immediate delivery in quantity



Patents Pending

**RADIO
INSTRUMENT COMPANY, INC.
WASHINGTON, D. C.**

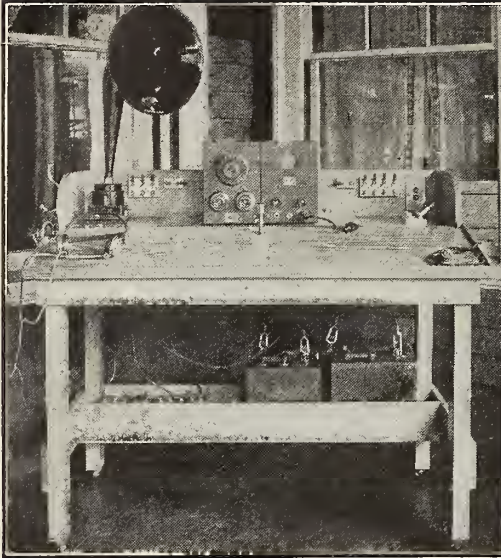

This Table Makes Your Radio Convenient

PRICE In Knock-down Form, Complete with Screws and Casters **\$12.00**

An experienced wireless operator designed the IDEAL RADIO TABLE. Mount all your instruments on it, batteries, charging outfit, loud-speaker. Have everything neat, compact, accessible, with the switches and controls at your hand. Take it anywhere on easy-rolling casters.

The IDEAL RADIO TABLE is furnished only in knock-down form; easily assembled from diagram. Accurately and neatly made of white pine and packed in a box. Shipping weight about 45 lbs. Size of table 24" wide x 36" long by 32" high. Shipped immediately on receipt of price, \$12, f.o.b. Milford, N. H. Specify choice of stain, Mission Brown, Mahogany, or in natural wood; also freight or express.

SPRING LUMBER CO.
MILFORD NEW HAMPSHIRE



High Efficiency Head Sets

ARMY AND NAVY TYPE:

2500 Ohm, per pair \$10.00
3200 Ohm, per pair 12.00

SWEDISH-AMERICAN TYPE:

2200 Ohm, per pair \$ 8.00

Ask For Prices On Our Radio Parts

American Electric

COMPANY

6450 STATE STREET

CHICAGO, U. S. A.

KNOTT Microdenser

(Trade Mark Registered)

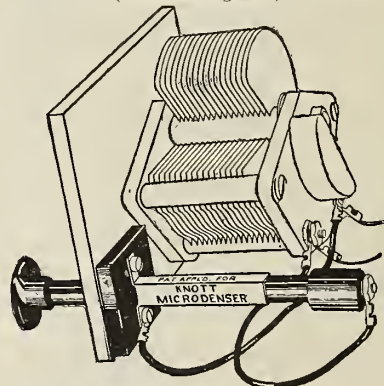

Showing how you connect to your condenser.

It Takes the Nervousness Out of Tuning

Tune your condenser to the whistle and bring in the message with this Micro.

It will stretch the critical adjustment on your condenser to two inches of adjustment.

Buy it of your dealer or send us \$3.00 for one by return mail postage paid complete with connecting wires and wrench-screwdriver.

Ask about Knott Sure Ground, Knott Radio Name Plates, Patent Dial, Rheostat, Quodcoil, Cincoil, Microstat.

Jobbers write for our proposition, it will interest you.

E. R. Knott Machine Company, 1 Ellery Street, Boston 27, Mass.



WESTINGHOUSE

RADIO

BATTERIES

Eliminate all Battery Troubles from Radio Sets

The Westinghouse "A" Battery is a full capacity, low voltage, slow discharge, long-life storage battery built exclusively for radio work.

For "B" battery requirements Westinghouse has perfected a baby storage battery. No more throwing away exhausted cells. No more continuous "B" battery expense.

The Westinghouse "B" is a permanent battery. It never has to be replaced. It will discharge its load with constant, steady voltage. Then it can easily be recharged. It gives continuous service to the point of exhaustion without growing "scratchy." If your vacuum tube is inclined to be noisy you can adjust the contact on the Westinghouse "B" to take off the exact voltage the V. T. requires.

Get a Westinghouse "A" and "B" from your dealer or the nearest Westinghouse Battery Service Station and eliminate all your radio battery troubles.

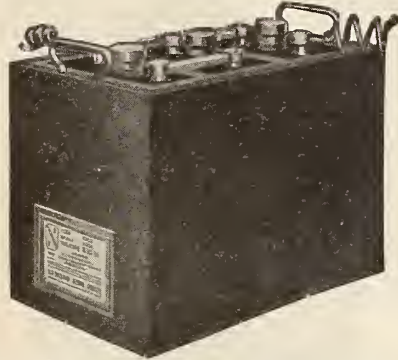

14¾ in. long
2½ in. wide
3¾ in. high

WESTINGHOUSE
UNION BATTERY CO.
Swissvale, Pa.

"The best
Westinghouse
can build."

A New Member of the Plug and Jack Family

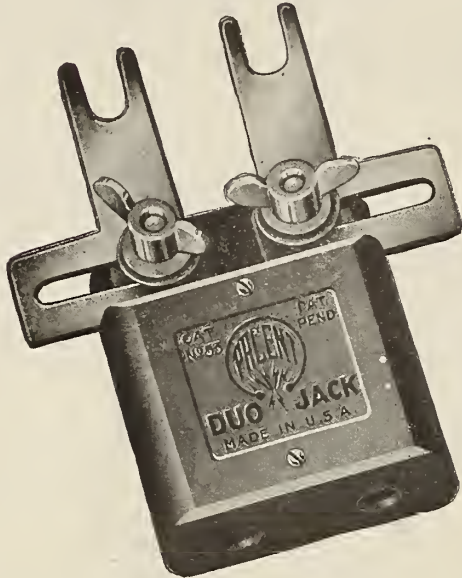

THE PACENT DUO JACK

This new Pacent Radio Essential, like all previous members of the Pacent Plug and Jack Combination, fills a definite existing Radio need.

The Duo Jack enables you to instantly convert an ordinary set equipped only with binding posts to a plug and jack set. It also facilitates connecting two pairs of phones or a loud speaker and a headset to your receiver.

The illustrations will suggest many applications for this very ingenious device.



Cat. No. 53 - - \$1.50

The Pacent Duo Jack will be in production by October 1 but dealers and jobbers are advised to place advance orders at the earliest possible date. Outline of Pacent Sales plan sent upon request.

DON'T IMPROVISE—PACENTIZE

Pacents Radio Essentials increase the pleasure of operating your equipment.

Pacents Universal Plugs

Pacents Radio Jacks

Pacents Multijack

Pacents Twin Adapter

Pacents Audioformer

Pacents Duo-lateral Coils

Pacents Universal Detector Stand

SEND FOR DESCRIPTIVE BULLETINS

PACENT ELECTRIC COMPANY

INCORPORATED

Manufacturers and Distributors of Radio and Electrical Essentials

Executive Offices:

**22 PARK PLACE
NEW YORK, N. Y.**



Branch Offices:

PHILADELPHIA, PA.
Bourse Bldg.

CHICAGO, ILL.
33 So. Clinton St.

WASHINGTON, D. C.
Munsey Bldg.

Member Radio Section, Associated Manufacturers of Electrical Supplies

REMLER

Cunningham

APPARATUS THAT RADIATES QUALITY

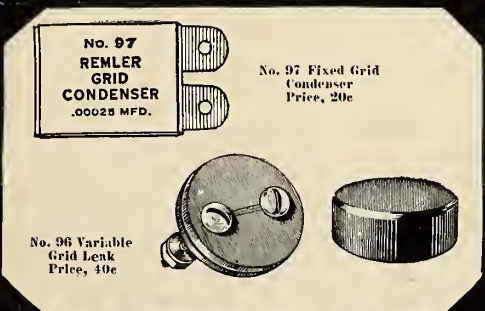
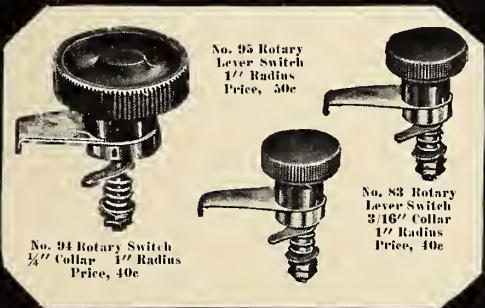
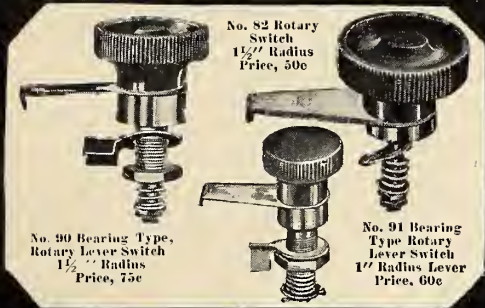

Type No. 100
3-inch Bakelite Dial with Knob and Bushing 75c

Remler Parts For Your Set

On this page are shown the popular line of Remler switches, the Remler Fixed Grid Condenser, the Remler Variable Grid Leak and the famous Remler Dial.

This represents but a small fraction of the Quality Radio Apparatus that has put Remler in the leading position it holds to-day. This small fraction, however, is built with the same care, accuracy and precision that has made the entire Remler line universally known as Quality Radio Apparatus.

It is becoming more and more apparent that Remler Apparatus is preferred in the building of sets because of its uniformity of construction—the well balanced proportion of each item giving an accurate and a pleasing appearance to the finished set.

Insist on Remler parts. If your dealer cannot supply you, write us direct for the name of a Radio dealer who can.

REMLER RADIO MFG. CO.

E.T. CUNNINGHAM GENERAL MGR.

248 FIRST ST. SAN FRANCISCO, CAL.

154 W. LAKE ST. CHICAGO, ILL.

Plan

BRISTOL LOUD SPEAKER

TRADE MARK

AUDIOPHONE

PATENTS PENDING DESIGN PATENTS PENDING

Multiplies the Pleasure of Radio

It will make your radio outfit a source of entertainment for the entire household—for all your family and for the friends who join you. Its rich, full tones carry from room to room—clearly audible and with no blurring of sound. The "Audiophone" is complete in itself—needs no separate storage battery for magnetising current—and can be used with all types of two or three stage power amplifiers. Its graceful lines and dull bronze finish adapt it for even the finest interiors.



Distinguished By Its NATURAL Tone And Perfect Articulation

The "Audiophone" reproduces either voice or instrument with fidelity and with a remarkable freedom from all mechanical distortion. It has a **Natural** tone—clear and strong and round, with ample carrying power. It is the outgrowth of years of development in sound reproduction, by an established engineering firm. It is for those who must have the best.

A new single stage power amplifier for use with the usual two stage amplifier can now be furnished, which will greatly increase the range of the "Audiophone" where desirable. List price \$25.00—write for the circular.

"AUDIOPHONE" Complete, 15-inch bell, List Price \$40.00

Ask your dealer for a demonstration. If he hasn't the "Audiophone" in stock, write us. We will see you are supplied.

THE BRISTOL COMPANY
WATERBURY, CONN.



Erck

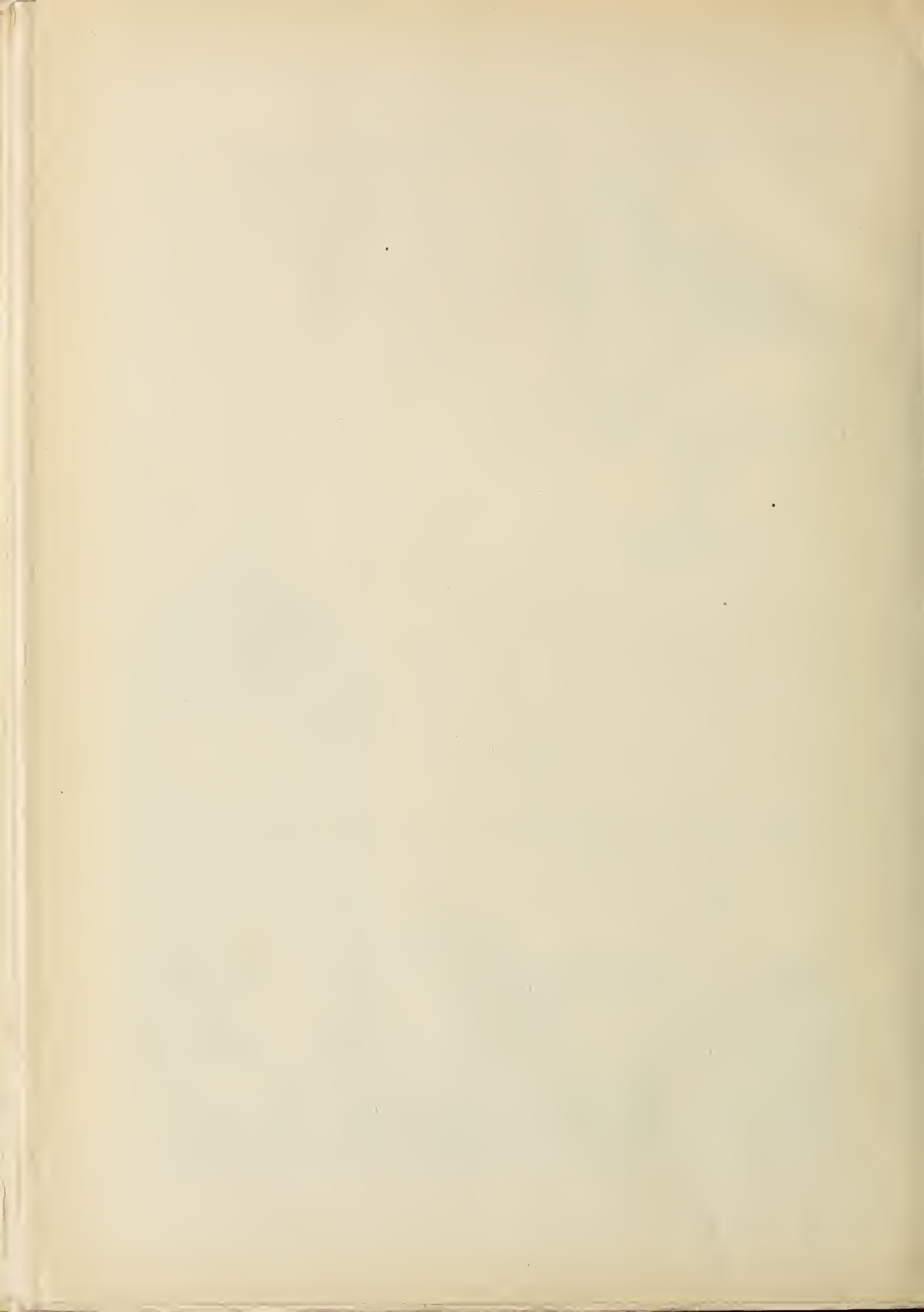

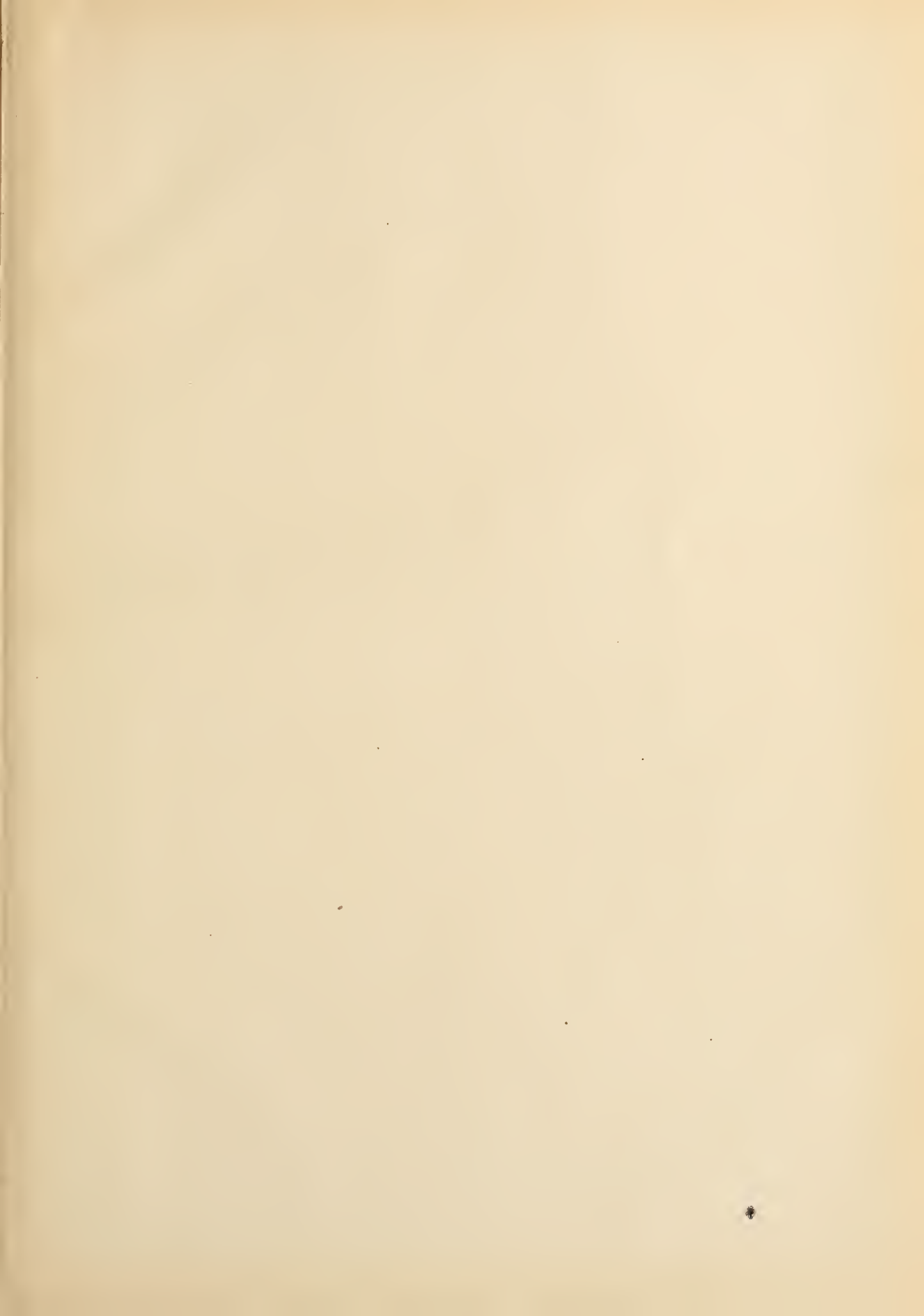

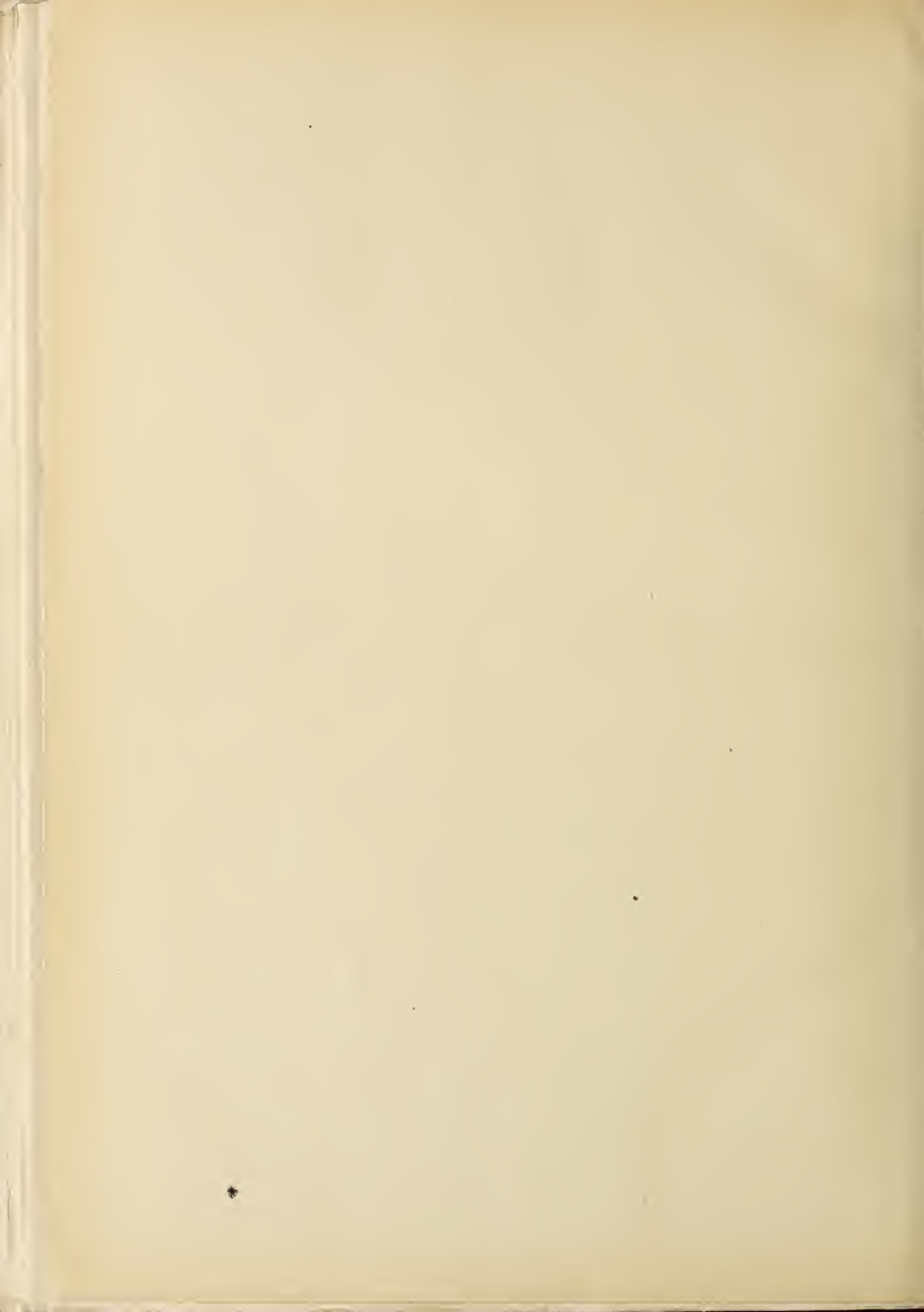

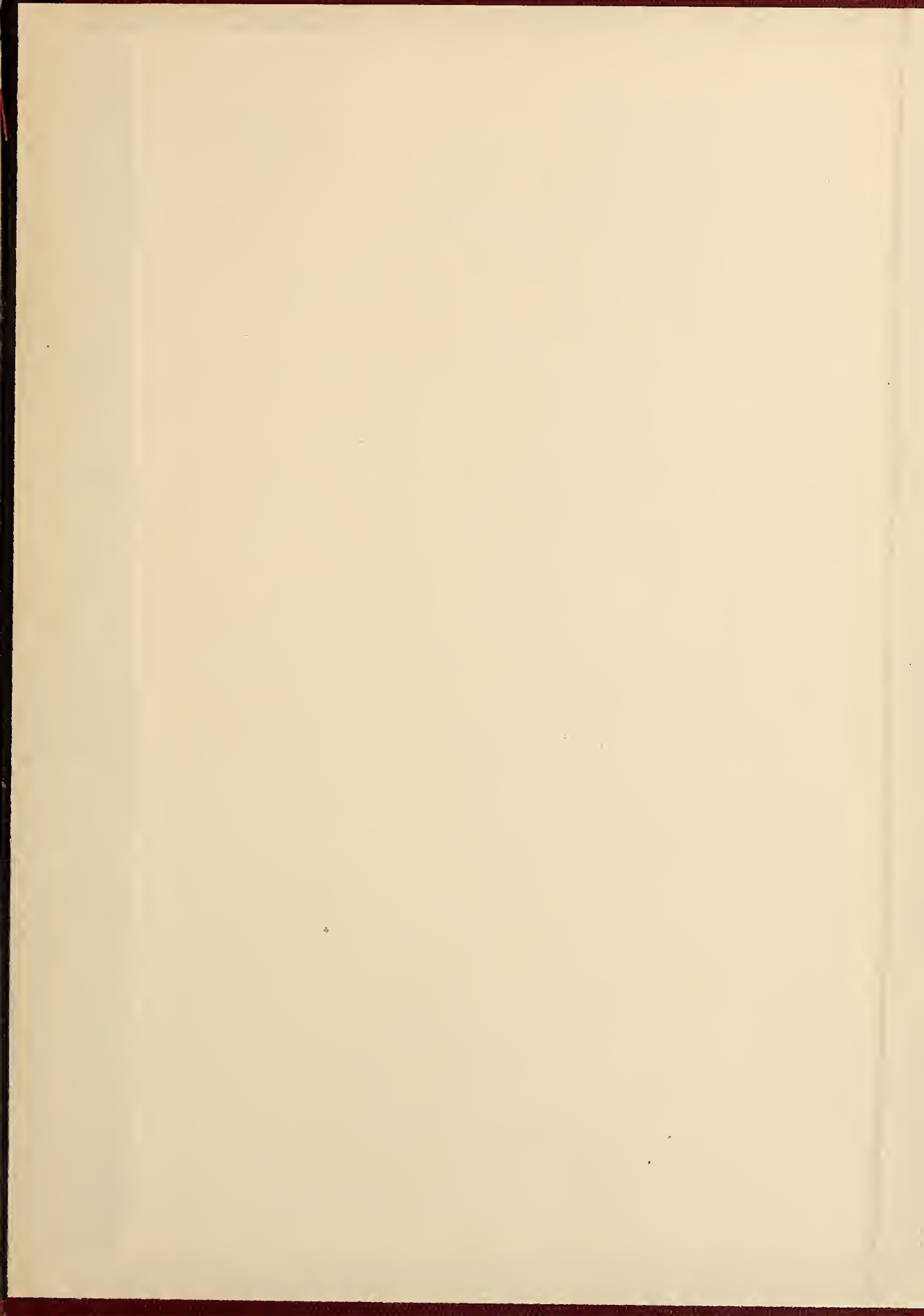

LIBRARY OF CONGRESS



0 019 315 270 3