

黑板画手本

青森縣師範學校教諭足立啓編

特 72

107

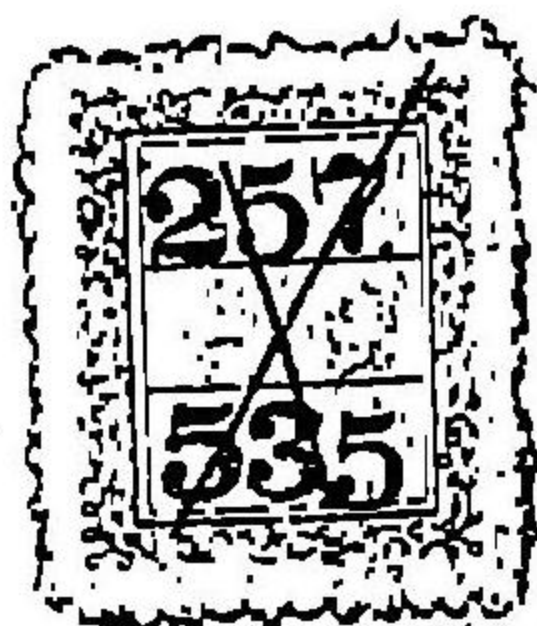

301649-001-7

特72-107

黑板画 手本

足立啓/編

M41.8

CEC-0001



特
107

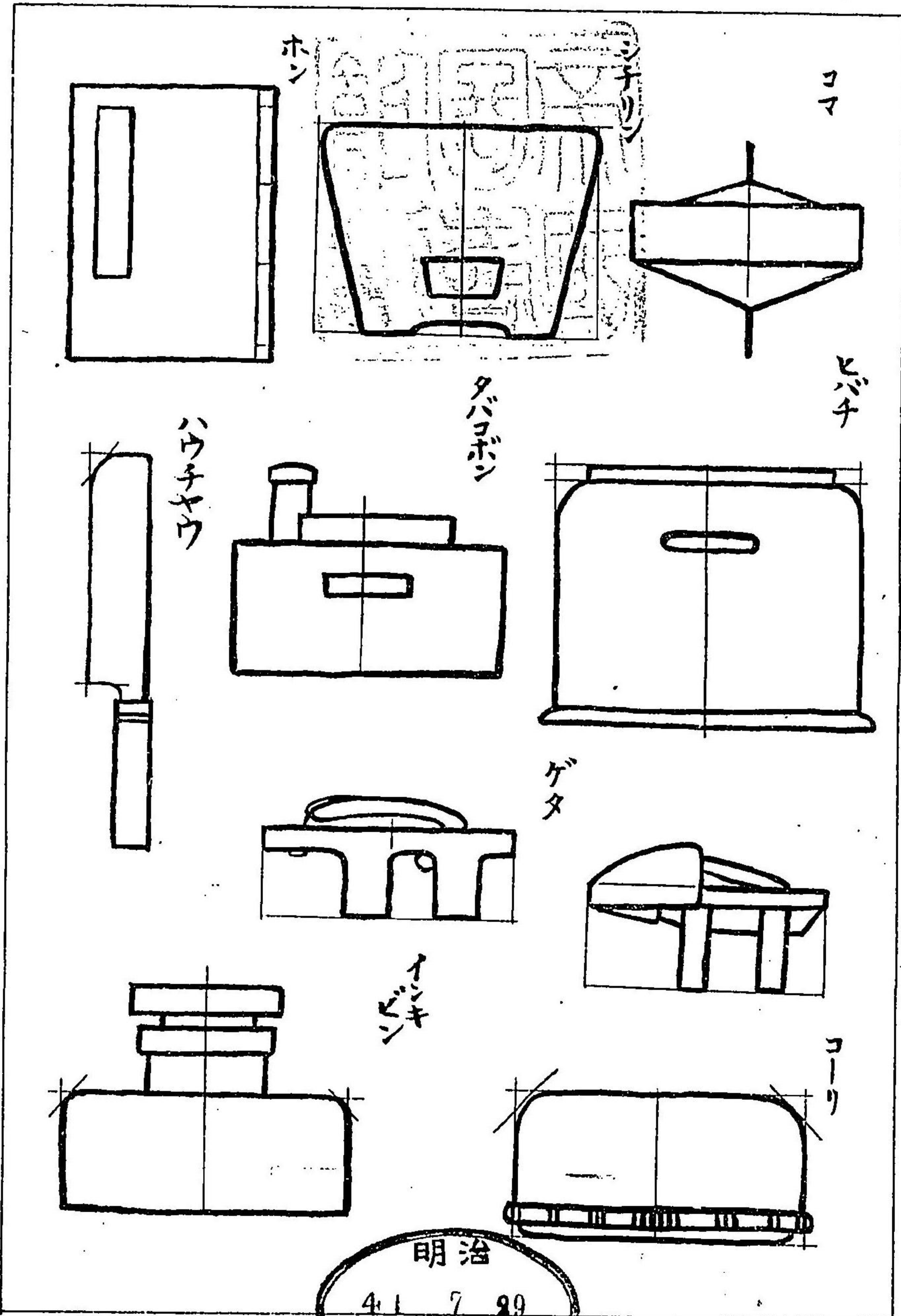

明治
41 7 29
内交

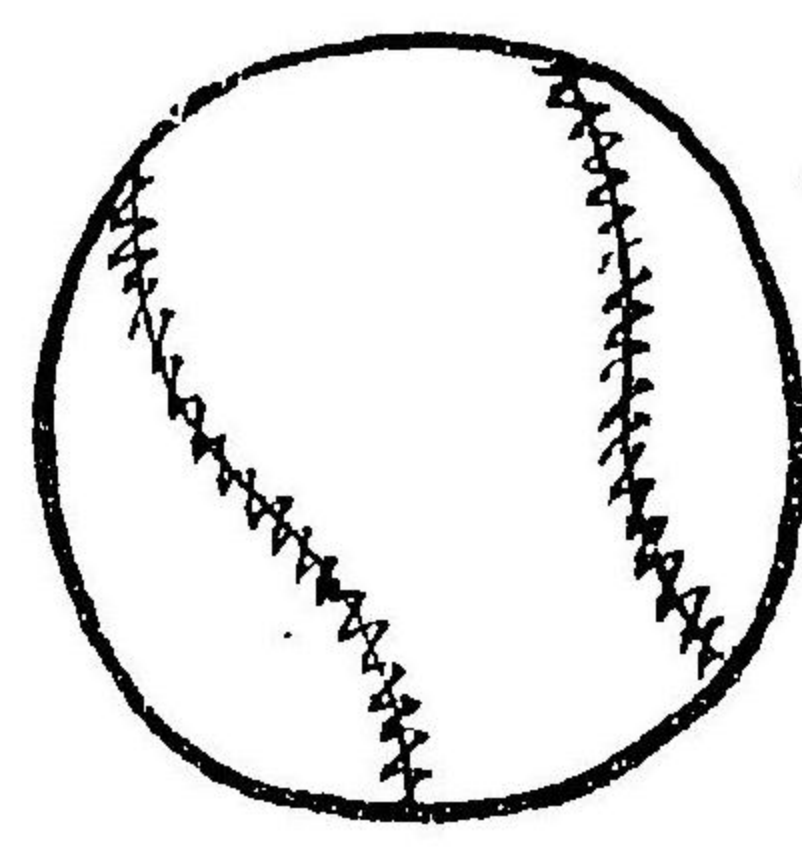

ベースボール

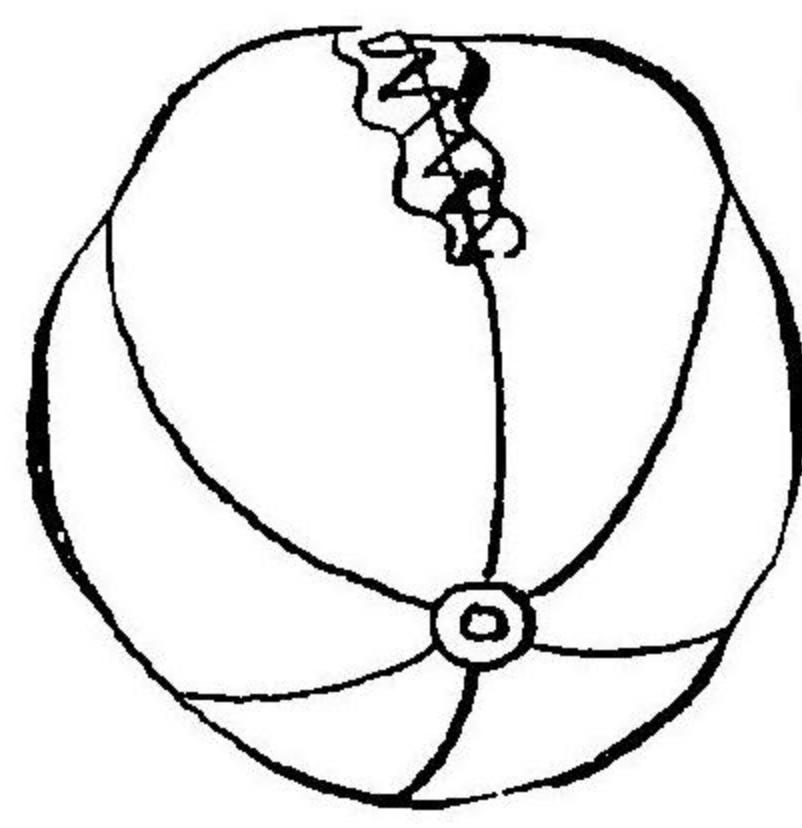

ソフトボール

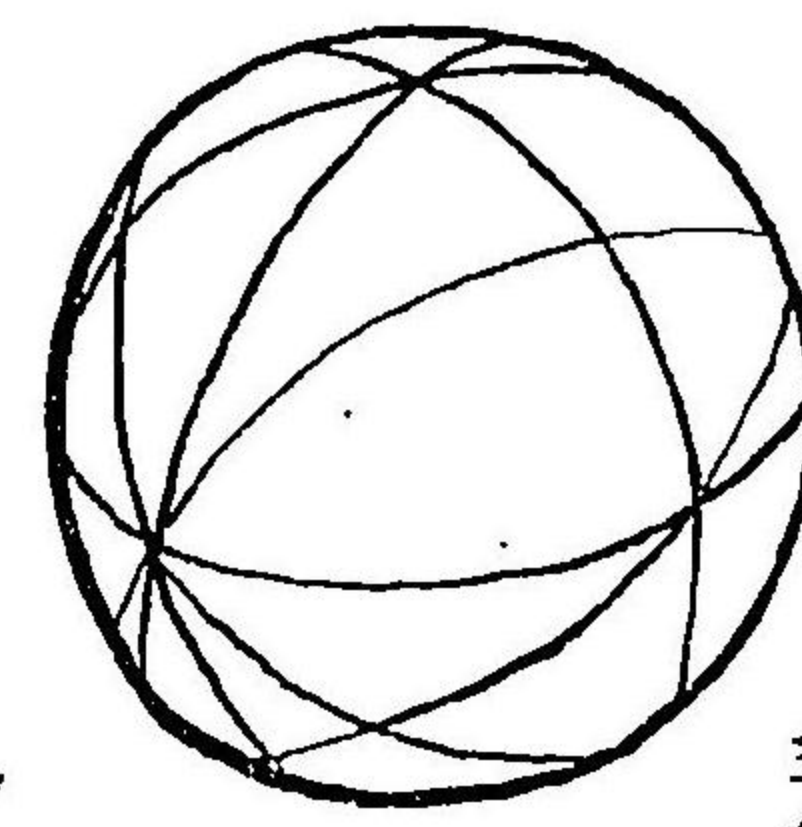

テマリ

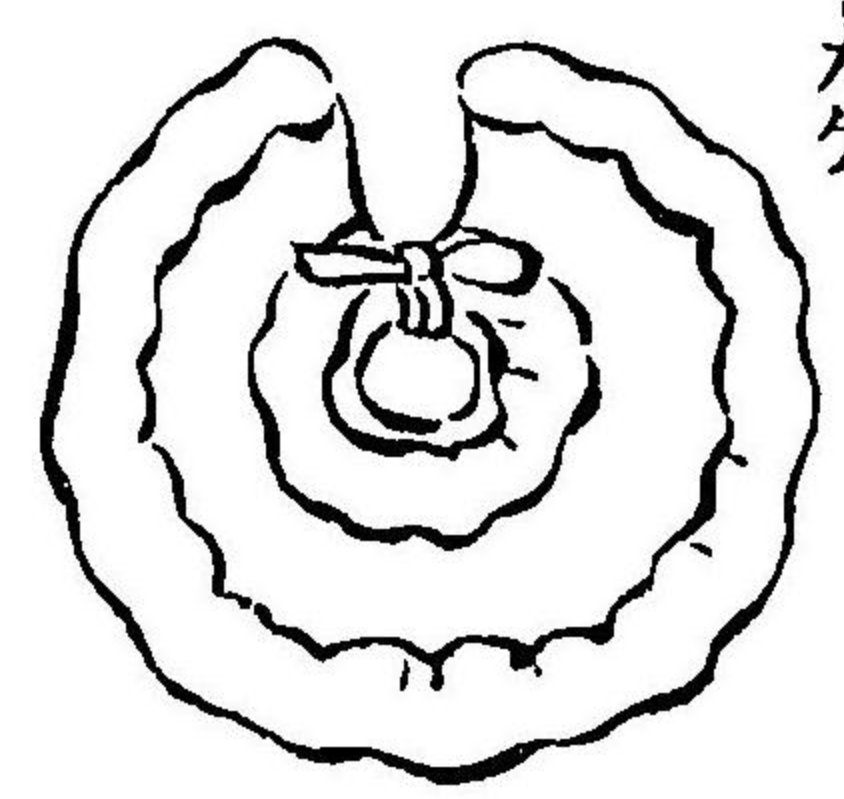

ヨダレカケ

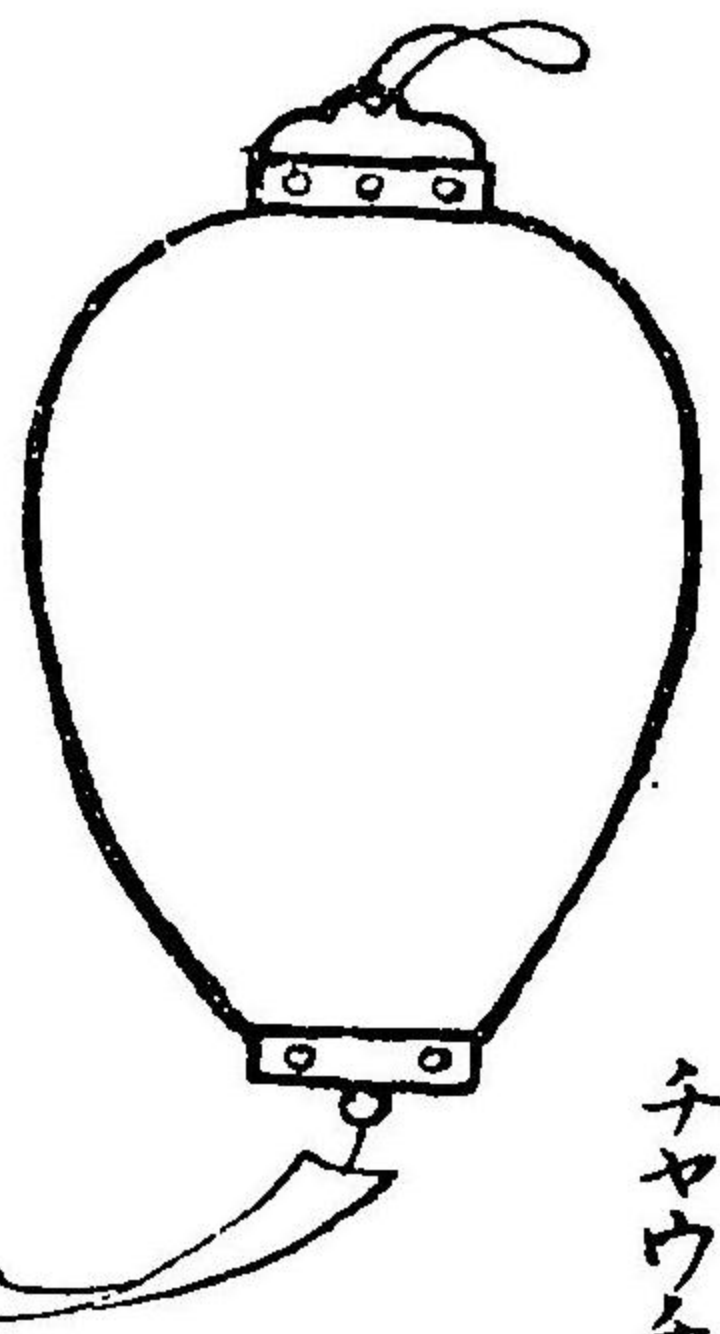

チヤウケン

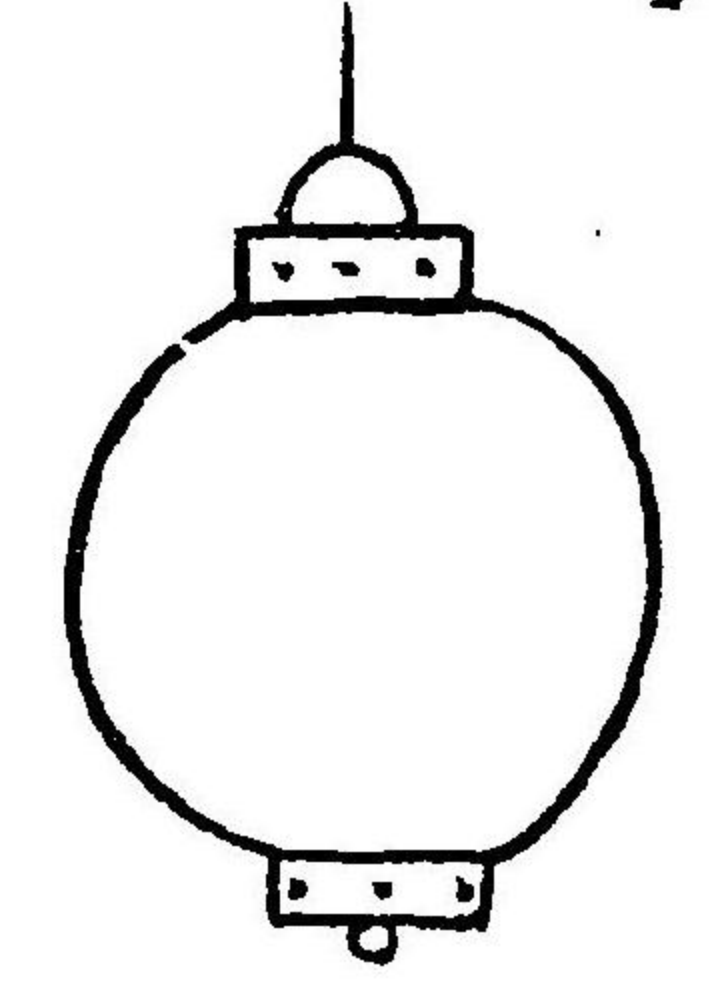

テマリ

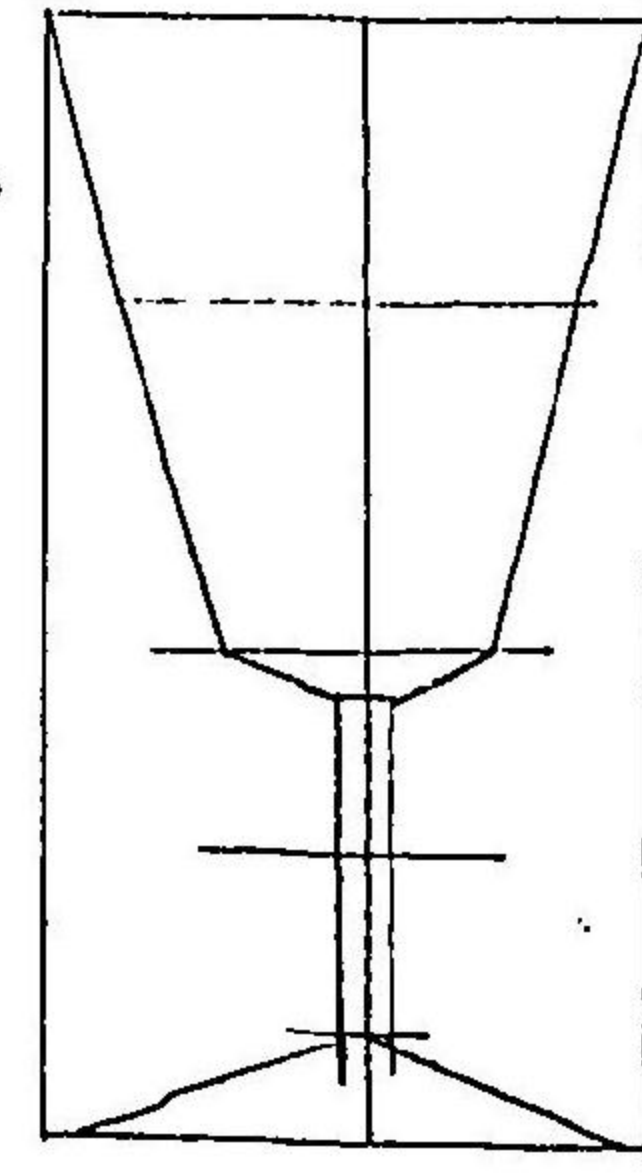

コップ

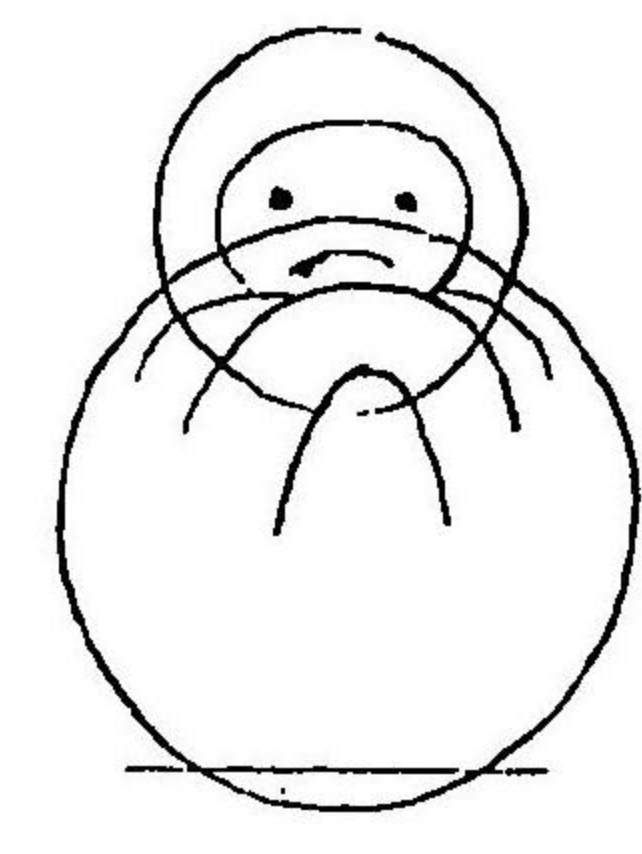

オキアガリ
コボウシ

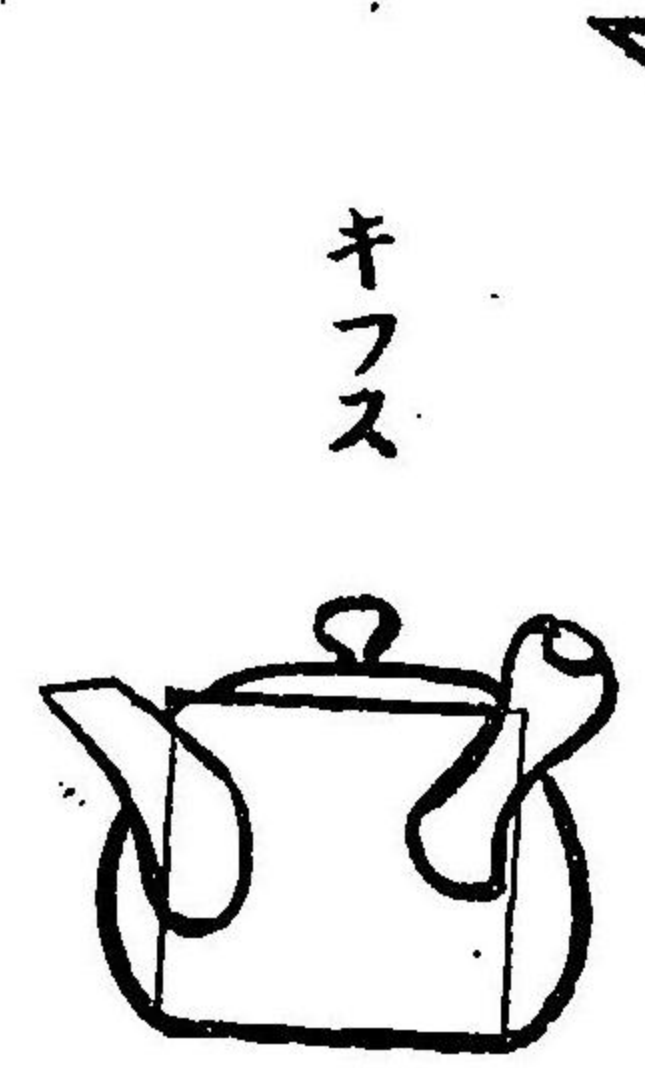
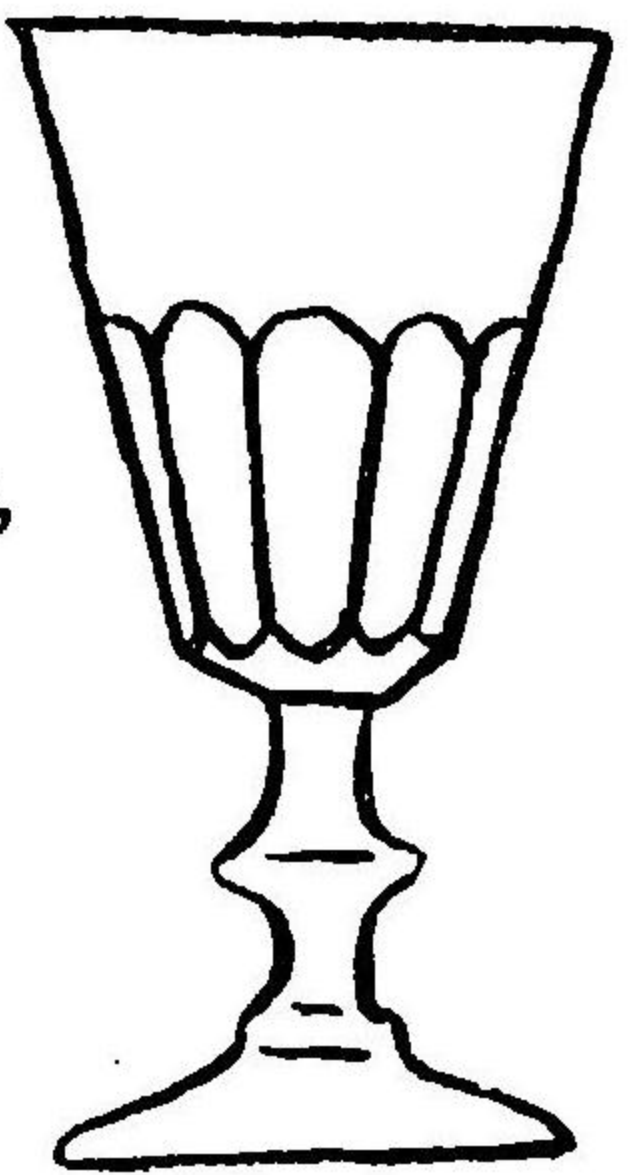

キフス

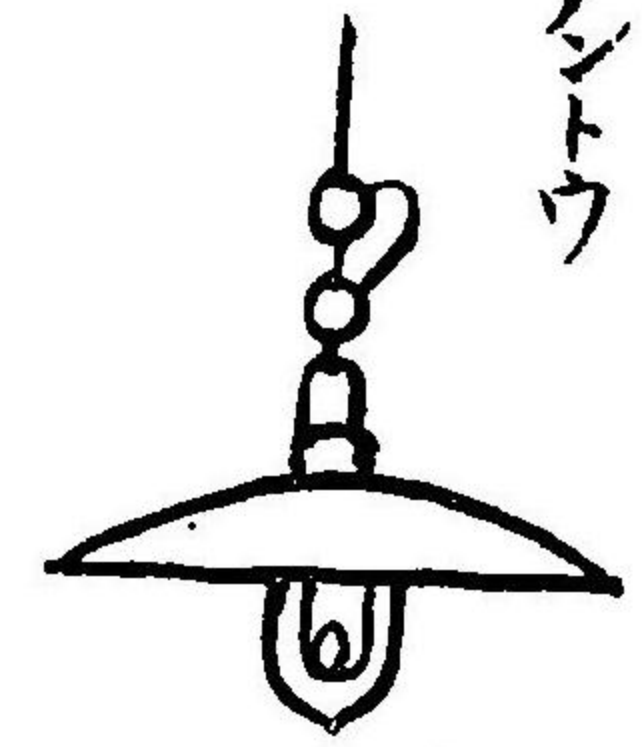

デントウ

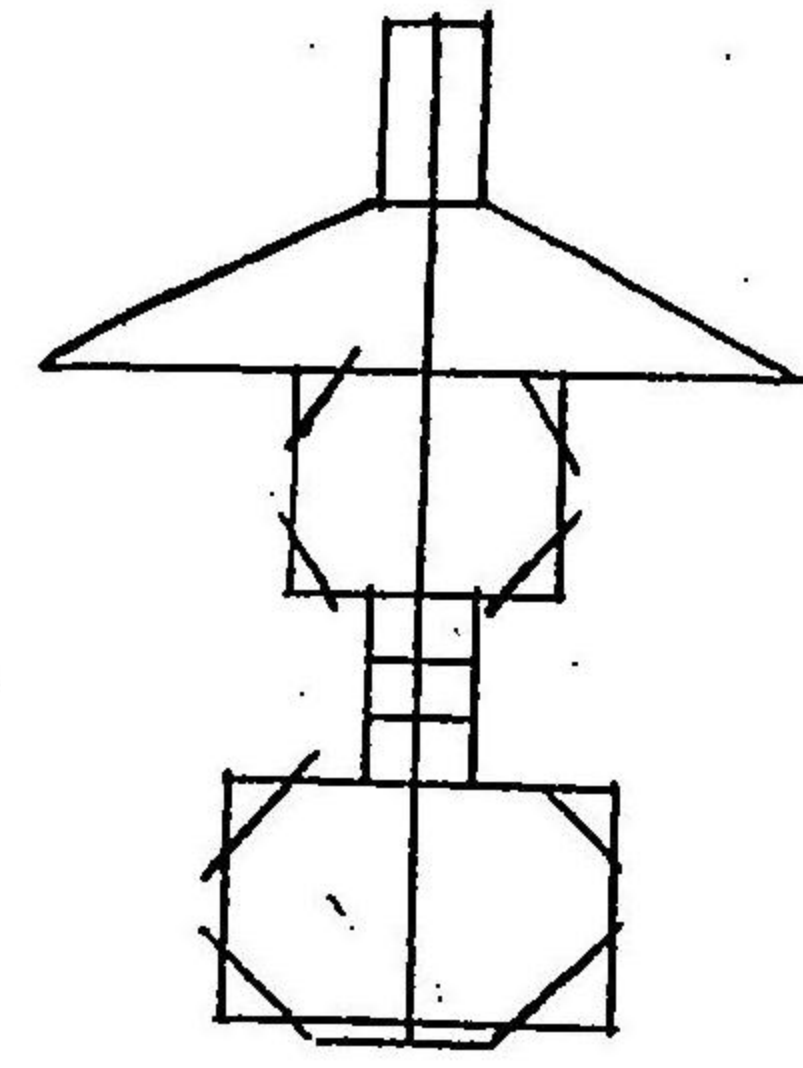

テロウ

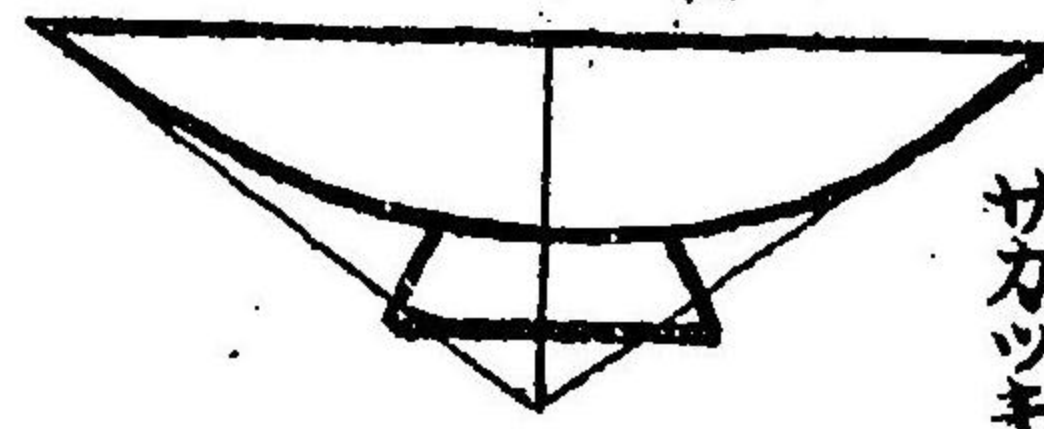

サカヅキ

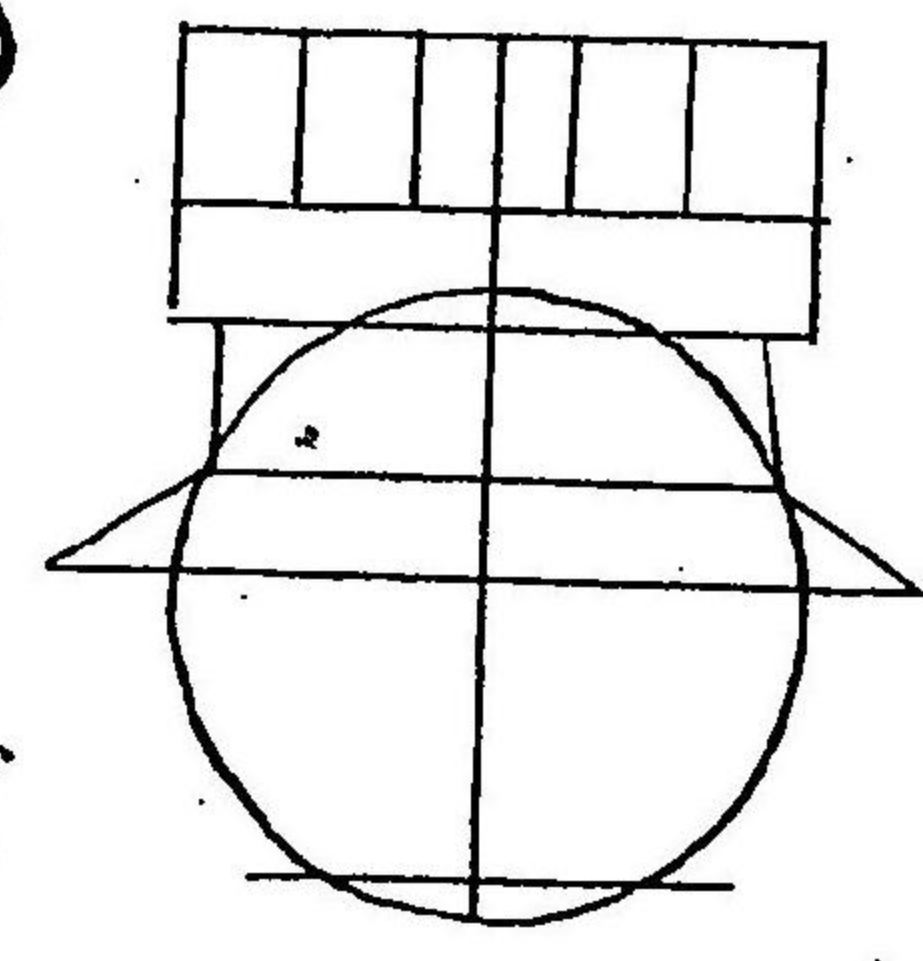

カマ

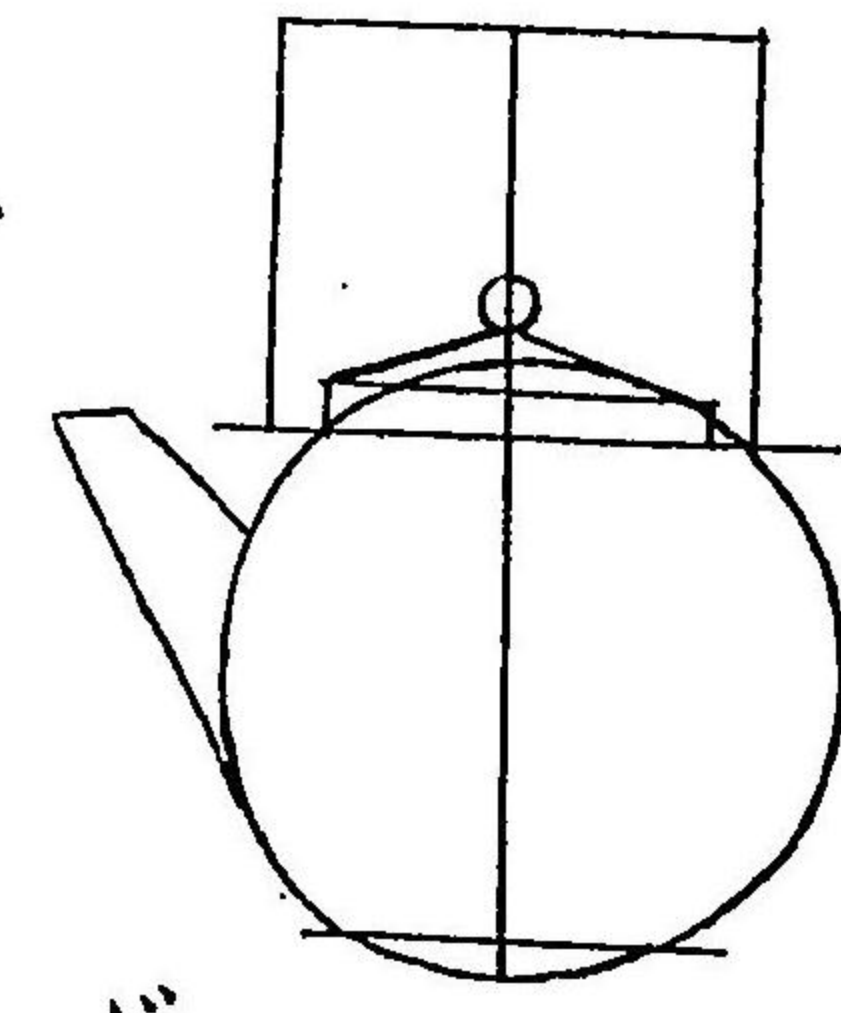
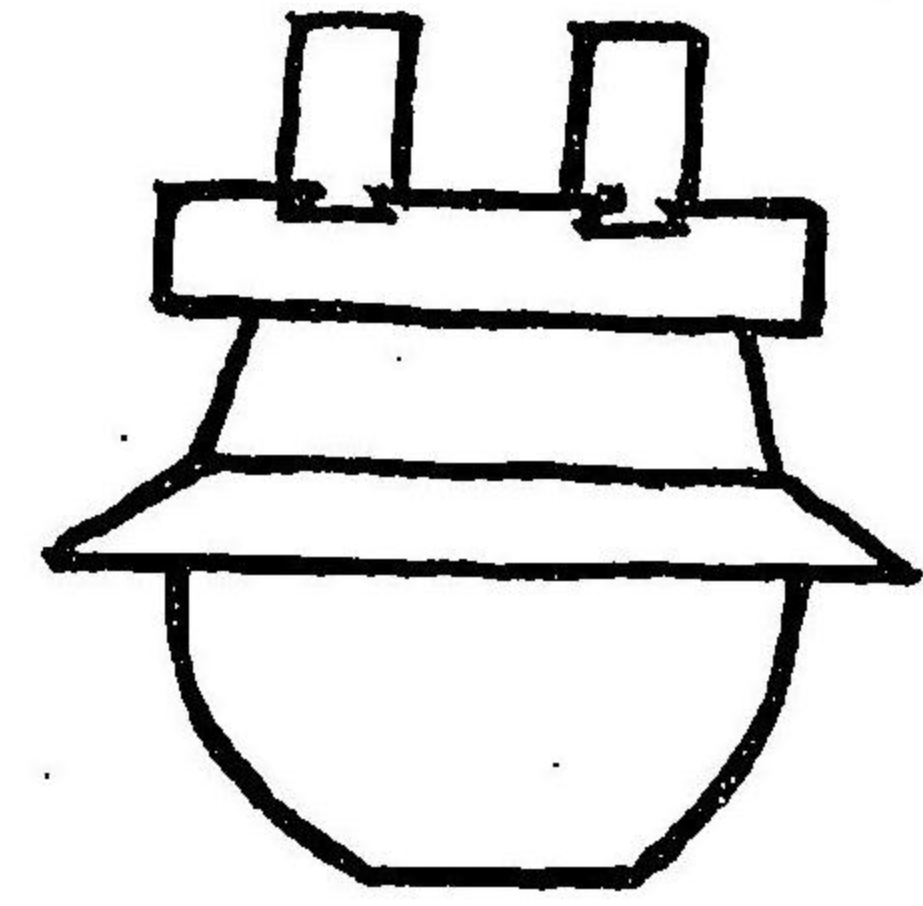

ミヅ

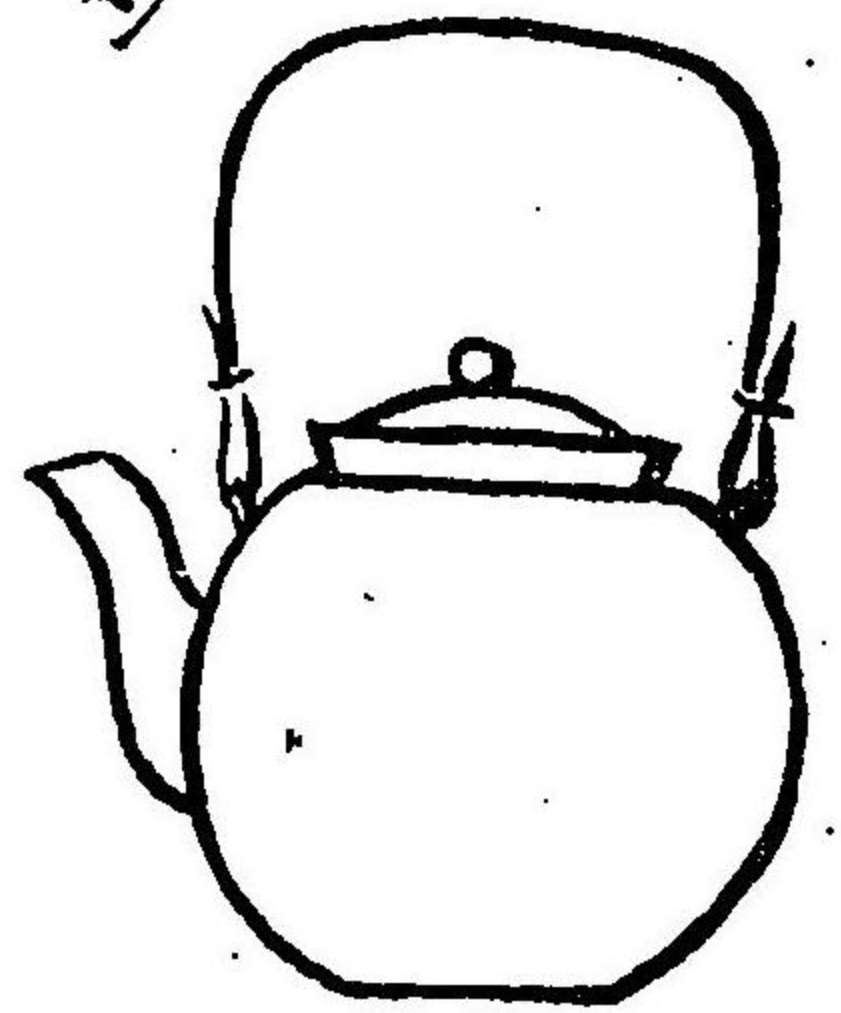

ランプ

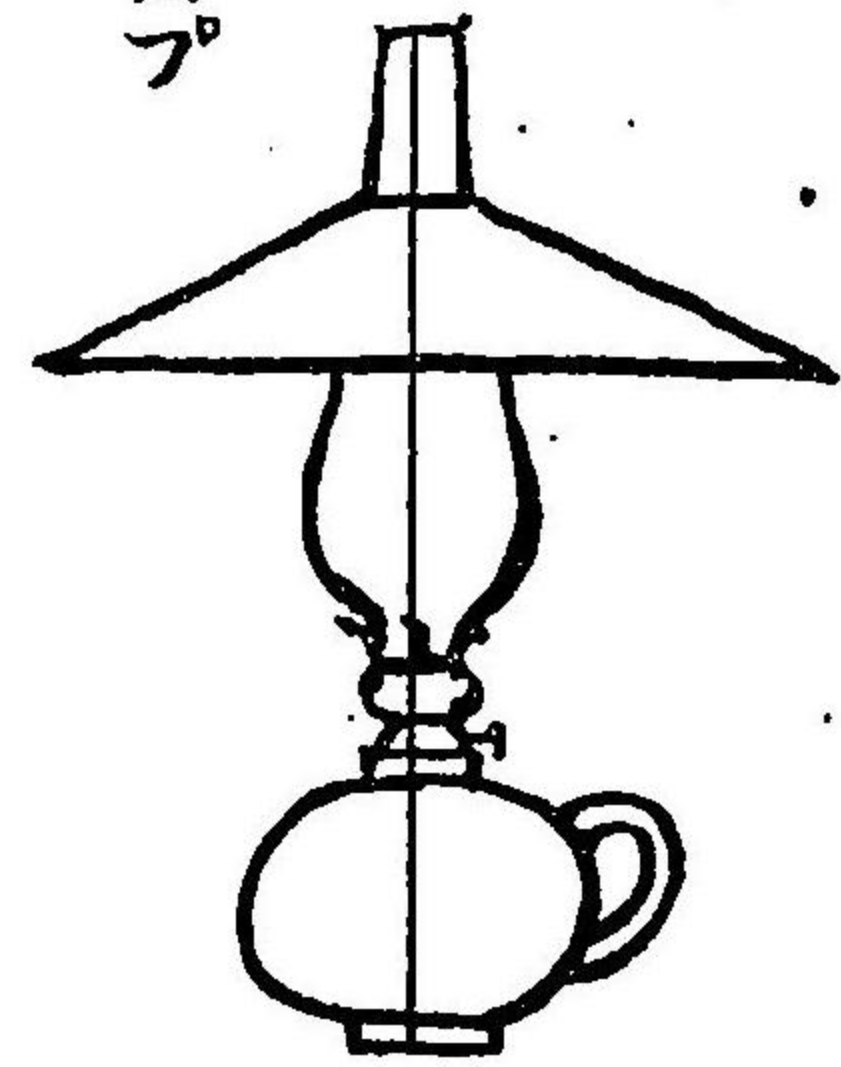

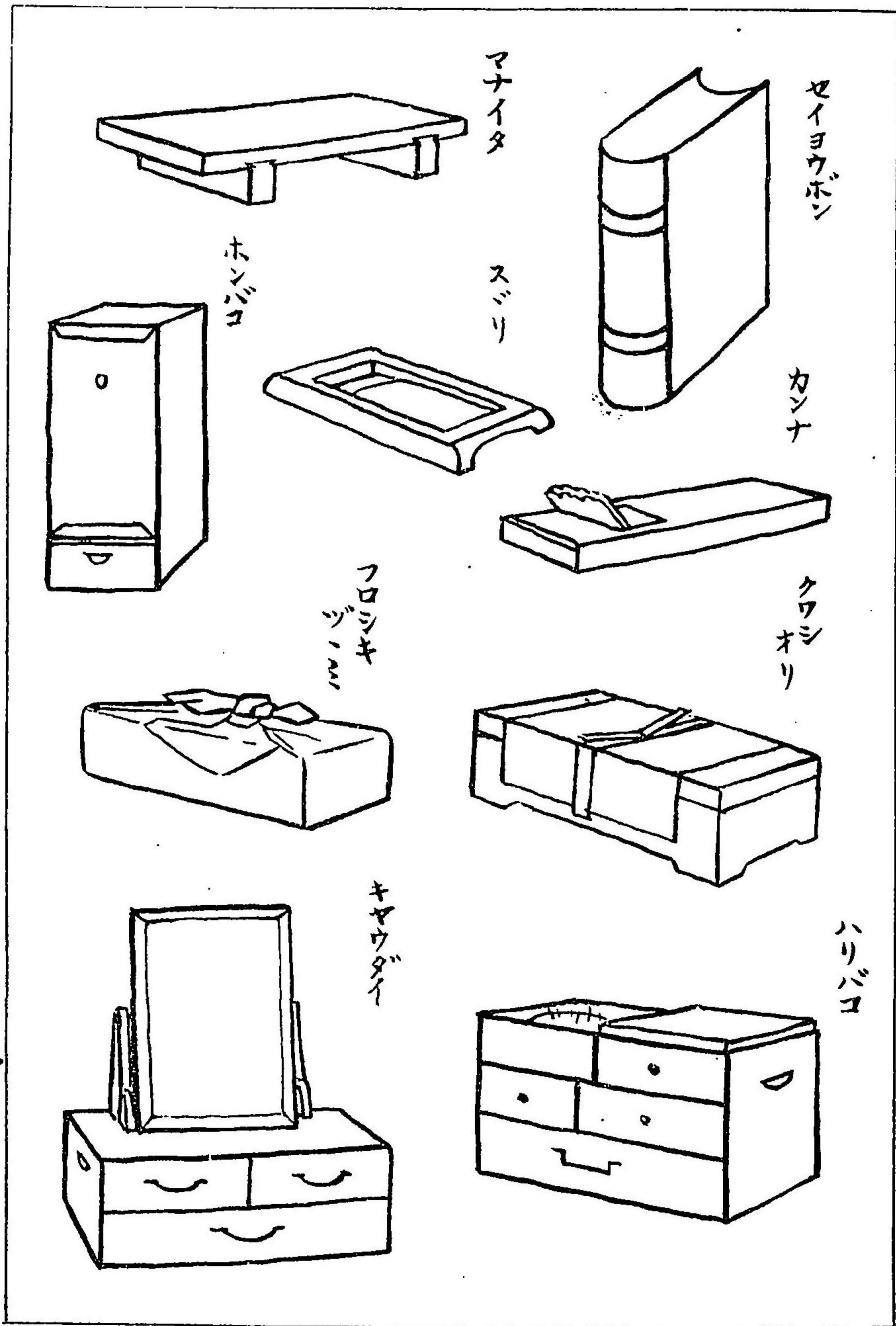

五

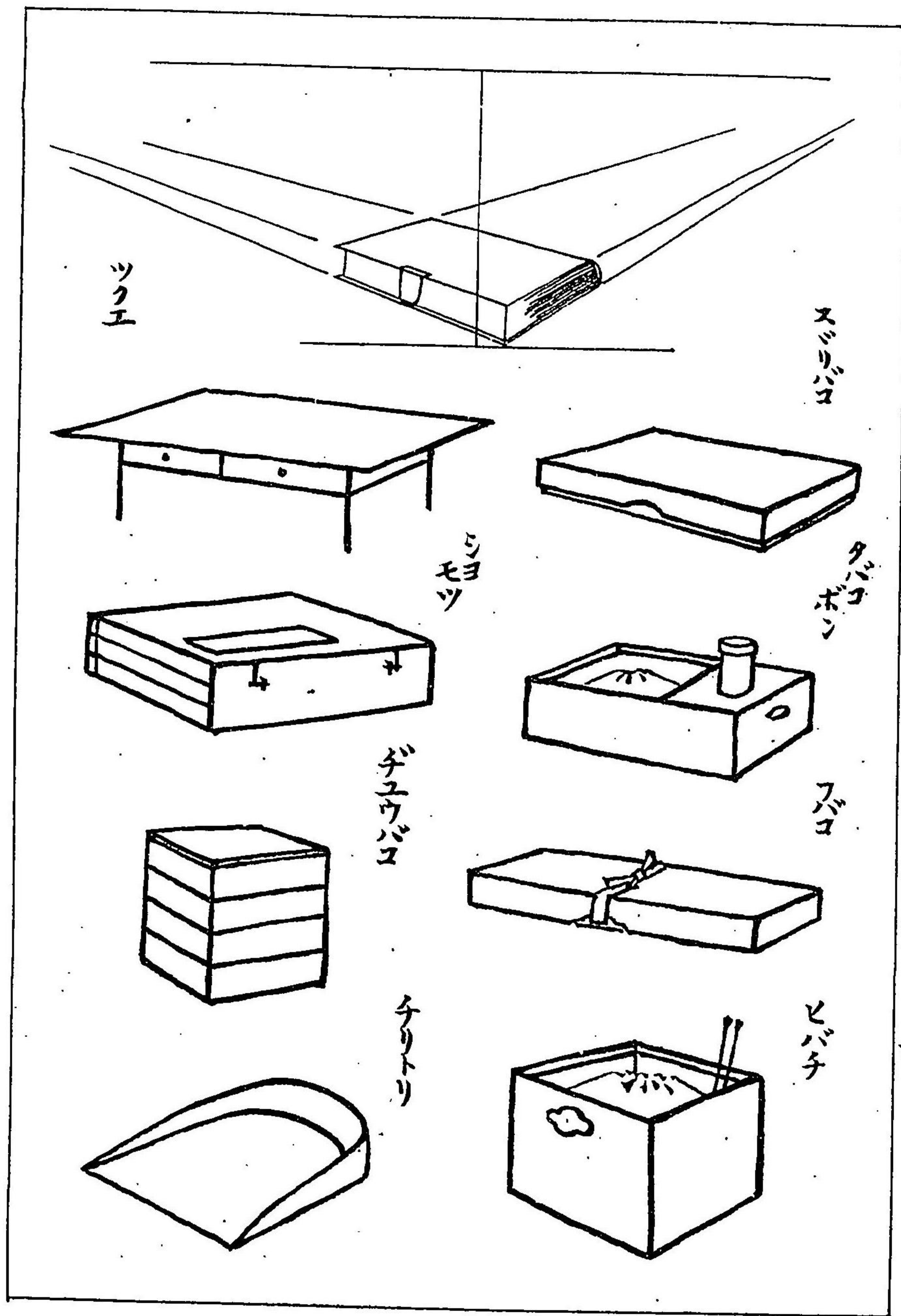

四

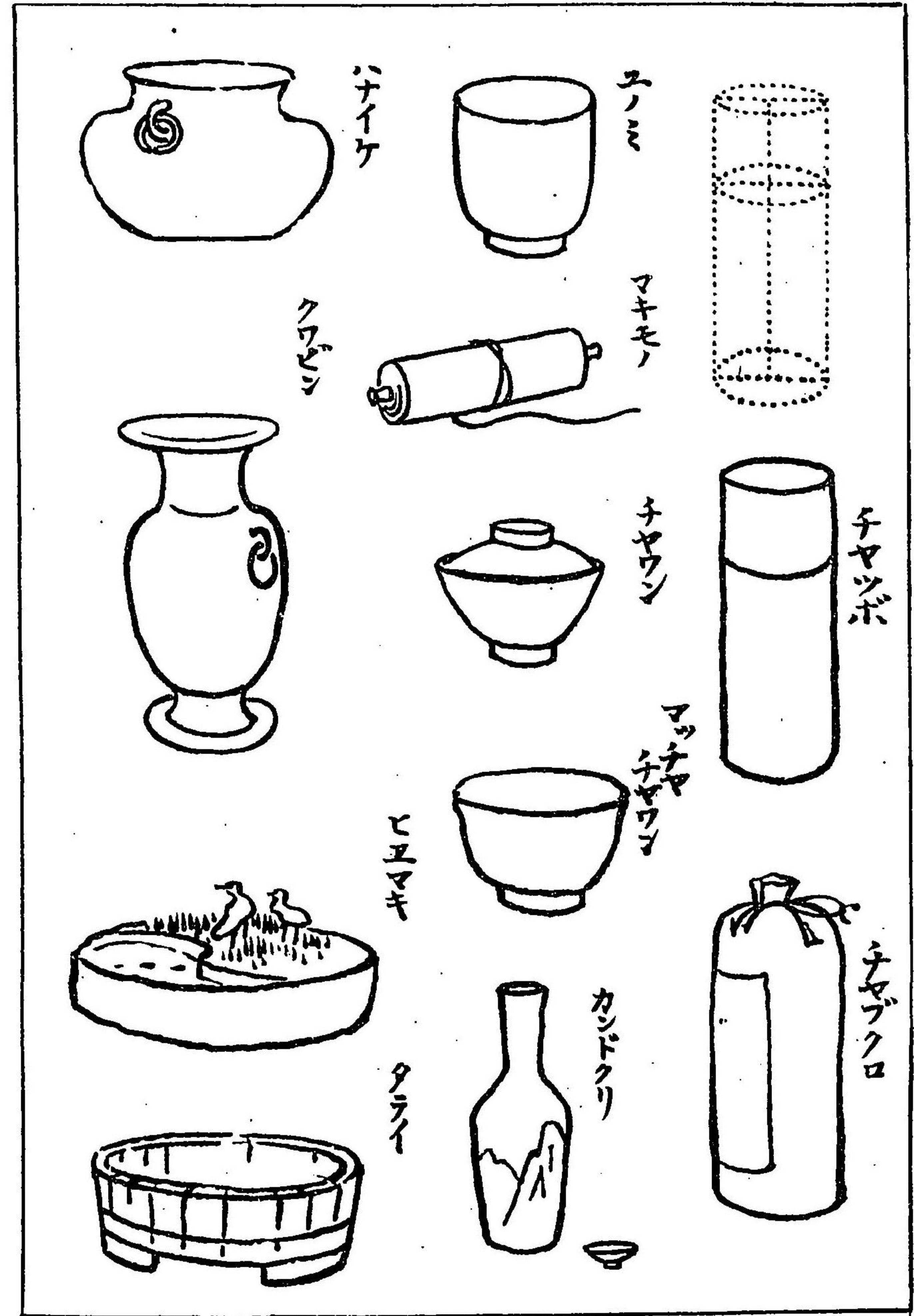
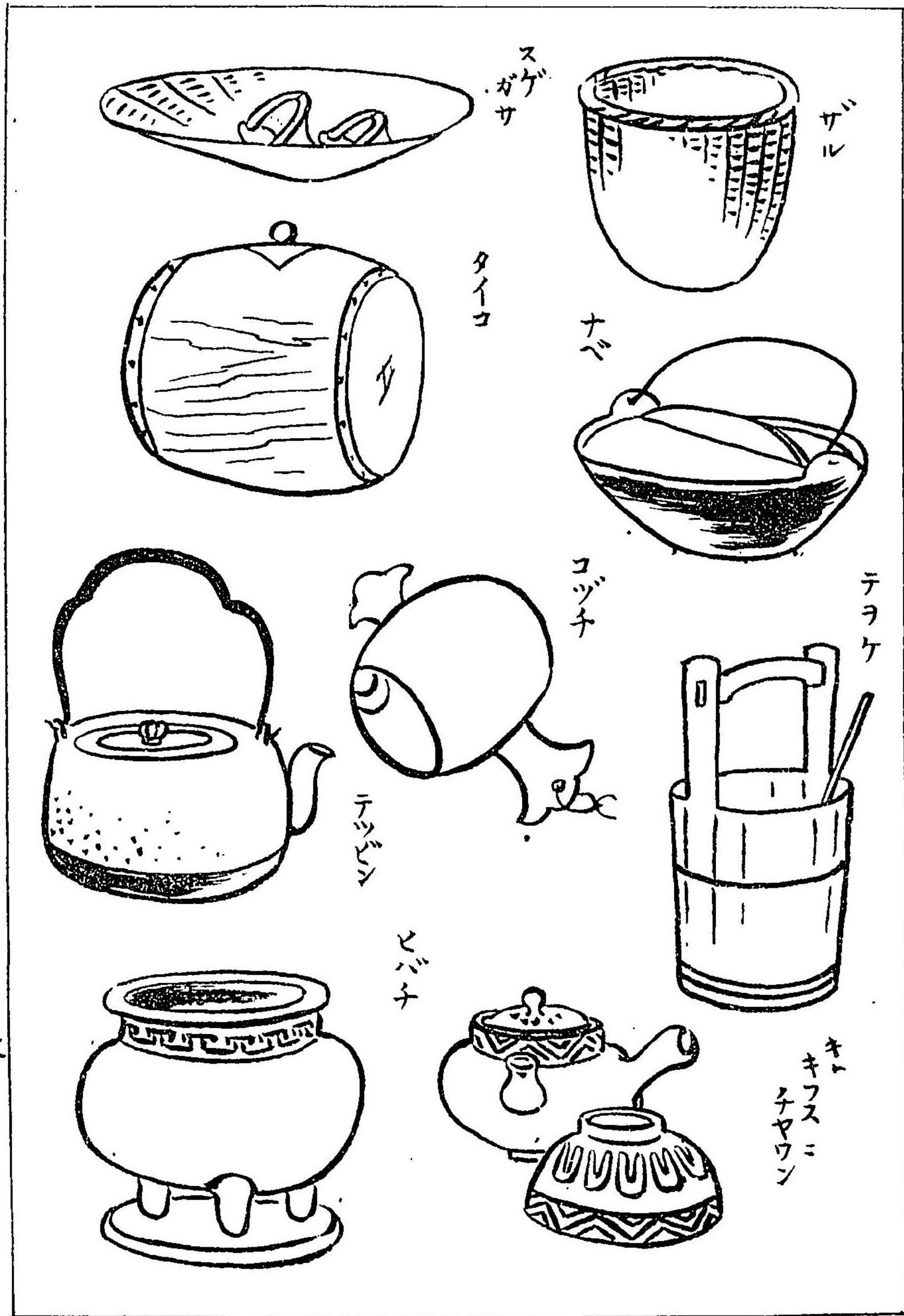

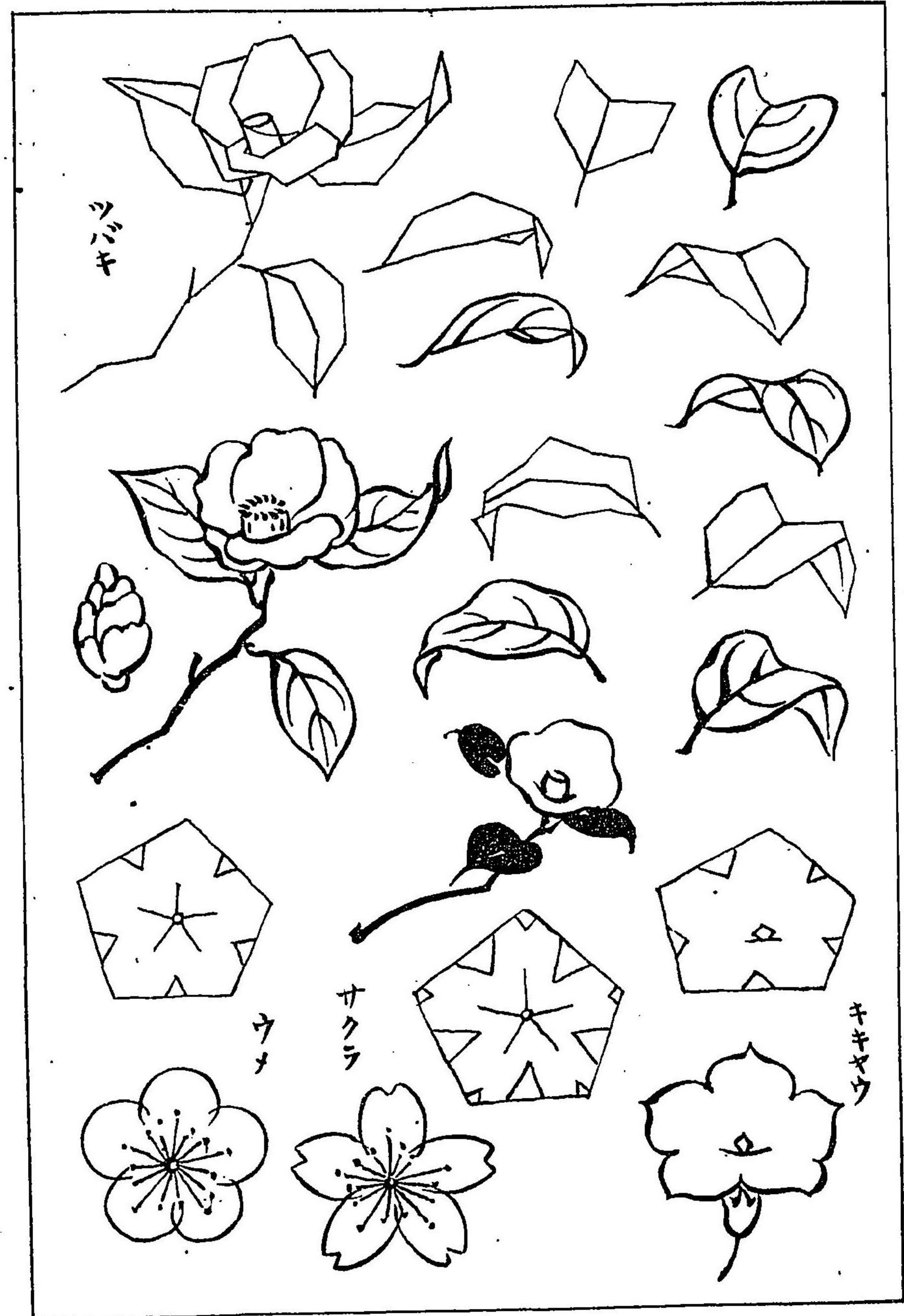

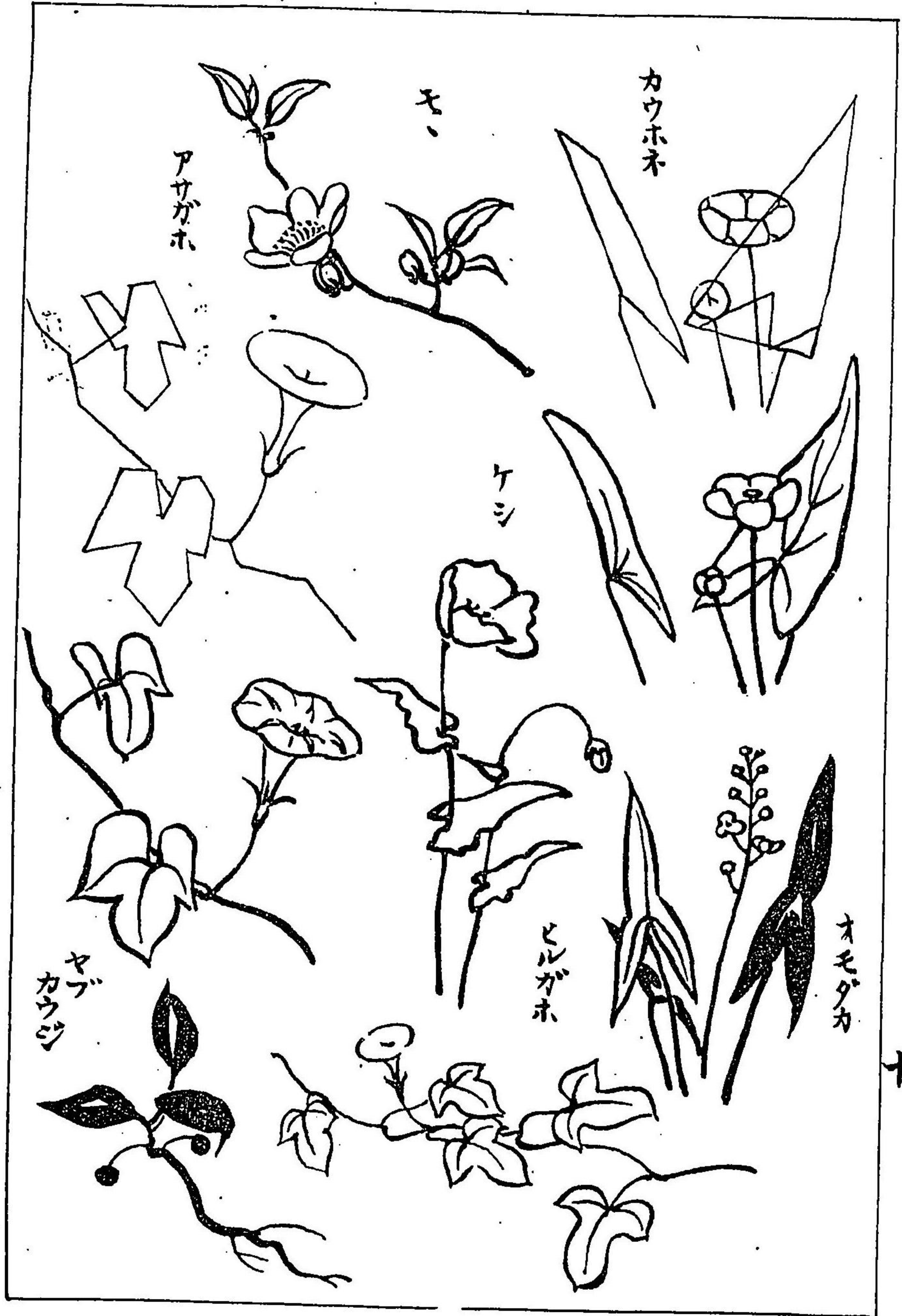

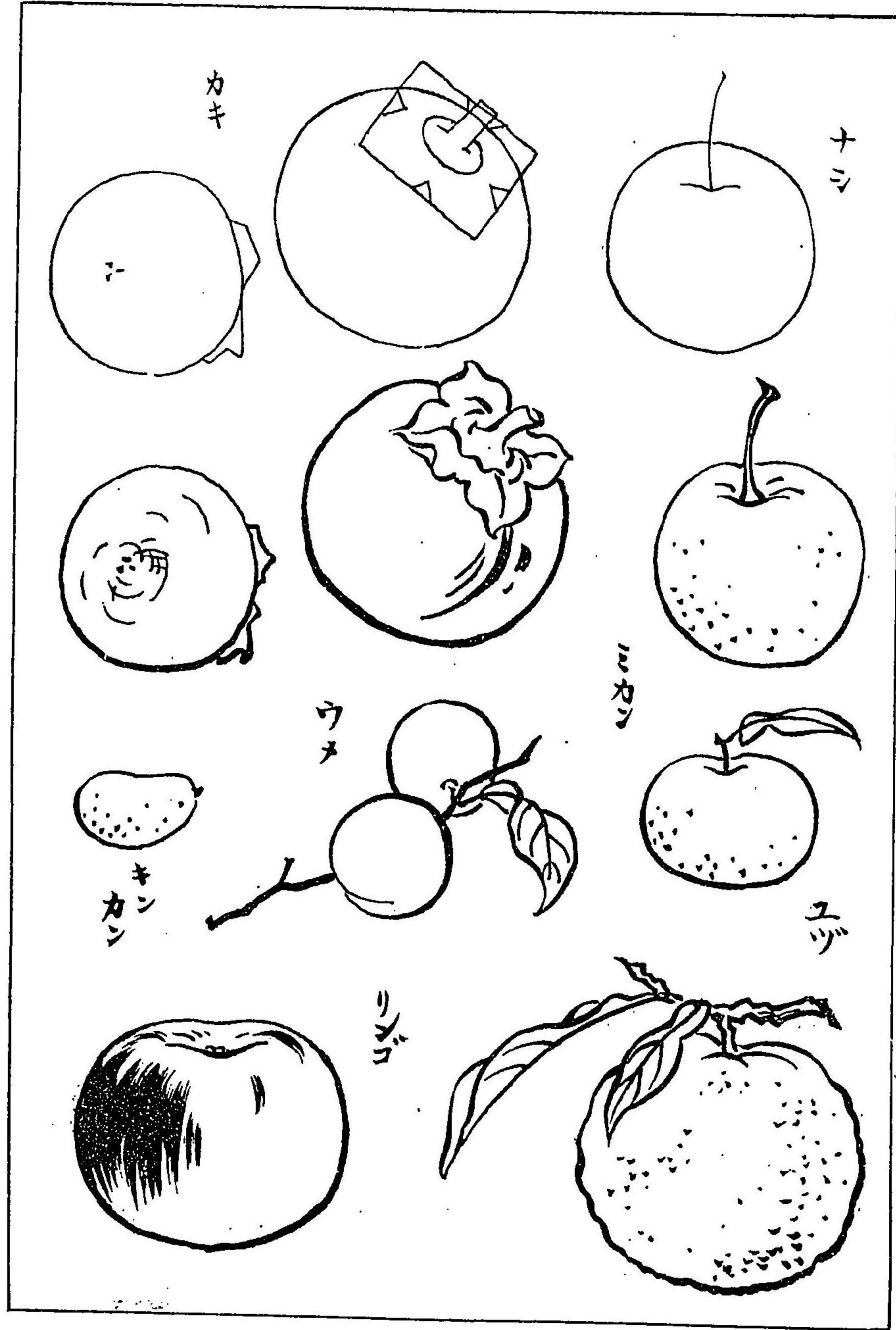
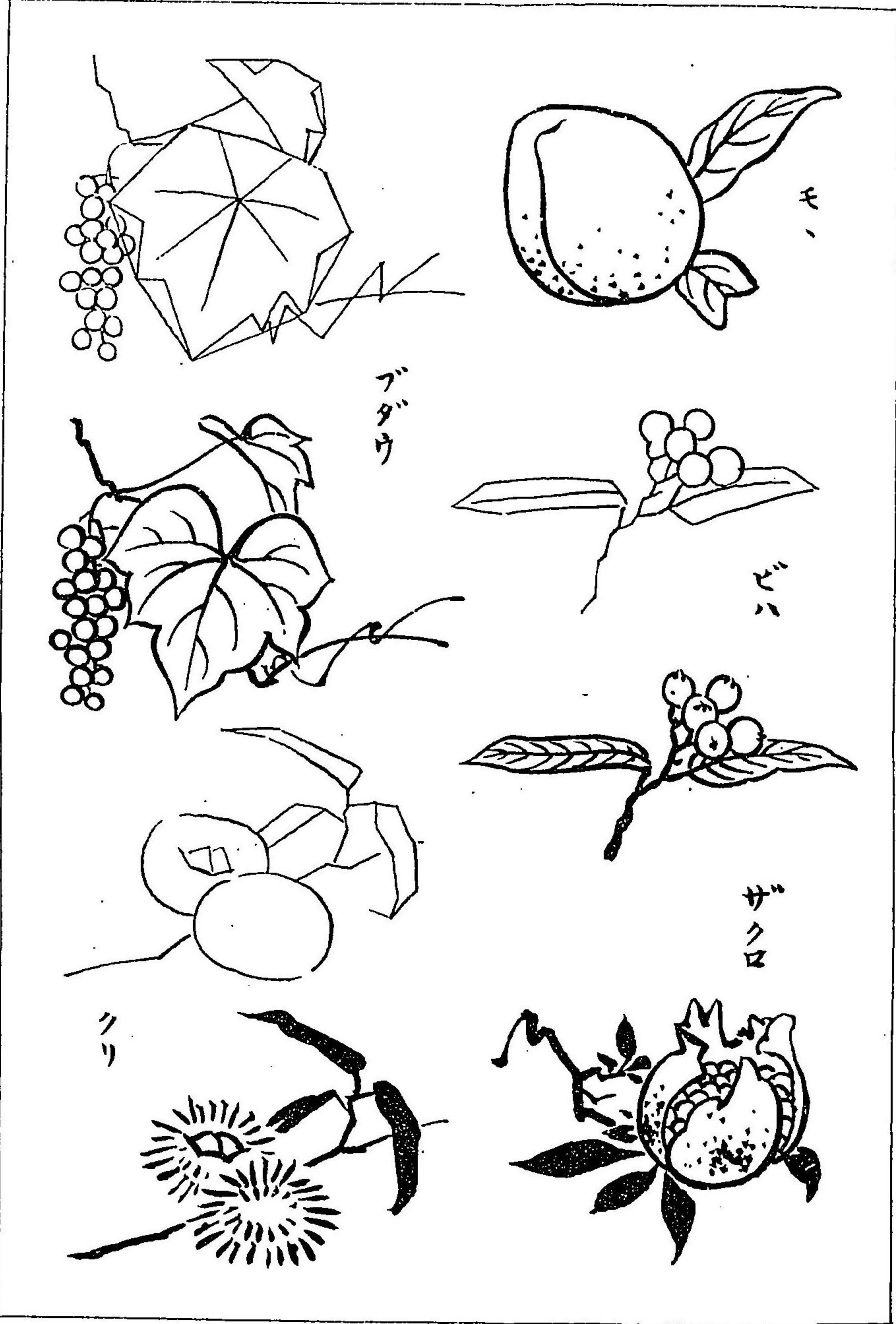

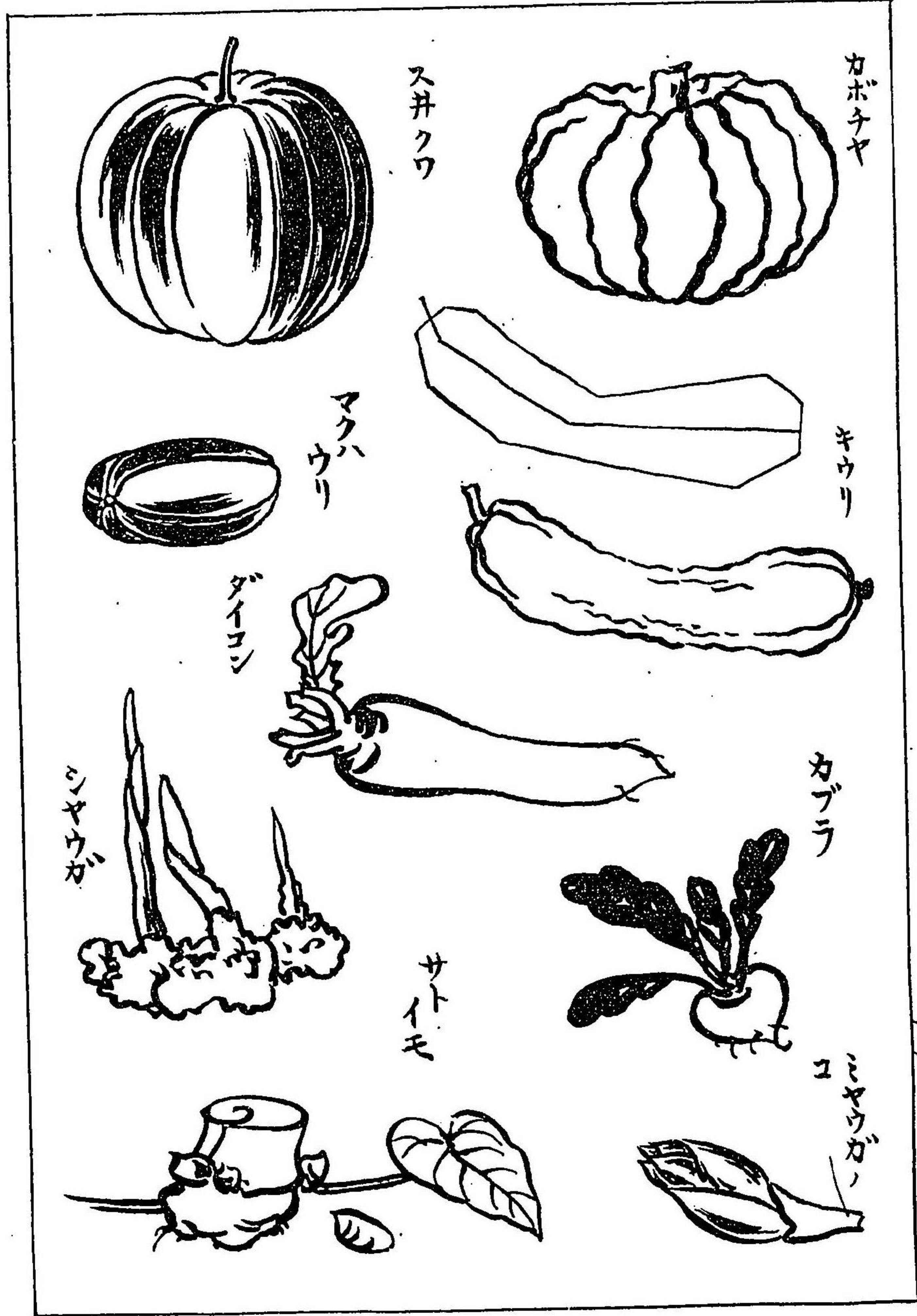
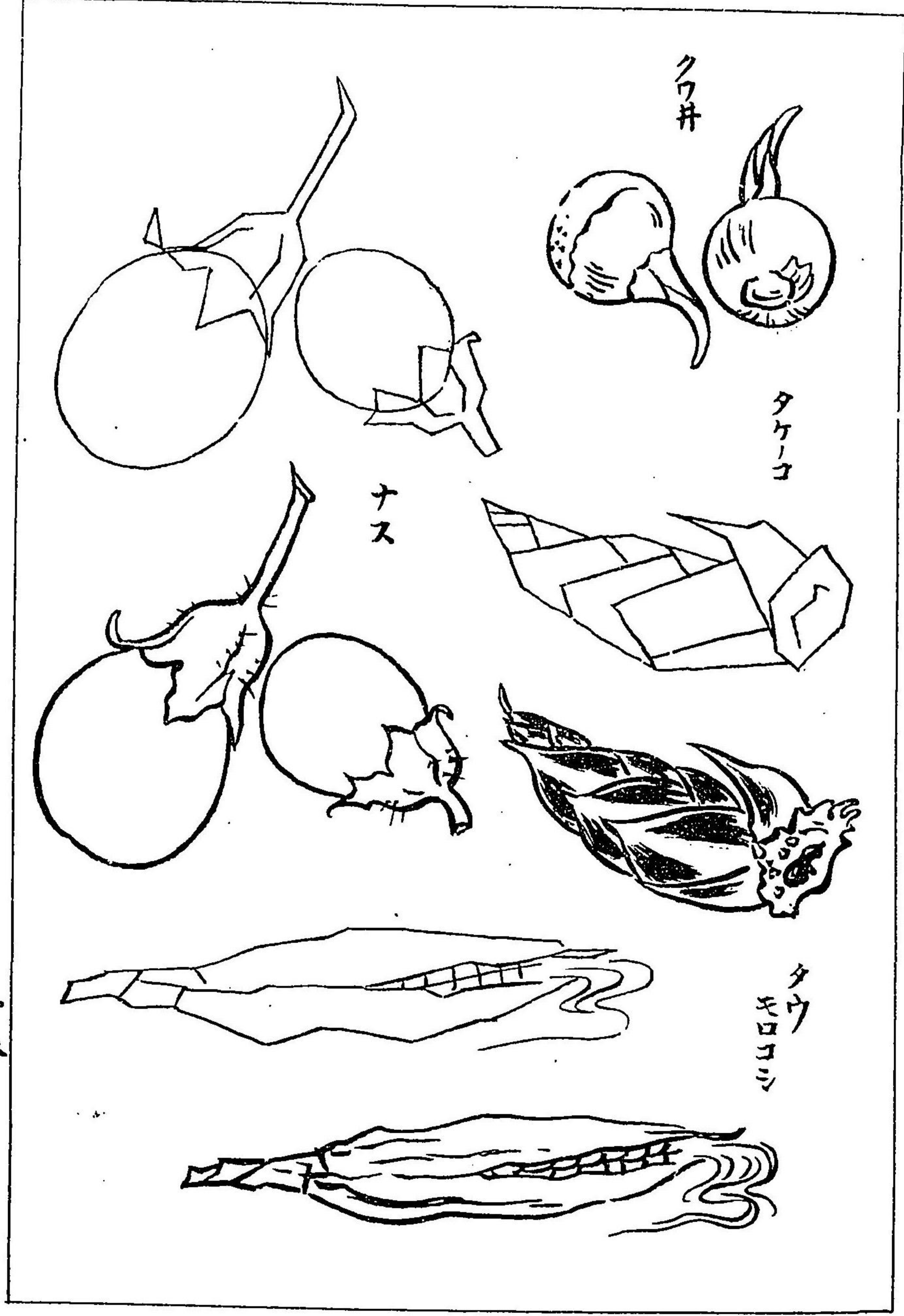

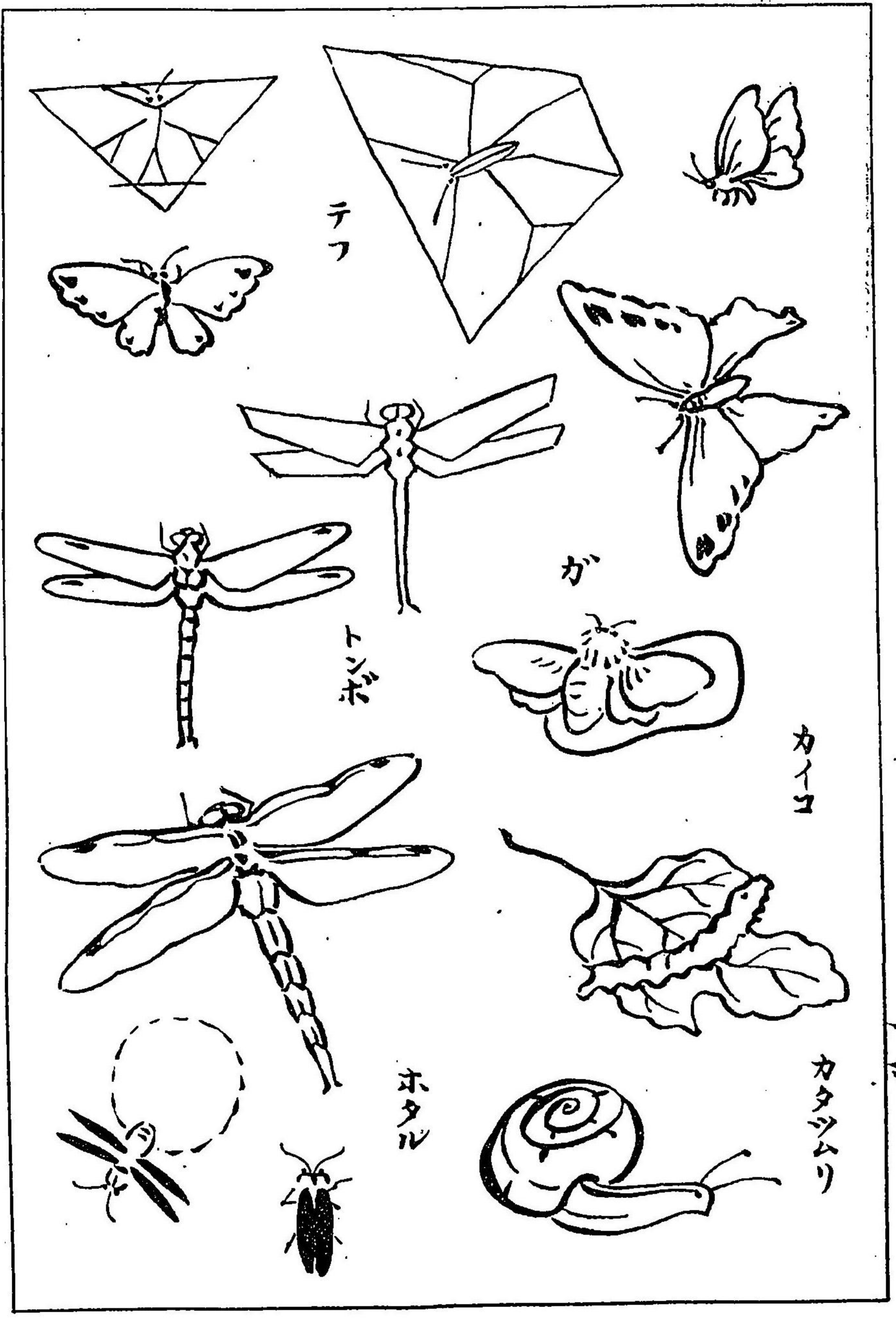
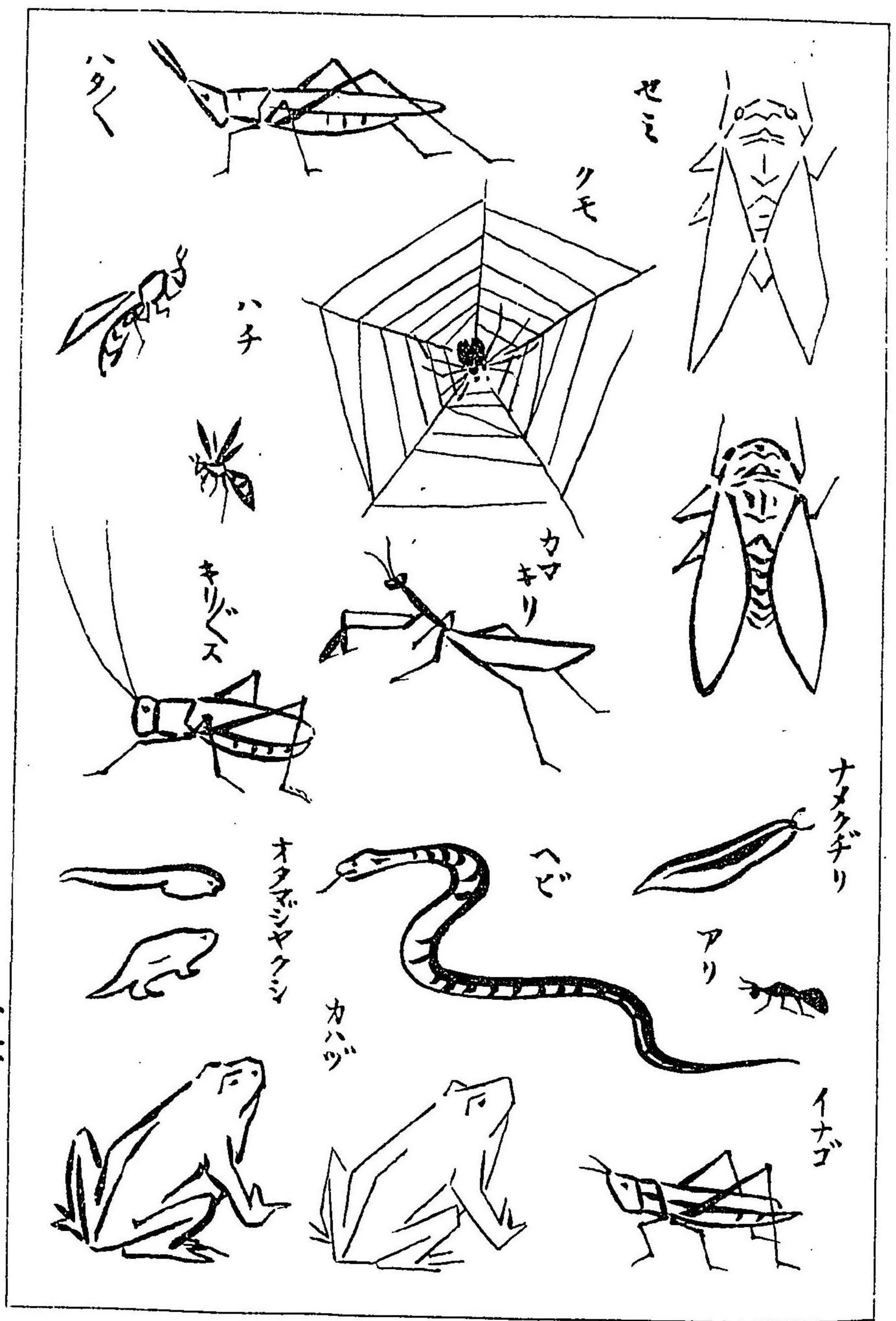

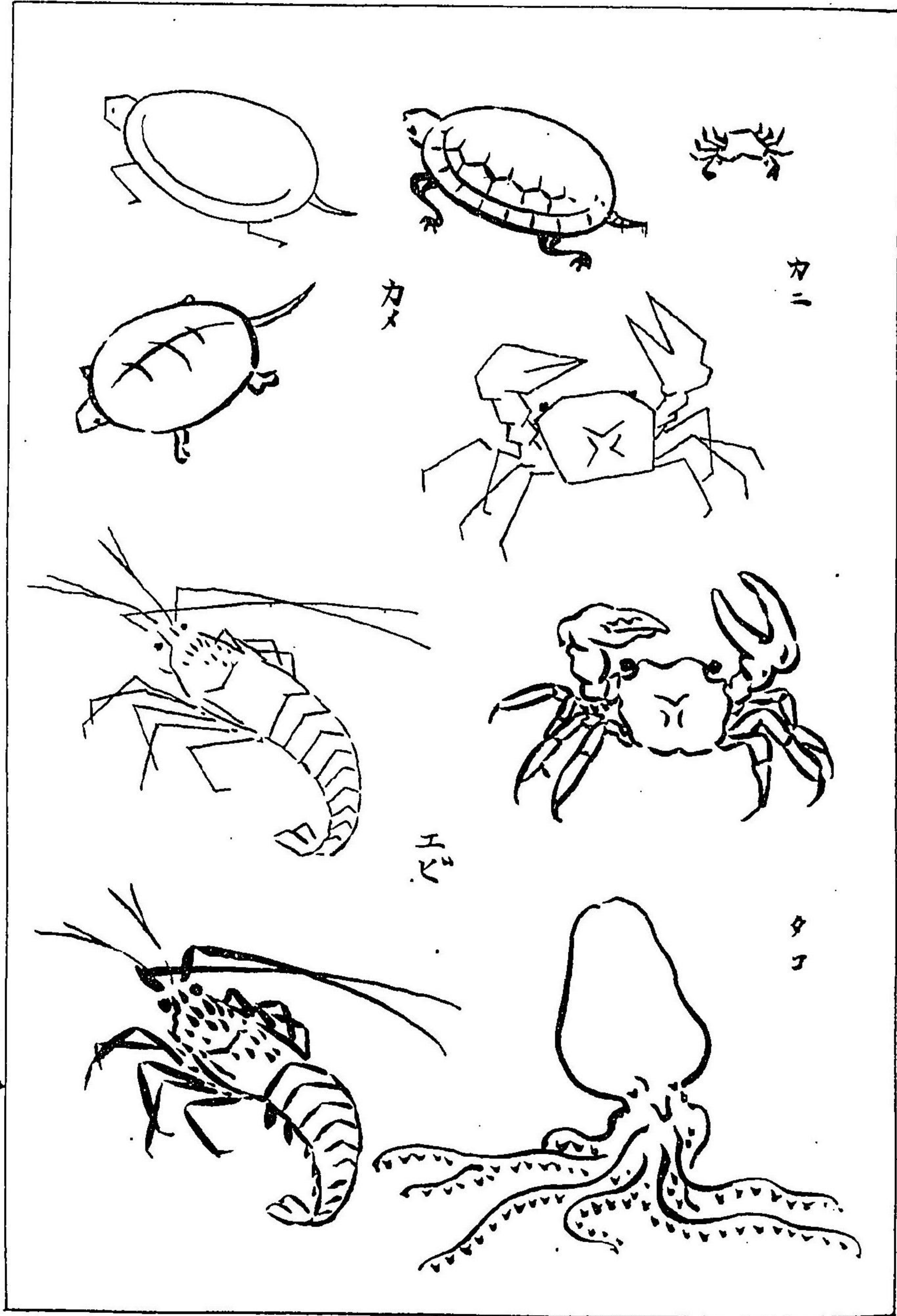

カニ

カメ

エビ

タコ

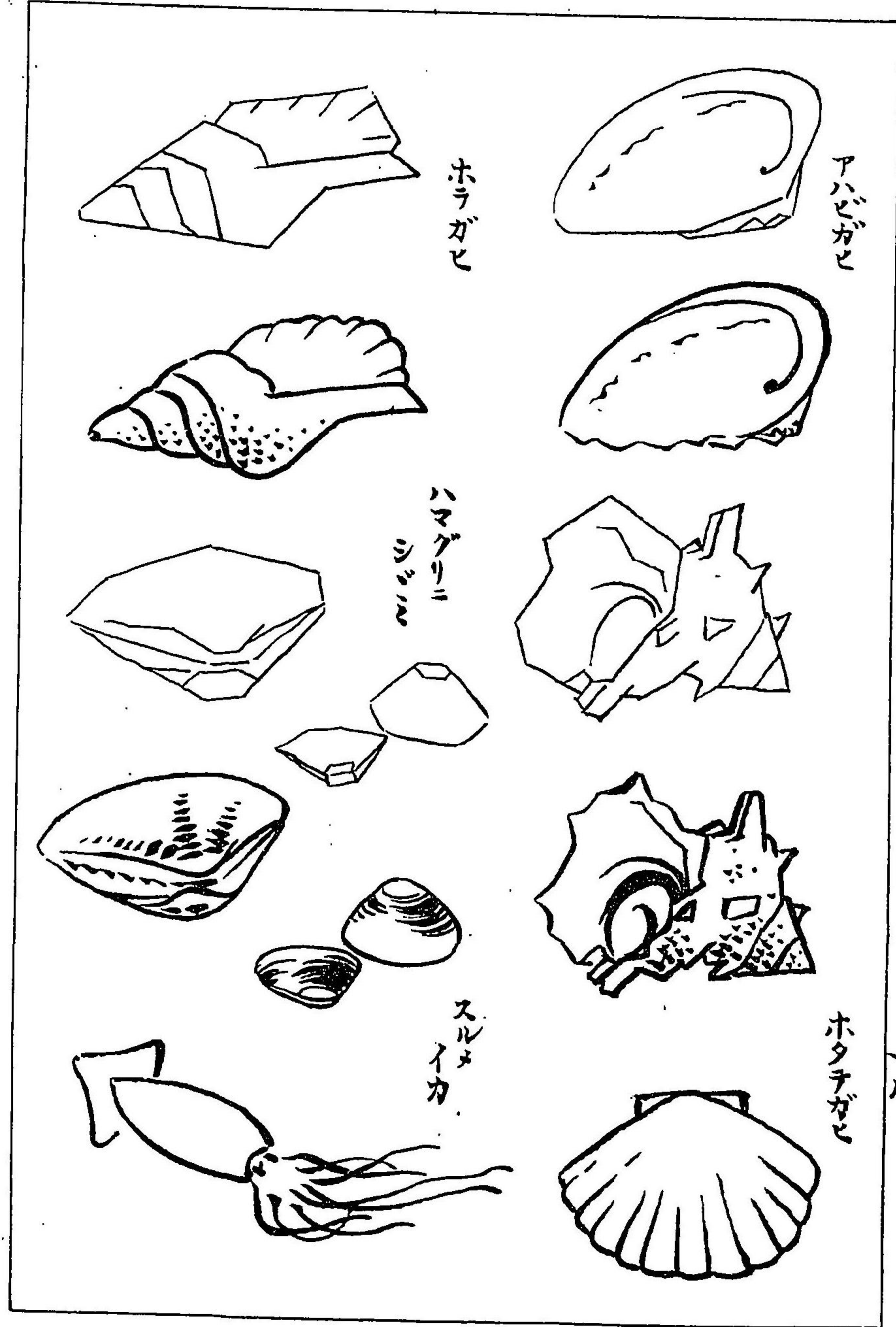

アハヒガヒ

ホラガヒ

ハマグリニ

シジミ

スルメ
イカ

ホタテガヒ

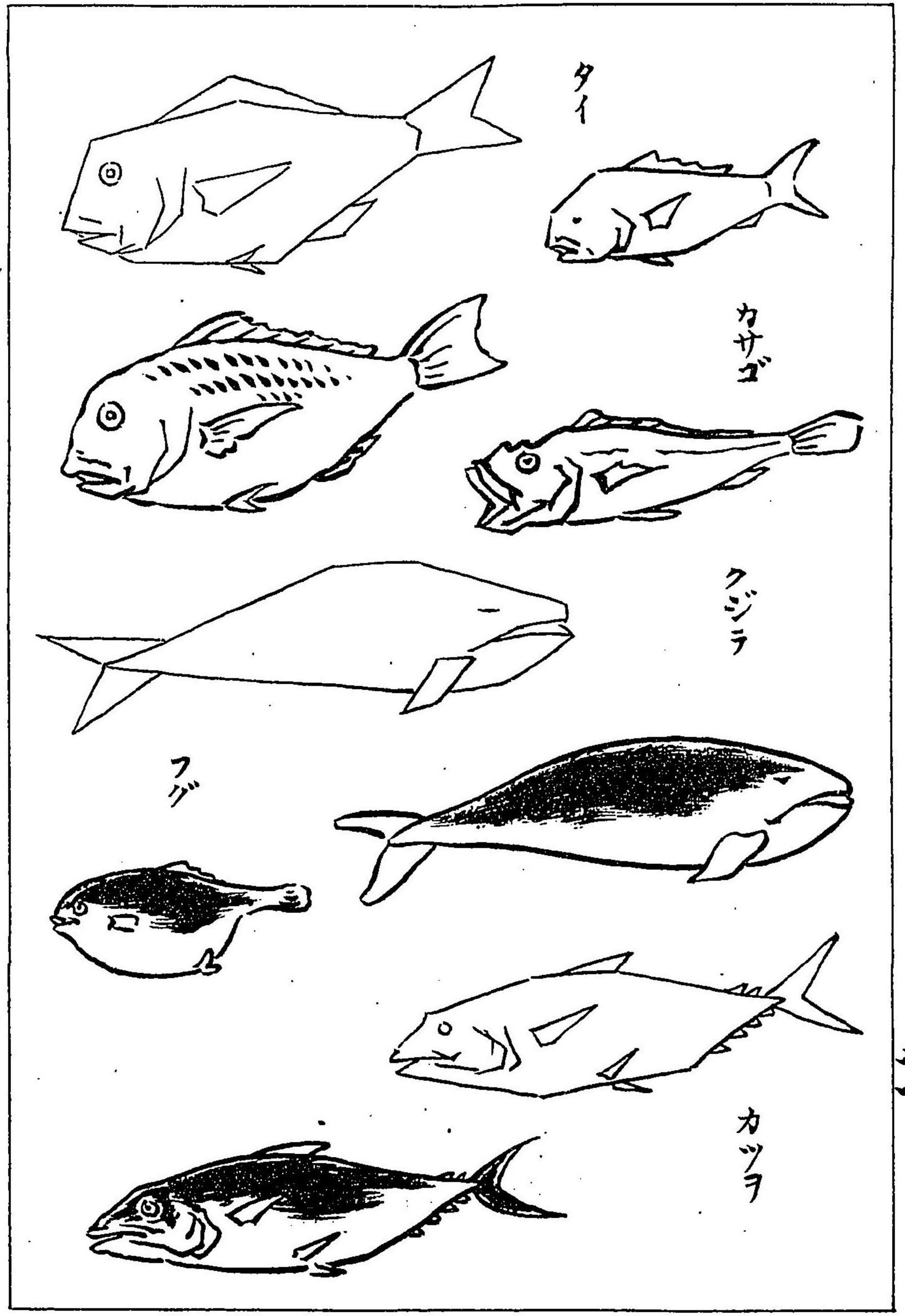
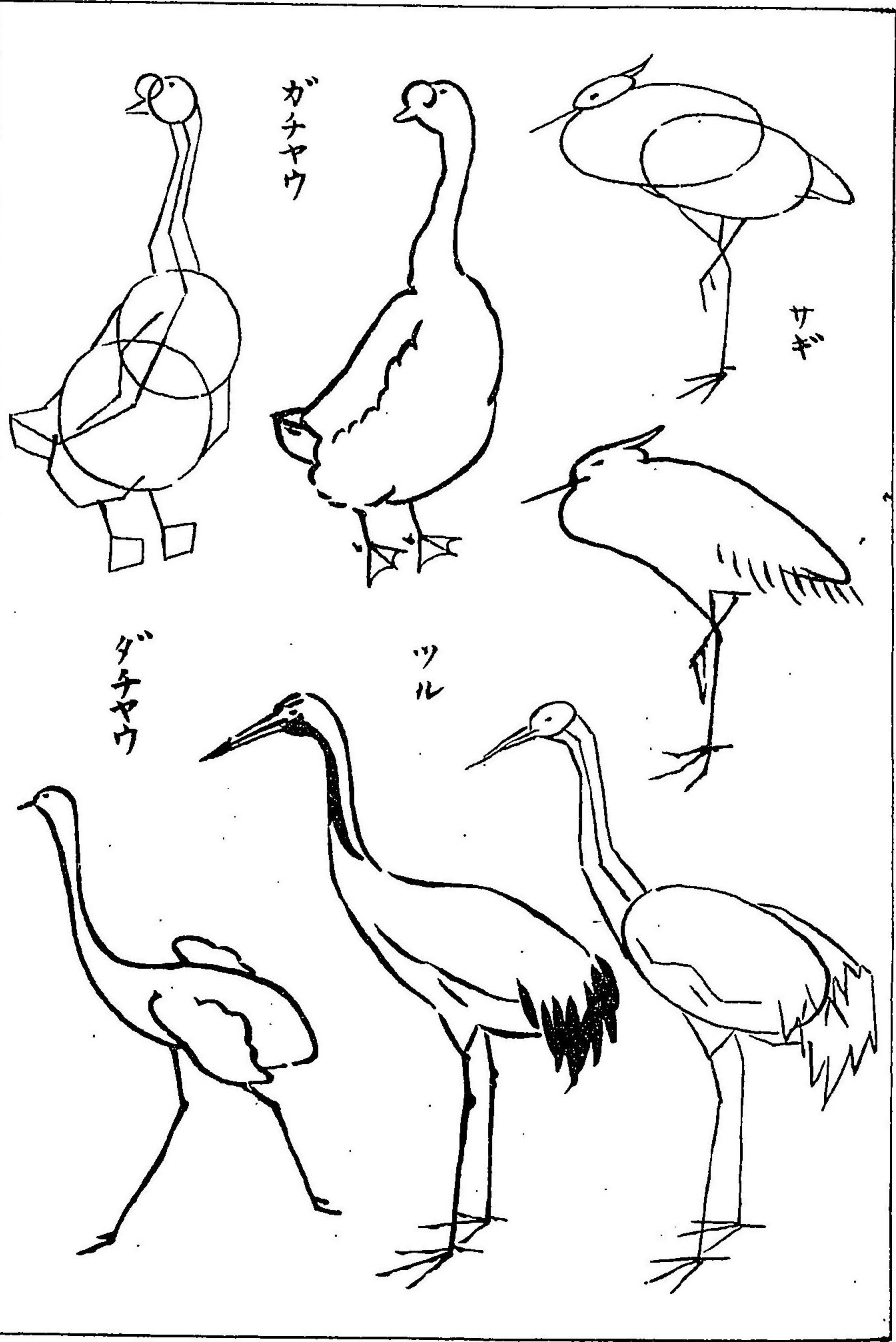

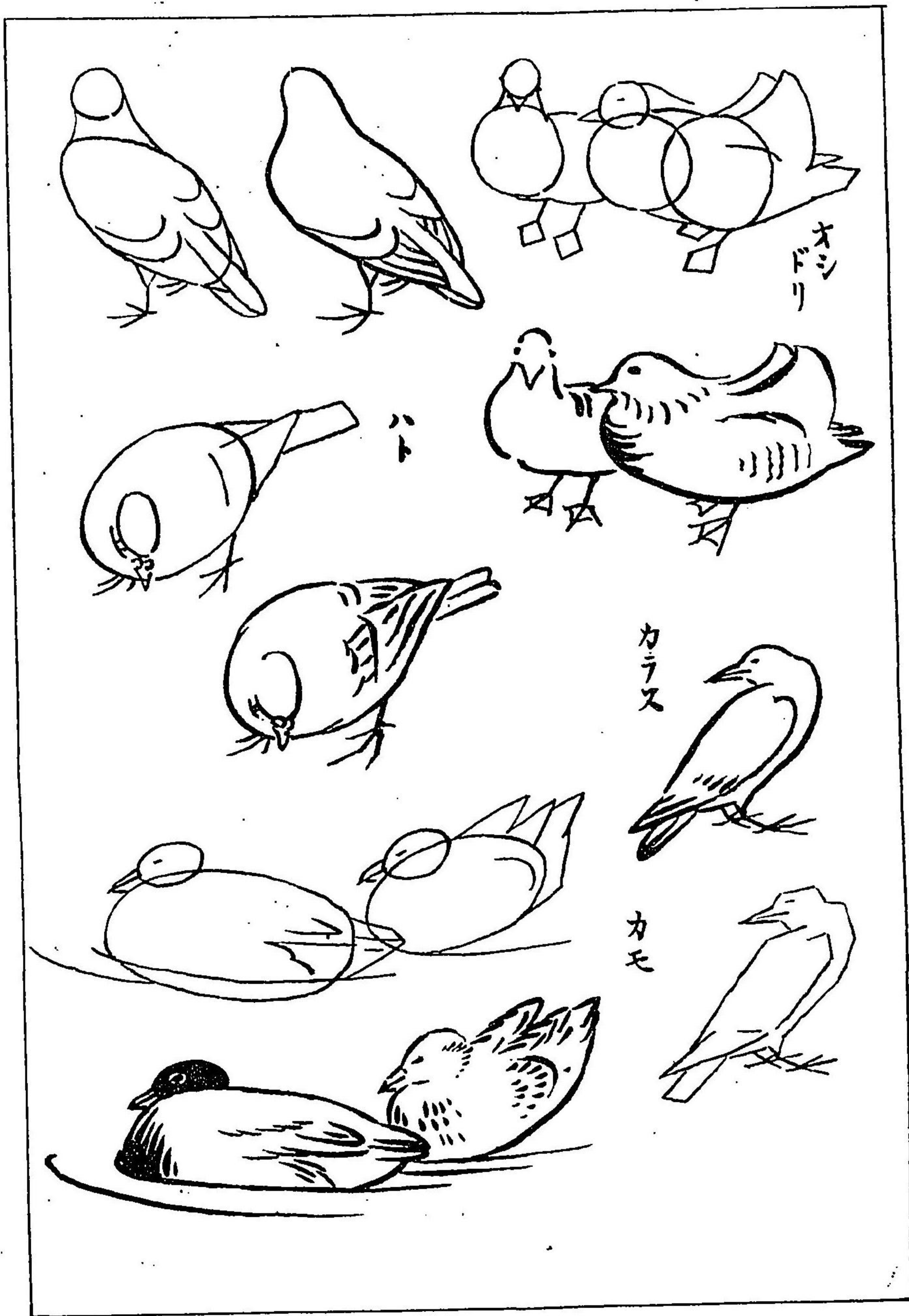
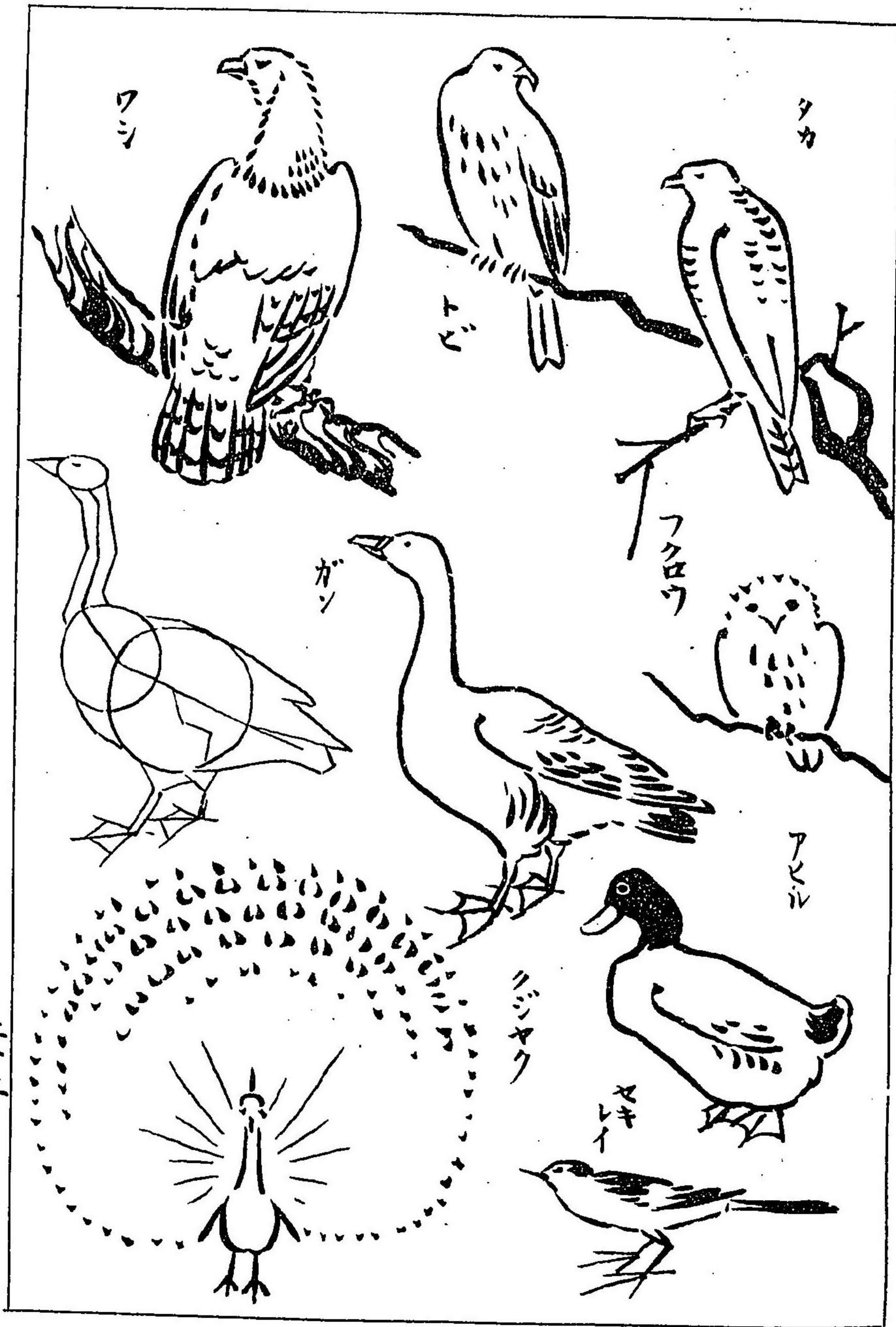

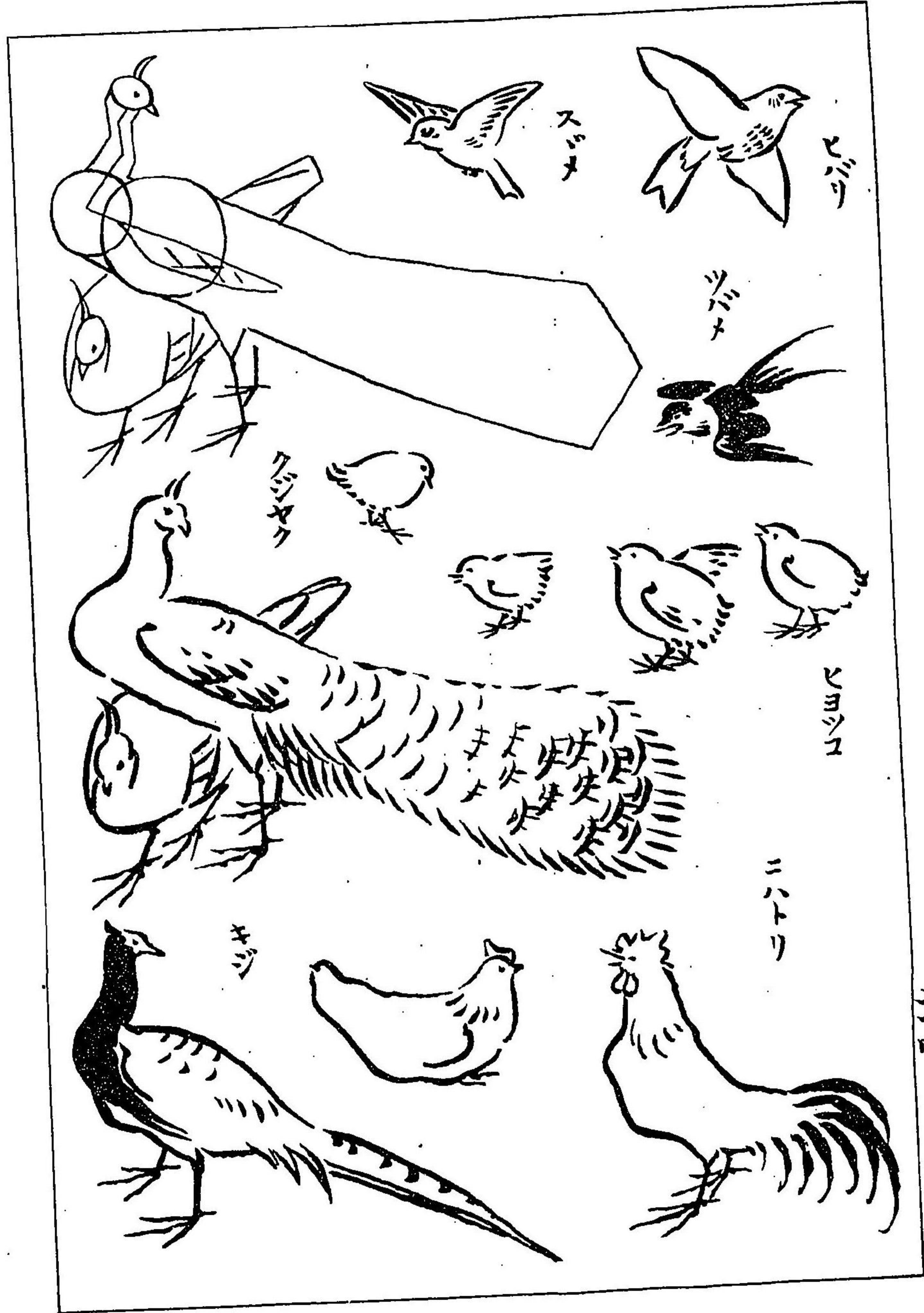
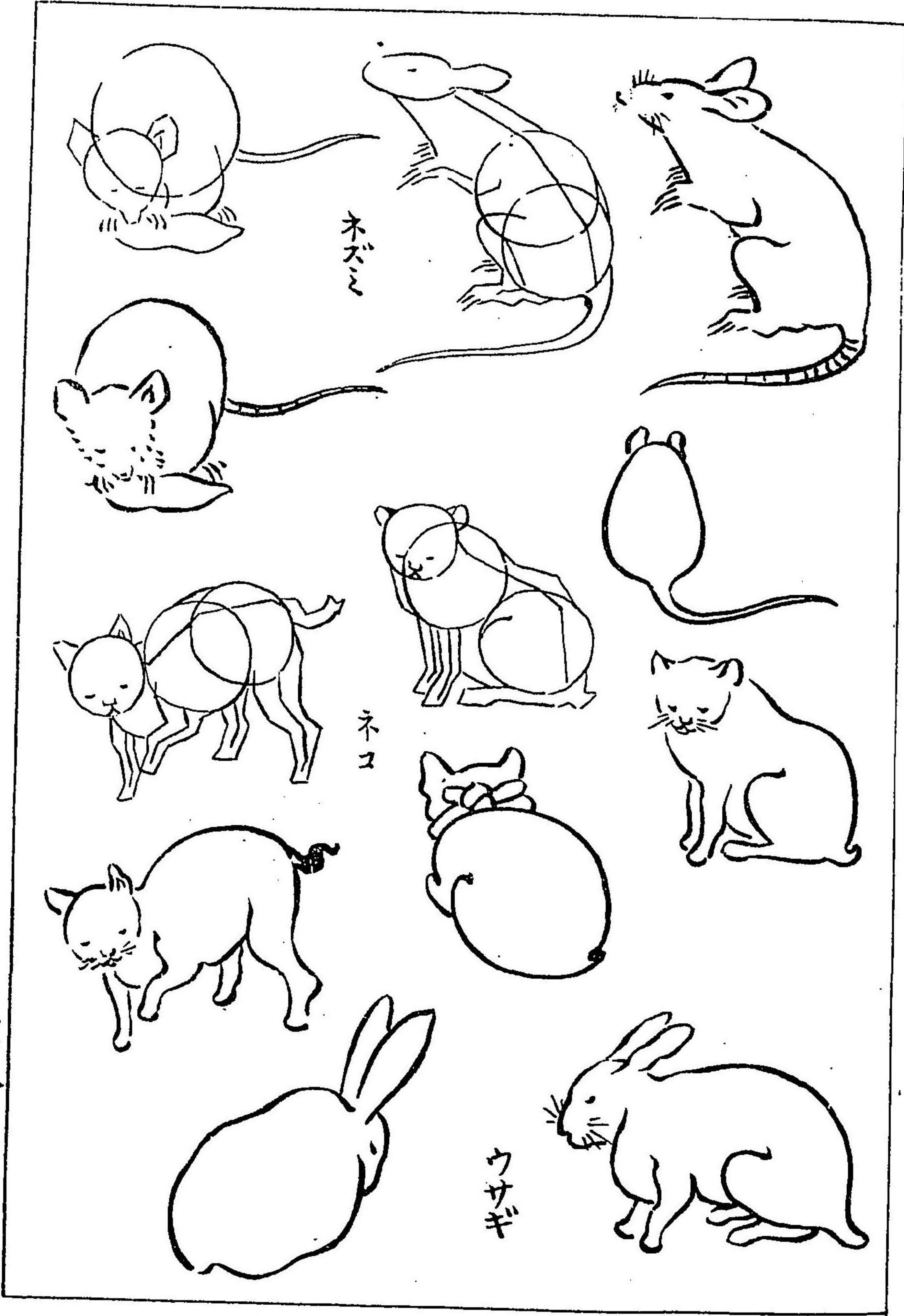

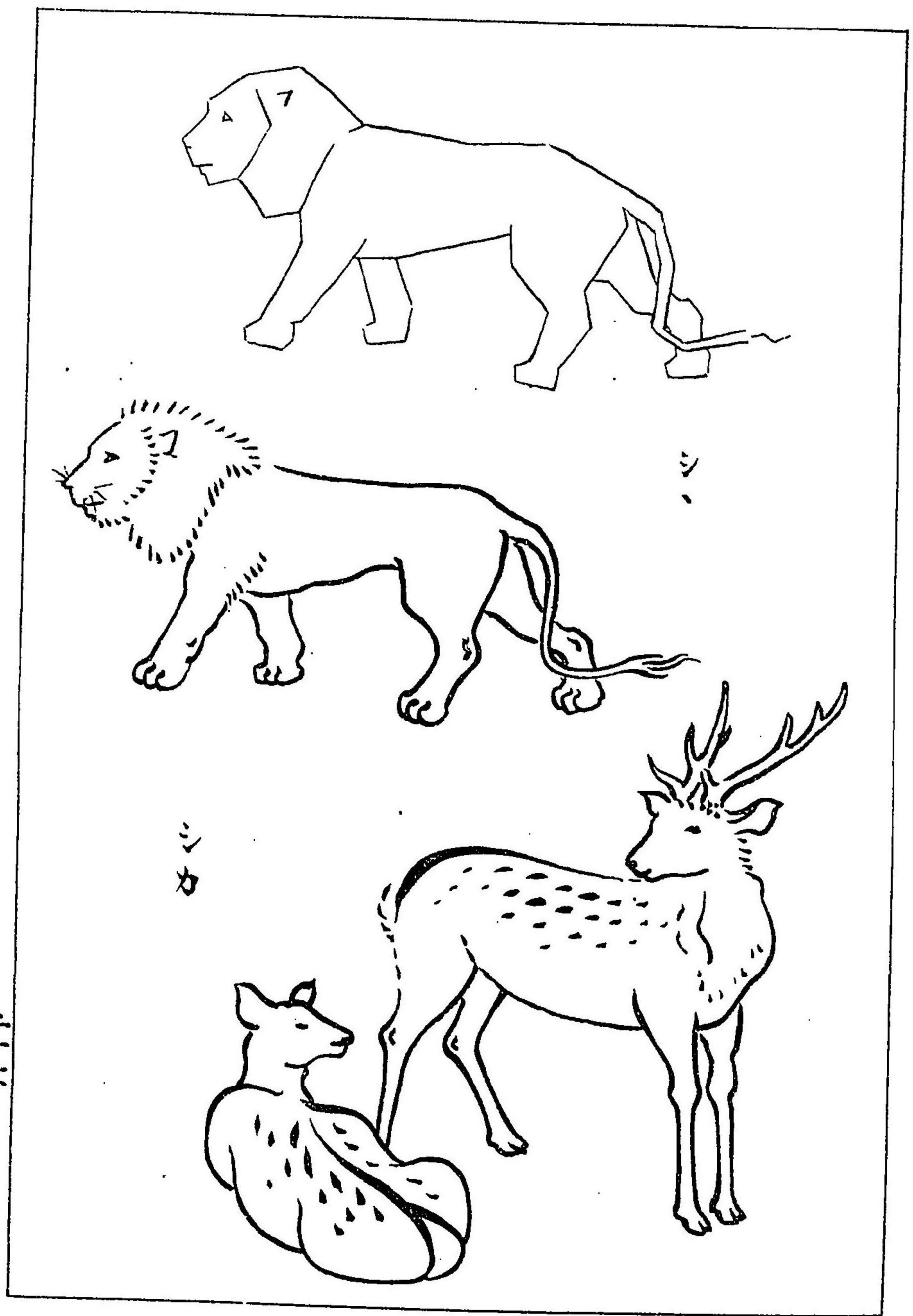

シシ

シメ

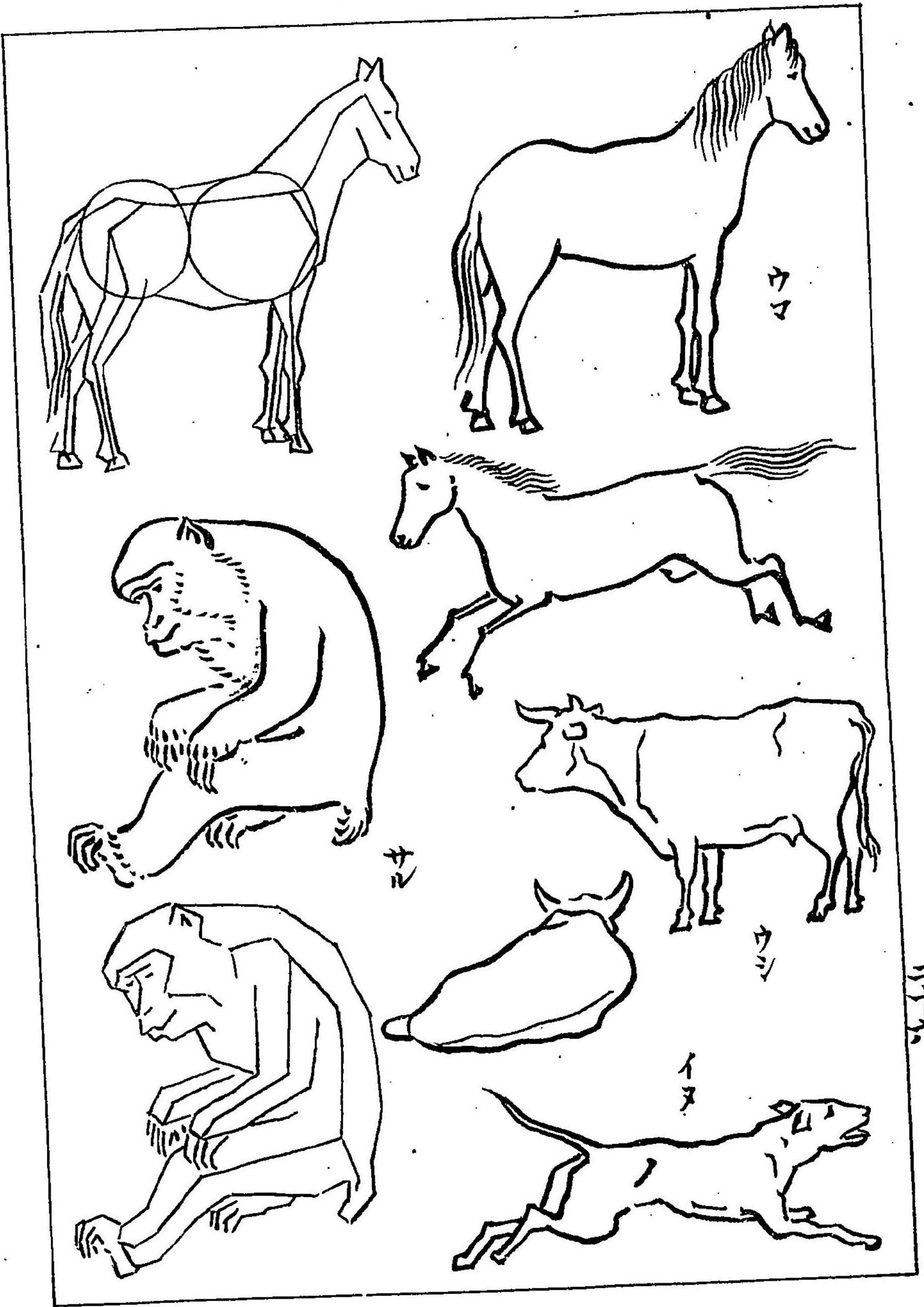

ウマ

サレ

ウシ

イヌ

二十六

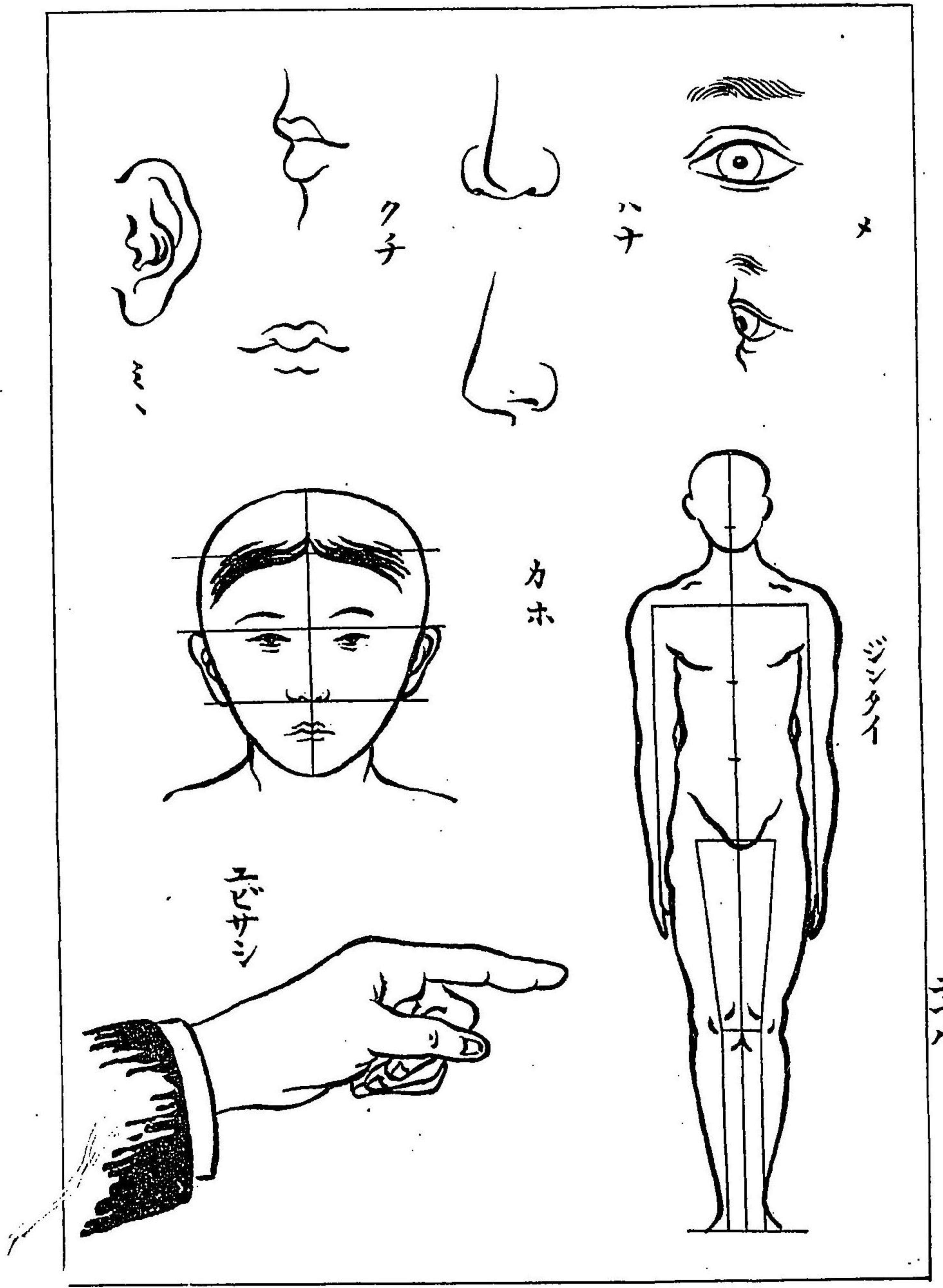
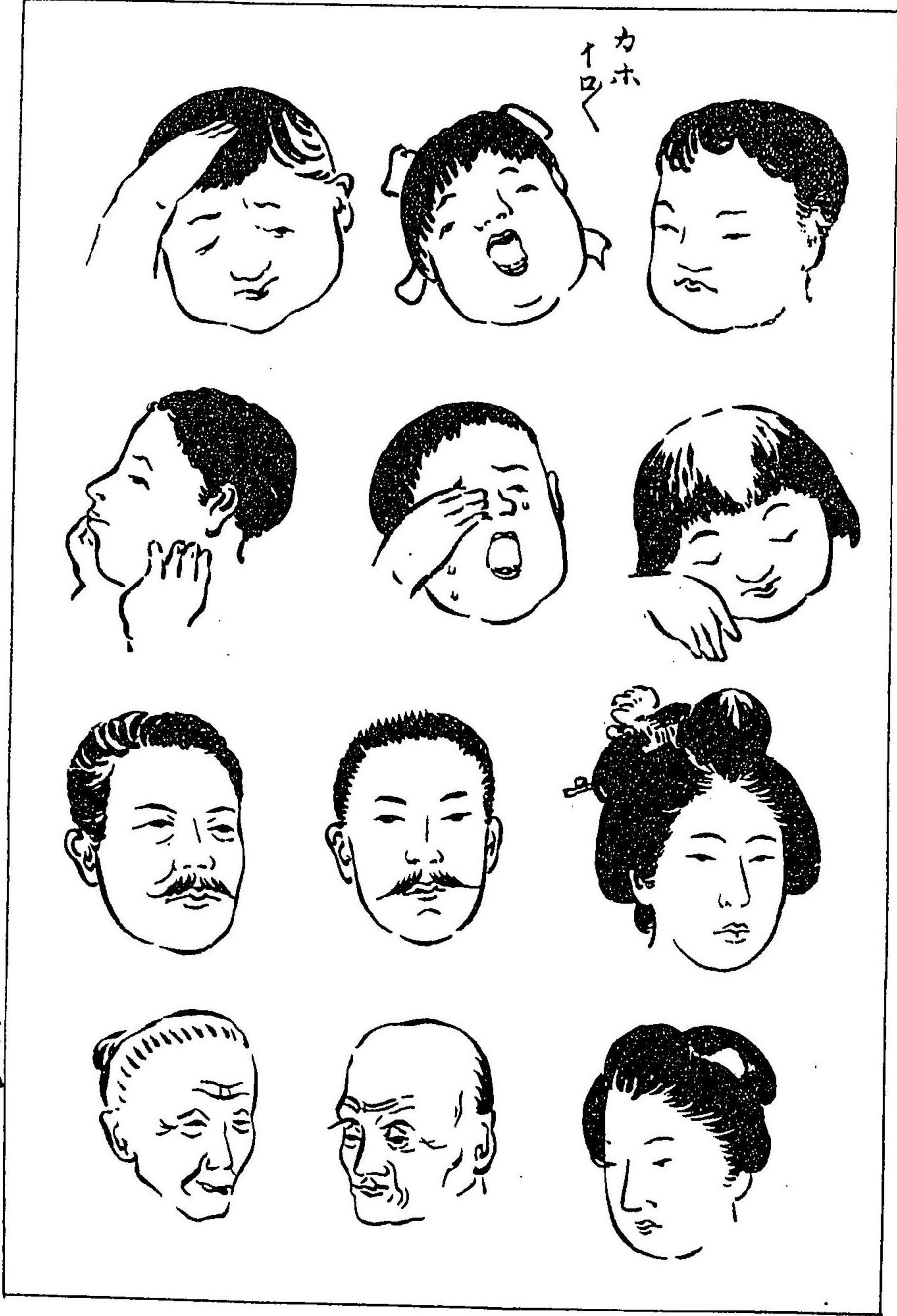



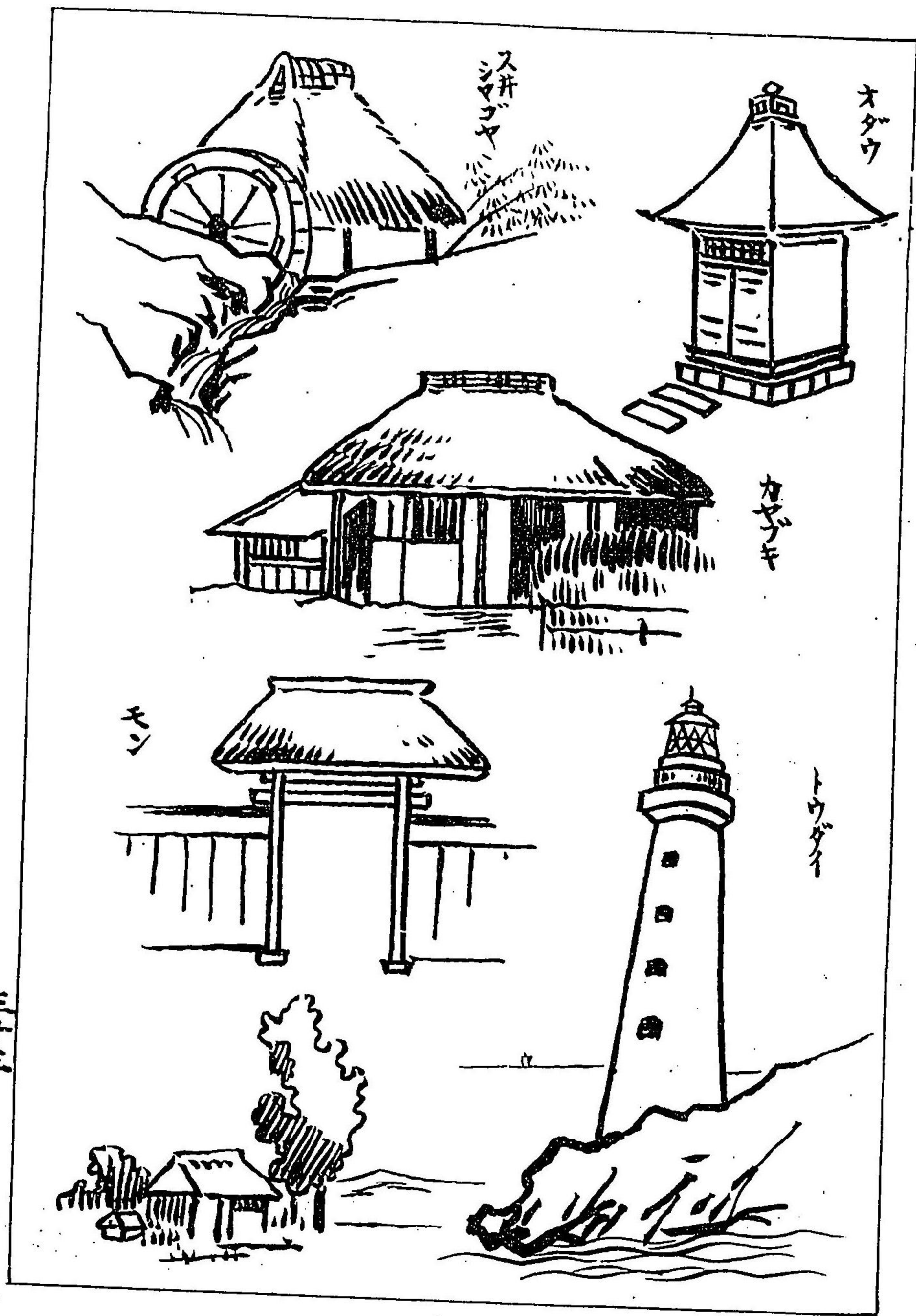

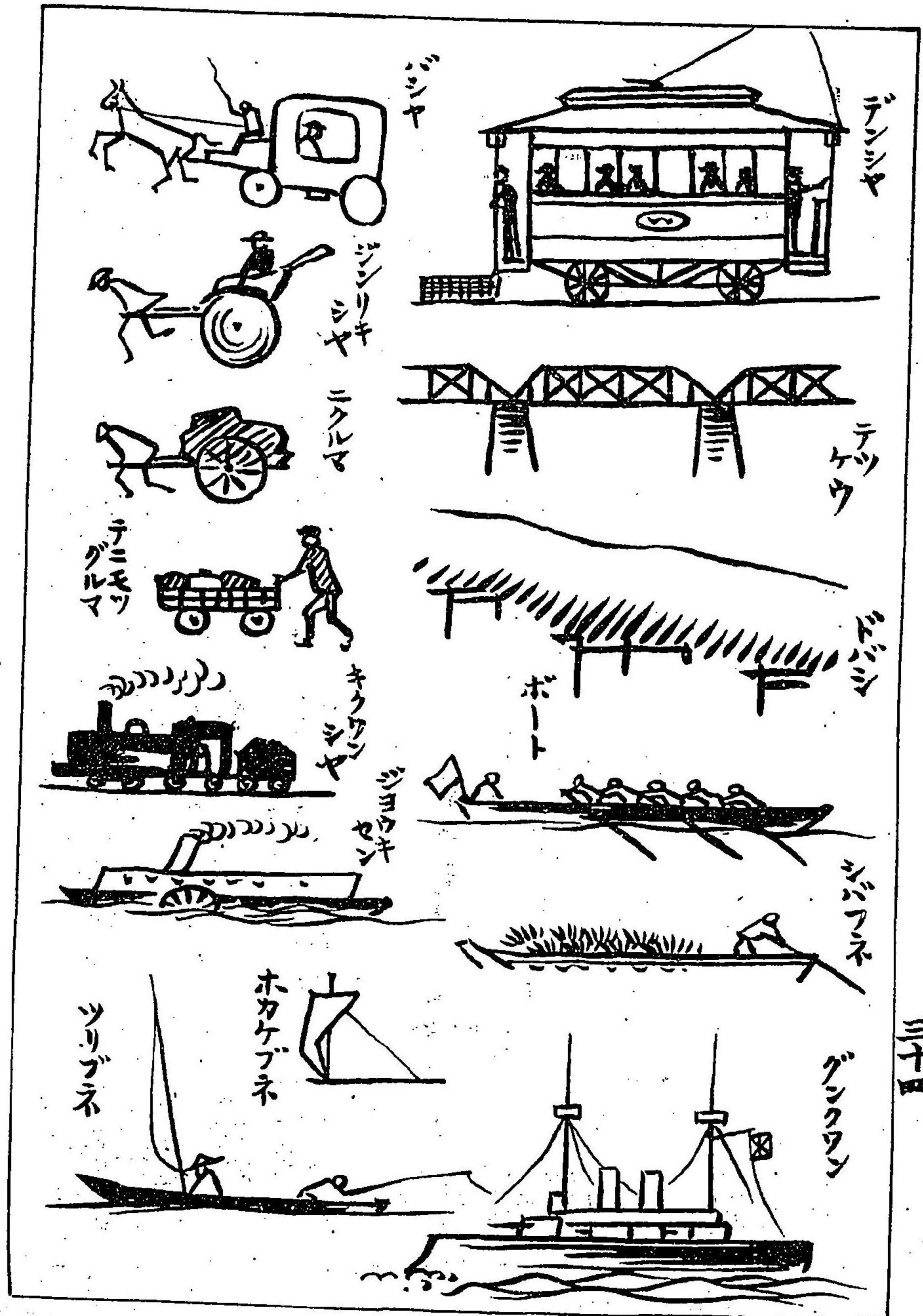
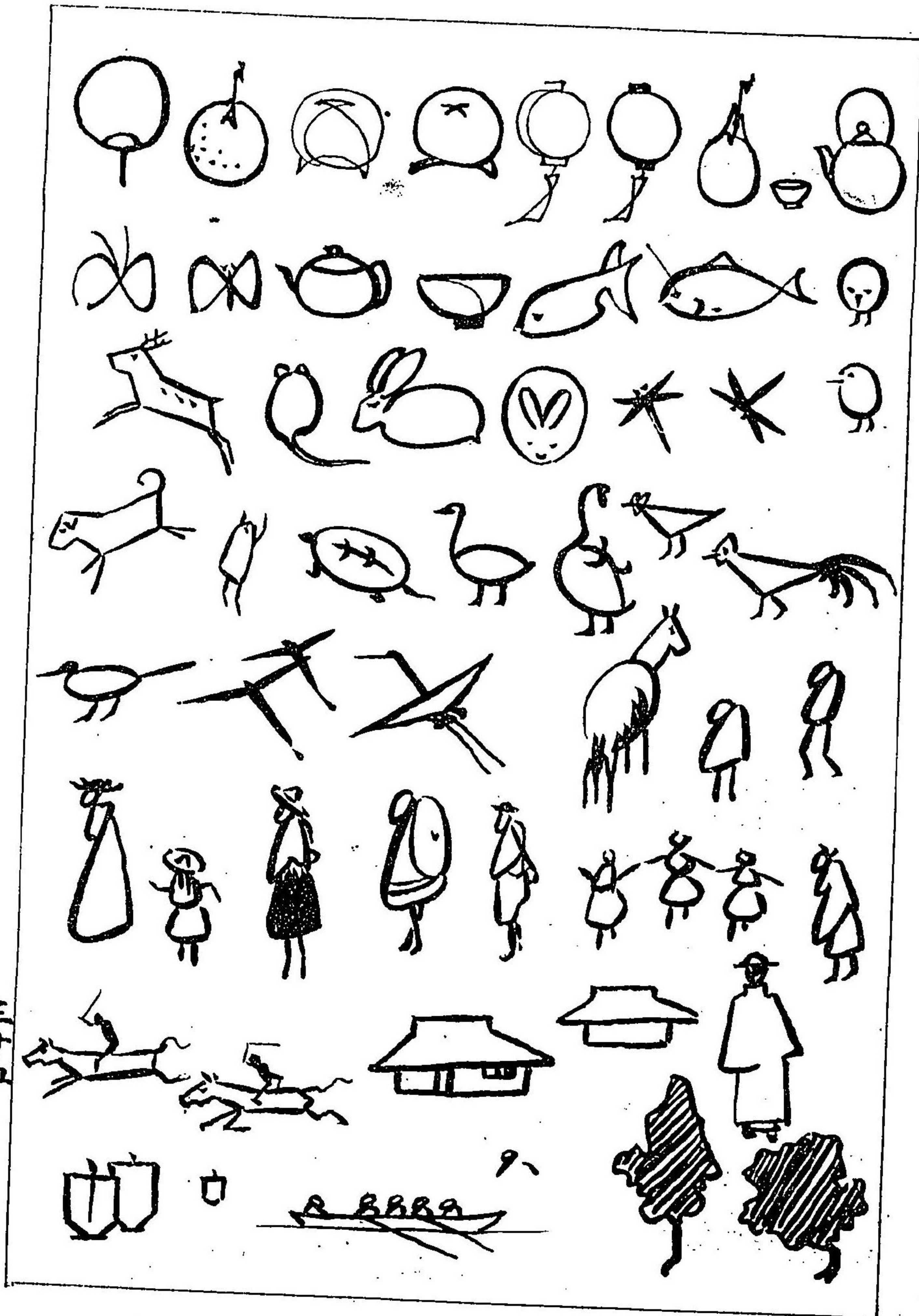

257
535

明治四十一年七月二十日印刷
明治四十一年八月一日發行

青森市大正町十二番地

編輯兼發行人 足立啓

青森市寺町四十六番地

印刷人 神良五郎

青森市寺町四十六番地

印刷所 一陽堂

