

FEDERAL INFORMATION
PROCESSING STANDARDS PUBLICATION

1976 MAY 1

U.S. DEPARTMENT OF COMMERCE / National Bureau of Standards

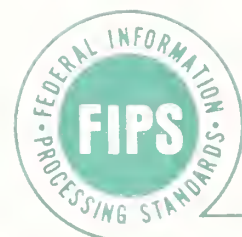

GUIDELINE
FOR
OPTICAL CHARACTER
RECOGNITION FORMS

JK
468
.A8A3
NO. 40
1976

CATEGORY: HARDWARE STANDARD
SUBCATEGORY: CHARACTER RECOGNITION

U. S. DEPARTMENT OF COMMERCE, Elliot L. Richardson, *Secretary*

James A. Baker, III, *Under Secretary*

Dr. Betsy Ancker-Johnson, *Assistant Secretary for Science and Technology*

NATIONAL BUREAU OF STANDARDS, Ernest Ambler, *Acting Director*

Foreword

The Federal Information Processing Standards Publication Series of the National Bureau of Standards is the official publication relating to standards adopted and promulgated under the provisions of Public Law 89-306, and Part 6 of Title 15 Code of Federal Regulations. The entire series constitutes the FEDERAL INFORMATION PROCESSING STANDARDS REGISTER.

The series is used to announce Federal Information Processing Standards, and to provide standards information of general interest and an index of relevant standards publications and specifications. Publications that announce adoption of standards provide the necessary policy, administrative, and guidance information for effective standards implementation and use. The technical specifications of the standard are usually attached to the publication, otherwise a reference source is cited.

Comments covering Federal Information Processing Standards and Publications are welcomed, and should be addressed to the Associate Director for ADP Standards, Institute for Computer Sciences and Technology, National Bureau of Standards, Washington, D.C. 20234. Such comments will be either considered by NBS or forwarded to the responsible activity as appropriate.

ERNEST AMBLER, *Acting Director*

Abstract

This publication provides materials relating to the design, preparation, acquisition, inspection, and application of OCR forms in data entry systems. Since the materials are advisory and tutorial in nature this publication has been issued as a guideline rather than as a standard in the FIPS publication series. Full color illustrations are employed to show specific features of reflective ink applications, a phenomena unique to OCR forms requirements. Appropriate references are made to cognizant standards in the OCR area.

Key words: Business forms, computers; data entry systems; information processing systems; information processing standards; OCR; OCR forms; optical character recognition; standards.

Nat. Bur. Stand. (U.S.), Fed. Info. Process. Stand. Publ. (FIPS PUB 40, 60 pages, (1975))

JUL 7 1976

**Federal Information
Processing Standards Publication 40**

1976 May 1

Announcing the Guideline for

OPTICAL CHARACTER RECOGNITION FORMS

Federal Information Processing Standards Publications are issued by the National Bureau of Standards pursuant to the Federal Property and Administrative Services Act of 1949 as amended, Public Law 89-306 (79 Stat. 1127), and as implemented by Executive Order 11717 (38 FR 12315), dated May 11, 1973, and Part 6 of Title 15 CFR (Code of Federal Regulations).

Name of Guideline. OPTICAL CHARACTER RECOGNITION FORMS (FIPS PUB 40)

Category of Guideline. Hardware, Character Recognition

Explanation. This guideline provides the description, scope, and procedures for designing, verifying, and writing of technical specifications for forms with special characteristics required for use with Optical Character Recognition (OCR) systems.

Approving Authority. Department of Commerce, National Bureau of Standards (Institute for Computer Sciences and Technology).

Maintenance Agency. Department of Commerce, National Bureau of Standards (Institute for Computer Sciences and Technology).

Cross Index.

- a. FIPS PUB 32, Optical Character Recognition Character Sets
- b. FIPS PUB 33, Character Set for Handprinting
- c. X3.17-1974, American National Standard Character Set and Print Quality for Optical Character Recognition, (OCR-A)
- d. X3.45-1974, American National Standard Character Set for Handprinting
- e. X3.49-1975, American National Standard Character Set for Optical Character Recognition, (OCR-B)
- f. ECMA 11-1975, Character Set for Optical Character Recognition
- g. ISO R1073, Character Sets for Optical Character Recognition
- h. Records Management Handbook, FORMS DESIGN, General Services Administration, National Archives and Records Service (National Stock Number 7610-00-753-4771)
- i. Records Management Handbook, FORMS MANAGEMENT, General Services Administration, National Archives and Records Service (National Stock Number 7610-00-142-9363)
- j. Records Management Handbook, FORMS ANALYSIS, General Services Administration, National Archives and Records Service (National Stock Number 7610-00-655-8220)
- k. Records Management Handbook, SPECIALTY FORMS, General Services Administration, National Archives and Records Service (National Stock Number 7610-00-133-5844).

Applicability. This Guideline is intended to provide reference material that will be useful in the design, development, or revision of OCR forms used in data entry systems within Federal agencies and in those applications where OCR forms are used for interchange of information between and among agencies. Use of this Guideline is encouraged, but is not mandatory.

Specifications. Federal Information Processing Standards Publication 40. (FIPS PUB 40), Optical Character Recognition Forms (affixed).

Qualifications. This Guideline contains numerous instances where specific references are made to trade names of products which are necessary to provide a descriptive characterization of their features. This, in no case, implies a recommendation or endorsement by the Federal government or the National Bureau of Standards, nor should this be construed as a certification that any product provides the indicated capabilities. The information provided was primarily obtained from producers' documents. This Guideline is only intended to be informative and instructive in state-of-the-art technologies, and not to be a competitive evaluation of any specific product.

In this Guideline, both SI and common measurement units are expressed where practicable.

Where to Obtain Copies of the Guideline.

a. Federal Government activities should obtain copies from established sources within each agency.

b. Others may obtain copies from the Superintendent of Documents, U.S. Government Printing Office, Washington, D.C. 20402. (SD Catalog Number C13.52:40). There is a 25 percent discount on quantities of 100 or more. When ordering, specify document number, title, and SD Catalog Number. Payment may be made by check, money order, or deposit account.

Recognition. FIPS Task Group 11 on OCR, which developed this Guideline, had the following participants:

G. Kent Godwin, Chairman
Max A. Butterfield, Vice Chairman

Ronald W. Adamson
Thomas C. Bagg
George Bernstein
William R. Brown
Marvin W. Burris
John Cavanaugh
George J. Collins
Katie H. Cudmore
Douglas Cunha
Donald D. Curry
Philip Diamond
Joseph R. Fera
Raymond J. Garvey
James G. Griffis
Carolyn M. Gugino
William F. Huf
James L. Kelly
Bruce J. Knowlton
Douglas Kozlay

J. K. Lach, Jr.
Cleda G. Macklin
John McCray
Howard V. Moffett
David A. Nagy
Charles Nosal
James B. Overbay
Charles Palla
Romayne L. Potosky
Jacob Rabinow
Fred Reikert
Paul M. Robinson, Jr.
Herbert Seifert
Joseph B. Skelly, Jr.
James L. Stevens
John T. Turner
Louis Venefra
Mary C. Wade
Gary F. Zaccagnini

Particular appreciation is expressed to Mr. John Dunham of Datafold Forms, Inc., Mr. Alfred Di-Bernardo of Sinclair and Valentine, Mr. Peter Varlan and Mr. Thomas Lee of the Social Security Administration, for special contributions to the illustrative material provided in this publication.



Federal Information Processing Standards Publication 40

1976 May 1



Specifications for

GUIDELINE FOR OPTICAL CHARACTER RECOGNITION FORMS

Contents

	Page
1. General	
1.1 Introduction	5
1.2. Scope	5
1.3. Purpose	5
1.4. Use of the Guideline	5
2. OCR Forms Analysis	
2.1. Systems Information	6
2.2. Forms Management Information	8
2.3. Data Processing Requirements	8
2.4. Output Record Information	14
2.5. Collateral Requirements	14
2.6. Forms Check List	15
3. OCR Forms Design	
3.1. Introduction	15
3.3. OCR Forms Materials	15
3.3. Layout of Forms	18
3.4. Human Factors	25
3.5. Multiple Copy Forms	29
3.6. Other Forms Layout Topics	30
3.7. Handprinted Character Data Entry	31
3.8. Forms Design for Multi-Scanner Operations	31
3.9. Reader Device Characteristics Summary Charts	31
4. OCR Forms Specification and Inspection	31
5. OCR Forms Design Tools	31
Appendix	
A. Illustrations of OCR Character Sets	37
B. Glossary of OCR Terms	39
C. OCR Forms Layout Tools	45
D. Reader Device Characteristics	50

LIST OF TABLES

Table	
1. Specifications for OCR Bond and Ledger Paper	15
2. Preferred Sizes for OCR Forms	22
3. OCR Forms Specification Check List	35

LIST OF FIGURES

Figure	
1. Conversion of Human Readable Characters to Machine Media	5
2. Typical OCR System	6
3. Form Reprint Identification	7
4. Distribution Shown on OCR Form Copies	8

	Page
5. OCR Test Form	8
6. OCR Reference Marks and Targets	10
7. Feedback Identification	10
8. Error Marking	11
9. Non-Read Information	12
10. Sample Handprinted Character Sets	13
11. Error Recovery Area	14
12. Checklist Between Form Designer and OCR System Manager	16
13. Sample Reflective Ink Colors	19
14. Blocked Format	20
15. Use of Guard Space with Long Vertical Mark	20
16. Free-Form Format	21
17. Sample Form Layout Sheet	23
18. Mechanical Properties of OCR Forms	24
19. Imprinting from Embossed Cards	25
20. Sample Form Showing Use of Top Copy for OCR Original and Second Copy for Legal Original Copy	26
21. Alignment Marks	27
22. Data Recording Font Indicator	27
23. End-of-Page Warning Markers	28
24. Tab Stop Setting Indicators	29
25. Mid-Form Alignment Guide	29
26. Data Field Captions	30
27. Handprinted Character Guidelines (from X3.45-1974)	32
28. Handprinted Character Guidelines—Numeric (Industry Standard)	33
29. Illustrative Set of Characters	34
A1. OCR-A—ANSI X3.17-1974 and FIPS 32	37
A2. OCR-B—ANSI X.49-1975 and FIPS 32	37
A3. HANDPRINTED CHARACTERS—ANSI X3.45-1974 and FIPS 33	38
C1. Spacing Chart—10 Pitch, 6 lines per inch	46
C2. Reflective Ink Pens—Portage	47
C3. Pentel Non-Reflective Ink Pen	48
C4. 8X Magnifiers—Agfa and Others	48
C5. Optical Comparator	49
C6. Reticle for Optical Comparator	49

FEDERAL INFORMATION PROCESSING STANDARDS GUIDELINE

OPTICAL CHARACTER RECOGNITION FORMS

1. General

1.1. Introduction. This document has been prepared by a committee of experienced OCR form designers, OCR system engineers, data system managers, OCR form printers and OCR process technicians. This diverse group has attempted to concentrate on the special requirements of OCR and to alert the designer to OCR form layout problems which reduce the power and efficiency of OCR processing. These suggestions should also help the OCR form designer develop forms which give data processing units greater flexibility in their working operation. Hopefully this Guideline will simplify the designer's task of compromising the sometimes conflicting requirements of different users of a given form and the task of producing forms suitable for processing on various types of optical scanning equipment.

1.2. Scope. Sections 2, 3, and 4 describe processes followed in defining, designing, verifying, and specifying OCR forms. Related tools and aids are described in Section 5 and the Appendix.

1.3. Purpose. The purpose of this FIPS PUB is to provide information to forms designers and analysts in the task of designing and qualifying OCR data entry forms. It is not possible to list all the design details and specifications that pertain, but an attempt is made to provide practical suggestions in order to avoid many potential mistakes.

1.4. Use of the Guideline. The bonus for good OCR form design is an efficient and economical design for both data entry and machine processing. Data entry form design includes all facets of forms design and analysis as detailed in the General Services Administration Handbooks (Handbooks on Forms Analysis and Forms Design—see Cross Index). The design for machine processing is specified by each equipment manufacturer; however, regardless of the manufacturer, optical readers do have many similarities. The intent of this guideline is to both flag these similarities and to point out significant differences.

An OCR system must detect typed and/or handprinted characters by means of differences in reflected light (see fig. 1). The differences in reflected light are detected by one or more photodetectors. Accordingly, there is a need (1) to provide unique location controls for the

placement of data and (2) to organize data fields to balance the machine and human factors requirements of data entry tasks. This is the basis of OCR forms design.

Optical character reading devices lack the versatility of human visual optic responses and usually each device has some distinctive characteristics. OCR readers are typically responsive to narrower and specific wavelength bands of light (or colors) as compared to the human eye. Some reader devices may be responsive to wavelengths outside the human visual range; some may be constrained to a very narrow band (laser system). Moreover, an OCR device generally lacks the discrimination of the human eye with respect to color contrast between a printed image and its background, or in responding appropriately to filled-in, broken, or incomplete character forms. The human visual response may be misleading unless the parameters of the specific reading device are known and taken into account. Many provisions of this guideline are therefore addressed to meeting these machine-based parameters and characteristics.

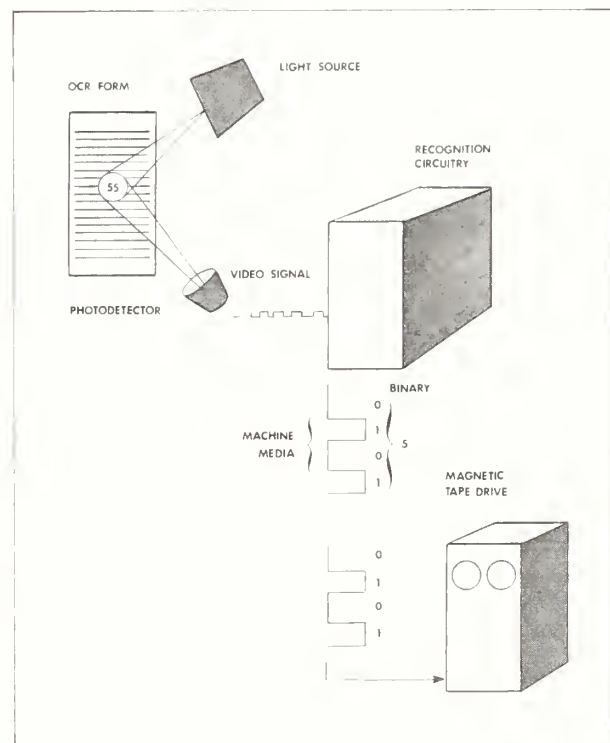

FIGURE 1. Conversion of human readable characters to machine media.

While optical scanning devices operate on the common principle that their sensors are required to detect contrast differences between very small areas of the printed data image and the paper, wide variations can exist between scanners as to the complexity and form of data that can be recognized and handled by the auxiliary data processing equipment. Some scanners can "read" only simple mark locations, others a limited selection of stylized characters, while the most complex machines may "read" almost any printed material within the scope of a human reader.

2. OCR Forms Analysis

2.1. Systems Information. This section is concerned with the environment in which OCR forms are to be used. It will describe the information necessary to the forms design task and suggest special requirements for given applications.

2.1.1. OCR Systems Configuration. The principal flow of data in many OCR systems is from SOURCE to the OCR READER and then to an OUTPUT DEVICE using any of the several machine media (magnetic tape, magnetic disk, punched card, on-line connection, etc. An important variation of this flow pattern is the TURN-AROUND form in which an OCR form is centrally prepared, distributed to a number of data points, and subsequently retrieved for reading.

The data flow and their relationships to an OCR system configuration is illustrated in figure 2.

Input to be collected in an OCR system will be FIXED data (station identification, form number, etc.), VARIABLE data (number of items, unit price, etc.), or a COMBINATION of fixed and variable data. The data will tend to be event or transaction oriented.

Data entry devices will generally include one or more of the following:

- letter press (preprinted material),
- typewriter (manually operated and/or programmed),
- business machine,
- imprinter,
- line printer,
- handprinting,
- hand marking.

It will be necessary in designing the input form to know precisely which device will be used. If more than one device is to be used, the location of data on the form must be known so that the appropriate provision can be made for each device. Turn-around forms are a special case, particularly if data is to be added in the system cycle.

The choice of character sets and data entry devices are two of the more important aspects

of systems design. A single character set and a single model or kind of data entry device will result in a much lower cost system than one with two or more character sets and a variety of data entry devices.

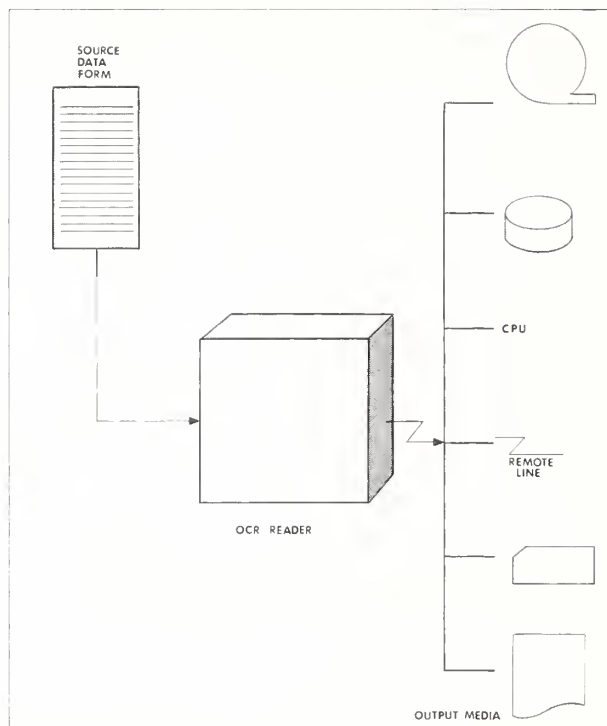

FIGURE 2. Typical OCR System.

2.1.2. Human Factors in OCR Forms Design. Present equipment capabilities make it possible to concentrate on the human involvement in data entry tasks. OCR forms should be designed so that data can be recorded in the sequence available, so that mishaps in recording can be corrected, and so that incorrect entries can be easily identified before the form goes forward. Additional important human factor features are the provision of data-field names above all entry spaces, use of standard headers and formats, provision of distinctive marks for correct selection between related or similar forms, use of line up marks and end-of-page warning markers, use of sample character shapes to be used, and provision of adequate space so that extreme care in data entry is not required.

An important systems check should be performed at the point of data entry—a verification that the entered data is in order. Aids should be provided to enable the human operator to easily review the complete form before it is dispatched, burst, signed, etc. A "check list" of important items may be included in the body of the form, outside of scan areas or in reflective ink as a part of the background area.

2.1.3. Equipment Factors in OCR Forms Design. Equipment related constraints are likewise an important consideration in OCR forms design. These constraints include forms size limitations, paper characteristics (mechanical and optical), margin, spacing, and clear area requirements, reference marks and targets, and the like. Specific handling of these topics is discussed in detail in Section 3.

In addition to equipment related constraints the down-stream data processing steps are of importance in OCR forms design. The reading equipment now available can provide a variety of quality control actions such as editing (zero balancing, hash total check, check digit verification, serial number validation, range check, table look-up); reject recovery (on-line entry; in-line review and reentry; off-line reconstruction and resubmission); reformatting (rearrangement of data field sequence; combination of fields, truncation; fill in from table data or stored data fields); summarization by batch, shift, or other period. These steps can be provided either by a dedicated controller or by subsequent computer operations. A knowledge of the procedure to be followed in these reading and processing steps is helpful in approaching OCR forms design assignments.

2.1.4 System Identification of Forms. In addition to identifying forms by a form title, number, date of issue/revision, there should also be a separate, unique printing identification. The identification of each printing reorder will help to pinpoint problems encountered during machine reading and to be able to relate it to a specific manufacturer. A suggested method is shown in figure 3.

CHECKED BY
DESIGNED BY
APPROVED BY
GMI FORM 62 (11-14-73) REPRINT 4: SEPT. 1974

FIGURE 3. Form reprint identification.

2.1.5. Data Field Layout. The primary task of the OCR form is to collect (capture) source data items (elements). It is essential, then, in designing an OCR form to know precisely the data elements and fields to be captured, their interrelationships, and their parameters. Continuous interaction between the

forms designer and the systems analyst is necessary to accomplish this. As a preliminary to the design of an OCR form each data item contained in the input record should be tabulated with its description. A suggested collection of items would be:

- data element number,
- data element title,
- relationship to any other data element of the input record,
- data capture sequence,
- field length (fixed, variable),
- number of characters or range (min/max),
- character type (numeric/alphanumeric/symbol/combination),
- accuracy required.

In addition to the content and characteristics of the input record it is essential to know the content and characteristics of the output record which is to be produced. In those instances where data elements are to be compared, truncated, combined, summarized, etc., the forms designer may be able to make adjustments that will enhance the total process, and ensure that all needed data has been provided.

2.1.6. Impact of Forms Volume. There are three important impacts of system volume on OCR forms design. The first concerns the greater sensitivity of OCR forms to storage and extended *shelf life* over ordinary business forms, particularly if humidity and temperature variations are present. Package sizes should be selected so that exposure in an unopened condition is minimized to a very few days.

The second concerns the *choice of reading device* to be used. Small intermittent quantities of unlike forms could best be handled in a service bureau reading environment. Large quantities of like forms, such as Form 1040 Tax Returns, or Standard Form 50 Personnel Action, will require extended study of the data processing system, reading machine selection, and data entry device used.

A third impact concerns the *printing methods* to be used. Low volume forms may be most economically produced by cut sheet printing methods whereas high volume forms will be most cost effective when printed with web printing methods. High volume forms situations require careful coordination in order to achieve an optimized installation.

2.1.7. Data Processing Steps. An outline of the intended data processing steps will often be helpful in the OCR forms design process. This is particularly true if extensive reformatting, summarization, or truncation of

the data is to be performed. Typical data processing operations are:

- zero balancing of columnar data,
- hash totals for error checking,
- check digit verification,
- serial number checking or validation,
- editing and validation,
- reject recovery,
- reformatting,
- Erase Character overlay for handprinted data,
- summarization of data fields by batch.

Most of the OCR systems in use today have sufficient controller computing capability, core storage, and adequate peripherals to perform a wide variety of data handling functions as a part of the data entry step.

2.1.8. Distribution of OCR Forms. OCR forms design must also include provision for post-reading end-use and distribution. Beyond the output hopper and reentry correction desk, OCR reading copies must be moved to their next assigned action—retention pending completion of down-stream processing, retention as a backup to magnetic tape or disk, filing as original action copies in record jackets, micro-filing, etc.

Clear instructions should be available for the distribution of the OCR form when the reading step has been completed. Where appropriate and possible, the distribution instructions should be given on the form itself (see fig. 4).

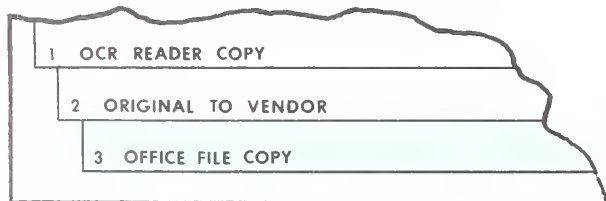

FIGURE 4. Distribution shown on OCR Form copies.

2.1.9. Systems Accuracy. The resulting output from an OCR data entry system, or any other data entry system, will of necessity be only as accurate as the information originally recorded. Design criteria must be adopted that will achieve the required accuracy level. An example is the definition of time or date—can the date recorded be “yesterday,” “today,” or “tomorrow” or “last week?” For example, if the action recorded is a personnel action step, it is mandatory that the specific date be described, i.e., “TODAY’S DATE.”

At an early point in the forms design task the tolerances for each process step should be reviewed from beginning to end to assure that the needed systems accuracy will in fact be obtained.

2.2. Forms Management Information. This section will describe the necessary steps involved in managing OCR forms as a part of an overall forms control system. In general, these requirements are identical to those for any other forms management system. However, there are some suggested practices of particular value in the handling of OCR forms, which are described herein.

2.2.1. Form Title and Number. OCR forms, as for any well designed form, should have a clearly identifiable title, form number, and date of issue or revision. Trial or test forms should be clearly identified as to their test status (see fig. 5). Successive editions of production forms should highlight the date of issue or date of printing (see Section 2.1.4) to minimize confusion between editions, and to rapidly identify the correct form. An alternative, if feasible, is to substantially modify either the title or number, or both, when any change occurs which may affect OCR performance.

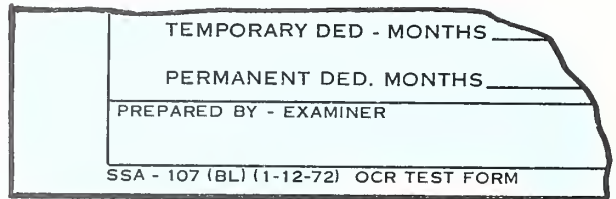

FIGURE 5. OCR Test Form.

2.2.2. Stock Order Number. Some paperwork systems may require that a form additionally carry a stock order number, or other special control number. Care should be taken to insure that this number is not confused with the form number. Some systems have found that it is advantageous to have the form number as an OCR readable number to facilitate control and retrieval.

2.2.3. Other Usage. The use of the OCR form as a multiple part form to achieve parallel actions should be considered. Combining several related steps can reduce the number of forms involved and improve the systems control. Multiform sets are an appropriate method of combining clerical and data recording steps.

2.3. Data Processing Requirements. This section will describe briefly some of the considerations for OCR forms design which arise from data processing requirements of the system.

2.3.1. Software Requirements. The development of the system software requirements is not the OCR forms designer’s responsibility. However, the forms designer must in-

sure that all source data needed are included on the form. The interaction between system, system software, and the form configuration is direct and important. The forms designer must be aware of these aspects and be able to reflect them in his final design product.

Software application packages and an appropriate operating system will be required for the OCR system controller if OCR reading operations (other than read from form to magnetic tape) are to be accomplished. Adequate memory and other related system considerations will be necessary to support these software features.

2.3.2. Serial Numbering. Often a serial number is to be read by the OCR system and hence must be included in the forms design both as accountable data and machine read data. One of the by-product advantages of an OCR reader system is that a scratch pad record of accountable serial numbers can be maintained to provide management summaries, audit information, and other control information.

It is necessary in some OCR applications to account for all copies or all sets of an OCR forms series. An example is the generation of sight drafts which are negotiable instruments.

Systems can be programmed so that identification number series can be broken without significance to the system. Where a number is used only for error recovery or data reentry purposes broken-number series should be acceptable. This will reduce cost and time required to obtain OCR forms.

It is important to remember that serial numbers or assigned numbers which are to be read by OCR devices must meet all of the applicable rules for alignment, position, approved font, ink, print quality, clear areas, and the like. Serial numbers as assigned numbers which are not to be read by OCR need not meet these requirements and should be located in nonread areas, i.e., in signature blocks, bottom-of-the-page areas, etc.

2.3.3. Identification Number. Some applications make use of a serial number printed as a part of the reading process. An example would be the assignment of an index for recovery from microfilmed copies. Usually this number need not be OCR readable and serves no further purpose on the OCR form after the microfilming step has been completed. The printing device is a peripheral attachment to the reader paper handling system. If this situation exists, space should be provided for printing this number.

2.3.4. Microfilming During OCR Processing. Many OCR readers can be arranged with a microfilm camera so that the form can be

microfilmed while passing through the paper handling unit. This provides a low-cost, permanent record in far less space than would be the case for the original paper form.

The primary OCR forms design requirement is to provide suitable clear space for any marking device used prior to the microfilming step. Other considerations will be the handling of rejected forms and their subsequent reentry. Form geometry must be compatible with the microfilm frame size.

The requirements of microfilming may impose special constraints affecting the overall systems performance. The forms designer should be alert to these situations.

2.3.5. Reference Marks and Targets. Many readers require a reference mark to designate the first read position. Others require targets for fast line-skip commands, or end-of-line indicators. In the application of hand-printed characters, targets are used by some readers to designate the first read position for each line to be read (see fig. 6).

The repertoire and application of reference marks required for the machines in the system should be available to the OCR forms designer. The best source of this information is the forms design specifications provided by the OCR equipment manufacturer.

2.3.6. Error Marking. A machine feature can sometimes be provided to indicate positions, lines, or fields in which a reject character is located. If used, space should be provided on the OCR form (usually in the margin), so that a machine marking pen will clearly indicate an error location. Space requirements and location will vary with individual reading machine models (see fig. 8).

2.3.7. Operational Information. Nearly all OCR forms will contain operational information that is not a part of the data to be captured. Items such as approval signatures, routing instructions, and the like may be required. The designer should position this information to insure that these items do not interfere with OCR reading. Normally these items should be placed at or near the bottom of the form to prevent smudging previously entered data. (see fig. 9).

This treatment will enable the reader to proceed directly to the first read area of the succeeding form. It also provides a "hand-rest" area at the bottom of the form so that problems in positioning handprinted characters at the end of a page are avoided.

Specific forms design treatment will be contained in Section 3.

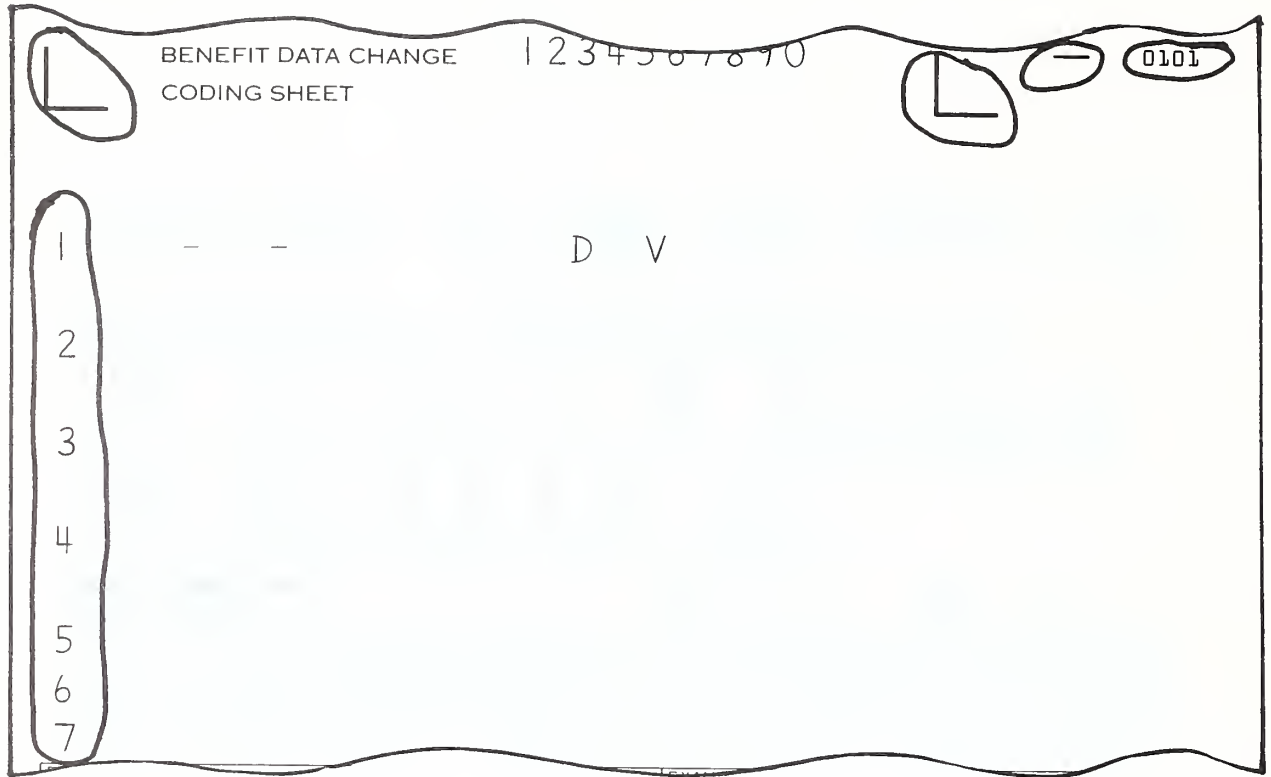

FIGURE 6. OCR reference marks and targets.

2.3.8. Handprinted Character Requirements. Handprinted characters involve a unique set of requirements which are described in FIPS PUB 33. In addition to the character set to be used there are requirements for guide boxes, line spacing, character spacing, stroke width, and the like. In addition to the provisions of these standards there are two application procedures of importance. One is that every form used for handprinted character entry should have a sample of the character set (including the shaded guide boxes) in the size to be read. The sample character set must be printed outside the scan area preferably as a part of the heading (see fig. 10). The second, is that an Error Recovery Area should be provided (usually at the bottom of the form), following all other data character entries (but within the scan area).

The Error Recovery Area should provide the opportunity to duplicate any of the fields or lines found in the form. In the event of error the data can be "Erased" (see fig. 11) and a replacement entered in the Error Recovery Area. When the form is read, the OCR reader controller will ignore the erased information and overlay the contents of the Error Recovery Area on the total record before beginning edit or validation routines.

2.3.9. Identification of Input Sources. Data entry devices may themselves cause errors. This is compounded by the fact that these devices are frequently located at widely separated points which supply input to the same centrally located reader. Thus, it is useful to identify the source location of all OCR data generated. Such identification serves as a quality control device on OCR data entry equipment and on the performance of personnel (see fig. 7).

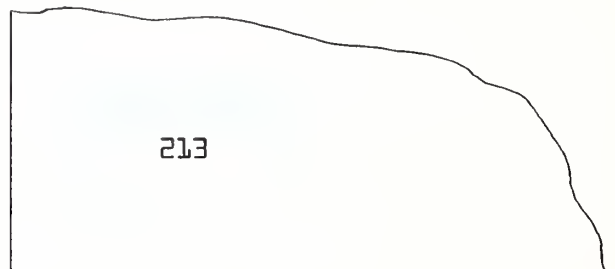

FIGURE 7. Feedback identification.

Identification of source data entry devices and/or personnel operating such equipment need not be shown on each form prepared. Such identification may be contained on batch control documentation, provided such documentation

Form 941
(Rev. Jan. 1974)
Department of the Treasury
Internal Revenue Service

Employer's Quarterly Federal Tax Return

SSA Use Only

F 2 U E
 S 1 L T
 X 0 V A

Schedule A—Quarterly Report of Wages Taxable under the Federal Insurance Contributions Act—FOR SOCIAL SECURITY

List for each nonagricultural employee the WAGES taxable under the FICA which were paid during the quarter. If you pay an employee more than \$13,200 in a calendar year report only the first \$13,200 of such wages. In the case of "Tip Income" see instructions on page 4. IF WAGES WERE NOT TAXABLE UNDER THE FICA MAKE NO ENTRIES IN ITEMS 1 THROUGH 9 AND 14 THROUGH 18.

1. Total pages of this return including this page and any pages of Form 941a 12	2. Total number of employees listed 228	3. (First quarter only) Number of employees (except household) employed in the pay period including March 12th 228
--	--	---

4. EMPLOYEE'S SOCIAL SECURITY NUMBER	5. NAME OF EMPLOYEE (Please type or print)	6. TAXABLE FICA WAGES Paid to Employee in Quarter (Before deductions)	7. TAXABLE TIPS REPORTED (See page 4)
000 00 0000		Dollars Cents	Dollars Cents
480 05 0194	BUTTERWORTH, NELS R. E.	3 456.78	MARKING PENS FOR REI INPUT 80
480 05 0225	BUTTERFALLS, LARAIN E. Z.	2 786.22	
920 05 2332	ZIRCON, SHINE W.	4 333.33	
920 09 3333	UPCOMING, CHARL S. T.	2 766.78	
920 00 3399	OUTDONE, B. Y.	4 266.99	
905 44 2798	DOOR, W. T.	9 766.27	

480 90 1940	BUTTONHED, X. Q.	7 234.69	MARKING PENS FOR IBM 1975
480 05 0125	BUTTONHED, Q. Z.	5 324.78	
905 84 4544	EALONE, D. T.	2 733.20	
920 48 5555	ABALONE, H. S.	2 875.98	
967 87 7843	OYSTERE, Z. X.	2 887.98	
785 21 7744	TURTLEE, H. S.	3 456.78	
If you need more space for listing employees, use Schedule A continuation sheets, Form 941a.			
Totals for this page—Wage total in column 6 and tip total in column 7 →		81 989.76	

8. TOTAL WAGES TAXABLE UNDER FICA PAID DURING QUARTER. \$ 876 453.22

(Total of column 6 on this page and continuation sheets.) Enter here and in Item 14 below.

9. TOTAL TAXABLE TIPS REPORTED UNDER FICA DURING QUARTER. \$ -----

(Total of column 7 on this page and continuation sheets.) Enter here and in Item 15 below. (If no tips reported, write "None.")

Employer's name, address, employer identification Trade name, if any Address and ZIP code Date quarter ended Employer Identification No.

Entries must be made both above and below this line; if address different from previous return check here

FIGURE 8. Error marking.

remains with the batch through the edit or error detection cycle of the system flow (and subsequent correction steps).

2.3.10. **Selecting Form Type.** Generally the reader selection is already available to the

OCR forms designer and the forms design task will be oriented to the capabilities and requirements of the equipment at hand. In this event both machine and form type will be a matter of that which is available. However, in the event of first system design there may be choices and selections to be made.

- 10- TOTAL DELETIONS THIS PAGE
- 11- TOTAL PAYROLL DELETIONS
- 12- TOTAL PAYROLL VALUE
- 13- ORIGINAL MACHINE PAYROLL TOTAL

I CERTIFY THAT THE INDIVIDUALS LISTED
HEREON WERE NOT PAID AND WERE DELETED
FROM THE ABOVE-DESCRIBED PAYROLL.

14. SIGNATURE

Willbur Jones

I hereby request the action as indicated hereon and further certify that arrangements have been made with any indicated banks, savings institutions, insurance companies, or agencies entitled to receive checks for deposit or custody, to insure acceptability of payment or remittance by allotment.

WITNESSED AND APPROVED, WHEN AND AS REQUIRED

John Smith, Sr. Col. 8/20/74
DATE

SIGNATURE/GRADE/TITLE

John Moreland

8/24/74

SIGNATURE

DATE

987-65-4321

SOCIAL SECURITY ACCOUNT NO. (In own handwriting)

987-65-4321

MILITARY SERVICE NO. (In own handwriting)

6

CODED BY <i>WV</i>	DATE <u>8/15/74</u>	REVIEWED BY <i>CTS</i>	DATE <u>8/17/74</u>
PUNCHED BY <i>APP</i>	<u>8/16/74</u>	VERIFIED BY <i>ATMB</i>	DATE <u>8/17/74</u>

SSA - #502 (1-12-72) OCR TEST FORM

CERTIFICATION: I certify that the data reported hereon was extracted from approved source documents, validated by a designated authenticating official. The original data has been codified to the machine language shown and I certify that, for every intent and purpose, the data contained hereon is identical in basic content and application as the source document.

13 TYPED NAME OF DISBURSING OFFICER

14 SIGNATURE

15 DATE

Charles Taylor

FIGURE 9. Non-read information.

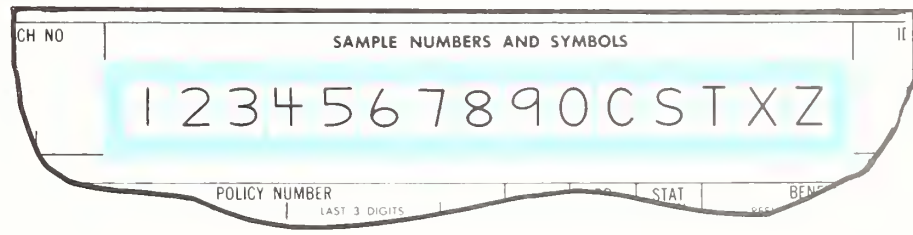
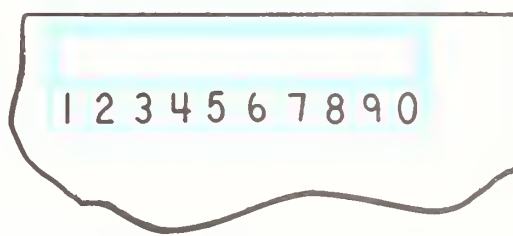
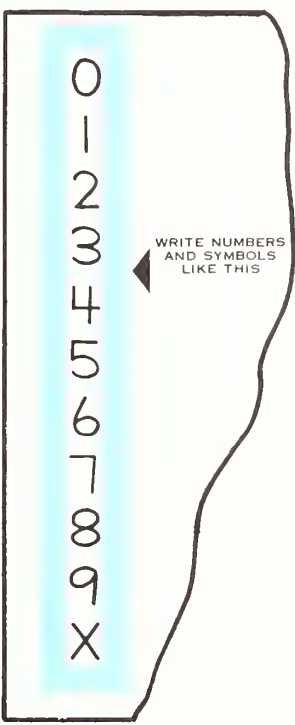
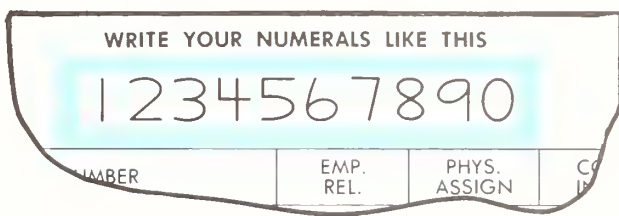

FIGURE 10. Sample handprinted character sets.

FIGURE 11. Error recovery area.

In general there are three broad classes of OCR readers:

- journal tape devices,
- document readers,
- page readers.

A quick characterization of each is as follows:

Journal tape devices read narrow adding machine or business machine tape rolls. The character set is usually numerics only with a limited set up to 5 or 6 special symbols or alphabetic characters (C, E, N, T, S, X, Z, +, <, >). The tapes are usually generated by adding machines or accounting machines.

Document readers usually process forms with one or two lines of data. The reading process occurs, usually, while the form is in motion. Many "turn-around" form applications are of the document reading category.

Page readers handle larger forms (up to 14" x 14") with several lines of data (sometimes many). The forms are sometimes read at rest so that the machine provides both vertical and horizontal reading motions. Both formatted and nonformatted applications are read on page reading devices. Many page readers will handle turn-around "documents" in addition to full size page forms, but at somewhat reduced throughput rates.

2.4. Output Record Information. This section will describe OCR forms design requirements related to the system output record requirements.

2.4.1. Content and Format. Output records which result from the reading of OCR forms are in machine sensible language and format. The method of recording generally will not concern the OCR forms designer. However, the *fields* and *data content* are of interest since these are the end product of reading an OCR form. The needed information should be available from the system designer's record layout. Questions can be referred to the ADP systems design or software design personnel who are involved.

2.4.2. Error Control Requirements. In any data processing system there must be provision for controlling certain classes of error conditions. These provisions may include such practices as check digits, redundant entries, zero balance, or hash totals. The requirement for the OCR data entry system will relate to the data processing system which receives this data, and usually can be obtained from the ADP system design staff.

2.5. Collateral Requirements. This section will cover miscellaneous provisions not described elsewhere in section 2.

Table 1
GPO SPECIFICATIONS FOR OCR PAPER

Property Values and (Test Methods Used)										
Basis Weight† 1000 Sheets 17 x 22 in (321.8x558.8 min)	Opacity (Bausch & Lomb) Min(%)	Smoothness † Sheffield		Porosity (Gurley) Min(sec)	Stiffness, Either Direction (Gurley) Min(mg)	Tear, Either Direction (Elmendorf) Min(gm)	Caliper, § Nominal		Brightness ▲ Average (Percent)	Fluorescent Brightener (Hunter) Max(%)
		Min(sec)	Max(sec)				Min	Max		
40 lb (75.2 g/m ²)	82	100	200	10	70	40	0.0034	0.0043	80	0.2
48 lb (90.2 g/m ²)	85	100	200	10	100	50	0.0043	0.0052	80	0.2
64 lb (120.3 g/m ²)	90	100	200	15	200	70	0.0056	0.0069	80	0.2

† Tolerance for this characteristic is $\pm 5\%$ of nominal value.

§ Thickness tolerance within a delivery is $\pm 5\%$ of nominal caliper.

▲ Tolerance for this characteristic is $\pm 4\%$ of nominal value.

Other Requirements

1. Grain direction as required by equipment.
2. Cleanliness—dirt particle count shall not exceed 10 parts per million (10 sq. mm. per m²); no particles shall exceed 0.006 in (0.152 mm.) diameter.
3. Stock shall be principally bleached chemical wood pulp, free from unbleached or groundwood pulp. No fluorescent (optical) brighteners shall be added to the pulp or paper during manufacture.

2.5.1. Protection Against Damage. An important point in the handling of OCR forms is that they must be protected against smudging, folding and other damage during storing, transportation and usage. Every effort should be made to avoid folding OCR forms. If it is unavoidable, OCR forms which must be folded should have special provision in the design, such as perforations or folding guide marks. Moreover, OCR documents should be folded so that the OCR printing is away from creased areas. Care should be taken to prevent shifting or movement within the envelope since this will cause smudging and damage to characters. It is important to protect against inadvertent bending and folding. This can be accomplished through the use of stiffeners as inserts.

Plastic carrier envelopes with a self-closing feature have provided protection to OCR documents in many installations. This practice gives instant visual recognition of the contents of OCR forms which require care in handling.

2.5.2. Interrelationship of Forms. Some OCR systems require more than one readable form to input all of the data required for the particular application. Although different forms should usually not be prepared or read within a single batch, the OCR forms designer should be aware of all forms which are required to input data to the system.

One basic example is where daily transmittal forms containing summary totals accompany the detail input records. The designer is cautioned not to use this as a means of overcontrolling the interrelationship.

2.6. Forms Check List. The forms requirements previously described have been summarized in a checklist of items of interest to the forms designer and OCR system manager. This checklist follows as figure 12.

3. OCR Forms Design

3.1. Introduction

This section addresses the specification of materials and layout required for forms to be processed in an optical character recognition system.

This information will be of assistance to OCR forms designers in avoiding errors in the layout of forms and will simplify the task of compromising the often conflicting requirements of the different users of a given form.

3.2. OCR Forms Materials

3.2.1. OCR Paper. The specifications for paper such as weight, caliper, opacity, porosity, smoothness, and color of paper to be specified for a particular form is dependent upon the intended usage and the operating characteristics of the scanning device upon which the form is to be processed. The GPO standard OCR paper should be used wherever possible (see table 1).

It should be noted that OCR specification paper may provide source problems and substitute paper grades may be suggested. These substitutes should meet the requirements of X3.17-1974 Character Set and Print Quality for OCR-A for physical and optical characteristics. Particularly, fluorescent whiteners must be avoided since these materials "flare" in response to the scanner light source and confuse the light detector elements.

3.2.2. OCR Ink. There are two distinctly different kinds of ink involved in printing OCR forms—*read ink*, and *reflective ink*. Each serves a specific purpose.

Read ink is used to form the shapes of *all* characters or marks to be *read* by an OCR

Figure 12. Checklist Between Form Designer & OCR System Manager

1. Forms Management Considerations

- a. Form Number, Title, Edition, Date
- b. Stock Order Number, if applicable
- c. Form usage other than OCR
- d. Number of parts if more than single sheet OCR form
- e. Distribution of each non-read part
- f. Distribution of OCR part:
 - (1) Microfilm
 - (2) Hold for master file update (_____ days)
 - (3) Hold for _____ days, then destroy
 - (4) Send or return to _____
 - (5) Other _____

2. Processing Considerations

- a. Requirements for machine readable data to be printed on the form by forms manufacturer, e.g., program number, serial number.
- b. Non-read serial numbering by printer – location
- c. Serial numbering by OCR equipment – location
- d. Data elements on form for machine reading (any internal machine instructions) and data elements included in output.
- e. Reflective ink requirements
- f. Location of machine required reference marks
- g. Non-read data elements on form – location impact on reading capability
- h. Correction process (error recovery) if form fails edit program
- i. Correction lines or fields to be included on form for error recovery, if any
- j. Particular or specialized requirements
- k. External processes – signatures, date stamps, etc.

Figure 12. Checklist Between Form Designer & OCR System Manager (Continued)

3, Machine Considerations

- a. Type of reader, including machine reading capability.
- b. Permissible overall form dimensions
- c. Read area dimensions, i.e., area on form where data to be machine-captured must be located.
To be considered:
 - (1) Right, left, top and bottom margins
 - (2) Location of program number, if applicable
 - (3) Location of preprinted serial number if OCR is required to capture
 - (4) Location of first data read line
 - (5) Field assignments and locations
 - (6) Field separators
 - (7) Position of error marking area
 - (8) Line spacing
 - (9) Character spacing
- d. Location of non-read lines if printed and/or typed in machine-readable ink, including signature line, if any.

4. Form Elements

- a. Data fields, read and non-read--for each data field show:
 - (1) Caption title
 - (2) Maximum length, in characters, including embedded spaces
 - (3) Method of recording (typed, printed, imprinted, etc.)
- b. Source, and sequence of capture for each data element.
- c. Output record order for each data element to be read.

scanning system; *reflective ink* is used to print all characters and other materials that should not be read by the scanning device, such as use instructions, data field headers or numbers, and the like, which appear in the reading area.

Nonread materials (logos, signature blocks, etc.), may be printed in black only if they appear in nonread areas or are programmed for nonread performance by the scanner system.

Read inks are usually carbon based and should have a matte (nongloss) surface (*varnish or smooth finishes for read ink causes a disastrous reflection in the scanner system*). Reflective ink colors are designated by the scanner manufacture and are usually available without problem from most OCR forms manufacturers.

Figure 13 provides typical sample reflective ink colors (courtesy of Sinclair and Valentine). The colors shown in figure 13 are only approximate and should not be used in actual specifications of form design. The manufacturers of particular OCR equipment and the suppliers of ink should be consulted by the user in designing their forms. Figure 13 is provided only to illustrate the wide variety of colors available for use in OCR forms design.

Further specific directions regarding reflective ink practice can be found in the manufacturers form design guide manuals.

OCR scanning systems which employ a laser light source require precise color formulations and manufacturer's recommendations must be followed carefully in these situations.

It is important to note that reflective inks should be printed at their maximum brightness so as to avoid reading or reference problems by humans. There ordinarily is a plateau in the comparison of reflectance value versus ink thickness—the thickness should be selected at its maximum value rather than the minimum value which meets reflectance criteria.

3.2.3. OCR Carbon Paper. Many man-years of effort have gone into the development of specifications for carbon papers suited to OCR applications. This work has been performed under the auspices of such organizations as the Technical Association of the Pulp and Paper Industry (TAPPI), and the Association for Testing and Materials (ASTM F-5). The OCR forms designer need not be aware of the highly technical description of this product. He need only be aware of the availability of such special materials and that he must make reference to them, to the mode of data entry, to the number of parts, and to the specific part of the set which is to be scanned, when developing instructions for the manufacture of the form.

There is no confirmed experience on the use of carbonless papers and therefore they are

not recommended unless they have been thoroughly coordinated between the OCR reader and OCR forms manufacturers.

3.3 Layout of Forms. The OCR reader operates most efficiently on layouts which closely sequence data and in which scan areas are located along single or multiple adjacent lines. However, this must be weighed against the human factors criteria of forms design—simplicity, ease of data entry, logical sequence of data elements, minimal writing, good visual effect, filing requirements, human scanning, compliance with legal requirements, etc. The areas in which preferential consideration must be given to human factors over the operating efficiency of the scanner are:

- ease of entry by the data entry device to be used,
- effort required to locate proper data entry areas,
- effort required of the human reader who may be seeking certain selected data elements,
- the ease with which the form can be filed and retrieved, and
- the ease with which data entry instructions and other nondata information can be located and interpreted.

The forms designer should study the data entry and machine reader capabilities and know their limitations so that he can design the form for optimum use.

3.3.1. Layout Procedures. One of the first considerations in the layout of a form for OCR processing is the amount of information that needs to be read (scanned) from the form. These data will be grouped on the form in fields which contain one or more characters to be read by the machine as a single item of information.

System considerations have led to two types of design for the layout of a data field. First, the *blocked field* in which the area reserved for the field will be delineated by a box whose horizontal dimension is set out by vertical bars printed in nonreflective, read ink (see fig. 14). The second case is the *free formatted* form in which the data field area is implied by marks outside of the scan area (see fig. 16). The free formatted form requires that field definition be dictated by a computer controlling the scanner.

Combinations of these two general types of form design can also be utilized. Wherever feasible the designer should allow extra character spaces in data fields for error recovery if the typist hits the wrong key—a good rule of thumb is one extra space for every ten characters. An additional field space or two should also be planned for error recovery

Figure 13
 Samples of the Wide Variety of Colors Available in Reflective Inks



FIGURE 13. Sample reflective ink colors.

4365443-44	WR	2234	RE	25	C	23	W254	65754323-3	657
4365444-32	WR	2255	CQ	25	D	43	R112	87654345-1	876
4364444-23	RR	3243	TR	12	S	32	E243	86534233-4	98
5342344-32	RW	2345	FF	13	D	65	K322	97654325-4	
5435466=34	EE	3255	SS	15	X	54	L333	86573456-6	
5446234-28	GE	4234	AA	13	S	34	H121	94563765-1	
5447542-34	JI	5462	CW	32	A	55	L43A	98452323-2	
5664352-20	KK	2342	CW	32	A	55	L434	87687634-3	
64532423-2	TR	4352	WD	65	X	35	K43S	9876547	
67532423-1	RT	4322	FD	77	S	35	J435	8745	

FIGURE 14. *Blocked format.*

when the entire field of data is affected. Experience to date suggests that it is better to go to a new form if more than two fields of data are lost.

In the case of blocked forms containing fixed fields, preferred practice is to use the Long Vertical Mark (LVM), a vertical bar provided in X3.17-1974 (OCR-A) as a field delimiter. The LVM (or delimiter) must extend above the highest point of any character and below the baseline of a field. These delimiters can either be preprinted on the form as rules of appropriate length (up to the entire length of the form), or they may be keyboarded at the time of data entry. Good practice dictates printing a guard space on each side of the preprinted bars in nonread ink so as to deter a typist from entering information on or near the LVM (see fig. 15). The LVM is a full width character, and requires a full space. Anything less can result in incorrect reading. The LVM stroke width dimensions are critical and the absolute limits are 0.008-0.036 inch. This provides recognition compatibility with all scanners.

Recommended line spacing practice dictates layouts of no more than four vertical data lines per inch and preferably three lines per

NEW ORLEANS	LA	70118
-------------	----	-------

FIGURE 15. *Use of guard space with Long Vertical Mark.*

inch. Some scanners can handle six data lines per inch under carefully controlled conditions, but such spacing is very likely to cause problems, especially if delimiter marks or vertical characters project into overlying or underlying fields.¹ Typewriters with half-line spacing can print either three or four lines per inch and this option should be specified in purchasing new equipment.

It is important to note that four-line-per-inch capability cannot be assumed for typewriters already owned. They should be checked

¹ Readers capable of handling six-line-per-inch materials are normally more complex, more costly, and generally must operate at the maximum potential device capability as opposed to those readers which will read three-lines-per-inch materials.

```

23A761254| 3276| A45 | 4455S |||H
24D452342| 3344| V23 | 2356T | 234 | 2345|H
87X233243| 8777| C2244| 7722KK| 3445||H
5678DDS22| 6655 |6656| V3354| 8345L| 344 |H
345X23433| 8744| B233| V233650| RRUU|H

```

```

76N453423| 9456| D7345|R946575| 4345| 4354|H
77Y233223| 7677| F7677| TST433| 2323| 3224|H
03465V234| 8354| L2384| 023984| 4354| 4365|H
45J65423 | 3455| D5466| R4354 | WED3| 4365|H
465K234 | 465234| 4566| B4365| L325| 4365| RRUU|HHH

```

FIGURE 16. *Free-form format.*

prior to proceeding with the forms design which involves line-spacing decisions.

As noted above, the system controller can give tremendous flexibility to some types of readers. Some forms can be converted to OCR simply by printing instructions in reflective (nonread) ink and setting up the reader to scan the data entry areas. This may not be the best approach however, as the old layout could have been dictated by considerations which no longer apply. The human being is less prone to transcription error when data elements are separated on the form. The OCR device is not subject to this type of reading error and actually can be expected to perform more efficiently when the data are contained along a single line.

Since most scanners read from an edge designated by the manufacturer the following practice is recommended:

Whenever a minimal amount of information is to be scanned on a single line, scanning speeds can usually be increased by placing the data nearest this starting edge. Most machines can be controlled to read only the length of the line actually used and thus operate at a maximum speed.

The designer should strive to compact data fields near the right (or left) reference edge

of the form. Form depth (length) should be kept short to reduce form feeding time by the OCR reader and to reduce forms manufacture costs.

3.3.2. Form Geometry and Spacing The preferred *shape* of an OCR form is *rectangular* with the nominal data line parallel to one edge. (Square forms should be avoided. See Sec. 3.6.1.) The dimensions of a form should not be permitted to vary from nominal size by more than ± 0.030 inch in length and width. The diagonal lengths should be held within ± 0.045 inch of each other. Problems in alignment and in forms feeding will be minimized if these tolerances are observed.

The *size* of the form will be determined by one or more of the following considerations. The form must:

1. contain all of the data fields, headings, and nonread areas required;
2. be convenient for filing;
3. be easily handled.

A rule-of-thumb is to start with $8\frac{1}{2} \times 11''$ and move to submultiples i.e., $8\frac{1}{2} \times 5\frac{1}{2}''$, or $8\frac{1}{2} \times 3\frac{2}{3}''$. Use $8\frac{1}{2} \times 13''$ if added length is

necessary. Avoid larger sizes except in unusual situations. Note that 8½ × 11" is the preferred OCR form size for use in the Federal Government.

There are many formulae quoted for estimating required form size which have proven to be *generally unreliable*. A recommended approach is to simply lay out the required form information on a preprinted grid which includes the OCR scanner space and margin requirements (see fig. 17, provided courtesy of Datafold Forms, Inc.).

The recommended grid spacing for most OCR machine applications is 10 characters per inch horizontal spacing and 6 lines per inch vertical spacing. Handprinted characters are set to larger spacing—5 horizontal spaces per inch for numeric characters, 4 horizontal spaces per inch for alphabetic characters with 3 vertical spaces per inch. In providing the horizontal data spaces add extra spaces for correction requirements.

3.3.3. Preferred Sizes. The majority of OCR forms are produced on standard rotary printing presses equipped with either 22, 17 or 14 inch cylinders. Standard form sizes are thereby restricted by the ability of the printer to lay out forms within the dimensions of the printing press web. When the design includes stubs and punched holes the restrictions are even more apparent. Table 2 lists OCR paper sizes that may be selected for maximum economy.

3.3.4. Mechanical Properties of OCR Forms.

Margins are the reserved areas adjoining each edge of an OCR form.

A *Printing Area* (or Scan Area) is the rectangular area located inside the margins and with boundaries parallel or perpendicular to a Reference Edge.

A *Reference Edge* is that OCR form edge used for positioning in the reading process.

A *Clear Area* is the space occupied by characters to be read plus an additional protective border around them. This is an area of the OCR form in which no other machine sensitive materials may be placed.

The mechanical properties of OCR forms are illustrated in figure 18.

3.3.4.1. Layout of Clear Area. The distance between the boundary of a printing area and that of its surrounding clear area should be at least 0.100 inch (2.54 mm) for the majority of scanners but is necessarily larger on a few devices.

On documents, the clear area should (at the time of reading) extend to the edge of the form on the side at which the scan starts, unless

TABLE 2. Preferred sizes for OCR forms

Type of form	Nominal width (inches)	Nominal depth (inches)
Cut Sheets	8½, 4¼, 4	14, 13, 11, 7, 5½, 4¼, 3¾, 3½
Continuous	8½, 4¼	14, 13, 11, 8½, 7, 5½, 4¼,* 3¾, 3½
Unit Sets	8½, 4¼	14, 13, 11, 7, 5½, 4¼, 3¾, 3½
Tabulating (Punch) Cards	7¾, 4⅞	3¼
Journal Tapes	1⅝ minimum, ¾ preferred, 4 maximum	Limited only by paper handling devices on reading equipment

* 4¼" size should not be used with any system requiring 3 or 6 lines per inch entry, to preclude misregistration.

Table Notes

Note 1: Widths and depths listed above for cut sheets or unit sets may be interchanged within either cut sheet or unit set categories. *Cut sheet sizes shall not be transferred to unit set listings.* (Width is parallel to, and depth is perpendicular to, nominal data lines to be read by an OCR device.)

Note 2: Most OCR scanners have length-to-width ratio limitations that must be considered. Square forms are generally to be avoided because of paper feed problems with some scanning equipment.

Note 3: Sizes are those of the form as it is being fed to the OCR reader. The designer should include provisions for the removal of gummed strips and pin-feed hole strips prior to processing on the OCR reader since many OCR scanners do not permit holes in margins; gummed strips may interfere with proper feeding.

Note 4: Most "page" readers will accept the minimum and maximum sizes listed above. Most document readers will accept forms with widths up to 8½ inches and depths up to 5½ inches.

Note 5: The majority of OCR readers cannot scan edge to edge of the wider forms and machine specifications should be consulted before attempting to use an extra wide form.

Note 6: Larger orders of OCR forms are likely to be produced as continuous forms; therefore, initial production of test forms should be of the same specifications. Selection of a particular width and depth can significantly affect the cost of form procurement (i.e., a 14" depth is available only from limited sources and consequently more expensive to procure).

some device such as a timing mark, is needed to indicate the beginning of the printing area. It is recommended that the clear area extend at least 0.250 inch (6.35 mm) on the trailing side. The vertical extent of the clear area should be at least 0.100 inch (2.54 mm) above and below the scan band area. This feature should also be plotted on the layout sheet.

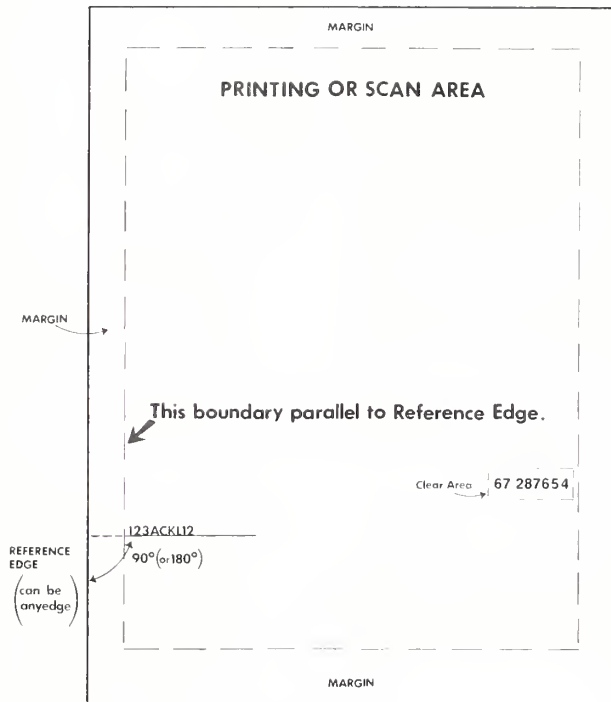

FIGURE 18. Mechanical properties of OCR forms.

3.3.4.2. Minimum Widths of Margins. All margins should be at least 0.250 inch (6.35 mm) at time of reading, except as specified otherwise herein.

3.3.4.3. Margins for Imprinting from Embossed Cards. OCR system which use embossed plastic cards for imprinting on pages or documents are often capable of imprinting and reading with a margin of only 0.125 inch (3.18 mm). The chances for misreading are increased because of the effects of forms printing tolerances and the increased danger of edge damage through handling of such forms. Small margins should be utilized only when required by the system design (see fig. 19 as an example of preferred practice).

3.3.4.4. Recommended Typing Margins. All typing areas should be located at least one inch from the top or bottom of the sheet in order to insure that alignment and print quality are maintained. This tolerance can be reduced to 0.25 inch (6.35 mm) on continuous forms but this will require typewriters with special hold-down devices and the designer must be sure such modifications are part of the system. Alignment in the scan area is best achieved by rulings (in reflective ink) showing the actual typing line. Prealignment of the typewriter can be best accomplished by providing test character fill boxes on each end of a test line.

3.3.5. Headings and Reference Marks. Preprinted material should be located with a nominal 0.25 inch (6.35 mm) margin from the reference edge, and even with an established base line parallel or perpendicular to the referenced edge. Skew tolerances for most scanners permit displacement from correct vertical position of one quarter character height between the first and last characters of a full length line.

3.3.6. Non OCR-Read Printing. Form entry guides such as blocks, rulings, and captions are aids to the proper placement of data on forms and instructions for entering data. They should be visible to the human eye, but not to the scanner. To accomplish this they are printed in reflective (nonread) ink. Such instructions are an important means of increasing speed and of reducing errors in entering data. Use of reflective ink permits these instructions to appear near their point of use. Other information may be in OCR visible ink if placed *outside* of read areas.

3.3.7. Other Users. It may be necessary to enter data on the form for human users as well as the OCR reader. These data include initials, date stamps, and filing instructions. It is possible that OCR readers may not ignore the usual stamp pad inks and ballpoint pen inks. Therefore, it is important to set aside for this purpose areas of the form which are not read by the OCR unit, preferably at the bottom of the form. Care should be taken to provide ample room for such entries. Consider the use of colored strip boundaries in order to protect against encroachment upon the OCR fields.

In some applications, such as purchase orders, sight drafts, leases, and like legal documents, recommended practice is to use an OCR record capture form as a top copy and use the second copy as the "original" copy for the normal document functions. The correct choice of carbon paper will produce an "original" indistinguishable from normal first (top) copies in a set, including protection from alteration when required. (see fig. 20).

3.3.8. Preprinted Data Entries. Preprinted material such as serial numbers, should be located with a nominal 0.25 inch (6.35 mm) margin from the reference edge, and with an established base line parallel or perpendicular to the referenced edge. Skew tolerances (the permitted angular displacement from correction horizontal orientation) are nominally one quarter character height per full line for most scanners.

3.3.9. Back Printing. It is recommended that OCR forms be free of back printing. Where back printing is required, the following

Please write like this 0 1 2 3 4 5 6 7 8 9

Please make remittance to: CORY COFFEE SERVICE PLAN, INC. D-U-N-S 175-2294
P. O. BOX 3932 SAN FRANCISCO, CALIFORNIA 94119

TERMS: NET CASH, FOB SHIPPING POINT

For merchandise shipments see address on carton.

INVOICE NUMBER 4507120

Ship to

Sold to

A. - C. I. - D.

AREA CODE NET CASH CASH COD VOID TYPE

0

FIGURE 19. Imprinting from embossed cards.

minimum specifications should be observed in order to prevent show-through or bleed-through:

- a. OCR paper minimum basis weight—40 pounds (1000 sheets).
- b. Minimum opacity of the paper before printing—85 percent.
- c. Back printing minimum surface reflectance—50 percent (in the spectral range of the OCR equipment being used. This can be obtained either by the proper choice of ink or printing a screen pattern with 40 to 50 percent screen).

3.4. Human Factors. Many aids have been devised for forms to ensure ease and accuracy of data entry. Most of them are basic to good forms design, but several of them are combinations of aids to the efficiency of data entry and processing through the OCR scanner.

3.4.1. Alignment Marks. Data alignment is essential for most OCR readers. To insure good alignment it is necessary to (1) incorporate areas for prealignment of forms in data entry typewriters, and (2) lay out

entry areas (fields) so that the typist is encouraged to type only in the scan area. Normally a 1/8" band at the top of the form can be made available to permit proper horizontal and vertical positioning of the form in the device used for data entry (see fig. 21). This may take the form of a line for trial characters extending across the top, or two 3-to-5 character fields, one at top left, the other at top right, in which trial alphabetic characters should be entered to test proper alignment. When possible, characters in the proper font (V's or W's) should be preprinted to provide a comparison and thus identify an incorrect font that may inadvertently be introduced into the data entry system.

3.4.2. End-of-Form Warning Marker. Warning markers should appear in reflective ink at the bottom of free form or multi-line entry forms as a precaution against entering data beyond the reading area of the form. One style of marker is a column of countdown line numbers opposite the last few lines; another would be a series of increasing width steps commonly referred to as a "staircase" (see fig. 23).

FORM CCC 678
12-26-70

U. S. DEPARTMENT OF AGRICULTURE
Agricultural Stabilization and Conservation Service

WAREHOUSE STORAGE NOTE AND SECURITY AGREEMENT

Name and Mailing Address of Producer	STATE & COUNTY CODES & FARM NO. WHERE PRODUCED					
	WAREHOUSE RECEIPT NO A	NET QUANTITY B	LOAN RATE C	COL. B X COL. C D	DELIVERY CHARGES E	LOAN VALUE COL. D MINUS COL. E F
Schedule of Commodity						

6 C/D	LOAN NO.	NOTE AMOUNT
7 CODE	EXCISE TAX	FEES
8 CODE	DRAFT NO.	AMOUNT
9		
10		
11		
12		
13		
14		
15		
16		
17		
18		
19		
20		
21		
22		
23		
24		
25		
26		
27		
28		
29		
30		
31		
32		
33		
34		
35		
36		
37		
38		
39		
40		
41		
42		
43		
44		
45		
46		
47		
48		
49		
50		
51		
52		
53		
54		
55		
56		
57		
58		
59		
60		
61		
62		
63		
64		
65		
66		
67		
68		
69		
70		
71		
72		
73		
74		
75		
76		
77		
78		
79		
80		
81		
82		
83		
84		
85		
86		
87		
88		
89		
90		
91		
92		
93		
94		
95		
96		
97		
98		
99		
100		

... date shown above) or upon such earlier date as CCC may make ... (hereinafter referred to as the "producer") jointly and severally prom- ... shown below, the "Note Amount" shown above, and interest on each ... unit of any amount under \$100 (rounded to the nearest \$10 increment) at ... the note amount is outstanding, exclusive of the calendar month of repayment if ... the "Note Amount" has been outstanding during all or any part of two or more calendar months, or to satisfy his obligations as provided in Section 6 of this instrument. If the producer(s) made a fraudulent representation herein or in obtaining the loan or in connection with settlement under the loan or has made an unlawful disposition of any portion of the commodity securing the loan, the principal amount of the loan, and any costs incurred by the holder of the note, shall bear interest from the date of disbursement at the rate of 12 per centum per annum except as provided in 6(b). The maker and endorsers severally waive presentment for payment, demand, protest, notice of protest, and notice of nonpayment of this note. The term "CCC" means Commodity Credit Corporation and includes any holder of the note to whom CCC may have assigned its interest therein.

2. **Pledged Commodity.** The producer hereby assigns and pledges to CCC and any subsequent holder of this note, as collateral security for the payment of the note, charges, and interest, the warehouse receipts and other documents representing the commodity described in the Schedule of Commodities (hereinafter referred to as the "pledged commodity").

3. **Producer's Representation.** The producer agrees that by signing this instrument he makes the representations and warranties and agrees to all the terms and conditions specified in this instrument, including the provisions on the reverse. Read carefully the entire instrument before signing.

WITNESSES	SIGNATURES	DATE

4. **Lienholder's Waiver.** The undersigned lienholder(s) (including secured parties) do hereby severally waive, relinquish and surrender all right, title, and interest in and to the pledged commodity. (If no lienholders, enter "None.")

LIENHOLDER(S) (Signature)	NAME AND ADDRESS OF COUNTY ASCS OFFICE
APPROVED FOR CCC (By)	DATE

ORIGINAL

FIGURE 20. Sample form showing use of top copy for OCR original and second copy for legal original copy.



FIGURE 21. *Alignment marks.*

3.4.3. Character Set Indicators. Character set indicators are desirable in operations where the entry devices may use a variety of fonts for different operations. One design might be a line of type in the proper character set to be compared with a trial line entered below it from the device (see fig. 22). Equipment capable of reading multi-font source data is much more expensive than single-font equipment. Thus, for economic reasons, it is preferable to avoid multi-font source data.

3.4.4. Tab Stop Settings. Paper guide, margin, and tab-stop settings for the form should be indicated at the top of the form to insure proper data layout. A common method of indicating tab-stop settings is the use of a

row of preprinted triangles in the top margin with points facing downward at the point of entry of the first character in the field (see fig. 24). In conjunction with the above, care should be taken during form layout to align fields vertically and to reduce the number of tab stops required.

3.4.5. Mid-Form Alignment Marks. On forms 11" or longer a line guide should be provided several times down the sheet, particularly if the form is of the free form type, or is provided as a continuous form. Care should be taken in placing these guides to ensure that normal spacing of the data entry recording equipment will feed the form so as to place the nominal data line centrally in the scan area

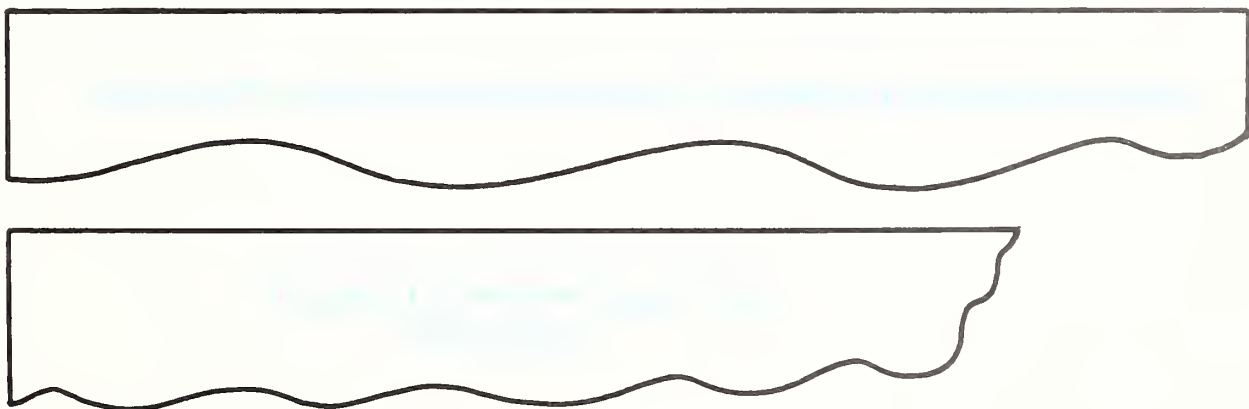

FIGURE 22. *Data recording font indicators.*

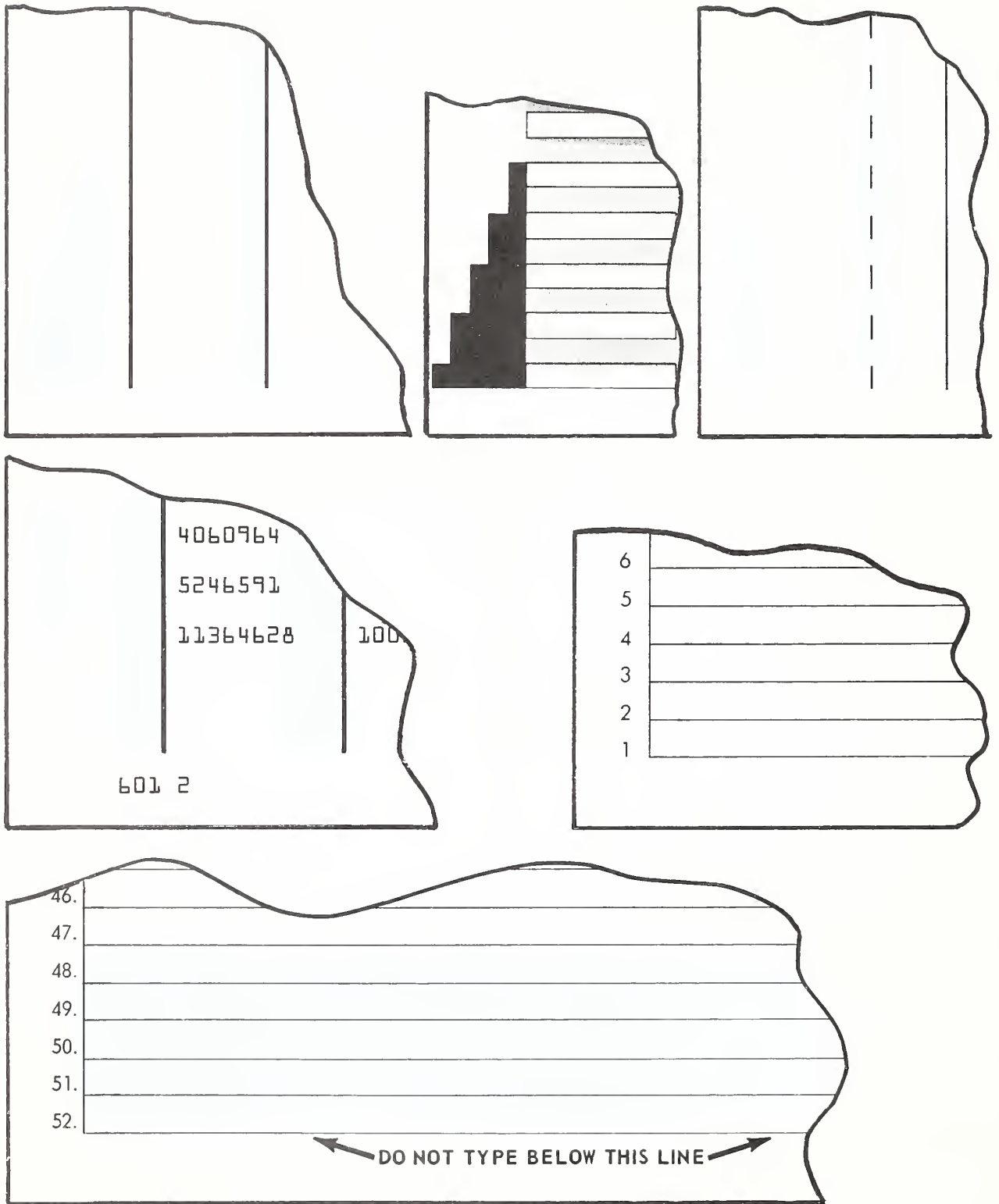

FIGURE 23. End-of-page warning markers.

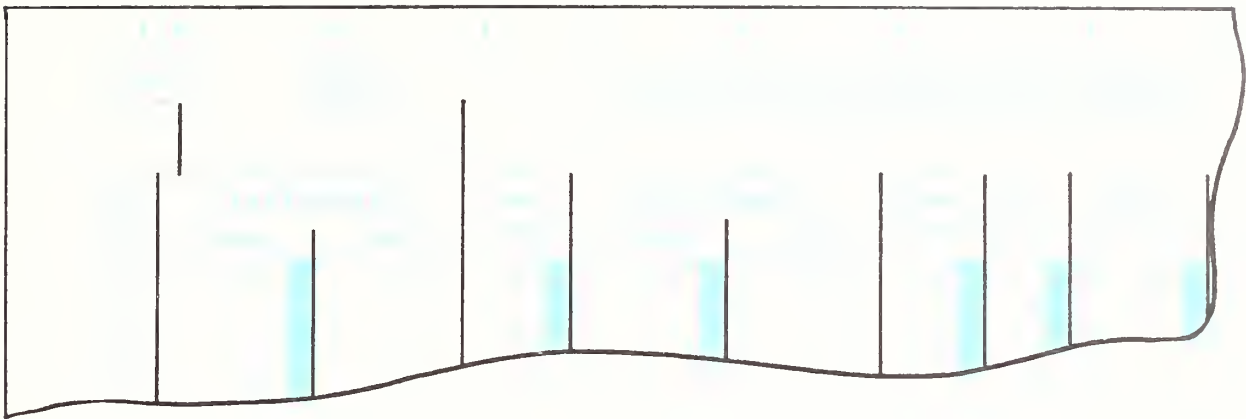

FIGURE 24. Tab stop setting indicators.

rather than near the lower border.

The line guide may be a pair of lines between which a typed line should fall, or a single line upon which the typed line rests (see fig. 25).

3.4.6. Data Field Captions. Data field labels and captions, preprinted in reflective ink for each field, number, data designation, and codes to be used, are extremely helpful in reducing entry errors. Titles or captions must be made large enough and bold enough to be easily read by humans, but still not be read by the reader.

Preprinted captions should be printed in a sans-serif type face, such as Helvetica (see fig. 26).

3.5. Multiple Copy Forms

3.5.1. Scanning Carbon Copies. The use of a carbon copy as a scannable form is not a common requirement in most OCR applications. Wherever possible, use of carbon copies for OCR scanning should be avoided in light of the attendant problems of image degradation, smudging, alignment problems, requirement for fine tuning of the scanning system, greater cost of the reader system, and like problems.

There are two situations where carbon copy reading may be of interest:

- imprinter applications involving plastic cards,
- negotiable or legal instruments, such as purchase orders, leases, sight drafts, etc.

FP001

NO. IN () INDICATES NO. OF CHARACTERS					
TIME AND ATTENDANCE					
BLOCK NO.(2)	EMPLOYEE NO.(6)	REG. HRS.(4)	PREM. HRS.(4)	NIGHT/SHIFT(4)	
ANN. LV.(2)	SICK LEAVE(2)	COMP. LV.(3)	LWOP(2)	AWOL(2)	OT
BLOCK NO.(2)	EMPLOYEE NO.(6)	REG. HRS.(4)	PREM. HRS.(4)	NIGHT/SHIFT(4)	
ANN. LV.(2)	SICK LEAVE(2)	COMP. LV.(3)	LWOP(2)	AWOL(2)	
BLOCK NO.(2)	EMPLOYEE NO.(6)	REG. HRS.(4)	PREM. HRS.(4)	NIGHT/SHIFT(4)	

FIGURE 25. Mid-form alignment guide.

PROVIDER BILLING FOR MEDICAL AND OTHER HEALTH SERVICES		
NOTICE: Anyone who misrepresents or falsifies essential information requested by this form may upon conviction be subject to fine and		
TYPE HHHHHHHH OVER THIS SPACE		
01. LAST NAME OF PATIENT BUTTERWORTH	FIRST NAME OF PATIENT AND MIDDLE INITIAL NELS R. E.	02. HEALTH INSURANCE 480-05-019
03. PATIENT'S ADDRESS—NO. AND STREET, 10715 FRANCIS DRIVE	CITY, STATE, ZIP CODE ROCKVILLE MD 20902	
05. PROVIDER NAME RHETT R. BUTTLER		06. PROVIDER NO. 11-646
PROVIDER ADDRESS—CITY AND STATE 1219 STONY DRIVE, ROCKVILLE, MD 20850		08. MEDICAL RECORD 2316
10. INSURING ORGANIZATION OR STATE AGENCY NAME PAN WESTERN LIFE ASSN.		11. PE
ADDRESS—NO. AND STREET, CITY, STATE, ZIP CODE 6 LIFE DRIVE, SA		

FIGURE 26. Data field captions.

For imprinter applications ordinarily the bottom copy is to be the scanning copy. This is not always the case since some readers will read reverse carbon images from the back of the top copy. Form set specifications should be reviewed carefully with the OCR manufacturer so that proper ordering information can be included in procurement specifications.

For negotiable instruments the usual practice is to designate the OCR data capture copy as the top copy of the form set. The second copy is used as the "original" or legal copy for signature purposes. The correct selection of the first carbon sheet will result in a form indistinguishable from forms produced as originals with carbon ribbons.

In situations other than the above, carbon copy reading should be avoided.

3.5.2. Registration Between Parts. In cases of multi-part forms, the part to be scanned (top or bottom copies) must be specified in forms procurement specifications. The type of data entry device to be used should also be a part of the specifications, as it makes a difference in how the form is manufactured.

Registration requirements for the non-OCR-read copies should be determined and included in procurement specifications.

3.6. Other Forms Layout Topics

3.6.1. Corner Treatment. The use of special corner treatment increases the production cost of the form but is sometimes dictated by overall system considerations. A corner cut should not extend more than 0.5 inch (12.75 mm) in horizontal or vertical direction from

the corner. Similarly, rounded corners should not have a radius exceeding 0.5 inch (12.75 mm). This value for rounded corners is compatible with the requirements of Federal Supply Specification GC-116 or ANSI X3.11, Paper Cards.

Corner cuts are especially useful for document in high speed feeding situations where incorrect form position will be troublesome. When it is absolutely necessary to design forms of a square or near-square geometry, corner cuts are extremely helpful in insuring that forms will be transported through the OCR reader correctly.

3.6.2. Pinfeed Holes. Pinfeed holes are important in OCR forms layout because they are used not only for feeding continuous forms but for locating the entry line with respect to the writing point of the recording device as well. It is therefore necessary to assure that the relationship between the holes and the form data fields be maintained. Further, care must be taken not to place holes which could interfere with the read areas of the form.

Standard pinfeed hole spacing is center-to-center distance of 0.500 in \pm 0.015 in (12.75 mm \pm 0.380 mm) along a line parallel to a vertical reference edge (or perpendicular to a horizontal reference edge) and horizontal position tolerance with respect to the reference edge is \pm 0.015 in (\pm 0.380 mm). Pinfeed holes should be spaced equally above and below form perforations, so that this distance will be 0.250 in \pm 0.015 in (6.35 mm \pm 0.380 mm) from the top edge of the form.

It should be noted that OCR typewriters and data entry devices now generally provide adequate paper feed capabilities so that pinfeed

holes are not required for registration purposes. Continuous nonpinfeed forms are a useful application for the production of OCR forms in high volume situations. Continuous forms, however, should be carefully burst before feeding to the OCR scanning system.

3.7. Handprinted Character Data Entry.

Handprinted character entry always involves the use of guide boxes (see FIPS PUB 33 and figs. 27 and 28). These boxes are placed on nominal data lines for continuity of data entry as is done for other methods of OCR data entry. Normally, vertical line spacing is 2 lines per inch.

Handprinted character data entry forms should be arranged to permit data entry from left to right and top to bottom. This arrangement helps prevent smudging of characters caused by working over previously coded data. Avoid using the bottom 3" of the form since the operator may not easily control the form when entering data in this area, thereby allowing more chance of degraded characters.

A set of characters used should always be preprinted on the form in actual size to illustrate the characters to be used (see fig. 29). Only the set or subset involved is needed and other characters may be confusing, i.e., show only the handprinted characters which the reader or system will accommodate.

Refer to FIPS PUB 32, ANSI X3.45-1974, or to manufacturer's specifications for further details regarding handprinted characters.

3.8. Forms Design for Multi-Scanner Operations. Based on the current level of technology in the field of OCR, it is now possible to design forms that can be used on several of the OCR readers now on the market. In the past, forms could not be easily designed for common use by different scanning equipment in a common data input system(s). Today it is now practical to design forms to be used on several different page readers if certain requirements are observed. These requirements fall in three general categories: forms materials, forms printing requirements, and forms format.

3.8.1. Materials. OCR readers available today operate on nearly the same range of physical and optical paper specifications. The differences from machine to machine are relatively minor. If certain ranges of OCR paper characteristics and inking practice are met, forms should be interchangeable between different makes of readers without undue problem. However, this situation should be continuously monitored, since it represents a combination of application requirements rather than the single set encountered in the more usual application.

If forms are printed on 20 to 24 lb. OCR

bond paper and meet other OCR paper requirements, interchangeability in various forms feeders should be achieved.

Read (black) inks will pose no interchangeability problems.

Reflective (nonread) inks may present major problems although several machines operate in the same general portion of the color spectrum. A particular problem will be encountered in using forms on machines with laser light sources since they operate on a very narrow spectral band.

3.8.2. Printing Requirements. Interchangeability of OCR forms should be achieved if the guidelines of section 3.3 are observed. Good forms manufacturing practice should be adequate as supplied by a reputable, experience OCR forms source.

3.8.3. Format. The guidelines of Section 3.3. are important in achieving any interchangeable reader applications. In addition, the special requirements of specific readers must be observed with regard to reference marks, clear areas, line targets, and field markers.

The special requirements of each reader in the system must be contained in the OCR forms to be interchanged.

3.9. Reader Device Characteristics Summary Charts. A listing of OCR Reader Characteristics for most of the presently available devices is given in Appendix D.

4. OCR Forms Specification and Inspection. A summary of requirements that will be helpful to the OCR forms designer in writing procurement specifications and inspecting finished forms for acceptance is given in table 3.

The experienced forms designer will be able to add items from his experience to increase the usefulness of this table to his systems design work.

After a form is designed, the forms designer is ready to place an order for production of the forms with a forms manufacturer. Aside from the rough draft copy of the form there are many other facts which must be provided to the forms manufacturer, as shown in the table.

5. OCR Forms Design Tools. There are a number of aids that will greatly assist in OCR form design task and contribute to precision in the finished layout. These include:

- a. *Form Layout Paper*—6 lines per inch vertical spacing and 10 lines per inch horizontal spacing (see fig. 17).
- b. *Preprinted "art" or "Vesi" type layout copy aids*—constraint boxes, hand print numbers, etc., which can be cut and pasted on graph paper during layout or used by draftsman for copy for printer.



FIGURE 27. Handprinted character guidelines (from X3.45-1974).



FIGURE 28. *Handprinted character guidelines—numeric (Industry Standard).*

- c. *Comparator* (for accurate location of design tolerances)—6X or 12X units are available from a number of reputable suppliers equipped with all necessary scales to measure $\frac{1}{2}$ " length with 0.005" units, and angular deviation within 1° . Reticles are available for OCR-A, and OCR-B character sets (see appendix C).
- d. *Form Design Rulers* (which simplify most of the actual drafting measurements utilized in laying out a form) (see appendix C).
- e. *Transparent grid sheets* (6 lines in vertical and 10 lines per inch)
- f. *Starret paper gauge*
- g. *8X comparator* (for checking field data entry quality)—these are available at most photographic supply counters or stores (See appendix C).

A B C D E F G H I J K L M N O P Q R S T U V W X Y Z

BENEFIT DATA CHANGE 1 2 3 4 5 6 7 8 9 0 — 0101

CODING SHEET

I - - D V

FORM SSA-1490T (2-7-61) SSA MEDICAL INSURANCE BENEFITS (PART B) CODING SHEET

CONTIN CODE TOTAL LINES WRITE YOUR NUMERALS LIKE THIS RELATED REFERENCE NO.

L 02557 0 1 2 3 4 5 6 7 8 9 0

JULIAN DATE	BLOCK NUMBER	SEQ. NUMBER	INTERMEDIARY (1490, 1554, 1556) GPPP NO. (1591)	CLAIM NUMBER	EMP. REL.	PHYS. ASSIGN	CORR INDIC	PHYSICI PROVID GPPP

FIGURE 29. Illustrative set of characters.

Table 3.—OCR FORMS SPECIFICATION CHECK LIST

All categories may not apply.

- | | |
|---|--|
| <p>1. Form name, form number, edition, date</p> <p>2. Optical reader(s) to be used — manufacturer, model, any optional features</p> <p>3. Construction
 --Continuous
 --Cut Single
 --Snap Apart (Unit Set)
 --Tab Card Set
 --Other</p> <p>4. Number of parts
 Which part(s) to be scanned</p> <p>5. Size
 ___width x ___ length</p> <p>6. Paper (detail for <u>each</u> part)
 --Color
 --Grade (OCR, Standard, etc.)
 --Finish
 --Basis Weight and Size
 --Special properties
 Moisture Resistant
 Grease Proof
 Other</p> <p>7. Inks (Detail for each part)
 --Reflective Ink(s) & Color Specs.
 --Read Ink — Color(s)
 --Regular Ink — Color(s)
 --Backer Ink—Color & Bleed Through Requirements</p> <p>8. Carbons (Detail for each part)
 --Color
 --Grade
 --Weight
 --Special Requirements
 Strip or Spot
 Double Face
 Other</p> | <p>9. Numbering Requirements
 --Font (Include size)
 --Pitch (Spacing)
 --Total Number of Digits
 --Check Digits (What Modulus Systems)
 --Location on Form
 --For OCR Use (Yes or No)
 --Ink Color
 --Printed or Crash Imprint
 --Starting/Ending Number
 --Special Instructions</p> <p>10. Other Construction Features
 --Corner Cut(s) — Location
 --Special Punching
 --Perforation(s)—Size & Location
 --Short Carbons or Opaques
 --Die Cutting
 --Fastenings
 --Backers
 --Other</p> <p>11. Form Copy
 --Areas to be Read
 --Location of Read Area
 --Size of Read Area
 --Data to be Read
 --Data Not to be Read
 --Special Reference or Registration Marks
 --Location of Reference or Registration Marks
 --Machine Alignment Marks (For Typewriter, Computer Printer, etc.)
 --Backer(s) (Which Parts)
 --Format Identifiers, etc.
 --Other</p> <p>12. Special Instructions
 --Explain Any Requirement Contrary to Published Specifications for the Optical Reader
 --Other</p> |
|---|--|

Table 3.--OCR FORMS SPECIFICATION CHECKLIST (Continued)

- | | |
|--|---|
| <p>13. Form Usage</p> <ul style="list-style-type: none">--High Speed Printer--Card Reader--Imprinter--Forms Handling Equipment (Burster, etc.)--Filing and Other Manual Handling <p>14. Quantity of Forms Required</p> <p>15. Delivery</p> <ul style="list-style-type: none">--Date Required (days after sample approval)--Location--F.O.B. Point--Pre-Production Samples Required--Other <p>16. Packaging</p> <ul style="list-style-type: none">--Quantity Per Package/Box--Package/Box Identification (Labels)--Special Wrapping (Water Proof) | <p>17. Proofs</p> <ul style="list-style-type: none">--Type (Color)--Number of Copies--Delivery Schedule--Special Approval Instructions--Sample Approval Reqmts. <p>18. Reproducible Copies (for use in user's manuals and publications)</p> <ul style="list-style-type: none">--Description of Copy--Quantity--Kind--Date Needed--Delivery Point/Person |
|--|---|

APPENDIX A.
OCR CHARACTER SETS

ABCDEFGHIJKLM
 NOPQRSTUVWXYZ
 abcdefghijklm
 nopqrstuvwxyz

 0123456789
 . , : ; = + / \$ * ^ & |
 ' - { } % ? [\] _
 ? , ' -
 Ü Ñ Ä Ø Ö Æ Å £ ¥

FIGURE A1. OCR-A—ANSI X3.17-1974 and FIPS 32.

1234567890
 ABCDEFGHIJKLM
 NOPQRSTUVWXYZ
 abcdefghijklm
 nopqrstuvwxyz
 * + - = / . / : ; " ' _
 ? ! () < > [] % # & @ ^
 ¤ £ \$ | \ ■ — ¥

FIGURE A2. OCR-B—ANSI X3.49-1975 and FIPS 32.

0 1 2 3 4 5 6 7 8 9 X ~~Y~~ ~~Z~~

Numeric Subset

0 1 2 3 4 5 6 7 8 9 A B C D E F G H I J
K L M N O P Q R S T U V W X Y Z + - . ,
~~Y~~ ~~Z~~ ~~A~~

Alphanumeric Subset

0 1 2 3 4 5 6 7 8 9 A B C D E F G H I J
K L M N O P Q R S T U V W X Y Z + - . ,
~~Y~~ ~~Z~~ ~~A~~ b | " # \$ % & ' () * / : ; <
= > ? @ \ ^ _

Programming Subset

0 1 2 3 4 5 6 7 8 9 A B C D E F G H I J
K L M N O P Q R S T U V W X Y Z + - . ,
~~Y~~ ~~Z~~ ~~A~~ b | " # \$ % & ' () * / : ; <
= > ? @ \ ^ _ [] ¡ ª « ¬ ® ¯ ° ± ² ³ ´ µ ¶ · ¸ ¹ º
» ¼ ½ ¾

Universal Subset

Scale approx. 1:1

Fig 2 USA Character Repertoires

FIGURE A3. HANDPRINTED CHARACTERS—ANSI
X3.45-1974 and FIPS 33.

APPENDIX B.

GLOSSARY OF OCR FORMS TERMS

The following glossary of terms is unique to OCR forms. The definitions used † have been selected to represent the usage only as it relates to design and applications for OCR forms and may well not include usages assigned under other contexts. In some instances, terms have been taken from other publications including:

ANSI X3.17-1974, American National Standard *Character Set and Print Quality for Optical Character Recognition, OCR-A*
 ANSI X3.45-1974, American National Standard *Character Set for Handprinting Business Forms Glossary*, International Paper Company
The Dictionary of Paper, American Pulp and Paper Institute (3rd Edition)
TAPPI OCR Glossary, Technical Association of the Pulp and Paper Industry
Compilation of Terms in Information Sciences Technology (PB 193 346), of the Federal Council for Science and Technology.

Appreciation is expressed herewith to the publishers of these sources for the helpful assistance to OCR forms technology and increased understanding of this art which is thereby provided.

ABSTRACT SYMBOL—a graphic shape for which specific meaning and use may be arbitrarily defined, i.e., HOOK, FORK, or CHAIR.

ACCURACY CONTROL CHARACTER—a graphic shape or symbol used to indicate data which are in error, are to be disregarded, or cannot be represented on a particular device.

ADJACENCY—two OCR characters printed on the same line with character spacing reference lines separated by the proper space for the character set and system.

ALIGNMENT EDGE—see Reference Edge.

ALIGNMENT MARKS—printed location indicators on an OCR form used to assure proper alignment.

ALPHAMERIC—see Alphanumeric Character Set.

ALPHANUMERIC—see Alphanumeric Character Set.

ALPHANUMERIC CHARACTER SET—a set or subset of graphic shapes that contains letters, numbers, and usually other characters, such as punctuation marks.

AMBIENT LIGHT—general level of room illumination.

ANGSTROM—one hundred millionth of a centimeter, or ten nanometers (used in expressing the wavelength of light).

ANSI—American National Standards Institute (formerly the United States of America Standards Institute, or the American Standards Association).

ASCII—American National Standard Code for Information Interchange, X3.4-1969; a coded character set of 7-bit coded characters used for information interchange among data processing systems, communication systems, and associated equipment.

AVERAGE BACKGROUND REFLECTANCE—the simple arithmetic average of background reflectance readings from at least five difference points on a sheet, expressed as a percent of a reflectance standard.

AVERAGE EDGE—an imaginary line bisecting the irregularities of a character boundary.

BACK PRINTING—material placed on the reverse side of a form.

BACKGROUND REFLECTANCE—a brightness measurement of paper, expressed as a percent of a reflectance standard.

BAND—the light frequency spectrum between two defined limits.

BAR CODE—a binary coding system consisting of vertical marks or bars and spaces.

BARIUM SULPHATE=BaSO₄—a standard of reflectance used to calibrate instruments for the measurements of reflectance of paper or ink. Also, see MgO, or magnesium oxide.

BASE LINE—a reference line used to specify the nominal relative vertical position of OCR characters printed on the same line.

BASIS WEIGHT—the weight of paper, in grams per square meter or in lb, of a given number of sheets in a specified size, i.e., 20 lb per 500 sheets, 17 in x 22 in.

BLEED THROUGH—reduction of background reflectance by material printed on the reverse side of an OCR form.

BLIND INK—see Reflective Ink.

BLOCKED FIELD—an area of an OCR form delineated by the graphic symbol LONG VERTICAL MARK, preprinted or imprinted in read ink.

BRIGHTNESS—a property of white paper measured in terms of reflectance in the blue-violet band of the spectrum.

BULK—see Caliper.

BURST—the separation of continuous forms into discrete parts.

BURST STRENGTH—a property of paper describing its resistance to rupture.

CALIPER—a property of paper describing its thickness, expressed in thousandths of an inch, or mills.

† Certain terms vary in a minor degree to identical term entries of ANSI X3.12-1970 Vocabulary for Information Processing. Differences represent, for the greatest part, advances in OCR applications and the present state of the art.

CANCEL CHARACTER=CAN—an accuracy control symbol used to indicate that the data with which it is associated are in error, or are to be disregarded.

CAPTURE—see Collect.

CBEMA—Computer and Business Equipment Manufacturer's Association, sponsor of the X3 Committee and X3 Subcommittees.

CENTERLINE—the vertical or horizontal axis about which elements of a graphic shape are located.

CHARACTER—a single graphic shape from the system character set or subset, i.e., any upper or lower case alphabetic letter, number, special, or abstract symbol.

CHARACTER ALIGNMENT—the vertical or horizontal position of characters with respect to a given reference line.

CHARACTER BOUNDARY—the smallest rectangle, with sides parallel and perpendicular to the form reference edge, that can be constructed with sides tangent to a given graphic shape.

CHARACTER DENSITY—the number of characters in a line of print per unit of length.

CHARACTER ERASE—an OCR graphic shape that will delete a single character or space.

CHARACTER OUTLINE—the graphic shape established by the stroke edges of a character (see Stroke Edge).

CHARACTER OUTLINE LIMIT=COL—the minimum, nominal, and maximum limits of a given graphic shape, as delineated by a COL gauge.

CHARACTER PRINTER—an imaging device that prints a single character at a time. See Line Printer and Imprinter.

CHARACTER READER—see Optical Character Reader.

CHARACTER READING—see Optical Character Recognition.

CHARACTER RECOGNITION—see Optical Character Recognition.

CHARACTER-REFERENCE LINE—see Base Line.

CHARACTER SET—a set of unique representations or graphic shapes. See Alphanumeric Character Set.

CHARACTER-SET INDICATOR—a replica of the data-entry character set to be used for a given OCR form.

CHARACTER SHAPE—see Graphic Shape.

CHARACTER SKEW—see Skew.

CHARACTER SPACE—the geometric area in a line of print assigned to an individual graphic shape.

CHARACTER SPACING—the pitch distance between adjacent characters.

CHARACTER-SPACING REFERENCE LINE—the vertical reference line parallel to the character center line which defines horizontal spacing of characters in a line of print. Certain characters are offset horizontally by specified distances to enhance recognition or esthetic appearance.

CHARACTER STRING—a connected or closely related set of characters entered as data (see Data Field).

CHARACTER STROKE WIDTH—the nominal distance between the average edges of a character element.

CHARACTER SUBSET—a designated collection of characters selected from the total population of an OCR system repertoire.

CHECK CHARACTER—a symbol used for the purpose of performing a verification operation (see Check Digit).

CHECK DIGIT—a symbol or character derived by formula which can be used to evaluate the validity of a character string (see Check Character).

CLEANLINESS—a measure of the absence of process dirt in paper.

CLEAR AREA—a specified geometric space occupied by characters to be read on an OCR form, that must be free of printing or other markings not related to machine reading (see Print Area).

CLEAR SPACE—see Clear Area.

CLOCK MARK—see Timing Mark.

COLLECT—record information for entry into a data processing system.

COLOR—the spectral reflectance of a printed image.

CONSTRAINT BOXES—see Guide Boxes.

CONTINUOUS FORM—a series of printed forms which are provided in either single or multiple ply, manufactured as a continuous web, to permit continuous form feed at a data entry device. Such forms are usually separated (burst) along perforated lines prior to machine reading.

CONTRAST—the difference in reflectance between a printed image and the background upon which it is placed.

CONTRAST-VARIATION RATIO=CVR—the ratio of PCS_{max}/PCS_{min} , where PCS = Print Contrast Signal.

CONTROL CHARACTER—see Print Control Character.

CORNER TREATMENT—the clipping or rounding of a form corner in the manufacturing process to indicate the orientation of a form in a stack.

COVERAGE—the extent to which paper is inked as a result of a half-tone screening process.

CUT SHEET—a form which is manufactured in individual sheets.

DATA ENTRY DEVICE—an imaging machine used to enter data on an OCR or other form.

DATA ELEMENT—a basic unit of information.

DATA FIELD—see Field.

DELIMITER—see Field Mark.

DEPTH=LENGTH—the distance between the two edges of a form at right angles to a nominal data line, measured at the time a form is ready for reading.

DIRT-IN-PAPER—non-reflective foreign particles embedded in a paper sheet resulting from the paper manufacturing process.

DOCUMENT—an OCR form, usually read while in motion passing through an OCR device.

DOCUMENT READER—an OCR reading device which typically scans one to five lines of data, in fixed line locations on a form, at a single pass.

DOCUMENT-REFERENCE EDGE—see Reference Edge.

DOCUMENT SCANNER—see Document Reader.

DROPOUT INK—see Reflective Ink.

EMBOSSMENT—distortion of a form surface.

END-OF-FORM MARKER—a preprinted indicator on OCR forms to advise data entry personnel to prepare for the end of data entry space.

ERASE CHARACTER—see Character Erase.

ERROR-CONTROL CHARACTER—see Accuracy Control Character.

ERROR MARKING—identification of reject or unrecognized characters, usually by a mark in form margins.

ERROR RATE—the percentage of total characters processed by an OCR device that are read incorrectly. (See Reject, Substitution).

ERROR-RECOVERY AREA—an assigned area on OCR forms that provides opportunity to enter corrected information for any field or line of the form.

EXTRANEIOUS INK—undesirable non-reflective ink or other materials on an OCR form.

FELT SIDE—the top side of paper sheets in the manufacturing process, as opposed to the bottom or wire side (see Wire Side).

FIELD—any group of characters defined as a unit of information.

FIELD BOUNDARY—the smallest rectangle, with sides parallel and perpendicular to a reference edge, which will contain all of the characters in a data field.

FIELD DELIMITER—see Delimiter.

FIELD LENGTH—the physical extent of a field.

FIELD MARK—a mark or symbol printed in read ink used to identify field boundaries.

FIELD-PREPARED FORM—a data entry form prepared at multiple points, for OCR reading at one or more central locations.

FIELD-SEPARATOR MARK—see Field Mark.

FILE—a collection of related records treated as a unit.

FIPS=FEDERAL INFORMATION PROCESSING STANDARDS—publications issued by the National Bureau of Standards specifying protocol and procedures to be followed in various areas of information processing practice in the U.S. Federal Government.

FIXED DATA—transaction information common to a continuing series of events, i.e., sender identification, location, etc. (see Variable Data).

FLARE—a situation wherein fluorescent whiteners in OCR paper forms confuse the light detecting element.

FLUORESCENCE—the phenomenon of material absorbing light in ultra violet spectral regions and re-emitting light energy at a different wave length, including visual spectrum regions. Optical brighteners added to paper enhance the apparent whiteness or brightness through this phenomenon.

FLYING-SPOT SCANNER—an electronic component employing a moving beam of light to sample designated areas of OCR forms, with the intensity of the transmitted or reflected light being measured by a photoelectric element.

FONT—see Alphanumeric Character Set.

FONT INDICATOR—see Character Set Indicator.

FORM—documents, pages, or journal tapes used for OCR data entry.

FRAMING—a printing problem associated with chain printers, which results in an individual character impression surrounded with a rectangular shadow, produced by the printing ribbon.

FREE FORM—a data-entry form in which data appear in variable length fields without the use of pre-printed symbols or guides.

FREE FORMATTED—see Free Form.

FULL MATRIX SCAN—a scanning method wherein light reflected from a graphic shape is projected upon a rectangular grid of photoelectric elements.

GLOSS—a high reflectance surface condition.

GRAPHIC SHAPE—the physical image used to represent a character or symbol.

GRAIN DIRECTION—the flow direction of paper in its manufacturing process.

GRID—two mutually orthogonal sets of parallel lines used for measuring or specifying character images.

GROUP ERASE—an OCR graphic shape used to delete a group or string of three or more characters.

GUIDE BOXES—preprinted reflective ink patterns used to control placement of handprinted characters on OCR forms.

HANDPRINT—manually formed graphic shapes used for OCR data entry.

HANDPRINT BOXES—guides used to control entry of handprinted characters.

HARD COPY—a machine printed copy of system output.

HORIZONTAL-REFERENCE EDGE—see Reference Edge.

IMAGE—the outline configuration of a graphic shape.

IMAGE DEGRADATION—distortion or degeneration of OCR characters resulting from carbon splatter, bleeding, or similar character generation problems.

IMAGE SPACING—see Character Spacing.

IMAGING—any method of entering information on an OCR form, through the creation of optical contrast.

FIPS PUB 40

IMAGING DEVICE—any equipment used to produce an image.

IMPRINTER—any device for entering information on a form, usually in parallel entry, as in a printing process.

INCIDENT LIGHT—light falling upon a surface.

INFINITE-PAD METHOD—the measurement of reflectance of a paper sheet such that doubling the number of backing sheets of the same stock will not change the measured reflectance.

INFORMATION—useful material of interest (see Data Element).

INFRARED RESPONSE—a type of optical system used in some OCR devices, which operates in the red-infrared region of the frequency spectrum.

INK—any material providing optical contrast to a paper form for the purpose of recording information or data.

JOURNAL TAPE—an OCR data entry form consisting of an imprinted paper ribbon of fixed width but indeterminate length.

JOURNAL-TAPE DEVICE—see Journal Tape Reader.

JOURNAL-TAPE READER—an OCR reading device which accepts journal tape rolls as input media.

LEADING EDGE—the forward edge of an OCR form as it is transported through an OCR device (see Reference Edge).

LENGTH=DEPTH—see Depth.

LIGHT STABILITY—resistance to change in color of an image or its paper substrate when exposed to radiant energy.

LINE BOUNDARY—the smallest rectangle, with sides parallel and perpendicular to the reference edge, which contains all characters of a line of print.

LINE PRINTER—an imaging device that prints all characters of a line as a unit.

LINE SEPARATION—the vertical distance between the upper line boundary of a line of print and the lower line boundary for the line immediately above.

LINE SPACING—the vertical distance between the average baseline of one line and the average baseline of the next line.

LINE TARGET—see Reference Mark.

LINE-UP MARKS—preprinted indicators used for line and character alignment of an OCR form in a data entry device.

LINE SKEW—the angular displacement of a line in relation to its intended position.

LINE SPACING—the distance between the average baseline of one line and the average baseline of the next.

LOGIC—the electronic components of an optical character recognition device wherein scan signals (analogues) are converted into corresponding machine language signals.

LONG-VERTICAL MARK=LVM—an OCR graphic shape used usually as a field delimiter (see Field Mark).

MACHINE CYCLE—the elapsed time required to execute one complete operation sequence.

MACHINE READABLE—character shapes or symbols of a set which can be read or sensed by an OCR device.

MAGNESIUM OXIDE=MgO—a standard of reflectance used to calibrate instruments for measuring the whiteness or reflectance of paper; now superseded by barium sulphate (BaSO_4). (Also, see Barium Sulphate).

MAGNETIC-INK CHARACTER RECOGNITION=MICR—machine reading of characters printed in magnetic ink, and in the E-13-B character set shapes.

MARGIN—the reserved area adjoining each edge of an OCR form.

MARK READING—optical machine reading of marks, usually vertical bars, which have been manually entered on a form.

MARK SENSING—the detection of manually recorded conductive marks on non-conductive substrates or surfaces, using weak electrical currents.

MARKING POSITION—an area designated for the entry of hand-entered mark information on a mark read-form; also called a Response Position.

MATTE—a low reflectance surface condition.

MEAN-CHARACTER SHAPE—the graphic shape whose electrical (analogue) representation as an output from scanning elements, matches a stored representation for that character.

MECHANICAL-DISK SCANNER—a scanning system embodying a rotating, slotted disk and a fixed, slotted aperture.

MID-FORM ALIGNMENT MARK—see Alignment Mark.

MOISTURE CONTENT—the water content of paper, expressed as a percent.

MOISTURE-RESISTANT PAPER—a category of OCR paper developed to meet unusual ambient or climatic conditions, such as census forms or meter reading forms.

MULTIFONT—a reading machine capability of recognizing characters printed in more than one type font or character set.

MULTIPART FORM—a set of like forms fastened together, one atop another by one of several conventional techniques, for the purpose of producing duplicate copies from a single data entry impression.

NOISE—non-information carrying variations of one or more characteristics of any entity.

NOMINAL-DATA LINE—a reference line across an OCR form which is the intended locus of characters in a line of print (see Base Line).

NOMINAL-STROKE WIDTH—the ideal or specified width of a character stroke.

NON-READ AREAS—portions of an OCR form used to enter information which is not to be machine read.

NON-READ INFORMATION—information on an OCR form that will not be machine read.

NON-READ INK—see Reflective Ink.

NON-REFLECTIVE INK—see Read Ink.

NON-SCAN INK—see Reflective Ink.

NUMERIC—a graphic shape representing one of the 10 numerical characters 0 through 9.

OCR DATA-ENTRY FORM—a business form designed for use in OCR data entry.

OCR TYPEWRITER—a data entry device used to enter printed OCR characters.

OPACITY—the property of paper which minimizes transmission of light.

OPTICAL BRIGHTENERS—see Fluorescence.

OPTICAL-CHARACTER READER—an information processing device which senses graphic shapes on paper, film, or other media, and converts them into machine language signals.

OPTICAL CHARACTER RECOGNITION=OCR—the process of converting data from humanly visible form to machine language signals.

OPTICAL-PAGE READER—see Page Reader.

OPTICAL READER—see Optical Character Reader.

OPTICAL SCANNER—see Optical Character Reader.

PAGE READER—an optical character reading device which scans multiple lines of data during a single pass of a page form through the device.

PAPER GRAIN—see Grain Direction.

PAPER REFLECTANCE—see Reflectance.

PAPER SMOOTHNESS—see Smoothness.

PHOTODETECTORS—light sensitive elements of an OCR device used to receive reflected light from typed or handprinted characters, and output electrical analogue signals.

PICA—a type size of 10 characters per inch of print line.

PITCH—the nominal character density of characters in a print line expressed in characters per inch.

POROSITY—the property of paper which permits or resists the passage of air through a paper sheet.

PRE-PRINTED DATA—the entry of specified recurring or fixed information on an OCR form at the time of manufacture.

PRINT AREA—that portion of an OCR form in which printed characters may be placed for machine sensing (see Clear Area).

PRINT-CONTROL CHARACTER—a graphic shape used to designate certain machine printing operations, i.e., line space, carriage return, etc.

PRINT-CONTRAST RATIO—see Print Contrast Signal.

PRINT-CONTRAST SIGNAL=PCS—a measure of contrast between a printed character and its paper substrate, defined by $PCS_p = (R_w - R_p) / R_w$.

PRINT QUALITY—the physical condition of imprinted graphic shapes and their surrounding areas.

PRINTED IMAGE—see Image.

PRINTING AREA—see Print Area.

READ AREA—see Print Area.

READ INK—any markings to which an OCR device is sensitive.

READ—mechanical interpretation of printed characters or marks (see Scan).

RECOGNITION LOGIC—see Logic.

RECORD—an organized set of related data elements.

REFERENCE EDGE—that edge of an OCR form which is used for alignment so that the printed character line will be parallel to the direction of scanning.

REFERENCE MARK—a preprinted indicator on an OCR used as a base location point by an OCR reading device.

REFLECTIVE INK—color not sensed by an OCR device but visible to the human eye.

REFLECTANCE=R—the measured level of light energy reflected by a paper substrate, or imprinted characters thereon, expressed in percent of a standard reference material.

REGISTRATION—correct geometric positioning of the several plies in a multi-part form.

REJECT—a character or mark which has been scanned but not recognized.

REJECT RATE—the number of rejects per given number of characters read expressed in percent.

REPertoire—all of the characters and graphic shapes used in an OCR imaging device or reading system.

SCAN—a search for data or information to be recognized.

SCAN AREA—see Print Area.

SCAN BAND—an area across an OCR form which is searched by an OCR device in a single stroke or pass.

SCAN INK—see Read Ink.

SCANNER—see Optical Character Reader.

SCAN SPEED—the rate at which an OCR device can search for information.

SHELF LIFE—the storage period which OCR forms can safely endure prior to applications use.

SHOW-THROUGH—see Bleed Through.

SKEW—the angular displacement of a line or graphic shape from its intended position.

SKEW TOLERANCE—the allowable angular displacement.

SMOOTHNESS—a measure of surface roughness of a paper sheet.

SOURCE-DATA-ENTRY DEVICE—any device used to enter data on a form at the point of original transaction or event.

SOURCE DOCUMENTS—original forms from which information input for a data entry system is derived.

SMUDGES—dirty streaks or smears that may confuse an OCR device, caused from slippage in a data entry device, mishandling of an OCR form, careless storage, bleeding, etc.

SPACE—a graphic shape which is a completely blank area.

SPACING—see Character Spacing.

SPECTRAL RESPONSE—variation in sensitivity of a scanning device to light energy of different wavelengths.

SPECIAL SYMBOL—see Abstract Symbol.

SPOTS—areas outside the Character Outline Limit (COL) which are contrasting with the background.

STACKER—a portion of an OCR device used for the accumulation of processed documents.

STIFFNESS—a measure of the rigidity of paper.

STRIP FORM—see Continuous Form.

STROKE—a straight or curved line-segment used in the construction of a graphic shape.

STROKE ANALYSIS—a technique of recognition in which the strokes of a character shape are considered to be uniquely descriptive of the character.

STROKE-AVERAGE WIDTH—the mean of actual stroke widths taken at points along the length of a stroke.

STROKE CENTERLINE—a line midway between the two stroke edges of a graphic shape.

STROKE EDGE—the boundary between a graphic shape and its substrate (see Character Outline).

STROKE WIDTH—see Character Stroke Width.

SUBSTITUTION—a character or mark that is incorrectly recognized as another character or mark in the output machine signal.

SUBSTITUTION RATE—the number of substitutions per given number of characters read expressed as a percent.

TAB-STOP SETTINGS—indicators printed in the top margin of an OCR form to indicate points of entry for succeeding lines of tabular or common item data entries.

TEAR STRENGTH—a property of paper expressing its resistance to edge rupture.

TENSILE STRENGTH—a property of paper expressing its tensile load bearing capability.

TEST GAUGE—a device suitable for use as a quality control tool.

THICKNESS—see Caliper.

TIMING MARK—a printed indicator along the edge of a mark-read form used to synchronize form position with machine-scan cycles.

THROUGHPUT—the rate at which OCR forms can be processed.

TRANSPORT—the mechanical component of an optical character device used to transport forms through the device, from input to output hoppers.

TURNAROUND FORM—an OCR form produced by an information processing system intended for future re-entry, possibly with added data.

TYPING LINE—the locus of characters placed on a data entry line (see Base Line).

ULTRAVIOLET RESPONSE—an OCR scanning system which reacts to light in the extreme blue region of the visual color spectrum.

UNIT SET—a form which is provided with a multiply assembly attached by one or more edges to assure registration of plies during data entry. Such forms are single units as contrasted to continuous forms.

VARIABLE DATA—information unique to an original transaction or event (see Fixed Data).

VERTICAL BAR—see Long Vertical Mark.

VERTICAL-FIELD SEPARATOR—see Long Vertical Mark.

VISIBLE RESPONSE—an OCR scanning system which reacts to a wide band of the visual color spectrum.

VOCABULARY—see Repertoire.

VOID—the inadvertant absence of ink within a character outline.

WAX-PICK TEST—a measure of the surface properties of a paper sheet.

WIDTH—the distance between the two edges of an OCR form, measured along a nominal data line as the form is fed to a reading machine.

WIRE SIDE—the side of a paper sheet next to the wire carrier in the manufacturing process; opposite from the felt side (see Felt Side).

APPENDIX C.—OCR FORMS
LAYOUT TOOLS

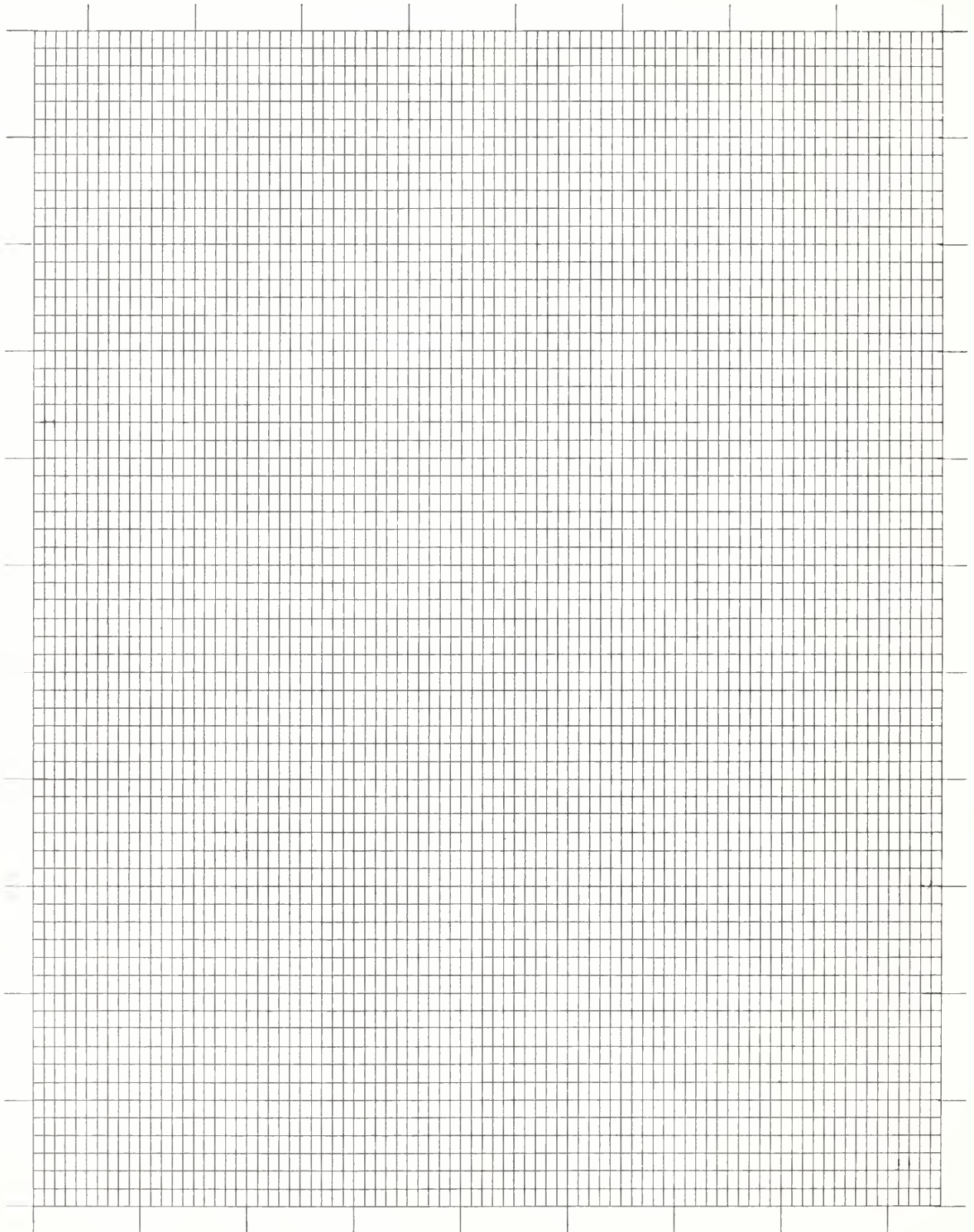

QUALITY CHECK GRID
10 Pitch with 6 Lines per inch.

Test Group Number
PQ-001-A

FIGURE C1. Spacing Chart—10 pitch, 6 lines per inch.

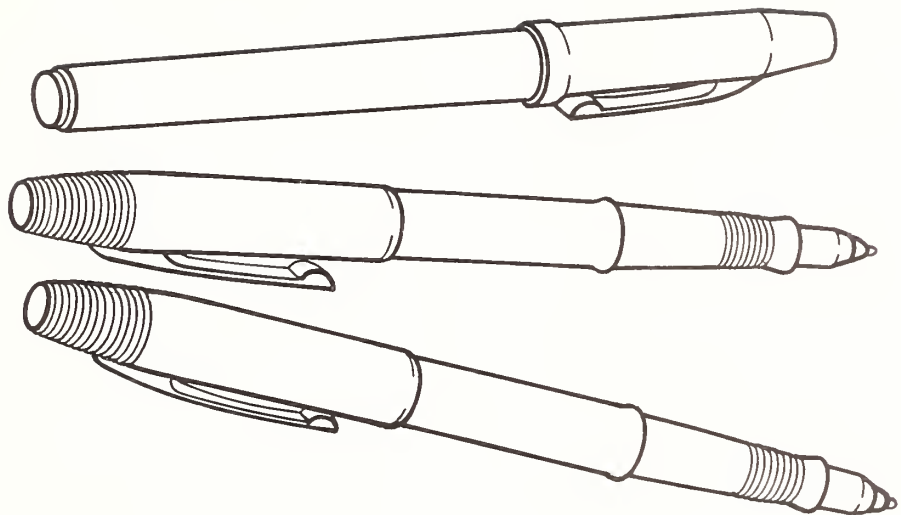

(RED, GREEN, BLUE)

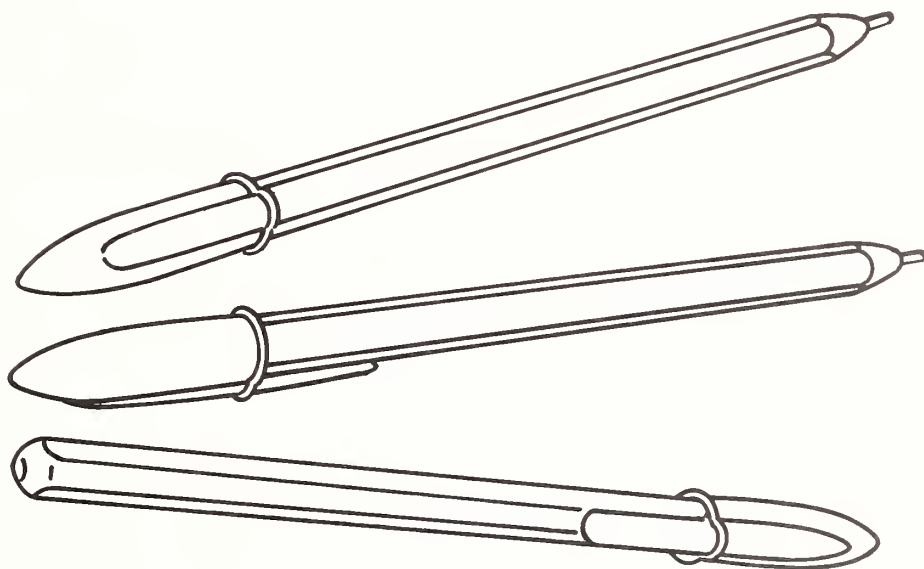

(RED, GREEN, BLUE)

FIGURE C2. *Reflective Ink Pens—Portage.*



FIGURE C3. *Pentel Non-Reflective Ink Pen.*

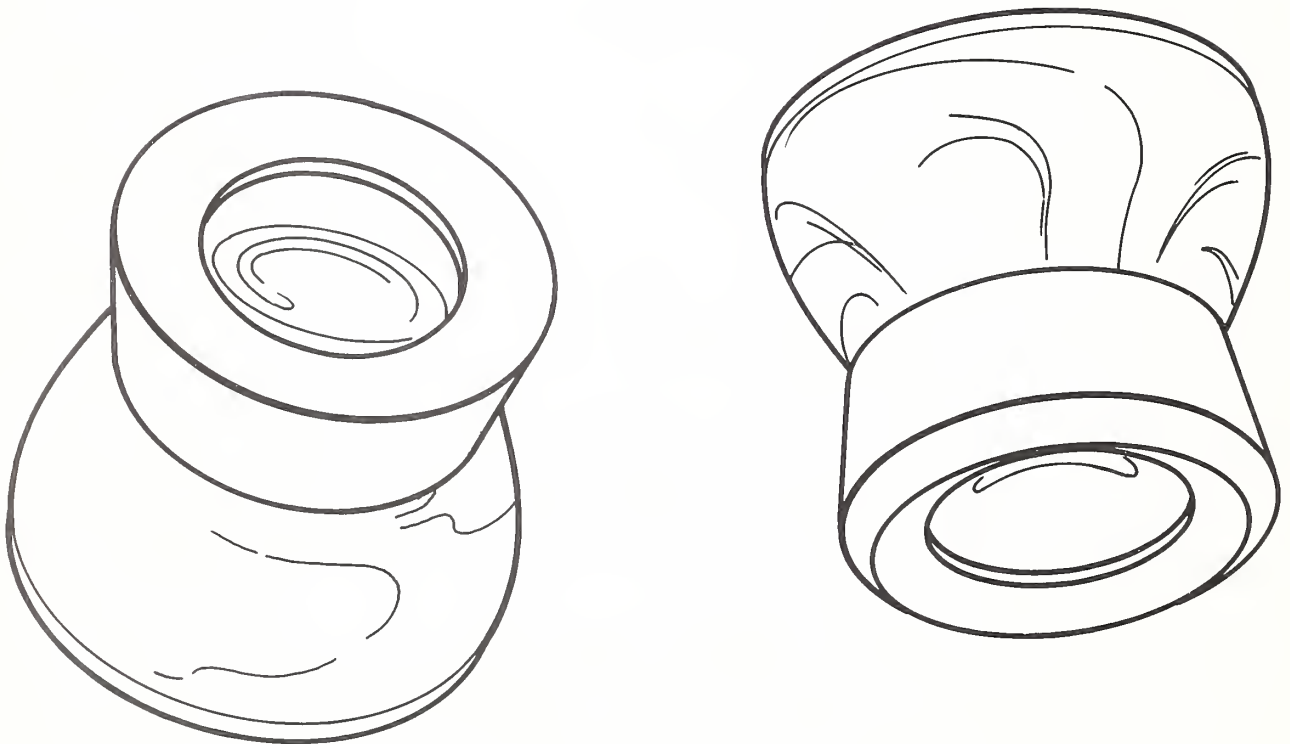

(8X MAGNIFICATION, APPROX.)

FIGURE C4. *8X Magnifiers—Agfa and others.*

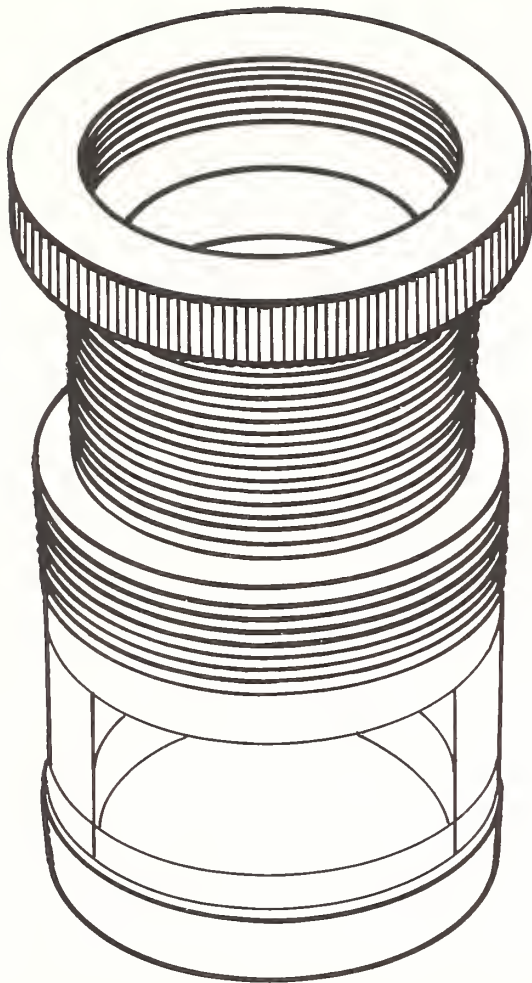

FIGURE C5. *Optical Comparator.*

(RETICLES USED TO SHOW CHARACTER OUTLINES)

0.3" x 0.4" rectangle, 0.025" squares; horizontal scale graduated 0.005".

Nine circles, from 0.1 mm. to 3 mm.

Horizontal scale 20 mm. long, graduated 0.1 mm.

Millimeter radius scale. Quarter circle line each 0.5 mm.

90° Scale, numbered each 10°, lines from center each 5°, lines at periphery each 1°.

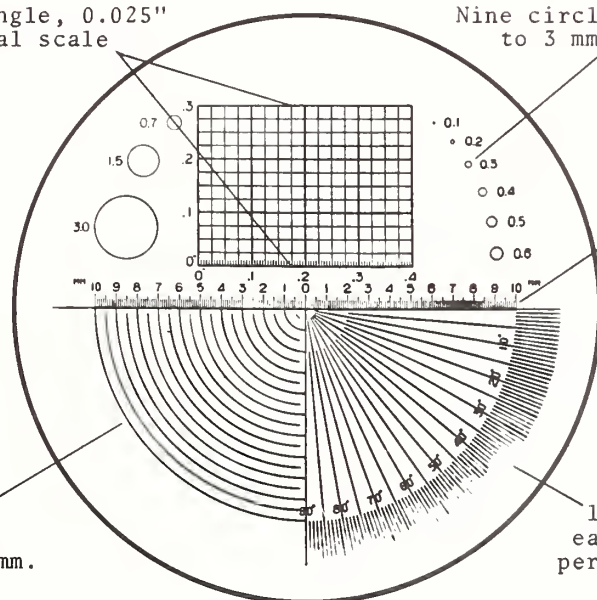

FIGURE C6. *Reticle for Optical Comparator.*

APPENDIX D. READER DEVICE CHARACTERISTICS

Characteristics	Type of Reader (Page, Document, etc.)
ADDRESSOGRAPH 9600 OPTICAL CODE READER	CONTROL DATA CORP. 915 PAGE READER
READS CHARACTERS	YES
READS MARKS	YES
READS BAR CODE	MARK SENSE CIRCLES
READS MICR (Optically)	
SCAN METHOD	
RECOGNITION METHOD	PARALLEL PHOTOCELLS
FONTS READ	CHARACTER ANALYSIS BY PHOTOCELL
CHARACTER SETS	915 VERSION OF USASCSOCR USASI
MAXIMUM READING SPEED (Characters per second)	ALPHANUMERIC PLUS SYMBOLS ALPHANUMERIC UPPER CASE ONLY
MAXIMUM DOCUMENTS (per minute)	370
FEED MECHANISM	APPROX. 180 LINES/MIN.
PAPER TRANSPORT (type)	VACUUM
SORTING MECHANISM	CONVEYER BELT
OUTPUT MEDIA	DUAL OUTPUT STACKER
OPERATING CONTROLS	DATA TO COMPUTER, PUNCHED CARD, PUNCHED PAPER TAPE OR MAGNETIC TAPE
ERROR CORRECTION ROUTINES	ON LINE WITH CDC 3000, 6000 and 8000 SERIES COMPUTERS
MACHINE FLEXIBILITY	CHARACTER DISPLAY, MARKS DOCUMENTS, RESCAN FEATURE, MANUAL CORRECTION
SPECIAL FEATURES	READS SELECTIVE FIELDS UNDER COMPUTER PROGRAM CONTROL (HAND FILLED)
TYPICAL APPLICATIONS	READS MARK SENSE CIRCLES
DOCUMENT SIZE	READS MARK SENSE DOCUMENTS
GUIDE EDGES	UPDATING OF FILES, SUBSCRIPTIONS, ADDRESSES, STATUS CHANGES
MARGINS PER LINE	4 x 2-1/2 to 12 x 14
TOLERANCE BETWEEN CHARACTERS	DEPENDENT ON DOCUMENT ORIENTATION
PAPER WEIGHT (ranges)	1/2"
GRAIN DIRECTION	110
RESPONSE SYSTEM (Visual, Ultraviolet, etc.)	.165"
IMPRINT METHOD	6
	15# to 100#
	PARALLEL TO FEED
	100# TAB CARD STOCK
	IMPRINTER
	TYPEWRITER, PENCIL (MARK SENSE)
	TYPEWRITER, HIGH SPEED PRINTER, PENCIL (MARK SENSE)
	CONTROL DATA CORP. 935 DOCUMENT READER
	YES
	YES
	VERTICAL PHOTOCELLS
	MATRIX MATCHING, CHARACTER ANALYSIS BY PHOTOCELL
	915 VERSION OF USASCSOCR, IBM 1428, 1428E, 407-1, SELF-CHEK 7B & 12F
	ALPHANUMERIC PLUS SYMBOLS
	750-A, 525-C
	150 TO 1500 DEPENDENT ON DOCUMENT SIZE
	VACUUM
	THREE OUTPUT STACKERS
	DATA TO COMPUTER, PUNCHED CARD, PUNCHED PAPER TAPE OR MAGNETIC TAPE
	OFF LINE CDC 1700, ON LINE CDC 1700
	READS SELECTIVE FIELDS
	BATCH LISTER CONTROL MARK SENSE
	TRAVEL TICKETS & TURN AROUND DOCUMENTS
	3 x 2-1/4 to 5-1/2 x 8-1/2
	BOTTOM OF CARD
	1/4"
	80
	.165"
	4 (Size A) 3 (Size C) 20# to 125#
	PARALLEL TO FEED

* The information provided in this appendix was primarily obtained from producers' documents. This appendix is only intended to be informative and instructive in state-of-the-art technologies, and not to be a competitive evaluation of any specific product.

Type of Reader
(Page, Document, etc.)

Characteristics

Characteristics	CUMMINS-CHICAGO ODPS 216	FARRINGTON 2030 PAGE READER	FARRINGTON 3010 DOCUMENT READER
READS CHARACTERS	NO	YES	YES
READS MARKS	YES	NO	YES
READS BAR CODE			
READS MICR (Optically)			
SCAN METHOD	PHOTOCELL	SCANNING DISK, MECHANICAL DISK	SCANNING DISC
RECOGNITION METHOD		STROKE ANALYSIS	
FONTS READ	A.M. FIVE LEVEL BINARY CODE, BINARY ONE CODE & PERFORATED CODES	USASCOCR, SELFCHCK 12F, 12L	USASCOCR, SELFCHCK 12F & 12L & 7B, IBM 1428
CHARACTER SETS	BAR & SPECIAL CODE	ALPHANUMERIC PLUS SYMBOLS	ALPHANUMERIC PLUS SYMBOLS
MAXIMUM READING SPEED (Characters per second)	400	330	330
MAXIMUM DOCUMENTS (per minute)	150-400 LINES/MIN.	440	440
FEED MECHANISM	VACUUM	FRICITION	FRICITION
PAPER TRANSPORT (type)	DRIVE ROLLERS	DRIVE BELT	DRIVE BELT
SORTING MECHANISM	DUAL OUTPUT STACKERS	THREE OUTPUT STACKERS	THREE OUTPUT STACKERS
OUTPUT MEDIA	PUNCHED PAPER TAPE	DATA TO COMPUTER, PUNCHED CARDS, PUNCHED PAPER TAPE, MAGNETIC TAPE	MAGNETIC TAPE
OPERATING CONTROLS	MAGNETIC TAPE	TAPE, MAGNETIC TAPE	ON OR OFF LINE
ERROR CORRECTION ROUTINES	OFF LINE	OFF LINE	ON OR OFF LINE
MACHINE FLEXIBILITY	RESCAN FEATURE, CHARACTER DISPLAY, MARKS DOCUMENT, KEYBOARD INSERTION	RESCAN FEATURE, CHARACTER DISPLAY, MARKS DOCUMENT, KEYBOARD INSERTION	FORMAT CONTROL BY PLUGBOARD, READS SELECTIVE FIELDS
SPECIAL FEATURES	READS SELECTIVE FIELDS	FORMAT CONTROL BY PLUGBOARD, READS SELECTIVE FIELDS	BATCH HEADER, MARK SENSE HEAD & LIST PRINTER OPTIONAL
TYPICAL APPLICATIONS	TURN AROUND DOCUMENTS, INVOICES, PAYMENT COUPONS, BANKING	UNDERSCORE FEATURE PERMITS ENCODING OF UPPER & LOWER CASE CHARACTER IN OUTPUT RECORD	TURN AROUND DOCUMENTS, BILLING, SALES RECEIPTS, INVENTORY
DOCUMENT SIZE	4-1/4 x 2-1/4 to 8-3/4 x 4	4-1/2 x 5-5/8 to 8-1/2 x 13-1/2	2 x 2-1/4 to 6 x 8-1/2
GUIDE EDGES		LEFT & RIGHT EDGE	BOTTOM EDGE
MARGINS	3/4" FROM TOP, 1/2" FROM RIGHT AND LEFT EDGE, 1" FROM BOTTOM	3/4" FROM TOP, 1/2" FROM RIGHT AND LEFT EDGE, 1" FROM BOTTOM	FARRINGTON
MAXIMUM CHARACTERS PER LINE	82	75	64
TOLERANCE BETWEEN CHARACTERS	.015"	.015"	.015"
MAXIMUM LINES (inch)	6	6	6
PAPER WEIGHT (ranges)	24# to 100#	20# to 28#	24# to 125#
GRAIN DIRECTION			PARALLEL TO FEED
RESPONSE SYSTEM (Visual, Ultraviolet, etc.)	HIGH SPEED PRINTER, IMPRINTER OR CUMMINS PERFORATORS	TYPEWRITER	HIGH SPEED PRINTER, PENCIL (MARK READ)
IMPRINT METHOD			

Characteristics	Type of Reader (Page, Document, etc.)		
	FARRINGTON 3020/3022 CARD READER PUNCH	FARRINGTON 3030 PAGE READER	FARRINGTON 3040 TAPE READER
READS CHARACTERS	YES	YES	YES
READS MARKS	MARK GUIDE CIRCLES	MARK GUIDE CIRCLES	NO
READS BAR CODE			
READS MICR (Optically)			
SCAN METHOD	SCANNING DISC, MECHANICAL DISC	SCANNING DISC, MECHANICAL DISC	FLYING SPOT
RECOGNITION METHOD	STROKE ANALYSIS	STROKE ANALYSIS	STROKE ANALYSIS
FONTS READ	USASCOCR, SELFCHEK 12F, 12L & 7B, IBM 1428 & 1428E	USASCOCR, SELFCHEK 12F & 12L	USASCOCR, SELFCHEK 12F, 12L IBM 1428 & NCR NOF
CHARACTER SETS	ALPHANUMERIC, NUMERIC PLUS E&P	ALPHANUMERIC PLUS SYMBOLS	NUMERIC PLUS ALPHA CONTROL SYMBOLS
MAXIMUM READING SPEED (Characters per second)	600	400	400 LINES/MIN.
MAXIMUM DOCUMENTS (per minute)	550	150-400 LINES/MIN.	JOURNAL REELS DRIVE ROLLERS
FEED MECHANISM	FRICTION	VACUUM	DATA TO COMPUTER MAGNETIC TAPE
PAPER TRANSPORT (type)	DRIVE BELT	DRIVE ROLLERS	ON OR OFF LINE
SORTING MECHANISM	DUAL OUTPUT STACKERS	DUAL OUTPUT STACKERS	RESCAN FEATURE, CHARACTER DISPLAY, MARKS TAPES, KEYBOARD INSERTION
OUTPUT MEDIA	PUNCHED CARDS	COMPUTER, PUNCHED CARDS, PUNCHED PAPER TAPES, MAGNETIC TAPE	FORMAT CONTROL BY PLUGBOARD OR EXTERNAL COMPUTER PROGRAM
OPERATING CONTROLS	OFF LINE	ON LINE WITH DMI620 COMPUTER	JOURNAL TAPE LABEL ENTRY, MAGNETIC TAPE LABEL ENTRY
ERROR CORRECTION ROUTINES	DATA FIELD CHECK DIGIT: AUTOMATIC INSERTION OF CHARACTER: PUNCH CHECK	RESCAN FEATURE, CHARACTER DISPLAY, MARKS DOCUMENTS, KEYBOARD INSERTION	REGISTER SALES & INVENTORY
MACHINE FLEXIBILITY	FORMAT CONTROL BY PLUGBOARD, LIMITED SELECTIVITY	READS SELECTIVE FIELDS, FORMATTING & EDITING FACILITIES PROVIDED	STANDARD JOURNAL TAPES 1.31 to 3-1/4
SPECIAL FEATURES	BATCH HEADER, SERIAL & SEQUENTIAL NUMBERING, READS REVERSE IMAGES	READS MARK SENSE, ACCUMULATES TOTALS, FORMATTING & EDITING	COMPUTER PROGRAM
TYPICAL APPLICATIONS	CREDIT CHARGING, PETROLEUM, RETAIL, HOSPITALS	UPDATING OF FILES, SUBSCRIPTIONS, ADDRESSES, STATUS CHANGES	JOURNAL TAPE LABEL ENTRY, MAGNETIC TAPE LABEL ENTRY
DOCUMENT SIZE	STANDARD 51 OR 80 COLUMN TAB CARD	4-1/2 x 5-5/8 to 8-1/2 x 13-1/2	REGISTER SALES & INVENTORY
GUIDE EDGES MARGINS	BOTTOM OF CARD .050" FROM TOP AND BOTTOM, .250" FROM RIGHT AND LEFT EDGE	LEFT AND RIGHT EDGE 3/4" FROM TOP, 1/2" FROM RIGHT AND LEFT EDGE, 1" FROM BOTTOM	STANDARD JOURNAL TAPES 1.31 to 3-1/4
MAXIMUM CHARACTERS PER LINE	65	75	32
TOLERANCE BETWEEN CHARACTERS	.015"	.015"	6
MAXIMUM LINES (inch)	6	20# to 28#	STANDARD JOURNAL TAPES
PAPER WEIGHT (ranges)	100# TAB CARD STOCK		
GRAIN DIRECTION			
RESPONSE SYSTEM (Visual, Ultraviolet, etc.)	IMPRINTER, TYPEWRITER, HIGH SPEED PRINTER PENCIL (MARK READ)	TYPEWRITER	CASH REGISTER, ADDING MACHINE, ETC.
IMPRINT METHOD			

Characteristics	Type of Reader (Page, Document, etc.)	
	IBM 1282 CARD READER PUNCH	IBM 1285 JOURNAL TAPE READER
READS CHARACTERS	YES	IBM 1287 DOCUMENT READER
READS MARKS	YES	YES
READS BAR CODE		YES
READS MICR (Optically)		
SCAN METHOD	MECHANICAL DISC	FLYING SPOT
RECOGNITION METHOD	STROKE ANALYSIS	CURVE TRACING & STROKE ANALYSIS
FONTS READ	IBM 1428 & 1428E, SELFCHCK 7B	IBM 1428, 1428E; SELF CHECK 7B, 12L, 12F; USASI; HANDPRINTED 3/16" GOTHIC
CHARACTER SETS	NUMERIC	ALPHANUMERIC
MAXIMUM READING SPEED (Characters per second)	267	2000
MAXIMUM DOCUMENTS (per minute)	200	3200 LINES PER MIN.
FEED MECHANISM	FRICITION	VACUUM
PAPER TRANSPORT (type)	CLUTCH	BELT
SORTING MECHANISM	SINGLE STACKER	THREE STACKERS
OUTPUT MEDIA	PUNCHED CARDS	COMPUTER
OPERATING CONTROLS	OFF LINE	ON LINE WITH IBM 360 SERIES
ERROR CORRECTION	RESCANS; SELF CHECK DIGITS & AUTOMATIC INSERTION OF CORRECT CHARACTER	RESCANS, MARKS DOCUMENTS, CHARACTER DISPLAY & KEYBOARD ENTRY
ROUTINES	READS SELECTIVE FIELDS	FORMAT CONTROL BY COMPUTER, LIMITED FIELD SELECTIVITY
MACHINE FLEXIBILITY	READS MARK SENSE DOCUMENTS AND REVERSE IMAGES	READS MARK SENSE DOCUMENTS AND HAND PRINTED DIGITS 0-9 & 5 ALPHA SYMBOLS, SERIAL NUMBERING
SPECIAL FEATURES		SALES RECEIPTS, TURN AROUND DOCUMENTS, INVENTORY, BILLING
TYPICAL APPLICATIONS	CREDIT CHARGING, PETROLEUM, RETAIL, HOSPITALS	REGISTER SALES & INVENTORY
DOCUMENT SIZE	STANDARD 51 OR 80 COLUMN TAB CARD	STANDARD JOURNAL TAPES 1.31 TO 3-1/4
GUIDE EDGES	LEFT AND RIGHT EDGE	RIGHT EDGE
MARGINS	DEPENDS ON FONT, DOCUMENT SIZE, AND FORMAT ORIENTATION	.100" FROM RIGHT EDGE .110" FROM LEFT EDGE
MAXIMUM CHARACTERS PER LINE	32	32
TOLERANCE BETWEEN CHARACTERS	1428 - .010", 1428E & 7B - .105"	.014"
MAXIMUM LINES (inch)	6	6
PAPER WEIGHT (ranges)	100# TAB CARD STOCK	15# TO 20#, CAL. .0025"-0.045"
GRAIN DIRECTION	PARALLEL TO FEED	
RESPONSE SYSTEM (Visual, Ultraviolet, etc.)	IMPRINTER, TYPEWRITER, PENCIL (MARK READ)	IMPRINTER, HIGH SPEED PRINTER, TYPEWRITER, HANDPRINTING, CASH REGISTER
IMPRINT METHOD	CASH REGISTER, ADDING MACHINE, ETC.	

Type of Reader
(Page, Document, etc.)

Characteristics	IBM 1288 PAGE READER	IBM 1418 DOCUMENT READER	IBM 1428 DOCUMENT READER
READS CHARACTERS	YES	YES	YES
READS MARKS	YES	YES	YES
READS BAR CODE			
READS MICR (Optically)			
SCAN METHOD	FLYING SPOT	MECHANICAL DISC	SCANNING DISC, MECHANICAL DISC
RECOGNITION METHOD	CURVE TRACING & STROKE ANALYSIS	MATRIX MATCHING	MATRIX MATCHING
FONTS READ	USASI—A, HANDPRINTED, 3/16" GOTHIC, USASCSOCR HANDPRINTING	IBM 407-1; IBM 407E-1	IBM 1428
CHARACTER SETS	ALPHANUMERIC	NUMERIC	ALPHANUMERIC (PLUS SYMBOLS)
MAXIMUM READING SPEED (Characters per second)	1000 (MACH.) 300 (HAND)	500	500
MAXIMUM DOCUMENTS (per minute)	DEPENDENT ON FONT STYLE READ AND OTHER FACTORS	420	400
FEED MECHANISM	BELT	FRICITION	FRICITION
PAPER TRANSPORT (type)	DUAL STACKERS	VACUUM DRUM - BELT	VACUUM DRUM - BELT
SORTING MECHANISM	COMPUTER	MULTI STACKER	MULTI-STACKER
OUTPUT MEDIA	ON LINE WITH IBM 360 SERIES	COMPUTER	DATA TO COMPUTER
OPERATING CONTROLS		ON LINE WITH IBM 1400 AND 360 SERIES	ON LINE TO IBM 1400 SERIES & 360 SERIES COMPUTERS
ERROR CORRECTION ROUTINES	RESCANS, CHARACTER DISPLAY	RESCANS, CHARACTER DISPLAY, KEYBOARD ENTRY	RESCANS
MACHINE FLEXIBILITY	FORMAT CONTROL BY COMPUTER, READS SELECTIVE FIELDS	FORMAT CONTROL BY COMPUTER, READS SELECTIVE FIELDS	READS SELECTIVE FIELDS
SPECIAL FEATURES	READS MARK SENSE DOCS & HAND PRINTED DIGITS 0-9 + C, Z, T, S, X, SERIAL NUMBERING OF PAGES.	READS MARK SENSE DOCUMENTS AND REVERSE IMAGES	READS MARK SENSE DOCUMENTS AND REVERSE IMAGES
TYPICAL APPLICATIONS	SALE & INVENTORY REPORTING UPDATING FILES	TURN AROUND DOCUMENTS, BILLING, INVENTORY	UPDATING FILES, SUBSCRIPTIONS, ADDRESSES
DOCUMENT SIZE	3 x 6.5 TO 9 x 14	BOTTOM EDGE	3-1/2 x 2-1/4 to 8-3/4 x 4-1/4
GUIDE EDGES	TOP OR LEFT EDGE, DEPENDENT ON ORIENTATION		BOTTOM EDGE
MARGINS	1" FROM TOP UNFORMATED MODE IS 1/2" FROM, ALL OTHER EDGES, FORMATED MODE IS 1/8"	BOTTOM EDGE .188" FROM TOP & BOTTOM, .275" FROM LEFT	.188" FROM TOP & BOTTOM, .275" FROM LEFT
MAXIMUM CHARACTERS PER LINE	81—FORMATED, 80 UNFORMATED	80	80
TOLERANCE BETWEEN CHARACTERS	.014"	.010"	.010"
MAXIMUM LINES (inch)	6	10	10
PAPER WEIGHT (ranges)	16# TO 100#	MODELS 1 & 2 - 20# TO 100#, MODEL #3 - 20# to 125#	MODELS 1 & 2 20# to 100#, Model 3 20# to 125#
GRAIN DIRECTION			
RESPONSE SYSTEM (Visual, Ultraviolet, etc.)			
IMPRINT METHOD	TYPEWRITER, HIGH SPEED PRINTER, HANDPRINTING	HIGH SPEED PRINTER, PENCIL (MARK READ)	HIGH SPEED PRINTER, TYPEWRITER PENCIL (MARK READ)

Characteristics	Type of Reader (Page, Document, etc.)	
	OPSCAN 100 & 70 PAGE READER	OPSCAN 288 DOCUMENT READER PHILCO 6000 PAGE READER
READS CHARACTERS	NO	YES
READS MARKS	YES	YES
READS BAR CODE		
READS MICR (Optically)		
SCAN METHOD	PHOTOCELL	FLYING SPOT
RECOGNITION METHOD	MARK READING ONLY	MULTIFONT
CHARACTER SETS		ALPHANUMERIC PLUS SYMBOLS
MAXIMUM READING SPEED (Characters per second)		800
MAXIMUM DOCUMENTS (per minute)		
FEED MECHANISM		
PAPER TRANSPORT (type)		
SORTING MECHANISM		
OUTPUT MEDIA	PUNCHED CARDS OR TAPE, MAGNETIC TAPE	MAGNETIC TAPE, PUNCHED CARDS OR PAPER TAPE, OR DATA TO COMPUTER
OPERATING CONTROLS	OFF LINE	OFF LINE
ERROR CORRECTION ROUTINES		ERROR CHARACTER SUBSTITUTED FOR UNREADABLE CHARACTERS
MACHINE FLEXIBILITY	READS SELECTIVE FIELD	SELECTIVE FIELDS; EXTENSIVE FORMATING AND EDITING FEATURES
SPECIAL FEATURES		MARK READING, HEADER DOCUMENTS CAN BE USED FOR FORMAT SPECIFICATIONS TO PROGRAM
TYPICAL APPLICATIONS	SCHOOL GRADING, INVENTORY, SALES & STATUS REPORTING	UPDATING FILES, INVOICING, SHIPPING
DOCUMENT SIZE	8-1/2 x 11	OPTIONAL SIZE RANGE AVAILABLE (DEPEND ON MODEL)
GUIDE EDGES		
MARGINS		
MAXIMUM CHARACTERS PER LINE	2840 RESPONSE POSITIONS AVAILABLE	75
TOLERANCE BETWEEN CHARACTERS		
MAXIMUM LINES (inch)		
PAPER WEIGHT (ranges)		
GRAIN DIRECTION		
RESPONSE SYSTEM (Visual, Ultraviolet, etc.)	3 (MACH.) - 2 (HAND) 20# TO 125#	20# to 125#
IMPRINT METHOD	PENCIL (MARK READ ONLY), HIGH SPEED PRINTER	TYPEWRITER, PENCIL (MARK READ)

Characteristics	Type of Reader (Page, Document, etc.)	
	RCA VIDEOSCAN DOCUMENT READER	REI ELECTRONIC RETINA DOCUMENT READER
READS CHARACTERS	YES	YES
READS MARKS	YES	YES
READS BAR CODE		
READS MICR (Optically)		
SCAN METHOD	VIDICON RECOGNITION	PARALLEL PHOTOCELLS, PHOTOCELL RETINA MATRIX MATCHING
RECOGNITION METHOD	STROKE ANALYSIS	MULTIFONT, HANDPRINTING
FONT READ	RCA N-2	ALPHANUMERIC PLUS SYMBOLS
CHARACTER SETS	NUMERIC PLUS SYMBOLS	ALPHANUMERIC PLUS SYMBOLS
MAXIMUM READING SPEED	1500	2400
(Characters per second)		
MAXIMUM DOCUMENTS	1800	24
(per minute)		
FEED MECHANISM	VACUUM	VACUUM
PAPER TRANSPORT (type)	BELT - DRUM	DRUM
SORTING MECHANISM	DUAL STACKERS	MULTI-STACKERS
OUTPUT MEDIA	DATA TO COMPUTER	PRINTER, PUNCHED CARDS OR TAPE, MAGNETIC TAPE
OPERATING CONTROLS	ON LINE WITH RCA SPECTRA 70	OFF LINE
ERROR CORRECTION	ERROR CHARACTER SUBSTITUTED	VARIABLES BY PROGRAM, RESCANS-SORTS OUT ERRORS
ROUTINES	-FOR UNREADABLE CHARACTER	RESCANS-SORTS OUT ERRORS
MACHINE FLEXIBILITY	LIMITED FIELD SELECTIVITY BY EXTERNAL COMPUTER	FORMATTING AND EDITING BY COMPUTER, READS INTERMIXED FONTS & SELECTIVE FIELDS
SPECIAL FEATURES	READS MARK SENSE & PUNCHED HOLES	MARK READING AND BAR CODES, ACCUMULATES TOTALS
TYPICAL APPLICATIONS	TURN AROUND DOCUMENTS, BILLING, INVENTORY	UPDATING FILES, SUBSCRIPTIONS, STATUS CHANGES, AIRLINE
DOCUMENT SIZE	2 1/4 x 4 TO 2 1/4 x 8 1/2	3 1/4 x 3 1/4 TO 14 x 14
GUIDE EDGES		RIGHT EDGE
MARGINS		.250" FROM TOP, BOTTOM & LEFT EDGE, .500" FROM RIGHT EDGE
MAXIMUM CHARACTERS PER LINE	80	150
TOLERANCE BETWEEN CHARACTERS		CHARACTERS MUST NOT OVERLAP
PAPER WEIGHT (rangs)	6	8
GRAIN DIRECTION	12# to 125#	16# to 32#
RESPONSE SYSTEM (Visual, Ultraviolet, etc.)		
IMPRINT METHOD	HIGH SPEED PRINTER, PENCIL (MARK READ)	IMPRINTER, TYPEWRITER, HIGH SPEED PRINTER, HANDPRINTING PENCIL (MARK READ)

Characteristics

Type of Reader
(Page, Document, etc.)

REMINGTON-RAND CARD READER SCAN DATA SERIES 300 PAGE READER

READS CHARACTERS	NO	DATA TO TAPE IN GENERAL PURPOSE COMPUTER
READS MARKS	YES	ON LINE TO SMALL GENERAL PURPOSE COMPUTER
READS BAR CODE	NO	
READS MICR (Optically)		
SCAN METHOD	PHOTOCELL	
RECOGNITION METHOD	MARK READING ONLY	
FONTS READ	FLYING SPOT	
CHARACTER SETS	MULTIFONT HANDPRINTING	
MAXIMUM READING SPEED	ALPHANUMERIC PLUS SYMBOLS	
(Characters per second)		
MAXIMUM DOCUMENTS (per minute)		
FEED MECHANISM		
PAPER TRANSPORT (type)		
SORTING MECHANISM		
OUTPUT MEDIA		
OPERATING CONTROLS		
ERROR CORRECTION ROUTINES		
MACHINE FLEXIBILITY		
SPECIAL FEATURES		
TYPICAL APPLICATIONS		
DOCUMENT SIZE	STANDARD 80 COLUMN TAB CARD	6½ x 8 TO 11 x 14
GUIDE EDGES MARGINS		
MAXIMUM CHARACTERS PER LINE	40	96
TOLERANCE BETWEEN CHARACTERS		
MAXIMUM LINES (inch)		
PAPER WEIGHT (ranges)	100# TAB CARD STOCK	15# TO 32#
GRAIN DIRECTION		
RESPONSE SYSTEM (Visual, Ultraviolet, etc.)		
IMPRINT METHOD	PENCIL (MARK READ)	TYPEWRITER, HIGH SPEED PRINTER, HANDPRINTING



NBS TECHNICAL PUBLICATIONS

PERIODICALS

JOURNAL OF RESEARCH reports National Bureau of Standards research and development in physics, mathematics, and chemistry. It is published in two sections, available separately:

• Physics and Chemistry (Section A)

Papers of interest primarily to scientists working in these fields. This section covers a broad range of physical and chemical research, with major emphasis on standards of physical measurement, fundamental constants, and properties of matter. Issued six times a year. Annual subscription: Domestic, \$17.00; Foreign, \$21.25.

• Mathematical Sciences (Section B)

Studies and compilations designed mainly for the mathematician and theoretical physicist. Topics in mathematical statistics, theory of experiment design, numerical analysis, theoretical physics and chemistry, logical design and programming of computers and computer systems. Short numerical tables. Issued quarterly. Annual subscription: Domestic, \$9.00; Foreign, \$11.25.

DIMENSIONS/NBS (formerly *Technical News Bulletin*)—This monthly magazine is published to inform scientists, engineers, businessmen, industry, teachers, students, and consumers of the latest advances in science and technology, with primary emphasis on the work at NBS. The magazine highlights and reviews such issues as energy research, fire protection, building technology, metric conversion, pollution abatement, health and safety, and consumer product performance. In addition, it reports the results of Bureau programs in measurement standards and techniques, properties of matter and materials, engineering standards and services, instrumentation, and automatic data processing.

Annual subscription: Domestic, \$9.45; Foreign, \$11.85.

NONPERIODICALS

Monographs—Major contributions to the technical literature on various subjects related to the Bureau's scientific and technical activities.

Handbooks—Recommended codes of engineering and industrial practice (including safety codes) developed in cooperation with interested industries, professional organizations, and regulatory bodies.

Special Publications—Include proceedings of conferences sponsored by NBS, NBS annual reports, and other special publications appropriate to this grouping such as wall charts, pocket cards, and bibliographies.

Applied Mathematics Series—Mathematical tables, manuals, and studies of special interest to physicists, engineers, chemists, biologists, mathematicians, computer programmers, and others engaged in scientific and technical work.

National Standard Reference Data Series—Provides quantitative data on the physical and chemical properties of materials, compiled from the world's literature and critically evaluated. Developed under a world-wide

BIBLIOGRAPHIC SUBSCRIPTION SERVICES

The following current-awareness and literature-survey bibliographies are issued periodically by the Bureau:

Cryogenic Data Center Current Awareness Service

A literature survey issued biweekly. Annual subscription: Domestic, \$20.00; foreign, \$25.00.

Liquefied Natural Gas. A literature survey issued quarterly. Annual subscription: \$20.00.

Superconducting Devices and Materials. A literature

program coordinated by NBS. Program under authority of National Standard Data Act (Public Law 90-396).

NOTE: At present the principal publication outlet for these data is the *Journal of Physical and Chemical Reference Data* (JPCRD) published quarterly for NBS by the American Chemical Society (ACS) and the American Institute of Physics (AIP). Subscriptions, reprints, and supplements available from ACS, 1155 Sixteenth St. N. W., Wash. D. C. 20056.

Building Science Series—Disseminates technical information developed at the Bureau on building materials, components, systems, and whole structures. The series presents research results, test methods, and performance criteria related to the structural and environmental functions and the durability and safety characteristics of building elements and systems.

Technical Notes—Studies or reports which are complete in themselves but restrictive in their treatment of a subject. Analogous to monographs but not so comprehensive in scope or definitive in treatment of the subject area. Often serve as a vehicle for final reports of work performed at NBS under the sponsorship of other government agencies.

Voluntary Product Standards—Developed under procedures published by the Department of Commerce in Part 10, Title 15, of the Code of Federal Regulations. The purpose of the standards is to establish nationally recognized requirements for products, and to provide all concerned interests with a basis for common understanding of the characteristics of the products. NBS administers this program as a supplement to the activities of the private sector standardizing organizations.

Federal Information Processing Standards Publications (FIPS PUBS)—Publications in this series collectively constitute the Federal Information Processing Standards Register. Register serves as the official source of information in the Federal Government regarding standards issued by NBS pursuant to the Federal Property and Administrative Services Act of 1949 as amended, Public Law 89-306 (79 Stat. 1127), and as implemented by Executive Order 11717 (38 FR 12315, dated May 11, 1973) and Part 6 of Title 15 CFR (Code of Federal Regulations).

Consumer Information Series—Practical information, based on NBS research and experience, covering areas of interest to the consumer. Easily understandable language and illustrations provide useful background knowledge for shopping in today's technological marketplace.

NBS Interagency Reports (NBSIR)—A special series of interim or final reports on work performed by NBS for outside sponsors (both government and non-government). In general, initial distribution is handled by the sponsor; public distribution is by the National Technical Information Service (Springfield, Va. 22161) in paper copy or microfiche form.

Order NBS publications (except NBSIR's and Bibliographic Subscription Services) from: Superintendent of Documents, Government Printing Office, Washington, D.C. 20402.

survey issued quarterly. Annual subscription: \$20.00. Send subscription orders and remittances for the preceding bibliographic services to National Bureau of Standards, Cryogenic Data Center (275.02) Boulder, Colorado 80302.

Electromagnetic Metrology Current Awareness Service Issued monthly. Annual subscription: \$24.00. Send subscription order and remittance to Electromagnetics Division, National Bureau of Standards, Boulder, Colo. 80302.

U.S. DEPARTMENT OF COMMERCE
National Bureau of Standards
Washington, D.C. 20234

OFFICIAL BUSINESS

Penalty for Private Use, \$300

POSTAGE AND FEES PAID
U.S. DEPARTMENT OF COMMERCE
COM-215



SPECIAL FOURTH-CLASS RATE
BOOK



75 YEARS
NBS
1901-1976