



THE MICROSCOPE :  
ITS  
HISTORY, CONSTRUCTION, AND APPLICATION,  
BEING  
A FAMILIAR INTRODUCTION TO THE USE OF THE INSTRUMENT  
AND THE STUDY OF MICROSCOPICAL SCIENCE.

BY JABEZ HOGG,  
MEMBER OF THE ROYAL COLLEGE OF SURGEONS OF ENGLAND, ETC.  
Illustrated with upwards of Five Hundred Engravings.



*FOURTH EDITION.*

LONDON :  
ROUTLEDGE, WARNES, AND ROUTLEDGE,  
FARRINGTON STREET.  
NEW YORK : 56, WALKER STREET.  
1859.



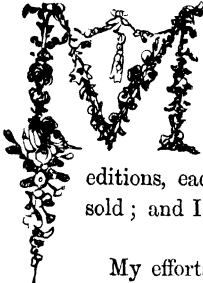

## PREFACE TO THE THIRD AND FOURTH EDITIONS.

 MY endeavour to produce a cheap and popular guide to the use of the Microscope has been rewarded by a success which has far exceeded my expectations. In a short space of time, three editions, each of *five thousand copies*, have been sold ; and I am now called upon for a Fourth.

My efforts on this occasion have been directed to a revision of the whole work ; much new matter, and a large number of additional cuts to illustrate the text, have been added ; and I trust I have succeeded in making the present Edition more free from blemish and more generally useful to the student and the public than those which preceded it. I have at all times freely and fully availed myself of the judicious suggestions and criticisms of kind friends ; and I wish to take this opportunity of acknowledging the obligations I am under to those who have so generously accorded to this small work, whatever its defects, their meed of approbation.

J. H.



## PREFACE TO THE FIRST EDITION.

---



HE Author of this Publication entered upon his task with some hesitation and diffidence; but the reasons which influenced him to undertake it may be briefly told, and they at once explain his motives, and plead his justification, for the work which he now ventures to submit to the indulgent consideration of his readers.

It had been to him for some time a subject of regret, that one of the most useful and fascinating of studies—the study that belongs to the domain of microscopic observation—should be, if not wholly neglected, at best but coldly and indifferently appreciated, by the great mass of the general public; and he formed a strong opinion, that this apathy and inattention were mainly attributable to the want of some concise, yet sufficiently comprehensive, *popular* account of the Microscope, both as regards the management and manipulation of the instrument, and the varied wonders and hidden realms of beauty that are disclosed and developed by its aid. He saw around him, valuable, erudite, and splendid volumes; which, however, being chiefly destined for circulation amongst a special class of readers, were necessarily, from the nature of their contents and the style of their production, published at a price that renders them practically unattainable by the great bulk of the public.

They constitute careful and beautiful contributions to the purposes of science, but they cannot adequately serve to bring the value and charm of microscopic studies home, so to speak, to the firesides of the people. Repeatedly, day after day, new and interesting discoveries, and further amplifications of truth already discerned, have been made, but they have been either scattered in serials, or, more usually, devoted to the pages of class publications; and thus this most important and attractive study has been, in a great measure, the province of the few only, who have derived from it a rich store of enlightenment and gratification: the many not having, however, participated, to any great extent, in the instruction and entertainment which always follow in the train of microscopical studies.<sup>1</sup>

The manifold and various uses and advantages of the Microscope crowd upon us in such profusion, that we can only attempt to enumerate them in the briefest and most rapid manner in these prefatory pages.

It is not many years since this invaluable instrument was regarded in the light of a costly toy; it is now the inseparable companion of the man of science. In the medical world, its utility and necessity are fully appreciated, even by those who formerly were slow to see its benefits; and knowledge which could not be obtained even by the minutest dissection is acquired readily by the aid of the Microscope, which has become equally as essential to the anatomist and pathologist as the scalpel and bedside observation. The smallest portion of a diseased structure, placed under a Microscope, will tell more in one minute to the experienced eye, than could be ascertained by days of examination of the gross mass of disease in the ordinary method; and microscopic agency, in thus assist-

(1) At the time this work was written, scarcely a book of the kind had been published at a price within the reach of the working classes.

ing the medical man, materially contributes to the alleviation of those multiplied "ills which flesh is heir to." So fully impressed were the Council of the Royal College of Surgeons with the importance of the facts brought to light in a short space of time, that, in 1841, they determined to establish a Professorship of Histology, and to form a collection of preparations of the elementary tissues of both animals and vegetables, healthy and morbid, which should illustrate the value of microscopical investigations in physiology and medical science: From that time, histological anatomy deservedly became an important branch of the education of the medical student.

In prosecuting the study of Vegetable Physiology, the Microscope is an indispensable instrument; it empowers the student to trace the earliest forms of vegetable life, and the functions of the different tissues and vessels in plants. Valuable assistance is derived from its agency in the detection of adulterations. In the examination of suspected flour, an article of the greatest importance to all, the Microscope enables us to judge of the size and shape of the starch-grains, their markings, their isolation and agglomeration; and thus to distinguish the starch-grains of one meal from those of another. It detects these and other "invisible ingredients, whether precipitated in atoms or aggregated in crystals, which adulterate our food, our drink, and our medicines. It displays the lurking poison in the minute crystallisations which its solutions precipitate. It tells the murderer that the blood which stains him is that of his brother, and not of the other life which he pretends to have taken; and as a witness against the criminal, it on one occasion appealed to the very sand on which he trod at midnight."

The Zoologist finds in the Microscope a necessary co-operator. To the Geologist it reveals, among a multiplicity

of other facts, "that our large coal-beds are the ruins of a gigantic vegetation; and the vast limestone rocks, which are so abundant on the earth's surface, are the catacombs of myriads of animal tribes, too minute to be perceived by the unaided vision."

By "conducting the eye to the confines of the visible form," the Microscope proves an effective auxiliary in defining the geometric properties of bodies. Its influence as an instrument of research upon the structure of bodies has been compared to that of the galvanic battery, in the hands of Davy, upon Chemistry. It detects the smallest structural difference, heretofore inappreciable, and, as an ally of Chemistry, enables us to discover the very small changes of form and colour effected by test-fluids upon solids; it dissects for us, so to speak, the most multiplex compounds; it opens out to the mind an extended and vast tract, opulent in wonders, rich in beauties, and boundless in extent.

The Microscope not only assists studies, and develops objects of profound interest, but it also opens up innumerable sources of entertainment and amusement, in the ordinary conventional acceptance of these terms;—it discloses to us peculiarities and attractions in abundance;—it impresses us with the wonderful and beautifully-skilful adaptation of all parts of creation, and fills our minds with additional reverence and admiration for the beneficent and Almighty Creator.

The Author begs to conclude these prefatory observations with a few words in explanation of his arrangements, and by way of acknowledgment to those to whom he is indebted. He has sought, in the volume that he now lays before the public, to point out and elucidate, at once in a practical manner and in a popular style, the vast fund of utility and amusement which the Microscope affords, and

has endeavoured to touch upon most of the interesting subjects for microscopic observation as fully as the restrictions of a limited space, and the nature of a succinct summary, would permit. To have dwelt upon each in complete detail would have necessitated volume upon volume,—expensive books must have resulted,—and this would have entirely frustrated the aim which the writer had in view; he has, therefore, contented himself with the humble, but, he trusts, not useless, task of setting up a finger-post, so to say, to direct the inquirer into the wider road. In the section of the work devoted to the minuter portion of creation, he has ventured to dwell somewhat longer here, in the belief that that department is more especially the province of the microscopist. He has arranged his topics under special headings, and in separate chapters, for the sake of perspicuity and precision; and has brought the ever-welcome aid of illustrations to convey his explanatory remarks more vividly to the minds of his readers. He is peculiarly indebted to Professor Quekett, whose valuable lectures, delivered annually in the Royal College of Surgeons, and other multifarious and successful researches, have pre-eminently distinguished him as *the* microscopist of the day. From notes made during the lectures spoken of, and from the many admirable papers which this gentleman has published, much sound information has been gleaned; and the author has to thank him, in the most sincere and cordial manner, for placing at his disposal the mass of contributions with which he has enriched microscopical science. A free use has been made of the researches of scientific investigators generally—Leeuwenhoek, Ehrenberg, Carpenter, Johnston, Ralfs, Busk, Gosse, Hassell, Lobb, and other members of the Microscopical Society of London. His acknowledgments are likewise due to Mr. George Pearson, for the



great care he has bestowed upon the engravings which adorn these pages.

Finally, it is the Author's hope that, by the instrumentality of this volume, he may possibly assist in bringing the Microscope, and its most valuable and delightful studies, before the general public in a more familiar, compendious, and economical form than has hitherto been attempted; and that he may thus, in these days of a diffused taste for reading and the spread of cheap publications, submit some further food for the exercise of the mental and intellectual faculties,—contribute to the additional amusement and instruction of the family circle around the domestic hearth,—and aid the student of nature in investigating the wonderful and exquisite works of the Almighty Hand. If it shall be the good fortune of this work, which is now confided with great diffidence to the consideration of the public, to succeed, in however slight a degree, in furthering this design, the Author will feel sincerely happy, and will be fully repaid for the attention, time, and labour that he has expended in writing, arranging, and compiling it.

6, GOWER STREET, BEDFORD SQUARE,  
*May, 1854.*

# CONTENTS

## PART I.

### HISTORY OF THE INVENTION AND IMPROVEMENTS OF THE MICROSCOPE.

---

#### CHAPTER I.

	PAGE
HISTORY OF THE MICROSCOPE . . . . .	1

#### CHAPTER II.

MECHANICAL AND OPTICAL PRINCIPLES INVOLVED IN THE CONSTRUCTION OF THE MICROSCOPE—LENSES—MODE OF ESTIMATING THEIR POWER, ETC.—ACHROMATIC LENSES—MAGNIFYING POWER—WOLLASTON'S DOUBLET—CODDINGTON'S LENS—ROSS'S SIMPLE AND COMPOUND MICROSCOPES—QUEKETT'S, WARINGTON'S, BAKER'S, AND POWELL'S MICROSCOPES—MICROMETERS, ETC. . . . .	15
--	----

#### CHAPTER III.

PRELIMINARY DIRECTIONS—ILLUMINATION—ACCESSORY APPARATUS—ACHROMATIC ILLUMINATOR—GILLET'S CONDENSER—COLLECTING OBJECTS—MODE OF INJECTING—PREPARING AND MOUNTING OBJECTS—POLARISED LIGHT—CAMERA LUCIDA—BINOCULAR INSTRUMENT—PHOTOGRAPHIC DRAWING, ETC. . . . .	69
---	----

## PART II.

## CHAPTER I.

	PAGE
<b>VEGETABLE STRUCTURE—VITAL AND CHEMICAL CHARACTERISTICS</b>	
—MICROSCOPIC FORMS OF VEGETABLE LIFE—THE VEGETABLE CELL—FUNGI—FUNGOID DISEASES—MOSESSES—ALGÆ	
—CONFERVÆ—DESMIDIACEÆ—STRUCTURE OF PLANTS—ADULTERATION OF ARTICLES USED FOR FOOD—PREPARATION FOR MICROSCOPIC EXAMINATION, ETC. . . . .	174

## CHAPTER II.

## DIVISION OF ANIMAL KINGDOM.

<b>PROTOZOA — HISTORY OF INFUSORIAL ANIMALCULES—RHIZOPODA—MONADS—DIATOMACEÆ—FOSSIL INFUSORIA—ROTIFERA—VORTICELLA—STENTORS—SPONGES—HYDRA—ZOOPHYTES—ETC. . . . .</b>	<b>260</b>
--	------------

## CHAPTER III.

<b>SUB-KINGDOM ANNULOSA — ARTHROPODA — ANNULATA — ANNULOIDA — MOLLUSCA — CONCHIFERA — GASTEROPODA — PTEROPODA — TUNICATA — CEPHALOPODA — CRUSTACEA — ANNELIDA — ARACHNIDA — SUCTORIA, ETC. . . . .</b>	<b>411</b>
--	------------

## CHAPTER IV.

<b>SUB-KINGDOM ARTICULATA—INSECTA . . . . .</b>	<b>469</b>
---	------------

## CHAPTER V.

## VERTEBRATA.—ANIMAL STRUCTURE.

<b>PHYSIOLOGY—HISTOLOGY—CELL THEORY—GROWTH OF TISSUES</b>	
—SPECIAL TISSUES—SKIN, CARTILAGE, TEETH, BONE, ETC. . . . .	523
<b>CORRIGENDA ET ADDENDA . . . . .</b>	<b>601</b>

**THE MICROSCOPE.**



# THE MICROSCOPE.

---

## PART I.

### HISTORY OF THE INVENTION AND IMPROVEMENTS OF THE MICROSCOPE.

---

#### CHAPTER I.

##### HISTORY OF THE MICROSCOPE.

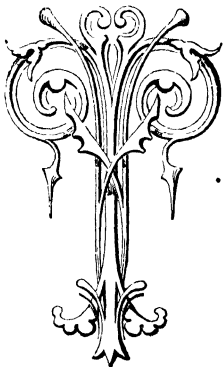

THE instrument known as the Microscope derives its name from two Greek words, *μικρός*, *small*, and *σκοπέω*, *to view*; that is, to see or view such minute objects as without its aid would be invisible.

The honour of the invention is claimed by the Italians and the Dutch; the name of the inventor, however, is lost. Probably the discovery did not at first appear sufficiently important to engage the attention of those men who, by their reputation in science, were able to establish an opinion of its merit, and to hand down the name of its inventor to succeeding ages.

If we consider the microscope as an instrument consisting of one lens only, it is not at all improbable that it was known at a very early period, nay even in a degree to

the Greeks and Romans ; at any rate, it is tolerably certain that spectacles were used as early as the thirteenth century. Now as the glasses of these were made of different convexities, and consequently of different magnifying powers, it is natural to suppose that smaller and more convex lenses were made, and applied to the examination of minute objects. Many among the learned refuse to the ancients a knowledge of magnifying lenses, and *à fortiori* that of refracting telescopes, since, according to them, the Greeks and Romans had only very imperfect notions with respect to the fabrication of glass.

From a passage in Aristophanes it is plain that globules of glass were sold at the shops of the grocers of Athens, in the time of that comic author. He speaks of them as "burning spheres."

Pliny states that the immense theatre (it was capable of containing eighty thousand persons) erected at Rome by Scæurus, son-in-law of Sylla, was three stories in height, and that the second of these stories was entirely inlaid with a mosaic of glass.

Ptolemy, in his "Optics," has inserted a table of the refractions which light experiences under different angles of incidence, in passing from air into glass. The values of these angles, which differ only in a slight degree from those obtained in the present day by means of similar experiments, prove that the glass of the ancients differed very little from that manufactured in our own times.

There is in the French Cabinet of Medals a seal, said to have belonged to Michael Angelo, the fabrication of which, it is believed, ascends to a very remote epoch, and upon which fifteen figures have been engraven in a circular space of fourteen millimètres in diameter. These figures *are not all visible to the naked eye.*

Cicero makes mention of an Iliad of Homer written upon parchment, which was comprised in a nutshell.

Pliny relates that Myrmecides, a Milesian, executed in ivory a square figure which a fly covered with its wings.

Unless it be maintained that the powers of vision of our ancestors surpassed those of the most skilful modern artists, these facts establish that the magnifying property of lenses was known to the Greeks and Romans nearly

two thousand years ago. We may besides advance a step further, and borrow from Seneca a passage whence the same truth will emerge in a manner still more direct and decisive. In the "Natural Questions" we read: "However small and obscure the writing may be, it appears larger and clearer when viewed through a globule of glass filled with water."

Dutens has seen in the Museum of Portici ancient lenses which had a focal length of only nine millimètres. He actually possessed one of these lenses, but of a longer focus, which was extracted from the ruins of Herculaneum.

At the meeting of the British Association, held at Belfast in the year 1852, Sir David Brewster showed a plate of rock-crystal worked into the form of a lens, which was recently found among the ruins of Nineveh. Sir David Brewster, so competent a judge in a question of this kind, maintained that this lens had been destined for optical purposes, and that it never was an article of dress.

It is not difficult to fix the period when the microscope first began to be generally known, and to be used for the purpose of examining minute objects; for though we are ignorant of the name of the first inventor, we are acquainted with the names of those who introduced it to public view. Zacharias Jansens and his son are said to have made microscopes before the year 1590: about that time the ingenious Cornelius Drebell brought one made by them with him to England, and showed it to William Borrell and others. It is possible this instrument of Drebell's was not strictly what is now called a microscope, but was rather a kind of microscopic telescope, something similar in principle to that lately described by M. Aepinus in a letter to the Academy of Sciences at St. Petersburg. It was formed of a copper tube six feet long and one inch in diameter, supported by three brass pillars in the shape of dolphins; these were fixed to a base of ebony, on which the objects to be viewed by the microscope were placed. Fontana, in a work which he published in 1646, says that he had made microscopes in the year 1618: this may be perfectly true, without derogating from the merit of the Jansens; for we have many instances in our own times of more than



one person having made the same invention nearly simultaneously, without any communication from one to the other. In 1685 Stelluti published a description of the parts of a bee, which he had examined with a microscope.

The history of the microscope, like that of nations and arts, has had its brilliant periods, in which it shone with uncommon splendour, and was cultivated with extraordinary ardour; and these have been succeeded by intervals marked with no discovery, and in which the science seemed to fade away, or at least to lie dormant, till some favourable circumstance—the discovery of a new object, or some new improvement in the instruments of observation—awakened the attention of the curious, and reanimated their researches. Thus, soon after the invention of the microscope, the field it presented to observation was cultivated by men of the first rank in science, who enriched almost every branch of natural history by the discoveries they made by means of this instrument.

*The Single, or Simple Microscope.*—We shall first speak of the single microscope, that having been invented and used long before the double or compound microscope. When the lenses of the single microscope are very convex, and consequently the magnifying power great, the field of view is small; and it is so difficult to adjust with accuracy their focal distance, that it requires some practice to render the use of them familiar. It was with an instrument of this kind that Leeuwenhoek and Swammerdam, Lyonet and Ellis, examined the invisible forms of nature, and by their example stimulated others to the same pursuit.

About the year 1665, small glass globules began to be occasionally applied to the single microscope, instead of convex lenses; and by these globules an immense magnifying power was obtained. Their invention has been generally attributed to M. Hartsoeker; though it appears that we are really indebted to the celebrated Dr. Hooke for this discovery, for he described the manner of making them in the preface to his *Micrographia Illustrata*, published in the year 1656.

Mr. Stephen Gray<sup>1</sup> having observed some irregular particles within a glass globule, and finding that they

(1) Philosophical Transactions, 1696.

appeared distinct and prodigiously magnified when held close to his eye, concluded, that if he placed a globule of water in which there were any particles more opaque than the water near his eye, he should see those particles distinctly and highly magnified. The result of this idea far exceeded his expectation. His method was, to take on a pin a small portion of water which he knew contained some minute animalcules; this he laid on the end of a small piece of brass wire, till there was formed somewhat more than a hemisphere of water; on applying it then to the eye, he found the animalcules enormously magnified; for those which were scarcely discernible with his glass globules, with this appeared as large as ordinary-sized peas.

Dr. Hooke thus describes the method of using this water-microscope: "If you are desirous," he says, "of obtaining a microscope with one single refraction, and consequently capable of procuring the greatest clearness and brightness any one kind of microscope is susceptible of, spread a little of the fluid you intend to examine on a glass plate; bring this under one of your globules, then move it gently upwards till the fluid touches the globule, to which it will soon adhere, and that so firmly as to bear being moved a little backwards or forwards. By looking through the globule, you will then have a perfect view of the animalcules in the drop."

The construction of the single microscope is so simple, that it is susceptible of but little improvement, and has therefore undergone few alterations; and these have been chiefly confined to the mode of mounting it, or to additions to its apparatus. The greatest improvement this instrument has received was made by Lieberkuhn,<sup>1</sup> about the year 1740: it consists in placing the small lens in the centre of a highly-polished concave speculum of silver, by which means a strong light is reflected upon the upper surface of an object, which is thus examined with great ease and pleasure. Before this contrivance, it was almost impossible to examine small opaque objects with any degree of exactness; for the dark side of the object being next the eye, and also overshadowed by the proximity of

(1) Dr. Nathaniel Lieberkuhn of Berlin.

the instrument, its appearance was necessarily obscure and indistinct. Lieberkuhn adapted a separate microscope to every object: but all this labour was not bestowed on trifling objects; his were generally the most curious anatomical preparations, twelve of which, with their microscopes, are deposited in the Museum of the Royal College of Surgeons.

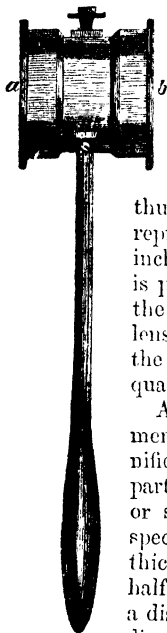

Fig. 1.

Lieberkuhn's instrument, fig. 1, is thus described by Professor Quekett:<sup>1</sup> *a b* represents a piece of brass tube, about an inch long and an inch in diameter, which is provided with a cap at each extremity; the one at *a* carries a small double-convex lens of half an inch in focal length, whilst the one at *b* carries a condensing lens three-quarters of an inch in diameter.

A vertical section of one of these instruments is seen in fig. 2: *a* represents the magnifier, which is lodged in a cavity formed partly by the cap *a*, and by the silver cup or speculum *l*. In front of the lens is the speculum *l*, which is a quarter of an inch thick at its edge, and whose focus is about half an inch; in front of this again there is a disk of metal *c*, three-eighths of an inch in diameter, connected by a wire with the small knob *d*; upon this disk the injected object is fastened, and is covered over with some kind of varnish which has dried of a hemispherical figure.

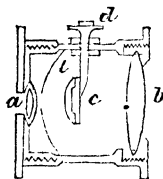

Fig. 2.  
Lieberkuhn's Microscope.

Between this knob and the inside and outside of the tube there are two slips of thin brass, which act as springs to keep the wire and disk steady. When the knob is moved, the injected object is carried to or from the lens, so as to be in its focus, and to be seen distinctly, whilst the condensing lens *b* serves to concentrate the light on the speculum. To the

(1) Practical Treatise on the Microscope, p. 16.

lower part of the tube a handle of ebony, about three inches in length, is attached by a brass ferrule and two screws. The use of this instrument is obvious: it is held in the hand in such a position that the rays of light from a lamp or white cloud may fall on the condenser *b*, by which they are concentrated on the speculum *l*; this, again, further condenses them on the object and the disk *c*, which object, when so illuminated, can readily be adjusted by the little knob *d*, so as to be in the focus of the small magnifier at *a*.

We must not omit in this place some account of Lccuwenhoek's microscopes, which were rendered famous throughout all Europe, on account of the numerous discoveries he had made with them. At his death he bequeathed a part of them to the Royal Society.

The microscopes he used were all single, and fitted up in a convenient and simple manner: each consisted of a very small double-convex lens, let into a socket between two plates riveted together, and pierced with a small hole; the object was placed on a silver point or needle, which, by means of screws adapted for that purpose, might be turned about, raised or depressed at pleasure, and thus be brought nearer to, or be removed farther from the glass, as the eye of the observer, the nature of the object, and the convenient examination of its parts required.

Lccuwenhoek fixed his objects, if they were solid, to these points with glue; if they were fluid, he fitted them on a little plate of talc, or thin-blown glass, which he afterwards glued to the needle in the same manner as his other objects. The glasses were all exceedingly clear, and of different magnifying powers, proportioned to the nature of the object and the parts designed to be examined. He observed, in his letter to the Royal Society, that "from upwards of forty years' experience, he had found the most considerable discoveries were to be made with glasses of moderate magnifying power, which exhibited the object with the most perfect brightness and distinctness." Each instrument was devoted to one or two objects; hence he had always some hundreds by him.

The three first compound microscopes that attract our notice are those of Dr. Hooke, Eustachio Divini, and Philip

Bonnani. Dr. Hooke gives us an account of his in the preface to his *Micrographia*, published in the year 1667 : it was about three inches in diameter, seven inches long, and furnished with four draw-out tubes, by which it might be lengthened as occasion required ; it had three glasses—a small object-glass, a middle glass, and a deep eye-glass. Dr. Hooke used all the glasses when he wanted to take in a considerable part of an object at once, as by the middle glass a number of radiating pencils were conveyed to the eye which would otherwise have been lost ; but when he wanted to examine with accuracy the small parts of any substance, he took out the middle glass, and only made use of the eye and object lenses ; “for,” he writes, “the fewer the refractions are, the clearer and brighter the object appears.”

Dr. Hooke also gave us the first and most simple method of finding how much any compound microscope magnifies an object. He placed an accurate scale, divided into very minute parts of an inch, on the stage of the microscope ; adjusted the microscope till the divisions appeared distinct, and then observed with the other eye how many divisions of a rule similarly divided and laid on the stage were included in one of the magnified divisions ; “for if one division, as seen with one eye through the microscope, extends to thirty divisions on the rule, which is seen by the naked eye, it is evident that the diameter of the object is increased or magnified thirty times.”

An account of Eustachio Divini's microscope was read at the Royal Society in 1668. It consisted of an object-lens, a middle glass, and two eye-glasses, which were plano-convex lenses, and were placed so that they touched each other in the centre of their convex surfaces. The tube in which the glasses were enclosed was as large as a man's leg, and the eye-glasses as broad as the palm of the hand. It had four several lengths : when shut up was 16 inches long, and magnified the diameter of an object 41 times, at the second length 90, at the third length 111, and at the fourth length 143 times. It does not appear that Divini varied the object-glasses.

Philip Bonnani published an account of his two microscopes in 1698. Both were compound. The first was

similar to that which Mr. Martin published as new, in his *Micrographia Nova*, in 1712. His second was like the former, composed of three glasses, one for the eye, a middle glass, and an object lens; they were mounted in a cylindrical tube, which was placed in a horizontal position; behind the stage was a small tube with a convex lens at each end; beyond this was a lamp; the whole capable of various adjustments, and regulated by a pinion and rack. The small tube was used to condense the light on to the object.

A short time before this, Sir Isaac Newton having discovered his celebrated theory of light and colours, was led to improve the telescope, and apply his principles most successfully to the construction of a compound reflecting microscope. On the 6th of February, 1672, he communicated to the Royal Society his "design of a microscope by reflection." It consisted of a concave spherical speculum of metal, and an eye-glass which magnified the reflected image of any object placed between them in the conjugate focus of the speculum. He also pointed out the proper mode of illuminating objects by artificial light, as he describes it, "of any convenient colour not too much compounded," *mono-chromatic*. We find other two plans of this kind; the first that of Dr. Robert Barker, and the second that of Dr. Smith. In the latter there were two reflecting mirrors, one concave, and the other convex: the image was viewed by a lens. This microscope, though far from being executed in the best manner, performed, says Dr. Smith, very well, so that he did not doubt it would have excelled others, had it been properly finished.

In 1738, Lieberkuhn's invention of the solar microscope was communicated to the public. The vast magnifying power obtained by this instrument, the colossal grandeur with which it exhibited the "minutiæ of nature," the pleasure which arose from being able to display the same object to a number of observers at the same time, by affording a new source of rational amusement, increased the number of microscopic observers, who were further stimulated to the same pursuits by Mr. Trembley's famous discovery of the polype. The discovery of the wonderful properties of this little animal, together with the works of Mr. Trembley,

Mr. Baker, and Mr. Adams, combined to spread the reputation of the instrument.

In 1742, Mr. Henry Baker, F.R.S., published an admirable treatise on the microscope. He also read several papers before the Royal Society on the subject of his microscopic discoveries. In the wood-cut (fig. 3) at the end of this chapter we have represented an elegant scroll "pocket microscope with a speculum," described by him as a new invention.

In 1770, Dr. Hill published a treatise, in which he endeavours by means of the microscope to explain the construction of timber, and to show the number, the nature, and office of its several parts, their various arrangements and proportions in the different kinds; and he points out a way of judging, from the structure of trees, the uses they will best serve in the affairs of life.

M. L. F. Delabarre published an account of his microscope in 1777. It does not appear that it was superior in any respect to those that were then made in England. It was inferior to some; for those made by Mr. Adams, in 1771, possessed all the advantages of Delabarre's in a higher degree, except that of changing the eye-glasses.

In 1774, Mr. George Adams, the son of the above, improved his father's invention, and rendered it useful for viewing opaque as well as transparent objects. This instrument, made and described by him,<sup>1</sup> continued in use up to the time of the invention of the achromatic improvement, proposed and made in 1815 for Amici, who subsequently gave so much time to the investigation of polarised light, and the adaptation of a polarising apparatus to the microscope.

In 1812, Dr. Wollaston proposed a doublet in which the glasses were in contact, under the name of a "Periscopic Microscope." And he says, "with this doublet I have seen the finest striæ and serratures on the scales of the lepisma and podura, and the scales on a gnat's wing."

In the year 1816, Fraunhofer, a celebrated optician of Munich, constructed object-glasses for the microscope of a single achromatic lens, in which the two glasses, although in juxtaposition, were not cemented together: these glasses

(1) Microscopical Essays, 1767.

were very thick, and of long focus. Although such considerable improvements had taken place in the making of achromatic object-glasses since their first discovery by Euler in 1776, we find, even at so late a period as 1821, M. Biot writing, "that opticians regarded as impossible the construction of a good achromatic microscope." Dr. Wollaston also was of the same opinion, "that the compound instrument would never rival the single."

In 1823, experiments were commenced in France by M. Selligues, which were followed up by Fraunhofer in Munich, by Amici in Modena, by M. Chevalier in Paris, and by the late Dr. Goring and Mr. Tulley in London. To M. Selligues we are indebted for the first plan of making an object glass composed of four achromatic compound lenses, each consisting of two lenses. The focal length of each object-glass was eighteen lines, its diameter six lines, and its thickness in the centre six lines, the aperture only one line. They could be used combined or separated.

A microscope constructed on this principle, by M. Chevalier, was presented by M. Selligues to the *Académie des Sciences* on the 5th of April, 1824. In the same year, and without a knowledge of what had been done on the Continent, the late Mr. Tulley, at the suggestion of Dr. Goring, constructed an achromatic object-glass for a compound microscope of nine-tenths of an inch focal length, composed of three lenses, and transmitting a pencil of eighteen degrees; this was the first that had been made in England.

Sir David Brewster first pointed out in 1813, the value of precious stones, the diamond, ruby, garnet, &c., for the construction of microscopes. "The durability," he says, "of lenses made of precious stones is one of their greatest recommendations. Lenses of glass undergo decomposition, and lose their polish in course of time. Mr. Baker found the glass lenses of Lceuwenhoek utterly useless after they became the property of the Royal Society. The glass articles found in Nimroud were decomposed, while the rock crystal lens was uninjured." Mr. Pritchard at one time made two plano-convex lenses from a very perfect diamond, one the twentieth of an inch focus, which was



purchased by the late Duke of Buckingham, and another the thirtieth of an inch focus.

In March 1825, M. Chevalier presented to the Society for the Encouragement of the Sciences, an achromatic lens of four lines focus, two lines in diameter, and one line in thickness in the centre. This lens was greatly superior to the one before noticed, which had been made by him for M. Selligues.

In 1826, Professor Amici, of Modena, who from the year 1815 to 1824 had abandoned his experiments on the achromatic object-glass, was induced, after the report of Fresnel to the Academy of Science, to resume them; and in 1827 he brought to this country and to Paris a horizontal microscope, in which the object-glass was composed of three lenses superposed, each having a focus of six lines and a large aperture. This microscope had also extra eye-pieces, by which the magnifying power could be increased. A microscope constructed on Amici's plan by Chevalier, during the stay of that physician in Paris, was exhibited at the Louvre, and a silver medal was awarded to its maker.<sup>1</sup>

"While these practical investigations were in progress," says Mr. Ross, "the subject of achromatism engaged the attention of some of the most profound mathematicians in England. Sir John Herschel, Professors Airy and Barlow, Mr. Coddington, and others, contributed largely to the theoretical examination of the subject; and though the results of their labours were not immediately applicable to the microscope, they essentially promoted its improvement."

Mr. Jackson Lister, in 1829, succeeded in forming a combination of lenses upon the theory propounded by these gentlemen, and effected one of the greatest improvements in the manufacture of object-glasses, by joining together a plano-concave flint lens and a convex, by means of a transparent cement, Canada balsam. This is desirable

(1) In 1855, when the Jury on Microscopes at the Paris Exposition were comparing the rival instruments, Professor Amici brought a compound achromatic microscope, comparatively of small dimensions, which exhibited certain striæ in test objects better than any of the instruments under examination. This superiority was produced by the introduction of a drop of water between the object and the object-glass.

to be taken as a basis for the microscopic object-glass: it diminishes very nearly half the loss of light from reflection, which is considerable at the numerous surfaces of a combination; the clearness of the field and brightness of the picture is evidently increased by doing this; and it prevents any dewiness or vegetation from forming on the inner surfaces. Since this time, Mr. Ross has been constantly employed in bringing the manufacture of object-glasses to their greatest perfection, and at length they have attained to their present improved manufacture. Having applied Mr. Lister's principles with a degree of success never anticipated, so perfect were the corrections given to the achromatic object-glass, so completely were the errors of sphericity and dispersion balanced or destroyed, that the circumstance of covering the object with a plate of the thinnest glass or talc disturbed the corrections, if they had been adapted to an uncovered object, and rendered an object-glass which was perfect under one condition sensibly defective under the other. Here was another and unexpected difficulty to be overcome, but which was finally accomplished; for in a communication made to the Society of Arts in 1837, Mr. Ross stated, that by separating the anterior lens in the combination from the other two, he had been completely successful. The construction of this object-glass will be illustrated and explained in a future chapter.

The rapid improvement in the manufacture of the achromatic compound microscope in this country has been greatly furthered by the spirit of liberality evinced by Sir David Brewster, the late Dr. Goring, Mr. R. H. Solly, and Mr. Bowerbank. To the patronage of Dr. Goring we owe the construction of the first triplet achromatic object-glass, of the diamond lens, and of the improved reflecting instrument of Amici by Cuthbert.

The achromatic microscopes now manufactured by our London makers, Mr. Ross, Messrs. Powell and Lealand, and Messrs. Smith and Beck, are unequalled in any part of the world. This opinion is confirmed by the reports of the juries on the Exhibition of Works of Industry of all Nations, 1851; at that time the instruments exhibited by Mr. Ross and Messrs. Smith and Beck, by far excelled

those of all other countries. Messrs. Powell and Lealand's microscope, with object-glasses, was selected by the Royal Society as the best against all competitors. See Juries' Reports for much interesting matter on this subject; article "*Microscope*," *Penny Cyclopædia*, by Mr. Ross; *Practical Treatise on the Microscope*, by Professor Quekett; Sir David Brewster's *Treatise on the Microscope*; Dujardin's *Observateur*; Maudl, *Traité pratique du Microscope*; Dr Robin, *Du Microscope*, &c.



Fig. 3.—Baker's Scroll or Pocket Microscope, and the Modern Compound Microscope of W. Ladd's manufacture.

## CHAPTER II.

MECHANICAL AND OPTICAL PRINCIPLES INVOLVED IN THE CONSTRUCTION OF THE MICROSCOPE—LENSES—MODE OF ESTIMATING THEIR POWER, ETC. — ACHROMATIC LENSES — MAGNIFYING POWER — WOLLASTON'S DOUBLET — CODDINGTON'S LENS — ROSS'S SIMPLE AND COMPOUND MICROSCOPES — MICROMETERS, ETC.

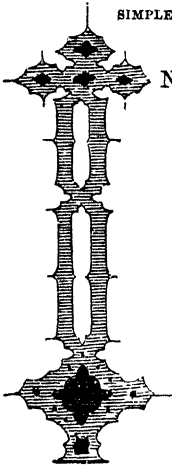

N the construction of the modern microscope, optical and mechanical principles of some importance are involved. These principles we shall briefly explain, together with the more recent improvements effected in the instrument generally.<sup>1</sup>

The microscope depends for its utility and operation upon concave and convex lenses, and the course of the rays of light passing through them. Lenses are usually defined as pieces of glass, or other transparent substances, having their two surfaces so formed that the rays of light, in passing through them, have their direction

changed, and are made to converge or diverge from their original parallelism, or to become parallel after converging or diverging. When a ray of light passes in an oblique direction from one transparent medium to another of a different density, the direction of the ray is changed both on entering and leaving; this influence is the result of the well-known law of *refraction*,—that a ray of light passing from a *rare* into a *dens.* medium is refracted towards the perpendicular, and *vice versa*.

(1) For a full explanation of the laws of optics, and their application to the construction of lenses, the reader is referred to Dr. Bird and Mr. Brooke's "Manual of Natural Philosophy," Professor Potter's "Elementary Treatise on Optics," Sir David Brewster's "Optics," &c.



perpendicular is called the angle of refraction. The ray projected from  $a$  to  $e$  and refracted to  $d$ , in passing out of the transparent medium as at  $d$ , is as much bent from the line of the refracted ray  $ed$  as that was from the line of the original ray  $ae$ ; the ray then passes from  $d$  to  $c$ , parallel to the line of the original ray  $ae$ . It follows, then, that any ray passing through a transparent medium, whose two surfaces, the one at which the ray enters, and the one at which it passes out, are parallel planes, is first refracted from its original course; but in passing out is bent into a line parallel to, and running in the same direction as the original line, the only difference being, that its course at this stage is shifted a little to one side of that of the original. If from the centre  $e$  a circle be described with any radius, as  $de$ , the arc  $aa'$  measures the angle of incidence  $ae$ , and the arc  $g'd$  the angle of refraction  $ged$ . A line  $ak$  drawn from the point  $a$  perpendicular to  $kh$  is called the sine of the angle of incidence; and the line  $dg$  drawn from the point  $d$  perpendicular to  $kh$  is called the sine of the angle of refraction. From the conclusions drawn from the principles of geometry, it has been found, that in any particular transparent substance the sine of the angle of incidence  $ak$  has always the same ratio to the sine  $dg$  of the angle of refraction, no matter what be the degree of obliquity with which the ray of incidence  $ae$  is projected to the surface of the transparent medium. If the ray of incidence passes from air obliquely into water, the sine of incidence is to that of refraction as 4 to 3; if it passes from air into glass, the proportion is as 3 to 2; and if from air into diamond, it is as 5 to 2.

By the help of glasses of certain forms, we unite in the same sensible point a great number of rays proceeding from one point of an object; and as each ray carries with it the image of the point from whence it proceeded, and all the rays united must form an image of the object from whence they were emitted, this image is brighter in proportion as there are more rays united, and more distinct in proportion as the order in which they proceeded is better preserved in their union. The point at which parallel rays meet after converging through a lens is called the *principal focus*, and its distance from the middle of

the lens the *focal length*. The radiant point and its image after refraction are called *conjugate foci*. These foci vary according to the distance of the radiant points. In every lens the right line perpendicular to the two surfaces is called the *axis* of the lens, and is seen in the annexed figure; the point where the axis cuts the surface is called the *vertex* of the lens.

Fig. 5 is intended to represent the different forms of lenses in use; *a* is a plane glass of equal thickness

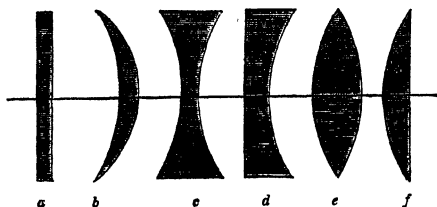

Fig. 5.

throughout; *b*, a meniscus, concave on one side, convex on the other; *c*, a double-concave; *d*, a plano-concave; *e*, a double-convex; *f*, a plano-convex.

The lenses employed in the construction of microscopes are chiefly *convex*; *concave* lenses being only used to make certain modifications in the course of the rays passing through those of a convex form, whereby their performance is rendered more exact. In accordance with the laws of refraction, when a pencil of parallel rays, passing through the air, impinges upon a *convex* surface of glass, the rays are made to converge; for they will be bent towards the centre of the circle, the radius being perpendicular to each point of curvature. Parallel rays, falling on a plano-convex lens, are brought to a focus at the distance of its diameter; and conversely, rays diverging from that point are rendered parallel. *Plano-convex* lenses possess properties which render them valuable in the construction of microscopes.

Parallel rays, falling on a *double-convex* lens are brought to a focus in the centre of its diameter; conversely, rays

diverging from that point are rendered parallel. Hence the focus of a *double-convex* lens will be at just half the distance, or half the length, of the focus of a *plano-convex* lens having the same curvature on one side. The distance of the focus from the lens will depend as much on the degree of curvature as upon the refracting power (called the index of refraction) of the glass of which it may be formed. A lens of crown-glass will have a longer focus than a similar one of flint-glass; since the latter has a greater refracting power than the former. For all ordinary practical purposes, we may consider the *principal focus*—as the focus for parallel rays is termed—of a double-convex lens to be at the distance of its radius, that is, in its centre of curvature; and that of a plano-convex lens to be at the distance of twice its radius, that is, at the other end of the diameter of its sphere of curvature. The converse of all this occurs when divergent rays are made to fall on a convex lens. Rays already converging are brought together at a point nearer than the principal focus: whereas rays diverging from a point within the principal focus are rendered still more diverging, though in a diminished degree. Rays diverging from points more distant than the principal focus on either side, are brought to a focus beyond it; if the point of divergence be within the circle of curvature, the focus of convergence will be beyond it; and *vice versa*. The same principles apply equally to a *plano-convex lens*; allowance being made for the double distance of its principal focus. They also apply to a lens whose surfaces have different curvatures; the principal focus of such a lens is found by multiplying the radius of one surface by the radius of the other, and dividing this product by half the sum of the radii.

The refracting influence of *concave* lenses will be precisely the opposite of that of convex. Rays which fall upon them in a parallel direction, will be made to diverge as if from the principal focus, which is here called the *negative focus*. This will be, for a *plano-concave* lens, at the distance of the diameter of the sphere of curvature; and for a *double-concave*, in the centre of that sphere. If a lens be convex on one side and concave on the other,



forming what is termed a *meniscus*, its effect will depend upon the proportion between the two curvatures.

The rules by which the foci of all lenses may be found, will be more advantageously studied in works on Optics. \*

As each ray carries with it the image of the object from whence it proceeded, it follows, that if those rays, after intersecting each other, and having formed an image at their intersection, are again united by refraction or reflection, they will form a new image, and that repeatedly, so long as their order is not disturbed. It follows, also, that when the course of the luminous ray through several lenses is under consideration, we may look on the image first produced as an object in reference to the second lens, and may consider the second image as produced by this object, and so on successively. This is, indeed, a principle involved in the adaptation of lenses to magnifying objects ; and in fig. 6, it is seen that if the point of light be situated

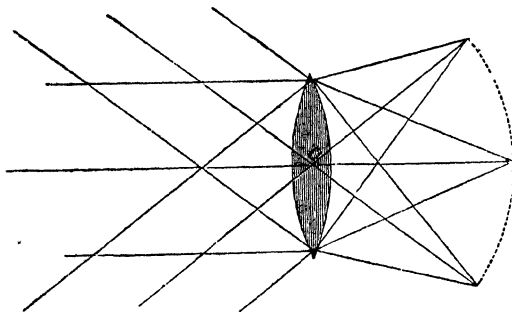

Fig. 6.

above the line of the axis, the focus will then be below it, and *vice versa* ; but the surface of every luminous body may be regarded as comprehending an infinite number of such points, from all of which a pencil of light-rays proceeds, and is refracted according to the general law ; so that a perfect but inverted image or picture of the object is formed upon any surface placed in the focus, and adapted to receive the rays. If any object be placed at twice the

distance of the principal focus, the image being formed at an equal distance on the other side of the lens, will be of the same dimensions with the object, as in fig. 7; but if

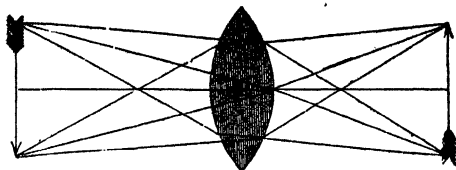

Fig. 7.

the object be placed nearer to the lens, the image will be farther from it, and of larger dimensions, as in fig. 8; and,

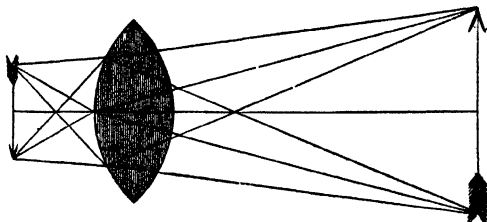

Fig. 8.

on the other hand, if the object be farther from the lens, the image will be nearer to it, and smaller than itself. But it is to be observed, that the larger the image is in proportion to the object, the less bright it will be, because the same amount of light has to be spread over a greater surface; whilst a smaller image will be much more brilliant.

*Aberration of Lenses.*—Although the image of an object produced by the convex lens, fig. 8, appears at first view to be an exact reproduction of the object, it is found, when submitted to rigorous examination, to be more or less confused and indistinct: which is augmented when viewed in a microscope. This indistinctness and confusion arises from two causes, one depending on form, and the other on the material of the lens. That which depends on the form of the lens we shall now proceed to explain.

In optical instruments the curvature of the lenses employed is spherical, that being the only form which can be given by grinding with the requisite degree of truth. But convergent lenses, with spherical curvatures, have the defect of not bringing all the rays of light which pass through them to one and the same focus. Each circle of rays from the axis of the lens to its circumference has a different focus, as shown in fig. 9. The rays *a a*,

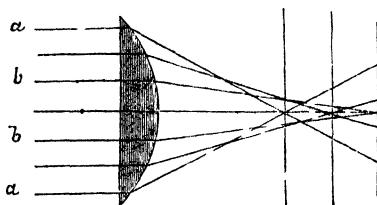

Fig 9.

which pass through the lens near its circumference, it is seen to be *more refracted*, or come to a focus at a shorter distance behind it than the rays *b b*, which pass through near its centre or axis, and are *less refracted*. The consequence of this defect of lenses with spherical curvatures, which is called *spherical aberration*, is that a well defined image or picture is not formed by them, for when the object is focused, for the circumferential rays, the picture projected to the eye is rendered indistinct by a halo or confusion produced by the central rays falling in a circle of dissipation, before they have come to a focus. On the other hand, when placed in the focus of the central rays, the picture formed by them is rendered indistinct by the halo produced by the circumferential rays, which have already come to a focus and crossed, now fall in a state of divergence, forming a circle of dissipation. The grosser effects of this spherical aberration are corrected by cutting off the passage of the rays *a a*, through the circumferences of the lens, by means of a stop diaphragm, so that the central rays, *b b*, only are concerned in the formation of the picture. This defect is reduced to a minimum, by

using the meniscus form of lens, which is the segment of an ellipsoid instead of a sphere.

The ellipse and the hyperbola are curves of this kind, in which the curvature diminishes from the central ray, or axis, to the circumference  $b$ ; and mathematicians have shown how spherical aberration may be entirely removed by lenses whose sections are ellipses or hyperbolas. For this curious discovery we are indebted to Descartes.

If  $a l$ ,  $a l'$ , for example, fig. 10, be part of an ellipse

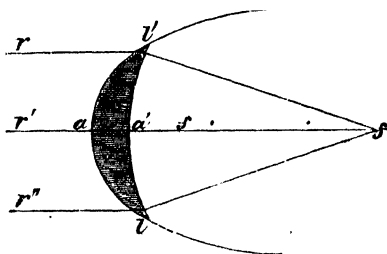

Fig. 10.

whose greater axis is to the distance between its foci  $f f'$  as the index of refraction is to unity, then parallel rays  $r l'$ ,  $r'' l$  incident upon the elliptical surface  $l' a l$ , will be refracted by the single action of that surface into lines which would meet exactly in the farther focus  $f$ , if there were no second surface intervening between  $l a l'$  and  $f$ . But as every useful lens must have two surfaces, we have only to describe a circle  $l a' l'$  round  $f$  as a centre, for the second surface of the lens  $l' l$ .

As all the rays refracted at the surface  $l a l'$  converge accurately to  $f$ , and as the circular surface  $l a' l'$  is perpendicular to every one of the refracted rays, all these rays will go on to  $f$  without suffering any refraction at the circular surface. Hence it should follow, that a meniscus whose convex surface is part of an ellipsoid, and whose concave surface is part of any spherical surface whose centre is in the farther focus, will have no appreciable spherical aberration, and will refract parallel rays incident on its convex surface to the farther focus.

In like manner, a concavo-convex lens, fig. 11,  $ll'$ , whose concave surface  $la'l'$  is a circle described round the farther

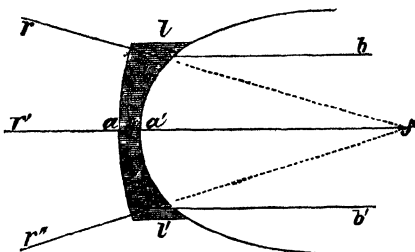

Fig. 11.

focus of the ellipse, will cause parallel rays  $bl, bl'$ , to diverge in directions  $lr, l'r''$ , which, when continued backwards, will meet exactly in the focus  $f$ , which will be its virtual focus.

If a plano-convex lens, fig. 12, has its convex surface  $la'l'$  part of a hyperboloid, formed by the revolution of a

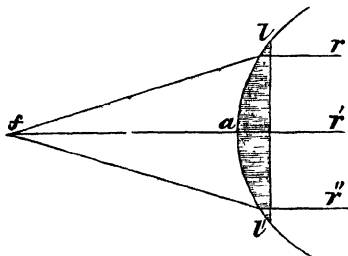

Fig. 12.

hyperbola whose greater axis is to the distance between the foci as unity is to the index of refraction, then parallel rays  $rl, r'l''$  falling perpendicularly on the plane surface, will be refracted without aberration to the further focus of the hyperboloid. The same property belongs to a plano-concave lens having a similar hyperbolic surface, and receiving parallel rays on its plane surface.<sup>1</sup>

(1) It must be borne in mind, that in none of those lenses would the object be correctly seen in focus, except at the one point known as the mathematical or geometrical axis of the lens.

When the convex side of a plano-convex lens is exposed to parallel rays, the distance of the focus from the plane side will be equal to twice the radius of its convex surface diminished by two-thirds of the thickness of the lens ; but when the plane is exposed to parallel rays, the distance of the focus from the convex side will be equal to twice the radius.

A meniscus with spherical surfaces, fig. 13, has the property of refracting all converging rays to its focus, if

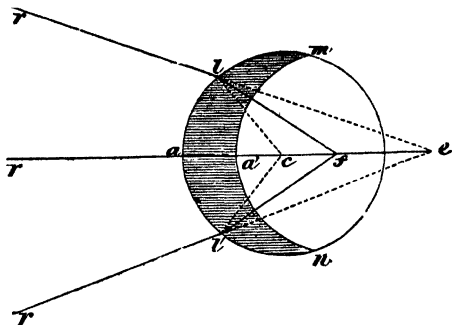

Fig. 13.

its first surface is convex, provided the distance of the point of convergence or divergence from the centre of the first surface is to the radius of the first surface as the index of refraction is to unity. Thus, if  $m l, l' n$  is a meniscus, and  $r l, r' l'$  rays converging to the point  $e$ , whose distance  $e c$  from the centre of the first surface  $l a l'$  of the meniscus is to the radius  $c a$ , or  $c l$ , as the index of refraction is to unity, that is as 1.500 to 1 in glass ; then if  $f$  is the focus of the first surface, describe, with any radius less than  $f a$ , a circle  $m a' n$  for the second surface of the lens. Now it will be found by projection, that the rays  $r l, r' l'$ , whether near the axis  $a e$  or remote from it, will be refracted accurately to the focus  $f$ ; and as all these rays fall perpendicularly on the second surface  $m n$ , they will still pass on, without refraction, to the focus  $f$ . In like manner, it is obvious that rays  $f l, f' l'$ , diverging from  $f$  will

be refracted into  $r l$ ,  $r l'$ , which diverge accurately from the virtual focus.<sup>1</sup>

*Spherical aberration* is not so much connected with the focal length of the lens as depending on the relative convexity of its surfaces, and is much reduced by observing a certain ratio between the radii of its anterior and posterior surfaces; thus the spherical aberration of a lens, the radius of one surface of which is six or seven times greater than that of the other, as in fig. 14, is very much

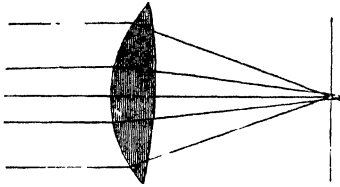

Fig. 14.

less when its more convex surface is turned forward to receive parallel rays, than when its less convex surface is turned forwards.

This is still better effected, or even got rid of altogether, by using combinations of lenses, so disposed that their opposite aberrations shall correct each other, whilst magnifying power is gained. For it is seen that, as the aberration of a concave lens is just the opposite of that of a



Fig. 15.

convex lens, the aberration of a convex lens placed in its most favourable position may be corrected by a concave lens of much less power in its most favourable position. This is the principle of a combination proposed by Sir John F. W. Herschel, fig. 15, an "aplanatic doublet," consisting of a double-convex lens and a meniscus; a doublet of this kind is found extremely useful and available for microscopic purposes: it affords a large field, like the Coddington lens.

*Chromatic aberration.*—Another and serious difficulty arises, in the unequal refrangibility of the different

(1) Brewster's "Treatise on Optics."

coloured rays which together make up white light, so that they are not all brought to the same focus, even by a lens free from spherical aberration. It is, indeed, this difference in their refrangibility which causes their complete separation by the prism into a spectrum.

The correction of chromatic with spherical aberration is effected in a most ingenious manner, by combining a convex lens made of crown-glass, and a concave lens of flint-glass. If we examine closely the image projected on the table of a camera obscura provided with a common lens, we see that it is bordered with the colours of the rainbow ; or if we look through a common magnifying-glass at the letters on the title-page of a book, we see them slightly coloured at their edges in the same manner. The cause of this iridescent border is that the primitive rays—red, yellow, and blue,—of which a colourless ray of light is composed, are not all equally refrangible. Hence they are not all brought to one point or focus, but the blue rays being the most refrangible, come to a focus nearer the lens than the yellow ones, which are less refrangible, and the yellow rays than the red, which are the least refrangible. Thus, in fig. 16, chromatic aberration proves still more

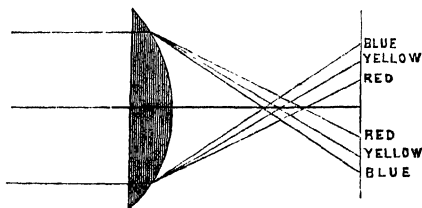

Fig. 16.

detrimental to the distinct definition of images formed by a lens, than spherical aberration. This arises more from the size of the circles of dissipation, than from the iridescent border, and it may still exist, although the spherical aberration of the lens be altogether corrected. Chromatic aberration is, as before stated, corrected by combining, in the construction of lenses, two media of opposite form, and differing from each other in the proportion in which they



respectively refract and disperse the rays of light ; so that the one medium may, by equal and contrary dispersion, neutralize the dispersion caused by the other, without, at the same time, wholly neutralizing its refraction. Remarkable enough, the media found the most valuable for such a purpose should be the combination of pieces of crown and flint glass, of *crown-glass* whose index of refraction is 1.519, and dispersive power 0.036, and of *flint-glass* whose index of refraction is 1.589, and dispersive power 0.0393. The focal length of the convex crown-glass lens must be  $4\frac{1}{2}$  inches, and that of the concave flint-glass lens  $7\frac{2}{3}$  inches, the combined focal length of which is 10 inches. The following fig. 17 will serve us to explain how a ray of light is brought to a single focus, free from colour.

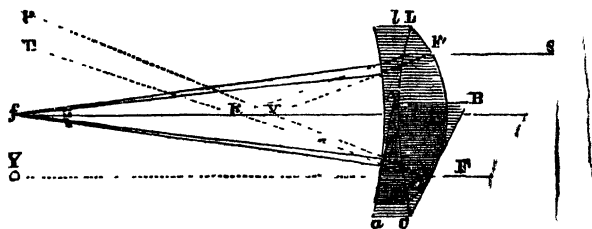

Fig 17.

In this diagram, *LL* is a *convex lens of crown-glass*, and *ll* a *concave one of flint-glass*. A ray of light (*s*) falling at *F* on a convex lens, will refract it exactly in the same manner as the prism *ABC*, whose faces touch the two surfaces of the lens at the points where the ray enters, and quits. The ray *sF*, thus refracted by the lens *LL*, or prism *ABC*, would have formed a spectrum (*PT*) on a screen or wall, had there been no other lens, the violet ray (*Fv*) crossing the axis of the lens at *v*, and going to the upper end (*P*) of the spectrum ; and the red ray (*FR*) going to the lower end (*r*). But, as the flint-glass lens (*ll*) or the prism *aac*, which receives the rays *Fv*, *FR*, at the same points, is interposed, these rays will be united at *f*, and form a small circle of white light, the ray (*sF*) being now refracted without colour from its primitive direction

( $s F Y$ ) into the new direction ( $F f$ ). In like manner, the corresponding ray ( $s' F'$ ) will be refracted to  $f$ , and a white and colourless image there formed by the two lenses.

*The Magnifying Power of Lenses.*—To assist us in gaining a clearer notion of the mode in which a single lens serves to magnify minute objects, it is necessary to take a passing glance at the ordinary phenomena of vision. The human eye is so constituted, that it can only have distinct vision when the rays falling upon it are parallel or slightly divergent; because the retina, on which the image impinges, requires the intervention of the crystalline lens to bring the rays to an accurate focus upon its surface. The limit of distinct vision is generally estimated at from six to ten inches; objects viewed nearer, to most persons, become indistinct, although they may be larger. The

apparent size of an object is, indeed, the angle it subtends to the eye, or the angle formed by two lines drawn from the centre of the eye to the extremity of the object. This will be understood upon reference to fig. 18. The lines drawn from the eye to  $A$  and  $R$  form an angle, which, when the distance is small, is nearly twice as great as the angle

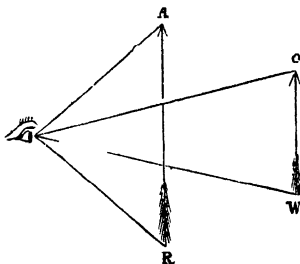

Fig. 18

from the eye to  $o w$ , formed by lines drawn at twice the distance. The arrow at  $A R$  will therefore appear nearly twice as long as  $o w$ , being seen under twice the angle; and in the same proportion for any greater or lesser difference in distance. This, then, is called the angle of vision, or the visual angle. Now the utility of a convex lens interposed between a near object and the eye consists in its reducing the divergence of the rays forming the several pencils issuing from it; so that they enter the eye in a state of moderate divergence, as if they had issued from an object beyond the nearest limit of distinct vision; and a well-defined image is consequently formed upon the retina. In fig. 19, a double-convex lens is placed before

the eye, near which is a small arrow, to represent the object under examination ; and the cones drawn from it

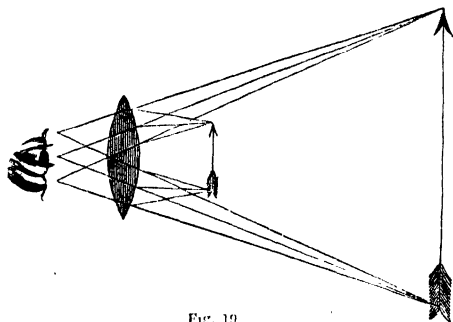

FIG. 19.

are portions of the rays of light diverging from those points and falling upon the lens. These rays, if permitted to fall at once upon the pupil, would be too divergent to allow of their being brought to a focus upon the retina by the dioptric media of the eye. But being first passed through the lens, they are bent into nearly parallel lines, or into lines diverging from some points within the limits of distinct vision. Thus altered, the eye receives them precisely as if they had emanated directly from a larger arrow placed at ten inches from the eye. The difference between the real and the imaginary arrow is called the magnifying power of the lens. The object, when thus seen, appears to be magnified nearly in the proportion which the focal distance of the lens bears to the distance of the object when viewed by the unassisted eye ; and is entirely owing to the object being distinctly viewed so much nearer to the eye than it could be without the lens.<sup>1</sup> With these preliminary remarks as to the medium by which microscopic power is obtained, we shall proceed to apply them to the construction of a perfect instrument.

*The Microscope.*—A microscope, as we have before explained, may be either a *single, simple, or a compound*

(1) "The Magnifying Power of Short Spaces" has been most ably elucidated by John Gorham, Esq. M.R.C.S. See *Journal of Microscopical Society*, October, 1854.

instrument. The *simple* microscope may consist of one, as seen in fig. 19, or of two or three lenses; but these latter are so arranged as to have the effect only of a single lens. In the compound microscope, not less than two lenses must be employed: one to form an inverted image of the object, which, being the nearest to the object, is called the *object-glass*; and the other to magnify this image, and from being next the eye of the observer, called the *eye-glass*. Both these may be formed out of a combination of lenses, as will be hereafter seen.

We have hitherto considered a lens only in reference to its enlargement of the object, or the increase of the angle under which the object is seen. A further and equally important consideration is that of the number of rays or quantity of light by which every point of the object is rendered visible; and much may be accomplished, as we have before pointed out, by the combination of two or more lenses instead of one, thus reducing the angles of incidence and refraction. The first satisfactory arrangement for this purpose was the invention of the celebrated Dr. Wollaston. His doublet (fig. 20) consisted of two plano-convex lenses having their focal lengths in the proportion of one to three, or nearly so, and placed at a distance which can be ascertained best by actual experiment. Their plane sides are placed towards the object, and the lens of shortest focal length next the object.

It appears that Dr. Wollaston was led to this invention by considering that the achromatic Huyghenean eye-piece, which will be presently described, would, if reversed, possess similar good properties as a simple microscope. But it will be evident, when the eye-piece is understood, that the circumstances which render it achromatic are very imperfectly applicable to the simple microscope, and that the doublet, without a nice adjustment of the stop, would be valueless. Dr. Wollaston makes no allusion to a stop, nor is it certain that he contemplated its introduction; although his illness, which terminated fatally soon after the presentation of his paper to the Royal Society, may account for the omission.

The nature of the corrections which take place in the doublet is explained in the annexed diagram, where  $l o l'$  is

the object,  $p$  a portion of the cornea of the eye, and  $d d$  the stop, or limiting aperture.

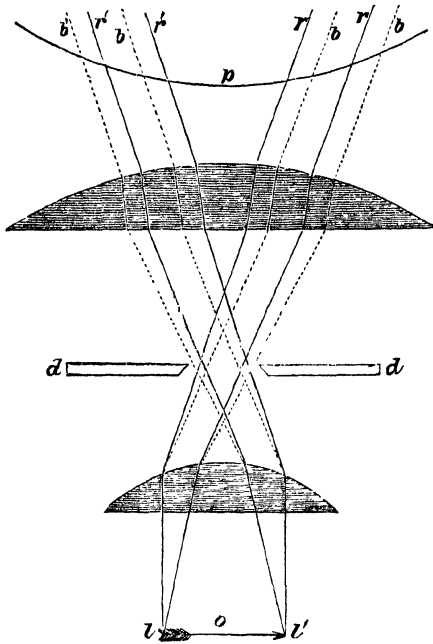

Fig. 20.

Now it will be observed that each of the pencils of light from the extremities  $l l'$  of the object is rendered excentric by the stop; consequently, each passes through the two lenses on opposite sides of their common axis  $o p$ ; thus each becomes affectedly opposite errors, which to some extent balance and correct each other. To take the pencil  $l$ , for instance, which enters the eye at  $r b, r b$ : it is bent to the right at the first lens, and to the left at the second; and as each bending alters the direction of the blue rays more than the red, and moreover as the blue rays fall

nearer the margin of the second lens, where the refraction, being more powerful than near the centre, compensates in some degree for the greater focal length of the second lens, the blue rays will emerge very nearly parallel, and of consequence colourless to the eye. At the same time, the spherical aberration has been diminished by the circumstance that the side of the pencil which passes one lens nearest the axis passes the other nearest the margin.

This explanation applies only to the pencils near the extremities of the object. The central pencils, it is obvious, would pass both lenses symmetrically, the same portions of light occupying nearly the same relative places on both lenses. The blue light would enter the second lens nearer to its axis than the red; and being thus less refracted than the red by the second lens, a small amount of compensation would take place, quite different in principle, and inferior in degree, to that which is produced in the excentric pencils. In the intermediate spaces the corrections are still more imperfect and uncertain; and this explains the cause of the aberrations which must of necessity exist even in the best-made doublet. It is, however, infinitely superior to a single lens, and will transmit a pencil of an angle of from  $35^{\circ}$  to  $50^{\circ}$  without any very sensible errors. It exhibits, therefore, many of the usual test-objects in a very beautiful manner.

The next step in the improvement of the simple microscope bears more relation to the eye-piece; this was effected by Mr. Holland: it consists in substituting two lenses for the first in the doublet, and retaining the stop between them and the third. The first bending being thus effected by two lenses instead of one, is accompanied by smaller aberrations, which are, therefore, more completely balanced or corrected at the second bending, in the opposite direction, by the third lens.

*Hand Magnifiers.*—Before we proceed further, it will be as well to bestow a passing notice on the simple hand magnifier, so often employed by microscopists in the preliminary examinations of objects.

A very good form of lens was proposed by Dr. Wollaston, and called by him the Periscopic lens: which consisted of

two hemispherical lenses cemented together by their plane faces, having a stop between them to limit the aperture. A similar proposal was made by Sir David Brewster in 1820, who, however, executed the project in a better manner, by cutting a groove in a whole sphere, and filling the groove with opaque matter. His lens, which is better known as the Coddington lens,<sup>1</sup> is shown at fig. 21: it gives a large field of view, which is equally good in all directions, as it is evident that the pencils *a b* and *b a* pass

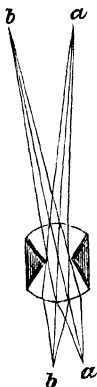

Fig. 21.



Fig. 22

through under precisely the same circumstances. Its spherical form has the further advantage of rendering the position in which it is held of comparatively little consequence. It is therefore very convenient as a hand magnifier; but its definition is, of course, not so good as that of a well-made doublet or achromatic lens. It is generally set in a folding case, as represented in the figure, and so contrived that it is admirably adapted for the waistcoat-pocket; which, together with the small *holder*, fig. 22, for

(1) The late Mr. Coddington, of Cambridge, who had a high opinion of the value of this lens, had one of these grooved spheres executed by Mr. Carey, who gave it the name of the Coddington Lens, supposing that it was invented by the person who employed him, whereas Mr. Coddington never laid claim to it, and the circumstance of his having one made was not until nine years after it was described by Sir David Brewster in the "Edinburgh Journal."

securing small objects and holding them during examination, are all that is required for a *field instrument* during a day's ramble. This useful little holder may be purchased in a case at Mr. Weedon's, 41, Hart-street, Bloomsbury. The Stanhope lens is similarly constructed, although not so good and convenient as the former, and is but seldom to be purchased properly made.

When the magnifying power of a lens is considerable, or when its focal length is short, and its proper distance from the object equally short, it then becomes necessary to be placed at a proper distance with great precision; it cannot therefore be held with sufficient accuracy and steadiness by the unassisted hand, but must be mounted in a frame, having a rack or screw to move it towards or from another frame or stage which holds the object. It is then called a microscope; and it is furnished, according to circumstances, with lenses and mirrors to collect and reflect the light upon the object, with other conveniences.

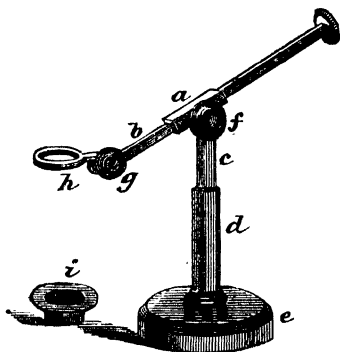

Fig. 23.—Ross's Simple Microscope.

The best of the kind was that contrived by Mr. Ross, represented in fig. 23; and consists of a circular foot *e*, from which rises a short tubular stem *d*, into which



slides another short tube *c*, carrying at its top a joint *f*; to this joint is fixed a square tube *a*, through which a rod *b* slides; this rod has at one end another but smaller joint *g*, to which is attached a collar *h*, for receiving the lens *i*. By means of the joint at *f*, the square rod can be moved up or down, so as to bring the lens close to the object; and by the rod sliding through the square tube *a*, the distance between the stand and the lens may be either increased or diminished: the joint *g*, at the end of the rod, is for the purpose of allowing the lens to be brought either horizontally or at an angle to the subject to be investigated. By means of the sliding arm the distance between the table and the jointed arm can be increased or diminished. This microscope is provided with lenses of one-inch and half-inch focal length, and is thereby most useful for the examination and dissection of objects. It is readily unscrewed and taken to pieces, and may be packed in a small case for the pocket.

Another highly-useful and more complete *simple microscope* was contrived by Mr. W. Valentine, and made for him by Mr. Ross in 1831. It is thus described by the latter gentleman, and is represented in fig. 24. It is supported on a firm tripod, made of bell-metal, the feet of which, *aaa*, are made to close up for the purpose of packing it in a box. The firm pillar *b* rises from the tripod, and carries the stage *e*; this is further strengthened by the two supports *rr*. From the pillar a triangular bar *d*, and a triangular tube *c*, is moved up and down by a screw, having fifty threads in the inch, and turned by a large milled head *v*, which is situated at the base of the pillar: this is the fine adjustment. The small triangular base *d* is moved up and down within the triangular bar *c*, by turning the milled head *t*, forming the coarse adjustment: this bar carries the lens-holder *mno**p*. The stage *e* consists of three plates; the lowest one is firmly attached to the pillar, and upon this the other two work. The upper one carries a small elevated stage *g*, on which the objects are placed; this stage is mounted on a tube *f*, and has a spring clip *h*, for holding, if necessary, the objects under examination. By means of two screws placed diagonally, one of which is seen at *s*, this elevated stage can be moved

in two directions, at right angles to one another; and thus different parts of objects can be brought successively into

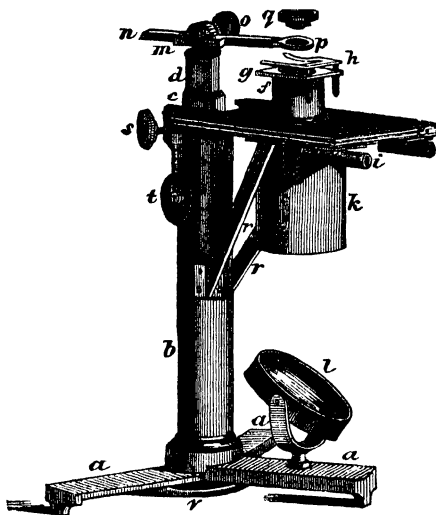

Fig. 24.—Valentine's Microscope.

the field of view. The arm  $np$ , for carrying the lenses, is attached to the triangular bar  $d$  by a conical pin, on which it is made to turn horizontally, and the arm itself can be lengthened or shortened by means of the rack and pinion  $mo$ ; hence the lens  $q$  can be applied to every part of an object without moving the stage.

The mirror  $l$  is fitted into the largest of the three legs, and consists of a concave and plane glass reflector. To the under side of the stage is fitted a Wollaston's condenser  $k$ ; and the lens is made to slide up and down by means of two small handles projecting from the cell in which the lens is set. Two small tubes  $i$ , with either a condensing lens for opaque objects, or a pair of forceps, may be attached to this side of the stage. The magnifiers are

either simple lenses or doublets; or it could be easily converted into a compound microscope by inserting a compound body, supported on a bent arm, in the place of the one carrying the single lenses.

An arrangement devised by Professor Quekett, for a dissecting microscope, represented in fig. 25, is one of value

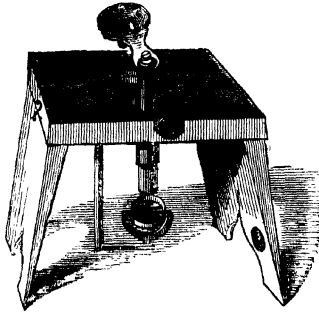

Fig. 25.—Quekett's Simple Microscope.

and convenience. The instrument is made by Mr. Ladd of Chancery Lane, and is furnished by him with three magnifiers, namely, an inch, and half-inch, ordinary lenses, and a quarter-inch Coddington; these will be found to be the powers most useful for the purposes to which this instrument is specially adapted. The lenses, mirror, condenser, vertical stem, &c., all fit into hollows cut for their reception on the under side of the stage, and are then covered and kept in place by the side flaps: so that, when packed together, and the flaps kept secure by an India rubber band, the instrument is very conveniently portable. The size and firmness of the stage afford great facilities for dissection, and other scientific investigations.

**THE COMPOUND MICROSCOPE.**—The compound microscope may, as before stated, consist of only two lenses, while a simple microscope has been shown to contain sometimes three. In the triplet for the simple microscope, however, it was explained that the object of the first two lenses was

to do what might have been accomplished, though not so well, by one; and the third merely effected certain modifications in the light before it entered the eye. But in the compound microscope the two lenses have totally different functions: the first receives the rays from the object, and bringing them to new foci, forms an image, which the second lens treats as an original object, and magnifies it just as the single microscope magnified the object itself.

Fig. 26 shows the earliest form of the compound microscope, with the magnified image of a fly, as given by Adams, which he describes as consisting of an object-glass,  $ln$ , a field glass  $de$ , and an eye-glass,  $fg$ ; the object,  $b'o'$ , being placed a little further from the lens than its principal focal distance, the pencil of rays from which converge to a focus, and form an inverted image of the object at  $p'q'$ , which image is viewed by the eye placed at  $a$  through the eye-glass  $fg$ . The rays remain parallel after passing out until they reach the eye, when they will converge by the refractive powers of this organ, and be collected on the retina. But the image differs from the real object in a very essential particular. The light being emitted from the object in every direction, renders it visible to an eye

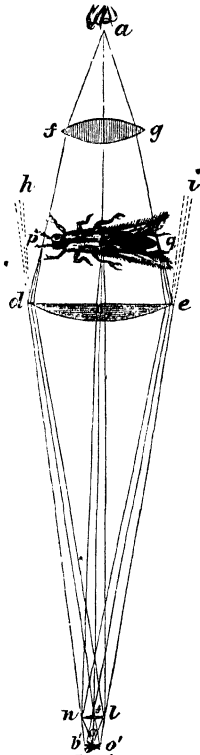

Fig 26.

placed in any position; but the points of the image formed by a lens emitting no more than a small conical body of rays, which it receives from the glass, can be visible only to the eye situate within its range. Thus the pencil of rays emanating from the object at  $o'$ , unless converged by the field-glass to  $f$ , would cross each other, and diverge

towards  $h$ , and therefore would never arrive at the lens  $fg$ , without the interposition of the plano-convex lens at  $de$ , placed at a smaller distance from the object; and by this means the pencil  $dn$ , which would have proceeded to  $h$ , is refracted or bent towards the lens  $fg$ , having a radial point at  $pg$ . The object is magnified upon two accounts: first, because if we view the image with the naked eye, it would appear as much longer than the object as the image is really longer than it, or as the distance  $fb$  is greater than the distance from the real object to  $f'$ ; and secondly, because this picture is again magnified by the eye-glass. The compound microscope, then, consists of an object-lens,  $ln$ , by which the image is formed, enlarged, and inverted; an amplifying lens,  $de$ , by which the field of view is enlarged, and is consequently called the *field-glass*; and an eye-glass or lens  $fg$ , by which the eye is permitted to approach very near, and consequently enabled to view the image under a large angle of apparent magnitude. The two, when combined, are termed the *eye-piece*.

Mr. Lister's investigations in the year 1829, made for the purpose of improving and correcting the imperfections of the object-glasses of the compound microscope, led to the most important results. Mr. Ross also presented to the Society of Arts, in 1837, a paper on the subject, this was published in the 51st volume of their *Transactions*: he thus writes:—

“In the course of a practical investigation, with the view of constructing a combination of lenses for the object-glass of a compound microscope which should be free from the effects of aberration, both for central and oblique pencils of great angle, I obtained the greatest possible distance between the object and object-glass; for in object-glasses of short focal length, their closeness to the object has been an obstacle in many cases to the use of high magnifying powers, and is a constant source of inconvenience.

“In the improved combination the diameter is only sufficient to admit the proper pencil; the convex lenses are wrought to an edge, and the concave have only sufficient thickness to support their figure: consequently the combination is the thinnest possible, and it follows that there





THE AQUARIUM.

See page 330.

will be the greatest distance between the object and the object-glass. The focal length is  $\frac{1}{8}$  of an inch, having an angular aperture of  $60^\circ$ , with a distance of  $\frac{1}{2}$  of an inch, and a magnifying power of 970 times linear, with perfect definition on the most difficult Podura scales. I have made object-glasses  $\frac{1}{16}$  of an inch focal length; but as the angular aperture cannot be advantageously increased if the greatest distance between the object and object-glass is preserved, their use will be very limited.

“The quality of the definition produced by an achromatic compound microscope will depend upon the accuracy with which the aberrations, both chromatic and spherical, are balanced, together with the general perfection of the workmanship. Now in Wollaston’s doublets and Holland’s triplets there are no means of producing a balance of the aberrations, as they are composed of convex lenses only; therefore the best thing that can be done is to make the aberrations a minimum. The remaining positive aberration in these forms produces its peculiar effect upon objects (particularly the detail of the thin transparent class), which may lead to misapprehension of their true structure; but with the achromatic object-glass, where the aberrations are correctly balanced, the most minute parts of an object are accurately displayed, so that a satisfactory judgment of their character may be formed. When an object has its aberrations balanced for viewing an opaque object, and it is required to examine that object by transmitted light, the correction will remain; but if it is necessary to immerse the object in a fluid, or to cover it with glass, an aberration arises from these circumstances which will disturb the previous correction, and consequently deteriorate the definition; and this defect will be more obvious from the increase of distance between the object and object-glass.

“If an object-glass is constructed as represented in fig. 27, where the posterior combination  $p$  and the middle  $m$  have together an excess of negative aberration, and if this be corrected by the anterior combination  $a$  having an excess of positive aberration, then this latter combination can be made to act more or less powerfully upon  $p$  and  $m$ , by making it approach to or recede from them; for when



the three act in close contact, the distance of the object from the object-glass is greatest, and consequently the rays from the object are diverging from a point at a greater distance than when the combinations are separated; and as a lens bends the rays more, or acts with greater effect, the more distant the object is from which the rays diverge, the effect of the anterior combination  $a$  upon the other two,  $p$  and  $m$ , will vary with its distance from thence.

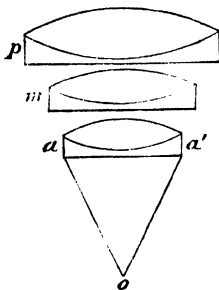

Fig. 27.

“When, therefore, the correction of the whole is effected for an opaque object, with a certain distance between the anterior and middle combination, if they are then put in contact, the distance between the object and object-glass will be increased; consequently, the anterior combination will act more powerfully, and the whole will have an excess of positive aberration. Now the effect of the aberration produced by a piece of flat and parallel glass being of the negative character, it is obvious that the above considerations suggest the means of correction, by moving the lenses nearer together, till the positive aberration thereby produced balances the negative aberration caused by the medium.

“The preceding refers only to the spherical aberration; but the effect of the chromatic is also seen when an object is covered with a piece of glass: for in the course of my experiments I observed that it produced a chromatic thickening of the outline of the Podura and other delicate scales; and if diverging rays near the axis and at the margin are projected through a piece of flat parallel glass, with the various indices of refraction for the different colours, it will be seen that each ray will emerge, separated, into a beam consisting of the component colours of the ray, and that each beam is widely different in form. This difference, being magnified by the power of the microscope, readily accounts for the chromatic thickening of the outline just mentioned. Therefore, to obtain the

finest definition of extremely delicate and minute objects, they should be viewed without a covering; if it be desirable to immerse them in a fluid, they should be covered with the thinnest possible film of talc, as, from the character of the chromatic aberration, it will be seen that varying the distances of the combinations will not sensibly affect the correction; though object-lenses may be made to include a given fluid, or solid medium, in their correction for colour.

“The mechanism for applying these principles to the correction of an object-glass under the various circumstances, is represented in fig. 28, where the anterior lens is set in the end of a tube *a*, which slides on the cylinder *b*, containing the remainder of the combination; the tube *a*, holding the lens nearest the object, may then be moved upon the cylinder *b*, for the purpose of varying the distance, according to the thickness of the glass covering the object, by turning the screwed ring *c*, or more simply by sliding the one on the other, and clamping them together when adjusted. An aperture is made in the tube *a*, within which is seen a mark engraved on the cylinder; and on the edge of which are two marks, a longer and a shorter, engraved upon the tube. When the mark on the cylinder coincides with the longer mark on the tube, the adjustment is perfect for an uncovered object; and when the coincidence is with the short mark, the proper distance is obtained to balance the aberrations produced by glass the hundredth of an inch thick, and such glass can be readily supplied. This adjustment should be tested experimentally by moving the milled edge, so as to separate or close together the combinations, and then bringing the object to distinct vision by the screw adjustment of the microscope. In this process the milled edge of the object-glass will be employed to adjust for character

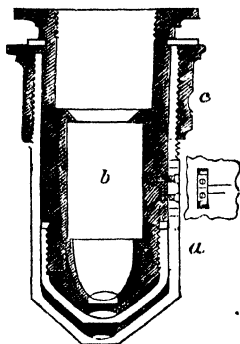

Fig. 28.

of definition, and the fine screw movement of the microscope for correct focus.

"It is hardly necessary to observe, that the necessity for this correction is wholly independent of any particular construction of the object-glass, as in all cases where the object-glass is corrected for an object uncovered, any covering of glass will create a different value of aberration to the first lens, which previously balanced the aberration resulting from the rest of the lenses; and as this disturbance is effected at the first refraction, it is independent of the other part of the combination. The visibility of the effect depends on the distance of the object from the object-glass, the angle of the pencil transmitted, the focal length of the combination, the thickness of the glass covering the object, and the general perfection of the corrections of chromatism and the oblique pencils.

"With this adjusting object-glass, therefore, we can have the requisites of the greatest possible distance between the object and object-glass, an intense and sharply-defined image throughout the field, from the large pencil transmitted, and the accurate correction of the aberrations; also, by the adjustment, the means of preserving that correction under all the varied circumstances in which it may be necessary to place an object for the purpose of observation."

*Angle of Aperture.*—The definition of an object-glass

much depends upon the increased "angle of aperture."

The angle of aperture is that angle, which the most extreme rays that are capable of being transmitted through the object-glass make with the point of focus:  $b a b$ , in figs. 29 and 30, is the angle of aperture; but it will be seen that the angle of aperture is much greater in fig. 29 than in fig. 30, which represents an uncorrected lens;

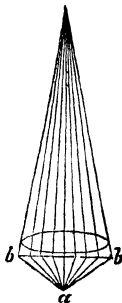

Fig. 29.

consequently, a much larger quantity of light is trans-

mitted by the former than by the latter, when any object is subjected to examination. In order to see an object distinctly with an uncorrected lens, it is necessary to diminish the aperture so much, by *the aid of stops*, as to interfere with the transmission of the amount of light required to see the object perfectly. The greatest angle of aperture of which a given lens is capable, will be found by determining the greatest obliquity with which it is possible for rays to fall upon the object-glass, so as to be refracted to the eye-glass. Dr. Goring and Mr. Pritchard contrived an instrument for ascertaining this, for any given object-glass; which instrument is fully described in Dr. Lardner's useful little work on the microscope.

A very perfect instrument for measuring the angle of aperture, designed by Mr. Gillett, consists of two microscopes, the optical axes of which may be adjusted to coincidence. One of these is attached horizontally to the traversing arm of a horizontal graduated circle, and is adjusted so that the point of a needle, made to coincide with the axis of motion of the movable arm, may be in focus and in the centre of the field of view. The other microscope, to which the object-glass to be examined is attached, is fixed, and so adjusted that the point of the same needle may be in focus in the centre of its field. The eye-piece of the latter is then removed, and a cap with a very small aperture is substituted, close to which a lamp is placed. It is evident that the rays transmitted by the aperture will pursue the same course in reaching the point of the needle as the visual rays from that point to the eye, but in a contrary direction; and being transmitted through the movable microscope, the eye will perceive an image of the bright spot of light throughout that angular space that represents the true aperture of the object-glass examined. The applications of this instrument in the construction of object-glasses are too numerous to be here detailed: amongst the most obvious of which may be mentioned the ready means it presents of determining the nature, and measuring the amount of aberration in any given optical combination.

There is yet another source of inaccuracy which is more mechanical than optical. All the lenses composing the

microscope require to be set in their respective tubes, so that their several axes shall be directed in the same straight line with the greatest mathematical precision. This is what is called *centering* the lenses, and it is a process which, in the case of microscopes, demands great skill on the part of the manufacturer. The slightest

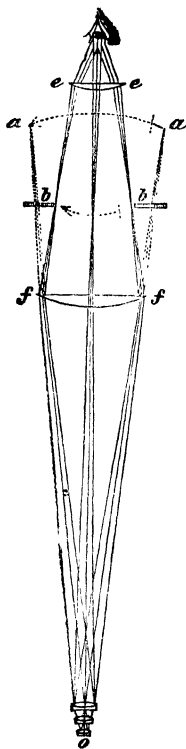

Fig. 31.

deviation from true centering would cause the images produced by the lenses to be laterally displaced, one being thrown more or less to the right, and the other to the left, or one upwards and the other downwards; and even though the aberrations should be perfectly effaced, the superposition of such displaced images would effectually destroy the efficiency of the instrument. It should also be so accurate, that the optical axis of the instrument should not be in the least altered by movement in a vertical direction; so that, if an object be brought into the centre of the field with a low power, and a higher power be then substituted, it should be found in the centre of *its* field, notwithstanding the great alteration in focus.

Fig. 31 represents the body of one of Mr. Ross's compound microscopes with the triple object-glass, where *o* is an object; and above it is seen the triple achromatic object-glass, in connection with the eye-piece *e e*, *f f* the plano-convex lens; *e e* being the eye-glass, and *f f* the field-glass, and between them, at *b b*, a dark spot or diaphragm. The course of the light is shown by three rays drawn from the centre, and three from each end of the object *o*; these rays, if not prevented by the lens *f f*; or the diaphragm at *b b*, would form an image at *a a*; but as they meet with the lens *f f* in their passage, they are

converged by it and meet at  $b b$ , where the diaphragm is placed to intercept all the light except that required for the formation of a perfect image; the image at  $b b$  is further magnified by the lens  $e e$ , as if it were an original object. The triple achromatic combination constructed on Mr. Lister's improved plan, although capable of transmitting large angular pencils, and corrected as to its own errors of spherical and chromatic aberration, would, nevertheless, be of little service without an eye-piece of peculiar construction.

The *eye-piece*, which up to this time is considered to be the best to employ with achromatic object-glasses, to the performance of which it is desired to give the greatest possible effect, is described by Mr. Cornelius Varley, in the fifty-first volume of the *Transactions of the Society of Arts*. The eye-piece in question was invented by Huyghens for telescopes, with no other view than that of diminishing the spherical aberration by producing the refractions at two glasses instead of one, and of increasing the field of view. It consists of two plano-convex lenses, with their plane sides towards the eye, and placed at a distance apart equal to half the sum of their focal lengths, with a stop or diaphragm placed midway between the lenses. Huyghens was not aware of the value of his eye-piece; it was reserved for Boscovich to point out that he had, by this important arrangement, accidentally corrected a great part of the achromatic aberration. Let fig. 32 represent the Huyghenian eye-piece of a microscope,  $f f$  being the field-glass, and  $e e$  the eye-glass, and  $l m n$  the two extreme rays of each of the three pencils emanating from the centre and ends of the object, of which, but for the field-glass, a series of coloured images would be formed from  $r r$  to  $b b$ ; those near  $r r$  being red, those near  $b b$  blue, and the intermediate ones green, yellow, and so on, corresponding with the colours of the prismatic spectrum. This order of colours is the reverse of that of the common compound microscope, in which the single object-glass projects the red image beyond the blue.

The effect just described, of projecting the blue image beyond the red, is purposely produced for reasons presently to be given, and is called over-correcting the object-glass

as to colour. It is to be observed also, that the images  $b b$  and  $r r$  are curved in the wrong direction to be distinctly seen by a convex eye-lens, and this is a further defect of the compound microscope of two lenses. But

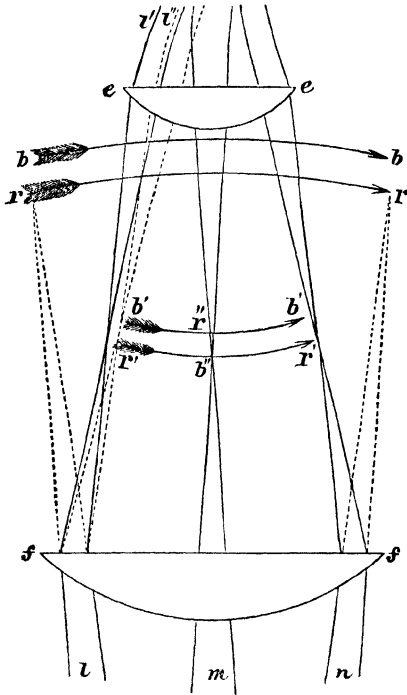

Fig. 32.

the field-glass, at the same time that it bends the rays and converges them to foci at  $b' b'$  and  $r' r'$ , also reverses the curvature of the images as there shown, and gives them the form best adapted for distinct vision by the eye-glass  $e e$ . The field-glass has at the same time brought the blue and red images closer together, so that they are adapted to

pass uncoloured through the eye-glass. To render this important point more intelligible, let it be supposed that the object-glass had not been over-corrected, that it had been perfectly achromatic; the rays would then have become coloured as soon as they had passed the field-glass; the blue rays, to take the central pencil, for example, would converge at  $b''$ , and the red rays at  $r''$ , which is just the reverse of what the eye-lens requires; for as its blue focus is also shorter than its red, it would demand rather that the blue image should be at  $r''$ , and the red at  $b''$ . This effect we have shown to be produced by the over-correction of the object-glass, which protrudes the blue foci  $b b$  as much beyond the red foci  $r r$  as the sum of the distances between the red and the blue foci of the field-lens and eye-lens; so that the separation  $b r$  is exactly taken up in passing through those two lenses, and the whole of the colours coincide as to focal distance as soon as the rays have passed the eye-lens. But while they coincide as to distance, they differ in another respect,—the blue images are rendered smaller than the red by the superior refractive power of the field-glass upon the blue rays. In tracing the pencil  $l$ , for instance, it will be noticed that, after passing the field-glass, two sets of lines are drawn, one whole and one dotted, the former representing the red, and the latter the blue rays. This is the accidental effect in the Huyghenian eye-piece pointed out by Boscovich. The separation into colours of the field-glass is like the over-correction of the object-glass,—it leads to a subsequent complete correction. For if the differently coloured rays were kept together till they reached the eye-glass, they would then become coloured, and present coloured images to the eye; but fortunately, and most beautifully, the separation effected by the field-glass causes the blue rays to fall so much nearer the centre of the eye-glass, where, owing to the spherical figure, the refractive power is less than at the margin, that that spherical error of the eye-lens constitutes a nearly perfect balance to the chromatic dispersion of the field-lens, and the blue and red rays  $l'$  and  $l''$  emerge sensibly parallel, presenting, in consequence, the perfect definition of a single point to the eye. The same reasoning



is true of the intermediate colours and of the other pencils. The eye-glass  $ee$  not only brings together the images  $b'b'$ ,  $r'r'$ , but it likewise has the most important effect of rendering them flat, thus at once correcting both the chromatic and spherical aberration.

The Huyghenian eye-piece, which we have described, is the best for merely optical purposes; but when it is required to measure the magnified image,

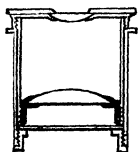

Fig. 33.

we use the eye-piece invented by Mr. Ramsden, and called by him the micrometer eye-piece. The arrangement may be readily understood upon reference to fig. 33. The field-glass has now its plano face turned towards the object; the rays from the object are made to converge immediately in front of the field-glass; and here is placed a plane-glass, on which are engraved divisions of 1-100th of an inch or less.

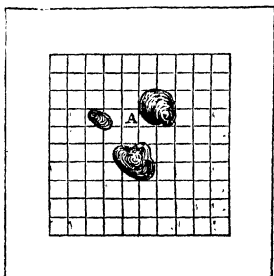

Fig. 34.

The markings of these divisions come into focus, therefore, at the same time as the image of the object, and both are distinctly seen together. The glass with its divisions is shown in fig. 34, on which, at A, are seen some magnified grains of starch. Thus the measure of the magnified image is given by mere inspection; and the value of such measurements,

in reference to the real object, when once obtained, is constant for the same object-glass.

It is affirmed by Mr. Ross, that if the achromatic principle were applied to the construction of eye-pieces, the latter is the form with which the greatest perfection would be obtained. That such an adaptation might be productive of valuable results, appears from Mr. Brooke's statement, that he has employed as an eye-piece, a triplet objective of one inch focus, the definition obtained by it being superior to that afforded by the ordinary Huyghenian eye-piece. Some of the lowest French achromatic

object-glasses answer extremely well for this purpose ; and as the sets are usually made removable, the front pair can be readily separated for the experiment.

Mr. Lister places on the stage of his microscope a divided scale, the value of which is known ; and viewing the scale as the microscopic object, observes how many of the divisions on the scale attached to the eye-piece correspond with one of those in the magnified image. If, for instance, ten of those in the eye-piece correspond with one of those in the image, and if the divisions are known to be equal, then the image is ten times larger than the object, and the dimensions of the object are ten times less than indicated by the micrometer. If the divisions on the micrometer and on the magnified scale are not equal, it becomes a mere rule-of-three sum ; but in general this trouble is taken by the maker of the instrument, who furnishes a table showing the value of each division of the micrometer for every object-glass with which it may be used.

Mr. Jackson invented the simple and cheap form of micrometer, represented in fig. 35, which he described in the *Microscopical Society's Transactions*, 1840. It consists of a slip of glass placed in the focus of the eye-glass, with the divisions sufficiently fine to have the value of the ten-thousandth of an inch with the quarter-inch object-glass, and the twenty-thousandth with the eighth ; at the same time the half, or even the quarter of a division may be estimated, thus affording the means of attaining all the accuracy that is really available. It may therefore entirely supersede the more complicated and expensive screw-micrometer, being much handier to use, and not liable to derangement in inexperienced hands.

The positive eye-piece gives the best view of the micrometer, the negative of the object. The former is quite free from distortion, even to the edges of the field ; but the object is slightly coloured. The latter is free from colour, but is slightly distorted at the edges. In the centre of the field, however, to the extent of half its diameter, there is no perceptible distortion ; and the clearness of the definition gives a precision to the measure-

ment which is very satisfactory. For this reason Mr. Jackson gives it the preference.

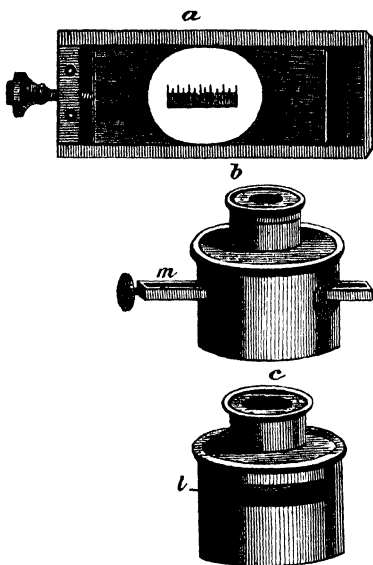

Fig. 35.—Mr. Jackson's Micrometer eye-piece.

Short bold lines are ruled on a piece of glass, *a*, fig. 35; and to facilitate counting, the fifth is drawn longer, and the tenth still longer, as in the common rule. Very finely levigated plumbago is rubbed into the lines, to render them visible; and they are covered with a piece of thin glass, cemented by Canada balsam, to secure the plumbago from being wiped out. The slip of glass thus prepared is placed in a thin brass frame, so that it may slide freely; and is acted on at one end by a pushing-screw, and at the other by a slight spring.

Slips are cut in the negative eye-piece on each side, *b*, so that the brass frame may be pressed across the field in the focus of the eye-glass, as at *m*; the cell of which should have a longer screw than usual, to admit of adjust-

ment for different eyes. The brass frame is retained in its place by a spring within the tube of the eye-piece; and in using it the object is brought to the centre of the field by the stage movements; and the coincidence between one side of it and one of the long lines is made with great accuracy by means of the small pushing-screw that moves the slip of glass. The divisions are then read off as easily as the inches and tenths on a common rule. The operation, indeed, is nothing more than the laying a rule across the body to be measured; and it matters not whether the object be transparent or opaque, mounted or not mounted, if its edges can be distinctly seen, its diameter can be taken.

Previously, however, to using the micrometer, the value of the divisions should be ascertained with each object-glass; the mode of doing which is best performed as follows:—

“Lay a slip of ruled glass on the stage; and having turned the eye-piece so that the lines on the two glasses are parallel, read off the number of divisions in the eye-piece which cover one on the stage. Repeat this process with different portions of the stage-micrometer, and if there be any difference, take the mean. Suppose the hundredth of an inch on the stage requires eighteen divisions in the eye-piece to cover it; it is quite plain that an inch would require eighteen hundred, and an object which occupied nine of these divisions would measure the two-hundredth of an inch. This is the common mode of expressing microscopical measurements; but I am of opinion that a decimal notation would be preferable, if universally adopted.

“Take the instance supposed, and let the microscope be furnished with a draw-tube, marked on the side with inches and tenths. By drawing this out a short distance, the image of the stage micrometer may be expanded until one division is covered by twenty in the eye-piece. These will then have the value of two-thousandths of an inch, and the object which before measured nine will then measure ten; which, divided by 2,000, gives the decimal fraction  $\cdot 005$ .

“Enter in a table the length to which the tube is drawn

out, and the number of divisions on the eye-piece micrometer equivalent to an inch on the stage; and any measurements afterwards taken with that micrometer and object-glass may, by a short process of mental arithmetic, be reduced to the decimal parts of an inch, if not actually observed in them.

“In ascertaining the value of the micrometer with a deep object-glass, the hundredth of an inch on the stage will occupy too much of the field; the two-hundredth or five-hundredth should then be used, and the number of divisions corresponding to that quantity be multiplied by two hundred or five hundred, as the case may be.

“The micrometer should not be fitted into too deep an eye-piece, for it is essential to preserve clear definition. The middle eye-piece is for most purposes the best, provided the object-glass be of the first quality; otherwise, use the eye-piece of lowest power. The lens above the micrometer should not be of shorter focus than three-quarters of an inch, even with the best object-glasses; and the slit cut in the tube can be closed at any time by a small sliding bar, as at *l*, fig. 35.”

We subjoin the following comparative micrometrical measures given by Dr. Hannover, as a reference-table.

Millemetre.	Paris lines.	Vienna lines.	Rhenish lines.	English inch.
1	0·443296	0·4555550	0·458813	0·0993708
2·255829	1	1 027643	1·035003	0·0888138
2·195149	0·973101	1	1·071625	0·0864248
2·179538	0·966181	0·992888	1	0·0858101
25·39954	11·25952	11·57076	11·65364	1

The wonderful tracing on glass executed by M. Nobert, of Barth, in Prussia, deserves attention. The plan adopted by him is, to trace on glass ten separate bands at equal distances from each other, each band being composed of parallel lines of some fraction of a Prussian inch apart; in some they are 1-1000th, and in others only 1-4000th of a Prussian inch separated. The distance of these parallel lines forms part of a geometric series:—

0·001000 lines.	0·000463 lines.
0·000857 ,,	0·000397 ,,
0·000735 ,,	0·000340 ,,
0·000630 ,,	0·000292 ,,
0·000540 ,,	0·000225 ,,

To see these lines at all, it is requisite to use a microscope with a magnifying power of 100 diameters; the bands containing the fewest number of lines will then be visible. To distinguish the finer lines, it will be necessary to use a magnifying power of 300, and then the lines which are only 1-4700th of an inch (Prussian) apart will be seen perfectly traced. Of all the tests yet found for object-glasses of high power, these would seem the most valuable. These tracings have tended to confirm the undulating theory of light, the different colours of the spectrum being exhibited in the ruled spaces according to the separation of the lines; and in those cases where the distances between the lines are smaller than the length of the violet-coloured waves, no colour is perceived; and it is stated, that if inequalities amounting to 0·000002 line occur in some of the systems, stripes of another colour would appear in them.

Achromatic object-glasses for microscopes are of various foci, differing from 2 inches to 1-16th of an inch.

*Magnifying Power of Mr. Ross's Object-Glasses with his various Eye-Pieces.*

EYE GLASSES, OR EYE-PIECES.	OBJECT GLASSES.					
	2-inch.	1-inch.	$\frac{1}{2}$ -inch.	$\frac{1}{4}$ -inch.	$\frac{1}{8}$ -inch.	$\frac{1}{16}$ -inch.
A	20	60	100	220	420	600
B	30	80	130	350	670	870
C	40	100	150	500	900	1200
Value of each space in the Micrometer eye-glass, with the various object-glasses.	$\frac{1}{4000}$ ·0025	$\frac{1}{1250}$ ·001031	$\frac{1}{1000}$ ·0005263	$\frac{1}{4500}$ ·0002325	$\frac{1}{2400}$ ·0001111	$\frac{1}{13125}$ ·000074

*Magnifying Power of Messrs. Powell and Lealand's  
Achromatic Object-Glasses.*

Object Glasses.	Angular Aperture.	Magnifying Power with the various Eye-Pieces.					Price.
		No. 1.	No. 2.	No. 3.	No. 4.	No. 5.	
Inches.	Deg.						£ s.
2	14	25	37	50	100	150	2 15
1	28	50	74	100	200	300	3 0
$\frac{1}{2}$	70	100	148	200	400	600	5 0
$\frac{1}{4}$	95	200	296	400	800	1200	5 5
$\frac{1}{3}$	125	400	592	800	1600	2400	8 8
$\frac{1}{2}$	145	600	888	1200	2400	3600	10 10
$\frac{1}{3}$	175	800	1184	1600	3200	4800	16 16

Schmidt's goniometer positive eye-piece, for measuring the angles of crystals, is so arranged as to be easily rotated within a large and accurately graduated circle. In the focus of the eye-piece a single cobweb is drawn across, and to the upper part is attached a vernier. The crystals being placed in the field of the microscope, and care being taken that they lie *perfectly flat*, the vernier is brought to zero, and then the whole apparatus turned until the line is parallel with one face of the crystal; the frame-work bearing the cobweb, with the vernier, is now rotated until the cobweb becomes parallel with the next face of the crystal, and the number of degrees which it has traversed may then be accurately read off.

To the most complete instruments a set of eye-pieces, consisting of not less than three, is usually made. These differ in power; the longest is always the lowest power, and is marked *A*. Its angular aperture, which determines the size of the field of view, is generally less than that of the others (if constructed on the Huyghenean plan), being limited by the diameter of the body. It is usually about 20 degrees. The next eye-piece, or middle power, marked *B*, and the deepest, *C*, have more than 30 degrees of angular aperture.

For viewing thin sections of recent or fossil woods, coal, the fructification of ferns and mosses; fossil-shells, seeds, small insects, or parts of larger ones; molluscs or

the circulation in the frog, &c., the eye-piece A is best adapted.

For examining the details of any of the above objects, it will be advisable to substitute the eye-piece B, which also should be used in the observation of crystals when illuminated by polarised light, the pollen of flowers, minute dissection of insects, the vascular and cellular tissues of plants, the Haversian canals and lacunæ of bone, and the serrated laminæ of the crystalline lens in the eyes of birds and fishes.

The eye-piece C is of use when it is requisite to investigate the intimate structure of delicate tissues; and also in observations upon fossil infusoria, volvox, scales from moths' wings, raphides, &c. The employment of this eye-piece, when a higher power is required, obviates the necessity of using a deeper object-glass, which always occasions a fresh arrangement of the illumination and focus. It must be borne in mind, that the more powerful the eye-piece, the more apparent will the imperfections of the object-glass become; hence less confidence should be placed in the observations made under a powerful eye-piece than when a similar degree of amplification is obtained with a shallow one and a deeper object-glass.

The degree of perfection in the construction of the optical part of a microscope is judged of by the distinctness and comfort with which it exhibits certain objects, the details of which can only be made visible by combinations of lenses of high magnifying power, and a near approach to correctness. Such are termed by the microscopist *test-objects*. Mr. C. Brooke, F.R.S., whose labours have been devoted to the correction of errors which have crept into this part of philosophical research, says:—In order to arrive at any satisfactory conclusions regarding the action of any transparent medium on light, it is necessary to form some definite conceptions regarding the external form and internal structure of the medium. This observation appears to apply in full force to microscopic test-objects; and for the purposes of the present inquiry, it will suffice to limit our observations to the structure of two well-known test-objects,—the scales of *Podura plumbea*, and the siliceous loriceæ, or valves of the genus *Pleurosigma*,



freed from organic matter: the former of these is commonly adopted as the test of the *defining* power of an achromatic object-glass, and the several species of the latter as the tests of the *penetrating* or *separating* power, as it has been termed. The defining power depends only on the due correction of chromatic and spherical aberrations, so that the image of any point of an object formed on the retina may not overlap and confuse the images of adjacent points. This correction is never theoretically perfect, since there will always be residual terms in the general expression for the aberration, whatever practicable number of surfaces we may introduce as arbitrary constants; but it is practically perfect when the residual error is a quantity less than that which the eye can appreciate. The separation of the markings of the Pleurosigmata and other analogous objects is found to depend on good defining power associated with large angle of aperture.

The Podura scale appears to be a compound structure, consisting of a very delicate transparent lamina or membrane, covered with an imbricated arrangement of epithelial plates, the length of which is six or eight times their breadth, somewhat resembling the tiles on a roof, or the long pile of some kinds of plush. This structure may be readily shown by putting a live Podura into a small test-tube, and inverting it on a glass-slide; the insect should then be allowed for some time to leap and run about in the confined space. By this means the scales will be freely deposited on the glass; and being subsequently trodden on by the insect, several will be found from which the epithelial plates have been partially rubbed off, and at the margin of the undisturbed portion the form and position of the plates may be readily recognised. This structure appears to be rendered most evident by mounting the scales thus obtained in Canada balsam, and illuminating them by means of Wenham's parabolic reflector. The structure may also be very clearly recognised when the scale is seen as an opaque object under a Ross's  $\frac{1}{2}$ th (specially adjusted for uncovered objects), illuminated by a combination of the parabola and a flat Lieberkuhn. The under-side of the scale thus appears as a smooth

glistening surface, with very slight markings, corresponding, probably, to the points of insertion of the plates on the contrary side. The minuteness and close proximity of the epithelial plates will readily account for their being a good test of *definition*, while their prominence renders them independent of the *separating* power due to large angle of aperture.

The structure of the second class of test-objects above mentioned differs entirely from that above described; it will suffice for the present purpose to notice the valves of three species only of the genus *Pleurosigma*; which, as arranged in the order of easy visibility, are, *P. formosum*, *P. hippocampus*, *P. angulatum*. These appear to consist of a lamina of homogeneous transparent silex, studded with rounded knobs of protuberances, which, in *P. formosum* and *P. angulatum*, are arranged like a tier of round shot in a triangular pile, and in *hippocampus* like a similar tier in a quadrangular pile, as has frequently been described; and the visibility of these projections is probably proportional to their convexity. The "dots" have by some been supposed to be depressions; this, however, is clearly not the case, as fracture is invariably observed to take place *between* the rows of dots, and not *through* them, as would naturally occur if the dots were depressions, and consequently the substance is thinner there than elsewhere.

This, in fact, is always observed to take place in the siliceous loriceæ of some of the border tribes that occupy a sort of neutral, and yet not undisputed, ground between the confines of the animal and vegetable kingdoms; as, for example, the *Isthmia*, which possesses a reticulated structure, with depressions between the meshes, somewhat analogous to that which would result from pasting together bobbin-net and tissue-paper. The valves of *P. angulatum*, and similar other objects, have been by some writers supposed to be made up of two substances possessing different degrees of refractive power; but this hypothesis is purely gratuitous, since the observed phenomena will naturally result from a series of rounded or lenticular protuberances of one homogeneous substance. Moreover, if the centres of the markings were centres of greatest density, if, in fact, the structure were at all analogous to that of the crystalline

lens, it is difficult to conceive why the oblique rays only should be visibly affected. When *P. hippocampus* or *P. formosum* is illuminated by a Gillett's condenser, with a central stop placed under the lenses, and viewed by a quarter-inch object-glass of  $70^\circ$  aperture, both being accurately adjusted, we may observe in succession, as the object-glass approaches the object, first a series of well-defined bright dots; secondly, a series of dark dots replacing these; and thirdly, the latter are again replaced by bright dots, not, however, as well defined, as the first series. A similar succession of bright and dark points may be observed in the centre of the markings of some species of *Coscinodiscus* from Bermuda.

These appearances would result if a thin plate of glass were studded with minute, equal, and equidistant plano-convex lenses, the foci of which would necessarily lie in the same plane. If the focal surface, or plane of vision, of the object-glass be made to coincide with this plane, a series of bright points would result from the accumulation of the light falling on each lens. If the plane of vision be next made to coincide with the surfaces of the lenses, these points would appear dark, in consequence of the rays being refracted towards points *now* out of focus. Lastly, if the plane of vision be made to coincide with the plane *beneath* the lenses that contain their several foci, so that each lens may be, as it were, combined with the object-glass, then a second series of bright points will result from the accumulation of the rays transmitted at those points. Moreover, as all rays capable of entering the object-glass are concerned in the formation of the second series of bright focal points, whereas the first series are formed by the rays of a conical shell of light only, it is evident that the circle of least confusion must be much less, and therefore the bright points better defined in the first than in the last series.

If the supposed lenses were of small convexity, it is evident that the course of the more oblique rays only would be sensibly influenced; hence probably the structure of *P. angulatum* is recognised only by object-glasses of large angular apertures, which are capable of admitting very oblique rays.

It does not appear to be desirable that objects should be

illuminated by an entire, or, as it may be termed, a *solid* cone of light of much larger angle than that of the object-glass. The extinction of an object by excess of illumination may be well illustrated by viewing with a one-inch object-glass the *Isthmia*, illuminated by Gillett's condenser. When this is in focus, and its full aperture open, the markings above described are wholly invisible; but as the aperture is successively diminished by the revolving diaphragm, the object becomes more and more distinct, and is perfectly defined when the aperture of the illuminating pencil is reduced to about  $20^{\circ}$ . The same point may be attained, although with much sacrifice of definition, by gradually depressing the condenser, so that the rays may diverge before they reach the object; and it may be remarked, generally, that the definition of objects is always most perfect when an illuminating pencil of suitable form is accurately adjusted to focus, that is, so that the source of light and the plane of vision may be conjugate foci of the illuminator. If a condenser of  $120^{\circ}$  aperture, or upwards, be used as an illuminator, the markings of Diatomaceæ will be scarcely distinguishable with the best object-glass, the glare of the central rays overpowering the structure of those that are more oblique.<sup>1</sup>

## MECHANICAL ARRANGEMENTS.

Having now explained the more important optical principles of the achromatic compound microscope, it remains for us to notice the mechanical and accessory arrangements, for giving those principles their full effect. The mechanism of a microscope is of much more importance than might be imagined by those who have not studied the subject. In the first place, steadiness, or freedom from vibrations not equally communicated to the object under examination and to the lenses by which it is viewed, is a point of the utmost consequence.

One of the best modes of mounting a compound microscope is that shown, fig. 36, which, although it does not

(1) *Object-finder*.—It is a great saving of time to use an object-finder, when very minute objects are not distinguishable by the naked eye. Many forms have been suggested and described by Mr. Tyrrel, Mr. Bridgman, and Mr. T. E. Amyot in the "Microscopical Journal" for 1855 and 1856.

exhibit all the details, will serve to explain the chief features of the arrangement.

In this and larger instruments, two uprights are

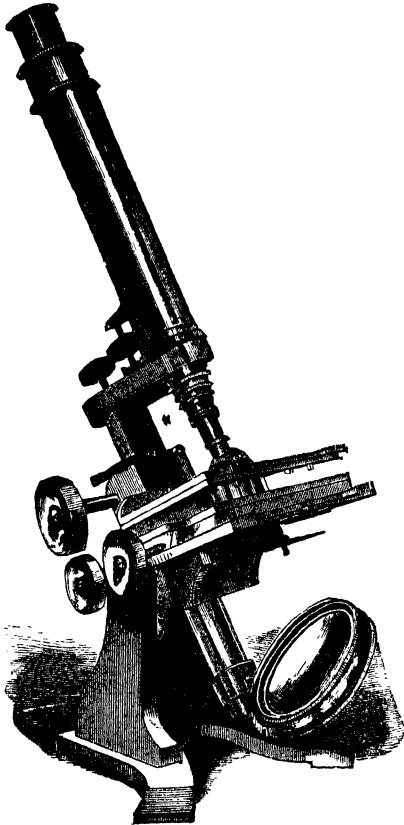

Fig. 36.—*Baker's Compound Microscope.*

strengthened by two internal buttresses mounted on a strong tripod; at the upper part, and between the uprights, we have an axis, upon which the whole of the

upper part of the instrument turns, so as to enable it to take a horizontal or vertical position, or any intermediate inclination,—such, for instance, as that shown in the drawing. This movable part is fixed to the axis near its centre of gravity, and consists of the stage, the arm screwed into the triangular bar which carries the microscope tube or body, at the upper end of this is the eyepiece, and at the lower the object-glasses. The stage has

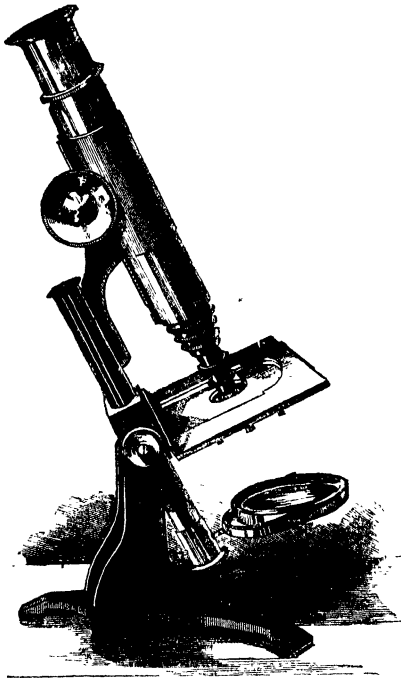

Fig. 37.—*Baker's Student's Microscope.*

rectangular movements one inch in extent on the ratchet-cylinders, moved by the pinions connected with the milled-heads. The triangular bar, together with the arm and

microscope-tube, is moved by the larger milled-heads; and a more delicate adjustment of this optical part is effected by the small milled-head above the bar. The other milled-head fixes the arm to the triangular bar. The mirror slides up or down the tube to which it is attached.

A smaller compound achromatic microscope, fig. 37, is particularly adapted for students: this is packed into a neat mahogany case, with excellent object-glasses, for the small sum of 5*l.* 15*s.*, by Mr. Baker, 244, Holborn, who likewise furnishes all the requisites for microscopical purposes, and well-selected specimens of mounted objects, very cheap.

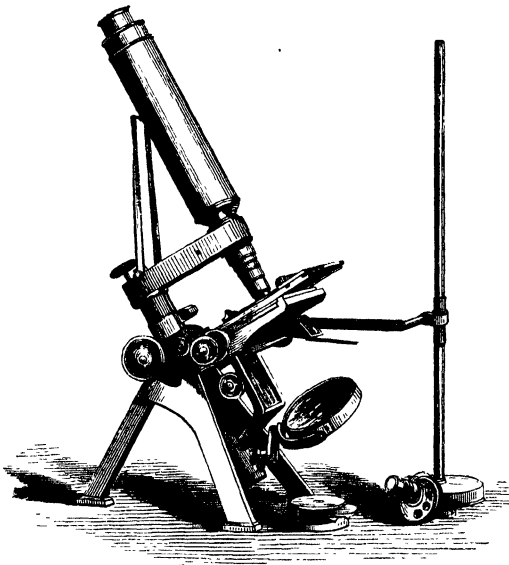

Fig. 38.—*Powell and Lealand's Microscope, with Amici prism, arranged for the oblique illumination of test-objects.*

Messrs. Powell and Lealand's improved microscope is represented in fig. 38. The three legs are considerably stouter and more inclined than in their former instrument,

which gives additional stability; they support, at their upper part, the trunnions to which the tube and the stage are attached. From out the tube a triangular bar is raised by a rack and pinion connected with the milled head. To the upper part of the triangular bar a broad arm is fixed, bearing the compound body; this arm is hollow, and contains the mechanism for the fine adjustment, which is effected by turning the small milled head. The arm is connected with the triangular bar by a strong conical pin, on which it turns, so that the compound body may be moved aside from the stage when necessary; by a mechanical arrangement it stops when central. The stage is of an entirely new construction, having vertical, horizontal, and circular movements, and graduated for the purpose of registering objects so as to be found at pleasure; and in order to do this effectually a clamping piece is provided against which the object slide rests, and the circular motion of the stage is stopped. It is an exceedingly effectual method of finding any favourite object. The stage is remarkably strong, and at the same time so thin, that the utmost obliquity of illumination is attainable, the under portion being entirely turned out: it has a dove-tailed sliding bar moveable by rack and pinion, on turning the milled head into this bar slides the under stage, having vertical and horizontal motions for centering, and also a circular motion; into the stage are affixed the various appliances for underneath illumination. The achromatic condenser, if of  $100^{\circ}$  of aperture, with nine apertures and five central stops, the apertures and stops having independent movements, the manipulator can regulate at will; this is considered to be a great improvement. There is an appliance provided for the dark-wells, which is put into the dove-tailed sliding bar instead of the underneath stage. The mirror is attached to a quadrant of brass and two arms, in order to obtain greater obliquity of illumination; the whole fits into a short piece of tube made to slide either up or down the long tube attached to the bottom of the stage by which the mirror is connected with the other part of the stand; the reflectors themselves are both plane and concave, as in other instruments. The achromatic prism for oblique light is



very useful in bringing out the fine markings of the most difficult Diatomaceæ with the high-power object-glasses. This instrument combines extreme steadiness with remarkable simplicity, together with every motion and

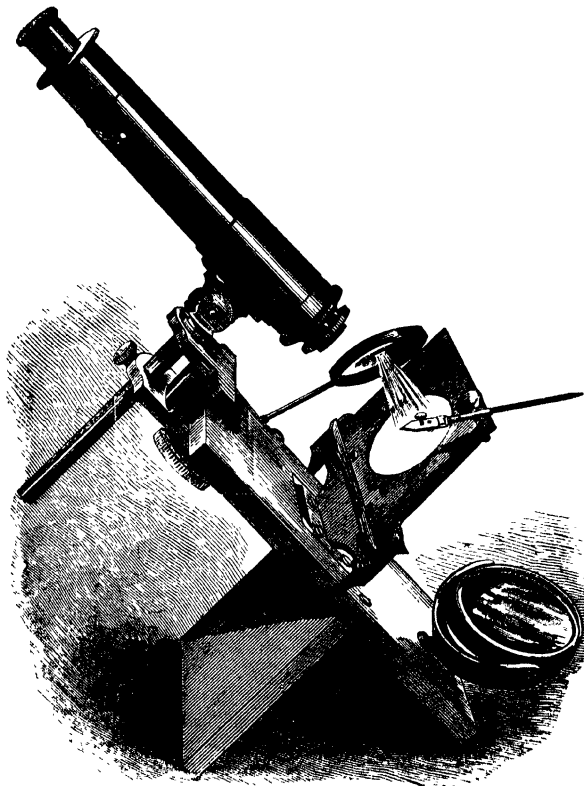

Fig. 39.—*Warington's Microscope.*

appliance that has ever been discovered for the microscope ; the compound body is supplied with a draw tube.

Messrs. Powell and Lealand's microscopes are sold at prices suitable to the wants and means of most persons; their No. 1, such as we have represented, but without object-glass, can be purchased for 22*l*. A smaller instrument, fit for the student, with  $\frac{3}{4}$  inch of motion to the stage by means of a lever, coarse and fine adjustments to body, plane and concave mirrors, revolving diaphragm, Lister's dark-wells, and two eye-pieces, 8*l*.

We wish to call attention to the movement made by the Society of Arts, with the object of supplying the public, at low prices, with approved and warranted microscopes. The Society offered prizes to all manufacturers for the best simple microscope, to be called a School Microscope, and to be sold at 10*s*. 6*d*.; and for the best compound microscope, to be called the Student's Microscope, and to be sold at 3*l*. 3*s*. Both prizes were awarded to Messrs. Field and Son, of Birmingham.

Whilst alluding to cheap microscopes, we would mention Warington's Travelling Microscope, made by W. J. Salmon, 100, Fenchurch Street. It has a simple, firm, wooden stand, whereby the cost is greatly diminished; and an arrangement of its parts, which enables it to be used for viewing objects in aquaria, and under other circumstances where any ordinary form of instrument could not be made available. It is altogether a useful student's microscope, besides having the recommendation of folding up into a smaller compass than any instrument of its size, and of not being liable to much injury from chemical or marine investigations. For 3*l*. this microscope is furnished

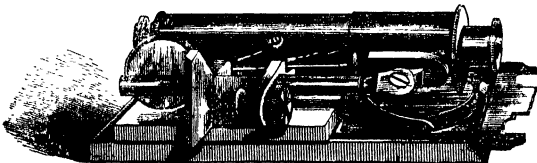

Fig. 40.—*Warington's Microscope packed.*

complete, with one eye-piece, quite sufficient for all ordinary investigations.

Fig. 39 is a representation of Warington's microscope,

When you look through the instrument, be sure to place your eye quite close to the eye-piece, otherwise the whole field of view will not be visible ; and observe, moreover, if you see a round disc of light, at least when the object is not on the slider-holder : if you do not, it is a sign that something is wrong ; perhaps the body is not placed directly before the stage aperture, or may not be properly directed towards the light. Use the smallest amount of light possible, if you work for any length of time. Choose a steady light, with a shade to protect the eyes, one of the old-fashioned *fan-shades* will be found useful for this purpose : use the eyes alternately. Sit in a comfortable position, and bring the instrument to the proper angle, which will prevent congestion of the eyes ; this is indicated if the microscopist is annoyed with little moving objects apparently floating before them : if the eye-lashes are reflected from the *eye-glass*, you are looking *upon* the eye-glass instead of *through* it. Take care that the mirror is properly arranged.

The following are Sir David Brewster's excellent directions for viewing objects :—

“ First. Protect the eye from all surrounding light, letting only the rays which proceed from the illuminated centre of the object fall upon it.

“ Secondly. Delicate observations should not be made when the fluid which lubricates the cornea is in a viscid state, or there is any irritation or inflammation about any part of the eye.

“ Thirdly. The best position for microscopic observations is with the microscope bent to such an angle with the body, that the head may always remain in a natural and easy attitude ; consequently, the worst position would be that which compels us to look downwards vertically.

“ Fourthly. If we lie horizontally on the back, parallel markings and lines on objects will be seen more perfectly when their direction is vertical, or in a contrary direction to that in which the lubricating fluid descends over the cornea of the eye.

“ Fifthly. Only a portion of the object should be viewed at one time, and every other part excluded. The light which illuminates that part should be admitted through a

small diaphragm : at night, from the concentrated light of a sperm-oil or gas lamp, having a faint blue-tinted chimney-glass, to correct the yellow colour which predominates in all our artificial illumination. If in the day-time, close a portion of the window-shutters.

“Sixthly. In all cases when high powers are used, the intensity of the illumination should be increased by optical contrivances below the object and stage : this is generally effected by using achromatic condensers beneath the stage. The apparatus for illumination should be as perfect as the magnifying power.”

If these directions are strictly followed, no injury to the eyes from using a microscope need be feared.

Mr. Ross very properly remarks, that the manner in which an object is lighted is second in importance only to the excellence of the glass through which it is seen. When investigating any new or unknown specimen, it should be viewed in turns by every description of light, direct and oblique, as a transparent object and as an opaque object, with strong and with faint light, with large angular pencils thrown in all possible directions. Every change will probably develop some new fact in reference to the structure of the object, which should itself be varied in the mode of mounting in every possible way.

It should be seen both wet and dry, and immersed in fluids of various qualities and densities ; such as water, alcohol, oil, and Canada balsam ; which last has a refractive power nearly equal to that of glass.

If the object be delicate vegetable tissue, it will be, in some respects, rendered more visible by gentle heating or scorching before a clear fire, between two plates of glass. In this way the spiral vessels of asparagus and other similar vegetables will be beautifully displayed. Dyeing the objects in tincture of iodine, or some one of the dye-woods, will, in some cases, answer the purpose better.

But the principal question in regard to illumination is the magnitude of the illuminating pencil, particularly in reference to transparent objects. Generally speaking, the illuminating pencil should be not quite so large as can be received by the lens : any light beyond this produces indistinctness and glare. The superfluous light from the

mirror may be cut off by a screen, having various-sized apertures placed below the stage.

The *Diaphragm*, fig. 41, is the instrument used for effecting this purpose. It consists of two plates of brass, one of which is perforated with four or five holes of dif-

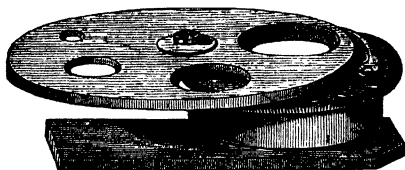

Fig. 41.—*The Diaphragm.*

ferent sizes ; this plate is of a circular figure, and is made to revolve upon another plate by a central pin or axis ; this last plate is also provided with a hole as large as the largest in the diaphragm-plate, and corresponds in situation to the axis of the compound body. To ascertain when either of the holes in the diaphragm-plate is in the centre, a bent spring is fitted into the second plate, and rubs against the edge of the diaphragm-plate, which is provided with notches. The space between the smallest and largest is great enough to use for the purpose of shutting off all the light from the mirror.

**GILLETT'S ILLUMINATOR, OR CONDENSER.**—The advantages of employing an achromatic condenser were first pointed out by Dujardin, since which time an object-glass has been frequently but inconveniently employed ; and more recently achromatic illuminators have been constructed by most of our instrument makers. Some years since, Mr. Gillett was led by observation to appreciate the importance of controlling not merely the quantity of light which may be effected by a diaphragm placed anywhere between the source of light and the object, but the angle of aperture of the illuminating pencil, which can be effected only by a diaphragm placed immediately behind the achromatic illuminating combination. Such a diaphragm is represented in fig. 42, manufactured by Mr. Ross : it consists of an achromatic illuminating lens *c*, which is

about equal to an object-glass of one-quarter of an inch focal length, having an angular aperture of  $80^{\circ}$ . This lens is placed on the top of a brass tube, intersecting

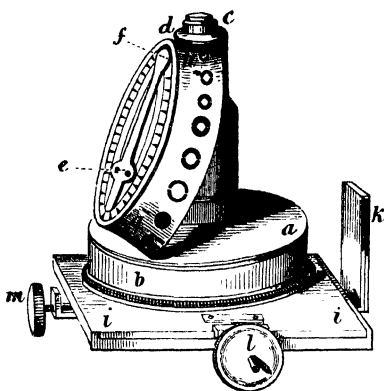

Fig. 42.—Gillett's Condenser.

which, at an angle of about  $25^{\circ}$ , is a circular rotating brass plate *a b*, provided with a conical diaphragm, having a series of circular apertures of different sizes *h g*, each of which in succession, as the diaphragm is rotated, proportionally limits the light transmitted through the illuminating lens. The circular plate in which the conical diaphragm is fixed is provided with a spring and catch *e f*, the latter indicating when an aperture is central with the illuminating lens, also the number of the aperture as marked on the graduated circular plate. Three of these apertures have central discs, for circularly oblique illumination, allowing only the passage of a hollow cone of light to illuminate the object. The illuminator above described is placed in the secondary stage *i i*, which is situated below the general stage of the microscope, and consists of a cylindrical tube having a rotatory motion, also a rectangular adjustment, which is effected by means of two screws *l m*, one in front, and the other on the left side of its frame. This tube receives and supports all the various

illuminating and polarising apparatus, and other auxiliaries which are placed underneath the object. The tube and its frame are affixed to a dovetailed sliding bar *k*, which can be easily moved up or down, or taken off for conveniently attaching the various apparatus. This sliding bar fits into a second sliding bar, which, by means of a milled-head screw, moving a rack and pinion, regulates the distance of the apparatus from the stage.

*Directions for Use by Day or Lamplight.*—In the adjustment of the compound body of the microscope with the illuminator above described, two important results are to be sought—first, their centricity, and secondly, the fittest condensation of the light to be employed. With regard to the first, place the illuminator in the cylindrical tube, and press upwards the sliding bar in its place, until checked by the stop; move the microscope body either vertically or inclined for convenient use; and with the rack and pinion which regulates the sliding bar, bring the illuminating lens to a level with the upper surface of the object-stage; then move the arm which holds the microscope body to the right, until it meets the stop, whereby its central position is attained; adjust the reflecting mirror so as to throw light up the illuminator, and place upon the mirror a piece of clean white paper to obtain a uniform disc of light. Then put on the low eye-piece, and a low power (the half-inch), as more convenient for the mere adjustment of the instrument; place a transparent object on the stage, adjust the microscope-tube, until vision is obtained of the object; then remove the object, and take off the cap of the eye-piece, and in its place fix on the eye-glass called the “centering eye-glass,” described below, which will be found greatly to facilitate the adjustment now under consideration, namely, the centering of the compound body of the microscope with the illuminating apparatus of whatever description.<sup>1</sup> The centering-glass, being thus affixed to the top of the eye-piece, is then to

(1) This centering-glass consists of a tubular cap containing two plano-convex lenses, which are applied and adjusted so that the image of the aperture in the object-glass, and the images of the apertures at the lenses and in the diaphragms contained in the tube which holds the illuminating combination, may all be in focus at the same time, as with the same adjustment they may be brought sufficiently near in focus to recognise their centricity.

be adjusted by its sliding-tube (without disturbing the microscope-tube) until the images of the diaphragms in the object-glass and centering lens are distinctly seen. The illuminator should now be moved by means of the left-hand screw on the secondary stage, while looking through the microscope, to enable the observer to recognise the diaphragm belonging to the illuminator, and by means of the two adjusting screws, to place this diaphragm central with the others; thus, the first condition, that of centricity, will be accomplished. Remove the white paper from the mirror, and also the centering-glass, and replace the cap on the eye-piece, also the object on the stage, of which distinct vision should then be obtained by the rack and pinion, or fine screw adjustment, should it have become deranged.

The second process is to ascertain that the fittest concentration of light is obtained. For this purpose the mirror should now be so inclined that the image of some intercepting distant object, such as a house-top, or chimney, tree, window-frame, or (if lamp-light be employed) the lamp's flame may be brought into the field of view; these, though not distinctly seen, may be recognised by partially darkening or otherwise occupying the field; then distinct vision of such object must be obtained by means of the rack and pinion moving the secondary stage to and from the object. Excepting the case of the lamp's flame, the above objects are considered as the representatives of the source of light; for when daylight is employed—as, for example, a white cloud—its motion prevents the image being easily produced: then it is convenient to employ a distant object, such as the above,—the difference of the focal length of the illuminating lens for such an object, and for the white cloud, being almost insensible. This last adjustment being effected by the movement of the secondary stage alone, the microscope tube remaining undisturbed, also the object on the object-stage uninterrupted in focus, the source of the illuminating light and the object to be examined will both be distinctly seen at the same time. These adjustments, whether for daylight or lamplight, being completed, the mirror may be turned so as wholly to reflect the light either of the sky or of the



lamp; and the eye-piece and object-glass suitable for examining the object may be employed, and the focus adjusted accordingly. The conical diaphragm with its various apertures may now be rotated, until that quality of illumination is obtained which gives a cool, distinct, and definite view of the object. Upon changing the object-glass, the centering eye-glass should always be employed to ascertain that the centricity of the illuminating condenser and microscope body has not been deranged.

It has been stated that the image of a white cloud opposite the sun is the best for illuminating transparent objects when viewed by transmitted light. Mr. Gillett has successfully imitated this natural surface by an apparatus consisting of a large parabolic reflector, with a small camphine lamp on an adjustable stand, having its flame nearly in the focus; also of two other reflectors of hyperbolic figure, which are employed according to the object-glasses used on the microscope. The parabolic mirror and one of these are attached opposite to each other on the bent arm by which they are supported, having their axes coincident, and the enamel disc placed between them. The small hyperbolic reflector receives the light reflected from the large parabolic reflector, and concentrates the rays on the small enamel disc. The surface of this disc is roughened, so that the forms of all the incident pencils are broken up, and the effect of a white cloud produced.

A good mode of imitating artificially the light of a white cloud opposite the sun has been proposed by Mr. Varley: he covers the surface of the mirror under the stage with carbonate of soda, or any similar material, and then concentrates the sun's light upon its surface by a large condensing lens.

*Ross's Achromatic Illuminator, or Condenser.*—When employing this apparatus, the general practice is to insert in it, as an illuminating lens, the object-glass next lowest in power to that which is intended to be attached to the microscope; so that when the one-eighth is used on the microscope, the one-fourth is screwed into the illuminating apparatus; and so, in like manner, with the rest. But when economy is not regarded, a system of three achro-

atic combinations is supplied, adapted for the illumination of the whole range of the powers of the microscope: the whole system being employed for the highest powers; two of such combinations with the middle powers; and the largest combination by itself for the lowest powers. This illumination is not required for objects when viewed with object-glasses transmitting small pencils of rays, or whose angular aperture is less than thirty degrees; that is, where the object-glass is of greater focal length than half an inch.

The apparatus is fixed to the under side of the stage of the microscope, in the place of the diaphragm-plate; and before fixing, the proper object-glass, as an illuminating lens, must be screwed on to it. In fig. 43, two tubes are seen sliding one within the other; to the outer one, *b*, is attached a flat plate *a*, which slides underneath the stage, and is adjusted for distance by the screw *f*; at *c* the milled-head is connected to a pinion; and by means of a rack attached, the inner tube, carrying the achromatic combination *d*, is raised or lowered: the upper part of the outer tube is larger than that where the milled-head is seen, for the purpose of allowing the milled ridge of the achromatic to pass up and down. For the  $\frac{1}{2}$  or  $\frac{1}{4}$  inch, the combination *d* is used; and for the higher power,  $\frac{1}{8}$  or  $\frac{1}{12}$ , the second *e* is slipped over *d*. Place the object to be viewed upon the stage of the microscope; and when the instrument is not directed at once to the source of light, such as the flame of a lamp, or a white cloud, arrange the reflector (having the plane mirror upwards) so as to throw the light up the tube of the apparatus; which may be ascertained by turning aside the microscope tube, and observing when the spot of light appears on the object placed on the stage. The microscope-tube is then to be replaced as nearly over the spot of light as possible, and vision of the

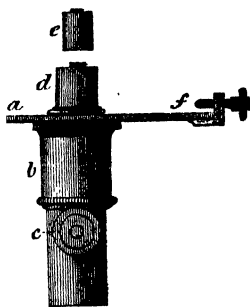

Fig. 43.—Ross's Condenser.

object obtained, disregarding the precise *quality* of the light. Then proceed for perfect adjustment, as directed in using Gillett's condenser.

*The Parabolic Reflector.*—F. H. Wenham, Esq., (*Micros. Trans.* 1851) proposed a new illuminator, for the purpose of obtaining perfect definition under high powers. Those who have experimented on the subject, may have observed that there is something in the nature of oblique light reflected from a metallic surface particularly favourable for the purpose of bringing out minute markings, which may, in some measure, be attributed to the circumstance of light so reflected being purely achromatic. In order to render this property available, Mr. Wenham contrived a very ingenious metallic reflector, by which the condensation of lateral light may be effected.<sup>1</sup>

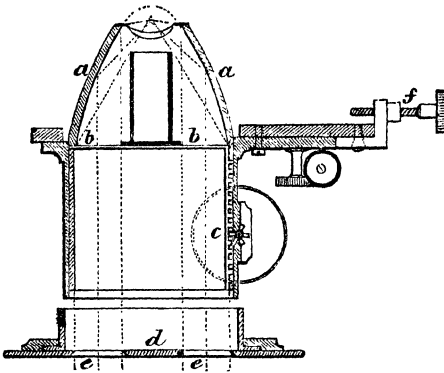

Fig. 44.—Wenham's Parabolic Reflector.

"The apparatus is shown in section in fig. 44: *a a* is a parabolic reflector, of a tenth of an inch focus, with a

(1) In Vol. IV. 1856, *Microscopical Society's Transactions*, p. 55, will be found another very instructive and scientific paper, "On the Method of Illuminating Opaque Objects under the Highest Powers of the Microscope," by Mr. Wenham. The principle of operation consists in causing rays of light to pass through the under side of the glass slip upon which the object is mounted, at the proper angle for causing total-internal reflection from the upper surface of the thin cover, which is thus made to act the part of a speculum, for throwing the light down upon the under-lying objects, immersed in the balsam on fluid.

polished silver surface, having the apex so far cut away as to bring the focal point at such a distance above the top of the apparatus (which is closed with a screw-cap when not in use) as may allow the rays to pass through the thickest glass commonly used for mounting objects upon before coming to a focus.

“At the base of the parabola is placed a disc of thin glass *b b*, in the centre of which is cemented a dark well, with a flange equal in diameter to the aperture at the top of the reflector, for the purpose of preventing the direct rays from the source of light passing through the apparatus.

“The reflector is moved to and from the object by means of the rack and pinion *c*, and has similar adjustments for centering, and is fixed under the stage of the microscope in the same way as the ordinary achromatic condenser: in addition, there is a revolving diaphragm *d*, made to slide on the bottom tube of the apparatus; it has two apertures *e e*, placed diametrically, for the purpose of obtaining two pencils of oblique light in opposite directions. The effects of the chromatic and spherical aberrations, in the shape of fog and colour about the objects, caused by the glass slides upon which they are mounted, frequently require compensation; for as the parabola has the property of throwing parallel rays uncoloured to a point, when used alone, it is most suitable for objects without glass underneath.

“By the addition of a meniscus, this compensation is obtained, and also greater purity and intensity of illumination is procured; and as the silver reflector is now closed with glass, it is hermetically sealed, and permanently protected from dust and damp, and will therefore retain its polish. The light most suitable for this method of illumination is lamp or candle light, the rays of which must in all cases be rendered parallel by means of a large plano-convex lens, or condenser; the light may then be used direct, or reflected from the plane mirror. The object having been adjusted, the illuminator is moved to and fro till the best effect is produced. For the purpose of viewing some objects, such as naviculæ, the circular diaphragm should be slid on the extremity of the apparatus, and

revolved till the two pencils of light are thrown most suitably across the object.

“As the method of illuminating microscopic objects by means of a large angular pencil of light, having the central rays obscured, is of recent introduction, I shall mention a few instances where transparent objects are shown, under similar circumstances, with perfect or improved definition. The lateral mode of illumination will be found to possess peculiar advantages in the examination of test-objects and the internal mechanism of infusoria. The markings on most of the test-objects are either depressions or projections by direct light: all parts of an object are illuminated with equal intensity, and delicate colours are in great part destroyed, consequently there is a want of contrast. The effect of an angular pencil of rays of  $175^\circ$ , with the central ones stopped, is, that there is a greater relative amount of light thrown on these prominences, as they intercept the largest portion of the marginal rays near the apex of the reflector, leaving the base of the prominence in comparative shadow, consequently the markings we wish to see are the most strongly lighted. The different organs in the interior of an animalcule may be much of the same colour and transparency, and yet possess a different refraction, according to their density. Direct light will pass through these transparent membranes in straight lines without being affected by their various refractive powers. The effect of lateral or oblique light on such tissues is, that the rays are more refracted according to their inclination, and proportionate to the various densities of the medium, the most refractive structure transmitting the greatest quantity of light, and being in consequence the most illuminated; and this reason is somewhat confirmed by the circumstance of lateral illumination showing the structure of some objects which, from slight variation in density, were invisible, except by the use of polarised light.” Mr. Shadbolt has since modified this reflector, which he denominates “a sphero-annular condenser:” it has superior reflecting arrangements, with less liability of derangement, and is constructed of a solid cylinder of glass terminating above in a solid cone, the surface of which has the form of a parabola, and replaces the silver reflecting surface.

It is due to Mr. Lister to mention that in his paper on the "Achromatic Object-Glass," published in the 120th vol. of the *Transactions of the Royal Society*, he makes mention "of some objects being better seen when the *central rays* are obscured." This observation has been carried out in many ways. Mr. Reade's "back-ground illuminator" is one in which the light is thrown under the object in such a direction as to avoid or pass by the aperture of the object-glass, and give a black field. The structure under view, if large, must have sufficient transparency to allow the light to enter into its substance, and to be diffused or radiated therefrom in all directions. This illuminator is very suitable for objects requiring only a low power to view them.

Mr. John Furze directed the attention of microscopists to a beautiful arrangement for the "illumination of objects by polarised light on a dark field, in such a manner as to give the object a stereoscopic effect by a due contrast of light and shade." To obtain this result, he uses a plano-convex lens, three-fourths of an inch in diameter. This, when fitted, is of so small a size, that it can be adapted to any instrument. Such an illuminating lens should be arranged with a system of both central and external stops, each revolving on a separate axis; and an adjustable cap to slide over the top of the lens, containing a crystal of Herapathite mounted between thin glass; a plate of selenite, mounted in the same way, should be used on the stage above it. Objects of too great density for transmitted light will appear under this mode of illumination as if in relief; and the definition of the various parts will be so accurately displayed as to constitute a most perfect method of viewing them.

*Condensing lenses*, fig. 45, are used either for opaque objects, or to condense the light upon the mirror attached to the microscope. A bull's-eye, or plano-convex lens, of three inches focal length, is best suited for the purpose. In fig. 46 the bull's-eye lens *c* slides up and down a brass rod, screwed into a steady foot; or it may be fixed into the stage of the microscope, through which the light is finally concentrated upon the object from the table gas-lamp *d*. Mr. Brooke's method of viewing opaque objects

under the highest powers of the microscope (the  $\frac{1}{8}$  and  $\frac{1}{12}$  inch object-glass) is effected by two reflections. The rays

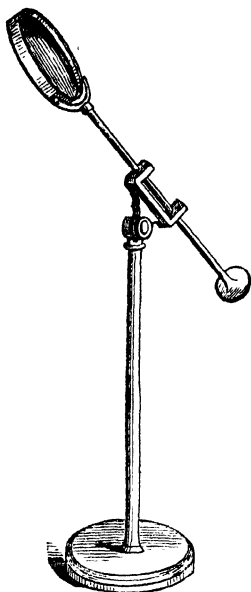

Fig. 45.

from a lamp rendered parallel by a condensing lens are received on an elliptic reflector, the end of which is cut off a little beyond the focus; the rays of light converging from this surface are reflected down on the object by a plane mirror attached to the object-glass, and on a level with the outer surface. By such means the structure of the scale of the Podura, and the different characters of its inner and outer surfaces, are rendered distinctly visible. Silver specula, known as Lieberkuhn's, are much employed, and preferred by some microscopists. The Lieberkuhn is concave, and attached to the object-glasses, from the two-inch to the half-inch, in the manner represented at

fig. 47, where *a* exhibits the lower part of the compound body; *b* the object-glass, over which is slid a tube and the Lieberkuhn *c* attached to it; the rays of light reflected from the mirror are brought to a focus upon an object *d*, placed between it and the mirror. The object may either be mounted on a slip of glass, or else held in the forceps *f*; and when too small to fill up the entire field of view, or when transparent, it is necessary to place behind it the dark-well *e*.

Each Lieberkuhn being mounted on a short piece of tube, can be slid up and down on the outside of the object-glass, so that the maximum of illumination may be readily obtained. In the higher powers the end of the object-glass is turned small enough to pass through the aperture in the

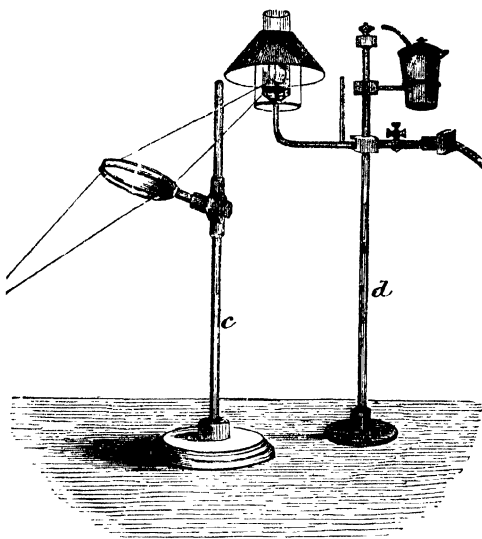

Fig. 46.—Condenser and Table-lamp.

centre of the Lieberkuhn; but in the lower powers, where a great amount of reflecting surface would be lost on account of the large size of the glasses employed if this plan were adopted, the aperture in the centre of the Lieberkuhn is made to admit as many rays as will fill the field of view, and no more.

*Lamps.*—The achromatic gas-lamp, fig. 48, is the best and most economical.<sup>1</sup> Gas, as a source of light, presents great advantages over oil and spirit, on account of cleanliness, being

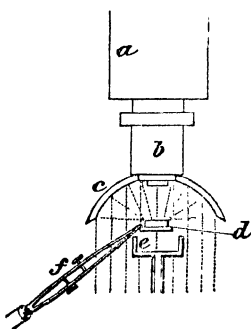

Fig. 47.

(1) Matthews, of Portugal Street, supplies lamps, condensers, and other articles useful to the microscopist.



ever ready for use, and affording a perfect control over the flame; but when the ordinary gas-lamps are used

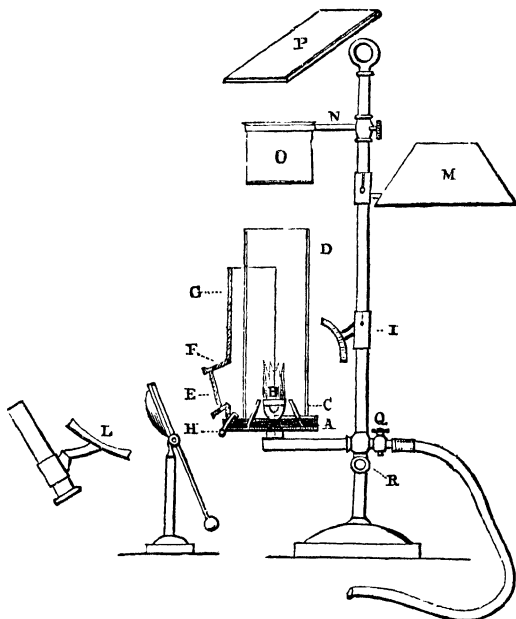

Fig. 48.—Gas-lamp, &c.

for the purpose of illuminating the field of the microscope, a yellow glaring light is given, alike injurious to the eye and the definition of the object under examination. To correct these evils, this lamp was arranged, which is also otherwise useful to the microscopist. It consists of a stage A, supported by a tube and socket, sliding on an upright rod rising from the stand. This carries an Argand burner B; a metal cone C rises to the level of the burner, and is about one-eighth of an inch from its outer margin.

This arrangement gives a bright *cylindrical* flame. The bottom of the stage A is covered with wire-gauze, to cut

off irregular currents of air, and thus secures a *steady flame*. Over the burner is placed a Leblond's blue glass chimney *D*. This corrects the colour of the flame to a certain extent ; but it is still further rectified by a disc of bluish-black neutral-tint glass *E*, fitted in a tube *F*, attached obliquely to the shield *G*. *G* is a half-cylinder of metal, which serves to shield the eyes from all extraneous light, but may be rotated on the stage *A* by aid of the ivory knot *H*, when the full light from the flame is desired. A metallic reflector *I*, fixed on its supports, so as to be parallel to *E*, concentrates the light. By the combination of the two glasses *D* and *E*, the yellow rays of the flame are absorbed, and the arrangement affords a soft white light, which may be still further improved by receiving the rays on a concave mirror, backed with plaster-of-Paris *L* ; and where a very strong light is required, a condensing lens should be interposed, as shown in the cut, between the lamp and the mirror of the microscope. By removing the shield *G*, and bringing the shade *M* over the burner, it may be used as a reading-lamp. A retort ring *N* supports a water-bath *O*, or a wrought-iron plate *P*, 6 inches by  $2\frac{1}{2}$  inches, both used in mounting objects. The stop-cock *Q* gives the means of regulating the flame. The screw *R* clamps the lamp-head at any height desired. The lamp may be attached to any gas-supply by vulcanised India-rubber tubing. Price, complete, thirty-five shillings.

*Forceps*.—For holding minute objects, such as parts of plants or insects, to be examined either as transparent or opaque objects, the most useful is represented by fig. 49,

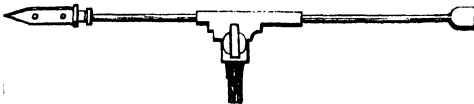

Fig. 49.

and consists of a piece of steel wire, about three inches long, which slides through a small tube, connected to a stout pin by means of a cradle-joint ; to one end of the wire is attached a pair of blades, fitting closely together by their own elasticity, but which, for the reception of any

object, may be separated by pressing the two projecting studs; to the opposite end of the wire is adapted a small brass cup, filled with cork, into which pins, passed through discs of cork, card-board, or other material, having objects mounted on them, may be stuck.

*Dipping-tubes for taking up Animalcules* are tubes of glass, fig. 50, about nine inches in length, open at both

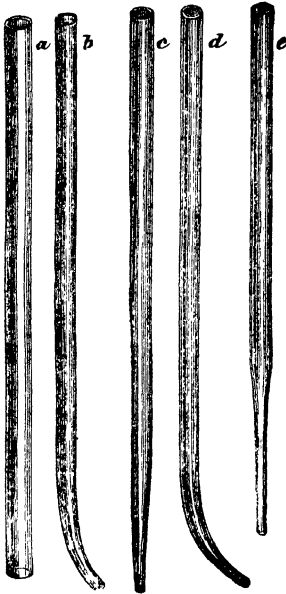

Fig. 50.



Fig. 51.

ends, and from one-eighth to one-fourth of an inch in diameter. The ends should be nicely rounded off in the flame of a blow-pipe; some of them may be straight, whilst others should be drawn out to a fine point, and made of either of the shapes represented. Mr. Varley thus describes the method of using them in volume 48 of the *Transactions of the Society of Arts*. "Supposing the animalcules that are about to be examined to be

contained in a phial or glass jar, as in fig. 51, having observed where they are most numerous,—either with the naked eye, if they are large, or with a pocket-magnifier, if they are small,—either of the glass-tubes, having one end previously closed by the thumb or fore-finger, wetted for the purpose, is introduced into the phial in the manner represented by the figure,—this prevents the water from entering the tube; and when the end is near to the object which it is wished to obtain, the finger is to be quickly removed and as quickly replaced. The moment the finger is taken off, the atmospheric pressure will force the water, and with it, in all probability, the desired objects, up the tube. When the finger has been replaced, the tube containing the fluid may be withdrawn from the phial; and as the tube is almost certain to contain much more fluid than is requisite, the entire quantity must be dropped into a watch-glass, which spreads it, and the insect may be again caught by putting the tube over it, when a small quantity of fluid is sure to run in by capillary attraction. This small quantity is to be placed upon the tablet; but should there be still too much for the tablet, if it be touched with the tube again, it will be diminished accordingly." If we wish to place several individuals together on the tablet, it is necessary that each should be taken up with the smallest amount of water: to effect this, Mr. Varley suggests that the tube should be emptied on a slip of glass, in separate drops; and with one of the capillary tubes, but just large enough to catch them, they may be lifted out one by one, and placed on the tablet. Generally speaking, it is necessary to add a small quantity of vegetable matter to animalcules, to keep them alive; and as many species are found on *confervæ* and duck-weed, some instrument is required to take small portions of such plants out of the



Fig. 52.

jar in which they are growing. For this purpose Mr. Varley uses the forceps fig. 52, made of brass; the points

are a little curved, to keep them accurately together, and the blades are provided with a hole and steadying-pin. This instrument is also useful for picking up minute objects, &c.



Fig. 53.—Collecting Net.

*Collecting Animalcules.*—For collecting the water animalcules, the cambric-muslin net, made similar to a landing-net, fig. 53, will be found to answer the purpose; this should be secured to a brass ring *a*, and fitted into a socket *b*, by which it can be attached to the end of a walking-stick, or, when not in use, the socket may be carried in the pocket; and the net, by contracting the diameter of the ring (which the construction admits of) may be put inside the hat.

“For<sup>1</sup> the purpose of collecting aquatic animalcules, I use, in preference to any kind of net, stout tin hoops, about four inches diameter, and one and a half deep, nested for stowage. Muslin of different degrees of fineness is strained over one opening of the hoop, and a screw is attached by its head to the rim, fig. 54. The net is thus portable, and is screwed into a hole in the end of a walking-stick, or, what is better, a fishing-rod. I find that for most purposes the fabric called bobbinet answers very well, and catches creatures much smaller than its own meshes, while the free escape of water through the openings, prevents their being washed out, as they frequently are in withdrawing the net from the surface. If the stick have a pike at the other end, it may be stuck in the ground, and those animals that are visible to the naked



Fig. 54.

(1) Communicated by Mr. Gibbons of Australia, to the author.

eye, leisurely picked out with a small thin spoon or palette knife, and transferred to bottles, care being taken that the more voracious ones be separated from their prey; while the thick residuum, containing infusoriæ, &c., may be ladled up, or strained off into its appropriate vessel. On arriving home, the contents of the bottles are poured into one of the finer nets, which is placed in a saucer of water; the drafting-net is then lifted up out of the water, and a final classification must be made. To catch individual creatures that are too large for a fishing-tube, a small spoon-net, made of slips of thin metal, bent into the form of a spoon, with a large hole punched out of the bowl, and muslin cemented to the rim, will be found convenient. This form of net is free from the inconvenience of loose parts of material, in which choice specimens may be confused and lost."

Fig. 55 is a box containing six bottles for holding the animalcules when caught. These bottles should be filled with the water when you collect the animalcules, and the larger put by themselves. When collecting from different localities, take care not to mix the animals from one brook with those from another, otherwise serious conflicts may take place, and on reaching home you will find the greater part of your stock either dead or dying. Always separate the various sizes and races as speedily as possible.

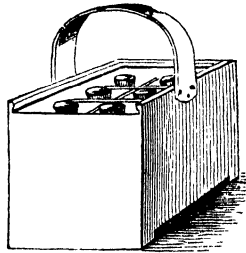

Fig. 55.

This can be done most easily by emptying each bottle in its turn into a soup-plate; then with the feather of a pen first lift out the smaller ones, and with the quill-end cut like a scoop lift out the larger, classifying and allotting each species to its separate "fish-pond."

The best localities in the neighbourhood of London for collecting, are Epping Forest, Hampstead Heath, and Blackheath.

Mr. Williamson uses a cheap and simple contrivance for converting the end of a walking-stick or umbrella into

what he terms a "collecting-stick." In fig. 56, *a* represents a piece of whalebone, about 18 inches long, bent round the end of the stick or umbrella, *b*, and made fast in that position by one or two rings, *c*, of gutta-percha, india-rubber, or of brass, *d*. A small wide-mouthed bottle, having a rim which will prevent its falling through, is now inserted in the loop thus formed, and is held tightly there by the ends of the whalebone being drawn further through the ring, and thus diminishing the size of the loop. The bottle thus fixed may be used for dipping out the animalcules. Whalebone can be moulded to any form by placing it for a short time near the fire.

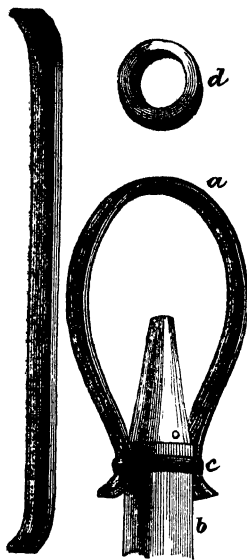

Fig. 56.

*Animalcule Cage.*—Mr. Varley, in the year 1831, greatly improved the form of this instrument by making a channel all round the object-plate, so that the fluid and the animalcules in

it were retained at the top of the object-plate by capillary attraction; and they then bear turning about in all directions without leaving the top, provided the cage be not suddenly shaken. The cover is made to slide down upon the object-plate. The plate of brass to which the tube supporting the tablet and cover is attached, is of a circular form, slightly flattened on two opposite sides for convenience of package. One of these instruments is seen in elevation and in section in fig. 57. *AB*, in both figures, is the flat plate of brass to which the short tube carrying the object-plate or tablet is fixed; *d*, the piece of brass into which the tablet *c* is fastened; *b*, the tubular part of the cover, into the rim of which the thin plate of glass *a* is cemented.

Many microscopists make use of a *compressorium*, an

instrument in which an object may be submitted to graduated pressure between two plates of glass, the parallelism

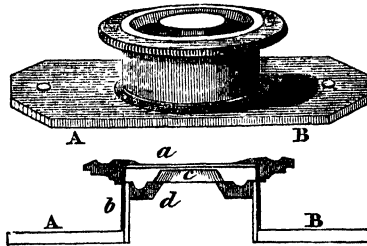

Fig. 57.—Varley's Animalcule-cage.

of which is perfectly maintained. The class of investigations in which the compressorium is valuable, is that in which such structures as the minute ovum need be closely scrutinised, without any further change in their shape than may render their contents more distinctly visible. For such purposes, a steady hand and a well-made animalcule cage, such as the one previously described, will answer very well.

Smith and Beck's troughs for chara and polypes, a sectional view of which is shown at fig. 58, are made of three pieces of glass, the bottom being a thick strip, and the front *a* of thinner glass than the back *b*; the whole is cemented together with Jeffery's marine-glue. The method adopted for confining objects near to the front glass varies according to circumstances. One of the most convenient plans is to place in the trough a piece of glass that will stand across it diagonally, as at *c*; then if the object be heavier than water, it will sink, until stopped by this plate of glass. At other times, when used to view chara, the diagonal plate may be made to press it close to the front by means of thin strips of glass, a wedge of glass or cork, or even a folded spring. When using the trough, it is necessary that the microscope should be in a position nearly horizontal.



Fig. 58.

. *Dissecting Knives, &c.*—Knives and needles of various



kinds and sizes are required for microscopic dissection : the best for the purpose are represented in figs. 59 and 60, being,

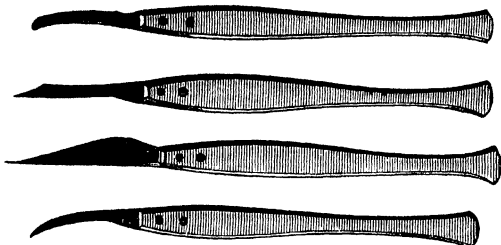

Fig. 59.

in fact, the very delicately made knives used by surgeons in operations upon the eye. Dissecting needles may be either straight or curved. They may be fixed, or made to take in and out of their handles. The most convenient

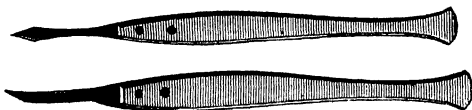

Fig. 60.

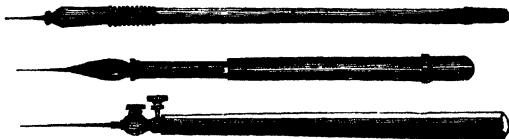

Fig. 61.

are shown in fig. 61 ; those made of Palladium by Mr. Weedon, Hart Street, are very much the best.

In the preparation of objects, no microscopist was ever more successful than Swammerdam : " His chief delight seems to have been in constructing very fine scissors, and giving them an extreme sharpness ; these he made use of

to cut very minute objects, because they dissected them equally, whereas knives, if ever so fine and sharp, are apt to disorder delicate substances. His knives, lancets, and styles were so fine, that he could not see to sharpen them without a magnifying glass." (Fig. 65.)

The mode adopted for breaking up tissues into very small pieces is usually conducted, as represented at fig. 62,

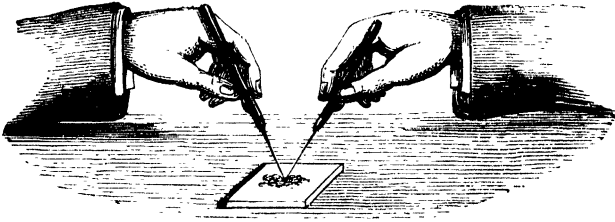

Fig. 62.—*Teasing-out membrane.*

with a pair of the small needles held firmly between the fore-finger and thumb. The structure must be *teased* out; an operation which requires care and perseverance, as most of the animal tissues are very difficult of separation. All substances should be carefully separated from dust and other impurities which renders their structure indistinct or confusing. With very delicate membranes, and with those of the nervous system of the smaller animals, insects, &c., it becomes necessary that the investigation should be carried on under water, or in fluid of some sort, in a glass cell, and having a strong light thrown down upon it by the aid of the condensing lens, as represented in fig. 63. A certain amount of change of structure must be expected and allowed for; as nearly all membranes imbibe some portion of the fluid. Delicate structures are often advantageously wetted with dilute solutions of sugar or common salt, to prevent the changes from endosmosis, which result from the use of pure water. The contents of bodies are frequently rendered more distinct by the addition of re-agents referred to further on.

Cells or troughs are made out of pieces of stout plate-glass, their edges being accurately ground, and cemented

together with *marine-glue* or sealing-wax : the size of the trough should be about three inches square and one deep.

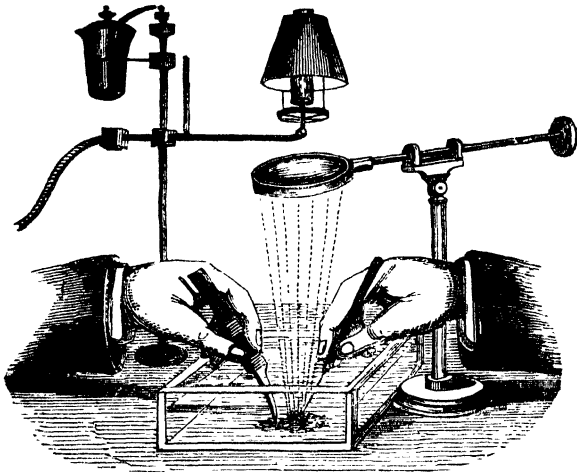

Fig. 63.—Dissecting under water.

If thought desirable to dissect under the microscope itself, the instrument must be brought over the trough, and the subject adjusted to the focus of an inch or a two-inch magnifier, as it is difficult to employ a higher power. The simple microscope is that generally employed for the purpose. If the object be a portion of an injected animal, it is better to pin it out on a piece of cork, covered with *white wax*, and then immerse it in the water-trough ; the more delicate the structure, the sooner after death should it be examined, especially animal tissues. With most vegetable structures, the dissection should be carried on under water. The separation of the woody and vascular tissues, and the spiral vessels, is best effected by maceration and tearing with fine needles.

*Valentin's Knife*.—For making fine sections of large substances, or those soft in structure, such as the liver,

spleen, kidney, &c., the double-bladed knife, the invention of Professor Valentin, may be used with advantage. An improved construction of this knife, by Professor Quekett, is represented in fig. 64. It consists

of two blades, one of which is prolonged by a flat piece of steel to form a handle, and has two pieces of wood riveted to it, for the purpose of its being held more steadily; to this blade another one is attached by a screw; this last is also lengthened by a shorter piece of steel, and both it and the preceding have slits cut out in them exactly opposite to each other, up and down which slit a rivet with two heads is made to slide, for the purpose either of allowing the blades to be widely separated or brought so closely together as to touch. One head of this rivet, being smaller than the hole in the end of the slit, can be drawn through it; so that the blade seen in the front of the figure may be turned away from the other in order to be sharpened, or allow of the section made by it being taken away from between the blades. The blades are so constructed that their opposed surfaces are either flat or very slightly concave, that they may fit accurately to each other, which is effected more completely by a steadying pin, seen at the base of the front blade. When the instrument is required to be used,

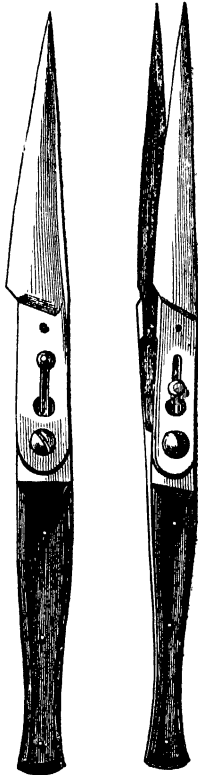

Fig. 64.

the thickness of the section about to be made will depend upon the distance the blades are apart: and this is regulated by sliding up or down the rivet, as the blades, by their own elasticity, will always spring open and keep the rivet in place; a cut is then to be made by it, as with an ordinary knife, and the part cut will be found between

the blades, from which it may be separated either by opening them as wide as possible by the rivet, or by turning them apart in the manner before described, and floating the section out in water.

*Dissecting Scissors.*—In addition to the forceps and knives, scissors will be necessary for the purposes of dissection: of these the most useful are shown in fig. 65. They



Fig. 65.—Dissecting Scissors.

are made both straight and curved; of the first kind, two pairs will be required, one having the extremities broad, and the other sharp-pointed; if large dissections be undertaken, a still stronger pair, with the extremities broad, and made rough like a file, will be necessary. In dissecting under the microscope, the curved-pointed pair shown at *f* are the most convenient. In all of these instruments the points should fit accurately together: sometimes those that are very sharp are apt to cross; this may in a great measure be prevented by having the branches wide at the base where they are riveted. The points can be sharpened on a hone, and a magnifier employed to examine if they fit closely together.

Fig. 66 represents Mr. Gibbon's "Section-cutting Machine." It consists of a stout brass frame, *A A*, having an opening in the top plate, for a tube *B*, half an inch in diameter, and in depth one and a half inches. In this tube a loose piston, *c*, works freely, and is steadied by the slot seen in it. To a female screw *D*, motion is given by the toothed wheel; and the teeth of which, *E*, answer the triple purposes of thumb-milling, ratchet-stop, and

graduation. This is screwed to a block of wood, *r*, having a rabbet cut in for the purpose of securing it to the table.

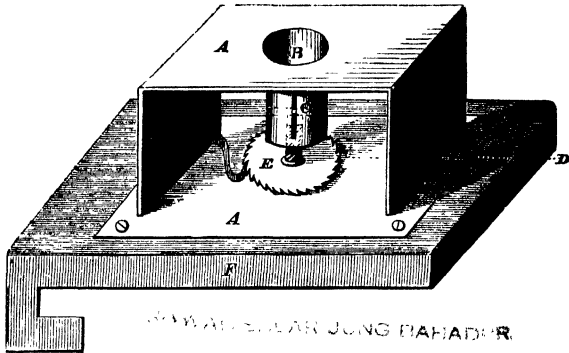

Fig. 66.—Section Cutting Machine.

The machine is self-regulating, and is capable of being worked as rapidly as the skill of the operator may dictate.

Sections of woods, when cut from hard woods containing gum, resin, &c., should be soaked in essential oil, alcohol, or ether, before they are mounted as transparent objects. A razor may be fixed to the bench for the purpose of cutting these fine sections, or a fine plane will answer very well. The instrument used by Mr. Topping, fig. 67, consists of *a b*, a flat piece of mahogany, seven inches long and four wide, to the under surface of which is attached, at right angles, a piece *g* of same size as *a b*. *d* is a flat plate of brass, four inches long and three wide, screwed to the upper surface of *a b*; to the middle of this plate is attached a tube of the same metal *e i*, three inches long and half an inch in diameter, and provided at its lower end with a screw *f*, working in a nut, and having a disk *k* exactly adapted to the bore of the tube; this disk is connected with the upper end of the screw, and is moved up or down by it. *c* is another screw connected with a curved piece of brass *h*, which is capable of being carried to the opposite side of the tube by it. The piece of wood about

to be cut is put into the tube *e*, and is raised or depressed by the screw *f*; whilst, before cutting, the curved piece of

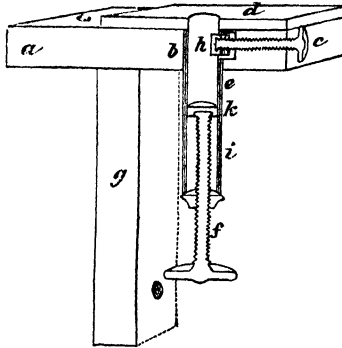

Fig. 67.—Topping's Section Cutting Machine.

metal *h* should be firmly pressed against it by the screw *c*. This instrument, if fastened to the edge of a bench or table, is always ready for use. The knife employed may be one constructed for the purpose; or a razor ground flat on one side.

*Method of making Sections.*—If the wood is green, it should be cut to the required length, and be immersed for a few days in strong alcohol, to get rid of all resinous matters. When this is accomplished, it may be soaked in water for a week or ten days; it will then be ready for cutting. If the wood be dry, it should be first soaked in water and afterwards immersed in spirit, and before cutting placed in water again, as in the case of the green wood. The wood, if too large, should be cut so as to fit tightly into the square hole, and be driven into it by a wooden mallet; if, on the contrary, it be round, and at the same time too small for the hole, wedges of deal or other soft wood may be employed to fix it firmly: these will have the advantage of affording support, and if necessary, may be cut with the specimen, from which they may afterwards be easily separated. The process of cutting consists in raising the wood by the micrometer screw, so that the

thinnest possible slice may be taken off by the knife; after a few thick slices have been removed to make the surface level, a small quantity of water or spirit may be placed upon it; the screw is then to be turned one or more divisions, and the knife passed over the wood until a slice is removed; this, if well wetted, will not curl up, but will adhere to the knife, from which it may be removed by pressing blotting-paper upon it, or by sliding it off upon a piece of glass by means of a wetted finger. The plan generally adopted is to have a vessel of water by the side of the machine, and to place every section in it: those that are thin can then be easily separated from the thick by their floating more readily in the water; and all that are good, and not immediately wanted, may be put away in bottles with spirit and water, and preserved for future examination. If the entire structure of any exogenous wood is required to be examined, the sections must be made in at least three different ways; these may be termed the transverse, the longitudinal, and the oblique, or, as they are sometimes called, the horizontal, vertical, and tangential: each of these will exhibit different

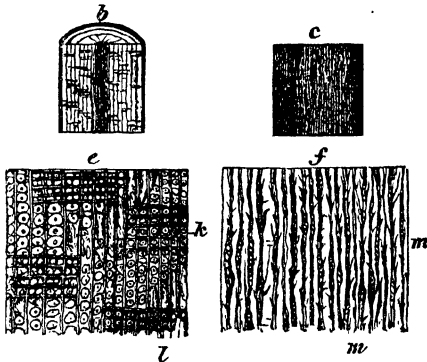

Fig. 68.—Sections of Wood.

appearances, as may be seen upon reference to fig. 68: *b* is a vertical section through the pith of a coniferous plant: this exhibits the medullary rays, which are known



to the cabinet-maker as the silver grain; and at *e* is a magnified view of a part of the same: the woody fibres are seen with their dots *l*, and the horizontal lines *k* indicating the medullary rays cut lengthwise; whilst at *c* is a tangential section, and *f* a portion of the same magnified: the openings of the medullary rays *m m*, and the woody fibres with vertical slices of the dots, are seen. Very instructive preparations may be made by cutting oblique sections of the stem, especially when large vessels are present, as then the internal structure of the walls of some of them may oftentimes be examined. The diagram above given refers only to sections of a pine; all exogenous stems, however, will exhibit three different appearances, according to the direction in which the cut is made; but in order to arrive at a true understanding of the arrangement of the woody and vascular bundles in endogens, horizontal and vertical sections only will be required. Many specimens of wood that are very hard and brittle may be much softened by boiling in water; and as the cutting-machine will answer other structures besides wood, it may here be stated, that all horny tissues may also be considerably softened by boiling, and can then be cut very readily.<sup>1</sup>

*Preparation of Hard Tissues.*—All sections of recent and greasy bones should be soaked in ether for some time, and afterwards dried in the air, before they are fit for the saw, file, and hone; by dissolving out the grease, the lacunæ and canaliculi show up very much better. When we wish to examine the bone-cells of fossil bone, chippings only are required; these may be procured by striking the bone with the sharp edge of a small mineralogical-hammer: carefully select the thinnest of the chips, and mount them at once, without grinding, in Canada balsam. If desirable to compare bone structures, it must be borne in mind that the specimens for comparison should be cut in one and the same direction; as the bone-cells, on which we rely for our determination, are always longest in the direction of the shaft of the bone, it follows that if one section were transverse, and the other longitudinal, there must be a vast difference in the measurement of the bone-cells, in consequence of their long diameter being seen in the one case,

(1) See Professor Quekett on the *Microscope*.

and their short diameter in the other. In all doubtful cases, the better plan is to examine a number of fragments, both transverse and longitudinal, taken from the same bone, and to form an opinion from the shape of bone-cell which most commonly prevails.

*The Teeth.*—The best mode of examining teeth is by making fine sections. Specimens should be taken, both from young and old teeth, to note the changes. A longitudinal or transverse slice should be first taken off; a circular saw, fitted to the lathe, fig. 69, cuts sections very quickly—then rub down, first by the aid of the *corundum-wheel*,—which should also be fitted to the head-stock of the lathe,—then finish them off between two pieces of water-of-Ayr stone, and finally clean and polish between plates of glass, or on a polishing strap with putty powder. The section requires to be washed in ether, to remove all dirt and impurities; when well polished and dried, it may be preserved under thin glass, and cemented down with gold-size or varnish.

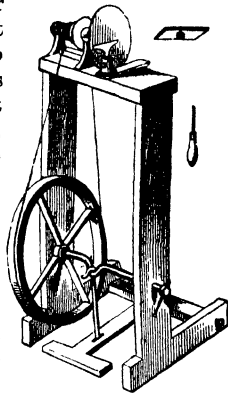

Fig. 69.—Small Lathe for polishing.

Such polished sections are preferable to many others which, on account of their irregular surface, require to be covered with fluids, as Canada-balsam, turpentine, &c., in order to fit them for examination with high powers. It almost always happens, that some portion of these fluids enters the dentine, which then becomes indistinct, and almost invisible in its ramifications.

Two sections made perpendicularly to one another through the middle of the crown and fang of a tooth, from before backwards, and from right to left, are sufficient to exhibit the more important features of the teeth; but sections ought also to be prepared, showing the surface of the pulp cavity and that of the enamel; and likewise various oblique and transverse sections through the dentine

in the fangs, to exhibit the anastomoses of their branches. The dental cartilage is easily shown by maceration in hydrochloric-acid, a process which requires a longer or shorter time, according to the concentration of the acid. It is very instructive also to macerate thin sections in acid, and to examine them upon a slip of glass, at intervals, until they entirely break up. The enamel prisms are readily isolated in developing enamel in this way, and the transverse lines readily seen when the section is moistened with hydrochloric acid. The early development may be studied in embryos of two, three, or four months with the simple microscope; and in transverse sections of parts hardened in spirits of wine. The pulp of mature teeth is obtained by breaking them in a vice, and the nerves can be made out without difficulty on the addition of a dilute solution of caustic soda.

To cut through the enamel of the tooth, it will be necessary to lessen the friction, by dropping water upon the saw as it is made to revolve. The section is afterwards very quickly ground down by holding it against the flat side of the corundum-wheel.<sup>1</sup> A small handle, mounted with shell-lac, to fix the section in, forms a ready holder: polish, as before directed, between two pieces of the water-of-Ayr stone, or on a hone of Turkey-stone kept wet with water. As the flatness of the polished surface is a matter of the first importance, that of the stones themselves should be tested from time to time; and whenever they are found to have been rubbed down on one part more than another, they should be flattened on a paving stone with fine sand, or on a lead plate with emery. When this has been sufficiently accomplished, the section is to be secured, with Canada balsam, to a slip of thick well-annealed glass, in the following manner:—Some Canada balsam, previously rendered somewhat stiff by evaporation of part of its turpentine, is to be melted on the glass-slip, so as to form a thick drop, covering a space somewhat larger than the size of the section, and it should then be set aside to cool; during which process, the bubbles that may have formed in it will usually burst. When cold, its

(1) Corundum is a species of emery composition; alumina, red oxide of iron, and lime; it is much used by dentists as a polishing material.

hardness should be tested with the edge of the thumb-nail, for it should be with difficulty indented by pressure, and yet should not be so resinous as to be brittle. If it be too soft, as indicated by its too ready yielding to the thumb-nail, it should be boiled a little more; if too hard, which will be shown by its chipping, it should be re-melted and diluted with more fluid balsam, and then set aside to cool as before. When of the right consistence, the section should be laid upon its surface, with the polished side downwards; the slip of glass is next to be gradually warmed until the balsam is softened, care being taken to avoid the formation of bubbles, and the section is then to be gently pressed down upon the liquefied balsam in a sort of wave towards the side, and an equable pressure being finally made over the whole. When the section has been thus secured to the glass, it may be readily reduced in thickness by grinding. When the thinness of the section is such as to cause the water to spread around it between the glass and the stone, an excess of thickness on either side may often be detected by noticing the smaller distance to which the liquid extends. In proportion as the section attached to the glass is ground away, the superfluous balsam which may have exuded around it will be brought into contact with the stone; and this should be removed with a knife, care being taken that a margin be still left round the edge of the section. As the section approaches the degree of thinness which is most suitable for the display of its organization, great care must be taken that the grinding process is not carried too far; and frequent recourse should be had to the microscope to examine it. The final polish must be given upon a leathern strap, or upon the surface of a board covered with buff-leather, sprinkled with putty-powder and water, until all marks and scratches have been rubbed out of the section.

In mounting sections of bone, or teeth, it is important to avoid the penetration of the Canada balsam into the interior of the *lacunæ* and *canaliculi*; since, when these are filled by it, they become almost invisible. The benefit which is derived from covering the surfaces of the specimen with Canada balsam, may be obtained, without the injury resulting from the penetration of the balsam

into its interior, by adopting the following method:— A small quantity of balsam, proportioned to the size of the specimen, is to be spread upon a slip of glass, and to be rendered stiffer by boiling, until it becomes nearly solid when cold; the same is to be done to the thin glass cover; next, the specimen being placed on the balsamed surface, and being overlaid by the balsamed cover, such a degree of warmth is to be applied as will suffice to liquefy the balsam, without causing it to flow freely; and the glass cover is then to be quickly pressed down, and the slide to be rapidly cooled, so as to give as little time as possible for the penetration of the liquefied balsam.

*Circular Disc.*—For the purpose of cutting glass covers or making shallow cells with jappanners' gold-size for mounting objects, fig. 70 will be found useful; it is made

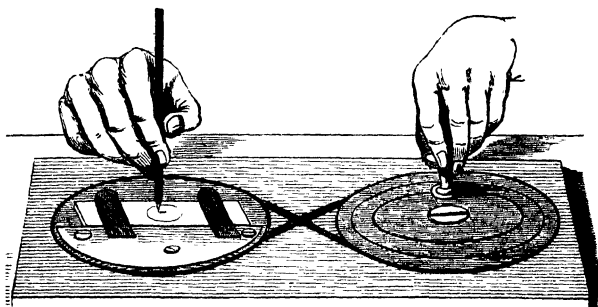

Fig. 70.—Circular Disc Machine.

of two circular wheels of wood, these being let into a solid block of wood, and secured there by central screws. A handle of wood is fixed into the upper part of one, for the purpose of turning it round, the motion being communicated to the other by an endless band of catgut running in the grooved edge of each. On the upper surface of the wheel, under the right hand, are fixed, by means of screws, two strips of brass, which serve as springs for securing the glass slip; a camel's-hair pencil, previously dipped in jappanners' gold-size, is then taken between the

finger and thumb, and held as represented in the woodcut, when the wheel is put in motion, and a perfect circle is rapidly formed ; the cell is then removed and put aside to dry. In the same way, by securing a sheet of thin glass under the brass springs, and substituting for the pencil a cutting diamond, a circular cover may be readily cut out. A cutting diamond is not only useful to the microscopist for the above purpose, but also for writing the names of mounted objects on the ends of the glass slides. A glazier's diamond for cutting glass slides is both convenient and economical : the mode of using it may be acquired in any glazier's shop. Mr. Brooke used a small brass press for the purpose of cutting out thin glass for cells. This does its work so quickly and so well, that it is likely to supersede all other methods.

*On mounting and preserving Objects.*—Microscopic objects are usually mounted on slips of glass three inches by one inch, either dry or immersed in some fluid. The minute structures, such as the tissues of animals, parts of insects, vessels of plants, &c., must be preserved in thin cells, made as directed above, with a small amount of fluid.<sup>1</sup> Clean the glass with a weak solution of ammonia or potash, from all grease, and wipe it dry with a piece of chamois leather or cotton velvet ; cloth generally leaves behind it small filaments, which are always unsightly when seen near the object. Let fall a drop of the preserving fluid or Canada balsam on the centre of the glass ; then place the object in it with a small pair of forceps, and

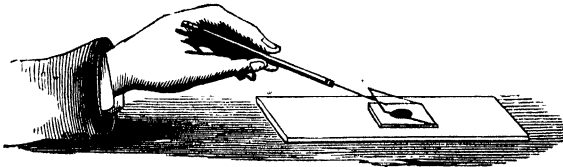

Fig. 71.

spread it out very carefully with the point of one of your fine needles. Select a thin glass cover, previously cleaned,

(1) Cells for microscopic purposes may be purchased of Mr. Bender, 6 Brunswick Place, City Road, or of Mr. Baker, 244, High Holborn.

touch its edges with cement, and let it fall gently and gradually down upon the object, as represented in fig. 71 ; press it lightly to exclude any excess of fluid, which remove with strips of blotting-paper, being careful to do all this with a light hand, that small bubbles of air may not insinuate themselves to replace any lost fluid : air-bubbles are at all times unsightly, and liable to spoil an object when allowed to remain. Lastly, cement the edges of the cover to the bottom glass with japanners' gold-size, or sealing-wax varnish, carefully drawn around the edges with a camel's-hair pencil. To accomplish this more effectually, Mr. J. Gorham invented the "*Brass cementing Pencil*," fig. 72. It is a brass tube, six inches long, with a conical bore, having a lid to screw on. A small portion of the cement, crumbled into fragments, is shot into the tube, which is then ready for use. In using this instrument, the extremity is gently heated in the flame of a spirit-lamp ; and when the cement begins to ooze out, holding the pencil like a pen, the point is traced along each side of the cover, leaving a line of cement in the angle. The cement recommended by Mr. Quekett for cementing deep cells, is made by melting together two ounces of black resin, one ounce of bees'-wax, and one of vermilion. Mr. Hett prefers dark-coloured, and old, japanners' gold-size for securing the cells of his beautifully delicate injected preparations.<sup>1</sup> Mr. Brooke uses Brunswick black, to which has been previously added a little India-rubber dissolved in mineral naphtha, to prevent its cracking when dry. A very useful cement for fine work will be made by heating Canada balsam until it becomes a hard resin : dissolve it in ether, and it is ready for use. It possesses the advantage of drying as rapidly as collodion, and, if kept carefully corked, remains fluid for any length of time.



Fig. 72.

Mr. Gorham's drawing and description of a "holder" is similar to one long used by the author, fig. 73, for the purpose of pressing together objects mounted in the dry

(1) For methods of making good cements, consult Ure's *Dictionary of Arts and Manufactures*.

way, and during the drying process, after maceration, which facilitates removal of objects from time to time, for the purpose of examining them. It is made of two strips of whalebone three or four inches in length, held together at each end with square pieces of brass; these can be



Fig. 73.

moved at pleasure towards the centre, and thus made to exert considerable pressure upon the pieces of glass and the object, which are placed crossways between the strips of whalebone. The small spring-nip sold under the name of the American clothes-peg, when filed down, makes an excellent holder.

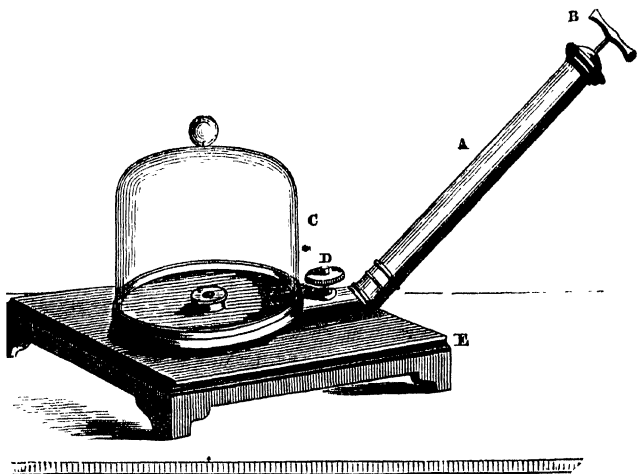

Fig. 74.—Air-Pump.

For the purpose of more effectually removing bubbles of air from the cells before the objects are cemented down,



the small air-pump, fig. 74, is very serviceable. This is made by Baker, of Holborn, at a moderate price. The mode of using it, after the object has been placed under the bell-glass *c*, is by drawing up and pushing down the handle *B*, to pump out the air from around the object to be secured and preserved. By turning the small screw at *D*, you let in sufficient air to remove the bell-glass: it is better to allow the object to remain under for several hours until the cement around the edge of the glass cover becomes perfectly dried and secure; then, upon exposure to the external air, it will no longer affect it. It will be also found useful in withdrawing the air from the cells of woods. The pump itself, *A*, when unscrewed, can be used as an injecting syringe for fine anatomical injections.

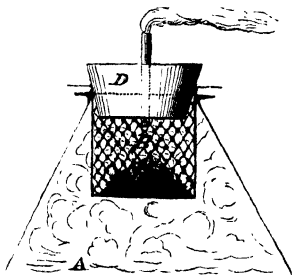

Fig. 75.—*Steam Bath*, by Mr. Gibbons.

The accompanying is a drawing of a simple form of *Steam Bath*, for mounting, and other uses. *A* is a conical tin boiler, five inches in diameter, just large enough to enable the operator to vaporize a small quantity of water when placed over a lamp. *B* is a cage of perforated metal, made to hold one or more objects, which should fit tightly at the collar *D*; into this a small escape-pipe is stopped with cork or luting, so that the steam shall pass around the object, and escape through it.

This will also serve for the immersion of objects, such as parts of insects, &c., in turpentine, previous to mounting them in balsam. The plan recommended is, to immerse

the objects in a bath of turpentine, and then exhaust it under the air-pump before applying the Canada balsam. The limpidity of the turpentine allows of the free escape of air, and when the object is removed from the bath to be mounted, the balsam blends with the turpentine, and follows it into the minute cavities whither it could not alone have penetrated. This turpentine bath is most useful for killing insects, and possesses the advantage of making them protrude their probosces, lancets, &c.; they are rendered more transparent than after killing by other means. If it is intended to dissect out any part, then Swammerdam's plan of suffocating in spirits will perhaps be more suitable. But the best plan is to touch the mouth and spiracles of the insect with a pencil dipped in creosote; this has also a preservative effect, and equally with spirit possesses the advantage of hardening the viscera, which tends materially to aid in their dissection, at least so long as the albuminous portions are not very much coagulated, so as to cause the delicate organs to adhere together.

Mr. Boys says:—"For mounting objects in Canada balsam, the first thing to be considered is the apparatus required.

"1st. A small single-wick oil-lamp, having a glass chimney about four inches long; the flame to be about the size of that in a hand-lantern: a spirit lamp will do even better.

"2d. Slips of glass of required size, and small pieces of thin glass to cover the object, all well cleaned.

"3d. A pair of nippers to hold the glass slips.

"4th. A pointed iron piercer in a wooden handle.

"5th. A bottle containing the clearest Canada balsam, diluted with the best spirits of turpentine to a consistency allowing it to drop readily from one end of the iron piercer, or Mr. Gorham's *cementing pencil*. The preceding articles being spread before you ready for use, and the object to be displayed well examined for choice of position, and cleaned if necessary, fix the glass slip in the nippers, dip the piercer into the balsam, and withdraw a full-sized drop to place upon the slide. The centre of the slide should now be rested across the chimney of the lamp until the balsam begins to spread, when it must be immediately withdrawn.

The object is then to be placed on this balsam, and at once covered with a second drop, applied in the same way as the first; in this state the slide should remain (covered to exclude the dust) for two or three minutes, that the balsam may have time to penetrate; the thin glass is then to be taken up between the finger and thumb, and placed gently upon the balsam covering the object. The slide being now held by the nippers at one end, place the other extremity over the lamp-chimney, so that the heat may be gradually extended towards the object. The proof of its having done so sufficiently will be that the balsam flows to the edge of the thin glass, taking with it all air-bubbles from that part nearest the heat. The slide is now to be turned, the heated end being placed in the nippers, and the process repeated. The slide should remain flat till nearly cool, when pressure should be made perpendicularly with a small piece of wood on the upper glass; this will expel all superfluous balsam, and with it all extraneous matter. Should any air-bubbles remain, they generally disappear in a few days. If the balsam requires hardening, place the slide on the mantel-piece, the gentle heat here will prove sufficient."

Mr. Deane recommends a composition of gelatine for mounting dry or moist animal or vegetable structures, in place of Canada balsam; his formula for which is as follows:—

"Take of White's patent size, 6 ounces by weight; honey, 9 ounces by weight; add a little spirits of wine and a few drops of creosote; mix and filter whilst hot, to render perfectly clear. Or take of pure glycerine, 4 fluid ounces; distilled water, 2 fluid ounces; gelatine, 1 ounce by weight; dissolve the gelatine in the water made hot, then add the glycerine and mix with care; this need not be filtered.

"It is probable that some animalcules may be better shown if some moisture be allowed to remain in the medium, the evaporation from which may be stopped at any stage by filling round the edge of the cover with some gold-size varnish, or even boiled linseed-oil. For many delicate objects this has a great advantage over Canada balsam, in not possessing the high refractive power of that substance; and the minute hairs and other parts of insects,

that are quite obliterated with the balsam, are beautifully shown in this medium."

Glycerine was introduced by Mr. Warington, as a preservative fluid for mounting organic substances in. The method adopted by him in the employment of glycerine, is simply to mount the object in the manner it is usually performed when spirit of wine or creosote-water is used as a medium, and having covered the immersed object with the thin glass, and removed all excess of liquid, to cement the margin with a coating of shell-lac varnish; the one usually employed consists of the ordinary black sealing-wax dissolved in rectified spirit of wine. Care must be taken during this operation to maintain the slider in a flat position, until the varnish has become dry from the evaporation of the spirit, and also until a sufficient number of coatings or layers of the varnish have been applied to render the subject perfectly secure, and prevent any escape of the fluid. Gold-size or copal dissolved in oil of lavender may be employed to effect the same purpose; and the second and third coatings may, with advantage, consist of either of these, which yield a tough varnish above the lac, which is otherwise liable to become brittle.

The glycerine may be used in its concentrated form or treacly state, or it may be diluted with distilled water to any required extent, according to the object of the operator, and the subject to be mounted; if there be extremely fine markings on the subject, it is better to add about four or five times its volume of water, as otherwise the thick fluid may prevent these from being so sharply defined as may be desired.

"I have," adds Mr. Warington, "a number of slides of *Desmidiæ*, which have been mounted from four to ten months by this means, and they have kept excellently. The glycerine may also be used with the addition of a small portion of culinary salt, corrosive sublimate, creosote, or spirit of wine, if considered desirable."

Glycerine and gelatine combined in certain proportions makes an excellent mounting material; it should be so mixed as to permit of its complete solidification, without liability to crack when cold and dry.

Castor-oil may be used as a medium for mounting

crystals of salts and other objects. The object required to be mounted is placed on the slider in its dry state, or deposited wet and allowed to dry; or if in solution, a drop of the liquid is to be placed on the slip of glass, and allowed to crystallise by spontaneous evaporation; in the latter case, take a drop of a warm saturated solution of the salt required, and when a good group of well-defined crystals has been obtained, break through the marginal ring of crystalline deposit with a small point of wood, and carefully conduct off the uncrystallised portion or mother-liquor to the extremity of the slide, at the same time placing it in a vertical position to drain until it is dry. A small quantity of castor-oil is to be next carefully dropped on the subject, and guided over the field with the point of a needle; in this way it readily displaces the air and occupies the most minute cavities. After a short time the upper glass is to be placed on the surface, taking care to lower it gradually so as to exclude the air; if the field is too full of oil, the excess may be removed by a small piece of bibulous paper; and if, on the contrary, sufficient oil has not been used, an additional portion can be readily introduced by the capillary action between the glasses. The shell-lac varnish is then to be used as the cementing medium in the same way as has been described, and with the same precautions. This varnish cannot be replaced by either of the others, as it is actually necessary (and this should always be borne in mind) that there should exist no affinity between the fluid in the cell and the varnish used to seal it permanently. Hundreds of excellent objects have been lost from this cause, and much valuable time and labour thrown away.

A moderately strong solution of *Arsenious Acid* is found to answer well for the preservation of animal substances; it is prepared as follows:—Boil some arsenious acid in distilled water; when saturated, dilute with four to six parts of distilled water, and filter it for use. Keep in a stopped bottle.

Mr. Goadby's fluids are cheap and most effectual for preserving and mounting animal structures in. The following are his formulæ:—

Take for No. 1 solution, bay salt, 4 oz.; alum, 2 oz.; corrosive sublimate, 2 grains; boiling water, 1 quart: mix.

For No. 2 solution, bay salt, 4 oz. ; alum, 2 oz. ; corrosive sublimate, 4 grs. ; boiling-water, 2 quarts : mix.

The No. 1 is too strong for most purposes, and should only be employed where great astringency is needed to give form and support to very delicate structures. No. 2 is best adapted for permanent preparation ; but neither should be used in the preservation of animals containing carbonate of lime (all the mollusca), as the alum becomes decomposed, sulphate of lime is precipitated, and the preparation spoiled. For such use the following :—

Bay salt, 8 oz. ; corrosive sublimate, 2 grs. ; water, 1 quart : mix.

The corrosive sublimate is used to prevent the growth of vegetation in the fluid ; but as this salt possesses the property of coagulating albumen, these solutions cannot be used in the preservation of ova, or when it is desired to maintain the transparency of certain tissues, such as the cellular tissue, the white corpuscles of the blood, &c.

Mr. Goadby's method of making *marine-glue* for cementing cells is as follows : dissolve separately equal parts of shell-lac and India-rubber in coal or mineral naphtha, and afterwards mix the solutions carefully by the application of heat. It may be rendered thinner by the addition of more naphtha, and is always readily dissolved by naphtha, ether, or solution of potash, when it becomes hard or dry in our stock-pots.

*Preparation and Preservation of Algæ, &c.*—Mr. Ralfs gives excellent directions for making preparations of algæ for microscopic investigations :—“The fluid found to answer best is made in the following way : to sixteen parts of distilled water add one part of rectified spirits of wine, and a few drops of *creosote*, sufficient to saturate it ; stir in a small quantity of prepared chalk, and then filter ; with this fluid mix an equal measure of camphor-water (water saturated with camphor) ; and before using, strain off through a piece of fine linen.

“This fluid I do not find to alter the appearance of the endochrome of algæ more than distilled water alone does after some time ; there is certainly less probability of confervoid filaments making their appearance in the preparations ; and there would seem to be nothing to prevent

such a growth from taking place, when the object is mounted in water only, provided a germ of one of these minute plants happen to be present, as well as a small quantity of free carbonic acid.

“ My method of making cells in which to mount preparations of algæ is as follows : some objects require very shallow, and others somewhat deeper cells. The former may be made with a mixture of jappanners’ gold-size and litharge, to which (if a dark colour is preferred) a small quantity of lamp-black can be added. These materials should be rubbed up together with a painter’s muller, and the mixture laid on the slips of glass with a camel-hair pencil as expeditiously as possible, since it quickly becomes hard ; so that it is expedient to make but a small quantity at a time. For the deeper cells marine-glué answers extremely well, provided it is not too soft. It must be melted and dropped upon the slip of glass ; then flattened, whilst warm, with a piece of wet glass, and what is superfluous cut away with a knife, so as to leave only the walls of the cell ; these, if they have become loosened, may be made firm again by warming the under surface of the slip of glass. The surface of the cells must be made quite flat ; which can be easily done by rubbing them upon a wet piece of smooth marble, covered with the finest emery-powder.

“ When about to mount a preparation, a very thin layer of gold-size must be put upon the wall of the cell, as well as on the edge of the piece of thin glass which is to cover it ; before this is quite dry, the fluid with the object is to be put into the cell, and the cover of thin glass slowly laid upon it, beginning at one end ; gentle pressure must then be used to squeeze out the superfluous fluid ; and, after carefully wiping the slide dry, a thin coat of gold-size should be applied round the edge of the cell, and a second coat so soon as the first is dry ; a thin coat or two of black sealing-wax varnish may then be put on with advantage, in order to prevent effectually the admission of air into the cell, or the escape of fluid out of it.

“ I would remark, that the gold-size employed should be of the consistence of treacle ; when purchased, it is usually too fluid, and should be exposed for some time in

an open vessel ; a process which renders it fit for use. In mounting the *Desmidiæ*, great attention is necessary to exclude air-bubbles, which cannot be avoided unless the fluid completely fills the cells ; and also not to use too much fluid, as in this case the smaller species will often be washed away on the escape of the superfluous portion. As the cells cannot be sealed whilst any moisture remains on their edge, it should be removed by blotting-paper, in preference to any other mode. A thin description of glass is manufactured expressly for the purpose of covering specimens when mounted.

“The rare species of *Desmidiæ* are frequently scattered amongst decayed vegetable matter, so that it is difficult to procure good specimens for mounting. In such cases, a small portion of the mass should be mixed with a little of the creosote fluid, and stirred briskly with a needle. After this has been done, the *Desmidiæ* will sink to the bottom, when the refuse should be carefully removed. Successive portions having been thus treated, specimens will at length be procured sufficiently free from foreign matter. Even in ordinary circumstances, if a small extra quantity of fluid be placed in the cell, and the slide gently inclined, most of the dirt may be removed by a needle before the cell is closed ; which process will materially increase the beauty of the preparation.

“If the cells are insufficiently baked, the japan occasionally peels off the glass after the specimen has been mounted for some time. To obviate this inconvenience, Mr. Jenner previously heats the cell, with much caution, over a rushlight, until the japan becomes of a dark colour, and vapour ceases to arise from it. When *gold-size* is used for closing the cell, the intrusion of some of it frequently destroys valuable specimens, whatever care may be taken. Mr. Jenner has therefore relinquished it, and now employs a varnish made of coarsely comminuted purified *shell-lac* or translucent sealing-wax, to which is added *rectified spirits of wine*, in sufficient quantity to cover it. This varnish will be ready for use in about twelve hours : when it is too thick, a little more spirit should be added. Mr. Jenner applies three coats of this varnish, and about a week afterwards a fourth, composed of *japan varnish* or *gold-*



size.<sup>1</sup> To preserve the brush in a fit state, it should always be cleaned with spirits of wine whenever it has been used."

Mr. Topping's fluid for mounting consists of one ounce of rectified spirits to five ounces of distilled water ; this he thinks superior to any other combination. To preserve delicate colours, however, he prefers to use a solution of acetate of alumina, one ounce of the acetate to four ounces of distilled water : of other solutions he says, that they tend to destroy the colouring matter of delicate objects, and ultimately spoil them by rendering them opaque.

*Injecting Minute Vessels.*—For minute injections, the most essential instrument is a proper syringe. This is

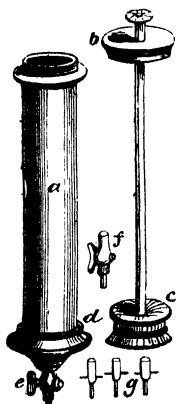

Fig. 76.

usually made of brass, of such a size that the top of the thumb may press on the button at the top of the piston-rod when drawn out, while the body is supported between the two fingers. Fig. 76 represents the syringe : *a* is a cylindrical brass body, with a screw at the top for the purpose of firmly screwing down the cover *b*, after the piston *c* is introduced into it ; this is rendered air-tight with leather ; the bottom of the syringe *d* also unscrews for the convenience of cleaning ; *e* is a stop-cock, on the end of which another stop-cock *f* fits accurately ; and on the end of this either of the small pipes *g*, which are of different sizes, may be fixed. The transverse wires across the pipes are intended to secure them more tightly to the

vessels, into which they may be inserted with thread, so that they may not slip out. In addition to the syringe, a large tin vessel, to contain hot water, with two or three lesser ones fixed in it, for the injections, will be found useful.

To prepare the material for injecting :—Take of the finest and most transparent glue one pound, break it into small pieces, put it into an earthen pot, and pour on it

(1) "Coachmaker's Black" is an excellent varnish.

three pints of cold water ; let it stand twenty-four hours, stirring it now and then with a stick ; then set it over a slow fire for half an hour, or until all the pieces are perfectly dissolved ; skim off the froth from the surface, and strain through a flannel for use. Isinglass and cuttings of parchment make an excellent size, and are preferable for very particular injections. If gelatine is employed it must be soaked for some hours in cold water before it is warmed. About an ounce of gelatine to a pint of water will be sufficiently strong, but in very hot weather it is necessary to add a little more gelatine. It must be soaked in part of the cold water until it swells up and becomes soft, when the rest of the water, made hot, is to be added. Good gelatine for injecting purposes may be obtained for two shillings a pound.

The size thus prepared may be coloured with any of the following :—

For Red.	To a pint of size, add 2 oz. of Chinese vermillion.
„ Yellow.	„ „ 2½ oz. of chrome-yellow.
„ White.	„ „ 3¼ oz. of flake-white.
„ Blue.	„ „ 6 oz. of fine blue smalts.

It is necessary to remember, that whatever colouring matter is employed must be very finely levigated before it is mixed with the injection. This is a matter of great importance: for a small lump or mass of colour, dirt, &c. will clog the minute vessels, so that the injection will not pass into them, and the object will be defeated. The mixture of size and colour should be frequently stirred, or the colouring matter will sink to the bottom. Respecting the choice of a proper subject for injecting, it may be remarked, that the injection will usually go furthest in young subjects ; and the more the fluids have been exhausted during life, the greater will be the success of the injection.

To prepare the subject, the principal points to be aimed at are, to dissolve the fluids, empty the vessels of them, relax the solids, and prevent the injection from coagulating too soon. For this purpose it is necessary to place the animal, or part to be injected, in warm water, as hot as the operator's hand will bear. This should be kept at nearly the same temperature for some time by occasionally adding hot water. The length of time required is in proportion to the size of the part and the amount of its

rigidity. Ruysch (from whom the art of injecting has been called the Ruyschian art) recommends a previous maceration for a day or two in cold water.

The size must always be kept hot with the aid of warm water; for if a naked fire be used, there is danger of burning it. The size may be placed in a vessel which can be heated by standing it in a common tin saucepan of hot water. A convenient form of apparatus for melting the size, and afterwards keeping it at a proper temperature, is

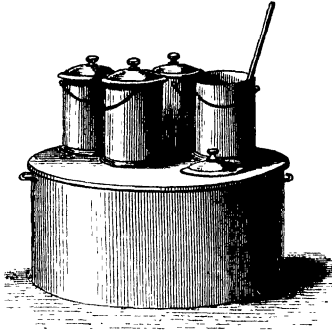

Fig. 77.—*Melting Vessel.*

shown in fig. 77. It consists merely of a water-bath, in which the cans containing the injecting fluid can be kept hot, and their contents protected from dust by means of their covers. A small apparatus of this kind could be made by any tin-worker, and fitted over a gas jet to stand on the table.

The operator should be provided with several pairs of strong forceps, for seizing the vessel or stopping the escape

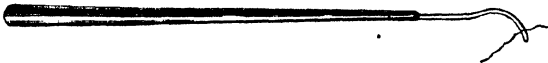

Fig. 78.

of injection. A small needle, fig. 78, will be found useful for passing the thread round the vessel into which the

injecting pipe is to be inserted. Where the vessels are large, a needle commonly known as an aneurism needle answers the purpose very well. The thickness of thread must vary according to the size of the vessel. The silk used by surgeons will be found the best adapted for the purpose, and not too thin, or it may cut through the vessel.

When the size and the subject have both been properly prepared, have the injection as hot as the fingers can well bear. One of the pipes *g*, fig. 76, must then be placed in the largest artery of the part, and made secure by tying. Put the stop-cock *f* into the open end of the pipe *e*, and it is then ready to receive the injection from successive applications to the syringe *a*, leaving sufficient space only for the piston *c*. The injection should be thrown in by a very steady and gentle pressure on the end of the piston-rod. The resistance of the vessels, when nearly full, is often considerable; but it must not be overcome by violent pressure with the syringe. When as much injection is passed as may be thought advisable, the preparation may be left (with the stop-cock closed in the pipe) for twenty-four hours, when more material may be thrown in.

As the method of injecting the minute capillaries with coloured size is often attended with doubtful success, various other plans have been proposed. Ruysch's method, according to Rigerius, was to employ melted tallow coloured with vermilion, to which in the summer a little white wax was added. Monro recommended coloured oil of turpentine for the small vessels; after the use of which, he threw in the common coarse injection. This is made of tallow and red lead, well mixed and heated before it is used. The cold paint injection succeeds well if thrown carefully into the minute arteries; but its tendency to become brown by age is an objection to its use.

Professor Breschet frequently employed with success milk, isinglass, the alcoholic solution of gum-lac, spirit varnish, and spirit of turpentine; but he highly recommends the colouring matter extracted from Campeachy, Fernambone, or Sandal woods. He says: "The colouring matter of Campeachy wood easily dissolves in water and in alcohol; it is so penetrating that it becomes rapidly spread through

the vascular net-works. The sole inconvenience of this kind of injection is, that it cannot be made to distend any except most delicate vessels, and that its ready penetration does not admit of distinguishing between arteries, veins, and lymphatics." He also recommends a solution of caoutchouc.

Another process, which may be termed the chemical process, was published in the *Comptes Rendus*, 1841, as the invention of M. Doyers. According to this, an aqueous solution of bichromate of potash, 1,048 grains to two pints of water, is thrown into the vessels; and after a short time, in the same manner and in the same vessels, an aqueous solution of acetate of lead, 2,000 grains to a pint of water, is injected. This is an excellent method, as the material is quite fluid, and the precipitation of the chromate of lead which takes place in the vessels themselves gives a fine sulphur-yellow colour. Mr. Topping prepares many fine injections in this way.

Mr. Goadby has improved upon the process last named by uniting to the chemical solutions a portion of gelatine, as follows:

Saturated solution of bichromate of potash, 8 fluid ounces; water, 8 ounces; gelatine, 2 ounces.

Saturated solution of acetate of lead, 8 fluid ounces; water, 8 ounces; gelatine, 2 ounces.

The majority of preparations thus injected require to be dried and mounted in Canada balsam. Each preparation, when placed on a slip of glass, will necessarily possess more or less of the coloured infiltrated gelatine, (by this is meant the gelatine coloured by the blood, which, together with the acetate of potash resulting from the chemical decomposition, may have transuded through the coats of the vessel,) which, when dry, forms, together with the different shades of the chromate of lead, beautiful objects, possessing depth and richness of colour. The gelatine also separates and defines the different layers of vessels: the arteries are always readily distinguishable by the purity and brightness of the chromate of lead within them, while the veins are detected by the altered colour imparted by the blood.

Those preparations which require to be kept wet can be

preserved perfectly in Mr. Goadby's No. 2 fluid, specific gravity 1.100; the No. 1 fluid destroys them.

"I would recommend that the slips of glass employed for the dry preparation be instantly inscribed with the name of the preparation, written with a diamond; for, when dry, it is difficult to recognise one preparation from the other, until the operator's eye be educated to the effects of this chemico-gelatinous injection. Where so much wet abounds, gummed paper is apt to come off. When dry, it is sufficient, for the purpose of brief examination by the microscope, to wet the surface of a preparation with clean oil of turpentine; immediately after examination, it should be put away carefully in a box, to keep it from the dust, until it can be mounted in Canada balsam.

"The bichromate of potash is greatly superior in colour to the chromate, which yields too pale a yellow; and subsequent experience has proved that the acetate of potash frequently effects its liberation by destruction of the capillaries, and this even long after the preparations have been mounted in Canada balsam; perhaps this may be owing to some chemical action of the acetate of potash upon them. I would suggest the substitution of the *nitrate* for the *acetate* of lead, as we should then have, in the liberated nitrate of potash, a valuable auxiliary in the process of preservation. Although highly desirable, as the demonstrator of the capillaries of *normal* tissues, I do not think this kind of injection fitted for morbid preparations; the infiltrated gelatine producing appearances of a puzzling kind, and calculated to mislead the pathologist. In preparing portions of dried well-injected skin for examination by the microscope, I have tried the effect of dilute nitric acid as a corroder with very good results. But, probably, liquor potassa would have answered this purpose better.

"When size-injection is to be employed, coloured either with vermilion or the chromate of lead, the animal should be previously prepared by bleeding, to empty the vessels; for if they be filled with coagulated blood, it is quite impossible to transmit even size, to say nothing of the colouring matter. Hence the difficulty of procuring good

injections of the human subject. But with the chemicogelatinous injections no such preparation is necessary; and success should always be certain, for the potash liquefies the blood, while constant and long-continued pressure by the syringe drives it through the parietes of the vessel into the cellular tissue."

*Transparent Injections.*—"Much more strongly," writes Dr. Beale, "can I recommend to you the use of *transparent* fluids for making injections. It is true, that these are not likely to be so much admired by general observers as opaque injections. Indeed, it is not easy to find any object which will rival in beauty many tissues which have been freely injected with vermilion or chromate of lead; although it must be confessed that from such preparations we learn but little save the general arrangement of the capillary vessels of the part, their capacity, and the magnitude of the meshes of the network. Of the relations which these vessels bear to the elementary structures which give to the texture under examination its peculiar properties, such preparations tell us nothing. Opaque injections are for the most part only adapted for examination with low powers, while the tissues to which the vessels are distributed can only be seen with the help of very high magnifying powers. Transparent injections, on the other hand, though they fail to excite the wonder of the uninitiated, show us not only the general arrangement of the capillary network, but the precise relation which each little tube bears to the tissue with which it is in contact.

"In order to make injected preparations for examination by transmitted light, several different substances may be used as injecting fluids.

*Injection with Plain Size.*—A tissue which has been injected with plain size, when cold is of a good consistence for obtaining thin sections, and many important points may be learned from a specimen prepared in this manner which would not be detected by other modes of preparation. A mixture of equal parts of gelatine and glycerine is, however, much to be preferred for this purpose, and the specimen thus prepared is sure to keep well.

*Colouring Matters for Transparent Injections.*—The chief

colouring matters used for making transparent injections are *carmine* and *Prussian blue*. The former is prepared by adding a little solution of ammonia (liquor ammonia) to the carmine, and diluting the mixture until the proper colour is obtained, or it may be diluted with size.

"*The Prussian Blue* consists of an insoluble precipitate, so minutely divided, that it appears like a solution to the eye. The particles of freshly prepared Prussian blue are very much smaller than those of any of the colouring matters employed for making opaque injections.

"*Advantages of Employing Prussian Blue.*—I have lately been employing Prussian blue very much, and according to my experience it possesses advantages over every other colouring matter. It is inexpensive,—may be injected cold,—the preparation does not require to be warmed,—no size is required—it penetrates the capillaries without the necessity of applying much force,—it does not run out when a section is made for examination,—neither do any particles which may escape from the larger vessels divided in making the section, adhere to it and thus render the section obscure,—a structure may be well injected with it in the course of a few minutes. Specimens prepared in this manner may be preserved in any of the ordinary preservative solutions, or may be dried and mounted in Canada balsam, (but I give the preference to glycerine, or glycerine jelly,) and they may be examined with the highest magnifying powers. After having tried very many methods of making this preparation I have found the following one to succeed best.

"*Composition of the Prussian Blue Fluid for Making Transparent Injections:*—

Glycerine . . . . .	1 oz.
Wood, naphtha, or pyroacetic spirit . . . . .	1½ drachms.
Spirits of wine . . . . .	1 oz.
Ferrocyanide of potassium . . . . .	12 grs.
Tincture of sesquichloride of iron . . . . .	1 drachm.
Water . . . . .	4 ozs.

"The ferrocyanide of potassium is to be dissolved in one ounce of the water, and the tincture of sesquichloride of iron added to another ounce. These solutions should be mixed together very gradually, and well shaken in a bottle.



*The iron being added to the solution of the ferrocyanide of potassium.* When thoroughly mixed, these solutions should produce a dark blue mixture, in which no precipitate or flocculi are observable. Next, the naphtha is to be mixed with the spirit, and the glycerine and the remaining two ounces of the water added. This colourless fluid is, lastly, to be slowly mixed with the Prussian blue, the whole being well shaken in a large bottle during the admixture. The tincture of sesquichloride of iron is recommended because it can always be obtained of uniform strength. It is generally called the *muriated tincture of iron*, and may always be purchased of druggists.

“Permit me, then, most earnestly to recommend all who are fond of injecting, to employ transparent injections, and to endeavour, by trying various transparent colouring matters, to discover several which may be employed for the purpose; for I feel sure that by the use of carefully prepared transparent injections, many new points in the anatomy of tissues will be made out.

*“Of Injecting Different Systems of Vessels with Different Colours.*—It is often desirable to inject different systems of vessels distributed to a part with different colours, in order to ascertain the arrangement of each set of vessels and their relation to each other. A portion of the gall-bladder in which the veins have been injected with white lead, and the arteries with vermilion forms a beautiful preparation. Each artery, even to its smallest branches, is seen to be accompanied by two small veins, one lying on either side of it.

“In this injection of the liver, four sets of tubes have been injected as follows:—The artery with vermilion, the portal vein with white lead, the duct with Prussian blue, and the hepatic vein with lake. There are many opaque colouring matters which may be employed for double injections, but I am acquainted with very few transparent ones, the employment of which affords very satisfactory results.

“*Mercurial Injections* are not much used for microscopical purposes, although mercury was much employed formerly for injecting lymphatic vessels and the ducts of glandular organs. The pressure of the column of mercury

supersedes the necessity of any other kind of force for driving it into the vessels. The mercurial injecting apparatus consists of a glass tube, about half an inch in diameter and twelve inches in length, to one end of which has been fitted a steel screw to which a steel injecting pipe may be attached. The pipes and stopcocks must be made of steel, for otherwise they would be destroyed by the action of the mercury.

*Injecting the Lower Animals.*—The vessels of fishes are exceedingly tender, and require great caution in filling them. It is often difficult or quite impossible to tie the pipe in the vessel of a fish, and it will generally be found a much easier process to cut off the tail of the fish, and put the pipe into the divided vessel which lies immediately beneath the spinal column. In this simple manner beautiful injections of fish may be made.

*Mollusca.*—(Slug, snail, oyster, &c.) The tenuity of the vessels of the mollusca often renders it impossible to tie the pipe in the usual manner. The capillaries are, however, usually very large, so that the injection runs very readily. In different parts of the bodies of these animals are numerous lacunæ or spaces, which communicate directly with the vessels. Now, if an opening be made through the integument of the muscular foot of the animal, a pipe may be inserted, and thus the vessels may be injected from these lacunæ with comparative facility.

*Insects.*—Injections of insects may be made by forcing the injection into the general abdominal cavity, when it passes into the dorsal vessel and is afterwards distributed to the system. The superfluous injection is then washed away, and such parts of the body as may be required, removed for examination.

*Of the Practical Operation of Injecting.*—I propose now to inject a frog and the eye of an ox, in order that you may see the several steps of the process. We must bear in mind that a successful injection cannot be made until the muscular rigidity which comes on shortly after death, and which affects the muscular fibres of the arteries as well as those of the muscles themselves, has passed off. In some few instances in which the fluid does not necessarily pass through arterial trunks before it reaches the

capillaries (as in the liver), the injection may be effected satisfactorily immediately after the death of the animal.

“The steps of the process are very similar in making the opaque injections, except that when size is employed, the specimen must be placed in warm water until warm through, otherwise the size will solidify in the smaller vessels, and the further flow of the injecting fluid will be prevented. Soaking for many hours is sometimes necessary for warming a large preparation thoroughly, and it is desirable to change the water frequently. The size must also be kept warm, strained immediately before use, and well stirred up each time the syringe is filled.

“In the first place, the following instruments must be conveniently arranged :—

“The syringe thoroughly clean and in working order, with pipes, stopcock, and corks.

“One or two scalpels.

“Two or three pair of sharp scissors.

“Dissecting forceps.

“Bull’s-nose forceps, for stopping up any vessel through which the injection may escape accidentally.

“Curved needle, threaded with silk or thread, the thickness of the latter depending upon the size of the vessel to be tied.

“Wash-bottle. Injecting fluid in a small vessel.

“I will commence with the frog. An incision is made through the skin, and the sternum divided in the middle line with a pair of strong scissors; the two sides may easily be separated, and the heart is exposed. Next the sac in which the heart is contained (pericardium) is opened with scissors and the fleshy part of the heart seized with the forceps; a small opening is made near its lower part, and a considerable quantity of blood escapes from the wound—this is washed away carefully by the wash-bottle. Into the opening—the tip of the heart being still held firmly by the forceps, a pipe is inserted and directed upwards towards the base of the heart to the point where the artery is seen to be connected with the muscular substance. Before I insert the pipe, however, I draw up a little of the injecting fluid so as to fill it, for if this were not done, when I began to inject, the air contained in the

pipe would necessarily be forced into the vessels, and the injection would fail.

“The point of the pipe can with very little trouble be made to enter the artery. The needle with the thread is next carried round the vessel and the thread seized with forceps, the needle unthreaded and withdrawn, or one end of the thread may be held firmly, while the needle is withdrawn over it in the opposite direction. The thread is now tied over the vessel, so as to include the tip of the pipe only, for if the pipe be tied too far up, there is greater danger of its point passing through the delicate coats of the vessel.

“The nozzle of the syringe, which has been well washed in warm water, is now plunged beneath the surface of the fluid, the piston moved up and down two or three times, so as to force out the air completely, and the syringe filled with fluid. It is then connected with the pipe, which is firmly held by the finger and thumb of the left hand, with a screwing movement, a little of the injection being first forced into the wide part of the pipe so as to prevent the possibility of any air being included.

“The pipe and syringe being still held with the left hand, the piston is slowly and gently forced down with a slightly screwing movement with the right, care being taken not to distend the vessel so as to endanger rupture of its coats. The handle of the syringe is to be kept uppermost, and the syringe should never be completely emptied, in case of a little air remaining, which would thus be forced into the vessels. The injection is now observed running into the smaller vessels in different parts of the organism.

“I will now proceed to inject the ox-eye in the same manner. The pipe is inserted into this branch of artery close to the nerve. Two minutes will probably be sufficient to ensure a complete injection. In making an injection of the eye, if the globe becomes very much distended by the entrance of the injecting fluid, an opening may be made in the cornea to allow the escape of the aqueous fluid which will leave room for the entrance of the injection, and permit the complete distension of the vessels.

"We will now examine these injections. A portion of the intestine of the frog may be removed with scissors, opened, and the mucous surface washed with the aid of the wash-bottle. It may be allowed to soak in glycerine for a short time, and then examined.

"This portion of the delicate choroidal membrane which has been carefully removed in the same manner shows the vessels perfectly injected, and in this preparation of the ciliary processes you will not fail to observe that all the capillary vessels are fully distended with fluid, although the injection was made so quickly.

"*Of Injecting the Ducts of Glands.*—The modes of injecting which we have just considered, although applicable to the injection of vessels, are not adapted for injecting the ducts and glandular structure of glands; for as these ducts usually contain a certain quantity of the secretion, and are always lined with epithelium, it follows that when we attempt to force fluid into the duct, the epithelium and secretion must be driven towards the secreting structure of the gland, which is thus effectually plugged up with a colourless material, and there is no possibility of making out the arrangement of the parts. In such a case it is obviously useless to introduce an injecting fluid, for the greatest force which could be employed would be insufficient to drive the contents through the basement membrane, and the only possible result of the attempt would be rupture of the thin walls of the secreting structure and extravasation of the contents. As I have before mentioned, partial success has been obtained by employing mercury, but the preparations thus made are not adapted for microscopical observation.

"After death the minute ducts of the liver always contain a little bile. No force which can be employed is sufficient to force this bile through the basement membrane, for it will not permeate it in this direction. When any attempt is made to inject the ducts, the epithelium and mucus, in their interior, and the bile, form an insurmountable barrier to the onward course of the injection. Hence it was obviously necessary to remove the bile from the ducts before one could hope to make a successful injection. It occurred to me, that any accumulation of fluid in the smallest

branches of the portal vein or in the capillaries, must necessarily compress the ducts and the secreting structure of the liver which fill up the intervals between them. The result of such a pressure would be to drive the bile towards the large ducts and to promote its escape. Tepid water was, therefore, injected into the portal vein. The liver became greatly distended, and bile with much ductal epithelium flowed by drops from the divided extremity of the duct. The bile soon became thinner, owing to its dilution with water, which permeated the intervening membrane, and entered the ducts. These long, narrow, highly-tortuous channels were thus effectually washed out from the point where they commenced as tubes not more than 1-300th of an inch in diameter, to their termination in the common duct, and much of the thick layer of epithelium lining their interior was washed out at the same time. The water was removed by placing the liver in cloths with sponges under pressure for twenty-four hours or longer. All the vessels and the duct were then perfectly empty and in a very favourable state for receiving injection. The duct was first injected with a coloured material. Freshly precipitated chromate of lead, white lead, vermilion, or other colouring matter may be used, but for many reasons to which I have alluded, the Prussian blue injection is the one best adapted for this purpose. It is the only material which furnishes good results when the injected preparations are required to be submitted to high magnifying powers. Preparations injected in this manner should be examined as transparent objects.”<sup>1</sup>

“*Of Preparing Portions of Injected Preparations for Microscopical Examination.*—When thin tissues, such as the mucous membrane of the intestines or other parts, have been injected, it is necessary to lay them perfectly flat, and wash the mucus and epithelium from the free surface, either by forcing a current of water from the wash-bottle, or by placing them in water and brushing the surface gently with a camel’s hair brush. Pieces of a convenient size may then be removed and mounted in solution of naphtha and creosote, in dilute alcohol, in

(1) Dr. L. Beale, “On the Anatomy of the Liver of Man and Vertebrate Animals.”

glycerine, or in gelatine and glycerine. The most important points in any such injections are shown if the preparation be dried and mounted in Canada balsam. The specimen must, in the first place, be well washed and floated upon a glass slide with a considerable quantity of water, which must be allowed to flow off the slide very gradually. The specimen may then be allowed to dry under a glass shade, in order that it may be protected from dust. The drying should be effected at the ordinary temperature of the air, but it is much expedited if a shallow basin filled with sulphuric acid be placed with it under a bell-jar."

*Chemical Re-agents.*—The following chemical re-agents and preservative fluids are recommended for microscopic uses:<sup>1</sup>

1. *Alcohol*, principally for the removal of air from sections of wood and other preparations; also as a solvent for certain colouring matters.

2. *Æther*, chiefly as a solvent for resins, fatty and other essential oils, &c.; also useful for the removal of air.

3. *Solution of Caustic Potass*, as a solvent for fatty matters; also of use occasionally in consequence of its action upon the rest of the cell-contents and thickening layers. This solution acts best upon being heated.

4. *Solution of Iodine* (iodine one grain, iodide of potassium three grains, distilled water one ounce) for the coloration of the cell-membrane and of the cell-contents.

5. *Concentrated Sulphuric Acid*, employed chiefly in the examination of pollen and spores.

6. *Diluted Sulphuric Acid* (three parts acid, one part water), for the coloration of cells previously immersed in the iodine solution. The preparation is first moistened with the iodine solution, which is afterwards removed with a hair pencil, and a drop of sulphuric acid added by means of a glass rod; the preparation is then immediately covered with a piece of glass. The action of the sulphuric acid and iodine, as well as that of the iodised chloride of zinc solution, is not always uniform throughout the whole

(1) A set of 12 test-bottles, packed in a small box, is supplied by Mr. Matthews of Portugal Street, Lincoln's Inn Fields, the price of which is only a few shillings.

surface of the preparation. The colour is more intense where the mixture is more concentrated; it frequently happens that many spots remain uncoloured. The colour changes after some time, the blue being frequently changed into red after twenty-four hours.

7. *A Solution of Chloride of Zinc, Iodine, and Iodide of Potassium.* A drop of this compound solution, added to a preparation placed in a little water, produces the same colour as iodine and sulphuric acid. This solution, which was first proposed and employed by Professor Schultz, is more convenient in its application than iodine and sulphuric acid, and performs nearly the same services, while it does not, like the sulphuric acid, destroy the tissues to which it is applied. It is prepared by dissolving zinc in hydrochloric acid; the solution is then saturated with iodide of potassium: more iodine is to be added if necessary, and the solution diluted with water.

8. *Nitric Acid*, or what is better, chlorate of potass and nitric acid, as an agent to effect the isolation of cells. The mode of employing this agent, also discovered by Professor Schultz, is as follows:—

The object, a thin section of wood, for instance, is introduced, with an equal bulk of chloride, or chlorate of potass, into a long and moderately wide tube, and as much nitric acid as will at least cover the whole.

The tube is then warmed over a spirit-lamp; a copious evolution of gas takes place, upon which the tube is removed from the flame, and the action of the oxidising agent allowed to continue for two or three minutes. The contents of the tube are then poured into a watch glass with water, from which the slightly cohering particles are collected and placed in a tube, and again boiled in alcohol as long as any colour is communicated.

They are again boiled in a little water. The cells may now be isolated under the simple microscope by means of needles. The boiling with nitric acid and chlorate of potass should never be carried on in the same room with the microscope, the glasses of which may suffer injury from the vapours. The same remark applies to all chemical vapours.

Thin sections of vegetable tissue are warmed for half a



minute, or a minute, in a watch-glass: boiling is here unnecessary. The section is taken out, and treated with water in another watch-glass.

9. *Oil of Lemons*, or any other essential oil, a drop of which will be found of value in the investigation of pollen and spores.

Lastly may be enumerated a pretty strong solution of *Carbonate of Soda* and also of *Acetic Acid*; which latter, however, is more especially useful in the investigation of animal tissues.

To the above may be added a test for protein compounds. This test is composed of sugar and sulphuric acid, and is thus employed:—A thin section or portion of the tissue to be examined is placed in a drop of simple syrup, this is then removed by means of a hair pencil, and a drop of the diluted sulphuric acid added; the red colour usually does not appear until after the lapse of about ten minutes.

In making thin sections of tissues, it is recommended that, in those objects the consistence of which differs in different parts, the section should be carried from the harder into the softer portion; also, in making a thin section of a very minute yielding substance, to enclose it between two pieces of cork, and to slice the whole together. It is also useful sometimes to saturate the object with mucilage, which is to be allowed to dry slowly; in this way very delicate tissues may be sliced, or otherwise divided without injury, and with great facility.

Some of the above re-agents must be used with caution, as it is not unusual for them to assume crystalline forms while under the microscope. Without a knowledge of this fact, and a perfect recognition of crystalline forms, errors in micro-chemical research must occur. For example, if a drop of liquor potassæ be allowed to evaporate on a slip of glass, crystals appear, chiefly of six-sided tables, precisely like cystine; when in quantity, they are often crowded together as the cystine plates are, and sometimes exhibit a similar nucleus-like body in their centres. This peculiarity of crystallization does not arise from the presence of impurities; perfectly pure potash often exhibits the same phenomenon.

The form of the crystals of acetate of potash varies according to the strength of the acid out of which it

crystallizes, and if formed out of strong acid, very much resembles that of the crystals of uric acid; when mixed up with other forms, long dagger-like or lancet-shaped crystals are seen, which might well deceive.

We may also notice in this place what Majendie pointed out, that in certain albuminous mixtures, iodine loses the property of colouring starch blue. This difficulty must be got rid of before iodine can be said to be an infallible test in micro-chemistry.

*Collecting Objects.*—Mr. G. Shadbolt contributes the following useful hints for collecting objects for microscopical examination:—

“Rivers, brooks, springs, fountains, ponds, marshes, bogs, and rocks by the sea-side, are all localities that may be expected to be productive; some being more prolific than others, and the species obtained differing, of course, in general, to a certain extent, according to the habitat. On considering the nature of some of the places indicated, it will be apparent that, in order to spend a day in collecting with any comfort, it will be necessary to make some provision for keeping the feet dry, for which a pair of India-rubber goloshes will answer, or better still, a pair of waterproof fishing-boots; but without one or other the work is by no means pleasant.

“A dozen or two of small bottles made of glass-tubing, about half an inch in diameter, and without necks, and from one to two inches in length, are the most convenient depositories for the specimens, if intended ultimately for mounting; and it is advisable also to take two or three wide-mouthed bottles of a larger size, holding from one to two fluid-ounces, an old iron spoon, a tin box, some pieces of linen or calico, two or three inches square, a piece of string, a slip or two of glass, with the edges ground, such as are used for mounting objects; and lastly, a good and pretty powerful hand-magnifier. Two Coddington lenses, mounted in one frame of about half an inch, and one-tenth of an inch in focal power, are specially convenient.

“Swanscombe Salt-marsh will be found well worth a visit; and it can be reached by steam-boat or railway from London-bridge to Northfleet. On quitting the railway station, make towards the almshouses on the top of

the hill; and arriving at the road, turn to the left, descend the hill, and cross a sort of bridge over a somewhat insignificant stream. Continue along the main-road a little farther, to a point where it begins to ascend again, and diverges to the left towards the railway; here quit it, taking your course along an obscure road, nearly in a direct line with the main one; passing a windmill on the right hand, and continuing until you arrive at another still more obscure road, turning off to the right; which road appears as if made of the mud dredged from the bottom of the river, and partially hardened. This is Swanscombe Salt-marsh; and the road just described leads towards Broad Ness Beacon. On either side is a sort of ditch; one containing salt or very brackish water, the other filled with a sort of black mud, about the consistence of cream, the surface being in parts of a slaty grey, with little patches here and there of a most *brilliant brown colour*, glistening in the sunshine, and presenting a striking contrast to the sombre shade. By carefully insinuating the end of one of the slips of glass under this brilliant brown substance, and raising it gently, it can be examined with the Coddington; and it will probably be found to consist of myriads of specimens of *Pleurosigma* (*navicula* of Ehrenberg) *angulatum*, or *balticum*, or some other species of this genus. The iron spoon is now useful, as by its aid the brown stratum, with little or no mud, can be skimmed off and bottled for future examination. On the surface of the water in the other ditch may be noticed a floating mass of a *dark olive colour*, which to the touch feels not unlike a lump of the curd of milk, and consists of *Cyclotella menighiniana*, and a *surirella* or two embedded in a mass of *Spirulina hutchinsia*; and another mass of floating weed, which feels harsh to the touch, proceeding from a quantity of a *synedra*, closely investing a filamentous alga; and elsewhere *Melosira nummuloides* (*gallionella* of Ehrenberg).

“In a trench by the *sea-wall*, as it is termed, is a mass of brown matter of a shade somewhat different to any hitherto observed, adhering to some of the parts of the trench, being partially submerged, and having a somewhat tremulous motion on agitating the water. This is a

species of *Schizonema*; and it consists of a quantity of gelatinous hollow filaments filled with an immense number of bright-brown shuttle-shaped bodies, like very minute *naviculæ*.

“It is not necessary to be particular about collecting the specimen free from mud, as the filaments are so tough that the mud can be readily washed away by shaking the whole violently in a bottle of water, and pouring off the mud, without at all injuring the specimen. The *Amphiporium alatum* communicates a somewhat frothy appearance to the otherwise clear water, and to get any quantity of this requires a little management; but by skimming the surface with the spoon, and using one of the larger bottles, an abundance may readily be obtained. Between the sea-wall and the river the marsh is intersected in every direction with a number of meandering creeks, being in some places eight to ten feet deep, though in others quite shallow; but it is exceedingly difficult to make one’s way amongst them, and I have never found them so prolific any where, on the few occasions of my visiting the place, as in the parts more away from the influence of the tide. It will be observed, that the brilliant brown colour, of a deep but bright cinnamon tint, is one of the best indications of the presence of *diatomaceæ*; and though this is by no means universal, the variation is most frequently dependent upon the presence of something which qualifies the tint. The peculiarity of the colour is due to the endochrome contained in the frustule; and this must in general be got rid of before the beautiful and delicate marking can be made out. But it is highly advantageous and instructive to view them in a living state; and this should be done as soon as possible after reaching home with all specimens procured from salt-water localities, as they rapidly putrefy in confinement, and emit a most disgusting odour, not unlike that arising from a box of inferior congreve-matches.

“Washing in fresh water, and then immersing in creosote water, preserves many of the species in a very natural-looking manner; but they are killed by the fresh water, and the endochrome becomes much condensed in the *Pleurosigmata* and some other species. The addition of

spirits quite spoils the appearance of the frustules, as it dissolves the endochrome.

“There is another salt-marsh a little farther down the same railway, at Higham, which it would be well to explore. The most favourable months for procuring *diatomaceæ*, are April, May, September, and October; but some species are found in perfection as early as February, and many as late as November, and a few at all times of the year. There is a piece of boggy ground near Keston, beyond Bromley, in Kent, where the river Ravensbourne takes its rise, where many interesting species of *desmidiæ* and other fresh-water algæ may be procured. From Bromley, walk on towards Keston, passing near Hayes Common and Bromley Common on the right. Continue for about another half-mile along the road, and then turn to the right hand; pass the reservoirs, and approach an open space where there is a bog of about a quarter of a mile in extent; and tending towards the right, make your way amongst heaths, ferns, mosses, and the beautiful *Drosera rotundifolia* (sun-dew), to the lower part of the little stream rippling through a sort of narrow trench in the *Sphagnum*, &c. By working your way *up* the stream, you avoid the inconvenience which would otherwise be experienced of the water being rendered turbid, in consequence of having to tread in the boggy ground. In the centre of the little stream may be observed something of a pale pea-green colour flickering about in the current, which, on your attempting to grasp, most likely eludes you, and slips through the fingers, from being of a gelatinous nature. It consists of a hyaline substance, with a comparatively small quantity of a bright green endochrome, disposed in little branches, and this is the *Draparnaldia glomerata*. Another object is a mass of green filaments, rather harsh to the touch, and very slippery. When viewed with a lens of moderate power, each filament is seen to be surrounded with several bands of green dots, looking like a ribbon twisted spirally, and may be recognised as a species of *Zygnema*. In various parts there are other *Zygnemaceæ*, as *tyndaridea*, *mougeotia*, *mesocarpus*, and many more.

“Keeping up the stream, and occasionally diverging a

little on either side of it, amongst the miniature bays and pools formed by the sphagnum, on looking straight down into the water we shall probably see at the bottom a little mass of jelly of a bright green, studded with numerous brilliant bubbles of oxygen-gas. This is the general appearance of most of the *desmidiæ*, as *Micrasterias*, *Euastrum*, *Closterium*, *Cosmarium*, &c. The spoon is also a handy tool in this case, though, by practice, the finger will do nearly as well; the chief difficulty arises when the specimen is brought to the surface of the water, it not being easy to get it out without losing a considerable portion of it. Little pools in the bog, made by the footsteps of cattle, are particularly good spots to find *desmidiæ*, many species being in a very contracted space. The most prolific bog is at Tunbridge Wells, near a house known as Fisher's Castle, not far from Hurst Wood. There is also a good one at Esher, at a spot called West-End. It must not be imagined that nothing can be obtained in this department of botany without going some distance from town; but assuredly only commoner and fewer species can be met with nearer home. At the West India Docks are *Synedra fasciculata*, *Gomphonema curvata*, *Diatoma elongatum*, *Diatoma vulgare*, *Surirella ovata*, &c.; and at this same place a few objects, not of the botanical class, as *Spongilla fluviatilis*, *Cordylophora lacustris*, *Alcyonella stagnorum*, &c., are obtainable in abundance in the autumn. In the ornamental water in St. James's Park may be found *Cocconema lanceolatum*, and other species of this genus, *Gomphonema cristatum*, &c. Epping Forest, about the neighbourhood of Leytonstone, Snarebrook, Wanstead, and Woodford Bridge, are also capital localities for the filamentous algæ, especially the last-named, where *Nitella translucens* and *Chara vulgaris* abound." <sup>1</sup>

On the north side of the Serpentine, Hyde Park, especially near the bridge, may be found:—

Cymbella maculata.	Cocconeis placentula.
Gomphonema cristatum.	Uveilla hyalina.
Scenedesmus quadricauda.	Galtonella nummuloides.
"    obliquus.	Euastrum elegans.
Ankistrodesmus falcatus.	Pixidula operculata.
Pediastrum Heptactys.	Cladophora glomerata and Sphæro-
Cocconema lanceolatum.	plea crispa, with many other
Amphora ovalis.	algæ.

(1) "Quarterly Journal of Microscopical Science."

Mr. Topping, of New Winchester Street, Pentonville, has furnished me with the following list of 100 interesting and popular objects prepared by him :—

**Tests :**

- Pleurosigma angulata*,  
 ,, *strigosa*  
 ,, *formosum*.  
 Scales of *Podura*.  
 ,, *Lepisma*.  
 Hair of Indian bat.  
 ,, mouse.  
 ,, Larva of *Dermestes*.

Triceratium from Thames mud.  
 Arachnoidiscus.

- Fos. infusoria from Guano.  
 Fos. infusoria, Barbadoes.  
 ,, Upper Bann, Ireland.  
 ,, Island of Mull.  
 ,, Tuscany.  
 Infusoria from Thames mud.  
 Spicules of *Gorgonia*.  
 ,, sponge.  
 ,, ,, fresh water.  
 Gemmules of sponge.

- Section of shell—*Pinna*.  
 ,, ,, crab.  
 ,, ,, *Haliotis*.  
 ,, spine of *Echinus*.  
 ,, ,, *Cidaris*.

- Xanthidia in flint.  
 Moss agate.  
 Limestone.

- Fossil tooth of shark.  
 ,, fish.  
 Fossil bone of whale.  
 ,, reptile.  
 ,, elk.

- Fossil wood (*Exogen*).  
 ,, (*Endogen*).

- Sections of coal.  
 Simple cellular tissue.  
 Stellate tissue.  
 Fibro-cellular tissue.  
 Spiral vessels.  
 Hairs from leaf of *Deutzia*.  
 Seeds of a fern.  
 Sections of fir.  
 ,, oak.  
 ,, mahogany.  
 ,, clematis.

Petal of geranium.

- Leaf insect.  
 Flea.  
 Parasite of peacock.  
 Skin of caterpillar.  
 Wing of a butterfly.

- Scales of ditto.  
 Proboscis of blow-fly.  
 Stomach of ditto  
 Foot of ditto.  
 Spiracles of *Dytiscus*.  
 Foot of *Ophion*.  
 Proboscis of moth.

- Tran. sects. of human hairs.  
 ,, hairs of elephant.  
 ,, whalebone.  
 Feather of bird.  
 Trans. sects. of human bone.  
 ,, bone of bird.  
 ,, ,, fish.  
 ,, ,, reptile.

- Blood of bird.  
 ,, fish.  
 ,, reptile.  
 ,, human.

**Opaque :—**

- Gold dust.  
 Fossil shells.  
 Pollens.  
 Fern spores.  
 Needle antimony.  
 Avanturine.

**Polariscope :—**

- Selenite.  
 Starch.  
 Hairs from leaf.  
 Embryo oysters.  
 Rhinoceros horn.  
 Hoof of horse.  
 Agate.  
 Sandstone.  
 Sulphate of Cadmium.  
 Salicine.  
 Tartaric acid.  
 Carbonate of lime.

**Anatomical :—**

- Section of cartilage, showing the  
 formation of the bone-cells.  
 Muscle of mammalia.  
 ,, reptile.  
 ,, bird.  
 ,, fish.

**Injections of :—**

- Human lung.  
 ,, intestine.  
 ,, skin.  
 ,, kidney.  
 ,, stomach.  
 ,, muscle.  
 ,, section of finger.

## THE CAMERA LUCIDA.

The Camera Lucida, fig. 79, invented by Dr. Wollaston, in 1807, is a valuable addition to the microscope, for making drawings of structures, and for obtaining, with a micrometer, accurate measurements. It consists

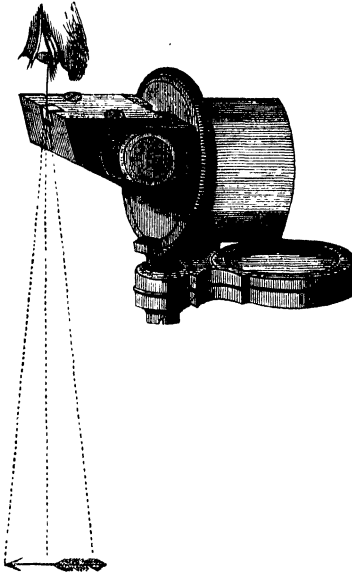

Fig. 79.

of a four-sided prism of glass, set in a brass frame or case, as represented in the figure annexed ; and by means of a short tube it is slipped over the front part of either of the eye-pieces, its cap having been previously removed. Mr. Ross attaches the prism, by two short supports, to a circular piece of brass at the end of the tube ; on this it can be slightly rotated, whilst the prism itself can also be turned up or down, by means of two screws with milled



heads. So arranged, the camera may be adapted to the eye-piece, the microscope having been previously placed in a horizontal position; if the light be then reflected up through the compound body, an eye placed over the square hole in the frame of the prism will see the image of any object on the stage upon a sheet of white paper placed on the table immediately below it. But should it happen that the whole of the field of view is not well illuminated, then, either by revolving the circular plate or turning the prism upon the screws, the desired object will be effected. The chief difficulty in the use of this instrument is for the artist to be able to see, at one and the same time, the pencil and the image. To facilitate this in some measure, the one or two lenses below the prism will cause the rays from the paper and pencil to diverge at the same angle as those received from the prism, whereby both object and pencil may be seen with the same degree of distinctness.

The following is the method for employing the Camera Lucida with the microscope. The first step to be taken, after the object about to be drawn has been properly illuminated, adjusted, and brought into the centre of the field of view, is to place the compound body of the microscope in a horizontal position, and to fix it there. The cap of the eye-piece having been removed, the camera is to be slid on in its stead: if the prism is properly adjusted, a circle of white light, with the object within it, will be seen on a piece of white paper placed on the table immediately under the camera, when the eye of the observer is placed over the uncovered edge of the prism, and its axis directed towards the paper on the table. Should, however, the field of view be only in part illuminated, the prism must either be turned round on the eye-piece, or revolved on its axis, by the screws affixed to its frame-work, until the entire field is illuminated. The next step is to procure a hard, sharp-pointed pencil, which, in order to be well seen, may be blackened with ink round the point; the observer is then to bring his eye so near the edge of the prism that he may be able to see on the paper, at one and the same time, the pencil-point and the image of the object. When he has accomplished this, the

pencil may be moved along the outline of the image, so as to trace it on the paper. However easy this may appear in description, it will be found very difficult in practice; and the observer must not be foiled in his first attempts, but must persevere until he accomplishes his purpose. Sometimes he will find that he can see the pencil-point, and all at once it disappears: this happens from the movement of the axis of the eye. The plan then is to keep the pencil upon the paper, and to move about the eye until the pencil is again seen, when the eye is to be kept steadfastly fixed on the same position until the entire outline is traced. It will be found the best plan for the beginner to employ at first an inch object-glass, and some object, such as a piece of moss, that has a well-defined outline, and to make many tracings, and examine how nearly they agree with each other; and when he has succeeded to his liking, he may then take a more complicated subject. If the operation is conducted by lamp-light, it will be found very advantageous not to illuminate the object too much, but rather to illuminate the paper on which the sketch is to be made, either by means of the lamp with the condensing lens, or a small taper placed near it. When the object is so complicated that too much time would be required for it to be completed at one sitting, the paper should be fixed to the table by a weight, or on a board by drawing-pins. An excellent plan to adopt is to fix the microscope on a piece of deal about two feet in length and one foot in breadth, and to pin the paper to the same; there will then be no risk of the shifting of the paper, as, when the wood is moved, both microscope and paper will move with it. In all sketches made by the camera, certain things must be borne in mind; the eye, when once applied to it, should be kept steadily fixed in one position; and if the sketches are to be reserved for comparison with others, the distance between the paper and the camera should be always the same. A short rule or a piece of wood may be placed between the paper and the under-surface either of the compound body or the arm supporting it, in order to regulate the distance, as the size of the drawing made by the camera will depend upon the distance between it and the paper. It is also very desirable,

before the camera is removed, to make a tracing in some part of the paper of two or more of the divisions of the stage micrometer, in order that they may form a guide to the measurement of all parts of the object. Some persons cover the whole of the drawing over with squares, to facilitate, not only the measurement, but in order that a larger or smaller drawing may be made from it than that given by the camera. It must be recollected, that an accurate outline is the only thing the camera will give: the finishing of the picture must depend entirely upon the skill of the artist himself.

ON THE POLARISATION OF LIGHT AS APPLIED TO THE  
MICROSCOPE.

Common light moves in two planes at right angles to each other, polarised light moves only in one plane. Common light may be turned into polarised light either by transmission or reflection; in the first instance, one of the planes of common light is got rid of by reflection, in the other, by absorption. Huyghens was among the first to notice that a ray of light has not the same properties in every part of its circumference, and he compared it to a magnet or a collection of magnets; and supposed that the minute particles of which it was said to be composed had different poles, which, when acted on in certain ways, arranged themselves in particular positions; and thence the term *polarisation*, a term having neither reference to cause nor effect. It is to Malus, however, who, in 1808, discovered polarisation by reflection, that we are indebted for the series of splendid phenomena which have since that period been developed; phenomena of such surpassing beauty as far to exceed anything which can be presented to our eyes under the microscope. It has been truly observed by Sir David Brewster, that "the application of the principles of double refraction to the examination of structures is of the highest value. The chemist may perform the most dexterous analysis; the crystallographer may examine crystals by the nicest determination of their forms and cleavage; the anatomist or botanist may use the dissecting knife and microscope with the most exquisite skill; but there are still structures in the mineral,

vegetable, and animal kingdoms, which defy all such modes of examination, and which will yield only to the magical analysis of polarised light. A body which is quite transparent to the eye, and which might be judged as monotonous in structure as it is in aspect, will yet exhibit, under polarised light, the most exquisite organisation, and will display the result of new laws of combination which the imagination even could scarcely have conceived. In evidence of the utility of this agent in exploring mineral, vegetable, and animal structures, the extraordinary organisation of Apophyllite and Analcime may be referred to; also the symmetrical and figurate depositions of siliceous crystals in the epidermis of equisetaceous plants, and the wonderful variations of density in the crystalline lenses of the eyes of animals.

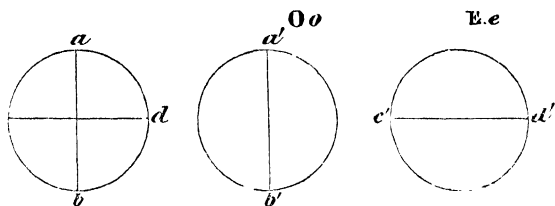

Fig. 80.

If we transmit a beam of the sun's light through a circular aperture into a darkened room, and if we reflect it from any crystallised or uncrystallised body, or transmit it through a thin plate of either of them, it will be reflected and transmitted in the very same manner, and with the same intensity, whether the surface of the body is held above or below the beam, or on the right side or left, provided that in all cases it falls upon the surface in the same manner; or, what amounts to the same thing, the beam of solar light has the same properties on all its sides; and this is true, whether it is white light as directly emitted from the sun, or from a candle or any burning or self-luminous body; and all such light is called *common* light. A section of such a beam of light will be a circle, like  $ab$   $cd$ , fig. 80; and we shall distinguish the section of a beam

of common light by a circle with two diameters  $a b, c d$ , at right angles to each other.

If we now allow the same beam of light to fall upon a rhomb of Iceland spar, and examine the two circular beams,  $O o E e$ , formed by double refraction, we shall find, 1st, that the beams  $O o E e$  have different properties on different sides, so that each of them differs in this respect from the beam of common light.

2d. That the beam  $O o$  differs from  $E e$  in nothing excepting that the former has the same properties at the sides  $a' b'$  that the latter has at the sides  $c'$  and  $d'$ ; or in general that the diameters of the beam, at the extremities of which the beam has similar properties, are at right angles to each other, as  $a' b'$  and  $c'$  and  $d'$  for example.

These two beams,  $O o, E e$ , are therefore said to be *polarised*, or to be beams of *polarised* light, because they have sides or *poles* of different properties and planes passing through the lines  $a b, c d$ ; or  $a' b', c' d'$ , are said to be the *planes* of *polarisation* of each beam, because they have the same property, and one which no other plane passing through the beam possesses.

Now it is a curious fact, that if we cause the two polarised beams  $O o, E e$  to be united into one, or if we produce them by a thin plate of Iceland spar, which is not capable of separating them, we obtain a beam which has exactly the same properties as the beam  $a b c d$  of common light. Hence we infer that a beam of common light,  $a b c d$ , consists of *two* beams of polarised light, whose plane of polarisation, or whose diameters of similar properties, are at right angles to one another. If  $O o$  is laid above  $E e$ , it will produce a figure like  $a b c d$ ; and we shall therefore represent polarised light by such figures. If we were to place  $O o$  above  $E e$ , so that the planes of polarisation  $a' b'$  and  $c' d'$  coincide, then we should have a beam of polarised light twice as luminous as either  $O o$  or  $E e$ , and possessing exactly the same properties; for the lines of similar property in the one beam coincide with the lines of similar property in the other. Hence it follows that there are three ways of converting a beam of common light,  $a b c d$ , into a beam or beams of polarised light.

1st. We may separate the beam of common light,  $a b c d$ ,

component parts  $O o$  and  $E e$ . 2d. We may turn round the planes of polarisation,  $a b c d$ , till they coincide or are parallel to each other. 3d. We may absorb or stop one of the beams, and leave the other, which will consequently be in a state of polarisation."<sup>1</sup>

The first of these methods of producing polarised light is that in which we employ a doubly refracting crystal, and was first discovered to exist in a transparent mineral substance called *Iceland spar*, *calcareous spar*, or *carbonate of lime*. This substance is admirably adapted for exhibiting this phenomenon, and is the one generally used by microscopists. Iceland spar is composed of fifty-six parts of lime and forty-four parts of carbonic acid; it is found

in various shapes in almost all countries; but whether found in crystals or in masses, we can always cleave it or split it into shapes represented by fig. 81, which is called a rhomb of Iceland spar, a solid bounded by six equal and similar rhomboidal surfaces, whose sides are parallel, and whose angles  $b a c$ ,  $a c d$ , are  $101^{\circ} 55'$  and  $78^{\circ} 5'$ . The

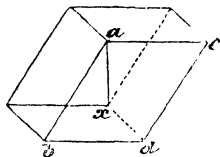

Fig. 81.

line  $a x$ , called the *axis of the rhomb*, or of the crystal, is equally inclined to each of the six faces at an angle of  $45^{\circ} 23'$ . It is very transparent, and generally colourless. Its natural faces when it is split are commonly even and perfectly polished; but when they are not so, we may, by a new cleavage, replace the imperfect face by a better one, or we may grind and polish an imperfect face.

It is found that in all bodies where there seems to be an irregularity of structure, as salts, crystallised minerals, &c., on light passing through them, it is divided into two distinct pencils. If we take a crystal of Iceland spar, and look at a black line or dot on a sheet of paper, there will appear to be two lines or dots; and on turning the spar round, these objects will seem to turn round also; and twice in the revolution they will fall upon each other, which occurs when the two positions of the spar are exactly opposite, that is, when turned one-half from the position

(1) Brewster's "Optics."

where it is first observed. In the accompanying diagram, fig. 82, the line appears double, as  $a b$  and  $c d$ , or the dot,

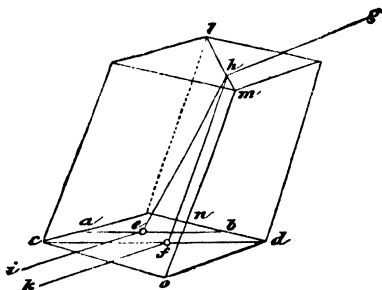

Fig. 82.

as  $e$  and  $f$ . Or allow a ray of light,  $g h$ , to fall thus on the crystal, it will in its passage through be separated into two rays,  $h f, h e$ ; and on coming to the opposite surface of the crystal, they will pass out at  $e f$  in the direction of  $i k$ , parallel to  $g h$ . The plane  $l m n o$  is designated the principal section of the crystal, and the line drawn from the solid angle  $l$  to the angle  $o$  is where the axis of the crystal is contained; it is also the optic axis of the mineral. Now when a ray of light passes along this axis, it is undivided, and there is only one image; but in all other directions there are two.

If two crystals of Iceland spar be used, the only difference will be, that the objects seem farther apart, from the increased thickness. But if two crystals be placed with their principal sections at right angles to each other, the ordinary ray refracted in the first will be the extraordinary in the second, and so on *vice versa*. At the intermediate position of the two crystals there is a subdivision of each ray, and therefore four images are seen; when the crystals are at an angle of  $45^\circ$  to each other, then the images are all seen of equal intensity.

Mr. Nicol first succeeded in making rhombs of Iceland spar into *single-image prisms*, by dividing one into two equal portions. His mode of proceeding is thus described in the *Edinburgh Philosophical Journal* (vol. vi. p. 83):

“A rhomb of Iceland spar of one-fourth of an inch in length, and about four-eighths of an inch in breadth and thickness, is divided into two equal portions in a plane, passing through the acute lateral angle, and nearly touching the obtuse solid angle. The sectional plane of each of these halves must be carefully polished, and the portions cemented firmly with Canada balsam, so as to form a rhomb similar to what it was before its division; by this management the ordinary and extraordinary rays are so separated that only one of them is transmitted: the cause of this great divergence of the rays is considered to be owing to the action of the Canada balsam, the refractive index of which (1·549) is that between the ordinary (1·6543) and the extraordinary (1·4833) refraction of calcareous spar, and which will change the direction of both rays in an opposite manner before they enter the posterior half of the combination.” The direction of rays

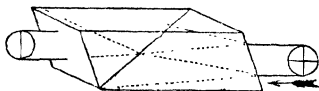

Fig. 83.

passing through such a prism is indicated by the arrow, fig. 83, and the combination is shown mounted, one for

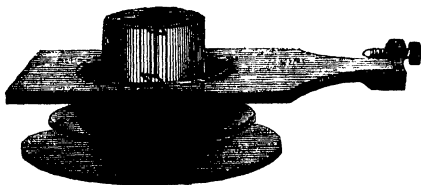

Fig. 84.

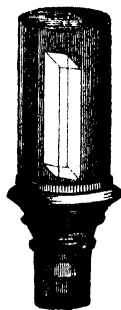

Fig. 85.

use under the stage of the microscope, fig. 84, termed the *polariser*; another, fig. 85, screwed on to and above the



object-glasses, is called the *analyser*. The definition is better if the analyser is placed at top of the *A* eye-piece, and it is more easily rotated than the polariser.

*Method of using the polarising Prism*, fig. 84.—After having adapted it to slide into a groove on the under-surface of the stage, it is held in its place by turning the small milled-head screw at one end: the other prism, fig. 85, is screwed on above the object-glasses, and made to pass into the body of the microscope itself. The light having been reflected through them by the mirror, it becomes necessary to make the axes of the two prisms coincide; this is done by regulating the milled-head screw, until by revolving the *polarising* prism, the field of view is entirely darkened twice during one revolution. This should be ascertained, and carefully corrected by the maker and adapter of the apparatus.

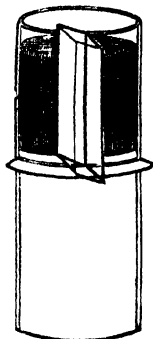

Fig. 86.

If very minute salts or crystals are to be viewed, it is preferable to place the analyser above the eye-piece; it will then require to be mounted as in fig. 86. Thus the *polariscope* consists of two parts; one for *polarising*, the other for *analysing* or testing the light. There is no essential difference between the two parts, except what convenience or economy may lead us to adopt; and either part, therefore, may be used as polariser or analyser; but whichever we use as the polariser, the other becomes the analyser.

The *tourmaline*, a precious stone of a neutral or bluish tint, forms an excellent analyser; it should be cut about  $\frac{1}{10}$ th of an inch thick, and parallel to its axis. The great objection to it is, that the transmitted polarised beam is more or less coloured. The best *tourmaline* to choose is the one that stops the most light when its axis is at right angles to that of the polariser, and yet admits the most when in the same plane. It is necessary to choose the stone as perfect as possible, the size is of no importance when used with the microscope.

In the illumination of objects by polarised light, when under view with high powers, for the purpose of obtaining

the maximum effect, it is also requisite that the angle of aperture of the polariser should be the same as the object-glass, each ray of which should be directly opposed by a ray of polarised light. The *Polarising Condenser* is merely an ordinary achromatic condenser of large aperture, close under the bottom lens of which is placed a plate of tourmaline, used in combination with a superposed film of selenite or not, as required. The effect of this arrangement on some objects is very remarkable, bringing out strongly colours which are almost invisible by the usual mode.

The production of colour by polarised light has been thus most clearly and comprehensively explained by Mr. Woodward, in his "Introduction to the Study of Polarised Light."<sup>1</sup>

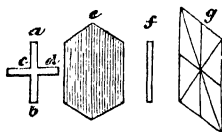

Fig. 87 A.

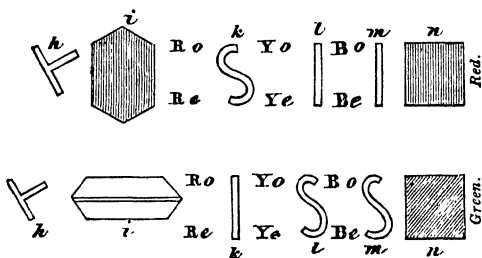

Fig. 87 B.

$a b c d$  represent the rectangular vibrations by which a ray of common light is supposed to be propagated.

$e$ , a plate of tourmaline, called in this situation the polariser, and so turned that  $a b$  may vibrate in the plane of its crystallographical axis.

(1) Mr. Woodward constructed a very available form of polariscope for most purposes; the instrument is described in *Elements of Natural Philosophy*, by the author.

*f*, light polarised by *e*, by stopping the vibrations *c d*, and transmitting those of *a b*.

*g*, a piece of selenite of such a thickness as to produce red light, and its complementary colour green.

*h*, the polarised light *f* bifurcated, or divided into ordinary and extraordinary rays, and thus said to be depolarised by the double refractor *g*, and forming two planes of polarised light, *o* and *e*, vibrating at right angles to each other.

*i*, a second plate of tourmaline, here called the analyser, with its axis in the same direction as that of *e*, through which the several systems of waves of the ordinary and extraordinary rays *h*, not being inclined at a greater angle to the axis of the analyser than that of 45 degrees, are transmitted and brought together under conditions that may produce interferences.

*k*, the waves *Ro* and *Re*, for red light of the ordinary and extraordinary systems meeting in the same state of vibration, occasioned by a difference of an even number of half undulations, and thus forming a wave of doubled intensity for red light.

*l m*, the waves *Yo* and *Ye* and *Bo* and *Be* for yellow and blue of the ordinary and extraordinary systems respectively meeting together, with a difference of an odd number of half undulations, and thus neutralising each other by interferences.

*n*, red light, the result of the coincidence of the waves for red light, and the neutralisation by interferences of those for yellow and blue respectively.

*h*, fig. 87 B, depolarised light, as fig. 87 A.

*i*, the analyser turned one quarter of a circle, its axis being at right angles to that of *i* in fig. 87 A.

*k*, the waves *Ro* *Re*, for red light of the ordinary and extraordinary systems meeting together with a difference of an odd number of half undulations, and thus neutralising each other by interference.

*l m*, the waves *Yo* *Ye* and *Bo* *Be*, for yellow and blue of the two systems severally meeting together in the same state of vibration, occasioned by the difference of an even number of half undulations, and forming by their coincidences waves of doubled intensity for yellow and blue light.

*n*, green light, the result of the coincidences of the waves for yellow and blue light respectively, and the neutralisation by interference of those for red light.

By substituting Nicol's prisms for the two plates of tourmaline, and by the addition of the object-glass and eye-piece, the diagrams would then represent the passage of polarised light through a microscope.

For showing objects by polarised light under the microscope that are not in themselves doubly refractive, put upon the stage a film of selenite, which exhibits, under ordinary circumstances, the red ray in one position of the polarising prism, and the green ray in another, using a double-image prism over the eye-piece; each arc will assume one of these complementary colours, whilst the centre of the field will remain colourless. Into this field introduce any microscopic object which in the usual arrangement of the polariscope undergoes no change in colour, when it will immediately display the most brilliant effects. Sections of wood, feathers, algæ, and scales, are among the objects best suited for this kind of exhibition. The power suited for the purpose is a two-inch object-glass, the intensity of colour, as well as the separating power of the prism, being impaired under much higher amplification; although in some few instances, such as in viewing animalcules, the one-inch object-glass is perhaps to be preferred.

*Selenite* is the native crystallised hydrated sulphate of lime. A beautiful fibrous variety called *satin gypsum* is found in Derbyshire. It is found also at Shotover Hill, near Oxford, where the labourers call it *quarry-glass*. Very large crystals of it are found at Montmartre, near Paris. The form of the crystal most frequently met with is that of an oblique rectangular prism, with ten rhomboidal faces, two of which are much larger than the rest. It is usually slit into thin laminæ parallel to these large lateral faces; the film having a thickness of from one-twentieth to the one-sixtieth of an inch. In the two rectangular directions they allow perpendicular rays of polarised light to traverse them unchanged; these directions are called the *neutral axes*. In two other directions, however, which form respectively angles of  $45^\circ$  with the

neutral axes, these films have the property of double refraction. These directions are known as the *depolarising axes*.

The thickness of the film of selenite determines the particular tint. If, therefore, we use a film of irregular thickness, different colours are presented by the different thicknesses. These facts admit of very curious and beautiful illustration, when used under the object placed on the stage of the microscope. The films employed should be mounted between two glasses for protection. Some persons employ a large film mounted in this way between plates of glass, with a raised edge, to act as a stage for supporting the object, it is then called the "selenite stage." The best film for the microscope is that which gives blue, and its complementary colour yellow. Mr. Darker has constructed a very neat stage of brass for this purpose, producing a mixture of all the colours by superimposing three films, one on the other; by a slight variation in their positions, produced by means of an endless-screw motion, all the colours of the spectrum are shown. When objects are thus exhibited, we must bear in mind that all the negative tints, as we term them, are diminished, and all the positive ones increased; the effect of this plate is to mask the true character of the phenomena. Polarised structures should therefore never be drawn and coloured under such conditions.

Dr. Herapath, of Bristol, described a salt of quinine, which is remarkable for its polarising properties. The salt was first accidentally observed by Mr. Phelps, a pupil of Dr. Herapath's, in a bottle which contained a solution of disulphate of quinine: the salt is formed by dissolving disulphate of quinine in concentrated acetic acid, then warming the solution, and dropping into it carefully, and by small quantities at a time, a spirituous solution of iodine. On placing this mixture aside for some hours, brilliant plates of the new salt will be formed. The crystals of this salt, when examined by reflected light, have a brilliant emerald-green colour, with almost a metallic lustre; they appear like portions of the elytræ of cantharides, and are also very similar to murexide in appearance. When examined by transmitted light, they scarcely possess

any colour, there is only a slightly olive-green tinge; but if two crystals, crossing at right angles, be examined, the spot where they intersect appears perfectly black, even if the crystals are not one five-hundredth of an inch in thickness. If the light be in the slightest degree polarised—as by reflection from a cloud, or by the blue sky, or from the glass surface of the mirror of the microscope placed at the polarising angle  $56^{\circ} 45'$ —these little prisms immediately assume complementary colours: one appears green, and the other pink, and the part at which they cross is a chocolate or deep chestnut-brown, instead of black. As the result of a series of very elaborate experiments, Dr. Herapath finds that this salt possesses the properties of tourmaline in a very exalted degree, as well as of a plate of selenite; so that it combines the properties of polarising a ray and of depolarising it. Dr. Herapath has succeeded in making artificial tourmalines large enough to surmount the eye-piece of the microscope; so that all experiments with those crystals upon polarised light may be made without the tourmaline or Nicol's prism. The brilliancy of the colours is much more intense with the artificial crystal than when employing the natural tourmaline. As an analyser *above the eye-piece*, it offers some advantages over the Nicol's prism *in the same position*, as it gives a perfectly uniform tint of colour over a much more extensive field than can be had with the prism.<sup>1</sup> These crystals frequently lose their polarising property. When out of use they should be kept in a dark, dry place. Mr. Lobb has had one in use three years, it is as good at the present time as it was on the day he purchased it from Messrs. Horne and Thornthwaite.

A variety of interesting phenomena have been described by Mr. S. Legg, in the *Transactions of the Microscopical Society*. He observes:

“The following experiments, if carefully performed, will illustrate the most striking phenomena of double refraction, and form a useful introduction to the practical application of this principle.

(1) Dr. Herapath has given a later and better process for the manufacture of these artificial tourmalines in the *Quarterly Journal of Microscopical Science* for January, 1854. Also, for further researches on their polarising properties, see *Philosophical Magazine*, May, 1855.

“A plate of brass, fig. 88, three inches by one, perforated with a series of holes from about one-sixteenth to one-

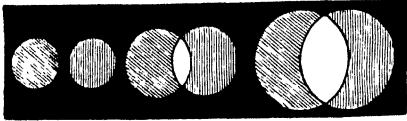

Fig. 88.—*Red* is represented by perpendicular lines; *Green* by oblique.

fourth of an inch in diameter; the size of the smallest should be in accordance with the power of the object-glass, and the separating power of the double refraction.

“*Experiment 1.*—Place the brass plate so that the smallest hole shall be in the centre of the stage of the instrument; employ a low power ( $1\frac{1}{2}$  or 2 inch) object-glass, and adjust the focus as for an ordinary microscopic object; place the double image prism over the eye-piece, and there will appear two distinct images; then, by revolving the prism, these will describe a circle, the circumference of which cuts the centre of the field of view; the one is called the ordinary, the other the extraordinary ray. By passing the slide along, that the larger orifices may appear in the field, the images will not be completely separated, but will overlap, as represented in the figure.

“*Experiment 2.*—Screw the Nicol’s prism into its place under the stage, still retaining the double image prism over the eye-piece; then, by examining the object, there will appear in some positions two, but in others only one image; and it will be observed, that at  $90^\circ$  from the latter position this ray will be cut off, and that which was first observed will become visible; at  $180^\circ$ , or one-half the circle, an alternate change will take place; at  $270^\circ$ , another change; and at  $360^\circ$ , or the completion of the circle, the original appearance.

“Before proceeding to the next experiment, it will be as well to observe the position of the Nicol’s prism, which should be adjusted with its angles parallel to the square parts of the stage. In order to secure the greatest brilliancy in the experiment, the proper relative position of the selenite may be determined by noticing the natural

flaws in the film, which will be observed to run parallel with each other; these flaws should be adjusted at about  $46^\circ$  from the square parts of the stage, to obtain the greatest amount of depolarisation.

*Experiment 3.*—If we now take the plate of selenite thus prepared, and place it under the piece of brass on the stage, we shall see, instead of the alternate black and white images, two coloured images composed of the constituents of white light, which will alternately change by revolving the eye-piece at every quarter of the circle; then, by passing along the brass, the images will overlap; and at the point at which they do so, white light will be produced. If, by accident, the prism is placed at an angle of  $45^\circ$  from the square part of the stage, no particular colour will be perceived; and it will then illustrate the phenomena of the neutral axis of the selenite, because when placed in that relative position no depolarisation takes place. The phenomena of polarised light may be further illustrated by the addition of a second double image prism, and a film of selenite adapted between the two. The systems of coloured rings in crystals cut perpendicularly to the principal axis of the crystal are best seen by employing the lowest object-glass.”

To show the phenomena of the rings round the optic axes of the crystals, Mr. Lobb adopts the following plan, which is by far the best, and the rings are exhibited in the greatest perfection:—

1. The *b* eye-piece without a diaphragm, and the lenses so adjusted that the field-lens may be brought nearer to, or farther from the eye-lens as occasion may require; thus giving different powers, and different fields, and when adjusted for the largest field it will be full 15 inches, and take in the widest separation of the axis of the aragonite.

2. A crystal stage to receive the crystals, and to be placed over the eye-piece, so constructed as to receive a tourmaline, and that to turn round.

3. A tourmaline of a blue tint.

4. A large Nicol's prism as a polariser.

5. A common two-inch lens, not achromatic; which must be set in a brass tube long enough when screwed into



the microscope to reach the polariser, that all extraneous light may be excluded.

The concave mirror should be used with a bull's-eye condenser by lamplight. The condenser may be dispensed with by daylight. The above apparatus is furnished by Messrs. Powell and Lealand.

The crystals best adapted to show the phenomena of rings round the optic axes, are:—

*Quartz*.—A uniaxial crystal, one system of rings, no entire cross of black, only the ends of it, the centre being coloured, and as the tourmaline is revolved, the colour gradually changing into all the colours of the spectrum, one colour only displayed at once.

*Quartz*.—Cut so as to exhibit right-handed polarisation.

*Quartz*.—Cut so as to exhibit left-handed polarisation; that is, the one shows the same phenomena when the tourmaline is turned to the right, as the other does when turned to the left.

*Quartz*.—Cut so as to exhibit straight lines.

*Calc Spar*.—A uniaxial crystal, one system of rings, and a black cross, which changes into a white cross on revolving the tourmaline, and the colours of the rings into their complementary colours.

*Topaz*.—A biaxial crystal, although it has two axes, only exhibits one system of rings with one fringe, owing to the wide separation of the axes. The fringe and colours change on revolving the tourmaline; this is the case in all the crystals.

*Borax*.—A biaxial crystal; the colours more intense than in topaz, but the rings not so complete,—only one set of rings taken in, from the same cause as topaz.

*Rochelle Salt*.—A biaxial crystal; the colours more widely spread. Very beautiful. Only one set of rings taken in.

*Carbonate of Lead*.—A biaxial crystal, axes not much separated, both systems of rings exhibited, far more widely spread than those of nitre.

*Aragonite*.—A biaxial crystal, axes widely separated; but both systems of rings exhibited, and decidedly the best crystal for displaying the phenomena of biaxial crystals.

The field-lens of the eye-piece requires to be brought as

close as possible to the eye-lens, to see properly the phenomena in quartz and aragonite; it must be placed at an intermediate distance for viewing topaz, borax, Rochelle salt, and carbonate of lead; it must be drawn out to its full extent to view nitre and calc spar.

The powers of the micro-polariscope cannot be better displayed than in the exhibition of the foregoing phenomena; there is nothing more beautiful, and few studies more interesting and enlarging to the mind than that of light, whether common or polarised, which must be entered upon if the phenomena are to be understood.

The crystal eye-piece, with an artificial tourmaline as an analyser, will be found very useful for polariscope objects generally; there is some spherical aberration, but the largeness of the field far more than compensates for the same; it does best for those objects that require the two-inch object glass.

Mr. Darker, 6, Princes Street, Lambeth, is the only person in England who cuts the crystals properly; and in Paris, M. Soliel, Rue de l'Odéon.

It was long believed that all crystals had only one axis of double refraction; but Brewster found that the great body of crystals, which are either formed by art, or which occur in the mineral kingdom, have *two axes* of double refraction, or rather axes around which the double refraction takes place; in the axes themselves there is no double refraction.

Nitre crystallises in six-sided prisms with angles of about  $120^\circ$ . It has two axes of double refraction, along which a ray of light is not divided into two. These axes are each inclined about  $2\frac{1}{2}^\circ$  to the axes of the prism, and  $5^\circ$  to each other. If, therefore, we cut off a piece from a prism of nitre with a knife driven by a smart blow of a hammer, and polish the two surfaces perpendicular to the axes of the prism, so as to leave the thickness of the sixth or eighth of an inch, and then transmit a ray of polarised light along the axes of the prism, we shall see the double system of rings shown in figs. 89 and 90.

When the line connecting the two axes of the crystal is inclined  $45^\circ$  to the plane of primitive polarisation, a cross is seen as at fig. 89, on revolving the nitre, it gradually

assumes the form of the two hyperbolic curves, fig. 90. But if the tourmaline be revolved, the black crossed lines will

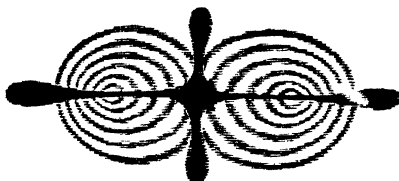

Fig. 89.



Fig. 90.

be replaced by white spaces, and the red rings by green, the yellow by indigo, and so on. These systems of rings have, generally speaking, the same colours as those of thin plates, or as those of a system of rings round one axis. The orders of the colours commence at the centres of each system; but at a certain distance, which corresponds to the sixth ring, the rings, instead of returning and encircling each pole, encircle the two poles as an ellipse does its two foci. When we diminish or increase the thickness of the plate of *nitre*, the rings are diminished, or increased accordingly.

Small specimens of salts may also be crystallised and mounted in Canada balsam for viewing under the stage of the microscope; by arresting the crystallisation at certain stages, a greater variety of forms and colours will be obtained: we may enumerate salicine, asparagine, acetate of copper, phospho-borate of soda, sugar, carbonate of lime, chlorate of potassa, oxalic acid, and all the oxalates found in urine, with the other salts from the same fluid, a few of which are shown at fig. 91.

Dr. W. B. Herapath contributed an interesting addition to the uses of polarised light, by applying it to discover the salts of alkaloids, quinine, &c. in the urine of patients.

He says : " It has long been a favourite subject of inquiry with the professional man to trace the course of remedies

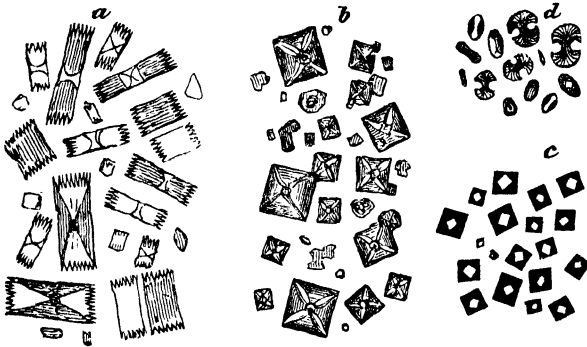

Fig. 91.—*Urinary Salts.*

*a*, Uric acid; *b*, Oxalate of lime, octahedral crystals of; *c*, Oxalate of lime allowed to dry, forming a black cube; *d*, Oxalate of lime, as it occasionally appears, termed the dumb-bell crystal.

in the system of the patient under his care, and to know what has become of the various substances which he might have administered during the treatment of the disease.

" Having been struck with the facility of application, and the extreme delicacy of the reaction of polarised light, when going through the series of experiments upon the sulphate of iodo-quinine, I determined upon attempting to bring this method practically into use for the detection of minute quantities of quinine in organic fluids; and after more or less success by different methods of experimenting, I have at length discovered a process by which it is possible to obtain demonstrative evidence of the presence of quinine, even if in quantities not exceeding the one-millionth part of a grain; in fact, in quantities so exceedingly minute, that all other methods would fail in recognising its existence. Take for *test-fluid* a mixture of three drachms of pure acetic acid, with one fluid-drachm of rectified spirits-of-wine, to which add six drops of diluted sulphuric acid.<sup>1</sup>

" One drop of this test-fluid placed on a glass-slide, and the merest atom of the alkaloid added, in a short time

(1) *A drop of a solution of Cinchonidine is better. See Addenda.*

solution will take place ; then, upon the tip of a very fine glass-rod let an extremely minute drop of the alcoholic solution of iodine be added. The first effect is the production of the yellow or cinnamon-coloured compound of iodine and quinine, which forms as a small circular spot ; the alcohol separates in little drops, which by a sort of repulsive movement, drive the fluid away ; after a time, the acid liquid again flows over the spot, and the polarising crystals of sulphate of iodo-quinine are slowly produced in beautiful rosettes. This succeeds best without the aid of heat.

“To render these crystals evident, it merely remains to bring the glass-slide upon the field of the microscope, with the selenite stage and single tourmaline, or Nicol’s prism, beneath it ; instantly the crystals assume the two complementary colours of the stage ; red and green, supposing that the pink stage is employed, or blue and yellow, provided the blue selenite is made use of. All those crystals at right angles to the plane of the tourmaline, producing

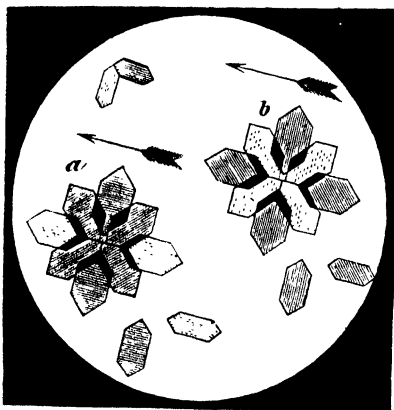

Fig. 92.—In this figure heraldic lines are adopted to denote colour. The dotted parts indicate *yellow*, the straight lines *red*, the horizontal lines *blue*, and the diagonal, or oblique lines, *green*. The arrows show the plane of the tourmaline, *a*, blue stage ; *b*, red stage of selenite employed.

that tint which an analysing-plate of tourmaline would produce when at right angles to the polarising-plate ;

whilst those at  $90^\circ$  to these educe the complementary tint, as the analysing-plate would also have done if revolved through an arc of  $90^\circ$ .

“This test is so ready of application, and so delicate, that it must become *the test, par excellence*, for quinine: fig. 92, *a* and *b*. Not only do these peculiar crystals act in the way just related, but they may be easily proved to possess the whole of the optical properties of that remarkable salt of quinine, the sulphate of iodo-quinine.

“To test for quinidine, it is merely necessary to allow the drop of acid solution to evaporate to dryness upon the slide, and to examine the crystalline mass by two tourmalines, crossed at right angles, and without the stage. Immediately little circular discs of white, with a well-defined black cross very vividly shown, start into existence, should quinidine be present even in very minute traces. These crystals are represented in fig. 93.

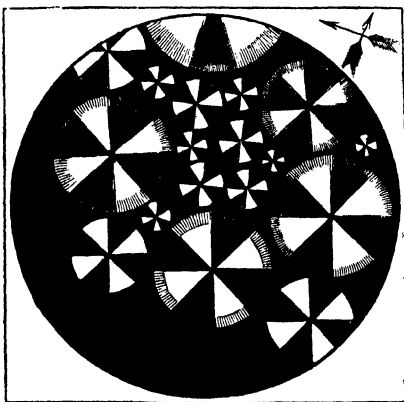

Fig. 93.

“If we employ the selenite stage in the examination of this object, we obtain one of the most gorgeous appearances in the whole domain of the polarising-microscope: the black cross at once disappears, and is replaced by one which consists of two colours, being divided into a cross

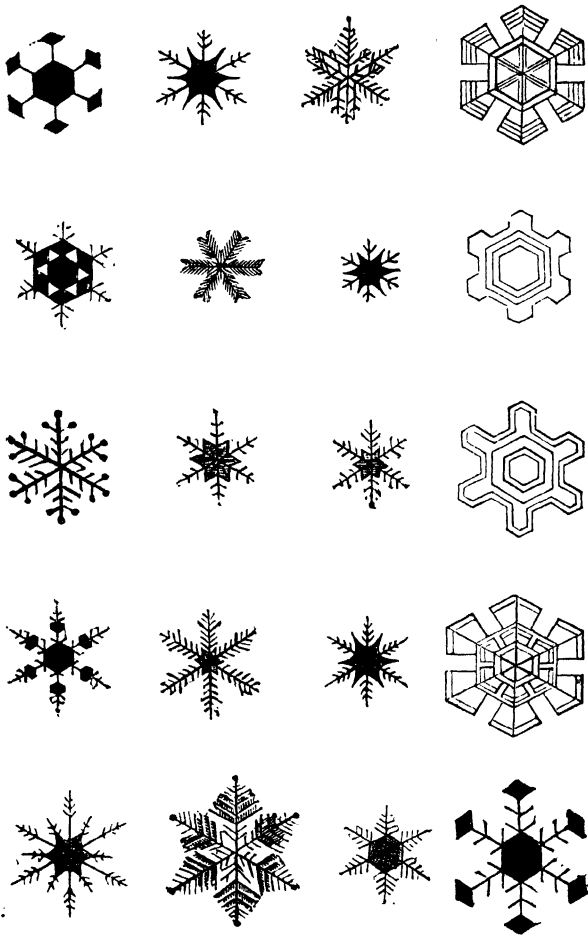

Fig. 94.—Snow Crystals.

having a red and green fringe, whilst the four intermediate sectors are of a gorgeous orange-yellow. These appearances alter upon the revolution of the analysing-plate of tourmaline; when the blue stage is employed, the cross will assume a blue or yellow tint, according to the position of the analysing-plate. These phenomena are analogous to those exhibited by certain circular crystals of boracic acid, and to those circular discs of salicine (prepared by fusion); the difference being, that the salts of quinidine have more intense depolarising powers than either of the other substances; besides which, the mode of preparation effectually excludes these from consideration. Quinine prepared in the same manner as quinidine has a very different mode of crystallisation; but it occasionally presents circular corneous plates, also exhibiting the black cross and white sectors, but not with one-tenth part of the brilliancy, which of course enables us readily to discriminate the two."

Ice doubly refracts, while water singly refracts. Ice takes the rhomboidic form; and snow in its crystalline form may be regarded as the skeleton crystals of this system. A sheet of clear ice, of about one inch thick, and slowly formed in still weather, will show the circular rings and cross if viewed by polarised light.

It is probable that the conditions of snow formation are more complex than might be imagined, familiar as we are with the conditions relating to the crystallisation of water on the earth's surface. Dr. Smallwood, of Isle Jesus, Canada East, has traced an apparent connection between the form of the compound varieties of snow crystals and the electrical condition of the atmosphere, whether negative or positive; and is instituting experiments for his better information on the subject.

A great variety of animal, vegetable, and other substances possess a doubly refracting or depolarising structure, as: a quill cut and laid out flat on glass; the cornea of a sheep's eye; skin, hair, a thin section of a finger-nail; sections of bone, teeth, horn, silk, cotton, whalebone; stems of plants containing silica or flint; barley, wheat, &c. The larger-grained starches form splendid objects; *tous-les-mois*, being the largest, may be taken as a type of all



the others. It presents a black cross, the arms of which meet at the hilum. On rotating the analyser, the

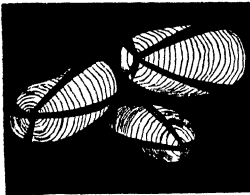

Fig. 95.

*Potato Starch, seen under polarised light.*

black cross disappears, and at  $90^\circ$  is replaced by a white cross; another, but much fainter black cross being perceived between the arms of the white cross. Hitherto, however, no colour is perceptible. But if a thin plate of selenite be interposed between the starch-grains and the polariser, most splendid and delicate colours appear. All

the colours change by revolving the analyser, and become complementary at every quadrature of the circle. West and East India arrow-root, sago, tapioca, and many other starch-grains, present a similar appearance; but in proportion as the grains are smaller, so are their markings and colourings less distinct.

“The application of this modification of light to the illumination of very minute structures has not yet been fully carried out; but still there is no test of differences in density between any two or more parts of the same substance that can at all approach it in delicacy. All structures, therefore, belonging either to the animal, vegetable, or mineral kingdom, in which the power of unequal or double refraction is suspected to be present, are those that should especially be investigated by polarized light. Some of the most delicate of the elementary tissues of animal, such as the tubes of nerves, the ultimate fibrillæ of muscles, &c., are amongst the most striking subjects that may be studied with advantage under this method of illumination. Every structure that the microscopist is investigating should be examined by this light, as well as by that either transmitted or reflected. Objects mounted in Canada balsam, that are far too delicate to exhibit any structure under transmitted, will often be well seen under polarised light; its uses, therefore, are manifold.”<sup>1</sup>

(1) Juekett's *Practical Treatise on the Use of the Microscope*.

## · APPLICATION OF BINOCULARITY TO THE MICROSCOPE.

The application of this principle to microscopic purposes seems to have been tried as early as 1677, by a French philosopher, le Père Cherubin, of Orleans, a Capuchin friar. The following is an extract from the description given by him of his instrument: "Some years ago I resolved to effect what I had long before premeditated, to make a microscope to see the smallest objects with the two eyes conjointly; and this project has succeeded even beyond my expectation, with advantages above the single instrument so extraordinary and so surprising, that every intelligent person to whom I have shown the effect, has assured me that inquiring philosophers will be highly pleased with the communication."

This communication long slumbered and was forgotten, and nothing more was heard of the subject until Professor Wheatstone's very surprising invention of the stereoscope, when it again attracted the attention of this philosopher, who applied to both Ross and Powell to make him a binocular instrument. But this was not done; and during the year 1853 a notice appeared in *Silliman's American Journal* of a binocular instrument constructed by Professor Riddell of America, who had contrived a binocular microscope in 1851, with the view "of rendering both eyes serviceable in microscopic observations." "Behind the objective," he writes, "and as near thereto as possible, the light is equally divided and bent at right angles, and made to travel in opposite directions, by means of two rectangular prisms, which are in contact by their edges somewhat ground away, the reflected rays are received, at a proper distance for binocular vision, upon two other rectangular prisms, and again bent at right angles, being thus either completely inverted for an inverted microscope, or restored to their first direction for the direct microscope." M. Nachet also constructed a binocular microscope, upon the same principle as his double microscope, with the tubes placed vertically and  $2\frac{1}{2}$  inches distant. This even had disadvantages and inconveniences, which Mr. F. H. Wenham ingeniously succeeded in modifying and improving.

In describing his improvements, he observes : " That in obtaining binocularity with the compound achromatic microscope, in its complete acting state, there are far greater practical difficulties to contend against, and which it is highly important to overcome; in order to correct some of the false appearances arising from what is considered the very perfection of the instrument.

" All the object-glasses, from the one-inch upwards, are possessed of considerable angular aperture ; consequently, images of the object are obtained from a different point of view, with the two opposite extremes of the margin of the cone of rays ; and the resulting effect is, that there are a number of dissimilar perspectives of the object all blended together upon the single retina at once. For this reason, if the object has any considerable bulk, we shall have a more accurate notion of its form by reducing the aperture of the object-glass.

" Select any object lying in an inclined position, and place it in the centre of the field of view of the microscope ; then, with a card held close to the object-glass, stop off alternately the right or left hand portion of the front lens : it will be seen that during each alternate change certain parts of the object will alter in their relative position.

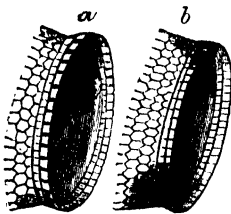

Fig. 96.

" To illustrate this, fig. 96 *ab* are enlarged drawings of a portion of the egg of the common bed-bug (*Cimex lecticularis*), the operculum which covers the orifice having been forced off at the time the young was hatched. The figures exactly represent the two positions that the inclined orifice will occupy when the right and left hand portions of the object-glass are stopped off. It was illuminated as an opaque object, and drawn under a two-thirds object-glass of about  $28^{\circ}$  of aperture. If this experiment is repeated, by holding the card over the eye-piece, and stopping off alternately the right and left half of the ultimate emergent pencil, exactly the same changes and appearances will be observed in the object under view.

The two different images just produced are such as are required for obtaining stereoscopic vision. It is therefore evident that if, instead of bringing them confusedly together into one eye, we can separate them so as to bring fig. 96 *a b* into the left and right eye, in the combined effect of the two projections, we shall obtain all that is necessary to enable us to form a correct judgment of the solidity and distances of the various parts of the object.

“Diagram 3, fig. 97, represents the methods that I have contrived for obtaining the effect of bringing the two eyes

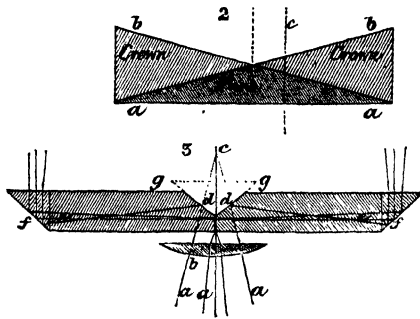

Fig. 97.

sufficiently close to each other to enable them both to see through the same eye-piece together. *a a a* are rays converging from the field lens of the eye-piece; after passing the eye-lens *b*, if not intercepted, they would come to a focus at *c*; but they are arrested by the inclined surfaces, *d d*, of two solid glass prisms. From the refraction of the under incident surface of the prisms, the focus of the eye-piece becomes elongated, and falls within the substance of the glass at *e*. The rays then diverge, and after being reflected by the second inclined surface *f*, emerge from the upper side of the prism, when their course is rendered still more divergent, as shown by the figure. The reflecting angle that I have given to the prisms is  $47\frac{1}{2}^\circ$ . I also find it is requisite to grind away the contact edges of the prisms, as represented, as it prevents the extreme margins

of the reflecting surfaces from coming into operation, which can seldom be made very perfect.

“The definition with these prisms is good; but they are liable to objection on account of the extremely small portion of the field of view that they take in, and which arises from the distance that the eyes are of necessity placed beyond the focus of the eye-piece, where, the rays being divergent, the pupil of the eye is incapable of taking them all in; also there is great nicety required in the length of the prisms, which must differ for nearly every different observer.

“I have constructed an adjusting binocular eye-piece, not differing in principle from the last. The first reflection is performed by means of a triangular steel prism, with the two inclined facets very highly polished; this is represented by the dotted outline *g g*. The rays, after having been reflected at right angles, are taken up by two rectangular glass prisms, shown by the dotted lines at *f f*. The best effect that I have yet produced in the way of binocular vision applied to the microscope, is that next to be described, in which I have altogether dispensed with reflecting surfaces, merely using three refracting prisms, which, when placed together, are perfectly achromatic. *a a*, diagram 2, fig. 97, is a single prism of dense flint-glass, with the three surfaces well polished; *b b* are two prisms of crown-glass of half the length of the under flint-prism, to the upper inclines of which they are cemented with Canada balsam.

“The angle of inclination to be given to the prisms must depend upon the dispersive power of the flint and crown glass employed. In the combination that I have worked out, I have used, for the sake of simplicity, some flint and crown that Mr. Smith kindly furnished me with, in which the dispersive powers are exactly as two to one; consequently, I have had to make the angle of the crown just double that of the flint, in order to obtain perfect achromatism. The refractive power of each must also be known, that we may determine the angles of the prisms suitable for refracting the rays from the object-glass into the two eyes, at a distance of nine inches. *c*, fig. 97, represents a ray of light incident at right angles upon the

under-surface of the flint-prism. On leaving the second surface, and entering the crown-prism, it is slightly bent inwards, and on finally emerging, it is refracted outwards in the direction required. The base of the compound prism should not be larger than is sufficient to cover the stop of the lowest object-glass, in order that they may be made very thin.

“The method of applying the prism to the binocular microscope is shown in fig. 98: *aa* is the object-glass; *b*, the prism placed as close behind it as the fittings will admit. The prism is set in an aperture in a flat disc of brass, which has a horizontal play in every direction, in order that it may be adjusted and fixed in such a position that the junction of the prisms may bisect the rays from the object-glass, and at the same time be at right angles to the transverse centres of the eye-piece; *cc* are the two bodies of the microscope, provided with the draw-tubes and the usual eye-pieces *dd*. The distance between them should be rather less than the average distance asunder of the eyes; and in cases where these are very wide apart, we can pull out the draw-tubes, which will increase the distance between the eye-pieces.

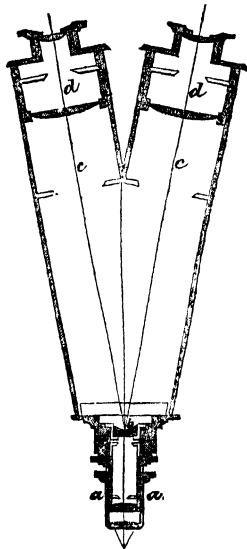

Fig. 98.

“With this apparatus I obtain the whole of the field of view in each eye; which circumstance I was not prepared to expect, as this must, in some measure, depend upon the correction of the oblique pencils of the object-glass, for we cannot expect to look obliquely through the objective of a compound achromatic microscope in the same way as in the single lens arrangement, but can only avail ourselves of such oblique pencils of rays as are corrected for passing through the axis of the microscope.”

Mr. Wenham subsequently improved and simplified this arrangement, a detailed account of which will be found in the volume of the *Journal of Microscopical Science* for 1854.

#### APPLICATION OF PHOTOGRAPHY TO THE MICROSCOPE.

At the time this book was projected, it was thought that if the objects so beautifully exhibited under the microscope could be drawn by light on the page of the book, or on the wood-blocks, so that the engraver might work directly from the drawings thus made, truthfulness would be insured, and we should present to the reader a valuable record of microscopic research never before seen or attempted. But in this we were doomed to disappointment by the existence of a patent, which presented obstacles too great to be surmounted; and the idea was abandoned, with the exception of a few drawings then prepared, and ready to hand: the patent restrictions having been since removed, we have embodied them in our pages. The eye and feet of fly, antenna of moth, paddles of whirligig, with a few others, were first taken on a film of collodion, then floated off the glass on to the surface of a block of wood, the wood having been previously and lightly inked with printer's ink or amber-varnish, and the film gently rubbed or smoothed down to an even surface, at the same time carefully pressing out all bubbles of air or fluid.

For the purposes of photography the only necessary addition to the ordinary microscope is that of a dark chamber; it should indeed form a camera obscura, having at one end an aperture for the insertion of the eye-piece end of the microscopic tube, and at the other a groove for carrying the crown-glass for focussing. This dark chamber must not exceed eighteen inches in length; for if longer, the pencil of light transmitted by the object-glass is diffused over too large a surface, and a faint and unsatisfactory picture results therefrom. Another advantage is, that pictures at this distance are in size very nearly equal to the object seen in the microscope. In some instances, better pictures are produced by taking away the eye-piece

of the microscope altogether. The time of producing the picture varies from five to twenty seconds, with the strength of the daylight. A camphine lamp, light Cannel coal-gas, or the lime-light, will enable a good manipulator to produce pictures nearly equal to those produced by sun-light. Collodion offers the best medium, as a strong negative can be made to produce any number of printed positives.

The light is transmitted from the mirror through the object and lenses, and brought to a focus on the ground-glass, or prepared surface of collodion, in the usual manner. Care must be taken not to use the burning focus of the lenses. The gas microscope may be used to make an enlarged copy of an object, it is only necessary to pin up against the screen a piece of prepared calotype paper to receive the reflected image. Mr. Wenham gives directions for improving "microscopic photography" in the *Quarterly Journal of Microscopical Science* for January, 1855. In this paper he has shown how to insure quick and accurate focussing; or, in other words, the making of the *actinic* and *visual* foci of the objective coincident. The simplest and cheapest way of producing coincidence is to screw a biconvex lens into the place of the back-stop of the object-glass, which thus acts as part of its optical combination. An ordinary spectacle lens, carefully centred and turned down to the required size, answers the purpose exceedingly well.

An excellent method has been proposed and adopted by Mr. Wenham, for exhibiting the form of certain very minute markings upon objects. A negative photographic impression of the object is first taken on collodion, in the ordinary way, with the highest power of the microscope that can be used. After this has been properly fixed, it is placed in the sliding frame of an ordinary camera, and the frame end of the latter adjusted into an opening cut in the shutter of a perfectly dark room. Parallel rays of sunlight are then thrown through the picture by means of a flat piece of looking-glass fixed outside the shutter at such an angle as to catch and reflect the rays through the camera. A screen standing in the room, opposite the lens of the camera, will now receive an image, exactly as from a magic lantern, and the size of the image will be propor-



tionate to the distance. On this screen is placed a sheet of photogenic paper intended to receive the magnified picture. We ought to add, however, that it requires considerable practice to avoid the distortion and error of definition occasioned by a want of coincidence in the chemical and visual foci. Imperfections are much increased when the highest powers of the microscope are employed; false notions of structure are also given, which is the case in Mr. Wenham's photograph of *P. Angulatum*.

Mr. S. Highley has a mode of adapting an object-glass to the ordinary camera, for the purpose of taking microscopic objects on collodion and other surfaces, fig. 99; a sectional view of his arrangement is here given, which is

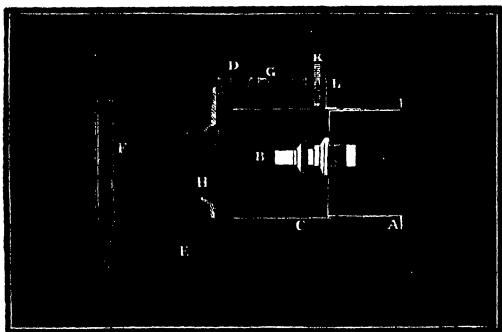

Fig. 99.—Highley's Camera.

very compact, steady, and ever ready for immediate use. The tube A screws into the flange of a camera which has a range of twenty-four inches; the front of this tube is closed, and into it screws the object-glass B. Over A slides another tube C; this is closed by a plate, D, which extends beyond the upper and lower circumference of C, and carries a small tube, E, on which the mirror F is adjusted. To the upper part of D the fine adjustment G is attached; this consists of a spring-wire coil acting on an inner tube, to which the stage-plate H is fixed, and is regulated by a graduated head, K, acting on a fine screw, likewise attached to

the stage-plate, after the manner of Oberhauser's microscopes. An index *L* is affixed opposite the graduated head *K*. The stage and clamp slides vertically on *H*; and by sliding this up or down, and the glass object-slide horizontally, the requisite amount of movement is obtained to bring the object into the field. The object being brought into view, the image is roughly adjusted on the focussing-glass by sliding *C* on *A*; the focussing is completed by aid of the fine adjustments *G K*, and allowance then made for the amount of non-coincidence between the chemical and visual foci of the object-glass. The difference in each glass employed should be ascertained by experiment in the first instance, and then noted. By employing a finely-ground focussing-glass greased with oil, this arrangement forms an agreeable method of viewing microscopical objects with both eyes, and is less fatiguing. As a very large field is presented to the observer, this arrangement might be advantageously employed for class demonstration.

Two exquisitely delineated *negative* objects obtained in this way by Mr. Delves were afterwards printed as *positives*, for the purpose of illustrating an excellent paper on the "Application of Photography to Microscopy," No. 3 of the *Quarterly Journal of Microscopical Science*.

## PART II.

### CHAPTER I.

VEGETABLE STRUCTURE—VITAL AND CHEMICAL CHARACTERISTICS—MICROSCOPIC FORMS OF VEGETABLE LIFE—THE VEGETABLE CELL—FUNGI—FUNGOID DISEASES—MOSESSES—ALGÆ—CONFERVÆ—DESMIDIACEÆ—STRUCTURE OF PLANTS—ADULTERATION OF ARTICLES USED FOR FOOD—PREPARATION FOR MICROSCOPIC EXAMINATION, ETC.



SINCE the introduction of the achromatic microscope, we have obtained nearly the whole of the valuable information which we now possess relative to the minute structure of vegetables. Before that time, although some progress had been made in vegetable physiology, yet the means of distinguishing one structure from another, with their several external characters, comprehended the amount of our botanical knowledge. "The vegetation which everywhere adorns the surface of the globe, from the moss that covers the weather-worn stone, to the cedar that crowns the mountain, is replete with matter for reflection. Not a tree that lifts its branches aloft, not a flower or leaf

that expands beneath the sunlight, but has something of habit, of structure, or of form, to arrest the attention."

The microscopist sees proof of a higher life in plants than he before conceived; and he becomes convinced, after examining the functions which their organs are destined to perform, that animals and plants are only separate links in the great chain of organic nature.

The vegetable kingdom is divided into three great classes—the *Dicotyledonous*, or Exogenous plants, the *Monocotyledonous*, or Endogenous plants, and the *Acotyledonous*. Plants of the first and second classes bear flowers, and are found in the temperate zones: those of the third do not flower, and include the simplest forms of vegetable life, being mostly found in warm climates. The characteristics of exogenous plants, are first the branched or reticulated veining of their leaves, next, the formation of their stems, which consist of central pith, wood, and bark: they increase in size by means of layers of new substance every year deposited between the two latter. This mode of growth gives to sections of their stems a ringed appearance, the number of rings corresponding to the number of years of growth. These rings are crossed at intervals by straight lines,—the medullary rays,—which diverge from the central pith, connecting them with the bark.<sup>1</sup>

Plants are organised beings; that is, organisms composed of a number of essential and mutually dependent parts: in common, therefore, with animals, they possess a principle which is in continued action; and which operates in such a manner, that the individual parts which it forms in the body, are adapted to the designs of the whole. Or, in more intelligible language, plants are *living bodies*; like animals, they are the offspring of other beings similar to themselves; they *grow*, are endowed with *excitability*, have their periods of *infancy*, *adult age*, *decay*, and *death*. Their affinity to animals is much closer than is commonly supposed. The vital or creative power exists already in the germ, in plants as well as in animals; and by its influence the essential parts of the future plant are formed. It might be supposed that the lateral generation of plants—namely, that renewal of the individual which is the result of budding or *gemmation*—is sufficient to dis-

(1) See Dr. Lindley's *Elements of Botany*, for an excellent description of vegetable structure; or Henfrey's *Elementary Course of Botany*.

tinguish them from animals; but this opinion is erroneous, as we find that the formation of gems or buds is common in animals belonging to the class *Protozoa*. In the *hydra* we perceive the germs developed as small ovoid elevations upon the cylindrical body of the animal, and are, when examined in this state, like the first formation of the buds in plants, mere masses of cells; but as their growth proceeds, these cells undergo a special arrangement, so as to produce the different tissues of the body, and acquire the proper form of the polype: on the same principle, the bud in the plant is gradually developed, until it terminates and becomes a branch.

Plants, like animals, possess excitability, or the faculty of being acted upon by external stimuli, impelling them to the exertion of their vegetable powers. Light acts on plants, directing the growth of the stem, vigour, and colour, the direction of the branches, position of leaves, the opening and shutting of flowers. Heat influences the protrusion of buds, and other stimulants affect vegetable irritability; as an instance of which, cut plants, when fading, revive if placed in water impregnated with certain chemicals.

Besides the physical and physiological distinctions generally pointed out as marking the line between animals and plants, chemistry furnishes many others. Thus, one of the great functions of a plant is to decompose water, and assimilate its components to the vegetable tissues; and it is equally a property of animal life constantly to reform itself from the same elements. The oxygen derived from the atmosphere, by whatever means it is introduced into the animal system, is expended in the production of carbonic acid and water, both of which are thrown off as excretions. It is true that water is exhaled in great quantities from the surfaces of plants; but it is that fluid which has been taken into the system of the plant, and has not undergone decomposition; it is, therefore, not actually found in the body of the vegetable, as it is in that of the animal. During the process of vegetation, *protein* is formed from the constituents of water with carbonic acid and ammonia; *protein* is formed in the animal body, and enters largely into the blood and muscle.

There is the closest affinity in the chemical nature of the products between plants and animals. Vegetable *albumen* is identical in composition with that in blood and in eggs; *casein* does not materially differ in milk and the juices of some plants: we have many other equally striking characteristics, which modern chemical investigations have unfolded. Plants in some characteristics differ most strikingly, in being almost destitute of voluntary sensation and motion: here we would not have *sensibility* confounded with *irritability*, a principle which plants, in common with animals, possess. The simplest forms of animal life manifest both sensation and volition, even those that are fixed to rocks and other bodies presenting a ramified and vegetative form; for instance, in the compound polypes, each individual polype displays both sensation and voluntary motion. It is, nevertheless, difficult to attribute satisfactorily the movement of some plants to irritability alone. Thus we find plants, in an apartment with light admitted on one side, not only turn the upper surface of their leaves to the light, but bend their stems and branches towards it. Many other instances might be cited; but none of them, excepting the movements of the *Oscillatoria*,<sup>1</sup> more closely resemble volition. Plants, again, differ from animals in having no nervous system.

Another great distinction is connected with the function of digestion, which the simplest form of animals possess: those even which turn inside out, the hydra, have an internal cavity, into which their food is taken at intervals; but vegetables are nourished from the surface, and by continual imbibition.

It has been supposed, because the sap rises in plants, and in the interior of the *internodia* and cells of some simple plants, a rotatory motion of fluid can be perceived, that plants, like animals, have a circulation of fluids. This opinion is at least disputable, the sap of plants as-

(1) *Oscillatoria*, a genus of confervoid algæ, the filaments of which are enclosed in tubular cellulose sheets, open at the ends, from which the fragments emerge when they are broken across. It is the remarkable spontaneous movements of the *Oscillatoria*, which make them objects of so much interest for the microscopist. They are found on damp ground, amongst mosses, rocks, stones, and in fresh and salt water. Another of the same family frequently covers over the surface of standing water, to which it imparts a green colour; it is called *Aphanizomenon Flos-aquæ*, by Morr and Dr. Hassall.

ending only once,—for that which is termed the descending sap of the plant is the proper juice prepared in the leaf; and the fact of currents being observed in opposite directions, is no proof of the existence of a circulation. But it may be asked, is the motion in the *Chara* or the cells of the *Vallisneria spiralis*, or in the hairs of the radicle fibres of *frog's-bit*, any proof of a circulation? It is certainly a proof of the motion of a fluid in the cells of a plant, and is very different from a general circulation of the sap; which is the only answer that can be made to such an inquiry: and the true circulation in animals is derived from an internal impelling power, and not from external influences.

A more distinctive character is obtained in the products of the respiratory function in plants: respiration is performed by the entire surface in most animals, as it is by all plants; but the products are different. In plants, the process consists chiefly in the conversion of carbonic acid and water into vegetable matter; hence oxygen is exhaled from the leaves, and carbonic acid absorbed by them from the atmosphere; and it is by the decomposition of that acid in the leaf, that the greater part of the oxygen is restored to the air. And although plants exhale carbonic acid during the night and in the shade, yet the quantity is small; and plants are, in reference to their respiration, a balance in the opposite scale to animals; they remove from the air the carbonic acid exhaled from the lungs and spiracles of animals, and re-supply the oxygen requisite for their respiration. Without the vegetable tribes, the atmosphere would soon cease to be fitted for the present race of animals; without the carbonic acid formed by animal respiration, plants would lose the greater part of their nutriment; and by their reciprocal action the atmosphere is preserved very nearly unchanged. Therefore the most important difference between the two may be said to be essentially that pointed out by Dr. Lankester, *in the nature of the distinctive character of the gases inhaled and exhaled by animals and by plants.*

Dr. Carpenter accepts this as a sufficiently distinctive line of demarcation between the two kingdoms. In an address to the Microscopical Society, he says: "I wish to

stop for a moment, to notice how strongly the differences between the vegetable and animal kingdoms are marked out, even in the lowest and simplest forms of both. The *Protophytes*, like the most perfect plants, draw their nutriment from the inorganic compounds which are everywhere within their reach,—water, carbonic acid, and ammonia; by decomposing carbonic acid, they give off oxygen; and they form for themselves the starch and the chlorophyll, the cellulose and the albumen, which they apply to the augmentation of their own substance. On the other hand, even those humblest *Protozoa*, the *Rhizopoda*, can only exist (so far as we can see) upon organic materials previously elaborated by other beings: these they receive ‘bodily’ into their interior; and though mouth, stomach, intestine, and anus, all have to be extemporized every time that the animal feeds, yet the digestion which the alimentary particles undergo in its interior, is not less complete than that which is performed by the most elaborate apparatus which we anywhere meet with; and the nutrient materials thus obtained seem to be appropriated, without any further conversion, to the augmentation of the substance of the body. Thus, notwithstanding the remarkable *analogy* which these two orders of beings exhibit, I cannot see that any difficulty need be experienced in separating them, when we are acquainted with their mode of nutrition. The *Gregarina* constitutes no real exception; for although it imbibes its nutriment through its entire surface, like the *Protophyte*, yet that nutriment has been previously digested and prepared for it by the animal whose body it inhabits; and in the absence of any oral orifice or digestive apparatus of its own, it corresponds with a far higher group of animals, the Cestoid Worms, which live under the same conditions. Some recent observations, it is true, would seem to invalidate this distinction, by showing that certain *Rhizopods* and *Infusoria* have their origin in undoubted plants; but we must be permitted for the present to withhold our assent from conclusions so strange, and to question whether they may not be invalidated by some unsuspected fallacy. It has been well remarked, however, that ‘there is no limit to the possibilities of Nature;’ and I should be the last to



attempt to set up as fixed laws what are merely the expressions of the present state of our knowledge, or to wish to throw discredit on the observations of accomplished and careful microscopists, merely because they overthrow distinctions which I had imagined to be well founded. I would strongly recommend the observations of Professor Hartig (*Quart. Journ. of Microsc. Science*, vol. iv., p. 51) and of Mr. Carter (*Ann. of Nat. Hist.*, Feb., 1856) to your attentive scrutiny."

As we pass on to a more intimate examination of the various structures entering into a plant, it will be seen that we have objects of the deepest interest presented to our notice; and strikingly differing as we find plants and animals in some essentials, we shall here, at our starting-point, find them gradually coalescing, until they meet in a common granule—"that of the simple and individual cell."

Mülder, in describing this starting-point of life, says: "The cell is a concave globule. This concave globule is an individual; in the most simple form in which it can possibly exist (in the lowest moulds), it possesses all the powers of the molecules united into one whole, and thus reduced to a state of equilibrium. This state depends, not only on the nature of the substances and of their elements, carbon, hydrogen, oxygen, and nitrogen, but also on their form. The state of equilibrium, therefore, could not exist, unless this concave globular form existed. Moreover, this hollow globule possesses the whole of these forces in a state of mutual combination, co-operating for one end; this being a peculiarity which also apparently depends on the globular form."

Cells from which plants are formed are very small delicate closed sacs, partaking of many forms, and enclosed in a perfectly transparent membrane, so excessively thin, that it is with difficulty detected, unless iodine or some colouring-matter be previously added. Dead and old cells form an exception, as they become thickened, and the broken surfaces are then readily detected. At one time the cells were said to be developed by an extrication of gaseous matter among mucus; but the double walls which separate cells are irreconcilable with such an origin. Mr. Thwaites

regards the original wall of the cell as a mere shell, having quite a subordinate office to perform in the growth of plants; and he ascribes all the vital powers of growth to the cytoblast and colouring-matter of the central nucleolus. He supposes the cell-membrane to arise from the action of electrical currents upon mucus, and that fissiparous division is caused by the presence of two centres of electrical force, each giving rise to a set of currents, and producing two cell-membranes instead of the original one.<sup>1</sup>

The first and most curious exemplification of the simple cell is the fungi known as the *Yeast Plant*: it consists of two parts, the *cell-wall*, composed of a matter termed *cellulose*, and the contents of the cells, resembling fat or oil. The notion that yeast was an organised living plant, was at first strongly opposed by even Berzelius and Liebig; but by the microscope they have been convinced both of its organisation and vitality. The scientific name by which it is known is *Fermentum cervisia*, or *Torula cervisia*; it

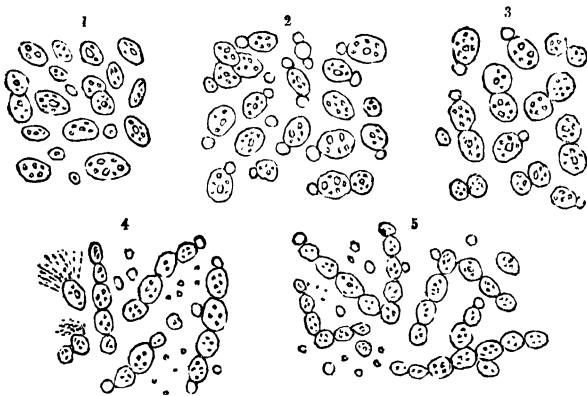

Fig. 100.—The growth of the Yeast Plant.

consists of globular or ovoidal transparent nucleated cells, represented in the accompanying fig. 100, and showing its

(1) For further information on this very interesting subject, see Henfrey's translation of Mohl's *Vegetable Cell*; Dr. J. B. Sanderson on "Vegetable Reproduction," *Cyclopædia of Anatomy and Physiology*, &c.

stages of growth as first observed by Turpin, who carefully watched the changes after mixing it with some newly-made beer. Fresh yeast has the appearance seen at No. 1; one hour after it had been added to the wort, germination commenced, and produced two buds or cells, as at No. 2. In three hours they were doubled, as at No. 3, and attained the size of the maternal cell. In eight hours the plants began to ramify, as at No. 4, and some to explode, emitting a fine powder; and in three days joined filaments with lateral branches were produced, as at No. 5.

Yeast-cells occasionally form in the human body under certain states of disease, principally occurring in the urine of patients, hence the cell has been named *Torula diabetica*: for the sake of comparison, a few of those cells, highly magnified, are represented at No. 9, fig. 102. Mr. Busk met with a peculiar disease of the stomach, in some patients under his care, vomiting another form of this remarkable fungi, named by Professor Goodsir *Sarcina ventriculi*; which under the microscope presents the appearance shown in fig. 101. Dr. John Ogle tells us that he

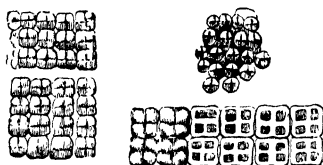

Fig. 101.—*Sarcina ventriculi*.

has met with *Sarcina* when disease was never previously suspected to exist, the average being one out of every five or six stomachs examined by him. Are not these *Sarcina* taken into the stomach with impure water?

The *Mycoderma cervisia* of Desmazières is another stage of growth of the same plant deposited in porter-vats. Its various stages are drawn in fig. 102, Nos. 6, 7, and 8; the perfect plant is seen, with its granular contents in the stem. One of the most remarkable of this tribe has been committing great devastation among our grape crops during the past two years. A section of the grape, mag-

nified 75 diameters, is represented in fig. 103 ; the fungi or mildew is growing from a section of the skin.

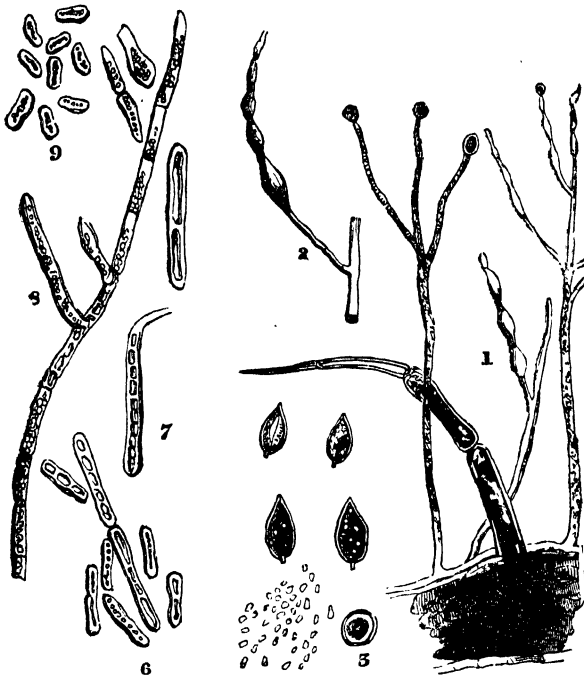

Fig. 102.—Fungoid disease.

1, A section of the Tomato, showing sporangiæ growing from the spawn or root (*mycelium*). 2, A budding from the upper part of a branch. 3, Vertical and lateral views of sporangiæ, with their granular contents turned out. 6, 7, and 8, Different stages of growth of *Mycoderma cervisia*. 9, *Torula diabetica*.

“Grapes,” says Mr. Harris, “when blighted, are covered with what appears to be a white powder, like lime, a little darkened with brown or yellow. These fungi send forth laterally, in all directions, thread-like filaments, which become so completely interwoven with one another as entirely to cover and enclose the skin of the grape in a

compact and firm network, and on each is seen the egg-shaped capsule or seed-pod."

Fungoid diseases among our growing crops attracted but little attention until the mischief produced by them

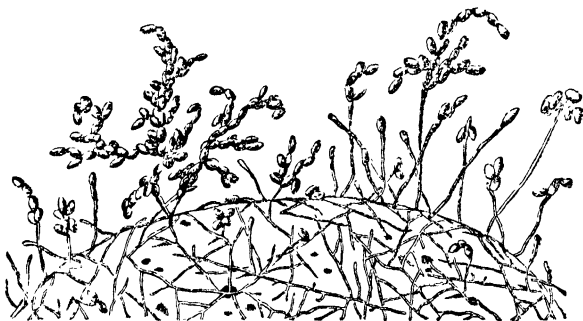

Fig. 103.—Section of a Grape.

became serious ; and the microscope has enabled us to determine and grapple with the destroyer in its variety of forms ; thus, we have our corn-crops withering under the blighting influence of the *Uredos* and *Pucinias*, our vines, &c., under that of the *Oidium*, our esculents under the *Botrytis infestans* (potato blight), and the same disease infects the tomata, fig. 102.

The microscope has revealed to us that many of the skin diseases attacking the human frame are but other forms of the same growth of parasitic fungi. *Cryptogamia*, a low form of plant presenting at first simple filaments, then ramified, consisting of a single elongated cell, or several cells placed end to end, as in those of the yeast-plant. The disease known as *Ringworm*, infesting the heads of children, is one out of forty-eight different species of *Cryptogamia*. The conditions of growth of this low form of vegetable life on the human body are the same as in other situations. Dr. Gudden, who has lately published a work upon *Cutaneous Diseases caused by "Parasitic Growths,"* describes Ringworm under the name of *Porrigofungus* ; the spores of which are round on the upper, and filamentous on the under surface. Whenever the healthy

chemical processes of nutrition are impaired, and the incessant changes between the solids and the fluids slacken, then the skin may furnish a proper soil for the fungi to take root in, should the sporules come in contact with it. That dreadful disease known as cancer will no doubt ultimately prove of vegetable growth, or a degeneration of the nutritive animal cell into that of a fungoid vegetable cell.

The Rev. S. G. Osborne, during the cholera visitation of 1854, endeavoured to direct public attention to the very general distribution of fungi. He says, "Only those who have closely studied these fungi can be aware how very minute and yet how systematically formed they are. Preparations of a dozen different species, taken from the grape, potato, parsnip, bean, cucumber, cineraria, veronica, &c., many of which have been in fluid for more than a year, retain their form as perfectly as if only taken from the plant a day. No two are alike in form; but all are alike in this—under the very high powers of the microscope, they show an external hyaline case, with a second utricle, or inner case, full of minute spores. If a few leaves of the infected haulm of the potato are taken and gently shaken over a piece of black paper, a quantity of very fine white powder is obtained: place a little of this in fluid, under a power of 500 linear; every atom of this powder will resolve itself into a distinct cell, somewhat of the form of an ace of spades, varying more or less in size from about 3-5000ths of an inch in length. There will be seen a well-defined outline of an inner cell, in which are many hundred greenish-looking spores; some of the cells will burst, and by using a still higher power it will be seen that these have all the shape and characteristics of the parent cell. Several of them lie easily between the lines on a micrometer, which lines are just 1-5000th of an inch apart. In one of our cuts the destructive effects upon the tuber are shown. There can scarcely be one spot of earth on which these fungi do not fall in their thousands. Insoluble in nature, they wait where they fall the growth of the particular plant for which each has its own affinity, that if that plant grows on that spot, its enemy is near, on the very soil

from which it is to draw life. But I further believe that there must be some peculiar disposition yet to be developed in the plant before the fungus will act upon it, to its own rapid development, and the destruction of the said plant."

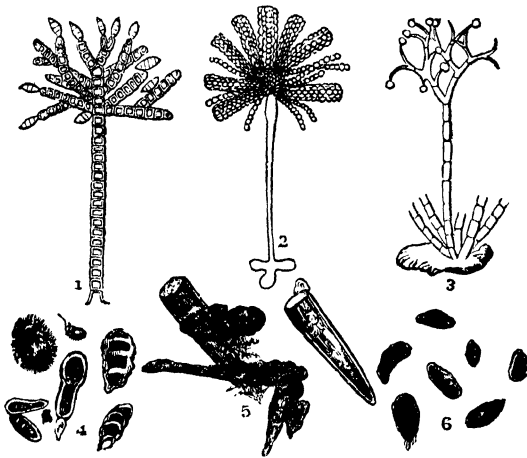

Fig. 104.—Fungi. (Magnified 200 diameters.)

1, *Brachycladium penicillatum*, found on the stem of a plant. 2, *Aspergillus glaucus*, found on cheese, &c. 3, *Botrytis*; the common form of mould on decaying vegetable substances. 4, Fungi caught over a sewer (*foul air*). 5, Fungi growing on a pumpkin. 6, Fungi caught in the air at the time of the cholera. (*Aerozoa?*)

Fig. 104, 4 and 6, represents forms of fungi taken in London by the author during the cholera visitation, September 1854. Our limited knowledge of the matter does not forbid the supposition that there may be some, even among the purely vegetable fungi, which might, in certain conditions of the human body, when taken into the frame, produce immediate severe constitutional disturbance. The *Sarcina* may be cited as an instance of this fact. It strikes us, however, as far more probable, that from drains and cesspools—reservoirs as they are for excrementitious animal matter—may emanate specific fungi, the spores of which under certain conditions of atmosphere, would be given out in such quantities, and in such minute particles, as

easily to be carried about by every current of air. Persons in health may inhale and swallow these spores, and escape injury from them. Other persons, depressed physically from local or accidental causes, may afford to them just the *pabulum* which will develop their poisonous quality.

Many animal organisms, such as infusorial animalcules and their ova, are frequently found floating about in the air, as well as the fungi spoken of.

The upholders of the spontaneous hypothesis were considerably shaken by an experiment instituted by Schultze, and recorded in the *Edinburgh New Philosophical Journal* for 1837. He found that if the decomposing substances, which always generate infusoria and fungi when the atmospheric air is freely admitted to them, be shut up in vessels to which the air is admitted only after passing through a red-hot tube, or through strong sulphuric acid, no animalcules or fungi appear. The experiment seemed conclusive. By destroying these germs—which the sulphuric acid did without altering the air—all development was prevented.

All the fungi that constitute mouldiness are so small as to escape observation; they clothe the surface of the body which they attack with light patches of yellow, blue, green, red, and various other colours; they are all interesting objects for microscopic observation. The species of these plants are extremely numerous; they chiefly belong to the Hyphomycetous division of the order; the peculiar characteristic of which is, that the plants are flocculent, naked (that is, not enclosed in a case, or seated upon a peculiar receptacle), distinct, but interwoven into a general mass, which looks like a thin web, or a collection of cobwebs.

One of the most common is the *Ascochora mucedo*, which forms a blue mould upon bread, paste, and substances prepared from flour: this is even found to live under circumstances that would be fatal to any other form of vegetation; that is, it flourishes in paste mixed up with a solution of the well-known poison, bichloride of mercury.

Their favourite soil is decaying animal or vegetable matter; but one species, the *Botrytis bassiana*, attacks the living silkworm just as it is about to enter the chrysalis



state, and kills it : others destroy house-flies, which may be seen in the autumn glued by these parasites to the window, on which they have alighted in a semi-torpid state.

Mother of vinegar (*mater acetii*) is a mould-plant which is developed in vinegar, and forms therein a thick leather-like coat, similar to the inflammatory crust which covers the crassamentum of blood drawn from rheumatic patients. It is produced not merely in but from the vinegar, and as it forms the acetic acid diminishes, until ultimately water alone remains.

This mould-plant belongs to the genus *mycoderma* of Persoon, or *hygrocrocis* of Agardh. It is one of the simplest vegetable formations, and belongs to the *Fungi* rather than to the *Algæ*. It is formed in vinegar obtained both from wine and beer, but not in that procured from wood. It exists in unmixed vinegar, and also in vinegar in which organic substances are preserved. These substances, however, contribute nothing towards the development of the plant, but merely promote the production of a germ or a cell from which the mould-plant is formed out of the elements of the acetic acid. In all cases, whether organic substances be or be not contained in the vinegar, the mycoderma has the same conformation and chemical composition.

Mulder analyzed three plants formed in vinegars containing different vegetable substances. His results gave as the formula for the plant,  $C_{136} H_{115} N_5 O_{96}$ . The quantity of nitrogen contained in protein, is taken as the basis of the formula. By potash all the protein may be removed, and the residue is pure cellulose. The latter, according to Payen's analysis, and corroborated by experiment, has for its formula,  $C_{24} H_{21} O_{21}$ .<sup>1</sup>

*Mycoderma acetii*, or mother of vinegar, consists, therefore, of protein and cellular tissue.

Animals, birds, insects, and fishes, alike suffer from the ravages of fungi. One of the most prevalent observed among our domestic pets is that found growing over the upper surface of the gold-fish ; death is almost certain when this white fungoid disease once commences its ravages upon them.

(1) Well manufactured paper is nearly, or wholly, composed of cellulose, and may be regarded as the microscopical standard of the cellulose contained in all vegetable tissues.

We range by the side of these, the fungi known as mushrooms, toadstools, puff-balls ; and also a large number of microscopic plants, forming those appearances which are referred to generally under the terms of mouldiness, mildew, blight, smut, dry-rot, &c. It is well known that fruit-preserves are very liable to be attacked by the common *bread-mould* (No. 3, fig. 104); which no care employed in completely closing the mouths of the jars can prevent. It is to be remarked, however, that they are much less liable to suffer in this way, if not left open for a night before they are tied down: and this fact induces us to believe that the germs of the mould sow themselves before the jar is covered. Some kinds of cheese derive their flavour from the quantity of a fungous growth which spreads through the mass whilst it is yet soft. This appears to owe its origin to a damp atmosphere, with diminution of light ; which conditions are especially favourable to the development of these bodies.

The power of reproduction of the vegetable *mould-plant*, *mucor*, is so great, that extensive tracts of snow are suddenly reddened by the *Gory-dew*, *Protococcus nivalis* (red-snow) of the northern regions. That the Red-snow plant consists of a cellular or filamentous tissue, may be easily ascertained by means of a microscope of even moderate powers ; and one of a higher power demonstrates that the filaments are nothing more than *cells drawn out*. Sometimes, as in the genus *Uredo*, the cells are spheroidal, having little connection with each other ; each cell containing propagating matter, and all separating from each other in the form of a fine powder when ripe. In plants of a more advanced organisation, as the genus *Monilia*, the constituent cells are connected in series which preserve their spherical, and also contain their own reproductive matter ; while in such plants as *Aspergillus* (fig. 104, No. 2), the cells partly combine into threads forming a stem, and partly preserve their spheroidal form for fructification. It is probable, however, that in all fungi, and certain that in most of them, the first development of the plant consists in what we here call a filamentous matter which radiates from the centre formed by the space or seeds ; and that all the cellular spheroidal appearances are subsequently deve-

developed, more especially with a view to the dispersion of the species.

One of the most remarkable of the lower forms of vegetable life is the *Protococcus pluvialis*, fig. 105, not uncommon in collections of rain-water, constituting the genus *Chlamydomonas* of Professor Ehrenberg, and the curious motile organs of which induced him to regard them as animalcules. Dr. Cohn describes the early form of the cell as a mass of endochrome, consisting of a colourless protoplasm, through which red or green-coloured granules are more or less uniformly diffused: on the sur-

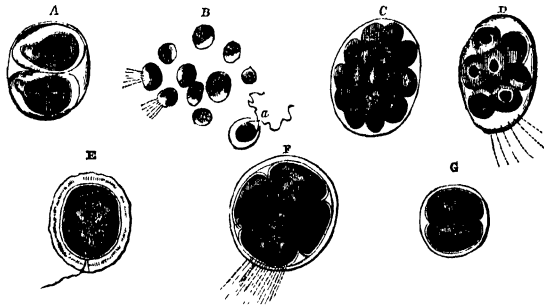

Fig. 105.—Vegetable Cell Development. (*Protococcus pluvialis*.)

- A, division of a simple cell into two, each primordial vesicle having developed a cellulose envelope around itself; B, Zoospores, after their escape from the cells; C, division of an encysted cell into segments; D, division of another cell, with vibratile filaments projecting from cell-wall; E, an encysted cell; F, division of an encysted cell into four, with vibratile filaments projecting; G, division of a cell into two.

face of this endochrome the colourless protoplasm is condensed into a more consistent layer, forming an imperfect "primordial utricle;" and this is surrounded by a tolerably firm layer, which seems to consist of cellulose, or of some modification of it. Outside this again, as in fig. 105 E, when the *still-cell* is formed by a change in the condition of the cell that has been previously "motile," we find another envelope, which seems to be of the same nature, but which is separated by the interposition of fluid. The multiplication of *still-cells*, by self-division, takes place as in the previous instance; the endochrome, enclosed in its primordial utricle, first undergoes separation into two halves,

as seen at c, and each of these again undergoing the same division in its turn. Sometimes the contents of the original cell subdivides at once into four, eight, or even thirty-two parts, many of which perish without any further change. The greater number, when set free, possess active powers of movement, and rank as *Zoospores*, fig. 105 B, which may either develop a loose cellulose investment or cyst, so as to attain the full dimensions of the original motile cell, or may become covered with a dense envelope, losing their vibratile cilia, and thus pass into the *still* condition. All these changes, whose relation to each other has been clearly proved by competent observers, have been regarded as constituting, not merely distinct species, but distinct genera of animalcules; such as *Chlamydomonas*, *Euglena*, *Trachelomonas*, *Gonium*, *Pandorina*, *Uvella*, *Monas*, *Astatia*, and several others.

The process of segmentation is often accomplished with great rapidity. Thus it is only necessary to pour the water containing those organisms from a smaller and deeper into a larger and shallower vessel, at once to determine segmentation. The *motile* cells seem to be favourably affected by light, for they collect themselves at the surface of the water and at the edges of the vessel; but when about to undergo segmentation, or pass into the *still* condition, they sink to the bottom of the vessel, or retreat to that part in which they are least subjected to light: if kept in the dark, they lose most of their colouring matter, and remain stationary, and do not undergo segmentation. Mr. Busk kept his plants for observation in little glass vessels, having the form of a truncated cone, about two inches deep, and one inch and a quarter in diameter, with a flat bottom polished on both sides, and filled with water to the depth of from two to three lines. In vessels of this kind he was able to follow the development of a number of various cells throughout. The ordinary small cupping-glass, or glass cells, such as we have described at page 93, answer the purpose equally well.

Another family of *Protophytes*, of singular beauty and interest to the microscopist, is the group known as *Volvocineæ*,—so closely allied to the former that they have been confounded by more than one observer.

The cell is commonly known as the *Volvox globator*, or revolving-cell, represented in figs. 106 & 120, Nos. 1, 2, 3. These revolving globular bodies are found of various sizes, some large enough to be discernible by the naked eye, and for a very long time, were classed with the lower forms of animal life; and there it remained for the micro-chemical investigators of the present time to settle the perplexing question, and assign to them a place amongst the lower order of plants.

Leeuwenhök first perceived the motion of what he termed *globes*, "not more than the 30th of an inch in diameter, through water; and judged them to be animated." These *globes* are

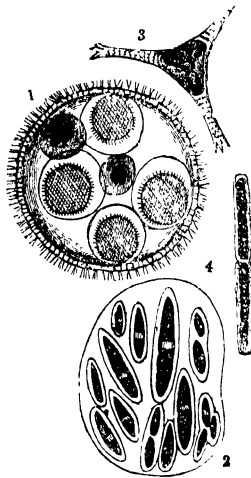

Fig. 106.

*Volvox*, just before the young burst forth, showing the vesicle which encloses each. 2, Parent cell of *Closteria*. 3, *Docidium clavatum*. 4, *Staurastrum gracilis*.

studded with innumerable minute green spots at their surface, each of which is a cell about the 3500th part of an inch in size, with a vivid nucleus having many ever-active cilia, that bristle over their spherical home and are bound to each other by bands forming a beautiful net-work. Within this globe busy active nature is at work carefully providing a continuance of the species; and from six to twenty little bright-green spheres have been found enclosed in the larger transparent case. As each one of these arrives

at maturity, the parent cell enlarges; then bursts asunder to launch forth its offspring into a watery world. Both the older and younger spheres possess openings through which the water freely flows, affording food and air to the little organised being.

Dr. Carpenter believes, "The *Volvocineæ*, whose vegetable nature has been made known to us by observation of cer-

tain stages in the history of their lives, are but the *motile forms* (*Zoospores*) of some other plants, whose relation to them is at present unknown." Professor Williamson, having carefully examined the *Volvox globator*, says:—"That the increase of its internal cells is carried on in a manner precisely analogous to that of the algæ; that between the outer integument and the primordial cell-wall of each cell, a hyaline membrane is secreted, causing the outer integument to expand; and as the primordial cell-wall is attached to it at various points, it causes the internal colouring-matter, or endochrome, to assume a stellate form (see fig. 120, No. 3), the points of one cell being in contact with those of the neighbouring cell, these points forming at a subsequent period the lines of communication between the green spots generally seen within the full-grown *Volvox*." Cilia can be distinctly seen on the outer edge of the adult *Volvox*; by compressing and rupturing one, they may even be counted. Professor Busk has been able to satisfy himself, by the addition of the chemical test *iodine*, of the presence of a very minute quantity of starch in the interior of the *Volvox*, which he considers as conclusive of their vegetable character. A singular provision is made in the structure of the gemmules, consisting of a slender elastic filament, by which each is attached to the parent cell-wall: at times it appears to thrust itself out, as if in search of food; it is then seen quickly to recover its former nestling-place by contracting the tether.

"Wonderful as it may appear, we have here an example of all the functions of vegetable life—namely, absorption, assimilation, exhalation, secretion, reproduction, &c.—effected by a single cell. This is ever continued in the highest and most complicated orders of vegetable life, in which there is a variety of organs adapted for the performance of different offices, the functions of which are effected by the agency of cells, obtaining materials of formation and support from the ordinary chemical agents around them. Thus the more man gains a knowledge of the wonders displayed in these minute objects of creation, the more is the mind humbled and inspired with reverence for the First Great Cause." <sup>1</sup>

(1) Dr. Mantell's *Wonders of Geology*.

*Desmidiaceæ*.—The disputed question of the animal or vegetable nature of these cells has received much valuable elucidation from Mr. Ralfs, who has given to the world the

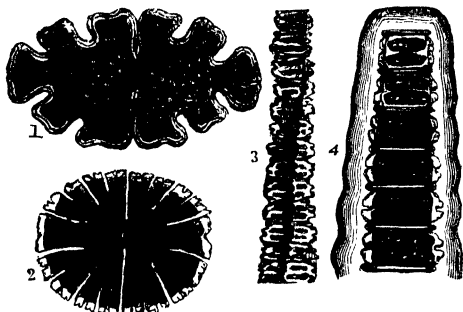

Fig. 107.

1, *Euastrum oblongum*. 2, *Microsterias rotata*. 3, *Desmidium quadrangulatum*.  
4, *Didymoprium Grevilli*.

results of his laborious researches in his excellent work on *The British Desmidiaceæ*, published in 1848; and the conclusions arrived at by this painstaking author have been generally accepted by men of science. The interest which has so long attached to this topic will warrant us in devoting some space to its consideration; and we avail ourselves for that purpose of Mr. Ralfs' labours, with a recommendation to those of our readers who would wish to familiarise themselves more completely with this peculiar species, to consult the pages of the book above referred to.

*Desmidiaceæ* are grass-green in colour, surrounded by a transparent structureless membrane, a few only having their integuments coloured; they are all inhabitants of fresh water. Their most obvious peculiarities are the beauty and variety of their forms and their external markings and appendages; but their most distinctive character is their evident division into two or more segments. Each cell or joint in the *Desmidiaceæ* generally consist of two symmetrical valves or segments; and the suture or line of junction is in general well marked. The multiplication of the cells by repeated transverse division is full of interest,

both on account of the remarkable manner in which it takes place, and because it unfolds the nature of the process in other families, and furnishes a valuable addition to our knowledge of their structure and physiology.

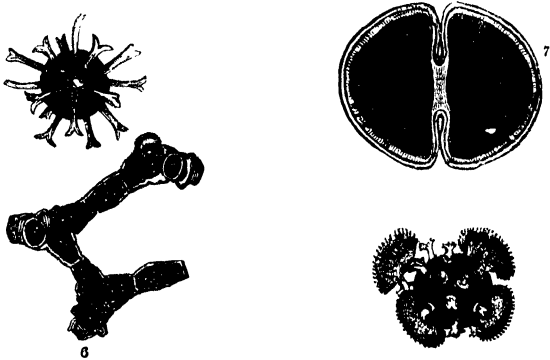

Fig. 108.

5, *Micrasterias denticulata*. 6, *Didymoprium Borreri*. 7, *Cosmarium Ralfsii*.  
8, *Staurastrum hirsutum*.

The compressed and deeply-constricted cells of *Enastrum* offer most favourable opportunities for ascertaining the manner of their division; for although the frond is really a single cell, yet this cell in all its stages appears like two, the segments being always distinct, even from the commencement. As the connecting portion is so small, and necessarily produces the new segments, which cannot arise from a broader base than its opening, these are at first very minute; though they rapidly increase in size. The segments are separated by the elongation of the connecting tube, which is converted into two roundish hyaline lobules. These lobules increase in size, acquire colour, and gradually put on the appearance of the old portions. Of course, as they increase, the original segments are pushed further asunder, and at length are disconnected, each taking with it a new segment to supply the place of that from which it has separated.

It is curious to trace the progressive development of the new portions. At first they are devoid of colour, and



have much the appearance of condensed gelatine ; but as they increase in size, the internal fluid acquires a green tint, which is at first very faint, but soon becomes darker ;

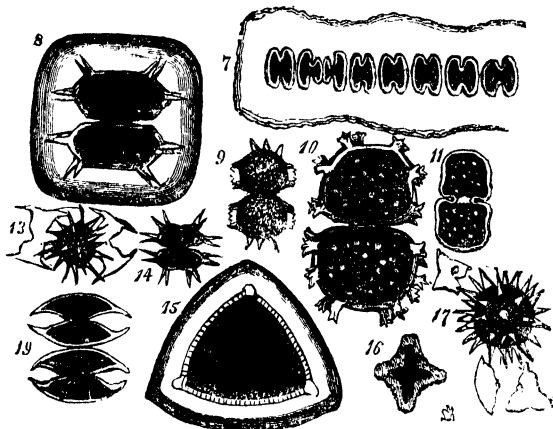

Fig. 109.

7, *Sphaerzosma vertebrautum*. *Xanthidia*. 8, 9, 10, 11, 13, 14, 17, 19, *Cosmarium Ralfsii*. 15, *Staurastrum tumidum*. 16, *Staurastrum dilatatum*.

at length it assumes a granular state. At the same time the new segments increase in size, and obtain their normal figure ; the covering in some species shows the presence of puncta or granules. In *Xanthidium* and *Staurastrum* the spines and processes make their appearance last, beginning as mere tubercles, and then lengthening until they attain their perfect form and size, armed with setæ ; but complete separation frequently occurs before the whole process is completed. This singular process is repeated again and again, so that the older segments are united successively, as it were, with many generations. When the cells approach maturity, molecular movements may be at times noticed in their contents, precisely similar to what has been described by Agardh and others as occurring in *Confervæ*. This movement has been aptly termed a swarming. All the *Desmidiaceæ* are gelatinous. In some the mucus is condensed into a distinct and well-defined

hyaline sheath or covering, as in *Didymoprium Grevillii* and *Staurastrum tumidum*; in others it is more attenuated, and the fact that it forms a covering is discerned

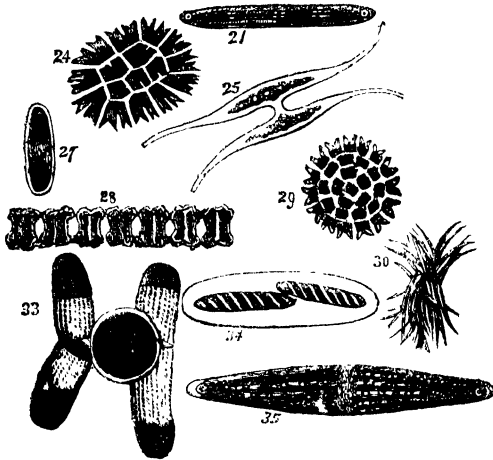

Fig. 110.

21, *Penium*. 24, *Pediastrum biradiatum*. 25, *Closterium*, showing self fission. 27, *Penium Jenneri*. 28, *Aptogonium desmidium*. 29, *Pediastrum pectinatum*. 30, *Ankistrodesmus falcatus*. 33, *Penium margaritaceum*. 34, *Sp. rotæmia*. 35, *Closterium*.

only by its preventing the contact of the coloured cells. In general its quantity is merely sufficient to hold the fronds together in a kind of filmy cloud, which is dispersed by the slightest touch. When they are left exposed by the evaporation of the water, this mucus becomes denser, and is apparently secreted in larger quantities, to protect them from the effects of drought. Meyen states, "that the large and small granules contain starch, and were sometimes even entirely composed of it;" and "in the month of May he observed many specimens of *Closterium* in which the whole interior was granulated; these grains gave with iodine the beautiful blue colour, indicative of the presence of starch."\*

(1) The test for starch can be easily applied, and so remove any doubt that may exist. It is only necessary to bear in mind that unless granular matter

“Did we trust solely to the eye, we should indeed be very liable to pronounce these variable and beautiful forms as belonging to animals rather than vegetables. All favours this supposition. Their symmetrical division into parts; the exquisite disc-form, finely cut and toothed *Micrasterias*; the lobed *Euastrum*; the *Cosmarium*, glittering as it were with gems; the *Xanthidium*, armed with spines; the scimitar-shaped *Closterium*, embellished with striæ; the *Desmidium*, resembling a tape-worm; and the strangely insect-like *Staurastrum*, sometimes furnished with arms, as if for the purpose of seizing its prey;—all these characteristics appear to a superficial observer to belong rather to the lowest forms of animal, than vegetable life.” Another indication Dr. Bailey adduced, by rendering apparent their power of motion; taking a portion of mud covered with *Closteria*, and placing it in water exposed to light; after a time, it will be seen that if the *Closteria* are buried in the mud, they work their way to the surface, and cover it with a green stratum: this is no doubt owing to the stimulus light exerted upon all matter, although at first appearing very like a voluntary effort. Another is afforded by their retiring beneath the surface when the pools dry up. Mr. Ralfs states that he has taken advantage of this circumstance to obtain specimens less mingled with foreign matter than they would otherwise have been.

During the summer of 1854 the Rev. S. G. Osborne drew attention to the economy of an interesting specimen of this family, the *Closterium Lunula*; and after many careful investigations we coincide in his opinion that the membrane of the endochrome, both on its inner and outer surface, is ciliated.

In the *Closterium Lunula*, we have ascertained that the best view of its circulation, and the *cilia* which give to it its impulse, are obtained by the use of strong daylight, transmitted through the combination of coloured glass

be seen in the interior of the cell, starch cannot be present. A small quantity of diluted tincture of iodine may be applied, removing the free iodine by the aid of heat, occasionally adding a little water to facilitate its removal. This also will assist in the removal of the *brownish stain* which at first obscures the characteristic *purple tint*; and then, by applying the highest power of the microscope, the peculiar colour of the purple iodide of starch will in general be perceived.

proposed by Mr. Rainey, and adapted to a 1-4th achromatic condenser; with which must be used a 1-8th object-glass. The Gillett's condenser, or parabolic reflector, will do equally well if used with a 1-8th objective. In diagram A, fig. 111, a specimen of the *C. Lunula*, as seen

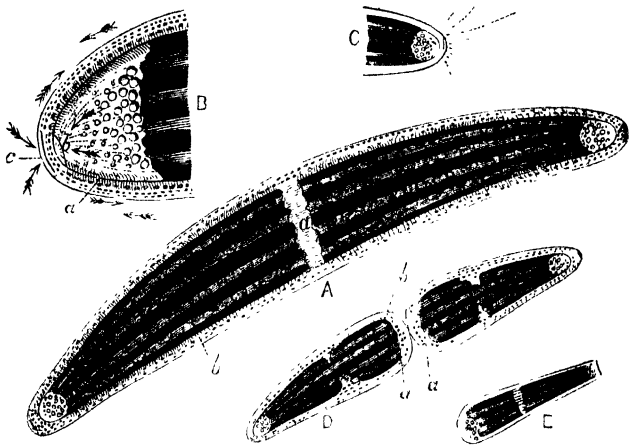

Fig. 111 — *Closteria Lunula*.

with the above arrangement of microscopic power, and a deep eye-piece, the cilia is in full action along the edge of the membrane which encloses the endochrome; and also, but not so distinctly, along the inside of the edges of the frond itself. Their action is precisely the same as that in the branchiæ of the mussel: there is the same wavy motion; and as the water dries up between the glasses in which the specimen is enclosed, the circulation becomes fainter, and the *cilia* are seen with more distinctness.

In diagram A, a line is drawn at *b* to a small oval mark; these exist at intervals, and more or less in number over the surface of the endochrome itself, beneath the membrane which invests it. These seem to be attached by small pedicles, and are usually seen in motion on the spot to which they are thus fastened; from time to time they

break away, and are carried by the circulation of the fluid, which works all over the endochrome, to the chambers at the extremities ; there they join a crowd of similar bodies, each in action within those chambers, when the specimen is a healthy one.

The circulation, when made out over the centre of the frond, for instance at *a*, is in appearance of a wholly different nature from that seen at the edges. In the latter, the matter circulated is in globules, passing each other, in distinct lines, in opposite directions ; in the circulation as seen at *a*, the streams are broad, tortuous, of far greater body, and passing with much less rapidity. To see the centre circulation, use a Gillett's illuminator and the 1-8th power ; work the fine adjustment so as to bring the centre of the frond into focus, then almost lose it by raising the objective ; after this, with great care, work the milled head till the dark body of the endochrome is made out ; a hair's-breadth more adjustment gives this circulation with the utmost distinctness, if it is a good specimen. It will be clearly seen, by the same means, at all the points where the spaces are put ; and from them may be traced, with care, down to both extremities.

The endochrome itself is evidently so constructed as to admit of contraction and expansion in every direction. At times the edges are in semi-lunar curves, leaving uninterrupted clear spaces visible between the green matter and the investing membrane ; at other times, the endochrome is seen with a straight margin, but so contracted as to leave a well-defined transparent space along its whole edge, between itself and the exterior case. It is interesting to keep changing the focus, that at one moment we may see the globular circulation between the outer and inner case, and again the mere sluggish movement between the inner case and the endochrome.

At B is given an enlarged sketch of one extremity of a *C. Lunula*. The arrows within the chamber pointing to *b*, denote the direction of a very strong current of fluid, which can be detected, and occasionally traced, most distinctly ; it is acted upon by cilia at the edges of the chamber, but its chief force appears to come from some impulse given from the very centre of the endochrome.

The fluid is here acting in positive jets, that is, with an almost arterial action ; and according to the strength with which it is acting at the time, the loose floating bodies are propelled to a greater or less distance from the end of the endochrome ; the fluid thus impelled from a centre, and kept in activity by the lateral *cilia*, causes strong *eddies*, which give a twisting motion to the free bodies. The line —*a*, in this diagram, denotes the outline of the membrane which encloses the endochrome ; on both sides of this *cilia* may be detected. The circulation exterior to it passes and repasses it in opposite directions, in three or four distinct courses of globules ; these, when they arrive at —*c*, seem to encounter the fluid *jetted* through an aperture at the apex of the chamber ; which disperses them so much, that they appear to be driven, for the most part, back again on the precise course by which they had arrived. Some, however, do enter the chamber ; occasionally, but very rarely, one of the loose bodies may be seen to escape from within, and get into the outer current, it is then carried about until it becomes adherent to the side of the frond.

With regard to the propagation of the *C. Lunula*, we have never seen anything like *conjugation* ; but we have repeatedly seen what Mr. Osborne has so well described— increase by self-division.

Observe the diagram D ; but for the moment suppose the two halves of the frond, represented as separate, to just overlap each other. Having watched for some time, the one half may be seen to remain passive ; the other has a motion from side to side, as if moving on an axis at the point of juncture : the separation then becomes more and more evident, the motion more active, until at last with a jerk one segment leaves the other, and they are seen as drawn. It will be observed, that in each segment the endochrome has already a *waist* ; but there is only one chamber, which is the one belonging to the one extremity of the original entire frond. The globular circulation, for some hours previous to subdivision, and for some *few* hours afterwards, runs quite round the obtuse end of the endochrome — *a*, by almost imperceptible degrees ; from the end of the endochrome symptoms of

an elongation of the membranous sac appear, giving a semi-lunar sort of chamber; this, as the endochrome elongates, becomes more defined, until it has the form and outline of the chamber at the perfect extremity. The obtuse end — *b* of the frond is at the same time elongating and contracting; these processes go on; in about five hours from the division of the one segment from the other, the appearance of each half is that of a nearly perfect specimen, the chamber at the new end is complete, the globular circulation exterior to it becomes affected by the circulation from within the said chamber; and, in a few hours more, some of the free bodies descend, become exposed to, and tossed about in the eddies of the chamber, and the frond, under a 1-6th power, shows itself in all its beautiful construction. E is a diagram of one end of a *C. didymotocum*, in which the same process was noticed.

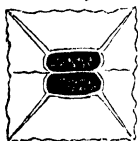

Fig. 112.

The *Euastrum Didelta* is well worthy of attention, as well as many other species, the *Xanthidium Penium*, *Docidium*, &c.

The *Arthrodesmus Incus* has a very beautiful hyaline membrane stretching from point to point, cut at the edges, something like the *Micrasterias*. This is represented at fig. 112.

*The Mode of Finding and Taking Desmidiaceæ.*—As the difficulty of obtaining specimens is very great, it will materially assist the efforts of the microscopist to know the method adopted by Mr. Ralfs, Mr. Jenner, and Mr. Thwaites. “In the water the filamentous species resemble the *Zygnemata*; but their green colour is generally paler and more opaque. When they are much diffused in the water, take a piece of lincn, about the size of a pocket handkerchief, lay it on the ground in the form of a bag, and then, by the aid of a tin box, scoop up the water and strain it through the bag, repeating the process as often as may be required. The larger species, *Euastrum*, *Micrasterias*, *Closterium*, &c., are generally situated at the bottom of the pool, either spread out as a thin gelatinous stratum, or collected into finger-like tufts. If the finger be gently passed beneath them, they will rise to the surface in little masses, and with care may be removed and

strained through the linen as above described. At first nothing appears on the linen except a mere stain or a little dirt ; but by repeated fillings-up and strainings a considerable quantity will be obtained. If not very gelatinous, the water passes freely through the linen, from which the specimen can be scraped with a knife, and transferred to a smaller piece ; but in many species the fluid at length does not admit of being strained off without the employment of such force as would cause the fronds also to pass through, and in this case it should be poured into bottles until they are quite full. But many species of *Staurastrum*, *Pediastrum*, &c., usually form a greenish or dirty cloud upon the stems and leaves of the filiform aquatic plants ; and to collect them requires more care than is necessary in the former instances. In this state the slightest touch will break up the whole mass, and disperse it through the water : for securing them, let the hand be passed very gently into the water and beneath the cloud, the palm upwards and the fingers apart, so that the leaves or stem of the inverted plant may lie between them, and as near the palm as possible ; then close the fingers, and keeping the hand in the same position, but concave, draw it cautiously towards the surface ; when, if the plant has been allowed to slip easily and equably through the fingers, the *Desmidiaceæ*, in this way brushed off, will be found lying in the palm. The greatest difficulty is in withdrawing the hand from the surface of the water, and probably but little will be retained at first ; practice, however, will soon render the operation easy and successful. The contents of the hand should be at once transferred either to a bottle, or, in case much water has been taken up, into the box, which must be close at hand ; and when this is full, it can be emptied on the linen as before. But in this case the linen should be pressed gently, and a portion only of the water expelled, the remainder being poured into the bottle, and the process repeated as often as necessary."

When carried home, the bottles will apparently contain only foul water ; but if it remain undisturbed for a few hours, the *Desmidiaceæ* will sink to the bottom, and most of the water may then be poured off. If a little filtered rain-water be added occasionally, to replace what has been



drawn off, and the bottle be exposed to the light of the sun, the *Desmidiaceæ* will remain unaltered for a long time.

The *Desmidiaceæ* prefer an open country. They abound on moors and in exposed places, but are rarely found in shady woods or in deep ditches. To search for them in turbid waters is useless; such situations are the haunts of animals not the habitats of the *Desmidiaceæ*; and the waters in which the latter are present are always clear to the very bottom.

That very curious fungus, known in Scotland as Siller-cups (*Nidularia campanulata*), fig. 113, consists of a



Fig. 113.—Siller-cups (*Nidularia campanulata*).

curious leathery cup, in which are a number of small thecæ, these contain the sporules; and each plant looks like a bird's nest with several eggs in it. It generally grows on a twig, or a bit of rotten wood, and one has been found growing on a wooden tally, fixed in a pot containing a greenhouse plant. Several kinds of *Agaricus* have blue stems, others orange, yellow, and green, with caps of various colours, some of which are scarlet or crimson, and others have beautiful shades of purple or violet.

The little group of *Hepaticæ* or Liverworts, which is intermediate between Lichens and Mosses, presents numerous objects of interest for the microscopist. These plants are produced by dust-like grains called *spores*, and minute cellular nodules called *gemmae* or buds. The *gemmae* of *Marchantia polymorpha* are produced in elegant membranous cups, with a toothed margin growing on the upper surface of the frond, especially in very damp court yards between the stones, or near running water, where its lobed fronds are found covering extensive surfaces of moist soil. At the period of fructification, these fronds send up stalks, which carry at their summit round shield-like or radiating discs. Besides which, it generally bears upon its surface a number of little open basket-shaped "conceptacles" which are borne upon the surface of the frond, as in fig. 114, and may be found in all stages of development. When mature it contains a number of little green round or oblong discs, each composed of two or more layers of cells; the wall is surmounted by a glistening fringe of teeth, whose edges are themselves regularly fringed with minute outgrowths.

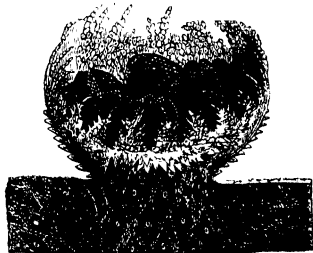

Fig. 114.—Gemmiparous Conceptacle of *Marchantia polymorpha*, expanding and rising from the surface of a frond.

The cup seems to be formed by a development of the superior epidermis, which is raised up and finally bursts and spreads out, laying bare the seeds. The development of this structure presents much analogy to that of the sori of Ferns.

*Muscaceæ*, mosses, are another low form of vegetable life, Linnæus called them *servi*,—servants, or workmen,—as they seem to labour to produce vegetation in newly-formed countries, where soil is not yet formed. They also fill and consolidate bogs, and form rich mould for the growth of larger plants, which they protect from the

winter's cold. The common, or Wall Screw-moss, fig. 115, growing almost every where on old walls and other brick-work, if examined closely, will be found to have springing from its base numerous very slender stems, each

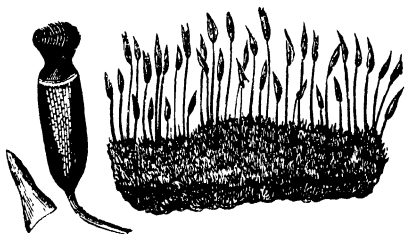

Fig. 115.—Screw Moss.

of which terminates in a dark brown case, which encloses its fruit. If a patch of the moss is gathered when in this state, and the green part of the base is put into water, the threads of the fringe will uncoil and disentangle themselves in a most curious and beautiful manner; from this circumstance the plant takes its popular name of Screw-moss. The leaf usually consists of either a single or a double layer of cells, having flattened sides, by which they adhere one to another. The

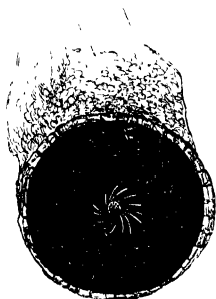

Fig. 116.—Mouth of Capsule of *Funaria*, showing Peristome.

leaf-cells of the *Sphagnum* bog-moss, fig. 136, exhibit a very curious departure from the ordinary type; for instead of being small and polygonal, they are large and elongated, and contain spiral fibres loosely coiled in their interior. Mr. Huxley pointed out, that the young leaf does not differ from the older, and that both are evolved by a gradual process of "*differentiation.*" Mosses, like liverworts, possess both antheridia and pistillida, which are engaged in the process of fructification. The fertilized cell becomes gradually developed into a conical body elevated

upon a foot stalk ; and this at length tears across the walls of the flask-shaped body, carrying the higher part upwards as a *calyptra* or hood upon its summit, while the lower part remains to form a kind of collar round the base. These spore-capsules are closed on their summit by *opercula* or lids, and their mouths when laid open are surrounded by a beautiful toothed fringe, termed the *peristome*. This fringe is shown in fig. 116 in mouth of capsule of *Funaria*, with its peristome *in situ*. The fringes of teeth are variously constructed, and are of great service in discriminating the *genera*. In *Neckera anti-pyretica*, fig. 117, the peristome is double, the inner being composed of teeth united by cross bars, forming a very pretty trellis. The seed spores are contained in the upper part of the capsule, where they are clustered round a central pillar, which is termed the *columella* ; and at the time of maturity, the interior of the capsule is almost entirely occupied by spores.



Fig. 117.—Double Peristome of *Neckera Anti-pyretica*.

It may here be mentioned, that all mosses and lichens are more easily detached from the rocks and walls on which they grow in frosty weather than at any other season, and consequently they are best studied in winter. One of the commonest, Scale-moss, fig. 118 (*Jungermannia bidentata*), grows in patches, in moist, shady situations, near the roots of trees, upon commons, and on hedge-banks. The seed-



Fig. 118.—Scale-Moss.

vessels are little oval bodies, which if gathered when unexpanded, and brought into a warm room, burst under the eye with violence the moment a drop of water is applied to them, the valves of the vessel taking the shape of a cross, and the seeds distending in a cloud of brown dust. If this dust be examined with the

microscope, a number of curious little chains, looking something like the spring of a watch, will be found among it, their use being to scatter the seeds; and if the

seed-vessel be examined while in the act of bursting, these little springs will be found twisting and writhing about like a nest of serpents. The undulating Hair-moss (*Polytrichum undulatum*), fig. 119, is found on moist shady banks, and in woods and thickets. The seed-vessel has a curious shaggy cap; but in its construction it is very similar to that of the Screw-moss, except that the fringe round its opening is not twisted. The *Funaria hygrometrica* is a remarkable moss, differing widely in its powers of adaptation, and, consequently, in its greater geographical range, from most of its congeners. The *Funaria* is found in fruit, not only in London, but in every brick-field around it.

*Confervoideæ* — *Algæ*. — The jointed *Confervæ* and some *Algæ* are met with in the smallest accumulations of fresh water standing for any length of time in the

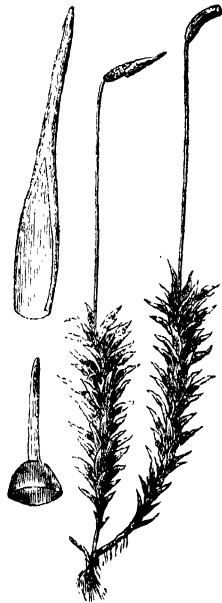

Fig. 119.—Hair-Moss in Fruit.

open air. They present the appearance of thread-like tubes, having joints differing in length, and the manner in which their contents are arranged. They multiply by means of little granules contained in their tubes, which are enclosed in tube after tube gradually added to the end of the previous one. Among these *Confervæ*, the most remarkable are the *Zygnema* and *Oscillatoria*, both of which evince certain degrees of approach to the animal kingdom. The species of the latter genus form dark green and purple slimy patches in damp places, or in water, and are exceedingly remarkable for the power they possess of moving spontane-

ously. When in an active state, their tubes are seen to unite and twist about, just as if they were vegetable worms; but they grow like plants, and their manner of increase is also vegetable. Disjointed *algæ* are extremely curious; they are characterised by their original or final spontaneous separation into distinct fragments, which have a common origin, but an individual life. They multiply by spontaneous division, as represented in fig. 120, Nos. 6

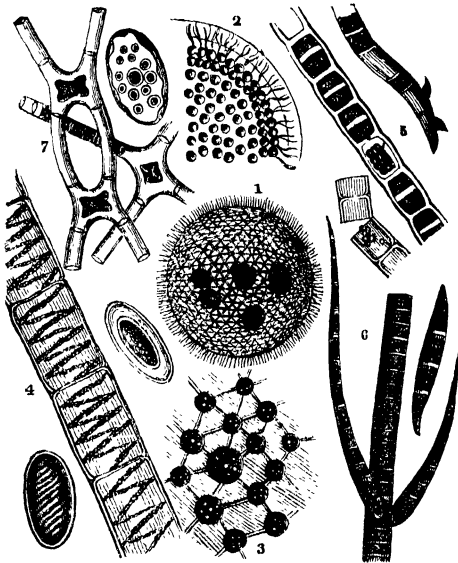

Fig. 120.

- 1, *Volvox globator*. 2, A section of volvox, showing the ciliated margin of the cell. 3, A portion more highly magnified, to show the young *Volvucinae*, with their nuclei and filamentary attachments. 4, *Spirogyra quinma*, near which are spores in different stages of development. 5, *Conferva floccosa*, with cells breaking up. 6, *Stigeoclonium protensum*, showing germinating zoospores. 7, *Staurocarpus gracilis*, cells dividing.

and 7; and are generally found attached to the stems of other plants immersed in water, or floating in pools or ditches.

*Algæ*, or marine sea-weeds, are usually classed by botanists in three great groups, each of which contains several families: these are again divided into genera; and these, in their turn, are made up of one or more species. The species found on the British coasts number about 380. They are grouped into 105 genera. We must not enter into the niceties of classification, but confine ourselves to their general features. Taken in the order in which they present themselves to us on the shore, and limiting each by its most obvious characteristic, that of colour, we may observe, that the group of green sea-weeds (*Chlorospermeæ*) abound near high-water mark, and in shallow tide-pools within the tidal limit; that the olive-coloured (*Melanospermeæ*) cover all exposed rocks, feebly commencing at the margin of high-water mark, and increasing in luxuriance with increasing depth, but that the majority of them cease to grow soon after they reach a depth which is never laid bare to the influence of the atmosphere; on the contrary, the red sea-weeds (*Rhodospereæ*) gradually increase in numbers and in purity of colour as they recede from high-water mark, and are never subjected to great changes of light or temperature.

Dr. Harvey<sup>1</sup> writes of *algæ*: "Some are so exceedingly minute as to be wholly invisible, except in masses, to the naked eye, and require the highest powers of our microscope to ascertain their form or structure.

"Others, growing in the depths of the great Pacific Ocean, have stems which exceed in length (though not in diameter) the trunks of the tallest forest-trees; and others have leaves that rival in expansion those of the palm.

"Some are simple globules or spheres, consisting of a single cellule, or little bag of tissue, filled with a colouring matter; some are mere strings of such cellules, cohering by their ends, as in *Mesogloia*, fig. 121; others, a little more perfect, exhibit the appearances of branched threads; in others, again, the branches and stems are compound, consisting of several such threads joined together, and in others, the tissue expands into broad flat fronds.

"Only the higher tribes show any distinction with

(1) See Dr. Harvey's *British Marine Algæ, or Phyc. Britan.*

stems and leaves ; and even in these, what appears a stem in the old plant has already served, at an earlier period of growth, either as a leaf, as in *Sargassum* and *Systoseira*, or as the mid-rib of a leaf, as in *Delesseria*.

“ The substance of which the frond consists is as variable as the form. Some are mere masses of slime or jelly, so loose that they fall to pieces on being removed from the water ; others resemble, in feel and appearance, threads of silk ; some are stiff and horny ; others are cartilaginous, or with aspect and elasticity of gristle ; others tough and coriaceous, resembling leather ; while the stems of some

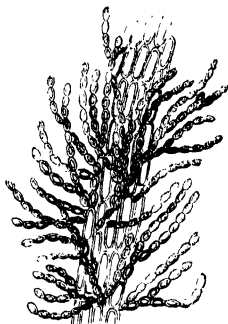

Fig. 121.—*Mesogloia reticularis*.

of the larger kinds are almost woody. The leaves of some are delicately membranaceous, glossy, transparent ; of others, coarse and thick, and either wholly destitute of nerves, or furnished with more or less defined ribs ; or beautifully veined.

“ In structure, whilst there is a great variety among the different tribes of *algæ*, we find, in material points, a perfect similarity among all. All consist of simple cellular tissue, or of its elements, *gelatine*, *membrane*, and *endochrome*, variously elaborated and perfected. No vessels or ducts have been discovered in any, nor does woody fibre exist among them.

“ The cellular tissue of *algæ* presents some varieties. The most common form of the cellule is cylindrical, often of very small diameter, in proportion to its length ; and in such cases the cellules always cohere by the ends into threads or *filaments*, bundles of which, either branched or single, form the fronds by lateral cohesion.

“ In colour, the *algæ* exhibit three principal varieties, with, of course, numerous intermediate shades, namely, *Grass-green*, *Olivaceous*, and *Red*. The grass-green is characteristic of those found in fresh water, or in very shallow parts of the sea, along the shores, and generally above



half-tide level; and is rarely seen in those which grow at any great depth. But to this rule there are exceptions.

“Several of the more perfect *Confervoideæ* and *Siphonaceæ* grow beyond the reach of ordinary tides; and others are sometimes dislodged from considerable depths, as the *Anadyomene*.

“The *olivaceous-brown*, or *olive-green*, is almost entirely confined to marine species, and is, in the main, characteristic of those that grow in half-tide level, becoming less frequent towards low-water mark; but it frequently occurs also at greater depths, in which case it is very dark, and passes into brown, or almost black. The *red*, also, is almost exclusively marine, and reaches its maximum in deep water. When it occurs above half-tide level it assumes either purple, or orange, or yellow tints, and sometimes even a cast of green; but in these cases it is sometimes brightened by placing the specimen for a short time in fresh water. It is rarely very pure within the range of extreme low-water mark, higher than which many of the more delicate species will not vegetate; and those that do exist, degenerate in form as well as in colour.

“How far below low-water mark the red species extend, has not been ascertained, but those taken from the extreme depths of the sea, are, like the olive series, found with the darkest and richest colouring.

“The green species are of the simplest structure, and differ remarkably in their mode of propagation from either of the other tribes, their seeds being endowed at the period of germination with a rotatory motion. The olivaceous are the most perfectly compound, and reach the largest size; and the red form a group distinguished *not less by their beauty* and delicacy of their tissues, than by producing seeds under *two* forms, thus possessing what is called a double fructification.”

The student must not entirely depend upon colour in referring plants which he may gather to their places in a system. *Laurencia pinnatifida*, growing near low-water mark, is of a fine, deep, purple-red—a little higher up it is a dull purple-brown; higher up still, a pale brownish-red, and at last, near high-water-mark, it is often yellowish

or greenish; *Chondrus crispus* changes colour in a similar way.

*Dasya coccinea*, the *hairy sea-weed*, is so called from the filamentous or feathery appearance of its branches; when of a fine colour it is one of the handsomest of the British species.

The *Dasya Kutzingiana*, fig. 122, represents an Italian species, bearing a seed-vessel with two rows of tetraspores; its colour is of a reddish brown or purple, growing on rocks at low-water mark.

Some of the most beautiful are those growing on other and larger species, as the *Sphacelaria*, a small and delicate plant, characterised by a symmetry that extends to the individual offsets. The seed-vessels, which are borne at the extremity of the fronds, contain, in some species, both "sperm-cells," and "germ-cells;" fig. 123 shows a terminal portion of a branch of *Sphacelaria cirrhosa*. A genus of *Cutleriaceæ* is very remarkable, inasmuch as its seeds, or zosporanges, occur at the bases of tufted hairs, are oblong-stalked bodies, divided by perpendicular and transverse septa, each of which contains a seed capable of germination. In fig. 124 is shown a section of a frond of the *Cutleria dichotoma*, with its eight chambers of zosporanges growing in tufts with intercalated hairs.

*Cladophora rupestris*, so called from its appearing like a series of branches upon branches, or *branch-bearing*, is commonly found near high-water mark.

*Rhodymenia jubata*, signifying *red membrane*, is one of the Dulse family. In the Islands of the Archipelago, it is a favourite ingredient in *ragouts*, to which it imparts a red colour,

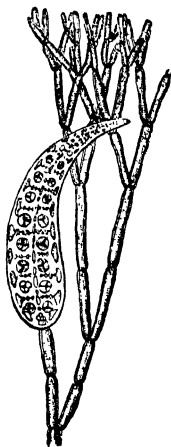

Fig. 122.—*Dasya Kutzingiana*.



Fig. 123.—*Sphacelaria cirrhosa*.

besides rendering them thicker. When dried, and infused in water, it exhales an odour resembling violets.

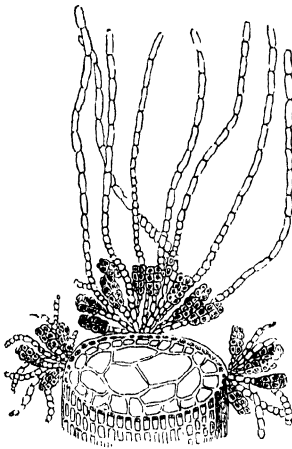

Fig. 124.—*Cutteria dichotoma*.

*Delessaria sanguinea*.—This beautiful biennial variety is so called after the celebrated French patron of science, Baron Delessert. It is, when first taken, of a rich *blood-colour*, which it soon loses.

*Seirospora Griffithsiana* derive its name from its celebrated discoverer, Mrs. Griffiths of Torquay, and two Greek words, signifying *chain-seed*.

*Chondrus crispus*, signifying a *crisp-cartilage*.—This and the next specimen are nourishing

and wholesome articles of food.

*Plocamium coccineum*, or *Braided hair plant*, is a perennial of a beautiful colour, especially when exposed a little to the sun after a shower of rain.

*Cladophora gracilis*, the *Gracious branch-bearing plant*, is of a yellowish-green, and obtained on rocks from half-tide level. When dried, it retains its glistening appearance. There are many varieties of this species.

*Phyllophora rubens*, receives its name from its *purple rose colour*.—It is perennial, and found in deep-water.

*Callithamnion plumula*, the *Feathery beautiful little shrub*, is a captivating alga, the colour fine, and the branches beautifully pectinated, which give to it a feathery appearance.

*Polysiphonia parasitica*, or *Many-tubed parasitic alga*.—Its colour is reddish-brown, it is pretty, and is regarded as rare.

*Wrangelia multifida*.—This beautiful plant derives its name from the celebrated Swedish naturalist, *Wrangel*,

the fine colour of which is soon lost in the open air, but its beauty of structure remains.

The above enumeration of a few selected specimens from this numerous and beautiful genera, exhibiting a wonderful multiplicity of forms, all of which will be found to possess much interest for the microscopist, have been taken at random, for the purpose of showing the principle upon which the Algologist proceeds with his nomenclature of the species.

Many kinds furnish man with a wholesome and palatable food: the Laver of our sea-shores, the Carrageen, or Irish Moss, with others, belonging to this group; and from them are formed the edible birds'-nests, which are considered a great delicacy by the Chinese. The valuable medicinal substance Iodine, is also produced from *algæ*.<sup>1</sup>

*Chara vulgaris* is the plant in which the important fact of vegetable circulation was discovered, and in which, from the extreme simplicity of its structure, much more is possibly observable, and with lower magnifying powers than other plants require. Fig. 125, No. 1, is a portion of the plant of the natural size. Every knot may produce roots; but it is remarkable, that they always proceed from the upper surface of the knot, and then turn downwards; so that it is not peculiar that the first roots also should rise upwards with the plant, and come out of the seed-skin, and then turn downwards.

The very remarkable "*Phytozoa* or plant animal" fructification which takes place in *chara*, at that part known as the globule, was first observed by Mr. Varley in 1833, since by Meyen and Unger in mosses, and by Nägeli in ferns.

Mr. Varley noticed:—"The ripe globule spontaneously open; the filaments expand and separate into clusters." "These tube-like filaments are divided into numerous compartments, in which are produced the most extraordinary objects ever observed of vegetable origin. Fig. 126 B. At first they are seen agitated and moving in their

(1) For further information, see Dr. Harvey's *Algæ*, and Dr. Hassall's *Fresh-Water Algæ*. Mr. John Grant is preparing for publication much new and interesting information on Sea-weeds. His preparation of specimens for the microscope are excellent. Mr. Baker, 244, Holborn, and Mr. Ladd, Chancery Lane, supply sets prepared by this gentleman.

At page 529 a drawing of the development of *Ulvæ* is given, which see.

cells, where they are coiled up in their confined spaces, every cell holding one. They gradually escape from their

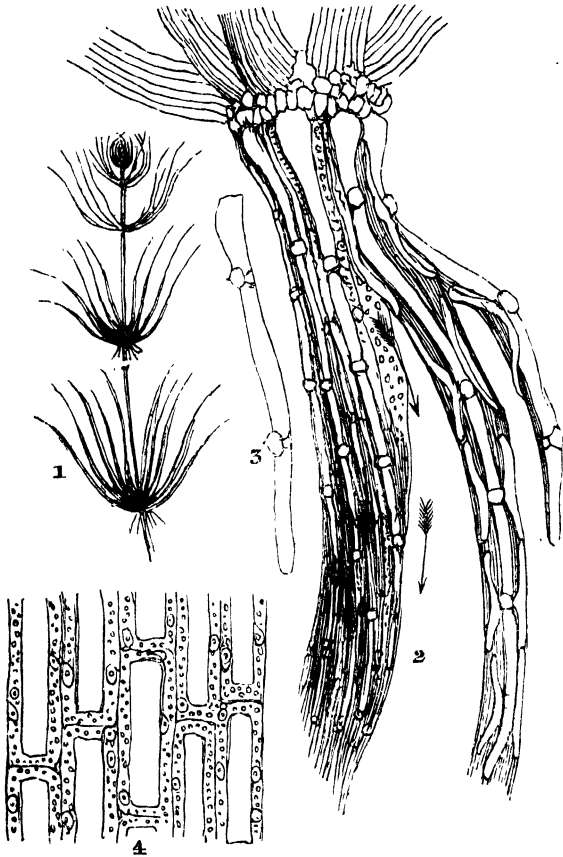

Fig. 125.

1, Branch of *Chora vulgaris*. 2, Magnified view: the arrows indicate the course taken by the granules in the tubes. 3, A limb of ditto, with buds at joints. 4, Portion of a leaf of *Vallisneria spiralis*, with cells and granules.

cells, and the whole field soon appears filled with life. They are generally spirals of two or three coils, and never become straight, though their agitated motion alters their shape in some degree. At their foremost end is a filament so fine as only to be seen by its motion, which is very rapid and vibratory, running along it in waves: and of a globule be forcibly opened before it is ripe, the filaments will give little or no indication of life."

They swim about freely for a time, but gradually getting slower and slower; in about an hour they become quite motionless. Unger described these moving filaments in *Sphagnum* (bog-moss) as *Infusoria*, under the name of

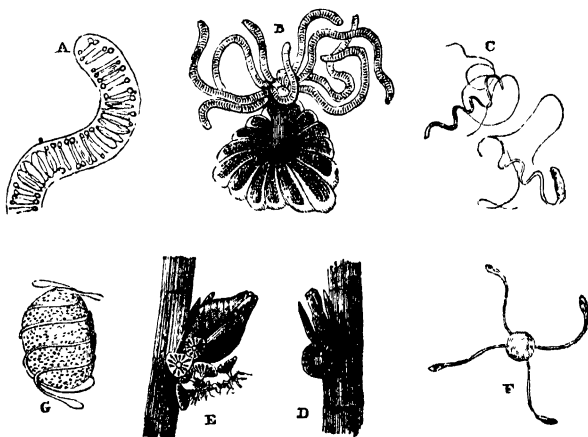

Fig. 126.—*Antheridia of Chara fragilis, &c.*

A, Portion of filament dividing into *Phytozoa*, "antheroids." B, A valve, with its group of antheridial filaments, composed of a series of cells, within each of which an *antherozoid* is formed. C, The escape of the mature *antherozoids* is shown. D, *Antheridium*, or globule, developed at the base of nucule. E, *Nucule* enlarged, and globule laid open by the separation of its valves. F, Spores and elaters of *Equisetum*. G, Spores surrounded by elaters of *Equisetum*.

*Spirillum*; and consequently they have been the cause of much controversy. Schleiden, very properly denying their animal nature, says:—"They are nothing more than fibre

in an early stage of development." This can scarcely be so, for we find that the reproductive apparatus of *Chara*

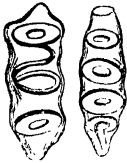

Fig. 127.—Spiral vessels from the *Opuntia vulgaris*.

consists of two sets of bodies, both of which grow at the bases of the branches, fig. 126, E. D; one set is known as the "globules," the other as the "nucules;" the globules are the antheridia, whilst the nucules contain the germ-cells; being the representatives of the *Spermatozoa* in the animal.

Mr. H. J. Carter, in a paper of great interest, published January, 1857, on the "Development of the Root-cell and its Nucleus, in *Chara Verticillata*," describes a structureless cell-wall, and a protoplasm composed of many organs. "This," he says, "is surrounded by a cell, the 'protoplasmic sac,' which is divided into a fixed and rotatory portion; these again respectively enclose the nucleus 'granules,' and axial fluid; while small portions of irregular shaped granular bodies are common to both. If we take the simple root-cell about the eighteenth hour after germination, when it will be about half-an-inch long, and 1-600th of an inch broad, and place it in water between two slips of glass for microscopic observation, under a magnifying power of about four hundred diameters, we shall find, if the circulation be active and the cell-wall strong and healthy, that the nucleus, which is globular, gradually becomes somewhat flattened, having several hyaline vacuoles of different sizes; the change goes on gradually until it appears of more elongated form, growing fainter on its outline, and then entirely disappears, leaving a white space corresponding to its capsule or cell-wall, with a faint remnant of some structure on the centre. Subsequently, this space becomes filled up with the fixed protoplasm, and after an hour or two the nucleus reappears a little behind its former situation, but now reduced in size, and with its nucleolus double, instead of single as before; each nucleolus being about one-fourth part as large as the old nucleolus, and hardly perceptible. Meanwhile a faint septum is seen obliquely extending across the fixed protoplasm, a little beyond the nucleus;

and if iodine be applied at this time, the division is seen to be confined to the protoplasm, as the latter, from contraction, withdraws itself from each side of the line where the septum appeared, and leaves a free space which is bounded laterally by an uninterrupted continuation of the protoplasmic sac. In this way changes go on until its shape is altered and it becomes converted into a bunch of rootlets. Thus the new cells are never entirely without a nucleus, which would appear to exert some influence upon their development, for as soon as the only two new cells which the root-cell gives off are formed, the old nucleus becomes effete.

“ Now as to the office of the nucleus, nothing more is revealed to us in the development of the roots of *Chara*, than that, so long as new cells are to be budded forth, the nucleus continues in active operation, but when this ceases it becomes effete; while the rotation of the protoplasm and subsequent enlargement of the cell, &c., which are much better exemplified in the plant-stem than in the root-cell, go on after the nucleus ceases to exist. Hence the development of the root-cells of *Chara* affords us nothing positive respecting the functions of this organ; and therefore, if we wish to assign to it any uses in particular, they must be derived from analogy with some organism in which there is a similar nucleus whose office is known. If for this purpose we may be allowed to compare the nucleus of *Chara* with that of the rhizopodous cell, which inhabits its protoplasm, we shall find the two identical in elementary composition; that is, both consist at first of a ‘nuclear utricle,’ respectively enclosing a structureless homogeneous nucleolus; the latter, too, in both, is endowed with a low degree of movement.

“ After this, however, the nucleolus of the *Rhizopod* cell becomes granular and opaque; and when, under circumstances favourable for propagation, a new cell-wall is formed around the nuclear utricle,—or this may be an enlargement of the nuclear utricle itself,—I do not know which; the granular substance of the nucleolus becomes circumscribed, and shows that it is surrounded by a spherical, capsular cell; the granules enlarge, separate, pass



through the spherical capsule into the cavity of the nuclear utricle; a mass of protoplasm makes its appearance, and this divides up into monads, or, as I first called them, 'gonidia.'<sup>1</sup> Further, should it hereafter be proved that the rhizopodous cells are developments of *Chara* itself, and not a foreign organism, it might not be found difficult to trace a connexion between the so-called 'gonidia' and the 'spiral filaments.' Thus *Chara*, in some forms, would then be an animal, and in others a vegetable, according to the distinction between it and *Amœba*, which will presently be mentioned; for the rhizopodous cells do not produce the 'gonidia,' or monads, until they have enclosed a portion of the cell-contents, after the manner of *Amœba* when taking its food. Again, I have shown how the nucleus of the latter divides up into granules and cells, producing new beings, and how it becomes lost in the development of the ovules;<sup>2</sup> and Stein has shown that the nucleus of *Vorticella* becomes divided up into cells, to produce a new litter; also, that it shrinks into a small elliptical effete mass of fine granules in the development of *Acinetæ* through the *Acineta*-form, which I have frequently been able to confirm; so that, if the nucleus in *Amœba* and *Vorticella* be identical with that of *Chara*, we shall probably not be far wrong in assigning a generative power to it generally; that is, through duplication in common reproduction, and by multiple division in the true process of generation. We must, therefore, if we adopt these views, regard the nucleus of the *globule* as merely a modification of that of the cells of *Chara* generally, to meet the requirements of the case; and hence, as a subordinate organ, which, together with the other parts of the protoplasm, is subject to a common developmental power. It has already been stated that the nucleus perishes as soon as its functions cease, while the cell to which it belonged goes on growing. Thus the internode of the large *Nitella* of Bombay, which may be half a foot long, loses its nucleus, probably, when, as a cell, it does not exceed the one-hundredth part of an inch, for the nucleus disappears long before the layer of green-cells is formed.

(1) *Ann. and Mag. Nat. Hist.* vol. xvii. 1856.(2) *Ibid.* vol. xviii.

“While the component parts of the first cell of the root of *Chara* are still fresh in the mind of the reader, it seems advisable that they should be compared with those of *Amœba*. *Chara* lives by nutriment obtained through endosmosis; *Amœba*, by taking in the crude material direct, and, having abstracted the nutritious parts by the process of digestion, ultimately throwing off the refuse. *Chara* is a vegetable, though there are animal cells, which also live by endosmose; but *Amœba* cannot be a vegetable, if we admit the distinction that I have given, viz. the taking in of crude form material. Nevertheless, the root-cell of *Chara* and *Amœba* greatly resemble each other.

“Thus the cell-wall of the former corresponds with the pellicular secretion or capsule of *Amœba*, which, in *Arcella*, &c. appears as a shell. The protoplasmic sac may correspond with the pellicula itself and diaphane. The nucleus is identical, and situated in the fixed portion of the protoplasm, as it appears in the fixed molecular sarcode of *Amœba*, when the latter assumes a spherical form. The most interesting point, however, which this analogy brings forth, is the correspondence between the rotatory motion of the protoplasm in the cell of *Chara*, and that of the sarcode of *Amœba* and other infusoria; since, by considering this motion in different organisms, we may, perhaps, arrive at some notion of the cause by which it is produced in all. In the *Planariæ* and *Rotatoria*, the lash of cilia, which projects from the hepatic cells that line the stomachs of these animalcules respectively, appears to rotate the food during the process of digestion; but in the second part of the alimentary canal of the *Rotatoria*, where there are no hepatic cells, the surface is seen, on the approach of anything into it, to be covered with cilia. Again, in *Forficella* and *Paramecium Aurelia*, the digestive globules also are slowly circulated round the abdominal cavity, if I may so term it, in the midst of the sarcode, or internal mucus; and when we watch this circulation narrowly, for instance, in the posterior part of *Vaginicola crystallina* (Ehr.), we see that the bodies in which the chief motion exists are very minute, and apparently stationary, and that, while their movements are very rapid, the circulation

of the pellets of food is very slow ; hence they would appear to be cilia. The same kind of circulation occurs in *Amœba*, but is so tardy, and this infusorium is so incessantly changing its shape, that it is not seen under ordinary circumstances.

“The movement of the rotating protoplasm in the *Characeæ* is also very slow ; for, when it is viewed in the long internodes of *Nitella* with a very low power, or even with the naked eye, it seems hardly to move faster than the foot of a *Gasteropod* ; still there is no positive evidence that it moves round the cell after the manner of the latter, although it would appear to possess the power of movement *per se*. Hence the question remains undecided, viz. whether it moves round the cell by itself, or by the aid of cilia disposed on the inner surface of the protoplasmic sac, in like manner to those which appear to exist in the abdominal cavity of *Vaginicola crystallina*, and which have been seen in *Closterium lunula*.”

The stems and arms of *Chara* are tubular, and entirely covered with smaller tubes, the circulation can mostly be observed in these, as shown at Fig. 125. Any ordinary cutting to obtain sections would squeeze the tube flat, and spoil it and the lining ; it is, therefore, better to avoid this, by laying the *Chara* on smooth wood, just covered with water ; then, with a sharp knife, make suddenly a number of quick cuts across it, and so obtain the various sections required. Wet a slip of glass, and turn the wood over so as just to touch the water, and the sections will fall from the wood on to the glass, ready for the microscope.

Mr. Varley gives the following directions for cultivating the plant. He says—

“The *Chara* tribe is most abundant in still waters or ponds that never become quite dry ; if found in running water, it is mostly met with out of the current, in holes or side bays, where the stream has little effect, and never on any prominence exposed to the current. If the *Chara* could bear a current, its fruit would mostly be carried on and be deposited in whorls ; but it sends out from its various joints very long roots into the water, and these would by agitation be destroyed, and then the plant

decays; for although it may grow long before roots are formed, yet when they are produced their destruction involves the death of the plant. In order, therefore, to preserve *Chara*, every care must be taken to imitate the stillness of the water by never shaking or suddenly turning the vessel. It is also important that the *Chara* should be disturbed as little as possible; and if requisite, it must be done in the most gentle manner, as, for instance, in cutting off a specimen, or causing it to descend in order to keep the summit of the plant below the surface of the water.

“Similar care is requisite for *Vallisneria*; but the warmest and most equal temperature is better suited to this plant. It should be planted in the middle of the jar in about two inches deep of mould, which has been closely pressed; over this place two or three handfuls of leaves, then gently fill the jar with water. When the water requires to be changed, a small portion is sufficient to change at a time. It appears to thrive in proportion to the frequency of the changing of the water, taking care that the water added rather increases the temperature than lowers it.”

The natural habitat of the *Frog-bit*, another water-plant of great interest, is on the surface of ponds and ditches; in the autumn its seeds fall, and become buried in the mud at the bottom during the winter; in the spring these plants rise to the surface, produce flowers, and grow to their full size during summer. *Chara* may be found in many places around London, the Isle of Dogs, and in ditches near the Thames bank.

*Anacharis alsinastrum*.—This remarkable plant is so unlike any other water-plant, that it may be at once recognised by its leaves growing *in threes* round a slender stringy stem. The watermen on the river have already named it “Water-thyme,” from a faint general resemblance which it bears to that plant. In 1851 the *Anacharis* was noticed by Mr. Marshall and others in the river at Ely, but not in great quantities. Next year it had increased so much, that the river might be said to be full of it.

The colour of the plant is deep green; the leaves are

nearly half an inch long, by an eighth wide, egg-shaped at the point, and beset with minute teeth, which cause them to cling. The stems are very brittle, so that whenever the plant is disturbed, fragments are broken off. Its powers of increase are prodigious, as every fragment is capable of becoming an independent plant, producing roots and stems, and extending itself indefinitely in every direction. Most of our water-plants require, in order to their increase, to be rooted in the bottom or sides of the river or drain in which they are found; but this is independent altogether of that condition, and actually grows as it travels slowly down the stream after being cut. The specific gravity of it is so nearly that of water, that it is more disposed to sink than float. A small branch of the plant is represented, with a Hydra attached to it, in a subsequent chapter.

Mr. Lawson pointed out the particular cells in which the current or circulation will be most readily seen—viz. the elongated cells around the margin of the leaf and those of the midrib. On examining the leaf with polarised light, these cells, and these alone, are found to contain a large proportion of silica, and present a very interesting appearance. A bright band of light encircles the leaf, and traverses its centre. In fact, the leaf is set, as it were, in a framework of silica. By boiling the leaf for a short time in equal parts of nitric acid and water, a portion of the vegetable tissue is destroyed, and the silica rendered more distinct, without changing the form of the leaf.<sup>1</sup>

It is necessary to make a thin section or strip from the leaf of *Vallisneria*, for the purpose of exhibiting the circulation in the cells, as shown in fig. 125, No. 4. Among the cells granules, a few of a more transparent character than the rest, may be seen, having a nucleolus within.

*Ferns.*—In the Ferns we have an intermediate state, somewhat between mosses and flowering plants; this would not apply to the reproductive apparatus, which is formed upon the same type as that of Mosses; and, furthermore, it is to be observed, that ferns do not form

(1) See also a paper in Vol. IV. *Microscopical Journal of Science*, on the Circulation in the Leaf of *Anacharis*, by Mr. F. H. Wenham.

buds like other plants, but that their leaves, or fronds as they are properly called, when they first appear, are rolled up in a circular form, and gradually unfold, as in fig. 128.



Fig. 128.—Male Fern.

Ferns have no visible flowers; and their seeds are produced in clusters, called *sori*, on the backs of the leaves. Each sorus contains numerous thecæ, and each theca encloses almost innumerable spores, and these again the seeds. There are numerous kinds of fern, all remarkable for some interesting peculiarity; but which from want of space we cannot here enumerate.

The first account of the true mode of development of Ferns from their spores was published in 1844, by Nägeli, in a memoir entitled *Moving Spiral Filaments (spermatie filaments) in Ferns*, wherein he announced the existence of the bodies now called *antheridia*; but, mistaking the *archegonia* for modified forms of the *antheridia*, he was led away from a minute investigation of them. If he had followed the development of the *prothallia* further, he would have detected the relations of the nascent embryo, which would probably have put him on the right track. As it was, the remarkable discovery of the moving spiral filaments occupied all his attention, and caused him to fall

into an error in certain important respects; for example, he has represented what is undoubtedly an *archegonium* filled with cellules, *sperm-cells*, which, he states, "emerged from it as from the *antheridia*." This description is not quite correct.

The reproduction of ferns had, until within the last few years, been a vexed question among botanists. The riddle was at length solved by the labours of Count Suminski, who discovered that it is in the structures developed from the spores in germination that the pistillidia and antheridia of ferns are to be sought. The nature of the phenomena by which the propagation of ferns is effected, is as follows. In all the different species of ferns, the spores are contained in brown dots, on lines collected on the under surfaces, or along the edges of the fronds. Each of the spore-cases

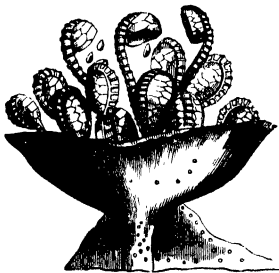

Fig. 129.—*Sorus of Deparia prolifera*.

is surrounded by an elastic ring, which when the time arrives for the spores to be set free, makes an effort to straighten itself, and in so doing causes the spore-case to which it is attached to split open, and the spore dust to be dispersed. Very soon after these spores have begun to germinate, a flat plate-like expansion, somewhat resembling a heart in form, shows itself. This expansion gradually thickens, the tube from which it had sprung withering away. So far, observes Mr. Henfrey, there is nothing very remarkable in the development of these plants from their spores, but the succeeding phenomena are exceedingly curious. The main particulars are thus described by him: "At an early period of the expanding growth of the leaf-like product of the spore, termed the prothallium or germ-frond, a number of little cellular bodies are found projecting from the lower surface, which, if placed in water when ripe, burst and discharge a quantity of microscopic filaments, curled like a corkscrew, and furnished with vibrating hair-like appendages, by the motion of

which they are rapidly propelled through the water. The cellular bodies from which these are discharged are termed the antheridia of the ferns, and are in their physiological nature the representatives of the pollen of the flowering plants. At a somewhat later period other cellular bodies of larger size and more complex structure are found in small numbers about the central part of the lower surface of the prothallium on the thickened portion, situated between the notch and the part where the radical filaments arise. These, the pistillidia or archegonia of the ferns, are analogous to the ovules or nascent seeds of flowering plants, and contain, like them, a germinal vesicle, which becomes fertilized through the agency of the spiral filaments mentioned above, and is then gradually developed into an embryo plant possessing a terminal bud. This bud begins at once to unfold and push out leaves with a circinnate vernation, which are of a very simple form at first, and rise up to view beneath the prothallium, coming out at the notch; single fibrous roots are at the same time sent down into the earth, the delicate expanded prothallium withers away, and the foundation of the perfect fern plant is laid. As the bud unfolds new leaves, the root-stock gradually acquires size and strength, and the leaves become larger and more developed; but it is a long time before they assume the complete form characteristic of the species."

These observations on Ferns have acquired vastly-increased interest from the subsequent investigations of Hofmeister, Mettenius, and Suminski, on the allied Cryptogams, and, above all, from Hofmeister's observations on the processes occurring in the impregnation of the Conifers. Not only have these investigations given us a satisfactory interpretation of the *archegonia* and *antheridia* of the Mosses and Liverworts, but they have made known and co-ordinated the existence of analogous phenomena in the *Equisetaceæ*, *Lycopodiaceæ*, and *Rhizocarpeæ*, and shown, moreover, that the bodies described by Mr. Brown in the Conifers, under the name of "corpuscles," are analogous to the *archegonia* of the Cryptogams; so that a link is hereby formed between these groups and the higher flowering plants.



*Cell Changes.*—We now find the cell changing in its outward form, and the transparent membranous cell wall becoming thickened; spontaneous fissure takes place, and thus is formed a series of connected cells variously modified and arranged, according to the conditions under which

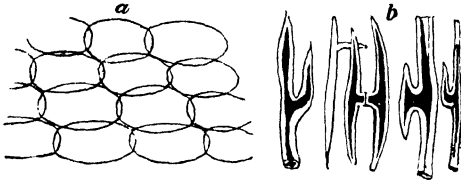

Fig. 130.—*a*, elementary cells; *b*, branched cellular tissue.

they are developed and the functions which they are destined to exercise. The typical form, as we have before observed, of the vegetable cell is spheroidal; but when developed under pressure within walls, or denser tissues, it takes other shapes; as the

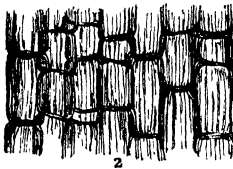
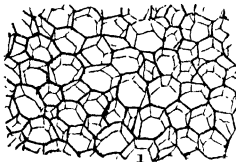

Fig. 131.

1, A transverse section of stem of *Equisetum*, showing the hexagonal shape of cells. 2, A vertical section of elongated cell.

oblong, lobed, square, prismatic, cylindrical, fusiform, muriform, stellate, filamentous, &c.: and is then termed *Parenchym*, and the cells woven together are called cellular tissue. In pulpy fruits the cells may be easily separated one from the other: a thin transverse section of a strawberry is represented at fig. 145, No. 15: within the cells are smaller cells, commonly known as pulp. Fig. 130, *a*, is the elementary form of oval cells or vesicles, passing on to the formation of branched cellular tissue, *b*. Remarkable specimens of the filamentous

tissue may be seen in fig. 145, No. 19, the fungiform elongated cells from the *Mushroom*; only another and more closely connected growth of mucedinous fungi, commonly called mushroom spawn.

Fig. 132, in the stellate tissue out from the stem of a *rush*, we have the formative network dividing into ducts for the purpose of conveying the juices to the leaves of the plant. These ducts may undergo other transformations; the cell itself become gradually changed into a spiral continuous tube or duct, as seen in fig. 155; these are sometimes formed by the breaking down of the partitions; in the centre of which we may have a compound spiral duct, resembling portions of tracheæ from the silkworm.

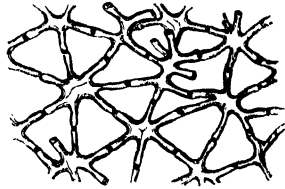

Fig. 132.—Stellate tissue, from stem of a *Rush*.

Another important change occurs in the original cell,—it is that of its conversion into *woody fibre*. Common woody fibre (*Pleurenchyma*) has its sides free from definite markings. In the *coniferous* plants, the tubes are furnished with circular discs; these discs are thought to be contrivances to enable the tubules of the woody tissues to discharge their contents from one to the other, or into the cellular spaces. Such plants as have aromatic secretions are furnished with glands,—a circumstance which has led to the division of woody tissue into simple and glandular. A large central gland is seen in a section of a leaf from *Ficus elastica*, India-rubber-tree, fig. 134, No. 2. Professor Quekett observes, “The nature of the pores, or discs, in *conifers*, has long been a subject for controversy; it is now certain that the bordered pores are not peculiar to one fibre, but are formed between two contiguous to each other, and always exist in greatest numbers on those sides of the woody fibres parallel to the medullary rays. They are hollow; their shape biconvex; and in their centre is



Fig. 133.—A section of stem of *Clematis*, with pores, highly magnified, to show the line which passes round them.

Such plants as have aromatic secretions are furnished with glands,—a circumstance which has led to the division of woody tissue into simple and glandular. A large central gland is seen in a section of a leaf from *Ficus elastica*, India-rubber-tree, fig. 134, No. 2. Professor Quekett observes, “The nature of the pores, or discs, in *conifers*, has long been a subject for controversy; it is now certain that the bordered pores are not peculiar to one fibre, but are formed between two contiguous to each other, and always exist in greatest numbers on those sides of the woody fibres parallel to the medullary rays. They are hollow; their shape biconvex; and in their centre is

a small circular or oval spot, fig. 156: the latter may occur singly, or be crossed by another at right angles,

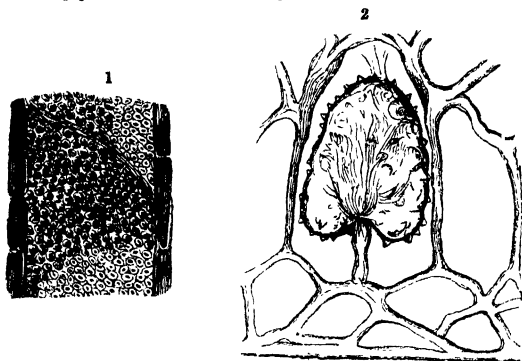

Fig. 134.

1, Vertical section of root of Alder, with outer wall. 2, A vertical section of a leaf of the India-rubber tree, exhibiting a central gland.

which gives the appearance of a cross, as in fig. 161, Nos. 3, 4, a vertical section of fossil wood, remarkable for having three or four rows of woody tissue occupied by large pores without central markings."

Plants are likewise furnished with *lactiferous* ducts or tissue,—the *proper vessels* of the old writers. These ducts convey a peculiar fluid, called *latex*, usually turbid, and coloured red, white, or yellow; often, however, colourless. It is supposed they carry latex to all the newly-formed organs, which are nourished by it. The fluid becomes

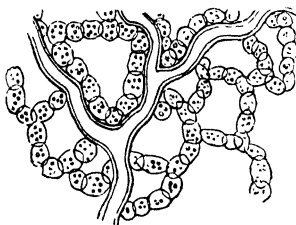

Fig. 135.—*Lactiferous tissue.*

darker after being mounted for specimens to be viewed under the microscope. This tissue is remarkable from its resemblance to the earliest aggregation of cells, the *yeast-plant*, and therefore has some claim to being considered the stage of development preceding that of the reticu-

lated ducts seen in fig. 137. In a section from the India-rubber-tree, fig. 134, No. 2, a network of these laciferous tubes will be found filled with a brownish or

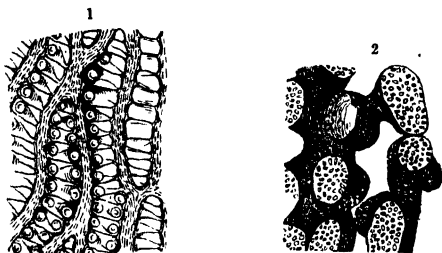

Fig. 136.

1, A portion of the leaf of *Sphagnum*, showing ducts, vascular tissue, and spiral fibre in the interior of its cells. 2, Porous cells, from the testa of Gourd-seed, communicating with each other, and resembling ducts.

granular matter; that in fig. 135 is an enlarged view of this tissue from the wood of an exogen, taken near the root.

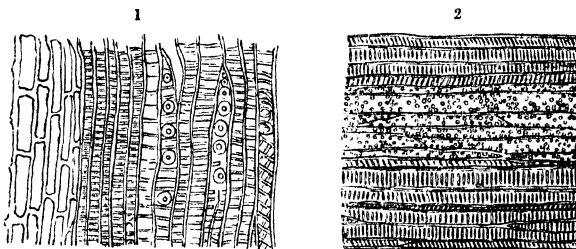

Fig. 137.

1, Reticulated ducts.

2, A vertical section of Fern-root.

In many plants external to the cuticle, there exists a very delicate transparent pellicle, without any decided traces of organisation, though occasionally somewhat granular in appearance, and marked by lines that seem to be impressions of the junction of the cells in contact with each other. In nearly all plants, the cuticle is perforated

by minute openings termed *Stomata*, which are bordered by cells of a peculiar form, distinct from those of the cuticle. In *Iris germanica*, fig. 138, each surface has nearly 12,000

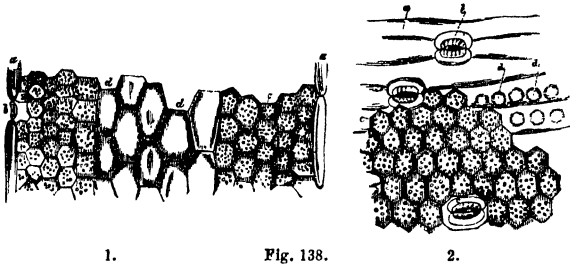

1.

Fig. 138.

2.

1, Portion of a vertical section of the Leaf of the *Iris*: *a, a*, elongated cells of the epidermis; *b, b*, stomata cut through longitudinally; *c, c*, cells of the parenchyma; *d, d*, colourless tissue of the interior of the leaf. 2, Portion of leaf of *Iris germanica*, torn from its surface; *a*, elongated cells of the cuticle; *b*, cells of the stomata; *c*, cells of the parenchyma; *d*, impressions on the epidermic cells; *e*, lacunæ in the parenchyma.

stomata in every square inch; and in *Yucca* each surface has about 40,000.

The structure of the leaf of the common *Iris* shows a central portion, formed by thick-walled colourless tissue, very different from ordinary leaf-cells or from woody fibre.

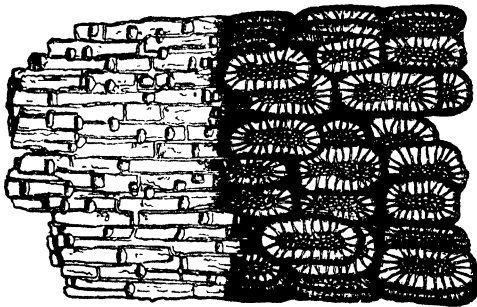

Fig. 139.—A portion of the epidermis of the Sugar-cane, showing the two kinds of cells of which it is composed. (Magnified 200 diameters.)

Various cut sections of leaves should be made, and slices taken parallel to the surfaces at different distances, for the purpose of microscopic examination.

Among the cell-contents of some plants, are beautiful crystals called *Raphides*: the term is derived from *ραφίς*, a *needle*, from the resemblance of the crystal to a needle. They are composed of the phosphate and oxalate of lime; there is a difference of opinion as to their use in the economy of the plant. "Whether the result of chemical affinity, or of a vital process, cannot be decided; but it is certain that they can be produced artificially in the tissue of plants."

The French philosopher, Geoffrey St. Hilaire, endeavoured to prove that crystals are the possible transition of the *inorganic to organic matter*. Crystals have naturally been supposed to conceal the first beginnings of the phase named *organic*, because in crystals we first meet with determinate *form* as a constituent element. The matter named *inorganic* has no determinate form; but a crystal is matter arranged in a particular and essential form. The differences, however, between the highest form of crystal and the lowest form of organic life known—a simple reproductive cell—are so manifold and striking, that the attempt to make crystals the bridge over which inorganic matter passes into the organic, is almost universally regarded as futile.<sup>1</sup>

If we examine a portion of the layers of an onion, fig. 140, No. 1, or a thin section of the stem or root of the garden rhubarb, fig. 140, No. 4, we shall find many cells in which, either bundles of needle-shaped crystals, or masses of a stellate form occur.

Raphides were first noticed by Malpighi in *Opuntia*, and subsequently described by Jurine and Raspail. According to the latter observer, the needle-shape or acicular are composed of phosphate, and the stellate of oxalate of lime. There are others having lime as a basis, in combination with tartaric, malic, or citric acid. These are easily destroyed by acetic acid, and are also very soluble in many of the fluids employed in the conservation of objects; some of them are as large as the 1-40th of an inch, others are as small as the 1-1000th. They occur in all

(1) See Addenda.

parts of the plant ; in the stem, bark, leaves, stipules, petals, fruit, root, and even in the pollen, with some exceptions. They are always situated in the interior of cells, and not, as stated by Raspail and others, in the

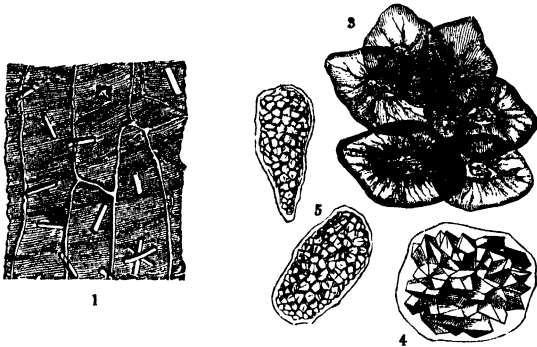

Fig. 140.

1, A section from the outer layer of the bulb of an Onion, showing crystals of lime with raphides. 3, Cells of the Pear, showing Sclerogen, or gritty tissue. 4, Cells of garden Rhubarb, filled with raphides. 5, Cells from same, filled with starch-grains.

intercellular passages.<sup>1</sup> Some of the containing cells become much elongated ; but still the cell-wall can be readily traced. In some species of Aloe, as, for instance, *Aloe verrucosa*, with the naked eye we are able to discern small silky filaments: when magnified, they are found to be bundles of the acicular form of raphides, which no doubt act the part of a stay or prop to the internal soft pulp.

In portions of the cuticle of the medicinal squill—*Scilla maritima*—several large cells will be observed, full of bundles of needle-shaped crystal. These cells, however, do not lie in the same plane as the smaller ones belonging to the cuticle. In the cuticle of an onion every cell is occupied either by an octahedral or a prismatic crystal of oxalate of lime: in some specimens the octahedral form predominates ; but in others from the same plant the

(1) "As an exception, many years ago they were discovered in the interior of the spiral vessels in the stem of the grape-vine; but with some botanists this would not be considered as an exceptional case, the vessels being regarded as elongated cells."—Quekett.

crystals will be principally prismatic, and are arranged as if they were beginning to assume a stellate form. Some plants, as many of the *cactus* tribe, are made up almost entirely of raphides. In some instances every cell of the cuticle contains a stellate mass of crystals; in others the whole interior is full of them, rendering the plant so exceedingly brittle, that the least touch will occasion a fracture; so much so, that some specimens of *Cactus senilis*, said to be a thousand years old, which were sent a few years since to Kew from South America, were obliged to be packed in cotton, with all the care of the most delicate jewellery, to preserve them during transport.

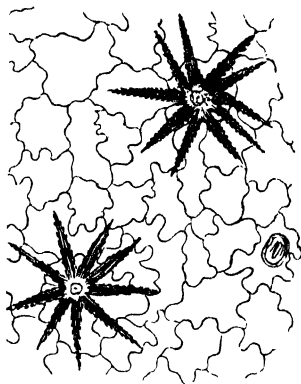

Fig. 141.—*Siliceous cuticle from under surface of leaf of Deutzia scabra.*

Raphides, of peculiar figure, are common in the bark of many trees. In the Hicory (*Carya alba*) may be observed masses of flattened prisms having both extremities pointed. In vertical sections from the stem of *Elæagnus angustifolia*, numerous raphides of large size are embedded in the pith. Raphides are also found in the bark of the apple-tree, and in the testa of the seeds of the elm; every cell contains two or more very minute crystals.

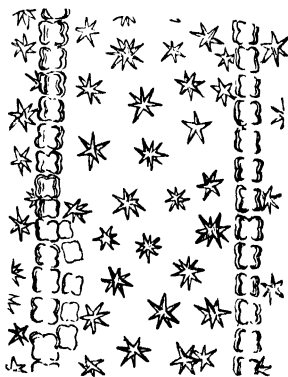

Fig. 142.—*Siliceous cuticle of Grass (Pharus cristatus).*

In figs. 141 and 142 we have other representations of the crystalline structure



of plants, in sections taken from grass, and the leaf of *Deutzia scabra*. This insoluble material is called silica, and is abundantly distributed throughout certain orders of plants, leaving a skeleton after the soft vegetable matters have been destroyed: masses of it, having the appearance of irregularly-formed blackened glass, will always be found after the burning of hay or straw; which is caused by the fusion of the silica contained in the cuticle combining with the potash in the vegetable tissue, thus forming a silicate of potash (glass). To display this siliceous structure, it is necessary to cut very thin slices from the cuticle, and mount them in fluid or Canada balsam.

In the *Graminaceæ*, especially the canes; in the *Equisetum hyemale*, or Dutch rush; in the husk of the rice,

wheat, and other grains,—silica is abundantly found. In the *Pharus cristatus*, an exotic grass, fig. 142, we have beautifully-arranged masses of silica with raphides. The leaves of *Deutzia*, fig. 141, are remarkable for their stellate hairs developed from the cuticle, of both their upper and under surfaces; forming most interesting and attractive objects when examined under the microscope, either with polarised or condensed light.

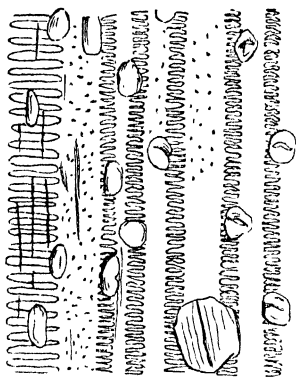

Fig. 143.—Portion of the husk of Wheat, showing siliceous crystals.

Silica is found in all *Rubiaceæ*; both in the stem and leaves, and if present in sufficient thickness, depolarises light. This is especially the case in the prickles, which all these plants have on the margin of the leaves and the angles of the stem. One of the order *Compositæ*, a plant popularly known as the "sneezewort," (*Archillæ ptarmica*) has a large amount of silica in the hairs found on the double serratures of its leaves; commonly said to be the

cause of its errhine properties when powdered and used as snuff. It is in the underlying or true epidermis, that the silica occurs. This membrane is permeable by fluids, not by means of pores, but by endosmotic force.

The most generally-distributed and conspicuous of the cell-contents is *Starch*; at the same time it is one of great value and interest, performing a similar office in the economy of plants as that of fat in animals. It occurs in all plants at some period of their existence, and is the chief and great mark of distinction between the vegetable and animal kingdoms. Its presence is detected by testing with a solution of iodine, which changes it to a characteristic blue or violet colour. Being insoluble in cold water, it can be readily washed away and separated from other matters contained

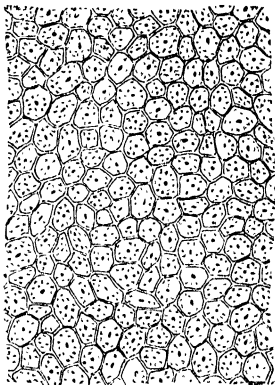

Fig. 144.—Section of a Cane; with cell-walls of silica, and internal pores filled with granular matter.

in the cellular parts of full-grown plants. It is often found in small granular masses in the interior of cells, shown in fig. 140, from the garden-rhubarb. Starch-grains are variable in size: the *tous-les-mois*, fig. 145, No. 5, are very large; in the *potato*, No. 14, they are smaller; and in *rice*, No. 6, they are very small indeed. Nearly all present the appearance of concentric irregular circles; and most of the granules have a circular spot, termed the *hilum*, around which a large number of curved lines arrange themselves: these are seen better under polarised light, fig. 95.

Leeuwenhœek, to whom we are indebted for the earliest notice of starch-granules, enters with considerable minuteness into a description of those of several plants—such as wheat, barley, rye, oats, peas, beans, kidney-beans, buckwheat, maize, and rice; and very carefully describes experiments made by him in order to investigate the *structure of starch-granules*. Dr. Reissek regards the

granule as a perfect cell, from the phenomena presented during its decay or dissolution, when left for some time in water. Schleiden and others, after examining its expansion and alteration under the influence of heat and of sulphuric acid, considered it to be a solid homogeneous structure.

Professor Busk agrees with M. Martin in believing the primary form of the starch-granule to be "a spherical or ovate vesicle, the appearance of which under the microscope, when submitted to the action of strong sulphuric acid, conveys the idea of an unfolding of plaits or rugæ, which have, as it were, been tucked in towards the centre of the starch-grain."<sup>1</sup> The mode of applying the concentrated sulphuric acid is thus described by Mr. Busk:—"A small quantity of the starch to be examined is placed upon a slip of glass, and covered with five or six drops of water, in which it is well stirred about; then with the point of a slender glass-rod the smallest possible quantity of solution of iodine is applied, which requires to be quickly and well mixed with the starch and water; as much of the latter as will must be allowed to drain off, leaving the moistened starch behind, or a portion of it may be removed by an inclination of the glass, before it is covered with a piece of thin glass. The object must be placed on the field of the microscope, and the  $\frac{1}{4}$ -inch object-glass brought to a focus close to the upper edge of the thin glass. With a slender glass-rod a small drop of *strong* sulphuric acid must be carefully placed immediately upon, or rather above the edge of the cover, great care being necessary to prevent its running over. The acid quickly insinuates itself between the glasses, and its course may be traced by the rapid change in the appearance of the starch-granules as it comes in contact with them. The course of the acid is to be followed by moving the object gently upwards; and when, from its diffusion, the re-agent begins to act slowly, the peculiar changes in the starch-granules can be more readily witnessed. In pressing or moving the glasses, the starch disc becomes torn, and is then distinctly seen, especially in those coloured blue, to

(1) Professor G. Busk, F.R.S., on the Structure of the Starch-granule; *Quarterly Journal of Microscopical Science*, April, 1853.

consist of two layers, an upper and a lower one; and the collapsed vesicular bodies of an extremely fine but strong and elastic membrane." Mr. Busk believes the hilum to be a central opening into the interior of the ovate vesicle.



Fig. 145.

1, Cells of Yeast-plant. 2, Stinging-nettle Hairs, *Urtica Dioica*. 3, Ciliated spores of *Conferva*. 4, Starch grains, broken by the application of heat. 5, Starch from *Tous-les-mois*. 6, Starch from Rice. 7, Starch from Sago. 8, Imitation Sago-starch. 9, Wheat-starch. 10, Rhubarb-starch, in isolated cells. 11, Maize-starch. 12, Oat-starch. 13, Barley-starch. 14, Potato-starch. 15, Section of Strawberry, cells ovoid and containing a nucleus. 16, Section of Potato, with starch destroyed by fungoid disease. 17, Potato, with nearly all starch-grains absent. 18, Section of Potato, cells filled with healthy starch. (These starches are grouped for comparison.) 19, Mushroom spawn, elongated cells.

Nitric acid communicates to wheat-starch a fine orange-yellow colour; and recently-prepared tincture of guaiacum gives a blue colour to the starch of good wheat-flour.

Pure wheat-flour is almost entirely dissolved in a strong solution of potash, containing twelve per cent. of the alkali; but mineral substances used for the purpose of adulteration remain undissolved.

Wheat-flour is frequently adulterated with various substances; and in the detection of these adulterations, the microscope, together with a slight knowledge of the action of chemical re-agents, lends important assistance. It enables us to judge of the size, shape, and markings on the starch grains, and thereby to distinguish the granules of

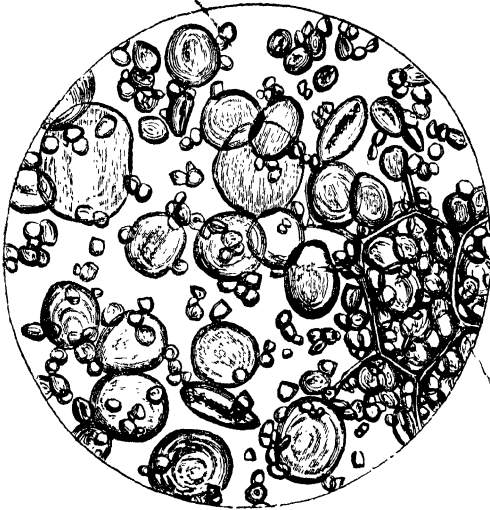

Fig. 146.—Wheat-Flour Starch-granules, with a small portion of its cellulose. (Magnified 420 diameters.)

one meal from that of another. In some cases the microscopic examination is aided by an application of a solution of potash. Thus we may readily detect the mixture of wheat-flour with either potato-starch, meal of the pea or bean, by the addition of a little water to a small quantity of the flour, then, by adding a few drops of a solution of potash (made of the strength one part *liquid potash* to three parts of water), the granules of the potato-

starch will immediately swell up, and acquire three or four times their natural size ; while those of the wheat-starch are scarcely affected by it ; if adulterated with pea or bean meal, the hexagonal tissue of the seed is at the same time rendered very obvious under the microscope. Polarised light will be of use as an additional aid ; wheat-starch presents a faint black cross proceeding from the central hilum, whereas the starch of the oat shows nothing of the kind.



Fig. 147.—*Potato Starch-granules, sold under the name of British Arrow-root, used to adulterate flour and bread. (Magnified 240 diameters.)*

The diseases of wheat and corn are readily detected under the microscope ; some of which will be seen to be produced by a parasitic fungus, and by an animalcule represented in another place : all are more or less dangerous when mixed with articles of food.

*Adulteration of bread with boiled and mashed potatoes,* next to that by alum, is, perhaps, the one which is most commonly resorted to. The great objection to the use of potatoes in bread, is, that they are made to take the place

of an article very much more nutritious. This adulteration can be instantly detected by means of the microscope. The cells which contain the starch-corpuscles are, in the potato, very large, fig. 147; in the raw potato they are adherent to each other, and form a reticulated structure, in the meshes of which the well-defined starch-granules are clearly seen; in the boiled potato, however, the cells separate readily from each other, each forming a distinct article: the starch-corpuscles are less distinct and of an altered form.

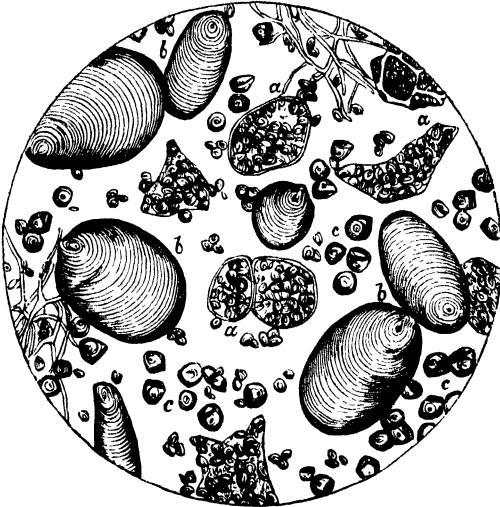

Fig. 148.—*Adulterated Cocoa, sold under the name of Homœopathic Cocoa.*  
(After Hassall.)

*a a a*, granules and cells of cocoa; *b b b*, granules of Canna-starch, or *Tous-les-mois*; *c*, granules of Tapioca-starch.

*Adulteration with alum and "stuff."*—This adulteration is practised with a twofold object: first to render flour of a bad colour and inferior quality white and equal, in appearance only, to flour of superior quality; and secondly to enable the flour to retain a larger proportion of water,

by which the loaf is made to weigh heavier. By dissolving out the alum in water and then re-crystallising it under the microscope, this adulteration is readily detected.

Before leaving the subject of starch, allusion may be made to the prevalent and destructive epidemic amongst potatoes, which is a disease of the tuber, not of the haulm or leaves. "Examined in an early stage, such potatoes are found to be composed of cells of the usual size; but they contain little or no starch: this will be seen upon reference to Nos. 16 and 17, fig. 145. Hence it may be



Fig. 149.—*Structure and Character of genuine Ground Coffee.* (After Hassall.)

inferred, that the natural nutriment of the plant being deficient, the haulm dies, the cells of the tuber soon turn black and decompose; and fungi developed as in most other decaying vegetable substances.

"This will undoubtedly explain the most prominent symptom of the potato-disease, the tendency to decomposition; and is a point in which the microscope confirms the result of chemical experiment: for it has been found



that the diseased potatoes contain a larger proportion of water than those that are healthy. A want of organizing power is evidently the cause of this deficiency of starch; but we fear the microscope will never tell us in what the want of this organising force consists." <sup>1</sup>

The adulteration of articles of food and drink has long been a matter of uneasy interest, and of strong, though vague, misgiving. Accum's *Death in the Pot*, between thirty and forty years ago, awoke attention to the subject; which has since been more or less accurately explored by

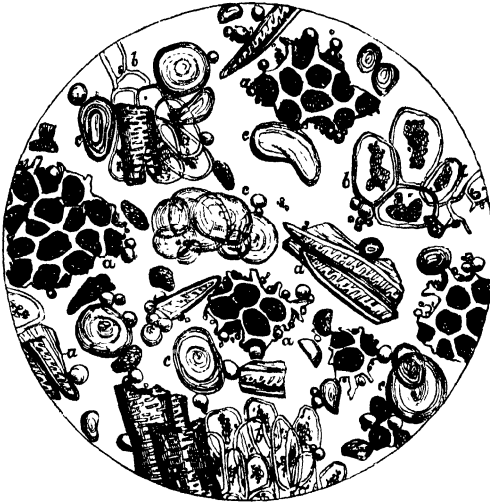

Fig. 150.—Sample of Coffee, adulterated with both Chicory and Roasted Wheat. (After Hassall.)

*a a a*, small fragments of coffee; *b b b*, portions of chicory; *c c c*, starch-granules of wheat.

Mitchell, Normandy, Chevalier, Jules Garnier, and Harel; and has at length derived a singularly lucid exposition from Dr. Hassall's researches, whose report of these inquiries fills between 600 and 700 closely printed pages

(1) Professor Quekett's *Histology of Vegetables*. We would refer the reader to an admirable work on *Fungi*, by Arimini, an Italian botanist, 1759.

of a large octavo, replete with details of the fraudulent contaminations commonly practised by the people's purveyors, at the people's expense of health and pocket.<sup>1</sup>

"In nearly all articles," said Dr. Hassall, before a committee appointed by the House of Commons to inquire into these adulterations, "whether food, drink, or drugs, my opinion is that adulteration prevails. And many of the substances employed in the adulterating process were not only injurious to health, but even poisonous." The microscope was the effective instrument in the work of

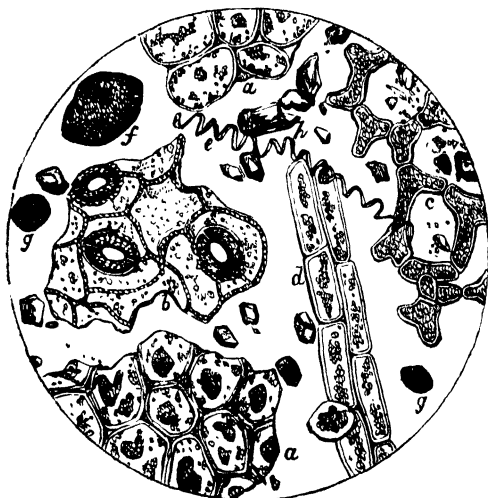

Fig. 151.—Tea adulterated with foreign leaves. (After Hassall.)

*a*, upper surface of leaf; *b*, lower surface, showing cells; *c*, chlorophyll cells; *d*, elongated cells found on the upper surface of the leaf in the course of the veins; *e*, spiral vessel; *f*, cell of turmeric; *g*, fragment of Prussian blue; *h*, particles of white powder, probably China clay.

detection. Less than five years ago, it would, we are told, have been impossible to detect the presence of chicory in coffee: in fact, the opinion of three distinguished chemists was actually quoted in the House of Commons to that effect;

(1) *Food and its Adulterations*; comprising the Reports of the Analytical Sanitary Commission of the *Lancet*, for the years 1851 to 1854 inclusive. By Arthur Hill Hassall, M.D.

whereas by the use of the microscope the differences of structure in these two substances, as in many other cases, can be promptly discerned. Out of thirty-four samples of coffee purchased, chicory was discovered in thirty-one; chicory itself being also adulterated with all manner of compounds. There is no falling back either upon tea or chocolate; for these seem rather worse used than coffee. Tea is adulterated, not only here, but still more in China; while as to chocolate, the processes employed in corrupting the manufacture are described as "diabolical." "It is

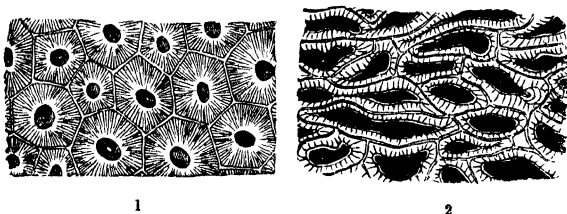

Fig. 152.

1, Radiating cells from the outer shell of the Ivory Nut. 2, Section of a Nut, showing cells with small radiating pores.

often mixed with brick-dust to the amount of ten per cent., ochre twelve per cent., and peroxide of iron twenty-two per cent., and animal fats of the worst description. In this country, cocoa is sold under the names of flake, rock, granulated, soluble, dietetic, homœopathic cocoa, &c., fig. 148. Now, these names are merely employed to show that they are compounds of sugar, starch, and other substances. Unfortunately, however, many of the preparations of the cocoa-nut sold under the names of chocolate and of cocoa flakes, consist of a most disgusting mixture of bad or musty cocoa-nuts, with their shells, coarse sugar of the very lowest quality, ground with potato-starch, old sea-biscuits, coarse branny flour, animal fat (generally tallow, or even greaves), &c."

If we look into drugs and pharmaceutical preparations we shall find that nearly all the most useful and important articles of the *Materia Medica* are systematically adulterated, often to an enormous extent; so that it is impossible to estimate the strength of the different remedies

administered, or the extent and character of the effects produced. (See Reports of the Analytical Sanitary Commission, *Lancet*, 1853 and 1854.)

We nevertheless believe that the growing intelligence and inquiring spirit of the masses, with the greatly increased facilities of detection so ably pointed out by Dr. Hassall, and afforded by modern science, will tend not merely to check the evil for the time being, but ultimately suppress such dangerous practices. Every man, and good housewife, should be able to ascertain the quality and general purity of the substances that form our daily food; this may be done by taking such a book as Dr. Hassall's *Adulterations Detected* for our guide, and there learn to look for adulterations, and to detect them instantly.

The next in order for investigation is the *Woody tissue* of plants, which consists of elongated transparent tubes of considerable strength: some are almost entirely made up of this tissue. It is by far the most useful, and supplies material for our linen, cordage, paper, and many other important articles in every branch of art. This tissue, remarkable for its toughness, is termed *fibre*, the outer membrane of which is usually structureless. In *Flax* and *Hemp*, in which the fibres are of great length, there are traces of transverse markings, and tubercles at short intervals. In the rough condition, in which it is imported into this country, the fibres have been separated, to a certain extent, by a process termed *hackling*. It is once more subjected to a repetition of *hackling*, maceration, and bleaching, before it can be reduced to the white silky condition required by the spinner and weaver, when it has the appearance of structureless tubes, fig. 153 A. *China-grass*, New Zealand flax, and some other plants, produce a similar material, but are not so strong, in conse-

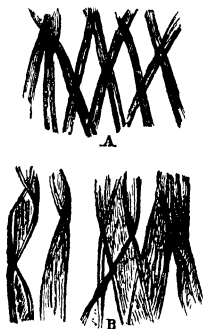

Fig. 153.  
A, Fibres of Flax. B, Fibres of Cotton.

quence of the outer membrane containing more *lignine*. It is important to the manufacturer that he should be able to determine the true character of some of the textures of articles of clothing, and this he may readily do with the microscope. In linen we find each component thread made up of the longitudinal, rounded, unmarked fibres of flax; but if cotton has been mixed, we recognise a flattened, more or less twisted band, as in fig. 153, having a very striking

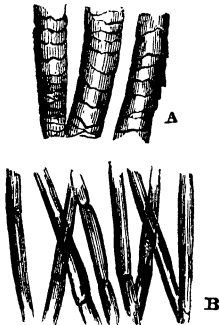

Fig. 154.

A, Wool of Sheep. B, Filaments of Silk.

resemblance to hair, which, in reality, it is; since, in the condition of elongated cells, it lines the inner surface of the pod. These, again, should be contrasted with the filaments of *silk*, fig. 154 B, and also of *wool*, fig. 154 A. The latter may be at once recognised by the zigzag transverse markings on its fibres. The surface of wool is covered with these furrowed and twisted fine cross lines, of which there are from 2,000 to 4,000 in an inch. On this structure depends its *felting* property. In judging of fleeces, attention should be paid to the fineness and elasticity

of the fibre,—the furrowed and scaly surface, as shown by the microscope,—the quantity of fibre in a given surface, the purity of the fleece, upon which depend the success of the scouring and subsequent operations.

In the mummy-cloths of the Egyptians, flax only was used, whereas the Peruvians used cotton alone. By recent improvements introduced into the manufacturing processes, flax has been reduced to the fineness and texture of silk, and made to resemble other materials.

Silk is secreted from a pair of long tubes ending in a pore of the under-lip of the silkworm. Each thread is made of two filaments coming from these, and they are glued together by a secretion from a small gland near. The quality of the silk depends on the character and difference of the two secretions.

All woody fibre is made up of elongated cells, generally

more or less pointed at both extremities, and having their walls strengthened by internal deposits. Occasionally, however, the fibre is short, as in the Clematis, Elder, &c. ; it is marked with pores or dots, from a deficiency of the internal deposits at these points.

*Vascular tissue* consists of cells, more or less elongated, joined end to end, or overlapping each other, in which either a spiral fibre, or a modification of the same, has been deposited ; hence, if the spiral be perfect, it is called a *true spiral vessel* ; if interrupted, or the fibre breaks up into rings, it is termed *annular* ; if the rings are connected together by branching fibres, so that a network is produced, the vessel is called *reticulated* ; if the vertical fibres are short, and equidistant, the vessel is said to be *scalariform*, from its resemblance to a ladder.

Spiral vessels have been also termed *tracheæ*, from their resemblance to the air-tubes of insects, as in fig. 155.

Under this head other membranous tubes are included, in which the arrangement of the fibre has been considerably modified in its deposition. Elongated tubes or ducts, with porous walls, come under the head of vascular tissue ; they somewhat differ from the spiral varieties, inasmuch as they cannot be unrolled without breaking. It is a curious fact, that mostly the spiral coils from right to left ; and it has been suggested that the direction of the fibre may determine that in which the plant coils round an upright pole. The Hop has *left-handed spirals*, and is a left-handed climber, which would therefore appear to support this theory. The nature of the fibre, and the development of the tissue, have been frequently the subject of dispute between botanists.

The late Mr. Edwin Quekett gave much attention on the

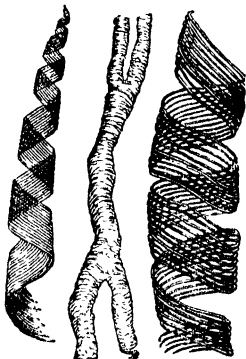

Fig. 155.—Spiral vessels.

subject; and published an excellent paper in the *Microscopical Society's Transactions*, 1840, which contains the results of his observations.

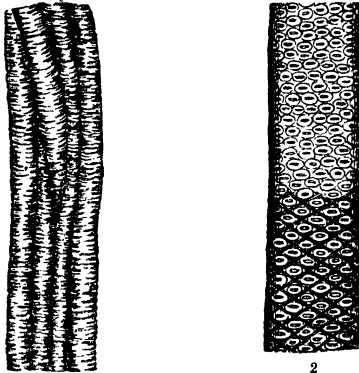

Fig. 156.

1, Interior cast of the siliceous portion of spiral tubes of the *Opuntia*. 2, Vertical section of Elm, showing spiral fibre.

In order to watch the development of the membranous tube of a vessel, no better example can be chosen than the

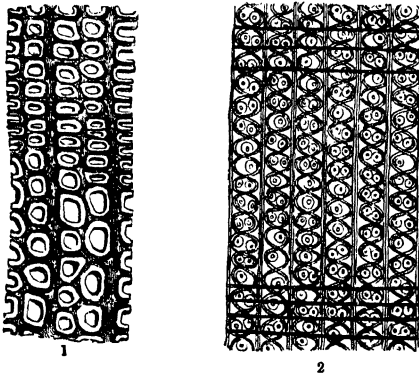

Fig. 157.

1, A transverse section of *Taxus baccata* (Yew), showing the woody fibre.  
2, Vertical section of the Yew, exhibiting pores and spiral fibres.

young flower-stalk of the long-leek (*Allium porrum*), in the state in which this vegetable is usually sent to market; it is then most frequently found to be about an inch or

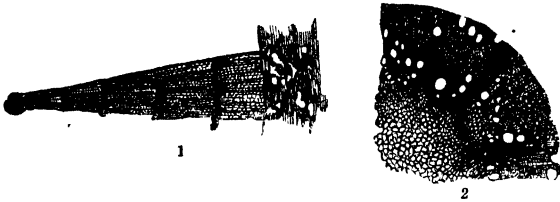

Fig. 158.

- 1, Portion of transverse section of stem of Cedar, showing pith, wood, and bark.  
2, Portion of transverse section of stem of Clematis, showing medullary rays.

more in length, and from a quarter to half an inch in diameter. This organ occurs very low down amidst the sheathing bases of the leaves; and from having to lengthen to two or three feet, and containing large vessels, forms a very fit subject for ascertaining the early appearances of the vascular tissue.

To examine the development of vessels, it is necessary to be very careful in making dissections of the recent plant; and it will be found useful to macerate the specimen for a time in boiling water, which will render the tissues more easily separable. When the examination is directed in search of the larger vessels, it will be found that at this early stage they present merely the form of very elongated cells, arranged in distinct lines; amongst which some vessels, especially the annular, will be found matured, even before the cytoblasts have disappeared from the cells of the surrounding tissue.

As development proceeds, the vessels rapidly increase in length, till they arrive at perfection. No increase in diameter is perceptible after their first formation. At this period, in the living plant the young vessels appear full of fluid, which is apparently, as remarked by Schleiden, of a thick character, and which he has designated vegetable jelly; by boiling which, or by the addition of alcohol, the contents, or at least the albuminous portion, become coagulated. From this circumstance, every cell appears



to enclose another in a shrivelled condition ; this state is sometimes so far extended, that a thick granular cord is all that can be seen of the contents.

“The period of growth at which the laying down of fibre commences, determines the distance between the

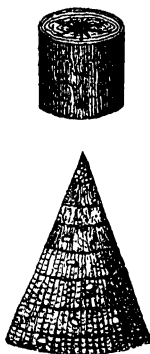

Fig. 159.—A section from the stem of a coniferous plant, with a transverse cutting magnified, to show the zones of annual growth, annual rings.

several coils ; for instance, when it is first formed, the coils are quite close, scarcely any perceptible trace of membrane existing between them. In the annular vessel, the development of the cell and the adherence of the granules to each other are conducted in the same manner ; the deposit showing a tendency towards the spiral direction, by the presence of a spire connecting two rings, or by a ring being developed in the middle of a spiral fibre. The annular vessel is the first observed in the youngest parts of plants, and when found alone indicates a low degree of organisation ; as shown by its occurrence in *Sphagnum*, *Equisetum*, and *Lycopodium*, which plants, in the ascending scale of vegetation, are almost the first that

possess vascular tissue.

“It will be found that spiral fibre occurring with rings marks a higher step in the scale of organising power ; the true spiral more so ; and the reticulated and dotted mark the highest ; this being the order in which these several vessels are placed in herbaceous exogens proceeding from within outwards, the differences of structure of the several vessels being indices of the vital energy of the plant at the several periods of its development. In those vessels in which the annular or spiral character of the fibre is departed from, some curious modifications of the above process are to be observed, as in the reticulated vessels met with in the common balsam (*Balsamina hortensis*). The primary formation of fibre in these vessels is marked by the tendency of the granules to take a spiral course, when it happens that some one of the granules becomes

enlarged by the deposition of new matter around it. This becomes a point originating another fibre or branch, which becomes developed by the successive attraction of granules into bead-like strings, taking a contrary direction to the original fibre, forming a cross-bar, or ramifying, thereby causing the appearance by which the vessel is recognised.

“In the exogenic vessel, the development of fibre proceeds in the same manner as in the last example; but the vessels will be seen to be dotted with a central mark, usually of a red colour, which, when viewed under high power, may be thought to resemble a minute garnet set in the centre of each dot. This red colour is owing to the dot being somewhat hollowed or cupped, and the centre only thin membrane. These vessels are best seen in the young shoots of the Willow. In the endogenic vessel the connecting branches are given off beneath each other, so that the dots, which are rounded, are arranged in longitudinal rows; but in the acrogenic, or scalariform, in which the vessels are generally angular, and present distinct facets, the branches come off in the same line, corresponding generally to the angles of the vessel; the spaces left between are linear instead of round.”

Mr. E. Quekett affirms, in opposition to the views entertained by Mirbel, Richard, and Bischoff, “that the dots left in these several vessels are not holes, neither do they consist of broken-up fibre, but are the membranous tubes, unsupported by internal deposit; and on account of the extreme tenuity of the tissue, and the minute space between the fibres, the light in its transmission becomes decomposed, and appears of a greenish-red hue. The structure of the dot is best seen by examining the broken edge of any such vessels, when it will be found that the fracture has been caused by the vessel giving way from one dot to another, so that the torn edge of the membrane can be observed in each dot.”

#### PREPARATION OF VEGETABLE TISSUES.

The proper mode of preparing and preserving vegetable tissues is a matter of some importance to the microscopist; we therefore propose to add a few general directions for the student's guidance.

Vegetable tissues are best prepared for the microscope by making thin sections, either by maceration, by tearing between the thumb and the blade of a knife, or by dissection.

The spiral and other vessels of plants require to be dissected out under a simple magnifying-glass. Take, for instance, a piece of asparagus, and separate with the needle-points the vessels, which require to be finished under a magnifying-glass, in a single drop of distilled water. When properly done, keep in spirits of wine and water until mounted.

Vascular tissue requires both maceration and dissection for its separation. The cuticle or external covering of plants is a highly interesting structure; it is best seen in the pelargonium, oleander, &c.; and which may be mounted dry or in Canada balsam.

Cellular tissue is best seen in fine sections from the pith of elder, pulp of peach, pear, &c. The petals of flowers are mostly composed of cellular tissue, and their brilliant colours arise from the fluid contained within the cells. In the petal of the *anagallis*, or scarlet chickweed, the spiral vessels diverging from the base, and the singular cellules which fringe the edge, are very interesting. The petal of the geranium is one of the most beautiful objects for microscopic examination. The usual way of preparing it is by immersing the leaf in sulphuric ether for a few seconds, allowing the fluid to evaporate, and then putting it up dry. Dr. Inman of Liverpool suggests the following method: "First peel off the epidermis from the petal, which may be readily done by making an incision through it at the end of the leaf, and then tearing it forwards by the forceps. This is then arranged on a slip of glass, and allowed to dry; when dry, it adheres to the glass. Place on it a little Canada balsam diluted with turpentine, and boil it for an instant over the spirit-lamp; this blisters it, but does not remove the colour; then cover it with a thin slip of glass, to preserve it. Many cells will be found showing the mamilla very distinctly, and the hairs surrounding its base, each being slightly curved and pointed towards the apex of the mamilla. It is these hairs and the mamilla which give the velvety appearance to the petal."

Fibro-cellular tissue is found readily in *Sphagnum* or

bog-moss, and in the elegant creeper *Cobæa scandens*. In some orchidaceous plants the leaves are almost entirely composed of it. A modification of this form of tissue is found in the testa of some seeds, as in those of *Salvia*, *Collomia grandiflora*, &c.

The curious and interesting sporules of ferns, when ripe, burst, and are dispersed to a distance; so that they should be gathered before they come to maturity, and mounted as opaque objects. The development of ferns may be observed by placing the seeds in moistened flannel, and keeping them at a warm temperature. At first a single cellule is produced, then a second; after this the first divides into two, and then others follow; by which a lateral increase takes place.

Pollen-grains from most flowers are very interesting objects; the darker kinds show best when mounted in Canada balsam, and viewed as opaque; the objects more

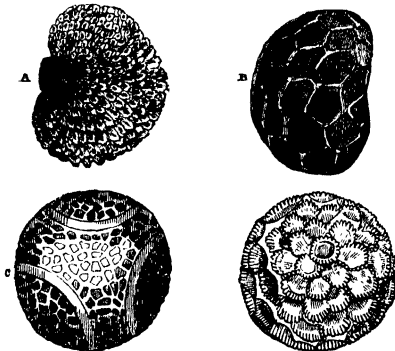

Fig. 160.—Pollen grains and seeds.

A, Seed of Clove-pink. B, Poppy seed. C, Pollen of Passion flower (*Passiflora cærulea*). D, Pollen of *Cobæa scandens*.

transparent in fluid, or even preserved dry, will show better. The prettiest and most delicate forms are found in *Amarantaceæ*, *Circurbitaceæ*, *Malvaceæ*, and *Passifloreæ*; others are furnished from the *Convolvulus*, *Geranium*, *Campanula*, *Hollyhock*, and some other plants. The curious peculiarities of a few are shown in fig. 160.

Many of the smaller kinds of seeds will reward the microscopist, seen under a low power; that of *Caryophyllum* (clove-pink), is regularly covered with curiously-jagged divisions; every one of which has a small bright, black hemispherical knob in its middle, represented in fig. 160, A.

The seeds of the carrot are remarkably formed, having some resemblance to a star-fish, with its long radiating processes. The seeds of *umbelliferous* plants have peculiar receptacles for essential oil, in their coats, termed *vitæ*, various points of interest may be noted as occurring in the *testæ*, envelopes of seeds, such as the fibre-cells of *Cobæa*, and the stellate cells of the *Star-anise*.

All plants are provided with hairs; and a few, like insects, with weapons of a defensive character. Those in the *Urtica dioica*, commonly called the *Stinging-nettle*, are elongated hairs, developed from the cuticle, usually of a conical figure, and containing an irritating fluid; in some of them a circulation is visible: when examined under the microscope, with a power of 100 diameters, they present the appearance seen at fig. 145, No. 2. At No. 3, same figure, are represented a few interesting ciliated spores from *Confervæ*.

The circulation of the fluid-contents of vegetable cells may be examined at the same time with the Chlorophyll globules, by selecting for the purpose the transparent water-plants *Chara*, *Nitella*, *Anacharis*, and *Vallisneria*, or the hairs of *Groundsel* and *Tradescantia*. The circulation of the sap in plants growing in water is termed by botanists *Cyclosis*.

*Fossil plants*.—We detect in some of the primordial fossils a noticeable likeness to families familiar to the modern algoologist. The cord-like plant, *Chorda filium*, known as 'dead men's ropes,' from its proving fatal at times to the too adventurous swimmer who gets entangled in its thick wreaths, had a Lower Silurian representative, known to the palæontologist as the *Palæochorda*, or ancient corda, which existed, apparently, in two species,—a larger and a smaller. The still better known *Chondrus crispus*, the Irish moss, or Carrageen moss, has, likewise,

its apparent, though more distant representative, in *Chondritis*, a Lower Silurian alga, of which there seems to exist at least three species. The fucoids, or kelp-weeds, appear to have also their representatives in such plants as *Fucoides gracilis*, of the Lower Silurians of the Malverns; in short, the *Thallogens* of the first ages of vegetable life, seem to have resembled, in the group, and in at least their more prominent features, the *Algæ* of the existing time. And with the first indications of land we pass direct from the *Thallogens* to the *Acrogens*,—from the sea-weeds to the fern-allies. The *Lycopodiaceæ*, or club-mosses, bear in the axils of their leaves minute circular cases, which form the receptacles of their spore-like seeds. And when, high in the Upper Silurian system, and just when preparing to quit it for the Lower Old Red Sandstone, we detect our earliest terrestrial organisms, we find that they are composed exclusively of those little spore-receptacles.

“The existing plants whence we derive our analogies in dealing with the vegetation of this early period, contribute but little, if at all, to the support of animal life. The ferns and their allies remain untouched by the grazing animals. Our native club-mosses, though once used in medicine, are positively deleterious; horsetails (*Equisetaceæ*), though harmless, so abound in silex, which wrap them round with a cuticle of stone, that they are rarely cropped by cattle; while the thickets of fern which cover our hill and dell, and seem so temptingly rich and green

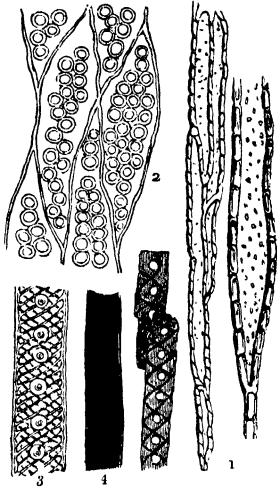

Fig. 161.

- 1, Woody fibre from the root of the Elder, exhibiting small pores. 2, Woody fibre of fossil wood, showing large pores. 3, Woody fibre of fossil wood, bordered with pores and spiral fibres. 4, Fossil wood taken from coal.

in their season, scarce support the existence of a single creature, and remain untouched, in stem and leaf, from their first appearance in spring, until they droop and wither under the frosts of early winter.

“ It is not until we enter into the earlier Tertiaries do we succeed in detecting a true dicotyledonous tree ; on such an amount of observation is this order determined, that when Dr. John Wilson, the Parsee Missionary, submitted to me specimens of fossil woods which he had picked up in the Egyptian Desert, in order that, if possible, I might determine their age, I told him that if they exhibited the coniferous structure, they might belong to any geologic period from the times of the Lower Old Red Sandstone downwards ; but if they manifested in their tissue the dicotyledonous character, they could not be older than the times of the Tertiary. On submitting them in thin slices to the microscope, they were found to exhibit the peculiar dicotyledonous structure as strongly as the oak or chestnut. And Lieutenant Newbold’s researches in the deposit in which they occur has since demonstrated, on stratigraphical evidence, that it belongs to the comparatively modern formations of the Tertiary.

“ The flora of the coal measures was the richest and most luxuriant, in at least individual productions, with which the fossil botanist has formed any acquaintance. Never before or since did our planet bear so rank a vegetation as that of which the numerous coal seams and inflammable shales of the carboniferous period form but a portion of the remains,—the portion spared, in the first instance, by dissipation and decay, and in the second by the denuding agencies. Almost all our coal,—the stored-up fuel of a world,—forms but a comparatively small part of the produce of this wonderful flora. Yet, with all this singularly profuse vegetation of the coal measures, it was a flora unfitted, apparently, for the support of either graminiverous bird or herbivorous quadruped. Nor does the flora of the Oolite seem to have been in the least suited for the purposes of the shepherd or herdsman. Not until we enter on the Tertiary periods do we find floras amid which man might have profitably laboured : nay, there are whole orders and families of plants, of the very first importance to man,

which do not appear until late in even the Tertiary ages. The true grasses scarce appear in the fossil state at all. For the first time, amid the remains of a flora that seems to have had its few flowers,—the Oolitic ages,—do we detect, in a few broken fragments of the wings of butterflies, decided traces of the flower-sucking insects. Not, however, until we enter into the great Tertiary division do these become numerous. The first bee makes its appearance in the amber of the Eocene, locked up hermetically in its gem-like tomb,—an embalmed corpse in a crystal coffin,—along with fragments of flower-bearing herbs and trees. Her tomb remains to testify to the gradual fitting up of our earth as a place of habitation for a creature destined to seek delight for the mind and eye, as certainly as for the proper senses, and in especial marks the introduction of the stately forest trees, and the arrival of the delicious flowers.”<sup>1</sup>

“ Sweet flowers ! what living eye hath viewed  
 Their myriads ? endlessly renewed ;  
 Wherever strikes the sun's glad ray,  
 Where'er the subtle waters stray,  
 Wherever sportive zephyrs bend  
 Their course, or genial showers descend.”

(1) Hugh Miller's *Testimony of the Rocks*.





## CHAPTER II.

### DIVISION OF ANIMAL KINGDOM.

PROTOZOA—HISTORY OF INFUSORIAL ANIMALCULES—RHIZOPODA—MONADS—  
DIATOMACEÆ — FOSSIL INFUSORIA, ROTIFERA,  
VORTICELLA, STENTORS, SPONGES, HYDRA,  
ZOOPHYTES, ETC.



SINCE our very limited space forbade more than a cursory glance at the many and varied points of beauty and arrangement displayed in every part of the vegetable kingdom ; so are we in the higher ranks of life, driven to be equally brief in noticing the wonders displayed by the help of the microscope, in the world of animal life. In the course of remarks made upon the early condition of vegetable

life, we drew attention to the difficulties presented in all attempts to mark out the boundary line between vegetables and animals, and to define where the one ends, and the other begins.

After reviewing the different characters by which it has been attempted to distinguish the special subjects of the botanist and zoologist, we find that animals and plants are not two natural divisions, but are specialised members of one and the same group of organised beings. When a certain number of characters concur in the same organism, its title to be regarded as a "plant," or an "animal," may be readily recognised ; but there are very numerous living beings, especially those that retain the

form of nucleated cells, which manifest the common organic characters, but are without the true distinctive superadditions of either kingdom.

Our difficulties are yet far from a satisfactory adjustment; only very lately it has been affirmed by Dr. Hartig that *amœba* may be produced by the transformation of the 'antherozoids' of *Chara*, *Marchantia*, or Mosses, and that, in their turn, they became metamorphosed, first into *Protococci* or other unicellular *Algæ*, and then into articulated *Algæ*. This consideration takes us back to the arguments adduced by Mr. Carter, in favour of the analogy between the nucleus of the cell of *Chara* and that of the Rhizopodous cell, which will be found given at some length in the preceding chapter.

"If"—writes Mr. Lewes—"plants and animals present difficulties in our early attempts to distinguish them from each other, they are all distinguishable from minerals by a triple phenomenon—assimilation, reproduction, and death. The same elements are common to the animate and the inanimate kingdoms; many forms are common to both: but no mineral assimilates—that is to say, grows by the intersusception of foreign material, which it converts into its own substance; no mineral dies, as the inevitable termination of a cycle of internal changes.

"Nutrition belongs to all animals; but although the final and fundamental act—assimilation—is the same in all, the preparatory and intermediate processes are singularly varied. Thus the *Infusoria*, or unicellular organisms, have no special organ whatever, the only distinction between the parts is that of 'envelope' and 'contents;' by its envelope the animal absorbs, feels, and moves; by its contents it assimilates. An *Amœba*, for example, may be looked upon as an assimilating surface having the property of contractility: nothing more. Gradually we observe fresh distinctions of parts: a hole is formed, by way of mouth; then we have two holes, one for reception, the other for rejection of food. Then the mouth becomes furnished with jaws; then with rudimentary teeth; afterwards with actual teeth, but all of one type; finally the teeth themselves become distinguished into incisors and molars; a tongue is added to the mouth; so that from a

simple opening to a complicated mouth we trace a series of differentiations. The alimentary canal is at first a mass of cells, then a variety of assimilative sacks or spaces, then a simple canal, then a complicated canal, then a canal formed of œsophagus, stomach, small intestines and large intestines. With this increasing complication there is an accompaniment of accessory organs, liver, parotis, pancreas, spleen, &c., secreting matters indispensable to the proper preparation of the food before it can be assimilated."

*Division of Animal Kingdom.*—The Animal Kingdom is primarily divided into :—

Animalia	{	<i>Hæmastomata</i> . . . . .	1. Vertebrata.
	{	<i>Neurostomata</i> . . . . .	2. Annulosa.
			3. Mollusca.
			4. Cœlenterata.
			5. Protozoa.

Which are again divided into sub-kingdoms ; each sub-kingdom being distinguished by its peculiar typical forms. Commencing from the lowest, we have, 1st. *Protozoa*, divided into :—1. *Gregarinida*. 2. *Rhizopoda*. 3. *Infusoria*.

The next sub-kingdom, that of the *Cœlenterata*, is divided into :—1. *Hydræzoa*. 2. *Actinozoa*. The typical form of first—is the *Hydra*: its modifications, the *Sertulariadae*, *Diphydae*, *Hydræmedusæ*, &c. The typical form of second, *Actinozoa*, is *Actinia* ; others, *Lucernaria*, *Beroë*, &c., its modifications are exhibited in other Anthozoic polypes.

Sub-kingdom *Annulosa*, presents difficulties of classification, owing to the great diversity of forms included among them ; but is primarily divided into three great groups. 1st. *Arthropoda*. 2d. *Annulata*. 3. *Annuloida*.

The first, embracing annulose animals having articulated members ; the second, those without articulated members, but having a ventral chain of ganglia ; and the third, those whose nervous system is composed of cords with one or more ganglia, not disposed in a ventral chain. The whole are arranged in the following classes :—

I. *Arthropoda* : 1, *Crustacea* ; 2, *Arachnida* ; 3, *Insecta* ; 4, *Myriapoda*. II. *Annulata* : 1, *Annelida* ; 2, *Suctoria*. III. *Annuloida* : 1, *Scolecida* ; 2, *Gephyrea* ; 3, *Echino-dermata* ; 4, *Rotifera*.

*Mollusca* are usually included in one of these classes, although subdivided into groups of *Mollusca propria*, and *Molluscoidea*, the latter consisting of *Polyzoa* and *Tunicata*. There is, indeed, a general relation between the Annulose and Molluscos sub-kingdoms.

*Cephalous Mollusca* are divided into the following classes:—1, *Gasteropoda branchiata*; 2, *Gasteropoda pulmonata*; 3, *Pteropoda*; 4, *Cephalopoda*. The last present us with modifications of *organisation* in the *Nautilus*, *Ammonite*, *Belemnenthis*, &c.

It would occupy too much of our space to give the numerous subdivisions into which the classes and families are broken up; we beg therefore to refer the reader to the works of Professor Owen, and Professor Rymer Jones, on the Animal Kingdom, or Mr. Gosse's *Manual of Marine Zoology*.

In these and other valuable voluminous treatises on this interesting department of nature, the above division is strictly adhered to; but as our object is to give a popular account of the wonders disclosed by the microscope, we will not closely follow the path of the learned investigators of this branch of science; but avoid as much as possible the adoption of terms so often alarming to the uninitiated, culling, as we pass, from objects of the greatest interest, and likely to create a desire for further knowledge, whereby there will be found a future pleasure in overcoming the obstacles, by which the learned render so mysterious to the popular mind, the stores of their gathered wealth.

#### PROTOZOA.<sup>1</sup>

*Gregarinida* present us with the simplest form of all the *Rhizopods*. A *gregarina* is a simple mass of granular, and usually transparent, substance, whose outer boundary presents, more or less distinctly, the aspect of a membrane, while its interior contains a clear spheroidal space, in the centre of which is a nucleus-like particle; so that the whole animal has a remarkable resemblance to an ovum.

(1) Mr. Huxley divides the *Protozoa* into two great groups: 1. The *Astomata*, or those which are unprovided with any permanent oral aperture—*Gregarinæ*, *Rhizopoda*, *Spongiadæ*, *Thalassicollidæ*. 2. The *Stomatoda*, which have a permanent oral aperture, and the rudiment of an alimentary canal—*Injutoria*, *Noctilucidæ*.

There is no contractile space, the sole ordinary manifestation of vitality consisting in an incessant change of form, without the elongated pseudopodia of the *Amœba* being ever thrust out. The mechanism of the nutritive act is, in a general sense, the same in this unicellular *Protozoa* as in a simple cell. In the *Gregarinae* the food is taken in indiscriminately at every point of the surface of the body by imbibition. The food most likely is in the fluid state. In *Spongilla*, also, this is probably the case. But it is generally agreed that in *Amœba*, *Actinophrys*, and *agastric Infusoria*, only solid alimentary particles are taken as food. The simplest animal is indeed far more complex than is implied in the word *unicellular*, and it can be clearly proved that there are few points in common between a simple cell and a so-called unicellular protozoon. The system of contractile vesicles and dependent sinuses, so general in the least organized protozoon, is unknown in the history of cells. Fluid absorption by the surface is the normal method of feeding in these low types of animal life. This absorptive faculty is an inherent property of the substance of which they are composed. It attracts certain aliments, as gelatine attracts water. Tissue, distinguished by the same character, prevails throughout the entire class of the *Entozoa*. The *Gregarina* inhabit the intestines of invertebrate animals, insects, worms, molluscs, &c. but have not been discovered in the alimentary canal or other organs of the *Vertebrata*. In this class they appear to be represented, however, by very closely allied organisms, the *Psorospermia*. Müller gave this last-mentioned name to some very singular minute bodies he discovered within sacs upon the skin and gills, and in the internal organs of many fishes. These animals are generally of a cylindrical or somewhat elliptical form, although sometimes a sort of head appears to be produced by the constriction of the anterior extremity of the body, and this head-like portion is occasionally furnished with a curious soft process and lobes. They are very sluggish in their movements, although a few possess true cilia. Their curious mode of development, with other points in the history of these minute parasites, are well worthy of investigation.

The *Rhizopoda* appear as creatures of a low type of organisation, and are considered, with the former, to hold a medium state between animals and vegetables. Almost all of them live in water; it would be a fruitless search to look for distinct internal organs, as the small bladder-looking spaces enclosed within their substance,—believed by Ehrenberg to be stomachs, and which have been termed by Dujardin *sarcode*,—present only the appearance of a transparent gelatinous cell, with or without moving spaces in their interior, which may be regarded as the earliest dawn of a circulatory system.

The term *Rhizopoda* is derived from the Greek, and

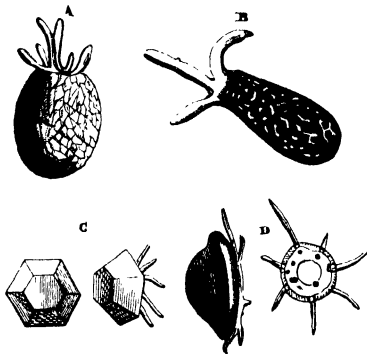

Fig. 162.—Simple Rhizopods.

A, *Diffugia proteiformis*. B, *Diffugia oblonga*. C, D, *Arcella acuminata* and *dentata*.

means “many-footed,”—the body is composed entirely of gelatinous matter, *sarcode*,—motion being effected by the extension of portions of their substance into processes, which partake of various forms.

*Amœba*.—In the deposit formed at the bottom of fresh-water ponds, we may often meet with a singular minute gelatinous body, which constantly changes its form even under our eyes; and moves about by means of finger-like processes, called *pseudopodia*, which it appears to have the power of shooting out from any part of its substance. This shapeless mass is well known to microscopic observers

under the name of the *Proteus* (*Amœba diffluens*, fig. 163,) which, from the continual changes of shape it presents,

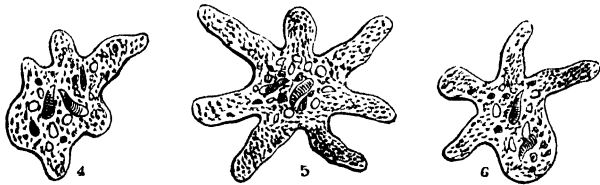

Fig. 163.—*Amœba diffluens*, or *Proteus*.

is honoured with the name of a fabled god, who could be either animal, vegetable, or elemental in his nature. This curious animal presents us with the essential characters of all the class *Rhizopoda* in their simplest form. It appears to be of an exceedingly voracious disposition, seizing upon any minute aquatic animals or plants that may come in its way, and appropriating them to the nutrition of its own gelatinous body. The mode in which this tender and apparently helpless creature effects this object is very remarkable. The gelatinous matter of which it is composed is capable, as we have seen, of extension in every direction; accordingly, when the *Amœba* meets with anything that it regards as suitable for its support, the substance of the creature, as it were, grows round the object until it is completely enclosed within its body. The substances swallowed (if such a term be admissible) by this hungry mass of jelly are often so large, that the creature itself only seems to form a sort of gelatinous coat enclosing its prey.

Professor Ecker believes in an exact similarity of *contractile substance* between that of the lower animal forms, such as the *Rhizopoda*, and that observed in the *Hydra*. He says: "The properties of this substance, in its simplest form, are seen in the *Amœba*, the body of which, as is known, consists of a perfectly transparent albumen-like homogeneous substance, in which nothing but a few granules are imbedded, and which presents no trace of further organisation. This substance is in the highest degree extensible and contractile; and from the main mass

are given out, now in one part and now in another, perfectly transparent rounded processes, which glide over the glass like oil, and are then again merged in a central mass. There is no external membrane. In the body of the *Amœba* there occur, besides the granules, clear spaces with fluid contents, which are sometimes unchangeable in form, and sometimes exhibit rhythmical contractions."

Allied to the preceding is the very curious *Acineta* of Ehrenberg, *Actinophrys sol*, "sun-animalcule." This creature consists of a jelly-like contractile substance, or *sarcode*, with tentacular filaments, radiating from the central mass, in such a manner as to have suggested the name for the species. It abounds in pools, where *Desmidiaceæ* are found, in many parts of Dorsetshire; they are ravenous feeders, not only upon the *Desmidiaceæ*, but also upon all kinds of minute spores and animalcules.

It was on examining some beautiful *Desmidiaceæ* that my attention was arrested by the curious appearance of two or three very small *Actinophrys* floating very lightly upon the surface of the water, in the form of a ball, with their delicate tentacular filaments perfectly erect all over their bodies; in fact, they seemed to be floating upon these delicate filaments.<sup>1</sup>

The most beautiful forms of the *Rhizopoda* are found among those possessing a calcareous covering, as the *Polythamia*, *Rosalina*, *Faujasina*, &c.; their systematic arrangement are founded upon their shells, which exhibit a most beautiful diversity in form. Out of these forms, it would appear, that the labours of various naturalists in the last hundred years have made known nearly 2,000 species of recent and fossil *Foraminifera*; and although the observations of Dr. Carpenter tend to show the probability that very many of these supposed species are merely varieties, still the number is sufficiently great to prove the importance and interesting nature of the inquiry.

Dr. Schultze acknowledges the difficulties attending the study of the *Rhizopoda*, and insists, very properly, upon the necessity of viewing them in all positions,

(1) See *Notes on Freshwater Infusoria*, by H. J. Carter, Esq. *Ann. Nat. Hist.* August, 1856.



and under different modes of illumination and of preparation, in order to arrive at a due conception of their astonishing conformation.

When the shells of *Foraminifera* are dissolved in dilute acid, an organic basis is always left after the removal of the calcareous matter, accurately retaining the form of the shell with all its openings and pores. The earthy constituent is mainly carbonate of lime; but Dr. Schultze has satisfied himself of the presence of a minute amount of phosphate of lime in the shells of recent *Orbiculina adunca* from the Antilles, and of *Polystomella strigilata* from the Adriatic.

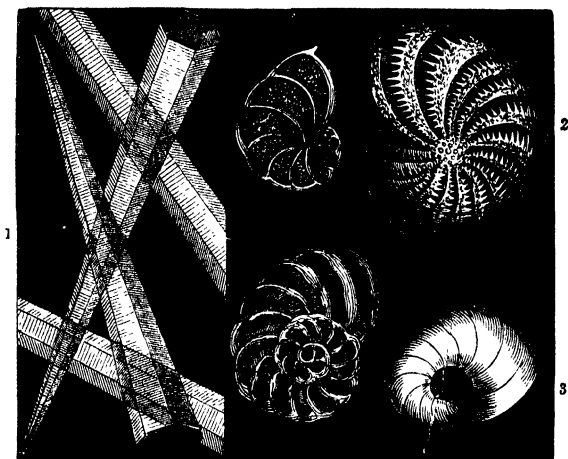

Fig. 164.

1, Separated prisms from outer layer of *Pinna* shell. 2, Skeletons of *Foraminifera* from limestone. 3, Recent shell of *Polystomella crispa*; viewed with the dark-ground illuminator.

The solitary *Rhizopoda*, furnished with a horny shell or capsule, forming a case for the animal, is nearly the only representative of the *Arcellidæ*. In the *Arcella*, from which the family derives its name, the shell is somewhat of a bell-shape, with a very large round opening. In *Englypha* it is of an oval or flask-like form, with the

opening at the smaller end, and the shell appears as though formed of a sort of mosaic of small horny pieces. In *Diffugia* the shell is often globular. Fig. 162, A B, Rhizopods, which never develop more than one chamber or loculus, are called *Monothalamia*.

The *Polythalamia*, or Multilocular Rhizopods, in their earliest state, are unilocular; but as the animal increases, successive chambers are added in a definite pattern for each family of the order. They all inhabit the sea, and frequently occur in such great numbers, that the fine calcareous sand which constitutes the sea-shore in many places consists almost entirely of their microscopic coats. At former periods of the earth's history, they existed in even greater profusion than at present; and their fragile shells form the principal constituents of several very important geological formations. Thus the chalk appears to consist almost entirely of the shells of these animals, either in a perfect state, or worn and broken by the action of the waves; they occur again in great quantities in the marly and sandy strata of the Tertiary epoch. The stone, which is universally employed in Paris as a building stone, is almost entirely composed of the fossil shells of those belonging to the order *Miliola*.

In the *Stichostegidæ* the chambers are placed end to end in a row, so as to form a straight or but slightly curved shell. In the second family, the *Enallostegidæ*, the chambers are arranged alternately in two or three parallel lines; and as the construction of the shell is always commenced with a single small chamber, the whole necessarily acquires a more or less pyramidal form. The third family, the *Helicostegidæ*, presents us with some of the most beautiful forms that it is possible to meet with in shells. They commence by a small central chamber; and each of the subsequent chambers are arranged in a spiral form so as to give the entire shell much the aspect of a minute flattened snail, is larger than the one preceding it. It is in this family that we find the nearest approach, in external form, to the large chambered shells of the cephalopodous mollusca, of which the *nautilus* and the *argonaut* are examples. The fourth family, the *Entomostegidæ*, stand in the same relation to the preceding as the *Enallostegidæ* to the

*Stichostegidæ*; that is to say, the chambers are also arranged in a spiral form, but in a double series. A fifth family includes those shells in which the chambers are arranged round a common perpendicular axis in such a manner that each chamber occupies the entire length of the shell. The orifices of the chambers are placed alternately at each end of the shell, and are furnished with a curious tooth-like process. The *Miliola* serve as an example of this family. Every handful of sea-sand, every shaking of a dried sponge, and the contents of the stomachs of most Lamellibranch molluscs, oyster and mussel, are pretty sure to exhibit a considerable admixture of these minute calcareous, or occasionally silicious, *Foraminifera*.

It is considered that the fossil shells, termed *Nummulites*, found in great quantities in the chalk and lower tertiary strata, are also to be regarded as members of this class; in a fossilized state, whole mountains consist almost entirely of their shells. Professor Quekett has had an opportunity of examining living specimens, which, he says, "are composed of a sarcode element, built up into a series of chambers with calcareous material."

The great Pyramid of Egypt, covering eleven acres of ground, is based on blocks of limestone consisting of *Foraminifera*, *Nummulites*, or *stone coin*, and other fossil animalcules. *Nummulites* vary in size from a very minute object to that of a crown-piece, and many appear like a snake coiled up in a round form. A chain of mountains in the United States, 300 feet high, seems wholly formed of one kind of these fossil-shells. The crystalline marble of the Pyrenees, and the limestone ranges at the head of the Adriatic gulf, are composed of small *Nummulites*. Vast deposits of *Foraminifera* have been traced in Egypt and the Holy Land, on the shores of the Red Sea, Arabia, and Hindostan, and, in fact, may be said to spread over thousands of square miles from the Pyrenees to the Himalayas.

The fossilized *Foraminifera* in the Poorbandar limestone, although occasionally reaching the twenty-fifth, do not average more than the hundredth part of an inch in diameter; so that more than a million of them may be computed to exist in a cubic inch of the stone. They may

be separated into two divisions—those in which the cells are large, the regularity of their arrangement visible, and their bond of union consists of a single constructed portion between each; and those in which the cells are minute, not averaging more than the 900th part of an inch in diameter, the regularity of their arrangement not distinctly seen, and their bond of union consisting of many thread-like filaments. To ascertain the mineral composition of the amber-coloured particles or casts, after having found that it was mostly carbonate of lime with which they were surrounded, they were placed for a few moments in the reducing flame of a blow-pipe, and it was observed that on subsequently exposing them to the influence of a magnet, they were all attracted by it. Hence, in a rough way, this rock may be said to be composed of carbonate of lime and oxide of iron.

Truthfully does Lamarck say of the *Foraminifera*,—“Their smallness renders their bodies contemptible to our eyes; in fact, we can hardly distinguish them; but we cease to think thus when we consider that it is with the smallest objects that nature produces the most imposing and remarkable phenomena. Now, it is here again that we have one of the numerous instances which attest that, in her production of living bodies, all that nature appears to lose on one side in volume, she regains on the other in the number of individuals, which she multiplies to infinity.”

Recent *Foraminifera* present symmetrical shells, of minute size for the most part, of various patterns, and consisting either of a single chamber or of two or more connected chambers. A jelly-like mass, or “sarcodé,” occupies the chambers and their connecting passages; and, protruding itself both from the external aperture of the last chamber, and in many cases from the sometimes numerous perforations in the shell-walls, extends itself not only over the surface of the shell, but also into radiating contractile threads or *pseudopodia*, and into gemmule-like masses, which latter become coated over with calcareous matter, and thus form additional segments of the animal.<sup>1</sup>

(1) Among the more important works on *Foraminifera*, reference may be made to D'Orbigny's *Foraminifères fossiles du Bassin Tertiaire de Vienne*

The shell may be hyaline and tubuliferous, or opaque and homogeneous, or arenaceous, *i. e.* made up of siliceous or other particles cemented with shell-material.

“*Foraminifera*, indeed, are to be compared with the other lowest orders of animals and of plants in the study of

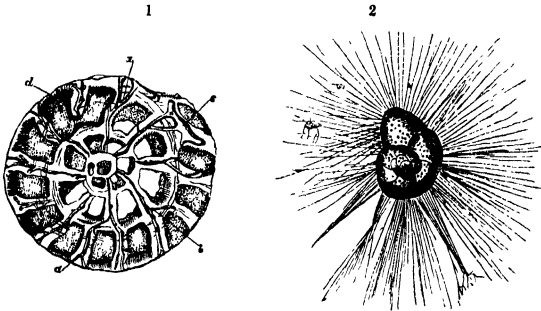

Fig. 165.

1, Section of *Faujasina*: *aa*, radiating interseptal canals; *b*, their internal bifurcations; *c*, a transverse branch; *d*, tubular wall of the chambers. 2, *Rosalina ornata*, with its pseudopodia protruded.

their specific relations. In these several low forms of creatures we have comparatively few species, but extremely numerous individuals, with an enormous range of variety. In the higher orders of plants and animals the specific forms are more definite, there being a more complex organization, harmonizing with the special habits of each creature; and the individuals of each species are less numerous than is the case in the Protozoans and Protophytes.

“These low animals, the *Foraminifera*, having great simplicity of structure, more easily adapt themselves to varying external conditions than the more complex and specialized higher animals.”

In the deep-sea soundings, portions of the beautiful Diatoms, lately figured and described by Professor W.

(Autriche); Schultze *Ueber den Organismus der Polythalamien*, 1854; Carpenter's and Williamson's *Researches on the Foraminifera*, *Phil. Trans.* 1856. Also an excellent paper by Mr. W. R. Parker, in the *Annals of Natural History*, April, 1857.

Smith, in gatherings from the Bay of Biscay, near Biarritz, are *Melosira cribrosa*, marine, orbicular, cellulate, cellules, all equal and hexagonal. He writes: "In December, 1853, I received isolated frustules of this species, collected

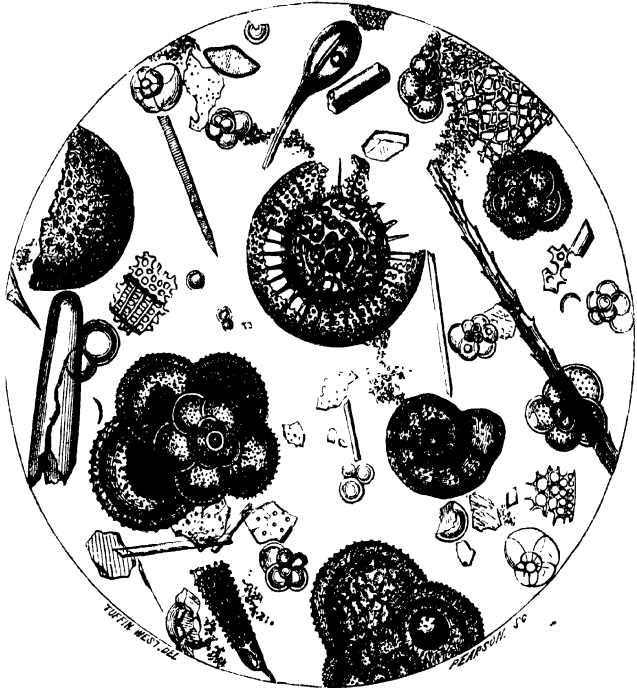

Fig. 166.—*Foraminifera* taken in Deep-sea Soundings. (Atlantic.)

on the coast of Normandy, under the above name, from M. de Brébisson; and I have since detected the same in a gathering from the Black Sea. In no case have I seen the frustules in a recent state, and do not know whether they ever form a lengthened filament. As this is the only circumstance that would justify their separation from *Cosci-*

*nodiscus*, to which the separated valve would otherwise seem to belong (*Synop. British Diatomaceæ*, vol. i. p. 22), their position in *Melosira* must rest upon the authority of my accurate correspondent."

In figs. 166 and 167 are represented many of the beau-

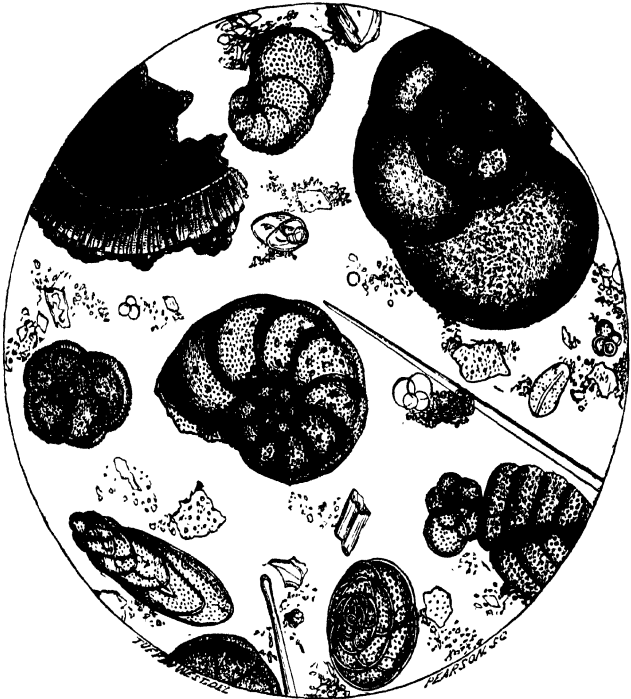

Fig. 167.—Foraminifera taken in Deep-sea Soundings. (Atlantic.)

tiful forms brought up with soundings made in 1856, for the purpose of ascertaining the depth of the Atlantic, prior to the laying down of the electric telegraph wire from England to America; some were taken from the depth of 2,070 fathoms. To C. Whitehouse, Esq., our acknowledg-

ments are due for having afforded us the opportunity of presenting our readers with these elaborate and beautiful engravings, drawn from specimens in his possession.

## SPONGIADÆ.—SPONGES.

The term *Porifera*, or *Canal-bearing Zoophyte*, was applied by Professor Grant to designate the remarkable class of organized beings known as sponges, which are met with in every sea, growing in great abundance on the surface of rocks.

Ellis, in the course of his investigations, was astounded by discovering that sponges possessed a system of pores and vessels, through which sea-water passed, with all the appearance of the regular circulation of fluids in animal bodies, and for the seeming purpose of conveying animalcules to the animals for food.

The description given of sponges by Dr. Johnston is, that they are "organized bodies growing in a variety of forms, permanently rooted, unmoving and irritable, fleshy, fibro-reticular, or irregularly cellular; elastic and bibulous, composed of a fibro-corneous axis or skeleton, often interwoven with siliceous or calcareous spicula, and containing an organic gelatine in the interstices and interior canals; and are reproduced by gelatinous granules called *gemmules*, which are generated in the interior, but in no special organ. All are aquatic, and with few exceptions marine."<sup>1</sup> Our author continues:—"Mr. John Hogg, in a letter to me dated June 25, states that the green colour of the fresh-water sponge (*Spongilla fluviatilis*) depends upon the action of light, as he has proved by experiments which showed that *pale-coloured* specimens became green when they were exposed for a few days to the light and full rays of the sun; while, on the contrary, *green* specimens were blanched by being made to grow in darkness or shade."

The living sponge, when highly magnified, exhibits a cellular tissue, permeated by pores, which unite into cells or tubes, that ramify through the mass in every direction, and terminate in larger openings. In most

(1) See Dr. Johnston's *History of British Sponges*, and Mr. Bowerbank's revision of the class, in the publications of the Ray Society.



sponges the tissue is strengthened and supported by spines, *spicula*, of various forms; and which, in some species, are siliceous, and in others calcareous. The minute pores, through which the water is imbibed, have a fine transverse gelatinous network and projecting spicula, for the purpose of excluding large animals or noxious particles; water incessantly enters into these pores, traverses the cells or tubes, and is finally ejected from the larger

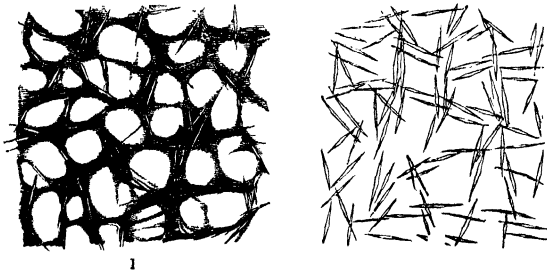

Fig. 168.

1, A portion of Sponge, *Halichondria simulans*, showing siliceous spicula imbedded in the sarcodine matrix. 2, Spicula divested of its matrix.

vents. But the pores of the sponge have not the power of contracting and expanding, as Ellis supposed; the water is attracted to these openings by the action of instruments of a very extraordinary nature (cilia), by which currents are produced in the fluid, and propelled in the direction required by the economy of the animal.

Mr. Bowerbank, in a paper on the "Structure and Vitality of *Spongiadae*," states that sponges consist principally of *sarcodine*, strengthened sometimes by a siliceous or calcareous skeleton, having remarkable reparative and digestive powers, and consequently a most tenacious vitality; so much so, that having cut a living sponge into three segments, and reversed the position of the centre piece, after the lapse of a moderate interval, a complete junction of the parts became effected, so as to render the previous separation indistinguishable.

Professor Grant's careful and laborious researches, have finally classed sponges in the animal series of the creation.

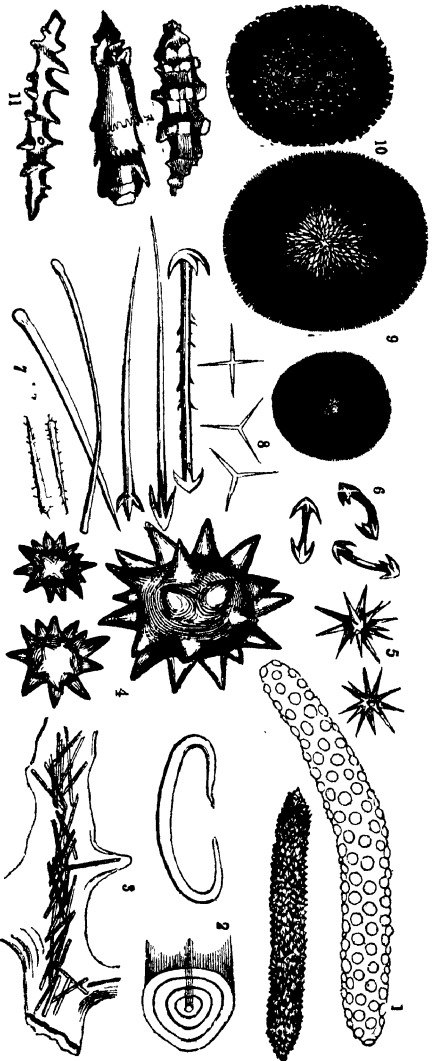

Fig. 169.

1, Skeleton of sponges of the acerate form, covered with rows of spines. 2, Horizontal section, showing rings of growth. 3, A portion of horny fibre, enclosing a bundle of spicula of the genus *Perongia*. 4, Spherostellate spicula of *Rethea*, highly magnified. 5, Spherostellate spicula of *Rethea*. 6, *Tricuspid anchorate* spicula. 7, *Acuate-dichotomate*, double recurvo-ternate, expando-ternate, deterradate spicula. 8, Triradiate spicula from a *Grassia*. 9, Gemmules of *Geodia*. 10, Gemmules of *Geodia*, in an advanced stage of growth. 11, Clavate spicula, covered with short spines.

He ascertained that the water was perpetually sucked into the substance of the sponge, through the minute pores that cover its surface, and again expelled through the larger orifices. His own account is so very interesting, that we cannot resist giving, in his own words, the results arrived at in these investigations:—"Having placed a portion of live sponge (*Spongia coalita*, fig. 1, No. 170) in a watch-

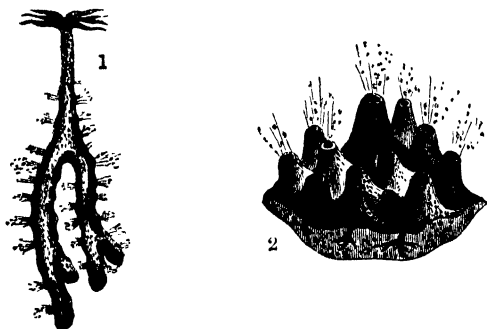

Fig. 170.

1, *Spongia coalita*. 2, *Spongia panicea*, highly magnified.

glass with some sea-water, I beheld for the first time the splendid spectacle of this living fountain, better represented in No. 2, vomiting forth from a circular cavity an impetuous torrent of liquid matter, and hurling along in rapid succession opaque masses, which it strewed everywhere around. The beauty and novelty of such a scene in the animal kingdom long arrested my attention; but after twenty-five minutes of constant observation, I was obliged to withdraw my eye from fatigue, without having seen the torrent for one instant change its direction, or diminish the rapidity of its course. In observing another species (*Spongia panicea*), I placed two entire portions of this together in a glass of sea-water, with their orifices opposite to each other at the distance of two inches; they appeared to the naked eye like two living batteries, and soon covered each other with the materials they ejected. I placed one of them in a shallow vessel, and just covered

its surface and highest orifice with water. On strewing some powdered chalk on the surface of the water, the currents were visible to a great distance; and on placing some pieces of cork or of dry paper over the apertures, I could perceive them moving, by the force of the currents, at the distance of ten feet from the table on which the specimen rested."

Sponges grow attached to almost every thing which may serve them as a point of support, whether fixed or floating; some cover rocks, shells, and other submarine objects, with a close spongy incrustation; whilst others shoot up a branched stem into the water; and others again hang freely from the sea-weeds floating in the ocean. Sometimes they select very unexpected objects on which to take up their abode. Thus, in one case recorded by Dr. Johnston in his *Natural History of British Sponges*, a specimen of the *Halichondria oculata*, a sponge not uncommon on some parts of the British coasts, was found growing from the back of a small live crab,—“a burden,” says the learned Doctor, “apparently as disproportionate as was that of Atlas,—and yet the creature has been seemingly little inconvenienced with its arboreous excrescence.”

In the next order, *Hyppocrepiæ*, all the members are inhabitants of fresh water; one of the most common species, and that which attracted the attention of Trembley as long ago as 1741, is the *Alcyonella stagnorum*. It occurs in great abundance, attached to the leaves of aquatic plants, on floating logs of timber, in the West India Docks. When first taken out of the water it is of a lobulated form and brown colour; the polypidom is soft and elastic, and feels very much like a sponge; but, as Mr. Teale observes, this polype “is organically connected with the mass, the tube forming its tunic, from which the animated body issues by a process of evolution similar to that which develops the horn of a snail. When developed, the head projects a short way, and is crowned with a beautiful expansion of tentacula, about fifty in number, arranged in an unbroken circle, which is, however, depressed into a deep concavity on one of its sides, so as to produce the appearance of a double row of tentacula, in a horse-shoe

form. About 1,600 polypes are situated on a square inch of surface of the mass, consequently the number of polypes in one specimen, which weighed 17 ounces, and measured  $14\frac{1}{2}$  inches in circumference, 'may be computed at 106,000, and the tentacula at 5,320,000!' This family is now classed with the *Polyzoa*: see Professor Allman's beautifully illustrated monograph of all the British species; published by the Ray Society, 1857.

Trembley gave an excellent and interesting account of the family of *Alcyonella*. Mr. J. Newton Tomkins has kindly furnished the following observations, on the development of a specimen of *Alcyonella Stagnorum*:—

"The ova, now under examination, ( $\frac{1}{2}$ -inch obj. A. eyepiece—100 lin. diam., Wollaston's condenser,) are the

products of some healthy specimens of *Alcyonella stagnorum*, given me by Mr. Lloyd, and sketched in full activity in September, 1856, fig. 171. Soon after this period their movements decreased in energy, numerous ova were detached, which floated to the surface of the water of the jar in which they were confined, and in the course of a very few weeks no trace remained of the parent animals, except a spongy mass of an almost gelatinous character, which still exists, though devoid of definite form, and appears composed of a mass of broken and disorganised cells.

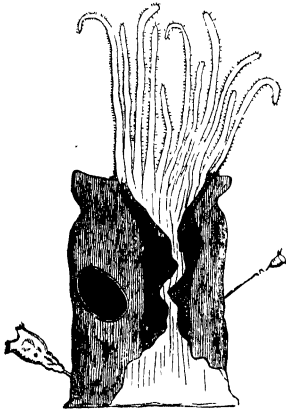

Fig. 171.—*Alcyonella Stagnorum*, with ova lying impacted in sarcode: *Rotifer vulgaris*, and *Vorticella campanulata*, adherent to the same. (Magnified 100 diameters.)

"In November, with a view of preserving the water in a normal condition, I introduced a sprig of *Anacharis Alsinastrum*, and finding it grew freely, but soon covered with a filamentous confervoid growth, threw in two small water-snails, which are there still. About January last,

the ova, which till then had floated on the surface of the water, began to sink and attach themselves to the leaves of the *Anacharis* and elsewhere. Latterly, they have all subsided to the bottom of the jar, where they lie in company with a quantity of decayed vegetable matter, spawn of the *Limnæus*, &c. They are of a light-brown colour, ovoid in shape, longest diameter  $\cdot 0089$ , shortest diameter  $\cdot 0172$ . The outer rim seems built up of cells of oblong shape, but necessarily ill-defined, owing to their being observed by light transmitted through two surfaces; the inner or central portion also cellular, but from the convexity of the object, more easy to determine as to its true nature, formed of larger hexagonal-shaped cells. Seen by higher power ( $\frac{1}{4}$ -in. obj. A. eye-piece—220 lin. diam.), these central cells, besides being unmistakably hexagonal in form, have each a distinct dark nucleus in the centre: this, however, may be an optical fallacy, due to their peculiar position on a curved surface. No movement yet visible, April 25, 1857."

In the journal of the Bombay branch of the Royal Asiatic Society for 1849, Surgeon H. J. Carter gives a very accurate account of fresh-water sponges found in the water tanks of Bombay. Of five species that he discovered, one was the *Spongilla friabilis*, the others he named *Sp. cinerea*, *Sp. alba*, *Sp. meyeri*, *Sp. plumosa*.

*Spongilla cinerea* is stated to present on its surface a dark, rusty, copper colour, lighter towards the interior, and purplish under water. It throws up no processes, but extends horizontally in circular patches, over surfaces two or three feet in circumference, or accumulates on small objects; and is seldom more than half an inch in thickness. It is found on the sides of fresh-water tanks, on rocks, stones, or gravel. Seed-like bodies spheroidal, about  $\frac{1}{63}$ d of an inch in diameter, presenting rough points externally. Spicula of two kinds, large and small; large spicula, slightly curved, smooth, pointed at both ends, about  $\frac{1}{67}$ th of an inch in length; small spicula, slightly curved, thickly spiniferous, about  $\frac{1}{380}$ th of an inch in length.

*Spongilla friabilis*.—Growing in circumscribed masses, on fixed bodies, or enveloping floating objects; seldom

attaining more than two inches in thickness. From the other sponges it is distinguished by the *smooth* spicula which surround its seed-like bodies, and the matted structure.

*Spongilla alba*.—Its texture is coarse and open ; structure reticulated. The investing membrane abounds in minute spicula ; has seed-like spheroidal bodies about 1-30th of an inch in diameter, with rough points externally. The large spicula are slightly curved, smooth, pointed at each end, about 1-54th of an inch in length ; the small spicula are slightly curved, thickly spiniferous, or pointed at both ends ; the former, pertaining to the seed-like bodies, are about 1-200th of an inch in length ; the latter, pertaining to the investing membrane, are more slender, and a little less in length ; these last numerous small spiniferous spicula when dry present a white-lace appearance, from which Mr. Carter gives them the name of *alba*.

*Spongilla meyeri* is massive, having large lobes, mammillary eminences, or pyramidal, compressed, obtuse, or sharp-pointed projections, of an inch or more in height ; also low wavy ridges. Its seed-like bodies are spheroidal, about 1-47th of an inch in diameter, studded with little toothed discs.

Mr. Carter enters very minutely into the structure of "fresh-water sponge, which"—he says—"is composed of a fleshy mass, supported on a fibrous, reticulated, horny skeleton. The fleshy mass containing a great number of seed-like bodies in all stages of development, and the horny skeleton permeated throughout with siliceous spicula. When the fleshy mass is examined by the aid of the microscope, it is found to be composed of a number of cells, imbedded in and held together by an intercellular substance.

"In the development of the sponge-cell of *Spongilla*, a set of large granules make their appearance at a very early period, and increase in number and size until they form a remarkable feature. At this time they are about 1-10,000th of an inch in diameter, of an elliptical shape, and of a light amber colour by transmitted light ; they are the colour bearing granules or cells, and give the

colour of chlorophyll to this organism when it becomes green. The transparent intercellular substance of *Spongilla* has a polymorphism equally great with the fully developed cells. This, however, can only be satisfactorily seen when the new sponge is growing out from the seed-like body, at which time it spreads itself over the glass in a transparent film, charged with contracting vesicles of different sizes, and in various degrees of dilatation and contraction. How this substance is produced so early, it is difficult to conceive, since it seems to come into existence independently of the development of the sponge-ovules, which are seen imbedded in it, and there undergoing their transformation into sponge-cells. The spicula, too, are developed synchronously with the advancing transparent border, from little glairy globules about the size of the largest ovules, which send out a linear process on each side, and thus gradually grow into their ultimate forms. The only way of accounting for the early appearance of this intercellular-substance is to consider that it is a development from some remnants of the original protoplasm; and perhaps possesses also the power of producing new sponge-cells, as we see the protoplasm in *Vorticella* and the roots of *Chara* producing new buds, independently of the cell-nucleus.

“The cells of the investing membrane are characterised by their uniformly granular composition and colourless appearance. They are nucleated, possess the contracting vesicle singly or in plurality, and are spread over the membrane in such numbers, that it seems to be almost entirely composed of them; while they are of such extreme thinness, and drawn out into such long digitated forms, that they present a foliated arrangement, not unlike a compressed layer of multifidous leaves, ever moving and changing their shapes. The apertures are circular or elliptical holes in the investing membrane in the cells. Through these apertures the particles of food are admitted into the cavity of the investing membrane. The *Parenchyma* consist of a mass of gelatinous substance, in which are embedded the smooth spicules and ovi-bearing cells, and through which pass the afferent and efferent canals. The ovi-bearing cells do not burst and allow their con-



tents to become indiscriminately scattered through the gelatinous mass in which they are imbedded, but each becomes developed separately in the following way:—the ovules and granules of the ovi-bearing cells subside into a granular mass by the former losing their defined shape and passing into small mono-ciliated and unciliated sponge cells; this mass then becomes spread over the interior surface of the ovi-bearing cell, leaving a cavity in the centre, into which the cilia of the monociliated sponge-cells dip and keep up an undulating motion; meanwhile, an aperture becomes developed in one part of the cell which communicates with the adjoining afferent canal, and thus the ovi-bearing cell passes into an ampullaceous spherical sac. The cilia may now be seen undulating in the interior; and if the *Spongilla* is fed with carmine, this colouring matter will not only be observed to be entirely confined to the ampullaceous sacs, but when the *Spongilla* is torn to pieces and placed under a microscope, particles of the carmine will be found in the interior of the mono-ciliated and unciliated sponge cells, proving that of such cells the ampullaceous sac is partly composed. This sac then must be regarded as the animal of *Spongilla*, as much as the Polype-cell is regarded as the animal of the *Polype*, and the whole mass of *Spongilla* as analogous to a *Polypidom*.

“The united efforts of all the ciliated sponge-cells in the ampullaceous sac are quite sufficient to produce a considerable current, and thus catch the particles of food as they pass through the afferent canals. Thus we find *Spongilla* composed of a number of stomachal sacs imbedded in a gelatinous substance permeated with spicules for its support, and an apparatus for bringing them food, as well as one for conveying away the refuse, while the nourishment abstracted by the process of digestion common to Rhizopodous cells (e. g. *Amœba*), no doubt passes through the intercellular gelatinous substance into the general development of the mass; and if right in comparing the ampullaceous sacs to the stomachal cavities of the simplest polypes, are we not further justified in drawing a resemblance between the ciliated sponge-cells and those which line the stomach of *Cordylophora*, of *Otostoma*, and many

of Ehrenberg's *Allotreta*, together with those in the stomach of *Rotatoria* and *Planaria*?

"The 'swarm-spore,' described by M. N. Lieberkuhn, appears to be a ciliated form of the seed-like body, and the same as the 'gemmule' described by Dr. Grant; I have not yet been able to see. The formation of the seed-like body, however, now that we know the structure of the ampullaceous sacs, seems very intelligible, for we have only to conceive an enlargement of the small sponge-cells lining the interior, with the addition of ovules to them respectively, and the spicule-bearing sponge-cells of the cortical substance supplying the spicular crust to the exterior, to have a globular capsule thus composed, with a hilum precisely like the seed-like body—a conjecture which seems to derive support from the fact, that in some instances, when *Spongilla* is beginning to experience the want of nourishment, these sacs, small as they are, assume a defined, rigid, spherical form, from their pellicle becoming hardened and encrusted with extremely minute spicules."<sup>1</sup>

*Clionæ*.—Not the least wonderful circumstance connected with the history of sponges, is the power possessed by certain species of boring into substances, the hardness of which might be considered as a sufficient protection against such apparently contemptible foes. Shells (both living and dead), coral, and even solid rocks, are attacked by these humble destroyers, gradually broken up, and, no doubt, finally reduced to such a state as to render substances which would otherwise remain dead and useless in the economy of nature available for the supply of the necessities of other living creatures.

These boring sponges constitute the genus *Cliona* of Dr. Grant. They are branched in their form, or consist of lobes united by delicate stems; they all bury themselves in shells or other calcareous objects, preserving their communication with the water by means of perforations in the outer wall of the shell. The mechanism by which a creature of so low a type of organisation contrives to produce such remarkable effects is still doubtful, from the great difficulties which lie in the way of coming to any satis-

(1) *Ann. of Nat. Hist.*, July, 1857.

factory conclusions upon the habits of an animal that works so completely in the dark as the *Cliona celata*—it will probably long remain so. Mr. Hancock, to whom we are indebted for a valuable memoir upon the boring sponges, published in the *Annals and Magazine of Natural History*, attributes their excavating power to the presence of a multitude of minute siliceous crystalline particles adhering to the surface of the sponge; these he supposes to be set in motion by some means analogous to ciliary action. In whatever way this action may be produced, however, there can be no doubt that these sponges are constantly and silently effecting the disintegration of submarine calcareous bodies—the shelly coverings, it may be, of animals far higher in organisation than they; nay, in many instances they prove themselves formidable enemies even to living mollusca, by boring completely through the shell. In this case the animal whose domicile is so unceremoniously invaded, has no alternative but to raise a wall of new shelly matter between himself and his unwelcome guest; and in this manner generally succeeds at last in barring him out.

*Skeletons of Sponges.*—The skeletons of sponges, as well as those of *Zoophytes*, possess no blood-vessels; they are secreted by the fleshy mass of the animal, and some of them are partially formed before the birth of the polypes which have to become their inhabitants.

The skeletons of sponges are composed principally of two materials, the one animal, the other mineral; the first of a fibrous horny nature, the second either siliceous or calcareous. The fibrous portion consist of a network of smooth, and more or less cylindrical threads of a light-yellow colour, and, with few exceptions, always solid; they frequently anastomose, and vary considerably in size; when developed to a great extent, needle-shaped siliceous bodies termed *spicula* (*little spines*) are formed in their interior; in a few cases only one of these spicula is met with, but most commonly they occur in bundles. In some sponges, as those belonging to the genus *Halichondria*, the same horny kind of material is present in greater or less abundance; but its fibrous structure has become obscure: the fibres, however, in these cases are represented by sili-

ceous needle-shaped spicula, and the horny matter server the important office of binding them firmly together, as shown in fig. 170, No. 1. There is, however, one remark-

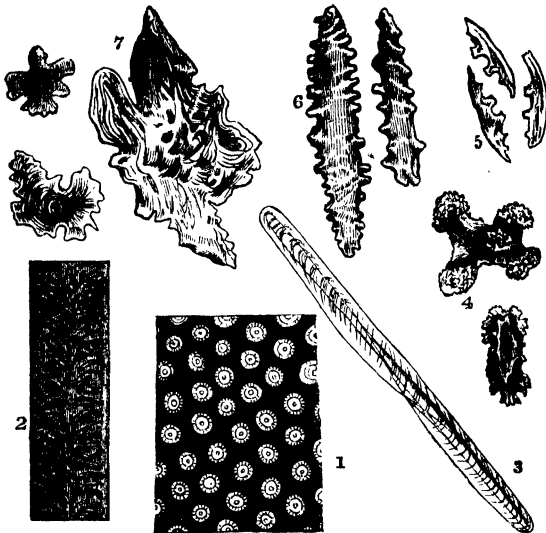

Fig. 172.

1, Transverse section of a branch of *Myriapora*. 2, A section of the stem of *Virgularia mirabilis*. 3, A spiculum from the outer surface of a Sea-pen. 4, Spicula from crust of *Isis hippuris*. 5, Spicula from *Gorgona elongata*. 6, Spicula from *Alcyonium*. 7, Spicula from *Gorgonia umbraculum*.

able exception to this rule, viz. *Dictyochalix pumiceus*, described by Mr. S. Stutchbury, in which the fibrous skeleton is composed of threads of siliceous matter quite as transparent as glass.

The mineral portion, as before stated, consists of spicula composed either of silica or carbonate of lime; the first kind is the most common and likewise most variable in shape, and presents every gradation in form, from the acute or needle-shaped to that of a star. The calcareous spicula, on the contrary, are more simple in their form,

being principally acicular, but not unfrequently branched or even tri or quadri radiate; the two kinds, the siliceous and calcareous, according to Dr. Johnston, not having hitherto been detected co-existent in any native sponges.

The spicula exhibit a more or less distinct trace of a central cavity or canal, the extremities of which are closed, or hermetically sealed; in their natural situation they are invested by an animal membrane, *sarcode*, which is not confined to their external surface; but in many of the large kinds, as pointed out by Mr. Bowerbank, its presence may be detected in their central cavity, by exposing them for a short time to a red heat, when the animal matter will become carbonised, and appear as a black line in their interior.

Many authors have described the spicula as being crystalline, and of an angular figure, and have considered them analogous to the *raphides* in plants; but it requires no great magnifying power to prove that they are always round, and, according to their size, are made up of one or more concentric layers, as shown in fig. 169, near No. 2. The spicula occupy certain definite situations in sponges; some are peculiar to the crust, others to the sarcode, others to the margins of the large canals, others to the fibrous network of the skeleton, and others belong exclusively to the gemmules. Thus, for instance, in *Pachymatisma Johnstonia*, according to Mr. Bowerbank, the spicules of the crust are simple, minute, and fusiform, having their surfaces irregularly tuberculated, and their terminations very obtuse; whilst those of the sarcode are of a stellate form, the rays varying in number from three to ten or twelve.

Silica, however, may be found in one or more species of sponge of the genus *Dysidea*, not only in the form of spicula, but as grains of sand of irregular shape and size, evidently of extraneous origin, but so firmly surrounded by horny matter as to form, with a few short and slightly-curved spicula, the fibrous skeleton of the animal. In these sponges the spicula are of large size, and are disposed in lines parallel with the masses of sand.

Most of the sponges of the earlier geological periods had

tubular fibres ; but in all existing species, with one or two exceptions, they are solid. These tubular fibres are very commonly filled with portions of iron, which accounts for the colour of many of the remains in flint.

The *Moss-agates*, found among the pebbles at Brighton and elsewhere, are flints containing the fossilised remains of sponges. The coloured fibres seen in the *Green-jaspers* of the East are of the same character. There is reason to believe that most flints were originally sponges ; those from chalk even retain their original form. Recent sponges from the Sussex coast present forms precisely similar to some chalk flints, but it is from sections made sufficiently thin to be transparent, for examination under the microscope, that we learn their true nature and origin.

Every horny sponge, whilst living, is invested with a coating of jelly-like substance, which can only be preserved by placing the sponge in spirit and water immediately after its removal from its place of growth. Spicula are not exclusively confined to the body of sponges, but occasionally form the skeleton of the gemmules, and are situated either on the external or internal surface of these bodies. A good example of the former kind occurs in the common fresh-water sponge (*Spongilla fluviatilis*), represented in fig. 173, No. 1, and No. 3. The spicula are very minute in size, and are disposed in lines radiating from the centre to the circumference, the markings on the outer surface of the gemmules being the ends of spicula. In all the young gemmules the spicula project from the outer margin as so many spines ; but in process of growth the spines become more and more blunt, until at last they appear as so many angular tubercles. Turkey sponge (*Spongia officinalis*) is brought from the Mediterranean, has a horny network skeleton rather fine in the fibres, solid, small in size, and light in colour. In some larger specimens there is a single large fibre, or a bundle of smaller ones. In *Halichondria simulans* the skeleton is a framework of siliceous needle-shaped spicula, arranged in bundles kept together by a thick coat of horny matter. Other species of *Halichondria* have siliceous spicula pointed at both extremities—acerate (fig. 169, No. 2) ;

while the spicula of some are round at one end, and pointed at the other—acuate ; and also spicula round at one end, the former being dilated into a knob—spinulate ; some have a spinous surface.

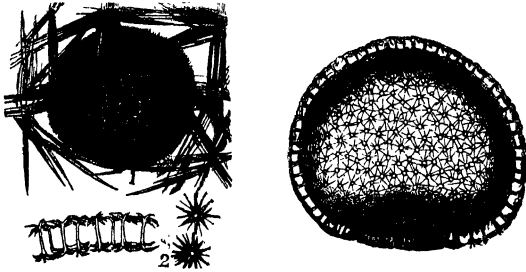

Fig. 173.

- 1, Gemmules of *Spongilla fluviatilis*, enclosed in spicula. 2, Birotulate spicula, from *Fluviatilis*. 3, Gemmules of *Spongilla fluviatilis*, after having been immersed in acid, to show its coating of birotulate spicula.

From the South Seas specimens are found having spicula with both ends rounded—cylindrical ; some curved, others straight. In an unclassified genus, the spicula are discovered rather cylindrical in form, pointed at both ends, having the surface covered with spines placed in an angular form (fig. 169, No. 11), and another in which the spicula exhibit many curious forms ; within the circle may be seen one spiculum of remarkable beauty, being of large size, rounded at both ends, and slightly bent ; its outer surface is covered with rows of tubercles of circular figure, which project some little distance beyond the free margin. In *Hali-chondria* from New Zealand, there are found some with the spicula of the acuate form covered with spines, blunt at one end and sharp at the other ; the spines are small, without order in their situation, but greater in number at the middle. In the genus *Pachymatisma* some spicula are sharp at one extremity and expand into two points at the other—expando-binate ; they are large, and their purpose is that of connecting the crust and the fleshy matter compactly together. The *P. Johnstonia* spicula are sharp at one end and expand into three points at the other—

expando-ternate, arranged at angles at  $45^{\circ}$  to the other part of the stem (Fig. 169, No. 7); there is also in this kind a variety having spicula sharp at one end and expanding into three branches at the other, each of which is again divided. In the genus *Tethea* there are spicula having hooks at both extremities—bi-recurvo-ternate: at one end they are not so large or so numerous as at the other; the stem is a little spinous. In *Tethea Lyncurium* the ends of the branches of the spicula are recurved, forming two, three, or four hooks, which serve to anchor the crust to the soft central fleshy part; they are termed recurvo-binate, and ternate. Of the recurvo-ternate we give a specimen from a species of *Pachymatisma* (fig. 169, No. 7).

Among the genus *Grantia*, *Geodia*, and Levant sponge, are found spicula of a large size, radiating in three directions—triradiate. In the Levant specimen, a central communicating cavity can be distinctly seen. Some Smyrna sponge, and a species of *Geodia*, have four rays—quadriradiate. Some spicula in *P. Johnstonia* and *Geodia* have as many as ten rays—multiradiati. In some species of *Tethea* and *Geodia* the spicula consist of a central spherical body, from which short conical spines proceed—stellate spicula. (Fig. 169, Nos. 4 and 5.) Spicula having both extremities bent alike—bicurvate—have been obtained from Trieste sponge. Some South Sea sponges have spicula twice bent, and have extremities like the flukes of an anchor—bicurvate-anchorate; sometimes the flukes have three pointed ends. (Fig. 169, No. 6.) The gemmules in fresh-water sponges are generally found in the oldest portions near the base, and each one is protected by a framework of bundles of acerate spicula of the flesh, as shown in fig. 169, No. 9; but in many marine species, *Geodia* and *Pachymatisma*, they are principally confined to the crust. In the fresh-water sponges, the amount of animal matter in the gemmules is considerable; but in *Pachymatisma*, *Geodia*, and many other marine species, a very small quantity only is ever to be found, the substance of each gemmule being almost entirely composed of minute siliceous spicula; and if they be viewed when taken fresh from the sponge, and after boiling in acid to



remove the animal matter, a slight increase in transparency is the only perceptible difference of appearance in these two opposite conditions.

#### INFUSORIA.

The class *Infusoria*, described by Ehrenberg in his work *Infusionsthierchen*, published in 1838, he divided into two great groups, the *Polygastrica*, or *many-stomached*; and the *Rotifera*, or *rotating*, wheel-animalcules: the latter are now classed with animals of a higher type of organisation. The classification of the *Infusoria* presents considerable difficulties, partly arising from their excessive minuteness, which renders the assistance of our best microscopes necessary to enable us even to see many of them, and partly from the impossibility of avoiding confusion from the intermixture of genera of more highly organised animals, and some plants, as the *Volvocineæ*, the *Desmidiaceæ*, *Bacillariæ*, &c., in their various stages of development.

The term *Infusoria*<sup>1</sup> is applied to them because they were first discovered in water where vegetable matter was decomposing, and therefore, the infusion was considered necessary for their production. Now, however, it is an established fact, that they are in a higher state of organisation when taken from pure streams and clear ponds than from putrid and stagnant waters. A little bundle of hay, or sage-leaves, left for about ten days in a mug containing some pure rain-water, caught before entering a butt, produces the common wheel-animalcules, which are found adhering to the sides of the mug near to the surface of the water. The only use of the vegetables seems to be to facilitate the development of the latent life of the atoms of organic matter, and perhaps as the first sources of their food. It is an indispensable condition that air be admitted to the infusion: and this circumstance, discovered by Leeuwenhoek in 1676, has always been regarded as one of the principal evidences in favour of the doctrine of *spontaneous generation*,—a doctrine which at one time had many supporters.

(1) *Infusoria*, from *infusor*, a pourer-in.

The astronomer turns his telescope from the earth, and ranges over the vast vault of heaven, to detect and delineate the beautiful objects of his pursuit. The naturalist turns his microscope to the earth, and in a drop of water finds a wondrous world of animated beings, more numerous than the stars of the milky way; and these he classifies into genera and families, and catalogues in his history of the invisible world.

The *Infusoria* are a mighty family, as they frequently, in countless myriads, cover leagues of the ocean, and give to it a beautiful tinge from their vivid hue. They are discovered in all climes, have been found alive sixty feet below the surface of the earth, and in the mud brought up from a depth of sixteen hundred feet of the ocean. They exist at the poles and the equator, in the fluids of the animal body, and plants, and in the most powerful acids. A brotherhood will be found in a little transparent shell, to which a drop of water is a world; and within these are sometimes other communities, performing all the functions granted them by their Creator, and eagerly pursuing the chase of others less than themselves as their prey.

The forms of the *Infusoria* are endless; some changing their shape at pleasure, others resembling globes, eels, trumpets, serpents, boats, stars, pitchers, wheels, flasks, cups, funnels, fans, and fruits.

The multiplication of the species is effected in some by spontaneous division or fissuration, in others by gemmation or budding; whilst some are oviparous, and others viviparous. The first step in the process by which infusorial animals are eliminated, is the formation of globular corpuscles or cells, which, by their aggregation in some cases, and individual evolutions in others, give birth to the organisms which subsequently appear.

The *Infusoria* have no night in their existence; they issue into life in a state of activity, and continue the duration of their being in one ceaseless state of motion; their term is short, they have no time for rest, and therefore have but one day, which ends only with their death and decomposition. Nevertheless, they appear to love that which promotes life,—the light of heaven; but others, born in the bowels of the earth, and who never

partook of the blessing, like the ignorant among mankind, have their own contracted round of unenlightened joys, perform their mechanical duties, and expire hidden and unknown.

On examining the structure of infusorial animalcules, some are found to have a soft yielding skin, so elastic as to stretch when food or other circumstances render it necessary, returning again to its previous condition as the cause of distension ceases; these are designated *illoricated*, which signifies shell-less. Others are termed *loricated*, from being covered with a shell, which is beautifully transparent, and flexible like horn. When the delicate and soft substance in which the functions of life perform their allotted duties perishes, the shell that protected it from injury during its hours of existence remains as a token of the past labours of nature; this sometimes consists entirely of flint, and in other cases of lime united with oxide of iron, destructible in some instances by fire, and in others not so.

Some of these minute beings have apportioned to them *setæ*, or bristles; these stiff hairs, attached to the surface of their bodies, do not rotate, but are movable, and appear to be a means for the support of their bodies, as aids in climbing over obstacles that present themselves, or as *feelers*. Others are possessed of *unci*, or hooks, projecting from the under part of the body, which are capable of motion; and by their means the animalcule can attach itself to anything that lies in its way. Some, again, have *styles*, which are a kind of thick bristle, jointed at the base, possessing a movement, but not rotary; they are in the shape of a cone, large at their base, and delicate at their summit. Many, also, can extend and withdraw their bodies at pleasure, in a similar manner to the snail or leech.

One of the most interesting and important organs possessed by infusorial animalcules is scientifically known by the term *cilium*, which is the Latin word for eyelash, the plural being *cilia*. Its appearance is that of a minute delicate hair.

The cilium is not only useful in the act of progression, but also as an assistance in procuring food; the two duties

being performed at the same time, the motion of the organs that propels it forward causing a current to set towards the mouth, which carries with it the prey on which the animal feeds. From the cilia being found in the gills or beard of the tadpole, the oyster, and mussel, it would appear that they are serviceable as organs of respiration, by imbibing oxygen, and emitting the carbonic acid generated in the blood during its circulation through the body; they are also believed to be the medium of taste and touch. It is not only at the mouth, but over the whole body that cilia are discovered; and it is now satisfactorily shown that cilia exist also in the internal organs of man and other vertebrated animals; and are agents by which many of the most important functions of the animal economy are performed. They vary in size from the 1000th to the 10,000th of an inch in length. These minute organs would often be invisible, were it not from the water being coloured when placed under a microscope; then the little currents made by the action of the cilia are easily perceived; and when the water is evaporated, the delicate tracing of their formation may be observed on the glass. They are differently placed, and vary in quantity in the numerous species of *Infusoria*. In some they are in rows the whole length of the body, in others on the base; many have them over the whole of the body; sometimes they fringe the mouth, form bands around projections on the body; and many have but two projecting from the mouth, as long as the body of the creature. Ehrenberg says they are fixed at their base by the bulb moving in a socket, in a similar manner to a man's outstretched arm; and by their moving round in a circle, they form a cone, of which the apex is the bulb. Poison, galvanism applied to the animal, and death, do not immediately stop the motion of the cilia, as they will continue in action some hours afterwards; even longer than nervous or muscular action can be sustained, until the fluids dry up, and they stiffen.

Very little is known of their muscular development, from their extreme minuteness; but there can be no doubt of the existence of this structure in all. Now in the wheel-animalcules the cilia are in circular rows; and

each revolves around its bulb, giving a singular appearance, seeming to move together like a wheel upon its axle, whence their name *Rotifera*; in a few of these muscles can be traced. The cilia must not be mistaken by the young microscopist for the stiff hairs and bristles found on some, and serving, as before stated, for the purpose of locomotion in crawling or climbing.

If the roof of the mouth of a living frog be scraped with the end of a scalpel, and the detached mucous membrane placed on a glass slide, and examined with a power of 300 diameters, the ciliated epithelium-cells will be well seen. When a number of these are collected together, the movement is effected with apparent regularity; but in detached scales it is often so violent, that the scale itself is whirled about in a similar manner to an animalcule provided with a locomotive apparatus of the same description, and has frequently been mistaken for such. The animals commonly employed for the examination of the cilia are the oyster and the mussel; but the latter are generally preferred.

To exhibit the movement to the best advantage, the following method must be adopted:—open carefully the shells of one of those molluscs, spilling as little as possible of the contained fluid; then with a pair of fine scissors remove a portion of one of the gills (*branchiæ*); lay this on a slide, or the tablet of an animalcule cage, and add to it a drop or two of the fluid from the shell; by means of the needle-points separate the filaments one from the other, cover it lightly with a thin piece of glass, and it is ready for examination. The cilia may then be seen in several rows beating and lashing the water, and producing an infinity of currents in it. If fresh water instead of that from the shell be added, the movement will speedily stop; hence the necessity of the caution of preserving the liquid contained in the shell. To observe the action of any one of the cilia, and its form and structure, some hours should be allowed to elapse after the preparation of the filaments as above given, their movements then will have become sluggish. If a power of 400 diameters be used, and that part of the cilia attached to the epithelium scale carefully watched, each one will be found to revolve a

quarter of a circle, whereby a "feathering movement" is effected, and a current in one direction constantly produced. In the higher animals, the action of the cilia can only be observed a very short time after death. In a polypus of the nose, when situated at the upper and back part of the Schneiderian membrane, the cilia may be beautifully seen in rapid action some few hours after its removal; but in the respiratory and other tracts, where ciliated epithelium is found, it would be almost impossible ever to see it in action, unless the body were opened immediately after death. In some animals it may be seen in the interior of the kidney, as first made known by Professor Bowman in the expanding extremity of the small tube surrounding the network of blood-vessels forming the so-called Malpighian body. In order to exhibit the ciliary action, the kidney should have a very thin slice cut from it; and this is to be moistened with the serum of the blood of the same animal. The vascular and secreting portions of the organ may then be seen with a power of 250 diameters, and also the cilia in the expanded extremity of each tube, as it passes over to surround the vessels; the epithelium of the tubes themselves is of the spheroidal or glandular character.

The infusorial and invisible atoms of life have various periods allotted to them for the enjoyments of existence; some accomplish their destiny in a few hours, others in a few weeks. The watchful devotee in this branch of science has traced an animalcule through a course of existence extending to the old age of twenty-three days. The vital spark flies instantaneously in general; but in those of a higher organisation there is a spasmodic convulsion, as if the delicate and intricate machinery rendered life so exquisite, that the parting with the "heavenly flame" was reluctant and painful. The most surprising circumstance attendant on the nature of some of the *Infusoria* is that of apparent death. When the water or mud in which they have sported in the fulness of buoyant health becomes dried up, they lie an inanimate speck of matter; but after months, nay, years, a drop of water being applied, their bodies will be resuscitated, and in a short time their frames become active with life. Leeuwenhoek kept some in a hard and dry condition,

and restored them to life after a sleep of death of twenty-one months. Professor Owen saw an animalcule that had been entombed in a grave of dry sand four years reborn to all the activity of life. Spallanzani tried the experiment of alternate life and death, and accomplished it in some instances on the same object *fifteen* times; after which nature was exhausted, and refused further aid in this miraculous care of those minute objects of her wonderful works. In darkness *Infusoria* are not developed.

Naturalists consider the phosphoric light of the marine animalcule to be the effect of vital action. The sparks are intermittent like the fire-fly; they measure from the 12,000th to the 100th of an inch in size. Captain Scoresby found that the broad expanse of waters at Greenland was nearly all discoloured by animalcules, and computed that of some species one hundred and fifty millions would find ample room in a tumbler of water. The phosphorescence of the sea is eloquently portrayed by Darwin, in his *Voyage of the Beagle*. Mr. Gosse thus describes the luminous appearances presented by a closer inspection of these minute animalcules: "Some weeks afterwards I had an opportunity of becoming acquainted with the minute animals, to which a great portion of the luminousness of the sea is attributed. One of my large glass vases of sea-water I had observed to become suddenly at night, when tapped with the finger, studded with minute but brilliant sparks at various points on the surface of the water. I set the jar in the window, and was not long in discovering, without the aid of a lens, a goodly number of the tiny jelly-like globules of *Noctiluca miliaris* swimming about in various directions. They swam with an even gliding motion, much resembling that of the *Volvox globator* of our fresh-water pools. They congregated in little groups, and a shake of the vessel sent them darting down from the surface. It was not easy to keep them in view when seen, owing rather to their extreme delicacy and colourless transparency than to their minuteness. They were, in fact, distinctly appreciable by the naked eye, measuring from 1-50th to 1-30th of an inch in diameter." *Noctiluca miliaris* belong to the highest class of the *Protozoa*, and with a power of about 200 diameters they are seen

of various forms and stages of growth, represented in fig. 174.<sup>1</sup>

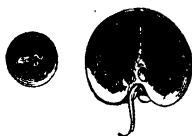

Fig. 174.—*Noctiluca miliaris*.

“Awaked before the rushing prow,  
The mimic fires of ocean glow,  
Those lightnings of the wave;  
Wild sparkles crest the broken tides,  
And, flashing round the vessel's sides,  
With elfish lustre lave;  
While far behind their livid light  
To the dark billows of the night  
A gloomy splendour gave.”—SCOTT.

MONADIDÆ.—*Monads*.—These are amongst the smallest atoms of matter possessing the mysterious principle of life, discernible by the highest magnifying power of the microscope. Minute, however, as they are, no one can say but that they derive their sustenance by preying on animals even less than themselves, as larger ones of the same species do upon them.

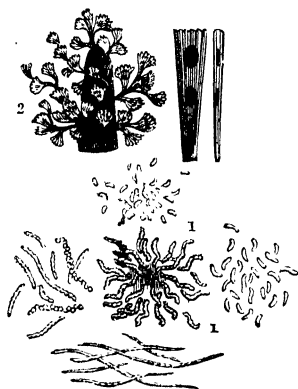

Fig. 175.

1, *Vibrio spirilla*. 2, *Echinella*, Fan-shaped animalcules; near which an enlarged view of one is shown.

Monads vary in their colours, some being red, green, yellow, others nearly colourless; in shape they are round or oval (5 and 6, fig. 185), and possessed of immense activity, having one or more parts devoted to the purpose of locomotion. Monads have been claimed by the botanist, and

accordingly placed among the genus *Volvocineæ*, confervoid

(1) See Gosse's *Naturalist's Rambles*: Huxley, *Micro. Journal*, 1855.



*Algæ.* Ehrenberg<sup>1</sup> regarded and described them as *Infusoria*. He says: "All true *Infusoria*, even the smallest monads, are organised animal bodies; some consist of a homogeneous jelly, and are distinctly provided with at least a mouth and internal nutritive apparatus." Perceiving small round spots within the bodies of these animalcules, he judged them to be stomachs, in contradiction to the supposition of the former great philosopher in this branch of science, Müller, in whose work, published in 1773, they were stated to be the animal's eggs. To test the truth of his idea, and convince the world, Ehrenberg fed the little things with colouring matter diffused in the water which contained them. If the water be clear in which the animalcule is living, the stomachs are transparent, more so than the other parts of the body; but are rendered visible by tinting the water with pure sap green, carmine, or indigo. Some of one of these colours must be rubbed on a piece of glass, then a few drops of water added; a portion of the water is then allowed to run off by tilting the glass on one side, and a little of the remainder of the coloured matter dropped into the water containing the animalcule. Portions of the coloured fluid are swallowed by the animalcule, when the stomachs, from their transparency, are distinctly seen of the same colour as the liquid, while the other portions of the body remain unchanged. It is now admitted that the spaces described by Ehrenberg as stomachs, are vesicular, sacs either filled with air or water. Sap green is the colour most easily imbibed by the tiny beings; carmine shows development better than any other; whilst the indigo, which Ehrenberg found to answer his purpose most satisfactorily, is rather difficult to manage. Care has always to be observed that the colours are not those that chemically combine with water, but only such as are diffusible through the fluid in a state of minute subdivision, as otherwise they are poisoned by it. This important discovery of feeding the

(1) Christian Gottfried Ehrenberg, medical councillor and professor at Berlin, was born at Delitzsch in 1795, and educated at Schulpforta and Leipzig. In 1820-25, he, in company with Hemprich, visited Egypt and Nubia at the expense of the Berlin Academy; and in 1829 he accompanied Alexander von Humboldt to the Ural Mountains. The results of these journeys he published in various invaluable works, which will hand his name down to posterity with undying honour.

little things on colour, set aside the opinion of previous naturalists, that they effected nutrition by "cuticular absorption;" it also led to a classification, not, as formerly, by shape, but structure.

The species most frequently observed is the *Gonium*, or *Tablet monad*, enclosed in a flat hyaline envelope, irregular in shape, and not larger than the 1-300th of an inch in length, in which is discovered a happy community of sixteen bright green-coloured cell masses, which at times exhibit a rhythmical contraction and expansion, as in the *Volvox*.

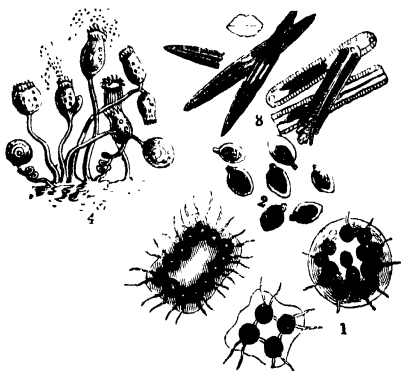

Fig. 176.

1, *Gonium pectorale*, Breast-plate animalcules. 2, *Enchelis*, Flask-animalcules. 3, *Bergh-mehl*, Norway. 4, *Vorticella cyanthina*, Bell-shaped animalcules.

They are sometimes called *Breast-plate animalcules* (fig. 176, No. 1). The twenty-four cilia projecting from the sides, and eight from the centre, appear to be actively engaged in satisfying that first law of nature, self-preservation. When they have all attained their growth, the shell divides into four parts, leaving four monads on each; these four grow in size, and each again divide into four, hence arises their magic number of sixteen; then, as soon as the sixteen are of a mature size, they divide into a community of four; and thus go on dividing and subdividing, endlessly fulfilling their appointed destiny in the unbroken links of creation.

**VIBRIO**—*Vibriones*.—In this family Ehrenberg includes the well-known eels in paste and vinegar, both of which are now placed in a different class.

*Vibrio spirilla*, *Trembling animalcules*, when motionless, are seen as very minute hairs; but when they exert the powers of locomotion, they take a spiral form, like the threads of a fine screw, and by undulations wind themselves through the water with rapidity. Each apparent hair is a collection of animals bound together by a pliant band; thus, as they are individually so small, little is known of their structure. Still they form very interesting objects to view; their very minuteness claiming attention, while their activity and motions excite surprise. The species are numerous, as represented at No. 1, fig. 175. One in particular has been the especial subject of investigation by the medical microscopist, is somewhat of an oval shape, and is quickly developed in diseased structure; doubtless it precedes, or leads to, the entire destruction of the tissue it is found in. This shape of the curious little animalcule, it should be observed, is confined to animal substances; whereas the long, or hair-shaped, is generally to be met with in all disorganised vegetable substances.

These hair-like animalcules were very accurately described by Baker, who ascribes the discovery of them to Mr. Anderson. He says: "They were discovered in a large ditch running into a river near Norwich, the bottom of which was covered with them to some thickness; when first examined, being motionless, they were taken for vegetable fibres; but on keeping them under the microscope, and occasionally viewing them, they were seen to move in various forms." Some *Confervæ* present a remarkable motion, like moving spiral threads, but are much larger than the preceding.

**ASTASIAÆ**.—*Astasia*, signifying without a station, in contradistinction to those living in groups, is the term given to a kind of crimson-coloured animalcule, the 350th of an inch in length, that exist in enormous numbers, and give the waters in which they live the appearance of their bodies. Ehrenberg describes several varieties of this family.

*Astasia Viridis*.—On the surface of ponds and stagnant waters is sometimes seen a crimson covering, which, when

examined by a microscope, is found to consist of a mass of oblong *blood-red animalcules*, the 300th of an inch in length. Ehrenberg states, that in the early part of their existence they are green; and that the red and green spots on their bodies are caused by the condition of the eggs at different periods in their stomach-cells. A cilium proceeding from the mouth gives it motion, sometimes in a straight line, at others rolling about in all manner of ways. When two cilia are seen, then the animal is about to divide into two perfect and separate beings, to proceed again in the career of its original. "They seem to have the power of changing their shapes at will; at one time they have a rolling-pin form, at another that of a fish without a tail, and are also seen with their bodies extended at the side like wings." *Astasia* are distinguishable from *Amœba* by the absence of the remarkable and irregular foot-like processes of the latter.

*Enchelia*, *Flask animalcules* (fig. 176, No. 2).—These are described by Müller as simple invisible animalcules of a cylindrical form. On the surface of the waters of ponds and ditches is often seen a kind of green scum, from which people are accustomed to turn with disgust, and ascribe to it some injurious property. When this is brought under the powers of the microscope, the water is seen to be pure and clean, and the green found to consist of innumerable slender cylindrical-formed animalcules, whose interiors impart the colour from their distension with vegetable matter. The wise and loving decrees of Providence are here exemplified, as by the innate wants of this growing and living speck, varying in size from the 1-1200th to 1-400th of an inch, the decaying and putrefying matter is removed, and its noxious effects on man and beast prevented. Others, of the same species of these industrious and useful mites in the animal economy of Nature, whose masses alone render them visible to the human eye as a coloured substance, exhibit much variety in form and habit. Both this and the former are now classed among the lowest forms of vegetable life.

Ehrenberg divided the genera *Enchelia* into several families, but Dujardin's family bearing the same name consists apparently of animals founded upon different

characters. Again, the *Astasia* of the former is the *Euglenia* of the latter; and so on with many other families of the *Polygastrica Infusoria*, which by the labours of later investigators have undergone a complete revision; and in their classification, some have been degraded to the vegetable kingdom, as the *Desmidiaceæ*, *Volvocineæ*, &c., whilst others have been advanced a step higher in the animal series; none having excited so much controversy, or received so much attention from microscopists, as *Desmidiaceæ* and *Diatomaceæ*. The first of these we have already disposed of, in our remarks on the vegetable kingdom, where we must be content to leave them for the present; not so the *Diatomaceæ*, which offer many interest-

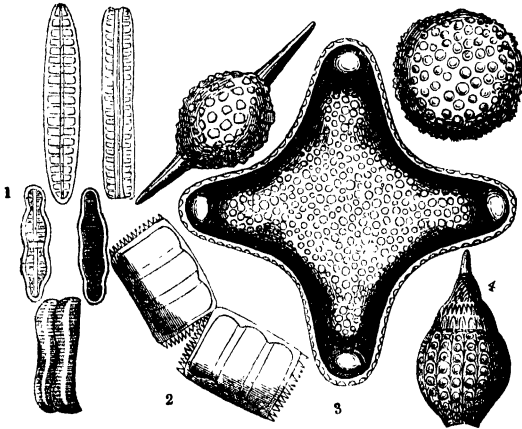

Fig. 177.

1 *Diatoma vulgare*. 2, *Achnanthis linearis*. 3, *Amphitetras antediluviana*. 4, *Orthosira spinosa*. Front view, with globular and oval forms. (From Springfield, Barbadoes.)

ing structural characteristics, of sufficient importance to warrant us in keeping them in the animal division. They are, indeed, most striking objects under the microscope, from the peculiarity, beauty, and variety of their forms, from their bilateral symmetry, external markings, and indestructible siliceous skeletons; that we believe they

would be more correctly placed in a median, or *Molluscian sub-kingdom*. Appearing everywhere with the first horn of life, and wherever matter is found in a condition fit for their development and nourishment, these marvellous little siliceous creatures have been preserved and brought down to us in forms unchanged, from the remotest periods of our globe's history; and supplying, as they do to the microscopist, some of the most valuable test-objects, the *Gyrosigma*, *Grammatophora*, *Fragilaria*, *Rhipidophora*, *Pleurosigma angulatum*, and many others; it cannot be a matter of surprise, that considerable interest should have been awakened in them.

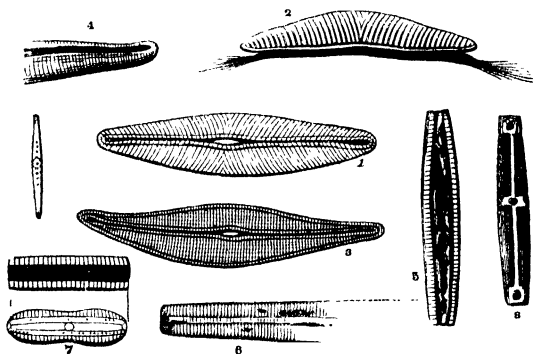

Fig. 178.

1, *Navicula*. 2, Side view of the same, showing apparent arrangement of cilia and sarcode of animal. 3, *Pleurosigma lanceolatum*. 4, Lateral view of a portion of the same. 5, *Synedra*. 6, A portion of *Pinnularia*. 7, *Pinnularia*. 8, *Stauroneis*.

Most of these little animals inhabit the waters of the earth, and are always met with in greatest profusion in places where *Confervæ* and other forms of aquatic vegetation are abundant. In these creatures, as in *Rhizopoda*, we find, in addition to the dark nucleus, one or more clear spaces which expand and contract alternately. These spaces are usually round, and sometimes exist in such numbers as to constitute a continuous chain-like vessel; and it seems probable, that in these spaces we have the first rudiments of a circulating system, which attains to a more

perfect state of development in the higher animals. Fluids are collected in these vacuoles, and it is supposed they have a communication, by means of some delicate vessels, with the water in which the minute animal lives, so that at each contraction fluids are expelled from the body, whilst at each dilatation water is drawn in. When we consider the very small size of these contractile organs, it is a subject which may well serve to excite our wonder.

We believe, with Kützing and others, that the *Diatomaceæ* are rightly placed by Ehrenberg among the earliest forms of animal life. During an examination of the ciliary

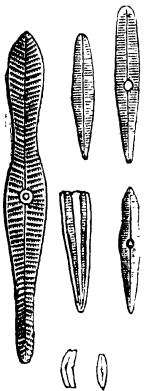

Fig. 179.—*Gomphonema elongatum* and *capitatum*.

motion in *Desmidiaceæ*, near the end of the summer of 1854, we frequently noticed in many of the more commonly-met-with forms of the *Diatomaceæ*, a similar movement of cilia. We have attentively watched a diatom moving slowly across the field of the microscope; and upon meeting with an obstacle to its progress, it has changed its course, or pushed the obstacle aside, as if conscious of an impediment. We have again and again satisfied ourselves that their motive power is derived from cilia, so arranged at either end, in some apparently around central openings, and so completely at the will of the little animals, that they are readily called into action as propellers, or paddles. Before satisfying ourselves of the presence of cilia, we thought the motion of these little creatures somewhat remarkable, steering their course as they did by a power which they evidently were able to call into action, or restrain at will; we were therefore agreeably surprised to find this motive power due to cilia. The distribution of the cilia differs from that observed in *Desmidiaceæ*; the ciliary motion seen in which we believe to be due to physical force acting independently of *controlling power*. On the contrary, the *Diatomaceæ*, with their cilia, may be said to act in obedience to a will, for intervals of rest and motion are clearly perceptible.

From that time to the present summer we have made

many observations, which fully confirm us in the view we then took of their motile power; with this slight difference, that cilia do not appear to be constant; and that the act of progression as performed by some, rather favours the idea of contractile tentacular filaments—*pseudopodia*—being the organs both of locomotion and prehension with them. These filamentous organs are of so delicate a nature, that, as yet, no power of the microscope has enabled us, positively, to make out their forms and attachment. Some deny the presence of a membranaceous hyaline covering, which we have certainly seen; the defining power used, and mode of illumination, is at fault; consequently, they cannot see what we do; but this constitutes no valid argument against the existence of cilia. Professor W. Smith admits the existence of a structureless membranaceous covering, at some periods of growth, in many of the *Diatomaceæ*, but he denies the existence of a ciliated or other motile power, save that occasioned by “exosmotic and endosmotic forces.”

Dr. Carpenter says:—“It is a question whether this be anything else than an optical illusion, arising from the existence of *currents* at these orifices, produced by the vital actions going on within the cell.” Both of the views above propounded, appear to us difficult of comprehension, and are far from satisfactory explanations of a simple motive power, found almost universally effected by the agency of cilia. Why then jump to the conclusion, that this motion is “endosmotic force”? How is it possible to prove such an assumption? Certainly not by the aid of microscopy, or its sister science chemistry. The same question may be put to the supporters of the *vital force theory*. What is it? where situated? how produced? and so forth. Aristotle, centuries ago, showed that *sensibility* especially characterises animal life. He says:—“That creatures endowed with *sensibility* are not merely living beings, but *animals*, although they may neither be motive nor change their locality. *Touch* is the sense first manifested in all creatures, and, as the nutritive faculty can be manifested independently of Touch and other senses, so the sense of Touch can be manifested independently of any other. We call *nutritive function*



that part of Vital Principle of which plants partake; but all animals appear besides it to have the sense of Touch; and we shall, hereafter, explain why each of those functions has been allotted. Let it suffice, for the present, to say that the Vital Principle in animals is the source of the nutritive, the sentient, cogitative, and motive faculties; and that by them it has been defined."

If we take this definition of animal life as our guide, we cannot go far wrong; at all events, we shall not run into the erroneous and false mode of reasoning found in the Preface to *British Diatomaceæ*, page 20. The author seriously tells us, that because bubbles of some kind of gas are seen to be given off, under the influence of light, when a mass of *Diatomaceæ* is present in the water, that this gas must be *oxygen*. Why not carbonic acid gas or hydrogen? Is it not as likely to be one as the other? Has the gas been collected, and an analysis made of it? Would not any one of these gases rise as steadily through water, "and float up portions of the Diatomaceous stratum by the buoyancy of their globules"?

Again, is it possible to take *Diatomaceæ* free from vegetable sporules of some kind or other? What do they live upon, vegetable or animal matters? If vegetable feeders, is it not more than probable, that when caught a portion of vegetable food is taken home with them to our glass jars, and that the gas is given off by the vegetable matters? The experience of all collectors would confirm such a view, for they are known to live much longer in confinement with vegetable matter, growing in the water in which they are placed, than when deprived of it. *Entomostraca* greedily devour *Diatomaceæ*; but not the *Confervæ*, *Algæ*, or other plants, contained in the same water. No starch has ever been shown, by the most delicate test, to enter into the formation of the *Diatomaceæ*; is not this another point in favour of their animal nature? This vegetable product has been detected in *Desmidiaceæ*. Many other features might be urged in support of our argument, but the most important of all is, the independent motile power exercised by these wonderful little organisms. In some beautiful specimens of *Surirella* and *Navicula* kept under a  $\frac{1}{4}$  object-glass for several hours, their activity and

rapidity of motion was almost continuous. Not "a series of jerks," nor "a languid roll," but in a lively movement, constantly changing about in search of food, pushing aside obstacles that impeded their course, or, if too large, passing over or under them with the motile force of "beings possessed of a power of self-direction." Fig. 178 was drawn from specimens lately obtained from a pond at Woodford, Essex.

Siebold says :—"I have been unable to detect six openings, fig. 180, in the *Navicula*; and precisely at the spots which Ehrenberg and others suppose they have seen openings, the siliceous cell-membrane becomes thickened, and forms rounded eminences which project internally. On the same two surfaces upon which the thickenings of the siliceous shield of *Navicula* are placed,

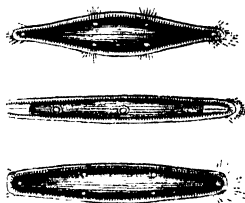

Fig. 180.

there may be observed four lines passing along the middle of the surfaces from one thickening to another. These lines—which have been long known, but hitherto little noticed—are to be referred to a suture, fissure, or rather gap, in which no siliceous matter is deposited; so that in these places the delicate primordial membrane which lines the siliceous shield can be brought in close relation with the outer world. It is exactly at these four sutures or fissures that the water surrounding the *Naviculæ* is set in motion. The existence of this current is readily demonstrated if some minute solid particles be added to the water in which are some fresh *Naviculæ*. When water coloured with indigo has come to a state of rest on the object-glass, it will soon be perceived by the microscope that those particles which come in contact with the living *Naviculæ* are set into a quivering motion, though previously quite still. It will also be perceived, that only those particles of indigo are set in motion which are in contact with the four sutures of the siliceous shield; whilst the particles adherent to the other parts of the shield remain altogether

motionless. Another striking motion is perceptible in these particles when they come in contact with the sutures of the siliceous shield, being forced rapidly up and down upon it. Those particles which are propelled from the terminal towards the two central eminences, are never observed to pass beyond the latter; at this point there is always a quiet space, from which the particles are again repelled towards the extremities. This proves that the linear sutures do not extend over the central eminences of the shield. At these clefts the current is sometimes so strong that comparatively large bodies are set in motion by it."

M. Kützing believes that every diatomean is formed of a siliceous shield, and a soft substance, sarcode; the shield consists of pure silica, or in some cases, perhaps, of silica combined with alumina. Nägeli thinks the silica is deposited in the outside organic membrane. In fact, an organic membrane ought to exist; for the silica could not become solid, except by crystallising or depositing itself on some pre-existing substance. Nägeli believes that it is also deposited externally; for in many genera, and especially in the *Achnantheidia*, the siliceous shield is covered with a very delicate dilatable membrane, itself containing silica, as is proved by its sustaining unchanged the action of fire and acids. Therefore, comparing this shield with other organic formations, whether animal or vegetable, containing, in like manner, either silica or some other so-called mineral element, we might reasonably consider it to be formed of an organic tissue permeated with silica.

"Comparing," says Kützing, "the arguments which seem to indicate the vegetable nature of *Diatomaceæ* with those which favour their animal nature, we are of necessity led to the latter opinion. If we suppose them to be plants, we must admit every frustule, every *Navicula*, to be a cell. We must suppose this cell with walls penetrated by silica, developed within another cell of a different nature, at least in every case where there is a distinct peduncle, or investing tube. In this siliceous wall we must recognise a complication certainly unequalled in the vegetable kingdom. It would still remain to be proved

that the eminently nitrogenous internal substance corresponded with the generic substance, and that the oil globules could take the place of starch. The multiplication would be a simple cellular reduplication; but it would remain to be proved that it takes place, as in other vegetable cells, either by the formation of two distinct primitive utricles, or by the introflexion or constriction of the wall itself. Finally, there would still remain unexplained the external motions and the internal changes; and we must prove the accumulated observations on the exterior organs of motion to be false, by a clearer line of argument than has hitherto been adopted, by those who are opposed to this view. But again, admitting their animal nature, much would remain to be investigated, both in their organic structure and their vital functions; excepting this, so far as we know, we have only one difficulty to overcome, that of the probably ternary non-azotised composition of the external gelatinous substance of the peduncles and investing tubes. But as the presence of nitrogen is not a positive character of *animal nature*, so the absence of it is not a proof of *vegetable*. And in order that the objection should really have some weight, it would be well to demonstrate that this substance is isomeric with starch. For then, supposing all the arguments in favour of the animal nature of *Diatomaceæ* were proved by new and more circumstantial observations, this peculiarity, if it deserve the name of objection, might still be regarded as an important discovery. We should then have in the animal, as well as in the vegetable kingdom, a ternary substance similar to that forming the bases of the vegetable tissue."

Did our space permit, many other arguments might be adduced in favour of the views we have herein advocated; we beg to refer the reader to the works of Kützing and Ehrenberg for further information.

Dr. Gregory believes that a large number of *Diatomaceæ* usually divided into separate species, are nothing more than transition forms of the same; and that more extended observation proves that in form, shape, or outline, they are not nearly so permanent in character as they were said to be: he adds, "the more the *Diatomaceæ* are studied, the

more we perceive that, in many species at least, the shape or outline is subject to endless variations." <sup>1</sup>

I recommend microscopists to conduct their observations of these and similar bodies in very shallow cells, say of from 1-50th to 1-100th of an inch deep, covered with glass of from 1-150th to 1-250th of an inch thick. The objective must be a 1-4th or 1-8th, with a good eye-piece, and careful illumination—Rainey's moderator with a Gillett's condenser or parabolic reflector. The examination should be conducted during very bright weather, or by sunshine.

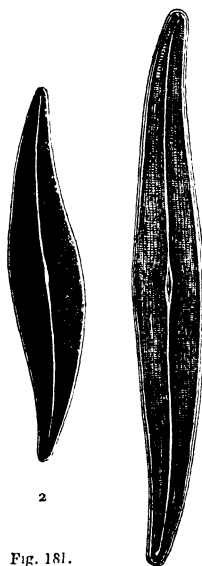

Fig. 181.

1, *Pleurosigma attenuatum*. 2, *Pleurosigma angulatum*, magnified 250 diameters. 3, *Pleurosigma Spencerii*, magnified 350 diameters..

The markings on the *Diatomaceæ* are best seen when mounted dry: they are usually mounted in Canadian balsam, or in weak spirit and water. Before quitting these interesting objects, we shall notice a few of the commoner forms, reserving our remarks upon other species until we come to fossil *Infusoria*.

*Pleurosigmata Naviculæ*.—*Navicula*, the Latin for ship, has been applied to these little creatures from their resemblance in form to a ship or boat. In the catalogue of the microscopist there are upwards of twenty-four different species

named, fourteen of which may be found alive, fig. 181. It was in 1841 that Messrs. Harrison and Mr. Sollitt dis-

\* Dr. Gregory, "On a remarkable group of Diatomaceous Forms."—*Quarterly Journal of Microscopical Science*.

covered the beautiful longitudinal and transverse *striæ* (groovings) on the *Pleurosigma hippocampus*, or sea-horse ship, No. 1. A curved graceful line runs down the shell, in the centre of which is an expanded oval opening. Near to the central opening the dots elongate crossways, presenting the appearance of small short bands. The *Pleurosigma angulatum*, No. 2, *cornered little ship*, was first discovered in the Humber; the lines upon its surface resemble the most elegant tracery, which are resolvable into raised minute dots. The markings are seen to be longitudinal, transverse, and oblique. Some observers believe the spaces to be hexagonal in shape; but this is certainly a deceptive appearance, arising from bad illumination or

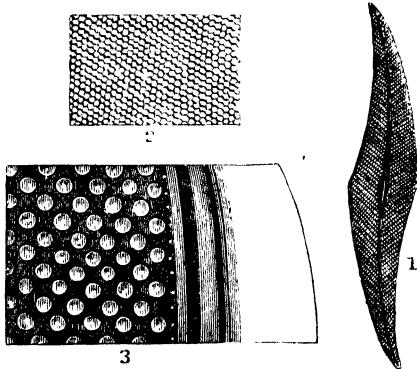

Fig. 182.

1, *Pleurosigma angulatum* 2, Portion of the same, magnified 1200 diameters.  
3, Portion of *P. formosum*, magnified 5500 diameters.

aberration in the glasses. Mr. Wenham's photograph of this shell is an exaggerated imperfection, produced by an error of foci in his camera lenses.

The *Green Navicula*, first found by Dr. Mantell in a pool on Clapham Common, is about the 100th part of an inch in length. In this specimen the ribbed division is distinctly seen, extending the whole length of its shell.

*Eunotia*.—In this species a furrow is seen the entire length of the shell, from which spring numerous ribs extending towards the edges; of these, eight may be counted

in the 1200th of an inch ; there can also be traced, in its whole length, a line, by which, when at maturity, spontaneous fissuration occurs, and in this manner it preserves its form from age to age.

COLLECTING AND PRESERVING DIATOMACEÆ.—The Rev. W. Smith's directions for collecting and preserving the *Diatomaceæ* will prove of use to the student: "Let him provide himself, in the first place, with the necessary apparatus for the field: this includes a good stock of small wide-mouthed bottles, that each gathering may be kept perfectly distinct; a long rod or stick, to which can be attached a small muslin net; a cutting-hook of about three inches in length, and a broad flat spoon;—the first, to collect such specimens as float upon the surface, or are held in suspension by the water; the second, to remove the larger *Algæ* which may be covered with parasitic *Diatorus*; and the third, to skim the surface of the mud for those which lie at the bottom of the pool.

"He will probably find, notwithstanding every care, that his specimens are mixed with much foreign matter, in the form of minute particles of mud or sand, which impair their value, and interfere with observation, especially with the higher powers of his instrument. These substances the student may remove in various ways: by repeated washings in pure water, and at the same time, profiting by the various specific gravities of the *Diatorus* and the intermixed substances, to secure their separation; but, more particularly, by availing himself of the tendency which the *Diatomaceæ* generally have to make their way towards the light. This affords an easy mode of separating and procuring them in a tolerably clean state; all that is necessary being to place the gathering which contains them in a shallow vessel, and leave them undisturbed for a sufficient length of time in the sunlight, and then carefully remove them from the surface of the mud or water.

"The simplest method of preserving the specimens, and the one most generally useful to the scientific observer, is simply to dry them upon small portions of talc, which can at any time be placed under the microscope, and examined without further preparation; and this mode possesses one great advantage,—that is, that the specimens can be sub-

mitted without further preparation to a heat sufficient to remove all the cell-contents and softer parts, leaving the siliceous epiderm in a transparent state."

In the vicinity of Hull many very interesting varieties of *Diatomaceæ* have been found, the beauty of the varied forms of which are such as to delight the microscopist; and, at the same time, some of them are highly useful, as forming that class of *test objects* which are best calculated of all others for determining the excellence and powers of object-glasses. It has been shown by Mr. Sollitt that the markings on some of the shells are so fine as to range between the 30,000th and 130,000th of an inch; the *Pleurosigma strigilis* having the strongest markings, and the *Pleurosigma acus* the finest.

*Fossil Infusoria*.—Startling and almost incredible as the assertion may appear to some, it is none the less a fact, established beyond all question by the aid of the microscope, that some of our most gigantic mountain-ranges, such as the mighty Andes, towering into space 25,250 feet above the level of the sea, their base occupying so vast an area of land; as also our massive limestone rocks, the sand that covers our boundless deserts, and the soil of many of our wide-extended plains; are principally composed of portions of invisible animalcules. And, as Dr. Buckland truly observes: "The remains of such minute animals have added much more to the mass of materials which compose the exterior crust of the globe than the bones of elephants, hippopotami, and whales."

The stratum of slate, fourteen feet thick, found at Bilin, in Austria, was the first that was discovered to consist almost entirely of minute flinty shells. A cubic inch does not weigh quite half an ounce; and in this bulk it is estimated there are not less than forty thousand millions of individual organic remains! This slate, as well as the Tripoli, found in Africa, is ground to a powder, and sold for polishing. The similarity of the formation of each is proved by the microscope; and their properties being the same, in commerce they both pass under the name of Tripoli: one merchant alone in Berlin disposes annually of many hundred tons weight. The thickness of a single shell is about the sixth of a human hair, and its weight the hun-



dred-and-eighty-seven-millionth part of a grain. The well-known Turkey stone, so much used for the purpose of sharpening razors and tools; the Rotten-stone of commerce, a polishing material; and the pavement of the quadrangle of the Royal Exchange, are all composed of infusorial remains.

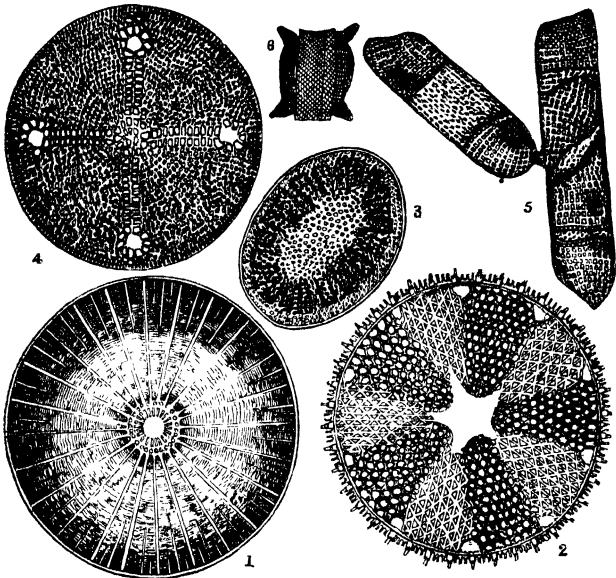

Fig. 183.

- 1, Shell of *Arachnoidiscus*. 2, *Actinocyclus* (Bermuda). 3, *Cocconeis* (Algoa Bay).  
4, *Coscinodiscus* (Bermuda.) 5, *Isthmia enervis*. 6, *Zygoceros rhombus*.

The *bergh-mehl*, mountain-meal, in Norway and Lapland, has been found thirty feet in thickness; in Saxony, twenty-eight feet thick; and it has also been discovered in Tuscany, Bohemia, Africa, Asia, the South Sea Islands, and South America; of this, almost the entire mass is composed of flinty skeletons of *Diatomaceæ*. That in Tuscany and Bohemia resembles pure magnesia, and consists entirely of a shell called *campilodiscus*, about the 200th of an inch in size.

Darwin, writing of Patagonia, says: "Here along the coast, for hundreds of miles, we have our great tertiary formation, including many tertiary shells, all apparently extinct. The most common shell is a massive gigantic oyster, sometimes a foot or more in diameter. The beds composing this formation are covered by others of a peculiar soft white stone, including much gypsum, and resembling chalk; but really of the nature of pumice-stone. It is highly remarkable, from its being composed, to at least one-tenth of its bulk, of *Infusoria*; and Professor Ehrenberg has already recognized in it thirty marine forms. This bed, which extends for five hundred miles along the coast, and probably runs to a considerably greater distance, is more than eight hundred feet in thickness at Port St. Julian." Ehrenberg discovered in the rock of the volcanic island of Ascension many siliceous shells of fresh-water *Infusoria*; and the same indefatigable investigator found that the immense oceans of sandy deserts in Africa were in great part composed of the shells of animalcules. The mighty Deltas, and other deposits of rivers, are also found to be filled with the remains of this vast family of minute organization. At Richmond in Virginia, United States, there is a flinty marl many miles in extent, and from twelve to twenty-five feet in thickness, almost wholly composed of the shells of marine animalcules; for in the slightest particles of it they are discoverable. On these myriads of skeletons are built the towns of Richmond and Petersburg. The species in these earths are chiefly *Naviculæ*; but the most attractive, from the beauty of its form, is the *Coscinodiscus*, or sieve-like disc, found alike near Cuxhaven, at the mouth of the Elbe, in the Baltic, near Wismar, in the guano, and the stomachs of our oysters, scallops, and other shell-fish. Another large deposit is found at Andover, Connecticut; and Ehrenberg states "that similar beds occur by the river Amazon, and in great extent from Virginia to Labrador." The chalk and flints of our sea-coasts are found to be principally shells and animal remains. Ehrenberg computes, that in a cubic inch of chalk there are the remains of a million distinct organic beings. The Paris basin, one hundred and eighty miles long, and averaging ninety in

breadth, abounds in *Infusoria* and other siliceous remains. Ehrenberg, on examining the immense deposit of mud at the harbour of Wismar, Mecklenburg-Schwerin, found one-tenth to consist of the shells of *Infusoria*; giving a mass of animal remains amounting to 22,885 cubic feet in bulk, and weighing forty tons, as the quantity annually deposited there. How vast, how utterly incomprehensible, then, must be the number of once living beings, whose remains have in the lapse of time accumulated! In the frigid regions of the North Pole no less than sixty-eight species of the fossil *Infusoria* have been found. The guano of the island of Ichaboe abounds with fossil *Infusoria*, which must have first entered the stomachs of fish, then those of the sea-fowl, and became ultimately deposited on the islands, incrustating its surface; whence they are transported, after the lapse of centuries, to aid the fruition of the earth, for the benefit of the present race of civilized man. The hazy and injurious atmosphere met with off Cape Verd Islands, and hundreds of miles distant from the coast of Africa, is caused entirely by a brown dust, which upon being examined microscopically by Ehrenberg, was found chiefly to consist of the flinty shells of *Infusoria*, and the siliceous tissue of plants: of these *Infusoria*, sixty-four proved to belong to fresh-water species, and two were denizens of the ocean. From the direction of the periodical winds, this dust is reasonably supposed to be the finer portions of the sands of the desert of the interior of Africa.

The deposit of the beneficent Nile, that fertilises so large a tract of country, has undergone the keen scientific scrutiny of Ehrenberg; and he found the nutritive principle to consist of fossil *Infusoria*. So profusely were they diffused, that he could not detect the smallest particle of the deposit that did not contain the remains of one or more of the extensive but diminutive family that once revelled in all the enjoyment of animal existence. It is very remarkable that at Holderness, in digging out a submerged forest on the coast, numbers of fresh-water fossil *Diatomaceæ* have been discovered, although the sea flows over the place at every tide.

*Mode of Preparing Fossil Infusoria.*—Before entering

on further details of the fossil *Infusoria*, we would first state how they may be prepared for microscopic examination. A great many of the infusorial earths may be mounted as objects without any previous washing or preparation ; some, such as chalk, however, must be repeatedly washed, to deprive the *Infusoria* of all impurities ; whilst others, by far the most numerous class, require either to be digested for a long time, or even boiled in strong nitric or hydro-chloric acid, for the same purpose. Place a small portion of the earth to be prepared in a test-tube, or other convenient vessel, capable of bearing the heat of a lamp ; then pour upon it enough diluted hydro-chloric acid to about half fill the tube. Brisk effervescence will now take place, which may be assisted by the application of a small amount of heat, either from a sand-bath or from a lamp : as soon as the action of the acid has ceased, another supply may be added, and the same continued until no further effect is produced. Strong nitric acid should now be substituted for the hydro-chloric, when a further effervescence will take place, which may be greatly aided by heat ; after two or three fresh supplies of this acid, distilled water may be employed to neutralise all the remains of the acid in the tube ; and this repeated until the water comes away perfectly clear, and without any trace of acidity. The residuum of the earth, which consists of silica, will contain all the infusorial forms ; and some of this may be taken up by a dipping-tube, laid on a slide, and examined in the usual manner. Should perfect specimens of the *Coscinodiscus*, *Gallionella*, or *Navicula* be present, they may be mounted in Canada balsam ; if not, the slide may be wiped clean, and another portion of the sediment taken, and dealt with in the same way, which, if good, after being dried, may be mounted in Canada balsam.

Dr. Redfern adopts an excellent mode of isolating *Naviculae* and other test-objects. He says : " Having found the methods ordinarily employed very tedious, and frequently destructive of the specimens, I adopted the following plan. Select a fine hair which has been split at its free extremity into from three to five or six parts, and having fixed it in a common needle-holder by passing it

through a slit in a piece of cork, use it as a forceps under a two-thirds of an inch objective, with an erecting eyepiece. When the split extremity of the hair touches the glass-slide, its parts separate from each other to an amount proportionate to the pressure, and on being brought up to the object, are easily made to seize it, when it can be transferred as a single specimen to another slide without injury. The object is most easily seized when pushed to the edge of the fluid on the slide. Hairs split at the extremity may always be found in a shaving-brush which has been in use for some time. Those should be selected which have thin split portions so closely in contact that they appear single until touched at their ends. I have also found entire hairs very useful, when set in needle-holders, in a similar manner; any amount of flexibility being given to them by regulating the length of the part of the hair in use."

We now proceed to notice in detail some of the most interesting of the fossil *Infusoria*.

Professor J. W. Bailey, of New York, has enriched the Museum of the College of Surgeons with several valuable specimens of the skeletons of *Infusoria*; among them is a fresh-water *Bacillaria*, named *Meridion circulare*, which Professor Quekett, in the *Historical Catalogue*, describes as "consisting of a series of wedge-shaped bivalve siliceous loricae, arranged in spiral coils; when perfect, and in certain positions, they resemble circles; each lorica is articulated by two lateral surfaces." It is asserted that they creep about when free from the stalk-plate. (Fig. 184, No. 16.) *Cocconema lanceolata* have two lanceolate flinty cases that taper towards their ends, one of which is attached to a little foot. Each lorica has a line marked in its centre, and transverse rows of dots on both sides: Ehrenberg says there are twenty-six rows in the one-hundredth of a line. (Fig. 184, No. 14.) *Achnanthes Longipes* have at the margins two coarse convex pieces roughly dotted, and two inner pieces firmly grooved; the inside seems filled with green matter. At one corner they are affixed to a jointed pedicle, which in many specimens contains green granules. In a specimen of a fossil *Eunotia*, found in some Bermuda earth, the flinty case is in four parts; it is of a half-

lanceolate shape, and a little indented on both margins ; two of them have curved rows of dots, and the other two are partly grooved with finer rows. Ehrenberg says they have four openings, all on one side (fig. 184, No. 13),

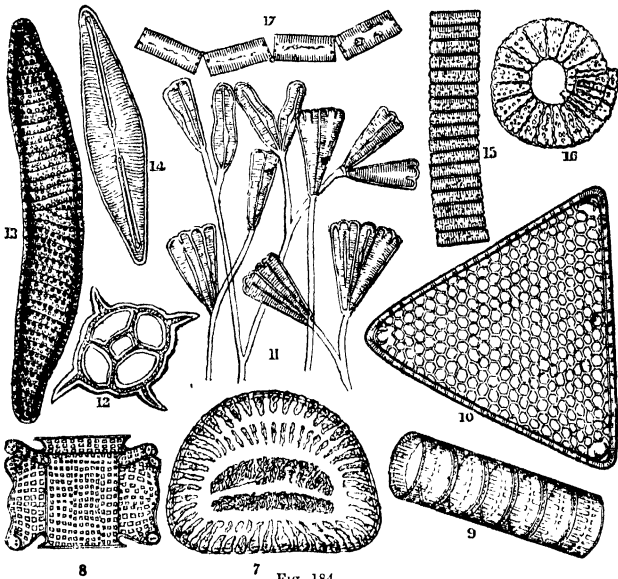

7 Fig. 184.

7, *Campilodiscus clypeus*. 8, *Amphitetras*. 9, *Galilonella sulcata*. 10, *Triceratium*, found in Thames mud. 11, *Gomphonema geminatum*, with their stalk-like attachments. 12, *Dictyocha fibula*. 13, *Eunotia*. 14, *Cocconeia*. 15, *Fragilaria pectinalis*. 16, *Meindon circulare*. 17, *Diatoma flocculosum*.

presenting a row of dots varying very much in number ; minute striæ in some cases extend from each dot towards the middle of the lorica ; and on the circumference there are two of these dots. The spirals and the individual lorica are very fragile, and therefore easily separated from each other. Of a glistening whiteness is the ribbon-like flinty case of *Fragilaria pectinalis*, which consists of many bivalve segments : on the articulating surface there are small grooves, represented in fig. 184, No. 15. A sin-

gular class of objects are *Diatoma flocculosum*, being rather oblong-looking, and joined to each other at opposite corners: they are sometimes grooved on each side. (Fig. 184, No. 17.) The "Swollen Eunotia" is generally about from the 11th to the 200th of an inch in length: a groove, widest in the centre, and tapering off to the ends, passes along its centre on both sides; it has curved lines proceeding from it. So wonderfully close are these lines or ribs, that as many as eight of them have been counted in the space of the 1200th of an inch. They are usually found when alive adhering to a branch of some weed that forms the green coating over stagnant waters. They propagate by self-division; a slight line running down the centre marks where the separation will occur, on each becoming perfectly developed as a distinct creature; and thus they grow and separate, filling the earth with their flinty shells.

*Gallionella sulcata* is found in many parts of North America; it somewhat resembles the cylindrical box for spices, which was at one time so common among good housewives; scientifically, it is described as consisting of chains of cylindrical bivalve loriceæ, having their outer surfaces marked or furrowed with longitudinal striæ; short joints may occasionally be seen, having their ends uppermost, the depth of the furrows being shown on the margin; within the margin is a thin transparent rim having radiating striæ. Sometimes as many as forty will be found joined together. (Fig. 184, No. 9.) The *Gallionella* received its designation from a celebrated French naturalist named Gaillon, it is often termed the *Box-chain Animalcule*, and when the flinty case is seen lying on its face, it much resembles a coin. These living *infusoria* are found in almost all waters, and are stated to be so rapid in their growth, that one hundred and forty millions will by self-division be produced in twenty-four hours. A species named the *Striped Gallionella* was discovered by Dr. Mantell near London; the same species is also found in the ocean. Sometimes the chains are three inches long; their size is from the 14th to the 400th part of an inch.

Professor Quekett, in the catalogue we have referred to, describes an "earth from Bohemia, particularly rich in

fossil specimens of *Navicula viridis*, which consists of four prismatic loriceæ, two ventral and two lateral; the former having round, the latter truncate extremities; and both provided with two rows of transverse markings and dots, longer and more marked on the ventral than on the lateral surfaces. The specimens having their ventral surfaces uppermost, exhibit a longitudinal marking in the centre, with a slight dilatation or knob at each extremity; this marking is interrupted in the middle of the lorica, and a diamond-shaped spot is left; if one of the lateral loriceæ be examined, two of the same spots will be seen, one on each side; they are of triangular figure, and appear to be thicker parts of the shell, described as holes by Ehrenberg." Four smaller triangular spots may be observed in the same lorica, one being situated at each corner; these also have been considered as openings by Ehrenberg: their length varies considerably; some exceed the 100th, whilst others are even smaller than the 1000th of an inch. *Isthmia ener-vis* (fig. 183, No. 5) is usually found attached to sea-weed; it is in three parts; and of a trapezoid shape, the centre part appears like a band passing over, and is bounded by broad straight lines: its outer surface is covered with a network of rounded reticulations, arranged in parallel lines. Among the most remarkable are *Amphitetras antediluviana*; they are of a cubical or box-like figure, and consist of three portions, the one in the centre being in the form of a band, as shown at fig. 184, No. 8, and the two lateral ones having four slightly projecting angles, with an opening into each. When viewed in detached pieces, the central one is like a box, and the two lateral portions resemble the cover and bottom. The former may be readily known, as consisting merely of a square frame-work with striated sides; but both the latter are marked with radiating reticulations. When recent, they are found in zigzag chains, from their cohering only by alternate angles. In some instances, as in *Biddulphia*, and *Isthmia*, two young specimens may be found within an old one. *Cocconeis* is marked with eight or ten lines proceeding from the inner margin to the centre; between which are dotted furrows, with the earlier spot in the centre of each. (Fig. 183, No. 3.)

*Campilodiscus clypeus* is oval, and curved in opposite



ways at the long and short diameters. On the margin there are two series of dots, sometimes joined; and on the oval centre there are also dots about the margin, while the middle is nearly plain. (Fig. 184, No. 7.) *Actinocyclus* has a round bivalve flinty case, with numerous cells formed by radiating partitions; very often every alternate cell only is on the same plane. The specimen in the Museum of the College of Surgeons is exquisite in its markings; it was found in some Bermuda earth, and has a beautifully-raised margin, and a five-rayed star in the centre; the number of cells is ten, five being on one plane and five on another. One set has the usual hexagonal reticulations crossed with diagonal lines, the other has the same lines, with a much smaller series of triangular reticulations, so disposed that they appear to form with each other parts of very small circles. One valve from this specimen is represented in fig. 183, No. 2.

As well as the beautiful shell of the *Coscinodiscus*, found both in a fossil and recent state, there is one of exquisite elegance and richness, of the genus *Arachnoidiscus*, so named from the resemblance of the markings of the shell to the slender fibres of a spider's web. (Fig. 183, No. 1.) This is found in the guano of Ichaboe, and also in earth from the United States, as well as among sea-weed from Japan, and the Cape of Good Hope. Mr. Shadbolt believes: "These shells are not, strictly speaking, bivalves, although capable of being separated into two corresponding portions; but are more properly *multivalves*, each shell consisting of *two* discoid portions, and *two* annular valves exactly similar respectively to one another." (See *Microscopical Society's Transactions*, for an excellent paper on these shells by Mr. Shadbolt.)

Artists who design for art-manufacturers might derive many useful hints from the revelations of the microscope, as evidenced in the arrangement of the shell last noticed, and in that of the genus *Coscinodiscus*; a very handsome object, the shells of which are marked with a network of cells in a hexagonal form, arranged in radiating lines or circles, and varying from 1-200th to 1-800th of an inch in diameter. A specimen found in Bermuda earth has on one of its valves two parallel rows of oval cells that form a kind of cross;

which gradually enlarge from the centre to the margin ; the angles of the cross are filled up with hexagonal cells as previously noticed. (Fig. 183, No. 4.)

The unskilled manipulator may for some time endeavour to adjust a slide, having a piece of glass exposed not larger in size than a pea, on which he is informed an invisible object worthy his attention is fixed, before he is rewarded by a sight of *Triceratium favus*, extracted from the mud of the too-muddy Thames. The hexagonal markings, cells, are beautiful, and at each corner there is a curved projecting horn or foot. (Fig. 184, No. 10.) In Bermuda earth there is a small species found, which has its three margins curved ; and also a curious species, which resembles the triradiate spiculum of a sponge.

It is remarkable how, in these minute and obscure organisms, we find ourselves met by the same difficulties concerning any positive laws governing the formation of generic types, as in larger and more complex forms of animal and vegetable life. It appears as if we could carry our real knowledge little beyond that of species ; and when we attempt to define kinds and groups, we are encountered on every side by forms, which set at nought our definitions.

Man even uses infusorial remains as food ; for the *bergmehl*, or *mountain-meal* found in Swedish Lapland, and which, in periods of scarcity, the poor are driven to mix with their flour, is principally composed of the flinty shells of the *Gallionella sulcata*, *Navicula viridis*, and *Gomphonema geminatum*. Dr. Trail, on analysing it, found it to consist of 22 per cent of organic matter, 72 of silica, 5.85 of alumina, and 0.15 of oxide of iron. This would seem to be the same substance described by M. Laribe the missionary, and put to a similar use in China : "This earth," he says, "is only used in seasons of extreme dearth."

XANTHIDIA.—In conjunction with the skeletons of the former species it will be as well to offer a few remarks upon animals long classed with *Infusoria*, and but rarely found except in the fossil state. There is every reason to believe that the *Xanthidia*, double-bar animalcules, are sporangia of *Desmidiaceæ*. In proof of this it can be shown that

their skeletons are composed of a horny substance, and not of silica, as was once supposed.

The name *Xanthidia* is derived from a Greek word signifying *yellow*, that being their prevailing hue. They are found plenteously in a fossil state, imbedded in flint, as many as twenty being detected in a piece the twelfth of an inch in diameter; in fact, it is rare to find a gun-flint without them. When living they may be described as having a round transparent shell, from which proceed spikes varying in size and shape. One kind, found by Dr. Bailey in the United States, was of an oval form, the 288th of an inch in length; and another species circular, found by the late Dr. Mantell, at Clapham: both were of a beautiful green colour. Specimens of *Branched Xanthidium*, found in flint by Dr. Mantell, were from the 300th to the 500th of an inch in diameter. Mr. Ralfs says: "That the orbicular spinous bodies so frequent in flint, are fossil sporangia of *Desmidiaceæ*, cannot, I think, be doubted, when they are compared with figures of recent ones. (Fig. 109.) Indeed, the late Dr. G. Mantell, who, in his *Medals of Creation*, without any misgiving, had adopted Ehrenberg's ideas concerning them, changed his opinion; and in his last work regards them as having been reproductive bodies, although he is still uncertain whether they are of vegetable origin."

The fossil forms vary as much as recent *Sporangia*, in being smooth, bristly, or furnished with spines, some are simple, and others branched at the extremity. Sometimes, a membrane may be traced, even more distinctly than in recent specimens, either covering the spines, or entangled with them. Writers have described the fossil forms as having been siliceous in the living state; but Mr. Williamson informs us that he possesses specimens which exhibit bent spines and torn margins; and this wholly contradicts the idea that they were siliceous before they were embedded in the flint. In the present state of our knowledge, it would be somewhat premature to identify the fossil with recent species; it is better, therefore, at least for the present, to retain the names bestowed on the former by those observers who have described them.

Near to Sydden Spoint, and the Round Down Cliff, on the Dover beach, Mr. H. Deane cut out a piece of pyrites with the adherent chalk, which, on examination, "exposed to view bodies similar to, if not identical with, *Xanthidia* in flints; he clearly recognised *X. spinosum*, *ramosum*, *tubiferum*, *simplex*, *tubiferum recurvum*, *malleoferum*, and *pyxidiculum*, together with casts of *Polythalamia*, and other bodies frequently found in flints. In shape they are somewhat flattened spheres, the greater part of them having a remarkable resemblance to gemmules of sponge, with a circular opening in the centre of one of the flattened sides. The arms or spines of all appear to be perfectly closed at the ends, even including those which have been considered in the flint, specimens decidedly tubiferous; showing that if the arms are tubes, they could afford no egress to a ciliated apparatus similar to those existing among Zoophytes. On submitting them to pressure in water between two pieces of glass, they were torn asunder laterally, like a horny or tough cartilaginous substance; and the arms in immediate contact with the glass were bent. Some specimens, put up after several weeks' maceration in water, were so flaccid, that, as the water in which they were suspended evaporated away, the spines or arms fell inclined to the glass. These circumstances alone seem clearly to disprove the idea of their being purely siliceous. The casts of the *Polythalamia*, portions of minute crustaceans, &c. appeared also to be, like the *Xanthidia*, some modification of organic matter; and in the case of the *Polythalamia*, the bodies are so perfectly preserved, that in some the lining membranes of the shells are readily distinguishable."

Mr. Wilkinson, who examined recent *Xanthidia* found in the Thames mud, and slime, on piles and stones at Greenhithe, said that, in his opinion, they are not siliceous, but of a horny nature, similar to the wiry sponges, which Mr. Bowerbank describes as being very difficult to destroy without the action of fire. He also met with a peculiarity in a *X. spinosum*, which he has never seen in any other species; it was in a piece of a gun-flint. There appeared, as it were, a groove or division round the circumference, similar to that formed by two cups when placed

on each other, so as to make their rims or upper edges meet.

The other fossil *Infusoria*, found most abundantly in the chalk and flint of England, are the *Rotalia*, or *wheel-shaped*, and the *Textularia* or *woven-work* animalcules; the latter having the appearance of a cluster of eggs in a pyramidal form, the largest being at the base, and lessening towards the apex.

We must here bring to a close this short notice of some of the marvellous creations in the invisible world; every glimpse inspiring awe, from the immensity, variety, beauty, and minuteness of its organised habitants. Immensity, in its common impression on the mind, hardly conveys the idea of the myriads upon myriads of *Infusoria* that have lived and died to produce the tripoli, the opal, the flints, the bog-iron, the ochres, and limestones of the world.

Professor Owen beautifully explains the uses of this vast amount of animalcule life:—"Consider their incredible numbers, their universal distribution, their insatiable voracity; and that it is the particles of decaying vegetable and animal bodies which they are appointed to devour and assimilate. Surely we must, in some degree, be indebted to these ever-active, invisible scavengers, for the salubrity of the atmosphere and the purity of water. Nor is this all; they perform a still more important office in preventing the gradual diminution of the present amount of organised matter upon the earth. For when this matter is dissolved or suspended in water, in that state of comminution and decay which immediately precedes its final decomposition into the elementary gases, and its consequent return from the organic to the inorganic world, these wakeful members of nature's invisible police are everywhere ready to arrest the fugitive organised particles, and turn them back into the ascending stream of animal life. Having converted the dead and decomposing particles into their own living tissues, they themselves become the food of larger *Infusoria*, and of numerous other small animals, which in their turn are devoured by larger animals; and thus a food, fit for the nourishment of the highest organised beings, is brought back, by a short route, from the extremity of the realms of organised matter.

These invisible animalcules may be compared, in the great organic world, to the minute capillaries in the microcosm of the animal body ; receiving organic matter in its state of minutest subdivision, and when in full career to escape from the organic system, turning it back, by a new route, towards the central and highest point of that system."

Such, then, seem to be some of the purposes for which are created the wonderful invisible myriads of infusorial animalcules. In the words of Holy Writ : "All these things live and remain for ever for all uses ; and they are all obedient. All things are double one against another ; and He hath made nothing imperfect. One thing establisheth the good of another ; and who shall be filled with beholding His glory ?"

VORTICELLIDÆ.—We now come to a family, which includes some of the most beautiful of living infusorial animalcules, and in which we meet with phenomena more curious than any yet witnessed, and perhaps as wonderful as any that will be presented to our notice, in the natural history of the higher classes of animals. The family of *Vorticellidæ*, *bell-animalcules*, are characterised by the possession of a fringe of rather long cilia, surrounding the anterior extremity, which can be exerted and drawn in at the pleasure of the creatures. Some *Euplotes* are furnished with a horny case for the protection of their delicate bodies, whilst others are quite naked.

The genus *Vorticella*, from which the name given to the family is derived, consists of little creatures placed at the top of a long flexible stalk, the other extremity of which is attached to some object, such as the stem or leaves of an aquatic plant. This stem, slender as it is, is nevertheless a hollow tube, through the entire length of which runs a muscular thread of still more minute diameter. When in activity, and secure from danger, the little *Vorticella* stretches its stalk to the utmost, whilst its fringe of cilia is constantly drawing to its mouth any luckless animalcule that may come within the influence of the vortex it creates ; but at the least alarm the cilia vanish, and the stalk, with the rapidity of lightning, draws itself up into a little spiral coil. But the *Vorticella* is not wholly condemned to pass a sort of vegetable existence,

rooted, as it were, to a single spot by its slender stalk ; its Creator has foreseen the probable arrival of a period in its existence when the power of locomotion would become

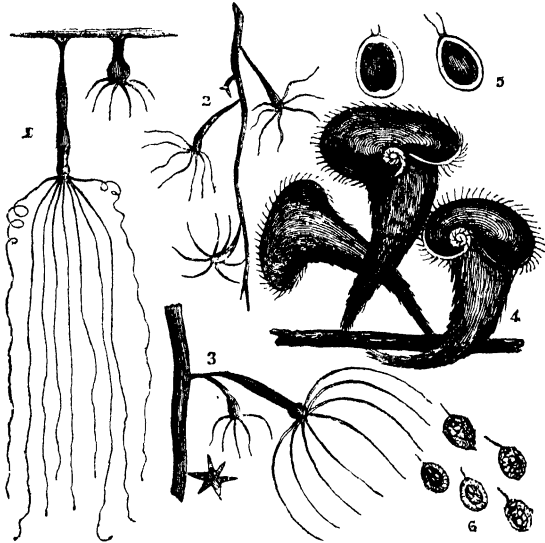

Fig. 185.

1, 2, 3, *Hydra*, fresh-water Polypes, in various forms and stages 4, A group of *Stentor polymorphus*, Multi-shaped Stentor. 5, 6, *Monads*, viviparous and Clouk monads.

necessary, and this necessity is provided for in a manner calculated to excite our highest admiration. At the lower extremity of the body of the animal, at the point of its junction with the stalk, a new fringe of cilia is developed ; and when this is fully formed, the *Vorticella* quits its stalk, and casts itself freely upon its world of waters. The development of this locomotive fringe of cilia, and the subsequent acquisition of the power of swimming by the *Vorticella*, is generally connected with the propagation of the species, which, in this and some of the allied genera, presents a series of most curious and complicated phenomena.

The *Vorticella* possess means of propagation which is denied to other *Infusoria*, with the exception of a few, although we meet with the same in other forms of animal life. The mode of reproduction referred to is called *gemination*; it consists in the production of a sort of bud, which gradually acquires the form and structure of the perfect animal. In the *Vorticellæ*, these buds, when mature, quit the parent stem after developing a cirlet of cilia at the lower extremity, and fix themselves in a new habitation in exactly the same manner as those individuals produced by the fissuration of the bell.

At an earlier or later period of their existence, the *Vorticellæ* withdraw the discs surrounded by cilia which forms the anterior portion of their bodies, and contracting themselves into a ball, secrete a gelatinous covering, which gradually solidifies, and forms a sort of capsule, within which the animal is completely inclosed. By this process the little animal is said to become *encysted*; and at this point of its history it is seen to be more complicated. Sometimes its further progress commences by the breaking up of the nucleus into a number of minute oval discs, which swim about in the thin gelatinous mass into which the substance of a parent has become dissolved. The body of the parent animal, inclosed within the cyst, now becomes apparently divided into separate little sacs or bags, some of which gradually acquire a considerable increase in size, and at length break through the walls of the cyst. After a time one of these projections of the internal substance bursts at the apex; and through the opening thus formed the gelatinous contents of the cyst, enclosed embryos, are suddenly shot out into the water, there to become diffused, giving rise to new generations. From the name *Acineta* given to them by Ehrenberg, who described them as a new genus, they are denominated *Acineta-forms*.

But the final object of this singular metamorphosis still remains to be described. The nucleus, which at the change of the encysted animalcule into the *Acineta-form* was still distinctly observable, becomes entirely and altogether converted into an active young *Vorticella*, acquiring an ovate form, with a cirlet of cilia round its narrower



extremity, and presenting at the opposite end a distinct mouth. Within this young animal, whilst still inclosed in the body of its parent, we see a distinct nucleus, and the usual contractile space of the full grown creature. When mature, the offspring tears its way through the membranes inclosing the *Acineta*, which, however, immediately close again. The latter continues protruding and retracting its filaments, and soon produces in its interior a new nucleus, which in its turn becomes metamorphosed into a young *Vorticella*.

The same faculty of inclosing themselves in a cyst is said to be made use of by the *Vorticella*, as a means of self-preservation if the water in which they have been living dries up. When the animal is thus encased, the mud at the bottom of the pool may be baked quite hard in the sun without doing it the least injury; and in this state the creatures are often taken up by the wind with the dust which it raises from the surface of the parched ground, and borne along to great distances, so as to cause their appearance in most unexpected localities (they are frequently found in roof gutters), where the first shower of rain calls them back to active life. These processes, or changes, may be looked for in several of the allied genera with so little variation, as far as observations have hitherto shown, that it will be unnecessary to allude to them more particularly.

*Vorticella cyanthina*, fig. 176, No. 4, has a fringe of cilia surrounding the margin of its cup. A single animal is first seen, which increases, and then divides into two perfect animals, joined by a stem.

The *Stentor*, "Trumpet animalcule," belongs to this family, fig. 185, No. 4. The body is of a trumpet-shape, and of various colours—white, blue, yellow, red, and green. They swim in a parallel line to their sides, sometimes tail first, rotating on their own axis; and attach themselves to objects by a sucker at the lower part. Some have cilia covering their bodies, and a long fringe over their gaping mouths, which is characteristic of their ravenous nature. The prey may be seen in their interior, as if strung like a string of beads; they differ from many gluttons by possessing great activity, and moving swiftly

through the water. Their increase is both by eggs and self-division ; and the various families are unlike in size, shape, and colour ; usually of about the hundredth part of an inch in size. When found they resemble a mass of green jelly encircling a twig ; and often, while swimming, they take the form of a cup, having the tail drawn within their body.

*Stentor Cœruleus*, "Blue stentor," is remarkable from having a crest extending along its body ; it assumes a peculiar shape when swimming, appearing to possess a thick tail nearly one half the breadth and length of its body. We may here notice a peculiarity with regard to animalcules procured from infusions ; in the first place, life appears generally in the *Monad* form, which in a very short period increase to a most extraordinary extent. These afterwards gradually decrease, larger and more perfect creatures supply their place, as *Enchelia*, *Peridinæa*, *Paramecia*, *Trachelina*, *Euplota*, with others ; and these, again, are supplanted by *Vorticellidæ*, *Brachionæa*, &c. The changes do not always occur in the order above indicated, even in the same infusions.

ROTATORIÆ, ROTATING OR WHEEL ANIMALCULES. — This class of Ehrenberg's *Infusoria* are now placed among the true *Annulosa*, and derive their name from the appearance presented by the motion of circles of cilia on the superior part of its body, which resemble the turning round of a wheel on its axis. Many have been the speculations as to the mechanism of this beautiful movement : some have considered it as a magnetic or electrical force ; and as one passes out of sight while the next appears, adding to the optical illusion, a philosopher of considerable note was once led to look upon the whole as a deception of sight, and affirmed that the wheels had no existence : they appear only in the head or upper part of the *Rotifera*.

Wheel-animalcules are generally found in water, which is their native element ; sometimes they are indwellers of the cells of moss and damp weed. They possess but one stomach, and generally have teeth and jaws to supply its wants. They can elongate and contract their bodies ; and some species have their extremity prolonged to a tail with a sucker ; others have a forked process, by which they

affix themselves to extraneous substances, while the cilia is in rapid motion, this prevents also the anterior portion of the body being drawn in by the force of the rotatory

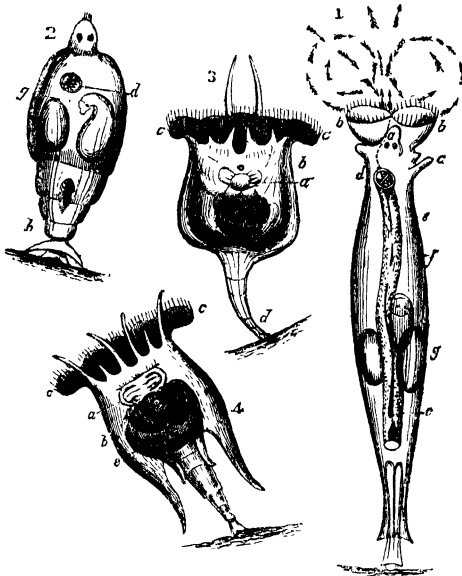

Fig. 186.

1, The common Wheel-Animalcule, *Rotifer vulgaris*, with its cilia or rotators *b*, protruded; *c*, its horn; *d*, oesophagus, *e*, gut; *f*, outer case; *g*, eggs. 2, The same in a contracted state, and at rest: at *g* is seen the development of the young. 3, Pitcher-shaped *Brachionus*: *a*, its jaws; *b*, shell; *c*, cilia, or rotators; *d*, tail. 4, Baker's *Brachionus*: *a*, the jaws and teeth; *b*, the shell; *c*, the rotators; *e*, the stomach.

action. They multiply by eggs; a few have been seen to bring forth their young alive. In the atmosphere the eggs have been discovered whirling along by the force of the wind to some resting-place, where, when circumstances admit, they spring into active life, and fulfil their appointed destiny. The eggs are of an oval form, and some ten, twenty, or thirty may be seen in an animal, of a brown colour, others are of a delicate pink and deep golden yellow. In those of a light colour, the young are sometimes

seen with their cilia in active vibration. Ehrenberg accurately described the upper part of a common wheel-animalcule, with the cilia, jaws, teeth, eyes, &c., as seen under a magnifying power of 200 diameters, and represented in fig. 186, No. 1. The small arrows indicate the direction of the currents produced by the cilia *b*, turning on their base. At the will of the animal a change is made in the direction in which the wheels appear to revolve, these it has the power of withdrawing, with the quickness of thought; a cluster of hairs appears at the extremity, that do not revolve, and certainly differ from the cilia: as they are usually protruded when the creature is moving from place to place, their function has been imagined to be that of feelers.

The red spots, at one time believed to be the eyes of the *Rotatoria*, are generally of a bright red colour; and the number and arrangement of these organs vary. In some species there have been discovered as many as eight, often placed on either side of the head, in a row, circle, or cluster, and in some they take a triangular shape. The *Rotatoria* delight in the sunshine; and when the bright luminary is hidden behind clouds, the animals sink to the bottom of the water, and there remain. When the water of their haunts is becoming much evaporated, they rise to the top, and give a bright-red tint to it; but when caught and placed in a jar, their beautiful colour fades in a few days. Locomotion is performed by swimming, the rotatory action of the crowns of cilia impelling it forward; in other instances it bends its body, then moves its tail up towards the head, with the two processes that serve as feet near the tail; it then jerks its head to a further distance, again draws up its tail, and so proceeds on its journey. Another peculiarity is that of drawing in the head and tail until nearly globular, and remaining in this condition fixed by the sucker; at other times they become a complete ball, and are rolled about by every agitation of the water.

The body of the wheel-animalcule is of a whitish colour; its form is indicated in the engraving. The tube for respiration appears to allow of water passing to the inside. On the food being drawn by the currents to the cup part

of the wheels, it passes through a canal in the neck to the mouth, which is situated lower down in the body; and there the food is crushed by teeth placed on the plates of the jaw, with a hammer-like action; from this it passes on through the alimentary canal for the sustenance of the animal.

BRACHIONÆA.—Ehrenberg's genus *Brachionus*, "Spine-bearing animalcule," belonging to the *Rotatoria*, are truly interesting, from their perfect, high, and complex organisation. Some are entirely enclosed in a shell, others only partially covered. Their structure, so beautiful and symmetrical, has caused them to become favourites with those who delight in microscopical studies.—*Brachionus striatus*, "Striped shell animalcule" (No. 3, fig. 186), of an elegant, jug-like form, has the transparent shell fluted lengthwise, and likewise six scallops at the upper part; through which

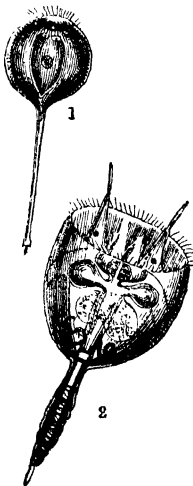

Fig. 187.

1, 2, Other forms of *Rotatoria*.

the citron-coloured inhabitant protrudes itself. Two hornlike processes are appended to its under-side. As occasions require, it sinks firmly and securely within its crystal home, which is sufficiently transparent to permit a view of its organisation. Its progress is effected by means of ciliary processes.

*Brachionus Pala*, or *Anura Cervicornis*, "Bent horn animalcule," is possessed of double rotatory organs, and four long processes, that project above the oval shell. It measures the 90th part of an inch.—*Brachionus Ovalis*, "Egg-shaped brachionus," is remarkable for the strength of its transparent shell, which is beyond that of other shelled creatures. Its projecting tail, as well as head, is at pleasure withdrawn into its very strong case.—*Brachionus Dentatus*, "Toothed brachionus." This active,

bright pink-eyed little creature, the 90th part of an inch in size, is apparently enclosed in a two-valved shell, having

each end indented so as to form two pair of teeth. Mr. Pritchard says:—"In addition to the rotatory organs for supplying it with food, I have observed it attached to a stem of *confervæ*, and abrading it with its teeth fixed in the bulbous œsophagus, which, during the operation, oscillates quickly; the rotatory cilia at the same time move rapidly, which makes it highly probable that they perform some office connected with the organs of respiration, as their motion seems altogether unnecessary while the creature is feeding in this manner."—*Brachionus Bakeri*, "Baker's brachionus," (fig. 186, No. 4), is a curious and beautifully-formed animal. At the points of a half-circle are situated the rotatory organs and cilia, between which rise some long spines, each side of the shell proceeding to a point in the lower part, while a square seems taken out of its body, forming thus two spines; from the central part of the body projects a long tail. The eggs are sometimes attached to these spines, and in other instances in the ovisac, found in the interior of the animal.

*Notommata Aurita*, the "Eared notommata."—The anatomy of this animal, a genus of *Rotatoria*, family *Hydatinæa*, has been most lucidly explained and illustrated by Mr. P. H. Gosse, in the *Microscopical Society's Transactions*.

Mr. Gosse states, that his specimens were found in a jar of water obtained in the autumn from a pond near Walthamstow, the jar having stood in his study-window through the winter; and from a swarm in the succeeding February he selected one the 70th of an inch in length when extended, but its contractions and elongations rendered its size variable.

"Its form, viewed dorsally, is somewhat cylindrical, but it frequently becomes pyriform by the repletion of the abdominal viscera. Viewed laterally, the back is arched gibbous posteriorly, with the head somewhat obliquely truncate, the belly nearly straight. The posterior extremity is produced into a retractile foot, terminating in two pointed toes; this, both in function and structure, is certainly analogous to a limb, and must not be mistaken for the tail, which is a minute projection higher up the body. When not swimming or rotating, the head assumes a rounded outline, displaying through the transparent

integument an oval mark on each side, within which a tremulous motion is perceived; but at the pleasure of the animal a semi-globular lobe is suddenly projected from each of these spots by evolution of the integument. These projections have suggested the trivial name of *aurita*. Each lobe is crowned with a wheel of cilia, the rapid rotation of whose waves forms the principal source of swift progression in swimming. The protrusions of these lobes are evidently eversions of the skin, ordinarily concealed in two lateral cavities. They may be protruded by pressure, and are then seen to be covered with long but firm and close-set cilia, which are bent backward, and move more languidly, as death approaches. The whole front is also fringed with short vibratile cilia, which extend all along the face, as far as the constriction of the neck. The whole body is clear and nearly colourless; but its transparency is much hindered by the net-work of dim lines and corrugations that are everywhere seen, particularly all about the head."

Mr. Gosse, throwing a little carmine into the water, saw the jaws working slightly, the points opening a little way, and then closing; the rods of the hammers were drawn towards the bottom for opening, and upwards for closing. A little mass of pigment was soon accumulated beneath the tips of the jaws, which spread itself over a rounded surface, but did not pass farther; nor did an atom at this time go into the stomach.

After entering into further minute details of the little animal, he observes: "They possess organs that many others do not, and want some that others possess. They prove that the minuteness of the animals of this class does not prevent them from having an organisation most elaborate and complex, and therefore it justifies the belief that the *Rotifera* should occupy a place in the scale of animal life much higher than that which has been commonly assigned to them."

Like most of the class, this *Notommata* is predatory. Mr. Gosse once saw one eagerly nibbling at the contracted body of a sluggish *Rotifer vulgaris*; the mouth was drawn obliquely forward, and the jaws were protruded to the food, so as to touch it. It did not appear, however, to do the

rotifer much damage. It appeared chiefly to feed on monads.

**FLOSCULARIÆ.**—*The Stephanoceros*, “Crowned animalcule.” This beautiful little creature is about the 36th of an inch in length; and is enclosed in a transparent cylindrical flexible case, over which it protrudes five long arms in a graceful manner, which, touching at their points, give a form from which it derives its name. These arms are furnished with several rows of short cilia, and retain the prey brought within their grasp until it can be swallowed. The case is attached to the animal on the part we may term the shoulders; so that when it shrinks down in its transparent home, the case is drawn inwards. To the bottom of its home it is secured by an elongation of the body; and this part, as well as the body, contracts instantly on the approach of danger, the arms coming close together are also withdrawn. Its mouth differs a little from the common wheel-animalcule; it has two distinct sets of teeth, with which it tears and crushes its food. The eggs of the *Stephanoceros*, after leaving the animal’s body, remain in their crystal-like shell until hatched; and Dr. Mantell from close observation found, that about eighty hours elapsed before their organs were all developed and fitted for use.

*Limnias Ceratophylli*, “Water-nymph,” is of this family, being about the 20th of an inch in size, and is enclosed in a white transparent cylindrical case, one-half the length of the animal; which, being glutinous, becomes of a brownish colour, from the adhesion of extraneous matter. Its rotatory apparatus is divided into two lobes, possessing vibrating cilia, as well as a singular projecting angular chin. In the rows of little eggs in the body of the parent, may clearly be distinguished most of the young organs in a state of activity. From its fondness for *hornwort*, it is often called by the name of that plant.

*Floscularia Ornata*, “Elegant floscularia,” is a beautiful type of the family, and has its rotatory organs divided into several parts; when it contracts itself into a small compass, its transparent covering becomes wrinkled. This creature is an interesting object, as its internal structure can be seen through the translucent sheath that constitutes



its dwelling. The little beings are very rapacious, although but the 108th part of an inch in size. *Floscularia Proboscidea*, "Horned floscularia," has six lobes, fringed with cilia shorter than in the preceding species. Its name is derived from a peculiar kind of horn or proboscis, also having cilia placed in the centre of the lobes. The eggs cast off by the parent enclosed in a sheath, are very pretty objects for microscopic observation. In fact, the tinted case, the light ethereal frame of the tiny animal, the variously coloured food, &c., in the stomach, combine in rendering it singularly interesting.

*Melicerta Ringens*, "Beaded melicerta."—Among the *Melicerta*, or "Honey floscularia," this is the most beautiful. Its crystalline body is first enclosed in a pellucid covering, wider at the top than the bottom, of a dark yellow or reddish-brown colour, which gradually becomes encrusted with zones of a variety of shapes, glued together by some peculiar exudation that hardens in water: it is these little pellets, appearing as rows of beads, give the name to the animal. Mr. Gosse furnishes an excellent account of the "architectural instincts of *Melicerta ringens*," which is not only truly surprising, but full of interest. He writes:—"This is an animalcule so minute as to be with difficulty appreciable by the naked eye, inhabiting a tube composed of pellets, which it forms and lays one by one. It is a mason who not only builds up his mansion brick by brick, but makes his bricks as he goes on, from substances which he collects around him, shaping them in a mould which he carries upon his body.

"The animal, as it slowly protrudes itself from its ingeniously-formed mansion, appears a complicated mass of transparent flesh, involved in many folds, displaying at one side a pair of hooked spines, and at the other two slender, short blunt processes projecting horizontally. As it exposes itself more and more, suddenly two large rounded discs are expanded, around which, at the same instant, a wreath of cilia is seen performing its surprising motions. Often the animal contents itself with this degree of exposure; but sometimes it protrudes farther, and displays two other smaller leaflets opposite to the former, but in the same plane, margined with cilia in like manner. The

appearance is not unlike that of a flower of four unequal petals; from which circumstance Linnæus gave it the name *ringens*, by which it is still known."

Below the large petals on the ventral aspect, and just above the level of the projecting respiratory tubes, is a small circular disc or aperture, within the margin of which a rapid rotation goes on. This little organ, which seems to have hitherto escaped observation, Mr. Gosse can compare to nothing so well as to one of those little circular ventilators which we sometimes see in one of the upper panes of a kitchen-window, running round and round, for the cure of smoky chimneys. The gizzard, or muscular bulb of the gullet, is always very distinct, and its structure is readily demonstrated. It consists of two sub-hemispherical portions, or jaws, each of which is crossed by three developed teeth, which are succeeded by three or four parallel lines, as if new teeth might grow from thence. The teeth are straight, slender, swelling towards their extremity, and pointed. These armed hemispheres work on each other, and on a V-shaped or tabuliform apparatus beneath, common to most of the Rotifers, but in this genus very small.

The pellets composing the case are very regular in form and position: in a fine specimen, about the 1-28th of an inch in length when fully expanded, of which the tube was the 1-36th of an inch, Mr. Gosse counted about fifteen longitudinal rows of pellets at one view, which might give about thirty-two or thirty-four rows in all.

In November, 1850, Mr. Gosse found a fine specimen attached to a submerged moss from a pond at Hackney; this he saw engaged in building its case, and at the same time discovered the use of the curious little rotatory organ on the neck. When fully expanded, the head is bent back at nearly a right angle to the body, so that the disc is placed nearly perpendicularly, instead of horizontally; the larger petals, which are the frontal ones, being above the smaller pair. Now, below the large petals (that is, on the ventral side) there is a projecting angular chin, which is ciliated; and immediately below this is the little organ in question. It appears to form a small hemispherical cup, and is capable of some degree of projection, as if on a short

pedicle. On mixing carmine with the water, the course of the ciliary current is readily traced, and forms a fine spectacle. The particles are hurled round the margin of the disc, until they pass off in front through the great sinus, between the larger petals. If the pigment be abundant, the cloudy torrent for the most part rushes off, and prevents our seeing what takes place ; but if the atoms be few, we see them swiftly glide along the facial surface, following the irregularities of outline with beautiful precision, dash round the projecting chin like a fleet of boats doubling a bold headland, and lodge themselves, one after another, in the little cup-like receptacle beneath. Mr. Gosse, believing that the pellets of the case might be prepared in the cup-like receptacle, watched the animal, and presently had the satisfaction of seeing it bend its head forward, as anticipated, and after a second or two raise it again ; the little cup having in the meantime lost its contents. It immediately began to fill again ; and when it was full, and the contents were consolidated by rotation, aided probably by the admixture of a salivary secretion, it was again bent down to the margin of the case, and emptied of its pellet. This process he saw repeated many times in succession, until a goodly array of dark-red pellets were laid upon the yellowish-brown ones, but very irregularly. After a certain number were deposited in one part, the animal would suddenly turn itself round in its case, and deposit some in another part. It took from two and a half to three and a half minutes to make and deposit a pellet. Some atoms of the floating carmine now and then passed down the gullet into the gizzard, and thence into the stomach ; but these were quite independent of, and unconnected with, the pellets, which were composed exclusively out of the torrent that had passed off the disc. On one occasion the cup was brought down to the margin, but, from some cause or other, failed to deposit its pellet ; it was raised for a moment, and then a second attempt was made, which was successful.

**POLYPIFERA, ZOOPHYTES.**—By the term Zoophytes, taken in its strictly limited sense, is understood a class of creatures which, in their form, or most remarkable characteristics, recall the appearance of a vegetable, or its leading pro-

perties. The most obvious character common to this vast race of animals, is, that their mouths are surrounded by radiating tentacula, arranged somewhat like the ray of a flower; and hence the term Zoophyte. So plant-like, indeed, are their forms, that the ancients regarded them as vegetating stones, and invented many theories to explain their growth.

This sub-kingdom, as before stated, is termed *Cœlenterata*, and is now divided and subdivided by Professor Huxley into the following:—

Septa, &c.,  $\times 5$  or 6.      Septa, &c.,  $\times 4$ .

*Simple soft-bodied.*

1. ACTINIDÆ.      1. BEROIDÆ.  
*Actinea, Minyas.*      *Cydippe, Cestum.*

*Compound—Skeleton spicular.*

2. ZOANTHIDÆ.      2. ALCYONIDÆ.  
*Zoanthus.*      *Alcyonium.*

*Compound—Skeleton sclerobasic.*

3. ANTIPATHIDÆ.      3. GORGONIDÆ.  
*Antipathes.*      *Gorgonia, Isis,*  
      *Corallium.*

*Compound and Simple—Skeleton thecal—continuous.*

4. PERFORATA.      4. TUBIPORIDÆ.  
*Porites, Madrepora.*      *Tubipora.*

5. TABULATA.      5. RUGOSA.  
*Millepora, Seriatopora.*      *Stauria, Cyathanonia,*  
      *Cyathophyllum,*  
      *Cystiphyllum.*

6. APOROSA.  
*Cyathina, Oculina.*  
*Astræa, Fungia.*

Opposed to all our common ideas of animal life is this singular portion of creation. If we cut a limb off a tree, or sever that of an animal, these parts will wither and decompose, by passing into other forms of matter. Cut a tree across its middle, and its natural symmetry is irreparably disfigured; slit it down its centre, and it is destroyed: all animals so treated suffer instant death, with the sole exception of the polype; for it will put forth new limbs, form a new head or tail, and if slit, become two separate perfect creatures.



Fig. 188.—*Asteroid Zoophytes.*

The seas which wash our shores swarm with beautiful forms of minute Polypes, having nearly the same organisation as the *Hydra*, but which are protected by an external horny integument. This peculiar covering sends forth shoots or buds, which are developed into new polypes, thus producing a compound animal; but the exercise of this gemmiparous faculty is prevented by a horny defence from effecting any other change than that of adding to the general size, and to the number of tentacles, prehensile fingers, and digestive sacs; yet the pattern according to which new polypes, and branches of polypes, are developed, is fixed and determinate in each species, and there consequently results a particular form of the whole compound animal, by which the species can be readily recognized.

In none of the *Hydridae* does the hardening outer layer extend over the base of the polypes, forming by its detachment here from the inner layer, a cup or cell; and it is by this circumstance that they are fundamentally distinguished from the next group, *Corynidae*, the tentacles of which are not arranged in a single transverse series, as in *Hydra*, but are usually scattered more or less irregularly over the surface of the polype; while in *Tubularia* there are two transverse rows of tentacles, an upper shorter, and a lower longer. The reproductive organs, which in *Hydra* are extremely simple, attain, in many of the *Corynidae* and *Tubulariadae*, to the condition of zooids, sometimes becoming detached, and swimming about freely before discharging their products. These free zooids have always the form of a bell or disc, from whose centre a pyriform or oval body—either a closed sac or an open-mouthed polype—is suspended; and they have been regarded as distinct animals, and grouped together with other forms of *Hydrozoa*, under the head of *Medusae*. The bell possesses considerable contractility, and at each contraction the water which fills its cavity is forced out, and the bell itself is thereby propelled in the opposite direction. In *Tubularia* a more completely medusiform body is developed, but is never detached.

In the *Sertulariadae*, the numerous digestive zooids, or polypes, developed from the original germ, remain always attached; but their most remarkable feature is the posses-

sion of a "cell," surrounding the base of each polype, and usually capable of receiving it when retracted. The development of this cell at once distinguishes it from the not altogether dissimilar group, the *Diphydæ* and *Physophoridæ*. In some *Sertulariadæ* (*Sertularia dynamena*), the margins of the cells are converted into membranous valves; and in the genus *Plumularia*, we find special organs of offence.

The *Diphydæ* are among the most remarkable and beautiful inhabitants of the ocean, to whose warmer regions, they, like the *Physophorida*, are principally confined. They are free swimmers in the adult state, and probably, at all times of their existence; but while actively locomotive by means of the contractions of the natatorial organs with which they are provided, they possess no special supporting apparatus, or "float," such as that developed in the *Physophorida*. The tentacle of the *Diphydæ* is a long filiform process of the peduncle, capable of great elongation and contraction; the terminal filament of which is closely beset with minute thread-cells, so that the whole must constitute a very efficient weapon of offence. Three genera of the *Physophorida* are particularly worthy of notice: the *Physalia*, whose air-vesicle may attain the length of eight or nine inches, while its formidable tentacles hang down for as many feet, inflicting instantaneous death upon the smaller animals, and giving rise to no small amount of pain and irritation, even in man; and the *Verella* and *Porpita*, in which the texture of the air-vesicle is so exceedingly firm, as to give it the appearance of an internal shell, while its cavity is subdivided into numerous chambers. Originally, however, the "shell" of the *Verella* is a perfectly simple air-vesicle, like that of any other *Physophorid*. In the very peculiar genus *Lucernaria*,—lovely "Lamp-polype," with little knobbed tentacles—we have a *Hydrozoon*, in which the polype occupies the centre of an expanded disc, the two presenting essentially the same structure and relations as in the Medusiform zooids of other divisions. In fact, a *Lucernaria* is in all essential respects comparable to an *Aurelia*, or other *Medusa* fixed by the middle of the upper surface of its disc.

Mr. Huxley prefers the term *Lucernariadæ* to that of

*Medusæ*; and he does so "from the fact that the *Medusidæ* of authors consists of two groups, the *Naked-eyed* (*Gymnophthalmata*) and the *Covered-eyed* (*Stegnnophthalmata*). Some of which, the *Aurelia*, is but a derivative zooid form of an animal, essentially resembling *Lucernaria*; while so far as regards the *Naked-eyed Medusæ*, we have no evidence that any genus except *Æginopsis*, is other than the reproductive zooid of one of the *Hybridæ* or *Sertulariadæ*. It seems better, therefore, to avoid the term *Medusæ*, as the denomination of an ascertained group, reserving it merely to denote the medusiform creatures of whose origin we are ignorant, but whose structure entitles them to a provisional place among the *Lucernariadæ*. As our knowledge increases, we shall be able to arrange those *Medusæ* which are the zooids of *Hybridæ*, *Sertulariadæ*, *Diphydæ*, or *Physophoridæ*, under their respective groups, while the rest will form the sub-sections of the *Lucernariadæ*; the first consisting of such forms as *Aurelia* and *Rhizostoma*, zooids developed by fission from fixed *Lucernariadæ*; the second consisting of such forms as *Æginopsis*, free *Lucernariadæ*, developed at once from the ovum, without any fixed state."

The *Actinozoa* are those *Cœlenterata* in which the stomach is a sac suspended within and entirely distinct from the body, from whose parietes it is separated by a portion of the general cavity of the body, which may receive the special denomination of "perivisceral cavity." The stomach communicates freely by an inferior aperture with the general cavity. A rough conception of the relations between the *Actinozoa* and the *Hydrozoa* may be obtained by supposing the walls of the natatorial disc of a *Lucernaria* to become united with those of its central polype; it would then become, to all intents and purposes, an *Actizoon*. As the *Hydra* is the type of the *Hydrozoa*, so the "Sea-anemone" (*Actinia*) is considered to be the type of the *Actinozoa*. As in the *Hydrozoa*, the body of the *Actinia* is essentially composed of two layers, a superficial layer, composed of polygonal cells, frequently detached and renewed again, beneath which lies a granular layer; whilst in the deep dermal layer two sets of muscular fibres are found,—a superficial circular, and a deep

longitudinal set : both are flattened, and exhibit no transverse striation. In some *Actiniæ*, such as *A. mesembryanthemum*, bright blue sacs are placed at the edges of the oral

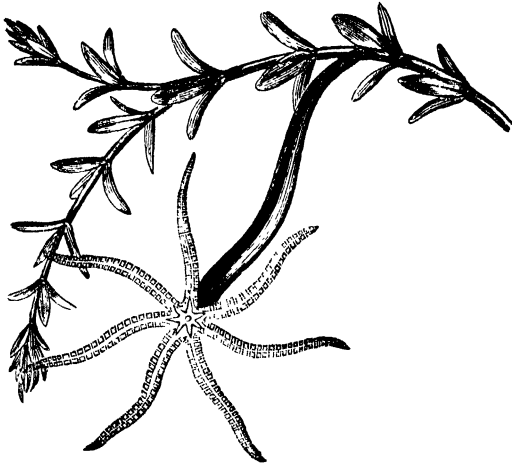

Fig. 189.—*Hydra*, with its tentacles displayed and magnified, adhering to a stalk of *Anacharis alsinastrum*.

disc, while in *A. gemmacca*, *A. sessilis*, &c. clear spots are scattered over the integument, which have been regarded as apertures or tubercles; M. Hollard, however, states, that these are imperforate *Ampullæ*, possessing a kind of bilabiate mouth, surrounded by a sphincter-like arrangement of muscular fibres. Any foreign body introduced into these ampullæ is seized and forcibly held; or if the finger be placed within reach, it gives the sensation of a very fine rasp passing over it. The margins of the radiate tentacles of the young animal are surrounded by cilia; the gastric epithelium is likewise ciliated, and doubtless secretes a powerfully solvent fluid. The majority of the *Actiniæ* are oviparous, the young being developed from ova within, and evacuated by the mouth: they are also capable of multiplication by budding, and occasionally by fission, while their power of restoring themselves after muti-



lation appears to be as great as that possessed by the *Hydra*.<sup>1</sup>

The great majority of the *Actinozoa* exhibit a structure closely corresponding with that of the *Actiminæ*; but from the manner in which they grow up into compound masses of associated Zooids, produced by gemmation or by fission, they stand in nearly the same relation to *Actinia*, as the compound *Hydrozoa* to *Hydra*.

Sir John Dayell believes that *Actiniæ* conquer their prey by mere strength; this is doubtless the case, as from experience we find nothing like a stinging property belonging to the tentacles; nor are there any poison vesicles attached thereunto. The tentacles appear to be armed with rows of spines, which give a clinging and slight rasping sensation when the finger is thrust against them; and by the same means they are able to obtain a firm hold of any smaller animal that falls within their reach. Animals with a hard case or shell seem to escape from their clutches without having sustained the smallest injury. The same remarks apply to the *Hydra*; they have neither the power to sting or benumb their prey, as asserted by many authorities. It has been said that certain minute organs found in polypes, and variously styled *thread capsules*, *filiferous capsules*, or *urticating cells*, are stinging organs. This thread Agassiz likens to a lasso thrown by the polype to secure its prey. Mr. Lewes writes:—"On a survey of the places where these 'urticating cells' are present, I stumbled upon an unlucky fact, and one likely to excite our suspicion. They are present in a few jelly-fish which urticate, in *Actiniæ* which urticate, and in all polypes, which, if they do not urticate,

(1) The Author's aquarium affords at this time a curious illustration of increase both by budding and fissuration, in a beautiful *A. dianthus*. In the first case an offset was seen to protrude; it resembled a small bud near the foot, this increased until it attained to a perfect animal of a considerable size, when it became detached. In another, the animal, after having remained for several weeks firmly adherent to the side of the glass, with a part of its disc out of the water, by a great effort tore itself away, leaving six small pieces behind, attached to the glass. For many days these pieces served only to mark so many spots, but in about a week rudimentary tentacles were observed to be sprouting out from each piece, which went on rapidly increasing, and ultimately six perfect animals resulted therefrom. The repair of the marginal portion of the disc of the parent animal was completed in a few days, and it suffered no injury whatever from its self-mutilation. This furnishes a proof, if one were wanting, of the hydrozoid character of this class of animals.

are popularly supposed to do so, and at any rate possess some peculiar power of adhesion. In all these cases, organ and function may be said to go together ; but the cells are also present in the majority of jelly-fish which do *not* urticate, in *Æolids* which do *not* urticate, and in *Planaria* which do *not* urticate. Here, then, we have the organ without any corresponding function ; urticating cells, but no urtication. It thus appears that animals having the cells, have none of the power attributed to the cells ; and that even in those animals which have the power, it is only present in the tentacles, where the cells are much less abundant than in parts not manifesting the power ; the conclusion, therefore, presses on us, that the power does not depend upon these cells. When at rest, and in an ordinary natural state, the animal is never seen to dart out these threads, nor upon capturing his prey ; it is only when some force is used to dislodge him from some spot to which he has securely attached himself, that he presses or squeezes out these threads ; more for the purpose of compressing himself into a closer and smaller mass, to add to the difficulty of detaching him.

“*Actiniæ* do not effect their preparation of nutriment by *chemical* means ; that is, they do not, in the strict sense of the term, *digest*, but simply derive nourishment by mechanical pressure, exerted upon any particle of food that they may draw into their stomachs. This has been proved by experiments made after the manner of Reaumur. A small piece of meat having been put into a quill, and allowed to remain in the stomach of the *Actinia* sufficiently long, and then withdrawn, *no solvent* fluid is found to have acted upon it. When placed under the microscope the muscle fibres are not at all disintegrated, and the striæ are as perfect as before the experiment, with the exception of a pulpiness and loss of colour, as in any ordinary mechanical maceration.

“Light has been thrown upon the reproductive system of the *Actiniæ* by M. Jules Haime, in the *Annales des Sciences Naturelles*, 1854, 4<sup>ième</sup> série, tom. i. ; which contains accurate and detailed descriptions and plates of the disposition of ova and spermatozoa in the *Actiniæ*. To find the ovaries it is only necessary to take a live animal,

and with a rapid, but not deep incision, lay open the envelope from the outside; a series of convoluted bands will bulge through the opening, but if these are quickly brushed aside, certain lobular or grape-like masses will be perceived, darker in colour, and almost entirely hidden by these bands, but growing from the wall of the envelope. They do not appear to have a fixed locality, as they may be found near the base, about the centre, or close to the disc; it is, therefore, sometimes necessary to make three or four incisions before detecting them; once seen, they will be easily distinguished from the convoluted bands, although very difficult to remove them without removing some of the bands."

The manner in which the aggregation of zooids, constituting a compound coral, is developed from the primarily solitary Actinozoic embryo, exercises an all-important influence upon the form of the *Corallum*. Sometimes, as in most *Turbinolidæ*, neither gemmation nor fission ever take place. In the *Oculinidæ*, gemmation alone occurs, and in these and other *Actinozoa*, the development of buds takes place either from the base or from the sides of a corallite, or from the cœnosarc. Certain of the extinct *Rugosa*, however, exhibit *calicular* gemmation, the buds being developed from the oral disc or cup, which can hardly have retained any active vitality. The massive coralla of some *Cyathophyllidæ*, thus standing like inverted pyramids, all the buds supported upon the narrow surface of the primary zooid, have a very singular and striking aspect. The *Beroidæ* appear at first to differ very widely from the type of structure which prevails among the other *Actinozoa*, but a close examination of any of their forms suffices to demonstrate the justice of the conclusion advocated by Frey and Leuckart, as to their essential identity with *Actinia*. The *Cydippe*, which abounds upon our own coasts, affords, from its small size and extreme transparency, an excellent subject for the student of *Beroidæ*. It is impossible here to enter into the varieties of form presented by the *Beroidæ*, and which chiefly arise from the development of lateral lobes, a process which is carried to so great a length in *Cestum* that the body becomes ribbon-like. The *Beroidæ* and the *Actinidæ*

inhabit the shallower and even deeper parts of all seas; *Alcyonidæ* and *Gorgonidæ* are found at considerable depths; *Corallium* and *Gorgonia* abound both in cold and warm latitudes. The *Perforata* and *Tabulata* almost exclusively haunt the shallower parts of warm seas, but the *Turbinolidæ* extend into very cold regions. The whole group of the *Rugosa* is now extinct, only one genus, *Holocystis*, having survived even the palæozoic period. Not only heat, but light, and probably rapid and effectual æration, are essential conditions for the activity of the reef-building *Actinozoa*. Different species of corals exhibit great differences as to the rapidity of growth, and the depth at which they flourish best; and no one must be taken as evidence for another in these respects. Certain species of *Perforata*, *Madreporidæ*, and *Poritidæ*, appear to be at once the fastest growers, and those which delight in the shallowest waters. The *Astræidæ* among the *Aporosa*, and *Seriatopora* among the *Tabulata*, live at greater depths, and are probably slower of increase. The most careful accounts of the structure of corals extant, are from the pens of M. M. Milne Edwards and Haime, published at various times in the *Annales des Sciences Naturelles*, in the *Mémoires du Museum*, and in the publications of the Palæontographical Society; and by Mr. Darwin, whose beautiful work on *Coral Reefs* will amply repay a careful perusal.

With these brief introductory observations, the principal part of which have been derived from Professor Huxley's lectures, we proceed to direct the reader's attention to some of the more interesting generic forms.

HYDRA, FRESH-WATER POLYPE.—In polypes of this family the body generally consists of a homogeneous aggregation of vesicular granules, held together by a sort of glairy intercellular substance, and capable of great extension and contraction; so that the creature can at pleasure assume a great variety of forms, extending its body and tentacles until the latter become so fine as to be almost invisible, and again retracting itself until it acquires the appearance of a small gelatinous mass. The tentacles which surround the anterior extremity are irregular in number; they are capable of extension to a very great

length when seeking for prey; and on coming in contact with any object floating through the water, they immediately twine round it, and convey it to the mouth. In some genera the tentacles appear to be tubular, the internal cavity being continuous with that of the stomach. The mouth is situated in the centre of the circle of tentacles, and leads directly into a simple digestive cavity.

*Hydræ* are found in ponds and rivulets, adhering to the leaves of aquatic plants, or twigs and sticks that have fallen into the water. When stretched out, they resemble pieces of hair, from a quarter to three-quarters of an inch in length. Some are of a light-green colour, and others brown or yellow; that is, the five varieties found in England. It received its name from its several long arms being supposed to resemble the fifty-headed water-serpent called *Hydra*, which was destroyed by Hercules in the lake of Lerna, as we are informed in fabulous history. Leeuwenhoek, in 1703, first drew attention to the *Hydra*; and in 1739, M. Trembley from the Hague, more accurately described its habits.

Polypes are not vegetarians; M. Trembley fed *Hydræ* on minced fish, beef, mutton, and veal; they are voracious and active in seizing worms and larvæ much larger than themselves, which they devour with avidity. They carefully and adroitly bring their food towards their mouth; and when near, pounce upon it with eagerness. To make up for the want of teeth, the mouth enlarges to receive the food brought to it by the arms that have twined around the sacrifice. The red worm that tinges the mud of the Thames appears to be the dainty dish they like best to have set before them. Dr. Mantell saw the *lasso* of a polype thrown over two worms at the same time; yet they could not escape, and lost all power of motion.

Dr. Johnston states: "Sometimes it happens that two polypes will seize upon the same worm, when a struggle for the prey ensues, in which the strongest gains, of course, the victory; or each polype begins quietly to swallow his portion, and continues to gulp down his half, until the mouths of the pair near, and come at length into actual contact. The rest that now ensues, appears to prove that they are sensible of their untoward position, from which

they are frequently liberated by the opportune break of the worm, when each obtains his share; but should the prey prove too tough, woe to the unready! the more resolute dilates the mouth to the requisite extent, and deliberately swallows his opponent; sometimes partially, so as, however, to compel the discharge of the bait; while at other times the entire polype is engulfed! But a polype is no fitting food for a polype, and his capacity of endurance saves him from this living tomb; for, after a time, when the worm is sucked out of him, the sufferer is disgorged with no other loss than his dinner."

The organ of prehension, which is called the *hasta*, consists of a sac opening at the surface of the tentacle, within which, at the lower portion, is placed a saucer-shaped vesicle, supporting a minute ovate body, which again bears a sharp calcareous piece called the *sagitta*, arrow. This can be pushed out at the pleasure of the animal, serving to roughen the surface of the tentacle, and afford a much firmer hold of its living prey. The polype increases rapidly: a portion of the body swells, a young one puts forth its head from the part, its arms begin to grow, it then is industrious in catching food; its body, communicating with that of its parent and participating in the fears and actions of its progenitor, is finally cast off to wander the world of waters. Sometimes, ere yet free from parental attachment, it has two generations on its own body. Four or five offspring are thus produced weekly. But the most extraordinary circumstance in respect to this creature is thus described by M. Trembley: "If one of them be cut in two, the fore part, which contains the head and mouth and arms, lengthens itself, creeps, and eats on the same day. The tail part forms a head and mouth at the wounded end, and shoots forth arms more or less speedily, as the heat is favourable. If the polype be cut the long way through the head, stomach, and body, each part is half a pipe, with half a head, half a mouth, and some of the arms at one of its ends. The edges of these half pipes gradually round themselves and unite, beginning at the tail end; and the half mouth and half stomach of each becomes complete. A polype has been cut lengthways at seven in the morning, and in eight hours afterwards

each part has devoured a worm as long as itself." Still more wonderful is the fact, that if turned inside out, the parts at once accommodate themselves to their new condition, and carry on all their functions as before the accident. Indeed, this animal seems so peculiarly endowed with the germs of vitality in every part of its body, that it may be cut into ten pieces, and everyone will become a new, perfect, living animal. This seems bordering on the vegetable kingdom, in which it is common to propagate by means of slips from the mature shrub.

The best known of the British species are *Hydra vulgaris*, Common polype, *H. viridis*, Green polype, *H. Tusca*, Brown polype, *H. verrucosa*, and *H. lutea*.

Every reflecting person who reads even the slight sketch we have given of this polype tribe must be struck with astonishment at a creature so primitive in structure, possessing the actions, sensations, and powers of higher organised beings. The stomach is but one simple structureless membrane or cell, the external surface-cells forming a kind of double skin, the inside a mere wall of cells running crosswise, possessed of a velvet-like surface, and red or brown coloured grains held together by a glutinous substance. This singular formation, with some of the functions of animal life, has led to many learned surmises and discussions tending to the most important results in the science of physiology.

TUBULARIADÆ.—The *Tubular* or *Vaginated Polypes* are of an arborescent appearance; the animals live near the ends of branches, and are found attached to stones, seaweeds, and shells.<sup>1</sup> The *Tubularia indivisa*, "Individed tubes," rise up like a tuft of herbage, of a horn colour, to the height of twelve inches. Ellis says, "they seem part of an oat-straw with the joints cut off." At the summit protrudes the scarlet-coloured polypes, well furnished with tentacula, and connected with a pinkish fluid that fills the tubes. It was in these that Dr. Roget discovered the singular peculiarity of a circulation, similar to that seen in many plants. He says, "In a specimen of the *Tubu-*

(1) These are grouped with *Hydroïda*, and at the head of the family stand Van Beneden's *Hydractinia*; and Gaertner's *Coryne*.

*laria indivisa*, when magnified one hundred times, a current of particles was seen within the tubular stem of the polype, strikingly resembling, in steadiness and continuity of its stream, the vegetable circulation in the *chara*. Its general course was parallel to the slightly spiral lines of irregular spots on the surface of the tube, ascending on the one side, and descending on the other; each of the opposite currents occupying one-half of the circumference of the cylindric cavity. At the knots, or contracted parts of the tube, slight eddies were noticed in the currents; and at each end of the tube the particles were seen to turn round, and pass over to the other side.

“The particles carried by it present an analogy to those of the blood in the higher animals of one side, and of the sap of vegetables on the other. Some of them appear to be derived from the digested food, and others from the melting down of parts absorbed; but it would be highly interesting to ascertain distinctly how they are produced, and what is the office they perform, as well as the true character of their remarkable activity and seemingly spontaneous motions; for the hypothesis of their individual vitality is too startling to be adopted without good evidence.”

Respecting the singular property of the head dropping off, *Tubularia indivisa*, Sir J. G. Dalyell observes, “The head is deciduous, falling in general soon after recovery from the sea. It is regenerated at intervals of from ten days to several weeks, but with the number of external organs successively diminishing, though the stem is always elongated. It seems to rise within this tubular stem from below, and to be dependent on the presence of the internal tenacious matter with which the tube is occupied. A head springs from the remaining stem, cut off very near the root; and a redundance of heads may be obtained from artificial sections, apparently beyond the ordinary provisions of nature. Thus, twenty-two heads were produced through the course of 150 days from three sections of a single stem.”

Included in this family are the *T. ramosa*, *T. ramea*, perfect trees in miniature; and the *Hermia glandulosa*



of Dr. Johnston, who says—"I found the name in Shakspeare :

' What wicked and dissembling glass of mine,  
Made me compare with Hermia's spherie eyne?'"

The fancy that the glands which surround the heads were the guardians of the animal, its "spherie eyne," suggested the name here adopted.

These polypes are adherent by a tubular fibre, and creep along the surface of the object on which they grow ; they are seldom an inch in height, irregularly branched ; the stem filiform, tubular, horny, sub-pellucid, wrinkled, and sometimes ringed at intervals, especially at the origin of the branches, each of which is terminated with an oval or club-shaped head of a reddish colour, and armed with short scattered tentacula, tipped with a globular apex. The ends of the branches are not perforated, but completely covered with a continuation of the horny sheath of the stem. The animal can bend its armed hands at will, or give to any separate tentaculum a distinct motion and direction ; but all its movements are very slow.

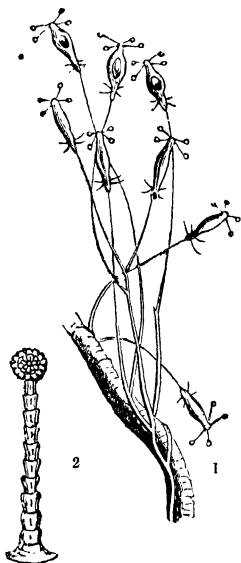

Fig. 190.

1, *Coryne stauridia*, Slender Coryne. 2, A tubercle detached, and magnified 200 diameters.

The beautiful little *Coryne stauridia*, "Slender coryne," (fig. 190, No. 1), is thus described by Mr. Gosse : "It was found by me adhering to the footstalk of a *Rhodymenia*, about which it creeps in the form of a white thread ; by placing both beneath the microscope, this thread appeared cylindrical and tubular, perfectly transparent, without wrinkles, but permeated by a central core, apparently cellular in texture, and hollow ; within which a rather slow

circulation of globules, few in number, and remote, is perceived. It sends off numerous branches; the terminal head of which is oblong, cylindrical, rounded at the end. At the extreme point are fixed four tentacula of the usual form, long, slender, and furnished with globular heads; one of which is shown at No. 2, detached, and more highly magnified. It is much infested with parasites: a vorticella grows on it, and a sort of vibrio; the latter in immense numbers, forming aggregated clusters here and there; the individuals adhering to each other, and projecting in bristling points in every direction. These animalcules vary in length; some being as long as 1-80th of an inch, with a diameter of 1-7000th of an inch. They are straight, equal in thickness throughout, and marked with distinct transverse lines; they bend themselves about with considerable activity, and frequently adhere to the polype by one extremity, while the remainder projects freely."

Some of this family attain a considerable size; the *Corymorpha nutans*, one of the most beautiful of the group, attains a length of four inches and a half. Of the beauty of its appearance, Forbes, who discovered it in the British seas, speaks in the following terms: "When placed in a vessel of sea-water, it presented the appearance of a beautiful flower. Its head gracefully nodded (whence the appropriate specific appellation given it by Sars), bending the upper part of its stem. It waved its long tentacula to and fro at pleasure, but seemed to have no power of contracting them. It could not be regarded as by any means an apathetic animal, and its beauty excited the admiration of all who saw it." The general colour of the creature is a delicate pink, with longitudinal lines of brownish or red dots. The tentacles are very numerous and long, and of a white colour; and the ovaries, which are situated immediately above the circle of tentacles, are orange. Most of the *Tubulariadæ* inhabit the sea; one species, the *Cordylophora lacustris*, is found in the dock of the Grand Canal, Dublin, in water which is perfectly fresh.

SERTULARIADÆ.—This interesting and beautiful family of polypes derive their name from their *plant*-like appearance, and are readily attainable on our own sea-shores.

Linnæus made a large genus of them; but Lamarck considerably reduced his classification. There are seventeen British species, which Dr. Fleming proposes to divide into two groups, with stems simple or compound.

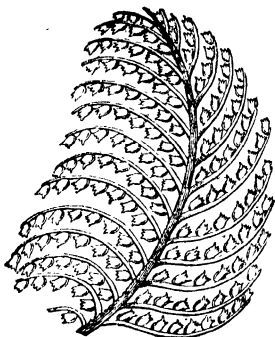

Fig. 191.—*Sertularia, Polypidom* of.

The tentacles of *Sertularia* are abundantly supplied with cilia; the cells are pitcher-shaped, arranged alternately, or in pairs obliquely, not exactly opposite, on the stem and branches of the polypidom, which is horny. Lamouroux classed with this family *Thoa*; of which there have been several kinds found in Great Britain. The name is supposed to be derived from the Greek word for sharp; but we think, with Dr. Johnston, that it more probably is a mis-spelling of *Thoe*, one

of the Nereids, nymphs of the sea. They are generally of a brown and yellow colour, branched, and from an inch and a half to six inches in height.

*Sertularia pumila*.—This is parasitic, and spreads its brown-coloured shoots over various fuci and sea-shells; but rarely attains more than half an inch in height. Stewart says:—"This species, and probably many others, in some particular states of the atmosphere, emits a phosphorescent light in the dark. If a leaf of the *fucus serratus*, with *Sertularia* upon it, receives a smart stroke in the dark, the whole is most beautifully illuminated, every denticle seeming to be on fire."

On the south-eastern coast of England the most common kind found is the *Sertularia setacea*, which, after rough weather, is cast on the shore attached to sea-weed. The stem and branches seem composed of separate pieces, fitting into each other as some foreign trees do, and terminate in a star-like head, from which radiate the feelers or arms. Dr. Mantell states he was present on one occasion when Mr. Lister was observing a living specimen: a little

globular animalcule swam rapidly by one of the expanded polypes; the latter immediately contracted, seized the globule, and brought it to the mouth or central opening by its tentacula; these gradually opened again, with the exception of one, which remained folded, with its extremity on the animalcule. The mouth instantly seemed filled with cilia, which, closing over the prey, was carried slowly down its stomach; here it was imperfectly seen, and soon disappeared.

Appertaining to this family are Dr. Fleming's *Thuiarea*, so named by him from their resemblance to a cedar-tree; some kinds look more like a knobbed thornstick with a bottle-clearer at the top; others resemble a fir-tree. *Antennularia* are so called from their resemblance to a lobster's antenna. They are plentiful on the north-eastern coast of England and the coast of Ireland, brown in colour, and covered with hair-like little branches; and as the hairy process is continued up its jointed stem, it is sometimes denominated *Sea-beard*. Dr. Hassall's *Coppinia* is another very interesting species.

The *Plumularia*, so named from their shoots and offsets being plumous, are an extensive and beautiful family. Professor Grant thus describes the *Plumularia falcata*: "This species is very common in the deeper parts of the Frith of Forth; its vesicles are very numerous, and its ova are in full maturity at the beginning of May. The ova are large, of a light-brown colour, semi-opaque, nearly spherical, composed of minute transparent granules,



Fig. 192.

1, *Plumularia pinnata*, Feather polype.  
2, *Doris tuberculata*, Sea slug.

ciliated on the surface, and distinctly irritable. There are only two ova in each vesicle; so that they do not require any external capsules, like those of the *Campanularia*, to allow them sufficient space to come to maturity. On placing an entire vesicle, with its two ova, under the microscope, we perceive through the transparent sides the cilia vibrating on the surface of the contained ova, and the currents produced in the fluid within by their motion. When we open the vesicles with two needles, in a drop of sea-water, the ova glide to and fro through the water, at first slowly, but afterwards more quickly, and their cilia propel them with the same part always forward. They are highly irritable, and frequently contract their bodies so as to exhibit those singular changes of form spoken of by Cavolini. These contractions are particularly observed when they come in contact with a hair, a filament of conferva, a grain of sand, or any minute object; and they are likewise frequent and remarkable at the time when the ovum is busied in attaching its body permanently to the surface of the glass. After they have fixed, they become flat and circular, and the more opaque parts of the ova assume a radiated appearance; so that they now appear, even to the naked eye, like so many minute grey-coloured stars, having the interstices between the rays filled with a colourless transparent matter, which seems to harden into horn. The grey matter swells in the centre, where the rays meet, and rises perpendicularly upwards surrounded by the transparent horny matter, so as to form the trunk of the future zoophyte. The rays first formed are obviously the fleshy central substance of the roots; and the portion of that substance which grows perpendicularly upwards, forms the fleshy central part of the stem. As early as I could observe the stem, it was open at the top; and when it bifurcated to form two branches, both were open at their extremities; but the fleshy central matter had nowhere developed itself as yet into the form of a polype. Polypes, therefore, are not the first formed of this zoophyte, but appear long after the formation of the root and stem, as the leaves and flowers of a plant."

Attached to fuci and shells in abundance on the southern coast of England, may be found the *Plumularia cristata*. It

is affixed by a horny, branching, interlacing, tubular fibre to the object on which it grows. At different parts there are plumous shoots, usually about an inch in height. The cells are of a yellow colour, set in the stalk, of a bell-shape, and are compared to the flower of the lily of the valley; the rim is cut into eight equal teeth; the polype minute and delicate, tentacles ten and annulate, with a mouth infundibuliform in shape.

"Each plume," says Mr. Lister, in reference to a specimen of this species, "might comprise from 400 to 500 polypes;" "and a specimen," writes Dr. Johnston, "of no unusual size, before me, has twelve plumes, with certainly not fewer cells on each than the larger number mentioned: thus giving 6000 polypes as the tenantry of a single poly-pidom! Now, many such specimens, all united too by a common fibre, and all the offshoots of one common parent, are often located on one sea-weed, the site then of a population which nor London nor Pekin can rival."

*Plumularia pinnata*, "Feather polyp," (represented magnified in fig. 192, No. 1,) is as remarkable for the elegance of its form, as its likeness to the feather of a pen. It serves not among the denizens of the deep the same purpose as its earthly prototype; nature writes her works in hieroglyphics formed by the objects themselves. It is plumous, and the cells in a close row, cup-like, and supported on the under side by a lengthened spinous process.

An interest pervades the valuable work of Dr. Johnston, arising from the circumstance that the plates and woodcuts which adorn the volume are, with few exceptions, engraved from drawings made for it by Mrs. Johnston, who also engraved several of them; and the Doctor states, he could not have undertaken the history without such assistance. From this devotion too, and understanding of the subject, it was natural, when an opportunity presented itself, to write in the catalogue of Zoophytes a lasting memorial of his "colleague:" and thus is written the graceful compliment of the beautiful *Plumularia Catharina*: "Catharine's Feather," whose stem is plumous, pinnæ opposite, bent inwards; cells distant, campanulate, with an even margin; vesicles scattered, pear-shaped, smooth.

Found in old shells, corallines, &c., in deep water; in Frith of Forth and in Berwick Bay, by Dr. Coldstream.

The sub-families, *Campanularia* and *Laomedea*, are also frequently found on our shores; they possess a simple circle of cilia on their feelers or arms, with pitcher-shaped cells on stalks that branch, twist, or climb on an axis.

*Campanularia volubilis*, "Twining polype," is the commonest of the family: it is parasitical, and infests the antennæ of crabs; its stem is filiform, and at the end of its slender branches are situated the cells containing the polypes. The polype itself is slender when protruded, somewhat like *Plumularia pinnata*, and becomes dilated at the base into a sort of foot which spreads over the diaphragm; widening again at the top, where it fills the mouth of the cell, and gives origin to about twenty slender tentacula, set in two or three series. From the central space, which is surrounded by tentacles, a large fleshy mouth protrudes, somewhat funnel-shaped, with lips, endowed with the power of protrusion and contraction; these appear to be very sensitive. Mr. Gosse found the species in great abundance round Small-mouth Caves.

The *Campanularia gelatinosa* and its beautiful bell-shaped cells, out of which the animal protrudes, give it the semblance of a green flower with a delicate pink stalk. It is indeed an interesting object, and currents may be seen in its tubes. Dr. Johnston says, "On Saturday, May 29th, 1837, a specimen of *Campanularia gelatinosa* was procured from the shore; and after having ascertained that the polypes were active and entire, it was placed in a saucer of sea-water. Here it remained undisturbed until Monday afternoon, when all the polypes had disappeared. Some cells were empty, or nearly so; others were half-filled with the wasted body of the polype, which had lost, however, every vestige of their tentacula. The water had become putrid, and the specimen was therefore removed to another vessel with pure water, and again set aside. On examining it on the Thursday, June 1st, the cells were evidently filling again, although no tentacula were visibly protruded; but on the afternoon of Friday, June 2d, every cell had its polype, complete, and

displayed in the greatest perfection. Had these singular facts been known to Linnæus, how eagerly and effectively would he have impressed them into the support of his favourite theory! Like the flowers of the field, the heads, or 'flores,' of these polypidoms expand their petaloid arms, which after a time fall, like blighted blossoms off a tree; they do become 'old in their youth,' and, rendered hebetous and unfit for duty or ornament by age or accident, the common trunk throws them off, and supplies its wants by ever-young and vigorous growths. The phenomena are of those which justly challenge admiration, and excuse a sober scepticism, so alien are they to all we are accustomed to observe in more familiar organisms. Faithful observation renders the fact undeniable; but besides that, a reflection on the history of the *Hydra* might almost have led us to anticipate such events in the life of these Zoophytes. 'Verily, for mine own part,' observes Baker, 'the more I look into Nature's works, the sooner am I induced to believe of her even those things that seem incredible.'"

ACTINIADÆ.—All persons accustomed to wander by the sea-shore must have admired the livid green, dark little jelly-masses adhering to the rocks,—called *Actinia*, from a Greek word signifying a ray,—and left in some little pool by the ebbing tide, living as they do principally within high and low water mark, and expanding their broad surfaces and fringing feelers to the finger of inquisitive youth, so often thrust into the centre, to feel the effect of the suction and rasping, as the poor animal draws itself up in the form of a little fleshy hillock.

Some few years ago it might have been necessary to explain what we meant by an *Actinia*, or "Sea-anemone;" thanks to the universal distribution of *aquaria*, this beautiful class of radiates is no longer unfamiliar to the world. Nevertheless, much as people read, and hear, and write, and observe in the matter, we do not hesitate to say that the natural arrangement of these animals is as little known in the world of naturalists, as their very existence was a short time ago to the world at large. A familiar instance of this position may be given in a few words. Dr. Johnston (*Hist. Brit. Zooph.*) describes three distinct



*Actiniæ*, under the names of *A. troglodytes* (the Cave-dweller), *A. viduata*, and *A. anguicomæ* (the Snaky-locked). Mr. Gosse, in his *Devonshire Coast*, makes *A. viduata* synonymous with *A. anguicomæ*; and gives a drawing and a description of an anemone which he calls *anguicomæ*, and which closely resembles undoubted specimens of Johnston's *A. troglodytes*. Many objections might be taken to Mr. Gosse's description of *species*, which he makes out from the number of their tentacles, although found in company with each other, and, as he justly remarks, are of "the same size and form." The following are at the present time said to be distinct species:—

GROUP I.—Skin smooth; a row of beads on the oral disc, close to the margin of the body, which contain "spike cases."

1. *Actinia mesembryanthemum* (the Common sea-anemone).—Striped with pea-green on an apple-green ground.

2. *Actinia fragacea* (the Strawberry anemone).—Skin soft, spotted with green on a liver-coloured ground.

3. *Actinia margaritifera* (the Pearly anemone).—Skin leathery, beads ultra-marine.

GROUP II.—Skin covered with numerous conical, large, coloured, perforated warts.

1. *Actinia gemmacea* (the Gem).—Warts arranged in vertical rows, six or more of which contain larger and whiter warts than the rest.

2. *Actinia clavata* (the Weymouth anemone).—Warts arranged in vertical rows, and all equal.

3. *Actinia coriacea* (the Thick-skinned anemone).—Warts irregularly arranged; varieties numberless.

GROUP III.—Warts flattened, and on the upper portion of the body only; white threads sent out from invisible pores, and containing spike-cases.

1. *Actinia bellis* (the Daisy).—Disc flat, two or three times as broad as the body, when the latter is at all lengthened; tentacles very numerous, small, and crowded horizontally on the outer edge of the disc.

2. *Actinia troglodytes* (the Cave-dweller).—Tentacles erect, few, taper, barred at their base with a dark ring, containing a white heart-shaped mark. Habit: hides under

stones ; body irregularly flattened when in a state of contraction.

3. *Actinia anguicom*a or *viduata* (the Snake-locked anemone).—Tentacles few, very long, taper, and flexible ; two vertical streaks down each tentacle. Habit : alternately very flat and columnar.

4. *Actinia rosea* (the Rosy anemone).—Tentacles few, rosy red ; mouth, a cross of four rounded lobes.

5. *Actinia candida* (the White anemone).—Tentacles graduated, those of the inner row being the largest, opaque snowy white ; inner row of tentacles ringed with dark red or brown ; body and disc white.

6. *Actinia dianthus* (the Plumose anemone).—Margin of the disc fringed with numerous small tentacles, and much lobed ; tentacles many, graduated ; body from one to five inches in diameter.

7. *Actinia parasitica* (the Parasitic anemone).—Outer tentacles smaller, and turned downwards over the rim of the disc ; tentacles about 500, and graduated ; body about two inches in diameter, and three in height, of a yellowish white, ribbed vertically with dark brown. Habit parasitic, chiefly on shells.

8. *Actinia aurora* (the Orange-tentacled anemone).—Outer tentacles smaller, and turned downwards ; tentacles about 80 in number, tinged with orange ; body half an inch in diameter, of brown or olive-green colour, lined with vertical bands of white.

9. *Actinia venusta* (the Orange-disced anemone).—Outer row of tentacles smaller than the rest, and turned downwards ; tentacles about 250, graduated, white ; body, half an inch in diameter, orange-brown ; disc oval, of a bright-orange colour ; base oval.<sup>1</sup>

The *Actiniæ* are more familiarly known by the name of *Sea-anemones*, or *Animal flowers*. In their appetites they are voracious, and seize the numerous little inhabitants of the sandy shores. Dr. Johnston says : “ I had once brought me a specimen of *Actinia gemmacea*, that might have been originally two inches in diameter, and that had somehow contrived to swallow a valve of *Pecten maximus*, of the size of an ordinary saucer. The shell, fixed within

(1) Mr. Tugwell's *Manual of Sea-Anemones*.

the stomach, was so placed as to divide it completely into two halves ; so that the body, stretched tensely over, had become thin, and flattened like a pancake. All communication between the inferior portion of the stomach and the mouth was of course prevented ; yet, instead of emaciating

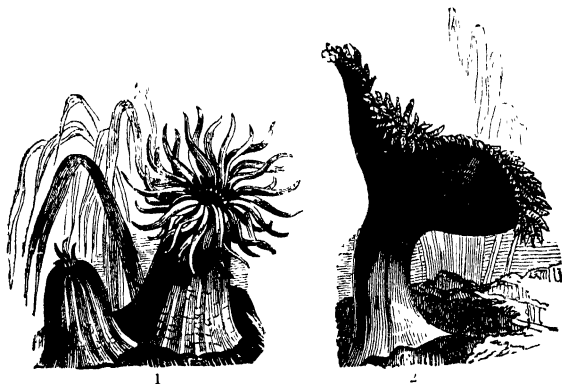

Fig. 193.

1, *Actinia rubra*, Sea marigold, near which is one shown retracted. 2, *Actinia bellis* Daisy sea-anemone (a side view of the animal).

and dying of atrophy, the animal had availed itself of what had undoubtedly been a very untoward accident, to increase its enjoyments and its chances of double fare. A new mouth, furnished with two rows of numerous tentacula, was opened up on what had been the base, and led to the under-stomach : the individual had, indeed, become a sort of Siamese twin, but with greater intimacy and extent in its unions." The following observations made by Diquemare on these rivals of the weather-wise leeches, are both interesting and curious to sea-shore residents : " My very earliest observation showed that the sea-anemones feel, and prognosticate within doors, the different changes of temperature in the atmosphere. I had not leisure at that time to form tables of their various indications ; but I have since done it. This fact, if applied to practice, might be of use in the formation of a sea-barometer—an object of no small importance, which several

ingenious men have hitherto endeavoured in vain to furnish us with. I should prefer the anemones of the first group for this purpose, their sensation being very quick; they are also easily procured, and may be kept without nourishment. Five of them may be put in a glass vessel four inches wide and as many in depth, in which they will soon cleave to the angle formed by the sides and the bottom. The water must be renewed every day; and as they do not require a great quantity of it, as much may be fetched from the sea (if they be kept on land) as will supply them for several days; its settling some time will only improve it. If the anemones be at any time shut or contracted, I have reason to apprehend an approaching storm; that is, high winds and an agitated sea. When they are all shut, but not remarkably contracted, they forbode a weather somewhat less boisterous, but still attended with gales and a rough sea. If they appear in the least open, or alternately and frequently opening and closing, they indicate a mean state both of winds and waves. When they are quite open, I expect tolerably fine weather, and a smooth sea. And lastly, when their bodies are considerably extended, and their limbs divergent, they surely prognosticate fixed fair weather and a calm sea. There are times when some of the anemones are open, and others shut; the number must then be consulted—the question is decided by the majority. The anemones used as barometers should not be fed; for then the quantity of nourishment might influence their predictions. Anemones of this and of the third group live and do well for several years without taking any other food but what they find disseminated in the sea-water; but should a respite of some days be granted them, they might then be fed with some pieces of mussels or soft fish, and thus restored to their original vigour. Whenever the vessel is sullied by the sediments of salts, slime, the first shoots of sea-plants, &c., the animals may, on changing the water, be cleansed.

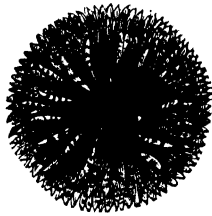

Fig. 194.—*Actinia bellis*, seen from above, with its crown of tentacles fully expanded.

by wiping them with a soft hair pencil, or even with the finger, carefully avoiding to rub or press hard on the anemones. Should any of them drop off during this operation, they may be left at liberty; for they will soon of their own accord fix themselves to some other place. Should any of them die, which will soon be discovered by the milky colour of the water, and an offensive smell on changing it, it must be taken out, and, on the first opportunity, another of the same species be put in its place; those of a moderate size are the most eligible."

*Anthea*, a flower, is the name given by Dr. Johnston to his family *Helianthoida*. *Anthea cereus* is of a pretty light-brown colour, having a somewhat cylindrical furrowed body. From 50 to 200 feelers arise from the disc of the animal, which, when expanded, are longer than the body, and of a bright sea-green colour tipped with red; in other kinds the colour varies. They belong to the *Actiniæ*, and are common on the Cornwall coast: Ellis says of them, "Their tentacula being disposed in regular circles, and tinged with a variety of bright lively colours, very nearly represent the beautiful petals of some of our most elegantly fringed and radiated flowers, such as the carnation, marigold, and anemone."

Allied to the family *Actiniæ*, are those laminated, circular-form corals, called *Fungia*, "Sea-mushrooms," usually found in great variety; colour white, of a flattened round shape, made up of thin plates or scales, around which is a translucent jelly-like substance, and within a large polype; for, unlike others, they exist as individuals: the lower portion, by which the animal is affixed to the rock whereon it lives, is of a stony character.

In Ellis's *Zoophytes* is the following passage, quoted from Rumphius, in regard to the *Fungia agariciformis*: "The more elevated folds or plaits have borders like the denticulated edge of needlework-lace. These are covered with innumerable oblong vesicles, formed of a gelatinous substance, which appear alive under water, and may be observed to move like an insect. I have observed these radiating folds of the animal, which secrete the lamellæ, and which shrink between them when the animal contracts itself on being disturbed. They are constantly moving in

tremulous undulations; but the vesicles appeared to me to be air-vessels placed along the edges of the

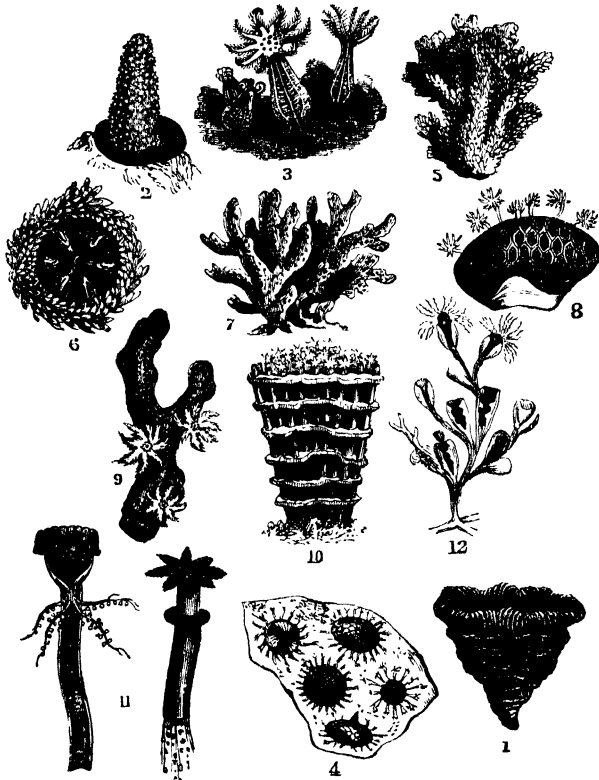

Fig. 195.—Zoophytes.

- 1, *Fungia agariciformis*. 2, *Alcyonium*, *Cydonium Mulleri*. 3, *Cydonium*, polypes protruding and tentacles expanded, others closed. 4, *Xanthidia*, in flint. 5, *Madrepore Abrotanoide*. 6, *Madrepore*, cell magnified showing internal structure. 7, *Corallidæ*; Coral. 8, *Coral*, polypes magnified and protruding from the cells. 9, *Gorgonia nobilis*, polypes magnified and expanded. 10, *Tubipora musica*, polypes protruded. 11, A tube of same, with polype expanded, and one cut longitudinally to show its internal structure. 12, *Sertularia*, polypes protruded; and others withdrawn into their cells.

folds, and the vesicles disappeared when the animal was touched."

In the British Museum there is a splendid specimen of the *Brainstone Coral*, or *Meandrina cerebriformis*, so named by the appearance of its surface resembling the convolutions of the medullary substance of the human brain. In a living state the mass is invested with a fleshy substance, variously coloured, and having numerous short, conical polypiform, confluent cells, arranged in rows between the ridges. It attaches itself by a strong stony secretion to rocks; and as one generation passes away, on the shelly remains another arises; and thus the imperishable charnel-houses are built upon and increased in magnitude.

LUCERNARIDÆ, "Lamp polypes."—These beautiful and singular animals may be seen swimming quickly through the waters, or more generally adhering to sea-weed, and spreading out and contracting their bodies as they seize their prey; for as soon as the little knobbed tentacles have seized an animal, it is carried to the mouth, and the body contracts, and closes up to consume it. They are of a jelly-like appearance, with a smooth and thickish skin; their bodies are arborescent, with bell-shaped cells, having small suckers at the bottom, and are divided into eight compartments, as we see in other species of the *Actinia*.

*Lucernaria campanulata*.—This graceful animal is about an inch in height, of a bell-shape, terminating in a sucker resembling the stand of a stalked drinking-glass. The upper part is indented by eight short processes or arms, stretching upward, and terminated by a delicate tuft of a blossom-like appearance; these, about sixty in number, are tentacles, by means of which it takes its prey. The interior resembles a flower, in the centre of which is a square mouth; from this spreads out four leaves, adding much to the beauty of its appearance. Its colours are various and rich.

Dr. Johnston mentions in the British family of *Lucernaria*, *L. fascicularis* and *L. auricula*; they differ but little from *L. campanulata*. They propagate by ova, which are seen as two rows of spots in the arms that extend around the mouth.

MADREPORIDÆ.—*Madrepores*, *Mother-pores*, "tree corals,"

differ from other corals in not having a smooth skeleton, but one inducted by numbers of small cells for the residence of the living animal: these are very visible in the *Madrepore muricata*, when the polype is dead and decomposed; but most distinct in the *Oculina ramea*, as they are situated at the apparently broken stumps that branch from the trunk of the skeleton (fig. 195, No. 5). Every branch is seen to be covered with multitudes of small pits or dots, scarcely visible to unassisted vision; but when viewed under the microscope, are found to be cells of the most beautiful construction, remarkable alike for their mathematical regularity and the exquisite fineness of the materials employed in their composition. A magnified drawing of one of the cells is given at No. 6. The living polypes are most beautiful in their native waters; their varying colours adding to the richness of the hues covering the bed of the ocean.

*Caryophylleadæ*, "Nut-leaf corals." The *Caryophyllia Smithii* is found fixed to rocks; it is round, and of a dingy white colour. Dr. Fleming says of the plates: "The lamellæ are disposed in fours, and may be divided into three different kinds. The first are the highest and the broadest at the margin; but as they descend into the disc, they become narrower before they join the central plate. The second kind are narrower than the preceding at the margin, but towards the middle they suddenly enlarge and join the middle plate. The third kind are the smallest, and terminate before reaching the middle plate. The space included between a pair of the first kind of plates contains one of the second kind in the middle, with one of the third kind in each of the lateral spaces. Those on the sides are rough, with small scattered tubercles, and their margins are curled. This last circumstance occasions the roughness externally, where the longitudinal striæ are the remains of the gills. The plate which occupies the bottom of the cavity is smooth, variously twisted, and connected with the base of the lateral plates."

Dr. Coldstream, writing to his friend Dr. Johnston, gives the following interesting account of the animal: "When the soft parts are fully expanded, the appearance of the whole animal resembles very closely that of an *Actinia*.



When shrunk, they are almost entirely hid amongst the radiating plates. The specimens I have seen have varied in size from three-tenths to half an inch in height. They are found pendent from large boulders of sandstone, just at low-water mark ; sometimes they are dredged from the middle of the bay (Torquay). Their colour varies considerably ; I have seen the soft parts white, yellowish, orange-brown, reddish, and of a fine apple-green. The tentacles are usually paler. During expansion, the soft parts rise above the level of the calcareous disc to about twice its height. The tentacles are pushed forth very slowly, but sometimes are as long as the whole height of the body ; and are terminated by a rounded head. The mouth has the appearance of an elongated slit in the centre of the disc ; it is prominent, and the lips are marked with transverse striæ of a white colour. When a solid body is brought into contact gently with the tentacles, they adhere pretty strongly to it, just as the *Actinia* do ; but when they are rudely touched, they contract very quickly, and if the irritation be continued, the whole soft parts sink within the calcareous cup."

ASTEROIDÆ.—This order of Zoophytes is named *Asteroida* from the polypes presenting the form of a star on the surface of the fleshy mass in which they reside. The fleshy tough mass is supported by hard calcareous spicula ; some have thick branching processes, performing the part of the skeleton in the human frame. This central internal support is usually denominated the axis. The fleshy mass, or covering, is possessed of sensation, and ramified by various tubes and canals for the sustenance and other functions of life of the polypes. Included with this genera are *Gorgoniadæ*, *Pennatulidæ*, *Alcyonidæ*, *Isidæ*, and *Tubiporidæ*.

PENNATULADÆ.—The family derives its name from *penna*, a quill, which the animal much resembles ; a spiculum from one is shown at No. 3, fig. 172. Naturalists call them *Sea-pens* ; a simple and appropriate term.

On many parts of the coast, when the fishermen haul in their nets, and more especially if baited with mussels, there are found attached to the bait a number of polypes, which the boatmen call *Cocks'-combs*, but naturalists,

*Pennatula phosphorea* (fig. 200, No. 1); they are from two to four inches long, of a purplish-red colour, except at the base of the smooth stalk, which is a pale yellow, from, as the fishermen say, this part being imbedded in the mud at the bottom of the sea. They are built up in the same manner as the former. The papillæ on the back of the rachis, and between the pinnæ, are disposed in close rows, and do not differ from the polype-cells except in size. The latter are placed along the upper margin of a flattened fin; they are tubular, and have the aperture armed with eight spinous points, which are moveable, and contract and expand at the will of the animated inmates. The polypes are fleshy white, provided with eight rather long retractile tentacula, beautifully ciliated on the inner aspect with two series of short processes, and strengthened moreover with crystalline spicula, there being a row of these up the stalk, and a series of lesser ones to the latter cilia. The mouth, in the centre of the tentacula, is somewhat angular, bounded by a white ligament, a process from which encircles the base of each tentaculum, which thus seems to issue from an aperture. The ova lie between the membranes of the pinnæ; they are globular, of a yellowish colour, and by a little pressure can be made to pass through the mouth.

Dr. Grant writes: "A more singular and beautiful spectacle could scarcely be conceived than that of a deep purple *Pennatula phosphorea*, with all its delicate transparent polypes expanded and emitting their usual brilliant phosphorescent light, sailing through the still and dark abyss, by the regular and synchronous pulsations of the minute fringed arms of the polypes." The power of locomotion is doubted by other writers, and the pale blue light is said only to be omitted when under the influence of some painful irritation.

In some genera, *Virgularia mirabilis* and *pavonaria*, to which the name of *Sea-rush* has been given, the central stem is from six to ten inches long (see No. 2, fig. 172). Sowerby describes them as like a quill stripped of its feathers. The base has some resemblance to a pen, as in the other species, swelling a little from the end, and then tapering. The upper part is thicker, with alternate semicircular pec-

minated swellings, larger towards the middle, tapering upwards, and terminating in a thin bony substance, which passes through the whole. Professor Grant writes of them: "Their *axis* is calcareous, solid, white, brittle, flexible, cylindrical, of equal thickness throughout, and exhibits no mark of attachment at either end. When broken, it exhibits a radiated surface, like the broken spine of an *echinus*. The axis appears to have little connection with the fleshy part, and to consist of concentric layers deposited by the soft parts surrounding it. When a portion of the axis is broken off from either extremity, the animal retracts at that part, so as continually to expose a fresh naked portion of the axis; hence we can take out the axis entirely from its soft sheath, and we always find the lower pinnæ of the animal drawn up closely together, as if by the frequent breaking of the base. These very delicate and brittle animals seem to be confined to a small circumscribed part of the coast, which has a considerable depth and a muddy bottom; and the fishermen accustomed to dredge at that place believe, from the clearness of the *Virgulariæ* when brought to the surface, that they stand erect at the bottom with one end fixed in the mud or clay. Müller's specimens were found on a part of the Norwegian coast with a muddy bottom."

ALCYONIDÆ.—The family of the *Alcyonium* derive their name from Alcyone or Halcyone, the daughter of Neptune and wife of Ceyx, who, hearing of her husband's death at sea, cast herself into it; and there, with her husband, was changed into birds of the same name, to keep the waters calm, while they were sitting in nests of sea-foam for the space of seven, eleven, or fourteen days. Thus Alcyon signifies Kingfisher, or sea-foam.

*Alcyonium digitatum*, "Fingered Alcyonium," (Fig. 195, No. 2).—The French call it *Main de Mer*, "sea-hand," the Germans *Diebshand*, "thief's hand." Sometimes they are very small; but when larger are named by the fishermen *Cows'-paps*, and others, differing a little in form, *Dead Men's Toes*, or *Dead Men's Hands*. Their spiculæ are calcareous, or siliceous crystalline, in the form of a cross, toothed at the sides, and lie scattered through a jelly-like mass. The cells occupied

by the polypes are placed at the terminations of canals which run through the polypidom, and which, by their union with each other, serve to maintain a communication between the individual polypes constituting the mass. The rest of the polypidom is made up of a transparent gelatinous substance, containing the calcareous spicula above mentioned, and pervaded by numerous small fibres, which form a sort of irregular network. *Alcyonidæ* are always attached to submarine bodies. The species already mentioned is exceedingly common round our coasts; so much so that, as Dr. Johnston says, "scarce a shell or stone can be dredged from the deep that does not serve as a support to one or more specimens."

"The ova," writes Professor Grant, "when placed under the microscope, and viewed by transmitted light, appeared as opaque spheres surrounded with a thin transparent margin, which increased in thickness when the ova began to grow, and such of the ova as lay in contact united and grew as one ovum. A rapid current in the water immediately around each ovum, drawing along with each all the loose particles and floating animalcules, was distinctly seen moving with an equal velocity as in other ciliated ova; and a zone of very minute vibrating cilia was perceptible, surrounding the transparent margin of all the ova. The progressive motion of the ova, always in a direction contrary to that of the current created by their cilia, was very obvious, though less rapid than in any other zoophyte in which I have observed the same remarkable phenomenon. The specimen suspended in a glass jar filled with pure seawater, I now brought so close to the transparent side of the vessel, that I could examine through it, with the assistance of a powerful lens, and without disturbing the animal, the motions and progress of the groups of ova passing through the colourless bodies of the polypes. To the naked eye, at first sight, all appeared motionless. The deep vermilion hue of the small round ova, and the colourless transparency of the outer covering of the polypes, formed a beautiful contrast with the pure white colour of the delicate longitudinal folds, the central open canal, and the slender filaments which wind down from its sides towards the clusters of white ova at the base: but the

living phenomena discovered within were even more admirable than the beautiful contrast of colours, the elegant forms, and the exquisite structure of all the parts ; when observed with a lens, the ova were seen to be in constant motion, and quite free within the bodies of the polypes. They moved themselves backwards and forwards, and frequently contracted their sides, as if irritated or capable of feeling. I could observe none passing upwards between the stomach and the sides of the polypes. They never assumed the appearance of a string of beads enclosed in a narrow, short, curved tube, as represented by Spix, but swam freely in the water which distended the polype, as figured by Ellis. Their motions in the polypes, though circumscribed, were so incessant, that, by watching attentively, I could observe them with the naked eye ; and they became more conspicuous as the ova advanced to the open base of the stomach. From their restlessness, as they approached the last passage which separates them from the sea, they seemed to feel the impulse of a new element, which they were impatient to enjoy ; and by following the direction of that impulse, they appeared to find their way into the lower extremity of the stomach, without any organic arrangement to lead them into that narrow canal. In their passage through the stomach, which was effected very slowly, the spontaneous motions of the ova were arrested, unless some imperceptible action of their cilia, or some contraction of their surface, might tend to irritate the sides of that canal, and thus direct or hasten their escape."

*Alcyonium gelatinosum*.—Attached to old stones and shells is this jelly-like transparent spongy zoophyte, growing to a height of nearly a foot, and sometimes much longer. It is branched, and of a brown or yellow colour, dotted with polypes, which are attached to the cells. Through angular openings they protrude their arms or feelers.

TUBIPORIDÆ.—To this family belong the handsome *Tubipora musica*, "Organ-pipe coral" (fig. 195, No. 10). The polypidum of which is composed of parallel tubes, united by lateral plates, or transverse partitions, placed at regular distances ; in this manner large masses, consisting of a congeries

of pipes or tubes, are formed. When the animals are alive, each tube contains a polype of a beautiful bright-green colour, and the upper part of the surface is covered with a gelatinous mass, formed by a confluence of the polypes. This species occurs in great abundance on the coasts of New South Wales, of the Red Sea, and of the Molucca Islands, varying in colour from a bright red to a deep orange. It grows in large hemispherical masses, from one to two feet in circumference, which first appear as small specks adhering to a shell or rock; as they increase, the tubes resemble a group of diverging rays, and at length other tubes are produced on the transverse plates; thus filling up the intervals, and constituting one uniform tubular mass; the surface being covered with a green fleshy substance beset with stellar polypes.

GORGONIADÆ.—This family is named after the three celebrated sisters, daughters of Phorcus and Ceto, who turned to stone all on whom they fixed their eyes, and one of whom had her hair turned into serpents. The species grow to a large size, rising to a foot or more in height, and being from fifteen to sixteen inches in width: they are flexible, and seem like plants growing to the rocks to which they are fixed. Some are branching, covered with lace-like work; others like a feather or fan; while some, again, are straight, and others of a drooping form. The stems flat, angular, or round, of a dark colour, with an outer crust of a soft substance full of pores, out of which the polypes thrust themselves. The flesh, when dry, is earthy and friable, a considerable proportion of carbonate of lime enters into its composition; but in a recent state it is soft and fleshy, and excavated by numerous cells for the lodgment of the polypes. When a portion of a branch is macerated in a weak acid, the lime is entirely removed; but the branch retains its original size and figure, and shows the framework to be an irregular close texture of corneous fibres, the interstices of which had been probably filled with a gelatinous fluid.

*Gorgonia flabellum*, sometimes called *Flabellum Veneris*, "Venus's fan," may often be seen of the height of five feet. It grows in the form of a net, with its branches compressed inwardly; the flesh is yellow, some-

times purple, with small mouths placed irregularly, having polypes with eight tentacles; the bone is black, horny, and slightly striated on the large branches. When alive, the colour is most beautiful, generally yellow with red spots, and is of a tough nature; but it varies much, both in shape and colour, presenting some of the most delicate and graceful forms that can be conceived. Its elegant skeleton is generally seen decorating the houses of sea-faring persons. Ray, referring to the fan-shape of some marine objects, says, "That the motion of the water descends to a good depth, I prove from those plants that grow deepest in the sea, because they all generally grow flat, in the manner of a fan, and not with branches on all sides like trees; which is so contrived by the providence of nature, for that the edges of them do in that posture with most ease cut the water flowing to and fro; and should the flat side be objected to the stream, it would soon be turned edgewise by the force of it, because in that site it doth least resist the motion of the water; whereas, did the branches of these plants grow round, they would be thrown backward and forward every tide. Nay, not only the herbaceous and woody submarine plants, but also the *Lythophyta* themselves affect this manner of growing, as I have observed in various kinds of corals."

In the British family there are also, *G. verucosa*, *G. placomus*, *G. anceps*, *G. lepadifera*, *G. umbraculum*, *G. nobilis*, fig. 195, No. 9, &c.

**ISIDEÆ**, the *Isis*, sea-shrubs, are small, but numerously scattered in a soft fleshy integument. *Isis hippuris*, "Horse-tail," so called from its resemblance to the *Equisetæ*, is the type by which this family is illustrated; it has a jointed stony stem, which rises into many loose branches. The stem or support of the animal consists of white, cylindrical, stony channelled joints, connected together by black, contracted, horny intermediate ones. The flesh is whitish, plump, and full of minute vessels; the surface of it is full of the little mouths of the cells, which are disposed in a quincunx order, covering the polypes with eight claws.

**ACALEPHÆ**.—In great variety of form and colour, swimming freely about the waters of the ocean, are found

in abundance the beautiful *Acalephæ*. From some of them having a remarkable stinging property, they have derived their name of *Sea-nettles*, while others, from their gelatinous nature, are better known as *Sea-jelly*, or *Jelly-fish*.

These interesting animals were first arranged in three orders: *A. stabiles* (fixed), *A. liberæ* (free), and *A. hydrostaticæ* (hydrostatic). Cuvier classed them in two orders: *A. simplices*, and *A. hydrostaticæ*. They are now, however, divided differently, and arranged in groups according to the peculiar mode by which they effect their locomotion. A very interesting point of connexion between this class and the preceding, is the interchange of form. Some of the *Zoophyta*, as the *Tube-*



Fig. 196.—*A Jelly-fish.*

*lariadæ* and the *Cumpanulariadæ*, give birth to a progeny which are in every respect *Naked-eyed Medusæ*; while, on the other hand, the young of the *Medusæ*, are, in their earlier stages stationary polypes.

The *Medusæ* spread on the surface of the water a beautiful jelly-like mass, that in form resembles an umbrella; and by a continual contraction and opening out of this part, they pass along in the path they desire. They are all more or less phosphorescent. The *Beroë*, like many of the *Infusoria*, propel themselves with active ciliated arms. The *Physalidæ* have an organ common to fishes,—swimming bladders,—by filling or emptying which they rise or sink, and move along in their watery home.

The *Portuguese Men-of-War* have a large bladder, which, when filled with air, rises above the surface of the waves, and is propelled by the wind—a contrivance something similar to, though more successful, we suspect, than the proposition to drag along land-carriages by means of balloons.

The flat circular horny disc forming the skeleton of *Propita gigantea*, to the naked eye exhibits both radiating and concentric markings; and when examined with a power of 40 diameters, its upper surface is found to be furrowed, and two rows of small projecting spines occur upon the ridges between the furrows, the ridges being the radiating fibres above noticed. The under-surface, or that



to which the greater portion of the soft parts of the animal are attached, is more deeply furrowed; and plicæ or folds of the mantle fit accurately into the furrows, from which they can easily be removed by the application of a gentle force. The concentric markings have in all cases small scalloped edges; they occur at certain regular intervals, and are so many indications of the lines of growth. In the centre there is a circular depression; and between its circumference and that of the first concentric marking, there are eight flattened radii. If the under-surface be examined with a power of 100 linear, the ridges will all be found to have small jointed tubular processes like hairs projecting from them. In no part of this horny tissue is there a trace of a cellular or a reticular structure.

Wonderfully beautiful as are these creatures in form and colour, the amount of solid matter contained in their tissues is incredibly small. The greater part of their substance appears to consist of a fluid, differing little, if at all, from the sea-water in which the animal swims; and when this is drained away, so extreme is the tenuity of the membranes which contained it, that the dried residue of a jelly-fish, weighing two pounds, which was examined by Professor Owen, weighed only thirty grains. The transparency of the tissues render the whole of the *Acalephæ* delightful objects for the microscope.<sup>1</sup>

ANNULOIDA.<sup>2</sup>—*Echinidæ* are found in abundance upon

(1) See an excellent paper in the *Transactions of the Microscopical Society*, "On the Anatomy of Two Species of Naked-eyed Medusæ," by G. Busk, Esq.; also Professor Forbes' works on this family.

(2) Description of our *Frontispiece*.—The *Aquarium*.

ASTEROIDEÆ.

a, *Astrophyton scutatum*.

n, *Ophsocomma rosula*.

NUBIURANCHIATA GASTROPODA.

b, *Doto pinnatifida*—back and side view.

ACALEPHÆ.

c, *Aequorea Forbesina*.

d, *Medusæ Bud*.

e, *Thaumantias corynetes*.

h, *Cydippe puleus*.

ECHINOIDEÆ.

f, *Echinus*. Young Sea-Urchins.

g, *Echinus sphaera*.

TUNICATA.

i, *Ascidia*.

k, *Botryllus violaceus*, clustering on the surface of a *Fucus*.

CRUSTACEA.

l, *Corystes cossivelanus*.

m, *Eurynome aspera*.

o, *Pagurus Prideauxii*, Hermit Crab.

p, *Ebalia Permanti*.

our sea-shores, lurking among the rocks, where they entrap their prey. Their spines and suckers are used as feet, or as a mode of progression, even to the climbing of rocks, in order to feed upon corallines and zoophytes: they march along with ease where apparently no footing could be found, or dig holes with their spines to bury themselves in the sand, to escape pursuers, or hide from observation. *Echinodermata*,<sup>1</sup> *sea-urchins*, or *sea-eggs*, derive their name from these curious spinous processes; they are divided into two principal orders, the *Echinoidea*, and *Holothurina*. These again are subdivided into families, as *Echinida*, *Asterida*, *Ophiurida*, *Crinoidea*, *Cystidea*, *Holothuriada*, and *Synaptida*.

The *Echinodermata* belong to the family *Annuloida*, the most familiar of examples of which are star-fishes and sea-urchins. The labours of that distinguished comparative anatomist and physiologist of Berlin, Johannes Müller, have made us better acquainted with the structure and development of these remarkable animals, than with those of most classes of the animal kingdom. The series of feet which protrude along certain fixed lines from the body of an *Echinoderm* have received the name of "ambulacra;" and hence, says Mr. Huxley, "we may distinguish their system of vessels as the ambulacral vascular system. The existence of an ambulacral vascular system has as yet been demonstrated only in the following orders:—*Echinoidea*, *Ophiuridea*, *Crinoidea*, *Asteridea*, and *Holothuridea*, with which the fossil *Cystidea* and *Blastoidea* are inseparably connected. I therefore limit the *Echinodermata* to the very natural group formed by these orders. A more or less complete calcareous skeleton is always developed within the *Echinoderms*, resembling that of the *Actinozoa*, not only in this respect, but also in consisting of detached spicula. In this form the skeleton remains in the *Holothuridea*, but in the other *Echinoderms*, the spicula coalesce into networks, which may become consolidated into dense plates by additional deposits. It is by the different shape and arrangement of these plates that the diversity exhibited by the skeletons of different *Echinodermata* is produced."

(1) Derived from *echinos*, a spine, and *derma*, skin.

In most *Echinoida* all the feet are expanded into sucking discs, at their extremities, and are here straightened by a calcareous plate or plates; but in the *Echino-cidaris* and some others, the feet of the oral portion of the ambulacra only have this structure, while those of the apical portion are pectinated, flattened, and gill-like. Müller distinguishes four kinds of feet in the *Spatangoida*,—simple locomotive feet, without any sucking disc; locomotive feet, provided with terminal suckers, and containing a skeleton; tactile feet, whose expanded extremity is papillose; and gill-like feet, triangular, flattened, more or less pectinated lamellæ.

In the *Clypeastroida* the petaloid portions of the ambulacra possess branchial feet, interspersed with delicate locomotive sucking feet, provided with a calcareous skeleton. In the *Ophiuridea* and *Crinoidea* the feet are tentaculiform; and there are no vesicles at the bases of the feet, while in the *Asteridea* they are well developed, but simpler than those of the *Echinidea*. The madreporic canal is, in the *Asteridea*, strengthened by a remarkable calcareous framework, which has given rise to the notion that it is filled with sand, and to the name "sand-canal," which has been applied to it. The canal terminates in the madreporic tubercle, which is always placed interradially on the antambulacral surface of the star-fish. In some genera—(*Echinaster*, *Ophidiaster*)—there are many canals and many tubercles. In the *Ophiuridea* the madreporic canal is strengthened by perforated calcareous plates.

In some *Holothuridea* the feet are scattered over the whole ambulacral region, as well in the inter-ambulacra as in the ambulacra. In others, *Psolus*, the feet are developed only from three of the five ambulacra; while in the *Synapta* and *Chirodata* there is only a circle of feet around the mouth.

Many star-fishes, and *Synapta* among the *Holothurida*, have the curious habit of breaking themselves up into fragments when taken; Müller has pointed out the very curious fact, that in *Synapta*, at any rate, this act may be prevented by cutting through the oral nervous circle. A nervous circle in the *Echinus* surrounds the œsophagus near the mouth, and is enclosed by the alveoli, between which the

ambulacral nerves pass to reach it. In the *Asteridea*, the circle lies at the extreme limit of the soft membrane, which surrounds the mouth, and may be readily exposed by cutting away the hard inter-ambulacral oral lips. In the *Holothuridea* it lies immediately beneath the perisoma of the oral disc. The only known organs of sense in the *Echinodermata* are the pigmented "eye-spots," developed in connexion with the ends of the ambulacral nerves, and on the oral nervous circle in many *Holothuridea*.

The great majority of the *Echinodermata* commence their existence as free-swimming larvæ covered with cilia, but a great difference exists in their further course, according as they belong to the *Asteridea*, the *Holothuridea*, and the *Crinoidea* on the one hand, or to the *Echinidea* and *Ophiuridea* on the other. Of the development of the *Crinoidea* we know very little, beyond the observations of Mr. Thompson, that the larva of the *Comatula* is provided with several transverse bands of cilia, almost like that of a *Holothuria*, and that the development of the *Echinoderm* commences while the larva is still free. At a later period, the young *Comatula* is seated upon a long, jointed stem, so as to resemble a *Pentacrinus*; and it becomes detached from this stem, in assuming its adult condition.

Mr. Huxley, after mature examination of this class of animals, says, "he can see no reason for retaining them amongst the *Radiata* of Cuvier, but, on the other hand, thinks them properly placed among the *Annuloida*."

The skeleton of these animals generally consists of an assemblage of plates, or joints, of calcareous matter. The minute structure of which presents a reticulated character, and the solid parts are usually composed of a series of super-imposed laminæ or scales. The openings, or areolæ, in one layer being always placed over the solid cell-walls of the layer beneath it, the spines are situated on the external surface of the shell; they are generally of a conical figure, and are articulated with the tubercles by a ball-and-socket joint. When a thin transverse section of one of these spines is examined with the naked eye, it appears to be made up of a series of concentric layers, varying considerably in number; not, however, with the size of the spine, but with the distance from the base at which

the section was made: when a section taken from the middle of the spine is examined with a power of fifty diameters, it will be seen that the centre is occupied by a reticulated structure; around the margin of this may be

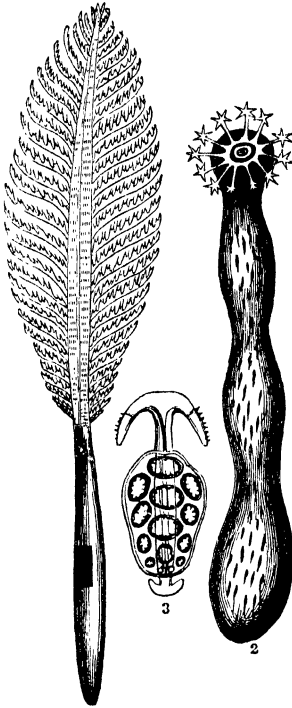

Fig. 197.

1, Polypidom of *Pennatula phosphorea*. 2, *Synapta*. 3, Highly-magnified anchor-shaped spiculum and plate from skin of *Synapta*.

observed a series of small structureless spots, arranged at equal distances apart (Fig. 198, No. 1): these are the ribs or pillars, and indicate the external surface of the first layer deposited; passing towards the margin, other rows of larger pillars may be seen, giving it a beautiful indented appearance; all the other parts of the section are occupied by the usual reticulated tissue. In the greater number of spines the sections of the pillars present no structure, in others they exhibit a series of concentric rings of successive growth, which strongly remind us of the medullary rays of plants; occasionally they are traversed by reticulated structures, as represented in Fig. 206, No. 1. When a vertical section of a spine is examined, it is found to

be composed of cones placed one over the other, the outer margin of each cone being formed by the series of pillars. In the genus *Echinus* the number of cones is considerable, while in that of *Cidaris* there are seldom more than one or two; so that

from these species transverse sections may be made, having no concentric rings, and in which only the external row of pillars can be seen.

“The skeleton of the *Echinodermata* contains very little organic matter. When it is submitted to the action of very *dilute acid*, to dissolve out the calcareous matter, the residuum is very small in amount. When obtained, it is found to possess the reticular structure of the calcareous shell (Fig. 198, No. 1); the meshes or areolæ being bounded

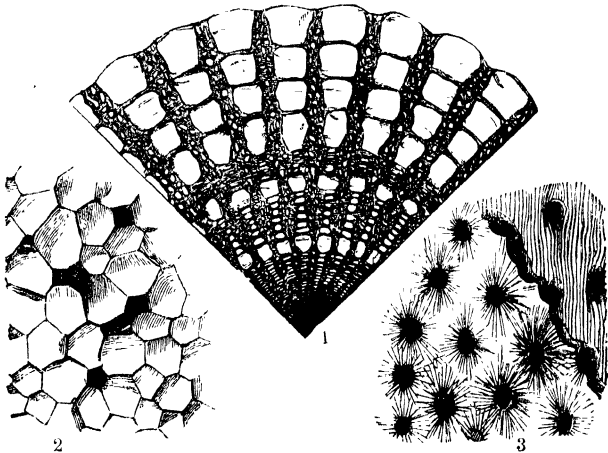

Fig. 198.

1, Section of spine of *Echinus*, exhibiting reticulated structure, the calcareous portion having been dissolved out by acid. 2, Transverse section of shell of the *Pinna ingens*. 3, Horizontal section of shell of *Terebratulata rubicunda*, showing its radiating perforations.

by a substance in which a fibrous appearance, intermingled with granules, may be discerned under a sufficiently high magnifying power, as originally pointed out by Professor Valentine. This tissue bears a close resemblance to the areolar tissue of higher animals; and the shell may probably be considered as formed, not by the consolidation of the cells of the epidermis, as in the *Mollusca*, but by the calcification of the fibro-areolar tissue of the true skin.

This calcification of areolar or simply fibrous tissue, by the deposit of mineral substance, not in the meshes of areolæ, but in intimate union with the organic basis, is a condition of much interest to the physiologist; for it presents us with an example, even in this low grade of the animal kingdom, of a process which seems to have an important share in the formation and growth of bone, namely, in the progressive calcification of the fibrous tissue of the periosteum membrane covering the bone.”<sup>1</sup>

From their peculiarity of structure they may be said to be almost imperishable. Their shells exist abundantly in all our chalky cliffs, innumerable specimens of which may be obtained, exhibiting the same wondrous forms and characters as those which now frequent our shores.

The *Crinoidea*, “Sea-lilies,”—so called from the resemblance which many of them present to the lily,—were exceedingly abundant in former ages of the world; and their remains often form the great bulk of large masses of rock, fig. 199. These animals were all supported upon a long stalk, at the extremity of which they floated in the waters of those ancient seas, spreading their long arms in every direction in search of the small animals which constituted their food. Each of the arms, again, was feathered with a double series of similarly jointed appendages; so that the number of separate calcareous pieces forming the skeleton of one of these animals was most enormous. It has been calculated that one species, the *Pentacrinus briareus*, must have been composed of at least 150,000 joints; and “as each joint,” according to Dr. Carpenter, “was furnished with at least two bundles of muscular fibre,—one for its contraction, the other for its extension,—we have 3,000 such in the body of a single *Pentacrinus*—an amount of muscular apparatus far exceeding any that has been elsewhere observed in the animal creation.” A furrow runs along the inside of the arms, which is covered with a continuation of the skin of the disc; and from this the ambulacra are protruded, as in other *Echinodermata*.

In the family of *Ophiuridea*, so called from the resemblance of their arms to a serpent’s tail, (Gr. *ophis*, a snake,

(1) Dr. Carpenter, *Cyclopædia of Anatomy and Physiology*.

oura, a tail); the body forms a roundish or somewhat pentagonal disc, furnished with five long simple arms, which have no furrow for the protrusion of the ambulacra. *Ophiuridea* are exceedingly plentiful in all our seas, and their remains occur in all the more recent marine strata of the earth's crust. They are more commonly called *Sand Stars*, or *Brittle Stars*.

"However much the faunas of the various geologic periods may have differed from each other, or from the fauna which now exists, in their aspect and character, they were all, if I may so speak, equally underlaid by the great leading ideas which still constitute the master types of animal life. And these leading ideas are four in number. First, there is the *star-like* type of life,—life embodied in a form that, as in the corals, the sea anemones, the sea urchins, and the star fishes, radiates outwards from a centre; second, there is the *articulated* type of life,—life embodied in a form composed, as in the worms, crustaceans, and insects, of a series of rings united by their edges, but more or less moveable on each other; third, there is the *bilateral* or *molluscan* type of life,—life embodied in a form in which there is a duality of corresponding parts, ranged, as in the cuttle fishes, the claws, and the snails, on the sides of a central axis or plane; and fourth there is the *vertebrate* type of life—life embodied in a form in which an internal skeleton is built up into two cavities placed the one over the other, the upper for the reception of the nervous centres, central and spinal,—the lower for the lodgment of the respiratory, circulatory, and digestive organs. Such have been the four central ideas of the faunas of every succeeding generation, except perhaps the earliest of all, that of the Lower Silurian System, in which, so far as is yet known, only three of the number existed,—the radiated, articulated, and molluscan ideas or types.

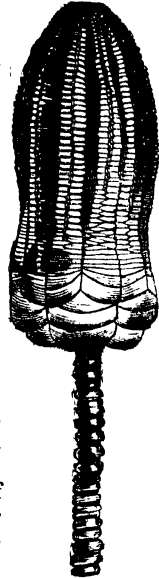

Fig. 199.—*Encrinurus*,  
*Sea-lily*.



That Omnipotent Creator, infinite in His resources—who, in at least the details of His workings, seems never yet to have repeated Himself, but, as Lyell well expresses it, breaks, when the parents of a species have been moulded, the dye in which they were cast,—manifests Himself, in these four great ideas, as the unchanging and unchangeable

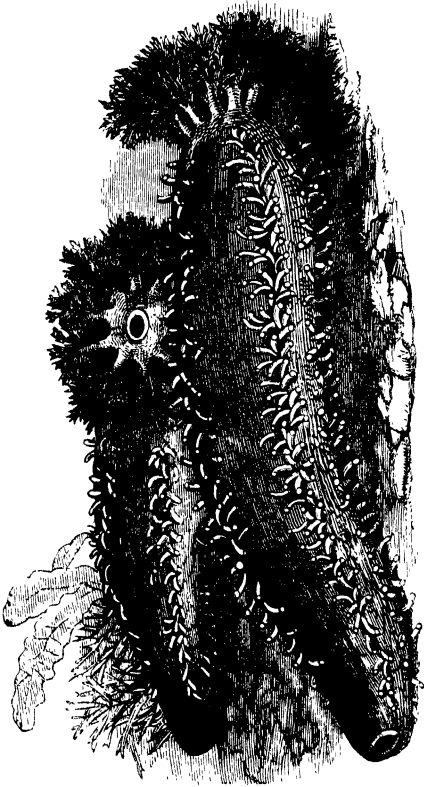

Fig. 200.—*Holothuridae*, Sea-cucumbers.

One. They serve to bind together the present with the past, and determine the unity of the authorship of a wonder-

fully complicated design, executed on a groundwork broad as time, and whose scope and bearing are deep as eternity." <sup>1</sup>

The *Synaptida* are characterised by a total absence of ambulacra, the motions of the animals being assisted by peculiar anchor-like processes of the calcareous grains which project from the skin, and roughen the surface of the animal. The spiculum represented at fig. 197 is serrated on the convex edge, and the opposite extremity is recurved, and appears to be connected in some peculiar way with the oval plate upon which it lies. It is a beautiful object when made to depolarise light.

*Holothuridea*, "Sea-cucumbers."—In this order the body acquires a worm-like form. The radiate structure is in fact scarcely recognisable in these animals, except in the arrangement of the tentacles which surround the mouth. The body is always more or less elongated, with the mouth at one end and the anal opening at the other; the calcareous deposit in the skin is reduced to scattered granules; and in one family the ambulacra are entirely wanting.

The *Holothurida* inhabit the seas of most parts of the world. Some of them are eaten even by European populations; the Trepanng (*Holothurida edulis*) is an article of luxury amongst the Chinese. A few living specimens were introduced into the tanks at the Zoological Gardens. Unfortunately, they live only a few weeks when in a state of captivity; fig. 200 has been drawn from animals in Mr. Lloyd's tanks.

POLYZOA, or *Bryozoa*, placed by Dr. Johnston under the head *Ascidiodida*; in the generality of works they are named *Bryozoa*, and the individual, *Bryozoon*; derived from the Greek words βρύον, sea-moss; ζῶον, animal. (Fig. 201.) The distinction to be drawn between it and the zoophytes previously described, consists in the polypidom forming a living portion of the polype, while they are unorganised; and a few also of the zoophytes examined are devoid of cilia, whereas in the *Bryozoon* these are most bountifully supplied. The play of the cilia is most energetic, for the purpose of securing an abundant

(1) Miller's *Testimony of the Rocks*.

supply of food, and apparently without exertion on the part of the creature itself. From this most marked characteristic, Dr. Farre was induced to give them the name of *Ciliobrachiata*. But it has since been determined by naturalists, from the *Bryozoa* possessing a higher organization than any of the preceding families of zoophytes, and also from the presence of *striped muscular fibre* in their bodies, to transfer them, with other allied genera, the *Flustra*, *Lepralia*, *Anguinaria spatulata*, *Notamia*, &c., to a sub-molluscan kingdom.<sup>1</sup>



Fig. 201.—*Bryozoa* Bowerbankia, "Bowerbank Bryozoan," showing its internal structure; near it is a smaller animal withdrawn into its cell.

*Polyzoa* are generally found living together in great numbers, and always clothed with hardy coverings or polypidoms. They subsist on small animals, and differ from most other *Mollusca* in being able to protrude themselves from their cells. When the creatures draw themselves within their protective homes, to the bottom of which they are attached by a sinewy ligament, they double themselves up by bending the lower part of the body upwards. It presents a

beautiful sight, from its blossom-like appearance and busy cilia; its protrusion and retraction are performed with surprising quickness, as it has two sets of muscles for the purpose, one acting on the body of the animal, the other

(1) Mr. Gosse, in his *Manual of Marine Zoology*, adopts the idea, now pretty general, that the *Polyzoa* belong to the Molluscos division, in spite of their external resemblances to Polypes, and he places them among Molluscs. In this, perhaps, he has thought more of systematic views on classification, than of the student's convenience. It seems to us quite clear that without adopting De Blainville's principle of classifying animals according to their envelope as the best principle of scientific classification, we should adopt it in works of reference like the present, since the external characters are necessarily those most immediately recognised by the student; and in the case of the *Polyzoa*, they are so remarkably similar in external characteristics to the hydroid polypes, that they were always classed with them, until the profounder investigations of Van Beneden, Allman, and others, revealed the resemblances between the internal characteristics of the *Polyzoa*, *Bryozoa*, and those of molluscs.

upon its cell. The oral extremity is surrounded by a circle of long tubular tentacles covered with cilia ; at each of these feelers or arms there is an aperture, the one at the base communicating with a canal that passes round the edge of the oral aperture or mouth. The food passes down a long gullet, that contracts during the process of swallowing. At the end of this is an orifice that opens into what appears to be a gizzard, having two bodies opposite to each other, with a rough surface, as if for the comminution of food, moved by muscular fibres. Those of the species without this gizzard have a digestive stomach that secretes a coloured fluid. From the upper part of the stomach near the entrance from the gizzard arises an intestine, having a narrow opening surrounded by cilia that proceeds upwards, ending in an orifice near to the tentacles, from which the refuse food is ejected.

Their cells are of various shapes, and from one, a family of millions come, budding forth from its sides ; and though the living matter disappears, the catacombs exist for the foundation of their families, branching out and enduring for ages.

*Bryozoon Bowerbankia* received its name from Dr. Arthur Farre, in honour of the well-known microscopist, Mr. Bowerbank. A magnified representation of the animal is seen in fig. 201. "When fully expanded, it is about one-twelfth of an inch in length. In its retracted state, it is completely enclosed in a delicate horny cell, sufficiently transparent to admit of the whole structure of the contained animal being seen through its walls. The cells are connected together by a cylindrical creeping stem, upon which they are thickly set, sessile, ascending from its sides and upper surface. The animal, when completely expanded, is seen to possess ten arms of about one-third the length of the whole body ; each arm being thickly ciliated on either side, and armed at the back by about a dozen fine hair-like processes, which project at nearly right angles from the tentacles, remaining motionless, while the cilia are in constant and active vibration."

*Notamia, Back-cell*, so named from the cells being exactly opposite, and united back to back with a thick partition, and having a joint above and below each pair. In some

species of the *Flustra* the interior of the cell is protected by a lid which bears some appearance to the head and beak of a bird, and hence it is termed the *bird's-head* process. This has been made the subject of investigation by many naturalists. George Busk, Esq., F.R.S.,<sup>1</sup> contributed to the *Transactions of the Microscopical Society*, 1849, an admirable paper on the *Notamia busaria*, "Shepherd's-purse Coralline," (represented in fig. 202, Nos. 1 and 3), which adds to our knowledge of this curious process. He says: "This most beautiful pearl-

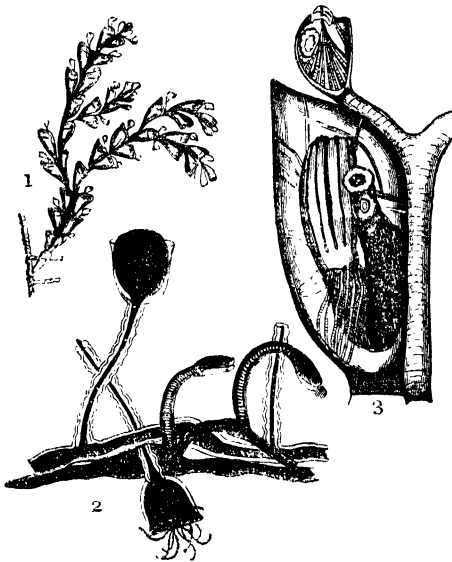

Fig. 202.

1, *Notamia busaria*. Shepherd's-purse Coralline. 2, *Anguinaria spatulata*, Snake Coralline, growing with the *Campanularia integra*. 3, The Shepherd's purse Animalcule withdrawn into its cup, and the internal organs shown greatly magnified.

coloured coralline adheres, by small tubes to fuci, from whence it changes into flat cells; each single cell, like

(1) Mr. Busk has added to the description here given of this bird's-head process in the *Quarterly Journal of Microscopical Science*, for January 1854.

the bracket of a shelf, broad at top and narrow at the bottom : these are placed back to back in pairs, one above another, on an extremely slender tube that seems to run through the middle of the branches of the whole coralline. The cells are open at top. Some of them have black spots in them ; and from the top of many of them a figure seems to issue out like a short tobacco-pipe, the small end of which seems to be inserted in the tube that passes through the middle of the whole. The cells in pairs are thought by some to have the appearance of the small pods of the plant "Shepherd's Purse," by others the shape of the seed-vessel of the *Veronica*, Speedwell.

"The polypidom of this bryozoon, like those of most of its congeners, may be said to consist of a radical portion, by which it is affixed to the objects upon which it grows, and of a celliferous portion or branches, upon which the polypes themselves are lodged. The radical portion in the present species consists of a central discoid body of a nearly circular form, and of branches radiating from the periphery of the disc, which thence exhibits something of the aspect of the body of an *ophiura*. The radical tubes or branches springing from the margin of the disc are usually five or six in number, and they are given off at pretty regular distances apart ; but besides these radical tubes, one or more celliferous branches are not unfrequently seen to arise immediately from the upper surface of the discoid portion.

"The central disc, and the radical tubes arising from it, exhibit a similar structure, and are formed of a thick, firm, apparently horny envelope, containing a coarse granular matter, of a yellowish-white colour, and which in some portions of the tubes assumes the form of distinct irregularly-globular masses, of nearly uniform size. The central disc is subdivided into distinct compartments by septa of considerable thickness, and each radiating branch arises from one of these distinct compartments ; so that there appears to be no communication between one radical branch and another. The radical branches give off at irregular distances secondary branches, which ultimately become celliferous. Each of these secondary branches, however, arises from a distinct compartment, as it were, of

the tube from which it springs. This compartment is formed, like those of the central disc, by a thick septum, which shuts off the origin of the secondary branch from the main cavity of the primary one."

The larger, or polypiferous cells, Mr. Busk proposes to term *cells*, and the smaller tobacco-pipe-shaped organs *cups*; the latter being usually above the former throughout the polypidom, "excepting immediately below each fork, where the cup is invariably absent above one of the cells of the pair from between which the fork springs. The polype-cells are several times larger than the cups, and their walls are much thinner; in fact, sufficiently transparent to allow of the contents of the cell being pretty well seen, without any preparation, even during the life of the animal. In shape they are inversely conical, and the outer and upper angle is usually produced into a prominent, sharp point. From the internal and upper angle arises the tubular prolongation going to form the next cell or cup, as the case may be, in succession. They are entirely closed at the top, contrary to what is stated by previous observers; and, as has been shown, there is no connexion whatever between the cell and the cup placed *immediately* above and behind it. The aperture of the cell is on the anterior face, and towards the upper margin; it is of a crescentic form, and placed obliquely, as it were, across the upper and internal angle of the cell, with the convexity of the curve directed upwards and inwards. The lips of the aperture are strengthened by thin bands of horny material; and, under favourable circumstances, indications of short muscular fibres, for the purpose of opening or closing the aperture, may be seen."

The shell, which Mr. Busk believes to be entire at the bottom, though closed only by a very delicate membrane, contains an ascidoid polype of the usual typical form of that class. "It has ten tentacles, and no gizzard. Two sets of muscular fibres at least may be distinguished as appertaining to the polype. The most important of these are the retractor muscles, which, arising from the bottom of the cell, in the form of long, somewhat flattened, transversely striped, isolated fibres, about the one ten-thousandth of an inch in width, are inserted, some of them

at the base of the tentacles, and others lower down the body of the polype."

When we consider the minuteness of the delicate little sprig which is the natural size of this polype, we cannot but wonder at the triumphs of the microscope in giving such precise details as Mr. Busk relates of the *Notamia bursaria*. Its beautiful and perfect organisation, the careful provision for the safety and engagements of this minute being, make us awe-stricken at the power of Divine intelligence.

CELLEPORIDÆ.—A family with calcareous polypidoms, cellular, irregularly-lobed, or branched, formed of pitcher-shaped cells, heaped together or arranged in quincunx, that is, resembling the five on playing-cards.

On the British shores are found *C. pumicosa*, *C. ramulosa*, *C. Skenei* (named after the talented Dr. David Skene), *C. cervicornis*, and *C. lævis*. This last, Dr. Fleming says, is "in height an inch and a quarter; diameter, one-tenth; the branches are smooth, with the orifices of the cells smooth and concave; towards the extremities the branches are rough with the forming cells, and the orifices are more declining, circumscribed, a little prominent, with a blunt process at the proximal margin."

*Lepralia*, "Sea-scurf,"—from the Greek for marine leprosy,—is the name given to this family of the *Celleporidæ* by Dr. Johnston.

*Lepralia nitida*, found attached to shells, is thus described: "Crust spreading circularly, closely adherent, rather thin, greyish white, calcareous; cells contiguous, in radiating rows, large, subalternate, ovate, ventricose, silvery, the walls fissured with six or seven cross slits which are on the mesial line; aperture subquadrangular, depressed, terminal; anterior to it there is often found a globular, pearly, smooth, oviferous operculum, with a round even aperture. The remarkable structure of the cells renders this one of the most interesting species under the microscope. There is sometimes an appearance of a spine on each side of the lower angle of the mouth, which is merely the commencement of the walls of the next cell."

*L. coccinea*, *L. variolosa*, *L. ciliata*, *L. trispinosa*, and *L. immersa*, are the other British species.



The family *Cellularia*, little-cells, have a curious and wonderful provision of nature for their protection, an operculum, a lid or cover over the apertures of each cell. *Cellularia ciliata* is parasitical, branching, calcareous, white and tufted ; grows about half an inch in height, and the oblique aperture is armed on the outer edge with four or five long hollow spines. The operculum is pearly, and near the base there is that singular appendage, described as the *bird's-head* process. Its beauty and transparency render it a favourite object with microscopists.

The *Cellularia* (now *Bugula*) *avicularia* are very accurately described by Mr. Gosse, from his own observations upon specimens secured on the Devonshire coast, during a residence there. He says : " Well does it deserve the name of *Bird's-head Coralline*, given to it by the illustrious Ellis ; for it presents those curious appendages that resemble vultures' heads in great perfection. All my specimens were most thickly studded with them ; not a cell without its bird's head, and all see-sawing, and snapping, and opening their jaws with the most amusing activity ; and what was marvellous, equally so in one specimen from whose cells all the polypes had died away, as in those in which they were still protruding their lovely bells of tentacles. The stem ascends perpendicularly from a slender base, which is attached to the rock, or to the cells of a *Lepralia* growing from the rock. The central part of the spine is most expanded, the diminution above and below being pretty regular ; during life, the usual colour is a pale buff, but the cells become nearly white in death. When examined microscopically it is, however, that the curious organisation of this zoophyte is discovered, especially when in full health and vigour, with all the beautiful polypes protruded and expanded to the utmost, on the watch for prey. It seems to me as poor a thing to strain one's eyes at a microscope over a dead and dry polypidom, as it does to examine a shrivelled and blackened flower out of a herbarium ; though I know well that both are often indispensable for the making out of technical characters. But if you want to get an insight into the structure and functions of these minute animals, or if you would be charmed with the perception of beauty, or delighted with new

and singular adaptations of means to an end,—or if you desire to see vitality under its most unusual, and yet most interesting phases,—or if you would have emotions of adoring wonder excited, and the tribute of praise elicited to that mighty Creator who made all things for His own glory,—then take such a zoophyte as this, fresh from the clear tide-pool, take him without inflicting injury ; therefore detach with care a minute portion of the surface-rock, and drop your prisoner, with every organ in full activity, into a narrow glass cell with parallel sides, filled with clear sea-water, and put the whole on the stage of the microscope, with a power of not more than 100 linear, at least, for the first examination. I greatly mistake if you will not confess that the intellectual treat obtained is well worth—ay, ten times more than worth—all your trouble.”

CRISIADÆ, signifying *a separation*; applied to a parasitical family. *Crisia cornuta*, “Goat’s-horn Coralline” of Ellis, having cells linked in a single series ; the same remark applies to *C. chelata*, “Bull’s-horn Coralline ;” the latter look like a number of shoes fitting close to the ankle, joined by the toe-part to the heel of others. Ellis says : “This beautiful coralline is one of the smallest we meet with. It rises from tubuli growing upon fuci, and passes from thence into sickle-shaped branches, consisting of single rows of cells, looking when magnified like bull’s horns inverted, each one arising out of the top of the other. The upper branches take their rise from the fore-part of the entrance of a cell, where we may observe a stiff, short hair, which seems to be the beginning of a branch. The opening of each cell, which is in the front of its upper part, is surrounded by a thin circular rim ; and the substance of the cells appears to consist of a fine transparent shell or coral-like substance.”

*Crisia eburnea*, “Tufted-ivory Coralline,” attains the height of an inch, and displays its beautiful white, bushy tufts, with often a dash of light-red intermingled. Its cells are loosely aggregated and cylindrical, with bent tubular orifices free ; while the *Crisia aculeata* have cells closely aggregated, cylindrical, nearly straight, with long slender spines springing from the margin of every cell, giving it a delicate and pretty appearance.

EUCRATIADÆ.—We select from this family a specimen of

great interest, the *Anguinaria*,—from the Latin *anguis*, a snake. This, and also *Notamia*, belong to the class *Polyzoa*. An account of the *Anguinaria spatulata*, “Snake-head Coralline,” appeared in the *Transactions of the Microscopical Society*, by Mr. Busk, who corrects the errors of other observers. The polype is parasitical upon fuci, and is not unfrequently associated with other kinds on the same plants, as in fig. 202, No. 2, on *Campanularia*. The *A. spatulata* “as a whole, consists, like all its congeners, of two distinct portions, one usually termed the radical, and another which constitutes the proper polype cells. In the present instance, the arrangement of these parts is in some respects very peculiar and curious; but it will be found upon strict examination to accord accurately with the universal type.”

“In the radical tubes, and on the dorsal or upper surface of the dilated extremity of the polype-cell, represented at No. 2, this earthy matter is deposited in the form of minute angular or rounded particles, presenting faint traces of a linear arrangement; but in the main body of the polype-cell, or the upright portion, the calcareous material is arranged in beautifully regular rings, giving that part of the zoophyte a peculiarly elegant appearance under the microscope. This calcareous ingredient is sufficiently abundant to render the contents of the radical tubes and polype-cells indistinct; and to obtain a satisfactory view of these parts it is necessary to remove the earthy matter by some weak acid. When this is done, it will be found that the contents of the radical portion are coarsely granular, and the wall rather thicker than those of the proper polype-cell. The latter contains an ascidian polype, which has about twelve tentacles, and no gizzard.” The polype, as far as Mr. Busk has observed, is always lodged in the upright portion of the cell; but the long retractor muscular fibres arise near the commencement of the horizontal portion of the cell, from its upper wall, and nearly at one point.

The expanded portion of the cell, besides the special muscles of the aperture, contains other muscular fibres, in all respects resembling those described by Dr. Farre, as conducing to the extrusion of the polype in *Bowerbankia*,

and which are also very distinct in the *Notamia*; but which, in the present instance, would seem to have for their chief function the drawing-up or corrugation of the membraneous portion of the polype-cell. These muscular fibres have a distinct central nucleus or thicker portion, as is the case in the analogous muscles in some other polypes.

ESCHARIDÆ.—This interesting family justly deserves the great attention many naturalists have bestowed upon it. Linnæus named it *Flustra*, from the Saxon word *flustran*, to weave; it is commonly called a *Seamat*, and resemble fine network spread over stones, rocks, shells, and marine plants. This network, when submitted to the powers of the microscope, is found to be a cluster of cells, in each of which dwells an animal, that protrudes its feelers when searching for food, and sinks into its little home when tired, or alarmed by approaching danger.

Dr. Grant estimates that a single *Flustran* has as many as four hundred millions of cilia on these restless feelers. The feelers vary from ten to twelve; their organisation consists of a long gullet, a gizzard, a stomach and intestines; the body being a transparent substance. Some take the form of a delicate minute tree, having cells in all parts, and of various colours; they inhabit every sea. Lamouroux says: "When the animal has acquired its full growth, it flings from the opening of its cell a small globular body, which fixes near the aperture, increases in size, and soon assumes the form of a new cell; it is yet closed, but through the transparent membrane that covers its surface the motions of the polype may be detected; the habitation at length bursts, and the tentacles protrude; eddies are produced in the water, and conduct to the polype the atoms necessary for its subsistence. The aperture of the cells is formed by a semicircular lid, convex externally and concave internally, which folds down when



Fig. 203.—*Eschara cervicornis*, Sea-moss polype; the animal is represented out of its chalky cell.

the polype is about to advance from the cell. The opening of this lid in the *F. truncata*, where it is very long, appears through the microscope like the opening of a snake's jaws; and the organs by which this motion is effected are not perceptible. The lids of the cells open and shut in the *Flustræ* without the slightest perceptible synchronous motion of the polypes."

In the formation of their stony skeletons, the animals appear to take a most insignificant part; they are principally secreted by the integuments or membranes with which they are invested, in like manner as the bones and nails in man are secreted by tissues designed for that purpose, and acting slowly and imperceptibly. From an analysis of the stony corals, it appears that their composition is very analogous to that of shells. The porcellaneous shells, as the cowry, are composed of animal gluten and carbonate of lime, and resemble, in their mode of formation, the enamel of the teeth; whereas the pearly shells, as the oyster, are formed of carbonate of lime and a gelatinous or cartilaginous substance, the earthy matter being secreted and deposited in the interstices of a cellular tissue, as in bones. In like manner, some corals yield gelatine upon the removal of the lime, while others afford a substance in every respect resembling the membranous structure obtained by an analysis of the nacreous (pearly) shells. A recent elaborate analysis of between thirty and forty species of corals, by an eminent American chemist (Mr. B. Silliman), has shown, contrary to expectation, that they contain a much larger proportion of fluorine than of phosphoric acid.

*Flustra foliacea*, the broad-leaved Horn-wrack of Ellis, is about four inches high, and of a brown colour. The cells are small, in alternating rows; and sometimes covered by a lid opening downwards. Hook says: "For curiosity and beauty, I have not, among all the plants or vegetables I have yet observed, seen any one comparable to this sea-weed." *Flustra truncata* is abundant in deep water, and grows to a height of about four inches; it is of a delicate yellow colour, and bushy. This is the narrow-leaved Horn-wrack of Ellis; for it must not be forgotten that the older writers regarded the whole genera as *plants*.

*Flustra chartacea*.—Ellis states: "The cells of this sea-mat are of an oblong square figure, swelling out a little in the middle of each side. The openings of the cells are defended by a helmet-like figure; from hence the polype-shaped suckers extend themselves. This sea-mat is of a slender and delicate texture, like a semi-transparent paper, of a very light straw-colour. It was first found on the coast of Sussex, adhering to a shell. I have since met, on the same coast, about Hastings, in the year 1765, with several specimens whose tops are digitated, and others that were very irregularly divided."

The *Flustra carbasea* grow out in a leaf-like manner, gradually widening to the end: they are found on shells of a yellowish-brown colour; on one of the sides the cells are both large and smooth. The animals have about twenty-two arms or feelers, which, says Dr. Grant, after a most careful examination of these polypes, "are nearly a third of the length of the body; and there appear to be about fifty cilia on each side of a tentacle, making 2200 cilia on each polype. In this species there are more than eighteen cells in a square line, or 1800 in a square inch of surface; and the branches of an ordinary specimen present about ten square inches of surface; so that a common specimen of the *F. carbasea* presents more than 18,000 polypes, 396,000 tentacles, and 39,600,000 cilia.

"They are very irritable, and frequently observed to contract the circular margin of their broad extremity, and to stop suddenly in their course when swimming; they swim with a gentle gliding motion, often appear stationary, revolving rapidly round their long axis, with their broad end uppermost, and they bound straight forward, or in circles, without any other apparent object than to keep themselves afloat till they find themselves in a favourable situation for fixing and assuming the perfect state. The transformation of the ova, from that moving, irritable, free condition of animalcules, to that of the fixed and almost inert zoophytes, exhibits a new metamorphosis in the animal kingdom not less remarkable than that of many reptiles from their first aquatic condition, or that of insects from their larva state."

*Flustra avicularis*.—This is another of the little beauties

of the deep, found usually on old shells, an inch in height, spreading itself fan-like, and of an ashy colour, deeply divided in a dichotomous manner into narrow, thin, plane segments, truncate at the end, formed of four or five series of oblong cells, capped with a hollow globose, pearly, operculum seated between the spines, of which there is one on either side of the circular aperture. The opercula are so numerous, that they give to the upper surface the appearance of being thickly strewn with orient pearls; the under surface is even and longitudinally striated, the number of striæ corresponding to the number of rows in which the cells are disposed. Dr. Johnston describes, amongst many other British species, *F. membranacea*, "a gauze-like incrustation on the frond of the sea-weed, spreading irregularly to the extent of several square inches."

*Eschara foliacea*.—This curious polypidom attains a large size, being often three or four inches high, and from twelve to twenty inches in diameter. It may be described as a broad membrane, twisted into winding folds, leaving large sinuosities and cavernous interstices; it is very light, and floats in water; crisp when dry, membrano-calcareous, cellular, of a yellowish-brown colour, roughish, and punctured with the numerous pores which open on both sides. When a portion of the skeleton is macerated in diluted muriatic acid, it retains the original form, but becomes soft and flaccid from the subtraction of the carbonate of lime. The cells are liable to all the changes of form and character resulting from age and death.

The species best known in its skeleton form is *Coralium rubrum*, "Red coral;" the coral of commerce, and an inhabitant of the Mediterranean and adjacent seas. In appearance it resembles a tree devoid of leaves and small branches. It requires about ten years to arrive at maturity, and is then about a foot in height. Its skeleton or axis is the polished brilliant red-stone used in ornamentations; being solid, channelled, ramified, and fixed by a broad base, with a thin external, fleshy covering, of a pale blue colour, and studded over with star-like polypes, which extend their feelers to grasp at prey. When brought into the air, the pulpy body of the animal soon decays,

and its remains are then prepared for market. A portion of the dried animal matter is usually found adhering to its surface, and contains abundance of spicula. This is an entirely different family to the *Corallines*, a genus of Florideous Algæ, at one time believed to be animals, and polype-cells were described by Ellis and Lamarck as existing upon their outer surface; such, however, has been shown to be an erroneous description, and the calcareous material existing in the form of a coating of variable thickness to a mass of cells evidently is of the vegetable character. In the *Nullapores* all the intercellular spaces are filled with lime, so that it would appear that the external surface of the cell-wall possesses the power of separating lime from the sea-water, the crystals of which take a certain definite form of arrangement. These are now classed among plants, *Corallinaceæ*, under the scientific terms of *Lithophytes*, Stone Plants, *Corallines*, and *Nullapores*.

As we glance at the map of the world, and think of the profusion of fragrant vegetation and delicious food almost spontaneously produced on the lovely sunny islands of the broad Pacific, how startling does it seem, when we are told that these islands, bearing on their bosoms gardens of Eden, are entirely formed by the slow-growing corals, which, rising up in beautiful and delicate forms, displace the mighty ocean,

defy its gigantic strength, and display a shelly bosom to the expanse of day! The vegetation of the sea, cast on its surface, undergoes a chemical change; the deposit from rains aids in filling up the little gaping catacomb, the fowls of the air and the ocean find a resting place,



Fig. 204 — *Corallium rubrum*.



and assist in clothing the rocks ; mosses carpet the surface, seed brought by birds, plants carried by the oceanic currents, animalcules floating in the atmosphere, live, propagate, and die, and are succeeded, by the assistance their remains bestow, by more advanced vegetable and animal life ; and thus generation after generation exist and perish, until at length the coral island becomes a paradise filled with the choicest exotics, the most beautiful birds and delicious fruits, among which man may indolently revel to the utmost desire of his heart.

Dr. Maccullock, in his *Highlands and Western Islands*, observes : “ Their plants are made of stone, and they construct islands and continents for the habitation of man. The labours of a worm, which man can barely see, form mountains like the Apennines, and regions to which Britain is as nothing. The invisible, insensible toil of an ephemeral point, conspiring with others in one great design, working unseen, unheard, but for ever guided by one volition,—by that One Volition which cannot err,—converts the liquid water into the solid rock, the deep ocean into dry land ; and extends the dominions of man, who sees it not, and knows it not, over regions which even his ships had scarcely traversed. This is the Great Pacific Ocean, destined at some future day to be a world. That same Power, which has thus wrought, by means which blind man would have despised as inadequate, by means which he has just discovered, here too shows the versatility, the contrast of its resources. In one hour it lets loose the raging engines, not of its wrath, but of its benevolence ; and the volcano and the earthquake lift up to the clouds the prop and foundation of new worlds, that from those clouds they may draw down the sources of the river, the waters of fertility and plenty.”

Ehrenberg, on beholding the coral-beds in the Red Sea, exclaimed : “ Where is the paradise of flowers that can rival in variety and beauty these living wonders of the ocean ? ”

Captain Basil Hall thus describes a coral-reef near Loo Choo : “ When the tide has left the rock for some time dry, it appears to be a compact mass, exceedingly hard and rugged ; but as the water rises, and the waves begin to

wash over it, the polypes protrude themselves from holes which were before invisible. These animals are of a great variety of shapes and sizes, and in such prodigious numbers, that in a short time the whole surface of the rock appears to be alive and in motion. The most common form is that of a star, with arms or tentacles, which are moved about with a rapid motion in all directions, probably to catch food. Others are so sluggish, that they may be mistaken for pieces of the rock, and are generally of a dark colour. When the coral is broken above high-water mark, it is a solid hard stone; but if any part of it be detached at a spot where the tide reaches every day, it is found to be full of polypes of different lengths and colours; some being as fine as a thread, of a bright yellow, and sometimes of a blue colour. The growth of coral appears to cease when no longer exposed to the washing of the sea. Thus a reef rises in the form of a cauliflower, till the top has gained the level of the highest tides, above which the animalcules have no power to advance; and the reef, of course, no longer extends upwards."

Of the myriads upon myriads of organised beings created to work out the grand designs of Providence, all calculation seems futile; as the result would be beyond the grasp of our comprehension. The Polynesian Archipelago, now considered to be one of the great divisions of the globe, has its foundation formed of coral reefs, the spontaneous growth of once-living zoophytes. Of the immense extent of the geographical changes effected by the tiny polypes, Dr. Mantell observes: "We may form some idea, from the facts stated by competent observers, that in the Indian Ocean, to the south-west of Malabar, there is a chain of reefs and islets 480 geographical miles in length; on the east coast of New Holland, an unbroken reef of 350 miles long; between that and New Guinea, a coral formation which extends upwards of 700 miles; and that Disappointment Islands and Duff's Group are connected by 600 miles of coral reefs, over which the natives can travel from one island to another."

Nothing can be more impressive than the manner in which these diminutive creatures carry out their stupendous undertakings, which we denominate instinct, intelligence,

or design. Commencing betimes from a depth of a thousand or fifteen hundred feet, they work upwards in a perpendicular direction; and on arriving at the surface form a crescent, presenting the back of the arch in that direction from which the storms and winds generally proceed; by which means the wall protects the busy millions at work beneath and within. These breakwaters will resist more powerful seas than if formed of granite; rising as they do in a mighty expanse of water, exposed to the utmost powers of the heavy and tumultuous billows that eternally lash against them.

The wonders we have brought to view in our glance at the families constituting the zoophytic kingdom, must be regarded with astonishment by every reflective being. We have seen how wonderfully and fearfully they are made—we have seen the surprising faculties with which they are endowed—we have seen the perfection and order bestowed upon them—we have seen the singular faculties they possess to perform the allotted duties of their destiny; and seeing all these things, we read in plain intelligible language, the wisdom, power, and goodness of an almighty and beneficent Being.

We may here state, that we have taken a somewhat more extended view of this department of animated nature, from the very circumstance of its presenting a wider field of deeply interesting and curious subjects for inquiry to the microscopist; and the more especially have these subjects attracted great public attention, since the spirited attempt on the part of the Zoological Society of London to afford us the opportunity of more closely and frequently observing their remarkable habits, when enclosed in glass tanks, forming what we now recognise as *marine vivaria* or *aquaria*. There the visitor may see the *Sabella*, the *Actinia*, of brilliant hues, and many kinds; *Mollusca*, *Annelida*, *Crustacea*, &c.; all pursuing their various avocations, enjoying themselves without restraint, under circumstances scarcely distinguishable from those of nature.

The author, in his management of *aquaria*, finds shallow glass vessels, of an inexpensive character, and natural seawater, best suited to the habits of the animals. The red

sea-weeds are well adapted to ensure success, and effect a perfect aeration of the water. They grow slowly, and prefer still waters. Any of the following weeds, or all, if variety is desirable, answer the purpose: *Griffithsia setacea*, *Wrangilia multifida*, *Dasya coccinea*, *Chylocladia ovalis*; with roots already attached to rock or debris of some sort. Introduce by slow degrees varieties of *Actiniæ*, *Annelida*, *Madriporida*, and other *Polyzoa*, with a *Nudibranch* or two; but do not overstock the tank with either animal or vegetable life; and keep all scrupulously clean, by removing decayed matter, vegetable or animal. Do not expose the tank to a strong light, or keep it in a warm place: a north-eastern aspect is the best. If such precautions are attended to, all will flourish, without the syringing, or other meddlesome and tiresome proceedings often recommended. The best scavenger for the removal of dead animal matter, is a fine active Prawn; he peeps and prys into every hole and corner for food; and for keeping down the *confervæ*, which grows on the sides of the tank, a *Nudibranch* (*Deudronotus arborescens*, or *Doto coronata*); and if the latter cannot be obtained, one of the species of Sea-snails, whose organization is adapted for crawling over rocks and feeding on sea-plants, *Purpura lapillus*, or *Nautica monilifera*, will be found to be an exceedingly useful addition to the Aquarium. Make a careful selection of animals, and if obliged to purchase, visit Mr. Lloyd, in the Portland Road, Regent's Park, whose experience in their management, and large daily supplies, enables him to give satisfaction to all his patrons.

The south coast of the Isle of Wight furnishes the whole of the animals represented in our Frontispiece, with many more very beautiful *Actiniæ* and *Algæ*. A short stay at that lovely spot, Freshwater Bay, will amply repay the naturalist; the bold rocks around this place abound in choice specimens.

Mr. N. B. Ward, whose charming fern-cases have become universal favourites, made the earliest attempt to establish, on a small scale, an "*aquarium for fish and plants*." He writes:<sup>1</sup> "I placed ten or twelve gold and silver fish, in

(1) *On the Growth of Plants in closely-glazed cases*, by N. B. Ward, Esq. F.R.S.

company with several aquatic plants, viz. *Vallisneria spiralis*, *Anacharis alismastrum*, *Pontederia crassipes*, *Papyrus elegans*, and *Pistia stratiotes*, which plants, by means of their vital actions, as had long been well known, maintained the purity of the water, and, as in the atmosphere, kept up the balance between the animal and vegetable respirations. Placed in the centre of my fern-house, and nearly surrounded by rock-work (rising five or six feet above the margin of the vessel), clothed with *Adiantum* and other lovely ferns, and partially overshadowed with the palmate leaves of *Corypha australis*, the plants and fish continued to flourish for years. The only enemy I had to contend with was a species of *Vaucheria*, which, from its rapid growth, required to be kept constantly in check. My friend, Mr. Bowerbank, always alive to scientific inquiries, followed up these experiments with equal success; but substituted sticklebacks and minnows for the gold-fish, and a few snails, to get rid of the decaying leaves of the plants."

#### PRESERVATION OF THE POLYPIDOMS OF ZOOPHYTES.

The following excellent and simple plan for preserving zoophytes as wet preparations, so as to retain the polypes and their tentacular arms *in situ*, was adopted by the late Dr. Golding Bird. "For this purpose a lively specimen should be chosen, and then plunged into cold pure water;<sup>1</sup> the polypes are killed almost immediately, and their tentacles often do not retract: proper-sized specimens should then be selected, and preserved in weak alcohol. Little phials about two inches long should be procured, made from thin flat glass tubes, so as to be half an inch wide, and about a quarter of an inch, or even less, from back to front. The specimens should be fixed to a thin platinum wire, and then placed in one of these phials (previously filled with weak spirits), so as to reach half-way down. When several are thus arranged, they should be put on a glass cylinder, and removed to the air-pump. On pumping out the air, a copious ebullition of bubbles will take

(1) A small quantity of gin thrown into distilled water answers the purpose better than pure water, and specimens may be put up in the same. The animals are nearly always preserved in their polypidoms by using this fluid to kill them.

place ; and many of the tentacles previously concealed will emerge from their cells. After being left in vacuo for a few hours, the bottles should be filled up, closely corked, and tied over, like anatomical preparations in general. For all examinations with a one or two-inch object-glass, these bottles are most excellent, and afford cheap and useful substitutes for the more expensive and difficultly-managed cells. In this manner, specimens of the genera *Membranipora*, *Alcyonidæ*, and *Crisiada*, &c., exhibit their structure most beautifully.

“ A few dozen of these little bottles hardly occupy any room, and would form a useful accompaniment to the microscopist by the sea-side. Any one visiting the caverns in St. Catherine’s Island at Tenby, could reap a harvest which would afford amusement and instruction for many weeks. These caverns are so rich in zoophytes and sponges, that they are literally roofed with the *Laomedææ*, *Grantiæ*, and their allies ; whilst the elegant *Tubulariæ* afford an ornament to the shallow pools on the floor ; and the walls are wreathed with the pink, yellow, green, and purple *Actiniæ*.

“ When these objects are examined by polarised light, most interesting results are produced. For this purpose, let a piece of selenite be placed on the stage of the microscope, and the polarising prisms arranged so that the ray transmitted is absorbed by the analyser. If a specimen of *Sertularia operculata* be placed on the selenite stage, and examined with a two-inch object-glass, the central stem is shown to be a continuous tube, assuming a pink tint throughout its whole extent. The cells appear violet in colour ; their pointed orifices are seen much more distinctly than when viewed with common light. The vesicles are paler than the rest of the object ; and their lids, which so remarkably resemble the operculum of the theca of a moss, are beautifully distinct, being of an orange-yellowish colour. This zoophyte is often covered with minute bivalve shells, distinguished by the naked eye from the vesicles only by their circular form ; and these, when present, add much to the beauty of the specimen, presenting a striated structure, and becoming illuminated with most beautiful colours.

“*Sertularia flicula* forms an interesting object; the waved stem becoming of a dusky red, whilst the cell assuming but little colour, render their mutual relation very obvious. *Sertularia abietina* is also a fine object, especially when loaded with vesicles, as it often is in the autumn. *Plumularia falcata* acquires fresh beauty under polarised light, the cells being a pale green, whilst the tubular stem becomes of a crimson hue; thus presenting a feathered appearance. The most splendid tints are exhibited by the calcareous structure of the *Polyzoa*, and of these the *Flustra truncata*, when viewed on the selenite stage. The *Cellularia avicularia* is very brilliant when viewed in the same way; its cells being covered with plates of carbonate of lime, present a fine display of beautiful tints, especially its *bird's-head* appendages.”

The structure of the spines and other solid parts of the skeleton of *Echinodermata* can only be displayed by making thin sections, in the way described for cutting bone, at page 100. But their peculiar texture requires that certain precautions should be taken, to prevent the section from breaking, whilst being reduced to a desirable thinness, and to prevent the interspaces of the network from being clogged by the particles abraded in the reducing process. In mounting the specimens, liquid balsam must be employed, and only a very gentle heat should be applied; and if, after it has been mounted, the section should be found too thick, it will be easy to remove the glass-cover and reduce it further, care being taken to harden the balsam, as recommended in preparing bone sections.

## CHAPTER III.

### SUB-KINGDOM, ANNULOSA.

ARTHIPODA — ANNULATA — ANNULOIDA — MOLLUSCA — CONCHIFERA — GASTEROPODA — PTEROPODA — TUNICATA — CEPHALOPODA — CRUSTACEA — ANNELIDA — ARACHNIDA — SUCTORIA, ETC.

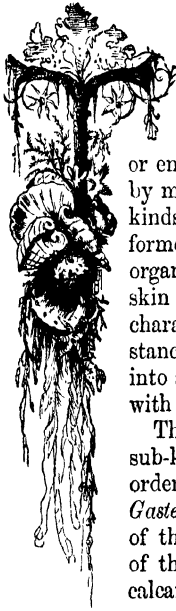

THE term *Mollusc* is derived from the Latin, and signifies soft; the body of the animal being soft, fleshy, and partly or entirely covered by a shell attached to it by means of muscles. Their shells are of two kinds; those of an epidermal character being formed upon the surface of a filmy cloak-like organ called a mantle, answering to the true skin of other animals; and those of a dermal character being concealed within the substance of the mantle, and frequently moulded into a great diversity of forms, and coloured with various tints.

The animals belonging to the molluscous sub-kingdom are divided into the following orders, viz. *Polyzoa*, *Tunicata*, *Conchifera*, *Gasteropoda*, *Pteropoda*, and *Cephalopoda*; of these, all, except the *Tunicata* and a few of the *Pteropoda*, are provided with a hard calcareous shell. In the first, the *Bryozoa* approximate so closely to *Zoophytes*, and having been, until very lately, classified with them, we have thought it more convenient to the microscopist to retain them in the place assigned to them by Ehrenberg.



The simplest form of shell occurs in the rudimentary oval plate of the common Slug, *Limax rufus*, (Fig. 206); it is imbedded in the shield situated at the back and near the head of the animal.

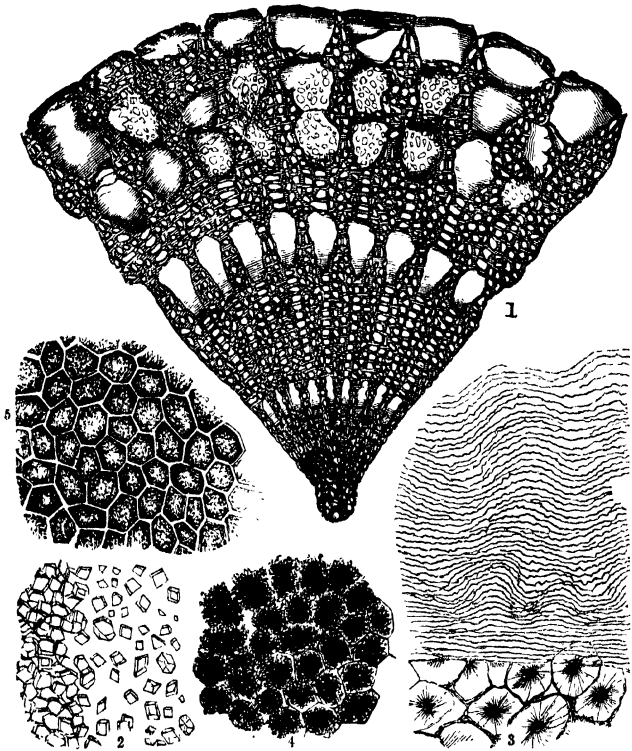

Fig. 205.

1, Portion of a transverse section of the spine of an *Echinus*. 2, Crystals of Carbonate of Lime, from the outer brown shell of the Oyster. 3, Horizontal section of shell of *Halotis splendens*, with stellate pigment in the interior. 4, Portion of shell of a crab, showing granules beneath the articular layer. 5, Another portion of the same shell, showing its hexagonal structure.

When a molluscous or conchiferous shell is composed of a single piece, it is then termed *univalve*; when of two

pieces, *bivalve*. The bivalve *Mollusca* exhibit no traces of any distinct head; whilst, in the univalve, this part of the body is well-marked, and usually furnished with special organs of sense (tentacles, eyes, &c.).

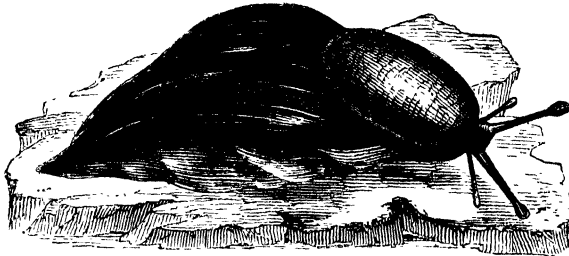

Fig. 206.—*Limax rufus*, the Common Slug.

The older naturalists also recognised a group of multi-valve shells, or shells composed of several valves. The majority of which belonged to the Cirrhopod order of *Crustacea*, and were regarded as *Mollusca* by earlier observers. The *Pholades*, however, which in other respects are true bivalve *Mollusca*, are furnished with a pair of accessory plates in the neighbourhood of the hinge; whilst the *Chitons*, a small but singular group of Molluscs nearly allied to the univalve limpets, have an oval shell composed of eight moveable plates, which gives them a great resemblance to enormous woodlice; and they have been regarded as forming a sort of transition towards the articulated division. Some *Mollusca* are not furnished with a shell, or have only a small calcareous plate enclosed within the mantle. These are called naked *Mollusca*; an example of this family is seen in fig. 207, *Aplysia*; but it is remarkable, that most of them are provided with a small shell when they first quit the egg. In the shell-bearing or *testaceous Mollusca*, this embryonic shell, which often differs greatly in shape and texture from the shell of the mature animal, nevertheless is a commencement of the latter, additions



Fig. 207.—*Aplysia*, Scahare.

being constantly made to the free edge by the secretion of calcareous matter at the margin of the mantle. The delicate membranous part of the mantle, which lines the interior of that part of the shell inhabited by the animal, has, also, the power of secreting a thin layer of shelly matter upon its inner surface. This is frequently of a pearly lustre; and in many bivalves a new layer of this substance is deposited at the time when the size of the shell is increased by additions to its margins,—for, it must be observed, that the formation of new shell is not constantly going on, but appears to be subject to periodical interruptions, as indicated by lines on the surface of the shell; which are called lines of growth. In many cases, the margin of the mantle, instead of being even, presents lobes or tubercles, these produce corresponding irregularities,—ribs, tubercles, or spines,—on the surface of the shell.

Mr. Bowerbank says, “Shell is developed from cells that in process of growth have become hardened by the deposition of calcareous matter in the interior.” This *earthy* matter consists principally of carbonate of lime, deposited in a crystalline state; and in certain shell, as in that of the common Oyster (fig. 205, No. 2), from the animal-cell not having sufficiently controlled the mode of deposition of the earth particles, they have assumed the form of perfect rhomboidal crystals.

The shell of the genus *Pinna*, “Wing-shells,” is composed of a series of hexagonal cells filled with transparent calcareous matter, seen at fig. 198, No. 2, the outer layer of which can be split up into prisms, like so many basaltic columns; as at No. 1.

Organs of sense are possessed by this class in an advanced condition of development. In the Scallop (*Pecten*), for example, eyes occur in great numbers, placed among the tentacles on the borders of the mantle. In other genera, the eyes are differently placed, in *Pinna* on the fore part of the mantle, and around the siphon-orifices in *Pholas* and *Solen*. In the Cockle (*Cardium*) the short siphons are surrounded with an extraordinary number of tentacles, capable of protrusion, each of which bears a pretty little eye; these are beautiful objects under the microscope. Cockles are able to perform vigorous leaps by means of a

well developed foot, which they possess; in other species the foot is grooved; and being associated with a gland which has the power of secreting a glutinous substance, the latter is drawn out into slender threads, with a sucker-like or flattened extremity, by which they attach themselves to rocks. The grooved foot is then withdrawn, and the thread hardens into an elastic sort of cord, called a *byssus*. It is by an aggregation of these threads that the common Mussel moors itself securely. The hinge of the shell is formed of variously shaped teeth and depressions; those under the beak are called *cardinal* teeth; those on either side are *lateral* teeth. They are all dwellers in deep water, and require to be sought for with the dredge.

The *Pholas* belongs to the family *Pholadidæ*, a series of animals that are remarkable for their destructive *boring* propensities. The *Teredo*, shipworm, is well known for the damage it does to the bottoms of ships, especially in the tropical seas. Others of this family give a preference to sand-stone, and even the most compact marble has been found bored through by them.

Mr. J. Robertson says:—"Having, while residing here, (Brighton,) opportunities of studying the *Pholas dactylus*, I have endeavoured during the last six months to discover how this mollusc makes its hole or crypt in the chalk,—by a chemical solvent? by absorption? by ciliary currents? or by rotatory motions? My observations, dissections, and experiments set at rest controversy in my own mind. Between twenty and thirty of these creatures have been at work in lumps of chalk in sea water in a finger glass and a pan, at my window, for the last three months. The *Pholas dactylus* makes its hole by grating the chalk with its rasp-like valves, licking it up when pulverized with its foot, forcing it up through its principal or branchial siphon, and squirting it out in oblong nodules. The crypt protects the *Pholas* from *Confervæ*, which, when they get at it, grow not merely outside, but even within the lips of the valves, preventing the action of the siphons. In the foot there is a gelatinous spring, or style, which even when taken out has great elasticity, and which seems the mainspring of the motion of the *Pholas dactylus*."<sup>1</sup>

(1) See Addenda.

*Tunicata*.—The most remarkable group of animals belonging to this order are the *Ascidians*. The cell of the Polyzoan is represented in the *Ascidian* by a *test* or *tunic*, of fleshy or membranous consistence, having two orifices, within which is another envelope, distinguished as the *mantle*. Few microscopic spectacles are more interesting than the sight of the circulation along this network of muslin-like fabric, and that of the ciliary movement by which the circulating fluid is kept moving. In the transparent species, such as *Clavelina* and *Perophora*, this movement is seen to great advantage. The animals are found very commonly adhering to the broad fronds of *fuci*, or on pieces of shell, near low water-mark. They thrive in tanks, and multiply, both by fissuration and budding. M. Milne Edwards, Professor Forbes, and others, have contributed memoirs upon these curious animals, one species of which is figured on the Frontispiece.

*Pteropoda*.—The most prominent character of this class is the possession of two broad muscular fins, one on either side of the neck, somewhat resembling the expanded wings of a butterfly, whence Cuvier gave them the name of *Pteropoda*, "wing-footed." In *Clio*, the anatomy of which has been carefully investigated, there is a very curious apparatus developed for seizing its prey. On each side of the mouth are three fleshy warts, covered with minute red specks. Under the microscope, these specks, numbering about three thousand on each tentacle, are seen to be transparent cylinders, each containing in its cavity twenty stalked discs, and forming so many adhesive suckers.

The Oyster is the type of the tribe *Ostracea*, and is *Acephalus*, (*non-headed*,) that is an animal without a distinct head. The gills, or breathing apparatus, form what is commonly called the beard of the oyster. The creature is attached by strong muscles to its shell. The mouth of the oyster is a mere opening in the body, without jaws or teeth; its food consists of nourishing substances suspended in the water, and which are drawn into the shell when it is open by means of cilia. Oysters attach one of their valves to rocky ground, or some fixed substance, by a mucilaginous liquid, which soon becomes as hard as the shell itself. They spawn some time in May; and their growth is

so rapid, that in three days after the deposition of the spawn, the shell of the young oyster is nearly a quarter of an inch broad; in three months it is larger than a shilling. The spawn is a very interesting object for microscopic examination, especially with polarised light. The young fry is represented in fig. 214; some have their cilia protruded.

In the stomach of the Oyster, and in the alimentary canal, myriads of living Monads and other Infusoria are found swimming about in great activity, and swarms of a conglomerate and ciliated living organism, which somewhat resemble the *Volvox globator*, but so extremely delicate in

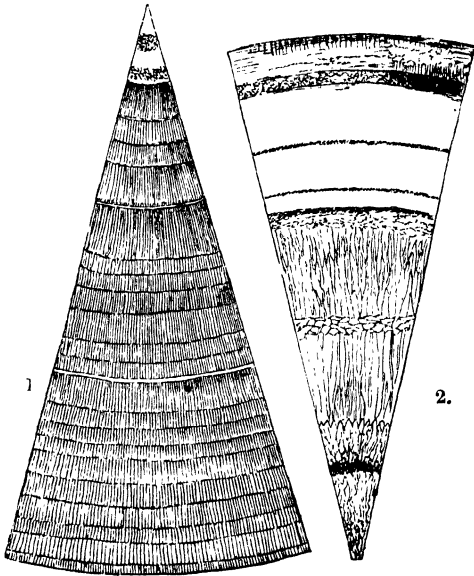

Fig. 208.

- 1, A transverse section of a Pearl from Oyster, showing its prismatic structure.
- 2, A transverse section of another Pearl, showing its central cellular structure, with outside rings of true pearly matter. (Magnified 50 diameters.)

their structure, that they require a slight charring to be rendered permanently visible.

Pearls are usually met with in the *Meleagrina Margaritifera*, "Pearl Oyster," which, however, does not belong to the family *Ostracea*. They are likewise found in the Mussel known as *Mya Margaritifera*, and an inferior kind in many Mussels of the rivers of Great Britain; and at one time, the pearl-fishery of Ireland was justly celebrated. Naturalists somewhat differ in their opinions as to the mode in which pearls are formed. Some think that they are produced by particles of sand getting into the stomach; the animal, to prevent the roughness of these particles from injuring its delicate structure, covers them over with a secretion from a gland, and by continual additions, they gradually increase in size. Mussels, in which artificial pearls were said to have been formed by the Chinese, have frequently found their way to this country. It is now, however, pretty generally admitted to be a disease; and that pearls are matured on a nucleus, consisting of the same matter as that from which the new layers of shell proceed at the edge of the Mussel or Oyster. The finest kind are formed in the body of the animal, or originate in the pearly-looking part of the shell. It is from the size, roundness, and brilliancy of pearls, that their value is estimated.

The microscope discloses a difference in the structure of pearls: those having a prismatic cellular structure have a brown horny nucleus, surrounded by small imperfectly-formed prismatic cells; there is also a ring of horny matter, followed by other prisms, and so on, as represented in fig. 208; these transverse sections of pearls from Oysters show successive rings of growth or deposit.

In a segment of a transverse section of a small purple pearl from a species of *Mytilus*, (fig. 209,) all trace of prismatic structure has disappeared, and only a series of fine curved or radiating lines are seen. The pearl consists of a beautiful purple-coloured series of concentric laminæ; and many of them have a series of concentric zones, and are of a yellow tint. The most beautiful sections for microscopic examination are obtained from Scotch Pearls.

True pearls, being composed entirely of nacre, are beautiful in their colouring. Some, again, are made up of nacre and prismatic cellular structure; the centre

having the prismatic formation, banded outside by two rings of true pearly matter—nacre, better known as “mother-of-pearl.”

*Brachiopoda*, “Lamp-shells,” or as the name literally signifies, *arm-footed*, was intended to express a most remarkable characteristic of these animals, the presence of a pair of arms, often of great length, rolled up in a spiral form, and believed by Cuvier to replace the foot in other bivalves. Professor Owen has shown that these organs are tubes closed at each end, and contain a fluid, which by the contraction of the circular muscular fibres of which the walls of the tube are composed, is propelled

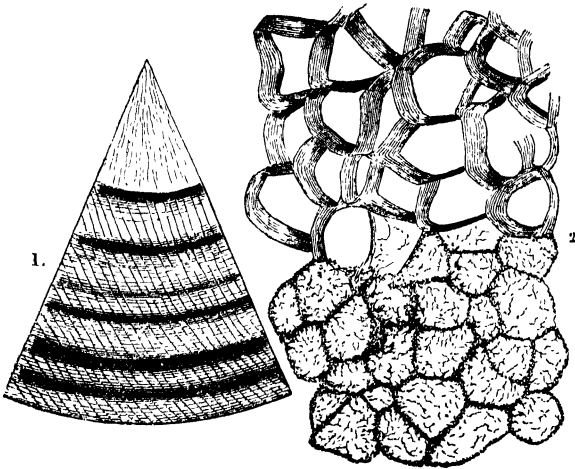

Fig. 209.

1, A transverse section of a small Pearl from a species of *Mytilus*. 2. Horizontal section of same Pearl magnified 250 diameters, to show prismatic structure, and transverse striae.

from the base to the extremity, thereby unrolling, as he believes, the spiral coils. One side of each arm is fringed with a vast number of long filaments, these are ciliated. The shell is opened by a peculiar process, which has given to the *Terebratula* the name of coach-spring shell. In the shell there are minute openings surrounded by a series of



radiating lines, these at first appear like dark oval spots ; but in a vertical section they are seen to be perforations or tubes running obliquely from the inner to the outer surface of the shell, and having a series of radiating lines on the edge, as in fig. 198, No. 3. The outer layer has been removed, to show a radiating structure around the perforations. Dr. Carpenter has accurately described the *Terebratula* in the *Philosophical Magazine*, 1854.

Not less curious than beautiful is the internal layer of many kinds of bivalves, which present an iridescent lustre, the whole surface being varied with a series of grooved lines running nearly parallel to each other. One of the most remarkable is the well-known Ear-shell, *Haliotis splendens*; this has been ascertained to consist of numerous plates, resembling tortoise-shell, forming a series of hexagonal cells, in the centre of which the stellate pigment is deposited (fig. 205, No. 3), alternating with thin layers of pearl, or *nacre*; and this exhibits, when highly magnified, a series of irregular undulating folds, represented in the upper portion of the section. The iridescent lines are often extremely pleasing; and if a piece be submitted to the action of diluted hydrochloric acid, until the calcareous portion of the nacreous layers are dissolved out, the plates of animal matter fall apart, each one carrying with it the membranous residuum of the layer of nacre that belonged to its inner surface. But the nacre and membrane covering some of these horny plates remain undisturbed; and their folded or plaited surfaces, although divested of calcareous matter, exhibit iridescent hues of the most gorgeous description. If the membrane is spread out with a needle, and the plates unfolded to a considerable extent, the iridescence is no longer seen; a fact which clearly demonstrates, that the beautiful colours presented by the nacreous portions of shells, commonly called mother-of-pearl, are produced solely by the disposition of single membranous layers in folds or plaits, lying more or less obliquely to the general surface.

**GASTEROPODA.**—*Belly-creeping* animals, Snails and Slugs; this family is characterised by having a fleshy disc, serving as a foot upon which to creep. The back is covered with

a cloak mantle, in or upon which the shell is secreted; this may consist of one or more pieces. All the shells are remarkable for the small amount of the animal as compared with that of the earthy matter, so that they are extremely brittle; the fractured surfaces have a crystalline appearance.

In the *Chitonidæ*, coat-of-mail shells, the shell consists of eight transverse plates, imbedded in the mantle; in the Limpets, the ordinary form is that of a cone.

The majority of the *Gasteropoda* are furnished with a shell, denominated *spirivalve*. The cause of this spiral arrangement is said to be owing to the shape of the body of the animal inhabiting the shell, which, as it grows, principally enlarges its shell in one direction; thus, of course, making it form a spine, modified in shape according to the degree in which each successive turn surpasses in bulk that which preceded it. It would rather appear that this is principally owing to the ciliary motion imparted to the early stage of the embryo; the first deposit of calcareous matter forming the *axis*, the tube continues to rotate upon its axial pillar or *columella*, as it is called; and by reason of some other peculiar vital tendency, the shell is gradually deposited in a series of cells; thus enlarging its conical form, and winding obliquely from right to left. Every turn around the axis is termed a *whorl*; and when the columella is hollow, it is said to be *umbilicated*. In the spirivalve-shelled *Gasteropoda*, we find a difference in structure between that part of the mantle which envelopes the viscera, and which is always concealed within the cavity of the shell, and the portion placed around its aperture.

The mouths of most *Gasteropoda* consist of a strong muscular cavity, and a single crescent-shaped horny tooth, armed along its upper edge with sharp points, and separated by semicircular cutting spaces, admirably adapted for the division of the vegetable food upon which they feed; furnishing beautiful objects for the microscope, and depolarising light, as in Fig. 210. Several kinds of Spails are found in our brooks and ditches. One of the most frequent of these is known as the *Planorbis corneus*, horny coil-

shell. The amber-snail, *Succinea amphibia*, has a beautiful transparent shell of a light amber colour; and it is from

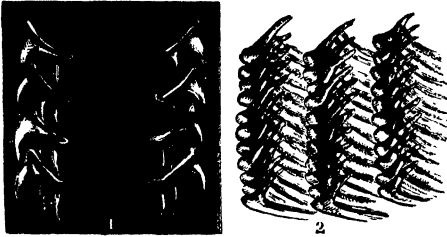

Fig. 210.

- 1, Palate of *Buccinum undatum*, common Whelk, seen under polarised light.  
2, Palate of *Doris tuberculata*, Sea-slug.

this that it derives its scientific name—*Succinum*, amber. The puddle-mud snail (*Limnæus peregra*) is also very gene-

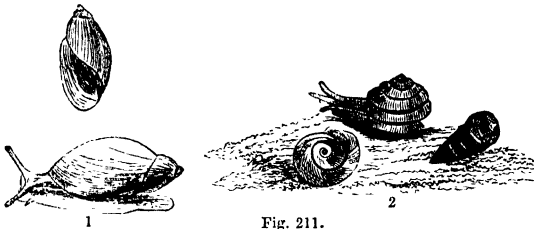

Fig. 211.

- 1, *Physa fontinalis*, the Amber Snail. 2, Moor Snail and Mountain *Bulimus*.

rally distributed. The shells of all the species (*Limnæa*) have the aperture on the right hand, and the plait on the left hand, which distinguishes them from the *Physa fontinalis*, stream-bubble shell.

It is extremely curious to watch the development of the spawn of these animals under a low magnifying power. The spawn of the Water-snail is usually found adhering to the surfaces of stones, pieces of weed, or other matters in the water; and generally connected together in long ribbon like delicate ova-sacs of a curious and beautiful form. The mass of eggs deposited by the *Doris* resembles a frill of lace of great beauty. In the *Aplysia* the spawn resembles long strings of vermicelli, of varying tints through-

out the different parts of the thread. The *Limnæus stagnalis* deposits small sacs, containing from fifty to sixty

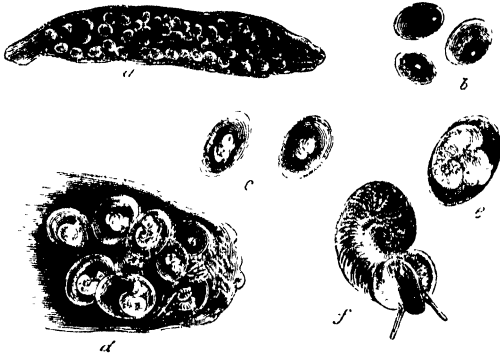

Fig. 212.—*Limnæa stagnalis*.

ova; one of which is represented at *a*, fig. 212. When examined soon after they are deposited, the vesicles appear to be filled with a perfectly clear fluid; at the end of twenty-four hours a very minute yellow spot, the nucleus, or germ, may be seen near the side of the cell-wall. In about forty-eight hours afterwards, this small germ has a smaller central spot rather deeper in colour, which is the nucleolus. On the fourth day the nucleus has changed its position, and is enlarged to double the size: a magnified view is given at *b*; upon viewing it more closely, a transverse fissure or depression is seen; this on the eighth day most distinctly divides the small mass into the shell and soft part of the future animal, *c*. It is then detached from the side of the cell, and moves with a rotatory motion around the cell-interior; the direction of this motion is from the right to the left, and is always increased when the sunlight falls upon it. The increase is gradual up to the sixteenth day, when the spiral axis can now be made out as at *d*; it presents a striking difference in appearance to the soft parts. On the eighteenth day, these changes are more distinctly visible, and the ova crowd down to the mouth of the ova-sac; by using a higher magnifying power, a minute black speck, the future eye, is seen protruded

with the tentacles, at *e*. Upon closely observing it, a fringe of cilia is noticed in motion near the edge of the shell. It is now apparent that the rotatory motion first observed must have been in a great measure due to this; and the current kept up in the fluid contents of the cell by the ciliary fringes. For days after the young animal has escaped from the egg, this ciliary motion is carried on, not alone by the fringe surrounding the mouth, but by cilia entirely surrounding the tentacles themselves,



Fig. 213.—*Limnæus stagnalis*.

which whips up the supply of nourishment, and at the same time the proper aeration of the blood is effected. Whilst in the ova, it probably is by this motion that the cell-contents are converted into tissues and shell. From the twenty-sixth to the twenty-eighth day, it appears actively engaged near the side of the egg, using all its force to break through the cell-wall, which at length it succeeds in doing; leaving the shell in the ova-sac, and immediately attaching itself to the side of the glass-vase, to recommence its ciliary play, and appears in the advanced stage represented at *f*. It is still some months before it grows to the perfect form represented at fig. 213,

where the animal is drawn with its sucker-like foot adhering closely to the side of the glass-vase. One of these snails may deposit from two to three of these ova-sacs a week; producing, in the course of six weeks or two months, from 900 to 1,000 young, thus supplying food for fish.

The shell itself is deposited in minute cells, which take up a circular position around the axis; on its under-surface a hyaline membrane is secreted. The integument expands, and at various points an internal colouring-matter or pigment is deposited. The increase of the membrane goes on until the expanded foot is formed, the outer edge of which is rounded off and turned over by condensed tissue in the form of a twisted wire; this encloses a net-work of small vessels filled with a fluid in constant and rapid motion. The course of the blood or fluid, as it passes

from the heart, may be traced through the larger branches to the respiratory organs, consisting of branchial-fringes placed above the mouth; the blood may also be seen returning through other vessels. The heart, a strong muscular apparatus, is *pear-shaped*, and enclosed within a pericardium or enveloping membrane, which is extremely thin and pellucid. Affixed to the sides of the heart are muscular bands of considerable strength, the action of which appears very like the alternate *to-and-fro* motion occasioned by drawing out bands of India-rubber, and which, although so minute, must be analogous to the muscular cords of the mammal heart; it beats or contracts at the rate of about sixty times a minute; and is placed rather far back in the body, towards the axis of the shell. The nervous system is made up of ganglia, or nervous centres, and distributed throughout the various portions of the body.

The singular arrangement of the eye cannot be omitted; it appears at an early stage of life to be within the tentacle, and consequently capable of being retracted into it. In the adult animal, the eye is situated at the base of the tentacle; and although it can be protruded at pleasure for a short distance, it seems to depend much upon the tentacle for protection as a coverlid—it invariably draws down the tentacle over the eye when that organ needs protection. The eye itself is pyriform, somewhat resembling the round figure of the human eye-ball, with its optic-nerve attached. In colour it is very dark, having a central pupillary-opening for the admission of light. The tentacle, which is cylindrical in the young animal, becomes flat and triangular in shape in the adult. The young animal is for some time without teeth; consequently, it does not very early betake itself to a vegetable sustenance: in place of teeth it has two rows of cilia, as before stated, which drop off when the teeth are fully formed. The lingual band bearing the teeth, or the “tongue,” as it is termed, consists of several rows of cutting spines, pointed with silica.

It is a fact of some interest, physiologically, to know that if the young animal is kept in fresh water alone, without vegetable matter of any kind, it retains its cilia, but arrest of development follows, and it acquires no gastric teeth, and never attains perfection in form or size.

If, at the same time, it is confined within a narrow cell, or space, it grows only to such a size as will enable it to move about freely; thus it is made to adapt itself to the necessities of a restricted state of existence. Some young animals in a narrow glass-cell, at the end of six months, were alive and well, and the cilia retained around the tentacles in constant activity; whilst other animals of the same brood and age, placed in a situation favourable to growth, attained their full size, and produced young, which grew in three weeks to the size of their elder relations.

Should any injury occur to the shell, or a portion of it become broken off, the calcareous deposit is quickly resumed, in order to replace the lost part; the cells being apparently only half the size of those originally deposited. This may be thought to afford some proof of the statement made by Professor Paget,—“that, as a rule, the reparative power in each perfect species, whether it be higher or lower in the scale, is in an inverse proportion to the amount of change through which it has passed in its development from the embryonic to the perfect state. And the deduction to be made from them is, that the powers for development from the embryo are identical with those exercised for the restoration from injuries; in other words, that the powers are the same by which perfection is first achieved, and by which, when lost, it is recovered. Indeed, it would almost seem as if the species that have the least means of escape or defence from mutilation were those on which the most ample power of repair has been bestowed,—an admirable instance, if it be only generally true, of the beneficence that has prepared for the welfare of even the least of the living world, with as much care as if they were the sole objects of the Divine regard.”

The primordial cell-wall of the cell does not appear to enter into the formative process of the embryo—the cell-contents alone nourishing the vital blastema of the nucleus. A gradual cycle of progressive development once set up, goes on, until the animal is sufficiently matured to break through the cell-wall and escape from the ova-sac. At the same time, it may be inferred, that all this is in some measure aided by the process of endosmose; and that cer-

tain gases or fluids are drawn into the interior, and thus aid in the supply of nourishment for the growth of the animal. The cell-wall appears to bear the same relation to the future perfect animal, that the egg-shell of the chick does to it; it is, in fact, but an external covering to a certain amount of gaseous and fluid matter, used for placing the germ of life in a more favourable state for development, assisted, as it is, by an increase of temperature, usually the resultant of a chemical action, set up or once begun in an *organism* and a *medium*. "The ovum destined to become a new creature originates from a cell, enclosing gemmules, from which its tissues are formed, and nutriment is assimilated, and which eventually enables the animal to successively renew its organs, through a series of metamorphoses that give it permanent conditions, not only different, but even directly contrary to those which it had primitively."

"Oh, there are curious things of which men know  
 As yet but little! secrets lying hid  
 Within all natural objects Be they shells,  
 Which ocean flingeth forth from off her billows  
 On the low sand, or flowers, or trees, or grasses,  
 Covering the earth; rich metals or bright ores,  
 Beneath the surface. He who findeth out  
 Those secret things hath a fair right to gladness:  
 For he hath well performed, and doth awake  
 Another note of praise on Nature's harp  
 To hymn her great Creator."

*Cephalopoda*.—Molluscous animals without a foot, with a distinct head, and covered with fleshy arms, bearing sucker-like discs. The Cuttles and Squids form the principal groups of this class, only a few species of which are found on our shores. These molluscs are the nearest approach of all invertebrate animals to the vertebrate forms; and all the senses appear to be highly developed in them. Their most characteristic peculiarity is, that the front of the body, which forms a large head, carries numerous fleshy *arms*, these are effective instruments for the seizing and holding of the living prey on which they feed; they are likewise used for crawling. One very curious circumstance in the economy of the Cuttles, is the power they possess of suddenly discharging a volume of fluid of intense blackness, which is secreted in the ink-bag. This fluid was used by the ancients for writing, and



at present in the preparation of Indian-ink and sepia. They have the power also of causing a constantly changing play of various colours on their surface ; this depends on the structure of the skin, which contains elastic cavities filled with variously coloured fluids, acting under the influence of a highly developed nervous system. Cartilage enters into the formation of the head.

*Structure of Shells.*—We may exhibit the structure of shells by using an acid solvent in the following manner. If a sufficient quantity of hydrochloric acid, considerably diluted with water (say one part acid to twenty-four of water), be poured upon a shell contained in a glass vessel, it will soon exhibit a soft floating substance, consisting of innumerable membranes, which retain the figure of the shell, and afford a beautiful and popular object for the microscope. In analysing shells of a finer texture than such as are generally submitted to the test of experiment, the greatest circumspection is necessary. So much so, that M. Herissant, whose attention was particularly devoted to the subject, after placing a porcelain shell in spirits of wine, added, from day to day, for the space of two months, a single drop of spirits of nitre, lest the air, generated or let loose by the action of the hydrochloric acid on the earthy substance, should tear the net-work of the fine membranaceous structure. This gradual operation was attended with complete success, and a delicate and beautifully reticulated film, resembling a spider's web in texture, rewarded the patience of the operator ; the organisation of which film, from its extreme fineness, he was not, however, able to delineate. In shells of peculiar delicacy, even five or six months are sometimes necessary for their complete development ; but in others of a coarser texture the process is soon completed. Sections of shells are usually mounted in Canada balsam, or in shallow cells without fluid.

*Crustacea.*—The skeletons of *Crustacea*<sup>1</sup> are external to the soft parts ; in a great number of species it is thin and membranous, in others it is of a horny material, thickened with calcareous matter, having a distinct series of pigment cells of a stellate figure, all supplying beautiful objects for microscopic examination.

(1) *Crustacea*, from *crusta*, a shell.

A crustaceous animal consists of three parts : the head, the body, and the carapace, which is covered with one entire shell, and is popularly called the tail, consisting of seven rings, or joints. There are properly fourteen rings in that part of the body which is called the carapace ; but they are only used when the animal changes its shell. The joints in the tail are to enable the animal to spring forward, which it does frequently when it wishes to change its position. It can also crawl ; but it moves in this manner awkwardly, and in an oblique direction. The Shrimp, though it has no claws, properly so called, has two feet larger than the rest, each of which has a hooked jointed process at the extremity. The Prawn differs from the Shrimp, and is nearly allied to the Crawfish, or thorny Lobster. Prawns (*Palæmon*), Shrimps, and Sand-raisers (*Crangon*), and *Thalassinidæ*, burrow in the sand, mostly in shallow water. Sand-hoppers (*Talitrus*) are found in great numbers on the beach ; whilst the *Podosomata* and the smaller *Entomostraca* are found in the tufts of seaweeds that grow between tide levels. All the *Crustacea* have the power of renewing their claws, if they are torn off at a joint, and they change their shells every year. The development of the Crayfish (*Astacus*) has been the subject of an admirable memoir by Rathke. The apparatus which is commonly regarded as the auditory organ was first demonstrated by Dr. Arthur Farre. He says : "The organs connected with the external antennæ, and considered by anatomists generally to have an auditory function, are not the true organs of hearing ; but that they are situated in an oval space, on the largest joint of the antennule. On cutting away the hairs close to the base, they are found to cover a funnel-shaped aperture of about one-sixteenth of an inch long. A nerve can be traced to the base of this canal. The eyes are divided into a great number of minute quadrilateral facets, each of which corresponds with the base of a quadrilateral pyramid, constituted by a membranous sheath, containing the clear vitreous humour, whose apex is prolonged towards the bulbous expansion of the optic nerve. The faces of the pyramids are separated throughout their whole length by a dark pigment, which performs the function of a choroid coat."

The *Astacus*, Crayfish, may be taken as the type of that large and important group of *Crustacea* to which the term *Podophthalma*, Stalk-eyed, is applied.

Dr. Carpenter describes the shell of the Crab and Lobster as being composed of three layers, viz. the epidermis or cuticle, the rete-mucosum or pigment, and the corium. The epidermis is of a horny nature, being generally more or less brown in colour, and under the highest magnifying powers presenting no trace of structure (fig. 198, No. 2); it invests all the outer parts of the shell, and has in many instances large cylindrical or feather-like hairs developed from certain portions of its surface. The rete-mucosum, or pigment cells, consist of either a series of hexagonal cells, forming a distinct stratum, or of pigmental matter diffused throughout a certain thickness of the calcareous layer. (Fig. 205, No. 5.) In the Crab and Lobster it is very thin, but in the Crayfish it occupies in some parts more than one-third of the entire thickness of the shell; when examined by the microscope, this portion appears to be composed of a large number of very thin laminae, which are indicated by fine lines taking the same direction on the surface of the shell, the number of lines being the greatest in the oldest specimens; these layers, even in the Crayfish, are covered by a thin stratum of very minute hexagonal cells, without any trace of cell matter in their interior. The corium is the thickest layer of the three, being the one on which the strength of the shell depends, in consequence of the calcareous material deposited in it. (Fig. 205, No. 4.) When a vertical section of the shell of the Crab is examined, it is found to be traversed by parallel tubes, like those in the *dentine* of the human tooth; these tubes extend from the inner to the outer surface of the shell, and are occasionally covered by wavy lines, probably those of growth, shown in a portion of No. 3, fig. 205. If a horizontal section of the same shell be made, so that the tubes be divided at right angles to their length, the surface will clearly exhibit their open mouths, surrounded by calcareous matter. In Shrimps and very small Crabs, the deposition of the calcareous matter takes place in concentric rings, like those of agate; and occasionally small centres of ossification, somewhat like *Pinna*, with radiating

strisæ, are met with in the Shrimp. If the calcareous portion of the shell be steeped in hydrochloric acid, a distinct animal structure or basis is left behind, and the characters of the part will be very accurately preserved. The calcareous matter, like that of bone, generally presents a more or less granular appearance as at No. 4, and so angular in figure as to resemble certain forms of rhomboidal crystals, shown at No. 2, from the outer brown shell of the Oyster. The beauty of all these structures is much increased if viewed with polarised light on a selenite stage.

*Cirrhopoda* or *Cirripedia*, when mature, attach themselves to rocks and other objects; the Barnacle (fig. 214) and Acorn-shell are the best known examples of this order; they generally select floating objects to dwell upon; and bottoms of ships have been covered by them to such an extent as even to impede their progress through the water. The soft bodies of these animals are enclosed in a case composed of many calcareous plates; from this circumstance they were grouped with the *multivalve shells* of the older conchologists. The limbs are converted into tufts of jointed cirri, and protrude through an opening in the mantle which lines the interior of

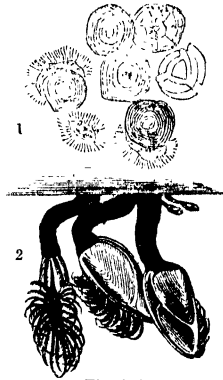

Fig. 214.

1, Young fry of the Oyster, a portion of them with cilia protruded. 2, Body and cirri of Barnacles.

the shell. The cirri, twelve in number, are covered with cilia, which, when the animal is alive, are in continual motion. The intestinal canal is complete, and the nervous system exhibits the usual series of ganglia, which is characteristic of the articulate type. The head is marked only by the position of the mouth, and is armed with a pair of jaws, if we may so term the shells.

*Balanidæ*, "Sea-acorns," a sessile species, whose curious little habitations may constantly be met with upon the rocks of the sea-shore, and not unfrequently upon many

species of marine shells. The shell forms a short tube, and is usually composed of six segments securely united together. The lower part of this tube is firmly fixed to the object on which the *Balanus* has taken up its abode; whilst the superior orifice is closed by a moveable roof, composed of from two to four valves, between which the little tenant of this curious domicile protrudes his delicate cirri in search of nourishment. In the young state the *Balanidæ* freely swim about and somewhat resemble the following group, the *Entomostraca*.

*Entomostraca* occur in countless swarms in all waters, whether salt or fresh; and, minute as they are, one of the species is said to constitute the principal food of the Whale. The genus *Cyclops* (fig. 215), specimens of which may be found in every stagnant pool, as well as the open seas, the type of the family *Cyclopidæ*, is characterised by the possession of a single eye. In the *Cetochilidæ* there are two of these organs.

The animals comprising the order *Ostracoda* are generally of very minute size; the body, which strongly resembles that of the *Copepoda*, is always enclosed in a little bivalve shell, the feet and antennæ being protruded between the lower edges of the valves. These little shells so closely resemble those of minute bivalve *Mollusca*, that those of some of the larger species have actually been described by conchologists as the coverings of animals belonging to that class. The antennæ are often curiously branched; and the hinder extremity is usually prolonged into a sort of tail, which is seen in constant action when the animal is in motion. In *Cypridina*, the body is entirely enclosed by a shell, of which the genus *Cypris* (fig. 215) is an example; and in *Daphnia*, "Water-fleas," the head is protruded beyond the shell. In *Polyphemida* the head is large, and almost entirely occupied by an enormous eye, giving the creatures a most singular appearance; the *Monoculus* is a well-known example of this group. Another family, not provided with a shell or carapace, called *Branchiopoda*, from the name of the typical genus, *Branchiopus stagnalis* (fig. 215), is often found after heavy rains in cart-ruts and other small pools. The *Artemia salina* inhabits a still more curious situation, namely, the salt-pans at Lyming-

ton, where it is usually found in those pans in which the evaporation of the water has proceeded to a considerable extent.

*Daphnia pulex* is found commonly in fresh water, and is scarcely inferior to its marine relative, *Talitrus locusta*, in agility. The *Corophium longicorne*, remarkable for its long antennæ, is not less so for its singular habits. It is found at Rochelle, where it burrows in the sand, and wages constant war with all other marine creatures of moderate size that come in its way.

A few years since, only a small number of the *Entomotraca* were described. Dr. Baird has lately contributed a valuable volume on the British species; published by the Ray Society, 1850.

In the *Maiada*, "Sea-spiders," the carapace is more or less narrowed in front, forming a projecting beak or rostrum; the legs are long and hairy; the back covered with spines and hairs, much resembling the Spider tribe, whence the name of Spider-crabs or Sea-spiders, by which these animals are known.

COLLECTING SALT-WATER SPECIMENS.—"Nothing," says Dr. Harvey, "can exceed the beauty of a clear rock-pool, seen under strong sunlight, and through a calm surface, tenanted by its various animated tribes, all fulfilling the duties allotted to their several kinds. Careful examination with a lens will generally detect a multitude of minute shells, some of very strange shapes, and others possessing structures of great elegance. These are the various species of *Foraminifera*. We should recommend these species to be studied in a living condition, whenever opportunity presents, as it will prove a study of great interest. The

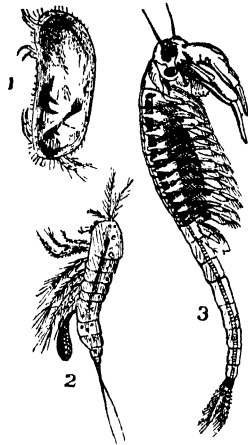

Fig. 215.

- 1, *Cypris*. 2, *Polyphemus, Cyclope*.  
3, *Branchiopus stagnalis*.

drift-sand will often be found to contain a wonderful variety of minute spiral univalve shells, though these are scarcely of so small a size as to come within the list of microscopic objects. Others may be obtained by the gatherers of sea-weeds, with little trouble, if they will only preserve the sediment that collects in the water in which the sea-weeds are washed. When the sea-weeds are plunged into fresh water, these minute molluscs (*Rissoæ*) are quickly killed, and fall to the bottom, and may then be secured by simply straining the water through a piece of canvas. Many other minute and curious animals, and sometimes *Diatomaceæ*, may be collected in a similar way.

“Having thus surveyed the rocks, sands, and weeds of the shore above low-water mark, if we launch upon the deep itself, a similar abundance of minute and interesting forms is still presented to us. A small muslin bag, the mouth of which is kept open by a wire ring about four inches in diameter, towed slowly behind a boat, on a calm and bright day, in any sheltered bay or inlet, will be found to have gathered multitudes of creatures of the most beautiful forms, and occasionally of the most brilliant colours,—creatures whose crystalline substance affords to our wondering gaze a ready insight into many things connected with the structure of the lower animals, which will in vain be sought elsewhere. In this way are collected the numerous species of minute *Naked-eye Medusæ*. Nothing can be conceived more elegant and graceful than the motions of these minute crystalline bodies in a glass of water. On almost every part of the coast, besides the beautiful *Tunis neglecta* and the allied *Beroes*, the towing-net will gather innumerable specimens of a creature resembling a slender spicula of glass, about an inch in length, but which is so slender and transparent as to be almost invisible except in a particular direction of the light: this is the *Sagitta bipunctata*; and its simple structure affords an excellent subject for microscopic research. When fishing for objects of this kind, it is best to have in the boat a large *white* basin half filled with sea-water; and into this the towing-net is to be inverted and gently shaken every now and then. In this way the delicate creatures it contains will come out of it without

injury; and though themselves perhaps at first wholly invisible, their shadows will be seen with great distinctness at the bottom of the basin; and thus many forms which might otherwise escape observation be rendered evident.

“The microscopic wonders of the sea, however, are still far from being exhausted; it presents as many, if not more, curiosities at the bottom, where its depths are never opened to view, than at the surface. The best and most convenient mode of obtaining these, is by the use of an instrument, with which all perhaps are acquainted in one shape or another,—we mean the *dredge*. The essential qualities of a microscopist’s dredge are, a small and convenient size, with sufficient weight to ensure its sinking to and keeping at the bottom, even when at a considerable depth and drawn with some velocity through the water. The dredge we should recommend is made of cast iron, which reduces the cost considerably; and it is, in practice, found to be sufficiently strong. It is about eighteen inches in length, and the opening is about four inches wide, the two sides diverging outwards at a slight angle, and coming to a sharp edge.”

ANNULOSA.—*Articulata*. The animals composing the sub-kingdom *Articulata* are characterised by having the body enclosed in a tunic, or integument, consisting of a series of rings, segments, or joints, “articulated” together by a flexible membrane.

*Arachnida*.—The animals forming the class *Arachnida*, include spiders and their allies, most of which are looked upon with disgust and aversion by the generality of mankind. *Arachnida* are divided into two orders, *Trachearia* and *Pulmonaria*. The first includes the *Acaridæ* or Mites, in which we find tracheæ, as in insects, but no distinct vascular apparatus: in the second, spiders and scorpions are included, and these have a pulmonary cavity, and a well-developed circulating system. The above are distinguished from *Podophthalmia* or *Arthropoda* by their aerial respiration, their possession of four pairs of legs attached to an anterior division of the body, and the total absence of antennæ. The body is also covered with a softish skin, which sometimes attains a horny consistency,



but nothing more. In the higher forms, the body may be said to be divided into two parts, the anterior of which, as in the *Crustacea*, consists of the thoracic segments, amalgamated with those of the head, and forming together a mass called the cephalothorax. In the highest the division of the thorax into separate segments becomes apparent; but the anterior segment is still amalgamated with the head. The structure of the abdomen varies greatly. In some cases it forms a soft round mass, without any traces of segmentation; whilst in others, as scorpions, it is continued into a long flexible jointed tail.

The *Annulosa* is divided, by Professor Huxley, into two principal groups, the *Articulata* and the *Annuloida*. The *Articulata*, comprising *Insecta*, *Myriapoda*, *Crustacea*, and *Arachnida*, possess a definitely segmented body; the segments being provided with appendages, the anterior of which are so modified as to subserve the functions of sensation and manducation. They have almost always a heart, communicating with the general cavity of the body, for propelling the true corpusculated blood which that cavity contains. The nervous system consists of a longer or a shorter chain of ganglia.

Nothing can be more variable than the characters of the body, the appendages, and the nervous system among the rest of the *Annulosa*, which are included under the *Annuloida*; nevertheless, there are two features in which they all agree; firstly, they possess a remarkable system of vessels, either ciliated, or deprived of cilia, and containing a fluid very different from the true blood which fills the general cavity of the body or perivisceral space; secondly, in no annuloid animal has any *true* heart been hitherto discovered. Contractile vessels belonging to the system just referred to abound, but no organ comparable in structure to the heart of other animals has yet been found in any of the *Annuloida*.

The *Annuloida*, as thus defined and limited, fall into two parallel series; in one of which, for the most part, diœcious forms predominate, as the *Annelida*, while of the latter, the *Trematoda* may be regarded as the typical example; on the other hand, the *Echinodermata* and

*Rotifera*, the *Tæniadæ* and the *Nematoidea*, may be considered as the most aberrant groups of their respective series.

Under the head *Annelida*, Mr. Huxley includes the errant and tubicular Annelids of Cuvier, and the *Gephyrea* of De Quatrefages; he thinks that the *Terricola*—the Earthworms and Naidæ—should be separated from the *Scoledæ* of Milne Edwards, and brought into the same group. So far as external structure is concerned, the genus *Polynœ* is, perhaps, the best fitted to serve as the type to which other *Annelida* may be referred: the commonest form of the genus being the *P. squamata*.<sup>1</sup> The best developed branchiæ among the Annelids are possessed by the *Amphinomidæ*, the *Ennicidæ*, the *Terebellidæ*, and the *Serpulidæ*. The branchiæ in the three former families are ciliated, branched plumes or tufts attached to the dorsal surface of more or fewer of the segments. In the last they are exclusively attached to the anterior segments of the body, and present the form of two large plumes, each consisting of a principal stem, with many lateral branches; this stem is itself supported on a kind of cartilaginous skeleton.

The teeth in a great number of the *Annelida* are very curious and distinctive. In the *Polynœ* there are four, planted in the muscular wall of the proboscis. In the *Nereis* there are two powerful teeth working horizontally, besides minute accessory denticles. In *Syllis* there is a circle of sharp teeth, surrounding a triangular median tooth. In *Glycera* there are a pair of teeth; but the most complex arrangement of teeth is that presented by the *Ennicidæ*. The tubicular Annelids possess neither proboscis nor teeth.

Many Annelids pass through a larval condition, in which the body exhibits mere indications of segments, and the appendages are entirely absent; locomotive function being performed by a circlet of cilia, disposed around the anterior part of the body. There is a large group of very remarkable organisms, observes Mr. Huxley, the minute "wheel animalcules," *Rotifera*, whose whole

(1) Consult a valuable paper on this genus in Müller's Archiv. 1857. Also Huxley's Lectures in *Medical Times*, July 12, 1856.

organization demonstrates, not merely their annulose nature, but their position among the *Annuloida*, and which exhibit precisely the same indistinct segmentation, the same general absence of appendages, and whose means of locomotion are in like manner confined to one or two ciliated circlets at the anterior part of the body. The connexion between the *Annelida* and the *Rotifera* is further illustrated by such remarkable forms as the *Polyophthalmus* of De Quatrefages, a true Annelid, which, nevertheless, possesses on each side of the head a ciliated lobe, capable of being voluntarily protruded and retracted, and presenting a close resemblance to the trochal disc of a Rotifer. *Hydatina senta* has been so well and accurately described by Dr. Cohn,<sup>1</sup> and others, that it may be taken as the typical form of the *Rotifera*. The trochal disc in the species, undergoes great changes of form. In *Hydatina*, it is circular, and its margin is skirted by two distinct continuous bands of cilia, the one immediately in front of, the other behind the mouth. In *Brachionus* the ciliated circlet fringing the edges of the trochal disc is horseshoe-shaped, but the circlet is produced into three lobes or processes, which stand out perpendicularly to the surface of the trochal disc. In *Stephanoceros* it fringes the edges of a number of tentaculiform processes, into which the trochal disc is produced, so as to give the whole animal somewhat the appearance of a Polyzoön.

The *Turbellaria*, a group of serpent-like worms, for the most part the inhabitants of fresh and salt waters, a few only being found in damp situations on land, are characterised by the ciliation of the entire surface of the body. In their internal organisation they approximate in many respects to the *Trematoda*, while in others they exhibit a certain affinity with the other great group of parasitic *Annuloida*, the *Nematoidea*. *Polycelis lævigatus*, one of the *Dendrocoela* so well described by De Quatrefages in his Monograph on the Marine *Planariæ*, may be most advantageously selected as a type of the group. The *Nemertidæ* have engaged the attention of the same learned authority, the ova of which undergo a remarkable kind of

(1) *Ueber die Fortfawung der Raderthiere*, Von Dr. F. Cohn, in Breslau, 1855.

metamorphosis. The embryo has at first a ciliated non-contractile, oval body, exhibiting no structure but a semi-lunar superficial cleft, provided with raised edges. After a time, a small actively-contractile, vermiform creature, resembling the parent, escapes from the interior of the larval form, which it leaves behind like a cast skin. The semilunar cleft becomes the mouth of the imago, and is only part of the larva carried away. The *Gordiacei*<sup>1</sup> best enable us to connect the *Turbellaria* with the very puzzling group *Nematoidea*, and the structure of several species belonging to the two genera which compose the group *Mermis* and *Gordius*, have recently been made the subject of two elaborate monographs by Meissner.<sup>2</sup>

The *Gordiacei* are excessively elongated, thread-like worms, plentiful enough in Thames mud, and, as Von Siebold discovered, partake both of the free habit of the *Nemertidæ*, and of the parasitic nature of the *Nematoidea*. The young *Mermis*, for instance, is parasitic upon insects, inhabiting the perivisceral cavity of the larva or of the imago.

The *Nemertidæ* seem to differ from their close allies the *Turbellaria*, in possessing a vascular system distinct from and added to the water-vessels. In the *Hirudinidæ*, Leeches and Earthworms, a system of vessels homologous with the pseud-hæmal system exists, and, in addition a series of more or less coiled tubules lie in the perivisceral cavity, and open, by pores, on the ventral surface of the body. These organs have been regarded sometimes as secretory, sometimes as respiratory apparatus; but all that we know about them in reality is that they are tubular, and are more or less richly ciliated within, and that, in some cases (*Nais*, *Lumbricus*), they present at their internal extremities a ciliated aperture, whereby they freely communicate with the perivisceral cavity.

There remains, however, yet another system of vessels in the *Annuloida*—the ambulacral vessels of the *Echinodermata*. These are frequently termed “water-vessels,” and, indeed, if we regard the structure with reference to

(1) Huxley, *General Natural History*.

(2) *Beiträge zur Anatomie und Physiologie von Mermis Albicaus*, v. *Zeitschrift für Wiss. Zoologie*, Bd. v 1854; and *Beiträge zur Anat. & Physiol. des Gordiacen*, *Ibid.* Bd. vii. 1855.

their peculiar functions, they singularly resemble true water-vessels; they open by an external pore, and are ciliated internally; they unite around the gullet, as do the water-vessels in some *Trematoda*, and are eventually shut off from such communication; the ambulacral vessels of the *Holothuridæ* undergo precisely this change, and thus they facilitate our comprehension of a transition from the water-vessels of the *Trematoda* to the pseud-hæmal vessels of the *Annelida*. We may take it as an established fact that, whatever the functions of this varied vascular system and its contents in different classes of the *Annuloida*, they have nothing to do with the blood or true blood vessels. The latter are entirely absent in all the *Annuloida* at present known, the blood (improperly called "chyle-aqueous fluid") being simply contained in the perivisceral cavity and its processes. The development of the *Nematoidea* appears to take place without metamorphosis; the embryo assuming within the egg a form nearly resembling that of the adult. Encysted asexual nematoid worms are frequently found in various parts of the body of fishes; and the remarkable *Trichina spiralis* is the asexual state of a nematoid worm, encysted within the substance of the muscles of man. Zooid development is only known to occur in one nematoid, the *Filaria Medinensis*, Guinea-worm. Mr. Busk's careful observations have long since placed this fact beyond a doubt.

The *Tæniadæ* and the *Acanthocephala*, like the *Trematoda*, entirely parasitic in their habits, differ from them in the total absence of mouth or digestive cavity. The *Tæniadæ*, Tapeworms, are ribbon-like creatures, usually divided throughout the greater part of their length into segments, whose usual habitation is the intestinal cavity of vertebrate animals; and apparently of a carnivorous vertebrate, in fact, though capable of existence elsewhere, it is there alone that they are able to attain their complete development. The anterior extremity of a tænid worm is usually called the head, and bears the organ by which the animal attaches itself to the mucous membrane of the creature which it infests. These organs are either suckers or hooks, or both conjoined. In *Tænia*, four suckers are combined with a circlet of hooks, disposed around a median

terminal prominence. The embryo passes through a similar course of development to the *Trematoda*; viz., four forms or changes: but the embryo itself is very peculiar, consisting of an oval non-ciliated mass, provided upon one face with six hooks, three upon each side of the middle line. The *Tæniadæ* are found in many other situations besides the alimentary canal; the eye, the brain, the muscular tissues, the liver, &c.; the following cystic worms are included in this genera, *Cysticercus*, *Anthocephalus*, *Cœnurus*, and *Echinococcus*.

Von Siebold, Leuckart, and others, have shown, by many interesting experiments, as feeding puppies with *Cysticercus pisiformis*, that in the course of a few weeks these *entozoa* are transformed into fully formed *Tænia serrata*; again, rabbits fed with the embryo of the *Tænia*, the embryo bore their way, by means of hooks, through the walls of the intestine, until they reach some blood-vessel: by the current of blood they are carried into the liver, and here Leuckart has traced their further development. These embryos grow to the 1-16th of an inch in length, and become elongated, so as almost to resemble an *Ascarid* in form, they then make their way to the surface of the liver, and pass out into the peritoneal cavity.

In like manner, *Cysticercus fasciolaris* is rapidly developed within the liver of white mice; and *Cysticercus cellulosa* in the muscles of the pig fed with the *Tænia solium*, produces the diseased state of pork familiarly known as "measly pork." If a lamb is the subject of the feeding experiment with *Tænia serrata*, the final transformation will be very different; within a fortnight, symptoms of a disease known as "staggers" are manifested, and in the course of a few weeks, the *Cœnurus cerebralis* will be found transformed and developed within the brain. Von Siebold pointed out the bearing of this fact upon the important practical problem of the prevention of "staggers." Others of the same family of parasites are quite as remarkable, in giving a preference to the alimentary canal of fishes. The *Echinorhynchus* is developed in the canal of the Flounder. *Tricœnophorus nodulosus* in the liver of the Salmon, attaining a more perfect development in the alimentary canal of the Perch and Pike. Another, found

in the Stickleback, becomes changed in the intestines of water birds, which devour these fish; and thus, by careful and repeated observations with the microscope, the connexion existing between the Cystic and Cestoid Entozoa have been most satisfactorily established.

*Distomidæ* possess two suckers, the anterior of which contains the mouth. One of this genus, and a well-known

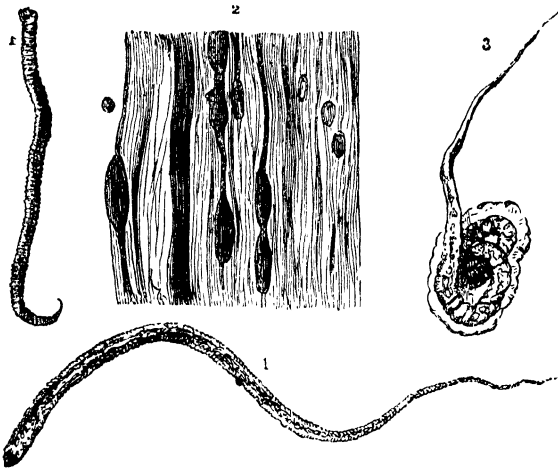

Fig. 215 A.—Guinea-worms, taken from the leg of a Negro.

- 1, The form of the worm when first taken from one of the sacs seen at (fig. 2).  
3, A young worm rolled up. 4, Young worm extended.

example, the Fluke (*Distoma hepaticum*), infests the livers of sheep. The *Polystomidæ* are characterised by the presence of several suckers at the extremity of the body, but the anterior extremity is either entirely destitute of those organs, or only possesses a small one, in which the mouth is situated. This family includes the singular *Diplozoon paradoxum*,—an animal which appears to be compounded, like the Siamese twins, of two perfect individuals, both having precisely the same organs.

The common *Ascaris*, or “Round-worm” of the human subject, as well as the little “Thread-worm,” often so

troublesome to children ; and also the *Strongylus gigas*, a worm sometimes attaining a length of two or three feet, and of considerable thickness, have been often found in the kidneys of swine, and in the same organ of the human body. This worm, by destroying the part in which it takes up its abode, frequently causes the death of its host.

The dreaded "Guinea-worm" (*Filaria medinensis*, fig.

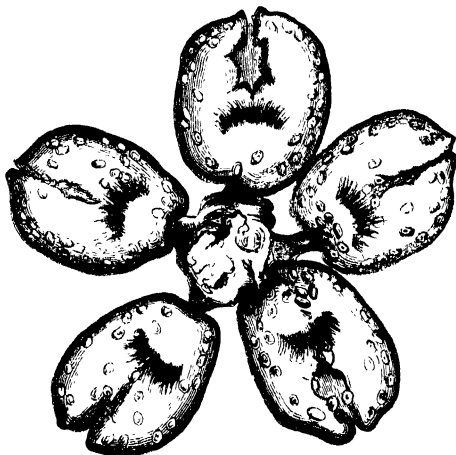

Fig. 216.—A bunch of *Echinococci* taken from the human liver, magnified 250 diameters.

215 A), appears only in tropical countries, Africa, &c. The worm lives in the cellular tissue beneath the skin of man, confining its attacks principally, though not exclusively, to the lower extremities, where it produces considerable pain. It is said occasionally to attain a length of twenty or thirty feet ; but its average length is five or six. It is extracted by winding it very slowly round, an operation in which great care is said to be necessary, as if the worm be broken, its fluids produce a very painful effect.

The *Echinococcus* is found in cysts. Fig. 216 represents a bunch taken from the liver of a boy who died in Charing-



cross Hospital from rupture of the liver, occasioned by the wheel of an omnibus passing over him. The simple cysts containing these animals are always situated in cavities in the interior. These cavities may be situated in any part of the tissues or organs of the body; they are more frequently found in the solid viscera, and especially in diseased livers. Fig. 217 represents the microscopical appearance of the contents of a cyst.

Mr. Busk, who has examined several of these cysts, says:—"When a large hydatid cyst,—for instance, in the liver of the sheep,—very shortly after the death of the animal, is carefully opened by a very small puncture, so as to prevent at first the too rapid exit of the fluid, and consequent collapse of the sac, its internal surface will be found covered with minute granulations resembling grains of sand. These bodies are not equally distributed over the cyst, but are more thickly situated in some parts than in others. They are detached with the greatest facility and on the slightest motion of the cyst, and are rarely found adherent after a few days' delay. When detached, they subside rapidly in the fluid, and consequently will then be usually found collected in the lowest part of the cyst, and frequently entangled in fragments of the inner thin membrane. When some of these granulations are placed between glass under the microscope, and viewed with a power of 250 diameters, upon pressure being employed it will be seen, after rupture of the delicate enveloping membrane, that the *Echinococci* composing the granulations are all attached to a common central mass by short pedicles; which, as well as the central mass, appear to be composed of a substance more coarsely granular by far than that of which the laminæ of the cyst are formed. This granular matter is prolonged beyond the mass of *Echinococci* into a short pedicle, common to the whole, and by which the granulation is attached to the interior of the hydatid cyst, as represented in fig. 216. In specimens preserved in spirits, *Echinococci* of all imaginable forms and appearances are to be met with,—differences owing to decomposition or to mechanical injury; and in many cases no traces of them can be found except the hooklets or spines, which, like the fossil remains of animals in geology, remain

as certain indications of their source, and not unfrequently afford the only proof we can obtain of the true nature of the hydatid."<sup>1</sup>

*Gordicea*, Hair-worms, or Thames mud-worms, are at once distinguishable by the extraordinary length of their bodies, which frequently present a close resemblance to a horse-hair; so close, indeed, that in former times the popular

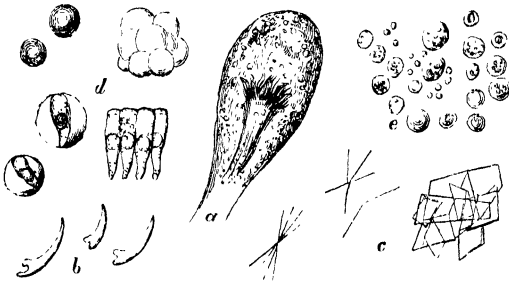

Fig. 217.—*Cystic Disease of Liver.* (Human.)

*a*, Cyst with an *echinococcus* enclosed. *b*, Detached hooklets from the head of *Echinococcus*, magnified 250 diameters. *c*, Crystals found in the cyst, *cholesterine*. *d*, Cylindrical *epithelium*, some of which are enclosed in structureless globules. *e*, *puro-mucus*, and fat *corpuscles*.

belief ascribed their origin to the introduction of horse-hairs into the water in which they are found. One of the most singular circumstances connected with their history is, that if by any chance, on breaking out of their insect-home, they find that dry weather has produced a state of things incompatible with their notions of comfort, they quietly allow themselves to be dried up, when they become perfectly hard and brittle; but, strange to say, the moment a shower of rain comes to refresh the earth with its moisture, the dormant *Gordii* immediately recover their activity, and start off in search of food.

*Anguillulæ* are very small eel-like worms, of which one species, *Anguillula fluviatilis*, is found in rain-water amongst *Confervæ* and *Desmidiaceæ*, in wet moss and moist earth, and sometimes in the alimentary canal of the

(1) *Microscopical Society's Transactions.*

*Limneus*, the frog, fish, &c. ; another species is met with in the ears of wheat affected with a blight termed the "cockle;" another, the *A. glutinis*, is found in sour paste; and another, *A. aceti*, in stale, bad vinegar. If grains of the affected wheat are soaked in water for an hour or two before they are cut open, the eels will be seen in a state of activity when placed under the microscope. The paste-eel makes its appearance spontaneously in the midst of paste that is turning sour; but the best means of securing a supply for any occasion, consists in allowing any portion of a mass of paste in which they show themselves, to dry up, and then lay it by for stock; if at any time a portion of this is introduced into a little fresh made paste, and the whole kept warm and moist for a few days, it will be found to swarm with these curious little worms. A small portion of paste spread over one face of a Coddington lens is a ready way of showing them.

*Planariæ*: a genus of the order *Turbellaria*. Some of the species are very common in pools, and resemble minute leeches; their motion is continuous and gliding, and they are always found crawling over the surfaces of aquatic plants and animals, both in fresh and salt water. The body has the flattened sole-like shape of the *Trematode Entozoa*; the mouth is surrounded by a circular sucker, this is applied to the surface of the plant from which the animal draws its nourishment. The mouth is also furnished with a long funnel-shaped proboscis, and this, even when detached from the body, continues to swallow anything presented to it.

"In imitation of the name bestowed on the trunk of the elephant, the extensile organ serving to imbibe the nutriment of many of the smaller animals is called a proboscis, whether it simply unfolds from the root, protrudes from a sheath, or unwinds from a regular series of volutions. But in none is the designation equally strict and appropriate as in the *Planariæ*. There it is absolutely the organ of the elephant in miniature, with this exception, that it is neither annulated nor composed of segments. It is of surprising length, being little, if any, shorter when fully extended than the whole animal. It seems of greater consistency, harder, and tougher than the rest of the body,

so as to admit insertion into decaying vegetables, and when stretched to the utmost the root becomes an apex of the slenderest cone."<sup>1</sup>

*Planariæ* multiply by eggs, and by spontaneous fissuration, in a transverse direction, each segment becoming a perfect animal. Professor Agassiz believes that the infusorial animals, *Paramecium* and *Kolpoda*, are nothing else than *Planarian larvæ*.

*Hirudinidæ*, the Leech tribe, are usually believed to form a link between the *Annelida* on the one hand, and the *Trematoda* on the other; but their affinities are closer connected with the latter than the former. Totally deprived of the characteristic setæ of the *Annelida*, and exhibiting no sectional divisions, they are provided with suckers so constantly possessed by the *Trematoda*, and present no small resemblance to them in their reproductive organs. On the other hand, in the arrangement of their nervous system and in their vascular system, the *Hirudinidæ* resemble the *Annelida*. The head in most of these animals is distinctly marked, and furnished with eyes, tentacles, mouth, and teeth, and in some instances with auditory vesicles, containing otolithes. The nervous system consists of a series of ganglia running along the ventral portion of the animal, and communicating with a central mass or brain.

The medicinal leech puts forth strong claims to our attention, on the ground of the services which it renders to mankind. The whole of the family live by sucking the blood of other animals; and, for this purpose, the mouth of the leech is furnished with an apparatus of horny teeth, by which they bite through the skin. In the common leech, three of these teeth exist, arranged in a triangular, or rather triradiate form, a structure which accounts for the peculiar appearance of leech-bites in the human skin. The most interesting part of the anatomy of the leech to microscopists is the structure of the mouth (fig. 218). "This piece of mechanism," says Professor Rymer Jones, "is a dilatable orifice, which would seem at first sight to be but a simple hole. It is not so; for we find that just

(1) Sir John Dalyell's *Observations on some interesting Phenomena exhibited by several Species of Planariæ*. 1814.

within the margin of this hole three beautiful little semi-circular saws are situated, arranged so that their edges

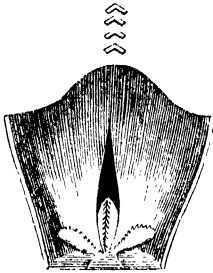

Fig. 218.—Mouth of Leech.

meet in the centre. It is by means of these saws that the leech makes the incisions whence blood is to be procured, an operation which is performed in the following manner: No sooner is the sucker firmly fixed to the skin, than the mouth becomes slightly everted, and the edges of the saws are thus made to press upon the tense skin; a sawing movement being at the same time given to each, whereby it is made gradually to pierce the surface, and cut its way to the small blood-vessels beneath. Nothing could be more admirably adapted to secure the end in view than the shape of the wound thus inflicted, the lips of which must necessarily be drawn asunder by the very contractibility of the skin itself; and that the enormous sacculated stomach, which fills nearly the whole body of the leech, was designed to contain its greedily devoured meal, there can be no reasonable question. The leech, in its native element, could hardly hope for a supply of hot blood as food; and, on the other hand, its habits are most abstemious, and it may be kept alive and healthy for years, with no other apparent nourishment than what is derived from pure water frequently changed; even when at large, minute aquatic insects and their larvæ form its usual diet."

In *Clepsinidæ*, the body is of a leech-like form, but very much narrowed in front, and the mouth is furnished with a protrusile proboscis. These animals live in fresh water, where they may often be seen creeping upon aquatic plants. They prey upon water-snails (*Limnææ*), &c.

*Tubicola*.—The worms belonging to this series of branchiferous *Annelida* are all marine, and distinguished by their invariable habit of forming a tube or case, within which the soft parts of the animal can be entirely retracted. This tube is usually attached to stones or other submarine bodies. It is often composed of various

foreign materials, such as sand, small stones, and the *débris* of shells, lined internally with a smooth coating of hardened mucus; in others it is of a leathery or horny consistency; and in some it is composed, like the shells of *Mollusca*, of calcareous matter secreted by the animal. The *Tubicola* generally live in societies, winding their tubes into a mass which often attains a considerable size: a few are solitary in their habits. They retain their position in their habitations by means of appendages very similar to those of free worms, with tufts of bristles and spines; the latter, in the tubicular *Annelides*, are usually hooked; so that, by applying them to the walls of its domicile, the animal is enabled to oppose a considerable resistance to any effort to draw it out of its case. In the best known family of the order (*Sabellidæ*), the branchiæ are placed on the head, where they form a circle of plumes or a tuft of branched organs. The *Serpulæ* form irregularly twisted calcareous tubes, and often grow together in large masses, when they secure themselves to shells and similar objects; other species, *Terebella*, which build their cases of sand and stones, appear to prefer a life of solitude. \*The curious little spiral shells seen upon the fronds of sea-weeds, are formed by an animal belonging to the family *Spirorbis*.

If the animals are placed in a vessel of sea-water, a very pleasing spectacle will soon be witnessed. The mouth of the tube is first seen to open, by the raising of an exquisitely-constructed door, and then the creature cautiously protrudes the anterior part of its body, spreading

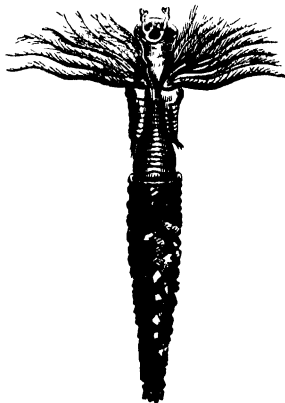

Fig. 219.—A *Serpula* protruded from its calcareous tube.

out at the same time two beautiful fan-like expansions, of a rich purple, or scarlet colour, which float elegantly in the surrounding water, and serve as branchial or breathing organs.

The *Serpula*, if withdrawn from its calcareous tube (fig. 219), is found to have the lower part of the body composed of a series of flattened rings, and entirely destitute of limbs or other appendages. Its food is brought to its mouth by currents created by the cilia on the branchial tufts.

Of *Errantia*, the family *Aphrodita*, better known as *Sea-mice*, are the more remarkable. In these animals the form of the body is long and ovate; the head small, and furnished with very short tentacles; the feet large, with immense tufts of bristles and spines, often of the most remarkable forms, and exhibiting exceedingly brilliant metallic colours. Each tuft of hair is retractile within a horny sheath, which not only serves to protect the soft parts of the animal from injury, but as weapons of defence. Another peculiarity is, that the dorsal surface is entirely or partially covered by a double series of large membranous scales attached to the alternate segments, between which the beautiful bristles of the feet make their appearance. These animals generally inhabit deep water, although numbers of them are thrown upon our coasts after a storm.

ACARINA — PARASITES.— Nearly all the animals included in this order, of which the common Mites are the best known examples, are recognisable at the first glance by the form of the body, which usually constitutes a roundish or oval mass, without a trace of segmentation. They are mostly parasitic animals, furnished with a proboscis having a pair of sharp spines, which serve for cutting and wounding, and on each side of the same a palpus. The proboscis is jointed and retractile; and sometimes it has an enlarged base, which has been called a head. The eyes, which are frequently wanting in parasites, are two in number when present, and placed on each side of the anterior portion of the body. *Acarina* are generally oviparous; a few bear living young, and these possess only three pairs of feet; the fourth pair do not make their appearance until after the first moult.

Parasites infest the skin, lurk among the hairs of quadrupeds, the feathers of birds, and even of many insects, whence they draw an abundant supply of nourishment for their singular mode of existence. Mr. Henry Denny figured and described a greater number of parasitic

animals in his *Monographia Anoplurorum* than any previous observer. He says, "that the opinion entertained of each animal having its peculiar parasite, is not entirely borne out by facts; nevertheless, that those infesting the quadruped will not be found in the bird, being almost always confined to animals of the same species, or of similar habits. For instance, the *Docophorus icteroïdes* is found on nearly every species of duck. The *Neimus obscurus* infests several species of sandpipers, godwits, &c.; the *Neimus rufus*, hawks and falcons; the *Docophorus lari*, the gull tribe. In quadrupeds it is rather more doubtful, as they are frequently transferred by association; as an instance, the *Trichodectes scalaris* has been found upon both the ox and the ass feeding in the same stall. The *Hæmatopinus piliferus*, infesting dogs, have been found in swarms upon the ferret. The *Pediculus*, besides being found on man, is also found on the *Quadrumana*, *Rodentia*, *Carnivora*, *Pachydermata*, and the *Ruminantia*." The family of *Ticks* (*Ricinæ*) belong to this class, one of which is a great pest to sheep. It is usual to include in this group both *Acarina* and *Parasites*; but from the former having eight legs, and the latter six, with a difference in habits, they are said not to belong to the same family.

Respiration goes on simply through the skin in the *Acarus* and *Sarcoptes*; while in *Gamasus*, *Cheyletus*, and some others with pincer-shaped mandibles, there is a complete system of tracheæ with spiracles, as in true insects. Besides these there are others with an intermediate plan of respiration, combining both the before-mentioned modes, and in which inspiration takes place through the skin, and expiration through a system of tracheæ, having an outlet above the insertion of the mandibles. *Trombidium* is an example in which a latticed aperture at the root of the mandibles forms the anterior outlet of two large air-pipes running the whole length of the body, each subdivided into a tuft of numerous unbranched simple tracheæ; there is also under the skin a round meshed network of a transparent and seemingly homogeneous substance, resembling the respiratory network beneath the skin of certain *Trematoda*.

The importance of a thorough examination of these



microscopic pests must be evident, from the fact that the type of the family to which the whole of them belong, is the noisome parasite of the human subject; another, as yet undetermined form, but of the same tribe, is thought to be connected with one of the most fatal ailments of the frame—dysentery; that two distinct *Sarcoptes* affect the horse and sheep; and even the common sparrow, our little pet canary-bird, and the useful bee, have not escaped the ravages of the family. The *Acarus autumnalis*, so very common in the autumn upon grass and other herbage, insinuates itself under the skin at the roots of the hairs, producing a painful irritation; this is known in some parts of the country as the harvest-bug.

“When, therefore, we reflect on the evils which these produce, and on the diminutive size of the creature which in its effects is so destructive to other tribes; and bear in mind that this mere speck, this particle of dust, is organised for all its purposes as completely as the most perfect of any of the whole sub-kingdom to which it belongs, even to the flexor, the extensor, and the rotator muscles of its truly atomic limbs; while the entire body of the creature, when first produced, measures scarcely more than the 16,000th of an inch in length; and then call to mind that the mere foot of the *Dinornis*, or of the *Palapteryx*, the ancient colossal bird of the antipodes, measures, as shown by Professor Owen, more than 750 times the whole size of this little body,—who can but feel astonished at the range of creation? Who can but feel that the study of natural history, not as the amusement of an hour, but as a sober contemplation, must tend to exalt as well as to extend the human intellect, and that the most microscopic atom of organised life, considered as part of the world, is as deserving of our fullest attention as the most gigantic?”<sup>1</sup>

The *Louse* (fig. 220, No. 1).—Whenever wretchedness, disease, and hunger seize upon mankind, this horrid parasite seldom fails to appear in the train of such calamities, and to increase in proportion as neglect of personal cleanliness engenders loathsome disease. When

(1) George Newport, Esq., F.R.S., “On a new genus of the family *Chalcididæ*, found in the nest of the bee.”—*Linnean Society's Transactions*, 1853.

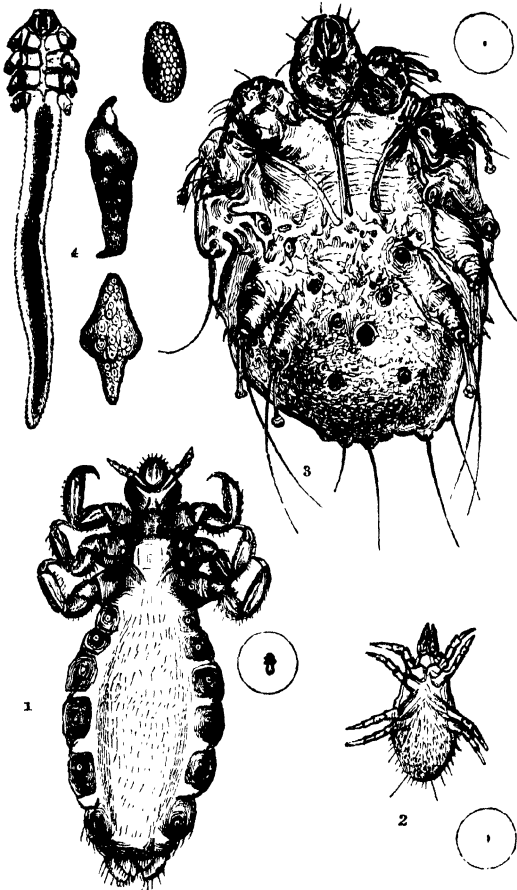

Fig. 220.—Parasites. Acarina.

- 1, Louse Human; magnified 50 diameters. 2, *Acarus domesticus*, Cheese-Mite; magnified 50 diameters. 3, *Acarus Scabiei*, Itch-Insect; magnified 350 diameters. 4, *Entozoon folliculorum*, Grub, from the human skin in various existence, from the egg upwards; magnified 250 diameters. (With small circles it is intended to represent the same about the natural size.)

examined under the microscope, our disgust of it is in no way diminished. In the head may be distinguished two

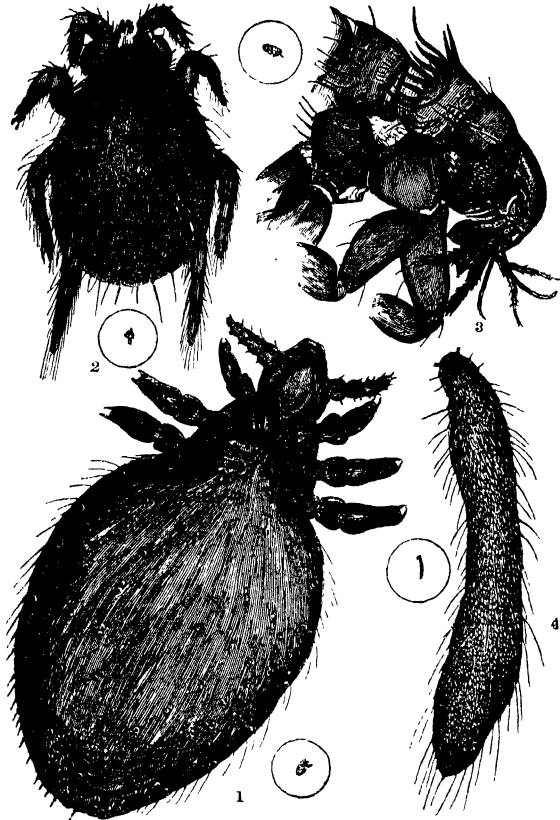

Fig. 221.

1, Dog's parasite. 2, Rat Acarus. 3, Head of Cat-Flea. 4, Larva, or grub of Flea. (The life size of each is given in the small circles.)

large eyes, and near to them are the two antennæ; the front of the head is long, and somewhat tapering off to form a snout, which serves as a sheath to the proboscis

and the instrument of torture with which it pierces the flesh and draws the blood. To the fore part of its body six legs are affixed, having each five joints, terminated by two unequal hooks; these, with other portions, are covered with short hairs. Around the outer margin of the body may be seen small circular dots, the breathing apertures, with which all the class are freely provided, rendering them very tenacious of life, and difficult to kill. There is another louse, rather differing in its characteristics from this, formed about the body of the very poor and dirty, called the body or crab-louse. Leeuwenhoek carried his researches on the habits of these insects further than most investigators, even allowing his zeal to overcome his disgust for such creatures as the louse. In describing its mode of taking food, &c., he observes: "In my experiments, although I had at one time several on my hand drawing blood, yet I very rarely felt any pain from their punctures; which is not to be wondered at, when we consider the excessive slenderness of the piercer; for, upon comparing this with a hair taken from the back of my hand, I judged, from the most accurate computation I could form by the microscope, that the hair was 700 times larger than this incredible slender piercer, which consequently by its punctures must excite little or no pain, unless it happens to touch a nerve. Hence I have been induced to think that the pain or uneasiness those persons suffer who are infested by these creatures, is not so much produced from the piercer as from a real sting, which the male louse carries in the hinder part of his body, and uses as a weapon of defence." He found, from experiments made to ascertain the possible increase of these vermin, that from two females he obtained in eight weeks the incredible number of 10,000 eggs.

The *scab* in sheep is caused by a family of *Acarina*, the *Sarcoptes scabiei*, which also produces the *itch* in the human being, and lately discovered to be the cause of *mange* in the dog. In one pustule from a dog, suffering from this disease, as many as thirty or forty of the parasites were found. This is the genus *Demodex* of Professor Owen, who classes them with *Arachnida*.

The *Itch-insect*, *Sarcoptes scabiei* (fig. 220, No. 3, magni-

fied 350 diameters). Dr. Bononio made out the true character of the very troublesome disease known as the itch. Upon examining one of the pustules, or little bladders, from between the fingers, with the points of very fine needles, under the microscope, he discovered a most minute animal, very nimble in its motion, covered with short hairs, having a formidable head with a pair of strong mandibles or cutting jaws, and eight legs, from the extremities of which are appended remarkable feet, each provided with a sucker; by means of which it no doubt sucks or draws its way beneath the skin, having first cut out a small section with its mandibles; here the pest forms a nest, lays its eggs, multiplying rapidly, and is most difficult to dislodge.

To find the itch-insect, the operator must examine carefully the parts surrounding each pustule, he will then see a red line or spot communicating with it; this part, and not the pustule, must be probed with a fine-pointed instrument; the operator must not be disappointed by repeated failures. As it is most difficult to detect the haunts of the insect, an eye-magnifier should be made use of to assist.

Dr. Bourguignon bestowed much time in studying the habits of this troublesome parasite. To arrive at a knowledge of its habits the Doctor had recourse to a peculiar kind of moveable microscope, which enabled him to observe it under the skin of the diseased person. The microscope is composed of the frame of an ordinary instrument, the optical and essential parts of which have been raised from the socket that supported it, and articulated to a moveable knee at the extremity of a lever. The rays of light from a lamp or candle are brought to a brilliant focus by means of the condensing or bull's-eye lens; which focus is directed upon the chosen point of observation. Warington's microscope answers the purpose equally well.

He then saw that the feet are armed with suckers, which enable it to fasten itself in the furrows under the skin, aided by its small bristles; being likewise covered by these bristles in various parts of the body, it more firmly fixes itself there, and with its terrible mandibles accomplishes its destructive mission. It has no eyes; but

in the moment of danger it quickly draws in its head and feet, somewhat resembling the tortoise; its march is precisely that of the tortoise. It usually lays sixteen eggs, which are carefully deposited in furrows under the skin, and ranged in pairs; these are hatched in about ten days.

No. 4, fig. 220, *Demodex folliculorum*, is another very remarkable parasite found beneath the skin of man, and may be obtained from a spot where the sebaceous follicles, or fat glands, are abundant; such as the forehead, the side of the nose, and the angles between the nose and lip; if the part where a little black spot or a pustule is seen, be squeezed rather hard, the oily matter there accumulated will be forced out in a globular form; if this is laid on a glass-slide, and a small quantity of oil added to it, to cause the separation of the harder portions, the little insect, in all probability, will float out; after the addition of more oil, it can then be taken away from the oily matter by means of a fine-pointed sable pencil-brush, and transferred to a clean slide; when dry, it should be immersed in Canada balsam, and covered over with thin glass, that is mounted in the usual way.

The Cheese-mite, *Acarus domesticus* (fig. 220, No. 2), has a peculiar elongation of its snout, forming strong, cutting, dart-shaped mandibles; these can be advanced separately or together, being tooth-like when in contact. Mites multiply very rapidly; they are both viviparous and oviparous; the eggs are hatched in about eight days; if deprived of food, they kill and eat each other very greedily. *Acarea* infest almost the whole of our dried articles of food. *Ac. passerinus* has two very long buccal bristles; it lives upon dried figs, and other saccharine fruits. *Ac. destructor* has long black hairs; it feeds upon the contents of entomological cabinets, especially butterflies; *Ac. hippopodos* is found upon the crusts of ulcers on horses' and sheep's feet. The various parts, as the mouth and legs, of acari will be best made out by crushing the animal upon a glass slide, with a thin glass cover; then wash away the exuded substance with water—sometimes a hot solution of potash is requisite, with a subsequent addition of acetic acid and washing; after drying, mount them in Canada balsam.

The *Acarus sacchari*, Sugar insect.—There is very commonly present in the more impure kinds of sugar, a beetle-like animal of the genus *Acareæ*. The discovery of the very general presence of this acarus rests, we believe, entirely with Dr. Hassall.

The Sugar acarus approaches somewhat, in organisation and habits, the Louse and the Itch-insect; it is in size so considerable, that it is plainly visible to the unaided sight.

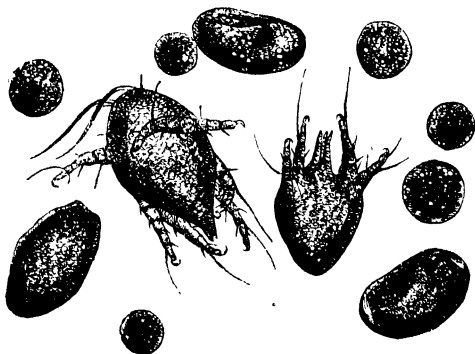

Fig. 222.

Ova and young of the *Acarus sacchari*, Sugar-Insect, after Hassall, magnified 200 diameters.

When present in sugar, it may always be detected by the following proceeding: two or three drachms or teaspoonsful of sugar should be dissolved in a large wine-glass of tepid water, and the solution allowed to remain at rest for an hour or so; at the end of that time the animals will be found, some on the surface of the liquid, some adhering to the sides of the glass, and others at the bottom, mixed up with the copious and dark sediment, formed of fragments of cane, woody fibre, grit, dirt, and starch-granules, which usually subside on the solution of even a small quantity of sugar in water. The acarus in question will be found to agree with the following brief description, premising, in the first place, that its development may be clearly traced out in almost every sample of brown sugar. The *Acarus sacchari* is first visible as a rounded body, or egg; this gradually enlarges, and becomes elongated and cylindrical, until it is about

twice as long as broad; after a time, from the sides and one extremity of this ovum, the legs and proboscis begin to protrude. These stages of the development of the acarus are exhibited in fig. 222.

The *Acarus farinæ*, Flour-mite.—This is of occasional occurrence in flour, but is never present unless it has become damaged. Any flour, therefore, containing the animal in question is in a state unfit for consumption. We believe that it is found more frequently in the flour of the *Leguminosæ* than that of the *Graminææ*.

This acarus differs considerably in structure from the Sugar-mite, particularly so in its pennate setæ.

Dr. Burnett established to his satisfaction the following facts: "1. That though there are single species of parasites peculiar to particular animals, there are others which are found on different species of the same genus; as is the case in the parasites living on birds of the genus *Larus* (gulls), and the diurnal birds of

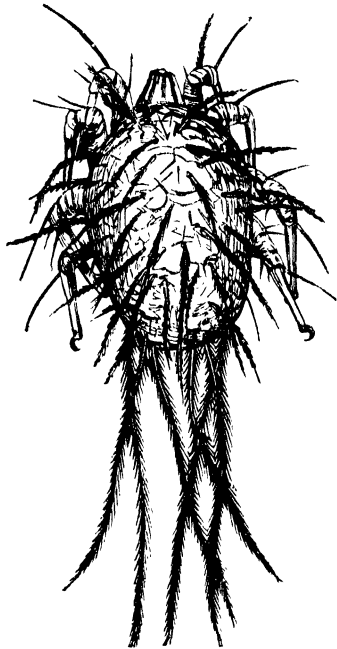

Fig. 223.—*Acarus farinæ*, Meal-Mite, magnified 250 diameters.



Fig. 224.  
1, *Hippobosca Hirundinis*. 2, *Nomi*, male and female, parasites infesting swallows.



prey. 2. The parasites of the human body confine themselves strictly to particular regions; when they are found

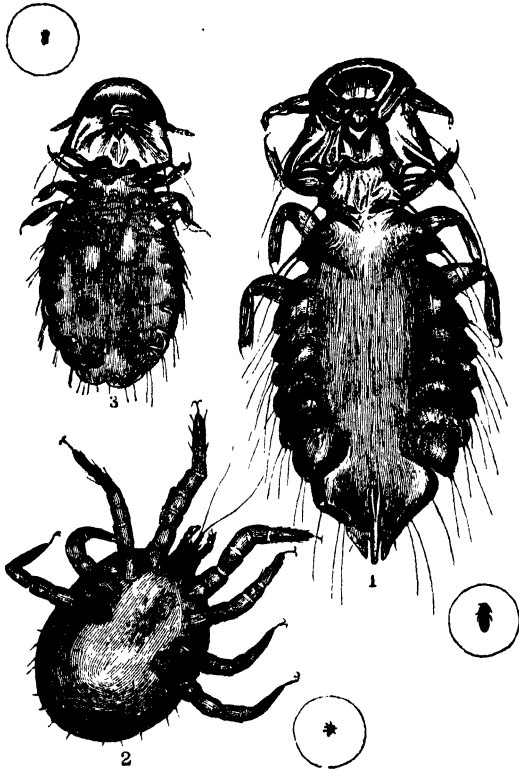

Fig. 225.

1, Parasite of Turkey. 2, *Acarus* of common Fowl, under surface. 3, Parasite of Pheasant. (The small circle encloses each about life size.)

elsewhere, it is the result of accident. Thus, the *Pediculi capitis* live in the head; *P. vestimenti*, upon the surface of the body; the *P. tabescentium*, on the bodies of those dying of marasmus; and the *P. inguinalis*, about the groins, arm-

pits, mouth, and eyes." From an examination of the structure of these parasites, Dr. Burnett is of opinion that

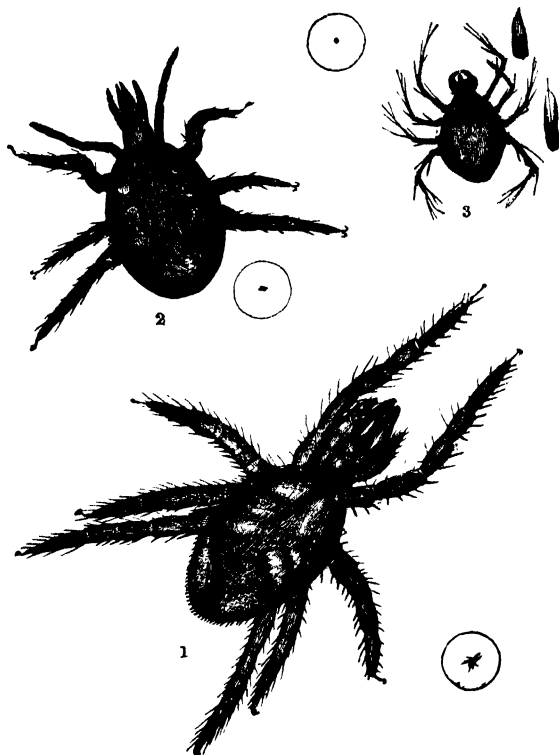

Fig. 226.

1, *Acarus* of Beetle. 2, *Acarus* of Fly. 3, *Acarus* of Clothes-Moth. (The circles enclose each about life size.)

they should be placed in an order by themselves, closely allied to *Insecta*; the mandibulate parasites occupying the highest, and the haustellate the lowest position in the order: thus confirming to some extent the observations made by Mr. Denny.

There is a remarkable species of acarus described by

Dr. Robins, found spinning a white silken web on the base of the sparrow's thigh, or on the fore-part of its body; on raising this delicate web, you perceive that it is filled with minute eggs, from which the young issue, being in due time hatched by the warmth of the body it is destined to



Fig. 227.—*Larvæ of the Parasite of Hornbill.*

annoy. In fig. 227 are seen some eggs of a parasite infesting the hornbill; they are glued to the feathers near the head of the bird; the larvæ are ready to leave the egg in two. Another, curiously enough, selects the pulmonic orifice of the snail: when the animal dilates this orifice,

for the purpose of allowing the air to penetrate its respiratory cavity, the female acarus slips through the opening, and lays her eggs in the folds of the mucous membrane, where they are gradually developed. The young, upon issuing forth from the eggs, select some portion of the snail's body upon which to feed and perfect their growth.

*Ixodidæ* are furnished with a powerful rostrum, armed with recurvate spines, with which they pierce the skin of the unfortunate animal upon whose blood they live. So firmly does this anchor-like organ retain its hold, that if the parasite is pulled away, it usually carries a portion of the skin of its victim with it. These creatures live upon a great variety of animals. The dog is very liable to their attacks, and many species fix themselves exclusively upon serpents and other reptiles. *Glyciphagus cursor* is found in the feathers of the owl, and in the cavities of the bones of skeletons. *Gamasidæ* are furnished with a sucking apparatus very similar to that of *Ixodidæ*, usually attaching themselves to the bodies of beetles; the common Dung-beetle (*Geotrupes*) is often found with the lower surface nearly covered with them.

There are other families leading a more active life, being furnished with eyes. One family, *Hydrachnidæ*,

Water-mites, inhabit the water, where they swim about with considerable rapidity by means of their fringed legs.

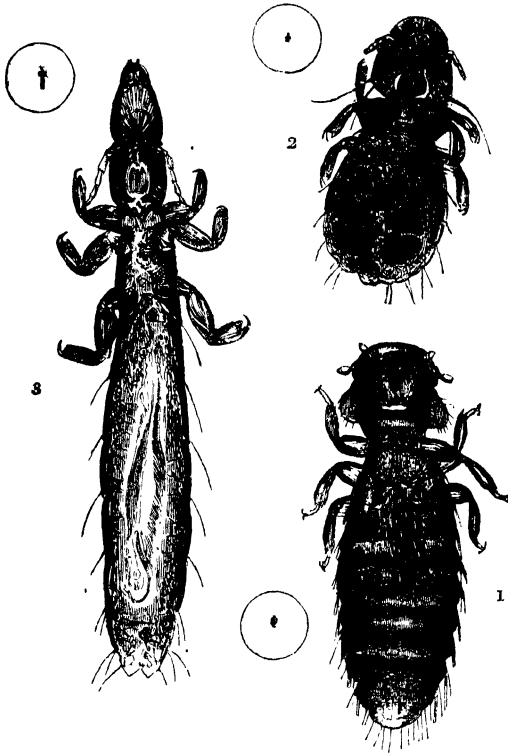

Fig. 228.

1, Parasite of Eagle. 2, Parasite of Vulture. 3, Parasite of Pigeon. (The circles enclose each about life size.)

In their young state, they attach themselves parasitically to aquatic animals; they then possess only six legs, and pass through a quiescent or pupa state before acquiring the fourth pair. *Oribitadæ*, unlike other *Acareæ*, live upon vegetable matter, principally damp leaves and moss;

they have a mouth adapted for biting such food, and are covered with a hard and very brittle skin. The *Bdellidæ*

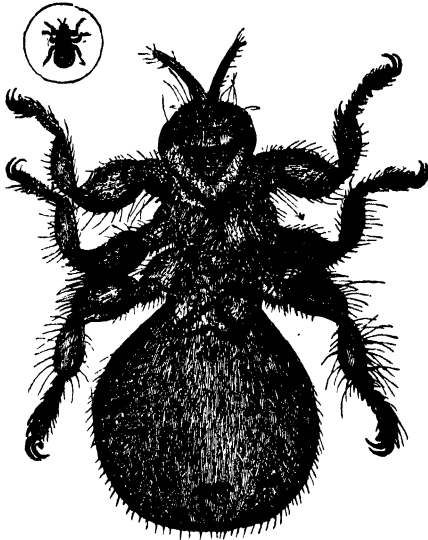

Fig. 229.—*Melophila ovinus*, Sheep-tick. (The small circle encloses one of life size.)

live among damp moss, have the body divided apparently into two parts by a constriction, and the rostrum and palpi very long; whilst *Trombidiidæ*, of which the little scarlet mite so often seen in gardens is an example, have their palpi converted into little raptorial organs.

Another family of parasites are commonly met with in the bodies of fishes, attaching themselves to the branchiæ, to the soft skin under the fins, or to the eyes, much to the annoyance of the unfortunate victim. Some of these found on fresh-water fish are sufficiently transparent to show the circulation of their fluids—most interesting objects for the microscope.

The Water-snail, *Limnæus*, is tormented with a parasite of the family *Distoma*, which attaches itself by a series of

hooklets and bristles to such parts of the body and mantle as give a secure lodgment; they look like little tufts of thread hanging from the sides of the animal.<sup>1</sup>

ARACHNIDA, Spiders.—The Diadem (*Epeira diadema*) is one of the largest of the British species of Garden Spiders, very readily recognised by the beautiful little gem-like marks on its body and legs. Spiders abound on every shrub; and if we consider that the Spider is destitute of a distinct head, without horns, one-half of its body attached to the other by a very slender connection, and so soft as not to

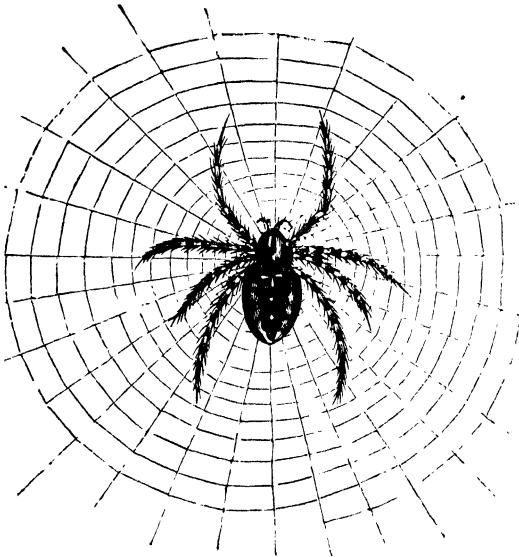

Fig. 230.—*Epeira diadema*, Garden Spider.

bear the least pressure,—its limbs so slightly attached to its body that they fall off at a very slight touch,—it appears ill-adapted, either to escape the many dangers which threaten it on all sides, or to supply itself with food; and

(1) A very interesting account of the parasite tribes is given in Rheidi's *Treatise de Generatione Insectorum*, and in H. Denny's *Monographia Anoplurorum Britannicæ*. Bohn: London, 1842.

the economy of such an animal is deserving of the microscopist's attention.

The several small appendages peculiar to the Spider tribe are represented in fig. 231. Of these, the two longest at No. 1, having articulated processes, appear to be *feelers*; the others, being the organs by which their silky threads are emitted, are four in number. Their structure is very remarkable; the surface of each of the spinnarets is pierced by an infinite number of minute holes, seen in No. 2, from each of which there escape as many little drops of a liquid, which, drying the moment they come in contact with the air, form so many delicate threads. Immediately after the filaments have passed out of the pores, they unite first together, and then with those of the next, to form one common thread; so that the thread of the Spider is composed of a large number of minute filaments, perhaps many thousands, of such extreme tenuity, that the eye cannot detect them until they are twisted together into the working thread. In the two pairs of spinnarets a different anatomical structure is to be detected; the pair above, which are a little longer than the lower, show a multitude of small perforations, the edges of which do not project, and which therefore resemble a sieve. The other shorter pair have projecting tubes independent of the perforations which also exist (No. 3). The tubes are hollow, and perforated at their extremities; and it is supposed that the agglutinating threads issue from these tubes, while those emitted from the perforations do not possess that property. It may be observed, by throwing a little dust on a circular Spider's web, that it adheres to the threads which are spirally disposed, but not to those that radiate from the centre to the circumference; the latter are also stronger than the others. The rapidity with which these webs are constructed is astonishing, as is also the accuracy with which the webs are formed. There are many different kinds of Spiders; but nearly all of them envelope their eggs in a covering of silk, forming a round ball, which the Spider takes care to hang up in some sheltered place till the spring. The mode in which the ball is formed is very curious: the mother Spider uses her own body as a gauge to measure her work, in the same way as a bird uses its

body to gauge the size and form of its nest. The Spider first spreads a thin coating of silk as a foundation, taking care to have this circular by turning round its body during the process. It then, in the same manner, spins a raised border round this till it takes the form of a cup, and at

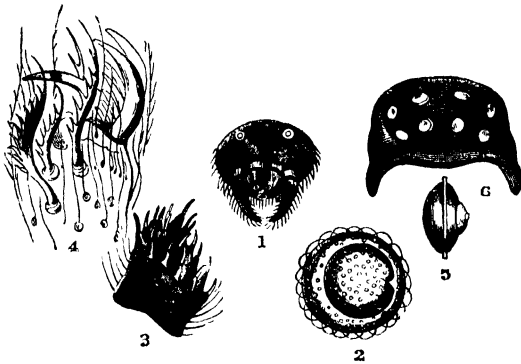

Fig. 231.

- 1, Spinnarets of Spider. 2, Extreme end of one of the upper pair of spinnarets. 3, End of under pair of spinnarets. 4, Foot of Spider. 5, Side view of eye. 6, The arrangement of the eight eyes.

this stage of the work it begins to lay its eggs in the cup, not only filling it with these up to the brim, but piling them up above it into a rounded heap, as high as the cup is deep. Here, then, is a cup full of eggs, the under half covered and protected by the silken sides of the cup, but the upper still bare and exposed to the air and the cold. It is now the Spider's task to cover these, and the process is similar to the preceding, that is, she weaves a thick web of silk all round them, and, instead of a cup-shaped nest, like some birds, the whole eggs are enclosed in a ball much larger than the body of the Spider that constructed it.

The feet of the Spider, one of which is represented at No. 4, are curiously constructed. Each foot, when magnified, is seen to be armed with strong, horny claws, furnished with bent teeth on the under-surface, which gradually diminish towards the extremity of the claw. By this apparatus the Spider is enabled to regulate the



issue of its rope from the spinnarets, and also to suspend itself with the greatest ease by the larger central claw. Some have, in addition, a remarkable comb-like claw, for the purpose of separating certain fibrous bands that enter into the composition of their delicate webs.

One of the most remarkable members of this family is the *Argyroneta aquatica*, Diving-spider, which weaves itself a curious little bell-shaped dwelling at the bottom of the water, whither it retires to devour its prey. As, notwithstanding its aquatic habits, this animal, like the rest of its order, is fitted only for aerial respiration, it takes care to fill its miniature balloon with air, which it carries down with it from the surface, entangled amongst the hairs with which its body is thickly clothed; a process very closely resembling that by which the earliest diving-bells were supplied with air.

The *Lycosidæ* agree in the structure of their jaws and palpi, and in the number of their spinnarets, with *Ara-neidæ*; but have eyes arranged in three rows. Unlike *Ara-neidæ*, the animals of this family never construct regular webs for the capture of prey; the utmost exertion of instinct in this direction consists in laying a few threads in the neighbourhood of their dwelling-places. They generally live under stones, in holes in the earth, or in old walls, sometimes lining their habitations with a silken tapestry; others live upon trees, and weave themselves a silken nest amongst the leaves or on the branches. A common example is the *Salticus scenicus*, a small species banded with black and white, met with on garden-walls.

Parasites may be quickly killed by immersing them in spirits of wine, or spirits of turpentine; in a short time take them out, and dry them: if transparent, they should be at once mounted in glycerine or Goadby's solution; if opaque, mount in Canada balsam. It has been found to answer better if both *acari* and other small insects are immediately transferred from the spirits of turpentine to a slide on which Canada balsam has been placed in readiness for mounting: so that no air may get into the bodies, &c., which spoils the transparency of the objects.

## CHAPTER IV.

SUB-KINGDOM ARTICULATA.—INSECTA.



AMONG the numerous objects which engage the attention of the microscopist, the insect tribes in general are far from being the least interesting; their curious and wonderful economy is a subject well deserving especial investigation. Earth, air, and water, teem with the various tribes of insects, for

the most part invisible to the unassisted eye of man, but presenting, when viewed with the microscope, the most beautiful mechanism in their frame-work, the most perfect regularity in their laws of being, and exhibiting the same wondrous adaptation of parts to the creature's wants, which, throughout all creation, furnishes traces of the love and wisdom that so strongly mark the works of God.<sup>1</sup>

"I cannot," says the excellent Swammerdam, "after an attentive examination of the nature and structure of both the least and largest of the great family of nature, but allow the less an equal, perhaps a superior degree of dignity. Whoever duly considers the conduct and instinct of the one, with the manners and actions of the other, must acknowledge all are under the direction and control of a superior and supreme Intelligence; which, as in the largest it extends beyond the limits of our comprehension, escapes our researches in the smallest. If, while we dissect with care the larger animals, we are filled with wonder

(1) We commend to the reader for perusal, the excellent *Introduction to Entomology*, by Kirby and Spence. Longmans. 1856.

at the elegant disposition of their limbs, the inimitable order of their muscles, and the regular direction of their veins, arteries, and nerves, to what a height is our astonishment raised when we discover all these parts arranged in the least of them in the same regular manner! How is it possible but that we must stand amazed, when we reflect that those little animals, whose bodies are smaller than the point of the dissecting knife, have muscles, veins, arteries, and every other part common to larger animals! Creatures, so very diminutive, that our hands are not delicate enough to manage, nor our eyes sufficiently acute to see them."

Want of space forbids anything like an attempt at classification, or arrangement, in this vast and most interesting department of natural history: we must, therefore, content ourselves by noticing a few of their more remarkable peculiarities; at the same time, we would commend the whole insect tribe to the rigid scrutiny of the microscopist, abounding as it does in all that is wonderful and beautiful.

The insect sub-kingdom is divided and sub-divided into many genera and families, the principal of which are—

*Lepidoptera*; typical forms, Butterfly, Moth.

*Diptera*; typical forms, Fly, Gnat, Gadfly.

*Aptera*; typical forms, Flea, Louse, Springtail.

*Coleoptera*; typical forms, Beetle, Water Beetle, &c.

*Orthoptera*; typical forms, Locust, Grasshopper.

*Neuroptera*; typical forms, Dragon-fly, May-fly.

*Hymenoptera*; typical forms, Bee, Wasp, Ant.

*Homoptera*; typical forms, Plant-louse (*Aphis*), Lantern-fly.

*Hemiptera*; typical forms, Water-scorpion, Water-boatman.

Insects are characterised by their aerial respiration; by the division of the body into three very distinct regions—of which the middle one, the thorax, bears three pairs of jointed legs, and usually two pairs of wings, represented in fig. 232—and by the possession of a single pair of jointed antennæ. The metamorphoses which most of them undergo, before they arrive at the perfect state and are able to fulfil all the ends of their existence, are more curious and striking than in any other department of nature; and in the greater

number of species the same individual differs so materially at the different periods of life, both in its internal and external conformation, in its habits, locality, and kind of food, that it becomes one of the most interesting investigations of the physiologist to ascertain the manner in which these changes are effected, to trace the successive



Fig. 232.—*Tipula*, Crane-fly (Female.)

steps by which that despised and almost unnoticed larva that but a few days before lay grovelling in the earth, with an internal organisation fitted only for the reception and assimilation of the grossest vegetable matter, has had the whole of its external form so completely changed, as now to have become an object of admiration and delight, and able to 'spurn the dull earth,' and wing its way into the open atmosphere, with internal parts adapted only for the reception of the purest and most concentrated aliment, which is now rendered absolutely necessary for its support, and the renovation increased energies demand.

The heads of insects are fit objects for the microscope; fig. 243 shows the head of a Gnat, detached from the thorax, magnified about 50 diameters; the eyes cover

nearly two-thirds of the head ; from the fore part is projected proboscis, lancets, antennæ, &c. In the mouths and tongues of insects, the most admirable art and wisdom are displayed ; and their diversity of form is almost as great

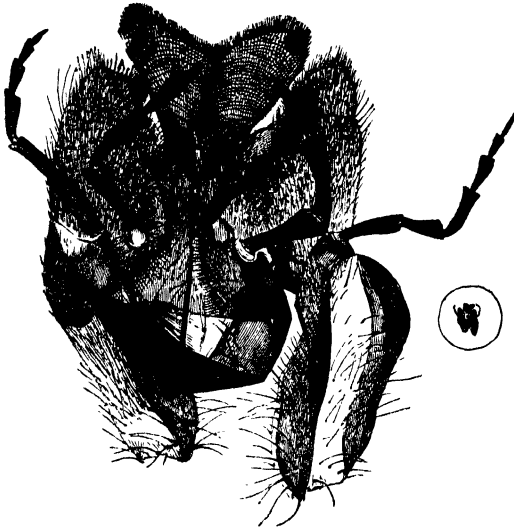

Fig. 233.— *Under-surface of a Wasp's tongue, Feelers, &c.* (Within the circle the life-size of the same is given.)

as the variety of species. The mouth is usually placed in the fore part of the head, extending somewhat downwards. Many have the mouth armed with strong jaws or mandibles, provided with muscles of great power, with which they bruise and tear their food, answering to the teeth of the higher animals ; and in their various shapes and modifications serving as knives, scissors, augurs, files, saws, trowels, pincers, or other tools, according to the requirements of each insect.

The tongue is generally a compact instrument, used principally to extract the juices on which the insect feeds, varying greatly in its length in the different species. It is

capable of being extended or contracted at the insect's pleasure; sometimes dexterously rolled up; taper and spiral, as in the Butterfly; tubular and fleshy, as in the Wasp. In fig. 233, the under-lip of the Wasp is represented with its brush on either side; above which are two jointed

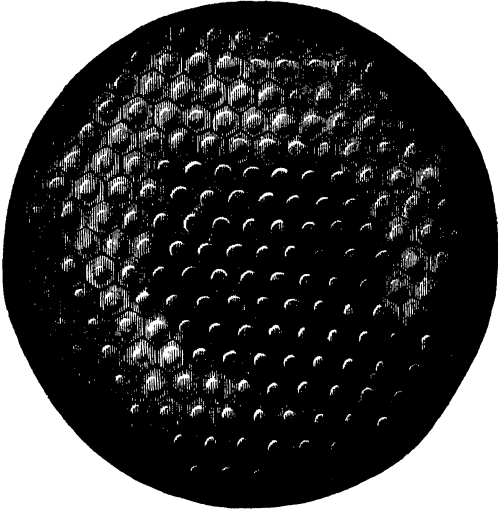

Fig. 234.—*Eye of Fly, magnified 150 diameters.*

feelers (*palpi labiales*), the use of which is probably for the purpose of making an examination of the food before it is taken into its mouth, or that of cleaning the tongue. Near these feelers the antennæ or horns are placed, as curious in form as they are delicate in structure. The antennæ of the male generally differ from those of the female: some writers believe these are organs of smell or hearing; others that they are solely intended to add to the perfection of touch or feeling, increasing their sensibility to the least motion or disturbance. Apart from their use, they are the most interesting and distinguishing characteristics of insects, and appear to be employed for the purpose of examining every object they alight upon.

The structure of the eye is in all creatures a most admirable piece of mechanism, in none more so than in those of the insect tribe. The eyes differ in each species; varying in number, situation, figure, simplicity of construction, and in colour.

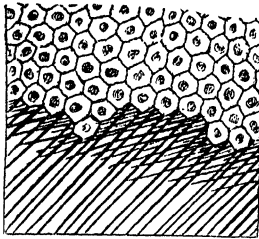

Fig. 235.

Fig. 234 represents a portion of the eye of the common Fly, drawn by the light of the sun upon a prepared photographic surface of wood ready for the engraver, not a line of which was added by the hand of the draughtsman. Fig. 235 represents a side view of the eye when thrown down, showing the compound nature of the organ, with its series of cylindrical tubes; better seen in fig. 236.

“ On examining the head of an insect, we find a couple of protuberances, more or less prominent, and situated symmetrically one on each side. Their outline at the base is for the most part oval, elliptical, circular, or truncated; while their curved surfaces are spherical, spheroidal, or pyriform. These horny, round, and naked parts, seem to be the corneæ of the eyes of insects; at least, they are with propriety so termed, from the analogy they bear to those transparent tunics in the higher classes of animals. They differ, however, from these; for when viewed by the microscope, they display a large number of hexagonal facets, which constitute the medium for the admission of light to as many simple eyes. Under an ordinary lens, and by reflected light, the entire surface of one corneæ presents a beautiful reticulation, like very fine wire gauze, with a minute papilla, or at least a slight elevation, in the centre of each mesh. These are resolved, however, by the aid of a compound microscope, and with a power of from 80 to 100 diameters, into an almost incredible number (when compared with the space they occupy) of minute, regular, geometrical hexagons, well defined, and capable of being computed with tolerable ease, their exceeding minuteness being taken into consideration. When viewed in this way, the entire surface bears a resemblance to that which

might easily and artificially be produced by straining a portion of Brussels lace with hexagonal meshes over a small hemisphere of ground glass. That this gives a tolerably fair idea of the intricate carving on the exterior, may be further shown from the fact, that delicate and beautiful casts in collodion may be procured from the surface, by giving this three or four coats with a camel-hair pencil. When dry, it is peeled off in thin flakes, upon which the impressions are left so distinct, that their hexagonal form can be discovered with a Coddington lens. This experiment will be found useful in examining the configuration of the facets of the hard and unyielding eyes of many of the *Coleoptera*, in which the reticulations become either distorted by corrugation, or broken by the pressure required to flatten them. It will be observed also, that by this method, perfect casts can be obtained without any dissection whatever; and that these *artificial exuviae*—for such they really are—become available for microscopic investigations, obviating the necessity for a more lengthened or laborious preparation. The dissection of the cornea of an insect's eye is by no means easy. I have used

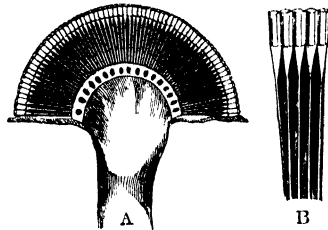

Fig. 236.

A. is a section of the eye of *Melolontha vulgaris* Cockchafer. B. a portion more highly magnified, showing the facets of the *cornea*, and its transparent pyramids, surrounded with pigment. At A they all meet to form the optic nerve.

generally a small pair of scissors, with well-adjusted and pointed extremities, and a camel-hair pencil, having a portion of the hairs cut off at the end, which is thereby flattened. The extremity of the cedar handle should be cut to a fine point, so that the brush may be the more easily revolved between the finger and thumb; and the coloured pigment on the interior may be scrubbed off by this simple process. A brush thus prepared, and slightly moistened, forms, as far as my experience goes, by far the best forceps for manipulating these objects preparatory to mounting; as, if only touched with any hard-pointed substance, they



often spring from the table from mere elasticity, and thus the labour of hours be lost in a moment. It does not appear to me desirable to attempt to flatten an entire cornea by pressure and maceration, although this is generally recommended, as it does not either aid in developing the beauty, or counting the number of its lenses. On the contrary, the rounded membrane becomes, if the margin remains intact, corrugated; and so one hexagon overlaps the other. It will be useful, therefore, to make two preparations of the eyes of one insect: the one entire, retaining its natural curved form, not having been subjected to pressure; the other nicked at its margin, or cut into small fragments, and pressed between two slides.

"Each hexagon forms the slightly horny case of an eye. Their margins of separation are often thickly set with hair, as in the Bee; in other instances naked, as in the Dragon-fly, House-fly, &c. The number of these lenses have been calculated by various authors, and their multitude cannot fail to excite astonishment. Hooke counted 7,000 in the eye of a House-fly; Leeuwenhoek more than 12,000 in that of a Dragon-fly; and Geoffry cites a calculation, according to which there are 34,650 of such facets in the eye of a Butterfly."<sup>1</sup>

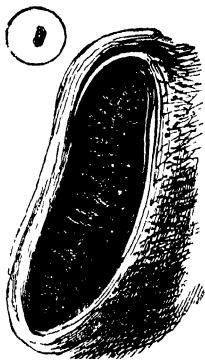

Fig. 237. — *Breathing-aperture, spiracle, of Silkworm.*  
(The circle encloses the object about the natural size.)

The trunk is situated between the head and the abdomen; the legs and wings are inserted into it. The thorax is the upper part of the trunk; the sides and back of which are usually armed with points or hairs. The abdomen forms the posterior part of the body, and is generally made up of rings or segments, by means of which the insect lengthens or shortens itself. Running along the sides of the abdomen are the spiracles, or breathing apertures, fig. 237, communicating directly with the internal respiratory organs. Pure air being thus freely admitted to every part, and the

(1) John Gorham, Esq., *Microscopical Journal*, 1853.

circulating fluids kept exposed to the vivifying influence of the atmosphere, the necessity for more complicated and cumbersome breathing organs is at once obviated; and the whole body is at the same time rendered lighter. The spiracles are usually nine or ten in number, and consist of a horny ring, of an oval form. The air-tubes are exquisitely composed of two thin membranes, between which a delicate elastic thread or *spiral fibre*, is interposed, forming a cylindrical pipe, and keeping the tube always in a distended condition; thus wonderfully preserving the sides from collapse or pressure in their passage through the air, which otherwise might occasion suffocation. Fig. 238 represents the beautiful mechanism of a portion of the tracheæ of a Silkworm moth, beneath this is a small portion of a tracheæ, highly magnified, to show the peculiar arrangement of the spiral tubes, which give elasticity and strength to the air-tubes of the *Hydrophilus*.

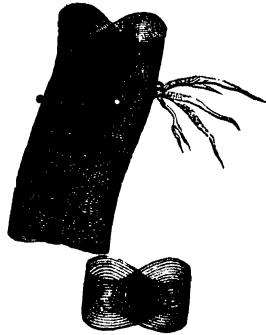

Fig. 238.—Magnified portions of the trachea of the *Hydrophilus*, showing spiral tubes and their arrangement.

The legs of insects are extremely curious and interesting; each leg consists of several horny cylinders, connected by joints and ligaments, enclosing within them sets of powerful muscles, whereby their movements are effected. The *tarsus*, or foot, is generally terminated by two horny hooks or claws, by which the insect holds to the object it is moving upon; between these hooks, in most species, is situated a cushion, sucker, or two broad flaps (*pulvilli*), wherewith to take hold of smooth surfaces. In fig. 240, legs are represented, marking peculiarities of structure; and in fig. 239, a sucker, somewhat resembling the admirably-constructed *sucker* attached to the under-surface of the feet of House-flies, by means of which—

“They tread the ceiling or inverted floor,  
And from its precipice depend secure.”

It was formerly supposed, from experiments made by Sir Everard Home, that Flies were enabled to walk against glass, and with the back downwards in various situations, solely by the creation of a vacuum under the soles of their feet, if we may so term them; for it was

observed that the margins of the feet were closely applied to the glass, while the central part was drawn up. It has, however, been discovered that this hypothesis was incorrect. Mr. Blackwell (a gentleman residing in Manchester, an acute observer of nature,) noticed that Flies remained attached to the sides of an exhausted glass receiver over an air-pump, even after they had entirely lost the power of locomotion, and that an evident distension of the body had been occasioned by the exhaustion of the air.

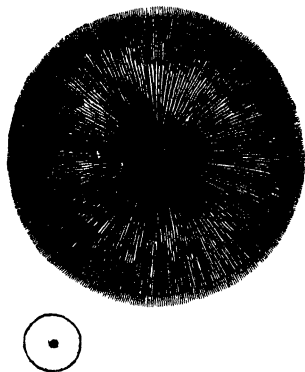

Fig. 239.—*Sucker on the leg of a Water-beetle.* (The circle encloses the object about the natural size.)

To detach them from such stations, Mr. Westwood adds, the employment of a small degree of force is found requisite. In prosecuting this subject, clean phials of transparent glass, containing Spiders and various insects in the larva and imago (perfect) states, capable of walking on their upright sides, were breathed into, till the aqueous vapour expelled from the lungs was copiously condensed on the inner surface of the phials. The result was remarkable; the moisture totally prevented those animals from obtaining any effectual hold on the glass, and the event was equally decisive if a small quantity of oil was substituted for the aqueous vapour. In fact, it was found that powder, or any substance on the inside of the phials, prevented the Flies from climbing; and the idea naturally suggested itself that, some glutinous substance was emitted by the feet of the Flies, which enabled them to adhere to the glass. The next point to be determined, therefore, was, whether

Spiders, and insects in the larva and perfect states, were found to leave any visible track behind them when they crawled over glass; and, by the aid of powerful magnify-

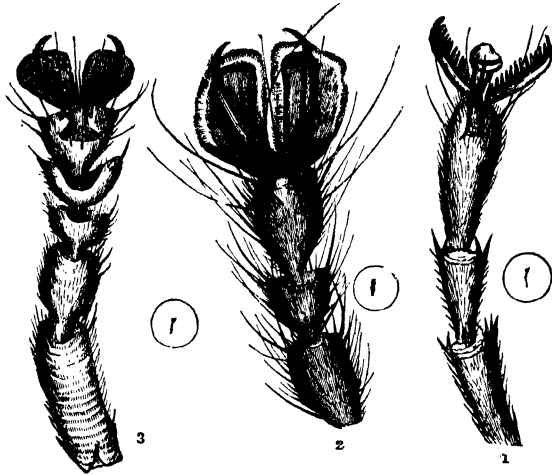

Fig. 240.

1, Foot and leg of *Ophion*. 2, Foot and leg of Blow-fly. 3, Foot and leg of Drone-fly. (The small circles enclose the objects about the natural size.)

ing-glasses, it was found that traces were left of an exceedingly minute quantity of glutinous matter, which appeared to have been emitted by the feet of these creatures; and subsequent experiments proved that the hair-like appendages which form the brushes of Spiders and Flies are all tubular. (See an interesting paper on this subject by J. Hepworth, in the *Microscopical Journal*, 1854.)

Fig. 241 represents the tongue and piercing apparatus of the Drone-fly. This remarkable compound structure, together with the admirable form and exquisite beauty of the apparatus, must strike the mind with wonder and delight, and lead the observer to reflect on the weakness and impotence of all human mechanism, when compared with the skill and inimitable finish displayed in the object before us. The fleshy outer case which encloses it has



Fig. 241.—*Tongue and Piercing Apparatus of the Drone-fly.*

been removed for the purpose of viewing the several parts, which consist of two spongy palpi, or feelers, covered with short hairs, and united to the head by a set of muscles; these feelers appear to be in frequent requisition for guarding the other organs from external injury. The two lancets seen above them are formed somewhat like a cutlass, or the dissecting knife of the anatomist, and are purposely intended for making a deep and sharp cut, also for cutting vertically with a sweeping stroke. The other and larger cutting instrument appears to be intended to enlarge the wound, if necessary; or it may be for the purpose of irritating and exciting the part around, thereby increasing the flow of blood to the part, being jagged or toothed at the extremity. The larger apparatus, with its three peculiar prongs, or teeth, is tubular, to permit of the blood passing through it and thence to the stomach; this is enclosed in a case which entirely covers it. The spongy tongue itself projects some distance beyond this apparatus, and is composed of a beautiful network of soft muscular spiral fibres, forming a series of absorbent tubes; and these are moved by powerful muscles and ligaments, the retractile character of which may be seen in the drawing of the proboscis of the Fly, fig. 242: by the aid of two hooklets placed in each side, he is enabled to draw in and dart out the tongue with wonderful rapidity. The striated appearance of another set of muscles is seen at the root of the whole.

“In the organisation of the mouth of various insects we have a modification of form, to adapt them to a different mode of use; as in the *Muscidæ*, or common House-flies. When the food is easily accessible, and almost entirely liquid, the parts of the mouth are soft and fleshy, and simply adapted to form a sucking tube, which in a state of rest is closely folded up in a deep fissure, on the under-surface of the head. The proboscis at its base appears to be formed by the union of the *lacinia* above and the *labium* below, the latter forming the chief portion of the organ, which is tenanted by dilated muscular lips. In the *Tabanus* these are exceedingly large and broad, and are widely expanded, to encompass the wound made by the insect with its lancet-shaped mandibles in the skin of

the animal it attacks. On their outer surface they are fleshy and muscular, to fit them to be employed as prehensile organs; while on their inner, they are more soft and delicate, but thickly covered with rows of very minute stiff hairs, directed a little backwards, and arranged closely together. There are very many rows of these hairs on each of the lips; and from their being arranged in a similar direction, they are easily employed by the insect in scraping or tearing delicate surfaces. It is by means of this curious structure that the busy House-fly often occasions much mischief to the covers of our books, by scraping off the white of egg and sugar varnish used to give them the polish, leaving traces of its depredations in the soiled and spotted appearance which it occasions on them. It is by means of these also that it teases us in the heat of summer, when it alights on the hand or face, to sip the perspiration as it exudes from and is condensed upon the skin. The fluid ascends the proboscis, partly by a sucking action, assisted by the muscles of the lips themselves, which are of a spiral form, arranged around a highly elastic, tendinous, and ligamentous structure, with other retractile additions for rapidity and facility of motion."<sup>1</sup>

The beautiful form of the spiral is best seen under a magnifying power of 250 diameters, or a quarter-inch object-glass.

These insects are of great service in the economy of nature, their province being the consumption of decaying animal matter, which is found about in quantities so small as to be imperceptible to most people, and is not removable by ordinary means, even in the best-kept apartments, during hot weather. It was asserted by Linnæus, that three flies would consume a dead horse as quickly as a lion. This was, of course, said with reference to the offspring of such three flies; and it is possible the assertion may be correct, since the young begin to eat as soon as they are born. A single Blow-fly has been known to produce twenty thousand living Maggots; and each of these continues to eat so voraciously, that in twenty-four hours it has increased its own weight above two hundred times; in five days it attains to its full

(1) Mr. G. Newport, *Cyclopædia of Anatomy and Physiology*.

size. When the Maggots are of full size, they change into the pupa state, and remain in that state a few days; they

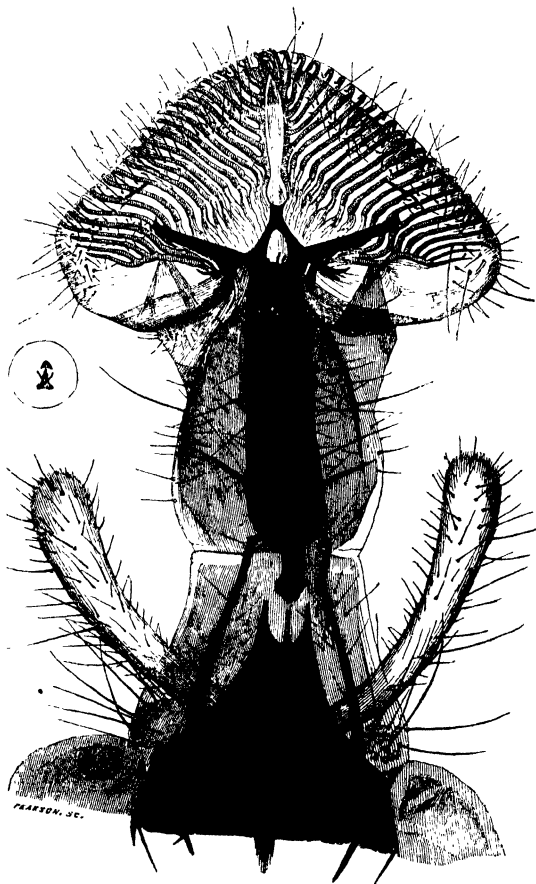

Fig. 242.—*Proboscis of House-fly*.—Drawn from a preparation by Topping. (The small circle encloses the same about the natural size.)

then become Flies, soon to produce thousands more



Maggots, which afterwards become Flies, and this goes on until the whole brood is destroyed by winter's cold.

We cannot resist an apt quotation on this interesting little insect: "A fly on the wing is no less curious an object than one on foot; yet, when do we trouble our heads about it, except as a thing which troubles us? The most obvious wonder of its flight is its variety of direction, most usually forwards, with its back upwards like a bird, but on occasions backwards, with its back downwards, as when starting from the window and alighting on the ceiling. Marvellous velocity is another of its characteristics. By fair comparison of sizes, what is the swiftness of a race-horse, clearing his mile a minute, to the speed of the fly cutting through her third of the same distance in the same time? And what the speed of our steaming giants, the grand puffers of the age, compared with the swiftness of our tiny buzzers; of whom a monster train, scenting their game afar, may even follow partridges and pheasants on the wings of steam in their last flight as friendly offerings? But, however, with their game the flies themselves would be most in 'keeping' on the atmospheric line,—a principal agent in their flight, as well as in that of other insects, being the air. This enters from the breathing organs of their bodies, in the nerves and muscles of their wings, from which arrangement their velocity depends, not alone on muscular power, but also on the state of the atmosphere. 'How does a fly buzz?' is another question more easily asked than answered. 'With its wings, to be sure,' hastily replies one of our readers. 'With its wings as they vibrate upon the air,' responds another, with a smile, half of contempt, half of complacency, at his own more than common measurement of natural philosophy. But how, then, let us ask, can the great Dragon-fly, and other similar broad-pinioned, rapid-flying insects, cut through the air with silent swiftness, while others go on buzzing when not upon the wing at all? Rennie, who has already put this posing query, himself ascribes the sound partially to air; but to air as it plays on the 'edges of their wings at their origin, as with an Eolian harp-string,' or to the friction of some internal organ on the root of the wing nervures. Lastly, how does the fly feed? The

busy, curious, thirsty fly, that 'drinks with me,' but does 'not drink as I,' his sole instrument for eating or drinking being his trunk or suck; the narrow pipe by means of which, when let down upon his dainties, he is enabled to imbibe as much as suits his capacity. This trunk might seem an instrument convenient enough when inserted into a saucer of syrup, or applied to the broken surface of an over-ripe blackberry; but we often see our sipper of sweets quite as busy on a solid lump of sugar, which we shall find on close inspection growing 'small by degrees' under his attack. How, without grinders, does he accomplish the consumption of such crystal condiment? A magnifier will solve the difficulty, and show how the fly dissolves his rock, Hannibal fashion, by a diluent, a salivary fluid passing down through the same pipe, which returns the sugar melted into syrup."<sup>1</sup>

The wings of insects exhibit variety in form and structure, as well as beauty of colouring, the art with which they are connected to the body, the curious manner in which some are folded up, the fine articulations provided for this purpose, with the various ramifications by which the nourishing fluids are circulated and the wing strengthened, all afford a fund of rational investigation highly entertaining, and exhibiting, when examined under the microscope, beautiful and wonderful design in their formation. Take the *Libellulidæ*, Dragon-flies, as an example, whose wings, with their horny framework, are as elegant, delicate, and as transparent as gauze, often ornamented with coloured spots, which, at different inclinations of the sun's rays, show all the tints of the rainbow. One species (*Calepteryx virgo*) will be seen sailing for hours over a piece of water, all the while chasing, capturing, and devouring the numerous insects that cross its course; at another time driving away competitors, or making its escape from an enemy, without ever seeming tired or inclined to alight.

In fine weather, female Dragon-flies are seen to deposit their eggs upon the water, making a strange noise, as though they were beating the water; the cluster of eggs look like a floating bunch of small grapes. The larvæ, when hatched, live in the water; and it is scarcely

(1) *Episodes of Insect Life*,—a charming book, published by Reeve, 1851.

possible to fancy more strange-looking creatures. They are short, comparatively thick, with movements heavy and clumsy, and after shedding their skins become pupæ; still continuing to live in the water. The pupæ differ from the larvæ principally in having four small scales on their sides; these conceal the future wings. While the Dragon-fly continues in its aquatic state, both as larva and pupa, it devours all the insects it can entrap; and as it only moves slowly, it is furnished with a very curious apparatus near its head, which it projects at pleasure, and uses as a trap. This apparatus consists of a pair of very large, jointed, moveable jaws, which the insect keeps closely folded over its head, like a large mask, till it sees its prey; when it does, it creeps softly along till it is sufficiently near, it then darts out those long, arm-like jaws, and suddenly seizing its prey conveys it to its mouth. When the Dragon-fly is about to emerge from its pupa-case, it places itself on the brink of the pond, or on the leaf of some water-plant sufficiently strong to bear its weight, and there divests itself of its pupa-case. When the perfect insect first appears, it has two very small wings; these gradually increase, the veins fill with coloured liquid globules, and in a short time two other wings appear. As soon as the wings are fully expanded, and have attained their beautiful gauze-like texture, the Dragon-fly begins to dart about, and slaughter every small insect that falls in its way.

Equally rapid, exactly steered, and unwearied in its flight, is the Gnat. The wings of a Gnat have been calculated, during its flight, to vibrate 3000 times in a minute: these wonderful wings are covered on surface and edge with a fine down or hair. The alternations of bright sunshine and rain so commonly seen in March, are extremely favourable to the appearance of Gnats. The first that appear are called Winter midges (*Trichocera hyemalis*). As the spring advances, these Midges are succeeded by others somewhat different, and as the weather becomes warmer, the true Gnats appear. The sting of the Gnat (*Culex pipiens*) is well known; although the insects themselves, so very rapid in their movements, are so much dreaded that very few people care to examine the delicacy and elegance of their

forms. The sting is very curiously contrived (see fig. 243), and enclosed in a sheath, folds up after one or

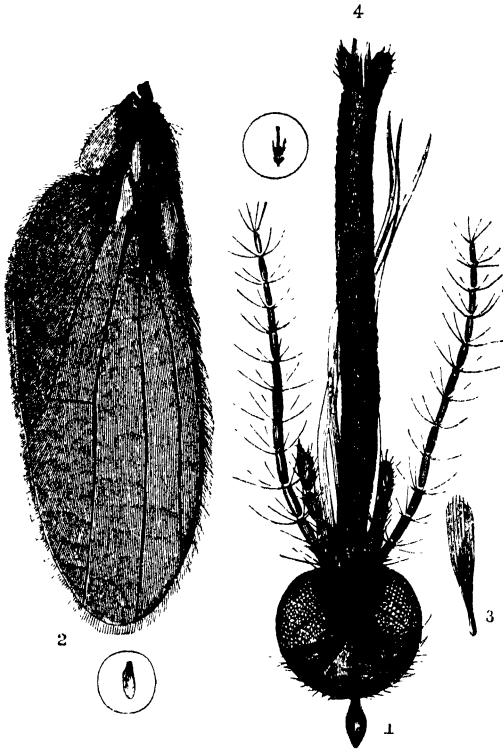

Fig. 243.

1, Head of *Cul. x pipiens*, Female Gnat, detached from the body. 2, Wing. 3, A Scale from the Proboscis. 4, Proboscis and Lancets. The reticulation on each side of the head shows the space occupied by the eyes. (The small circles enclose the objects about the natural size. The feather or scale from proboscis is magnified 250 diameters.)

more of the six lancets have pierced the flesh; it will inflict a severe though minute wound, the pain of which is increased by an acrid liquor injected into it through a

curiously-formed proboscis ; this latter is covered over with feathers or scales. A magnified view of one of these feathers is seen at No. 3. Another scale from a Gnat's wing is magnified 500 diameters, fig. 249, No. 7. The proboscis



Fig. 244.—Female Gnat depositing her eggs.

is protected on either side by antennæ, or feelers. Any one who takes the trouble to watch the operations of the female (fig. 244), when she is about to make her nest, must be much struck with the ingenuity and admirable instinct

this little creature displays.

The bodies of insects are covered with a hard skin ; this answers the purpose of an internal skeleton, and is one of their chief characteristics. All animals, and most fishes, have an internal skeleton of bones, which give attachment to muscles : but the interior of an insect is a soft mass, and the muscles are affixed to the exterior casing or horny skin ; this answers all the purposes of bone, connecting the various parts, maintaining them in their proper places, and at the same time it forms a perfect covering to the body. In some insects this horny skin is remarkable for its strength, as in the Beetle tribe, many of which are exceedingly curious in their construction.

The family *Phryganeidæ*, the larvæ of which are aquatic, present almost as little resemblance to the imago as those of some metabolous insects. They are long, softish grubs, furnished with six feet, and with a horny head armed with jaws, generally fitted for biting vegetable matters, although some appear to be carnivorous. To protect their soft bodies, which constitute a very favourite food with fishes, the larvæ are always enclosed in cases formed of bits of straw and sticks, pebbles, and even small shells. The materials of these curious cases are united by means of fine silken threads, spun like those of the caterpillars of the *Lepidoptera*, from a spinnaret situated on the labium. In increasing the size of its case to suit its growth, the larva is said to add to the anterior part only, cutting off a portion of the opposite extremity. When in motion, the larva pushes its head and the three thoracic segments, which are of a harder consistence than the rest of the

body, out of its case; and as the latter is but little, if at all, heavier than the water, the creature easily drags it along behind, thus keeping its abdomen always sheltered. It adheres stoutly to the inside of its dwelling by means of a pair of articulated caudal appendages, generally assisted by three tubercles on the first abdominal segment. Before the change to the pupa state, the larva fixes his case to some object in the water, and then closes up the two extremities with a silken grating, through which the water necessary for the respiration of the pupa readily passes. The pupa is furnished with a large pair of hooked jaws, by means of which, when about to assume the perfect state, it bites through the grating of its prison, and thus sets itself free in the water. In this form the pupæ of some species swim freely through the water by means of their long hind legs, or creep about plants with the other four; frequently rising to the surface of the water, they there undergo their final change, using their deserted skin as a sort of raft, from which to rise into the air; others climb to the surface of aquatic plants for the same purpose.

The perfect insect (*Phryganea grandis*) has four wings, with branched nervures, the anterior pair of which, clothed with hairs, are more frequently used than the posterior. The organs of the mouth, except the palpi, are rudimentary, and apparently quite unfit for use. The head is furnished with a pair of large eyes, and with three ocelli; the antennæ are generally very long. Some species are so exactly like Moths, that they have often been supposed to belong to the Lepidopterous order; in point of fact, these insects may be considered to form a connecting link between the *Neuroptera* and the *Lepidoptera*. The females have been seen to descend to the depth of a foot or more in water, to deposit their eggs.

Many species of these insects are found in Britain. The larvæ are well known to anglers, under the names of Caddis-worms and Straw-worms. They are said to be excellent baits.

*Butterflies* and *Moths* belong to the highest order of the suctorial insects, *Lepidoptera*, and pass through a complete metamorphosis. The female Butterfly deposits her eggs

upon such substances as are proper to nourish the caterpillars: thus the common Cabbage - butterfly lays them on the cabbage; the Peacock-butterfly on the nettle; the Swallow-tailed butterfly on fennel or rue;



Fig. 245.—Eggs of Lackey Moth.

the Atalanta-butterfly on the nettle. The eggs are simply attached by some glutinous secretion to leaf or stem; in a similar way are the eggs of Moths deposited, a few being enclosed in down.

Moths and Butterflies supply the microscopist with some of the most beautiful objects for examination. What can be more wonderful in its adaptation than the



Fig. 246.—Moth.

antenna of the Moth, represented in fig. 247, No. 1, with a thin finger-like extremity almost supplying the insect with a perfect and useful hand, moved throughout its extent by a muscular apparatus, the whole being of a feathery construction! The tongue, No. 2, is made for the purpose of dipping into the interior of flowers and extracting the honey; this is endowed with a series of muscles, an enlarged view of a portion is given at No. 3.

The inconceivably delicate structure of the maxillæ or tongues (for there are two) of the Butterfly, rolled up like the trunk of an elephant, and capable, like it, of every variety of movement, have been carefully examined and described by Mr. Newport. "Each maxilla is convex on

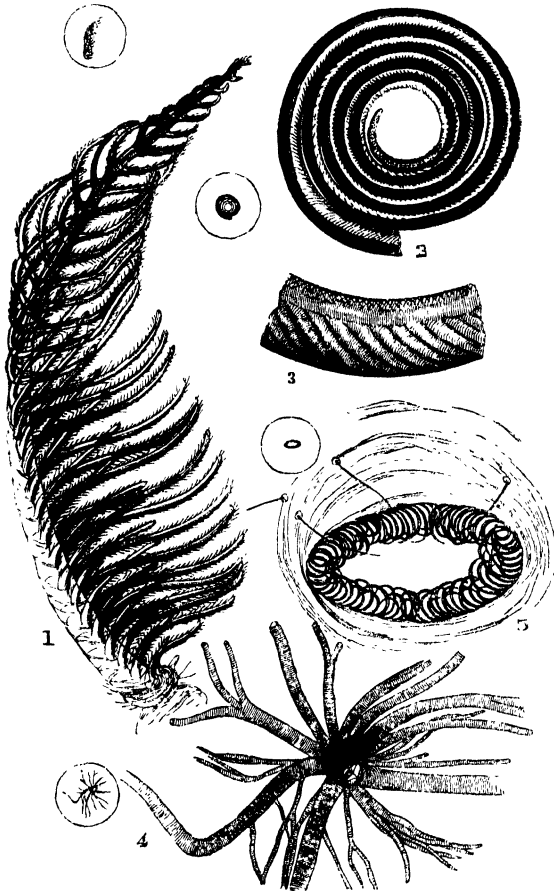

Fig. 247.

1, The *Antenna* of the Silk worm-moth. 2, The *Tongue*. 3, A portion of the *Tongue* highly magnified, showing its muscular fibre. 4, The *Tracheæ* of Silk worm. 5, The *Foot* of Silk worm. (The small circles enclose each about the natural size.)



its outer surface, but concave on its inner; so that when the two are approximated, they form a tube by their union, through which fluids may be drawn into the mouth. The inner or concave surface, which forms the tube, is lined with a very smooth membrane, and extends throughout the whole length of the organ; but that each maxilla is hollow in its interior, forming a tube 'in itself,' as is generally described, is a mistake; which has doubtless arisen from the existence of large tracheæ, or breathing-tubes, in the interior of each portion of the proboscis. In some species, the extremity of each maxilla is studded externally with a great number of minute papillæ, or fringes—as in the *Vanessa atalanta*—in which they are little elongated barrel-shaped bodies, terminated by smaller papillæ at their extremities." Mr. Newport supposes that the way in which the insect is enabled to pump up the fluid nourishment into its mouth is this: "On alighting on a flower, the insect makes a powerful expiratory effort, by which the air is expelled from the interior air-tubes, and from those with which they are connected in the head and body; and at the moment of applying its proboscis to the food, it makes an inspiratory effort, by which the central canal in the proboscis is dilated, and the food ascends it at the same instant to supply the vacuum produced; and thus it passes into the mouth and stomach: the constant ascent of the fluid being assisted by the action of the muscles of the proboscis, which continues during the whole time that the insect is feeding. By this combined agency of the acts of respiration and the muscles of the proboscis, we are also enabled to understand the manner in which the Humming-bird sphynx extracts in an instant the honey from a flower while hovering over it, without alighting; and which it certainly would be unable to do, were the ascent of the fluid entirely dependent upon the action of the muscles of the organ."<sup>1</sup>

The wings of Moths and Butterflies are covered with scales or feathers, carefully overlapping each other, as tiles are made to cover the tops of houses. The iridescent variety of colouring on their wings arises from a peculiar wavy arrangement of the scales. Figs. 248 and 249 are magni-

(1) *Cyclop. Anat. Physiol.*, article "Insecta."

fied representations of a few of them. No. 1 is a scale of the *Morpho menelaus*, taken from the side of the wing, of a

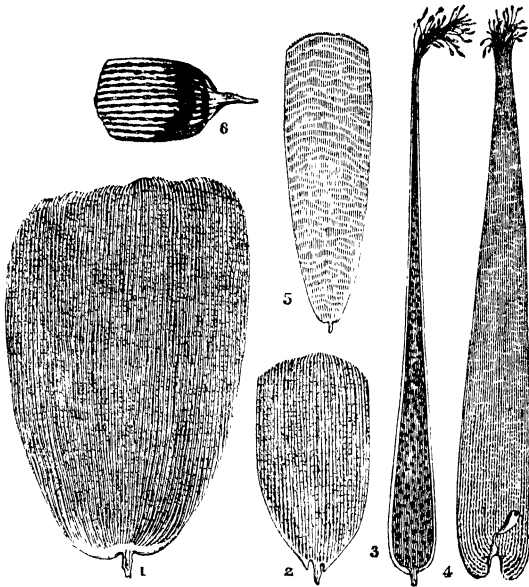

Fig. 248.—Scales from Butterflies' and Moths' wings. (Magnified 200 diameters.)

1, Scale of *Morpho Menelaus*. 2, Large Scale of *Polyommatus Argiolus*, azure blue. 3, *Hipparchia Janira Argiolus*. 4, *Pontia Brassica*. 5, *Podura Plumbea*. 6, Small Scale of Azure Blue.

pale-blue colour: it measures about 1-120th of an inch in length, and exhibits a series of longitudinal stripes or lines, between which are disposed cross-lines or striæ, giving it the appearance of brick-work. The microscope should be enabled to make out these markings with the spaces between them clear and distinct, as shown in fig. 249, No. 1 a.

*Polyommatus argiolus*. Azure-blue, Nos. 2 and 6, are large and small scales taken from the under-side of the wing of this beautiful blue butterfly; the small scale is covered with a series of spots, and exhibits both longitu-

dinal and transverse striæ, which should be clearly defined, and the spots separated: this is a good test of the defining power of a quarter-inch object-glass.

No. 3, *Hipparchia janira*, Common Meadow Brown Butterfly scale: on this we see a number of brown spots of irregular shape and longitudinal striæ.

No. 4, *Pontia brassica*, Cabbage-butterfly, affords an excellent criterion of the penetration and definition of a microscope: it is provided at its free extremity with a brush-like appendage. With a high power, the longitudinal markings appear like rows of little beads. Chevalier's test-object is the scale of the *Pontia brassica*, the granules of which must be rendered distinct. Mohl and Schacht use *Hipparchia janira* as a test for penetration, with a moderate angular aperture and oblique illumination. Amici's test-object is *Navicula Rhomboides*, the display of the lines forming the test; this is also a good test for angular aperture.

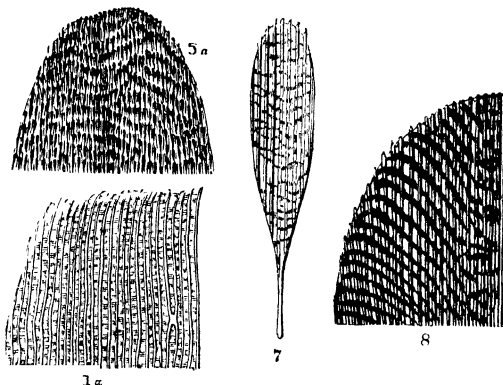

Fig. 249.—Portions of Scales, magnified 500 diameters.

1a, Portion of Scale of *Morpho Menelaus*. 5a, Portion of Large Scale of *Podura Plumbea*. 7, Scale from the Wing of Gnat; its two layers are here represented. 8, Portion of a Large Scale of *Lepisma Saccharina*.

The *Tinea vestianella*, Clothes-moth, possesses very delicate and unique scales; two of these are imperfectly represented near the *Acarus* taken from one of these moths, at page 461. The feathers from the under-side of the

wing are the best, requiring some management of illumination to bring out the lines sharp and clear.

The common Clothes-moth generally lays its eggs on the woollen or fur articles it is bent upon destroying; the larva begins to eat immediately it is hatched; then with the hairs or wool it first gnaws off, it forms a case or tube, under the protection of which it devours the substance of the article on which it fixes its abode. This tube is of parchment-like consistence, and quite white; is cylindrical in its shape, and furnished at both ends with a kind of flap, which the insect raises at pleasure, and crawls out; or it projects the front part of its body with its fore-feet through the opening, just enough to enable it to creep about without removing the rest of its body from the tube, which it draws after it. There are several kinds of Clothes-moths, the caterpillars of many bury themselves in the article on which they feed, instead of making the tube before-mentioned. The moths also differ very much in appearance, the commonest is of a light buff colour; one species, *Tinea tapetzella*, fig. 250, is nearly black, with the larger wings white tipped, or pale grey.



Fig. 250.—The Black Clothes-moth.

Mr. Topping, the well known preparer of microscopic objects, generally furnishes three kinds of *test-objects*, which he covers with the thinnest glass, in order that object-glasses of the highest powers may be used in their examination. The following are arranged in their order of value as test-objects :

Amician test.  
 N. v. Rhomboides.  
 Grammatophora subtilisima.  
 Pleurosigma fasciola.  
 — cuspidata.  
 — angulatum.  
 — strigosum.  
 — prolongatum.  
 — Spencerii.  
 — Balticum.  
 — hippocampus.  
 — strigilis.  
 — formosum.

SCALES.  
 Meadow Brown.  
 Pontia Brassica.  
 Azure Blue.  
 From Gnat's Wing.  
 Tinea Vestianella.  
 Amathusia Horsefieldii.  
 Morpho Menelaus.  
 Poctura plumbea.  
 Lepisma saccharina.

HAIRS.  
 Indian Bat.  
 „ Mouse.  
 „ Mole.  
 Larva of Dermestes.

Mr. J. T. Norman, of Fountain Place, City Road, preparer of specimens for the microscope, furnished the author with a similar list for publication.

The foot of the caterpillar is made up of a series of hooklets, which enable it to cling to the surface of leaf or stalk of a plant. A magnified view of one is given at No. 5, fig. 247.

The *Coccina*, one of a family group of the order *Hemiptera*, comprises numerous minute insects, the history of which is still very imperfectly recorded. Their feet have only one joint; the males are furnished with two wings, with a few straight nervures; they are destitute of a rostrum, and pass their pupa stage in a state of repose. The females are without wings, but possess a rostrum, and appear to undergo no metamorphosis whatever. These curious little creatures, with a history so singular that some authors have proposed the formation of a separate order for their reception, are principally inhabitants of the warmer regions of the earth, although many species are found in our own country, where some of them are well known to gardeners under the name of "the bug;" they do great injury to many plants, especially in hothouses.

It would be impossible to find insects more dissimilar in appearance than the two sexes of *Coccina* (fig. 251). The

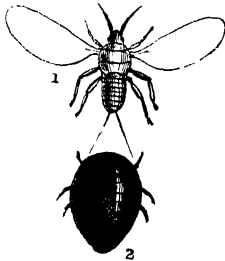

Fig. 251—*Cochineal Insect*.  
1, Male. 2, Female.

females look like a mere fleshy mass, are nearly destitute of limbs, and remain attached to one spot or branch of the plant, from which they continue to imbibe nutriment, by the agency of the rostrum, until they attain a considerable size. The males, on the contrary, are generally very minute and really elegant creatures, furnished with a single pair of filmy wings; the only representatives of the second wings being a

pair of organs somewhat similar to the *halteres* of the *Diptera*. Hence some etymologists have put forward the opinion that the males of the *Coccina* are, in reality, dipterous parasites. The abdomen of the male is generally furnished with a pair of long setæ. In most instances the females retain their limbs and power of motion through life; sometimes they undergo a slight change.

In a genus *Coccina* (*Dorthesia*), several species of which are found in this country, the female—although apterous and active in all stages—is completely covered with a snow-white secretion, which gives it more the appearance of a little plaster-cast than any thing else.

In another tribe, the *Phytophthiria*, both sexes are either wingless or furnished with four distinctly veined wings. The rostrum springs apparently from the breast; the tarsi are two-jointed and furnished with two claws. The most familiar species of this tribe are the *Aphides*, Plant-lice, which have ever been regarded with considerable interest by the naturalist, and whose curious history is doubtless well known to every one. They are all small animals, with a more or less flask-shaped body, furnished with six feet, a pair of antennæ, and very generally with a pair of short tubes close to the extremity of the abdomen, from which a clear sweet secretion exudes. Both sexes are at one period winged, at another wingless; and individuals of the same species are often winged and apterous at different periods of the year. They all live upon plants, the juices of which they suck; and when they occur in great numbers, cause considerable damage to vegetation; a fact well known to the gardener and farmer. Many plants are liable to be attacked by swarms of *Aphides*, which cause the leaves to curl up, they grow sickly, and their produce is greatly reduced. One striking instance is presented in the devastation caused by the Hop-fly (*Aphis humuli*).

The *Cicadellina* or *Cercopidæ*, of which the *Aphrophora bifasciata*, common Frog-hopper, have the antennæ placed between the eyes, and the scutellum visible—that is to say, not covered by a process of the prothorax. The eyes, never more than two in number, are sometimes wanting. These little creatures are always furnished with long hind legs, which enable them to perform most extraordinary leaping feats.

The best-known British species, because so very abundant in gardens, is the Cuckoo-spit, Froth-fly. The names Cuckoo-spit and Froth-fly both allude to the peculiar habit of the insect, while in the larva state, of enveloping itself in a kind of frothy secretion, somewhat resembling saliva; and this, indeed, was at one time supposed to be

the saliva of the cuckoo, being found on the young shoots of plants just about the time the cuckoo is heard in the woods. The frothy secretion is supposed to be intended to preserve the tender body of the insect from the overpowering effects of the sun; it has been observed to be produced in exact proportion to the heat of the weather.



Fig. 252.—*Aphrophora spumaria*,  
Cuckoo-spit.

*a*, The frothy substance. *b*, The pupa.

It is not known exactly how the froth is produced; and if by any chance it becomes condensed, it drops like rain from the plants on which the insect is feeding; it is only during the larva state that it produces this froth.



Fig. 253.—Perfect  
insect of the Cuc-  
koo-spit.

The larva and the pupa resemble the perfect insect, the difference simply is that the larva is wingless, and the pupa have very small wings; the perfect insect, having both wings and wing-cases, which are occasionally employed in the act of flying; and at times these insects are seen in vast multitudes on the wing. One of the peculiarities of this insect is its power of leaping, which is so great, that, unassisted by its wings, it will sometimes leap a distance of five or six feet, or more than 250 times its own length; about equal to a leap a quarter of a mile high, could a man take it. This extraordinary activity appears to be principally due to the great length of the thighs of the insect, and these are furnished on their outer margins with a fringe of stiff hairs or strong spines, which must be of use to the insect in leaping.

The *Hymenoptera* are distinguished from other insects with membranous wings, by the presence of an ovipositor of peculiar construction at the extremity of the abdomen of the females, which serves for placing the eggs in the required position; and in the males of some (Bees, Wasps, &c) constitutes a most formidable offensive weapon. As the structure of this organ, which is rarely absent, is essentially the same throughout the order, the form of its component parts being merely modified to suit the exigencies

of the different insects, a short description of its structure will not be considered out of place. The ovipositor, borer, or sting, generally consists of five pieces: a pair of horny supports (fig. 258) forming a sheath for the borer or ovipositor, being jointed at the point where they issue from the cavity of the last abdominal segment, and the last joint is usually as long as the borer itself. The latter consists of three bristles, of which the superior is channelled along its lower surface, for the reception of a pair of finer bristles, and these are toothed at the point. The three pieces, when fitted together, form a narrow tube, through which the eggs pass to their destination, the poisonous fluid also, which renders the sting of the Bee so painful, is forced down the same into the wound. In the Saw-fly, a part of this organ remains rudimentary, in other respects it does not differ.



Fig. 254.—Winged Ant.

The larvæ of most of the *Hymenoptera* are footless grubs, furnished with a soft head, and exhibiting but little, if any, advance upon the maggots of the *Diptera*. In the Saw-fly, however, the larva, instead of being, as above described, a mere footless maggot, presents the closest resemblance to the caterpillar of the *Lepidoptera*; it is provided with a distinct horny head, and not only with six thoracic legs, but in most cases, from twelve to sixteen pro legs are appended to the abdominal segments.

The Saw-fly, fig. 255, most destructive to the gooseberry-bush, is remarkable for the way in which the female provides for the safety of her eggs. This fly has a flat yellow body, and four transparent wings, the outer two of which are marked with brown on the edge. The female lays her eggs on the under-side of the leaf, along the projecting veins; these are so firmly attached, that they cannot be removed without crushing. The instrument which the little insect uses for the purpose of cutting the leaf, is the most remarkable piece of perfect mechanism imaginable; securely lodged, when not in use, in a long narrow slit beneath the abdomen, and protected by two horny plates,



which at first appear to consist of a single piece; but upon closer inspection four plates are seen to enter into

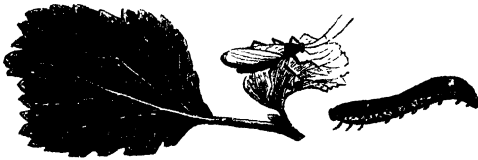

Fig. 255.—*The Caterpillar and Saw-fly of Gooseberry-Tree.*

their construction: namely, two saws, placed side by side, as in fig. 256; and two supports, somewhat like the saws in shape. A deep groove runs along the thicker edge

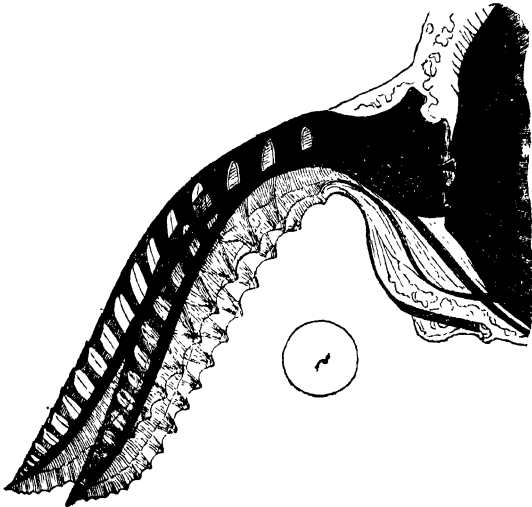

Fig. 256.—*Saws of Saw-fly.* (The small circle encloses the same nearly the natural size.)

of the latter, which is so arranged that the saws glide backwards and forwards, without a possibility of running out of the groove. When the cut is made, the four are drawn together; and through a central canal, which is now formed by combining the whole, an egg is protruded

into the fissure made by the saws in the leaf. The cutting edges of the saws are provided with about eighteen or twenty teeth, these have sharp points of extreme delicacy, and together making a serrated edge of the exact form given to the finest and best-made surgical saws. In the summer-time the proceedings of this little insect can be watched, and the method of using this curious instrument seen, by the aid of a hand magnifying-glass; they are not easily alarmed when busy at their work.

Many other insects are provided with instruments for boring into the bark or solid wood itself. The *Cynip* bores a hole into the side of the oak-apple, for the purpose of depositing its egg, the larva when hatched finds a comfortable lodging, and a good supply of food; when full grown, it eats its way out of the nut, and dropping to the ground, it assumes the form of the perfect fly. The most important of this family is the *Cynip gallæ tinctoriæ*, fig. 257, which is the cause of the gall-nut, a nut most extensively employed in the manufacture of ink and for dyeing purposes.

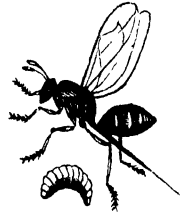

Fig. 257.—Female Eglantine Gall-fly and Larva.

Some of the Wasp tribe, so very peculiar in their habits, are active agents in the economy of nature. The Solitary, Mason-wasps, curiously construct nests in the form of cells, for the purpose of carefully rearing their young. The social wasps, like bees, live in communities, and have nearly the same divisions of labour and regulations for the good government of their colony. The structure and mechanical contrivance of the wasp's sting can only be seen under the microscope. The sting consists of two *barbed darts*, which will penetrate the flesh deeply, and from a peculiar arrangement of their serrated edges, their immediate withdrawal is prevented; by the great muscular effort required for this purpose, a small sac or bag near the root is pressed upon, and its irritating contents squeezed out into the wound. After the fluid is injected, the wasp has the power of contracting the barbed points, and then it withdraws the sting from its victim. In fig. 258 the sting of the wasp is shown, with

its attachments and muscular arrangement; and it will be seen that the sting is most wonderfully adapted to



Fig. 258.

1, Sting of Wasp. 2, Sting of Bee. (The small circles show each nearly the full size)

become an instrument of a very effective and dangerous character. The brushes near it are placed there for the purpose of cleaning or wiping it; at all events, this appears to be one of the uses they are put to.

The proboscis or trunk of the Honey-bee next demands attention; this it uses, with its accessories, to collect the honey for its food while roving about from flower to flower. The proboscis itself (fig. 259) is very curiously divided; the divisions are elegant and regular, beset with triangular hairs, which being numerous, appear at first sight as a number of different articulations. The two outside lancets are spear-shaped, of a membranaceous or horny substance, set on one side with short hairs, and having their interior hollow; at the base of each is a hinge-articulation, which permits of considerable motion in several directions, and is evidently used by the busy insect for the purpose of opening the internal parts of flowers, and thus facilitating the introduction of its proboscis. The two shorter feelers are closely connected to the proboscis, and terminate in three jointed articulations. Swammerdam thought these were used as fingers in assisting the removal of obstructions; but it is more probable that they are made use of by the insect for storing, removing the bee-bread to and from the pocket-receptacles in the legs. The lower part of the proboscis is so formed that it may be considerably enlarged at its base, and thus made to contain a larger quantity of the collected juice of flowers, at the same time, it is in this cavity that the nectar is transformed into pure honey by some peculiar chemical process. The proboscis tapers off to a little nipple-like extremity, and at its base will be seen two shorter and stronger mandibles, which serve the little insects in the construction of their cells, and from between which is protruded a long and narrow tongue or lance; the whole is most ingeniously connected to the head by a horny material, and a series of muscles and ligaments. The proboscis, being cylindrical, extracts the juice of the flower in a somewhat similar way to that of the butterfly; when it is loaded with honey, its next care is to fill the very ingenious pockets situated in its hind-legs (one of which is shown at No. 2) with bee-bread; when these little pockets are filled with as much pollen as the bee can conveniently carry, it flies back to the hive with its valuable load, where it is speedily assisted to unload by its fellow-workers;

the pollen is at once kneaded and packed closely in the cells provided for its preservation. The quantity of this collected in one day by a single hive during favourable

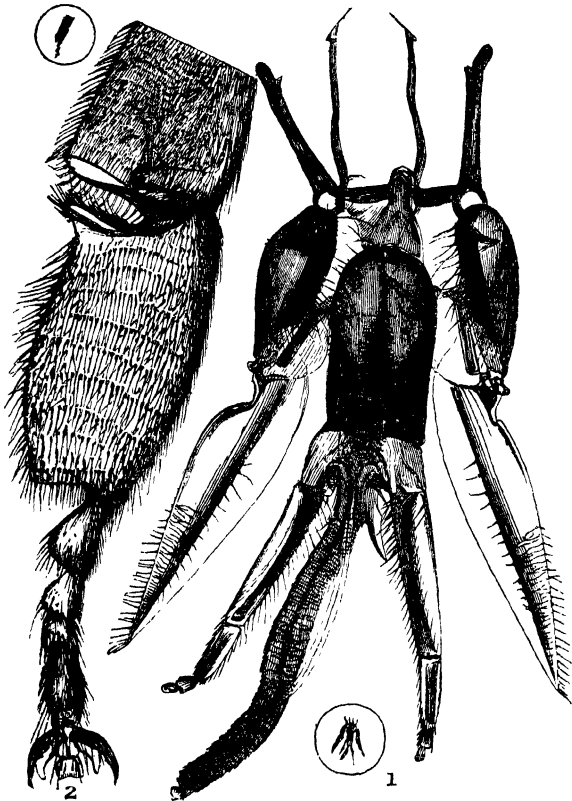

Fig. 259.

1, Honey-bee's tongue. 2, Leg, showing pocket for carrying the Bee-bread. (The small circles show the objects about the natural size.)

weather is said to be at least a pound; this chiefly constitutes the food of the working-bees in the hive. The

wax is another secretion exuding through the skin of the insect, it is found in little pouches in the under-part of the body; but is not collected and brought home ready for use, as has been generally supposed. The waxen walls of the cells are, when completed, strengthened by a varnish, called *propolis*, collected from the buds of the poplar and other trees, and besmeared over by the aid of the wonderful apparatus represented in the engraving. If a bee is attentively observed as it settles down upon a flower, the activity and promptitude with which it uses the whole apparatus is truly surprising; it lengthens the tongue, applies it to the bottom of the petals, then shortens it, bending and turning it in all possible directions, for the purpose of exploring the interior, and removing the whole of the pollen. In the words of Brook :

“ The dainty suckle and the fragrant thyme,  
 By chemical reduction they sublime ;  
 Their sweets with bland attempering suction strain,  
 And curious through their neat alembics drain ;  
 Imbib'd recluse, the pure secretions glide,  
 And vital warmth concocts th' ambrosial tide.”

The leading characteristic of the vast order *Coleoptera*, Beetles, consists in the leathery or horny texture of the anterior wings (*elytra*), which serve as sheaths for the posterior wings in repose, and generally meet in a straight line down the back.

The common Black-beetle (*Blatta orientalis*, fig. 260), strictly speaking, is not of the Beetle family, but very nearly allied to the Cricket and Grasshopper genus. All the insects belonging to this class are very destructive, as they continue to eat through all their transformations. The female Black-beetle does not lay her eggs singly, but always sixteen at a time, and these eggs she encloses in a capsule, which resembles a small oblong box (see upper part of cut). The mother carries this capsule about with her, until the sides of it have attained a proper firmness, and the colour changes from white to brown. If this receptacle for the eggs is more closely examined, it will be seen that one of the two longer margins is very finely serrated, being composed of two layers, so constructed that the teeth of one easily fit into the spaces between the teeth of the other. This margin is also so firmly united

by means of a gummy substance, that it might be easier opened at any other part than at this toothed edge. As

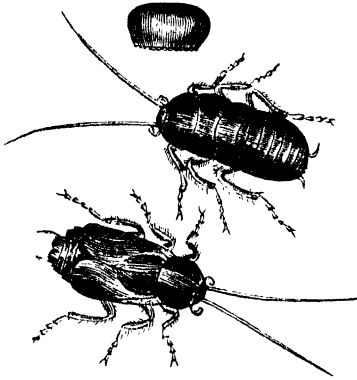

Fig. 260.—Male and Female *Blatta Orientalis*.

soon as the young are hatched, and have quitted the egg, they emit a fluid from their mouths, by which is softened the cement that united the two layers of the capsule together, and thus contrive to open the door of their prison-house.

*Melolontha vulgaris*, Cockchafer, being very abundant in our island, it has received a variety of

names in different parts of the country; as the brown tree-beetle, blind-beetle, May-bug, chaffer, May-bob, or oak-web, jack-horner, jeffry-cock, and acre-bob. Its larva is soft and grey, with the head and legs protected by a horny covering of a yellow-brown colour. While in the larva state, which continues for a space of two or three



Fig. 261.—*Melolontha Vulgaris*, Cockchafer.

years, it devours the roots of corn, grass, and other vegetables.

Their eggs are laid in small detached heaps, beneath the surface of some clod; and the young, when first hatched, are scarcely more than one-eighth of an inch in length,

gradually increasing, and at intervals changing their skins, until they are of the size of two inches or more. At this time they descend into the earth to the depth of two feet, there to construct an oval cell, smooth inside; and here after a certain time, they divest themselves of their last skin, and appear in the chrysalis form, in which they continue till the succeeding spring, when they change into the perfect beetle; for a considerable time they remain in a weak state, not venturing out until the warm days of May or June; about this time the beetle emerges from its retirement, and commences its depredations on the leaves of plants and trees. Their antennæ have a remarkable comb-shaped appearance, and generally find a place in the microscopist's cabinet.

The elytra or wing-cases of diamond beetles are amongst the most brilliant of opaque objects. Some are improved by being mounted in Canada balsam, whilst others are more or less injured by it: a trial of a small portion, by first touching it with turpentine, decides this point.

To the genus *Ptinus* belongs a small beetle, known as the Death-watch, fig. 262. This and the species *Anobium* are found in our houses, doing much injury whilst in the larva state. The eggs are often deposited near some crack in a piece of furniture, or on the binding of an old book. As the larvæ are hatched, they begin to eat their way into any furniture on which they may have been deposited; and having attained a sufficient depth, they undergo transformations, and return, by other passages, as perfect beetles. In furniture attacked by them, small round holes, about the size of the head of a pin, may be seen, and to these holes the term *worm-eaten* has been applied; and the noise, made by the insect striking its head against the wood, has given rise to the name of Death-watch. The larva is called a Book-worm when it attacks books; old books and those seldom used, are often found bored through by it. Kirby and Spence mention, that in one case twenty-seven folio volumes were eaten through, in a



FIG. 262.  
The Death-watch,  
*Atropus*, magnified.



straight line, by this insect. The beetle is very small, and almost black. The head is particularly small; and from the prominence of the thorax, looks as if it were covered with a hood. The *Anobium puniceum*, fig. 263, attacks dried objects of natural history, and all kinds of bread and biscuits, particularly sailors' biscuits, in which maggots frequently abound. In collections of insects, it first consumes the interior; when the larva assails birds, it is generally the feet that it devours first; and in plants, the stem or woody part. The larva, a small white maggot the body of which is wrinkled, and consists of several segments covered with fine hairs; its jaws are strong and horny, and of a dark brown. The body is white, and so transparent, that every part of the perfect insect can be seen through it. The beetle itself is of a reddish-brown colour, covered with fine hairs.



Fig. 263.—*Anobium puniceum*, magnified.

The Bacon-beetle (*Dermestes lardarius*) is another of this destructive beetle family. The larva of this beetle is particularly partial to the skin of any animal that may fall in its way; consequently it destroys stuffed animals and birds in collections of natural history, whenever it can gain access to them. It attacks hams and bacon for the skin's sake; and being a very glutton, extends its ravages to the flesh. This larva is long and slender, its body nearly round, and is divided into thirteen segments, of a blackish-brown in the middle, and white at the edge; the whole being furnished with bristle-shaped reddish-brown hairs.

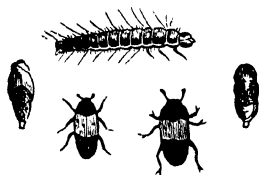

Fig. 264.—*Dermestes lardarius*.  
Larva, pupa, and imago.

The beetle is black about the head and tail, with an ash-grey band across the back, having three black spots on each wing-case. Sometimes this band takes a yellowish tinge, and then the hairs, which are here disposed in tufts, are likewise of a yellowish-grey colour. The beetle is

most destructive in spring. The larvæ are but seldom seen, being careful to conceal themselves in the bodies they attack, and their presence can only be guessed at by finding occasionally their cast-off skins, which they change several times during their larvæ state. Whenever, therefore, little rolls of black skins are found near where ham or bacon is kept, or in cases containing objects of natural history, it is more than probable this beetle has there taken up its abode. The small scales covering many species of *Dermestes*, as well as hairs, are beautiful microscopic objects, and may be mounted in the dry state.

In the *Gyrinus*, Whirligig, we have a combination of contrivances to facilitate the creature's movements in the element it lives in. The hind legs are converted into a pair of oars of remarkable efficiency, the point of their connection with the body being adapted with great precision to ensure the most effectual application of the propelling power; as it strikes out behind in the act of swimming, a membranous expansion of a portion of the legs enables the insect to move about with great rapidity; upon the legs being drawn back again towards the body, the membrane closes up, and thus offers but a small resistance to the water (fig. 265). If the insect wishes to remain below the surface of the water, he employs the small hooks placed at the extremity of the feet for the purpose of holding on to the roots or stems of aquatic plants. The eyes are not the least curious part of the merry little creature; the upper portions of them, being fitted for seeing in the air, are fixed on the upper part of the head, while the lower portion, fitted for seeing in water, are placed at the lowest part, a thin division separating the two.

*Hemiptera*, or *Heteroptera*, Bugs, form two principal groups, distinguished by their structure and habits,—the *Hydrocores*, Water-bugs, and the *Geocores*, Land-bugs. The latter never possess wings: the disagreeable Bed-bug (*Cimex lectularius*) is the typical form of this group. The former are recognisable by the small size of their antennæ, which are divided into three or four short joints, and are concealed beneath the eyes. Of these, the *Notonectida* are distinguished by their broad, rounded head, which occu-

pies the whole width and front of the body. They swim rapidly in the water, with their bellies always directed upwards, rowing themselves along by means of flattened hind legs, which are thrown out on each side very much like oars. Hence the *Notonecta* is generally known as the Boat-fly. It carries the air required for its respiration in a space left for this purpose between the wings and the back, and is a very active and predaceous animal; when captured some are able to inflict painful wounds with their powerful rostrums. Several species may be met with in almost every piece of water. In the second group, the *Nepina*, the head is small, triangular, and generally much narrower than the thorax. Their legs are less distinctly formed for swimming than in the preceding group; but the anterior pair are converted into powerful raptorial organs.

*Nepa cinerea* is a British example of this group, met with in every pond; they respire by means of filaments placed near the caudal extremity, which are so arranged as to be always nearest the surface of the water; the only available stigmata being situated at the base of these filaments.

*Dytiscus*, the principal genus of this tribe, is common in fresh and still waters. Its larva feed upon other aquatic larvæ, such as the Gnat, Dragon-fly, &c. The suckers on the legs, the feet, &c., are most interesting objects.

To the *Orthoptera* belong *Locustina*, *Gryllina*, and *Achetina*, all herbivorous insects. The first is represented by our well-known Grasshopper (*Gryllus viridissimus*), the second, the *Gryllina*, appear to frequent trees and shrubs more than the other tribes, the members of which generally keep among herbage; and, in accordance with this habit, many of the exotic species have wing-cases, which present the most perfect resemblance to leaves both in colour and veination. Of the *Achetina*, the common Cricket (*Acheta domestica*), fig. 266, the noisy little denizen of the kitchen-hearth, is the best example. These insects have the antennæ slender and tapering, and often considerably longer than the body. They agree with the *Gryllina* in the structure of their singing apparatus; but the wings, instead of being arranged in the form of a high pitched

roof, are laid flat upon the back. Some of them possess ocelli, whilst others are destitute of those organs. The

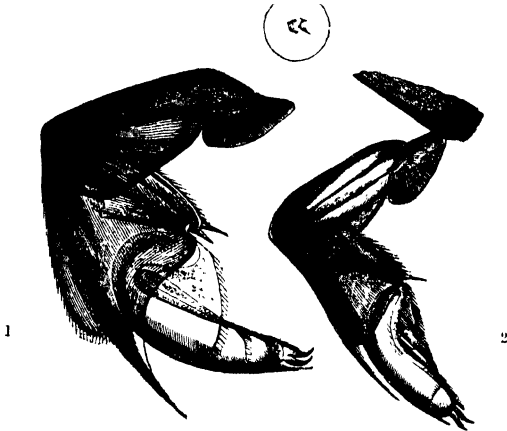

Fig. 265.

1, Leg of *Gyrinus*, Whirligig, with paddle expanded. 2, With paddle closed up.

wings are very long, and folded up in such a manner as to project beyond the wing-cases in the form of a pair of tapering tails; the abdomen is also furnished, in both sexes, with a pair of pilose, bristle-shaped, caudal appendages; in the female these form a long slender ovipositor, the two filaments being placed side by side, and somewhat thickened at the tip. The tarsi are three-jointed. The horny covering and muscular apparatus under the wing-cases of the Cricket are very curious and will repay for a careful examination. The Cricket has



Fig. 266.—*The Cricket*.

two wings, covered by elytra or wing-cases of a dry membranous consistency, near the base of which is a horny ridge having transverse furrows, exactly resembling a rasp or file; this it rubs against its body with a very brisk

motion, and produces the well known merry chirp; the intensity of which is increased by a hollow space, called the tympanum, acting as a sounding-board. It must be stated, however, that various other explanations of the origin of the stridulating noise produced by these insects have been given.

In *Thysanura* there is a remarkable diversity of structure; they undergo no metamorphosis, and have no wings. This order contains two families, *Poduridæ*, Spring-tails, and *Lepismenæ*. In the former, the caudal appendage has the form of a forked tail (*Podura*, fig. 267), which is bent under the body when not in use, by its sudden extension the insect causes itself to spring to a



Fig. 267.—*Podura plumbea*. (The small circle encloses the insect of life-size.)

very great distance, in comparison with its size. The body is covered with numerous minute scales, mostly of a beautiful silvery or pearly lustre, and curiously striated. Some of the genus are found jumping about on the surface of the water, whilst others are met with in profusion upon snow and ice.

*Podura plumbea*, Lead-colour Springtail, are generally found in wine-cellars, amongst the sawdust, leaping about like fleas, and are very difficult to take. The following is generally the plan resorted to: sprinkle a little oatmeal on a piece of black paper, near their haunts; after a few hours, remove it carefully to a large glazed basin, so that when they leap from the paper, as they will when brought to the light, they may fall into the basin, and thus become separated from the meal. The best way of separating the very fine scales from their bodies has been previously explained (see page 58), the markings on which cannot be seen with a lower power than a quarter-inch object-glass. Under a power of 500 diameters, the surface appears to be covered with extremely delicate longitudinal and wavy lines. The smaller scales are much more difficult to resolve than the larger, and these form a good test of the defining power of a 1-8th or 1-12th object-glass. No. 8, Fig. 249, is a portion of a large scale. In Fig. 248,

No. 5, the longitudinal markings are shown under a lower power.

The *Lepisma* have a spindle-shaped body, usually covered with silvery scales, and furnished along the sides of the abdomen with a series of appendages or false feet, besides several long-jointed bristle-like organs at the extremity. The head is concealed under a pro-thorax; the eyes are usually compound, and frequently occupy the whole of the head. The antennæ are very long, and composed of numerous joints; the maxillary palpi, which consist of from five to seven joints, are very conspicuous. These insects generally inhabit moist places. The most common species, *Lepisma saccharina*, is frequently found about houses, especially in sash-frames, or in old sugar-casks; from the latter it derives its name. The scales from these little insects (Fig. 249, No. 8) have ever been favourite objects with microscopists, and generally used for testing the power of *penetration* and *definition* of the instrument itself.

The metamorphosis is complete in the *Suctoria*, or *Siphonaptera*, a wingless family—the larva, pupa, and imago of which are very distinct in their appearances—the well-known Flea is the best example of this small group. By many authors these insects have been arranged with the *Diptera*; this would appear to be incorrect, as they differ in many particulars. The external covering of the Flea (fig. 268) is a horny case, divided into distinct segments; those upon the thorax being always disunited. Although apterous, the Flea has the rudiments of four wings, in the form of horny plates on both sides of the thoracic segments. Its mouth consists of a pair of sword-shaped mandibles, finely-serrated; these, with a sharp, needle-like organ, constitute the formidable weapons with which it pierces the skin of its victim.

The neck is long, the body covered over with scales, the edges of which are set with short spikes or hairs; from its head project a pair of antennæ, feelers or horns, a proboscis, which forms a sheath to the pair of lance-shaped weapons. On each side of the head a large compound eye is placed. It has six many-jointed powerful legs, terminating in two hooked claws; the pair of long hind

legs are kept folded up when the insect is at rest, which in the act of jumping it suddenly straightens out, and in

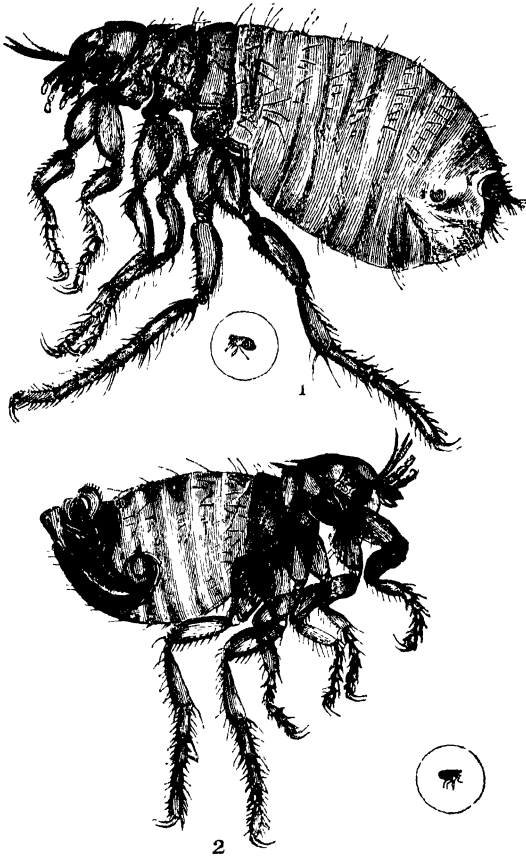

Fig. 268.

1, Female Flea. 2, Male Flea. (The small circles enclose them the natural size.)

so doing exerts its whole strength at the same moment.

The female Flea, fig. 268, lays a great number of eggs, sticking them together with a glutinous matter; the Flea infesting the dog, or cat, glues its eggs fast to the roots of the hairs; in four days' time the eggs are hatched, and a small white worm or grub is seen crawling about, and feeding most actively. No. 4, fig. 221, is a magnified view of one, covered with short hairs, doubtless for the purpose of preventing its dislodgment. After remaining in this state about nine or ten days, it assumes the pupa form, which it retains four days; and in nine days more it becomes a perfect Flea. The head of the Flea found in the cat (No. 3, fig. 221) is seen to be somewhat different in form from that of the Flea infesting the human being. Its jaws are furnished with formidable hooklets, and from the first and second joints behind the head short strong spines project; these are for assisting it in maintaining a firmer and better hold on the animal.

We have before referred to Swammerdam's careful dissections under the microscope. In no department of nature did he bestow so much care, as in this of the insect tribes. He first killed them by immersion in spirits of wine and water, or in spirits of turpentine; preserving them for some time in the same fluid, to give firmness, and render dissection more easy.<sup>1</sup> When he had divided the insect transversely with fine scissors, he particularly noted the relative position of the various parts, and then proceeded to remove the viscera very cautiously with fine-pointed instruments, carefully washing away all the fat and other matters with soft camels'-hair pencils; by putting the whole into water, and then shaking them gently, he separated the air-vessels, or tracheæ, in a perfect state from the other parts. At other times, he made use of a very fine syringe, to inject water into and thoroughly cleanse them; after which they were distended by blowing in air, and hung up to dry. Sometimes he succeeded better by first immersing the insects in liquid balsam; again, he frequently made punctures with a fine needle, and after squeezing out the soft parts through the holes made in this manner, he blew air into their interiors by means of a very slender glass tube, then having dried them in the shade, anointed them with oil of spike, in

(1) The vapour of cyanide of potassium, in a close-stopped wide-mouthed bottle, kills all insects without injury to their appearance in any way.



which a little resin had been dissolved previously : prepared in this way, they retain their forms and keep well for years. Swammerdam discovered that the fatty material in insects is perfectly soluble in spirit of turpentine ; after steeping in it, he washed them well out with water, and was thus enabled to show the viscera plainly. He frequently spent whole days in cleansing a single caterpillar, in order to trace the structure of its heart. His singular mode of stripping off the skin of the caterpillar, just as it is on the point of spinning its cone, was effected by taking hold of its thread, and letting it drop into scalding water, then suddenly withdrawing it. After this it was immersed in distilled vinegar and spirits of wine mixed in equal proportions, which gives firmness to the whole, and the exuvia or skin readily separates : the pupa is sometimes seen enclosed, and the butterfly in the pupa.

The following list comprises a few of the insects, whose eyes, antennæ, &c., are best adapted for microscopic preparations : Coleoptera—*Cincindela*, *Dyticus*, *Melolontha*, *Lucanus*, Stag-beetle, Diamond-beetle ; Orthoptera—*Acheta*, Crickets, *Locusta*, &c. ; Hemiptera—*Notonecta*, Boat-fly ; Neuroptera—*Libellula*, *Agrion* ; Hymenoptera—*Vespidæ*, *Apidæ*, Wasps and Bees of all kinds ; Lepidoptera—*Vanessa*, and all the various species of Butterflies, Sphynx, or Privet Hawk-moth, Bombyx, Silkworm-moth, &c. ; Diptera—*Tabanus*, Gadfly, *Eristalis*, Drone-fly, *Tipula*, Crane-fly, *Musca*, House-fly, &c.

The circulation of the blood can be watched in many of the larvæ of insects ; that in the larva of the *Ephemera marginata*, Day-fly, is very interesting, being a series of small currents diverging from the gill-like appendages placed near the head. In the larva of the Gnat, the body is almost entirely occupied by the visceral cavity ; and the blood is seen to move backwards and forwards in the space that surrounds the alimentary canal, which here serves the purpose of the channels usually running through the solid tissues. This condition very nearly approximates to that found in many *Annelida*.

In the wings of pupæ of many insects, the circulation may be seen ; in that of the *Agrion puella*, a Dragon-fly, each of the "nerves" of the wings present.

tracheæ, or air-tubes, which branch off from the larger system in the body. The common Fly, if caught when only a few hours old, shows this equally well.

The breathing apparatus of insects affords many interesting objects for the microscopic cabinet.

Mr. Quekett recommends the following as a simple method of obtaining a perfect system of tracheal tubes from larvæ:—A small opening having been made in the body, it is to be placed in strong acetic acid, which softens or decomposes all the viscera: the trachea may then be well washed with a syringe, and removed from the body, by cutting away the connexions of the main trunks with the spiracles, by means of fine-pointed scissors. In order to mount them, they should be floated on to the glass-slide, and laid out in the position best adapted for displaying them. If they are to be mounted in Canada balsam, they should be allowed to dry upon the slide, and should then be treated in the usual way; but their natural appearance is best preserved by mounting in weak spirit and water, or Goadby's solution, using a shallow cell, to prevent pressure. The spiracles are easily dissected out with a fine knife and pair of scissors: they should be mounted in fluid, when their texture is soft, and in balsam, when the integument is hard and horny.<sup>1</sup>

Another way of preparing insects, is to press them as much as possible between two glass slides, without crushing, and to fasten the slides together with india-rubber bands or a fine string, so that the parts may dry in the compressed state. When subsequently soaked in oil of turpentine, and mounted in Canada balsam, they become much more transparent and distinct. By prolonged maceration in the turpentine, the whole of the pigment may be removed, the structure is then seen more distinctly. When the organs are very hard and thick, they may be first softened in boiling water, or a solution of potash, before being pressed.

#### TRANSFORMATION OF INSECTS.

The metamorphoses of the insect race offer some of the most curious and wonderful of nature's phenomena for them by R. *Mémoire sur les Objets qui peuvent être conservés en Préparations Micro-* Paris, 1856, which contains a complete list of all objects of interest.

(1) The bottle, k.

contemplation. "We see," says an old author, "some of these creatures crawl for a time as helpless worms upon the earth, like ourselves; they then retire into a covering, which answers the end of a coffin or a sepulchre, wherein they are invisibly transformed, and come forth in glorious array, with wings and painted plumes, more like the inhabitants of the heavens than such worms as they were in their former state. This transformation is so striking and pleasant an emblem of the present, intermediate, and glorified state of man, that people of the most remote antiquity, when they buried their dead, embalmed and enclosed them in an artificial covering, so figured and painted as to resemble the caterpillar in the intermediate state; and as Joseph was the first we read of that was embalmed in Egypt, where this custom prevailed, it was probably of Hebrew origin."

Faint and imperfect symbol though it be, yet it may, perchance, offer a glimpse of the metamorphosis awaiting our own frail bodies. Between the highest and lowest degree of corporeal and spiritual perfection, that there are many intermediate degrees, the result of which is one universal chain of being, no one can for a moment gainsay. Thus the angel Raphael is made to say, in Milton's *Paradise Lost*,—

———"What surmounts the reach  
Of human sense, I shall delineate so,  
By likening spiritual to corporeal forms,  
As may express them best: though *what if earth*  
*Be but the shadow of heaven, and things therein*  
*Each to other like, more than on earth is thought!*"

The great class of insects, which furnishes four-fifths of the existing species of the animal kingdom, has two chief divisions. In the one, the *Ametabola*, we have an imperfect, in the other, the *Metabola*, a perfect metamorphosis; that is, in the former there is no quiescent pupa state, and the metamorphosis is accompanied by no striking change of form; in the latter, there is an inactive pupa that takes no nourishment, and so great a change of form, that only by watching the progress of the metamorphosis can we recognise the pupa and the imago as belonging to the same animal.

The degree of metamorphosis is, however, very different

in different groups of insects. In its most *complete* form, as exemplified in the Butterflies, Moths, Beetles, and many other insects, the metamorphosis takes place in three very distinct stages. In the first, which is called the *larva* state, the insect has the form of a grub, sometimes furnished with feet, sometimes destitute of those organs. Different forms of insects in this state are popularly known as Caterpillars, Grubs, and Maggots. During this period of its existence, the whole business of the insect is eating, which it usually does most voraciously, changing its skin repeatedly, to allow for the rapid increase in its bulk ; and after remaining in this form for a certain time, which varies greatly in different species, it passes to the second period of its existence, in which it is denominated a *pupa*. In this condition the insect is perfectly quiescent, neither eating nor moving. It is sometimes completely enclosed in a horny case, in which the position of the limbs of the future insect is indicated by ridges and prominences ; sometimes covered with a case of a softer consistence, which fits closely round the limbs, as well as the body, thus leaving the former a certain amount of freedom. *Pupæ* of this description are sometimes enclosed within the dried larva skin, which thus forms a horny case for the protection of its tender and helpless inmate. After lying in this manner, with scarcely a sign of life, for a longer or shorter period, the insect, arrived at maturity, bursts from its prison in the full enjoyment of all its faculties. It is then said to be in the *imago* or perfect state. This metamorphosis is one of the most remarkable phenomena in the history of insects, and was long regarded as perhaps the most marvellous thing in nature ; although recent researches have shown that the history of many of the lower animals presents us with circumstances equally if not more wonderful, nevertheless the metamorphosis of the higher insects is a phenomenon which cannot fail to arrest our attention. To see the same animal appearing first as a soft worm-like creature, crawling slowly along, and devouring everything that comes in its way, and then, after an intermediate period of death-like repose, emerging from its quiescent state, furnished with wings, adorned with brilliant colours, and confined in its choice of food to the

most delicate fluids of the vegetable kingdom, is a spectacle that must be regarded with the highest interest; especially when we remember that these dissimilar creatures are all composed of the same elements, and that the principal organs of the adult animal were in a manner shadowed out in all its previous stages.

Nor is the singularity of their natural history the only claim that these insects have upon our attention. Lowly as they seem in point of organisation, there are few animals that exceed them in commercial importance. To give an instance or two; the finest red dyes known to our manufacturers, are derived from insects. The *Lecanium ilicis*, an inhabitant of the *Ilex*, Evergreen-oak, growing in countries near the Mediterranean, was employed for this purpose by the ancient Greeks and Romans, as it is still by the Arabs; and, until the introduction of the Mexican cochineal, another species, the *Coccus polonicus*, living on the roots of the *Scleranthus perennis* in Central Europe, was much used for the same purpose. The Mexican cochineal, which has driven all other kinds out of the field, is the species *Coccinia*, represented in fig. 251; this was long regarded as a parasite upon the *Cactus opuntia*, Prickly-pear—a plant common in Central America. The commercial importance of this insect is shown by a single fact: in 1850, no less than 2,514,512 lbs. of cochineal were imported into Great Britain alone (value about 7s. per lb.); and as about 70,000 insects are required to weigh a pound, we may form some idea of the almost countless numbers annually destroyed. For many years the cultivation, or rather feeding, of cochineal was entirely confined to Mexico; but the insect has lately been introduced into Spain, and the French possessions in Africa, with every prospect of success. A fourth species, of great importance, is the Lac insect, *Coccus lacca*, an inhabitant of the East Indies, where it feeds upon the Banian-tree, *Ficus religiosa*, and other trees. It is to this insect we are indebted, not only for the dye-stuffs known as *lac-dye* and *lac-lake*, of which upwards of 18,000 cwts. were imported in 1850, but also for the well-known substance called *shell-lac*, so much used in the preparation of sealing-wax and varnishes. It is somewhat remark-

able that only the female insects yield a good colouring matter.

Of all the secretions peculiar to insects, *silk* may well be regarded as the most valuable, since it has become as much an essential to the purposes of mankind as to the economy of its producers. The fluid, before it comes in contact with the air, is viscous and transparent in the young larva, but thick and opaque in the more mature. It is found, by chemical analysis, to be chiefly composed of Bombic acid, a gummy matter, a portion of a substance resembling wax, and a little colouring-matter. Silk may be placed in boiling water without undergoing any change; the strongest acids are required to dissolve it; and it has never yet been imitated artificially. More than 500,000 of human beings derive their sole support from the culture and manufacture of silk; and upwards of 200,000*l.* sterling may be said to be circulated annually by the Silkworm. Then we have large sums of money changing hands from the labours of the useful little Bee; tons' weight of honey and wax are yearly consumed; England pays more than 50,000*l.* for foreign honey and wax, in addition to her own valuable produce. A great variety of *scents*, which from their agreeable odours are much used in perfumery, are manufactured from insects. The Spanish Fly is an indispensable article in the treatment of certain forms of disease; and that invaluable agent, Chloroform, was first made from formic acid; an acid discovered in the *Formic ant*, and from which it has derived its name. Then there are Gall-nuts, produced by a small fly, for which a substitute could not be found in dyeing and ink-making.

“ Much more extensive and important than any of the foregoing, but, as less palpable, even more disregarded, are the general uses of insect existence. Disease, engendered of corruption in substances animal and vegetable, would defy all the precautions of man, unless these were aided by scavenger-insects, those myriads of flies and carrion beetles, whose perpetual labours, even in our tempered climate—but infinitely more so in warmer regions—are essentially important to cleanliness and health.

“ A use of this nature, and one performed perhaps to an extent we little think of, is the purification of standing

waters by the innumerable insects which usually inhabit them. We have witnessed ample proof of the efficacy in this respect of Gnat larvæ, when keeping them to observe their transformations. Water swarming with these 'lives of buoyancy,' has been perfectly sweet at the end of ten days; while that from the same pond, containing only vegetable matter, has become speedily offensive.

"We have already pointed out the utility of insects in affording ever-new subjects of interesting inquiry. And let those who will look scorn upon our pursuit; but few are more adapted to improve the mind. In its minute details, it is well calculated to give habits of observation and of accurate perception; while, as a whole, the study of this department of nature, so intimately linked with others above and below it, has no common tendency to lift our thoughts to the great Creative Source of Being, to Him who has not designed the minutest part of the minutest object without reference to some use connected with the whole."

"The shapely limb and lubricated joint  
Within the small dimensions of a point  
Muscle and nerve miraculously spun,  
His mighty work, who speaks, and it is done;  
The invisible in things scarce seen revealed,  
To whom an atom is an ample field."

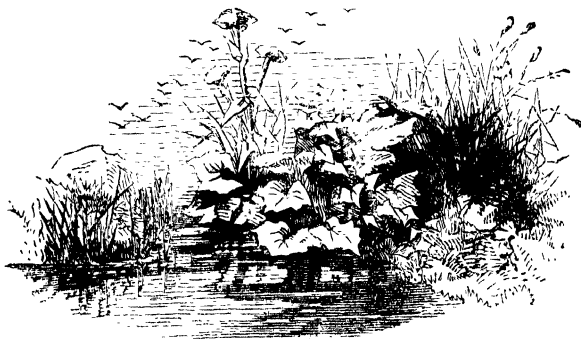

## CHAPTER V.

### VERTEBRATA.—ANIMAL STRUCTURE.

PHYSIOLOGY—HISTOLOGY—CELL THEORY—GROWTH OF TISSUES—SPECIAL TISSUES—SKIN, CARTILAGE, TEETH, BONE, ETC.



THE most complicated state in which matter exists, is where, under the influence of life, it forms bodies with a curious internal structure of tubes and cavities, in which fluids are moving and producing incessant internal change," says the philosophic Dr. Arnott. These are called *organised bodies*, because of the various *organs* which they contain, and they form two remarkable classes; the individuals of the lowest class are fixed to the soil, and are recognised as *vegetables*,—the structure of these we have already considered; the individuals of the higher order are endowed with power of locomotion, and are called *animals*: it is some of the peculiarities and minute structure of the latter that we are now about to examine. The phenomena of growth, decay, death, sensation, self-motion, and many others, belong to animal life; but, from occurring all in material structures, which subsist in obedience to the laws of physics and chemistry, life is truly a superstructure on these two, and cannot be studied independently of them. Indeed, the greater part of the phenomena of life are chemical and physical phenomena, modified by an important additional principle. The phenomena of life, from thus involving generally the agency of all the



sets of laws, are by far the most complex of any; and the discovery or detection of the peculiar *laws of life*, although fixed as the laws of chemistry or physics, has been very slow, and is as yet far from being completed.

The study of the Science of Life, or the building up of the living structure, is termed *Physiology*, or *Biology*;<sup>1</sup> and that part of it more particularly relating to the minute structure of the organs of animals has been termed *Histology*.<sup>2</sup>

Physiology has for its object the scientific ordination of the phenomena and laws of life; yet, writes Mr. Lewes, "the attempts to define what we are to understand by Life, have hitherto proved almost if not quite valueless. We must be content for the present, at least, to remain in ignorance of what Life is; and in doing this, accept it as an ultimate fact, to be studied in its manifold forms. We are utterly ignorant of the nature of Gravitation: but we have learned to appreciate some of the laws of its operation. We know nothing of chemical force; but we are daily registering the facts of combination. Let us, then, cease to vex with noisy questions the imperturbable reserve of Nature, and be content to watch the processes with reverent patience. Instead of trying to discover the mystery of Life, let us try to understand the various phenomena of Life, and learn with Coleridge to see, 'Life everywhere and nowhere death.'"

In our previous investigations, we must have seen the value and advantage of "studying Life in its simpler forms, if Life is to be understood in its more complex forms; and no sooner do we apprehend the fact that the lower animals present all the more important phenomena of Life under simpler forms and conditions, than we at once recognise the study as indispensable. Nevertheless, such a conception is of quite recent date. Comparative anatomy has been more or less studied from the days of Aristotle downwards: but it has been studied either from mere curiosity, or because human anatomy being interdicted, the anatomy of the lower animals was the only

(1) From *βίος*, *life*, and *λόγος*, *discourse*—a discourse on life; a more expressive term than *physiology*.

(2) From *ἵστος* a *tissue* or *web*, and *λόγος* a *discourse*.

available source of instruction. Not until quite recently has comparative anatomy been studied, with the philosophic purpose of gathering answers to the more difficult problems of Biology. Hunter was ridiculed by his professional brethren; and some of the sons of those laughers are amongst the most studious of his followers. Men like Swammerdam, Burnett, Lyonnet, Trembley, and Spallanzani, devoted patient days to the minute labour of investigating the structure and functions of insects and polypes; but even these great workers were moved by curiosity rather than by biological philosophy. The marvels of organisation fascinated them. They saw in these marvels new and surprising proofs of creative wisdom, and were content with such discoveries. Swammerdam, indeed, declares, 'that the organisation of these inferior creatures is more wonderful than that of man,'—an exaggeration natural and excusable in one who had given his life to the dissection of what in those days of imperfect classification were called 'insects.' Ray, Paley, and other natural theologians, have also sought for arguments in these marvels. But in none of these writers is there a glimmering of the conception now familiar to every student of Biology, viz. that in these simpler forms we must seek the materials for a true elucidation of vital phenomena."

In organised beings, the way in which nature works out her most secret processes is by far too minute for observation by unassisted vision; even with the aid of the improved microscope, only a small portion has, up to this time, been revealed to us. To point out in detail the discoveries made through the employment of this instrument, as regards physiology, would be to give a history of modern biological science; for there is no department in this study which is not more or less grounded upon the facts and teachings of the microscope.

To the casual observer, the brain and nerves appear to be composed of fibres. The microscope, however, reveals to us, as was first pointed out by Ehrenberg, that these supposed fibres do not exist, or rather, that they all consist of numerous tubes, the walls of which are distinct, and contain a fluid which may be seen to flow from their broken extremities on pressure. In looking at a muscle, it appears

to be made up of fine longitudinal fibres only. The microscope tells us that each of these supposed fine fibres is composed of numerous smaller ones, and that these are crossed by lines which have received the name of transverse striæ; that muscular contraction, the cause of motion in animals, is produced by the relaxation or approximation of these transverse striæ.

The microscope has shown us that a distinct network of vessels lies between the arteries and veins, partaking of the properties of neither, and possessed of others peculiar to themselves. These have been denominated *intermediary* vessels by Berres, and serve to connect the arterial with the venous system.

On regarding with the naked eye the different glands in which the secretions are formed, how complex they appear, how various in conformation! The microscope teaches us that they are all formed on one type; that the ultimate element of every gland is a simple sacculated membrane, to which the blood-vessels have access; and that all glands are formed from the greater or less number, or different arrangement only of the primary structure.

Our notions respecting the skin were vague until the microscope discovered its real anatomy, and showed us the existence and relations of the papillæ, of the sudorific organs and their ducts, the inhalent muscular apparatus, and so on. All our knowledge of epidermic structures, such as hair, horn, feather, &c., the real structure of cartilage, bone, tooth, tendon, cellular tissue, and, in a word, of all the solid textures, has been revealed to us by the same agency; so that it may be truly said, that all our real knowledge of structural anatomy, and all our acquaintance with the true composition of every organ in the body, have been arrived at by means of the microscope, and could never have been known without it.

In addition to this, and what is of greater importance, after having studied the healthy structure of the body, most beneficial aid is afforded in the investigation of changes produced by diseases, which were overlooked, or undistinguishable without the assistance of this instrument; it is on this account constantly resorted to by the medical profession for the benefit of their fellow-creatures.

Dr. Andrew Clarke, after having carefully studied the appearances of sputa from patients under his care, says, "that the microscopical inspection of expectoration affords, at a very early period of consumption, definite information, not otherwise attainable, regarding the nature of the malady; and at all times must furnish valuable aid in forming a prognosis regarding the cause of the complaint."

The expectoration generally shows pus cells, lung tissue, blood corpuscles and moleculo-granular material, mixed with, at times, a small amount of fat corpuscles.

The space allotted to this division of our subject enables us to give only a short and imperfect sketch of a few of the fundamental tissues of the animal body. First, enumerating merely the elementary substances recognised by chemistry as entering into the formative processes, we shall proceed to inquire into that most interesting and wonderful starting-point of life, the *cell*; admitted to be, and indeed demonstrable as, the *common centre* alike of animal and vegetable organisms.

#### THE HUMAN BODY, ITS PHYSIOLOGICAL COMPOSITION AND CHARACTER.

The *elementary substances* found in the human body are oxygen, hydrogen, carbon, azote, phosphorus, sulphur, chlorine, fluorine, iron, manganese, titanium, and lime. Silenium is found in the hair, and fluorine in combination with lime forms the enamel of the teeth. Iron is the colouring-matter of the blood, the black pigment of the choroid of the eye, and in the skin.

Manganese is found in the bones, hair, blood; titanium in the salts from the supra-renal capsule. Other substances and gases are found distributed throughout the body.

Azotised and *non-azotised* substances constitute the proximate organic principles. The azotised are, protein and its compounds, albumen, fibrin, casein, and pepsin; extractive matters, gelatine, hæmatine, cholestrine or bile matters, urea, and uric acid. The *non-azotised* are, lactine, or sugar of milk, and fatty matters.

*Cells*.—All animal and vegetable structures, the microscope has revealed to us, are developed from cells; the

materials for building up animal structures are furnished from the yolk and the blood.

The *nucleated cell*, fig. 269, No. 1, is a delicate membrane of a globular form, enclosing a granulous fluid; in the

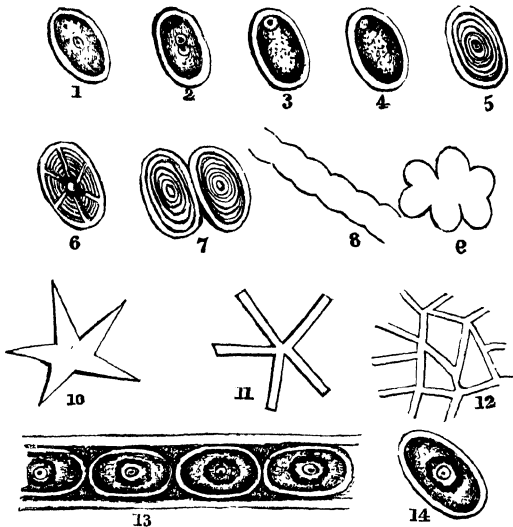

Fig. 269.—Diagram showing the development of Animal Cells.

1, Shows a newly formed cell. 2, Subdivision of the *nucleus*. 3, The *nucleus* changes its situation, and at 4, subdivides and disappears. 5, The walls of the cell increase in thickness. 6, The cell becomes branched, or *stellate*. 7, Two cells are seen to coalesce. 8, They have coalesced and run into each other. 9, Again they take another form and become *multilocular*. 10, 11, 12, Cells sprouting out to form membrane and vessels. 14, Development of complicated cells, which at 13, have coalesced to form tissue.

wall of which is an oval body somewhat darker than the rest—this is the nucleus: there are one or two, seldom more; these enclose central spots, termed the nucleoli. The size of a cell may be 1-300th part of an inch in diameter, some are larger, some smaller; the nucleus may be 1-3000th of an inch in diameter; the nucleolus 1-10,000th of an inch in diameter, more or less.

The wall of a cell is chemically different from the nucleus; if treated with dilute nitric acid, the wall is dissolved, and the nucleus unaffected, so that we can in this manner isolate the nucleus. It is not known whether there exists any chemical difference between the latter and the nucleolus; and it is probable that the nucleolus is a space in the nucleus containing a fluid.

The elementary cell is imbedded in an amorphous matter, which is termed cytoblastema, and is a fluid of greater or less consistence; so that in one case the cell may float, and in the other it may be imbedded. The matter between cells is called intercellular substance. Cells differ in their contents, which implies a difference in their walls, inasmuch as they secrete the interior.

The nucleolus was first discovered by Robert Brown in plants, and its use made out by Schleiden. He discovered that the nucleus was formed before the cell, and the latter was formed around it. After this, cells of different kinds were found in animals, and Schwann collected many instances, showing that animal and vegetable tissues were developed from cells: this was an important generalisation.

The mode of origin of the nucleated cell is this: cytoblastema first exists; in it is developed the nucleus, and around the latter is formed the membrane of the cell from matters drawn from the cytoblastema. The way in which the cell itself is formed is this: around a granule we have a deposit forming a nucleolus, round it again is formed the nucleus; a swelling of this membrane takes place; at length it covers over all like a watch-glass, and thus the exterior cell is formed. (Fig. 269, No. 1.) Coalescence of the granules forms a nucleus, and in the interstices be-

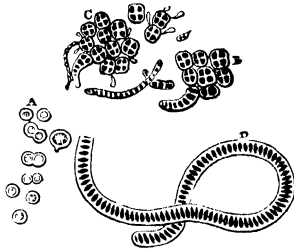

Fig. 270.—Development of *Ulva*.

A, isolated cells resembling those of some *Vertebrata*. B and C, clustering of the same. D, cells in the filamentous stage (confervoid).

tween these we find a fluid which is thought by Henle to form the nucleoli. It has been observed, that a globule of oil placed in contact with a small quantity of albumen drew from it a thin coating, which enveloped the globule of oil; and this albumen became coagulated, forming a cell. When this globule was so surrounded, the coating became wrinkled; but when placed in contact with water it became distended, thus proving it to be capable of endosmosis, or more probably an absorption of water by the wall of the cell, which in consequence became distended or swollen up, as there is no attraction between oil and water. Nevertheless, elementary granules appear to be granules of oil, surrounded by a covering of a protein compound. Milk globules, being composed of oil, surrounded by a covering of casein and dissolved fibrin, have been shown to attract a covering of albumen.

In this way the chyle, for instance, is taken as food into the body. The chyle is composed of protein compounds and fatty matters, which are reduced to a pulp by the digestive process; the protein compounds being converted into albuminous matters. The villi throughout the intestinal canal are permeable to these fluids; the oily particles meeting with a protein compound, are attracted to them, forming a covering, and so an elementary granule is produced. In their subsequent development, cells, if fully formed, never lose their character as cells while they exist; but they may dissolve other cells before they are changed into certain tissues. Cells may receive additional parts, which may remain as such, or form tissues; such are termed complicated cells: nerves and muscular fibre are formed from these. Examples of cells that undergo no further metamorphosis after full development are found in the cells of the epithelium, epidermis, and in the corpuscles of the blood. The elementary constituents of glands are cells, and the fluids are absorbed by them: they are the great agents of absorption and secretion.

*Change of Cells into Tissues.*—This may take place by a joining together or coalescence of cells in a rudimentary state. Cells may meet, and at the point of contact coalesce and run into each other, thus forming a tube; indeed,

in this manner minute tubular structures are formed. Another mode is: cells aggregate into a mass, and at the point of contact run into each other, thus producing a multilocular cavity; see No. 9. Glandular structures are formed in this way. Membrane is formed of a deposit from the cytoblastema; before the cell-membrane is formed, the substance from the cytoblastema coalesces with those particles close at hand, thus forming a delicate film-like membrane. This membrane Professor T. Wharton Jones calls endosmotic, or retentive membrane. We may have the cells coalesce to form a filament or fibre. The nucleus may disappear, or form another structure. Where regeneration of tissue is proceeding, there is found a larger number of granules.

*Multiplication of Cells.*—Cells may be formed in cytoblastema independent of any pre-existing cells; this is cited as an instance of that mysterious agency designated *spontaneous generation*. As an example of independent formation, we may instance the epithelium and epidermoid cells, corpuscles of the blood, and other juices of the body. Cells are formed from cells in three ways. First, there is gemmiparous generation, that is to say, sprouts occur from previous cells and become detached, forming in their turn cells; this is also termed exogenous generation, inasmuch as the process takes place from the exterior. Endogenous generation is the second mode, and by it is meant that one cell is formed within the body, as it were, of the parent cell. The third manner is denominated fissiparous generation, and is where one cell becomes constricted, and eventually, at the point of constriction, divides into two. Of these three kinds or modes of multiplication, one only is found to occur in animals—it is the endogenous. The exogenous is only seen in the lowest plants. Fissiparous generation occurs in vegetables, and has been supposed by some to occur in animals also. The most striking example of endogenous generation that can be adduced, is that which takes place in the ovum of animals or birds. The first part formed of the ovum is the germinal cell, in the centre of the yolk; this approaches the surface, is dissolved, and there is then developed a new cell, which is called the embryo cell, from which is generated a numerous



progeny; the contents of these cells are the cytoblastema to other nucleated cells.

As an instance where cells are not directly derived from cells, but previously-existing cells exert an influence on those to be formed, we may instance a fractured bone, between the ends of which osseous matter is deposited. We infer from this, that the substance of the bone determines, as it were, the formation of other cells, first into cartilage, and then into bone. (See drawings of these further on.) Generally, however, where a part has to be repaired, it does not seem to determine the generation of a texture similar to itself—muscle and skin, for examples. We have an exception to the last observation in the case of nerves, which, if cut across, a substance is formed between the ends which can transmit the nervous influence; but the ends must not be separated to any great distance, or this will not occur. The same remark applies to bone. Cells may retain an independent existence, although changes may take place in their walls and contents, or they may become eventually dissolved and be succeeded by new ones. They may change their form, that is, a globular cell may pass to the compressed form; and this may arise from the difference of the contents to the material outside it, as in the corpuscles of the blood. Flattening of cells may arise from the pressure they exert upon each other, as, for example, in the cells of the epidermis and the epithelium. In some cases the cells become so thin, that their thickness cannot be measured. Sometimes, where there is but a single layer of cells, flattened, the hexagonal form of cell is assumed; at other times, the polygonal. When a mass of cells compress each other, they take the polygonal form, and have length, breadth, and thickness, as in the fat-cells of ruminating animals; this is readily seen in the fat of beef, but in human fat the round form is maintained. There may be a single layer of cells so arranged side by side, and presenting a columnar or basaltic form; this arrangement is seen in the cells of the intestinal tract, fig. 274, *a*. Another change of cell is this: they shoot out processes from certain parts of them, as seen at fig. 269, Nos. 10, 11; the same occurs also in the choroid plexus; and on the inner surface of the sclerotic

coat of the eye, the *lamina fusca*, as it is called. The cylindrical form of cell is found with delicate processes shooting out from the broad end; these are called ciliated, seen at fig. 274, *d*, and the cilia are endowed with the power to move spontaneously, having a vibratile motion, intended to urge on the secretions of the part in a particular direction..

*Change of the Nucleus.*—Fig. 269, No. 1, 2, 3, and 4. The nucleus may undergo a change; it may be smooth, round, compressed, like the cell to which it belongs; it may disappear altogether, and the cell which contained it remain. The corpuscles of the blood and the epidermic scales in the last stage of development are examples. The contents may change with the membrane itself. Some cells are filled with a granulous matter, others with pigment, or colouring-matter, as the cells of the choroid of the eye. Others, again, become filled with matters which form the secretions; the cell-membrane breaking, and pouring out its contents. The cell-membrane may become so changed, as to be of a horny consistence, not capable of being acted on by acetic acid, as it could have been before; this is well seen in the last changes of the epidermoid and epithelium scales.

In some cases the walls of the cell increase in thickness. (Fig. 269, No. 5.) Under the microscope, some cells appear to be composed of concentric laminae. In plants this is the common mode of increase in the thickness of the cell, but the deposit does not take place entirely around, but only here and there, so that vacant spaces are left which form canals, and may become branched, these canals are named pore-canals. (Fig. 269, No. 6.) They do not perforate the outer layers, consequently the blind ends are seen through the outer membrane, and were supposed, indeed, to be apertures; but they are not so. Henle thinks he has found canals in such cells in animals, similar to those in vegetables—in the cartilage of the epiglottis, for instance. Another mode of development is, that the cells may not remain free and independent, but may coalesce with each other. (Fig. 269, No. 7.) Of this there are two modes—the first is, before coalescence, the cell may have attained its full development as a cell; secondly, when coalescence occurs, the cell may be simply a

solid plate or cell in a rudimentary state. The first kind is seen in cartilage; here the walls of the cell become increased in thickness and coalesce with each other, mixing at the same time with the intercellular substance, while the cavities or *vacuolæ* remain distinct, but are rendered smaller by this process of deposition. In the second kind, cells coalesce, but their cavities or *vacuolæ* run into each other: the tubules of some glands are thus formed. (Fig. 269, No. 8.) Where the cells touch they coalesce, and the thin walls dissolving, a single elongated cavity is formed. Another mode is, the cells may be aggregated, like a bunch of raisins, and the parts in contact with each other disappear, so constituting a multilocular cavity: examples of this are seen in the racemose glands. (Fig. 269, No. 9.) Schwann conjectures another mode of coalescence. From cells formed as usual, processes sprout out; but this change takes place at the expense of the cell-membrane itself, and when it has gone on to some extent, we have the appearance of a net-work formed. (Fig. 269, No. 11, and 12.) Capillary vessels are formed in this way. Cells, we thus perceive, coalesce to form tissues, when they have not attained their full growth as such; or when they have been fully formed they become flattened, and assume the solid form. Deposits of matter may take place from the cytoblastema with similar adjoining substance, constituting a delicate membrane, with here and there nuclei, as in the capsule of the lens, the membrane of the aqueous humour of the eye, or sheath of the primitive fasciculus of muscle; or the cells may coalesce in the linear series, to form fibre.

*Development of Complicated Cells.*—Here the nucleated cell is surrounded by a deposit, and that again surrounded so as to constitute a membrane; so that the nucleated cell may be looked upon as the nucleus to the cell so formed. (Fig. 269, Nos. 14 and 13.) Sometimes the nucleus undergoes important changes in the development of tissues, as well as the cell itself. In some cases, where the cells have joined in the linear series, the nucleus becomes oval, elongated, so that the nucleus of one cell tends to meet the nucleus of another cell; they subsequently coalesce, and thus fibre is formed. That so-constituted filament differs

from that formed by the coalescence of the cells themselves, which is acted upon by nitric acid, whilst that formed from the nucleus resists it. The nucleus may be on the exterior of the cell, and sometimes imbedded in the wall. As an example of the first, may be instanced the nucleus of the pigment-cell of the eye, fig. 271. If, instead of the fibre being flat, it is cylindrical, it is formed by the nucleus. When the nucleus is outside, the fibres of the cell and those of the nucleus unite, fibre by the side of fibre. As an example, we have the bone of the tooth; in this the fibres of the cell and nucleus alternate. Again, if the nucleus be arranged externally, it unites across either behind or in front, and thus a spiral filament is formed: this is seen in cellular tissue and tendon. The last-described form may alternate with that described before it, and there are all intermediate shades of difference. Nuclei sometimes disappear when they are very nearly developed, as in the cornea of the eye.

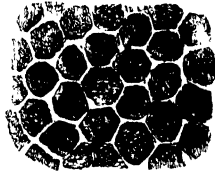

Fig. 271.—Black pigment cells from the human eye.

*Action of Cells.*—The subsequent changes of these depend in a great degree on endosmosis. The nature of the membrane is a necessary condition, for it determines the way in which the stream should pass; and we find in general that the current is from the rarer to the denser fluid. If we take common salt and fill a tube with it, and put the latter in water, we find that the salt rises, from the water having passed into the tube, and at the same time the water outside is saltish to the taste. It is not a constant circumstance that the stream is from the rarer to the denser fluid; with alcohol and water, for instance, the stream is from the latter to the former. Mineral substances permit of endosmosis, as pipeclay and chalk, in a low degree; but sandstone does not allow of endosmosis at all; thus proving that there must be something in the nature of the material to be permeated.

As to the process of secretion, these depend in a great degree on endosmosis, inasmuch as the materials are drawn from the blood, and so thrown off.

*Intercellular Substance.*—In certain tissues the basis is made up of a homogeneous matter, granular or fibrous, or of a tissue composed of cells. The intercellular tissue must be the cytoblastema after the cells have been formed from it, and differs in quantity in different tissues; in some it is very slight in quantity, so that it has been overlooked; but still the parts are held together, and this must be by cytoblastema, which is proved by chemical action. In epithelium and other parts, on the contrary, it is in great quantity. This intercellular substance is sometimes formed into fibre, whether it be constituted of cytoblastema or of cells, and may exist in three conditions: 1st, as a homogeneous substance; 2d, as granular matter; 3d, as fibre. As an example of the first kind we have the epidermis, and of the second the cellular tissue.<sup>1</sup> As hyaline membrane it exists in cartilage. In some cartilages it is by age developed into fibre, called cartilage fibre—an example is that between the vertebra; for the part in immediate connection with the bone, Professor T. Wharton Jones has shown to be true cartilage. Sometimes the spaces between cells have no intercellular substance, there may be instead fluid or air; such cavities may present different forms—they are termed intercellular passages, and are for the conveyance of fluid or the passage of secretions: they exist in animals and vegetables, but are more highly developed in animals. In vegetables there are other cells lining these intercellular passages, so as to form a regular tube, with walls consisting of different coats. Cells exist in the neighbourhood of these passages, and have shot out pro-

(1) Mr. Huxley has ascertained that in all the animal tissues the so-called nucleus (endoplast) is the homologue of the primordial utricle, with nucleus and contents (endoplast) of the plant, the other histological elements being invariably modifications of the periplastic substance. Upon this view we find that all the discrepancies which had appeared to exist between the animal and vegetable structure disappear: and it becomes easy to trace the *absolute identity* of plan in the two, the differences between them being produced merely by the nature and form of the deposits in, or modifications of, the periplastic substance. In both plants and animals there is but one histological element—the endoplast—which does nothing but grow and vegetatively repeat itself; the other element—the periplastic substance—being the subject of all the chemical and morphological metamorphoses in consequence of which specific tissues arise. The differences between the two kingdoms are mainly, firstly, That in the plant the endoplast grows, and, as the primordial utricle, attains a large comparative size, while in the animal the endoplast remains small, the principal bulk of its tissues being formed by the periplastic substance; and secondly, In the nature of the chemical changes which take place in the periplastic substance in each case.

cesses and coalesced to form vessels with similar offsets from other cells: ultimately these are seen to join the intercellular passages, and become continuous with them. In glands, the cells being filled with their peculiar fluid, are conveyed to the wall of the intercellular passage, and through this the secretion arrives at the surface of the body.

*The Epithelium.*—If we cut very thin slices from the superficial portions of the skin, we can raise from it a delicate membrane; or, what is better, by using chemical or mechanical irritation, we obtain what is ordinarily called a blister: to it we give the name of *epidermis*. The microscope has shown this to be a tissue of high and remarkable organisation; being, in point of fact, an aggregation of laminated cells, differing, in different situations, in regard to form, colour, and composition. This investment serves to protect the delicate structures beneath, and is likewise a bad conductor of heat,—thus tending to maintain the temperature of the body; besides these uses, it answers the purposes of excretion, and is sometimes an agent of motion, fig. 272. These laminated elementary cells, found on the surfaces, have generally nuclei. The form of the nucleus is rounded or oval, and is the 1-3000th to 1-5000th of an inch in diameter.

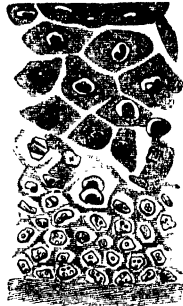

Fig. 272.—A section of the Epidermis.

Each nucleus has two or three nucleoli, with outlines more or less irregular; a cell surrounds the whole, which has transparent walls. The cell varies in this latter arrangement: it may be flattened, and the nucleus may be attached to one side of it; or, again, the nucleus may be in the centre, and the cell prolonged at either end. The cells of the epithelium may be divided into three kinds: the 1st is termed the tessellated or pavement; 2d, the columnar or basaltic; 3d, the ciliated or vibratile epithelium. Some make a 4th, combining the tessellated and the columnar: this may be considered as transition epithelium, and is found only in certain mucous passages. These cells are represented in Fig. 274, *a*, *b*, *c*, and *d*.

Tessellated epithelium is the simplest form, and, as its name implies, resembles flags of pavement, overlapping each other at their edges. They assume, more or less, the polygonal form, and their size varies in the different serous membranes. The cells of the pericardium, or covering membrane of the heart, are much smaller than those of the covering membrane of the lungs, or the serous

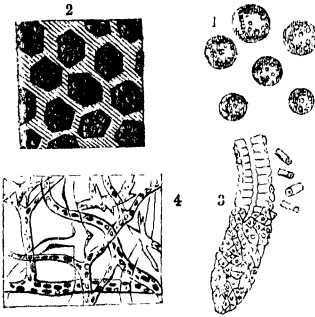

Fig. 273.

1, Simple isolated cells containing reproductive granules. 2, Mucous membrane of stomach, showing nucleated cells. 3, One of the tubular follicles from a pig's stomach. 4, Section of a lymphatic, magnified 50 diameters.

we have many layers; in the skin it will be found of comparatively great consistence. If a vertical section of such be made, and viewed under the microscope, it will be seen to be composed of numberless layers, shown in fig. 272. The skin taken from the sole of the foot, in consequence of the continued pressure there experienced, presents this distinctly stratified appearance. These layers of cells are held together by intercellular substance, which exists in quantities in the epithelium of the mucous membranes; if the epithelium is taken from these membranes,

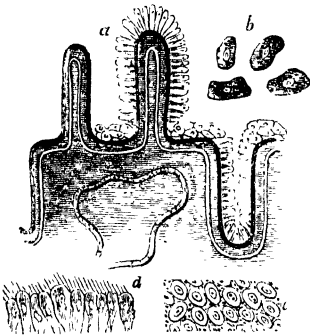

Fig. 274. (1)

(1) a is a diagram of a portion of the involuted mucous membrane, showing the continuation of its elements in the follicles and villi, with a nerve entering

it is more easily seen, because the cells are not so closely aggregated together as in the skin; therefore a piece of epithelium from the mouth is recommended for display under the microscope, and by the addition of a drop of the solution of iodine the cells are still better seen. The cells from serous and mucous membranes are acted upon by acetic acid, and dissolved if the acid be of considerable strength; but if the acid be weaker, the cells swell up. Cells are not affected by alcohol, æther, ammonia, or its salts; but they are dissolved by caustic potash, which dissolves the intercellular substance also.

*Columnar or cylindrical epithelium*, Fig. 274, *a*.—The nucleus is generally better seen than in the former kind of cells, although formed from them. If we examine a portion sideways, it resembles those at *d*, the upper being broader, and the nucleus being midway between the two extremities. When the cells of the cylindrical epithelium are closely aggregated together, they become compressed into the prismatic form; when they are less so, the rounded shape prevails. Consequently, when we take a bird's-eye view of them, from above or below, they appear like the pavement epithelium, as at *c*, and thus error might creep in: but we must satisfy ourselves by examining them sideways, and with various reagents. Their chemical composition is the same, and the cells dissolve in strong acetic acid. As examples of the situations in which this form of epithelium may be found, we may instance the intestinal tract, along the ducts of the glands, as the liver, &c.

In no situations do we find these two kinds of epithelium terminating abruptly the one in the other; but there is a gradual change of the one kind into that of the adjoining: as, for example, where the tessellated epithelium is gradually supplanted by the cylindrical, as it passes from the œsophagus to line the interior of the stomach. This is *transition epithelium*.

its submucous tissue. The upper surface of one villus is seen covered with cylindrical epithelium; the other is denuded, and with the dark line of basement membrane only running round it; *b*, pavement epithelium scales, separated and magnified 200 diameters; in the centre of each is a nucleus, with a smaller spot in its interior, called the *nucleolus*. *c*, pavement epithelium scales, from the mucous membrane of the bronchial or air tubes of the lung, showing nuclei, with a double nucleoli in some. *d* represents another form of epithelium, termed the *vibratile or ciliated*; the nuclei are visible, with cilia at their upper or free surfaces, magnified 250 diameters.



*Ciliated epithelium*, Fig. 274, *d.*—The cells of this do not differ materially from those of the cylindrical; the great distinction between the two is, that in the former there are no cilia attached to the broad end. Examples of the situations in which these are found are, investing membrane of the respiratory passages, upper part of the pharynx, larynx, and bronchi, the lateral ventricles of the brain, &c.

Epithelium is found to grow from the surface of the cutis outwards—in most places it is constantly growing outwards, and as continually being thrown off from the surface: it must at the same time be remembered, that though the epithelium is in close connexion with the cutis, or true skin, it is not a deposit from it, but derives only its materials of formation and nourishment from it. Cyto-blastema is given out from the blood, the nucleus is first formed by granules, and around the nucleus is established the cell membrane, taking, at the same time, the particular form of the epithelium to be developed; and this development is dependent upon the individual energies of the cell itself, and not the cutis, whence it derives its nourishing materials. Its uses would seem to be to protect the delicate cutis from friction and external agents.

The epidermis is destitute of sensibility, yet it invests very sensitive parts: it is not vascular, but invests very vascular parts. Its exfoliation takes place regularly, as may be exemplified in reptiles and the *Batrachia*, who throw off their skin; the moulting of birds is analogous. In the early periods of life in the human subject, exfoliation takes place from the surface of the skin; from the mouth the morsel of food is always mixed with detached cells. In the process of digestion the same thing occurs—in fact, it is only when the epithelium cells are thrown off that the gastric juice is secreted by the tubes of the stomach.

*Cilia*.—The most remarkable circumstance in connexion with cells is the movement of their cilia: these are delicate processes, microscopically thin, and square at the end in man generally, but tapering in animals. These cilia are in constant motion—by them fluids and particles suspended in fluids are carried along, and in this manner reach the surface. There are three ways in which the cilia

ordinarily move—the rotatory, the undulatory, and the waving, like a field of wheat set in motion by a steady breeze. No satisfactory explanation has been given of the cause of this vibratile motion. The current produced by them is from within outwards, in most places; in the respiratory passages, on the contrary, it is from without inwards. In the Frog's mouth it takes the same course. The ciliary motion may be seen in the kidney of the Frog or Newt; the cilia in the latter continue in active motion for some minutes after the animal is dead. Make a very thin section of the kidney with a sharp knife, and take care to disturb the structure as little as possible; then moisten it with a little of the serum of the animal, place it in a glass cell, and cover with thin glass.

*Pigment.*—Pigment granules are found in greater or less quantities in the skin and bodies of white and dark races. In the eye there is pigment, and it affords a good example of nucleated cells, in which are contained the pigment particles, fig. 275. These are placed there for an optical purpose, that of absorbing the rays of light. In the peculiar colouration found in the eyes of some animals, called *Tapetum lucidum*, the colour is not owing to the pigment particles, but to the interference of the light: it is reflected from it, as in mother-of-pearl, coloured feathers, scales of fishes, &c. The colour of the skin is owing to the granulous contents of the pigment cells; these are like ordinary elementary granules, with the addition of colour; and this latter may be removed by the action of chlorine.

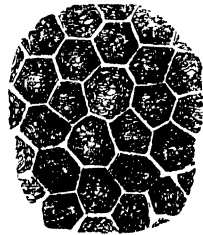

Fig. 275.—Pigment cells from the eye.

*The Nails* are appendages to the epidermis, and present a mould of the cutis beneath; from the cutis the materials are furnished for the formation and growth of the nail. Like the epidermis, the nail is stratified, the markings are parallel to the surface, and the appearance is produced by the coalescence of the cells and their lying over each other. This arrangement gives an iridescence to sections examined with polarised light.

*Hairs.*—The form and structure of these differ much; some are cylindrical, others flattened.

A hair is divided into a body or shaft, and a root which is in the skin. (Fig. 276.) The shaft is again divided into two parts: the external is termed the cortical portion, and the internal the medullary portion; the latter does not usually exist in the whole length of the shaft. The cortical part consists of fibres, arranged parallel to each other: besides these there are, on the exterior, minute scales, like epithelium, which are arranged like the tiles on a house, and produce the appearance of transverse markings. The fibres gradually expand out, forming a wall to the bulb enclosed in its capsule. The development of a hair commences at the bottom of the follicle, and by the aggregation of successive cytoblasts, or new cells, is gradually protruded from the follicle, both by the elongation of its constituent cells, and by the addition of new layers of these to its base; the apex and shaft of hair being formed before the bulb, just as the crown of a tooth is before its fang. The cyto-

blasts are round and loose at the base of the hair, but are more compressed and elongated in the shaft; and



Fig. 276.—A single Hair, seen near its bulb.



Fig. 277.

1, Transverse section of human hair, showing the cylinder of medullary substance. 2, Longitudinal section, showing the fibrous character of the same pigment or colouring matter, and serrated edges.

by this rectilinear arrangement the hair assumes a fibrous character. Of sixteen species of the Bat tribe, the hairs of

which have been examined by Professor Quekett, all were analogous in structure to fig. 278, No. 1; and the curious surfaces which these hairs present, are in reality owing to the development of scales on their exterior. By submitting hairs to a scraping process, these minute scale-like bodies, tolerably constant as regards their size and figure, can be procured; so that Bats' hair may be said to consist of a shaft invested with scales, which are developed to a greater

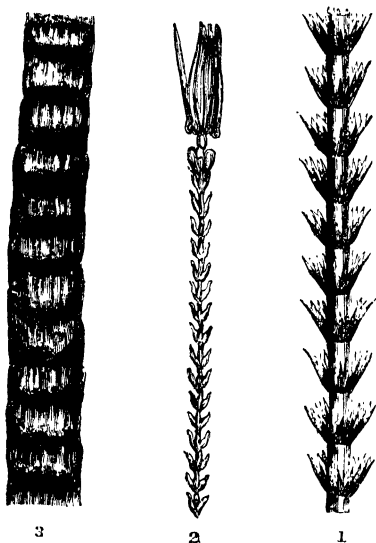

Fig. 278.

1, Hair from the Indian Bat, magnified 500 diameters. 2, Hair from the Dermestes, magnified 250 diameters. 3, Hair from the Mouse, magnified 250 diameters.

or less degree, and varying in their mode of arrangement in the different species of the animal; that part of the hair nearest the bulb is nearly free from scales, but as we proceed toward the apex the scaly character becomes evident. Many of the scales are not unlike in shape those from the wings of butterflies, but are very much smaller, and exhibit no trace of striæ on their surfaces; those taken

from dark-coloured hairs have colouring-matter deposited on them in small patches. In some cases they appear to terminate in a pointed process, like the quill part of butterflies' scales; and in others the free margin is serrated.

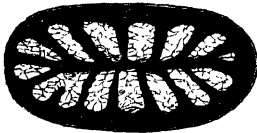

Fig. 279.—*Transverse section of Hair of Pecari, showing its fibrous and cellular structure.*

By scraping, many of them will be detached separately; but in some few cases, as many as four or five will be found joined together: in the larger hairs, the cellular structure of the interior, as well as the fibrous character of the shaft, are better seen after the scales have been removed.

The hair owes the greater part of its colour to *pigment-cells*: as these decay, and become gradually divested of their colouring-matter, they appear whitened, or "turn grey." These hexagonal cells also give colour to the skin of the negro, and are situated immediately beneath the transparent coat. A small portion is shown in fig. 280, the vacant space denoting the situation of a lost hair.

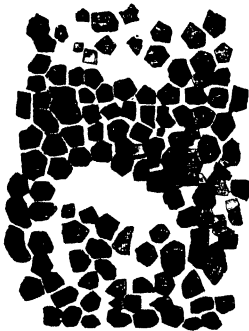

Fig. 280.—*Pigment Cells from the skin.*

Certain parts of the skin and mucous membranes are especially supplied with *papillæ*, which serve as organs of touch; throughout the greater part of the skin there are *papillæ* more or less sensitive, but only at the extremities of the fingers, lips, and in a few other situations, are these highly developed, as in fig. 281. *Papillæ* are either filiform or tubi-

form, and have entering into them nerves and blood-vessels; the former supplying the sensibility of the skin, and terminating in loops, as shown in fig. 283.

The skin is the seat of two processes in particular; one of which is destined to free the blood from a large quantity of fluid, and the other to draw off a considerable

amount of solid matter. To effect these processes, we meet with two distinct classes of glandulæ in its substance: the sudoriferous, or sweat glands; and the sebaceous, or oil glands. They are both formed, however, upon the same simple plan, and can frequently be distinguished only by the nature of their secreted product.

The sudoriferous or perspiratory glands form small oval or globular masses, situated just beneath the cutis, in almost every part of the surface of the body. Each is formed by the convolution of a single tube, which thence runs towards the surface, as the efferent duct, making numerous spiral turns in its passage through the skin, and penetrating the epidermis rather obliquely; so that its orifice is covered by a sort of little valve of scarf-skin, which is lifted up as the fluid issues from it. Mr. Erasmus Wilson says: "To arrive at something like an estimate of the value of the perspiratory system, in relation to the rest of the organism, I counted the perspiratory pores on the palm of the hand, and found 3,528 in a square inch.

Now, each of these pores being the aperture of a little tube of about a quarter of an inch long, it follows that in



Fig. 281.—A section of skin from the finger, showing the vascular network of papillæ, at the surface of the cutis.

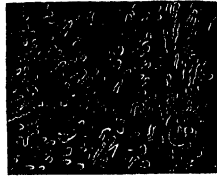

Fig. 282.—Capillary network and distribution of papillæ over the tongue.

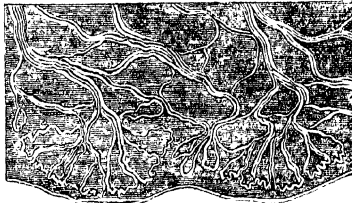

Fig. 283.—Distribution of the tactile nerves at the extremity of the fingers, as seen in a thin perpendicular section of the skin.

a square inch of skin on the palm of the hand there exists a length of tube equal to 882 inches, or 73½ feet. Surely such an amount of drainage as 73 feet in every square inch of skin—assuming this to be the average for the whole body—is something wonderful; and the thought naturally intrudes itself, What if this drainage were obstructed?"<sup>1</sup> Would it be possible to furnish a stronger proof of the necessity for maintaining a healthy state of skin?

The oil-glands of the skin are similar in structure to

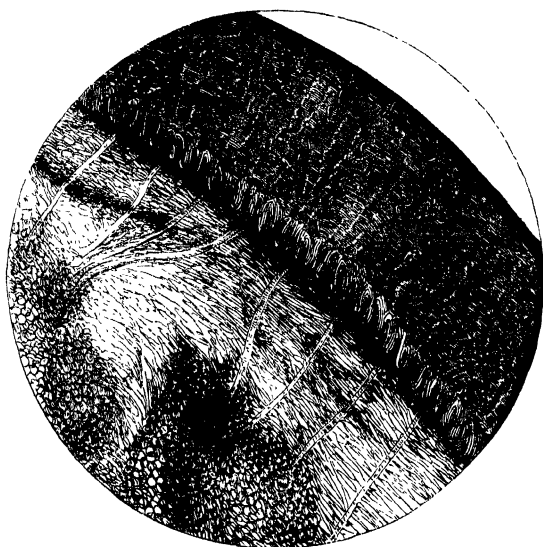

Fig. 284.—A vertical section of the Human Skin, showing the sweat-glands, surrounded by fat-globules, the ducts passing upwards through the *epithelial* layer to the *epidermis* or external *cuticle*, magnified 250 diameters.

the perspiratory ducts, being composed of three layers derived respectively from the scarf-skin, which lines their interior; the sensitive skin, which is the medium of distribution for the vessels and nerves; and the corium, with

(1) Wilson on the *Management of the Skin*.

its fibres, giving them strength and support. Like the perspiratory tubes, they are in some situations spiral; but this is not a constant feature; more frequently they pass directly to their destination; they are also larger, as shown in the drawing, proceeding from the oil or fat vesicle situated at its lower extremity. Oil-glands are freely distributed to some parts, whilst in others they are entirely absent: in a few situations they are worthy of particular notice, as in the eyelids, where they possess great elegance of distribution and form, and open by minute pores along the edges of the lids; in the ear-passages, where they produce that amber-coloured substance known as the wax of the ears; and in the scalp, where they resemble small clusters of grapes, and open in pairs into the sheath of the hair, supplying it with a pomade of Nature's own preparing.

*Internal parts of the body.*—We shall now have under consideration, cells of a much higher order than any before referred to; the cell found floating in the animal fluids is known as the blood-cell, and requires a vascular system of its own for its distribution over the whole animal body. The red blood cells, or corpuscles, have a rounded form, somewhat flattened, and under the microscope it is clearly seen that the central portion is hollowed out. Their size is about 1-3,200th of an inch in diameter; but in consequence of the form of the corpuscle, the thickness is different at the circumference to what it is at the centre; in the former situation, it is about the 1-12,000th of an inch in thickness. It is a cell, possessing a biconcave form in consequence of being empty or collapsed: this we can readily understand, for when the thick walls of a cell are collapsed, the central portion, in consequence of the approximation of the sides, appears thin, whilst the circumference, presenting an edge formed by a fold, must be thicker. This structure of the corpuscle is further proved to be its condition from the changes which it is made to assume by the action of re-agents: which in some cases produce endosmosis, causing the corpuscle to become distended, and of a globular form like a cell. Again, re-agents may cause exosmosis, or a drawing out the fluid from the interior, and thus render the corpuscle again biconcave.



The wall of the cell is a transparent structureless membrane, and is of greater thickness than we find the analogous membrane of cells to be generally. The contents, being thicker than the outer membrane, and composed of a protein compound, are the colouring-matter constituting the redness of the corpuscles. The red corpuscles of birds, reptiles, &c., possess a distinct nucleus; but on examining those of the human subject and other *Mammifera*, no distinct nucleus can be made out. By applying dilute acetic acid, the red corpuscle becomes bleached, and its walls distended, but no nucleus appears. If a red corpuscle from the Frog be treated in the same manner, we see a nucleus, and the red colouring-matter is drawn out by exosmosis.

Water causes the corpuscle to swell up, and the colouring-matter disappears, but its real nature is masked; upon employing a drop of solution of iodine, the wall is coloured or tinged, and made distinct.

The cells themselves have a tendency to undergo spontaneously certain changes, one of the most common is a wrinkling up of the walls, with a surface somewhat like that of a mulberry; this may also be produced by mechanical pressure, the addition of oil, &c.

There is another set of corpuscles, slightly larger than the red set; these are termed *colourless corpuscles*, which, when distended by the action of water, are seen as nucleated cells, whose diameter is about the 1-2,500th of an inch, and a double contour of the walls is observed; sometimes there is a slight tinge of colour to be seen in the nucleus. There is a third kind of corpuscles in the blood, more numerous than those above referred to, but of about the same diameter; when distended, they are seen to be cells filled with granular matter; sometimes a clear spot is noticed on one side: very dilute acetic acid being applied, the granules are dissolved out, and a clear central nucleus remains, if the acid be used stronger, an appearance is seen as if there were several nuclei aggregated together. This latter appearance was considered to be the natural state of the nucleus, the particles of which were either tending to unite with one another, or there was a separation of the nucleus into several smaller portions.

Wharton Jones, however, says there is no subdivision of the nucleus.

If we examine a drop of blood under the microscope,

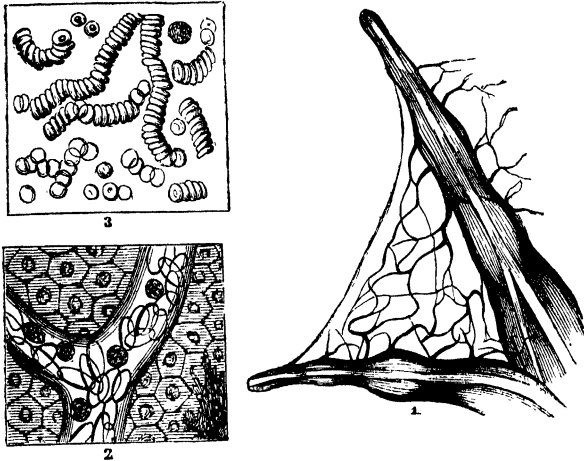

Fig. 285.

1, A portion of the web of a Frog's foot, spread out and slightly magnified to show the distribution of the blood-vessels. 2, A portion of the same highly magnified, showing the ovoid form of the blood discs in the vessel, beneath which a layer of hexagonal nucleated epithelium-cells appear. 3, Human blood discs, as they appear when fresh drawn (magnified 250 diameters).

the corpuscles aggregate themselves together like rolls of coins, fig. 285, No. 3, which present a kind of network so long as they remain suspended in their *liquor sanguinis*. After the lapse of a few minutes, the fibrin, from its elasticity, contracts more and more, and a yellow fluid, called serum, is pressed out,—or, in other words, the components of the *liquor sanguinis*, with the exception of the fibrin; and only a shrunken, jelly-like mass remains.

The blood corpuscles of the lower animals Mr. Gulliver has especially studied. In the blood corpuscles of birds, and animals below them, there are nuclei; but the cells, instead of being round, as in the human subject, are elliptical and larger. The corpuscles in *Mammifera* in general are like those of man in form and size, being a little larger or smaller. The most marked exception is in the blood of

the Musk-deer, in which the corpuscles are of extreme smallness, about the 1-12,000th of an inch in diameter. The Elephant has the largest, which are about the 1-2,000th of an inch in diameter. The Goat, of all common animals, has very small corpuscles; but they are, withal, twice as large as those of the Musk-deer. Another exception in regard to form is in the Camel-tribe, where they are oval, and resemble those of the oviparous *Vertebrata*, as the Frog, shown in fig. 285, No. 2. In the Proteus, they are of a much larger size than in any animal, being the 1-400th of an inch in the longest diameter; in the Salamander, or Water-newt, 1-600th; in the Frog, 1-900th; Lizards, 1-1,400th; in Birds, 1-1,700th; and in Man, the 1-3,200th of an inch. Of Fishes, the cartilaginous have the largest corpuscles; in the Gold-fish, they are about the 1-1,700th of an inch in their longest diameter.

The large size of the blood-discs in reptiles, especially in the *Batrachia*, has been of great service to the physiologist, by enabling him to ascertain many particulars regarding their structure which could not have been otherwise determined with certainty. Among other facilities which this occasions, is that of procuring their separation from the other constituents of the blood; for they are too large to pass through the pores of ordinary filtering-paper, and are therefore retained upon it after the fluid part of the blood has flowed through.

A new and very interesting subject has lately been noticed—the production from the blood, under certain conditions, of red albuminous crystals,—which, although formed from animal matter, and sometimes, in all probability, during life, have the same regular forms as inorganic crystals. Virchow was the first who paid particular attention to their actual nature, and proved them to differ from saline or earthy crystals. If we add water to a drop of blood spread out under the object-glass of the microscope, as the drop is beginning to dry up, the edges of the heaps of blood corpuscles are seen to undergo a sudden change: a few corpuscles disappear, others have dark thick edges, become angular and elongated, and are extended into small well-defined rodlets. In this manner an enormous quantity of crystals are formed, which are too small to enable us to

determine their shape; they rapidly move lengthways, the entire field of vision being gradually covered by a dense network of acicular crystals, crossing one another in every direction, with other crystals presenting the form of rhombic plates.

Dr. Garrod discovered, that by a slow evaporation of portions of the serum of blood taken from patients labouring under gout, he could obtain strings of crystals of uric acid. His mode of procedure is to pour a little serum into a watch-glass, and add a few drops of acetic acid; in this mixture place a few very fine filaments of silk or tow, and stand it by for twenty-four hours under a glass-shade. Upon removing the glass and submitting the filaments to microscopical examination, they are seen to be studded with minute crystals of uric acid.

No. 1, fig. 285, the foot of the Frog is stretched out, to show the distribution of the blood-vessels in the web: the two sets of vessels—the arteries and veins—are very readily made out when kept steadily on the stage of the microscope; the rhythm and valvular action of the latter may be observed, although they are much better seen in the ear or wing of the Long-eared Bat, as first pointed out by Professor Wharton Jones.

The circulation in the foot of the Frog and the tail of the Newt is, for the most part, the capillary circulation. The ramifications of the minute arteries form a continuous network, from which the small branches of the veins take their rise. The point at which the arteries terminate and the minute veins commence, cannot be exactly defined; the transition is gradual; but the intermediate network is so far peculiar, that the small vessels which compose it maintain nearly the same size throughout; they do not diminish in diameter in one direction, like arteries and veins; hence the term capillary, from *capillus*, a hair. (Fig. 287.) The size of the capillaries is proportioned in all animals to that of the blood cor-

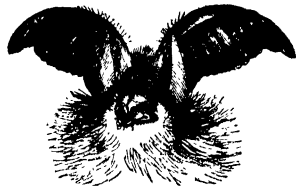

Fig. 286.—Head of long-eared Bat.  
(*Plecotus Auritus*.)

puscles; thus, amongst the *Reptilia*, where the blood corpuscles are the largest, the capillaries are also the largest: but it does not follow that they should be always



Fig. 287.—A network of capillaries conveying blood to the lungs.

of the same size in all the tissues of one and the same animal; for if we examine and carefully measure in the human subject their sizes in different tissues, we shall find that they vary greatly even in individual tissues, and, at a rough estimate, examples may occur as large as a thousandth, whilst others are so small as the four or five-thousandth of an inch. They should be measured, if possible, in their natural state; when injected, their size is slightly increased; but when dried, they diminish so considerably, that in some specimens vessels imperfectly filled with injection have been known to shrink from the three to the twenty-thousandth of an inch.

Capillaries are, with very few exceptions, always sup-

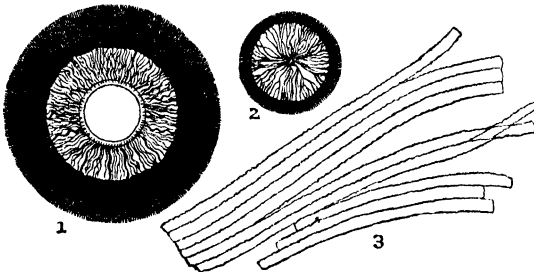

Fig. 288.

1, Blood-vessels of the Eye; back view of the *Iris* and ciliary processes. 2, Vessel of the *membrana pupillaris*, from the eye of a Kitten. 3, Fibres or tubes from the lens of the Ox.

ported by an areolar network, which serves not only as an investment to them, but connects them intimately with

the tissues they are destined to supply. A possibility arises, in first examinations, of mistaking or confounding capillaries with nerves, especially if the part under observation should have been left for some time in strong preserving or alkaline solutions.

A weak solution of caustic soda, and also another of acetic acid, are both of use; the first is available for the purpose of tracing nerves; the latter in making out vessels, structure of papillæ, unstriped muscle, &c., inasmuch as it renders their nuclei more obvious, while soda thickens and makes them less so. It is very useful sometimes to use these re-agents alternately; and the rule is, to apply them to the object while under the microscope, so as to watch their gradual operation.

It is not in the blood alone that cells float in a fluid; the chyle and lymph are colourless corpuscles, flowing along their especially - adapted tubes and ducts, and carrying the nutritive particles gathered from the food to the

blood-vessels, for the reparation of the framework, or growth that incessantly goes on in the animal body. Fig. 272 *d*, represents the

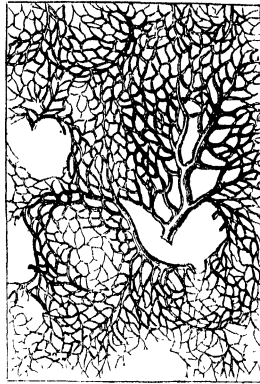

Fig. 289 — *The bronchi, a fine network of air-tubes for supplying the lungs with air.*

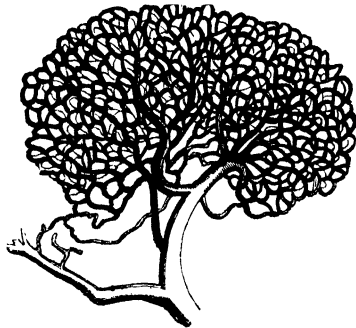

Fig. 290.—*A capillary of blood-vessels distributed in the fat tissue.*

arrangement of the chyloferous tubes, with their corpuscles, enclosed in a structureless membrane.

*Classification of the Animal Tissues.*—Professor Schwann classifies the fundamental tissues of the human body as follows :—and it will be seen that more than half are made up of cellular tissue or simple membrane.

- |  |                            |  |
|--|----------------------------|--|
| 1. Simple membrane : employed alone in the formation of compound membranes . . . . .   | }                          | Examples : Walls of cells, capsule of lens of the eye, sarcolemma of muscle, &c.           |
| 2. Fibrous tissues . . . . .   |                            | Examples : White and yellow fibrous tissue, areolar tissue, elastic tissue, &c.            |
| 3. Cellular tissues . . . . .  | }                          | Examples : Cartilage, fat, pigment, grey nervous matter, &c.                               |
| 4. Sclerous or hard tissues . . . . .  |                            | Examples : Rudimentary skeleton of invertebrata, bone, teeth, &c.                          |
| 5. Compound membranes : composed of simple membrane and a layer of cells of various forms (epithelium or epidermis), or of areolar tissue and epithelium . . . . . | }                          | Examples : Mucous membrane, skin, true or secreting glands, serous and synovial membranes. |
| 6. Compound tissues ; a, those composed of tubes of homogenous membrane, containing a peculiar substance   |                            | }  |
| b, those composed of white fibrous tissues and cartilage . . . . .   | Example : Fibro-cartilage. |  |

*Cellular Membrane or Tissue.*—Cellular or areolar tissue is generally distributed throughout the body, and various

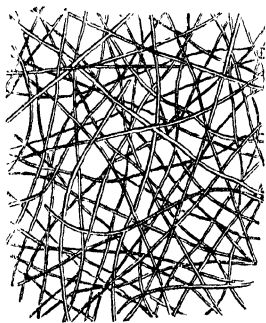

Fig. 291.—Fibrous tissue, lining the interior of the eggshell, the lime having been previously removed by immersion in dilute hydrochloric acid.

forms of this cell fibre are found ; it is seen uniting together component parts, filling up interstices between them, and affording a support to the blood-vessels and nerves, before they are distributed to the various organs. This fibre is soft, clear, smooth, and extremely minute, being the 1-12,000th of an inch in diameter, sometimes less. The fibre is usually found united together in bundles, the 1-2000th of an inch broad : if these be acted upon by dilute acetic acid, they swell up, become transparent, and the

appearance of fibrous structure is no longer seen, although some fibres that were not previously observed may become

more distinct. The first kind does not refract the light strongly; the second kind does, showing some chemical difference in their composition.

Cellular tissue, if dried, becomes a yellowish, brittle, transparent mass; but regains its former state if placed in water. The fibres have a remarkable arrangement and disposition. They are often deposited in a spiral manner; at other times they are regularly undulating. In fibres taken from some parts of the body, we find a fasciculus wound round in a spiral form. As a consequence, when acetic acid is applied, we perceive projections of swollen cellular tissue, and the depressions, from not having been acted on, have a constricted appearance. The fibrous tissue lining the eggshell, fig. 291, is the simplest form in which it is found.

Fat is generally found in the cellular tissue; it is not secreted from it, but is contained in its proper cells, and termed *adipose-tissue*; the elementary cells of which are from the 1-300th to the 1-600th of an inch in diameter. (Fig. 292.) The cell-wall is very delicate and transparent; sometimes there are one or two nuclei enclosed. Æther dissolves out the fat-cells from the tissues. Acetic acid acts upon the cell-wall, and causes the contents to pass from within outwards.

*Fibrous tissue*, clastic and non-elastic, is usually divided into *white* and *yellow* fibrous tissue. The yellow is elastic, and of great strength, consisting of bundles of fibres which are highly elastic. (Fig. 294, No. 2.) The white (fig. 294, No. 1), though non-elastic, is of great strength, and of a shining, silvery appearance.

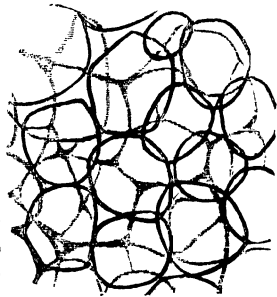

Fig. 292.—Cells from adipose tissue, or fat, magnified 100 diameters.

These two kinds of fibrous tissue differ from each other in many respects, but chiefly in their ultimate structure, their physical properties, and their colour: both are largely employed in those parts subservient to the organs of locomotion.



The white fibrous tissue is (when perfectly cleared of the areolar) of a silvery lustre, and composed of bundles of fibres running, for the most part, in a parallel direction ;

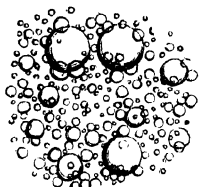

Fig. 293.—The contents of a single fat-cell, separated, and magnified 250 diameters.

but if there is more than one plane of fibres, they cross or interlace with each other: in some specimens it is very difficult to make out the fibres distinctly, except with oblique light ; from this circumstance it would appear that this tissue is composed of longitudinally striated membrane, which is often found split up into fibres. The white fibrous tissue is

principally employed in the formation of ligaments and tendons—a purpose for which it is admirably fitted on account of its inelasticity : it also enters into the formation



Fig. 294.

1, White fibrous or non-elastic tissue. 2, Yellow fibrous, or elastic tissue, taken near a ligament.

of fibrous membranes, viz. the pericardium, dura-mater, periosteum, perichondrium, sclerotic coat of the eye, and all the fasciæ. It is sparingly supplied with capillaries and nerves : the former always run in the areolar tissue,

connecting the bundles of fibres together; in the generality of the fibrous tissues, the capillaries are not well seen, except in that of the dura-mater and periosteum; in other parts it must be injected to show them.

The yellow fibrous tissue is highly elastic; it consists of bundles of fibres covered with, and connected together by, areolar tissue: the fibres are of a yellow colour, some round, others flattened; they are not always parallel, but frequently bifurcate and anastomose with neighbouring fibres. It is always difficult to separate the fibres from each other; and when separated, the elasticity of each individual fibre is shown



Fig. 295.—White fibrous tissue connecting tendons.

by its tendency to curl up at the end. The fibres in the human subject vary in diameter from the 1-5000th to 1-10,000th of an inch. Acetic acid of ordinary strength does not act on yellow fibrous tissue; nor for a very long time after maceration in water or spirit does its elasticity diminish. Very long boiling extracts from it a minute quantity of a substance nearly allied to gelatine; neither nuclei nor a trace of a cell can be seen in it after the addition of acetic acid: both are readily seen when white fibrous element is treated with this acid.

*Muscular Fibre.*—There are three different kinds of muscular fibre found in the animal body: 1st, in the muscle of the skeleton; 2d, in the muscle of the heart; and 3d, in the stomach, intestine, &c. The functions of muscular fibre may be referred to two kinds—voluntary and involuntary. The muscles endowed with voluntary power are those of the skeleton; the involuntary are those of the heart, stomach, intestine, &c.

Muscular fibre is held together by a very delicate tubular sheath, nearly resembling simple structureless membrane. This cannot always be discerned; but when the two ends are drawn asunder, it will be perceived to rise up in

wrinkles, or the fragments of the torn muscle will be seen to be connected by the untorn membrane, as at Fig. 296. This membrane is termed *Myolemma*. It is best seen when a piece of muscle is subjected to the action of

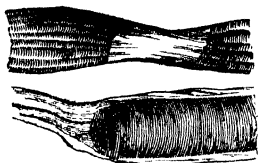

Fig. 296.—Muscular fibre, broken across the fragments connected by the untorn structureless membrane, *myolemma*. (Magnified 100 diameters.)

fluids, as diluted acetic or citric acid, or the fluid alkalis; which occasion it to swell and become easy of separation. It has no share in the contraction of the muscle itself, which is made up of a series of bundles of highly elastic fibres: portions of a separated bundle are shown at fig. 297, and the ultimate structure of

a fibre, under a magnifying power of 600 diameters, at Fig. 298, No. 1.

Dr. Hyde Salter pointed out, that in the tongue, the muscles pass directly into the bundles of the submucous

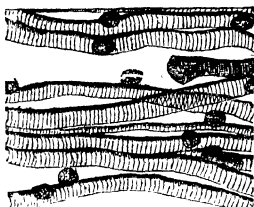

Fig. 297.—Muscular fibre, broken up into irregular and distinct bands; a few blood globules are distributed about. (Magnified 200 diameters.)

connective tissue, which serve as their tendons. Such a transition is shown in fig. 298, No. 2; the tendon, the lower part of which may be seen passing insensibly into the striped muscle, the glandular sarcous elements of the latter appearing, as it were, to be deposited in the substance of the tendon (just as calcareous particles are

deposited in bone), at first leaving the tissue about the walls of the cavities of the endoplasts, and that in some other directions, unaltered. These portions, which would have represented the elastic element in ordinary connective tissue, disappear in the centre of the muscular bundle, and the endoplasts are immediately surrounded by muscle: just as in many specimens of bone (see figs. of bone), the lacunæ have no distinguishable walls. On the other hand, at the surface of the bundle the representative of the elastic element remains, and often becomes as much de-

veloped as its sarcolemma. There is no question here of muscle resulting from the contents of fused cells. It is obviously and readily seen to be but a metamorphosis of the periplastic substance, in all respects comparable to that which occurs in ossification, or in the development of tendon. In this case, we might expect, that as there is an areolar form of connective tissue, so should

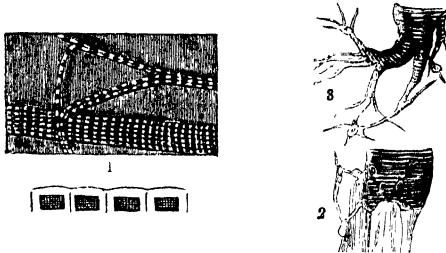

Fig. 298.

1, Muscular fibre, and a *fasciculus* of muscle taken from a young Pig. (Magnified 600 diameters.) 2, Muscular fibre from the tongue of Lamb, showing continuity of the upper portion, with connective tissue of the lower portion. 3, Branched muscle, ending in stellate connective cells, from the upper-lip of the Rat.

we find some similar arrangement of muscle ; such may, indeed, be seen very beautifully in the termination of the branched muscles, as they are called. In fig. 298, No. 3, the termination of a muscular fibre from the lip of a Rat, is shown ; and the stellate "cells" of areolated connective tissue are seen passing into the divided extremities of the muscular bundle, becoming gradually striated as they do so. In the muscle it is obvious enough, that whatever *homology* there may be between the stellate "cells" and the muscular bundles with which they are continuous, there is no *functional analogy*, the stellate bodies having no contractile faculty. The nervous tubule is developed in essentially the same manner as a muscular fasciculus, the only difference being, that fatty matters take the place of syntonin. Now, it commonly happens that the nerve-tubule terminates in stellate bodies (fig. 300) of a precisely similar nature ; these are supposed to possess important nervous functions ; and are now known as "ganglionic cells."

The muscular fibre, known as the *non-striated*, or involuntary, consists of a series of tubes presenting a flattened appearance, without the transverse striæ so characteristic of the former: elongated nuclei immediately appear upon the application of a little dilute acetic acid. Professor Wharton Jones first demonstrated this structure in his lectures at Charing Cross Hospital, about 1843: he was led to infer, from appearances in very young fibre, that the striped muscular fibre is originally composed of similar elements to the *unstriped*, or plain muscular tissue, which, in the process of development, becomes enclosed in a sarcolemma (simple membrane) common to many of them; the fibres then split into smaller fibres (*fibrillæ*). Thus accounting for the nuclei of striped muscular fibre; which, according to his views, are "the persistent nuclei of the primitive muscular-fibre cells."

The non-striated fibre is beautifully seen in connexion with the skin surrounding the hairs of the head, a few

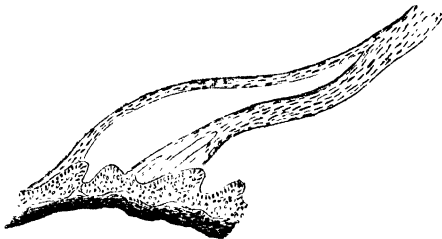

Fig. 299.—A portion of involuntary muscular fibre surrounding the hair.

fibres of which are separately shown in fig. 299. Professor Kölliker originally described these muscles of the skin, of which there appear to be one or two in connexion with each hair-follicle, arising from the more superficial parts of the outer skin, then passing down to the root of the hair, close behind the fat-gland, and there embracing it. It is indeed most remarkable that skin, when covered with hair, should alone be provided with these muscular fibres; the effect of the contraction of which must be to thrust up the hair-follicles and depress the intermediate portions of skin, and thus produce that peculiar

and before unaccountable state of the surface known as *goose-skin*.

*Nerves*.—The nervous system consists of brain, spinal marrow, and nerves. There are two sets of nerves in the body; in the one set the nerves are white, firm, shining, more or less rounded, with transverse markings; in the other, they are softer, not so consistent, of a reddish grey colour, and generally flat.

Under the microscope, nerves are seen to be composed of minute fibres or tubules, full of nervous matter, arranged in bundles, and connected by an intervening fibro-cellular tissue, through which capillaries ramify. A layer of the same, or of a more delicate, transparent, structureless tissue surrounds the whole nerve, forming a sheath. The slight pressure of the thin glass, when placed on the nerve fibre, causes nearly the whole of the contents to flow out in the form of a granular material; it therefore becomes necessary to exercise considerable care in breaking up structures to view these tubules, which should be immersed in a very weak solution of spirit and water. Mr. Lockhart Clarke, while engaged in his researches on the minute structure of the spinal cord, placed the cord, immediately after removal, into strong spirits of wine.

This, he found, hardened it, and he was thus enabled to make very thin sections. As nerves approach the brain or spinal cord, they gradually become smaller, measuring 1-10,000th to 1-14,000th of an inch in diameter. The dif-

ference in the nerve substances is not an affair of colour only; it refers also to their intimate structure and organisation; the white matter is made up of bundles of tubular fibres, the grey is composed

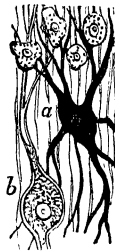

Fig. 300.—*A stellate nerve-corpuscle, with tubular processes issuing out, which at a is filled with a corpuscle containing black pigment, above this are corpuscles with nuclei and their nucleoli: at b is a corpuscle enclosing within its sheath granular matter: this is taken from the root of a spinal nerve.*

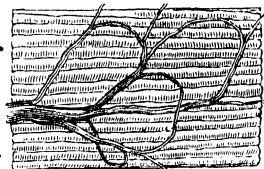

Fig. 301.—*Termination of nerve loops in muscles.*

of aggregated cells, and is usually denominated the vesicular neurine. To collections of this vesicular substance the term "ganglion" is applied. Physiological and pathological researches have rendered it more than probable that the vesicular and the fibrous substances have universally separate and distinct offices in the animal economy; the ganglionic structures being the source of *functional change*, and the fibrous matter being simply for the *conduction* of impressions originating in the former.

All the sensory ganglia, it may here be noticed, besides their instrumentality in inducing the simpler forms of consciousness, react upon the muscular system, when stimulated from without; and that, too, in apparent independence of thought or volition. The movements thus arising, Dr. Carpenter very aptly designates *consensual*: they are seen when the dazzled eye withdraws instinctively from the light, or when the startle follows upon a loud and unexpected sound.

*Consolidated Tissues.*—Such tissues are formed by a chemical combination with the gelatine of the fibre; this



.....  
 etable tissue, with superimposed  
 layers.

in cartilaginous formations is termed *chondrine*, the cells of which become consolidated by calcareous deposits, and a gradual transition results therefrom. Cartilage is the firmest structure next to bone met with; it is very elastic, and as an intercellular substance is generally divided into two kinds. Between the ribs we find this substance uniform, with a bluish appearance, and slightly granular; this is termed true, or white cartilage. The other form of intercellular sub-

stance is developed in fibrous substances; and it is in this peculiarly-formed felt-work, that cells with nuclei are found. This is termed yellow, fibrous, or spongy cartilage, the yellow colour depending on the mode of fibrous arrangement of the intercellular substance: it is found in the ears, and other parts.

Cartilage forms the entire skeleton in some kinds of fishes, the Skate, Lamprey, &c. ; and it is nourished with-

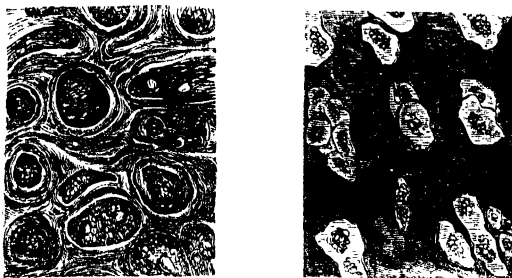

1

2

Fig. 303.

1, Cartilage from Rabbit's ear, showing large cells imbedded in a fibrous matrix.  
2, Cartilage from Human ribs, with cells in groups, each having a granular nucleus. (Magnified 200 diameters.)

out coming into direct contact with the blood-vessels, therefore it is said to be *non-vascular*; nourishment is derived by imbibition from the *surrounding* blood-vessels. When examined microscopically, the simplest form of cartilage is seen to resemble in a striking manner the cellular tissue of vegetables; it consists of an aggregation of cells of a spherical or oval form, capable in some cases of being separated from each other, and every cell having a nucleus, with a nucleolus in its interior. In figs. 302, 303, and 304, we have varieties of this structure. In the more highly organized scale of animals, a strong fibrous capsule, or sheath, surrounds the cartilage-cells; some of the fibres dip in amongst the cells, and bind them firmly together. In those inhabitants of the water, the Ray and Shark, the entire skeleton being cartilaginous, the cell is imbedded in a matrix, which may

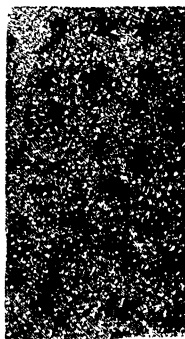

Fig. 304.—Cartilage from the Cuttle-fish, showing stellate form of cells.



be strictly termed *intercellular*. Cells are frequently or entirely isolated, as in the section from the ear of a Mouse (Fig. 302), they then rarely become converted into bone. In the highest animals it is generally invested by a fine and

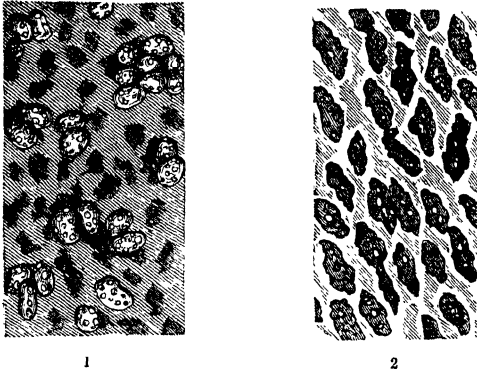

Fig. 305.

1, Cartilage from the head of Skate, with clusters of nucleated cells and nucleoli enclosed. 2, Cartilage from the Frog, with cells having nucleoli, magnified 200 diameters.

delicate membrane, termed *perichondrium*, which brings blood-vessels in close contact with the cartilage; and when in actual contact with the extremities of bones, is covered by a fringed membrane having a large number of vessels terminating in it, for the purpose of supplying a lubricating fluid to the end of the bones: this, the *synovial membrane*, is a very beautiful structure when injected and viewed under a 1-inch power.

In the earliest stages of existence, the framework—or a very large proportion—is composed of cartilage, which, by a gradual addition of earthy matter, becomes consolidated into bone. The mode of development, and the change from one to the other, is represented in the section (fig. 306); it will there be seen that the calcareous matter is deposited in nearly straight lines, which stretch from the ossified surface into the substance of the matrix of the cartilage, the amount of calcareous matter in which gradually diminishes as we recede from the ossified part. If the deposit has taken place to any great extent, the

calcareous matter becomes crowded and consolidated; as the process advances, the bone thickens, and a series of grooves, of a stellate form as in the annexed cut (fig. 307, No. 2), are found upon its surface, which become gradually converted into canals for the passage of blood-vessels.

In certain forms of disease, many of the soft parts of the human body are converted into cartilaginous and bony masses, which have received the name of *Enchondroma*. (Figs. 308 and 309.) The microscopical characteristics of this change have been described by the author in the *Transactions of the Pathological Society of London*, vol. iv.

*Teeth*.—It is desirable to become acquainted with the structure of teeth under the microscope; they are highly interesting to the physiologist, and important guides to the naturalist in the classification of animals. Professor Owen has said, "If the microscope is essential to the full and true interpretation of the vegetable remains of a former world, it is not less indispensable to the investigator of the fossilised parts of animals. It has sometimes happened that a few scattered teeth have been the only indications of animal life throughout an extensive stratum; and when these teeth happened not to be characterised by any well-marked peculiarity of external form, there remained no other test by which their nature could be ascertained than that of the microscopic examination of their intimate tissue. By the microscope alone could the existence of Keuper-

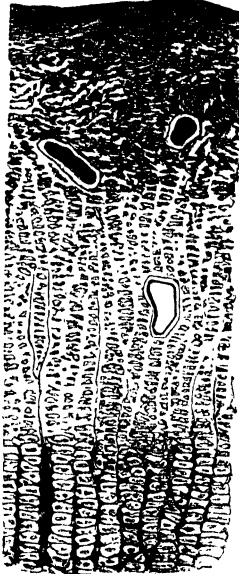

Fig. 306. — A vertical section of cartilage, with clusters of cells arranged in columns previous to conversion into bone, which is seen consolidated at the upper surface. The greater opacity of this portion is owing to the increase of osseous fibres, the opacity of the cell contents, and the multiplication of oil-globules; the dark intercellular spaces become occupied by vessels.

reptiles in the Lower sand-stones of the New red system,



Fig. 307.

1, Section of the tendo-Achillis as it joins the cartilage; showing the stellate cells of tendon gradually coalescing to form the round or oval cells of the cartilage. 2, A small transverse section of the same, showing the gradual change of the cartilage-cells at *a* into the true bone-cells, termed *lacunæ*, at *b*, with their characteristic *canaliculi*.

in Warwickshire, have been placed beyond a doubt. By

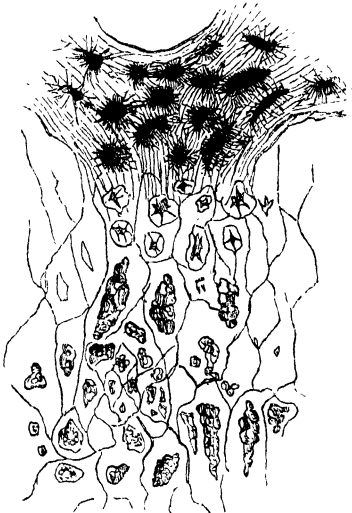

Fig. 306.—Microscopical character of *Enchondroma*, from a finger. The cartilage undergoes a gradual change, and is seen converted into bone at the upper portion.

the microscope, the supposed monarch of the Saurian tribes—the so-called *Basilosaurus*—has been deposited, and removed from the head of the Reptilium to the bottom of the Mammiferous class. The microscope has degraded the *Saurocephalus* from the class of reptiles to that of fishes. It has settled the doubts entertained by some of the highest authorities in palæontology as to the true affinities of the gigantic *Megatherium*; and by

demonstrating the identity of its dental structure with that of the Sloth, has yielded us an unerring indication of the true nature of its food."

The teeth of Man and of most of the higher animals are composed of three different substances, *Dentine* (known as *ivory* in the tusk of the elephant), *Enamel*, and *Cementum*, or *crustapetrosa*. These are variously disposed, according to the purposes which the tooth is to serve: in Man the whole crown of the tooth is covered with enamel, shown in the darker marginal part of fig. 310; its root or fang is covered with cementum, whilst the substance or body of the tooth is composed of dentine.

In the human subject, two sets of teeth are developed, the milk and permanent: the first are formed from one

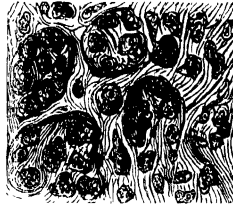

Fig. 309.—*Enchondromatous mass, with nucleated-cells embedded in fibrous tissue.*



1



2

Fig. 310.—*Sections of Human Molar Tooth, (magnified 50 diameters.)*  
1, Vertical Section. 2, Horizontal Section.

set of bulbs, which in time shrink, and let the teeth fall out; the permanent set is then produced from new bulbs,

situated by the side of the old ones. Blandin was the first to point out that the teeth are developed in the mucous membrane, in a similar way to hair and nails. Other observers have been led to the same conclusion; and, more lately, Professor Goodsir demonstrated that the teeth are first formed in grooves of the mucous membrane, and subsequently converted into closed sacs by a process of involution, and that their final adhesion to the jaw is a comparatively late part of the process. It is now generally conceded that teeth belong to the *muco-dermoid*, and not

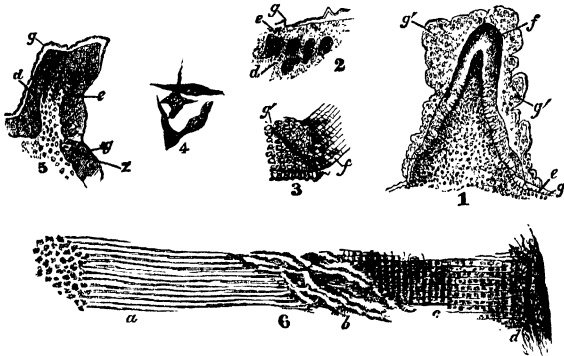

Fig. 311.

1, A section of a cusp of the posterior molar, upper jaw of a *Fœtus*. The inner outline represents it before the addition of acetic acid—the outer afterwards, when Nasmyth's membrane *g* is seen raised up in folds; *f*, the enamel organ; *e*, the dentine. The central portion is filled up with pulp. 2, Edge of the pulp of a molar cusp, showing the first rudiment of the dentine, commencing in a perfectly transparent layer between the nuclei of the pulp and the *membrana preformativa*. 3, Nasmyth's membrane detached from the subjacent enamel by acetic acid. 4, The stellate-cells of the enamel-organ. 5, Tooth of the Frog, acted on by dilute hydrochloric acid, so as to dissolve out the enamel and free Nasmyth's membrane. The structure of the dentine *e* is rendered indistinct. At the base, Nasmyth's membrane is continued over the bony substance at *z*, in which the nuclei of the *lacunæ* are visible. (After Huxley.) 6, Decalcified tooth-structure; *a*, the dentine; *b*, enamel organ; *c*, enamel; *d*, Nasmyth's membrane.

to the periosteal, series of tissues; that, instead of standing in close relation to the endo-skeleton, they are part of the dermal or exo-skeleton; their true analogues being the hair, and some other epidermic appendages. Professor Huxley has proved that, although teeth are developed in

two ways, these are mere varieties of the same mode in the animal kingdom. In the first, which may be typified by the Mackerel and the Frog, the pulp is never free, but from the first is inclosed within the capsule, seeming to sink down as fast as it grows. In the other, the pulp projects freely at one period above the surface of the mucous membrane, becoming subsequently included within a capsule formed by the involution of the latter; this occurs in the human subject. The Skate offers a sort of intermediate stage.

The *enamel* forms a continuous layer, and invests the crown of the tooth; it is thickest upon the masticating surface, and decreases towards the neck, where it usually terminates. The external surface of the enamel appears

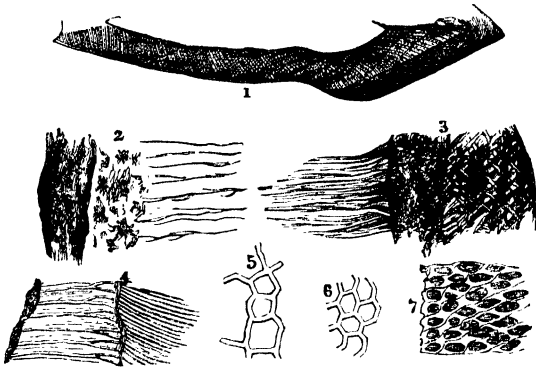

Fig. 312.—Tooth Structure.

- 1, Longitudinal section of superior canine tooth, exhibiting general arrangement, and contour markings. 2 & 3, Portions from same, highly magnified, showing the relative position of *bone-cells*, oementum at 2, dentine fibres, and commencement of enamel at 3. 4, Dentine fibres decalcified. 5, Nasmyth's membrane separated and the calcareous matter dissolved out with dilute acid. 6, Cells of the pulp laying between it and the ivory. 7, A transverse section of enamel, showing the sheaths of fibres, contents removed, and magnified 300 diameters.

smooth, but is always marked by delicate elevations and transverse ridges, and covered by a fine membrane (Nasmyth's membrane), containing calcareous matter: this membrane is separable after the action of hydrochloric acid; it then appears like a network of areolar tissue, shown in fig. 312, No. 6; which is Huxley's *calcified membrana*

*preformativa of the whole pulp.* Nasmyth says: "In all cases where this covering has been removed by means of acid, it has, of course, the appearance of a simple membrane, in consequence of the earthy deposit having been dissolved out, and the animal tissue only remaining. The structure and appearance of the covering detached in this manner from the enamel, is the same in every respect as that observed in the capsule of the unextruded tooth, and consisting, like it, of two layers, fibrous externally, and having on its internal surface the peculiar reticulated appearance common to both."

"On examining carefully fine sections of several teeth under the microscope, I perceived here also," observes Nasmyth, "that the structure in question was continuous with the *crusta petiosa* of the fang of the tooth."

The enamel has a fibrous bluish aspect, is very brittle, and much harder than the other dentinal structures; it is, indeed, so hard, that it strikes fire with steel; if an attempt is made to cut it without the application of water to keep it cooled down, it burns with an ammoniacal odour, such as we perceive when horse-hoof is burnt. It is composed of prisms, about 1-5000th of an inch in breadth, more or less wavy, and transversely striped. Two kinds of bands or stripes are seen traversing enamel, the direction of one of which nearly coincides with that of the dentine fibres; the other set of stripes indicate the laminated structure of enamel. Under polarised light, a third set become visible, arising from the variable inclination of the axes of the fibres to the plane of polarisation. The enamel is often traversed by cracks or fissures, mostly running parallel with one set of the fibres: these are sometimes described as canals; but as they resemble splits, and are seldom seen in young teeth, it is more likely that they are caused by the nature of the food and drink, which is taken into the mouth at temperatures varying many degrees; we also trace the commencement of disease from a fissure in the enamel. When a section of the enamel is cut obliquely, it has somewhat of a hexagon or six-sided appearance. The dentine consists of a transparent basement membrane, with alternating layers of calcareous matter, traversed by very fine branching tubuli,

which commence at the pulp cavity, and pass up to the enamel.

Czermak discovered that the curious appearances of globular conglomerate formations in the substance of dentine, depend on its mode of *calcification* and the presence of earthy material; and he attributes the contour lines to the same cause. Contour markings vary in intensity and number; they are most abundant in the root, and most marked in the crown. Vertical sections exhibit them the best; as Fig. 312, No. 1. In preparing a specimen, first make the section accurately, then decalcify it by submersion in dilute muriatic acid; then dry it and mount in Canada balsam with continued heat, so as to allow the specimen to soak in the fluid resin for some time before it cools. It is the white opacity at the extremity of the contour markings which gives the appearance of rings on the tooth-fang.

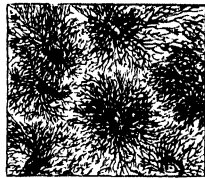

Fig. 313.—*Transverse section of Tooth of Pristis*, showing orifices of medullary canals, with systems of radiating fibres (*tubuli*) analogous to the Haversian canals in true bone.

“The tooth-substance appears,” says Czermak, “on its inner surface, not as a symmetrical whole, but consisting of balls of various diameter, which are fused together into a mass with one another in different degrees, and on which the dentinal tubes in contact with the germ cavity are terminated. By reflected light, *back-ground* illumination, one perceives this stalactite-like condition of the inner surface of the tooth-substance very distinctly, by means of the varied illumination of the globular elevations, and by the shadows which they cast. Here one has evidently to do with a stage of development of the tooth-substance; for the older the tooth is, the less striking in general are these conditions, and the more even is the surface of the wall of the germ-cavity. In very old teeth considerable unevenness again makes its appearance; these, however, are not globular, but have a cicatrised, distorted appearance. It is best to make the preparation from a tooth of which the root is not perfectly completed. With such preparations, one is readily convinced that the ground-



substance of the last-formed layer of the tooth-substance appears, at least partly, in the form of balls, which are fused one among another, and with the balls of the penultimate layers; and one also perceives that in general their diameter becomes less and less, somewhat in the form of a point, towards the periphery of the tooth-substance. To obtain specimens, procure a tooth of which the fang is half-grown; then introduce the point of a penknife into its open extremity, and scraping the inner surface, detach small portions, which exhibit the globules admirably."<sup>1</sup>



Fig. 314.—Transverse section of Tooth of *Myliobates*, Eagle-ray, viewed as an opaque object, to show its radiating fibrous structure.

The cementum is the cortical layer of osseous tissue, forming an outer coating to the fangs, which it sometimes cements together. It commences as a very thin layer at the part where the enamel ceases, and increases in thickness towards the ends of the fangs. Its internal surface is intimately united with the *dentine*, and in many teeth it would appear as if the earliest determined arrangement of the fibres of the dentine started from the *canaliculi*, as they radiate from the lacunæ in the cement. The interlacunar layer is often striated, and exhibits a laminated structure: sometimes it appears as if Haversian canals were running in a perpendicular direction to the pulp cavity. The *canaliculi* frequently run out into numerous branches, connecting one with another, and anastomosing with the ends of the dentine fibres. The thick layers of cement which occur in old teeth show immense quantities of aggregated lacunæ of an irregular and elongated form. Professor Owen believes that by age the pulp ceases to produce or nourish the dentine, which then becomes converted into *osteo-dentine*, and thereby the layer of crusta is so much increased as often to fill up the pulp cavity of the tooth. Professor Simonds assures us that this is not the case in the *Herbivora*. For instance, in the horse, the obliteration

(1) Czermak; translated by James A. Salter, M.B., *Quarterly Journal of Microscopical Science*, July, 1853. See also Addenda.

tion of the cavity is gradually effected by an increased formation of dentine ; and this is not supplanted by an *abnormal* or diseased growth, as would be the case were the pulp to become ossified, but as the pulp diminishes, so is the supply of nutriment to the tooth lessened, and at length entirely cut off from the interior. "To provide for the vitality of the tooth under these circumstances, the crusta increases in quantity on the fang, at the expense of the perfectly-formed dentine, which is lying in immediate contact with its inner surface. Through the medium of the canals in the crusta, which open on its borders, the tooth now draws its nourishment from the blood-vessels of the socket ; and thus it continues, long after the obliteration of its pulp cavity, to serve all the purposes as a part of the living organism."<sup>1</sup>

*Bone*—The elements of bone are lamellæ and small corpuscles ; the latter are possibly merely spaces between the former, in which is deposited the earthy substance. The lamellæ have for their basis a cartilaginous substance combined with earthy matter, or salts. These salts are chemically combined with the organic basis. Acids dissolve only the earthy salts, and leave the organic basis of the same form as the bone itself. The lamellæ are homogeneous throughout, like the intercellular substance of cartilage, but chemically it is different, being resolved by boiling in water into *colla*, whereas cartilage is resolved into *chondrine*.

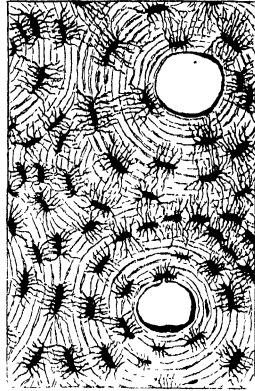

Fig. 315.—A transverse section of the human clavicle, or collar-bone, magnified 95 diameters ; which exhibits the Haversian canals, the concentric laminae, and the concentric arrangement of bone-cells around them. Some of the Haversian canals are white, others black ; the latter are filled with a deposit of opaque matter, used in the grinding and polishing the section. When viewed under a lower power, they appear to be only a series of small black dots, as shown in fig. 316.

(1) Professor Simonds, on the "Structure and Development of Teeth of Animals."

Professor Quekett has given, in the *Microscopical Society's Transactions*, an excellent account of the "Intimate Structure of Bone." To this paper we are indebted for the following microscopic investigation of bone:—

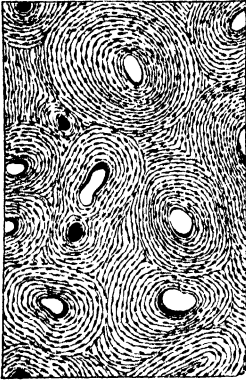

Fig. 316.—The same, viewed under a lower power, appear to be a series of small black dots.

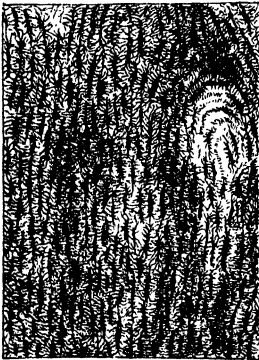

Fig. 317.—A transverse section of the Humerus, or fore-arm bone, of a Turtle (*Chelonia mydas*). It exhibits traces of Haversian canals, with a slight tendency to a concentric arrangement of bone-cells around them. The bone-cells are large and very numerous, but occur for the most part in parallel rows.

"Bone consists of a hard and soft part; the hard is composed of carbonate, phosphate, and fluuate of lime, and of carbonate and phosphate of magnesia, deposited in a cartilaginous or other matrix; whilst the soft consists of that matrix, and of the periosteum which invests the outer surface of the bone, and of the medullary membrane which lines its interior or medullary cavity, and is continued into the minutest pores. If we take for examination a long bone of one of the extremities of the human subject, or of any mammalian animal, we shall find that it consists of a body or shaft and two extremities; if a vertical section of such a bone be made, we shall also find that the middle of the shaft contains a central cavity, termed the medullary cavity, which extends as a canal throughout the whole of it, or else is entirely or partially filled up with a cellular bony structure, which cells are termed cancelli, and the structure a cancellated structure. On a more careful examination of the bony sub-

stance, or shaft, we shall find it to be slightly porous, or rather occupied, both on its external and internal surfaces, by a series of very minute canals, which, from their having been first described by our countryman Clopton Havers, are termed to this day the Haversian canals, and serve for the transmission of blood-vessels into the interior of the bone. Further than this we cannot proceed without optical assistance; but if now a thin transverse section of the same bone be made, and be examined by the microscope with a power of 200 linear, we shall see the Haversian canals very plainly, and around them a series of concentric bony laminæ, from three to ten or twelve in number. If the section should consist of the entire circle of the shaft, we shall notice, besides the concentric laminæ round the Haversian canals, two other series of laminæ, the one around the outer margin of the section, the other round the inner or medullary cavity. Between the laminæ is situated a concentric arrangement of spider-like looking bodies, which have, by different authors, received the name of osseous corpuscles, lacunæ, or bone-cells, according as to whether they were ascertained to be solid or hollow:

these bone-cells have little tubes or canals radiating from them, which are termed canaliculi by some authors, and tubes and pores by others: those bone-cells which are nearest the Haversian canals have the canaliculi of that side radiating towards the opening into the Haversian canals; whilst the canaliculi of the opposite side communicate with those of the layer of canaliculi more external to them; and those in the outer row have most of their canaliculi given off from that side of the bone-cell which is nearest its own Haversian canal: hence

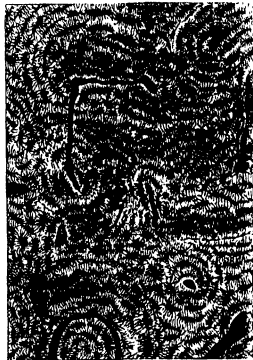

Fig. 318.—A transverse section of the Femur, or leg-bone of an Ostrich, (magnified 95 diameters.) When contrasted with the preceding figure, it will be noticed that the Haversian canals are much smaller and more numerous, and many of them run in a transverse direction.

arises the transparent white line which often may be noticed as surrounding each concentric system of laminae and bone-cells: in some cases, however, part of the bone-cells of the external row anastomose with another series of bone-cells, which are situated between the concentric laminae. The average length of the lacunae, or bone-cells, in the human subject, is the 1-2000th of an inch;

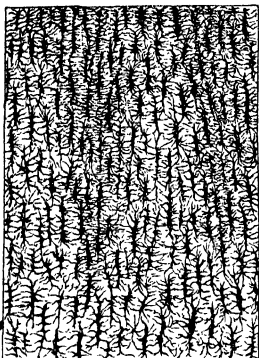

Fig. 319 — *A horizontal section of the lower Jaw-bone of a Conger eel, which exhibits a single plane of bone-cells arranged in parallel lines. There are no Haversian canals present; and when this specimen is contrasted with that of fig. 317, it will be noticed that the canaliculi given off from each of the bone-cells of this fish are very few in number in comparison with that of the reptile.*

they are of an oval figure, and somewhat flattened on their opposite surfaces, and are usually about one-third greater in thickness than they are in breadth; hence, as will be presently shown, it will become necessary to know in what direction a specimen is cut, in order to judge of their comparative size. The older anatomists supposed them, from their opacity, to be little solid masses of bone; but if the section be treated with spirits of turpentine coloured with alkanet-root, or if it have been soaked in very liquid Canada balsam for any great length of time, it can then be unequivocally demonstrated that both these substances will gain entrance into the bone-cells through the canaliculi. The bone-cells, when viewed by transmitted light, for the most part appear perfectly opaque; and they will appear the more opaque the nearer the section of them approaches to a transverse one: for when the cells are cut through their short diameter, they are often of such a depth that the rays of light interfere with each other in their passage through them, and darkness results; whereas, if the section be made in the long diameter of the cells, they will appear transparent. When viewed as an opaque object, with a dark ground at the back and condensed light, the bone-cells and canaliculi will appear quite white,

and the intercellular substance, which was transparent when viewed by transmitted light, is now perfectly dark.

“Thus much may be said to compose the hard part of the bone; we must now turn our attention to the soft part. This, as has been before stated, consists of the periosteum, which invests the outer, and of the medullary membrane, which invests the inner surface, lines the Haversian canals, and is continued from them, through the canaliculi, into the interior of the bone-cells; and of the cartilaginous or other matrix, which forms the investment of the minute ossific granules. The earthy matter of the bone may be readily shown by macerating the section for a short time in a dilute solution of caustic potash.

“The animal matter may be procured by using dilute hydrochloric acid instead of caustic potash; when all the earthy matter is removed, the section will exhibit nearly the same form as when the earthy constituent was present; and if then viewed microscopically, it will be noticed that all the parts characterising the section previous to its maceration in the acid will be still visible, but not so distinct as when both constituents were in combination. When, however, the animal matter is removed, the bone will not exhibit the cells and the canaliculi, but is opaque and very brittle, and nothing but the Haversian canals and a granular structure can be seen.

“If we consider what has been already mentioned as entering into the composition of a bone, viz. the medullary cavity, the Haversian canals, the canaliculi, and the bone-cells, we shall find that every part described has been more or less hollow; where, then, is the true bony sub-

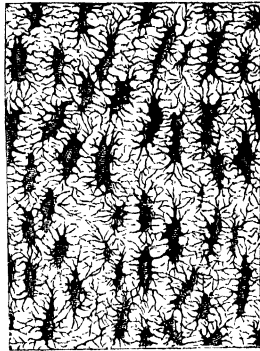

Fig. 320.—A portion of the Cranium of a *Siren* (*Siren lacertina*), remarkable for the large size of the bone-cells and of the canaliculi, which are larger in this animal than in any other yet examined. As in the preceding specimen, no Haversian canals are present.

stance? This is no other than the small granules of ossific matter, which are situated between the canaliculi of the bone-cells, each granule having an investment of soft animal matter, by which the whole mass of granules is kept in firm apposition.

“The parts which a transverse or a longitudinal section of a long bone of a mammalian animal exhibits, will be the Haversian canals, the concentric bony laminae, the bone-cells and their canaliculi; even these, except the bony laminae, may be seen in all mammalian bones. (Fig. 315.)



Fig. 321.—A small portion of bone taken from the exterior of the shaft of the Humerus of a *Pterodactyle*; this exhibits the elongated bone-cells characteristic of the order *Reptilia*.

Whether long or otherwise, they are, nevertheless, so differently arranged in the flat bones, such as those of the skull, and in the irregular bones, as the vertebræ, as to require a short description at this stage of our inquiry.

“The bones of the cranium are in all cases composed of two thin layers of compact texture; enclosed between which is another layer of variable thickness, of a cellular or cancellated structure. The two outer layers are called tables, —the one being the outer, the other the inner table; and the middle or cancellated layer is termed the diploe: in this

last the principal blood-vessels ramify. The outer table of the skull is less dense than the inner; the latter, from its brittleness, is termed by anatomists the vitreous table. When a vertical section of a bone of the skull is made so as to include the three layers above mentioned, bone-cells may be seen in all; but each of the three layers differ in structure: the middle or cancellated structure will be found to resemble the cancellated structure in the long bones, viz. thin plates of bone, with one layer of bone-cells without Haversian canals; the outer layer will exhibit Haversian canals of large size, with bone-cells of large size, and a

slightly laminated arrangement; but the inner or vitreous layer resembles the densest bone, as the outer part of the shaft of a long bone for instance, and will exhibit both smaller Haversian canals, and more numerous bone-cells of ordinary shape around them.

“A transverse section of the long bone of a bird, when contrasted with that of a mammal, exhibits the following peculiarities: the Haversian canals are more abundant, much smaller, and often run in a direction at right angles to that of the shaft, by which means the concentric laminated arrangement is in some cases lost; the direction of the canals follow the curve of the bone; the bone-cells also are much smaller and more numerous; but the number of canaliculi given off from each of the cells is less than from those of mammals, Fig. 318: the average length of a bone-cell of the Ostrich is 1-2000th of an inch, the breadth 1-6000th.



Fig. 322. — A horizontal section of a scale, or flattened spine, from the skin of a *Trygon*, or *Sting Ray*; this exhibits large Haversian canals, with numerous wavy parallel tubes, like those of dentine, communicating with them. This specimen shows, besides these wavy tubes, numerous bone-cells, whose canaliculi communicate with the tubes, as in many specimens of dentine.

“In the *Reptilia*, the bones may be either hollow, cancellated, or solid; and, generally speaking, whichever form prevails, the bone may be said to be very compact and heavy, but the specific gravity is not so great as that of birds or mammals. The short bones of most of the Chelonian reptiles are solid, but the long bones of the extremities are either hollow or cancellated; the ribs of the Serpent tribe are hollow, the medullary cavity performing the office of an Haversian canal; the bone-cells are accordingly arranged in concentric circles around the canal. The vertebræ of these animals are solid; and the bone, like that of some of the birds, is remarkable for its density and its whiteness. When a transverse section is taken from



one of the long bones, and contrasted with that of a mammal or bird, we shall notice at once the difference which the reptile presents: there are very few, if any, Haversian canals, and these of large size; and at one view, in the section, Fig. 317, we shall find the canals and the bone-cells arranged both vertically and longitudinally: the bone-cells are most remarkable for the great size to which they attain; in the Turtle they are  $1\text{-}375^{\text{th}}$  of an inch in length, the canaliculi are extremely numerous, and are of a size proportionate to that of the bone-cell.

“In fishes we have a greater variation in the minute structure of the skeleton than in either of the three classes already noticed; and there are certain remarkable peculiarities in the bones of fishes which are so characteristic, that a bone of one of these creatures can never be confounded with that of any animal of a higher order, when once its true structure has been satisfactorily understood. Of all the varieties of structure in the bones of fishes, by far the greater number exhibit nothing more than a series of ramifying tubes, like those of teeth; others exhibit Haversian canals, with numerous fine tubes or canaliculi, like ivory tubes, connected with them; a few consist of Haversian canals, with fine tubes and bone-cells, Fig. 319; and a rare form, found only as yet in the sword of the Swordfish (*Istiophorus*), exhibits Haversian canals and a concentric lamiated arrangement of the bone, but no bone-cells. The Haversian canals, when they are present, are of large size, and very numerous, and then the bone-cells are, generally speaking, either absent or but few in number; their place being occupied by tubes or canaliculi, which are often of a very large size. The bone-cells are remarkable for their graduate figure, and the canaliculi which are derived from them are few in number; they are seen to anastomose freely with the canaliculi given off from neighbouring cells; and if the specimen under examination is a thin layer of bone, such as the scale of an osseous fish, from the cells lying nearly all in one plane, the anastomoses of the canaliculi are seen beautifully distinct. In the hard scales of many of the osseous fishes, such as the *Lepidosteus* and *Calichthys*, and in the spines of the *Siluridæ*, the bone-cells are beautifully seen;

in the true bony scales comprising the exo-skeleton of the cartilaginous fishes, the bone-cells are to be seen in great numbers. In the spines of some of the Ray family may be noticed a peculiar structure: the Haversian canals are large and very numerous, and communicating with each canal are an infinite number of wavy tubes, which are connected with the canals in the same manner as the dentinal tubes of the teeth are connected with the pulp-cavity; and if such a specimen were placed by the side of a section of the tooth of some of the Shark tribe, the discrimination of one from the other would be no easy matter. In the spine of a Ray, Fig. 322, the analogy between bone and the ivory of the teeth is made more evident; for in this fish we have tubes, like those of ivory, anastomosing with the canaliculi of bone-cells.

“From our investigation of the minute structure of the bone composing the skeleton in the four vertebrated classes, let us proceed at once to the application of the facts which have been laid down; and let us, for example, suppose that a fragment of bone of an extinct animal is the subject of investigation. It has been stated, that the bone-cells in *Mammalia* are tolerably uniform in size; and if we take 1-2000th of an inch as a standard, the bone-cells of birds will fall below that standard: but the bone-cells of reptiles are very much larger than either of the two preceding; and those of fishes are so entirely different from all three, both in size and shape, that they are not for a moment to be mistaken for one or the other; so that the determination of a minute yet characteristic fragment of fishes' bone is a task easily performed. If the portion of bone should not exhibit bone-cells, but present either one or other of the characters mentioned in a preceding paragraph, the task of discrimination will be as easy as when the bone-cells exist. We have now the mammal, the bird, and the reptile to deal with; in consequence of the very great size of the cells and their canaliculi in the reptile, a portion of bone of one of these animals can readily be distinguished from that of a bird or a mammal; the only difficulty lies between these two last: but notwithstanding that on a cursory glance the bone of a bird appears very like that of a mammal, there are certain

points in their minute structure in which they differ ; and one of these points is in the difference in size of their bone-cells. To determine accurately, therefore, between the two, we must, if the section be a transverse one, also note the comparative sizes of the Haversian canals, and the tortuosity of their course ; for the diameter of the canal bears a certain proportion to the size of the bone-cells, and after some little practice the eye will readily detect the difference."

#### FISH.

It has often been observed, that we are surrounded by wonders which we do not notice because they are of daily occurrence, but which excite the greatest surprise when they are pointed out to us. The truth of this observation is forcibly exemplified as regards fish. We see them every day exposed for sale on stalls, and we eat them frequently at our tables, without once considering by what a curious and delicate organisation these creatures are enabled to see and breathe in an element that carries death to us and to quadrupeds. The sight of fishes appears to be remarkably strong, as it is by sight chiefly that they discover their prey. Hence a fish is easily deceived by an artificial fly, or the imitation of a frog or other small aquatic or amphibious animal ; which, if it were guided by the smell, or any other sense than the sight, could not happen. The mode in which fishes breathe is, however, the most curious. They have no lungs ; but, instead of them, they have gills, carefully covered with a lid and a flap, both of which the fish can open or keep closed at pleasure. The gills are composed of arches bordered by a kind of fringe, which, examined through the microscope, is seen to be a velvet-like membranaceous covering ; and over this numberless wonderfully minute blood-vessels are spread out like a delicate network. There are commonly four of these fringed arches, which are movable, and allow the currents of water driven down by the action of the mouth to flow freely through them, so as to lave every fibril. It is absolutely necessary that this should be the case, since the gills lose their power of acting as soon as they become dry ; hence a fish cannot live long after it is taken out of the

water. As there is danger, however, of the food taken by the fish being carried through the gills by the stream of water constantly flowing through them, the minor curve of the arch formed by the gills is studded with spines, which arrangement prevents everything but air or water passing through them. For viewing the circulation of the blood, take the young Stickleback.<sup>1</sup> Fig. 324.

A knowledge of the form and structure of scales of fishes, (fig. 323) like that of teeth, has been shown by M. Agassiz to afford an unerring indication of the particular class to which the fish may belong: in the examination of fossil remains, the application of this knowledge has been attended with extraordinary results. As a class of objects for the microscopes, the scales of fishes are exceedingly curious and beautiful, especially when mounted in fluid or Canada balsam, and viewed by polarised light. Many are seen best as opaque objects, and are then mounted dry between glasses. M. Agassiz divided the scale into four orders, which he named *Placoid*, *Ganoid*, *Ctenoid*, and *Cycloid*; in the first two the scales are more or less coated with enamel, in the others they are of a horny nature. To the *Placoid* order belong the Skates, Dog-fish, Ray, and Sharks; cartilaginous fishes, having skins covered with small prickly or flattened spines. To the *Ganoid* belong the Sturgeon, Lepidosteus, Hassar-fish, and Polyp-terus; fish of this order are more generally found in a fossil state, and their scales are of a bony structure. To the *Ctenoid* belong the Pike, Perch, Pope, Basse, Weaver-fish, &c.; their scales are notched like the teeth of a comb. To the *Cycloid*

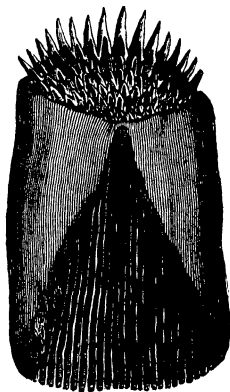

Fig. 323.—Scale of *Sole*.

(1) A remarkable observation, with regard to the Stickleback, is deserving of record. This active little favourite of the *Aquarium* bears, without inconvenience, to be transferred from his native fresh-water pond, to the *Salt-water* companionship of *Actinia*, &c., and appears equally at home and happy in the denser medium.

belong the Salmon, Herring, Eel, Carp, Blenny, and the majority of our edible fishes; their scales are circular and laminated. The scales of the Eel tribe are of an oval figure, and are among the most remarkable that can be selected for microscopic examination. To procure them, a sharp knife must be passed beneath the epidermal layer, and a portion of it raised, in a similar manner as directed for tearing off the cuticle from plants: after a few trials some will be detached. They are of an oval figure, rather softer than the scales of other fishes, and in some parts of the skin do not form a continuous layer. When the skin has been stripped off, previous to the fish being cooked, the scales can be obtained from the under surface, with a knife or pair of forceps. The scales of the viviparous Blenny are of a circular figure, situated under the epidermal layer; they were described by Mr. Yarrell as mucous glands, from their figure and small number. The surface of the skin of this fish, when fresh, appears to be covered with follicles;

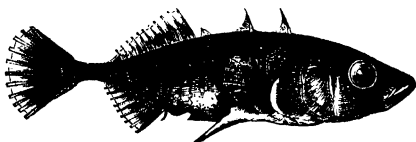

Fig. 324.—*The Stickleback.*

if, however, a portion is scraped off, it will be seen to be a mass of delicate circular scales. A piece of the skin, when dried, exhibits the scales to great advantage, and, like those of the Eel, are beautiful objects for polarised light. The prismatic colours exhibited by fish are said to be due to the presence of fatty matter in the skin; but the beautiful metallic tints displayed by so many of them are rather due to the numerous microscopic plates, or scales, distributed over the surface of the skin.

Having thus brought our brief examination of a few of the more important structures of the animal economy to a close, it only remains for us to express a hope that it will be found to smooth the way, or in some degree assist the investigations of the student to a better and more general survey of the whole fabric. Such a survey will

not be unattended with its difficulties and disappointments, but it will bring its own reward for any amount of labour bestowed. To the medical student, desirous of obtaining further information in his especial department of microscopy, we recommend an excellent little book by Dr. Beale, "*The Microscope, and its Application to Clinical Medicine.*"<sup>1</sup>

The importance of becoming thoroughly familiar with the structural and microscopical characters of any particular organ in a healthy condition, cannot be too strongly urged upon the attention of the student; as to a want of this knowledge must be attributed many erroneous descriptions of morbid appearances. All who wish to use the microscope successfully, with reference to the examinations of organs in a diseased state, will do well to acquaint themselves with minute anatomy generally, not only of the human subject, but of the lower animals; without such knowledge it will be found impossible to study pathology, or prosecute pathological inquiries with any degree of success.

A large amount of wrong observation has been recorded on cells and cellular structures: since Schwann announced his "cell theory," almost everything round has been regarded as a cell; any single body within this, or where there are several, the largest, has been regarded as a nucleus, and any spot within the nucleus has been viewed as a nucleolus. Whereas many of the so-called cells are homogeneous spheres; many of the nuclei are vacuoles, and so forth.

Such errors are natural, at first inevitable; they can be corrected only by practice, by testing observations in other ways, especially by chemical re-agents, and by comparison with the observations of others. "The marvel is not that the microscope should suggest false views—do not our eyes play us that trick?—but that it should reveal so many astounding facts as it really does; and the one con-

(1) The *Cyclopædia of Anatomy and Physiology* will be found a most valuable book of reference for the student in all matters relating to physiology and minute anatomy. A valuable paper appears in the *Medico-Chir Review*, Oct. 1857, from the pen of Mr. G. Rainey, M.R.C.S.: "On the Formation of the Skeletons of Animals and other hard Structures formed in connexion with Living Tissues." Also consult Dr. Lankæster's translation of Dr. Küchenmeister's "Animal and Vegetable Parasites of the Human Body." Published by the Sydenham Society, 1857.

solatory reflection which accompanies the difficult task of microscopic investigation is the *unanimity* which now reigns among observers on so vast a body of observations. If we read in physiological works of the yolk cells and coloured oil globules of the yolk, and the beautiful function of assimilation which has been attributed to them, they exist but in the imagination of the authors who have regarded the one as cells simply because they are round, and the other as consisting of fat because they are highly refractive,—such errors of *interpretation* do not discredit it any more than the mis-interpretations, which have helped to make Ehrenberg's name at once famous and suspicious, alter the facts which he saw, and could not rightly interpret. In truth, the eye is only a preliminary instrument in science. What we see has to be interpreted; and as it is very difficult to confine ourselves to pure observation unmixed by hypothetical interpretation, we need many collateral confirmations."

The principal physical characters to be regarded in microscopic examinations may be summed up as follows:—

1. *Shape*.—Accurate observation of the shape of bodies is very necessary, as many are distinguished by this physical property. Thus the human blood-globules present a round biconcave disc, and are in this respect different from the oval corpuscles of birds, reptiles, and fishes. The distinction between round and globular is very requisite. Human blood corpuscles are round and flat; but they become globular on the addition of water. Minute structures seen under the microscope may also be likened to the shape of well-known objects, such as that of a pear, balloon, kidney, heart, &c.

2. *Colour*.—The colour of structures varies greatly, and often differs under the microscope from what was previously conceived regarding them. Thus the coloured corpuscles of the blood, though commonly called red, are, in fact, yellow. Many objects present different colours, according to the mode of illumination; that is, as the light is reflected from or transmitted through their substance, as in the case of certain scales of insects, feathers of birds, &c. Colour is often produced, modified, or lost, by re-agents; as when iodine comes in contact with starch-granules, when

nitric acid is added to chlorophyle, or chlorine-water to the pigment-cells of the choroid, and so on.

3. *Edge or Border.*—This may present peculiarities worthy of notice. Thus, it may be dark and abrupt on the field of the microscope; so fine as to be scarcely visible; or it may be smooth, irregular, serrated, beaded, &c.

4. *Size.*—The size of the minute bodies, fibres, or tubes, which are found in the various textures of animals, can only be determined with exactitude by actual measurement. It will be observed, for the most part, that these minute structures vary in diameter; so that when their medium size cannot be determined, the variations in size from the smaller to the larger should be stated. Human blood-globules in a state of health have a pretty general medium size, and these may consequently be taken as a standard with advantage, and bodies described as being two, three, or more times larger than this structure; or all may be measured with a micrometer, as explained at page 51.

5. *Transparency.*—This physical property varies greatly in the ultimate elements of numerous textures. Some corpuscles are quite diaphanous; others are more or less opaque. The opacity may depend upon corrugation or irregularities on the external surface, or upon contents of different kinds. Some bodies are so opaque as to prevent the transmission of the rays of light; in this case they look black when seen by transmitted light, though white if viewed by reflected light: others, such as fatty particles and oil-globules, refract the rays of light strongly, and present a peculiarly luminous appearance.

6. *Surface.*—Many textures, especially laminated ones, present a different structure on the surface from that which exists below. If, then, in the demonstration, these have not been separated, the focal point must be changed by means of the fine adjustment. In this way the capillaries in the web of the Frog's foot may be seen to be covered with an epidermic layer, and the cuticle of certain minute *Fungi* or *Infusoria* to possess peculiar markings. Not unfrequently, the fracture of such structures enables us, on examining the broken edge, to distinguish the difference in structure between the surface and the deeper layers of the tissue under examination.



7. *Contents.*—The contents of those structures which consist of envelopes, as cells, or of various kinds of tubes, are very important. These may consist of included cells or nuclei, granules of different kinds, pigment matter, or crystals: a fair illustration of the changes effected by disease is given in fig. 217, from a cyst in a diseased liver: occasionally their contents present definite moving currents, as in the cells of some vegetables; or trembling rotatory molecular movements, as in the ordinary globules of saliva in the mouth.

8. *Effects of Re-agents.*—These are most important in determining the structure and chemical composition of numerous tissues. Thus water generally causes cell-formations to swell out from endosmosis; while syrup, gum-water, and concentrated saline solutions, cause them to collapse from exosmosis. Acetic acid possesses the valuable property of dissolving coagulated albumen, and in consequence renders the whole class of albuminous tissues more transparent. Thus it operates on cell-walls, causing them either to dissolve, or become so thin as to display their contents more clearly. Ether, on the other hand, and the alkalies, operate on fatty compounds, causing their solution and disappearance. The mineral acids dissolve most of the mineral constituents that are met with; so that in this way we are enabled to tell with tolerable certainty, at all events, the group of chemical compounds to which any particular structure may be referred.

Many, if not all, animal structures require examination in several ways before an accurate idea of their general structure can be obtained. It is of much importance to examine a body by reflected light, transmitted light, and by polarised light; when immersed in water, or in a highly refracting fluid, such as glycerine, oil, turpentine, and Canada-balsam; with a cover and without a cover, with the application of distilled water and of chemical re-agents. The most scrupulous cleanliness must always be observed in microscopical examinations; many errors have arisen in consequence of a want of sufficient care not having been taken to prevent the admixture of various accidental substances. The better way of avoiding errors from this cause, is to become familiar with the characters

of common substances which are likely to be mixed up with preparations, as the following :—oil globules, air bubbles, portions of worsted, cotton and linen, silk and wool fibres, hairs from plants, vegetable tissues, human hair, portions of feathers, and the starches—wheat and potato starch from bread crumbs. In taking fluids from bottles and vessels, the possibility of mixing small portions of their contents must be avoided ; the *pipette* should be washed immediately after it has been used. Another fallacy arises from the great transparency of some structures ; a membrane may appear perfectly clear and transparent when in reality it is covered with a delicate layer of epithelium, which only becomes visible after the application of some chemical re-agent ; on the other hand, by the action of re-agents, a fibrous appearance is produced. Acetic acid, when added to many preparations, frequently produces a swelling of the tissue, which looks like basement membrane, but which in reality has been formed by the action of the acid. The mechanical pressure of the thin glass, if pressed down tightly, alters structures very much ; the appearance of the blood discs are, at times, much distorted in this way, and lead to false conclusions and erroneous descriptions.

Should it be desirable to make an examination of the vital fluid, *blood*, the smallest drop, caused by the prick of a fine needle, may be placed on a strip of glass, and waved backwards and forwards, that the blood may dry as quickly as possible ; in this way the corpuscles or blood-discs retain their form ; and if the preservation of the specimen is wished, a thin glass-cover carefully placed over it, and cemented down, in the way directed at page 105.

To the advanced observer, the examination of the mucous membrane will afford some instruction. Should the specimen be small, it will be better to pin it to a piece of cork ; then well wash it by means of a small syringe. If the investing epithelium is required for examination, a portion can be detached from the surface by a knife ; when placed on a glass slide, add a drop of iodine solution, then view it with a  $\frac{1}{4}$ -inch power. Villi and papillæ are best made out in injected specimens.

The wood section cutting instrument may be used for

cutting sections of hoof, horn, claws, quill, &c. ; but the substance, if very hard, requires a previous soaking in warm water. A curious modification of horn is presented in the appendage borne by the Rhinoceros upon its snout, which in many points resembles a bundle of hairs. When a transverse section is made and viewed by polarised light, each cylinder is seen to have a cross diverging from a central



Fig.325.—*Transverse section of Horn of Rhinoceros, seen by polarised light.*

spot ; the lights and shadows of this cross are replaced by bands of contrasted complementary colours, if the selenite plate is interposed. (Fig. 325.) Whalebone is almost identical in structure, and is similarly affected by polarised light. Sections of the horny tissues are always mounted in

Canada balsam.

It is preferable to mount and preserve specimens of animal tissues in shallow glass cells, which prevents undue pressure on the preparation. Cells may be made of various materials for dry objects ; an efficient cell is readily formed out of a ring of card-board fixed with gum upon the glass slide, or a hole may be punched out of wood, mill-board, or gutta-percha, and cemented to the slip of glass. If, however, the cell is intended to contain a preparation immersed in fluid, it must be made of some substance impervious to the fluid used. The Brunswick-black cells (directions for making which are given at page 114) answer for many purposes, but the best and most useful are those made with circles of thin glass, and cemented to the glass slide with marine glue, such as we have here represented.

Fig. 326.—*Glass-cells for Mounting.*

(Fig. 326.) The surface of the glass should be slightly roughened by grinding before the cement is applied, as it adheres much more intimately to a roughened surface than to the polished glass. The glass must be warmed upon a plate of iron or over a spirit lamp, so that the heat may be applied gradually and equally. It

should be handled with wooden forceps, or the ordinary forceps, the extremities of which have been covered with pieces of cork. When the piece of glass is warm enough, a few pieces of glue, cut small, should be allowed to melt exactly in the spot on which the ring of glass is to be fixed; the glass-ring is then applied and pressed down upon a deal board, so as to press out as much of the marine-glue as possible: all the superfluous glue should be scraped off with a knife while it is yet warm, and cleaned when cold with a solution of Potash (*Liquor Potassæ*), and finally finished in soap and water with an old nail-brush.

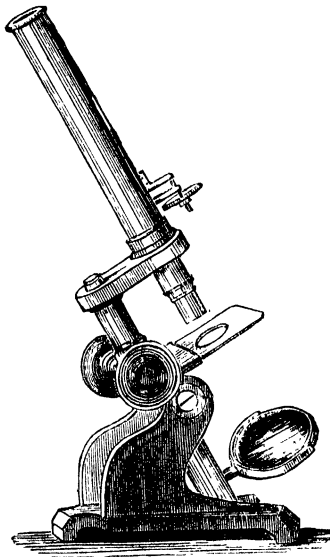

Fig 327.—Baker's Student's Microscope.

Mr. Baker, of Holborn, has produced an economical and useful form of microscope, in every way suitable to the requirements of the medical student during his hospital

career. This instrument, made on the model of the Society of Arts Students' Microscope, is well finished, with a coarse and fine adjustment, an adaptation of the  $\frac{1}{4}$ ,  $\frac{1}{2}$ , and 1-inch powers, live-box, and forceps, all packed in a neat case, for the small price of 3*l.* 3*s.*

TO VIEW THE CIRCULATION OF BLOOD IN THE FROG.

The part most commonly employed for this purpose is the transparent web of the hind foot; and in order to secure the animal, and keep its web open, various contrivances have been had recourse to. The older microscopists, Baker, Adams, and others, were in the habit of tying the frog to a frame of brass with some cord; in the present day the entire body of the animal, with the exception of the foot about to be examined, is secured in a black silk bag; and this is fastened to a plate of brass, termed the frog-plate, shown at *aaa* in fig. 328: this should be

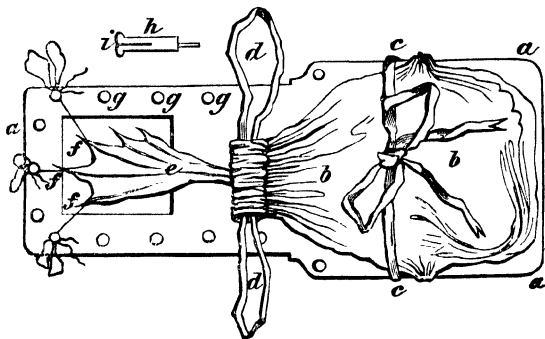

Fig. 328.

secured firmly to some part of the stage of the microscope, and, at the same time, permit of its being moved about with it. Although the shape of the plate is made to differ by every maker, the mode of using it, nevertheless, is nearly the same in all. The bag provided should be from three to four inches in length, and two and a half inches broad, as shown at *bb*, having a piece of tape, *cc*, sewn to each side, about midway between the

mouth and the bottom; and the mouth itself capable of being closed by a drawing-in string, *dd*. Into this bag the frog is placed, and only the leg which is about to be examined kept out of the mouth; the string *dd* is then to be drawn so tight around the small part of the leg, as to prevent the foot from being pulled into the bag, but not to stop the circulation; three short pieces of thread, *fff*, are now to be passed around the three principal toes; and the bag with the frog is to be fastened to the plate *aa* by means of the tapes *cc*. When this is accomplished, the threads *fff* are to be passed either through some of the holes in the edge of the plate, three of which are shown at *ggg*, in order to keep the web open; or, what answers better, in a series of pegs of the shape represented by *h*, each having a slit *i* extending more than half-way down it; the threads are wound round these two or three times, and then the end is secured by putting it into the slit *i*. The plate is now ready to be adapted to the stage of the microscope: the square hole upon which the foot must be placed is brought over the aperture in the stage through which the light passes to the object-glass, so that the web may be strongly illuminated by the mirror. The power required to view the circulation will be a one-inch or half-inch object-glass; a higher power will be needed to show the rhythm in the veins.

In the common Newt, as well as the Frog, the circulation may be viewed: the tail of the young animal being much



Fig. 329. — *The Triton, or Lissotriton; Newt, or Est: male.*

used for this purpose, and showing other interesting points of structure.

The warty Newt is in a state of great activity early in spring. It is common in ponds and large ditches, where it feeds upon the tadpole of the common Frog. The male and female Newt are nearly the same in appearance during winter; but in spring a beautifully-cut crest rises from the back of the male, which is highly ornamental. The egg is very slightly tinged with buff, and is surrounded by a substance resembling the white of a common egg, in which it keeps continually whirling round. It goes through several changes from the egg before it becomes a perfect animal; for a considerable time it remains in a tadpole state, very like the common Frog.

Before we conclude, we beg to call the attention of our readers to the beautiful experiments of Mr. John Gorham,<sup>1</sup> as illustrating the wonderful magnifying power of the human eye. The fact itself is one of great interest to the microscopist, who has hitherto almost exclusively availed himself of the optician's aid in his examinations of minute bodies.

We are only able to notice the results arrived at by this able investigator, which are as follows: "That when small bodies are brought very near to the eye, their images are magnified, just as images of larger objects, when seen at a distance, are diminished, and by the same law. The apparent magnitude of objects depends on their visual angle. The visual angle, for short distances, may be well illustrated by employing a small circular disc of light. This minute circular disc of light is procured by perforating a card with a needle. A sewing-needle, of the size marked No. 7, produces an aperture about the one-fortieth of an inch in diameter. In order to examine the light which is transmitted through such an aperture, all extraneous rays should be excluded; hence the plane in which the opening is made should be placed at the end of a tube. The pencil of light admitted through an opening of this kind, held within an inch or so of the eye, consists of rapidly-diverging rays falling upon the cornea. Some of these are entirely lost, others are intercepted by the iris,

(1) *Quarterly Journal of Microscopical Science*, October 1854.

while the remainder pass on through the pupil, which communicates to the image formed on the retina its circular form.

“For the purpose of presenting very small objects mounted on microscopic slides in the usual way before the eye, and to exclude the surrounding rays of light, take an upright box of pasteboard about one inch and a half deep, and an inch and a quarter in diameter (two pill-boxes joined will do very well); cut a couple of slits through one of its sides, sufficiently large to admit of the slips of glass sliding to and fro. Make two apertures (perforations with a needle) opposite to each other—the first the 1-30th of an inch, and the second the 1-40th of an inch in diameter;<sup>1</sup> let these be so disposed, that when

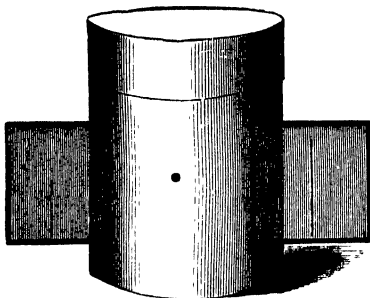

Fig. 330.

the glass slip, with a small object mounted on its centre, is introduced through the slits, the two apertures and the object shall all correspond, and be in one straight line, while the slide is about a quarter of an inch behind the smaller opening, as in fig. 330. The image becomes more distinct when more than one aperture is used; for the intensity of light by which it is illuminated is thereby increased, being almost in a direct ratio with the number of the openings which are employed.

(1) Sewing-needles are ordinarily sold in papers, numbered from 1 to 12, according to their thickness. The diameters of apertures made with needles from the papers marked Nos. 6, 7, 8, 9, and 10, when measured with the micrometer, are equal to the 1-36th, the 1-38th, the 1-41th, the 1-50th, and the 1-70th of an inch.



“It is found that the magnifying power of the eye is limited by the magnitude of the visual angle on the one hand, and by the intensity of light on the other. If the visual angle be too large, the rays are not sufficiently refracted by the humours of the eye to converge to a focus and form an image on the retina; and if too small, the image is reduced to a mere point. The exact amount of divergence of the rays, therefore, for any individual eye, lies somewhere between these two extremes. Again, however accurately adjusted the visual angle may be to the refractive powers of the eye, if the light be too strong the pupil becomes so contracted that only the innermost rays are admitted; while if it be of small intensity, the object is so dimly illuminated as to be scarcely visible. If, then, whilst a small object is held very near to the eye, so as to ensure a rapid divergence of the rays proceeding from it, the pupil can be dilated by the small quantity of light which is used, and to which, like a photometer, it immediately responds, so as to admit as large an angle as the lens and humours of the eye are capable of refracting, at the same time that the object is rendered distinctly visible, then, under such circumstances, we have arrived at the utmost limit to the available magnifying power of the eye.”

Indeed, the improvement of the microscope, as well as other optical instruments, gradually followed after the wondrous perfection of the Dioptric apparatus of the human eye, became unfolded to the scientific mind. “Before the days of Sir Isaac Newton, men knew that they saw by means of the eye, and that the eye was constructed upon optical principles; but the reason of its peculiar conformation they knew not, because they were ignorant of the different refrangibility of light. When his discoveries taught this truth, it was found to have been acted upon, and, consequently, known by the Being who created the eye. Still, our knowledge was imperfect, and it was reserved for Mr. Dolland to discover another law of nature—the different dispersive powers of different substances—which so enabled him to compound an object-glass that more effectually corrected the various refrangibility of the rays. It was now observed that this truth must also have

been known to the maker of the eye ; for upon its basis is that instrument far more perfect than the achromatic glass of Dolland framed."

Well may we inquire with the immortal Newton : " Was the eye contrived without skill in optics ? " or with the divine Psalmist : " He that formed the eye, shall He not see ? "

By vision, aided by knowledge, we pierce into the heavens and the interior of bodies, examine the minutest fragments of matter, and the universe of stars ; by our motion on the surface of the globe, and by its motion, we measure space, and are at once convinced that the infinitely small, and the infinitely great, of which we get an idea by vision, have for us no bounds—nothing that we can reach and measure. Infinity is everywhere around us, and the evidences of this revealed by the microscope carry with them convictions that are not to be surpassed for their solemnity and grandeur.

The restless curiosity of the human intellect led to the invention of the telescope, by which man daringly pierced the mysterious and illimitable space above us ; revealing to his understanding a great and wonderful series of worlds lost to his unaided powers of vision ; while by the microscope, he has discovered an animal, vegetable, and mineral kingdom, of which he was previously ignorant, on account of its minuteness placing it beyond the keenest observation of the naked eye. In this last-named, new, and amazing world there is displayed a beauty, a perfection, adaptation, and reproduction, surprisingly surpassing those objects with which we are familiar in every-day life. With the microscope we search into the mysteries of creation, and detect many of the secret workings of nature. We see the utility of a busy, multitudinous, invisible world of animal life, to the health, comfort, and preservation of human-kind ; and the unbounded love of God in the admirable secret provisions for the unceasing changes in the form of matter. The more powerful the instrument, the more astounding its revelations ; until we marvel in what sized atom organic matter ceases ; and our facts become stranger than fiction, and far beyond the imaginings of the most poetic brain.

It would be a vain attempt were we to try to convey to our readers any idea of the great discoveries which have been made by the microscope, or of the important purposes to which it has been applied. Second only to the telescope, though in many respects superior to it, the microscope transcends all other instruments in the scientific value as well as in the social interest of its results. While the human eye, the telescope and microscope combined, enables us to enjoy and examine the scenery around us, to study the forms of life with which we are more immediately connected, it fails to transport us into the depth of space, to throw into relief the planets and the stars, and to indicate the forms and arrangements in the worlds of life and motion, which distance diminishes and conceals. To these mysterious abodes, so long unrevealed, the telescope has at last conveyed us. It has shown us those worlds and systems, of which our own earth and our own system are the types; but it fails to enlighten us respecting the nature and constitution of the celestial bodies, and the forms of life for which they were created.

In its downward scrutiny, as well as in its upward aspirations, the human eye has equally failed. In the general view which it commands of animal, vegetable, and mineral structures, it cannot reach those delicate organizations on which life depends, or those structures of inorganic matter from which its origin and composition can be derived. Into these mysterious regions, where the philosopher has been groping his way, the microscope now conducts him. The dark abodes of unseen life are lighted up for his contemplation,—organizations of transcendent beauty appeal to his wonder—new aspects of life, new forms of being, new laws of reproduction, new functions in exercise, reward the genius of the theoretical and practical optician, and the skill and toil of the naturalist. With wonders like these all nature is pregnant: the earth, the ocean, and the air—times past and times present, now surrender their secrets to the microscope.

What we know at present, even of things the most near and familiar to us, is so little in comparison of what we know not, that there remains an illimitable scope for our inquiries and discoveries; and every step we take serves to

enlarge our capacities, and give us still more noble and just ideas of the power, wisdom, and goodness of God. This marvellous universe is so full of wonders, so teems with objects of latent beauty, that perhaps eternity alone will open up and develop sufficient opportunities to enable us to survey and admire and appreciate them all.

“ And lives the man, whose universal eye  
Has swept at once th' unbounded scheme of things ;  
Mark'd their dependence so, and firm accord,  
As with unfaltering accent to conclude  
That this availeth nought? Has any seen  
The mighty chain of beings, lessening down  
From infinite perfection to the brink  
Of dreary nothing, desolate abyss!  
From which astonish'd thought, recoiling, turns?  
Till then, alone let zealous praise ascend,  
And hymns of holy wonder, to that Power,  
Whose wisdom shines as lovely on our minds,  
As on our smiling eyes his servant sun.”—THOMSON.

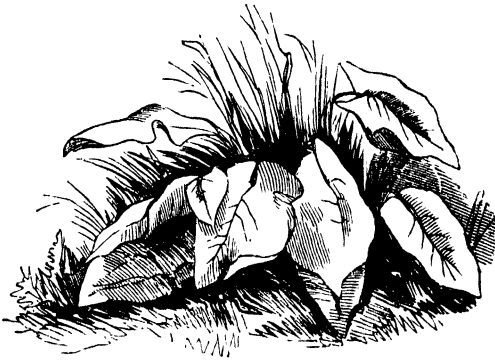



## CORRIGENDA ET ADDENDA.

---

P. 43, note.]—Mr. Rylands calls attention to the fact that in treating of the “*penetrating power*” of the microscope, much error prevails, and authors on the subject too frequently confound it with *definition* or *angular aperture*. The reader is referred to “*Microscopical Journal*,” p. 27, October, 1858, “*On the Optical Powers of the Microscope*,” by Mr. Rylands.

P. 61, note.]—With regard to the value of the *Diatomaceæ* as test-objects, pointed out at page 57, it is only due to Mr. J. D. Sollitt, of Hull, to state that he was the first observer who proposed the use of their shells for *test-objects*, and published a paper on them in the “*Magazine of Science*,” April 4th, 1846. In 1841 Mr. Sollitt and Mr. Harrison first made out the markings of *Pleurosigma attenuatum*, not *hippocampus*, as stated at page 313. The following are the measurements of the cross-lines, in a few of the species :—

Amphipleura	Pellucida, or Acus,	130,000 in the inch, cross lines.
—	Sigmoidea,	70, 000 in the inch.
Navicula	Rhomboides,	111,000 in the inch, cross lines.
Pleurosigma	Fasciola, fine shell,	86,000 in the inch, cross lines.
—	— strong shell,	64,000 in the inch, cross lines.
—	Strigosum,	72,000 in the inch, diagonal lines.
—	Angulatum,	51,000 in the inch, diagonal lines.
—	Quadratum,	50,000 in the inch, diagonal lines.
—	Spencerii,	50,000 in the inch, cross lines.
—	Attenuatum,	42,000 in the inch, cross lines.
—	Balticum,	40,000 in the inch, cross lines.
—	Formosum,	32,600 in the inch, diagonal lines.
—	Strigilis,	30,000 in the inch, cross lines.

Mr. Sollitt says :—“I bring out the difficult markings on all these shells in the way described by me in the ‘*Quarterly Journal of Microscopical Science*,’ vol. iii. p. 87. No other mode of illumination brings out the lines on the *Acus* so well. The  $\frac{1}{4}$  object-glass shows the *Fasciola* in squares, and the  $\frac{1}{12}$  brings out separate dots.”

Mr. Norman, of Hull, has favoured me with the following :—

“HINTS TO COLLECTORS OF DIATOMACEÆ.

“These minute forms are found in all waters, but the most interesting species are those found in salt water, especially shallow lagoons, salt water marshes, estuaries of rivers, pools left by the tide, &c.

“Their presence in any quantity is always shown by the colour they impart to the aquatic plants and sea-weeds they are found attached to, and if found on the mud, which is very frequently the case, they impart to it also a yellowish brown colour approaching to black brown, if in great numbers.

“This brownish pellicle, if carefully removed with a spoon (without disturbing the mud) will be found very pure. Capital gatherings of Diatomaceæ might be obtained by carefully scraping the brown coloured layer from mooring posts, and piles of wharfs and jetties.

“In clear running ditches the plants and stones have often long streamers of yellowish brown slimy matter attached to them, which is generally entirely Diatomaceous.

“When found in large quantities on the mud the layer is often covered with bead-like bubbles of oxygen. This often detaches them from the bottom and buoys them to the surface, where they form a dense brown scum, which is blown to leeward in large quantities, and presents the general appearance of dark-coloured yeast.

“In this form it may be collected in abundance, often quite free from particles of sand and other impurities.

“Good and rare species have been obtained from the stomachs of oysters, scallops, and other shell-fish inhabiting deep water.

“The sea-cucumbers (Holothuridæ) found so frequently in southern latitudes contain many species.

“These animals might be simply dried and preserved just as found, and the contents of the stomach afterwards obtained by dissection.

“The Noctiluçæ which cause the phosphorescence in the sea are Diatom feeders, and might be caught in large quantities in a fine gauze towing-net, and preserved.

"The Ascidians found attached to oyster shells and stones from deep water have yielded excellent gatherings.

"The Salpæ often noticed in warm latitudes floating on the surface of the sea, and assuming chain and other like forms, should be bottled up for examination. These Salpæ are well known Diatom feeders.

"Deep-sea soundings ought to be preserved, especially from great depths, and are often exclusively Diatomaceous. Sea-weed from rocks ought to be preserved, especially the smaller species, and if covered with a brown furriness, so much the better.

"Very rare species have been found in immense quantities in the ARCTIC and ANTARCTIC regions, by melting the 'pancake ice,' which is often found discoloured of a brown tint, in consequence of the great numbers of these minute beings.

"The sea is often observed to be discoloured by brownish patches. The discoloured water (or 'spawn' as it is called) should be collected, filtered through cotton wool, and the brown residue preserved.

"When a fine impalpable dust is observed to be falling at sea, it ought to be collected from the folded sails and other places where it lodges. This may yield Diatomaceæ, which from the method of collecting would be highly interesting to examine.

"The roots of the various species of Mangrove (*Rhizophora*), which form impenetrable barriers along the salt water rivers and estuaries in the tropical parts of Africa, Australia, the Eastern Archipelago, &c., are found frequently covered with a brown mucous slime very rich in Diatomaceæ.

"When the Diatomaceæ are collected from any of the above-mentioned sources, they may be at once transferred to small bottles, or the deposit may be partially dried and wrapped up in pieces of paper or tinfoil. When placed in bottles, a few drops of spirits added will keep them nice and sweet.

"In all cases it is essential to keep the gatherings separate and distinct, and that the locality whence obtained be written on the package.

"All shells and stones from deep water which are



covered with sea-weed ought to be preserved as affording interesting and little known species. The rougher these are the better, and on no account should they be washed."

Travellers, especially to distant countries, would do well to collect specimens, which might be easily sent home in a letter for microscopic examination; a very interesting knowledge of the distribution of species might in this way be gained.

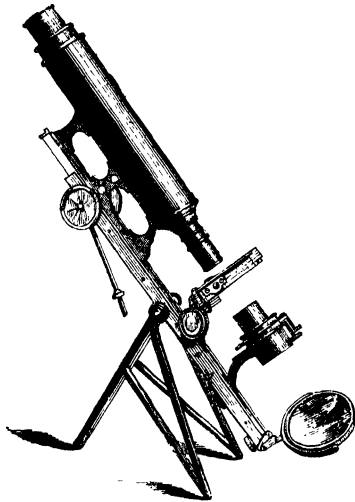

*Ladd's Improved Microscope.*

P. 68.]—An improved form of microscope has been recently manufactured by Mr. Ladd, of Chancery Lane; having a stand so simple and light in its construction as to render it very portable and useful. It is fitted with a *magnetic stage*, which facilitates the moving of the objects when placed on it by the unaided fingers; a point of some importance to such microscopists as desire to retain and cultivate delicacy of touch in preference to that growing dependence upon mechanical movements. The main

features of the new form of microscope are, that the bearings for the compound body, stage, and sub-stage are all fitted, while connected together into the dovetailed slide running from top to bottom of the instrument. The magnet is attached to the under part of the stage, and a gilt iron bar, ledge, or keeper, serves for an object-rest. The sub-stage is constructed of three thin plates having rectangular movements, the top one having a tube attached, into which is fitted the Polariscope, spotted lens, &c., the focussing of which is by a rack placed below. The mirror, being provided with a double-jointed arm, can be used with any amount of obliquity. The stand forms a tripod strengthened by cross bars, the beauty of the chain movements (with which all Mr. Ladd's microscopes are furnished) is made apparent by a simple and effective fine adjustment attached to the *milled* head, thus making the one adjustment subsidiary to both purposes. The general appearance of the instrument is one of elegance, stability, lightness, and compactness.

P. 159.]—Mr. Norman writes me:—"The beautiful rosette crystals described by Dr. Herapath are best made in the following manner:—

"I make a pretty strong solution of *Cinchonidine* in Herapath's test-fluid (as described in your work). A little of this is dropped on the centre of a slide and laid down for a time, until the first crystals are observed to be forming near the margin. The slide is now placed upon the stage of the microscope, and the progress of formation of the rosettes closely watched. When these have arrived at a size large enough, and it is deemed necessary to stop their further development, the slide must be quickly transferred to the palm of the hand, the warmth of which will be found sufficient to stop further crystallization. I have found this preferable to holding the slide over the lamp, however carefully it may be done. I may state with *Cinchonidine* this plan is certain, but with *Quinine* impossible."

P. 184.]—The author, in following Robin and Gudden in the investigation of *cutaneous diseases*, referred to at page 184, gave only their results. He has since in-

vestigated the subject more closely for himself, and finds that, in place of being *forty-eight* species, the whole are nearly identical with the yeast fungus, and that one will produce the other. See the "Microscopical Journal," April, 1859.

P. 223.]—The motion of the sap in the *chara* and other vegetables has been explained on the principle of *osmose* and *exosmose*. A fluid of lower density (water) chemically acts on and penetrates membranous tubes containing a liquid of greater density (sap or chlorophyl); that fluid which begins the flow into the tubes may sustain it in continued current through them, so long as a difference in density and composition between the water and sap is maintained. A similar principle, doubtless, aids the motion of fluids in the animal body in some instances; in others the movements observed (as in the air-tubes, &c.) have been traced to the vibrations of cilia, and are therefore no proof of the existence of vital attractions and repulsions.

P. 233.]—At page 233 I state that *it is futile to expect to prove that crystals are the possible transition of the inorganic to ORGANIC MATTER*. In correction, I beg to call attention to the highly valuable contributions of Mr. George Rainey, who has pointed out the remarkable fact that many of the appearances presented by the hard structures of animals, and which had been usually referred to cell-development, are really produced by the physical laws which govern the aggregation of certain crystallizable salts when exposed to the action of vegetable and animal substances in a state of solution. The importance and interest of this subject can hardly be overrated. I therefore subjoin Mr. Rainey's process for obtaining artificial calculi:—

"The chemical substances to be employed in the production of the artificial calculi are, a soluble compound of lime, and carbonate of potash or soda, dissolved in separate portions of water; and some viscid vegetable or animal substance, such as gum or albumen, to be mixed with each of these solutions. And the mechanical conditions required to act in conjunction with the chemical means are, the presence of such a quantity of the viscid

material in each solution as will be sufficient to make the two solutions, when mixed together, of about the same density as that of the nascent carbonate of lime, and a state of perfect rest of the fluid in which the decomposition is going on, so that the newly-formed compound may be interfered with as little as possible in its subsidence to the sides and bottom of the vessel. This will require two or three weeks, or longer, according to the size and completeness of the calculi. But I have not found that they increase at all after six weeks.

“The specific gravity of the compound solution should be 1.4068, when one ounce will weigh 672 grains. This solution must be perfectly clear; all the carbonate of lime which had been formed by the decomposition of the malate of lime contained in the gum, and also all the triple phosphate set free by the alkali, must have been allowed completely to subside. Next, two clean microscopic slides of glass, of the ordinary dimensions, are to be introduced, with the upper end of one slide resting against that of the other, and with their lower ends separate as far as the width of the phial will permit; and lastly, the bottle is to be filled up with a solution of gum arabic in common water, of 1.0844 specific gravity, one fluid ounce of which will weigh 520 grains. This solution must also be perfectly clear, having been first strained through cloth, and then left to stand for some days to allow of the subsidence of all the floating vegetable matter. It must also be added carefully to the alkaline solution, that the two solutions may be mixed as little as possible in this part of the process. The bottle must now be kept perfectly still, covered with a piece of paper to prevent the admission of dust, for three weeks or a month. Time would be saved by having a dozen bottles thus charged, and examining their contents at stated intervals, according to the chief object sought for in the experiment. The soluble salts of lime to be decomposed by the sub-carbonate of potash are contained in the gum, in combination with malic acid, and also in the common water; ammoniacomagnesian or triple phosphate is also contained in the gum, and is set free by the alkali. Muriate of lime, dissolved in a solution of gum from which all the lime had

been previously separated, would answer a similar purpose, provided the muriate were not in too great excess for the gum, in which case crystals of carbonate would be formed together with the globules, and the surface of the slide would become covered with coalescing patches of the latter. Also muriate of barytes and muriate of strontia, when treated in the same manner as the muriate of lime, furnish each a globular carbonate, the spherical form of the latter being particularly perfect and beautiful. But muriate of magnesia, when decomposed in the same manner, and under precisely the same conditions, does not furnish globules, but crystals of carbonate of magnesia, evincing no tendency to become globular.

"If the density of the alkaline solution exceed much the degree mentioned, and if that of the simple solution of gum is not equal to the degree there specified, the alkali diffusing itself through the simple solution of gum more rapidly than the gum contained in the lower solution, a larger quantity of carbonate will be found than there will be gum to combine with it in the proportion necessary to form the globular carbonate, and, consequently, the carbonate of lime found in the upper part of the bottle will be deficient in gum, and therefore it will be crystalline and not globular. An excess of carbonate of potash is also ordered to be put into the denser solution, so that, after one portion of alkali has precipitated the carbonate, the other may set free the triple phosphate, and these combining form the largest kinds of artificial calculi."<sup>1</sup>

Mr. Rainey shows the analogy or identity of his artificially formed crystals with those found in natural products both in animals and vegetables, chiefly confining himself to the structure and formation of shells and bone, pigmental and other cells, and the structure and development of the crystalline lenses, which, he contends, are all formed upon precisely the same physical principles as the artificial crystals. Take, for instance, the calculi found in the body: these cannot be distinguished from the crystals of artificially formed carbonate of lime. Again,

(1) G. Rainey, "*On the Mode of Formation of Shells, Bone, &c., by a process of Molecular Coalescence.*" 1858.

the shell of the crustaceans; the resemblance between these and the artificial products is, in some respects, more complete than in that of the calculi. All the appearances in shells can be best observed by merely cleaning them in water, and examining them in glycerine, grinding being unnecessary and injurious. Polarised light is indispensable; as in the young hermit-crab, at the part where the calcareous and membranous portions of the shell are continuous, the circular forms of globular carbonate are so delicate that no evidence whatever of its presence can be detected under powerful lenses, and with the best illumination, until polarised light is brought to bear upon the specimen. To obtain the most satisfactory results in the investigation of the process of calcification of animal tissues, it is indispensably necessary that the parts examined should be in the earliest stages of the process, and before the calcifying membrane is entirely covered with the globular coalescing deposit. The usual plan of examining shells in thin vertical sections is entirely useless, unless it be simply to see the number and arrangement of their layers; the part of the section in such specimens, in which the calcifying process ought to be best seen, being entirely ground off. This part, being the softest, can only be preserved in the process of grinding by extreme care, and by keeping the lower edge of the section always thicker than the upper.

“The resemblance between dentine and crab-shell, as observed by Dr. Carpenter, is in most respects correct, and sufficiently striking to justify the inference that they are formed in a similar manner. The globular particles of carbonate of lime in shell are doubtless analogous to the globular dentine in teeth, and the apparent spaces between the radiating lines in the former correspond in a great measure to the so-called dentinal tubes in the latter. But respecting the fact of there being in either case tubes, the results of my experience and investigations are opposed to this view. I may observe, that in the end of the crab's claw, as seen by the microscope, there are, as in other parts, two different kinds of structure, one consisting of alternate dark and light, generally sinuous lines, extending from the superficial towards the deep surface of the shell,

generally considered to be tubular. These lines exist in every part of the shell sufficiently thick to present them, and in certain positions, as in the end of the claws, their course gives them very much the appearance of dentine; but before they arrive at the cavity of the claw, they degenerate into mere dots, and have nothing in the character of tubuli. There can be little doubt that the same may be said of the spaces existing between the longitudinal portions of dentine. These latter spaces are in principle analogous to the canaliculi of bone; hence in one form of bone, the cementum or crusta petrosa canaliculi and dentinal canals sometimes exist together. The dentinal canals are merely spaces of feeble or imperfect cohesion, continued from the interglobular spaces, where such exist, between longitudinal portions of coalesced dentine, to the pulp cavity. These passages, becoming a little widened from the contraction of the part in drying, and containing air, seem to have, under the microscope, especially if appearances depending upon distance are not sufficiently allowed for, the appearance of tubes. It is, however, incompatible with the function of tubes, as they exist in other parts, that a system of such organs, intended for the conveyance of secreted fluids, should be simple prolongations of the interstices of the body, as are the spaces between globular portions of dentine and the pulp-cavity of a tooth, this latter, notwithstanding its size, being only a cellular interval. The other structure is distinctly tubular. It does not exist, excepting in the tegumentary part of the shell. These tubes pass from the external surface of the shell, through its substance, to its deeper one. They have distinct parietes; and their peripheral extremities in different parts of the same shell present very different forms. All along the convex border of the claw each of these tubes projects beyond the surface, where it becomes free, presenting generally a feathery extremity, or sometimes it seems split up into small fibres like a brush. Just at the point, and all along the biting edge, these tubes are rather smaller and more numerous; but, as might have been expected, they have not the feathery appendage. Notwithstanding, their ends are free and prominent. In the tubes alluded to, no projecting

ends are shown, these having been most probably ground off in making the preparation, but, in other respects, they perfectly agree with those I am describing, but in no respects with the flexuous lines before described. I have thin sections of crab's claw which had not been boiled, showing these tubes, but they are difficult to prepare. They can be most easily shown in the very young crab, but the best way to see them is in the decalcified shell. Now, I can easily imagine that tubes thus constructed, with one of their extremities expanded, and thus rendered favourable for the operation of extensive endosmose or exosmose, and with the other extremity close to the part of the shell where the globular carbonate of lime is chiefly found, would serve admirably to convey the water in contact with the surface of the animal, containing salts of lime, to the membrane lining the shell, where a quantity of sub-carbonate of soda is always present, and thus to bring into operation all the conditions required to form the globular carbonate which occurs in this situation. But, on the contrary, in the ivory of the tooth, circumstanced altogether unlike the claw of the crab, such tubes could be of no use, especially as they would be covered with a layer of enamel, and in some animals with a layer also of cementum. Now, as it is extremely probable that, with organs so decidedly tubular, there would not exist another set of tubes to perform the same function, an additional reason is here afforded in favour of the opinion of the structure of these alternating dark and light lines being as before described. It may be observed, further, that interstices of precisely the same character as those existing between the particles of dentine are found also between the analogous portions of enamel, which are also considered by some anatomists as distinct tubes."

"Dr. Carpenter says, that he has ascertained that the nacreous lustre of certain shells is due to the plication, or folding of a single layer of this membrane in such a mode, that the folds shall lie over one another in an imbricated manner. Although Dr. Carpenter's evidence upon this point appears very clear and circumstantial, it does not agree at all with the facts which occurred to me in examining the same parts, and therefore I am obliged to



differ from him. I have never seen in this membrane, when completely separated from the calcareous matter, any trace of this nacreous lustre, and consequently believe it to be due entirely to the carbonate of lime, and not to the membrane on which it is deposited. In my experiments I have always employed the polariscope, which furnishes the best means of deciding this point. Moreover, the nacreous lustre of a piece of shell is not in the least impaired by boiling it for any length of time in *liquor potassæ*, and but little so by heating it to redness, which must have been the case if the lustre were produced by the delicate folds of what Dr. Carpenter has called the nacre-membrane."

P. 236.]—My friend Mr. Millar writes me first with regard to the siliceous structure of wheat, &c. :—

"A few years ago, whilst examining the siliceous skeleton of the grasses with the Rev. J. B. Reade, I discovered that, by adding *carefully* to the hot nitric acid and vegetable matter some strong sulphuric acid, almost immediate solution took place of the vegetable matter; and in this way the process, instead of requiring hours for its accomplishment, was completed in a few minutes.

#### "ON MOUNTING INSECTS.

"In mounting whole insects, or parts of insects, I first soak them in the ordinary liquor potassæ of the Pharmacopœia, for a period varying with the density of the chitine and the amount of muscular fibre to be softened. They are then to be washed in water, and pressed until the muscular tissue is got rid of. The object may then be set out with water in the position it is intended to remain in, on a slide; cover it with another, tie them together, and then immerse in turpentine; in a few hours, the turpentine hardens the chitine, and, if allowed to remain long enough in it, will displace all the water. The object is then to be mounted in balsam in the usual way; should any water still remain in the object, it will cause a milkiness to appear around it when the cover is pressed down. The cover must be removed and the object washed in turpentine, as long as any milkiness is seen. If the legs

of the insect are allowed to dry, air gets into them, and it is almost impossible to get it out again; by this plan, they need never get dry. Some practice and manipulative dexterity are, of course, necessary to mount these objects well. Strong acetic acid will clean insects, but not so quickly as the potass. This has the same disadvantage as the liquor potassæ in containing water: a medium is required which will destroy the muscular tissues, soften the chitine, and combine with turpentine or balsam; this medium, I believe, the Rev. J. Thornton, of Asten Abbots, has found out, and by this means he is enabled to mount the very beautiful insects which we see about.

“The addition of sulphuric acid to the nitric acid, in destroying the animal matter of guano, I have also found to be useful.

“In covering objects, I have found that by wetting the cover with turpentine before dropping it on the balsam, it prevents the accumulation of air-bubbles.”

P. 415.]—Mr. Harper, having closely observed the boring *Pholades*, says:—

“They work with a ‘hyaline stylet,’ and, as far as I have been able to learn, there is very little indeed said about the organ in question, even in professedly scientific books. Its use up to the present time has been a mystery, but the general opinion of authors seems to be, that it is the gizzard of the Pholas. This I very much doubt, for it is my belief that the presence of such an important muscle is solely for the purpose of aiding the animal’s boring operations. Being situated in the centre of the foot, we can readily conceive the great increase of strength thus conveyed to the latter member, which is made to act as a powerful fulcrum, by the exercise of which the animal rotates, and at the same time presses its shell against and rasps the surface of the rock. The question being asked, ‘How can the stylet be procured to satisfy curiosity?’ I answer, by adopting the following extremely simple plan:—Having disintombed a specimen, with the point of a sharp instrument cut a slit in the base of its foot, and the object of your search will be distinctly visible in the shape of, if I may so term it, an opal cylinder. Sometimes I have

seen the point of this organ spring out beyond the incision, made as above described. Mr. Robertson says, 'The discovery of the function of the hyaline stylet is not merely a new discovery, it is the discovery of a kind of instrument as yet unique in physiology.' Now, although the *function* of the stylet may be considered novel, the statement of the fact of this object being in the foot of the *Pholas* cannot be called 'a new discovery,' as it occurs also in *Mytilus*, and, I believe, in almost all the bivalve mollusca."

# INDEX.

- ACALEPHÆ**, 378.  
**Acarina**, 450.  
**Acarus** of beetle, 461.  
 — of clothes moth, 461.  
 — farinæ, 459.  
 — of fly, 461.  
 — of fowl, 460.  
 — of rat, 454.  
 — sacchari, 458.  
 — scabiei, 455.  
**Achetina**, 511.  
**Achnanthes longipes**, 320.  
**Achromatic illuminator**, 76.  
 — object-glasses, 44.  
**Actinia gemmacea**, 363.  
 — mesembryanthemum, 364.  
**Adams' microscope**, 10.  
**Adulteration of food**, 242.  
**Alcyonella stagnorum**, 280.  
**Alcyonidæ**, 374.  
**Alcyonium digitatum**, 374.  
 — gelatinosum, 376.  
**Algæ**, development of, 208, 529.  
 —, preparation of, 113.  
**Air-pump** for removing air-bubbles, 108.  
**Amœba**, 266.  
**Amici's microscopes**, 12.  
**Anacharis alsinastrum**, 223.  
**Angle of aperture**, 44.  
 — of incidence, 16.  
 — of refraction, 17.  
 — mode of measuring, 45.  
**Anguillulæ**, 445.  
**Anguinaria**, 398.  
**Animalcule sun**, 265.  
 — breastplate, 301.  
**Animalcules**, cilia of, 294.  
 — collecting, 88.  
 — history of, 295.  
 — infusorial, 292.  
 — marine, 298.  
 — polygastrica, 292.  
 — rotifera, 333.  
**Animal cell**, history of, 527.  
 — action of cilia in, 540.  
 — cells, change of into tissues, 530.  
 — pigment cells, 535.  
 — classification of tissue, 554.  
 — division of kingdom, 262.  
 — elementary tissue, 554.  
 — epithelial, 536.  
**Animal fibrous membrane**, 555.  
 — life, 524.  
 — membrane, 554.  
 — multiplication of cells, 531.  
 — mounting tissues, 590.  
 — structure, mode of investigating, 585.  
 — tissues, submucous, 538.  
 — tissue, consolidated, 561.  
**Animals**, articulata, 436.  
**Annelida**, 449.  
**Annuloida**, 368.  
**Anthea**, 380.  
**Aplysia**, 413.  
**Aquarium** for fish and plants, 407.  
**Arachnidæ**, 435.  
**Arachnoidiscus**, 324.  
**Aristophanes**, microscope known to, 2.  
**Articulata**, 436.  
**Artists**, designs for, 324.  
**Ascaris**, 442.  
**Astasia**, 302.  
**Asteroidedæ**, 372.  
**BAKER ON THE MICROSCOPE**, 10.  
**Baker's Student's Microscope**, 591.  
**Balanidæ**, 311.  
**Barnacle**, 431.  
**Bat**, head of, 551.  
**Beale, Dr.**, on injecting, 122.  
**Bed-bug's egg**, 166.  
**Bee's tongue**, leg, &c., 503.  
**Beetles**, description of, 505.  
**Berg-mehl**, 325.  
**Binocular microscope**, 165.  
**Bird, Dr Golding**, on zoophytes, 408.  
**Blackwell**, on flies, 478.  
**Blood corpuscles**, 549.  
 — crystallization of, 550.  
**Blow-fly**, 482.  
**Bone**, 573.  
 — birds', 579.  
 — cutting sections of, 100.  
 — fishes', 580.  
 — ostrich, 575.  
 — human, 573.  
 — reptiles', 578.  
 — sting ray, 579.  
**Bonnan's microscope**, 8.  
**Bourguignon, Dr.**, on sarcoptes scabiei, 456.  
**Bowerbank** on sponges, 276.

- Boys, Mr. Thomas, on mounting, 109.  
 Brachionæ, 386.  
 Brachiopoda, 419.  
 Brewster, Sir David, on viewing objects, 70.  
 Brooke, Mr., on opaque objects, 81.  
 — on test objects, 57.  
 Bryozoa, 389.  
 — Bowerbankia, 391.  
 Burnett, Dr., on parasites, 459.  
 Busk, Mr., on *anguinaria spatulata*, 390.  
 — on hydatids, 443.  
 — on notamia, 392.  
 — on starch granules, 238.  
 — on echinococci, 444  
 Butterflies and moths, 489.
- CALEPTERYX VIRGO**, 485.  
 Camera-lucida, 139.  
 Campanularia, 362.  
 — *volubilis*, 362.  
*Campilodiscus clypeus*, 323.  
 Cane section, 237.  
 Capillaries, 552.  
 — in fat, 553.  
 Carpenter, Dr., on plants, 178.  
 — on diatomaceæ, 307.  
 Cartilage, 562.  
 — fang, &c., 563.  
 Carter, Mr., on chara development, 218.  
 — on spongilla, 281.  
 Caryophilleadæ, 371.  
 Cell formation, animals, 527.  
 — changes, 530.  
 — development, 534.  
 — pigment, 545.  
 — changes, vegetable, 228.  
 Cells, vegetable, 180.  
 Cells of glass for dissections, 104.  
 Celleporidæ, 395.  
 Cellulariæ, 396.  
 — *avicularia*, 396.  
 Cellular tissue of plants, 228  
 — in animals, 554.  
 Cementing pencil, 106.  
 Cements, 106.  
 Cephalopoda, 427.  
 Chara vulgaris, 215.  
 — antheridia of, 217.  
 — development, 218.  
 Chitonidæ, 421.  
 Cheese-mite, 457.  
 Chemical re-agents, 130.  
 Cilia, 296.  
 Ciliated epithelium, 539.  
 Circulation of blood in frog, to view, 592.  
 Cirrhipoda, 431.  
 Clematis section, 251.  
 Clepsinidæ, 448.  
*Closterium lunula*, 198.  
 Clionæ, 285.  
 Cœlenterata, 343.  
 Coldstream, Dr., on caryophyllia, 370.  
 Cocconema, 320.  
 Cochineal insect, 496.  
 Cockchafer, 506.  
 Collecting objects, 133.  
 — salt-water, 433.  
 — animalcules, 87.  
 — stick, Mr. Williamson's, 89.  
 Collodion for multiplying objects, 171.  
 — taking casts of insects' eyes in, 474.  
 Confervoidæ, 208.  
 Consolidated tissues, 562.  
 Corallines, 403.  
 Coral reefs, Captain Basil Hall on, 404.  
 — Dr. Macculloch on, 404.  
 Coryne-stauridia, 356.  
 Coscinodiscus, 324.  
 Crane-fly, 470.  
 Cricket, 511.  
 Crinoidea, 386.  
 Crisiadæ, 397.  
 — *eburnea*, 397.  
 Crustacea, 428.  
 Crystals of snow, 162.  
 — quinine, 160.  
 — urinary salts, 159.  
 — mode of showing optical axis, 156.  
*Cutleria dichotoma*, 214.  
 Cutting machine, 96.  
 Cyclops, 432.  
 Cypridæ, 432.  
 Cysticercus, 441.  
 — *fasciolaris*, 441.  
 — *pisiformis*, 441.  
 Czernak upon tooth substance, 571.
- DALYELL, SIR J. G., on tubularidæ, 335.  
 — on actiniæ, 348.  
*Daphnia pulex*, 433.  
*Dasya Kutziana*, 213.  
 Deane, Mr., on mounting objects, 110.  
 Death-watch beetle, 507.  
 Delabarre's microscope, 10.  
*Demodex folliculorum*, 457.  
 Denny, Mr., on parasites, 450.  
 Dentine, 568.  
 Dermestes, 508.  
 — hair from, 543.  
 Desmidiaceæ, 194.  
 — finding and preserving, 202.  
 — Mr. Ralls, on collecting, 202.  
*Deutzia scabia*, 235.  
 Diaphragm, description of, 72.  
 Diatomaceæ, 304.  
 — Kützing on, 310.  
 — Rev. W. Smith on collecting and preserving, 314.  
*Diffugia*, 265.  
*Diphydæ*, 345.  
 Dipping tubes, 87.  
 Disc, circular, 104.  
 Dissecting knives and needles, 91.  
 Distomidæ, 442.  
 Divini's microscope, 7.

Dragon-fly, description of, 485.  
Drone-fly, 479.

**ECHINIDÆ**, 380.  
Echinococci, 443.  
Echinodermata, 385.  
Ecker, on protozoa, 267.  
Egg of bed-bug, 166.  
Eggs of insects, 485.  
Ehrenberg on infusoria, 292.  
Elder root section, 257.  
Elm section, 250.  
Enamel, 569.  
Enchelia, 303.  
Enchondroma, 565.  
Entomostraca, 432.  
Entozoa, 441.  
Epithelium, 537.  
— columnar, 539.  
Epizoa, 455.  
Escharidæ, 399.  
— foliacea, 402.  
Eucratiadæ, 397.  
Eunotia, 313.  
Eye-glass, 31.  
Eye, human vessels in, 552.  
— pigment, 535.  
— kitten, vessels in, 552.  
— magnifying power of, 594.  
Eye-pieces, value of, 86.  
Eyes of insects, 474.

FAT cells, 555.  
Feet of insects, 477.  
Ferns, 224.  
— section of root, 231.  
Fibre, muscular, 557.  
— in the tongue, 559.  
— involuntary, 560.  
Fibrous tissue, 555.  
— white and yellow, 556.  
Fish, 582.  
Fishes' scales, 583.  
Flask animalcules, 303.  
Flax, 247.  
Flea, 513.  
— cat's, 515.  
— larva of, 515.  
Floscularia ornata, 329.  
— proboscidea, 346.  
Floscularidæ, 339.  
— Gosse's description of, 340.  
— stephanoceros, 339.  
Flustræ, 399.  
— avicularis, 401.  
— carbacea, 401.  
— chartacea, 401.  
— foliacea, 400.  
— Lamouroux on, 399.  
Fly, foot and leg of, 484.  
Foraminifera, 268.  
— faujasina, 272.  
Forceps for holding objects, 85.  
Fossil infusoria, 315.  
— mode of preparing, 318.

Fossil plants, 256.  
Frauenhofer's glasses, 10.  
Frog-plate, 592.  
— circulation, 551.  
— foot, 549.  
Fungi floating in air, 185.  
Fungoid growths, 184.  
Furze, Mr. J., on illumination, 81.  
**GALLIONELLA sulcata**, 322.  
Garrod's, Dr., crystals in blood, 551.  
Gas-lamp, 83.  
Gasteropoda, 420.  
Gillett's illuminator, 72.  
— mode of measuring angle of aperture, 45.  
Glycerine, for mounting objects, 111.  
Gnat, description of, 486.  
Goadby's fluids, 112.  
Gomphonema, 306.  
Gordiacea, 445.  
Gorgoniadæ, 377.  
— spiculæ from, 287.  
Gorgonia flabellum, 377.  
Gorham's, Mr., holder, 106.  
— on eyes of insects, 474.  
— on the magnifying power of the eye, 594.  
Goring, Dr., achromatic object glasses, 13.  
Gosse, Mr., on marine animalcules, 299.  
— on cellularity, 396.  
— on coryne stauridia, 356.  
— on melicerta ringens, 340.  
Graminacæ, 236.  
Grant, Dr., on flustra, 401.  
— on aleyonidæ, 375.  
— on plumularia, 359.  
— on sponges, 276.  
Grape blight, 183.  
— section of, 184.  
Grass, cuticle of, 235.  
Gregarinida, 263.  
Guinea worm, 443.  
Gyrius, 509.  
**HAIR**, human, 542.  
— bat, Indian, 543.  
— mouse, 543.  
— pecari, 544.  
Haliotus splendens, 420.  
Hand magnifiers, 33.  
Harvey, Dr., on algæ, 210.  
— on collecting salt-water specimens, 433.  
Hassall, Dr., on the adulteration of food, 245.  
Hepaticæ, 205.  
Herapath's, Dr., polarising crystal, 152.  
— iodo-quinine, 158.  
Heteroptera, 509.  
Highley's photographic camera for microscopic objects, 172.  
Hill's microscope, 10.

- Himoptera,**  
*Hipparchia janira*, 494 :  
*Hirudinidæ*, 447.  
**History, Natural, division of,** 262.  
**Holland's eye-piece,** 33.  
**Holothuridæ,** 389.  
 — drawing of, life size, 388.  
**Hooke's microscope,** 7.  
**Human body,** 527.  
**Huxley, T. H., on the cell theory,** 536.  
 — on *echinidæ*, 381.  
 — on *polypifera*, 345.  
**Huyghenian eye-piece,** 47.  
**Hydatids,** 444.  
**Hydra,** 351.  
**Hydrachnidæ,** 462.  
**Hydrophilus,** 477.  
**Hymenoptera,** 498.
- ICELAND spar,** 145.  
**Improvements in microscope,** 10.  
**India-rubber tree, section of leaf,** 230.  
**Infusoria, Ehrenberg's account of,** 292.  
 — fossil, 315.  
 — history of, 292.  
**Infusorial animalcules,** 309.  
**Injecting, mode of,** 116.  
 — lower animals, 125.  
 — Dr. Beale's mode of, 122.  
**Injections, transparent,** 122.  
 — various colours, 124.  
**Insects,** 469.  
 — changes of, 517.  
 — commercial importance of, 520.  
 — dissection of, Swammerdam's, 515.  
 — distribution of, 470.  
 — eggs, 485.  
 — feet, 477.  
 — mode of mounting, 517.  
 — mouths, 472.  
 — parts for examination, 471.  
 — probosces, 481.  
 — stings, 487.  
 — tongues, 472, 479.  
 — uses of, 482.  
 — wings of, 485.  
 — internal parts, 517.  
**Iris leaf,** 232.  
**Isidæ,** 378.  
**Isis hippuris,** 378.  
**Ixodidæ,** 462.
- JACKSON'S, Mr., micrometer,** 51.  
**Jellyfish,** 379.  
**Johnston, Dr., on sponges,** 275.  
 — on *actinia*, 365.  
 — on *campanularia*, 362.  
**Jones, Mr. Wharton, on non-striated muscular fibre,** 560.  
 — on the circulation in frog's foot, 551.
- KNIVES, Quekett's and Valentin's,** 94.  
**Kölliker on the skin,** 560.
- LAMPS,** 83.  
**Lankester, Dr., on plants and animals,** 178.  
**Leech, medicinal,** 447.  
**Leeuwenhoek's microscope,** 6.  
**Legg, Mr. S., on polarisation,** 153.  
**Lenses, achromatic,** 26.  
 — chromatic aberration of, 26.  
 — Coddington, 34.  
 — concavo-convex, 19.  
 — condensing, 81.  
 — different forms of, 18.  
 — double convex, 18.  
 — meniscus, 20.  
 — method of tracing progress of rays through, 15.  
 — periscopic, 33.  
 — plano-convex, 18.  
 — refraction of light through, 15.  
 — spherical aberration of, 22.  
 — Stanhope, 35.  
**Lepidoptera,** 488.  
**Lepisma,** 513.  
**Lepralia,** 395.  
 — nitida, 395.  
**Lewes, Mr. G. H., on animal life,** 261.  
 — on physiology, 524.  
 — on *actinidæ*, 348.  
**Libellulidæ,** 485.  
**Lieberkuhn's microscope,** 5.  
 — specula, 83.  
**Life, theory of animal,** 524.  
**Limax rufus,** 413.  
**Limnæa stagnalis,** 423.  
**Limnias ceratophylli,** 339.  
**Lister's lenses,** 12.  
**Liver, diseased,** 444.  
**Liverworts,** 205.  
**Lobb, Mr., on the polarising axis of crystals,** 155.  
**Louse,** 452.  
**Lucernaridæ,** 370.  
 — *campanulata*, 370.  
**Lung capillaries,** 552.  
**Lycosidæ,** 468.
- MADREPORIDÆ,** 370.  
**Marine vivaria,** 406.  
**Melolontha, eye of,** 475.  
**Mechanical arrangements,** 61.  
**Melicerta ringens,** 340.  
**Mesogloia vermicularis,** 211.  
**Micrometers,** 50.  
**Microscope, Baker on the,** 10.  
 — Baker's, 62.  
 — Bonnan's, 8.  
 — compound, 38.  
 — Huyghenian, eye-piece of, 47.  
 — Lieberkuhn's, 5.  
 — Powell and Leland's, 64.  
 — Ross's, body of, 46.  
 — simple, for dissections, 35.  
 — Quekett's, 38.  
 — Warington's, 67.  
**Miller, Hugh, on fossil plants,** 256.

- Mite, cheese, 457.**  
 — flour, 459.  
**Mollusca, 411.**  
**Monads, 299.**  
**Moss-agates, 289.**  
**Mosses, 205.**  
**Moths and butterflies, 489.**  
**Mülder on the vegetable cell, 180.**  
**Muscular fibre, 557.**  
**Mycoderma aceti, 188.**
- NAILS, the, 541.**  
**Naviculæ, 312.**  
**Nemeritidæ, 439.**  
**Nerves, 560.**  
**Newport on moths, 492.**  
**Newt, 587.**  
**Nicols' prism, 146.**  
**Nitella, 220.**  
**Nobert's ruled lines on glass, 54.**  
**Noctiluca miliaris, 298.**  
**Notamia busaria, 392.**  
**Notommata aurita, 337.**
- OBJECT-GLASSES, 31.**  
 — Boss's, 55.  
**Objects, Shadbolt on collecting, 133.**  
 — mounting and preserving, 105.  
 — Boys on mounting, 109.  
 — salt-water specimens, 267.  
**Onion, section of, 234.**  
**Ophiuridæ, 886.**  
**Osborne, Rev. S. G., on air fungi, 185.**  
 — on closterium lunula, 198.  
**Oscillatoria, 177.**  
**Ostracoda, 432.**  
**Owen, Professor, on animalcules, 328.**  
 — on microscopic investigation, 565.  
**Oyster, 416.**  
 — fry, 431.
- PARABOLIC REFLECTORS, 78.**  
**Parasites, 450.**  
 — from cat, 454.  
 — from dog, 454.  
 — from eagle, 463.  
 — from fowl, 460.  
 — from hornbill, 462.  
 — from human being, 457.  
 — from pheasant, 460.  
 — from pigeon, 463.  
 — from sheep, 455.  
 — from swallow, 459.  
 — from turkey, 460.  
 — from vulture, 463.  
**Pear, section of, 234.**  
**Pearls, 417.**  
 — artificial, 418.  
**Pediculi, 460.**  
**Pennatuladæ, 372.**  
 — phosphorea, 384.  
**Pholas dactylus, 415.**  
**Photography applied to microscope, 170.**  
**Phryganeidæ, 488.**  
**Pigment cells, 540.**
- Pinna ingens, section of, 385.**  
**Planariæ, 440.**  
**Plants, cellular tissue of, 228.**  
 — circulation in, 216.  
 — crystals in, 234.  
 — fossil, 256.  
 — lactiferous tissue of, 220.  
 — lice, 497.  
 — pollen grains, 255.  
 — pollen and seeds from, 255.  
 — preparation of tissues, 253.  
 — raphides in, 233.  
 — sections of, 254.  
 — silica in, 236.  
 — siliceous cuticle of, 235.  
 — starch in, 237.  
 — starch of potato, 243.  
 — structure of, 174.  
 — vascular tissue of, 249.  
 — vital characteristics, 175.  
**Pleurosigmata, 312.**  
**Plumularia, 359.**  
**Podura plumbea, 512.**  
**Polarisation of light as applied to the microscope, 142.**  
**Polyzoa, 389.**  
**Polygastrica of Ehrenberg, 292.**  
**Polyommatus argiolus, 493.**  
**Polypifera, 342.**  
**Polythalamia, 269.**  
**Pontia brassica, 494.**  
**Porifera, 342.**  
**Potato, disease of, 243.**  
**Preparation of insects, 517.**  
**Preparing sections of bone, 100.**  
**Preservation of algæ, 113.**  
 — zoophytes, 408.  
**Prism, Dujardin's, 68.**  
**Proteus, the, 266.**  
**Protococcus pluvialis, 190.**  
**Protozoa, 263.**  
**Pteropoda, 416.**
- QUEKETT, Edwin, on the vascular tissue of plants, 249.**  
 — Professor, on the advantages of polarised light, 164.  
 — on raphides in plants, 229.  
 — on the structure of bone, 574.  
 — dissecting microscope, 38.
- RALFS, Mr., on desmidiæ, 194.**  
**Raphides in plants, 235.**  
**Read's, Rev. J. B., background illuminator, 81.**  
**Reagents, effects of, 586.**  
**Redfern, Dr., on naviculæ, 319.**  
**Reflector, parabolic, 78.**  
 — Shadbolt's, Mr., 80.  
**Rhinoceros horn, 585.**  
**Rhizopoda, 265.**  
**Robinson, Mr., on pholas, 415.**  
**Roget, Dr., on tubulariæ, 354.**  
**Rainey, Mr., on the artificial formation of crystals, &c. page 606.**



- Ross, Mr., on illumination, 71.  
 Rotatoridæ, 333.
- SALTER**, Mr. J. A., on dentine, 571.  
 — Dr. Hyde, on muscle, 558.  
*Sarcina ventriculi*, 182.  
*Sarcoptes scabiei*, 455.  
 Saw-fly, 499.  
 Schultze, Dr., on rhizopoda, 267.  
 Scissors, dissecting, 96.  
 Sea-mice, 450.  
 — slug, 422.  
 — soundings, 273.  
 Section cutting-machine, 96.  
 Selenite, 151.  
 Serpula, 450.  
*Sertularidæ*, 357.  
 — pumila, 358.  
 — setacea, 358.  
 Shadbolt, Mr., on collecting, 133.  
 Sheep tick, 464.  
 Silk, 248.  
 Silkworm's breathing aperture, 476.  
 Siller-cups, 204.  
 Single microscope, 4.  
 Skeletons of zoophytes, 408.  
 Skin, fungoid diseases of, 184.  
 — section of, 546.  
 — capillaries of, 545.  
 — nerves of, 545.  
 Smith and Beck's troughs, 91.  
 Smith, Professor W., on foraminifera, 273.  
 — on diatomaceæ, 307.  
 Snails, 432.  
 Snow, crystals of, 163.  
 — red, 189.  
*Spacelaria cirrhosa*, 213.  
*Sphagnum*, leaf of, 231.  
 Spiders, 465.  
 — diving, 468.  
 Sponges, 275.  
 — skeletons of, 286.  
 — spicula from, 277.  
*Spongilla cinerea*, 281.  
 — alba, &c., 282.  
 — development of, 282.  
 Starch in plants, 237.  
 — potato polarised, 164.  
 — tests for, 411, 424.  
 Steam bath, 108.  
 Stellate tissue from a rush, 229.  
 Stentor, 332.  
 Stinging-nettle, leaves of, 256.  
 Stickleback, 584.  
 Structure of shell, 428.  
 Sugar insect, 458.  
 — cane, 232.  
 Swammerdam's dissection of insects, 469.  
 Swarm-spore, 285.  
*Synaptidæ*, 382.
- TENIADE**, 440.
- Teeth, 567.  
 — Nasmyth's membrane, 569.  
 — structure of, 570.  
 Test objects, 57, 495.  
 — navicula, 313.  
*Thysanura*, 512.  
*Tinea vestianella*, 494.  
 Tissue, woody, 247.  
 — animal, 530.  
 Tissues, consolidated animal, 561.  
 — elastic and non-elastic, 555.  
 Tomata, diseased, 183.  
 Tomkins, Mr. J. N., on alcyonella, 280.  
 Tooth, section of, 567.  
 — of prestis, 571.  
 — of ray, 572.  
 Topping's test-objects, 495.  
*Torula cerevisia*, 182.  
 — diabetica, 182.  
 Tourmaline, 148.  
 Transformation insect, 517.  
 Trembley on hydra, 352.  
*Trichocera hyemalis*, 486.  
 Troughs, animalcule, 91.  
*Tubicola*, 448.  
*Tubiporidae*, 376.  
*Tubularidæ*, 354.  
*Turbellaria*, 438.  
*Tunicata*, 416.
- VALLISNERIA**, 223.  
 Varley, Mr., on the culture of water-plants, 222.  
 Vegetable structure, 174.  
 — cellular tissue, 228.  
 — fungi, 183.  
 — hairs, 256.  
 — preparation of tissues, 253.  
 — raphides, 229.  
 — starch, 237.  
 — vascular tissue, 251.  
*Vibrio spirilla*, 302.  
 Vinegar plant, 188.  
*Virgularia mirabilis*, 373.  
 Vivaria, the mode of forming, 405.  
 Volvox, 192.  
*Vorticellidæ*, 329.
- WARD** on aquaria, 407.  
 Warrington's microscope, 67.  
 — preservative fluid, 111.  
 Wasp's tongue, 472.  
 Water-beetle, sucker of, 478.  
 Water microscope, 5.  
 Water-bugs, 509.  
 Water-mites, 463.  
 Welk, palate of, 422.  
 Wenham's, Mr., photography applied to microscopic drawing, 171.  
 — binocular microscope, 165.  
 — illuminator, 78.  
 Wheat-flour, adulterations of, 240.

- |   |   |
|---|---|
| <p>Wheat-flour, portion of husk, 236.<br/> Wollaston's and Coddington's lenses, 33.<br/> Wood, mode of cutting sections, 99.<br/> Woodward, Mr., on polarised light, 142.<br/> Wool, 248.</p> <p><b>XANTHIDIA, 325.</b></p> | <p><b>YEAST-PLANT, 181.</b><br/> Yew, section of, 250.</p> <p><b>ZOOLOGICAL Society's aquaria, 406.</b><br/> Zoophytes, 342.<br/> — skeletons of,<br/> — preservation of polypidoms of, 408.<br/> Zygoceros rhombus, 316.</p> |
|---|---|



THE END.