



PARTS CATALOGUE
MODEL A & AA

錄 目 件 配 特 福
A 及 AA 式

日一月四年一十二國民華中
Effective April 1st, 1923

Ford Motor Company, Exports Inc.

SHANGHAI

海 上

司 公 車 汽 特 福

USE GENUINE FORD PARTS ONLY
件 零 特 福 正 真 用 請



Ford
THE UNIVERSAL CAR.

PARTS CATALOGUE
MODEL A & AA

錄 目 件 配 特 福
A 及 AA 式

日一月四年一十二國民華中
Effective April 1st, 1932

Ford Motor Company, Exports Inc.

SHANGHAI

海 上
司 公 車 汽 特 福

USE GENUINE FORD PARTS ONLY
件 零 特 福 正 真 用 購 請

INDEX

MODEL A

A	Page	P	Page
Accelerator	37	Pan—Engine	25
Accessories	76	Pan—Oil	25
Ammeter	41	Panel—Instrument	45
Axle—Front	9	Pins	92
Axle—Rear	14	Piston	22
		Plugs	93
B		Plug—Spark	46
Battery	41	Pump—Oil	25
Battery Support	17	Pump—Water	33
Bolts	79		
Brake—Service	3	R	
Brake Controls—Service	4	Radiator	31
Brake Controls—Emergency	8	Rivets	90
Brake—Emergency	6	Running Board	61
Bumper	72		
		S	
C		Screws—Machine	79
Camshaft	23	Screws—Wood	90
Carburetor	35	Shield—Running Board	61
Clamps—Wiring	56	Shield—Splash	61
Clutch	28	Shock Absorber	74
Coil—Ignition	46	Spark Plugs	46
Condenser	46	Speedometer	64
Connecting Rod	22	Spring—Front	18
Control—Spark and Throttle	37	Spring—Rear	20
Cooling System	31	Standard Parts	79
Cotters	91	Starter Drive	43
Cowl	31	Starter Motor	41
Crankshaft	23	Steering Gear	11
Cylinder	21	Studs	93
		Switch—Ignition	45
D-E		Switch—Lighting	45
Distributor	46	Switch—Starter	44
Drive—Starter	43		
Electrical System	37	T	
Engine	21	Terminals	55
		Tools	63
F		Tools—Special	139
Fan	33	Transmission	26
Fasteners	93		
Fender—Front	57	V	
Fender—Rear	59	Valves	24
Flywheel	24		
Frame	16	W	
Fuel System	34	Washers	87
		Wheels	1
G		Windshield Wings	75
Gear Shift	28	Wiper—Windshield	65
Generator	37	Wiring	53
		TRUCK PARTS—MODEL AA	
H		Axle—Front	106
Hand Brake Lever	6	Axle—Rear	106
Hood	62	Brake—Service	100
Horn	53	Brake Control—Service	102
		Brake—Emergency	101
K		Brake Control—Emergency	105
Keys	92	Clutch	129
		Dual High	114
L		Electrical System	130
Lamp—Cowl	49	Fenders	132
Lamp—Dome	52	Frame	118
Lamp—Fender	49	Gear Shift—Four Speed	127
Lamp—Head	47	Miscellaneous Parts	139
Lamp—Instrument Panel	52	Radiator	130
Lamp—Rear	50	Running Board	132
License Bracket	50	Shaft—Coupling	114
Lubricator Fittings	93	Shield—Running Board	132
		Spring—Front	121
M		Spring—Rear	123
Manifold—Inlet and Exhaust	35	Transmission—Four Speed	128
Mirror—Rear View	70	Tools	135
Motor—Starter	27	Universal Joint	126
Muffler	18	Wheels	95
		Wheel Carrier	97
N			
Nuts	85		

目 錄

“A” 式

	頁數		頁數
加速桿	37	車框	16
常備零件	76	汽油系	34
指電表	41	更換齒輪	28
前輪軸	9	發電機	37
後輪軸	14	手掣桿	6
電池	41	車轆蓋	62
電池架	17	喇叭	53
螺絲	79	鍵	92
停車掣	3	轆蓋燈	49
停車掣運用	4	半光燈	52
意外停車掣運用	8	車翅燈	49
意外停車掣	6	車頭燈	47
車擋	72	御前板燈	52
偏心軸	23	尾燈	50
化汽機	35	執照架	50
電線夾	56	注油嘴	93
傳力盒	28	進迴氣管	35
發火線圈	46	照後鏡	70
凝電器	46	發動機	27
接連桿	22	消聲器	18
火桿及風桿	37	螺絲帽	88
散熱系	31	引擎底	25
鎖針	91	油池	15
轆蓋	34	御前鑲板	45
拐軸	23	針	92
汽缸	21	活塞	22
分電器	46	塞	93
發動機齒輪	43	火星塞	46
電系	37	抽油機	25
引擎	21	抽水機	23
風扇	33	水箱	31
扭扣	93	帽釘(又名窩釘)	90
前車翅	57	登車板	61
後車翅	59	螺絲釘	79
飛輪	24	螺絲釘	90

目 錄—續

“A” 式—續

	頁數		頁數
登車板防塵殼.....	61	點燈開關.....	45
防泥殼.....	61	發動開機關.....	44
避震器.....	74	終點.....	55
火星塞.....	46	用具.....	63
速度表.....	64	特別用具.....	139
前彈簧.....	18	傳力機.....	26
後彈簧.....	20	汽門.....	24
標準零件.....	79	圈片及鎖環.....	87
發動齒輪.....	43	車輪.....	1
發動機.....	41	屏風翼.....	75
駕駛舵輪.....	11	屏風水擦.....	65
螺絲(無頭).....	93	電線.....	53
發火開關.....	45		

“AA” 式貨車零件

	頁數		頁數
前輪軸.....	106	雜件.....	139
後輪軸.....	106	水箱.....	130
停車掣.....	100	登車板.....	132
停車掣運用.....	102	接軸.....	114
意外停車掣.....	104	登車板防塵殼.....	132
意外停車掣運用.....	105	前彈簧.....	121
傳力盒.....	129	後彈簧.....	123
高複機.....	114	傳力機.....	126
電系.....	130	用具.....	135
車翅.....	132	總關節.....	126
車框架.....	118	車輪.....	95
更換齒輪—四速度.....	127	車輪架.....	97



PARTS CATALOGUE

FORD MODEL A

EFFECTIVE JULY 1, 1931

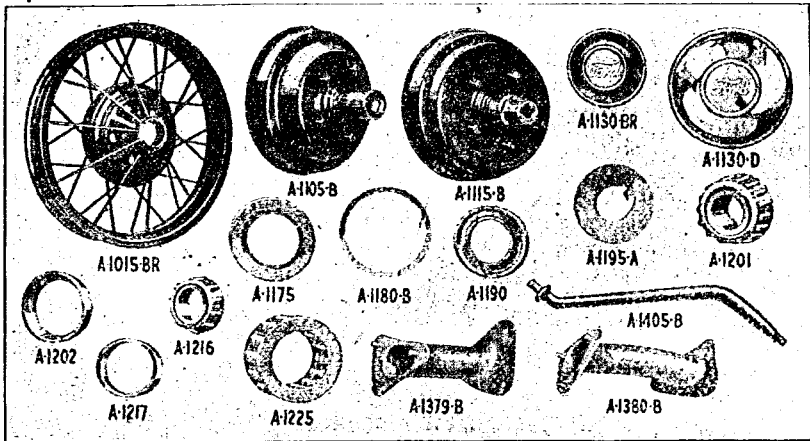

Part No.	Name of Part	Year	貨名
----------	--------------	------	----

WHEELS 車輪

A-1012-AR	Hub bolt nut (Old No. 21837-AR-S7)	1928	輪心螺絲帽
A-1012-B	Hub bolt nut (Old No. A-21837-B)	1928-31	輪心螺絲帽
A-1015-AR	Wheel	1928	車輪
A-1015-BR	Wheel	1928-29	車輪
A-1015-D	Wheel	1930-31	車輪
	Rim lining (use 61% of A-158332)	1928-29	鋼圈護帶
A-1024-B	Rim lining	1930-31	鋼圈護帶
A-1105-AR	Front hub and brake drum	1928	前輪心與車制殼
A-1105-B	Front hub and brake drum	1928-31	前輪心與車制殼
†A-1107-AR	Bolt—1 3/8" (Old No. A21213-R)	1928-29	螺絲
**A-1107-B	Bolt—1 11/32" (Old No. A21234-S7)	1928-31	螺絲
A-1012-AR	Nut	1928	螺絲帽
A-1012-B	Nut	1928-31	螺絲帽
A-1115-AR	Rear hub and brake drum	1928	後輪心與車制殼
A-1115-B	Rear hub and brake drum	1928-31	後輪心與車制殼
A-22374	Gasket	1928-31	墊
A-22371	Washer	1928-31	垫片
*A-1118	Bolt (Old No. A-21232-S7)	1928-31	螺絲
A-1012-AR	Nut	1928	螺絲帽
A-1012-B	Nut	1928-31	螺絲帽
A-1130-BR	Hub cap	1928-29	輪心帽
A-1130-D	Hub cap	1930-31	輪心帽
A-1175	Rear Wheel grease retainer assembly	1928-31	後輪儲油帽總成

** With emergency brake.

† Without emergency brake.

Part No.	Name of Part	Year	貨名
A-1180-B	Rear wheel grease retainer ring	1928-31	後輪儲油帽總成
A-1190	Front hub dust cap	1928-31	前輪心塵塵圈
A-1195-A	Front hub grease retainer washer	1928-31	前輪心儲油帽圈片
A-1201	Front wheel inner brg. cone assembly	1928-31	前輪內部滑滾總成
A-1202	Front wheel inner bearing cup	1928-31	前輪內部滑滾蓋
A-1216	Front wheel outer bearing cone assembly	1928-31	前輪外部滑滾總成
A-1217	Front wheel outer bearing cup	1928-31	前輪外部滑滾蓋
A-1225	Rear wheel bearing	1928-31	後輪滑滾
A-24405	Lubricator fitting	1928-31	注油嘴
A-1378-R	Wheel carrier assembly—60A-B	1928-29	常備輪架總成
A-1379-AR	Wheel carrier assembly—40A, 45A, 54A, 50A, 68A	1928-29	常備輪架總成
A-1379-B	Wheel carrier assembly—40B, 45B, 50B, 68B	1930-31	常備輪架總成
A-1380-B	Wheel carrier assembly—35A, 35B, 55A, 55B, 135A, 140A, 155A-B, 165A-B-C-D	1928-31	備常輪架總成
A-20935-S1	Bolt (carrier to body) lower	1928-31	螺絲(輪架連車身)下
A-22245	Washer— $\frac{3}{8}$ "	1928-31	圓片
A-21136-S4	Bolt (carrier to body) upper— $2\frac{15}{16}$ "	1928-31	螺絲(輪架連車身)上
A-21133-S4	Bolt (carrier to body) upper— $1\frac{3}{4}$ "	1928-31	螺絲(輪架連車身)上
A-21125-S1	Bolt (carrier to body) upper— $2\frac{1}{4}$ "	1928-31	螺絲(輪架連車身)上
A-22300	Washer— $7/16$ "	1928-31	圓片
A-21127-S4	Bolt (carrier to body)	1928-31	螺絲(輪架連車身)
A-1012-AR	Nut	1928	螺絲帽
A-1012-B	Nut	1928-31	螺絲帽
A-21846-S7	Check nut	1928-31	螺絲帽
A-22330	Spacer washer	1928-31	格片
A-1395-AR	Tire cover	1928-29	輪胎殼
A-1395-B	Tire cover	1930-31	輪胎殼
A-1395-C	Metal tire cover (black)	1930-31	金屬輪胎殼(黑)
A-1395-D	Metal tire cover (chrome)	1930-31	金屬輪胎殼(鍍)
A-1395-E	Tire cover with rustless steel moulding.	1931	輪胎殼有不銹鋼料模線者
A-1398-AR	Tire cover wire assembly	1928-31	輪胎殼模線成
A-1402	Wheel carrier flange—R. H.	1930-31	輪架沿邊 右
A-1405-AR	Wheel carrier support	1928-30	輪架支柱
A-1405-B	Wheel carrier support	1930-31	輪架支柱
A-21894	Support nut	1928-31	架螺絲帽
A-22370	Washer	1928-31	圓片
A-23552	Cotter	1928-31	銷針
A-1406-AR	Wheel carrier flange	1928-30	輪架沿邊
A-1406-B	Wheel carrier flange—L. H.	1930-31	輪架沿邊 左
A-1410-AR	Wheel carrier support anti-rattler	1928-30	輪架帶消聲器
A-1410-B	Wheel carrier support anti-rattler	1930-31	輪架帶消聲器
A-1411	Wheel carrier assembly—160A-B-C	1931	輪架總成
A-1413	Wheel carrier assembly—190A	1930-31	輪架總成
A-1415-AR	Wheel carrier bracket	1928-30	輪架托
A-1415-B	Wheel carrier bracket	1928-31	輪架托
A-20732	Bolt (carrier to frame)	1928-31	螺絲(架連車框)

Part No.	Name of Part	Year	貨名
A-21701-S2	Nut	1928-31	螺絲帽
A-23516	Cotter	1928-31	鎖針
SERVICE BRAKE 車 掣			
A-2011	Front brake housing plate Assembly	1928-31	前車掣殼護片總成
A-20919	Bolt—with forged hub	1928-30	螺絲
A-20949	Bolt—with pressed steel hub	1928-31	螺絲
A-21745	Nut	1928-31	螺絲帽
A-23534	Cotter	1928-31	鎖針
A-2019	Brake shoe assembly	1928-31	車制片總成
A-2021	Brake lining	1928-31	車制護帶
A-22997	Rivet	1928-31	窩釘
A-2023-A	Brake shoe roller	1928-31	車制片滑輪
A-23870-S7	Pin—long	1928-31	長針
A-23873-S7	Pin—short	1928-31	短針
A-23551	Cotter	1928-31	鎖針
A-2035	Brake retracting spring—long	1928-31	長度車制縮彈簧
A-2036	Brake retracting spring—short	1928-31	短度車制縮彈簧
A-2041	Brake adjusting wedge	1928-31	車制調節楔
A-24460-AR	Brake adjusting bracket plug	1928-31	車制調節架塞
A-2042	Brake adjusting shaft	1928-31	車輪調節軸
A-2050	Front brake operating wedge	1928-31	前車輪運用楔
A-2051	Operating wedge stud assembly	1928-31	運用楔螺絲總成
A-21839-S1	Nut	1928-39	螺絲帽
A-22302-B	Washer	1928-31	隔片
A-23551	Cotter	1928-31	鎖針
AA-2059-AR	Front brake grease baffle assembly— with forged hubs	1928-30	前車制護油片總成
A-2060-B	Front brake grease baffle—with pres- sed steel hub	1928-31	前車制護油片
A-2075	Front brake operating pin	1928-31	前車制運用針
A-2076-B	Front brake shaft—R. H.	1928-31	右前車制軸
A-2077-B	Front brake shaft—L. H.	1928-31	左前車制軸
A-24404-S7	Lubricator fitting	1928-31	注油嘴
A-2078-C	Front brake shaft housing	1928-31	前車制軸殼
A-23534	Nut	1928-31	螺絲帽
A-22300	Lock Washer	1928-31	鎖環
A-2082	Front brake shaft housing bushing	1928-31	前車制軸殼套
A-2084-C	Front brake lever	1928-31	前車制桿
A-23766	Pin	1928-29	針
A-2087	Front brake lever dustring	1928-31	後車制桿遮塵環
A-2211-B	Rear brake housing plate assembly	1928-31	前車制殼護片總成
A-21151-S1	Bolt—short	1928-31	短螺絲
A-21152-S1	Bolt—long	1928-31	長螺絲
A-21791-S3	Nut	1928	螺絲帽
A-21801	Nut	1928-31	螺絲帽
A-23531	Cotter	1928-31	鎖針
‡A-2211-CR	Rear brake housing plate assembly	1928-29	後車制殼護片總成
A-21211-R	Bolt—short	1928-29	短螺絲

‡When used to replace A-2211-AR also use A-2235-C or A-2236-C and A-2231-B.

Part No.	Name of Part	Year	貨名
A-21210-R	Bolt—long	1928-29	長螺絲
A-21791-S3	Nut	1928	螺絲帽
A-21801	Nut	1928-29	螺絲帽
A-23531	Cotter	1928-31	鎖針

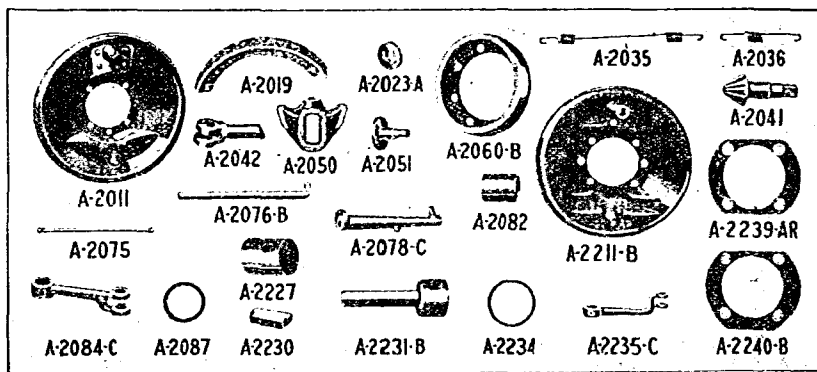

A-2227	Rear brake camshaft bracket bushing	1928-31	後車制凸輪軸架墊
A-24404-S7	Lubricator fitting	1928-31	注油嘴
A-2230	Rear brake cam	1928-31	後車制凸輪
A-2231-AR	Rear brake camshaft	1928	後車制凸輪軸
A-2231-B	Rear brake camshaft	1928-31	後車制凸輪軸
A-2234	Rear brake camshaft dust ring	1928-31	後車制凸輪軸避塵環
A-2235-AR	Rear brake camshaft lever—R. H.	1928	後車制凸輪軸桿 右
A-2235-C	Rear brake camshaft lever—R. H.	1930-31	後車制凸輪軸桿 右
A-2236-AR	Rear brake camshaft lever—L. H.	1928	後車制凸輪軸桿 左
A-2236-C	Rear brake camshaft lever—L. H.	1930-31	後車制凸輪軸桿 左
A-23782	Pin	1928-31	針
A-2239-AR	Rear brake grease baffle	1928	後車制護油片
A-2240-B	Rear brake grease baffle	1928-31	後車制護油片

SERVICE BRAKE CONTROLS 車製 運用







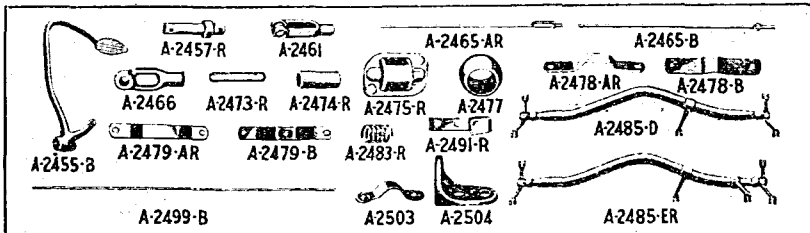

†A-2455-AR	Brake pedal	1928-29	車制腳踏板
A-2455-B	Brake pedal	1928-31	車制腳踏板
A-7508-B	Brake pedal bushing	1928-31	車制腳踏板套
A-24404-S7	Lubricator fitting	1930-31	注油嘴
A-2457-R	Brake pedal clevis pin	1928-29	車制腳踏板U形針
A-23555	Cotter	1928-31	鎖針
A-2461	Brake rod clevis—adjustable	1928-31	車制桿U形鐵 隨意調節
A-2465-AR	Brake pedal to equalizer shaft rod— 15 1/2"	1928	車制腳踏板連等力軸桿
A-21700	Nut	1928	螺絲帽
A-23822-S7	Link pin	1928	連接針
A-23555	Cotter	1928	鎖針

†Use with multiple disc clutch.

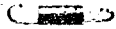
Part No.	Name of Part	Year	貨名
A-2465-B	Brake pedal to cross shaft rod—15 ¹¹ / ₁₆ "	1928-31	車制踏踏板連橫桿
A-21700	Nut	1930-31	螺絲帽
A-23822-S7	Pin	1930-31	針
A-23555	Cotter	1930-31	鎖針
A-2466	Brake rod eye (adjustable)	1928-31	車制桿孔(隨意調節)
A-2473-R	Brake equalizer operating shaft pin	1928	車制均力運用軸針
A-2474-R	Equalizer operating shaft bushing	1928	均力運用軸套
A-2475-R	Equalizer operating shaft pin cap	1928	均力運用軸針蓋
A-20738-S1	Bolt	1928	螺絲
A-21701-S2	Nut	1928	螺絲帽
A-23515	Cotter	1928	鎖針
A-2477	Brake cross shaft bushing	1928-31	車制橫軸套
A-2478-AR	Brake cross shaft frame bracket	1928	車制橫軸架
A-2478-B	Brake cross shaft frame bracket	1928-31	車制橫軸架
A-20747-S2	Bolt	1928-31	螺絲
A-21701-S2	Nut	1928-31	螺絲帽
A-23515	Cotter	1928-31	鎖針
A-2479-AR	Brake cross shaft frame bracket shim	1928	車制橫軸架墊
A-2479-B	Brake cross shaft frame bracket shim	1928-31	車制橫軸架墊
A-2483-R	Brake cross shaft socket spring	1928	車制橫軸高彈簧
A-2485-D	Brake cross shaft assembly	1928-31	車制橫軸總成
A-2485-ER	Brake cross shaft assembly	1928-29	車制橫軸總成
A-2491-R	Brake cross shaft guide	1928	車制橫軸導引
A-20954	Bolt	1928	螺絲
A-21745	Nut	1928	螺絲帽
A-23531	Cotter	1928	鎖針
A-2499-B	Cross shaft to axle brake rod—50 ¹ / ₂ "	1928-31	橫軸連輪軸車制桿
A-21700	Nut	1930-31	螺絲帽

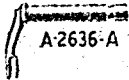

A-2461	Brake rod clevis—adjustable	1928-31	車制桿U形鐵 隨意調節
A-23822-S7	Pin	1928-31	針
A-23555	Cotter	1928-31	鎖針
A-2503	Brake rod spring	1928-31	車制桿彈簧
A-20705-S1	Bolt (spring to bracket)	1928-31	螺絲(彈簧連架)
A-21702-S2	Nut	1928-31	螺絲帽
A-22217	Washer	1928-31	隔片
A-2504	Brake rod spring bracket—front	1928-31	車制桿彈簧架 前
A-23281	Rivet (spring bracket—front to frame)	1928-31	釘(前彈簧連車樞)

Part No.	Name of Part	Year	貨名
			
A-2600	A-2609	A-2624	A-2628
			
		A-2636-A	A-2642
			
			A-2632
			
			A-2647

EMERGENCY BRAKE 意外車製

A-2600	Emergency brake carrier plate assembly—R. H.	1928-31	意外車製架片總成 右
A-2601	Emergency brake carrier plate assembly—L. H.	1928-31	意外車製架片總成 左
A-2609	Emergency brake band and lining assembly	1928-31	意外車製鋼圈總成
A-2624	Emergency brake band retracting spring	1928-31	意外車製鋼縮彈簧
A-2628	Emergency brake toggle link	1928-31	意外車制兩端臂
A-2632	Emergency brake toggle connecting link	1928-31	意外車制兩端連接環
A-23843-S7	Pin	1928-31	針
A-23534	Cotter	1928-31	鎖針
A-2636-A	Emergency brake toggle lever	1928-31	意外車制兩端桿
A-23844-S8	Pin	1928-31	針
A-2227	Emergency brake toggle lever bushing	1928-31	意外車制兩桿套
A-2642	Emergency brake lever—R. H.	1928-31	意外車制桿 右
A-2643	Emergency brake lever—L. H.	1928-31	意外車制桿 左
A-23904	Key	1928-31	鑰子
A-20843-S1	Bolt	1928-31	螺絲
A-22217	Washer	1928-31	隔片
A-2646	Emergency brake lever spring—R. H.	1928-31	意外車制桿彈簧 右
A-2647	Emergency brake lever spring—L. H.	1928-31	意外車制桿彈簧 左

HAND BRAKE LEVER (SIDE) 旁手製桿

A-2705-R	Hand brake lever assembly	1928	手制桿
A-2791-C	Hand brake lever button	1928	手制桿鈕
A-23637	Pin	1928	針
A-2710-BR	Hand brake lever pawl rod	1928	手制子桿
A-2710-CR	Hand brake lever pawl rod	1928	手制子桿
A-2711-R	Hand brake lever pawl rod spring	1928	手制子桿彈簧
A-2713-AR	Hand brake lever latch	1928	手制插鎖
A-23735-R	Pin	1928	針
A-23250-R	Hand brake lever top latch rivet	1928	手桿頂插鎖鉚釘
A-2715-R	Hand brake lever pawl	1928	手制子
A-23824-R	Pin	1928	針
A-23530	Cotter	1928	鎖針
A-2739-R	Hand brake lever bracket assembly	1928	手桿架總成
A-20732	Bolt	1928	螺絲
A-21701-S2	Nut	1928	螺絲帽
A-23515	Cotter	1928	鎖針
A-2227	Hand brake lever bracket bushing	1928	手桿架套

Part No. Name of Part Year 名 號

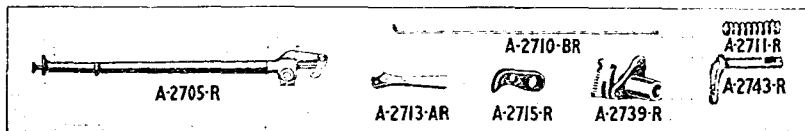

A-2743-R	Hand brake lever arm	1928	手桿臂
A-20930-S2	Bolt	1928	螺絲
A-21745	Nut	1928	螺絲帽
A-23534	Cotter	1928	鎖針
A-23827-S8	Clevis pin	1928	U形針
A-2744-R	Hand brake lever retracting spring	1928	手桿縮彈簧
A-20748-R	Bolt	1928	螺絲
A-21701-S2	Nut	1928	螺絲帽
A-23515	Cotter	1928	鎖針
A-2465-AR	Hand brake lever to equalizer shaft rod assembly	1928	手桿連均力軸桿總成
A-2457-R	Pin	1928	針

HAND BRAKE LEVER (CENTER) 中手 掣桿

A-2780-AR	Hand brake lever assembly	1928-29	手掣桿總成
A-2780-F	Hand brake lever assembly	1929-31	手制桿總成
A-2785-AR	Hand brake lever pawl rod—13" long	1928	手桿掣子桿
A-2785-BR	Hand brake lever pawl rod—14 ⁵⁵ / ₆₄ " long	1928-29	手桿掣子桿
A-2785-C	Hand brake lever pawl rod—17 ³ / ₄ " long	1929-31	手桿掣子桿
A-23530	Cotter	1928-29	鎖針
A-2711-R	Hand brake lever pawl rod spring	1928-29	手桿掣子桿彈簧
A-2786-AR	Emergency hand brake lever pawl	1928-29	手制桿掣子
A-2786-BR	Emergency hand brake lever pawl	1928-29	手桿制子
A-2786-C	Hand brake lever pawl	1929-30	手桿制子
‡A-2786-DR	Hand brake lever pawl— ¹ / ₄ " thick	1929-30	手桿制子
A-2786-E	Hand brake lever pawl— ⁵ / ₁₆ " thick	1930-31	手桿制子
A-2787-R	Hand brake lever pawl pin	1928-29	手桿制子針
A-23827-S8	Hand brake lever pawl pin	1929	手桿制子針
A-23530	Cotter	1928-29	鎖針
A-23555	Cotter	1929	鎖針
A-2791-AR	Hand brake lever button	1928-29	制桿鈕
A-23637	Pin	1928-31	針
A-2792-AR	Hand brake lever button sleeve	1928-29	手桿鈕套管
A-2793-AR	Hand brake lever pawl rod spring	1928-29	手桿制子桿彈簧
A-2795-AR	Emergency hand brake lever sector	1928-29	手桿三角止動片
A-20771	Screw	1928-29	螺絲
A-2795-B	Hand brake lever sector	1929-30	手桿三角止動片
‡A-2795-CR	Hand brake lever sector— ¹ / ₄ " thick	1929-30	手桿三角止動片
A-2795-D	Hand brake lever sector— ⁵ / ₁₆ " thick	1930-31	手桿三角止動片
A-20962	Bolt	1929-31	手桿三角止動片

‡When used to replace previous type also use A-2795-CR.

‡When used to replace previous type also use A-2786-DR.

Part No.	Name of Part	Year	貨名
A-21745	Nut	1929-31	螺絲
A-23534	Cotter	1929-31	螺絲帽
A-2797-R	Emergency hand brake lever arm	1928-29	鎖針
A-20930-S2	Bolt	1928-29	手桿臂
A-21745	Nut	1928-29	螺絲
A-23534	Cotter	1928-29	螺絲帽
A-2227	Hand brake lever arm bushing	1928-29	鎖針
A-20961	Screw (hand brake lever to gear shift housing)	1929-31	手桿臂套
A-22245	Washer	1929-31	螺絲(手桿連更換齒輪殼) 垫片

EMERGENCY BRAKE CONTROL 手急 掣運用

A-2828-AR	Emergency brake cross shaft assembly	1928-29	手制橫軸總成
A-2828-B	Emergency brake cross shaft assembly	1930-31	手制橫軸總成
A-24407	Lubricator fitting	1928-29	注油嘴
A-2833-C	Emergency brake cross shaft end lever		
—R. H.		1930-31	手制橫軸尾桿 右
A-2834-C	Emergency brake cross shaft end lever		
—L. H.		1930-31	手制橫軸尾桿 左
A-23830	Pin	1930-31	針
A-2839-R	Emergency brake cross shaft bearing	1928-29	手制橫軸滾珠
A-2840-R	Emergency brake cross shaft spring	1928-29	手制橫軸彈簧
A-2845-AR	Emergency brake cross shaft bracket	1928-29	節制橫軸架
A-20705-S1	Bolt	1928-31	螺絲
A-21702-S2	Nut	1928-31	螺絲帽
A-22217	Washer	1928-31	垫片
A-24177	Emergency brake cross shaft bushing	1928-31	手制橫軸套
A-2845-B	Emergency brake cross shaft to frame bracket	1930-31	手制橫軸連車框架
A-2849-B	Emergency brake cross shaft support	1930-31	手制橫軸撐
A-20705-S1	Bolt	1930-31	螺絲
A-21702-S2	Nut	1930-31	螺絲帽
A-22217	Washer	1930-31	垫片

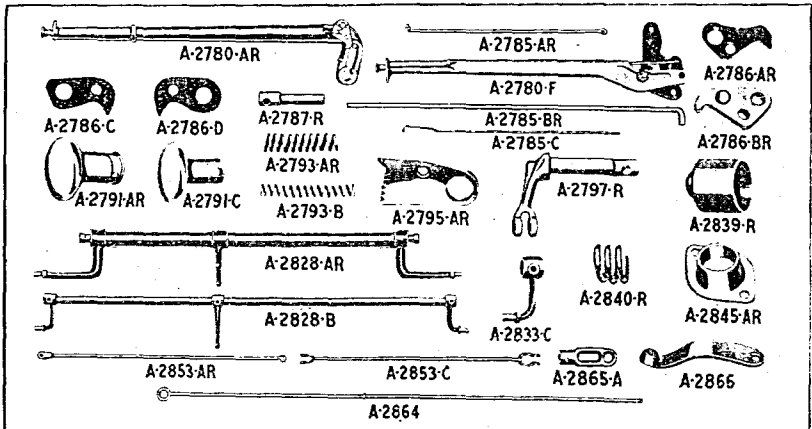

Part No.	Name of Part	Year	貨名
A-2853-AR	Emergency brake lever to cross shaft rod—20%”	1928-29	手制連橫軸桿
A-2853-D	Emergency hand brake lever to cross shaft rod—18%”	1930-31	手制桿連軸桿
A-23827-S8	Pin (clevis)—short	1929-30	針(U形) 短
A-23822-S7	Pin (clevis)—long	1929-30	針(U形) 長
A-23822-S7	Pin (emergency brake lever to cross shaft)	1928-31	針(手桿連橫軸)
A-23555	Cotter	1928-31	鎖針
A-2864	Emergency brake cross shaft to rear axle rod—41%”	1928-31	手制橫軸連後輪軸桿
A-21700	Check nut	1928-31	節制螺絲帽
A-23822-S7	Pin	1928-31	針
A-23555	Cotter	1928-31	鎖針
A-22418-R	Emergency brake cross shaft bracket felt	1928-29	手制橫軸架絨圈
A-2865-A	Emergency brake cross shaft to rear axle rod adjustable end	1928-31	手制橫軸連後輪軸桿調節尼
A-2866	Emergency brake rod spring	1928-31	手制桿彈簧

FRONT AXLE 前輪軸

A-3010-C	Front axle	1928-31	前輪軸
A-3030	Front spring perch assembly	1928-31	前彈簧架總成
A-21893	Nut	1928-31	螺絲帽
A-23550	Cotter	1928-31	鎖針
A-3034	Front spring perch bushing	1928-31	前彈簧架套
A-3105	Spindle assembly	1928-31	橫鈕軸總成
A-21920	Nut	1928-31	螺絲帽
A-23565	Cotter	1928-31	鎖針
A-24404-S7	Lubricator fitting—lower	1928-31	注油嘴 下
A-24407-S7	Lubricator fitting—upper	1928-29	注油嘴 上
A-3109	Spindle bushing—upper	1928-31	橫鈕軸套 上
A-3110	Spindle bushing—lower	1928-31	橫鈕軸套 下
†A-3115-C	Spindle bolt—R. H.	1928-31	橫鈕軸螺絲 右
†A-3116-C	Spindle bolt—L. H.	1928-31	橫鈕軸螺絲 左
A-22155	Spindle bolt grease retainer felt	1928-31	橫鈕軸螺絲柱油絨圈
A-22416	Spindle bolt felt washer	1928-31	橫鈕軸螺絲絨圈片
A-3122-BR	Spindle bolt locking pin	1928-29	橫鈕軸螺絲鎖針
A-21793-S1	Nut	1928-29	螺絲帽
A-23531	Cotter	1928-29	鎖針
A-3122-C	Spindle bolt locking pin	1928-31	橫鈕軸螺絲鎖針
A-3123-AR	Spindle bolt bearing assembly	1928	橫鈕軸螺絲滾成
A-3123-B	Spindle bolt bearing assembly—1.665” O. D.	1928-31	橫鈕軸螺絲滾成
A-3124	Spindle bolt locking pin nut	1929-31	橫鈕軸螺絲鎖針螺絲帽
A-22300	Washer	1929-31	圈片
A-3130-B	Spindle arm—R. H.	1928-31	橫鈕軸臂 右
A-3131-B	Spindle arm—L. H.	1928-31	橫鈕軸臂 左
A-21878	Nut	1928-31	螺絲帽

†When used to replace previous design also use A3122C, A3124 And A22300. (On AA trucks use AA3124.)

Part No.

Name of Part

Year

名貨

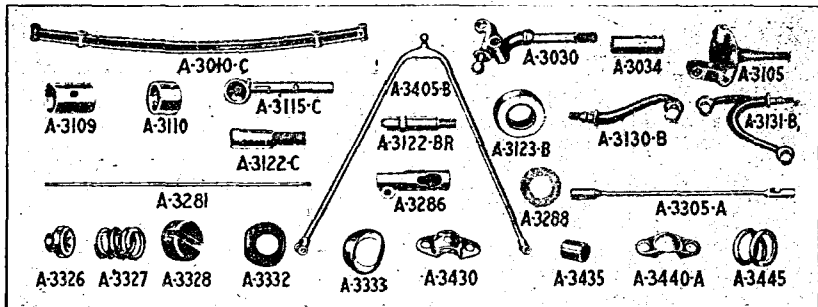

A-23550	Cotter	1928-31	鎖針
A-3281	Spindle connecting rod tube	1928-31	橫鈕軸接連桿管
A-3285	Spindle connecting rod end—R. H.	1928-31	橫鈕軸接連桿頭 右
A-3286	Spindle connecting rod end—L. H.	1928-31	橫鈕軸接連桿頭 左
A-20919	Clamp bolt	1928-31	鎖螺絲
A-21745	Nut	1928-31	螺絲帽
A-23531	Cotter	1928-31	鎖針
A-3326	Spindle connecting rod ball seat	1928-31	橫鈕軸接連桿球座
A-3327	Spindle connecting rod ball spring	1928-31	橫鈕軸接連桿球彈簧
A-3328	Spindle connecting rod ball plug	1928-31	橫鈕軸接連桿球塞
A-23553	Cotter	1928-31	鎖針
A-24405	Lubricator fitting	1928-30	注油嘴
A-24404-S7	Lubricator fitting	1930-31	注油嘴
A-3332	Spindle connecting rod grease retainer	1928-31	橫鈕軸接連桿護油圈
A-3333	Spindle connecting rod grease retainer cap	1928-31	橫鈕軸接連桿護油圈帽
A-3288	Spindle bolt felt retainer	1928-31	橫鈕軸螺絲絨圈
A-3305-A	Drag link	1928-31	索力連桿
A-24405	Lubricator fitting	1928-31	注油嘴
A-3320	Drag link ball socket	1928-31	索力連球座
A-3326	Drag link ball seat	1928-31	索力連球座
A-3327	Drag link ball spring	1928-31	索力連球彈簧
A-3328	Drag link ball plug	1928-31	索力連球塞
A-23553	Cotter	1928-31	鎖針
A-3332	Drag link grease retainer	1928-31	索力連護油圈
A-3333	Drag link grease retainer cap	1928-31	索力連護油圈帽
A-3405-B	Front radius rod	1928-31	前半徑桿
A-3425	Front radius rod ball felt	1928-31	前半徑桿球絨
A-3430	Front radius rod ball socket	1928-31	前半徑桿球座
A-3435	Front radius rod ball cap bolt sleeve	1928-31	前半徑桿球帽螺絲套
A-3440-A	Front radius rod ball cap	1928-31	前半徑桿球帽
A-21118	Bolt	1928-31	螺絲
A-21785	Nut	1928-31	螺絲帽
A-23533	Cotter	1928-31	鎖針
A-23765	Retaining pin	1928-31	管針
A-23530	Cotter	1928-31	鎖針
A-3445	Front radius rod ball cap spring	1928-31	前半徑桿球帽彈簧

Part No. Name of Part Year 貨名

STEERING GEAR 駕駛

A-3503-H	Steering gear assembly	1928-31	駕駛總成
A-3505-D	Steering gear housing and column assembly	1928-31	駕駛柱殼總成
A-21122	Bolt (housing to frame)	1928-31	螺絲(殼連框)
A-21791-S3	Nut	1928-31	螺絲帽
A-23531	Cotter	1928-31	鎖針
A-24405	Housing lubricator fitting	1928-29	殼注油嘴
A-24466	Housing plug	1929-31	殼塞
A-20215-S7	Steering column tube screw	1928-29	駕駛柱管螺絲
†A-3507	Steering column clamp	1929-31	駕駛柱鎖鐵
A-20782-S2	Bolt	1929-31	螺絲
A-21702-S2	Nut	1929-31	螺絲帽
A-22217	Lock washer	1929-31	鎖環
†A-3509-BR	Steering column tube and control rods assy	1928-30	駕駛柱管及運用桿總成
A-3509-C	Steering column tube and control rods assy	1930-31	駕駛柱管及運用管總成
A-3514	Steering column support spacer—180-A	1930-31	駕駛柱架隔片
A-20844-S7	Screw (support—upper to lower) (with A-3514)	1930-31	螺絲(架 上連下)
A-3517	Steering shaft upper bearing and bushing assy	1928-31	駕駛軸上滑滾及套總成
A-3519	Steering column support—lower	1928-31	駕駛柱架 下
A-20703-S7	Screw	1928-31	螺絲
A-22215	Washer	1928-31	隔片
A-3521	Steering column support anti-rattler	1928-31	駕駛柱架消聲墊

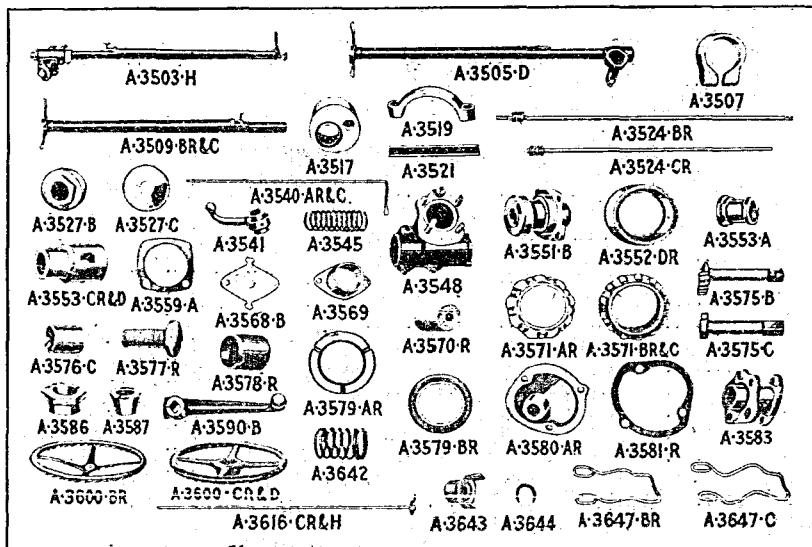

†Used only with 2 tooth sector steering gear.

Part No.	Name of Part	Year	貨名
A-3524-BR	Steering shaft and worm assembly	1928-30	駕駛軸及齒齒總成
†A-3524-CR	Steering shaft and worm assembly	1929	駕駛軸及齒齒總成
A-22238	Steering gear housing oil seal	1929	駕駛殼油封
A-3524-D	Steering shaft and worm assembly	1930-31	駕駛油及齒齒總成
A-3527-BR	Steering shaft felt retainer	1928-30	駕駛軸絨圈
†A-3527-C	Steering gear housing oil seal retainer	1929-31	駕駛殼油封圈
A-3529	Steering gear lighting switch tube silencer	1929-31	駕駛車燈開關管消聲墊
A-3540-AR	Steering gear control rod	1928-29	駕駛油火桿
A-3540-C	Steering gear control rod	1930-31	駕駛油火桿
A-3541	Steering gear control rod lever	1928-31	駕駛油火桿槓桿
A-23635	Pin	1928-31	針
A-3545	Control rod spring	1928-31	油火桿彈簧
†A-3548	Steering gear housing	1929-31	駕駛殼
†A-20924	Bolt	1929-31	螺絲
†A-21741-S8	Nut	1929-31	螺絲帽
†A-22245	Lock washer	1929-31	鎖環
A-22238	Steering gear housing oil seal	1928-29	駕駛殼油封
A-3551-BR	Steering shaft lower bearing assembly	1929-31	駕駛軸下滑滾總成
A-20550	Bolt	1928-31	螺絲
A-22150	Lock washer	1928-31	鎖環
†A-3552-DR	Steering gear worm bearing cup	1929	駕駛齒齒滑滾杯
†A-3552-E	Steering gear worm bearing cup	1929-31	駕駛齒齒滑滾杯
A-3553-AR	Steering gear housing bushing	1928-30	駕駛殼套
†A-3553-CR	Steering gear worm adjusting sleeve	1929	駕駛齒齒調節套管
†A-3553-D	Steering gear worm adjusting sleeve	1929-31	駕駛齒齒調節套管
†A-21161	Screw (steering gear adjusting)	1929-31	螺絲(調節駕駛)
†A-21802	Lock nut	1929-31	鎖螺絲帽
A-22305	Lock washer	1929-31	鎖環
A-3554-AR	Steering shaft bushing—lower	1928-30	駕駛軸套 下
A-3558	Steering shaft lower bearing shim .005"	1928-31	駕駛軸下滑滾墊
A-3559-AR	Steering shaft lower bearing shim .009"	1928-30	駕駛軸下滑滾墊
A-3123-AR	Steering worm thrust bearing 1.630" O. D.	1928-29	駕駛齒齒推進滑滾
A-3123-B	Steering worm thrust bearing 1.665" O. D.	1928-31	駕駛齒齒推進滑滾
†A-3568-B	Steering gear housing end plate	1929-31	駕駛殼尾片
†A-20538	Screw	1929-31	螺絲
†A-22150	Lock washer	1929-31	鎖環
†A-3569	Steering gear lighting switch bracket	1929-31	駕駛車燈開關架
A-3570-R	Steering shaft felt	1928-30	駕駛軸絨圈
†A-3571-AR	Steering worm bearing roller assembly	1929	駕駛齒齒碾子滑滾總成
†A-3571-BR	Steering worm bearing roller assembly	1929-30	駕駛齒齒碾子滑滾總成
A-3571-C	Steering worm bearing roller assembly	1930-31	駕駛齒齒碾子滑滾總成
A-3575-BR	Steering worm sector	1928-30	駕駛扇形齒輪
†A-3575-C	Steering worm sector	1929-31	駕駛扇形齒輪
†A-3576-C	Steering worm sector bushing	1929-31	駕駛扇形齒輪套

†Used only with 2 tooth sector steering gear.

Part No.	Name of Part	Year	貨名
A-3577-R	Steering worm sector thrust screw	1928-30	駕輪扇形齒輪推進螺絲
A-21836	Lock nut	1928-30	鎖螺絲帽
A-3578-R	Steering worm sector bushing	1928-30	駕輪扇形齒輪套
A-3579-AR	Steering worm sector thrust washer	1928-30	駕輪扇形齒輪推進圓片
†A-3579-B	Steering worm sector thrust washer	1929-30	駕輪扇形齒輪推進圓片
†A-21278	Screw (steering worm sector thrust)	1929-31	螺絲(駕輪扇形齒輪推進)
†A-21879	Nut	1929-31	螺絲帽
†A-22358	Washer	1929-31	圓片
A-3580-AR	Steering gear housing cover	1928-30	駕輪殼蓋
A-20550	Bolt	1928-30	螺絲
A-22150	Lock washer	1928-30	鎖環
A-3581-R	Steering gear housing cover gasket	1928-30	駕輪殼蓋墊
†A-3583	Steering worm housing cover and bushing assy	1929-31	駕輪齒齒殼蓋及套捲成
†A-24027	Stud	1929-31	螺絲
†A-21757	Nut	1929-31	螺絲帽
†A-22290	Lock washer	1929-31	鎖環
†A-22448	Steering worm housing cover gasket	1929-31	駕輪齒齒殼蓋墊
†A-3584	Steering worm housing eccentric rivet	1929-31	駕輪齒齒殼偏心釘
†A-3585	Steering worm housing cover adjusting stud	1929-31	駕輪齒齒殼蓋調節螺絲
†A-21757	Nut	1929-31	螺絲帽
†A-22257-S2	Lock washer	1929-31	鎖環
†A-3586	Steering worm eccentric adjusting sleeve	1929-31	駕輪齒齒偏心調節套管
†A-3587	Steering worm eccentric adjusting sleeve lock ring	1929-31	駕輪齒齒偏心調節套管鎖環
A-3590-B	Steering gear arm	1928-31	駕輪臂
A-21150	Clamp bolt	1928-31	夾螺絲帽
A-21791-S3	Nut	1928-31	螺絲帽
A-23531	Cotter	1928-31	銷針
A-3595-R	Steering shaft lower bearing shim	1928-30	駕輪軸下滑滾墊
A-3600-AR	Steering wheel assembly	1928-29	駕輪輪總成
†A-3600-BR	Steering wheel assembly	1929	駕輪輪總成
A-3600-CR	Steering wheel	1930	駕輪輪
A-3600-D	Steering wheel	1930-31	駕輪輪
A-21890	Steering wheel nut	1928-31	駕輪輪螺絲帽
A-3609-A	Steering wheel key (use with A-3600-D) (Old No. A-23909)	1929-31	駕輪輪
A-3616-BR	Lighting switch handle and horn switch assy	1928-29	車燈開關柄及叭喇開關總成
†A-3616-CR	Lighting switch handle and horn switch assy	1929	車燈開關柄及叭喇開關總成
A-3616-FR	Lighting switch handle and horn switch assy	1930	車燈開關柄及叭喇開關總成
A-3616-GR	Lighting switch handle and horn switch assy	1930	車燈開關柄及叭喇開關總成
A-3616-H	Lighting switch handle and horn switch assy	1930-31	車燈開關柄及叭喇開關總成

†Used only with 2 tooth sector steering gear.

Part No.	Name of Part	Year	貨名
A-22267-S7	Lighting switch handle washer	1928-29	車燈開關柄圈片
A-3639	Horn wire terminal insulator—lower	1928-31	喇叭電線終點絕下
A-3642	Lighting switch operating spider spring	1928-31	車燈開關運用彈簧
A-3643	Lighting switch operating spider	1928-31	車燈開關運用架
A-3644	Lighting switch operating spider retainer	1928-31	車燈開關運用架圓片
†A-3647-BR	Steering gear lighting switch bail	1928-30	駕駛燈開關機
A-3647-C	Steering gear lighting switch bail	1930-31	駕駛火開關機

REAR AXLE 後輪軸

A-4000-C	Rear axle and drive shaft assembly (9.37)	1928-31	後輪軸及驅動軸總成
A-4000-B	Rear axle and drive shaft assembly (9.34)	1928-31	後輪軸及驅動軸總成
A-4010-B	Axle shaft housing	1928-31	輪軸殼
A-24405	Lubricator fitting	1928-31	注油嘴
A-4020	Rear axle spring perch bushing	1928-31	後輪軸彈簧架套
A-4024	Rear spring perch ball	1930-31	後彈簧架球
A-4025-A	Rear axle differential housing	1928-31	後輪軸分速殼
A-20929	Screw	1928-31	螺絲
A-24457	Filler plug	1928-31	注油塞
A-24457	Drain plug	1928-31	放油塞
A-4035-A	Rear axle housing gasket—.009"	1928-31	後輪軸殼墊
A-4035-B	Rear axle housing gasket—.004"	1928-31	後輪軸殼墊
A-4205-B	Differential gear case—L.	1928-31	分速齒輪盒 左
A-4206	Differential gear case—R.	1928-31	分速齒輪盒 右
A-20908-R	Bolt	1928-29	螺絲
A-20952	Bolt	1928-31	螺絲
A-21745	Nut	1928-31	螺絲帽
†A-4209-AR	Differential driving gear and driving pinion (matched) 9-34	1928	分速驅動齒輪及小齒輪
A-4209-B	Differential driving gear and driving pinion (matched) 9-34	1928-31	分速驅動齒輪及小齒輪
A-4209-C	Differential driving gear and driving pinion (matched) 9-37	1928-31	分速驅動齒輪及小齒輪
A-4211	Differential spider	1928-31	分速齒輪架
A-4215	Differential pinion (same as T-2524-C)	1928-31	分速小齒輪
A-4221	Differential bearing cone assembly	1928-31	分速錐形滑環總成

†Used only with 2 tooth sector steering gear.

‡Pinion not threaded for bearing lock nut.

Part No. Name of Part Year 貨名

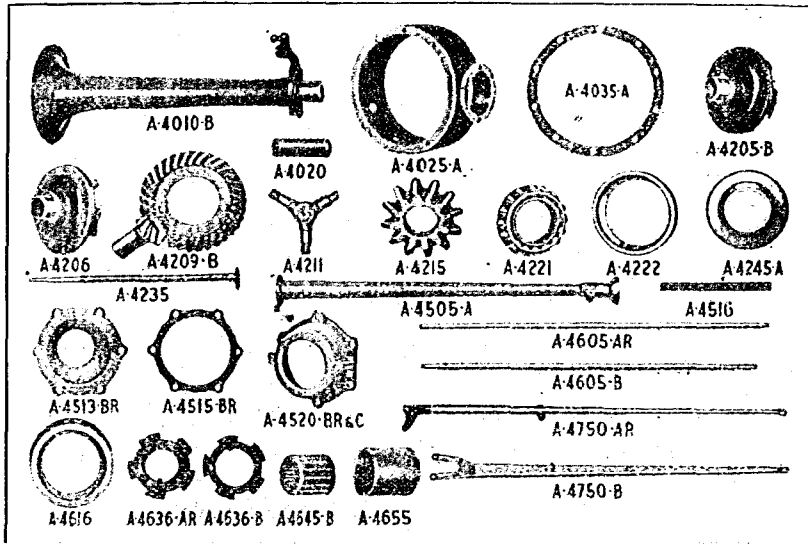

A-4222	Differential bearing cup	1928-31	分速滑滾套
A-4235	Rear axle shaft and gear	1928-31	後輪軸棍及齒輪
A-21892	Nut	1928-31	螺絲帽
A-23550	Cotter	1928-31	速針
A-4243	Rear axle shaft key (Same as T-2816-B)	1928-31	後輪軸棍鍵
A-4245-A	Rear axle shaft grease retainer assembly	1928-31	後輪軸棍瀝油隔棉成
A-4505-A	Torque tube	1928-31	總軸殼
A-20900	Screw (torque tube to differential housing)	1928-31	螺絲(總軸殼連分速殼)
†A-4513-A	Universal joint housing cap—inner (Old No. AA-4513)	1928-31	總關節內殼
*A-4513-BR	Universal joint housing cap—inner	1928-29	總關節內殼
†A-4515-A	Universal joint housing gasket (Old No. AA-4515)	1928-31	總關節殼墊
*A-4515-BR	Universal joint housing gasket	1928-29	總關節殼墊
A-4516	Universal joint housing cap felt	1928-31	總關節殼絨圈
*A-4520-BR	Universal joint housing cap—outer assembly	1928-29	總關節外殼棉成
†A-4520-C	Universal joint housing cap—outer assembly (Old No. AA-4520)	1928-31	總關節外殼絨成
A-20905	Bolt	1928-31	螺絲
A-21741-S8	Nut	1928-31	螺絲帽
A-22245	Lock washer	1928-31	鎖環
§A-20953	Bolt (cap to transmission)	1928-31	螺絲

§When used to replace bolt 1⁵/₂₃" long also use 1 A-22257-S2.

*Holes unequally spaced. †Holes equally spaced.

Part No.	Name of Part	Year	貨名
A-21745	Nut	1928-31	螺絲帽
A-23534	Cotter	1928-31	鎖針
A-4605-AR	Drive shaft	1928-29	驅動軸
A-4605-B	Drive shaft	1928-31	驅動軸
A-4243	Driving pinion key	1928-31	驅動小齒輪鍵
A-21891	Driving pinion nut	1928-31	驅動小齒輪螺絲帽
A-23533	Cotter	1928-31	鎖針
A-4221	Driving pinion bearing cone assembly	1928-31	驅動小齒輪錐形滑滾總成
A-4616	Driving pinion bearing cup	1928-31	驅動小齒輪滑滾套
A-21950-AR	Driving pinion bearing lock nut	1928-29	驅動小齒輪滑滾鎖螺絲帽
A-21950-B	Driving pinion bearing lock nut	1928-31	驅動小齒輪滑滾鎖螺絲帽
A-4636-AR	Drive pinion bearing nut lock washer	1928	驅動小齒輪滑滾鎖螺絲帽鎖環
A-4636-B	Driving pinion bearing nut lock washer	1928-31	驅動小齒輪滑滾鎖螺絲帽鎖環
A-4637	Driving pinion bearing thrust washer	1928-31	驅動小齒輪滑滾推進隔片
A-4645-B	Drive shaft bearing	1928-31	驅動軸滑滾
A-4655	Drive shaft bearing sleeve	1928-31	驅動軸滑滾套管
A-4245-A	Drive shaft grease retainer assembly	1928-31	驅動軸護油圈總成
A-4750-AR	Rear radius rod assembly—R. H.	1928-29	後半徑桿總成 右
A-4750-B	Rear radius rod assembly—R. H.	1928-31	後半徑桿總成 右

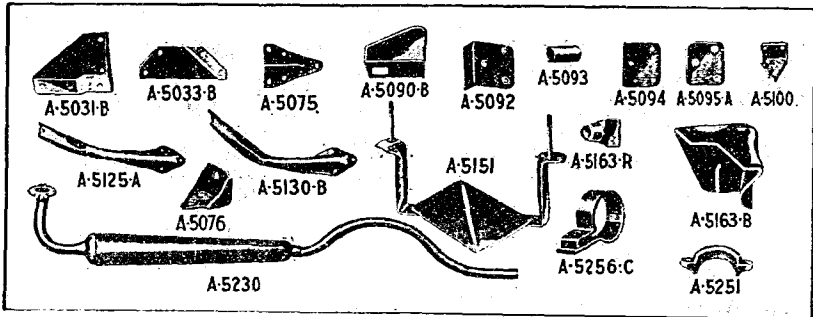

A-4751-AR	Rear radius rod assembly—L. H.	1928-29	後半徑桿總成 左
A-4751-B	Rear radius rod assembly—L. H.	1928-31	後半徑桿總成 左
A-21275	Bolt—front	1928-31	前螺絲
A-21875	Nut	1928-31	螺絲帽
A-23550	Cotter	1928-31	鎖針
A-21210-R	Bolt—rear	1928	後螺絲
A-21152-S1	Bolt—rear	1928-31	後螺絲
A-21791-S3	Nut	1928	螺絲帽
A-21801	Nut	1929-31	螺絲帽
A-23531	Cotter	1928-29	鎖針

FRAME 車 框

A-5005-C	Frame assembly	1928-31	車框總成
A-5015-B	Frame side member—R. H.	1928-31	車框旁梁 右
A-5016-B	Frame side member—L. H.	1928-31	車框旁梁 左
A-5020-B	Frame front cross member	1928-31	車框前橫梁

Part No.	Name of Part	Year	貨名
A-5025	Frame center cross member	1928-31	車框中橫樑
A-5030-B	Frame rear cross member	1928-31	車框後橫樑
A-5031-B	Frame rear corner bracket—upper R. H.	1928-31	車框後右上角架
A-5032-B	Frame rear corner bracket—upper L. H.	1928-31	車框後左上角架
A-5033-B	Frame rear corner bracket—lower	1928-31	車框後下角架
A-5075	Body bracket on frame—front	1928-31	框上前車身架
A-5076	Frame body bracket No. 6 body bolt— 190A, 160A-B-C	1930-31	車框身架第六車身螺絲
A-5090-B	Engine rear support bracket on frame	1928-31	框上引擎後架
A-5092	Engine rear support cushion—inner	1928-31	引擎後架 內
A-5093	Engine rear support spacer	1928-31	引擎後架隔套
A-5094	Engine rear support cushion—outer	1928-31	引擎後架 外
A-5095-A	Engine rear support plate	1928-31	引擎後架片
A-20740-S2	Bolt (engine rear support)	1928-31	螺絲(引擎後架)
A-21701-S2	Nut	1928-31	螺絲帽
A-23515	Cotter	1928-31	鎖針
A-5100	Hood clip bracket—on frame	1928-31	轆蓋夾架 在框上
A-5125-A	Running board to frame bracket—No. 1	1928-31	登車板連車框架 第一
A-5130-B	Running board to frame bracket—rear R. H.	1928-31	登車板連車框架 後右
A-5131-A	Running board to frame bracket—rear L. H.	1928-31	登車板連車框架 後式
A-2504	Brake rod spring bracket—front	1928-31	車制桿彈簧前架
FRAME RIVETS			車框帽釘
A-23262	$\frac{1}{4} \times \frac{3}{4}$ round head rivet		圓套帽釘
A-23291	$\frac{1}{4} \times 1\frac{1}{16}$ round head rivet		圓套帽釘
A-23292	$\frac{1}{4} \times \frac{7}{8}$ round head rivet		圓套帽釘
A-23372	$\frac{5}{16} \times 1\frac{1}{16}$ button head rivet		鈕頭帽釘
A-23385	$\frac{11}{16} \times 1\frac{11}{16}$ button head rivet		鈕頭帽釘
A-23371	$\frac{15}{16} \times 1\frac{15}{16}$ button head rivet		鈕頭帽釘
BATTERY SUPPORT 電池架			
A-5151	Battery support assembly	1928-31	電池架總成
A-20705-S4	Bolt (support to frame)	1928-31	螺絲(架連框)
A-21702-S2	Nut	1928-31	螺絲帽
A-22217	Washer	1928-31	隔片
A-21741-S8	Battery support rear nut	1930-31	電池架後螺絲帽
A-22245	Washer (support to frame screw)— rear	1930-31	隔片(架連框螺絲) 後
A-24050	Battery support stud	1928-31	電池架螺絲
A-5154	Battery support bolt	1928-31	電池架螺絲
A-5163-AR	Battery clamp	1928	電池鎖鐵
A-5163-B	Battery clamp	1930-31	電池鎖鐵
A-21761-S7	Nut	1930-31	螺絲帽

Part No. Name of Part Year 名貨

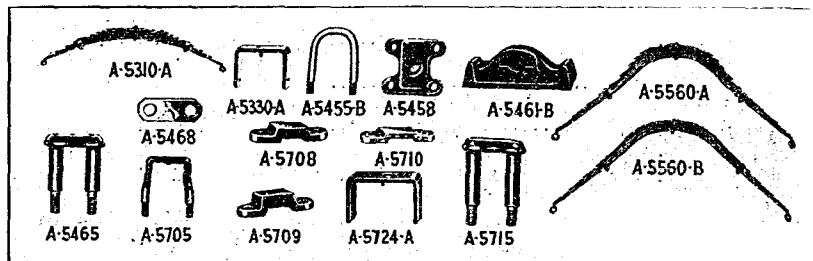

A-5166-AR	Battery cover	1928	電池蓋
A-5166-B	Battery cover	1928-30	電池蓋
A-21740-S1	Nut	1928-29	螺絲帽
A-21741-S8	Nut	1930	螺絲帽

MUFFLER 消聲器

†A-5230	Muffler assembly	1928-31	消聲器總成
A-5251	Muffler inlet pipe clamp	1928-31	消聲器入汽管鎖環
A-20955	Bolt	1928-31	螺絲
A-21752	Nut	1928-31	螺絲帽
A-5256-C	Muffler outlet pipe bracket	1928-31	消聲器出氣管架
A-20953	Bolt	1928-31	螺絲
A-21745	Nut	1928-31	螺絲帽
A-23534	Cotter	1928-31	鎖針

FRONT SPRING 前彈簧

A-5310-A	Front spring assembly—10 leaf	1928-31	前彈簧總成一十頁
A-5310-B	Front spring assembly—12 leaf	1930-31	前彈簧總成一十二頁
A-5313	Front spring leaf No. 1 assembly	1928-31	前彈簧第一頁總成
A-5315	Front spring leaf No. 2	1928-31	前彈簧第二頁
A-5316	Front spring leaf No. 3	1928-31	前彈簧第三頁
A-5317	Front spring leaf No. 4—with A-5310-A	1928-31	前彈簧第四頁
A-5318	Front spring leaf No. 5—with A-5310-A	1928-31	前彈簧第五頁
A-5319	Front spring leaf No. 6—with A-5310-A	1928-31	前彈簧第六頁
A-5320	Front spring leaf No. 7—with A-5310-A	1928-31	前彈簧第七頁
A-5321	Front spring leaf No. 8—with A-5310-A	1928-31	前彈簧第八頁
A-5322	Front spring leaf No. 9—with A-5310-A	1928-31	前彈簧第九頁
A-5323	Front spring leaf No. 10—with A-5310-A	1928-31	前彈簧第十頁
A-5318	Front spring leaf No. 6—with A-5310-B	1930-31	前彈簧第六頁
A-5319	Front spring leaf No. 7—with A-5310-B	1930-31	前彈簧第七頁

†For models 79B, 150B and 255A see AA-5230.

Part No.	Name of Part	Year	名貨
A-5320	Front spring leaf No. 8—with A-5310-B	1930-31	前彈簧第八頁
A-5321	Front spring leaf No. 9—with A-5310-B	1930-31	前彈簧第九頁
A-5322	Front spring leaf No. 10—with A-5310-B	1930-31	前彈簧第十頁
A-5322	Front spring leaf No. 11—with A-5310-B	1930-31	前彈簧第十一頁
A-5323	Front spring leaf No. 12—with A-5310-B	1930-31	前彈簧第十二頁
A-5326	Front spring leaf No. 4—with A-5310-B	1930-31	前彈簧第四頁
A-5327	Front spring leaf No. 5—with A-5310-B	1930-31	前彈簧第五頁
A-3034	Front spring bushing	1928-31	前彈簧套
A-5330-A	Front spring clamp	1928-31	前彈簧撐鐵
A-20545	Bolt	1928-31	螺絲
A-21663-S2	Nut	1928-31	螺絲帽
A-5330-B	Front spring clamp (Old No. AA-5330-AR) with A-5310-B	1930-31	前彈簧撐鐵
A-5346-R	Front spring tie bolt	1928-29	前彈簧鎖螺絲
A-20847	Front spring tie bolt—with A-5310-B	1930-31	前彈簧鎖螺絲
A-20717	Front spring tie bolt—with A-5310-A	1928-31	前彈簧鎖螺絲
A-20869	Front spring tie bolt—with A-5310-B and A-5347-R	1930-31	前彈簧鎖螺絲
A-21706	Nut	1928-31	螺絲帽
A-5347-R	Cross member reinforcement	1930-31	橫樑增固器
A-5455-B	Front spring clip	1928-31	前彈簧夾
A-5455-C	Front spring clip—with A-5310-B	1930-31	前彈簧夾
A-5455-DR	Front spring clip—with A-5310-B and A-5347-R	1930-31	前彈簧夾
A-5458	Front spring clip bar	1928-31	前彈簧夾門
A-21839-S1	Nut	1928-31	螺絲帽
A-23531	Cotter	1928-31	鎖針
A-5461-B	Starting crank bearing	1928-31	搖車柄滑套
A-5465	Front spring hanger	1928-31	前彈簧吊架
A-21794	Nut	1928-31	螺絲帽
A-23531	Cotter	1928-31	鎖針
A-5468	Front spring hanger bar—same as T-3841	1928-31	前彈簧吊架門
A-24404-S7	Front spring lubricator fitting	1928-31	前彈簧注油嘴

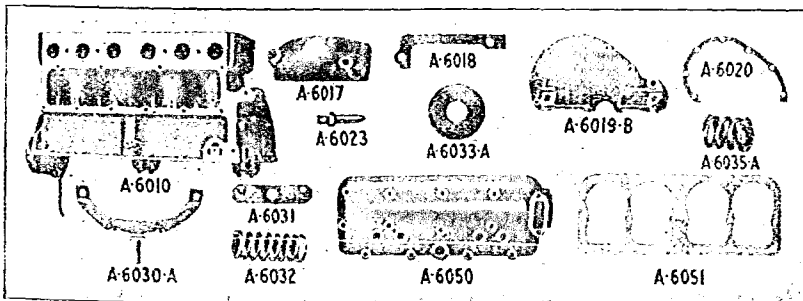

Part No.	Name of Part	Year	貨名
REAR SPRING 後彈簧			
A-5560-A	Rear spring assembly—55A, 55B, 130A, 140, 295A	1928-31	後彈簧總成
A-5560-B	Rear spring assembly—35A-B, 45A-B, 49A, 50A-B, 54A, 68A-B, 190A	1928-31	後彈簧總成
A-5560-C	Rear spring assembly—40A, 40B	1928-31	後彈簧總成
A-5560-D	Rear spring assembly—10 leaf—60A-B-C, 130A-B, 155A-B-C-D, 165A-B-C-D, 170A-B, 255A	1930-31	後彈簧總成
A-5560-E	Rear spring assembly—76A-B, 78A, 79A-B, 82A-B, 85A-B, 150A-B, 225A	1928-31	後彈簧總成
A-5563-A	Rear spring leaf No. 1—with A-5560-A-B-C	1928-31	後彈簧第一頁
A-5563-B	Rear spring leaf No. 1—with A-5560-D-E	1928-31	後彈簧第一頁
A-5565-A	Rear spring leaf No. 2—with A-5560-A-B-C-D	1928-31	後彈簧第二頁
A-5565-B	Rear spring leaf No. 2—with A-5560-E	1928-31	後彈簧第二頁
A-5566	Rear spring leaf No. 3—with A-5560-A-B-C-D-E	1928-31	後彈簧第三頁
A-5567-A	Rear spring leaf No. 4—with A-5560-A-B-D-E	1928-31	後彈簧第四頁
A-5567-B	Rear spring leaf No. 4—with A-5560-C	1928-31	後彈簧第四頁
A-5568-A	Rear spring leaf No. 5—with A-5560-A-B-C	1928-31	後彈簧第五頁
A-5568-B	Rear spring leaf No. 5—with A-5560-D-E	1928-31	後彈簧第五頁
A-5569-A	Rear spring leaf No. 6—with A-5560-A-B-C	1928-31	後彈簧第六頁
A-5569-B	Rear spring leaf No. 6—with A-5560-D-E	1928-31	後彈簧第六頁
A-5570-A	Rear spring leaf No. 7—with A-5560-A-D	1928-31	後彈簧第七頁
A-5570-B	Rear spring leaf No. 7—with A-5560-C	1928-31	後彈簧第七頁
A-5570-C	Rear spring leaf No. 7—with A-5560-E	1928-31	後彈簧第七頁
A-5571	Rear spring leaf No. 7—with A-5560-B	1928-31	後彈簧第七頁
A-5571	Rear spring leaf No. 8—with A-5560-A-D-E	1928-31	後彈簧第八頁
A-5573	Rear spring leaf No. 8—with A-5560-B	1928-31	後彈簧第八頁
A-5572	Rear spring leaf No. 9—with A-5560-A-D-E	1928-31	後彈簧第九頁
A-5573	Rear spring leaf No. 10—with A-5560-A-D-E	1928-31	後彈簧第十頁
A-5585	Rear spring dummy leaf—with A-5560-C	1928-31	後彈簧假頁
A-4020	Rear spring bushing	1928-31	後彈簧套
A-20927	Rear spring tie bolt—with A-5560-B-C	1928-31	後彈簧鎖螺絲
A-20942	Rear spring tie bolt—with A-5560-D-E	1928-31	後彈簧鎖螺絲
A-20920	Rear spring tie bolt—with A-5560-A	1928-31	後彈簧鎖螺絲

Part No.	Name of Part	Year	貨名
A-21749-S1	Nut	1928-31	螺絲帽
A-5705	Rear spring clip	1928-31	後彈簧夾
A-21876	Nut	1928-31	螺絲帽
A-23550	Cotter	1928-31	鎖針
A-5708	Rear spring clip bar— $27/32$ " thick	1928-31	後彈簧夾門
A-5709	Rear spring clip bar— $17/32$ " thick	1928-31	後彈簧夾門
A-5710	Rear spring clip bar— $11/16$ " thick	1928-31	後彈簧夾門
A-5715	Rear spring hanger	1928-31	後彈簧吊架
A-21794	Nut	1928-31	螺絲帽
A-23531	Cotter	1928-31	鎖針
A-5468	Rear spring hanger bar	1928-31	後彈簧吊架門
A-24404-S7	Rear spring lubricator fitting	1928-31	後彈簧注油嘴
A-5724-A	Rear spring clamp—with A-5560-C	1928-31	後彈簧鎖鐵
A-5724-C	Spring clamp—with A-5560-A-B-D and E	1928-31	彈簧鎖鐵
A-20546	Bolt	1928-31	螺絲
A-21663-S2	Nut	1928-31	螺絲帽

ENGINE 引擎

CYLINDER

A-6005	Engine assembly less clutch and transmission	1928-31	引擎總成傳力倉及傳力機
A-6010	Cylinder	1928-31	汽缸
A-24455	Cylinder oil hole plug	1928-31	汽缸油孔塞
A-24052	Cylinder head stud— $5^{23}/32$ "	1928-31	汽缸頂螺絲
A-24051-AR	Cylinder head stud— $4\ 7/16$ "	1928-29	汽缸頂螺絲
A-24051-BR	Cylinder head stud— $4\ 1/16$ "	1928-29	汽缸頂螺絲
A-24051-C	Cylinder head stud— $3^{11}/16$ "	1928-31	汽缸頂螺絲
A-24050	Cylinder head stud— $3\ 1/2$ "	1928-31	汽缸頂螺絲

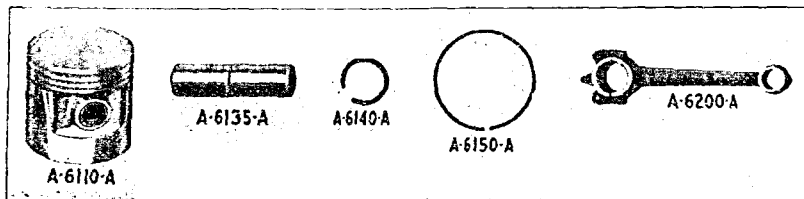

A-21788-S8	Nut	1928-31	螺絲
A-24053	Exhaust and intake manifold stud	1928-31	出氣及入氣管螺絲
A-21788-S8	Nut	1928-31	螺絲帽
A-9443	Manifold clamp	1928-31	汽管鎖鐵
A-9440	Manifold gland	1928-31	汽管銅環
A-9448-A	Manifold gasket	1928-31	汽管墊
A-6017	Cylinder timing gear cover side	1928-31	汽缸時輪側蓋
A-21111	Bolt—long	1928-31	長螺絲
A-21120-S2	Bolt—short	1928-31	短螺絲
A-6018	Cylinder timing gear cover gasket	1928-31	汽缸時輪蓋墊
A-6019-B	Cylinder front cover	1928-31	汽缸前蓋

Part No.	Name of Part	Year	貨名
A-20902-S2	Bolt	1928-31	螺絲
A-22245	Lock washer	1928-31	鎖環
A-6020	Cylinder front cover gasket	1928-31	汽缸前蓋墊
A-21220	Bolt (front cover to frame)	1928	螺絲(前蓋連框)
A-22330	Lock washer	1928	鎖環
A-6700	Front cover packing	1928-29	前蓋油塞
A-6023	Timing pin	1928-31	定時針
A-6030-A	Engine front support	1928-31	引擎前架
A-21240	Screw	1928-31	螺絲
A-22330	Washer	1928-31	圓片
A-21791-S3	Nut	1928-31	螺絲帽
A-22323	Washer	1928-31	圓片
A-23531	Cotter	1928-31	鎖針
A-6031	Engine front support auxiliary spring	1928-31	引擎前架副彈簧
A-6032	Engine front support spring	1928-31	引擎前架彈簧
A-6033-A	Engine front support stop washer	1928-31	引擎前架停環
A-6035-A	Engine front support retaining spring	1928-31	引擎前架鎖彈簧
A-6050-A	Cylinder head	1928-31	汽缸頂
A-6050-B	Cylinder head—high compression	1928-31	汽缸頂 高壓
A-6051-A	Cylinder head gasket	1928-31	汽缸頂墊
A-6051-B	Cylinder head gasket—with A-6050-B	1928-31	汽缸頂墊
PISTON AND CONNECTING ROD			
A-6110-A	Piston	1928-31	活塞及接過桿
A-6110-BR	Piston—.005" O. S.	1928-31	活塞
A-6110-CR	Piston—.010" O. S.	1928-31	活塞
A-6110-ER	Piston—.020" O. S.	1928-31	活塞
A-6110-GR	Piston—.030" O. S.	1928-31	活塞
A-6135-A	Piston pin	1928-31	活塞針
A-6135-BR	Piston pin—.002" O. S.	1928-31	活塞針
A-6140-A	Piston pin retainer—.115" wide	1928-31	活塞針鎖環
A-6140-BR	Piston pin retainer—.126" wide	1928-31	活塞針鎖環
A-6150-A	Piston ring	1928-31	活塞環
A-6150-BR	Piston ring—.005" O. S.	1928-31	活塞環
A-6150-CR	Piston ring—.010" O. S.	1928-31	活塞環
A-6150-ER	Piston ring—.020" O. S.	1928-31	活塞環
A-6150-GR	Piston ring—.030" O. S.	1928-31	活塞環
A-6151-R	Piston control ring (with strut design piston)	1928-29	活塞制環
A-6152-AR	Oil control ring—.1/8"	1928-30	護油環
A-6152-BR	Oil control ring—.005" O. S.—1/8" wide	1928-30	護油環
A-6152-CR	Oil control ring—.010" O. S.—1/8" wide	1928-30	護油環
A-6152-ER	Oil control ring—.020" O. S.—1/8" wide	1928-30	護油環
A-6152-GR	Oil control ring—.030" O. S.—1/8" wide	1928-30	護油環
A-6153-A	Oil control ring—.5/32" wide	1928-31	護油環
A-6153-BR	Oil control ring—.005" O. S.—5/32" wide	1928-31	護油環
A-6153-CR	Oil control ring—.010" O. S.—5/32" wide	1928-31	護油環
A-6153-ER	Oil control ring—.020" O. S.—5/32" wide	1928-31	護油環
A-6153-GR	Oil control ring—.030" O. S.—5/32" wide	1928-31	護油環
A-6200-A	Connecting rod assembly	1928-31	接連桿總成
A-21799	Nut	1928-31	螺絲帽
A-23534	Cotter	1928-31	鎖針

Part No.	Name of Part	Year	貨名
A-6220	Connecting rod shim	1928-31	接連桿片
CAMSHAFT AND CRANKSHAFT			偏心軸及拐軸
A-6250-A	Cam shaft	1928-31	偏心軸嵌釘
A-6253-B	Cam shaft dowel	1928-31	偏心軸齒輪
A-6256	Cam shaft gear	1928-31	偏心軸螺絲帽
A-6259	Cam shaft nut	1928-31	

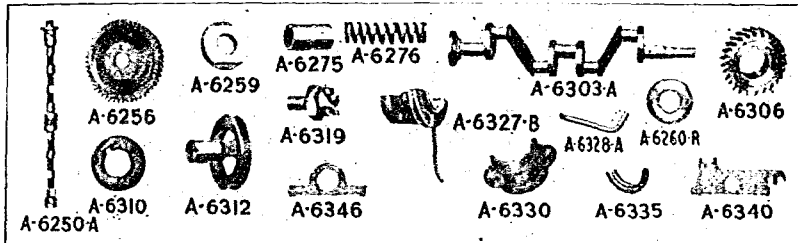

A-6260-R	Camshaft washer	1930-31	偏心軸圖片
A-6275	Camshaft thrust plunger	1928-31	偏心軸圖片壓力套
A-6276	Camshaft thrust plunger spring	1928-31	偏心軸壓力至彈簧
A-6303-A	Crankshaft	1928-31	拐軸
A-6306	Crankshaft gear	1928-31	拐軸齒輪
A-23003	Key	1928-31	鍵
A-6310	Crankshaft oil slinger	1928-31	拐軸油圈
A-6312	Crankshaft pulley assembly	1928-31	拐軸皮帶盤總成
A-6319	Crankshaft ratchet	1928-31	拐軸爪
*A-6327-AR	Crankshaft rear bearing cap assembly	1928-29	拐軸後滑滾箱總成
*A-6327-B	Crankshaft rear bearing cap assembly	1928-31	拐軸後滑滾箱總成
*A-6327-CR	Crankshaft rear bearing cap assembly (undersize)	1928-31	拐軸後滑滾箱總成
A-21214-AR	Bolt—3 3/8" long	1928-29	螺絲
A-21214-B	Bolt—4 3/16" long	1928-31	螺絲
A-21841	Nut	1928-31	螺絲帽
A-23531	Cotter	1928-31	鎖針
A-24454	Crankshaft rear bearing cap plug	1928-31	拐軸後滑滾箱塞
A-6328-A	Crankshaft rear bearing oil pipe Assy. (ball check type) 5/16" O. D.	1928-30	拐軸後滑滾油管總成
A-6328-B	Crankshaft rear bearing oil pipe Assy. (ball check type) 3/8" O. D.	1930-31	拐軸後滑滾油管總成
*A-6330	Crankshaft front and center bearing cap	1928-31	拐軸前及中滑滾箱
A-21215	Bolt	1928-31	螺絲
A-21841	Nut	1928-31	螺絲帽
A-23531	Cotter	1928-31	鎖針
A-6335	Crankshaft rear bearing seal	1928-31	拐軸後滑滾柱油墊
A-6340	Crankshaft rear bearing shim	1928-31	拐軸後滑滾片
A-6346	Crankshaft front & center bearing shim	1928-31	拐軸前及中滑滾片

*Specify finished or rough babbitted.

Part No. Name of Part Year 貨名

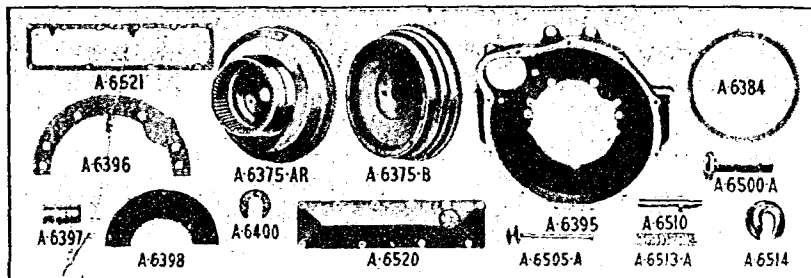

FLYWHEEL AND VALVES 飛輪及汽門

†A-6375-AR	Flywheel assembly	1928	飛輪總成
A-6375-B	Flywheel assembly	1928-31	飛輪總成
A-21113	Bolt	1928-31	螺絲
A-6384	Flywheel ring gear	1928-31	飛輪圈齒輪
A-6387	Flywheel to crankshaft dowel	1928-31	飛輪連拐軸鐵釘
A-6395	Flywheel housing	1928-31	飛輪殼
A-21110	Bolt (housing to cylinder) 1 1/16"	1928-31	螺絲(殼連汽缸)
A-21121	Bolt (housing to cylinder) 1 1/16"	1928-31	螺絲(殼連汽缸)
A-22300	Lock washer	1928-31	鎖環
A-21207	Bolt (housing to engine rear support)	1928-31	螺絲(殼連引擎後架)
A-22330	Lock washer	1928-31	鎖環
A-6396	Flywheel housing gasket	1928-31	飛輪殼墊
A-6397	Flywheel housing dowel	1928-31	飛輪殼鐵釘
A-6398	Flywheel housing shield	1928-31	飛輪殼護片
A-20534-S2	Bolt	1928-31	螺絲
A-22150	Lock washer	1928-31	鎖環
A-6400	Flywheel housing to cylinder shim	1928-31	飛輪殼連汽缸片
A-6500-A	Valve push rod	1928-31	汽門推進桿
A-6505-A	Intake and exhaust valve	1928-31	入氣及出氣汽門
A-6510	Valve guide bushing	1928-31	汽門襯套
A-6513-A	Valve spring	1928-31	汽門彈簧
A-6514	Valve spring retainer	1928-31	汽門彈簧座
A-6520	Valve chamber cover	1928-31	汽門室蓋
A-20718	Bolt	1928-31	螺絲
A-22217	Lock washer	1928-31	鎖環
A-6521	Valve chamber cover gasket	1928-31	汽門室蓋墊

†Use with multiple disc clutch.

Part No. Name of Part Year 貨名

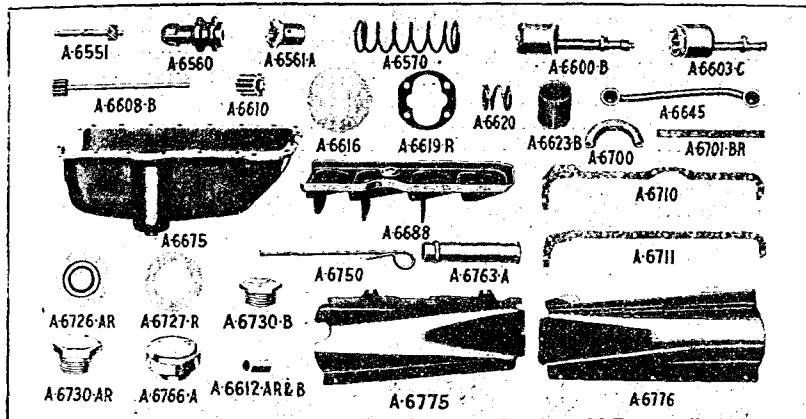

OIL PUMP, OIL PAN AND ENGINE PAN

A-6551	Oil pump drive gear	1928-31
A-6560	Oil pump drive bearing	1928-31
A-6561-A	Oil pump drive gear sleeve	1928-31
A-23670	Pin	1928-31
A-6570	Oil pump drive gear bearing retainer spring	1928-31
A-6600-B	Oil pump assembly	1928-31
A-6603-C	Oil pump body assembly	1928-31
A-6608-AR	Oil pump shaft assembly	1928
A-6608-B	Oil pump shaft assembly	1928-31
A-6610	Oil pump gear	1928-31
A-6612-AR	Oil pump body bushing	1928-29
A-6612-B	Oil pump body bushing	1929-31
A-6616	Oil pump cover	1928-31
A-20622	Bolt	1928-29
A-20534-S1	Bolt	1930
A-22151	Lock washer	1928-31
A-6618	Oil pump retaining spring clamp	1928-31
A-6619-R	Oil pump cover gasket	1928-29
A-6620	Oil pump retaining spring	1928-31
A-6623-B	Oil pump screen	1928-31
A-6645	Oil return pipe assembly	1928-31
A-20720	Bolt	1928-31
A-22220	Washer	1928-31
A-22430	Oil return pipe gasket	1928-31
A-6675	Oil pan assembly	1928-31
A-20718	Bolt	1928-31
A-22217	Lock washer	1928-31
A-6688	Oil pan tray	1928-31
A-6700	Oil pan packing—front	1928-31

抽引機油症及引擎底
抽油機齒輪
抽油機滑環
抽油機齒輪套
針
抽油機齒輪滑環座彈簧
抽油機機殼
抽油機機身總成
抽油機軸總成
抽油機軸總成
抽油機齒輪
抽油機身套
抽油機身套
抽油機蓋
螺絲
螺絲
鎖環
抽油機彈簧鎖環
抽油機蓋墊
抽油機彈簧
抽油機網
抽油管總成
螺絲
隔片
回油管墊
油池總成
螺絲
鎖環
油盆
油池前油塞

Part No. Name of Part Year 貨名

A-6701-BR	Oil pan packing—rear— $\frac{13}{16}$ " wide	1928-29	油池後油塞
A-6701-DR	Oil pan packing—rear— $\frac{3}{8}$ " wide	1930-31	油池後油塞
A-6710	Oil pan gasket—R. H.	1928-31	油池墊 右
A-6711	Oil pan gasket—L. H.	1928-31	油池墊 左
A-6726-AR	Oil pan cleanout plate	1928-29	油池清潔片
A-20534-S2	Bolt	1928-29	螺絲
A-22150	Lock washer	1928-29	鎖環
A-6727-R	Oil pan cleanout plate gasket	1928-29	油池清潔片墊
A-6730-AR	Oil pan drain plug	1928-29	油池放油塞
A-22424	Oil pan drain plug gasket	1928-29	油池放油塞墊
A-6730-B	Oil pan drain plug	1929-31	油池放油塞
A-22398	Oil pan drain plug gasket	1929-31	油池放油塞墊
A-6750	Oil level indicator	1928-31	量油桿
A-6763-A	Oil filler pipe assy.	1928-31	注油管總成
A-6766-A	Oil filler cap assy.	1928-31	注油蓋總成
A-6775	Engine pan—R. H.	1928-31	引擎底 右
A-6776	Engine pan—L. H.	1928-31	引擎底 左
A-20534-S2	Bolt	1928-31	螺絲
A-21666	Nut	1928-31	螺絲帽
A-22150	Washer	1928-31	隔片

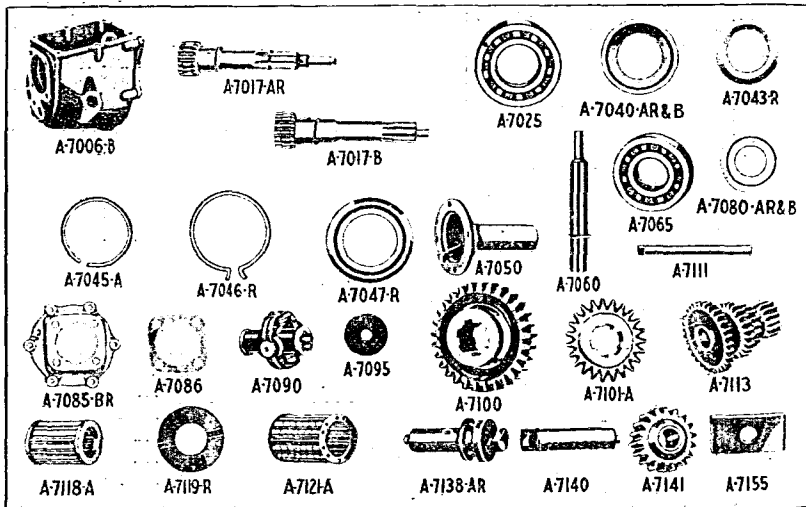

TRANSMISSION AND CLUTCH 傳力機及傳力盒

TRANSMISSION			傳力機
†A-7006-B	Transmission case	1928-31	傳力機殼
A-24452	Filler plug	1928-31	注油塞
A-24452	Drain plug	1928-31	注油塞
†A-7017-AR	Transmission main drive gear	1928	傳力機鍵齒齒輪
†Use with multiple disc clutch.			

Part No.	Name of Part	Year	貨名
A-2194	Nut	1928	螺絲帽
A-22420	Washer	1928	圓片
A-23554	Cotter	1928	鎖針
A-7017-B	Transmission main drive gear	1928-31	傳力機總軸齒輪
A-7025	Trans. main drive gear ball bearing	1928-31	傳力機總軸齒輪鋼珠滑滾
A-7040-AR	Trans. main drive gear bearing oil baffle—2 $\frac{3}{4}$ " O. D.	1928-29	傳力機總軸齒輪護油圈
A-7040-B	Trans. main drive gear bearing oil baffle—2 $\frac{1}{2}$ " O. D.	1929-31	傳力機總軸齒輪護油圈
A-7043-R	Trans. main drive gear brg. oil thrower	1928-29	傳力機總軸齒輪撥油圈
A-1180-B	Trans. main drive gear brg. retainer snap ring	1929	傳力機總軸齒輪滑滾位置環
A-7045-AR	Trans. main drive gear snap ring	1928	傳力機總軸齒輪位置環
A-7045-B	Trans. main drive gear snap ring	1928-31	傳力機總軸齒輪位置環
A-7046-R	Trans. main drive gear brg. oil ring	1928-29	傳力機總軸齒輪滑滾護油圈
A-7047-R	Trans. main drive gear brg. oil retainer	1928-29	傳力機總軸齒輪滑滾護油圈
A-7050	Trans. main drive gear brg. retainer	1928-31	傳力機總軸齒輪滑滾圓片
A-20718	Screw (Brg. retainer to trans. case)	1928-31	螺絲 (滑滾座連傳力機殼)
A-22217	Lock washer	1928-31	鎖環
A-7051	Trans. main drive gear brg. retainer gasket	1930-31	傳力機總軸齒輪滑滾座墊
A-7060	Trans. main shaft and collar assy.	1928-31	傳力機總軸及軸領總成
A-7118-A	Trans. main shaft pilot bearing	1928-31	傳力機總軸滑滾
A-7063	Transmission pilot bearing spacer	1928-31	傳力機滑滾隔片
A-7065	Transmission main shaft ball bearing	1928-31	傳力機總軸鋼珠滑滾
A-7070	Trans. main shaft brg. retainer ring	1929-31	傳力機總軸滑滾座環
A-7080-AR	Trans. main shaft bearing oil baffle	1928-29	傳力機總軸滑滾護油圈
A-7080-B	Trans. main shaft bearing oil baffle	1929-31	傳力機總軸滑滾護油圈
A-7084	Universal joint spider, bushing and ring assembly—in carton	1931	總關節架至及圈總成
‡A-7085-A	Trans. main shaft bearing retainer	1928-31	傳力機總軸滑滾座
**A-7085-BR	Trans. main shaft bearing retainer	1928-29	傳力機總軸滑滾座
A-7086	Bearing retainer gasket	1928-31	滑滾座墊
A-21116	Screw (Brg. retainer to trans. case)	1928-31	螺絲 (滑滾座連傳力機殼)
A-22300	Washer	1928-31	圓片
A-7090	Universal joint assembly	1928-31	總關節總成
A-24405	Universal joint lubricator fitting	1928-31	總關節注油嘴
A-7095	Universal joint front knuckle retainer	1928-31	總關節前保特片
A-20905	Screw	1928-31	螺絲
A-22245	Lock washer	1928-31	鎖環
A-7100	Trans. low and reverse sliding gear	1928-31	傳力機慢速度及倒車齒輪
A-7101-A	Trans. high and intermediate sliding gear	1928-31	傳力機高速度及中速度齒輪
A-7111	Transmission countershaft	1928-31	傳力機對動軸
A-7113	Transmission countershaft gear	1928-31	傳力機對動軸齒輪
A-7115	Trans. countershaft gear brg. spacer	1928-31	傳力機對動軸齒輪滑滾隔片
A-7118-A	Countershaft gear bearing—short	1928-31	對動軸齒輪滑滾 短
A-7119-R	Countershaft gear thrust washer	1928-29	對動軸齒輪壓圈
A-7121-A	Countershaft gear bearing—long	1928-31	對動軸齒輪滑滾 長
A-7138-AR	Trans. reverse idler shaft assembly	1928-29	傳力機倒車發動軸總成
A-7140	Trans. reverse idler shaft	1928-31	傳力機倒車發動軸

‡Holes equally spaced.

**Holes unequally spaced.

Part No.	Name of Part	Year	貨名
A-7141	Reverse idler gear and bushing assy.	1928-31	倒車變動齒輪及套棧成
A-7155	Trans. countershaft and reverse idler shaft retainer	1928-31	傳力機對動軸及倒車變動軸
A-20904	Screw—1"	1928-29	螺絲
A-20961	Screw— $\frac{3}{4}$ "	1928-31	螺絲
A-22245	Lock washer	1928-31	鎖環

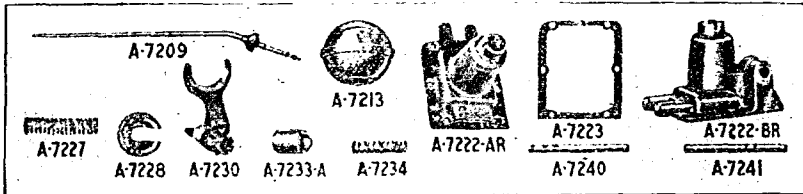

GEAR SHIFT

A-7209	Gear shift lever assembly	1928-31	更換齒輪桿總成
A-7213	Gear shift lever ball	1928-31	更換齒輪桿球
A-7222-AR	Gear shift housing (hand brake on side of car)	1928	更換齒輪殼
A-7222-BR	Gear shift housing (hand brake on front of housing)	1928-29	更換齒輪殼
A-7222-C	Gear shift housing (hand brake on side of housing)	1929-30	更換齒輪殼
A-20718	Screw—short	1928-31	螺絲 短
A-20720	Screw—long	1928-31	螺絲 長
A-22217	Lock washer	1928-31	鎖環
A-24451	Gear shift housing plug	1928-31	更換齒輪殼塞
A-7223	Gear shift housing gasket	1928-31	更換齒輪殼墊
A-7227	Gear shift lever spring	1928-31	更換齒輪桿彈簧
A-7228	Gear shift lever spring seat	1928-31	更換齒輪桿彈簧座
A-7229-R	Gear shift housing bushing	1928-29	更換齒輪殼套
A-7230	Gear shifter fork	1928-31	更換齒輪叉
A-23731	Pin	1928-31	針
A-7233-A	Gear Shifter lock plunger	1928-31	更換齒輪鎖軸柱
A-7234	Shifter shaft lock plunger spring	1928-31	更換齒輪鎖軸柱彈簧
A-7240	Shifter shaft—low and reverse	1928-31	更換軸 低及倒
A-7241	Shifter shaft—high and intermediate	1928-31	更換軸 高及中

CLUTCH

†A-7501-AR	Clutch housing assembly	1928	傳力盒
A-7501-B	Clutch housing assembly	1928-31	傳力盒殼總成
A-20904	Screw (housing to flywheel housing)	1928-31	螺絲(殼連飛輪殼)
A-22245	Lock washer	1928-31	鎖環
A-21117	Screw (housing to transmission case)	1928-31	螺絲(殼連傳力機殼)
A-22300	Lock Washer	1928-31	鎖環
†A-7506-AR	Clutch and brake pedal shaft	1928	傳力盒及車制踏板軸
A-7506-B	Clutch and brake pedal shaft	1928-31	傳力盒及車制踏板軸
A-23288	Pin	1928-31	針
A-23791	Pin	1928-31	針

†Use with multiple disc clutch.

Part No. Name of Part Year 貨名

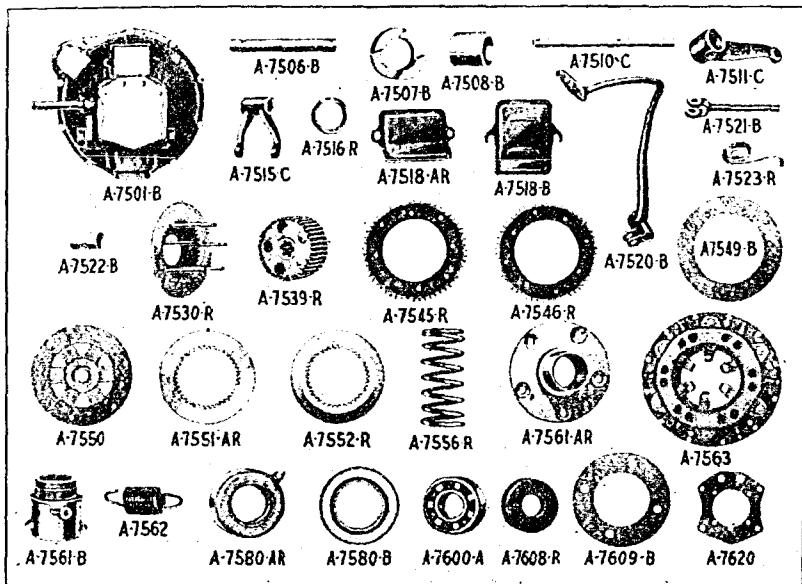

†A-7507-AR	...Pedal shaft collar1928	脚踏軸管頭
A-7507-BPedal shaft collar1928-31	脚踏軸管頭
†A-23781Pin1928	針
A-23789Pin1928-31	針
A-23530Colter1928-31	鎖針
A-7508-AR	...Clutch release shaft bushing1928-29	傳力盒放鬆軸套
†A-7508-BClutch release shaft bushing1928-31	傳力盒放鬆軸套
†A-7510-AR	...Clutch release shaft1928	傳力盒放鬆軸
A-7510-CClutch release shaft1928-31	傳力盒放鬆軸
†A-24404-S7	...Lubricator fitting1928	注油嘴
†A-7511-AR	...Clutch release shaft arm1928	傳力盒放鬆軸臂
A-7511-CClutch release shaft arm1928-31	傳力盒放鬆軸臂
A-23734Pin1928-29	針
A-23830Pin1928-31	針
A-23901Key1928-29	鍵
A-7512Clutch and brake pedal shaft spring washer1929-31	傳力盒及車制踏板軸彈簧回片
†A-7515-AR	...Clutch release shaft fork1929	傳力盒放鬆軸叉
A-7515-CClutch release shaft fork1929-31	傳力盒放鬆軸叉
A-23732Pin1928-29	針
A-23830Pin1928-31	針
A-23901Key1928-29	鍵

†Use with multiple disc clutch.

Part No.	Name of Part	Year	貨名
†A-7516-R	Clutch release shaft collar	1928	傳力盒放鬆軸套頭
†A-23732	Pin	1928	針
†7518-AR	Clutch housing hand hole cover	1928	傳力盒殼柄孔蓋
A-7518-B	Clutch housing handle hole cover	1929-31	傳力盒殼柄孔蓋
A-20707	Screw	1928-31	螺絲
†A-7520-AR	Clutch pedal	1928	傳力盒踏板
A-7520-B	Clutch pedal	1929-31	傳力盒踏板
A-24404-S7	Lubricator fitting	1928-31	注油嘴
A-7508-B	Clutch pedal bushing	1929-31	傳力盒踏板套
†A-7521-AR	Clutch pedal to release shaft arm rod	1928	傳力盒踏板連放鬆軸臂桿
A-7521-B	Clutch pedal to release arm rod	1929-31	傳力盒踏板連放鬆臂桿
†A-7522-AR	Clutch pedal to release shaft arm turn-nion	1928	傳力盒踏板連放鬆軸臂桿母螺絲
A-7522-B	Clutch pedal to release shaft arm rod turnnion	1929-31	傳力盒踏板連放鬆軸臂桿母螺絲
A-23820	Pin	1928-31	針
A-23555	Cotter	1928-31	鎖針
†A-7523-R	Clutch pedal spring	1928	傳力盒踏板彈簧
†A-7530-R	Clutch driven disc and stud assembly	1928	傳力盒驅動片及螺絲總成
†A-21700	Nut	1928	螺絲帽
†A-22217	Lock washer	1928	鎖環
†Use with multiple disc clutch.			
‡When used to replace ¹⁵ / ₁₆ " bushing drill hole for lubrication.			

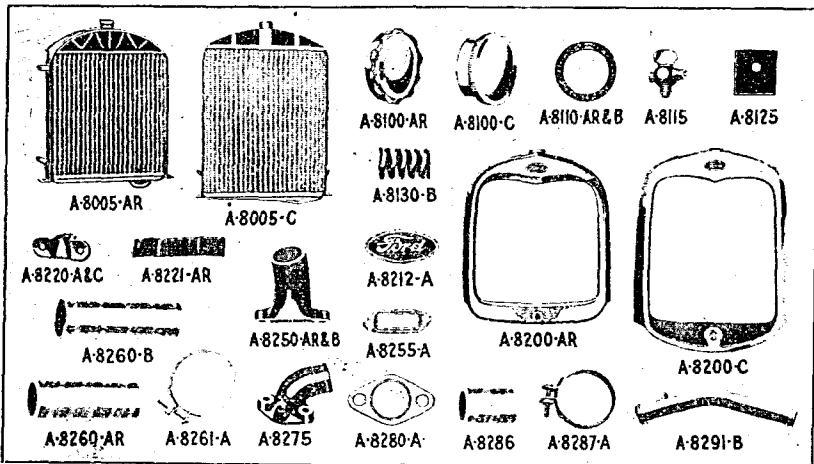

†A-7539-R	Clutch disc drum assembly	1928	傳力片及驅動輪總成
†A-7545-R	Clutch disc and lining assembly	1928	傳力片及鑲面總成
†A-7546-R	Clutch disc and lining assembly—rear	1928	傳力片及鑲面總成 後
A-7549-B	Clutch disc facing	1929-31	傳力片面
A-22993	Rivet	1929-31	帽釘
A-7550	Clutch disc assembly	1929-31	傳力片總成
†Use with multiple disc clutch.			

Part No.	Name of Part	Year	名 貨
†A-7551-AR	Clutch driven disc	1928	傳力盒鼓驅片
†A-7552-R	Clutch driven disc—rear	1928	傳力盒鼓驅片 後
†A-7556-R	Clutch spring	1928	傳力盒彈簧
†A-7561-AR	Clutch thrust bearing hub	1928	傳力盒壓力滑滾軸輪心
A-7561-B	Clutch release bearing hub	1929-31	傳力盒放鬆滑滾軸輪心
A-7562	Clutch release bearing spring	1929-31	傳力盒放鬆滑滾彈簧
A-7563	Clutch pressure plate and cover assembly	1928-31	傳力壓片及蓋總成
A-20718	Screw (cover to flywheel)	1928-31	螺絲(蓋連飛輪)
A-22217	Washer	1928-31	隔片
†A-7580-AR	Clutch thrust bearing assembly	1928	傳力盒壓力滑滾總成
A-7580-B	Clutch release bearing assembly	1928-31	傳力盒壓力滑滾總成
A-24405	Lubricator fitting	1928-31	注油嘴
†A-7045-AR	Clutch thrust bearing snap ring	1928-29	傳力盒壓力滑滾位置環
A-7600-A	Clutch pilot bearing	1928-31	傳力盒滑滾
†A-7608-R	Clutch pilot bearing felt	1928	傳力盒滑滾絨封
†A-7609-AR	Clutch pilot bearing felt retainer	1928	傳力盒滑滾絨封架
A-7609-B	Flywheel dowel retainer	1928-31	飛輪嵌窩墊
A-7620-A	Clutch housing gasket	1928-31	傳力盒蓋墊
**A-7620-B	Clutch housing gasket	1928-31	傳力盒蓋墊

COOLING SYSTEM 散 熱 系

RADIATOR

A-8005-AR	Radiator (less shell)	1928-29	水箱
A-8005-B	Radiator (less shell)	1930-31	水箱(無殼)
A-8100-AR	Radiator cap	1928-29	水箱蓋
A-8100-C	Radiator cap	1930-31	水箱蓋
A-8110-AR	Radiator cap gasket	1928-29	水箱蓋墊
A-8110-B	Radiator cap gasket	1930-31	水箱蓋墊
A-8115	Radiator drain cock—same as T-1515	1928-31	水箱放水嘴
A-8125	Radiator support pad	1928-31	水箱架墊
†A-8126-R	Radiator support shim	1929-30	水箱架片
‡A-20984	Bolt—2½" (radiator to frame)	1929-30	螺絲(水箱連車框)
A-20975	Bolt—2" (radiator to frame)	1928-31	螺絲(水箱連車框)
A-20916	Bolt—1½" (radiator to frame)	1928-30	螺絲(水箱連車框)
A-21745	Nut	1928-31	螺絲帽
A-23534	Cotter	1928-31	鎖針
§A-8130-B	Radiator bolt spring	1928-31	水箱螺絲彈簧
A-8133-AR	Radiator rod	1928-31	水箱桿
A-8133-B	Radiator rod (25%)	1930-31	水箱桿
A-21793-S1	Nut—rear	1928-30	後螺絲帽
A-21741-S2	Nut—rear	1928-31	後螺絲帽
A-22257-S2	Lock washer	1928-31	鎖環
A-22305	Lock washer	1928-30	鎖環
A-21702-S2	Nut—front	1928-31	前螺絲帽
A-22337	Cup washer	1928-31	蓋環

†Use with multiple disc clutch.

§When replacing previous type also use A-20975.

**When used to replace A-7620-A also use A-7051.

‡Use with A-5005-C Frame.

Part No.	Name of Part	Year	貨名
A-22217	Washer	1928-31	圓片
A-8200-AR	Radiator shell assembly (nickel)	1928-29	水箱殼總成(鍍鎳)
A-8200-C	Radiator shell assembly	1930-31	水箱殼總成
A-8200-E	Radiator shell assembly (black)	1930-31	水箱殼總成(黑色)
A-8201-R	Radiator shell assembly (black)	1928-29	水箱殼總成(黑色)
A-20401-S2	Bolt	1928-31	螺絲
A-21632-S7	Nut	1928-31	螺絲帽
A-22139-S3	Washer	1928-31	圓片
A-8212-A	Radiator name plate assembly	1928-30	水箱名版總成
A-8212-B	Radiator name plate	1930-31	水箱名版
A-8212-C	Radiator name plate (black background) (use with A-8200-E, AA-8200-D)	1931	水箱名版
A-8216-A	Starting crank hole cover	1928-31	搖車柄孔蓋
A-22885-S6	Rivet	1928-31	帽釘
A-22047-S2	Lock washer	1928-31	鎖環
A-22038-S7	Plain washer	1928-31	圓片
A-8220-A	Hood hinge retainer on radiator shell (Same as T-4002-B)	1928-31	箱殼上絞蓋盒葉附著耳水
A-8220-C	Hood hinge rod retainer	1928-31	絞蓋盒葉附著耳
A-23033	Rivet	1928-31	帽釘
A-8222-B	Hood pad on radiator	1928-31	水箱殼上車墊
A-22900-S4	Rivet	1928-31	帽釘
A-8250-AR	Cylinder head outlet connection	1928-29	汽缸出水頭
A-8250-B	Cylinder head outlet connection	1930-31	汽缸出水頭
A-24052	Stud	1928-31	螺絲
A-21788-S8	Nut	1928-31	螺絲帽
A-8255-A	Cylinder head outlet connection gasket	1928-31	汽缸出水頭墊
A-8260-AR	Radiator inlet hose	1928-29	水箱注水皮管
A-8260-B	Cylinder head outlet hose	1930-31	汽缸放水皮管
A-8261-A	Radiator inlet hose clip assy. (Same as T-3007)	1928-31	水箱注水皮管夾總成
A-8275	Cylinder water inlet connection	1928-31	汽缸入水頭
A-21120-S2	Bolt	1928-31	螺絲
A-22300	Washer	1928-31	圓片
A-8280-A	Cylinder inlet connection gasket (Same as T-1018)	1928-31	汽缸入水頭墊
A-8286	Radiator outlet hose	1928-31	水箱放水皮管
A-8287-A	Radiator outlet hose clip assy. (Same as T-3945)	1928-31	水箱放水皮管夾總成
A-8291-B	Radiator outlet pipe	1928-31	水箱放水箱

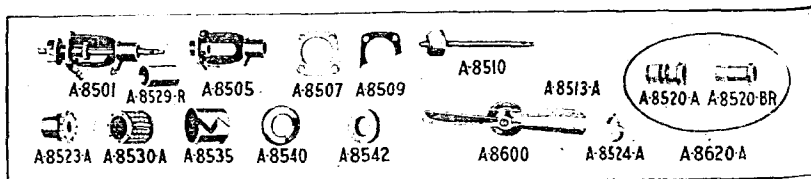

Part No.	Name of Part	Year	貨名
WATER PUMP AND FAN			
A-8501	Water pump assembly	1928-31	抽水機及風扇
A-244406	Lubricator fitting	1928-31	抽水機油嘴
A-8505	Water pump cover assembly	1928-31	注油嘴
A-24025	Stud	1928-31	抽水機蓋緣成
A-21741-S8	Nut	1928-31	絲絲
A-22245	Lock washer	1928-31	螺絲帽
A-8507	Water pump cover gasket	1928-31	鎖環
A-8509	Water pump cover shim	1928-31	抽水機蓋墊
A-8510	Water pump shaft assembly	1928-31	抽水機蓋片
A-8513-A	Water pump impeller washer	1928-31	抽水機軸緣成
A-8520-A	Water pump rear bushing	1928-31	抽水機推進器隔片
A-8520-BR	Water pump rear bushing assembly—oil-less	1929-30	抽水機後套
A-8523-A	Water pump bushing nut	1928-31	抽水機後套緣成
A-8524-A	Water pump bushing packing	1928-31	抽水機套螺絲帽
A-8529-R	Water pump front bushing	1929-30	抽水機套殼
A-8530-A	Water pump shaft roller bearing assy.	1928-31	抽水機前套
A-8535	Water pump shaft roller bearing sleeve	1928-31	抽水機軸棍子滑滾緣成
A-22373	Water pump bearing felt retainer washer	1928-31	抽水機軸棍子滑滾套管
A-8540	Water pump bearing felt retainer	1928-31	抽水機滑滾絨圈護片
A-8542	Water pump bearing felt	1928-31	抽水機滑滾絨圈殼
A-24406	Lubricator fitting	1928-31	抽水機滑滾絨圈
A-8600	Fan assembly	1928-31	注油嘴
A-23902	Key	1928-31	風扇緣成
A-21791-S3	Nut	1928-31	鍵
A-23531	Cotter	1928-31	螺絲帽
A-24405	Lubricator fitting	1928-31	鎖針
A-8620-A	Fan belt	1928-31	油注嘴
			風扇皮帶

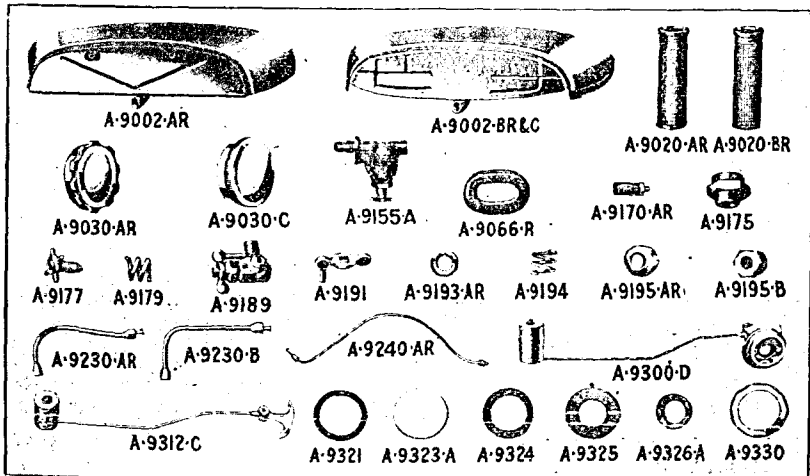

Part No.	Name of Part	Year	貨名
FUEL SYSTEM 燃料系			
COWL			
‡A-9002-AR	Cowl tank assembly	1928-29	轆蓋
A-9002-BR	Cowl tank assembly	1930	轆蓋箱總成
A-9002-C	Cowl tank assembly	1930-31	轆蓋箱總成
A-9002-E	Cowl tank assembly	1931	轆蓋箱總成
A-9020-A	Cowl tank filler screen	1928-31	轆蓋箱濾網
A-9020-BR	Cowl tank filler screen	1930-31	轆蓋箱濾網
A-9030-AR	Cowl tank cap	1928-29	轆蓋箱蓋
A-9030-C	Cowl tank cap	1930-31	轆蓋箱蓋
A-9035-AR	Cowl tank cap gasket	1928-29	轆蓋箱蓋墊
A-9035-B	Cowl tank cap gasket	1930-31	轆蓋箱蓋墊
A-9066-R	Cowl tank speedometer cable support grommet	1928-29	轆蓋箱速度表線架帶頭
A-35266-A	Cowl tank clamp	1928-29	轆蓋箱鎖夾
A-20566-S8	Bolt	1928-29	螺絲
A-21668-S2	Nut	1928-29	螺絲帽
A-22151	Washer	1928-29	隔片
A-9155	Sediment bulb assembly	1928-31	沉渣壺總成
A-21923	Nut (sediment bulb to dash)	1928-31	螺絲帽(沉渣壺表板)
A-22392	Lock washer	1928-31	鎖環
A-9161	Gasoline filter bowl	1931	濾油壺
A-22384	Washer	1931	隔片
A-22333	Washer	1931	隔片
A-9170-A	Sediment bulb screen assembly—same as S-194	1928-31	沉渣壺濾網總成
A-9175	Sediment bulb screen retainer	1928-31	沉渣壺濾網殼
A-22422	Sediment bulb screen retainer gasket	1928-31	沉渣壺濾網殼墊
A-9176	Gasoline filter screen	1931	沉油網
A-9177	Sediment bulb drain plug and handle assembly	1928-31	沉渣壺放油塞及柄總成
A-9179	Sediment bulb drain plug spring	1928-31	沉渣壺放油塞彈簧
A-9181	Gasoline filter plug	1931	濾油器塞
A-9182	Gas filter drain screw spring	1931	濾油器放油塞螺絲彈簧
A-9185	Gasoline filter bowl drain plug assembly	1931	濾油器放油塞總成
A-9189	Gasoline valve assembly	1928-31	汽油門總成
A-9189-B	Gasoline valve assembly	1931	汽油門總成
A-9191	Gasoline valve handle	1928-31	汽油門柄
A-9193-AR	Gasoline valve packing—same as S-196	1928-29	汽油門墊
A-9193-B	Gasoline valve packing	1930-31	汽油門墊
A-22289	Gasoline valve washer	1928-31	汽油門隔片
A-9194-R	Gasoline valve spring	1928-31	汽油門彈簧
A-9195-AR	Gasoline valve pack nut	1928-29	汽油門墊帽
A-9195-B	Gasoline valve pack nut	1930-31	汽油門墊帽
A-21665-S8	Gasoline valve lock nut	1928-31	汽油門鎖帽
A-22150-S1	Gasoline valve lock washer	1928-31	汽油門鎖環
A-9230-AR	Cowl tank to sediment bulb pipe assy.	1928-29	汽油箱連沉渣壺管總成
A-9230-B	Cowl tank to sediment bulb pipe assy.	1930-31	汽油箱連沉渣壺管總成

‡When used to replace tank with easy-on type cap, also supply A-9020-AR and A-9030-AR.

Part No.	Name of Part	Year	貨名
A-9240-B	Sediment bulb to carburetor pipe assy.	1928-31	沉渣器連化汽機管總成
A-9240-C	Cowl tank to carburetor pipe assembly.	1931	積蓋箱連化汽機管總成
A-9300-E	Gas gauge assembly	1928-31	指油表總成
A-9312-D	Gas gauge dial, float and rod assembly.	1928-31	指油表桿及浮囊總成
A-9316-B	Gas gauge dial pin	1928-31	指油表針
A-9321	Gas gauge frame gasket	1928-31	指油表墊
A-9323-A	Gas gauge glass	1928-31	指油表玻璃
A-9324	Gas gauge glass gasket	1928-31	指油表玻璃墊
A-9325	Gas gauge shield	1928-31	指油表護殼
A-9326-A	Gas gauge cover	1928-31	指油表蓋
A-9330	Gas gauge to flange nut	1928-31	指油表連沿邊螺絲帽
A-22442	Washer	1928-31	圓片

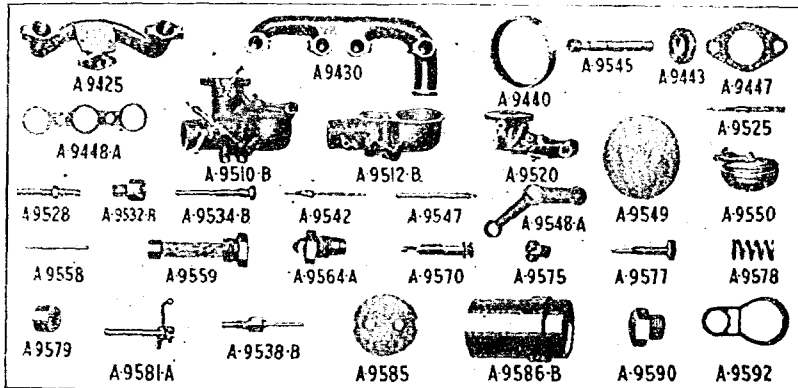

MANIFOLDS

A-9425	Intake manifold	1928-31
A-24455	Intake manifold plug	1929-31
A-20718	Bolt	1928-31
A-22217	Washer	1928-31
A-9430	Exhaust manifold	1928-31
A-24053	Stud (manifold to cylinder)	1928-31
A-21788-S8	Nut	1928-31
A-9440	Intake and exhaust manifold gland	1928-31
A-9443	Intake and exhaust manifold clamp	1928-31
A-9447	Carburetor to intake manifold gasket	1928-31
A-9448-A	Intake and exhaust manifold gasket	1928-31

氣管
 進汽管
 進汽管塞
 螺絲
 圓片
 出氣管
 螺絲(氣管連氣缸)
 螺絲帽
 進出汽管墊環
 進出汽管鎖鐵
 化汽機連進汽管墊
 進出汽管墊

CARBURETOR

A-9510-B	Carburetor assembly	1928-31
A-9510-C	Carburetor assembly	1931
A-20718	Screw (carburetor to intake manifold)	1928-31
A-22217	Washer	1928-31
A-9512-B	Carburetor bowl assembly	1928-31

化汽機
 化汽機總成
 化汽機總成
 螺絲(化汽機連進汽管)
 圓片
 化汽機油碗總成

Part No.	Name of Part	Year	貨名
A-20933-S7	Screw (bowl to upper body)	1928-31	螺絲(油碗連上體)
A-22257-S2	Washer	1928-31	隔片
A-9520-A	Carburetor upper body assembly	1928-31	化汽機上體總成
A-9520-B	Carburetor upper body assembly	1931	化汽機上體總成
A-9525	Carburetor adjusting needle assembly	1928-31	化汽機調節針總成
A-9528	Adjusting needle housing assembly	1928-31	調節針殼總成
A-9532-R	Carburetor adjusting needle seat	1928-29	化汽機調節針座
A-22086	Washer	1928-29	隔片
A-9534-B	Carburetor main jet assembly	1928-31	化汽機正噴嘴總成
A-22086	Washer	1928-31	隔片
A-9538-B	Carburetor cap jet assembly	1928-31	化汽機副噴嘴總成
A-22086	Washer	1928-31	隔片
A-9542	Carburetor idling jet assembly	1928-31	化汽機怠速度噴嘴總成
A-9545	Carburetor secondary well	1928-31	化汽機次油井
A-9547	Carburetor air shutter shaft	1928-31	化汽機塞汽軸
A-21548-S7	Nut	1928-31	螺絲帽
A-22062	Washer	1928-31	隔片
A-9548-A	Carburetor air shutter lever	1928-31	化汽機塞氣桿
A-9549	Carburetor air shutter plate	1928-31	化汽機塞氣片
A-20042-S7	Screw	1928-31	螺絲
A-9550	Carburetor float assembly	1928-31	化汽機浮蛋總成
A-9558	Carburetor float axle	1928-31	化汽機浮蛋軸
A-9559	Carburetor strainer assembly	1928-31	化汽機濾網總成
A-22333	Washer	1928-31	隔片

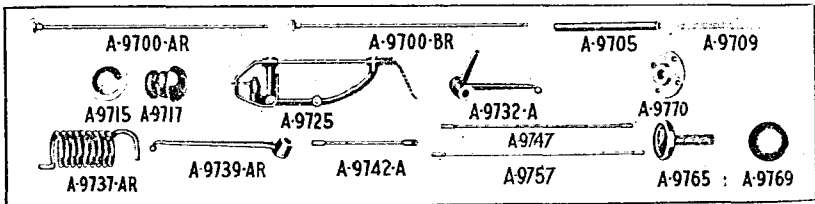

A-9564-A	Carburetor fuel valve assembly	1928-31	化汽機燃料閥總成
A-22333	Carburetor fuel valve washer	1928-31	化汽機燃料閥隔片
A-9570	Carburetor adjusting needle driver assembly	1928-31	化汽機調節針轉動手總成
A-9575	Carburetor compensator jet	1928-31	化汽機怠速度噴嘴
A-22086	Washer	1928-31	隔片
A-9577	Carburetor idling adjusting needle	1928-31	化汽機怠速度調節針
A-9578	Carburetor idling adjusting spring	1928-31	化汽機怠速度調節彈簧
A-9579	Carburetor idling adjusting spring cap	1928-31	化汽機怠速度調節彈簧蓋
A-9581-A	Carburetor throttle shaft assembly	1928-31	化汽機風桿軸總成
A-20108-S7	Carburetor throttle lever stop screw	1928-31	化汽機風桿擋螺絲
A-9585	Carburetor throttle plate	1928-31	化汽機風桿片
A-20042-S7	Screw	1928-31	螺絲
A-9586-B	Carburetor main venturi	1928-31	化汽機總噴嘴筒
A-9590	Carburetor lower plug	1928-31	化汽機底塞

Part No.	Name of Part	Year	貨名
A-22256	Washer	1928-31	隔片
A-9592	Carburetor bowl gasket	1928-31	化汽機油碗墊
A-9700-AR	Carburetor adjusting rod—22"	1928-29	化汽機調節桿
A-9700-BR	Carburetor adjusting rod—26"	1928-29	化汽機調節桿
A-9700-C	Carburetor adjusting rod—28½"	1930-31	化汽機調節桿
A-9705	Carburetor adjusting rod locking sleeve	1928-31	化汽機調節桿鎖筒
A-9709	Carburetor adjusting rod spring	1928-31	化汽機調節桿彈簧
A-22172-S2	Carburetor adjusting rod spring collar	1928-31	化汽機調節桿彈簧鎖
A-9715	Carburetor adjusting rod anti-rattler on dash	1928-31	化汽機調節桿防聲墊在表板上
A-9717	Carburetor adjusting rod anti-rattler—on cowl tank	1928-31	化汽機調節桿防聲墊在暖蓋箱上

SPARK AND THROTTLE CONTROLS

A-9725	Throttle control assembly	1929-31	火桿及風桿
A-9732-A	Accelerator bell crank	1928-31	風桿總成
A-23849	Pin	1928-31	加速桿橫桿
A-22287	Washer	1928-31	針
A-23531	Cotter	1928-31	隔片
A-23635	Accelerator pedal pin	1928-29	鎖針
A-11471	Accelerator pedal pad	1928-31	加速桿腳踏針
A-22217	Lock washer	1928-31	加速桿腳踏墊
A-9737-AR	Accelerator spring	1928-29	鎖環
A-9737-B	Accelerator spring	1929-31	加速桿彈簧
A-9737-AR	Accelerator shaft lever	1928-29	加速桿彈簧
A-23635	Pin	1928-29	加速桿軸橫桿
*A-9742-A	Accelerator to steering gear rod	1928-31	針
A-9747	Accelerator to carburetor rod	1928-31	加速桿連氣輪桿
A-9757	Spark control rod	1928-31	加速桿連化汽機桿
A-9765	Accelerator foot rest	1928-31	火桿
A-21741-SS	Nut	1928-31	加速桿底座
A-9769	Accelerator foot rest cushion	1928-31	螺絲帽
A-9770	Accelerator foot rest floor plate	1928-31	加速桿底座墊
A-22541	Screw	1928-31	加速桿底座地板片

ELECTRICAL SYSTEM 電系

A-10000-B	Generator assembly	1928-31	發電機
A-10005-AR	Generator armature	1928-29	發電機繞成
A-10005-BR	Generator armature	1929-30	發電機電子
A-10005-C	Generator armature	1930-31	發電機電子
A-10048	Generator brush holder insulating bushing	1929-31	發電機電刷架絕滑套
A-10049	Generator brush holder stop pin insulator	1929-31	發電機電刷架停針絕滑
†A-10050-BR	Generator brush holder assembly	1928-29	發電機電刷架總成
A-20056-S5	Screw (brush holder to yoke)	1928-29	螺絲(電刷架連外殼)
A-22047-S2	Lock washer	1928-29	鎖環
A-22057	Lock washer	1928-29	鎖環

Part No.	Name of Part	Year	貨名
A-10051	Generator brush holder (Replaces A-10060-C)	1929-31	發電機電刷架
A-22056	Screw washer	1929-31	螺絲帽片
A-22177	Washer (generator brush holder insulating)	1929-31	隔片(發電機電刷架絕沿)

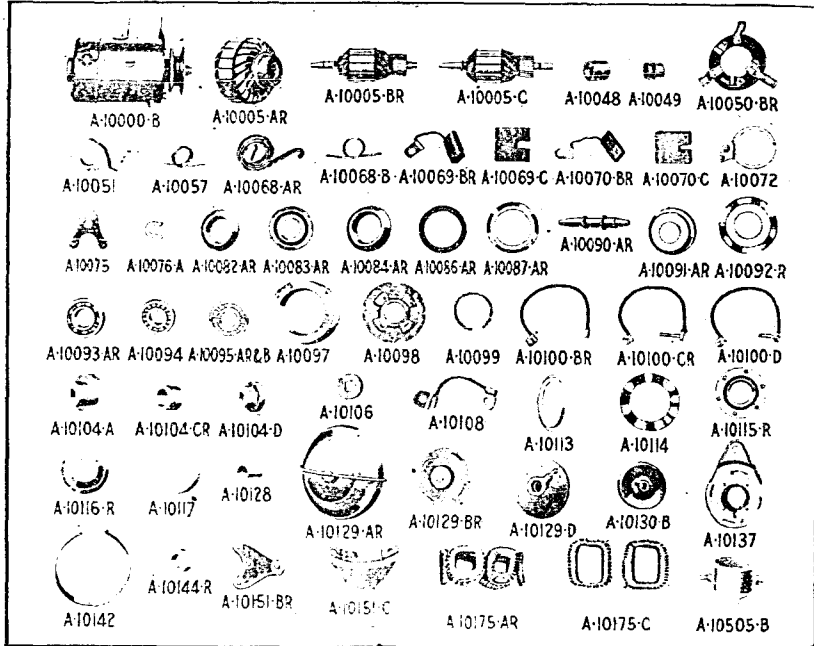

A-10057	Generator third and grounded brush spring	1929-31	發電機第三及最下電刷彈簧
A-10068-AR	Generator brush spring	1928-29	發電機電刷彈簧
A-10068-B	Generator insulated main brush spring	1929-31	發電機絕沿總電刷彈簧
*A-10069-AR	Generator brush	1928-29	發電機電刷
‡A-10069-BR	Generator brush	1928-29	發電機電刷
A-10069-C	Generator main brush	1929-31	發電機總電刷
*A-10070-AR	Generator field control brush	1928-29	發電機小電刷
‡A-10070-BR	Generator field control brush	1928-29	發電機小電刷
A-20056-S5	Screw (generator brush holder)	1928-29	螺絲(發電機電刷架)
A-10070-C	Generator third brush	1929-31	發電機第三電刷
A-20106-S7	Screw (generator brush ground)	1929-31	螺絲(發電機電刷架)
A-22056	Washer	1928-29	隔片
A-20121-S8	Screw (generator brush)	1929-31	螺絲(發電機電刷)
A-10072	Generator third brush plate assembly	1929-31	發電機第三電刷片總成

‡For 3-brush generator. *For 5-brush generator.

Part No.	Name of Part	Year	貨名
A-10075	Generator third brush plate retainer spring	1929-31	發電機第三電刷片彈簧
A-20106-S7	Screw	1929-31	螺絲
A-10076	Generator brush holder stud clip	1929-31	發電機電刷架螺絲夾
A-22074	Washer	1929-31	隔片
A-10082-AR	Generator oil thrower—rear	1928-29	發電機滑油圈 後
A-10083-AR	Generator oil thrower cup—front	1928-29	發電機滑油圈座 前
A-10084-AR	Generator oil thrower—front	1928-29	發電機滑油圈 前
A-10086-AR	Generator oil thrower gasket—front	1928-29	發電機滑油圈墊 前
A-10087-AR	Generator bearing spring	1928-29	發電機滑滾彈簧
A-10090-AR	Generator shaft	1928-29	發電機軸
A-10091-AR	Generator front end cap	1928-29	發電機前帽
A-20531	Screw (generator armature to shaft clamp)	1928-29	螺絲(發電機電子連軸鎖鐵)
A-22451	Washer	1928-29	隔片
A-10092-R	Generator bearing spring washer	1929	發電機滑滾彈簧隔片
A-10093-AR	Generator shaft bearing—large—same as L-2259	1928-29	發電機軸滑滾 大
A-10094	Generator shaft bearing—small—same as T-5122	1928-29	發電機軸滑滾 小
A-10094	Generator bearing—drive end	1929-31	發電機滑滾 驅動頭
A-10095-AR	Generator bearing—commutator end	1929	發電機滑滾 變換機頭
A-10097	Generator bearing spacer	1929-31	發電機滑滾隔片
A-22409-R	Washer (generator bearing)	1929	隔片(發電機滑滾)
A-10098	Generator bearing retainer plate	1929-31	發電機滑滾護片
A-23101-S4	Rivet	1929-31	釘
A-10099	Generator bearing retainer ring	1929-31	發電機滑滾護片環
A-10100-BR	Generator terminal and lead assembly	1928-29	發電機終點總成
A-10100-CR	Generator terminal and lead assembly	1929	發電機終點總成
A-10100-D	Generator terminal and lead assembly	1929-31	發電機終點總成
A-10104-AR	Generator terminal bushing	1928-29	發電機終點套
A-10104-CR	Generator terminal bushing	1929	發電機終點套
A-10104-D	Generator terminal bushing	1929-31	發電機終點套
A-22135-B	Washer (generator terminal)	1928-29	隔片(發電機終點)
A-21570	Nut (generator terminal)	1928-31	螺絲帽(發電機終點)
A-22450	Washer (generator main terminal)	1928-31	隔片(發電機終點)
A-2020-1C	Bolt (generator terminal)	1929-31	螺絲(發電機終點)
A-21570	Nut (generator terminal bolt)	1929-31	螺絲帽(發電機終點)
*A-10104-E	Generator terminal bushing	1929-31	螺絲帽(發電機終點螺絲)
A-10106	Washer (generator terminal post insulating)	1929-31	發電機終點套
A-10108	Generator brush to ground lead assy.	1929-31	隔片(發電機終點柱絕滑)
A-22453	Generator bearing felt—drive end	1929-31	發電機電刷底起點總成
A-10113	Generator bearing felt retainer—drive end	1929-31	發電機滑滾絨 驅動頭
A-10114	Generator bearing corrugated washer	1929-31	發電機滑滾絨圈
A-22408-R	Generator bearing felt—commutator end	1929-31	發電機滑滾絨 變換機頭
A-10115-R	Generator bearing felt retainer—brush end	1929-30	發電機滑滾絨圈 電刷頭

*For 5-brush generator.

Part No.	Name of Part	Year	貨名
A-10116-R	Generator bearing felt retainer washer —commutator end	1929-30	發電機滑環絨圈環 電 刷頂
A-10117	Generator terminal insulator washer ..	1929-31	發電機終點絕沿滑片
A-10128	Generator bushing	1930-31	發電機套
A-10129-AR	Generator end cover and bail assembly ..	1928-29	發電機頂蓋及半環總成
A-10129-BR	Generator rear end plate assembly ..	1929-30	發電機後端片總成
A-10129-D	Generator rear end plate assembly ..	1930-31	發電機後端片總成
†A-10130-B	Generator pulley assembly	1928-31	發電機皮帶盤總成
A-20532-R	Screw	1928-29	螺絲
A-22271	Washer	1928-31	圓片
Λ-10137	Generator front end plate	1929-31	發電機前端片
A-20623	Bolt (generator frame)	1929-31	螺絲(發電機框)
A-21663-S2	Nut	1929-31	螺絲帽
A-22151	Washer	1929-31	圓片
Λ-10141	Generator commutator end oil cup ..	1930-31	發電機變換器頭油杯
A-10142	Generator cover band	1929-31	發電機蓋邊
A-20310	Screw	1929-31	螺絲
A-21572	Nut	1929-31	螺絲帽
A-10143	Generator pulley cap screw	1930-31	發電機皮帶盤帽螺絲
A-10144-R	Generator pulley spacer washer	1928-29	發電機皮帶盤隔環
A-10145	Generator commutator end plate wick and spring assembly	1930-31	發電機變換器頭片燭心 及彈簧總成
A-10146-A	Generator commutator end plate oiler ..	1930-31	發電機變換器頭片注油器
A-10149	Generator commutator end bearing plug	1930-31	發電機變換器頭滑環套
A-10151-BR	Generator support	1928-29	發電機架
A-10151-C	Generator support	1929-31	發電機架
A-20574	Screw	1928-29	螺絲
A-20622	Screw	1929-31	螺絲
A-22164	Washer	1928-31	圓片
A-21241	Bolt	1929-31	螺絲
A-21845	Nut	1929-31	螺絲帽
A-22330	Washer	1929-31	圓片
A-10175-AR	Generator field coil assembly	1928	發電機繞圈總成
A-20056-S5	Crew (field coil grounding)	1928-29	螺絲(繞圈接地)
A-22046	Lock washer	1928-29	鎖環
A-10175-C	Generator field coil assembly	1929-31	發電機繞圈總成
A-10505-B	Generator cutout assembly—same as T-5055	1928-31	發電機斷電器總成
A-20217-S2	Screw (cutout to generator yoke) ..	1928-31	螺絲(斷電器連發電機外殼)
A-20223-S5	Screw (cutout to generator yoke) ..	1928-29	螺絲(斷電器連發電機外殼)
†A-22450	Washer	1928-31	圓片
A-10550	Generator cutout to generator con- nector	1928-31	發電機斷電器連發電機 接連器
A-10562	Generator cutout to gen. terminal in- sulator	1928-31	發電機斷電器連發電機 斷點絕沿
A-20288-S8	Screw (generator cutout connector) ..	1928-31	螺絲(發電機斷電器接連器)
A-22112	Washer (gen. cutout terminal screw) ..	1928-31	圓片(發電機斷電器終 點螺絲)
A-10563	Cutout battery terminal insulator	1928-31	斷電器電池終點絕沿

Part No.	Name of Part	Year	貨名
A-10564	Cutout battery terminal screw (Old No. A-20289)	1928-31	斷電器電池終點螺絲
A-22112	Washer	1928-31	圓片
BATTERY			
A-10655-A	Battery assembly	1928-31	電池
A-10660-A	Battery case assembly	1928-31	電池總成
A-10675	Battery plate separator (same as T-5185)	1928-31	電池箱總成
A-10680-B	Battery negative group assembly	1928-31	電池木隔片
A-10682-B	Battery negative terminal post	1928-31	電池陰鉛片總成
A-10684	Battery negative plate (same as T-5178-B)	1928-31	電池陰終點柱
A-10690-B	Battery positive group assembly	1928-31	電池陰鉛片
A-10692-B	Battery positive terminal post	1928-31	電池陽鉛片總成
A-10694	Battery positive plate (same as T-5186-B)	1928-31	電池陽終點柱
A-10705-B	Battery cell cover	1928-31	電池陽鉛片
A-10715	Battery cell connector (same as T-5177)	1928-31	電瓶蓋
A-10720	Battery filler plug (same as T-5184-C)	1928-31	電瓶接連器
A-22446-R	Battery filler plug gasket	1928-31	電瓶塞

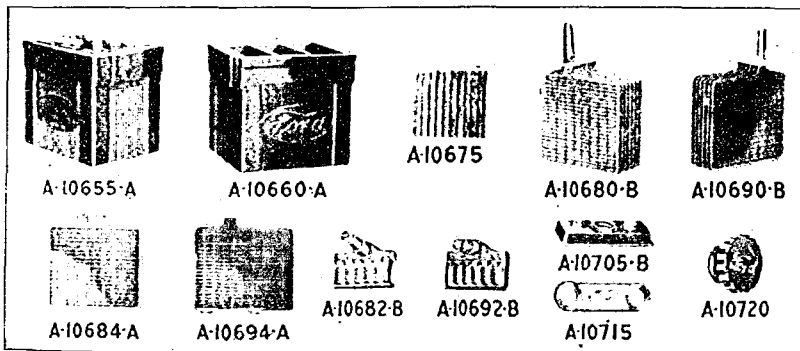

AMMETER

A-10850	Ammeter assembly (same as T-5016B)	1928-31	指電表總成
A-10865	Ammeter lens (same as T-5017-C)	1928-31	指電表玻璃
A-21550	Nut—insulated (ammeter terminal)	1928-31	螺絲帽 絕緣(指電表終點)
A-21549	Nut (ammeter terminal)	1928-31	螺絲帽(指電表終點)
A-22056	Lock washer	1928-31	鎖環

STARTER MOTOR

A-11002-C	Starter assembly	1928-31	發動機
†A-11002-DR	Starter assembly	1928	發動機總成
†A-11005-CR	Starter armature assembly	1928	發動機電子總成
A-11005-D	Starter armature assembly	1928-31	發動機電子總成

Part No.	Name of Part	Year	貨名
*A-22372 Starter armature thrust washer—front	1928-31	發動機電子前扭圈
A-11049 Starter brush end plate and bushing assembly 1928-31	發動機電刷尾片及套總成
A-11050-AR	.. Starter brush end bracket assembly	... 1928	發動機電刷尾架總成
A-11052-BR	.. Starter brush end bracket bushing 1928	發動機電刷尾架總成
A-20254 Screw (brush end bracket to yoke)	... 1928	螺絲(電刷尾架連外殼)
A-22088 Washer 1928	圓片
A-11053-AR	.. Starter brush end cap 1928	發動機電刷帽
A-11053-BR	.. Starter brush end cap 1928-29	發動機電刷帽
A-11054 Starter brush assy.—insulated—long	.. 1928-31	發動機電刷總成 絕緣長
A-20208 Screw (starter brush to holder) 1928	螺絲(發動機電刷連架)
A-22088 Washer 1928	圓片
A-11056-B Starter brush assembly—grounded 1928-31	發動機電刷總成
A-20224 Bolt (starter brush terminal to yoke)	1928-31	螺絲(發動機電刷終點連外殼)
A-11059-BR	.. Starter brush spring 1928-31	發動機電刷彈簧
A-11061-BR	.. Starter brush holder 1928	發動機電架
A-11061-C Starter brush holder 1928-31	發動機電架
A-11062-BR	.. Starter brush holder insulator 1928	發動機電刷架絕緣
A-11062-C Starter brush holder insulator 1928-31	發動機電刷架絕緣
A-22909-S8	.. Rivet—long 1928-31	長桁釘
A-22889 Rivet—short 1928-31	短桁釘
A-11063-BR	.. Brush holder screw insulator 1928	電刷架螺絲絕緣
A-11067 Brush holder screw insulator bushing	1928	電刷架螺絲絕緣套
A-20254 Screw (starter insulated brush holder to end bracket) 1928	螺絲(發動機絕緣固定刷架連尾架)
A-20249-R	.. Screw (starter grounded brush holder to end bracket) 1928	螺絲(發動機接地電刷架連尾架)
A-22057 Washer 1928	圓片
A-11060 Starter field coil assembly 1928	發電機繞圈總成
A-11082-B Starter field coil No. 1 1928-31	發電第一球
A-11083-B Starter field coil No. 2 1928-31	發電第二球
A-11084-B Starter field coil No. 3 1928-31	發電第三球
A-11085-B Starter field coil No. 4 1928-31	發電第四球
A-11087-B Starter field coil end insulator 1929-31	發動機繞圈尾絕緣
A-11090-AR	.. Starter field coil to yoke insulator (Same as T-2066-X) 1928-29	發動機繞圈連外殼絕緣
A-22041 Insulator—small (starter field coil rivet) 1928-29	絕緣小(發動機繞圈桁釘)
A-22040 Insulator—large (starter field coil rivet) 1928-29	絕緣大(發動機繞圈桁釘)
A-11102-C Starter field contactor (use with A-11450-C) 1928-31	發電球連接器
A-22258 Washer 1928-29	圓片
A-11107-B Starter field contactor bushing 1928-31	發電球連接器套
A-22334 Washer 1928-31	圓片
A-11125-AR	.. Starter cover band assembly 1928	發動機夾環總成

Part No. Name of Part Year 貨名

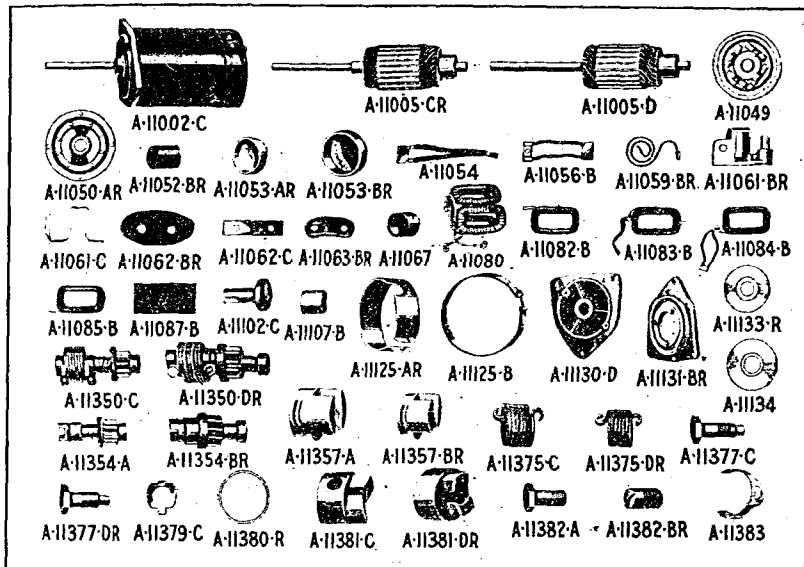

A-20277-S1	Bolt	1928	螺絲
A-21572	Nut	1928	螺絲帽
A-11125-B	Starter cover band assembly	1928-31	發動機蓋環總成
A-20310	Bolt	1928-31	螺絲
A-21578	Nut	1928-31	螺絲帽
A-11130-AR	Starter rear end plate assembly	1928	發動機後尾片總成
A-11130-D	Starter rear end plate assembly	1928-31	發動機後尾片總成
A-11131-BR	Starter end plate	1928	發動機尾片
A-20248-R	Screw (starter end plate to yoke)	1928	螺絲(發動機尾片連外殼)
A-22088	Washer	1928	圓片
A-20904	Screw (end plate to flywheel housing)	1928-31	螺絲(尾片連飛輪殼)
A-22245	Washer	1928-31	圓片
A-10093-AR	Starter rear bearing	1928	發動機後滑滾
A-18495	Starter rear bearing retainer—outer	1928	發動機後滑滾管頭 外
A-11134	Starter rear bearing retainer—inner	1928	發動機後滑滾管頭 內
A-20251-R	Bolt	1928	螺絲
A-21579-R	Nut	1928	螺絲帽
A-22057	Lock washer	1928	鎖環
A-20590	Screw (starter frame)	1928-31	螺絲(發動機框)
A-22151	Washer	1928-31	圓片
STARTER DRIVE			發動機開
A-11350-C	Starter drive assembly	1928-31	發動機開總成

Part No.	Name of Part	Year	貨名
‡A-11350-DR	Starter drive assembly	1928	發動機開關總成
A-11354-A	Starter drive shaft and pinion assy.	1928-31	發動機開關軸及齒輪總成
‡A-11354-BR	Starter drive shaft and pinion assy.	1928	發動機開關軸及齒輪總成
A-11357-A	Starter drive screw shaft sleeve	1928-31	發動機開關螺絲軸套
‡A-11357-BR	Starter drive screw shaft sleeve	1928	發動機開關螺絲軸套
A-11375-C	Starter drive spring	1928-31	發動機開關彈簧
‡A-11375-DR	Starter drive spring	1928	發動機開關彈簧
A-11377-C	Starter drive head spring screw	1928-31	發動機開關彈簧螺絲
‡A-11377-DR	Starter drive head spring screw	1928	發動機開關彈簧螺絲
A-11379-C	Starter drive spring screw lock washer (Same as T-5025)	1928-31	發動機開關彈簧螺絲鎖帽
‡A-11380-R	Starter drive shaft spring lock ring	1928	發動機開關彈簧鎖環
A-11381-C	Starter drive head	1928-31	發動機開關頭
‡A-11381-DR	Starter drive head	1928	發動機開關頭
A-11382-A	Starter drive shaft spring screw	1928-31	發動機開關彈簧螺絲
‡A-11382-BR	Starter drive shaft spring screw	1928	發動機開關彈簧螺絲
A-11383	Starter drive spring clip	1928-31	發動機開關彈簧夾
A-23908	Key (starter drive)	1928-31	鑰

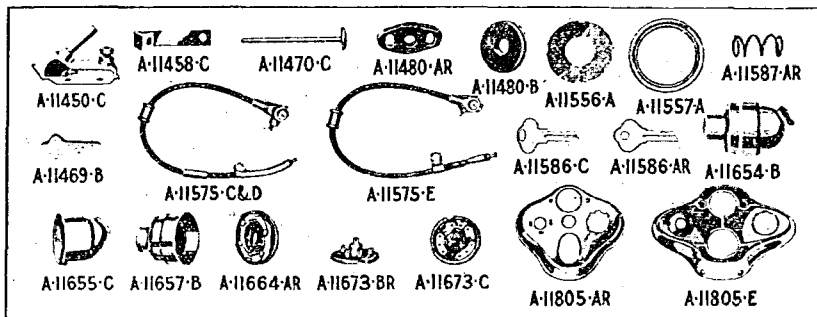

STARTER SWITCH

A-11450-C	Starter switch assembly	1928-31
A-20217-S2	Screw (starter switch to motor)	1928-31
A-22088	Lock washer	1928-31
A-11458-C	Starter switch contactor	1928-31
A-11469-B	Starter switch plunger button	1928-31
A-11470-C	Starter switch push rod	1928-31
A-11480-AR	Starter switch rod grommet	1928-31
A-21742	Nut (starter switch terminal screw)	1928-31
A-22286	Washer (starter switch terminal insulating)	1928-31
A-22259-S7	Washer (starter switch terminal steel)	1928-31
A-22451	Lock washer (starter switch terminal)	1928-31
A-23550	Cotter	1928-29

發動機開關
發動機開關總成
螺絲(發動機開關連引器)
鎖環
發動機開關連接器
發動機開關接觸柱
發動機開關推進桿
發動機開關桿管頭
螺絲帽(發動機開關終點螺絲)
隔片(發動機開關終點絕緣)
隔片(發動機開關終點鋼)
鎖環(發動機開關終點)
鎖針

‡Special service starter drive.

Part No.	Name of Part	Year	貨名
A-11480-B	Starter switch rod grommet	1930-31	發動機開關桿管頭
A-11480-C	Starter switch push rod grommet cover	1930-31	發動機開關推進桿管頭蓋
A-11481-A			發動機開關推進桿管頭蓋
A-20427-S2	Bolt (cover to dash)	1928-31	螺絲(蓋速表板)
A-22139	Washer	1928-31	圈片
A-22976-S3	Rivet	1930-31	釘
‡A-11481-BR	Starter switch push rod grommet cover	1928-30	發動機開關推進桿管頭蓋
‡A-21639	Nut	1928-30	螺絲帽
IGNITION AND LIGHTING SWITCHES			
A-11556-A	Ignition switch plate	1928-31	發火及點火開關
A-11557-A	Ignition switch plate ring	1928-31	發火開關片
A-11575-C	Ignition switch assembly	1928-31	發火開關片環
A-11575-D	Ignition switch assembly	1928-31	發火開關總成
A-11575-E	Ignition switch assembly	1928-31	發火開關總成
A-20058-S8	Screw (switch to instrument panel)	1928-31	發火開關總成
A-22047-S2	Lock washer	1928-31	螺絲(開關速印前板)
A-11581	Ignition switch body to collar screw	1930-31	鎖環
†A-11582-AR	Ignition lock cylinder assembly	1928-30	發火開關身連鎖螺絲
A-20245-S7	Screw (ignition lock cylinder guide)	1928-30	螺絲(發火鎖圓塔)
A-22057	Lock washer	1928-30	鎖環
†A-11582-B	Ignition lock cylinder assembly	1930	發火鎖圓塔總成
†A-11582-C	Ignition lock cylinder assembly	1931	發火鎖圓塔總成
A-11586-AR	Ignition switch key-specify serial number	1928-30	發火開關匙
A-11586-C	Ignition Switch Key—Special Serial Number	1931	發火開關匙
A-11587-AR	Ignition lock cylinder spring	1928-30	發火鎖圓塔彈簧
A-11587-B	Ignition lock cylinder spring	1931	發火鎖圓塔彈簧
A-11654-B	Lighting switch assembly	1928-31	發火開關總成
*A-11655-C	Lighting switch cover—lower	1928-31	發火開關蓋 下
A-11657-B	Lighting switch body and contact assy.	1928-31	發火開關身及接連總成
A-11664-AR	Lighting switch contact support block assembly	1928-29	發火開關接連帶架總成
A-11673-BR	Lighting switch plate assembly	1928-29	發火開關片總成
A-11673-C	Lighting switch plate assembly	1928-31	發火開關片總成
INSTRUMENT PANEL			
A-11805-AR	Instrument panel assembly	1928-30	印前儀板
A-20211-S6	Screw (panel mounting)	1928-30	印前儀板總成
A-11805-E	Instrument panel	1930-31	螺絲(安裝儀板)
A-20221-S6	Screw (panel to speedometer cable support)	1928-29	印前儀板
A-11818-S6	Instrument panel to gas gauge screw	1930-31	螺絲(儀板連速度表線架)
			印前儀板連汽油表螺絲

*When replacing previous type also supply A-3647-C. †Includes keys.

‡Use with A-11480-AR grommet.

Part No.

Name of Part

Year

貨名

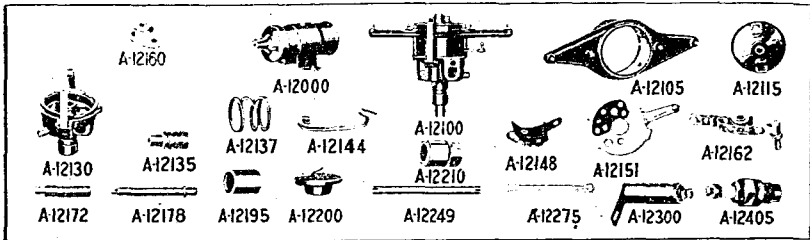

IGNITION COIL, DISTRIBUTOR AND CONDENSER

A-12000	Ignition coil assembly	1928-31
A-20535-S1	Bolt (ignition coil to dash)	1928-31
A-22150	Washer	1928-31
A-21577-S2	Nut (ignition coil terminal) outer	1928-31
A-22150	Lock washer	1928-31
A-22104-S7	Plain washer	1928-31
A-12100	Distributor assembly	1928-31
A-20925-S8	Screw (distributor set)	1928-31
A-21750-S8	Nut	1928-31
A-12105	Distributor body	1928-31
A-12115	Distributor cap assembly	1928-31
A-12130	Distributor base assembly	1928-31
A-22094	Washer (distributor base insulation)	1928-31
A-12132	Distributor base bushing	1928-31
A-12135	Distributor base oiler	1928-31
A-12137	Distributor breaker plate friction spring	1928-31
A-12144	Distributor cap clamp	1928-31
A-22902	Rivet	1928-31
A-12148	Distributor bus bar support assembly	1928-31
A-20106-S7	Screw	1928-31
A-22056	Washer	1928-31
A-12151	Distributor breaker plate and insulator assembly	1928-31
A-21547-S7	Nut (distributor breaker arm spring stud)	1928-31
A-22072-S6	Washer	1928-31
A-22056	Lock washer	1928-31
A-12160	Distributor contact screw bracket	1928-31
A-20116-S8	Screw (bracket to plate)	1928-31
A-22056	Lock washer	1928-31
A-22071-S7	Washer	1928-31
A-12162	Distributor breaker arm assembly	1928-31
A-12172	Distributor breaker contact screw assy.	1928-31
A-20107-S7	Screw (distributor breaker contact lock)	1928

發火線圈分電器及凝電器

發火線圈總成
螺絲(發火線圈連表板)
圓片
螺絲帽(發火線圈終點)外
鎖環
平圓片
分電器總成
螺絲(分電器調節)
螺絲帽
分電器身
分電器蓋總成
分電器底總成
圓片(分電器底絕緣)
分電器底套
分電器底油嘴
分電器斷電片彈簧
分電器蓋頂鐵
帽釘
分電器移動片架總成
螺絲
圓片
分電器斷電片及絕緣紙成
螺絲帽(分電器斷電臂彈簧螺絲)
圓片
鎖環
分電器接觸點螺絲架
螺絲(架連片)
鎖環
圓片
分電器斷電臂總成
分電器接觸點螺絲總成
螺絲(分電器接觸點鐵)

Part No.	Name of Part	Year	貨名
A-20067-S7	Screw (distributor breaker contact lock)	1928-31	螺絲(分電器接觸型鎖)
A-22056	Washer	1928	圓片
A-22047	Washer	1928-31	圓片
A-12178	Distributor cam shaft	1928-31	分電器撥柱軸
A-22331	Washer (distributor cam shaft thrust)	1928-31	圓片(分電器撥柱軸壓力)
A-12195	Distributor cam shaft sleeve	1928-31	分電器撥柱軸套管
A-23670	Pin	1928-31	針
A-12200	Distributor rotor assembly	1928-31	分電器轉柱總成
A-12210	Distributor cam	1928-31	分電器撥柱
A-20744-S7	Screw	1928-31	螺絲
A-22222-S7	Washer	1928-31	圓片
A-22236	Lock washer	1928-31	鎖環
A-12249	Distributor coupling shaft	1928-31	分電器雙連桿
A-12275	Distributor to spark plug connector	1928-31	分電器連火星塞鋼片
A-12300	Condenser assembly	1928-31	凝電器總成
A-20106-S7	Screw (condenser ground connection)	1928-31	螺絲(凝電器連地)
A-22056	Washer	1928-31	圓片
A-20223-S5	Screw (condenser to bus bar)	1928-31	螺絲(凝電器連移動片)
A-12405	Spark plug	1928-31	火星塞
A-22424	Spark plug gasket	1928-31	火星塞墊
A-12407	Spark plug porcelain	1928-31	火星塞磁瓦
A-12409	Spark plug terminal nut	1928-31	火星塞終點螺絲帽

HEAD LAMP

A-13004-AR	Head lamp assembly (black)	1928-29	頭燈
A-13004-CR	Head lamp assembly (2 bulb) (black)	1929	頭燈總成(黑)
A-13005-AR	Head lamp assembly (nickel)	1928-29	頭燈總成(兩泡)(黑)
A-13005-CR	Head lamp assembly (2 bulb) (nickel plate)	1929	頭燈總成(鎳鍍)
A-13005-DR	Head lamp assembly (1 bulb) (nickel plate)	1929	頭燈總成(單泡)(鎳鍍)

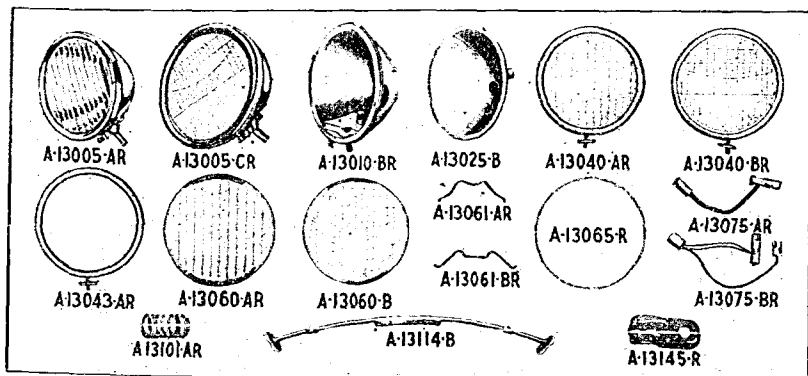

Part No.	Name of Part	Year	貨名
A-13005-F	Head lamp assembly (2 bulb)	1930-31	頭燈總成(兩泡)
A-13005-G	Head lamp assembly (1 bulb)	1930-31	頭燈總成(單泡)
A-13005-K	Head lamp assembly (2 bulb) (black)	1930-31	頭燈總成(兩泡)(黑)
A-13007-AR	Head lamp bulb—same as T-6572-H	1928-29	頭燈泡
A-13007-C	Head lamp bulb (21-21 C.P.)	1929-31	頭燈泡
A-13007-D	Head lamp bulb (32-21 C.P.)	1929-31	頭燈泡
A-13466	Head lamp parking bulb	1929-31	頭燈停車燈泡
A-13007-E	Head lamp bulb (32-32 C. P.)	1929-31	頭燈泡
A-13009-AR	Head lamp case and support assembly (black)	1928-29	頭燈殼及架總成(黑)
A-13009-BR	Head lamp case and support assembly (black)	1929	頭燈殼及架總成(黑)
A-13009-D	Head lamp case and support assembly (black)	1930-31	頭燈殼及架總成(黑)
A-13010-AR	Head lamp case and support assembly (nickel)	1928-29	頭燈殼及架總成(鍍鎳)
A-13010-BR	Head lamp case and support assembly (nickel plate)	1929	頭燈殼及架總成(鍍鎳)
A-13010-D	Head lamp case and support assembly	1930-31	頭燈殼及架總成
A-21845-S2	Nut (head lamp swivel bolt)	1930-31	螺絲帽(頭燈旋迴螺絲)
A-22330-S1	Lock washer	1930-31	鎖墊
A-13017-B	Head lamp door spring	1928-31	頭燈門彈簧
A-13025-AR	Head lamp reflector assembly	1928-29	頭燈反射殼
A-13025-B	Head lamp reflector assembly (2 bulb)	1928-31	頭燈反射殼(兩泡)
A-13025-C	Head lamp reflector assembly (1 bulb)	1929-31	頭燈反射殼(單泡)
A-13040-AR	Head lamp door and lens assembly	1928-29	頭燈門及玻璃總成
A-13040-BR	Head lamp door and lens assembly	1929	頭燈門及玻璃總成
A-13040-C	Head lamp door and lens assembly	1930-31	頭燈門及玻璃總成
A-13043-AR	Head lamp door assembly	1928-29	頭燈門總成
A-13043-B	Head lamp door assembly	1930-31	頭燈門總成
A-13060-AR	Head lamp lens	1928-29	頭燈玻璃
A-13060-B	Head lamp lens	1929-30	頭燈玻璃
A-13061-AR	Head lamp lens retainer	1928	頭燈玻璃管鋼絲
A-13061-BR	Head lamp lens retainer	1928-29	頭燈玻璃管鋼絲
A-13061-C	Head lamp lens retainer	1930-31	頭燈玻璃管鋼絲
A-13065-R	Head lamp lens gasket assembly	1928-31	頭燈玻璃墊總成
A-13075-AR	Head lamp socket assembly (1 bulb)	1928-29	頭燈泡架總成(單泡)
A-13075-BR	Head lamp socket assembly (2 bulb)	1928-29	頭燈泡架總成(單泡)
A-13075-CR	Head lamp socket assembly (1 bulb)	1929	頭燈泡架總成(單泡)
A-13075-D	Head lamp socket assembly (2 bulb)	1930-31	頭燈泡架總成(單泡)
A-13075-E	Head lamp socket assembly (1 bulb)	1930-31	頭燈泡架總成(單泡)
A-13081	Lamp socket spring	1928-31	燈泡架彈簧
A-20525-S13R	Screw (head lamp focusing)	1928-29	螺絲(頭燈對光)
A-20255-S13	Screw (head lamp focusing)	1930-31	螺絲(頭燈對光)
A-13101-AR	Head lamp focusing screw spring	1928-29	頭燈對光螺絲彈簧
A-13101-B	Head lamp focusing screw spring	1930-31	頭燈對光螺絲彈簧
A-13114-AR	Head lamp support and tie rod assy.	1928-30	頭燈架及連桿總成
A-20906-S1	Bolt (head lamp support)	1928-30	螺絲(頭燈架)
A-13114-B	Head lamp support and tie rod assy.	1930-31	頭燈架及連桿總成

Part No.	Name of Part	Year	貨名
A-20912-S1	.Bolt—1" (head lamp support to fender brkt.)	1930	螺絲 (頭燈架連車翅架)
A-20972-S1	.Bolt—1½" head lamp support to fender brkt.)	1930-31	螺絲 (頭燈架連車翅架)
A-21740-S1	.Nut	1928-31	螺絲帽
A-22245Lock washer	1928-31	鎖環
A-13145Front license clip—same as L-8597-D	1928-31	前執照夾
A-20604-S1	.Bolt	1928-31	螺絲
A-21668-S2	.Nut	1928-31	螺絲帽
A-22166-S8	.Washer	1928-31	隔片
A-22151Lock washer	1928-31	鎖環
FENDER LAMP			車翅燈
A-13200Fender lamp assembly—in carton	1928-31	車翅燈總成
AF-13202-BFender lamp—R. H.	1928-31	車翅燈 右
AF-13203-BFender lamp—L. H.	1928-31	車翅燈 左
A-13335Fender lamp switch	1928-31	車翅燈開關
AF-13224Fender lamp wire shield	1928-31	車翅燈線殼
A-21788-S8	.Nut	1928-31	螺絲帽
A-22305Lock washer	1928-31	鎖環
COWL LAMP			轆蓋燈
A-13300-AR	..Cowl lamp assembly—in carton	1928-29	轆蓋燈總成
A-13300-ECowl lamp assembly—in carton	1930-31	轆蓋燈總成
A-13302-AR	..Cowl lamp assembly	1928-29	轆蓋燈總成
A-13302-ECowl lamp assembly	1930-31	轆蓋燈總成
A-13466Cowl lamp bulb	1928-31	轆蓋燈泡
A-13308-BR	..Cowl lamp lens	1928-29	轆蓋燈玻璃
A-13308-DCowl lamp lens	1930-31	轆蓋燈玻璃
A-13309-AR	..Cowl lamp lens gasket	1928-29	轆蓋燈玻璃墊
A-13309-CCowl lamp lens gasket	1930-31	轆蓋燈玻璃墊
A-13315-CCowl lamp reflector assembly	1930-31	轆蓋燈反射鏡總成
A-13316Cowl lamp lens retainer	1930-31	轆蓋燈玻璃管鋼絲
A-14341Cowl lamp socket wire assembly	1930-31	轆蓋燈泡架及線總成
A-13319-RCowl lamp socket and wire assembly	1928-29	轆蓋燈泡架及線總成
A-13320-RCowl lamp bracket support—R. H.	1928-29	轆蓋燈支架 右
A-13321-RCowl lamp bracket support—L. H.	1928-29	轆蓋燈支架 左
A-20562-S2	.Bolt	1928-29	螺絲
A-21668-S2	.Nut	1928-29	螺絲帽
A-22151Washer	1928-29	隔片
A-13322-AR	..Cowl lamp bracket—R. H.	1928-29	轆蓋燈架 右
A-13322-CCowl lamp bracket—R. H.	1930-31	轆蓋燈架 右
A-13323-AR	..Cowl lamp bracket—L. H.	1928-29	轆蓋燈架 左
A-13323-CCowl lamp bracket—L. H.	1930-31	轆蓋燈架 左
A-21242Screw	1928-31	螺絲
A-22341Washer	1928-29	隔片
A-22330Lock washer	1928-31	鎖環
A-20211-S6	.Screw (lamp to bracket)	1928-29	螺絲 (燈連架)
A-20309-S6	.Screw (lamp to bracket)	1930-31	螺絲 (燈連架)

Part No.	Name of Part	Year	貨名
A-22075-S8	Washer	1930-31	隔片
A-13324-R	Cowl lamp bracket grommet	1928-29	轆蓋燈架首頭
A-13325	Cowl lamp wire support	1929-31	轆蓋燈線架
A-13335	Cowl lamp switch	1928-31	轆蓋燈開關
A-20535-S1	Bolt (switch to cowl tank)	1928-31	螺絲(開關連轆蓋箱)
A-20119-S13	Screw (cowl lamp shell to yoke)	1928-29	螺絲(轆蓋燈殼連外殼)
A-20075-S6	Screw (cowl lamp door to body)	1930-31	螺絲(轆蓋燈門連身)
A-13081	Cowl lamp socket spring	1930-31	轆蓋燈泡架彈簧
REAR LAMP AND LICENSE BRACKET			
A-13406-B	Rear license bracket	1929-30	尾頭及執照架
A-13407-A	Rear lamp assembly	1929-30	後執照架
A-13407-C	Rear lamp assembly (black enamel)	1930-31	尾燈總成
A-13408-A	Rear lamp body assembly	1929-30	尾燈總成(黑珐琅)
A-13408-B	Rear lamp body assy.—black enamel	1930-31	尾燈殼總成
A-13410-R	Rear lamp socket assembly	1928-29	尾燈殼總成(黑珐琅)
A-20025	Screw (rear lamp socket)	1928-29	尾燈泡架總成
A-13412	Rear lamp socket wire assembly (black)	1929-30	螺絲(尾燈泡架)
A-13413	Stop light socket wire assembly (green)	1929-30	尾燈泡架線總成(黑)
A-13432	Rear lamp bracket—225A	1931	尾燈泡架線總成(青)
A-20657-S3	Bolt—225A	1931	尾燈架
A-21668-S2	Nut—225A	1931	螺絲
A-22167-S7	Washer—225A	1931	螺絲帽
A-22151	Lock washer—225A	1931	隔片
A-13433	Rear lamp bracket pad—225A	1931	鎖環
A-13434	Rear lamp wire conduit—225A	1931	尾燈架墊
A-13435	Rear lamp wire conduit grommet cover—225A	1931	尾燈線管
A-22647-S2	Rear lamp wire conduit grommet cover screw—225A	1931	尾燈線管管頭蓋
A-13436	Rear lamp wire conduit grommet—225A	1931	尾燈線管管頭蓋螺絲
A-13439-R	Rear lamp body (black)	1928-29	尾燈線管管頭
A-13440-AR	Rear lamp body (nickel)	1928-29	尾燈殼(黑)
A-20100-S13	Screw	1928-29	尾燈殼(銀)
A-13445-AR	Rear lamp white lens	1928-29	螺絲
A-13445-B	Rear lamp white lens	1929-30	尾燈白玻璃
A-13446	White lens retainer	1928-31	尾燈白玻璃
A-20058-S8	Screw	1929-30	白玻璃管片
A-13447	Rear lamp white lens gasket	1929-30	螺絲
A-13448	Rear lamp door	1929-30	尾燈白玻璃墊
A-13450-AR	Red lens	1928-29	尾燈門
A-13450-B	Rear lamp red lens	1929-30	紅玻璃
A-13456-AR	Red lens retainer—inner	1928-29	尾燈紅玻璃
A-13456-B	Rear lamp red lens retainer	1929-30	紅玻璃管片 內
A-22239-R	Washer (metal)	1928-29	尾燈紅玻璃管片
A-13457-R	Red lens retainer—outer	1928-29	隔片(金屬)
A-22216-R	Washer	1928-29	紅玻璃管片 外
			隔片

Part No. Name of Part Year 貨名

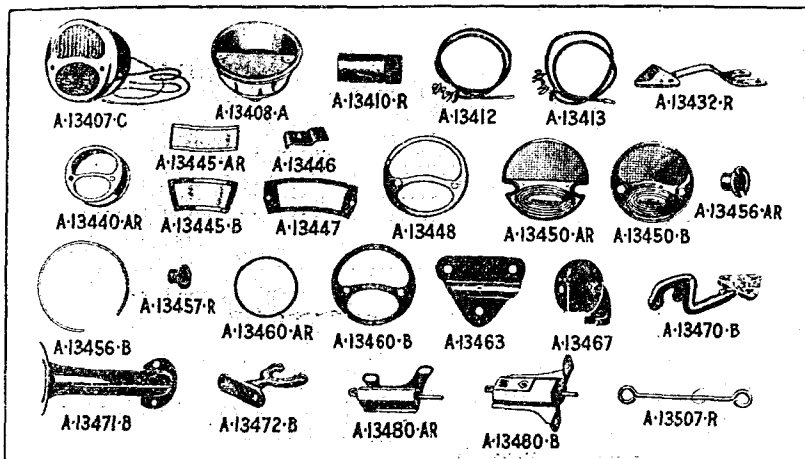

A-13460-AR .. Rear light body gasket	1928-29	尾燈殼墊	
A-13460-B Rear lamp door gasket—inner	1929-30	尾燈門墊 內	
A-20100-S13. Screw (rear lamp door to body)	1929	螺絲(尾燈門連殼)	
A-13461	Rear lamp door gasket—outer	1929-30	尾燈門墊 外
A-13463	Rear lamp bracket fender reinforcement	1929-30	尾燈架車翅增固鐵
A-13464	Rear lamp bracket to cross sill screw—130B, 229A	1930-31	尾燈架連橫鉛螺絲
A-22215	Washer—229A	1931	圓片
A-13465	Stop light bulb—same as T-3178-SX	1928-31	停車燈泡
A-13466	Tail light bulb—same as T-6520-X	1928-31	尾燈泡
A-13467	Rear lamp wire shield	1929-30	尾燈線殼
A-20705-S1 .Bolt (rear lamp and license brckt. to support)	1928-29	螺絲(尾燈及執照架連支架)	
A-21702-S2 .Nut	1928-29	螺絲帽	
A-22217 Washer	1928-29	圓片	
A-13468-R Rear lamp and license brckt. support—Fordor	1928	尾燈及執照支架	
A-13470-AR .. Rear lamp and license brckt. support—79A, 78A, AA chassis	1928-29	尾燈及執照支架	
A-13470-B Rear lamp and stop light and license bracket support—AA chassis, except 85A-B, 195A and dump bodies	1928-31	燈及停車燈及執照支架	
A-13471-AR .. Rear lamp and license bracket support—40A, 45A, 49, 50A, 54, 68A	1928-29	尾燈及執照支架	
A-13471-B Rear lamp bracket—on fender	1928-31	尾燈架 車翅上	
A-21664-S2 .Nut	1929-31	螺絲	
A-22151 Washer	1929-31	圓片	

Part No.	Name of Part	Year	貨名
A-20614-S1	Screw (rear lamp to bracket)	1929-31	螺絲(尾燈連架)
A-22150-S1	Washer	1929-31	隔片
A-13472-AR	Rear lamp and license bracket support —150A	1928-29	尾燈及執照支架
A-13472-B	Rear lamp, stop light and license bracket support—79B, 85B, 150B, 130B, 195A, 229A	1928-31	尾燈停車燈及執照支架
A-13473-AR	Rear lamp and license bracket support —35A, 55A, 135A, 130A	1928	尾燈及執照支架
A-20763-S1	Bolt (support to body)	1928-29	螺絲(架連殼)
A-22217	Washer (support to body)	1928-31	隔片(架連殼)
A-13480-AR	Stop light switch assembly	1928-29	停車燈開關總成
A-13480-B	Stop light switch assembly	1929-31	停車燈開關總成
A-20562-S2	Bolt (switch to frame)	1929-31	螺絲(開關連框)
A-21663-S2	Nut	1929-31	螺絲帽
A-22151	Washer	1929-31	隔片
A-13494-AR	Stop light switch terminal insulator (Old No. A-10863)	1928-29	停車燈開關終點絕緣 螺絲帽(停車燈開關終 點螺絲)
A-21545-S8	Nut (stop light switch terminal bolt)	1928-29	螺絲帽(停車燈開關終 點螺絲)
A-22056	Lock washer	1928-29	鎖環
A-20116-S8	Screw (stop light switch terminal)	1929-31	螺絲(停車燈開關終點)
A-22056	Washer	1929-31	隔片
A-13507-R	Stop light switch to brake pedal link	1928-29	停車燈開關連車制踏 板連桿

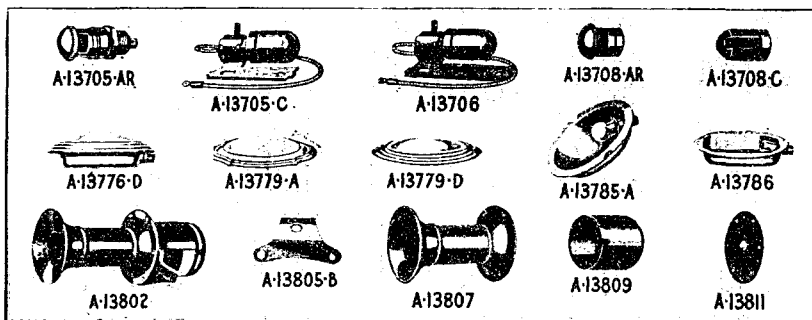

INSTRUMENT PANEL LAMP, DOME LAMP AND HORN

A-13705-AR	Instrument panel lamp assembly	1928-30	御前板燈半光燈及喇叭
A-13705-C	Instrument panel lamp assembly	1930-31	御前板燈總成
A-13706	Instrument panel lamp assembly	1930-31	御前板燈總成
A-20541-S6	Screw	1930-31	螺絲
A-22151	Nut	1930-31	螺絲帽
A-21661	Lock washer	1930-31	鎖環
A-35392	Instrument panel lamp anti-rattler	1930-31	御前板燈消聲器
A-13708-AR	Instrument panel lamp cap	1928-30	御前板燈帽
A-13466	Instrument panel lamp bulb	1928-31	御前板燈燈泡

Part No.	Name of Part	Year	貨名
A-13708-C	Instrument panel lamp cap	1930-31	御前板燈帽
A-13752-B	Dome lamp switch	1928-30	半光燈開關
A-13752-C	Dome lamp switch assy.—155C, 155D, 170B	1930-31	半光燈開關總成
A-13770-B	Dome lamp switch cover—60A, 60B, 130A, 135A	1928-30	半光燈開關蓋
A-13770-D	Dome lamp switch escutcheon—155A, 155B, 155C, 155D, 170B (DL), 140B for toggle type switch	1929-30	半光燈開關片
A-13770-E	Dome light switch escutcheon—155C, 155D, 170B (DL) for slide type switch	1930-31	半光燈開關片
A-13776-D	Dome lamp assembly—155C-D, 170B (DL)		半光燈總成
A-13777-B	Dome lamp assembly		半光燈總成
A-13779-A	Dome lamp lens and rim assembly—130A and B	1928-30	半光燈玻璃及沿邊總成
A-13779-BR	Dome lamp dome assembly—town car	1929-30	半光燈圓頂總成
A-13779-C	Dome lamp lens and rim assembly—140B, 155C, 155D, 170B (DL)	1929-30	半光燈玻璃及沿邊總成
A-13779-D	Dome lamp lens and rim assy.—155C, 155D, 170B (DL)	1930-31	半光燈玻璃及沿邊總成
A-13780	Dome lamp lens and rim assembly—135A (same as T-18902-B)	1928-31	半光燈玻璃及沿邊總成
A-13785-A	Dome lamp reflector assy. (same as T-18901-B)	1928-31	半光燈反射總成
A-13786	Dome lamp reflector assembly	1928-31	半光燈反射總成
A-13466	Dome lamp bulb	1928-31	半光燈燈泡
A-13794	Dome lamp switch lever	1928-31	半光燈開關桿
A-13799	Dome lamp bulb—15 c.p.	1928-31	半光燈燈泡
A-13802	Horn assembly	1928-31	喇叭總成
A-13805-B	Horn bracket	1928-31	喇叭架
A-20412-S2	Bolt (horn flange) long	1928-31	螺絲(喇叭架)長
A-20411-S2	Bolt (horn flange) short	1928-31	螺絲(喇叭架)短
A-21636-S3	Nut	1928-31	螺絲帽
A-22139	Washer	1928-31	圓片
A-13807	Horn projector assembly	1928-31	喇叭射音器總成
A-13809	Horn motor cover	1928-31	喇叭電子蓋
A-20111-S7	Screw	1928-31	螺絲
A-22056	Washer	1928-31	圓片
A-13811	Horn diaphragm assembly	1928-31	喇叭隔膜總成
A-13812	Horn diaphragm gasket	1928-31	喇叭隔膜墊
A-13817	Horn motor brush	1928-31	喇叭電刷
A-13818	Horn motor brush spring	1928-31	喇叭電刷彈簧
WIRING			電線
A-14300-AR	Battery to switch cable assembly	1928-29	電池連開關組線總成
A-14300-B	Battery to switch cable assembly	1928-31	電池連開關組線總成
A-21742	Nut	1928-31	螺絲帽
A-22451	Washer	1928-31	圓片
A-14301	Battery to ground connector assembly	1928-31	電池連地鉛片總成
A-20970-S8	Bolt (connector to frame)	1928-31	螺絲(地鉛片連框)

Part No.	Name of Part	Year	貨名
----------	--------------	------	----

A-21741-S8	Nut	1928-31	螺絲帽
A-22245	Washer	1928-31	隔片
A-22259-S7	Plain washer	1930-31	平隔片

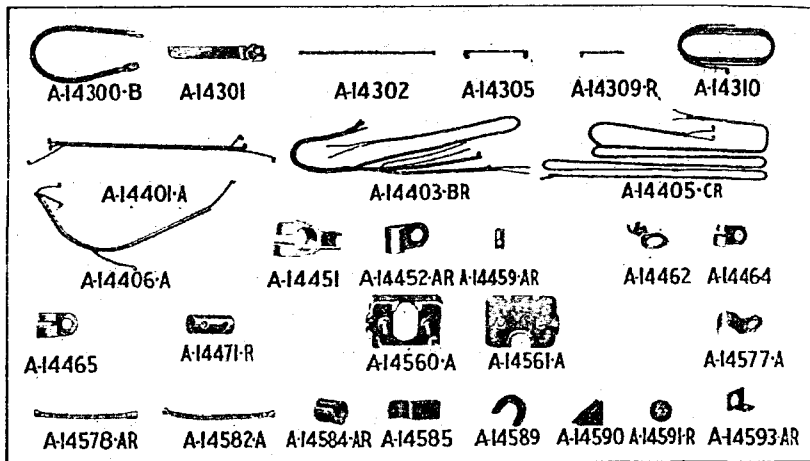

A-14302 Coil to distributor wire assembly 1928-31	線圈連分電器電線總成
A-14305 Ignition coil to terminal block wire assembly 1928-31	發火線圈連終點座電線總成
A-14306 Terminal box to dome lamp wire assembly, 112"—130B 1930-31	終點箱連牛光燈電線總成
A-14309-R Instrument panel lamp wire assembly 1928-30	御前板釘電線總成
A-14310 Windshield wiper wire assembly 1928-30	屏風水擦電線總成
A-14312 Lighting switch to connector wire assembly—cars with fender or cowl lamps 1928-31	電燈開關連接器電線總成
A-14315-R Terminal box to windshield wiper wire assembly 67"—35A, 35B, 40A, 40B, 76A 1928-30	終點箱連屏風水擦電線總成
A-14316-AR Terminal box to windshield wiper wire assembly 60A, 60B, 140A, 170A, 155B, 165B 1928-29	終點箱連屏風水擦電線總成
A-14316-B Terminal box to body header wire assembly—155C, 165C 1930	終點箱連殼架電線總成
A-14317-R Dome lamp switch to light wire assembly—A and AA Panel 1928-30	牛光燈開關連電線總成
A-14319-AR Dome lamp to ground wire assembly—A and AA Panel 1928-29	牛光燈連接地電線總成
A-14319-B Dome lamp to ground wire assembly—A and AA Panel 1930-31	牛光燈連接地電線總成
A-14320-R Dome lamp switch to light wire assembly—Fordor 1928-29	牛光燈開關連電線總成
A-14321-R Dome lamp switch to terminal box wire assembly—Fordor 1928-29	牛光燈開關連終點箱電線總成

Part No.	Name of Part	Year	貨名
A-14322-R	Dome lamp switch to ground wire assembly—Fordor	1928-29	半光燈閉期連接地電線總成
A-14327-R	Dome lamp switch to terminal box wire assembly—De Luxe Delivery	1928-31	半光燈閉期連終點箱電線總成
A-14328	Windshield wiper drop header wire assembly	1929-30	屏風水擦垂架電線總成
A-14331	Dome lamp to ground wire assembly	1929-31	半光燈連地線總成
A-14333	Body header to windshield wiper wire assembly	1929-30	身架連屏風水擦電線總成
A-14336	Body header to dome lamp switch wire assembly	1929-31	身架連半光燈開關電線總成
A-14340	Dome lamp to ground wire assembly	1929-31	半光燈連地線總成
A-14341	Cowl lamp socket wire assembly	1930-31	轆蓋燈泡架電線總成
A-14342	Terminal box to dome light wire assembly—45B (DL)	1930-31	終點箱連半光燈電線總成
A-14349	Rear lamp ground wire assy.—225A	1931	尾燈地線電線總成
A-14401-B	Wiring assembly on cowl	1928-31	轆蓋上電線總成
A-14403-BR	Head lamp wiring assembly (1 bulb)	1928-29	頭燈電線總成(單泡)
A-14403-C	Head lamp wiring assembly (2 bulb)	1929-31	頭燈電線總成(二泡)
A-14403-D	Head lamp wiring assembly (1 bulb)	1929-31	頭燈電線總成(單泡)
*A-14405-CR	Rear lamp wiring assembly	1928-29	尾燈電線總成(單泡)
‡A-14405-D	Rear lamp wiring assembly	1929-31	尾燈電線總成(單泡)
A-14406-A	Cutout to terminal block wire and conduit assy.	1928-31	斷電箱連終點座線及管總成
A-14423-A	Rear lamp extension wire assembly—8" long	1928-29	尾燈加長電線總成
A-14423-B	Rear lamp extension wire assembly—43 1/2" long	1929	尾燈加長電線總成
A-14423-C	Rear lamp wire extension assembly—51 1/2" long	1931	尾燈加長電線總成
A-14487	Rear lamp extension wire connector and sleeve assembly—225A	1931	尾燈加長管線接連器及套管總成
A-14426	Cowl lamp wiring assy.—45B (DL), 68A, 68B, 140A, 155A, 155B, 155C, 155D, 170B (DL), 180A	1929-31	轆蓋燈電線總成
†A-14428	Cowl lamp wiring assembly	1928-31	轆蓋燈電線總成
A-14429	Cowl lamp switch wiring assembly	1928-31	轆蓋燈開關電線總成
A-14430	Fender lamp switch wiring assembly	1929-31	車翅燈開關電線總成

TERMINALS

A-14451	Battery negative terminal	1928-31	電池陰終點
A-20729-S16	Bolt	1928-31	螺絲
A-21707-S16	Nut	1928-31	螺絲帽
A-14452-AR	Battery to switch cable terminal	1928	電池連開關線終點
A-14452-B	Battery to switch cable terminal	1928-31	電池連開關線終點
A-14459-AR	Head lamp plug terminal	1928-29	頭燈電線連接終點
A-14459-BR	Head lamp plug terminal	1929	頭燈電線連接終點
A-14461-B	Wire terminal	1930-31	電線終點
**A-14461-C	Wire terminal	1928-31	電線終點

*When used to replace previous type also use A-14423-BR. ‡Use with A-13480-B.

Part No.	Name of Part	Year	貨名
A-14462	Wire terminal	1928-31	電線終點
A-14464	Wire terminal	1928-31	電線終點
A-14465	Horn and switch wire terminal (on cutout)	1928-31	喇叭及開關電線終點
A-14471-R	Windshield wiper connector assembly	1928-30	屏風水擦接連筒總成
A-14474	Lighting switch wire terminal—single	1928-31	車燈開關電線終點
A-14475	Lighting switch wire terminal—double	1928-31	車燈開關電線終點
A-14476	Windshield wiper terminal extension—Fordor	1928-31	屏風水擦終點加長門車
A-14487	Wire connector and sleeve assembly	1929-31	電線接連筒及套管總成
WIRING CLAMPS, SUPPORTS, ETC.			
A-14550	Battery to switch cable support assy.	1928-31	電池連開關線架總成
AF-14556	Fender lamp wire clip	1928-29	車燈線夾
A-14560-A	Terminal box	1928-31	終點箱
A-14561-A	Terminal box cover	1928-31	終點箱蓋
A-21569	Nut	1928-31	螺絲帽
A-20280-S2	Screw (box to dash)	1928-31	螺絲(箱連表板)
A-22088	Washer	1928-31	圈片
A-14564	Wire connector assembly	1929-31	電線接連筒總成
A-14565	Rear lamp wire clip (on fender brckt.)	1929-31	尾燈電線夾(車翅架上)
A-14567-A	Horn wire conduit grommet	1928-31	喇叭線管套筒
A-14567-A	Head lamp wire conduit grommet	1928	頭燈電線管套筒
A-14567-B	Head lamp wire conduit grommet (2 bulb lamp)	1929-31	頭燈電線管套筒(兩泡燈)
A-14567-C	Head lamp wire conduit grommet (1 bulb lamp)	1929	頭燈電線管套筒(單泡燈)
A-14577-A	Terminal box to generator conduit clip	1928-31	終點箱連發電機管夾
A-20427-S2	Bolt (clip to dash)	1928-31	螺絲(夾連表板)
A-22189	Washer	1928-31	圈片
A-20534-S2	Bolt (clip to inlet connection)	1928-31	螺絲(夾連內銷片)
A-22150	Washer	1928-31	圈片
A-14577-B	Speedometer cable to dash clip for 1 ⁹ / ₆₄ " casing	1929-31	速表綫連表板夾
A-14578-AR	Head lamp wire conduit assembly	1928-29	頭燈線管總成
A-14578-B	Head lamp wire conduit assembly	1928-31	頭燈線管總成
A-14578-D	Head lamp wire conduit assembly—non-metallic—AA Chassis—76B, 78A, 79B, 82B, 85B, 88A, 88B, 89A, 185B, 225A	1930-31	頭燈線管總成
A-14581-B	Head lamp wire conduit ferrule	1928-31	頭燈線管接頭
A-14582-A	Horn wire conduit assembly	1928-31	喇叭線管總成
A-14582-C	Horn wire conduit assembly—non-metallic—AA Chassis—76B, 78A, 79B, 82B, 85B, 88A, 88B, 89A, 185B, 225A	1930-31	喇叭線管總成
A-14584-AR	Head lamp plug	1928-29	頭燈塞
A-14584-BR	Head lamp plug	1929	頭燈塞
A-14584-D	Head lamp plug	1929-31	頭燈塞
A-20026-R	Screw (plug terminal)	1928-29	螺絲(塞終點)
A-14585	Rear lamp wire clip on frame	1928-31	車軀上尾燈線夾
A-14587-R	Rear lamp wire grommet—Fordor	1928-29	尾燈電線套筒 四門車

Part No.	Name of Part	Year	貨名
A-14588	Rear lamp wire clip on body—285A, 290A	1931	車身上尾燈絲夾
A-22613-S1	Screw (clip to body)	1931	屏風水線電線護片套管
A-14589	Windshield wiper wire finish strip grommet	1928-31	屏風水擦電線套管
A-14590	Windshield wiper wire grommet on belt rail	1928-31	電線套管
A-14591-A	Wire grommet—35B, 40B, 76B, 180A	1928-30	
A-14592	Rear lamp wire clip on body—200A, 202A, 204A, 206A, 208A	1929-31	尾燈線夾
A-14588	Rear lamp wire clip on roof rail—rear—225-A	1931	尾燈線夾
A-14592	Rear lamp wire clip on roof rail—side—225-A	1931	尾燈線夾
A-22647-S2	Screw (rear lamp wire clip) 225A	1931	螺絲(尾燈線夾)
A-20812-S4	Bolt (rear lamp stop light and license bracket support) 195A	1931	螺絲(尾燈線車燈及執照支架)
A-14593-AR	Wire grommet support	1928-30	電線套管
A-14593-B	Wire grommet support	1930-31	電線套管
A-14595-AR	Rear lamp wire clip-on support	1928-29	尾燈線夾
A-14595-B	Rear lamp and stop light wire clip-on support	1930-31	尾燈及線車燈線夾
A-14596-R	Windshield wiper wire clip	1928-30	屏風水擦線夾
A-14597	Rear lamp wire conduit	1929-31	尾燈線管
A-14598	Headlamp wire clip (on frame)	1929-31	頭燈線夾(車框上)
A-14601-R	Headlamp plug spacer washer	1929-30	頭燈塞隔片

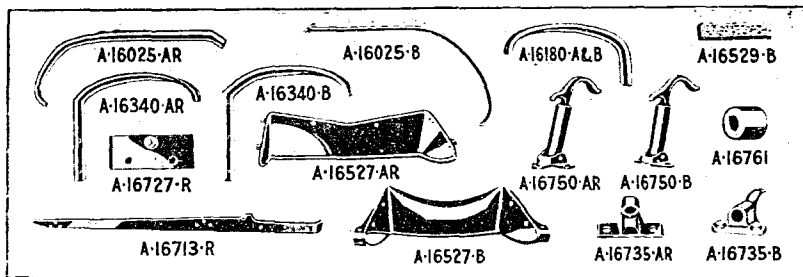

FENDERS, RUNNING BOARDS AND SHIELDS 車翅登車板及防塵殼

FRONT FENDERS

Part No.	Name of Part	Year	貨名
A-16005-AR	Front fender—R. H.	1928-29	前車翅 右
A-16005-B	Front fender—R. H.	1930	前車翅 右
A-16005-C	Front fender—R. H.	1930-31	前車翅 右
A-16006-AR	Front fender—L. H.	1928-29	前車翅 左

*When used to replace previous type on head lamp wire also use A-14584-D.

*All cars not having cowl lamps as standard equipment.

*When used to replace longer plug also use A-14601-R.

Part No.	Name of Part	Year	貨名
A-16006-B	Front fender—L. H.	1930	前車翅 左
‡A-16006-C	Front fender—L. H.	1930-31	前車翅 左
A-16025-AR	Front fender bracket	1928-30	前車翅架
A-16025-B	Front fender bracket	1930-31	前車翅架
A-16029	Front fender shield—R. H.	1930	前車翅殼 右
A-16030	Front fender shield—L. H.	1930	前車翅殼 左
A-16035-AR	Front fender with well—R. H.	1928-30	前車翅車輪架 右
A-16035-B	Front fender—R. H. (with well)	1930	前車翅 右(有輪架者)
A-16035-C	Front fender—R. H. (with well)	1930-31	前車翅 右(有輪架者)
A-16036-AR	Front fender with well—L. H.	1928-30	前車翅車輪架 左
A-16036-B	Front fender—L. H. (with well)	1930	前車翅 左(有輪架者)
§A-16036-C	Front fender—L. H. (with well)	1930-31	前車翅 左(有輪架者)
A-16050-R	Front fender shield—R. H.	1930	前車翅殼 右
A-16051-R	Front fender shield—L. H.	1930	前車翅殼 左
A-16070	Front fender to hood clip support bracket anti-squeak	1930-31	前車翅連轆蓋夾架消音片
A-16071-AR	Front fender to running board shield anti-squeak	1928-30	前車翅車登車板殼消音片
A-16071-B	Front fender to running board shield anti-squeak assembly	1930-31	前車翅車登車板殼消音片總成
A-16071-C	Front fender shield to running board anti-squeak	1930-31	前車翅殼連登車板消音片
FRONT FENDER BOLTS			
A-20556-S1	$\frac{1}{4}$ "—20 x $\frac{3}{8}$ " carriage bolt		前車翅螺絲
A-20560-S4	$\frac{1}{4}$ "—20 x $\frac{7}{8}$ " oval hd. mach. screw		圓頭螺絲
A-20566-S8	$\frac{1}{4}$ "—20 x 1" hex. hd. bolt		六角螺絲
A-20594-S1	$\frac{1}{4}$ "—20 x $\frac{7}{8}$ " carriage bolt		圓頭螺絲
A-20606-S3	$\frac{1}{4}$ "—20 x $\frac{9}{16}$ " carriage bolt		圓頭螺絲
A-20608-S1R	$\frac{1}{4}$ "—20 x $1\frac{1}{8}$ " carriage bolt		圓頭螺絲
A-20711-S1	$\frac{5}{16}$ "—18 x $\frac{3}{4}$ " carriage bolt		圓頭螺絲
A-20718-S2	$\frac{5}{16}$ "—18 x $\frac{3}{4}$ " hex. hd. mach. bolt		六角螺絲
A-20932-S1	$\frac{3}{8}$ "—24 x $1\frac{5}{16}$ " hex. hd. bolt		六角螺絲
A-20953	$\frac{3}{8}$ "—24 x $1\frac{7}{32}$ " hex. hd. bolt—with cotter hole.		六角螺絲
A-20971-S1R	$\frac{3}{8}$ "—24 x $1\frac{1}{32}$ " hex. hd. bolt		六角螺絲
FRONT FENDER NUTS			
A-21668-S2	$\frac{1}{4}$ "—20 ($\frac{3}{16}$ " x $\frac{1}{2}$ ") hex. nut		前車翅螺絲
A-21707-S2	$\frac{5}{16}$ "—18 ($\frac{1}{2}$ " x $\frac{1}{2}$ ") hex. nut		六角螺絲
A-21741-S8	$\frac{3}{8}$ "—24 ($\frac{21}{64}$ " x $\frac{9}{16}$ ") hex. nut		六角螺絲
A-21845	$\frac{1}{2}$ "—20 ($\frac{7}{16}$ " x $\frac{3}{4}$ ") hex. nut		六角螺絲
FRONT FENDER WASHERS			
A-22151	$\frac{1}{4}$ " ($\frac{1}{16}$ " x $\frac{35}{64}$ ") lock washer		前車翅圓片
A-22154-S8	$\frac{1}{4}$ " ($\frac{1}{16}$ " x $\frac{3}{4}$ ") plain washer		鎖環
A-22166-S8	$\frac{1}{4}$ " ($\frac{1}{16}$ " x $\frac{3}{4}$ ") plain washer		平圓片
A-22217-S2	$\frac{5}{16}$ " ($\frac{1}{16}$ " x $\frac{37}{64}$ ") lock washer		鎖環
A-22223-S2	$\frac{5}{16}$ " ($\frac{1}{16}$ " x $\frac{3}{4}$ ") plain washer		平圓片
A-22245-S1	$\frac{3}{8}$ " ($\frac{3}{32}$ " x $\frac{21}{32}$ ") lock washer		鎖環
A-22330	$\frac{1}{2}$ " ($\frac{1}{8}$ " x $\frac{7}{8}$ ") lock washer		鎖環

‡When replacing previous type also use A-16030.

Part No.	Name of Part	Year	貨名
REAR FENDERS			後車翅
*A-16160-AR	Rear fender assembly—R. H.	1928-30	後車翅總成 右
A-16160-B	Rear fender assembly—R. H.—40B, 45B, 50B, 68B, 78A	1930-31	後車翅總成 右
*A-16161-AR	Rear fender assembly—L. H.	1928-30	後車翅總成 左
**A-16161-BR	Rear fender assy.—L. H. with holes for lamp	1929-30	後車翅總成 式
A-16161-D	Rear fender assy.—L. H.—40B, 45B, 68B, 78A	1930-31	後車翅總成 左
A-16168	Rear fender assembly—R. H.—78B	1931	後車翅總成 右
A-16169	Rear fender assembly—L. H.—78B	1931	後車翅總成 左
*A-16180-A	Rear fender bracket	1928-30	後車翅架
A-16180-B	Rear fender bracket—40A, 40B, 45A, 45B, 50B, 68A, 68B, 68C, 78A	1929-31	後車翅架
A-16182	Rear fender bracket—78B	1931	後車翅架
A-16210	Rear fender—R. H.—180A	1930-31	後車翅 右
A-16211	Rear fender—L. H.—180A	1930-31	後車翅 左
A-16240	Rear fender bracket—180A	1930-31	後車翅架
†A-16310-AR	Rear fender assembly—R. H.	1928-30	後車翅總成 右
A-16310-B	Rear fender assembly—R. H.—35B, 55B, 79B, 130B, 140B, 150B, 155C, 155D, 160A, 160B, 160C, 165C, 165D, 170B, 190A, 225A, 225A, 295A, 400A	1930-31	後車翅總成 右
†A-16311-AR	Rear fender assembly—L. H.	1928-30	後車翅總成 左
††A-16311-B	Rear fender assy.—L. H.—with holes for lamp	1929-30	後車翅總成 左
A-16311-C	Rear fender assy.—L. H.—without holes for lamps—79B, 130B, 150B, 255A, 295A	1930-31	後車翅總成 左
A-16311-D	Rear fender assy.—L. H.—with holes for lamp—35B, 55B, 140B, 155C, 155D, 160A, 160B, 160C, 165C, 165D, 170B, 190A, 400A	1930-31	後車翅總成 左
§A-16340-AR	Rear fender bracket	1928-29	後車翅架
A-16340-B	Rear fender bracket—35B, 55B, 79B, 130B, 140B, 150B, 155C, 155D, 160A, 160B, 165C, 165D, 170B, 190A, 225A, 255A, 295A, 400A	1930-31	後車翅架
A-16343	Rear fender to body anti-squeak— 150B	1930-31	後車避連車身消音片
A-16344-AR	Rear fender to body anti-squeak Pick- up	1928-29	後車避連車身消音片
A-16344-B	Rear fender to body anti-squeak—78A	1930-31	後車避連車身消音片
A-16346	Rear fender to body anti-squeak A Panel	1928-31	後車避連車身消音片
A-16347-AR	Rear fender to body anti-squeak— Fordor, Tudor, Phaeton	1928-30	後車避連車身消音片

†When replacing previous type also use A-16029.

*When used to replace previous type also use A-16050.

§When used to replace previous type also use A-16051.

Part No.	Name of Part	Year	貨名
A-16347-B	Rear fender to body anti-squeak—55B, 35B, 130B	1930-31	後車翅連車身消音片
A-16348-AR	Rear fender to body anti-squeak—Roadster, Coupe, Sport Coupe	1928-30	後車翅連車身消音片
A-16348-B	Rear fender to body anti-squeak—68B, 45B, 50B, 40B	1930-31	後車翅連車身消音片
‡A-16350	Rear fender assembly—R. H.	1928-29	後車翅總成 右
‡A-16351-A	Rear fender assembly—L. H.	1928-29	後車翅總成 左
‡A-16351-B	Rear fender assy.—L. H.—with holes for lamp	1929	後車翅總成 左
A-16369	Rear fender to body anti-squeak—190A	1931	後車翅連車身消音片
A-16370	Rear fender to body anti-squeak—Fordor, Town Car	1928-30	後車翅連車身消音片
A-16372-AR	Rear fender to body anti-squeak—155A, 155B, 160A, 165B, 170A	1929-30	後車翅連車身消音片
A-16372-B	Rear fender to body anti-squeak—155D, 165D, 170B	1930-31	後車翅連車身消音片
A-16372-C	Rear fender to body anti-squeak—155C, 165C, 195A, 197A, 285A	1930-31	後車翅連車身消音片
A-16373-R	Rear fender to body anti-squeak—Taxi	1929	後車翅連車身消音片
A-16374	Rear fender to body anti-squeak—180A	1930-31	後車翅連車身消音片

REAR FENDER BOLTS AND SCREWS

A-20594-S1	$\frac{1}{4}$ "— $20 \times \frac{3}{8}$ " carriage bolt	圓頭螺絲
A-20596-S7	$\frac{1}{4}$ "— $20 \times \frac{3}{4}$ " hex. head bolt	六角螺絲
A-20705-S1	$\frac{5}{16}$ "— $24 \times \frac{11}{16}$ " hex. head bolt	六角螺絲
A-20711-S1	$\frac{5}{16}$ "— $18 \times \frac{3}{4}$ " carriage bolt	圓頭螺絲
A-20718-S2	$\frac{5}{16}$ "— $18 \times \frac{3}{4}$ " round head bolt	圓頭螺絲
A-20719-S1	$\frac{5}{16}$ "— $18 \times \frac{9}{16}$ " carriage bolt	圓頭螺絲
A-20753-S1	$\frac{5}{16}$ "— 24×1 " hex. head bolt	六角螺絲
A-20763-S1	$\frac{5}{16}$ "— $24 \times \frac{25}{32}$ " hex. head bolt	六角螺絲
A-20774	$\frac{5}{16}$ "— $24 \times 4\frac{5}{8}$ " hex. head bolt	六角螺絲
A-20783	$\frac{5}{16}$ "— $18 \times \frac{5}{8}$ " carriage bolt	圓頭螺絲
A-22675	No. 12 $\times 1\frac{1}{4}$ " flat head wood screw	扁頭木螺絲

REAR FENDER NUTS

A-21668-S2	$\frac{1}{4}$ "— 20 ($\frac{3}{16}$ " \times $\frac{1}{2}$ ") hex. nut	六角螺帽
A-21702-S2	$\frac{5}{16}$ "— 24 ($\frac{17}{64}$ " \times $\frac{3}{2}$ ") hex. nut	六角螺帽
A-21707-S2	$\frac{5}{16}$ "— 18 ($\frac{1}{4}$ " \times $\frac{1}{2}$ ") hex. nut	六角螺帽
A-21793-S1	$\frac{7}{16}$ "— 20 ($\frac{3}{8}$ " \times $\frac{11}{16}$ ") hex. nut	六角螺帽

REAR FENDER WASHERS

A-22151	$\frac{1}{4}$ " ($\frac{1}{16}$ " \times $\frac{35}{64}$ ") lock washer	鎖環
A-22154-S8	$\frac{1}{4}$ " ($\frac{1}{16}$ " \times $\frac{3}{4}$ ") plain washer	平圓片
A-22166-S8	$\frac{1}{4}$ " ($\frac{1}{16}$ " \times $\frac{3}{4}$ ") plain washer	平圓片
A-22217-S2	$\frac{5}{16}$ " ($\frac{1}{16}$ " \times $\frac{37}{64}$ ") lock washer	鎖環
A-22223-S2	$\frac{5}{16}$ " ($\frac{1}{16}$ " \times $\frac{3}{4}$ ") plain washer	平圓片

*40A, 45A, 54A, 49A, 68A, 78A.

Part No.	Name of Part	Year	貨名
RUNNING BOARDS AND SHIELDS			登車板及防護殼
A-16450-BR	.. Running board and shield assembly— R. H.	1930	登車板及防護殼總成 右
A-16450-C Running board assembly—R. H.	1930-31	登車板總成 右
A-16451-AR	.. Running board assembly	1928-30	登車板總成
A-16451-BR	.. Running board and shield assembly— L. H.	1930	登車板及防護殼總成 左
A-16451-C Running board assembly—L. H.	1930-31	登車板總成 左
A-16459-R Running board assembly—Commercial Chassis except 130A and 150A	1928-30	登車板總成
A-16462-C Running board moulding	1930-31	登車板型線
A-16468 Running board assembly—R. H.—79B, 76B, 82B	1930-31	登車板總成 右
A-16469 Running board assembly—L. H.—79B, 76B, 82B	1930-31	登車板總成 左
A-16495 Running board to shield anti-squeak	1930-31	登車板連殼消音片
A-16527-AR	.. Front splash shield assembly	1928-30	前蓋泥殼總成
A-20600-S6	Bolt (shield to frame)	1928-31	螺絲(殼車框)
A-16527-B Front splash shield assembly	1930-31	前蓋泥殼總成
A-20646-S1	Screw (shield to bumper arm stud)	1930-31	螺絲(殼連車擋臂螺絲)
A-22150-S1 Washer	1930-31	圓片
A-16529-AR	.. Front splash shield pad	1928-30	前蓋泥殼墊
A-16529-B Front splash shield pad	1930-31	前蓋泥殼墊
A-22985-S4 Rivet	1930	帽釘
A-22991-S4 Rivet	1930-31	帽釘
A-16532-R Running board shield—R. H.—A Chas- sis except 130B, 150B, 79B, 76B, 82B, 255A	1930	登車板殼 右
A-16533-R Running board shield—L. H.—A Chas- sis except 130B, 150B, 79B, 76B, 82B, 255A	1930	登車板殼 左
A-16535-AR	.. Running board shield—R. H.	1928-30	登車板殼 右
A-16535-C Running board shield—R. H.	1930-31	登車板殼 右
A-16536-AR	.. Running board shield—L. H.	1928-30	登車板殼 左
A-16536-C Running board shield—L. H.	1930-31	登車板殼 左
*A-16538-B Running board shield—R. H.	1930-31	登車板殼 右
A-16539-AR	.. Running board shield—L. H.—A Com- mercial except 135A, 150A	1928-29	登車板殼 左
*A-16539-B Running board shield—L. H.	1930-31	登車板殼 左
A-16540-AR	.. Running board shield to frame anti- squeak—front	1928-30	登車板殼連車框消音片 前
A-16540-B Front fender to frame anti-squeak	1930-31	前車翅連車框消音片
A-16541 Running board shield to frame anti- squeak—rear	1928-31	登車板殼連車框消音片 後
A-16542 Front body bracket to running board shield anti-squeak	1928-31	前身架連登車板殼消音 片
A-16543 Running board shield to rear body bracket anti-squeak—190A	1930-31	登車板殼連後身架消音 片

*With hole for side wheel carrier. **40A, 45A, 50A, 54A, 49A, 68A.

‡35A, 55A, 60A, 60B, 60C, 79A, 140A, 150A, 155A, 155B, 165A, 165

‡35A, 55A, 79A, 130A, 135A, 140A,

††35A, 55A, 130A, 135A, 140A, 155

Part No.	Name of Part	Year	貨名
RUNNING BOARD BOLTS			
A-20412-S2 ... No. 12—24 x $19/32$ " special oval head bolt ...			登車板螺絲
A-20606-S3 ... $1/4$ "—20 x $9/16$ " special head carriage bolt ...			特別扁頭螺絲
A-20614-S1 ... $1/4$ "—28 x $5/8$ " round head screw ...			特別圓頭螺絲
A-20760-S4 ... $5/16$ "—18 x $13/16$ " special head bolt ...			圓頭螺絲
A-20761-S4 ... $5/16$ "—18 x $3/4$ " special head bolt ...			特別頭螺絲
RUNNING BOARD NUTS			
A-21636-S3 ... No. 12—24 ($5/32$ " x $3/8$ ") hex. nut ...			登車板螺絲
A-21668-S2 ... $1/4$ "—20 ($3/16$ " x $1/2$ ") hex. head nut ...			六角螺帽
A-21707-S2 ... $5/16$ "—18 ($1/4$ " x $1/2$ ") hex. nut ...			六角螺帽
RUNNING BOARD WASHERS			
A-22139 ... $7/32$ " ($1/16$ " x $27/64$ ") lock washer ...			登車板圓片
A-22150 ... $1/4$ " ($3/64$ " x $29/64$ ") lock washer ...			鎖環
A-22151 ... $1/4$ " ($1/16$ " x $35/64$ ") lock washer ...			鎖環
A-22217 ... $1/4$ " ($1/16$ " x $37/64$ ") lock washer ...			鎖環
HOOD 車 轆 蓋			
A-16610-AR ... Hood assembly ...	1928-30		轆蓋總成
A-16610-B ... Hood assembly ...	1930-31		轆蓋總成
A-16622 ... Hood corner pad ...	1928-31		轆蓋角墊
A-22985-S4 ... Rivet ...	1930-31		帽釘
A-16640-BR ... Hood assembly—Fordor ...	1928-29		轆蓋總成 四門車
A-16713-R ... Hood shelf—R. H. ...	1928-30		轆蓋架 右
A-16714-R ... Hood shelf—L. H. ...	1928-30		轆蓋架 左
A-16718 ... Hood bumper bracket assembly ...	1930-31		轆蓋擋架總成
A-20579 ... Bolt (bracket to frame) ...	1930-31		螺絲 (架連框)
A-21668-S2 ... Nut ...	1930-31		螺絲帽
A-22151 ... Washer ...	1930-31		圓片
A-16727-R ... Hood shelf support ...	1928-31		轆蓋架帶
A-20600-S6 ... Bolt (hood shelf to splash shield brkt.) ...	1928-29		螺絲 (轆蓋架連蓋泥殼架)
A-16735-AR ... Hood hinge rod retainer ...	1928-30		轆蓋合葉桿管頭
A-20413 ... Bolt ...	1928-31		螺絲
A-21632-S7 ... Nut ...	1928-31		螺絲帽
A-22139 ... Washer ...	1928-31		圓片
A-16735-B ... Hood hinge rod on dash retainer ...	1930-31		轆蓋合葉桿表板上管頭
A-20408-S1 ... Bolt ...	1930-31		螺絲
A-22139 ... Washer ...	1930-31		圓片
A-22153 ... Washer ...	1930-31		圓片
A-16736-AR ... Hood hinge rod retainer shim ...	1928-29		轆蓋合葉桿管頭片
A-16736-B ... Hood hinge rod retainer shim ...	1930-31		轆蓋合葉桿管頭片
A-16739 ... Hood pad on dash and clip assembly ...	1930-31		表板上轆蓋墊及夾總成
A-16740-AR ... Hood pad on dash—side ...	1928-30		表板上轆蓋墊 旁
A-16741-R ... Hood pad on dash—top ...	1928-31		表板上轆蓋墊 頂

Part No.	Name of Part	Year	貨名
A-16742-R	Hood pad on dash top—Fordor—Town Sedan—Cabriolet	1928-29	表板頂緣蓋墊
A-20236-S7	Screw (pad to dash clamp)	1928-29	螺絲(墊連表板夾)
A-21572	Nut	1928-29	螺絲帽
A-22088	Washer	1928-29	圈片
A-23043-S4	Rivet (pad to cowl panel)	1928-29	帽釘(墊連轆蓋頂板)
A-20437-S7	Bolt (hood pad to dash) center	1930-31	螺絲(轆蓋墊連表板)中
A-20439-S7	Bolt (hood pad to dash) side	1930-31	螺絲(轆蓋墊連表板)旁
A-21633-S2	Nut (hood pad to dash)	1930-31	螺絲帽(轆蓋墊連表板)
A-16750-AR	Hood clip assembly	1928-30	轆蓋鎖搭成
A-20240-S1	Bolt (clip to hood shelf) short	1928-30	螺絲(鎖連轆蓋架)短
A-20274-S4	Bolt (clip to hood shelf) long	1928-30	螺絲(鎖連轆蓋架)長
A-21572	Nut	1928-30	螺絲帽
A-22088	Washer	1928-30	圈片
A-16750-B	Hood clip assembly	1930-31	轆蓋鎖搭成
A-20240-S1	Bolt (clip to frame)	1930-31	螺絲(鎖連框)
A-21572	Nut	1930-31	螺絲帽
A-22088	Lock washer	1930-31	鎖環
A-20276-S1	Bolt (clip to hood clip support)	1930-31	螺絲(鎖連轆蓋鎖架)
A-21572	Nut	1930-31	螺絲帽
A-22095	Washer	1930-31	圈片
A-16760	Hood clip bumper	1931	轆蓋鎖擋
A-16761	Hood clip bumper	1928-31	轆蓋鎖擋
A-22985-S4	Rivet	1928-31	帽釘

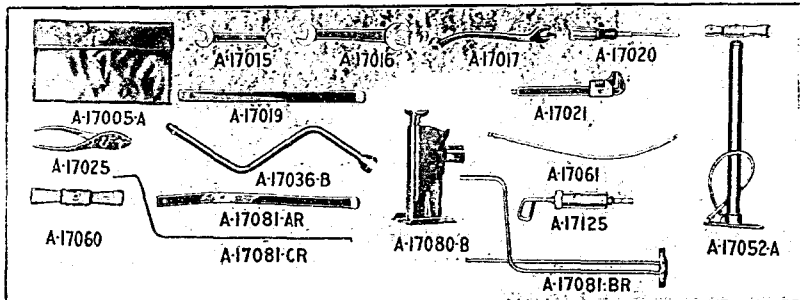

TOOLS 用具

A-17005-A	Tool bag (same as T-2336)	1928-31	用具袋
A-17012	Tire repair kit (old number T-7962-ARX)	1928-31	輪胎修理器具
A-17015	$3/16" \times 1/2"$ hex. open end wrench	1928-31	開口搬鉗
A-17016	$3/16" \times 5/8"$ hex. open end wrench	1928-31	開口搬鉗
A-17017	Spark plug and cylinder head nut wrench	1928-31	火星塞及汽缸頂螺絲帽鉗
A-17019	Tire iron (same as T-2340)	1928-31	輪胎鐵
A-17020	Screw driver	1928-31	螺絲鐵

Part No.	Name of Part	Year	貨名
A-17021	Adjustable wrench	1928-31	活動搬釘
A-17025	Pliers (same as T-1903)	1928-31	鉗子
A-17036-AR	Starting crank and wheel wrench	1928-29	搖車柄及車輪釘
A-17036-B	Starting crank and wheel wrench	1928-31	搖車柄及車輪釘
A-17052-A	Tire pump assembly (same as T-2338)	1928-31	輪胎搖機成
A-17058	Tire pump plunger (same as T-1422-X)	1928-31	打氣筒總成
A-17060	Tire pump handle (same as T-1433-BX)	1928-31	打氣筒活塞
A-17061	Tire pump hose assembly (same as T-1438-X)	1928-31	打氣筒柄
†A-17080-C	Jack assembly—less handle	1928-31	打氣筒及管總成
A-17081-AR	Jack handle (ratchet type jack)	1928-30	杠重機總成 無柄
†A-17081-B	Jack handle (folding type for screw jack)	1930-31	杠重機柄
†A-17081-CR	Jack handle (solid type for screw jack)	1930	杠重機柄
A-17125	Grease gun	1928-31	油鎗

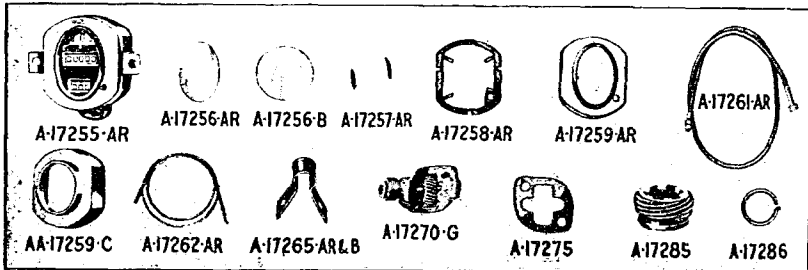

SPEEDOMETER 速度表

A-17254	Speedometer lens retainer and cover assembly—North East	1930-31	速度表玻璃管頭及蓋機成
A-17255-AR	Speedometer head and bracket assembly	1928-30	速度表頭及架機成
A-17255-D	Speedometer head and bracket assembly	1930-31	速度表頭及架機成
A-20535-S1	Bolt (speedometer mounting)	1928-31	螺絲(安裝速度表)
A-21661	Nut	1928-31	螺絲帽
A-22150	Lock washer	1928-31	鎖環
A-17256-AR	Speedometer lens	1928-30	速度表玻璃
A-17256-B	Speedometer lens—Stewart-Warner and Waltham	1930-31	速度表玻璃
A-17257-AR	Speedometer lens gasket	1928-30	速度表玻璃墊

§Use as required.

†Use A-17081-B handle with this jack.

‡Not interchangeable.

Part No.	Name of Part	Year	貨名
A-17257-B	Speedometer lens gasket—Stewart-Warner and Waltham	1930-31	速度表玻璃墊
A-17258-AR	Speedometer lens retainer	1928-30	速度表玻璃管頭
A-17258-B	Speedometer lens retainer—Stewart-Warner	1930-31	速度表玻璃管頭
A-17258-C	Speedometer lens retainer—Waltham	1930-31	速度表玻璃管頭
A-17259-AR	Speedometer cover	1928-30	速度表蓋
A-17259-C	Speedometer cover—Stewart-Warner	1930-31	速度表蓋
A-17259-D	Speedometer cover—Waltham	1930-31	速度表蓋
A-17261-AR	Speedometer shaft casing	1928-30	速度表軸殼
A-17261-C	Speedometer shaft casing	1930-31	速度表軸殼
A-17262-AR	Speedometer shaft	1928-30	速度表軸
A-17262-C	Speedometer shaft	1930-31	速度表軸
A-17265-AR	Speedometer cable support	1928-30	速度表線架
A-17265-B	Speedometer cable support for 19/64" cable	1928-30	速度表線架
A-20705-S1	Bolt	1928-31	螺絲
A-21702-S2	Nut	1928-31	螺絲帽
A-22217	Washer	1928-31	隔片
A-14577-A	Speedometer cable to dash clip	1928-31	速度表線連表板夾
A-20427-S2	Bolt	1928-29	螺絲
A-22139	Washer	1928-31	隔片
A-14567-B	Speedometer cable grommet—in dash	1929-30	速度表線套管 表板上
A-17270-DR	Speedometer gear and cap assembly (3.78)	1928-30	速度錶齒輪及帽構成
A-17270-ER	Speedometer gear and cap assembly (4.111)	1928-30	速度錶齒輪及帽構成
A-17270-F	Speedometer gear and cap assembly (3.78)	1930-31	速度錶齒輪及帽構成
A-17270-G	Speedometer gear and cap assembly (4.111)	1930-31	速度錶齒輪及帽構成
A-24454	Plug	1928-31	塞
A-20530-S2	Screw	1928-31	螺絲
A-22150	Washer	1928-31	隔片
A-17273-AR	Speedometer driven gear shaft	1928-30	速度表被驅動齒輪軸
A-17274-AR	Speedometer driven gear shaft retainer	1928-30	速度表被驅動齒輪軸管頭
A-17275	Speedometer drive cap gasket	1928-31	速度表驅動帽墊
A-17285	Speedometer driving gear	1928-31	速度表驅動齒輪
A-17286	Speedometer driving gear retainer	1928-31	速度表驅動齒輪管頭
A-22431	Washer (speedometer driving gear thrust)	1928-31	隔片(速度表驅動齒輪壓力)

WINDSHIELD WIPERS 屏風水擦

VACUUM WINDSHIELD WIPER

†A-17500	Vacuum windshield wiper assy.—With fittings	1928-31	真空屏風水擦
A-20247-S7	Bolt (vacuum windshield wiper mounting) 225A	1929-30	真空屏風水擦構成
A-17508-A	Vacuum windshield wiper motor assembly—45B, 50B, 55B, 130B, 79B, 85B, 82B, 150B, 155C, 155D, 165C, 165D, 170B, 225A, 255A	1928-31	螺絲(安裝真空屏風水擦)

Part No.	Name of Part	Year	貨名
A-17508-B	Vacuum windshield wiper motor assembly—180A, 40B (DL)	1930-31	真空屏風水擦馬達總成
A-17508-C	Vacuum windshield wiper motor assembly—76B	1930-31	真空屏風水擦馬達總成
†Used on cars not originally equipped with vacuum wiper.			
A-17508-D	Vacuum windshield wiper motor assembly—35B, 40B (Std.)	1930-31	真空屏風水擦馬達總成
A-17508-E	Vacuum windshield wiper motor assembly—chrome—68B	1930-31	真空屏風水擦馬達總成
A-17508-F	Vacuum windshield wiper motor assembly (black) 160A-B-C, 190A, 330A	1931	真空屏風水擦安裝總成
A-17508-G	Vacuum windshield wiper motor assembly—190A	1930-31	真空屏風水擦安裝總成
A-17592-BR	Vacuum windshield wiper mounting bracket 35B, 40B, 76B	1930-31	真空屏風水擦安裝架
A-17593-A	Vacuum windshield wiper mounting clamp 35B, 40B, 76B	1930-31	真空屏風水擦安裝夾
A-20257-S13	Bolt (vacuum windshield wiper mounting) 180A, 40B (DL)	1930-31	螺絲(真空屏風水擦安裝)
A-20257-S2	Bolt (vacuum windshield wiper mounting) 35B, 40B (Std.) 76B	1930-31	螺絲(真空屏風水擦安裝)
A-22088-S7	Washer (vacuum windshield wiper mounting) 180A, 40B (DL)	1930-31	圈絲(真空屏風水擦安裝)
A-22088-S2	Washer (vacuum windshield wiper mounting) 35B, 40B (Std.) 76B	1930-31	圈絲(真空屏風水擦安裝)
A-22224-S13	Washer (vacuum windshield wiper shaft mounting) 160B-C, 190A, 295A		圈片(真空屏風水擦軸安裝)
A-17589-A	Vacuum windshield wiper to windshield clamp—35B, 40B, (Std.), 76B	1930-31	真空屏風水擦連屏風鎖鐵
A-17589-B	Vacuum windshield wiper to windshield clamp—180A, 40B (DL)	1930-31	真空屏風水擦連屏風鎖鐵
A-17513-A	Vacuum windshield wiper nut (black)	1931	真空屏風水擦螺絲帽(黑)
A-17513-B	Vacuum windshield wiper nut (chrome)	1930-31	真空屏風水擦螺絲帽(銀)
A-17514	Vacuum windshield wiper spacer	1930-31	真空屏風水擦隔片
A-17515	Vacuum windshield wiper grommet	1930-31	真空屏風水擦套管
A-17516	Vacuum windshield wiper washer—inner	1030-31	真空屏風水擦圈片 內
A-17517-A	Windshield wiper tube on stanchion—upper—chrome—35B, 40B (Std.)	1930-31	屏風水擦管在支柱上 上 銀
A-17517-B	Windshield wiper tube on stanchion—upper—black	1930-31	屏風水擦管在支柱上 上 黑
A-17519	Windshield wiper to stanchion tube (rubber) 14"	1930-31	屏風水擦連支柱管(樹膠)
A-17520	Windshield wiper tube on stanchion—lower—(rubber) 10½"	1930-31	屏風水擦管在支柱上 下 樹膠
A-17521	Windshield wiper tube on stanchion—chrome—180A, 40B (DL)	1930-31	屏風水擦管在支柱上 銀
A-17522	Vacuum windshield wiper tube—dash to stanchion—35B, 40B, 76B, 180A	1930-31	真空屏風水擦管 表板連支柱

Part No.	Name of Part	Year	貨名
A-17668 Vacuum windshield wiper tube clip— lower—35B, 40B, 180A	1930-31	真空屏風水擦管夾 下
A-17671 Vacuum windshield wiper tube clip— lower—76B,	1930-31	真空屏風水擦管夾 下
A-22538-S2	.. Screw—35B, 40B (Std.), 76B	1930-31	真空屏風水擦管夾 上
A-17669-B Vacuum windshield wiper tube clip— upper—35B, 40B (Std.), 76B	1930-31	真空屏風水擦管夾 上
A-22538-S2	.. Screw—35B, 40B (Std.), 76B	1930-31	螺絲
A-17669-A Vacuum windshield wiper tube clip— upper—40B (DL), 180A	1930-31	真空屏風水擦管夾 上
A-22538-S13	.. Screw—40B (DL), 180A	1930-31	螺絲
A-14591-A Vacuum windshield wiper tube support on dash—35B, 40B, 76B, 180A	1930-31	真空屏風水擦管架在表 板上
A-14593-B Vacuum windshield wiper support grommet—35B, 40B, 76B, 180A	1930-31	真空屏風水擦架套管
A-17523 Vacuum windshield wiper tube to windshield upper grommet	1930-31	真空屏風水擦管連屏風 上套管
†A-17524-R Vacuum windshield wiper mounting plate	1929-30	真空屏風水擦安裝片
†A-17526-R Vacuum windshield wiper mounting plate to windshield wiper motor assembly	1929-30	真空屏風水擦安裝片連 屏風水擦馬達總成
A-17527-AR	.. Vacuum windshield wiper blade	1928-31	真空屏風水擦葉片
A-17527-B Windshield wiper blade—chrome— 180A, 40B (DL) 68B, 190A	1930-31	屏風水擦葉片
A-17529-A Vacuum windshield wiper arm and spring assembly—black—6¾"	1928-31	真空屏風水擦臂及彈簧 總成 黑
A-17529-B Vacuum windshield wiper arm and spring assembly—chrome—6¾"	1930-31	真空屏風水擦臂及彈簧 總成 鉻
A-17529-C Vacuum windshield wiper arm and spring assembly—black—8¼"	1931	真空屏風水擦臂及彈簧 總成 黑
A-17529-D Vacuum windshield wiper arm and spring assembly—chrome—8¼"	1930-31	真空屏風水擦臂及彈簧 總成 鉻
A-17529-E Vacuum windshield wiper arm and spring assembly—black—9¾"	1931	真空屏風水擦臂及彈簧 總成 黑
A-17530-A Vacuum windshield wiper arm spring retainer—black	1928-31	真空屏風水擦臂彈簧管 頭 黑
A-17530-B Vacuum windshield wiper arm spring retainer—chrome	1930-31	真空屏風水擦臂彈簧管 頭 鉻
A-17534-A Vacuum windshield wiper control as- sembly	1929-31	真空屏風水擦桿總成
†A-17534-BR	.. Vacuum windshield wiper control as- sembly	1928-30	真空屏風水擦桿總成
†A-17538-R Vacuum windshield wiper tube connec- tion on dash	1928-30	真空屏風水擦管接連在 表板上
A-17539-AR	.. Vacuum windshield wiper hose—5½"	1929-30	真空屏風水擦皮管
A-17539-B Vacuum windshield wiper tube (fabric) 32"	1930-31	真空屏風水擦管
A-17539-C Vacuum windshield wiper tube (fabric) 3¾"	1930-31	真空屏風水擦管
A-17540 Vacuum windshield wiper tube conn. on manifold	1929-31	真空屏風水擦管接連在 汽管上

†Used when replacing electric wiper with vacuum wiper.

Part No.	Name of Part	Year	貨名
A-17541	Vacuum windshield wiper tube conn. on dash	1929-31	真空屏風水擦管接連在表板上
A-21836-S7	Nut	1930-31	螺絲帽
A-17542	Vacuum windshield wiper tube conn. nut	1929-31	真空屏風水擦管接連螺絲帽
A-17543-B	Vacuum windshield wiper tube—dash to manifold	1929-31	真空屏風水擦管 表板連汽管
†A-17544-A	Vacuum windshield wiper tube—wiper to dash (closed cars)	1928-30	真空屏風水擦管 水擦連表板
A-17544-B	Vacuum windshield wiper tube (dash to windshield header) 45B, 50B, 55B, 130B, 155C-D, 165C, 165D, 170B, 79B, 85B, 82B, 150B, 225A, 68B, 225A, 215A, 210A, 270A, 275A, 280A, 285A, 290A, 300A	1930-31	真空屏風水擦管(表板連屏風架)
A-17616	Vacuum windshield wiper tube to windshield header clip	1930-31	真空屏風水擦管連屏風架夾
A-17544-C	Vacuum windshield wiper tube (dash to windshield header) 160A, 160B, 160C, 190A, 295A, 330A, 400A	1930-31	真空屏風水擦管(表板連屏風架)

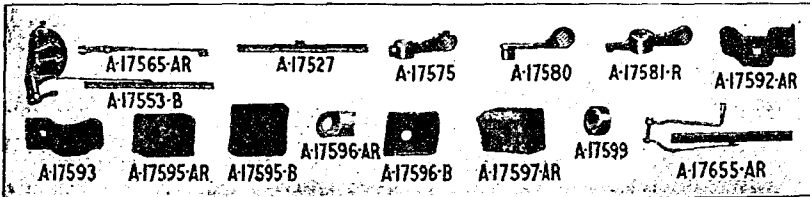

ELECTRIC WINDSHIELD WIPER

A-17551-BR	Electric windshield wiper assembly	1928-30	電氣屏風水擦
A-17553-BR	Electric windshield wiper assembly	1928-30	電氣屏風水擦總成
A-20247-S7	Bolt (electric windshield wiper mounting)	1928-30	電氣屏風水擦總成螺絲(電氣屏風水擦安裝)
A-21577-S2	Nut	1928-29	螺絲帽
A-22088	Lock washer	1928-29	鎖環
A-17562-AR	Electric windshield wiper swing arm lever—2 ⁹ / ₁₆ " long	1928-30	電氣屏風水擦搖臂桿
A-17563-R	Electric windshield wiper swing arm lever—1 ³ / ₈ " long	1928-29	電氣屏風水擦搖臂桿
A-17564-AR	Electric windshield wiper swing arm lever—1 ³ / ₈ " long	1928	電氣屏風水擦搖臂桿
A-17564-B	Electric windshield wiper swing arm lever—2 ⁷ / ₁₆ " long	1928-30	電氣屏風水擦搖臂桿
A-23626	Pin	1928-30	針
A-20107-S7	Screw	1928-29	螺絲
A-20061-A-S7	Tension bolt	1928-30	壓力螺絲
A-17565-AR	Electric windshield wiper swing arm assembly	1928-29	電氣屏風水擦搖臂桿總成
A-17565-B	Electric windshield wiper swing arm	1928-30	

†Used on cars not originally equipped with vacuum wiper.

Part No.	Name of Part	Year	貨名
A-20061-A-S7	Tension bolt	1928-30	壓力螺絲
A-21527-S6	Nut	1928-30	螺絲帽
A-17527-AR	Electric windshield wiper blade	1928-30	電氣屏風水擦葉片
A-23519-S6	Cotter	1928-30	鎖針
A-17575	Electric windshield wiper hand operating lever—1 ⁹ / ₁₆ " long	1928-30	電氣屏風水擦手動桿
A-20060-S7	Screw	1928-30	螺絲
A-17576-R	Electric windshield wiper hand operating lever—2 ¹⁵ / ₁₆ " long	1928-29	電氣屏風水擦手動桿
A-17577-AR	Electric windshield wiper hand operating lever—3" long	1928-30	電氣屏風水擦手動桿
A-17580	Electric windshield wiper switch lever—1 ¹¹ / ₁₆ " long	1928-30	電氣屏風水擦開關桿
A-21520-S7	Nut	1928-30	螺絲帽
A-22047	Lock washer	1928-30	鎖環
A-17581-R	Electric windshield wiper switch lever—2 ³ / ₁₆ " long	1928-30	電氣屏風水擦開關桿
A-17583-A	Electric windshield wiper switch lever—chrome	1929-30	電氣屏風水擦開關桿
A-17583-BR	Electric windshield wiper switch lever—1 ¹ / ₂ " long	1929-30	電氣屏風水擦開關桿
A-20027-S2	Screw	1928-29	電氣屏風水擦馬達蓋螺絲
A-17586	Electric windshield wiper motor cover	1928-30	電氣屏風水擦馬達蓋
A-20027-S2	Screw	1928-30	真空屏風水擦連框夾螺絲
A-17589-A	Vacuum windshield wiper to frame clamp—black—35B, 40B, (Std.) 76B	1930-31	真空屏風水擦連框夾鉗
A-17589-B	Vacuum windshield wiper to frame clamp—chrome—180A, 40B, (DL)		
A-17590	Windshield wiper bracket boot plate—Town Car, Taxi	1928-29	屏風水擦架靴盤片
A-17592-AR	Electric windshield wiper mounting bracket	1928-29	電氣屏風水擦安裝架
A-17592-BR	Electric windshield wiper mounting bracket	1929-30	電氣屏風水擦安裝架
A-20287-S2R	Bolt (wiper to bracket)	1928-29	螺絲(水擦連架)
A-21577-S2	Nut	1928-29	螺絲帽
A-22111-S2	Washer	1928-29	隔片
A-17593-A	Electric windshield wiper mounting clamp	1928-31	電氣屏風水擦安裝夾
A-20276-S1	Screw	1928-29	螺絲
A-21577-S2	Nut	1928-29	螺絲帽
A-17595-AR	Electric windshield wiper bracket boot	1928-29	電氣屏風水擦架靴盤
A-17595-B	Electric windshield wiper bracket boot—Fordor	1928-29	電氣屏風水擦架靴盤
A-17596-AR	Electric windshield wiper bracket boot plate	1928-29	電氣屏風水擦架靴盤片
A-17596-B	Electric windshield wiper bracket boot plate	1928-29	電氣屏風水擦架靴盤片
A-17597-AR	Electric windshield wiper bracket boot—R. H.	1928-29	電氣屏風水擦架靴盤 右

Part No.	Name of Part	Year	貨名
A-17597-B	Electric windshield wiper bracket boot	1928-29	電汽屏風水擦架靴盤 右
A-17598-R	Electric windshield wiper bracket boot —L. H.	1928-29	電汽屏風水擦架靴盤 左
A-64287-A	Electric windshield wiper bolt bushing	1928-30	電汽屏風水擦螺絲套
A-17613	Vacuum windshield wiper tube to windshield header clip—190A	1930-31	真空屏風水擦管連屏風 架夾
A-17616	Electric windshield wiper wire to windshield header clip—150B, 155C, 155D, 170B, 68B, 45B, 50B, 165C, 165D, 82B, 85B, 79B, 255A	1930	真空屏風水擦管連屏風 架夾
*A-17655-AR	Windshield wiper assembly (same as T-18257-X)	1928-30	屏風水擦總成
*A-17656-R	Windshield wiper assembly—A and AA panel delv. and cab	1928-30	屏風水擦總成
A-17668	Windshield wiper tube clip—lower— chrome—180A, 35B, 40B	1930-31	屏風水擦管夾 下 鉗
A-17669-A	Windshield wiper tube clip—upper— chrome—180A, 40B (DL)	1930-31	屏風水擦管夾 上 鉗
A-17669-B	Windshield wiper tube clip—upper— black—35B, 40B (Std.) 76B	1930-31	屏風水擦管夾 上 黑
A-17671	Vacuum wiper tube on stanchion clip— 76B	1930-31	真空屏風水擦在支柱夾 上
REAR VIEW MIRROR 照 後 鏡			
A-17681	Rear view mirror bracket assembly (open cars)	1928-31	照後鏡架總成
A-17682-B	Rear view mirror bracket assembly	1928-31	照後鏡架總成
A-17683	Rear view mirror and bracket assem- bly—40B (DL) 180A	1930-31	照後鏡及架總成
A-17704	Rear view mirror (same as T-18253- X)	1928-31	照後鏡
A-20274-S4	Bolt (mirror to windshield)	1928-31	螺絲 鏡連屏風)
A-20211-S6	Bolt (mirror to windshield) 68B	1930-31	螺絲 鏡連屏風)
A-21577-S2	Nut	1928-31	螺絲帽
A-22088	Washer	1928-31	隔片
A-17593-A	Rear view mirror clamp	1928-31	照後鏡鎖鐵
A-20276-S1	Bolt	1928-31	螺絲
A-21588-S2	Nut	1928-31	螺絲帽
A-17716	Rear view mirror assembly—140A	1928-29	照後鏡總成
A-20795-S13	Bolt (mirror bracket) 140A	1928-31	螺絲(鏡架)
A-17723-A	Rear view mirror assembly—side— chrome	1931	照後鏡總成 旁 鉗
A-17723-B	Rear view mirror assembly—side— black	1931	照後鏡總成 旁 黑
A-17724-A	Rear view mirror supporting arm to swivel acorn nut (chrome)	1931	照後鏡支臂連旋道核螺 絲帽
A-17724-B	Rear view mirror supporting arm to swivel acorn nut—black	1931	照後鏡支臂連旋道核螺 絲帽
A-17728-R	Rear view mirror assembly (black)	1928-30	照後鏡總成(黑)
A-20798-S3	Bolt (mirror bracket) 82A, 130A, 150A	1928-30	螺絲(鏡架)

*Hand operated wiper.

Part No.	Name of Part	Year	貨名
A-17729-R	Rear view mirror assembly—nickel 130A, 130B, 135A, 150A	1928-31	照後鏡總成 鍍
A-17730	Rear view mirror only	1928-31	照後鏡
A-17741-A	Rear view mirror bracket—79A, 82A, 85A, 130A, 135A, 150A, 150B, 255A	1928-31	照後鏡架
A-20796-S3	Bolt (rear view mirror clamping)	1928-29	螺絲(照後鏡夾)
‡A-20778	Bolt (rear view mirror bracket)	1928-30	螺絲(照後鏡架)
§A-20725-S3	Bolt (rear view mirror bracket)	1928-31	螺絲(照後鏡架)
A-20807-S3	Bolt (rear view mirror bracket) 255A	1930-31	螺絲(照後鏡架)
A-21707-S2	Nut	1928-31	螺絲帽
A-22223-S2	Washer	1928-31	圈片
A-22217-S1	Lock washer	1928-31	鎖環
A-17741-B	Rear view mirror bracket—82B with- out platform, 79B, 85B, 130B, 215A, 225A	1930-31	照後鏡架
A-17741-C	Rear view mirror brkt. (black enamel) 150B, 255A	1931	照後鏡架
A-17742-A	Rear view mirror bracket (chrome) 285A, 270A, 275A, 280A, 300A	1931	照後鏡架
A-17742-B	Rear view mirror bracket—79B, 225A, 85B, 82B, 290A, 130B	1931	照後鏡架
A-17742-C	Rear view mirror bracket—270A, 275A, 280A, 285A, 300A	1931	照後鏡架
A-20428-S3	Bolt (mirror bracket)	1930-31	螺絲(鏡架)
A-22139-S4	Washer	1930-31	圈片
A-22150-S7	Lock washer	1930-31	鎖環
A-80380	Pin (mirror bracket to hinge)	1930-31	(針鏡架連接)
A-20796-S3	Set screw (mirror bracket)	1930-31	(調節螺絲)
A-17743-R	Rear view mirror bracket pad	1929-30	架照後鏡架墊鏡

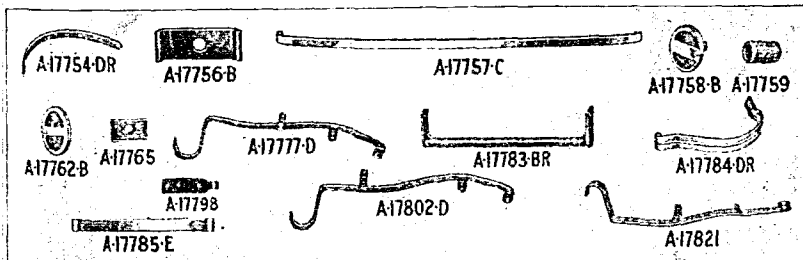

‡For bracket with round holes.

§For bracket with square holes.

Part No.	Name of Part	Year	貨名
BUMPER 車擋			
A-17750-B	Front bumper assembly	1928-31	前車擋總成
AA-17754-BR	Front bumper arm—R. H.	1928-29	前車擋臂 右
A-17754-E	Front bumper arm—R. H.	1930-31	前車擋臂 右
AA-17755-BR	Front bumper arm—L. H.	1928-29	前車擋臂 左
A-17755-E	Front bumper arm—L. H.	1930-31	前車擋臂 左
A-21219-S1	Bolt (arm to frame)	1928-31	螺絲(連臂框)
A-21845	Nut	1928-31	螺絲帽
A-22330	Lock washer	1928-31	鎖環
A-17756-B	Bumper bar end clamp—inner	1928-31	車擋橫鐵尾夾 內
†A-17757-C	Bumper bar	1928-30	車擋橫鐵
†A-17757-D	Bumper bar	1928-31	車擋橫鐵
A-17758-B	Bumper bar end clamp—outer	1928-31	車擋橫鐵尾夾 外
A-21877-S1	Nut	1928-31	螺絲帽
A-22355-S1	Lock washer	1928-31	鎖環
A-17759	Bumper bar spacer	1928-31	車擋橫鐵隔套
A-21141	Bolt (bumper bar end)	1928-31	螺絲(車擋橫鐵尾)
A-21798-S1	Nut	1928-31	螺絲帽
A-22300	Washer	1928-31	隔片
A-17762-B	Bumper center clamp assembly	1928-31	車擋中央總成
A-20794-S4	Bolt	1928-29	螺絲
A-21707-S2	Nut	1928-31	螺絲帽
A-21740-S1	Nut	1928-29	螺絲帽
A-22217	Lock washer	1928-31	鎖環
A-17765	Bumper center clamp—inner (same as T-3114-SX)	1928-31	車擋中央 內
A-17766	Front bumper arm to splash shield stud—rear	1930-31	前車擋臂連蓋泥殼螺絲 後
A-17767	Front bumper arm to splash shield stud—front	1930-31	前車擋臂連蓋泥殼螺絲 前
A-22150	Washer	1930-31	隔片
A-17772	Rear bumper bracket anti-rattler	1930-31	後車擋架消聲片
A-17775-B	Rear bumper assembly fender guard design—40A, 40B, 45A, 45B, 49A, 50A, 50B, 54A, 68A, 68B	1928-31	後車擋總成 翅帶式
A-17776-B	Rear bumper assembly—cross bar design—40A, 40B, 45A, 45B, 49A, 50A, 50B, 68A, 68B	1928-31	後車擋總成 橫鐵式
A-17777-D	Rear bumper arm assembly—R. H.(use with A-17775-B-6B)	1928-31	後車擋臂總成 右
A-17778-D	Rear bumper arm assembly—R. H.(use with A-17775-B-6B)	1928-31	後車擋臂總成 右
A-21127-S1	Bolt (arm to frame)	1928-31	螺絲(連臂框)
A-21793-S1	Nut	1928-31	螺絲帽
A-22300	Lock washer	1928-31	鎖環
A-20905	Bolt (arm to cross member)	1928-31	螺絲(連臂橫梁)
A-21741-S8	Nut	1928-31	螺絲帽
A-22245	Lock washer	1928-31	鎖環
A-17783-BR	Rear bumper arm cross brace	1928-29	後車擋臂橫帶
A-21128-S4	Bolt	1928-29	螺絲

†When used to replace previous type replace both bars.

Part No.	Name of Part	Year	貨名
§A-17783-D	Rear bumper arm cross brace	1928-31	後車擋臂橫帶
A-21127-S1	Bolt	1928-31	螺絲
A-21793-S1	Nut	1928-31	螺絲帽
A-22300	Lock washer	1928-31	鎖環
A-17784-DR	Rear fender guard	1928-29	後翅帶
A-21128-S4	Bolt (guard to arm)	1928-29	螺絲(帶連臂)
‡A-21159-S4	Bolt (guard to arm)	1928-31	螺絲(帶連臂)
A-21793-S1	Nut	1928-31	螺絲帽
A-22300	Lock washer	1928-31	鎖環
A-17758-B	Rear fender guard clamp	1928-29	後翅帶夾
A-17785-E	Rear fender guard bar	1930-31	後翅帶橫鐵
A-17785-F	Rear fender guard bar—160A-B-C	1931	後翅帶橫鐵
A-17798-A	Rear fender guard bar bracket—35B, 40B (std.), 45B, 50B, 55B, 68B, 155C, 155D, 165C, 165D, 190A	1930-31	後翅帶橫鐵架
A-17798-B	Rear fender guard bar bracket—160A- B-C	1931	後翅帶橫鐵架
¶A-17799	Rear bumper arm spacer	1928-31	後車擋臂隔套
A-17800-B	Rear bumper assembly—fender guard design—35B, 35A, 55A, 130A, 60A, 60B	1928-31	後車擋總成 翅帶式
A-17801-B	Rear bumper assembly—cross bar de- sign—35B, 130B, 35A, 55A, 60A, 60B	1928-31	後車擋總成 橫帶式
A-17802-D	Rear bumper arm assembly—R. H.— Phaeton, Tudor, Fordor	1928-31	後車擋臂總成 右
A-17803-D	Rear bumper arm assembly L. H.— Phaeton, Tudor, Fordor	1928-31	後車擋臂總成 左
A-21127-S1	Bolt (arm to frame)	1928-31	螺絲(連臂樞)
A-21793-S1	Nut	1928-31	螺絲帽
A-22300	Lock washer	1928-31	鎖環
A-20905	Bolt (arm to cross member)	1928-29	螺絲(連臂橫樑)
A-21741-S8	Nut	1928-31	螺絲帽
A-22245	Lock washer	1928-31	鎖環
A-20718	Bolt (arm to body)	1928-31	螺絲(連臂車身)
‡A-20721	Bolt (arm to body)	1929-31	螺絲(連臂車身)
A-21707-S2	Nut	1928-31	螺絲帽
A-22217	Lock washer	1928-31	鎖環
A-22219	Washer	1929-30	隔片
A-17806	Spare wheel guard assembly	1930-31	常備車輪帶總成
A-21127-S1	Screw (guard to bumper)	1930-31	螺絲(帶連車擋)
A-21793-S1	Nut	1930-31	螺絲帽
A-22300	Washer	1930-31	隔片
A-17809-B	Rear bumper assembly—135, 190A	1928-29	後車擋總成
A-17810-B	Rear bumper assembly—cross bar de- sign—135, 190A	1928-29	後車擋總成 橫帶式

§When used to replace previous design also use 2 A-17799.

‡Town Sedan, Town Car and Deluxe Phaeton.

Part No.	Name of Part	Year	貨名
A-17811-B	Rear bumper arm—R—with 17809-B-10-B	1930-31	後車擋臂 右
A-17812-B	Rear bumper arm—L—with 17809-B-10-B	1930-31	後車擋臂 左
A-17814	Rear bumper assembly—130B	1930-31	後車擋總成
A-17815-BR	Rear bumper assembly—170A, 165A, 165B, 140, 155A, 155B	1928-29	後車擋總成
A-17816-B	Rear bumper assembly—crossbar design—170A, 165A, 165B, 140, 155A, 155B, 180A	1928-29	後車擋總成 橫鐵式
A-17817-B	Rear bumper arm—R—with A-17815-BR-16-BR	1930-31	後車擋臂 右
A-17818-B	Rear bumper arm—L—with A-17815-BR-16-BR	1930-31	後車擋臂 左
A-17819	Rear bumper assembly—with fender guard—55B, 155C, 155D, 165C, 165D, 170B	1930-31	後車擋總成 連翅帶
A-17820	Rear bumper assembly—with cross bar—55B, 155C, 155D, 165C, 165D, 170B	1930-31	後車擋總成 連橫帶
A-17821	Rear bumper arm assy.—R. H.—with A-17819-20	1930-31	後車翅臂總成 右
A-17822	Rear bumper arm assy.—L. H.—with A-17819-20	1930-31	後車翅臂總成 左
A-17830	Rear bumper arm body clamp assembly—130B	1930-31	後車翅臂身夾總成
A-20980-S1	Bolt—130B	1930-31	螺絲
A-21741-S2	Nut—130 B	1930-31	螺絲帽
A-22245-S1	Washer—130B	1930-31	圈片
A-17831	Rear bumper extension assembly	1938-31	後車擋力加長總成
A-17832	Rear bumper extension center brace	1928-31	後車擋加長中帶
A-17833	Rear bumper extension arm	1928-31	後車擋加長臂
A-21245-S4	Bolt	1928-31	螺絲
A-21845	Nut	1928-31	螺絲帽
A-22330	Lock washer	1928-31	鎖環
A-17841	Rear bumper arm assembly.—R. H.—130B—with A-17814	1930-31	後車擋臂總成 右
A-17842	Rear bumper arm assembly.—L. H.—130B—with A-17814	1930-31	後車擋臂總成 左
A-20853	Bolt (arm to body)—130B	1930-31	螺絲(臂連車身)
A-21707-S2	Nut—130B	1930-31	螺絲帽
A-22217	Washer—130B	1930-31	圈片
A-17845	Rear fender guard bracket—130-B	1930-31	後翅帶架
A-17911	Rear bumper arm assembly—R. H.—160A, 160B, 160C	1931	後翅擋臂總成 右
A-17912	Rear bumper arm assembly—L. H.—160A, 160B, 160C	1931	後翅擋臂總成 左
SHOCK ABSORBER 避震器			
A-18015-B	Shock absorber body assembly—front—R and Rear—L	1928-31	避震器身總成 前 右 及後 左
A-18016-B	Shock absorber body assembly—front—L and Rear—R	1928-31	避震器身總成 前 左 及後 右

Part No.	Name of Part	Year	貨名
A-21140	Bolt (shock absorber to frame)	1928-31	螺絲(避震器連框)
A-21793-S1	Nut	1928-31	螺絲帽
A-22300	Washer	1928-31	圓片
A-18037-A	Shock absorber needle valve assembly	1928-31	避震器針形身總成
A-18043-B	Shock absorber cover packing washer (cork)	1928-31	避震器蓋殼隔片(軟木)
A-22443	Shock absorber reservoir gasket (rubber)	1928-31	避震器油壘(樹膠)
A-18047-B	Front shock absorber arm	1928-31	前避震器臂
A-18052-B	Rear shock absorber arm	1928-31	後避震器臂
A-20916	Bolt (shock absorber arm clamp)	1928-31	螺絲(避震器臂夾)
A-21745	Nut	1928-31	螺絲帽
A-23534	Cotter	1928-31	鎖針

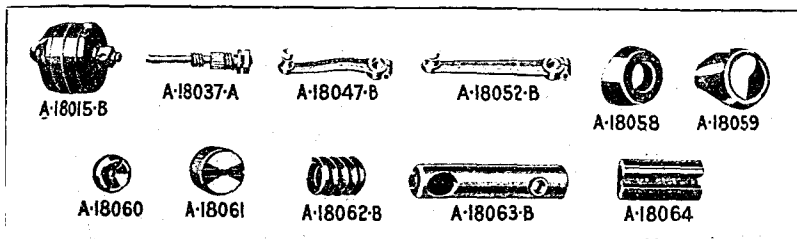

A-18058	Shock absorber grease retainer	1928-31	避震器護油片
A-18059	Shock absorber grease retainer cup	1928-31	避震器護油片杯
A-18060-A	Shock absorber link ball seat	1928-31	避震器連柱球座
A-18061	Shock absorber link plug	1928-31	避震器連柱塞
A-23552	Cotter	1928-31	鎖針
A-18062-B	Shock absorber link spring	1928-31	避震器連柱彈簧
A-18063-B	Shock absorber link tube	1928-31	避震器連柱管
A-24409	Lubricator fitting	1928-31	注油嘴
A-24465	Shock absorber filler plug	1928-31	避震器注油塞
A-18064	Shock absorber link spring spacer	1928-31	避震器連柱彈簧隔墊

WINDSHIELD WINGS 屏風翼

A-18252-AR	Windshield wing glass	1928-29	屏風翼玻璃
A-18252-B	Windshield wing glass	1930-31	屏風翼玻璃
A-18252-C	Windshield wing glass—180A, 40B (DL)	1930-31	屏風翼玻璃
A-18254-AR	Windshield wing bracket—upper—R. H.	1928-29	屏風翼架 上右
A-18254-B	Windshield wing bracket—R. H.	1930-31	屏風翼架 右

*Used only when A-17757-C cross bar used to replace fender guards or A-17783-D used to replace previous design brace.

†Town Sedan, Town Car and DeLuxe Phaeton.

‡Used only with stamping design brace.

Part No.	Name of Part	Year	貨名
A-18255-AR	Windshield wing bracket—upper—L. H.	1928-29	屏風翼架 上 左
A-18255-B	Windshield wing bracket—L. H.	1930-31	屏風翼架 左
A-18256-AR	Windshield wing bracket—lower—R. H.	1928-29	屏風翼架 下 右
A-18257-AR	Windshield wing bracket—lower—L. H.	1928-29	屏風翼架 下 左
A-18265	Windshield wing bracket pad	1928-31	屏風翼架墊
A-18270	Windshield wing bracket support screw washer	1928-29	屏風翼架帮螺絲圈片
A-20770	Screw (bracket support) long	1928-29	螺絲(架帮)長
A-20769-S8	Screw (bracket support) short	1928-29	螺絲(架帮)短
ACCESSORIES 附屬零件			
A-18275	Draft deflectors (pair in carton) 45A, 49A, 50A, 54A, 55B	1931	擋風器
A-18276	Draft deflectors (pair in carton) 45B, 50B	1931	擋風器
A-18277	Draft deflectors (pair in carton) 160A, 160B, 160C	1931	擋風器
A-18278	Draft deflectors (pair in carton) 190A	1931	擋風器
A-18305-AR	Spare wheel and tire lock assembly	1928-29	常備車輪及輪胎鎖總成
A-18305-C	Spare wheel and tire lock assembly	1930-31	常備車輪及輪胎鎖總成
A-18305-D	Spare wheel and tire lock assembly— less lock cylinder	1930-31	常備車輪及輪胎鎖總成 無圓筒
A-18305-ER	Spare wheel and tire lock assembly— less lock cylinder	1928-29	常備車輪及輪胎鎖總成 無圓筒
A-18317-A	Spare wheel and tire lock nut	1928-31	常備車輪及輪胎鎖螺絲帽
A-18317-BR	Spare wheel and tire lock nut	1928-29	常備車輪及輪胎鎖螺絲帽
A-46122	Spare wheel and tire lock key (specify serial number)	1928-31	常備車輪及輪胎鎖鑰
A-22337	Washer (spare wheel and tire lock spacer)	1928-29	圓片(常備車輪及輪胎 鎖隔套)
A-21846-S7	Nut (spare wheel and tire lock check)	1928-29	螺絲帽(常備車輪及輪胎鎖)
A-18320	Spare wheel and tire lock cylinder retaining spring	1931	常備車輪及輪胎鎖面磚 彈簧
A-18330-A	Spare wheel lock assembly	1928-31	常備輪胎鎖總成
A-18345-A	Spare wheel lock nut	1928-31	常備輪胎鎖螺絲帽
A-18345-BR	Spare wheel lock nut	1928-29	常備輪胎鎖螺絲帽
A-46122	Spare wheel lock key (specify serial number)	1928-29	常備輪胎鎖鑰
A-18352-AR	Radiator cap and motor-meter	1928-29	水箱蓋及指熱表
A-18352-B	Radiator cap with motor-meter	1930-31	水箱蓋及指熱表
A-18354-AR	Motor-meter	1928-29	指熱表
A-18354-B	Motor-meter	1930-31	指熱表
A-18360-AR	Radiator cap—for motor-meter	1928-29	水箱蓋 用於指熱表
A-18360-B	Radiator cap—for motor-meter	1930-31	水箱蓋 用於指熱表
A-18362-AR	Radiator cap gasket—upper—Stant design	1928-29	水箱蓋墊 上 司丹脫 式
A-18362-BR	Radiator cap gasket—upper—Jarvis design	1928-29	水箱蓋墊 上 渣威士 式
A-18362-C	Radiator cap gasket—upper	1930-31	水箱蓋墊 上

Part No.	Name of Part	Year	貨名
A-18363-AR	Radiator cap gasket—lower—Stant design	1928-29	水箱蓋墊 下 士丹特式
A-18363-BR	Radiator cap gasket—lower—Jarvis design	1928-29	水箱蓋墊 上 渣威士式

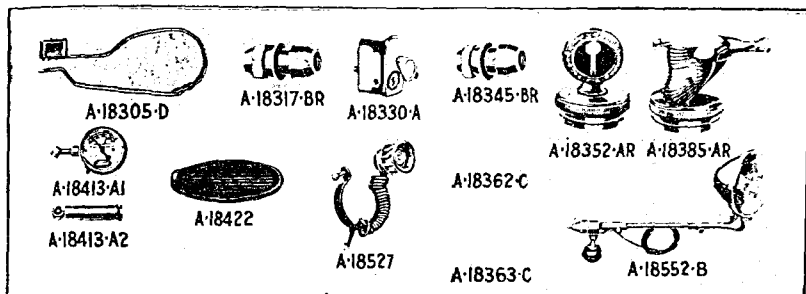

A-18363-C	Radiator cap gasket—lower	1930-31	水箱蓋墊 下
A-18385-AR	Radiator cap and ornament	1928-29	水箱蓋及飾物
A-18385-B	Radiator cap and ornament	1930-31	水箱蓋及飾物
A-18400	Spring cover (set of 4 in carton)	1928-31	彈簧蓋(每套四個紙盒裝)
A-18413-A1	Tire gauge—U. S.	1928-31	美國輪胎氣表
A-18413-A2	Tire gauge—Schrader	1928-31	美國輪胎氣表
A-18422	Pedal pad (set of 2 in carton)	1928-31	腳踏板墊(每套兩件紙盒裝)
A-18500	Air filter	1928-31	空氣濾清器
A-18527	Cigar lighter	1928-31	吸煙點火器
A-18540	Clock	1928-31	時辰鐘
A-18552-B	Sport light—less brackets	1930-31	遠射燈 無架
A-18561	Set of sport light brackets—L. H. C.—open cars	1930-31	遠射燈架全套
A-18565	Sport light lens	1929-31	遠射燈玻璃
A-18566	Sport light lens gasket	1929-31	遠射燈玻璃墊
A-18573-AR	Set of sport light brackets—L. H. C.—closed cars	1928-29	遠射燈架全套
A-18573-B	Set of sport light brackets—L. H. C.—closed car—straight front	1930-31	遠射燈架全套
A-18573-C	Set of sport light brackets—L. H. C.—cars—slanting front	1930-31	遠射燈架全套
A-18575-A	Luggage carrier rack (in carton)	1929-31	行李箱架(紙盒裝)
A-18575-B	Luggage carrier rack (in carton) 180A	1930-31	行李箱架(紙盒裝)
A-18575-C	Luggage carrier rack (in carton) 40B (DL)	1930-31	行李箱架(紙盒裝)
A-18575-D	Luggage carrier rack (in carton) 190A	1931	行李箱架(紙盒裝)
A-18577	Luggage carrier rack—180A	1930-31	行李箱架
A-20977-S7	Belt (rack to support)	1930-31	螺絲(架連帶)
A-21754-S7	Nut	1930-31	螺絲帽
A-21761-S7	Lock nut	1930-31	鎖螺絲帽

Part No.	Name of Part	Year	貨名
A-22251-S7	Washer	1930-31	圈片
A-18587	Luggage carrier rack link—short— 180A	1930-31	行李箱架連柱 短
A-20977-S7	Bolt (rack to link—short)	1930-31	螺絲(架連柱) 短
A-21754-S7	Nut	1930-31	螺絲帽
A-21761-S7	Lock nut	1930-31	鎖螺絲帽
A-22251-S7	Washer	1930-31	圈片
A-20905-S7	Bolt (link—short—to-link—long)	1930-31	螺絲(短柱連長柱)
A-21754-S7	Nut	1930-31	螺絲帽
A-21761-S7	Lock nut	1930-31	鎖螺絲帽
A-22251-S7	Washer	1930-31	圈片
A-18588	Luggage carrier rack link—long— 180A	1930-31	行李箱架連柱 長
A-18589	Luggage carrier rack hook—180A	1930-31	行李箱架鉤
A-20606-S7	Bolt (rack to hook)	1930-31	螺絲(架連鉤)
A-21678-S7	Nut	1930-31	螺絲帽
A-22259-S7	Washer	1930-31	圈片
A-22150-S7	Lock washer	1930-31	鎖環
A-18590	Luggage carrier rack brace—10½" long	1929-31	行李箱架帶
A-18591	Luggage carrier rack bracket	1928-31	行李箱支架
A-20923-S2	Bolt (bracket to brace)	1928-31	螺絲(架連帶)
A-22248-S2	Washer	1928-31	圈片
A-22257-S2	Lock washer	1928-31	鎖環
A-20923-S2	Bolt (bracket to platform)	1928-31	螺絲(架連平台)
A-22291	Washer	1928-31	圈片
A-22257-S2	Lock washer	1928-31	鎖環
A-21164-S1	Bolt (bracket to bumper arm)	1928-31	螺絲(架連車擋臂)
A-21793-S1	Nut	1928-31	螺絲帽
A-22300	Lock washer	1928-31	鎖環
A-18593	Luggage carrier rack bracket to bumper spacer	1928-31	行李箱支架連車擋隔套
A-20923-S2	Bolt (brace to platform)	1928-31	螺絲(帶連平台)
A-22291	Washer	1928-31	圈片
A-22257-S2	Lock washer	1928-31	鎖環
A-18596	Luggage carrier rack support—R. H. —180A	1930-31	行李箱支架 右
A-18597	Luggage carrier rack support—L. H.— 180A	1930-31	行李箱支架 左
A-21121-S1	Bolt (rack support to bumper)	1930-31	螺絲(支架連車擋)
A-21787-S1	Nut	1930-31	螺絲帽
A-22300-S1	Lock washer	1930-31	鎖環
A-18598	Luggage carrier to luggage carrier rack bolt nut	1929-31	行李箱連行李箱架螺絲 帽
A-18599-R	Luggage carrier to luggage carrier rack bolt reinforcing washer	1929-31	行李箱連行李箱架螺絲 增固圈片
A-18600	Luggage carrier rack slat—40B (DL) —180A	1930-31	行李箱架片
A-20637-S7	Bolt	1930-31	螺絲
A-21681-S7	Nut	1930-31	螺絲帽

Part No.	Name of Part	Year	貨名
A-22180-S7	Washer	1930-31	圓片
A-18601	Luggage carrier rack rod—40B (DL) —180A	1930-31	行李箱架桿
A-21754-S7	Nut	1930-31	螺絲帽
A-21761-S7	Lock nut	1930-31	鎖螺絲帽
A-22251-S7	Washer	1930-31	圓片
A-18602	Luggage carrier	1929-31	行李架
A-20568	Bolt (luggage carrier to rack)	1928-29	螺絲(行李箱連架)
A-20588	Bolt (luggage carrier to rack)	1930-31	螺絲(行李箱連架)
A-18604	Luggage carrier rack support—R. H.—40B (DL)	1930-31	行李箱連架 右
A-18605	Luggage carrier rack support— L. H.—10B (DL)	1930-31	行李箱連架 左
A-21121-S1	Bolt (rack support to bumper)	1930-31	螺絲(支架連車擋)
A-21787-S1	Nut	1930-31	螺絲帽
A-22300-S1	Lock washer	1930-31	鎖環
A-18606	Luggage carrier rack link—short— 40B (DL)	1930-31	行李箱架連柱 短
A-18607	Luggage carrier rack link—long—40B (DL)	1930-31	行李箱架連柱 長
A-18608	Luggage carrier rack hook—40B (DL)	1930	行李箱架鈎
A-18612	Luggage carrier rack—40B (DL)	1930	行李箱架
A-18614	Luggage carrier rack support—R. H.—with A-18575-D	1931	行李箱支架 右
A-18615	Luggage carrier rack support—L. H. with A-18575-D	1931	行李箱支架 左
A-18625	Seat covers—Fördor	1928-31	座位套 四門車
A-18626	Seat covers—Coupe	1928-31	座位套 小轎車
A-18627	Seat covers—Tudor	1928-31	座位套 二門車
A-18628	Seat covers—Town Sedan	1928-31	座位套 華貴大轎車

STANDARD PARTS 標準零件

BOLTS AND MACHINES SCREWS

A-20025	No. 4—36 x ³ / ₁₆ fill. hd. screw (same as T-6973-A-2-X)
A-20026-R	No. 4—36 x ⁵ / ₁₆ fill. hd. screw
A-20027-S2	No. 4—36 x ¹ / ₄ rd. hd. screw
A-20027-S13	No. 4—36 x ¹ / ₄ rd. hd. screw
A-20042-S7	N. 5—40 x ¹⁹ / ₆₄ French hd. bolt
A-20056-S5	No. 6—32 x ¹ / ₄ rd. hd. screw
A-20058-S8	No. 6—32 x ⁹ / ₃₂ button hd. screw (same as T-2062-X)
A-20060-S7	No. 6—32 x ¹ / ₄ rd. hd. set screw
A-20061-A-S7	No. 6—32 x ¹ / ₂ sq. hd. screw
A-20067-S7	No. 6—32 x ⁷ / ₁₆ fill. hd. screw
A-20075-S6	No. 6—32 x ³ / ₈ rd. hd. mach. screw
A-20100-S13	No. 8—32 x ⁷ / ₁₆ rd. hd. mach. screw
A-20106-S7	No. 8—32 x ¹ / ₄ rd. head screw
A-20107-S7	No. 8—32 x ¹ / ₂ fill. hd. screw
A-20108-S7	No. 8—36 x ⁵ / ₈ fill. hd. screw

各種螺絲

第四號旋紋頭螺絲
第四號旋紋頭螺絲
第四號圓頭螺絲
第四號圓頭螺絲
第五號法國頭螺絲
第六號圓頭螺絲
第六號圓頭螺絲
第六號圓頭螺絲
第六號旋紋頭帶槽螺絲
第六號圓頭螺絲
第六號圓頭螺絲
第六號圓頭螺絲
第六號旋紋頭螺絲
第六號旋紋頭螺絲

Part No.	Name of Part	Year	貨名
A-20111-S7	... No. 8—32 x $1\frac{3}{16}$ rd. hd. screw—beveled end		第八號圓頭螺絲
A-20116-S8	... No. 8—32 x $5\frac{1}{16}$ rd. hd. screw		第八號圓頭螺絲
A-20119-S13	... No. 8—32 x $\frac{5}{8}$ oval hd. screw		第八號扁圓頭螺絲
A-20121-S8	... No. 8—32 x $\frac{1}{2}$ fill. hd. screw		第八號旋紋頭螺絲
A-20201-C	... No. 10—32 x $3\frac{1}{32}$ sq. hd. special screw		第十號方頭特別螺絲
A-20211-S6	... No. 10—32 x $\frac{1}{2}$ oval hd. mach. screw (same as T-4636-X)		第十號扁頭螺絲
A-20215-S7	... No. 10—32 x $5\frac{1}{16}$ flat hd. bolt (same as T-5313-X)		第十號平頭螺絲
A-20217-S2	... No. 10—32 $5\frac{1}{16}$ rd. hd. screw (same as T-1070 X)		第十號圓頭螺絲
A-20221-S6	... No. 10—32 x $\frac{1}{2}$ oval hd. screw		第十號扁圓頭螺絲
A-20223-S5	... No. 10—32 x $7\frac{1}{32}$ rd. hd. screw		第十號圓頭螺絲
A-20224	... No. 10—32 x $\frac{1}{2}$ flat hd. mach. screw (same as T-4688-X)		第十號平頭螺絲
A-20236-S7R	... No. 10—32 x $\frac{3}{4}$ clamp screw		第十號夾螺絲
A-20240-S1	... No. 10—32 x $\frac{3}{4}$ rd. hd. bolt		第十號圓頭螺絲
A-20245-S7R	... No. 10—32 x $9\frac{1}{32}$ fill. hd. special screw		第十號旋紋特別螺絲
A-20247-S7	... No. 10—32 x $7\frac{1}{8}$ rd. hd. bolt		第十號圓頭螺絲
A-20249-R	... No. 10—32 x $17\frac{1}{32}$ fill. hd. screw		第十號旋紋頭螺絲
A-20251-R	... No. 10—32 x $29\frac{1}{32}$ special flat hd. screw		第十號特別平頭螺絲
A-20254	... No. 10—32 x $39\frac{1}{64}$ fill. hd. bolt (same as T-3266)		第十號旋紋頭螺絲
A-20255-S13	... No. 10—32 x $1\frac{1}{16}$ oval hd. mach. screw		第十號扁頭螺絲
A-20257-S2	... No. 10—32 x 1 rd. hd. bolt		第十號圓頭螺絲
A-20274-S4	... No. 10—32 x $1\frac{3}{8}$ rd. hd. bolt		第十號圓頭螺絲
A-20276-S4	... No. 10—32 x $\frac{5}{8}$ rd. hd. bolt		第十號圓頭螺絲
A-20280-S2	... No. 10—32 x $\frac{3}{8}$ rd. hd. bolt		第十號圓頭螺絲
A-20287-S2	... No. 10—32 x $1\frac{1}{16}$ flat hd. carriage bolt		第十號平頭頂担螺絲
A-20288-S8	... No. 10—32 x $\frac{3}{8}$ fill. hd. screw		第十號旋紋頭螺絲
A-20289-S8	... No. 10—32 x $\frac{1}{2}$ fill. hd. screw		第十號旋紋頭螺絲
A-20309-S6	... No. 10—32 x $\frac{3}{8}$ oval hd. screw (special hd.—pointed end)		第十號扁頭螺絲
A-20310	... No. 10—32 x $1\frac{1}{4}$ rd. hd. bolt		第十號圓頭螺絲
A-20401-S2	... No. 12—24 x $19\frac{1}{32}$ special hd. screw (same as T-4641-X)		第十二號特別頭螺絲
A-20408-S1	... No. 12—24 x $\frac{5}{8}$ mach. screw (same as T-2449-BX)		第十二號機製螺絲
A-20411-S2	... No. 12—24 x $13\frac{1}{32}$ spec. oval hd. bolt		第十二號特別扁頭螺絲
A-20412-S2	... No. 12—24 x $19\frac{1}{32}$ special oval hd. bolt		第十二號特別扁頭螺絲
A-20413	... No. 12—24 x $\frac{5}{8}$ rd. hd. bolt		第十二號圓頭螺絲
A-20427-S2	... No. 12—24 x $\frac{1}{2}$ rd. hd. bolt		第十二號圓頭螺絲
A-20428-S3	... No. 12—24 x $\frac{3}{8}$ special hd. screw		第十二號特別頭螺絲
A-20437-S7	... No. 12—24 x $\frac{3}{4}$ special hd. screw		第十二號特別頭螺絲
A-20439-S7	... No. 12—24 x 1 special hd. screw		第十二號特別頭螺絲
A-20525-S13R	$\frac{3}{16}$ —32 x 1 oval hd. special screw		扁頭頭特別螺絲
A-20530-S2	$\frac{1}{4}$ —28 x 1 hex. hd. screw		六角頭螺絲
A-20531	$\frac{1}{4}$ —28 x $9\frac{1}{16}$ hex. hd. special screw		六角頭特別螺絲
A-20532	$\frac{1}{4}$ —28 x $7\frac{1}{16}$ hex. hd. special screw		六角頭特別螺絲
A-20534-S2	$\frac{1}{4}$ —28 x $\frac{1}{2}$ hex. hd. bolt		六角頭螺絲

Part No.	Name of Part	Year	貨名
A-20535-S1	... ¼—20 x ½ rd. hd. bolt (same as T-3894)	圓頭螺絲
A-20537-S2	... ¼—20 x 1¼ carriage bolt (same as T-4819)	圓担螺絲
A-20538 ¼—20 x ⅝ hex. hd. bolt (same as T-4865)	六角頭螺絲
A-20538-S1	... ¼—20 x ⅝ hex. hd. bolt	六角頭螺絲
A-20541-S6	... ¼—20 x 11/16 oval hd. mach. screw	扁圓頭螺絲
A-20545 ¼—20 x 2⅝ sq. hd. bolt	方頭螺絲
A-20546 ¼—20 x 2⅝ sq. hd. bolt	方頭螺絲
A-20550 ¼—28 x 21/22 hex. hd. bolt	六角頭螺絲
A-20556-S1	... ¼—20 x ¾ carriage bolt	圓担螺絲
A-20560-S4	... ¼—20 x ⅞ oval hd. mach. screw	扁圓頭螺絲
A-20562-S2	... ¼—20 x ½ hex. hd. bolt	六角頭螺絲
A-20566-S8	... ¼—20 x 1 hex. hd. bolt (same as T-4691)	六角頭螺絲
A-20568 ¼—20 x 1¼ flat hd. screw (same as T-8171-X)	平頭螺絲
A-20571 ¼—20 x 2 standard carriage bolt (same as T-2648-X)	標準圓担螺絲
A-20571-S2	... ¼—20 x 2 standard carriage bolt	標準圓担螺絲
A-20574 ¼—28 x ½ flat countersunk hd. screw	平頭螺絲
A-20579 ¼—20 x ⅞ hex. hd. bolt (same as T-4796-X)	六角頭螺絲
A-20588 ¼—20 x 1 flat hd. bolt	平頭螺絲
A-20590 ¼—20 x 6¾ fill. hd. screw	旋紋頭螺絲
A-20594-S1	... ¼—20 x ⅞ carriage bolt	圓担螺絲
A-20600-S6	... ¼—20 x 1¼ oval hd. mach. screw	扁圓頭螺絲
A-20604-S4	... ¼—20 x 1⅝ hex. hd. bolt	六角頭螺絲
A-20606-S3	... ¼—20 x 9/16 special hd. carriage bolt	特別圓担螺絲
A-20606-S7	... ¼—20 x 9/16 special hd. carriage bolt	特別圓担螺絲
A-20614-S4	... ¼—28 x ⅝ rd. hd. screw	圓頭螺絲
A-20622 ¼—28 x 7/16 fill. hd. screw	旋紋頭螺絲
A-20623 ¼—20 x 6 fill. hd. screw	旋紋頭螺絲
A-20631-S3	... ¼—28 x ⅞ rd. hd. screw	圓頭螺絲
A-20637-S7	... ¼—20 x ⅝ special carriage bolt	特別圓担螺絲
A-20646-S4	... ¼—28 x ½ rd. hd. screw	圓頭螺絲
A-20653-S2	... ¼—28 x 2½ hex. hd. bolt	六角頭螺絲
A-20656 ¼—20 x 1½ rd. hd. bolt	圓頭螺絲
A-20657-S3	... ¼—20 x 2½ hex. hd. bolt	六角頭螺絲
A-20665 ¼—28 x 2⅞ rd. hd. bolt	圓頭螺絲
A-20703-S7	... 5/16—24 x 1 fill. hd. screw	旋紋頭螺絲
A-20705-S4	... 5/16—24 x 11/16 hex. hd. bolt (same as T-4869)	六角頭螺絲
A-20707 5/16—18 x ⅝ rd. hd. screw (same as T-3367)	圓頭螺絲
A-20709 5/16—24 x ⅝ hex. hd. bolt	六角頭螺絲
A-20711-S1	... 5/16—18 x ¾ oval hd. bolt (same as T-4805-B)	扁圓頭螺絲
A-20717 5/16—18 x 213/32 sq. hd. bolt (same as T-3811-C)	方頭螺絲
A-20718 5/16—18 x ¾ hex. hd. mach. bolt (same as T-6275)	六角頭螺絲
A-20718-S2	... 5/16—18 x ¾ hex. hd. bolt	六角頭螺絲
A-20720 5/16—18 x 1⅝ hex. hd. bolt (same as S-757)	六角頭螺絲
A-20721 5/16—18 x 2½ hex. hd. bolt	六角頭螺絲
A-20725-S2	... 5/16—18 x 2½ carriage bolt	圓担螺絲
A-20725-S3	... 5/16—18 x 2½ carriage bolt	圓担螺絲

Part No.	Name of Part	Year	貨名
A-20729-S16	$\frac{5}{16}$ —18 x $1\frac{1}{4}$ sq. hd. bolt (lead coated) (same as T-5052)		方頭螺絲
A-20731-R	$\frac{5}{16}$ —18 x $3\frac{3}{16}$ sq. hd. bolt		方頭螺絲
A-20732	$\frac{5}{16}$ —24 x $2\frac{29}{32}$ hex. hd. bolt (same as T-5014-B)		六角頭螺絲
A-20735	$\frac{5}{16}$ —24 x $5\frac{9}{16}$ sq. hd. bolt		方頭螺絲
A-20736	$\frac{5}{16}$ —24 x $3\frac{3}{16}$ hex. hd. bolt		六角頭螺絲
A-20738-S1	$\frac{5}{16}$ —24 x $\frac{5}{8}$ hex. hd. bolt—with cotter hole		六角頭螺絲
A-20740-S2	$\frac{5}{16}$ —24 x $1\frac{3}{8}$ hex. hd. bolt—with cotter holes		六角頭螺絲
A-20744-S7	$\frac{5}{16}$ —30 x $2\frac{25}{64}$ fill. hd. bolt		旋紋頭螺絲
A-20747-S2	$\frac{5}{16}$ —24 x $2\frac{23}{32}$ hex. hd. bolt—with cotter hole (same as T-1905-X)		六角頭螺絲
A-20748-R	$\frac{5}{16}$ —24 x 1 hex. hd. special bolt		六角頭特別螺絲
A-20751-S2	$\frac{5}{16}$ —24 x $1\frac{17}{32}$ hex. hd. bolt—with cotter hole		六角頭螺絲
A-20753-S1	$\frac{5}{16}$ —24 x 1 hex. hd. bolt		六角頭螺絲
A-20755	$\frac{5}{16}$ —24 x $2\frac{25}{32}$ hex. hd. bolt—with cotter hole (same as T-3452)		六角頭螺絲
A-20760-S4	$\frac{5}{16}$ —18 x $1\frac{3}{16}$ special hd. bolt		特別頭螺絲
A-20761-S4	$\frac{5}{16}$ —18 x $\frac{3}{4}$ special hd. bolt		特別頭螺絲
A-20763-S1	$\frac{5}{16}$ —24 x $2\frac{23}{32}$ hex. hd. bolt		六角頭螺絲
A-20764	$\frac{5}{16}$ —18 x $\frac{7}{8}$ hex. hd. bolt		六角頭螺絲
A-20769-S8	$\frac{5}{16}$ —24 x $1\frac{3}{8}$ hex. hd. screw		六角頭螺絲
A-20770	$\frac{5}{16}$ —24 x $1\frac{1}{8}$ hex. hd. screw		六角頭螺絲
A-20771	$\frac{5}{16}$ —18 x $1\frac{1}{16}$ flat countersunk slotted hd. screw		平頭螺絲
A-20772	$\frac{5}{16}$ —24 x $4\frac{9}{16}$ sq. hd. bolt		方頭螺絲
A-20774	$\frac{5}{16}$ —24 x $4\frac{5}{8}$ hex. hd. bolt		六角頭螺絲
A-20778	$\frac{5}{16}$ —18 x $2\frac{3}{8}$ hex. hd. bolt		六角頭螺絲
A-20782S-2	$\frac{5}{16}$ —24 x $1\frac{3}{8}$ hex. hd. bolt		六角頭螺絲
A-20783	$\frac{5}{16}$ —18 x $\frac{5}{8}$ special step bolt		特別螺絲
A-20794-S4	$\frac{5}{16}$ —24 x $1\frac{1}{2}$ hex. hd. bolt		六角頭螺絲
A-20795-S13	$\frac{5}{16}$ —18 x $\frac{7}{8}$ hex. hd. bolt		六角頭螺絲
A-20796-S3	$\frac{5}{16}$ —18 x $1\frac{13}{32}$ hex. hd. screw		六角頭螺絲
A-20807-S3	$\frac{5}{16}$ —18 x $3\frac{1}{4}$ carriage bolt		圓頭螺絲
A-20812-S2	$\frac{5}{16}$ —18 x $2\frac{5}{8}$ carriage bolt		圓頭螺絲
A-20828	$\frac{5}{16}$ —18 x $2\frac{5}{8}$ hex. hd. bolt		六角頭螺絲
A-20838	$\frac{5}{16}$ —24 x 1 hex. hd. bolt (hole in end)		六角頭螺絲
A-20843-S1	$\frac{5}{16}$ —24 x $1\frac{3}{8}$ hex. hd. bolt		六角頭螺絲
A-20844-S7	$\frac{5}{16}$ —24 x $2\frac{23}{16}$ fill. hd. bolt		旋紋頭螺絲
A-20847	$\frac{5}{16}$ —18 x $2\frac{3}{4}$ sq. hd. bolt		方頭螺絲
A-20853	$\frac{5}{16}$ —18 x $5\frac{1}{2}$ step bolt		加段螺絲
A-20900	$\frac{3}{8}$ —24 x $\frac{3}{4}$ hex. hd. screw (hole in head)		六角頭螺絲
A-20902-S2	$\frac{3}{8}$ —16 x $1\frac{1}{8}$ oval hex. hd. screw		扁圓形六角頭螺絲
A-20904	$\frac{3}{8}$ —16 x 1 hex. hd. screw		六角頭螺絲
A-20905	$\frac{3}{8}$ —24 x 1 hex. hd. bolt		六角頭螺絲
A-20905-S7	$\frac{3}{8}$ —24 x 1 hex. hd. bolt		六角頭螺絲
A-20906-S1	$\frac{3}{8}$ —16 x $1\frac{9}{16}$ special hd. carriage bolt		特別頭圓頭螺絲
A-20907	$\frac{3}{8}$ —24 x $1\frac{15}{32}$ hex. hd. bolt (hole in end)		六角頭螺絲
A-20908-R	$\frac{3}{8}$ —24 x $3\frac{1}{4}$ special hd. bolt		特別頭螺絲

Part No.	Name of Part	Year	貨名
A-20912-S1	... $\frac{3}{8}$ —16 x 1 carriage bolt		圓頭螺絲
A-20916 $\frac{3}{8}$ —24 x 1 $\frac{1}{8}$ hex. hd. bolt (hole in end)		六角頭螺絲
A-20919 $\frac{3}{8}$ —24 x 1 $\frac{1}{32}$ hex. hd. bolt (hole in end)		六角頭螺絲
A-20920 $\frac{3}{8}$ —16 x 2 $\frac{7}{8}$ sq. hd. bolt		方頭螺絲
A-20922-S1	... $\frac{3}{8}$ —24 x 2 $\frac{3}{8}$ carriage bolt		圓頭螺絲
A-20924 $\frac{3}{8}$ —24 x 1 $\frac{15}{16}$ hex. hd. bolt		六角頭螺絲
A-20927 $\frac{3}{8}$ —16 x 2 $\frac{7}{16}$ special sq. hd. bolt (same as T-3837)		特別方頭螺絲
A-20928-S8	... $\frac{3}{8}$ —24 x 1 $\frac{1}{16}$ special headless set screw		特別無頭鉸帽螺絲
A-20929 $\frac{3}{8}$ —24 x $\frac{5}{8}$ hex. hd. bolt		六角頭螺絲
A-20930-S2	... $\frac{3}{8}$ —24 x 1 $\frac{17}{32}$ special hd. bolt—with cotter hole		特別頭螺絲
A-20931 $\frac{3}{8}$ —24 x 1 $\frac{5}{32}$ hex. hd. bolt—with cotter hole		六角頭螺絲
A-20932-S1	... $\frac{3}{8}$ —24 x 1 $\frac{15}{16}$ hex. hd. bolt		六角頭螺絲
A-20933-S7	... $\frac{3}{8}$ —24 x 3 $\frac{3}{16}$ hex. hd. bolt		六角頭螺絲
A-20935-S1	... $\frac{3}{8}$ —24 x $\frac{3}{8}$ hex. hd. bolt (same as T-3017-E)		六角頭螺絲
A-20936 $\frac{3}{8}$ —24 x 1 hex. hd. bolt—with cotter hole (same as T-4808)		六角頭螺絲
A-20942 $\frac{3}{8}$ —16 x 2 $\frac{31}{32}$ sq. hd. bolt		方頭螺絲
A-20949 $\frac{3}{8}$ —24 x 1 $\frac{3}{16}$ hex. hd. bolt—with cotter hole		六角頭螺絲
A-20950 $\frac{3}{8}$ —24 x 2 $\frac{3}{4}$ hex. hd. bolt		六角頭特別螺絲
A-20952 $\frac{3}{8}$ —24 x 3 $\frac{1}{4}$ hex. hd. special bolt—with cotter hole		六角頭螺絲
A-20953 $\frac{3}{8}$ —24 x 1 $\frac{17}{32}$ hex. hd. bolt—with cotter hole		六角頭螺絲
A-20954 $\frac{3}{8}$ —24 x $\frac{7}{8}$ hex. hd. bolt—with cotter hole		六角頭螺絲
A-20955 $\frac{3}{8}$ —16 x 1 $\frac{15}{16}$ hex. hd. bolt		六角頭螺絲
A-20958-S2	... $\frac{3}{8}$ —16 x 3 step bolt		加段螺絲
A-20961 $\frac{3}{8}$ —16 x 1 $\frac{3}{16}$ hex. hd. bolt		六角頭螺絲
A-20962 $\frac{3}{8}$ —24 x 1 $\frac{1}{4}$ special hex. hd. bolt—with cotter hole		特別六角頭螺絲
A-20963 $\frac{3}{8}$ —24 x 1 $\frac{1}{2}$ hex. hd. bolt—with cotter hole		六角頭螺絲
A-20968 $\frac{3}{8}$ —24 x 2 $\frac{1}{8}$ hex. hd. bolt—with cotter hole		六角頭螺絲
A-20969 $\frac{3}{8}$ —24 x 1 $\frac{1}{4}$ hex. hd. bolt		六角頭螺絲
A-20970-S1	... $\frac{3}{8}$ —24 x $\frac{3}{4}$ hex. hd. bolt		六角頭螺絲
A-20970-S8	... $\frac{3}{8}$ —24 x $\frac{3}{4}$ hex. hd. bolt		六角頭螺絲
A-20971-S1	... $\frac{3}{8}$ —24 x 1 $\frac{5}{32}$ hex. hd. bolt (same as T-4072)		六角頭螺絲
A-20972-S1	... $\frac{3}{8}$ —16 x 1 $\frac{3}{4}$ rd. hd. carriage bolt		圓頭圓頭螺絲
A-20975 $\frac{3}{8}$ —24 x 2 hex. hd. bolt—with cotter hole		六角頭螺絲
A-20976 $\frac{3}{8}$ —16 x 3 $\frac{7}{32}$ special upset hd. bolt		特別頭螺絲
A-20977-S7	... $\frac{3}{8}$ —24 x $\frac{7}{8}$ special carriage bolt		特別圓頭螺絲
A-20980-S4	... $\frac{3}{8}$ —24 x 1 $\frac{9}{16}$ hex. hd. bolt		六角頭螺絲
A-20984 $\frac{3}{8}$ —24 x 2 $\frac{3}{8}$ hex. hd. bolt—with cotter hole		六角頭螺絲
A-21110 $\frac{7}{16}$ —14 x 1 $\frac{1}{16}$ hex. hd. screw (hole in head)		六角頭螺絲
A-21111 $\frac{7}{16}$ —14 x 2 $\frac{3}{16}$ hex. hd. screw		六角頭螺絲
A-21113 $\frac{7}{16}$ —20 x 1 $\frac{3}{16}$ hex. hd. screw (holes in head)		六角頭螺絲
A-21116 $\frac{7}{16}$ —20 x 1 hex. hd. screw (hole in head)		六角頭螺絲
A-21117 $\frac{7}{16}$ —14 x 1 $\frac{1}{4}$ hex. hd. screw ($\frac{15}{16}$ thread)		六角頭螺絲

Part No.	Name of Part	Year	貨名
A-21118 $\frac{7}{16}$ —20 x 2 $\frac{1}{4}$ spec. hd. screw (hole in end)		特別頭螺絲
A-21120-S2 $\frac{7}{16}$ —14 x 1 $\frac{3}{8}$ oval hex. hd. screw		扁圓形六角頭螺絲
A-21121 $\frac{7}{16}$ —14 x 1 $\frac{11}{16}$ hex. hd. screw		六角頭螺絲
A-21121-S1 $\frac{7}{16}$ —14 x 1 $\frac{11}{16}$ hex. screw		六角頭螺絲
A-21122 $\frac{7}{16}$ —20 x 1 $\frac{5}{32}$ hex. hd. bolt (hole in end)		六角頭螺絲
A-21125-S1 $\frac{7}{16}$ —20 x 2 $\frac{1}{4}$ hex. hd. bolt		六角頭螺絲
A-21127-S4 $\frac{7}{16}$ —20 x 1 hex. hd. screw (same as T-3602-E)		六角頭螺絲
A-21128-S4 $\frac{7}{16}$ —20 x 1 $\frac{7}{16}$ oval hex. hd. bolt		扁圓形六角頭螺絲
A-21133-S4 $\frac{7}{16}$ —20 x 1 $\frac{3}{4}$ hex. hd. bolt		六角頭螺絲
A-21136-S4 $\frac{7}{16}$ —20 x 2 $\frac{5}{16}$ hex. hd. bolt		六角頭螺絲
A-21137 $\frac{7}{16}$ —20 x 2 $\frac{3}{8}$ hex. hd. bolt (hole in end) (same as TT-1003)		六角頭螺絲
A-21139-R $\frac{7}{16}$ —20 x 1 $\frac{13}{16}$ special hd. bolt (hole in end) (same as TT-2457-X)		特別頭螺絲
A-21140 $\frac{7}{16}$ —20 x 1 $\frac{1}{8}$ special hd. bolt		特別頭螺絲
A-21141 $\frac{7}{16}$ —20 x 5 $\frac{1}{8}$ special hd. bolt		特別頭螺絲
A-21144-S3 $\frac{7}{16}$ —20 x 2 $\frac{1}{2}$ hex. hd. bolt		六角頭螺絲
A-21145-R $\frac{7}{16}$ —20 x 1 $\frac{1}{8}$ hex. hd. bolt (hole in head)		六角頭螺絲
A-21147-S7 $\frac{7}{16}$ —20 x 3 $\frac{1}{4}$ carriage bolt		圓頭螺絲
A-21150 $\frac{7}{16}$ —20 x 1 $\frac{15}{16}$ special hd. bolt—with cotter hole		特別頭螺絲
A-21151-S1 $\frac{7}{16}$ —20 x 1 $\frac{17}{32}$ special bolt		特別螺絲
A-21152-S1 $\frac{7}{16}$ —20 x 1 $\frac{7}{8}$ special bolt—with cotter hole		特別螺絲
A-21153-S1 $\frac{7}{16}$ —20 x 1 $\frac{7}{8}$ special bolt		特別螺絲
A-21156-R $\frac{7}{16}$ —20 x 2 $\frac{5}{32}$ slotted hdless. set screw (pointed end)		帶槽無頭調節螺絲
A-21159-S4 $\frac{7}{16}$ —20 x 1 $\frac{1}{4}$ oval hex. hd. bolt		扁圓形六角頭螺絲
A-21161 $\frac{7}{16}$ —20 x $\frac{7}{16}$ hex. hd. set screw		六角頭調節螺絲
A-21164-S4 $\frac{7}{16}$ —20 x 3 $\frac{1}{4}$ oval hex. hd. bolt		扁圓形六角頭螺絲
A-21168 $\frac{7}{16}$ —14 x 2 $\frac{1}{4}$ hex. hd. screw (hole in head)		六角頭螺絲
A-21169-S4 $\frac{7}{16}$ —14 x 1 $\frac{1}{4}$ carriage bolt		圓頭螺絲
A-21207 $\frac{1}{2}$ —13 x 1 $\frac{1}{8}$ hex. hd. bolt (drolled head)		六角頭螺絲
A-21210-R $\frac{1}{2}$ — $\frac{7}{16}$ —20 x 2 $\frac{7}{64}$ special hex. hd. bolt (hole in end)		特別六角頭螺絲
A-21211-R $\frac{1}{2}$ — $\frac{7}{16}$ —20 x 1 $\frac{25}{32}$ special hex. hd. bolt (hole in end)		特別六角頭螺絲
A-21214-AR $\frac{1}{2}$ —20 x 3 $\frac{5}{8}$ special hd. bolt		特別頭螺絲
A-21214-B $\frac{1}{2}$ —20 x 4 $\frac{3}{16}$ special hd. bolt—with cotter hole		特別頭螺絲
A-21215 $\frac{1}{2}$ —20 x 5 $\frac{5}{8}$ special hd. bolt		特別頭螺絲
A-21219-S4 $\frac{1}{2}$ —20 x 1 $\frac{1}{4}$ hex. hd. bolt		六角頭螺絲
A-21220 $\frac{1}{2}$ —13 x 1 $\frac{3}{16}$ hex. hd. bolt (same as S-243)		六角頭螺絲
A-21222-R $\frac{1}{2}$ —13 x 1 $\frac{3}{8}$ hex. hd. bolt (hole in end) (same as TT-1006)		六角頭螺絲
A-21223 $\frac{1}{2}$ —20 x 1 $\frac{1}{4}$ hex. hd. bolt—with cotter hole		六角頭螺絲
A-21238-R $\frac{1}{2}$ —20 x 2 $\frac{3}{8}$ special hd. bolt—with cotter hole		特別頭螺絲
A-21240 $\frac{1}{2}$ —13 x 1 $\frac{1}{16}$ hex. hd. bolt		六角頭螺絲
A-21241 $\frac{1}{2}$ —20 x 2 $\frac{3}{4}$ hex. hd. bolt		六角頭螺絲
A-21242 $\frac{1}{2}$ —20 x 1 hex. hd. bolt		六角頭螺絲
A-21243 $\frac{1}{2}$ —13 x 1 $\frac{1}{8}$ hex. hd. bolt		六角頭螺絲

Part No.	Name of Part	Year	貨名
A-21244 $\frac{1}{2}$ —20 x $1\frac{5}{8}$ hex. hd. bolt—with cotter hole ..		六角頭螺絲
A-21245-S4	... $\frac{1}{2}$ —20 x $1\frac{5}{8}$ hex. hd. bolt		六角頭螺絲
A-21247 $\frac{1}{2}$ —20 x $1\frac{3}{8}$ hex. hd. bolt		六角頭螺絲
A-21249-S2	... $\frac{1}{2}$ —20 x 2 hex. hd. bolt		六角頭螺絲
A-21264 $\frac{1}{2}$ —13 x $3\frac{1}{4}$ carriage bolt		圓頭螺絲
A-21275 $\frac{9}{16}$ —18 x $3\frac{3}{8}$ hex. hd. bolt		六角頭螺絲
A-21276 $\frac{9}{16}$ —18 x $2\frac{7}{8}$ hex. hd. bolt		六角頭螺絲
A-21278 $\frac{9}{16}$ —18 x $1\frac{5}{16}$ headless slotted set screw ...		無頭帶槽調節螺絲
A-21279 $\frac{9}{16}$ —12 x $1\frac{11}{16}$ hex. hd. screw		六角頭螺絲
A-21280-S4	... $\frac{9}{16}$ —12 x $1\frac{1}{2}$ carriage bolt		圓頭螺絲
A-21281-S1	... $\frac{9}{16}$ —18 x 2 hex. hd. bolt		六角頭螺絲
A-21300 $\frac{5}{8}$ —18 x $3\frac{25}{32}$ hex. hd. bolt—with cotter hole (same as TT-1074)		六角頭螺絲
A-21301 $\frac{5}{8}$ —18 x $1\frac{1}{2}$ special hd. bolt		特別頭螺絲
A-21304 $\frac{5}{8}$ —18 x $1\frac{3}{4}$ hex. hd. bolt		六角頭螺絲
A-21311-S4	... $\frac{5}{8}$ —11 x $1\frac{3}{4}$ carriage bolt		圓頭螺絲
A-21312-S4	... $\frac{5}{8}$ —11 x 2 carriage bolt		圓頭螺絲
A-21320 $\frac{3}{4}$ —16 x $4\frac{3}{16}$ sq. hd. special bolt		方頭特別螺絲
NUTS			螺絲帽
A-21520-S7	... No. 6—32 ($\frac{7}{64}$ x $\frac{5}{16}$) hex. nut		第六號六角螺帽
A-21527-S6	... No. 6—32 ($\frac{1}{8}$ x $\frac{3}{8}$) special nut		第六號特別螺帽
A-21545-S8	... No. 8—32 ($\frac{1}{8}$ x $1\frac{11}{32}$) hex. nut (same as T-6029-X)		第八號六角螺帽
A-21547-S7	... No. 8—32 ($\frac{3}{32}$ x $1\frac{11}{32}$) hex. check nut ...		第八號六角螺帽
A-21548-S7	... No. 8—36 ($\frac{5}{32}$ x $\frac{5}{16}$) hex. nut		第八號六角螺帽
A-21549	... No. 8—32 ($\frac{1}{8}$ x $1\frac{11}{32}$) special nut		第八號特別螺帽
A-21550	... No. 8—32 special nut		第八號特別螺帽
A-21552	... No. 8—32 ($\frac{1}{8}$ x $\frac{5}{16}$) sq. nut		第八號方頭螺帽
A-21569-A	... No. 10—32 special nut		第十號特別螺帽
A-21570	... No. 10—32 ($\frac{1}{8}$ x $\frac{7}{16}$) hex. nut		第十號六角螺帽
A-21572	... No. 10—32 ($\frac{1}{8}$ x $\frac{3}{8}$) sq. nut (same as T-4739-X)		第十號方頭螺帽
A-21577-S2	... No. 10—32 ($\frac{1}{8}$ x $\frac{3}{8}$) hex. nut (same as T-5316-X)		第十號六角螺帽
A-21579-R	... No. 10—32 ($\frac{5}{32}$ x $\frac{3}{8}$) hex. nut (hardened) ..		第十號六角螺帽
A-21588-S2	... No. 10—32 ($\frac{1}{8}$ x $\frac{3}{8}$) hex. nut		第十號六角螺帽
A-21632-S7	... No. 12—24 ($\frac{3}{16}$ x $\frac{1}{2}$) sq. nut (same as T-7016-X)		第十二號六角螺帽
A-21636-S3	... No. 12—24 ($\frac{5}{32}$ x $\frac{3}{8}$) hex. nut (same as T-17343-X)		第十二號六角螺帽
A-21639	... No. 12—24 ($\frac{5}{32}$ x $\frac{7}{16}$) special hex. nut ...		第十二號特別六角螺帽
A-21661 $\frac{1}{4}$ —20 ($\frac{3}{16}$ x $\frac{1}{2}$) sq. nut (same as T-4866) ..		方頭螺帽
A-21663-S2	... $\frac{1}{4}$ —20 ($\frac{3}{16}$ x $\frac{1}{2}$) hex. nut (same as T-3667) ..		六角螺帽
A-21664-S2	... $\frac{1}{4}$ —20 ($\frac{1}{4}$ x $\frac{1}{2}$) sq. nut (same as T-3088-E) ..		方頭螺帽
A-21665-S5	... $\frac{1}{4}$ —28 ($\frac{1}{8}$ x $\frac{1}{2}$) hex. nut		六角螺帽
A-21665-S8	... $\frac{1}{4}$ —28 ($\frac{1}{8}$ x $\frac{1}{2}$) hex. nut (same as T-5134) ..		六角螺帽
A-21666 $\frac{1}{4}$ —28 ($\frac{3}{16}$ x $\frac{1}{2}$) sq. nut (same as T-4710-X) ..		方頭螺帽
A-21668-S2	... $\frac{1}{4}$ —20 ($\frac{3}{16}$ x $\frac{7}{16}$) hex. nut		六角螺帽
A-21678-S7	... $\frac{1}{4}$ —20 x $\frac{7}{16}$ blind nut (low crown)		暗螺帽

Part No.	Name of Part	Year	貨名
A-21681-S7 ...	$\frac{1}{4}$ -20 ($\frac{1}{8}$ x $\frac{3}{8}$) special hex. nut		特別六角螺帽
A-21700	$\frac{5}{16}$ -24 ($\frac{3}{16}$ x $\frac{1}{2}$) hex. check nut		六角螺帽
A-21701-S2 ...	$\frac{5}{16}$ -24 ($\frac{21}{64}$ x $\frac{1}{2}$) castle nut (same as T-3452-B)		堡塞螺帽
A-21702-S2 ...	$\frac{5}{16}$ -24 ($\frac{17}{64}$ x $\frac{1}{2}$) hex nut (same as T-2503-F)		六角螺帽
A-21705-S1 ...	$\frac{5}{16}$ -18 ($\frac{1}{4}$ x $\frac{9}{16}$) sq. nut (same as T-4805-C)		方頭螺帽
A-21705-S2 ...	$\frac{5}{16}$ -18 ($\frac{1}{4}$ x $\frac{9}{16}$) sq. nut		方頭螺帽
A-21706	$\frac{5}{16}$ -18 ($\frac{5}{16}$ x $\frac{19}{32}$) sq. nut (same as T-3811-B)		方頭螺帽
A-21707-S2 ...	$\frac{5}{16}$ -18 ($\frac{1}{4}$ x $\frac{1}{2}$) hex. nut (same as T-3514)		六角螺帽
A-21707-S16 ...	$\frac{5}{16}$ -18 ($\frac{1}{4}$ x $\frac{1}{2}$) hex. nut		六角螺帽
A-21740-S1 ...	$\frac{3}{8}$ -16 ($\frac{9}{32}$ x $\frac{5}{8}$) hex. nut (same as T-2825-B)		六角螺帽
A-21741-S2 ...	$\frac{3}{8}$ -24 ($\frac{21}{64}$ x $\frac{9}{16}$) hex. nut (same as T-3066-B)		六角螺帽
A-21741-S8 ...	$\frac{3}{8}$ -24 ($\frac{21}{64}$ x $\frac{9}{16}$) hex. nut		六角螺帽
A-21742	$\frac{3}{8}$ -16 ($\frac{5}{32}$ x $\frac{5}{8}$) hex. nut same as T-5112)		六角螺帽
A-21745	$\frac{3}{8}$ -24 ($\frac{13}{32}$ x $\frac{9}{16}$) castle nut (same as T-2515)		堡塞螺帽
A-21749-S1 ...	$\frac{3}{8}$ -16 ($\frac{3}{8}$ x $\frac{9}{16}$) sq. nut (same as T-3837-B)		方頭螺帽
A-21749-S2 ...	$\frac{3}{8}$ -16 ($\frac{3}{8}$ x $\frac{7}{16}$) sq. nut		方頭螺帽
A-21750-S8 ...	$\frac{3}{8}$ -24 ($\frac{1}{4}$ x $\frac{9}{16}$) hex. check nut		六角螺帽
A-21752	$\frac{3}{8}$ -16 ($\frac{3}{8}$ x $\frac{9}{16}$) hex. nut		六角螺帽
A-21754-S7 ...	$\frac{3}{8}$ -24 ($\frac{19}{32}$ x $\frac{9}{16}$) acorn nut		櫛子螺帽
A-21757	$\frac{3}{8}$ -24 ($\frac{3}{8}$ x $\frac{5}{8}$) hex. nut		六角螺帽
A-21761-S7 ...	$\frac{3}{8}$ -24 ($\frac{5}{8}$ x $\frac{3}{16}$) special check nut		特別螺帽
A-21785	$\frac{7}{16}$ -20 ($\frac{29}{64}$ x $\frac{7}{8}$) castle nut		堡塞螺帽
A-21787-S1 ...	$\frac{7}{16}$ -14 ($\frac{7}{16}$ x $\frac{25}{32}$) hex. nut		六角螺帽
A-21788-S8 ...	$\frac{7}{16}$ -20 ($\frac{7}{16}$ x $\frac{11}{16}$) hex. nut		六角螺帽
A-21789	$\frac{7}{16}$ -20 ($\frac{3}{8}$ x $\frac{5}{8}$) slotted hex. nut		六角帶槽螺帽
A-21791-S3 ...	$\frac{7}{16}$ -20 ($\frac{29}{64}$ x $\frac{5}{8}$) castle nut (same as S-82)		堡塞螺帽
A-21793-S1 ...	$\frac{7}{16}$ -20 ($\frac{3}{8}$ x $\frac{11}{16}$) hex. nut (same as T-4817-B)		六角螺帽
A-21794	$\frac{7}{16}$ -20 ($\frac{29}{64}$ x $\frac{11}{16}$) castle nut (same as T-3815)		堡塞螺帽
A-21798-S1 ...	$\frac{7}{16}$ -20 ($\frac{1}{4}$ x $\frac{5}{8}$) hex. nut		六角螺帽
A-21799	$\frac{7}{16}$ -20 ($\frac{7}{16}$ x $\frac{21}{32}$) castle nut		堡塞螺帽
A-21801	$\frac{7}{16}$ -20 ($\frac{43}{64}$ x $\frac{5}{8}$) castle nut		堡塞螺帽
A-21802	$\frac{7}{16}$ -20 ($\frac{3}{16}$ x $\frac{7}{8}$) hex. nut		六角螺帽
A-21836-S7 ...	$\frac{1}{2}$ -20 ($\frac{3}{16}$ x $\frac{3}{4}$) hex. nut		六角螺帽
A-21839-S4 ...	$\frac{1}{2}$ -20 ($\frac{9}{16}$ x $\frac{3}{4}$) castle nut (same as T-2551-B)		堡塞螺帽
A-21840-S1 ...	$\frac{1}{2}$ -13 ($\frac{1}{2}$ x $\frac{7}{8}$) hex. nut		六角螺帽
A-21841	$\frac{1}{2}$ -20 ($\frac{9}{16}$ x $\frac{3}{4}$) castle nut (same as T-3809)		堡塞螺帽
A-21842-R ...	$\frac{1}{2}$ -20 ($\frac{1}{2}$ x $\frac{3}{4}$) special castle nut		特別堡塞螺帽
A-21845-S1 ...	$\frac{1}{2}$ -20 ($\frac{7}{16}$ x $\frac{3}{4}$) hex. nut		六角螺帽
A-21846-S7 ...	$\frac{1}{2}$ -20 ($\frac{1}{8}$ x $\frac{13}{16}$) hex. check nut		六角螺帽
A-21875	$\frac{9}{16}$ -18 ($\frac{39}{64}$ x $\frac{7}{8}$) castle nut (same as T-2548)		堡塞螺帽

Part No.	Name of Part	Year	貨名
A-21876 $\frac{9}{16}$ -18 ($\frac{39}{64} \times \frac{7}{8}$) castle nut (Cyanide) (same as T-3809-B)		堡塞螺帽
A-21877-S1	... $\frac{9}{16}$ -18 ($\frac{31}{64} \times \frac{7}{8}$) hex. nut (same as T-2549)		六角螺帽
A-21878 $\frac{9}{16}$ -18 ($\frac{5}{8} \times 1\frac{1}{16}$) castle nut (special)		堡塞螺帽
A-21879 $\frac{9}{16}$ -18 ($\frac{3}{16} \times \frac{3}{4}$) hex. check nut		六角螺帽
A-21880-S1	... $\frac{9}{16}$ -12 ($\frac{3}{64} \times \frac{7}{8}$) hex. nut		六角螺帽
A-21881 $\frac{9}{16}$ -18 ($\frac{3}{16} \times \frac{7}{8}$) hex. nut		六角螺帽
A-21890 $\frac{5}{8}$ -18 ($\frac{3}{8} \times 1\frac{5}{16}$) hex. nut		六角螺帽
A-21891 $\frac{5}{8}$ -18 ($\frac{7}{16} \times 1\frac{5}{16}$) slotted hex. nut (same as T-2598)		六角螺帽螺帽
A-21892 $\frac{5}{8}$ -18 ($\frac{23}{32} \times 1\frac{5}{16}$) castle nut (hardened) (same as T-121-X)		堡塞螺帽
A-21893 $\frac{5}{8}$ -18 ($\frac{13}{16} \times 1\frac{5}{16}$) special castle nut		特別堡塞螺帽
A-21894 $\frac{5}{8}$ -18 ($\frac{23}{32} \times 1\frac{5}{16}$) castle nut (same as T-2507)		堡塞螺帽
A-21895 $\frac{5}{8}$ -18 ($\frac{35}{64} \times 1\frac{5}{16}$) hex. nut		六角螺帽
A-21901-S2	... $\frac{5}{8} \times 11$ hex. nut		六角螺帽
A-21920 $\frac{3}{4}$ -16 ($\frac{1}{2} \times 1\frac{1}{8}$) castle nut		堡塞螺帽
A-21921 $\frac{3}{4}$ -16 ($\frac{9}{16} \times 1\frac{1}{8}$) castle nut		堡塞螺帽
A-21922-A-S7R $\frac{3}{4}$ -16 ($1\frac{3}{8} \times 1\frac{9}{16}$) special hex. nut		特別六角螺帽
A-21923 $\frac{3}{4}$ -16 ($\frac{5}{16} \times 1\frac{1}{8}$) hex. nut		六角螺帽
A-21927 $\frac{3}{4}$ -16 ($\frac{13}{16} \times 1\frac{1}{4}$) special castle nut		特別堡塞螺帽
A-21928-S7 $\frac{3}{4}$ -16 ($\frac{21}{32} \times 1\frac{1}{16}$) std. hex. nut		六角螺帽
A-21940 $\frac{7}{8}$ -14 ($\frac{9}{16} \times 1\frac{1}{4}$) castle nut		堡塞螺帽
A-21941 $\frac{7}{8}$ -14 ($\frac{29}{32} \times 1\frac{1}{4}$) castle nut (same as TT 1015)		堡塞螺帽
A-21943 $\frac{7}{8}$ -14 ($\frac{13}{16} \times 1\frac{1}{4}$) special castle nut		特別堡塞螺帽
A-21950-AR	... $1\frac{1}{8}$ ($\frac{3}{8} \times 2$) hex. check nut		六角螺帽
A-21950-B $\frac{19}{16}$ -20 ($\frac{3}{8} \times 2\frac{1}{8}$) hex. check nut		六角螺帽
A-21951-R	... $\frac{17}{16}$ -16 ($\frac{9}{16} \times 1\frac{11}{16}$) hex. check nut		六角螺帽
A-21956 $1\frac{1}{2}$ -20 ($\frac{5}{16} \times 2$) hex. check nut		六角螺帽
WASHERS			圓片及鎖環
A-22038-S7	... $\frac{1}{8}$ ($\frac{1}{32} \times \frac{5}{16}$) plain washer		平圓片
A-22040 $\frac{1}{8}$ ($\frac{1}{32} \times \frac{5}{16}$) plain washer (bakelite)		平圓片
A-22041 $\frac{1}{8}$ ($\frac{1}{16} \times 1\frac{5}{16}$) plain washer (fiber)		平圓片
A-22046No. 1906 shakeproof washer (No. 6) (bronze)		圓片
A-22047No. 6 ($\frac{1}{32} \times 1\frac{17}{64}$) lock washer (same as T-1657-X)		鎖環
A-22056No. 8 ($\frac{3}{64} \times \frac{3}{16}$) lock washer (tangleproof) (same as T-6266)		鎖環
A-22057No. 1210 shakeproof washer (No. 10)		圓片
A-22062 $\frac{5}{32}$ ($\frac{1}{64} \times 1\frac{11}{32}$) No. 1208 shakeproof lock washer		鎖環
A-22071-S7	... $\frac{11}{64}$ ($\frac{1}{32} \times \frac{3}{8}$) plain washer (brass)		平圓片
A-22074No. 8 ($\frac{1}{32} \times \frac{3}{8}$) plain washer		平圓片
A-22072-S6	... $\frac{11}{64}$ ($\frac{3}{32} \times 1\frac{13}{32}$) plain washer		平圓片
A-22075-S8	...No. 8 shakeproof countersunk external teeth lock washer		鎖環

Part No.	Name of Part	Year	貨名
A-22086	$3/16$ ($3/64 \times 5/16$) plain fiber washer		平圓片
A-22088	$3/16$ ($3/64 \times 7/32$) (tangleproof) lock washer same as T-5142-B)		鎖環
A-22088-S2	$3/16$ ($3/64 \times 7/32$) lock washer (tangleproof) regular		鎖環
A-22088-S7	$3/16$ ($3/64 \times 7/32$) lock washer (tangleproof) regular		鎖環
A-22094	$3/16$ ($3/32 \times 9/16$) phenol fabric washer		芬歐裂圓片
A-22095	$3/16$ ($1/32 \times 7/16$) plain washer (same as T-1235-X)		平圓片
A-22104-S7	No. 10 ($1/32 \times 3/8$) plain washer		平圓片
A-22111-S2	$3/16$ ($1/32 \times 7/16$) plain washer		平圓片
A-22112	$3/16$ ($3/64 \times 5/16$) lock washer (tangleproof) light		鎖環
A-22135-BR	$3/16$ ($1/8 \times 31/64$) plain hard fiber washer		平硬纖維圓片
A-22139-S3	$7/32$ ($1/16 \times 27/64$) lock washer (tangleproof)		鎖環
A-22139-S7	$7/32$ ($1/16 \times 27/64$) lock washer (tangleproof)		鎖環
A-22150	$1/4$ ($3/64 \times 29/64$) lock washer (same as T-3261-C)		鎖環
A-22150-S1	$1/4$ ($3/64 \times 29/64$) lock washer		鎖環
A-22150-S7	$1/4$ ($3/64 \times 29/64$) lock washer (tangleproof) light		鎖環
A-22151	$1/4$ ($1/16 \times 23/64$) lock washer (same as T-4868)		鎖環
A-22153	$1/4$ shakeproof lock washer		鎖環
A-22154	$1/4$ ($1/16 \times 3/4$) plain washer		平圓片
A-22154-S8	$1/4$ ($1/16 \times 3/4$) plain washer		平圓片
A-22155	$1/4$ ($1/4 \times 13/16$) felt washer		絨圓片
A-22164	$1/4$ ($1/32 \times 17/32$) shakeproof lock washer internal		鎖環
A-22166-S3	$1/4$ ($1/16 \times 3/4$) plain washer		平圓片
A-22167-S7	$1/4$ ($1/16 \times 5/8$) plain washer		平圓片
A-22172	$1/4$ ($7/64 \times 3/4$) countersunk washer		圓片
A-22172-S2	$1/4$ ($7/64 \times 3/4$) finishing washer (No. 12)		圓片
A-22177	$1/4$ ($1/16 \times 9/16$) plain washer (bakelite)		平圓片
A-22180-S7	$1/4$ external tooth shakeproof washer		圓片
A-22215	$5/16$ ($1/16 \times 11/32$) lock washer		鎖環
A-22216-R	$5/16$ ($3/64 \times 5/8$) plain washer (cardboard) (same as T-3171-SX)		平圓片
A-22217	$5/16$ ($3/32 \times 37/64$) lock washer (same as T-4864)		鎖環
A-22217-S1	$5/16$ ($3/32 \times 37/64$) lock washer (tangleproof) heavy		鎖環
A-22217-S2	$5/16$ ($3/32 \times 37/64$) lock washer (tangleproof) heavy		鎖環
A-22219	$5/16$ ($1/8 \times 1 1/8$) plain washer		平圓片
A-22220	$5/16$ ($1/16 \times 1/2$) brass washer		銅圓片
A-22222-S7	$5/16$ ($1/32 \times 35/64$) plain washer		平圓片
A-22223-S2	$5/16$ ($1/16 \times 3/4$) plain washer		平圓片
A-22236	$5/16$ ($1/32 \times 17/32$) lock washer		鎖環
A-22238	$11/32$ ($1/4 \times 1 1/4$) plain washer—cork		平圓片
A-22239-R	$11/32$ ($1/32 \times 5/8$) plain washer		平圓片

Part No.	Name of Part	Year	貨名
A-22245	$\frac{3}{8}$ (401-411) ($\frac{3}{32}$ x $\frac{21}{32}$) lock washer (same as T-4806-C)		鎖環
A-22245-S1	$\frac{3}{8}$ (401-411) ($\frac{3}{32}$ x $\frac{21}{32}$) lock washer		鎖環
A-22245-S2	$\frac{3}{8}$ (401-411) ($\frac{3}{32}$ x $\frac{21}{32}$) lock washer		鎖環
A-22248-S2	$\frac{3}{8}$ ($\frac{1}{16}$ x $\frac{11}{16}$) plain washer		平圓片
A-22251-S7	$\frac{3}{8}$ ($\frac{1}{16}$ x $\frac{3}{8}$) plain washer		平圓片
A-22256	$\frac{3}{8}$ ($\frac{3}{64}$ x $\frac{9}{16}$) plain fiber washer		平圓片
A-22257-S2	$\frac{3}{8}$ ($\frac{1}{16}$ x $\frac{41}{64}$) lock washer		鎖環
A-22258	$\frac{3}{8}$ ($\frac{1}{16}$ x $\frac{55}{64}$) plain fiber washer		平圓片
A-22259-S7	$\frac{3}{8}$ ($\frac{1}{16}$ x $\frac{3}{8}$) plain washer		平圓片
A-22267-S7	$\frac{3}{8}$ ($\frac{1}{64}$ x $\frac{23}{32}$) plain washer		平圓片
A-22271	$\frac{3}{8}$ external shakeproof lock washer (steel)		鎖環
A-22286	$\frac{13}{32}$ ($\frac{1}{16}$ x $\frac{3}{8}$) hard fiber washer (same as T-5110)		圓片
A-22287	$\frac{13}{32}$ ($\frac{1}{16}$ x $\frac{5}{8}$) plain washer (same as T-7833-X)		平圓片
A-22289	$\frac{13}{32}$ ($\frac{3}{64}$ x $\frac{9}{16}$) plain washer		平圓片
A-22290	$\frac{13}{32}$ ($\frac{3}{32}$ x $\frac{29}{32}$) special lock washer (tangle proof)		特別鎖環
A-22291	$\frac{13}{32}$ ($\frac{3}{16}$ x $\frac{3}{8}$) plain washer		平圓片
A-22300	$\frac{7}{16}$ ($\frac{1}{8}$ x $\frac{13}{16}$) lock washer (same as T-3078-C)		環鎖
A-22300-S1	$\frac{7}{16}$ ($\frac{1}{8}$ x $\frac{13}{16}$) lock washer		鎖環
A-22302-B	$\frac{7}{16}$ ($\frac{1}{8}$ x $1\frac{1}{2}$) plain washer		平圓片
A-22305	$\frac{7}{16}$ ($\frac{1}{16}$ x $\frac{49}{64}$) lock washer (tangleproof)		鎖環
A-22306	$\frac{7}{16}$ ($\frac{3}{16}$ x 2) plain washer		平圓片
A-22323	$\frac{15}{32}$ ($\frac{3}{32}$ x $\frac{13}{16}$) plain washer		平圓片
A-22330	$\frac{1}{2}$ ($\frac{1}{8}$ x $\frac{3}{8}$) lock washer (same as S-183)		鎖環
A-22330-S1	$\frac{1}{2}$ ($\frac{1}{8}$ x $\frac{3}{8}$) lock washer		鎖環
A-22331	$\frac{1}{2}$ ($\frac{1}{32}$ x $\frac{11}{16}$) plain washer—fiber		平圓片
A-22333	$\frac{1}{2}$ ($\frac{3}{46}$ x $\frac{3}{8}$) plain fiber washer		平圓片
A-22334	$\frac{1}{2}$ ($\frac{1}{8}$ x $\frac{29}{32}$) plain fiber washer		平圓片
A-22337	$\frac{1}{2}$ ($\frac{3}{32}$ x $\frac{7}{8}$) plain washer		平圓片
A-22341	$\frac{1}{2}$ ($\frac{3}{64}$ x $\frac{7}{8}$) shakeproof lock washer		鎖環
A-22355-S1	$\frac{9}{16}$ ($\frac{5}{32}$ x $\frac{29}{32}$) lock washer (same as T-2550)		鎖環
A-22358	$\frac{9}{16}$ ($\frac{3}{32}$ x $\frac{31}{32}$) lock washer		鎖環
A-22367	$\frac{5}{8}$ ($\frac{5}{32}$ x $\frac{11}{16}$) lock washer (same as S-477-B)		鎖環
A-22367-S2	$\frac{5}{8}$ ($\frac{5}{32}$ x $\frac{11}{16}$) lock washer		鎖環
A-22369	$\frac{5}{8}$ ($\frac{1}{16}$ x $\frac{11}{16}$) plain washer		平圓片
A-22370	$\frac{5}{8}$ ($\frac{3}{16}$ x $1\frac{1}{2}$) plain washer		平圓片
A-22371	$\frac{5}{8}$ ($\frac{9}{64}$ x $1\frac{1}{4}$) plain washer		平圓片
A-22372	$\frac{5}{8}$ ($\frac{1}{32}$ x $1\frac{1}{4}$) plain fiber washer		平圓片
A-22373	$\frac{21}{32}$ ($\frac{1}{32}$ x $\frac{15}{32}$) plain washer		平圓片
A-22374	$\frac{5}{8}$ ($\frac{1}{8}$ x 1) plain washer—compressed asbestos		平圓片
A-22384	$\frac{23}{32}$ ($\frac{1}{16}$ x 1) plain fibre washer		平圓片
A-22392	$\frac{3}{4}$ ($\frac{1}{16}$ x $1\frac{1}{8}$) lock washer		鎖環
A-22398	$\frac{3}{4}$ ($\frac{1}{16}$ x $\frac{15}{16}$) copper asbestos gasket		銅石棉墊
A-22408-R	$\frac{13}{16}$ ($\frac{1}{8}$ x $1\frac{3}{8}$) plain washer—felt		平圓片

Part No.	Name of Part	Year	貨名
A-22409-R	... ²⁹ / ₃₂ (.008 x 1 ³ / ₈) plain washer		平圓片
A-22410	... ²⁹ / ₃₂ (³ / ₁₆ x ²³ / ₁₆) plain washer		平圓片
A-22411-R	... ⁷ / ₈ (¹ / ₂ x ¹¹ / ₁₆) plain washer—compressed asbestos		平圓片
A-22416	... ¹³ / ₁₆ (³ / ₁₆ x ⁵ / ₁₆) felt washer		絨圓片
A-22418-R	... ⁷ / ₈ (³ / ₈ x 1 ³ / ₈) felt washer		絨圓片
A-22420	... ⁷ / ₈ (¹ / ₈ x ¹⁷ / ₆₄) plain washer		平圓片
A-22421-R	... ²⁹ / ₃₂ (³ / ₁₆ x 1 ¹ / ₈) special plain washer		特別平圓片
A-22422	... ⁷ / ₈ (³ / ₆₄ x 1 ¹ / ₈) lead gasket (same as T-2155 X)		鉛墊
A-22424	... ⁷ / ₈ (⁵ / ₆₄ x 1 ¹ / ₈) copper asbestos gasket (same as L-209)		銅石棉墊
A-22430	...1 ¹ / ₂ (¹ / ₈ x 1 ³ / ₄) compressed asbestos gasket		壓石棉墊
A-22431	... ¹⁷ / ₆₄ (¹ / ₁₆ x ¹³ / ₁₆) plain washer		平圓片
A-22438	...2 ¹ / ₂ (¹ / ₂ x 3) felt washer		絨圓片
A-22439-R	...1 ¹ / ₂ (¹ / ₁₆ x ¹⁶³ / ₆₄) plain washer		平圓片
A-22441-R	... ¹³³ / ₆₄ (¹ / ₁₆ x 2 ⁷ / ₈) washer		圓片
A-22442	... ¹¹⁹ / ₃₂ (01 x ¹²⁵ / ₃₂) plain washer—brass		平圓片 銅
A-22443	... ²¹⁵ / ₁₆ (³ / ₃₂ x 3 ¹ / ₈) plain rubber washer		平樹膠圓片
A-22446	... ¹³ / ₃₂ (¹ / ₈ x 1 ¹ / ₂) soft rubber washer (same as T-5143-BX)		軟樹膠圓片
A-22448	... ¹²⁵ / ₃₂ (³ / ₃₂ x ²⁹ / ₃₂) plain cork washer		平軟木圓片
A-22450	...No. 1110 shakeproof washer (No. 10— ³ / ₁₆)		圓片
A-22451	...No. 1220 shakeproof washer (³ / ₈)		圓片
A-22453	...1 (⁵ / ₃₂ x 1 ¹ / ₈) plain washer—felt		平圓片 絨
A-22538-S2	...No. 6 x ⁵ / ₁₆ rd. hd. self tapping metal screw		第六號圓頭金屬螺絲
A-22538-S13	...No. 6 x ⁵ / ₁₆ rd. hd. self tapping metal screw		第六號圓頭金屬螺絲
WOOD SCREWS			
A-22541	...No. 6 x ³ / ₄ oval hd. wood screw		木螺絲
A-22613-S1	...No. 9 x ⁵ / ₈ rd. hd. wood screw		卵頭木螺絲
A-22647-S2	...No. 10 x 1 rd. hd. wood screw		圓頭木螺絲
A-22715	...No. 14 x 1 flat hd. wood screw		扁頭木螺絲
A-22750	... ⁵ / ₁₆ x 1 ¹ / ₄ lag screw		莖螺絲
RIVETS			
A-22885-S6	... ¹ / ₈ x ¹ / ₄ oval hd. tubular rivet—brass		帽釘
A-22889	...118— ¹²¹ / ₁₆ x ³ / ₁₆ oval hd. tubular rivet (same as T-1998-X)		卵形管式帽釘
A-22900-S4	... ¹ / ₈ x ¹ / ₄ oval hd. split rivet (same as T-3772-X)		卵形裂口帽釘
A-22902	... ¹ / ₈ x ¹⁵ / ₁₆ oval hd. split rivet		卵形裂口帽釘
A-22909-S3	... ¹ / ₈ x ⁹ / ₃₂ oval hd. tubular rivet		卵形管式帽釘
A-22976-S3	... ⁹ / ₆₄ x ¹ / ₄ oval hd. tubular rivet		卵形管式帽釘
A-22985-S4	... ⁹ / ₆₄ x ⁵ / ₁₆ oval hd. tubular rivet (same as TT-2495)		卵形鈕式帽釘
A-22991-S4	... ⁹ / ₆₄ x ³ / ₈ oval hd. tubular rivet		卵形管式帽釘
A-22993	... ⁹ / ₆₄ x ²⁵ / ₆₄ flat countersunk hd. tubular rivet—brass		扁頭管式帽釘
A-22997	... ⁹ / ₆₄ x ⁵ / ₁₆ flat countersunk hd. tubular rivet		扁頭管式帽釘
A-22998	... ⁹ / ₆₄ x ¹ / ₄ flat countersunk hd. tubular rivet		扁頭管式帽釘

Part No.	Name of Part	Year	貨名
A-23033 $\frac{5}{32} \times \frac{5}{16}$ oval hd. rivet		卵形帽釘
A-23033-S7 $\frac{5}{32} \times \frac{5}{16}$ special hd. rivet		特別帽釘
A-23043-S4 $\frac{5}{32} \times \frac{7}{16}$ oval hd. split rivet		卵形裂口帽釘
A-23100 $\frac{3}{16} \times \frac{7}{16}$ ctsk. hd. tubular rivet		錐形管式帽釘
A-23101-S4 $\frac{3}{16} \times \frac{3}{16}$ oval hd. tubular rivet (same as T-17626-X)		卵形管式帽釘
A-23138 $\frac{3}{16} \times \frac{1}{2}$ ctsk. hd. tubular rivet		錐形管式帽釘
A-23225 $\frac{7}{32} \times \frac{1}{2}$ flat hd. rivet (special)		平頭帽釘
A-23250-R $\frac{3}{32} \times \frac{5}{8}$ special rivet		特別帽釘
A-23262 $\frac{1}{4} \times \frac{3}{4}$ rd. hd. rivet (same as T-3115)		圓頭帽釘
A-23281 $\frac{1}{4} \times 1\frac{13}{16}$ rd. hd. knurled rivet		圓頭帽釘
A-23288 $\frac{1}{4} \times 1\frac{3}{4}$ rd. hd. rivet		圓頭帽釘
A-23291 $\frac{1}{4} \times 1\frac{11}{16}$ rd. hd. rivet		圓頭帽釘
A-23292 $\frac{1}{4} \times \frac{7}{8}$ rd. hd. rivet		圓頭帽釘
A-23293 $\frac{1}{4} \times 1\frac{1}{2}$ rd. hd. rivet		圓頭帽釘
A-23368 $\frac{5}{16} \times \frac{5}{8}$ oval hd. rivet (same as TT-8309-X)		卵形帽釘
A-23371 $\frac{5}{16} \times 1\frac{11}{16}$ rd. hd. rivet		圓頭帽釘
A-23372 $\frac{5}{16} \times \frac{7}{8}$ rd. hd. rivet		圓頭帽釘
A-23377 $\frac{5}{16} \times 1\frac{13}{16}$ rd. hd. rivet		圓頭帽釘
A-23381 $\frac{5}{16} \times \frac{1}{2}$ oval hd. rivet		卵形帽釘
A-23384 $\frac{5}{16} \times 1\frac{15}{16}$ rd. hd. rivet		圓頭帽釘
A-23385 $\frac{5}{16} \times 1\frac{11}{16}$ rd. hd. rivet		圓頭帽釘
A-23389 $\frac{5}{16} \times 1\frac{1}{4}$ rd. hd. rivet		圓頭帽釘
A-23435 $\frac{3}{8} \times 1\frac{1}{2}$ rd. hd. rivet		圓頭帽釘
A-23436 $\frac{3}{8} \times 1$ rd. hd. rivet		圓頭帽釘
A-23437 $\frac{3}{8} \times 1\frac{1}{8}$ rd. hd. rivet		圓頭帽釘
A-23438 $\frac{3}{8} \times \frac{7}{8}$ oval hd. rivet (same as T-8819-X)		卵形帽釘
A-23439 $\frac{3}{8} \times 1$ flat countersunk hd. rivet		扁頭帽釘
A-23441 $\frac{3}{8} \times 1\frac{1}{4}$ rd. hd. rivet		圓頭帽釘
A-23442 $\frac{3}{8} \times 4\frac{1}{8}$ rd. hd. rivet		圓頭帽釘
A-23445 $\frac{3}{8} \times \frac{3}{4}$ rd. hd. rivet		圓頭帽釘
A-23468 $\frac{1}{2} \times 1\frac{1}{8}$ rd. hd. rivet		圓頭帽釘
COTTERS			鉗針
A-23515 $\frac{1}{16} \times \frac{1}{2}$ cotter pin (same as T-544-X)		鉗針
A-23516 $\frac{1}{16} \times \frac{3}{4}$ cotter pin (same as L-389)		鉗針
A-23519-S6 $\frac{1}{16} \times \frac{3}{8}$ cotter pin		鉗針
A-23530 $\frac{3}{32} \times \frac{1}{2}$ cotter (same as T-66-X)		鉗針
A-23531 $\frac{3}{32} \times \frac{3}{4}$ cotter (same as T-753-X)		鉗針
A-23533 $\frac{3}{32} \times 1$ cotter (same as T-421-X)		鉗針
A-23534 $\frac{3}{32} \times \frac{5}{8}$ cotter (same as T-88-X)		鉗針
A-23550 $\frac{1}{8} \times 1$ cotter (same as T-82-X)		鉗針
A-23551 $\frac{1}{8} \times \frac{3}{4}$ cotter (same as T-614-X)		鉗針
A-23552 $\frac{1}{8} \times 1\frac{1}{4}$ cotter (same as TT-1094)		鉗針
A-23553 $\frac{1}{8} \times 1\frac{1}{2}$ cotter		鉗針
A-23554 $\frac{1}{8} \times 1\frac{3}{8}$ cotter		鉗針
A-23555 $\frac{1}{8} \times \frac{5}{8}$ cotter		鉗針
A-23565 $\frac{5}{32} \times 1$ cotter (same as TT-2461-X)		鉗針
A-23566 $\frac{5}{32} \times 1\frac{1}{2}$ cotter (same as TT-1014)		鉗針

Part No.	Name of Part	Year	貨名
PINS			針
A-23626 $\frac{5}{64} \times \frac{1}{2}$ plain pin		平針
A-23635 $\frac{3}{32} \times \frac{21}{32}$ plain pin		平針
A-23637 $\frac{3}{32} \times \frac{23}{64}$ plain pin		平針
A-23670 $\frac{1}{8} \times \frac{25}{32}$ plain pin		平針
A-23731 $\frac{3}{16} \times 1\frac{11}{16}$ flat hd. tubular pin (special)		扁頭管式針
A-23732 $\frac{3}{16} \times 1\frac{1}{4}$ flat hd. tubular pin (special)		扁頭管式針
A-23734 $\frac{3}{16} \times 1\frac{1}{2}$ plain pin		平針
A-23735-R $\frac{3}{16} \times \frac{3}{8}$ plain pin (same as L-421)		平針
A-23765 $\frac{7}{32} \times 4\frac{15}{16}$ flat hd. clevis pin		扁頭U形針
A-23766 $\frac{1}{4} \times 1\frac{5}{16}$ flat hd. pin		扁頭針
A-23767-R $\frac{7}{32} \times \frac{1}{4}$ flat hd. pin (same as TT-1055)		扁頭針
A-23781 $\frac{1}{4} \times 2\frac{1}{8}$ flat hd. pin		扁頭針
A-23782 $\frac{1}{4} \times 1\frac{3}{16}$ flat hd. pin		扁頭針
A-23789 $\frac{1}{4} \times 1\frac{9}{16}$ flat hd. clevis pin		扁頭U形針
A-23791 $\frac{1}{4} \times 1\frac{1}{2}$ groove pin		槽針
A-23820 $\frac{5}{16} \times \frac{7}{8}$ flat hd. clevis pin		扁頭U形針
A-23822-S7 $\frac{5}{16} \times 1\frac{5}{16}$ button hd. clevis pin		鈕頭U形針
A-23824-R $\frac{5}{16} \times \frac{7}{16}$ ($\frac{1}{4} \times \frac{9}{16}$) flat hd. special pin		扁頭特別針
A-23825 $\frac{5}{16} \times 1\frac{5}{16}$ plain pin		平針
A-23826-R $\frac{5}{16} \times 1\frac{1}{8}$ plain pin		平針
A-23827-S8 $\frac{5}{16} \times 1\frac{3}{16}$ button hd. clevis pin		鈕頭U形針
A-23828-S7 $\frac{5}{16} \times 1\frac{7}{16}$ button head clevis pin (same as T-3905)		鈕頭U形針
A-23829-S8 $\frac{5}{16} \times 1\frac{3}{16}$ flat hd. clevis pin		扁頭U形針
A-23830 $\frac{5}{16} \times 1\frac{1}{4}$ groove pin (galvanized)		槽針
A-23843-S7 $\frac{3}{8} \times 4\frac{5}{64}$ flat hd. clevis pin		扁頭U形針
A-23844-S8 $\frac{3}{8} \times \frac{9}{16}$ flat hd. clevis pin		扁頭U形針
A-23845-S7 $\frac{3}{8} \times 2\frac{29}{32}$ flat hd. clevis pin		扁頭U形針
A-23846-S7 $\frac{3}{8} \times 1\frac{5}{32}$ flat hd. clevis pin		扁頭U形針
A-23849 $\frac{3}{8} \times 1\frac{1}{2}$ button hd. pin		鈕頭針
A-23860-R $\frac{3}{8} \times 2\frac{1}{2}$ plain pin (same as L-3404)		平針
A-23861-R $\frac{3}{8} \times 2\frac{1}{4}$ flat hd. clevis pin (same as L-3405)		扁頭U形針
A-23870-S7 $\frac{7}{16} \times \frac{61}{64}$ flat hd. clevis pin—with cotter hole		扁頭U形針
A-23873-S7 $\frac{7}{16} \times \frac{53}{64}$ flat hd. clevis pin—with cotter hole		扁頭U形針
A-23890 $\frac{9}{16} \times 1\frac{17}{32}$ button hd. pin		鈕頭針
KEYS			鍵
A-23901 $\frac{3}{16} \times 1 \times 2\frac{7}{64}$ Woodruff key No. 13 (same as L-270)		烏勒夫鍵
A-23902 $\frac{1}{8} \times \frac{31}{64} \times \frac{3}{16}$ Woodruff key No. 3 (same as T-5020)		烏勒夫鍵
A-23903 $\frac{1}{4} \times 1\frac{1}{8} \times 1\frac{15}{32}$ Woodruff key No. 18 (same as L-278)		烏勒夫鍵
A-23904 $\frac{5}{8} \times \frac{1}{8}$ Woodruff key No. 5		烏勒夫鍵
A-23906-R $\frac{1}{4} \times \frac{5}{16} \times 2\frac{3}{4}$ key (same as L-5366)		鍵
A-23907 $\frac{5}{16} \times 1 \times 2\frac{7}{64}$ "B" Woodruff key		烏勒夫鍵
A-23908No. 6 Woodruff key		烏勒夫鍵

Part No.	Name of Part	Year	貨名
STUDS			螺絲(無螺頭)
A-24025 $\frac{3}{8}$ —16 and $\frac{3}{8}$ —24 x $1\frac{1}{4}$ plain stud		平螺絲
A-24027 $\frac{3}{8}$ —16 and 24 x $1\frac{7}{16}$ plain stud		平螺絲
A-24050 $\frac{7}{16}$ —14 and 20 x $3\frac{1}{2}$ plain stud		平螺絲
A-24051-AR $\frac{7}{16}$ —14 and 20 x $4\frac{7}{16}$ plain stud		平螺絲
A-24051-BR $\frac{7}{16}$ —14 and 20 x $4\frac{1}{16}$ plain stud		平螺絲
A-24051-C $\frac{7}{16}$ —20 and 14 x $3\frac{11}{16}$ plain stud		平螺絲
A-24052 $\frac{7}{16}$ —14 and 20 x $5\frac{23}{32}$ plain stud		平螺絲
A-24053 $\frac{7}{16}$ —14 and 20 x $2\frac{3}{16}$ plain stud		平螺絲
LUBRICATOR FITTINGS			注油嘴
A-24404-S7	... $\frac{5}{16}$ drive lubricator fitting (plain type)		注油嘴
A-24405 $\frac{3}{8}$ pipe thread lubricator fitting assy. (check valve type)		注油嘴
A-24406 $\frac{1}{8}$ pipe thread lubricator fitting assy. (water pump type)		注油嘴
A-24407 $\frac{5}{16}$ lubricator fitting—drive fit—70° elbow		注油嘴
A-24408 $\frac{3}{8}$ pipe thread lubricator fitting (long type)		注油嘴
A-24409 $\frac{3}{8}$ pipe thread 67 $\frac{1}{2}$ ° lubricator fitting		注油嘴
PLUGS			塞
A-24451 $\frac{1}{2}$ —20 x $\frac{5}{16}$ hdless. slotted plug		無頭帶槽塞
A-24452 $\frac{3}{4}$ x $\frac{15}{16}$ sq. hd. pipe plug (same as TT-1012)		方頭管塞
A-24454435/.440 x .036/.039 expansion plug		加長塞
A-24455 $\frac{1}{8}$ x $\frac{5}{16}$ hdless. slotted pipe plug (same as T-3980)		無頭帶槽管塞
A-24457 $\frac{1}{2}$ x $\frac{9}{16}$ hdless. plug (same as T-2532-B)		無頭塞
A-24460-AR	... $\frac{13}{16}$ x $\frac{5}{64}$ expansion plug		漲開塞
A-24461744/.748 x $\frac{1}{16}$ expansion plug		漲開塞
A-24465 $\frac{1}{8}$ x $\frac{3}{8}$ sq. hd. pipe plug		方頭管塞
A-24466 $\frac{1}{4}$ —18 standard pipe plug		標準管塞
A-24500 $\frac{3}{8}$ steel ball (same as T-2811)		鋼球
A-24603 1" plug		塞
A-24613 $\frac{11}{32}$ x $\frac{5}{16}$ flat hd. rubber plug button—brass		扁頭樹膠塞鈕 銅
A-24623 $\frac{5}{8}$ plug		塞
FASTENERS			鈕扣
A-24550-S6	... Grommet for post type fastener—double (same as T-6905-RX)		鈕扣管頭 雙
A-24551-S6	... Grommet washer for post type fastener		鈕扣管頭圈片
A-24552-S6	... Grommet for post type fastener—single		鈕扣管頭 單
A-24553-S6	... Clinch fastener—single (same as T-8939-X)		密嵌鈕扣 單
A-24554-S6	... Clinch fastener washer		密嵌鈕扣圈片
A-24555-S13	... Clinch fastener eyelet		密嵌鈕扣眼
A-24556-S6	... Clinch fastener eyelet washer (same as T-8943-X)		密嵌鈕扣眼圈片
A-24559-S6	... Spring lock fastener—female		彈簧鎖鈕扣
A-24560-S6	... Spring lock fastener washer		彈簧鎖鈕扣圈片

Part No. Name of Part Year 貨名

A-24562-S6 ...Single snap fastener 單栓鈕扣
 A-24563-S6 ...Double snap fastener (same as T-8938-X).... 雙栓鈕扣
 A-24563-S6 ...Snap fastener socket 栓扣嵌框
 A-24566-S6 ...Flush type fastener 平面式鈕扣

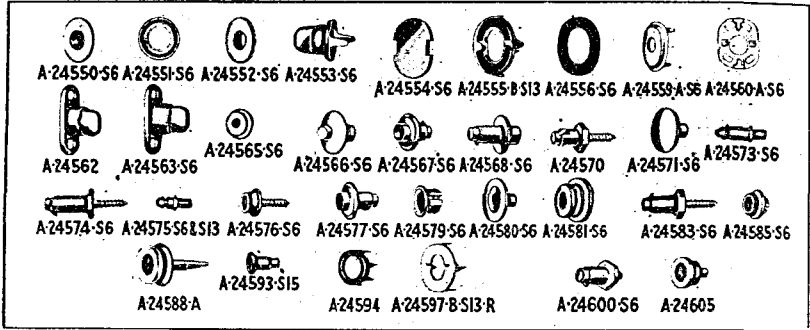

A-24567-S6 ...Post type fastener—single tubular rivet base) 單鈕扣
 A-24568-S6 ...Post type fastener—double tubular rivet base) 雙鈕扣
 A-24570-S6 ...Post type fastener (No. 10 wood screw base) .. 鈕扣
 A-24571-S6 ...Snap fastener button 鈕扣鈕
 A-24573-S6 ...No. 10—32 double curtain fastener stud 雙帷鈕扣螺絲
 A-24574-S6 ...Triple post type fastener (No. 10 wood screw type) 三開鈕扣
 A-24575-S6 ...No. 10—32 single stud (machine screw base) (same as T-41128-X) 單螺絲
 A-24575-S13 ...No. 10—32 single stud—machine screw base .. 單螺絲
 A-24576-S6 ...Single curtain fastener stud (wood screw type) 單帷鈕扣螺絲
 A-24577-S6 ...Post type fastener tubular rivet 鈕扣管式螺釘
 A-24579-S6 ...Flush type fastener—female—single (same as T-41124-X) 平面式鈕扣 陰 單
 A-24579-S13 ...Rear bumper flush type fastener—female—single 後車擋鈕扣 陰 單
 A-24580-S6 ...Snap fastener eyelet (clinch type) 鈕扣環
 A-24581-S6 ...Snap fastener stud (clinch type) 鈕扣螺絲
 A-24583-S6 ...Post type double fastener (No. 10 wood screw—base) 雙鈕扣
 A-24585-S6 ...Snap fastener stud (expansion type) 鈕扣螺絲
 A-24588-S6 ...Floor carpet fastener—male assy. (11/16 drive screw type) 地毯鈕扣
 A-24593-S15 ...Carpet fastener stud 地毯鈕扣螺絲
 A-24594 Carpet fastener—female 地毯鈕扣 陰
 A-24597-S6 ...Clinch fastener eyelet 鈕扣環
 A-24600-S6 ...Double post type fastener (screw base) 雙鈕扣
 A-24605“Durable Dot” snap fastener stud (tubular rivet) 鈕扣螺絲

Part No.

Name of Part

Year

貨名

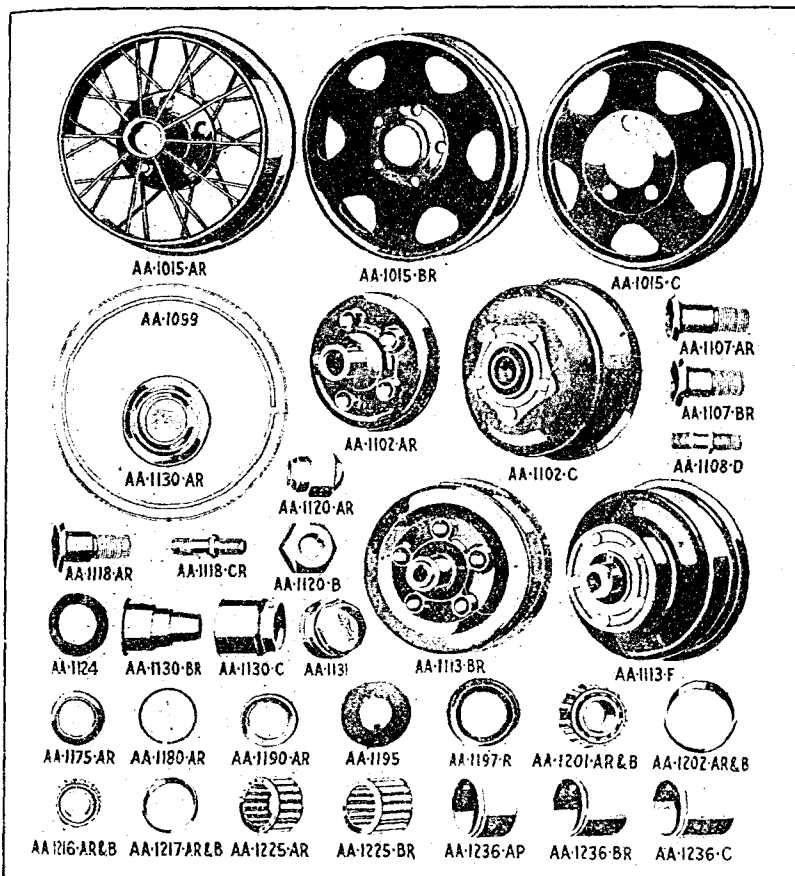

WHEELS 車輪

AA-1015-AR ..Wheel	1928-29	車輪
AA-1015-BR ..Disc wheel	1928	車輪
AA-1015-C ...Disc wheel	1930-31	車輪
AA-1015-E ...Wheel (steel spoke)	1931	車輪(鋼輻)
AA-1099Wheel rim flange (same as TT-1106-G)	1928-31	車輪樣邊

Part No.	Name of Part	Year	貨名
HUBS AND BRAKE DRUMS			
AA-1102-AR	..Front hub and brake drum—R. H.	1928-29	輪心及車掣殼 右
AA-1102-C	...Front hub and brake drum—R. H.	1930-31	前輪心及車掣殼 右
AA-1102-E	...Front hub and drum assembly—R. H. —use with AA-1015-E	1931	前輪心及殼總成 右
AA-1103-AR	..Front hub and brake drum—L. H.	1928-29	前輪心及車掣殼 左
AA-1103-C	...Front hub and brake drum—L. H.	1930-31	前輪心及車掣殼 左
AA-1103-E	...Front hub and drum assembly—L. H.— use with AA-1015-E	1931	前輪心及殼總成 左
§AA-1107-AR	..Hub bolt—front—R. H. (Old No. A- 21375)	1928-29	輪心螺絲 前 右
AA-1107-BR	..Hub bolt—front—R. H.	1928-29	輪心螺絲 前 右
AA-1107-D	...Front hub bolts—R. H. thread	1930-31	輪心螺絲 右
§AA-1108-AR	..Hub bolt—front—L. H.	1928-29	輪心螺絲 前 左
AA-1108-BR	..Hub bolt—front—L. H.	1928-29	前心螺絲 前 左
AA-1108-D	...Front hub bolts—L. H. thread	1930-31	前輪心螺絲 左旋線
A-21928-S7	..Nut	1930-31	螺絲帽
†AA-1113-AR	..Rear hub and brake drum—R. H. (Old No. AA-1115-AR)	1928-29	後輪心及車掣殼 右
‡AA-1113-BR	..Rear hub and brake drum—R. H. (Old No. AA-1115-B)	1928-29	後輪心及車掣殼 右
AA-1113-F	...Rear hub and brake drum—R. H.	1930-31	前輪心及車掣殼 右
AA-1113-G	...Rear hub and drum assembly—R. H.— with AA-1015-E	1931	後輪心及殼總成 右
†AA-1114-AR	..Rear hub and brake drum—L. H.	1928-29	後輪心及車掣殼 左
‡AA-1114-BR	..Rear hub and brake drum—L. H.	1928-29	後輪心及車掣殼 左
AA-1114-F	...Rear hub and brake drum—L. H.	1930-31	後輪心及車掣殼 左
AA-1114-G	...Rear hub and drum assembly—L. H.— with AA-1015-E	1931	後輪心及殼總成 左
AA-1118-AR	..Rear hub bolt—R. H. thread (Old No. A-21323)	1928-29	後輪心螺絲 右旋線
A-22421-R	..Washer	1928-29	圈片
A-22411-R	..Washer (oil retaining)	1928-29	圈片(護油)
AA-1118-CR	..Rear hub bolt—R. H. thread	1930-31	後輪心螺絲 右旋線
AA-1118-E	...Rear hub bolt—R. H. thread	1930-31	後輪心螺絲 右旋線
AA-1119-AR	..Rear hub bolt—L. H. thread	1928-29	後輪心螺絲 左旋線
AA-1119-CR	..Rear hub bolt—L. H. thread	1930-31	後輪心螺絲 左旋線
AA-1119-E	...Rear hub bolt—L. H. thread	1930-31	後輪心螺絲 左旋線
A-21922A-S7R	..Nut	1928-29	螺絲帽
A-21928-S7	..Nut	1930-31	螺絲帽
AA-4243-B	..Key	1930-31	鍵
AA-1120-AR	..Hub bolt nut—R. H. thread	1928-29	輪心螺絲帽 右旋線
AA-1120-B	...Disc wheel nut—R. H. thread	1930-31	車輪螺絲帽 右旋線
AA-1121-AR	..Hub bolt nut—L. H. thread	1928-29	輪心螺絲帽 左旋線
AA-1121-B	...Disc wheel nut—L. H. thread	1930-31	車輪螺絲帽 左旋線
AA-1124	...Rear hub washer	1930-31	後輪心圈片

†Without emergency brake.

‡With emergency brake.

§Use with forged hub.

Part No.	Name of Part	Year	貨名
AA-1130-AR	..Hub cap	1928-29	輪心帽
AA-1130-BR	..Hub cap—disc wheel	1928-29	輪心帽
AA-1130-C	...Rear hub cap	1930-31	後輪心帽
AA-1131Front hub cap	1930-31	前輪心帽
AA-1132Disc wheel inner nut—R. H. thread ...	1930-31	輪心內螺絲帽 右旋線
AA-1133Disc wheel inner nut—L. H. thread ...	1930-31	輪心內螺絲帽 右旋線
AA-1134-A	...Disc wheel outer nut—R. H. thread ...	1930-31	輪心內螺絲帽 右旋線
AA-1135-A	...Disc wheel outer nut—L. H. thread ...	1930-31	輪心內螺絲帽 左旋線
AA-1137Hub cap—with AA-1015-E	1931	輪心帽
AA-1175-AR	..Rear wheel grease retainer assembly ..	1928-29	後輪儲油帽總成
AA-1175-B	...Rear wheel grease retainer assembly ..	1930-31	後輪儲油帽總成
AA-1180-AR	..Rear wheel grease retainer ring	1928-29	後輪儲油帽環
AA-1180-B	...Rear wheel grease retainer ring	1930-31	後輪儲油帽環
AA-1190-AR	..Front hub dust cap	1928-29	前輪心遮塵帽
AA-1190-B	...Front hub dust cap	1930-31	前輪心遮塵帽
AA-1195Front hub grease retainer washer ...	1928-31	前輪心儲油帽隔片
AA-1197-R	..Front wheel outer bearing grease re- tainer	1928-29	前輪外滑滾儲油帽
AA-1201-AR	..Front wheel inner bearing cone assem- bly	1928-29	前輪內錐形滑滾總成
AA-1201-B	...Front wheel inner bearing cone and roller assy.	1930-31	前輪內形及楔子滑滾 總成
AA-1202-AR	..Front wheel inner bearing cup	1928-29	前輪內滑滾蓋
AA-1202-B	...Front wheel inner bearing cup	1930-31	前輪內滑滾蓋
AA-1216-AR	..Front wheel outer bearing cone assy. ...	1928-29	前輪外錐形滑滾總成
AA-1216-B	...Front wheel outer cone and roller assy. ...	1930-31	前輪外錐形及楔子滑滾 總成
AA-1217-AR	..Front wheel outer bearing cup	1928-29	前輪外滑滾蓋
AA-1217-B	...Front wheel outer bearing cup	1930-31	前輪外滑滾蓋
AA-1225-AR	...Rear wheel bearing	1928-29	後輪滑滾
AA-1225-BR	..Rear wheel bearing	1928-29	後輪滑滾
AA-1225-C	...Rear wheel bearing assembly	1930-31	後輪滑滾總成
AA-1225-D	...Rear wheel bearing—1¾" long	1931	後輪滑滾
A-24405	...Lubricator fitting	1930-31	注油嘴
AA-1236-AR	..Rear hub sleeve	1928-29	後輪心套管
AA-1236-BR	..Rear hub sleeve	1928-29	後輪心套管
A-23225	...Rivet (sleeve retainer)	1928-29	帽釘(套管環)
AA-1236-C	...Rear hub sleeve	1930-31	後輪心套管
WHEEL CARRIER 輪架			
WHEEL CARRIER			橫架
AA-1404-AR	..Wheel carrier support—85A, 89A	1930-31	輪架帶
AA-1405-AR	..Wheel carrier support	1928-29	輪架帶
A-21941	...Nut	1928-29	螺絲帽
AA-1406-AR	..Wheel carrier flange assembly	1928-30	輪架緣邊總成
AA-1406-AR	Nut (wheel to carrier)	1928-29	螺絲帽(車輪連架)
A-21924-S7R	Lock nut (wheel to carrier)	1928-31	鎖螺絲帽(車輪連架)

Part No. Name of Part Year 貨名

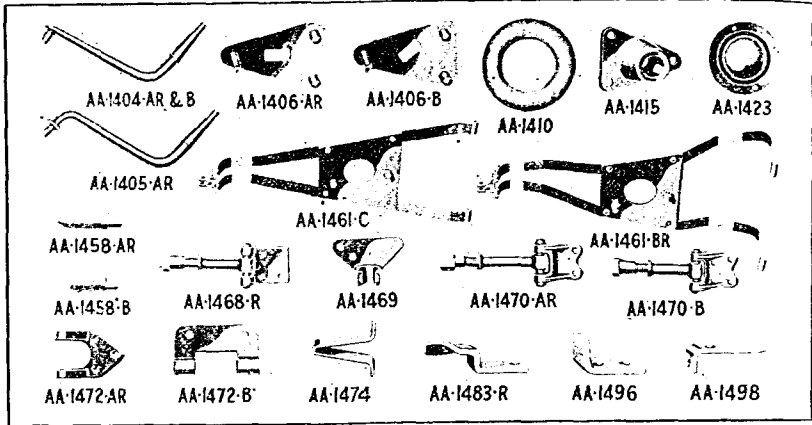

WHEEL CARRIER—REAR

Part No.	Name of Part	Year	貨名
AA-1404-B	Carrier support—85B	1930-31	輪架 旁架帶
A-21940	Nut	1931	螺絲帽
A-23552	Cotter	1931	銷針
A-22306	Washer	1931	隔片
xAA-1405-D	Carrier support—290A	1931	架帶
A-21940	Nut	1931	螺絲帽
A-23552	Cotter	1931	銷針
A-22306	Washer	1931	隔片
AA-1406-B	Carrier flange assembly—85B	1930-31	輪架緣邊捲成
AA-1410	Carrier support anti-rattler	1928-31	輪架帶消音片
xAA-1415	Carrier support bracket—85A, 85B, 89A and 290A	1928-31	輪架帶支架
A-21223	Bolt	1931	螺絲
A-21839-S1	Nut	1931	螺絲帽
A-23533	Cotter	1931	銷針
†AA-1416	Carrier support bracket—199A, 229A, 242A, 270A, 275A, 280A, 285A, 300A and Dump Trucks	1930-31	輪架帶支架
A-21223	Bolt	1931	螺絲
A-21839-S1	Nut	1931	螺絲帽
A-23533	Cotter	1931	銷針
†AA-1417	Carrier support—199A, 210A, 229A, 242A, 270A, 290A and 300A	1930-31	輪架帶
A-21940	Nut	1931	螺絲帽
A-23552	Cotter	1931	針銷
A-22306	Washer	1931	隔片
x*AA-1418	Carrier flange assembly—270A, 275A, 280A, 285A, 290A and 300A	1931	輪架緣邊捲成

Part No.	Name of Part	Year	貨名
AA-1423	Carrier support nut cover—85A, 85B, 89A, 199A, 210A, 229A, 270A, 290A, 300A and Dump Trucks	1931	輪架帶螺絲帽蓋
A-20413	Bolt	1931	螺絲
A-21632-S7	Nut	1931	螺絲帽
A-22139-S7	Lock washer	1931	鎖環
AA-1424	Carrier support—270A, 275A, 280A, 285A, 290A and 300A	1931	輪架帶
A-21940	Nut	1931	螺絲帽
A-23552	Cotter	1931	鎖針
A-22306	Washer	1931	隔片
AA-86557	Carrier strap—85B, 290A	1930-31	輪架搭條
AA-86556-B	Carrier strap plate (with bolt holes in line) 85B	1930-31	輪架搭條片
AA-86556-C	Carrier strap plate (with bolt holes staggered) 85B and 290A	1931	輪架搭條片
A-20537-S2	Bolt	1931	螺絲
A-21668-S2	Nut	1931	螺絲帽
A-22154	Washer	1931	隔片
A-22150-S1	Lock washer	1931	鎖環
AA-1120-B	Nut (wheel to carrier)	1930-31	螺絲帽(車輪連架)
AA-1431	Carrier flange—210A, 290A, 270A, 300A, 242A; 199A and 229A	1931	輪架緣邊
WHEEL CARRIER—REAR			輪架 後
AA-1443	Carrier strap assembly—185B, 195A, 197A and 330A	1931	輪架搭條
A-23442	Rivet (strap to front hinge)	1931	帽釘(搭條連前鉸)
AA-1458-AR	Spare wheel carrier pilot	1928-29	常備輪架螺絲
A-21922-A-S7R	Nut	1928-29	螺絲帽
AA-1458-B	Spare wheel carrier stud	1930-31	常備輪架螺絲
AA-1120-B	Nut	1930-31	螺絲帽
AA-1461-BR	Spare wheel carrier strap assembly	1928-29	常備輪架搭條總成
AA-1461-C	Carrier strap assembly—88A and 187A	1930-31	輪架搭條總成
A-23442	Rivet (strap to front hinge)	1930-31	
AA-1464	Carrier hinge—rear—195A	1931	輪架後鉸
A-20958-S2	Bolt (hinge to body)	1931	螺絲(鉸連車身)
A-21749-S2	Nut	1931	螺絲帽
A-22245-S2	Lockwasher	1931	鎖環
AA-1468-R	Spare wheel carrier rear hinge bolt and nut assembly—185A	1930	常備輪架鉸螺絲及螺絲帽總成
A-20725-S2	Bolt (floor cross sill No. 7 to spare wheel hinge rear—lower)	1930	螺絲(地板橫基第七條連常備輪架後鉸 下)
A-21705-S2	Nut	1930	螺絲帽
A-20828	Bolt (floor cross sill No. 7 to spare wheel hinge rear—upper)	1930	螺絲(地板橫基第七條連常備輪架後鉸 上)

*Fender—Steel spoke.

xSide—Steel spoke.

†Fender—Disc.

°Side—Disc.

Part No.	Name of Part	Year	貨名
A-22217-S2	Lock washer	1930-31	鎖環
AA-1460	Spare wheel carrier strap end—88A, 185A-B, 187A, 195A, 197A	1928-31	常備輪架搭背尾
A-23437	Rivet	1928-31	帽釘
AA-1470-AR	Spare wheel carrier rear hinge and bolt assembly—88A	1928-29	常備輪架後鉸及螺絲挽成
AA-1470-B	Carrier hinge—rear—88A, 185B, 187A, 197A and 330A	1930-31	輪架後鉸
A-23372	Rivet (hinge to body)	1930-31	帽釘(鉸連車身)
AA-1472-AR	Spare wheel carrier front hinge	1928-29	常備輪架前鉸
AA-1472-B	Carrier hinge—front—88A	1928-31	輪架前鉸
A-23372	Rivet (hinge to frame)	1931	帽釘(鉸連車身)
AA-1474	Carrier stop—88A and 187A	1928-31	輪架掣子
A-23368	Rivet	1928-29	帽釘
A-23381	Rivet	1930-31	帽釘
A-23372	Rivet (front hinge to frame)—185-A, 187-A	1928-31	帽釘(前鉸連框)
A-23442	Rivet (front hinge)	1928-31	帽釘(前鉸)
AA-1483-R	Spare wheel stop—R. H.—185-A	1930	常備車輪掣子 右
AA-1484-R	Spare wheel stop—L. H.—185-A	1930	常備車輪掣子 左
A-20812-S2	Bolt	1930-31	螺絲
A-21705-S2	Nut	1930-31	螺絲帽
A-22217-S2	Washer—330-A	1930-31	圓片
AA-1493	Carrier hinge—front—185B, 197A and 330A	1930-31	輪架前鉸
A-23372	Rivet (hinge to frame)	1930-31	帽釘(鉸連框)
AA-1495	Carrier hinge—front assembly—187A	1931	輪架前鉸總成
A-23372	Rivet (hinge to frame)	1930-31	帽釘(鉸連框)
AA-1120-B	Nut (wheel to carrier)	1931	螺絲帽(車輪連架)
AA-1496	Spare wheel stop center—185-B, 197-A and 330A	1931	常備車輪掣子中心
A-23371	Rivet (stop center to rear cross member)	1931	帽釘(掣子中心連後橫樑)
A-23389	Rivet (stop to frame)	1931	帽釘(掣子連框)
AA-1498	Spare wheel stop—side—P. P.—185B, 197A, 330A	1931	常備車輪掣子 旁 右
AA-1499	Spare wheel stop—side—L. H.—185B, 197A, 330A	1931	常備車輪掣子 旁 左
A-23372	Rivet (spare wheel carrier hinge to frame) A—185B and 187A	1931	帽釘(常備輪架鉸連框)

SERVICE BRAKE 車 掣

AA-2011	Front brake housing plate assembly	1930-31	前車掣殼護片總成
A-20919	Bolt	1928-29	螺絲
A-21244	Bolt	1930-31	螺絲
A-21839-S1	Nut	1930-31	螺絲帽
A-23531	Cotter	1930-31	鎖針
AA-2019	Brake shoe assembly	1928-31	車掣片總成
A-2023-A	Brake shoe roller	1928-31	車制片滑輪
A-23870-S7	Brake shoe pin	1928-31	車制片針

Part No.	Name of Part	Year	貨名
A-23551	Brake shoe pin cotter	1928-31	車制片鎖針
AA-2021	Brake lining	1928-31	車制襯帶
A-23100	Rivet— $7/16"$	1928-31	帽釘
A-23138	Rivet— $1/2"$	1931	帽釘
AA-2035	Brake retracting spring—short	1928-31	車制縮彈簧 短
AA-2036-B	Brake retracting spring—long	1928-31	車制縮彈簧 長
AA-2041	Brake adjusting wedge	1928-31	車制調節楔
AA-2042	Brake shoe link	1928-31	車制片連臂
AA-2051	Front brake operating wedge stud assembly	1930-31	前車制運用楔螺絲總成
A-21839-S1	Nut	1930-31	螺絲帽
A-23531	Cotter	1930-31	鎖針
A-2050	Front brake operating wedge	1930-31	前車制運用楔
A-22302-B	Wedge washer	1930-31	楔圓片
AA-2059-AR	Front brake grease baffle assembly	1928-29	前車制護油圍總成
AA-2059-B	Front brake grease baffle assembly	1930-31	前車制護油圍總成
A-2076-B	Front brake shaft—R. H.	1930-31	前車制軸 右
A-2077-B	Front brake shaft—L. H.	1930-31	前車制軸 左
A-24404-S7	Lubricator fitting	1930-31	注油嘴

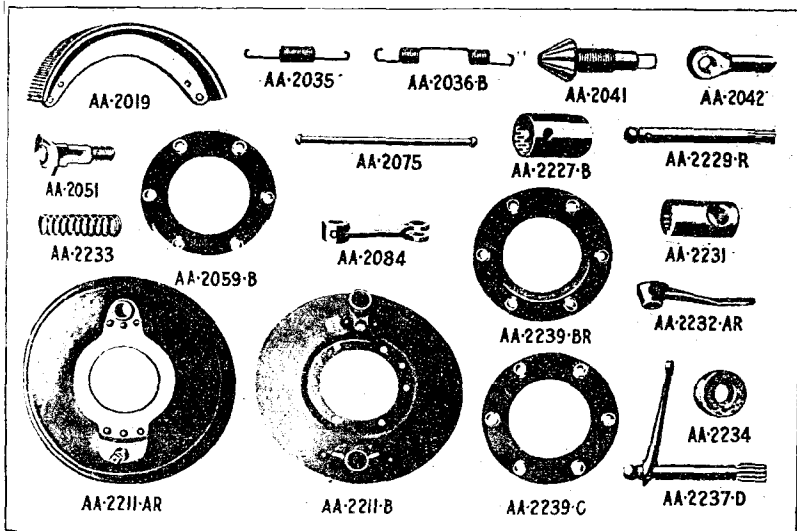

A-2078-C	Front brake shaft housing assembly	1930-31	管車制軸殼總成
A-21793-S1	Nut	1930-31	螺絲帽
A-22300	Washer	1930-31	圓片
A-2082	Front brake shaft housing bushing	1930-31	前車制殼套
AA-2075	Front brake operating pin	1930-31	前車制運用針
AA-2084	Front brake lever	1930-31	前車制桿

Part No.	Name of Part	Year	貨名
A-23766	Pin	1930-31	針
A-2087	Front brake lever dust ring	1930-31	前車制桿避塵環
AA-2211-AR	Rear brake housing plate assembly	1928-29	後車制殼護片總成
AA-2211-B	Rear brake housing plate assembly	1928-31	後車制殼護片總成
A-21139-R	Bolt	1928	螺絲
A-21153-S1	Bolt	1929-30	螺絲
A-21791-S3	Nut	1928-31	螺絲帽
A-23531	Cotter	1928-31	鎖針
AA-2227-B	Brake cam shaft bushing	1928-31	車制凸輪套
AA-2229-R	Rear brake cam shaft extension	1928-29	後車制伸長凸輪
A-2230	Rear brake cam	1928-31	後車制凸夾
AA-2231	Rear brake cam shaft	1928-31	後車制凸輪
A-24404-S7	Lubricator fitting	1930-31	注油嘴
AA-2232-AR	Rear brake cam shaft lever	1928-29	後車制凸輪桿
A-23825	Pin	1928-29	針
AA-2233	Rear brake cam shaft spring	1928-31	後車制凸輪彈簧
AA-2234	Rear brake cam shaft dust ring	1928-31	後車制凸輪避塵環
†AA-2237-C	Rear brake cam shaft extension—R. H.	1928-29	後車制伸長凸輪 右
AA-2237-D	Rear brake cam shaft extension—R. H.	1930-31	後車制伸長凸輪 右
†AA-2238-C	Rear brake cam shaft extension—L. H.	1928-29	後車制伸長凸輪 左
AA-2238-D	Rear brake cam shaft extension—L. H.	1930-31	後車制伸長凸輪 左
AA-2239-AR	Rear axle grease baffle assembly	1928-29	後輪軸護油圍總成
AA-2239-BR	Rear brake grease baffle assembly	1928-29	後車制護油圍總成
AA-2239-C	Rear axle grease baffle assembly	1930-31	後輪軸護油圍總成

SERVICE BRAKE CONTROL 車制運 用

AA-2455	Brake pedal	1930-31	車制踏板
†AA-2465-AR	Brake pedal to cross shaft rod— 15 ¹³ / ₁₆ "	1928-29	車制踏板連橫軸桿
AA-2465-B	Brake pedal to cross shaft rod— 25 ¹ / ₈ "	1930-31	車制踏板連橫軸桿
A-24407	Lubricator fitting		注油嘴
A-2461	Brake pedal to cross shaft brake rod clevis	1930-31	車制踏板連橫軸車制 桿U形鐵
A-21700	Nut	1930-31	螺絲帽
A-2465-B	Brake pedal to cross shaft rod	1930-31	車制踏板連橫軸桿
A-2457-R	Pin (brake pedal clevis)	1930-31	針(車制踏板U形鐵)
A-23555	Cotter	1930-31	鎖針

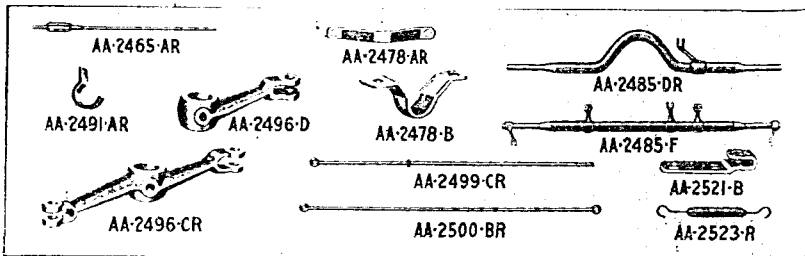

†Trucks with emergency brake.
‡Trucks without emergency brake.

Part No.	Name of Part	Year	貨名
A-23822-S7	.Pin (brake pedal to cross shaft rod)	1930-31	針(車制踏板連橫軸桿)
A-23553Cotter	1930-31	鎖針
AA-2465-C	..Brake pedal to cross shaft rod—50% —AA-157	1930-31	車制踏板連橫軸桿
A-2461Clevis	1930-31	U形鐵
A-21700Nut	1930-31	螺絲帽
AA-2478-AR	Brake cross shaft to frame bracket	1928-29	車制橫軸連框架
A-20705-S1Bolt	1928-29	螺絲
A-21702-S2Nut	1928-29	螺絲帽
A-22217Washer	1928-29	圓片
AA-2478-B	..Brake cross shaft to frame bracket— AA-157	1930-31	車制橫軸連框架
A-2478-BBrake cross shaft to frame bracket— AA-131	1930-31	車制橫軸連框架
A-20755Frame bolt—short	1930-31	框螺絲 短
A-20838Frame bolt—long	1930-31	框螺絲 長
A-21702-S2Nut	1930-31	螺絲帽
A-23515Cotter	1930-31	鎖針
AA-2479Brake cross shaft to frame shim—AA- 157	1930-31	車制橫軸連框片
A-2479-B	..Brake cross shaft frame bracket shim —AA-131	1930-31	車制橫軸框架片
AA-2485-CR	..Brake cross shaft assembly	1928-29	車制橫軸總成
AA-2485-DR	..Brake cross shaft assembly	1928-29	車制橫軸總成
AA-2485-F	..Brake shaft assembly	1930-31	車制軸總成
A-2477Brake cross shaft bushing	1930-31	車制橫軸套
AA-2491-AR	..Brake cross shaft guide	1928-29	車制橫軸片
A-20747-S2Bolt	1928-29	螺絲
A-21701-S2Nut	1928-29	螺絲帽
A-23516Cotter	1928-29	鎖針
AA-2496-CR	..Brake cross shaft end lever—R. H.	1928-29	車制橫軸尾桿 右
AA-2496-D	..Brake cross shaft to front brake lever	1930-31	車制橫軸連前車制桿
A-23830Pir	1930-31	針
AA-2497-CR	..Brake cross shaft end lever—L. H.	1928-29	車制橫軸尾桿 左
A-21700Nut (front brake rod)	1930-31	螺絲帽(前車制桿)
A-23822-S7	.Pin (brake rod cross shaft to axle clevis)	1930-31	針(車制桿橫軸連輪軸 U形鐵)
A-23555Cotter	1930-31	鎖針
AA-2499-CR	..Rear brake rod—rear—38"	1928-30	後車制桿 後
AA-2499-D	..Cross shaft to rear axle brake rod— 65 ⁵ / ₁₆ "	1930-31	橫軸連後輪軸車制桿
A-21700Nut	1930-31	螺絲帽
A-2461Clevis	1928-31	U形鐵
A-23822-S7	.Pin	1930-31	針
A-23550Cotter	1930-31	鎖針
A-2503Rear brake rod spring	1928-31	後車制桿彈簧
A-20705-S1Bolt	1928-31	螺絲
A-21702-S2Nut	1928-31	螺絲帽
A-22217Washer	1928-31	圓片
AA-2500-AR	..Rear brake rod—front—39 ¹ / ₂ "	1928-29	後車制桿 前

Part No.	Name of Part	Year	貨名
AA-2500-BR	Rear brake rod—front—38 $\frac{1}{2}$ "	1928-29	後車制桿 前
AA-2501	Cross shaft to front axle brake rod—61 $\frac{1}{2}$ "	1930-31	橫軸連前輪軸車制桿
A-2466	Cross shaft to front axle brake rod adjustable eye	1930-31	橫軸連前輪軸車制桿調節孔
AA-2511	Cross shaft to rocker arm brake rod—25 $\frac{7}{16}$ "—AA-157	1930-31	橫軸連搖動臂車制桿
AA-2521-B	Front brake rocker arm—AA-157	1930-31	前車制搖動臂
AA-2522-B	Bolt	1930-31	螺絲
A-22369	Washer	1930-31	隔片
A-21789	Nut	1930-31	螺絲帽
A-23531	Cotter	1930-31	鎖針
A-23828-S7	Pin	1930-31	針
A-23555	Cotter	1930-31	鎖針
AA-2521-B	Rear brake rocker arm	1928-29	後車制桿動臂
AA-2522-AR	Rear brake rocker arm bolt	1928-29	後車制桿動螺絲
AA-2522-B	Rear brake rocker arm bolt	1928-29	後車制桿動螺絲
A-21789	Nut	1928-29	螺絲帽
A-22369-R	Washer	1928-31	隔片
A-23531	Cotter	1928-31	鎖針
A-23828-S7	Pin	1928-29	針
A-23555	Cotter	1928-31	鎖針
AA-2523-R	Rear brake rocker arm retracting spring	1928-29	後車制搖動臂縮彈簧

†Trucks without emergency brake.

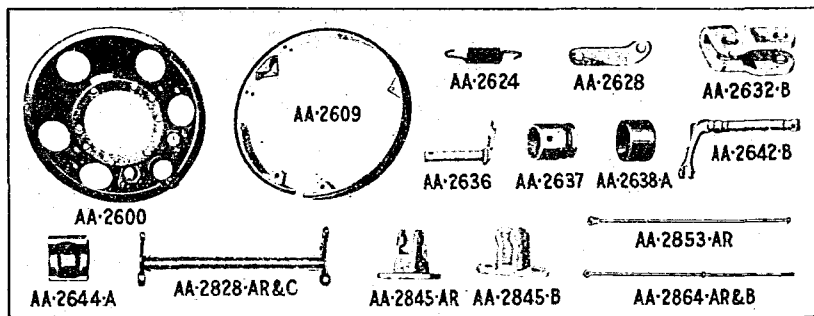

EMERGENCY BRAKE 意外停車掣

AA-2600	Emergency brake carrier plate assembly—R. H.	1928-31	意外車掣架片總成 右
AA-2601	Emergency brake carrier plate assembly—L. H.	1928-31	意外車掣架片總成 左
AA-2609	Emergency brake band and lining assembly	1928-31	意外車掣綱圈及襯帶總成
AA-2620	Emergency brake band lining	1928-31	意外車掣綱圈襯帶
A-23100	Rivet	1928-31	帽釘

Part No.	Name of Part	Year	貨名
AA-2624	Emergency brake band and lever re-tracting spring	1928-31	意外車制棚圈及桿縮環
AA-2628	Emergency brake toggle link	1928-31	意外車制肘節鎖環
A-23846-S7	Pin	1928-31	針
A-23534	Cotter	1928-31	鎖針
AA-2632-B	Emergency brake toggle connecting link	1928-31	意外車制肘節連環
AA-2636	Emergency brake toggle lever	1928-31	意外車制肘節槓桿
A-23829-S8	Pin (emergency brake lever sleeve)	1928-31	針 (意外車制桿套筒)
A-23534	Cotter	1928-31	鎖針
AA-2637	Emergency brake toggle lever connection	1928-31	意外車制肘節桿接連
A-23845-S7	Pin	1928-31	針
A-23534	Cotter	1928-31	鎖針
AA-2638-A	Emergency brake toggle lever bushing	1928-31	意外車制肘節桿套
AA-2642-B	Emergency brake lever	1928-31	意外車制桿
AA-2644-A	Emergency brake lever bushing	1928-31	意外車制桿套

EMERGENCY BRAKE CONTROL 意外車制運用

AA-2828-AR	Emergency brake cross shaft assembly	1928-29	意外車制橫軸總成
AA-2828-C	Emergency brake cross shaft assembly	1930-31	意外車制橫軸總成
A-23890	Pin	1928-31	針
A-23533	Cotter	1928-31	鎖針
AA-2845-AR	Emergency brake cross shaft bracket	1928-29	意外車制橫軸架
AA-2845-B	Emergency brake cross shaft bracket	1930-31	意外車制橫軸架
A-20936	Bolt	1928-31	螺絲
A-21745	Nut	1928-31	螺絲帽
A-23534	Cotter	1928-31	鎖針
AA-2853-AR	Emergency brake lever to cross shaft rod—29 $\frac{11}{16}$ "	1928-29	意外車制桿連橫軸桿
AA-2853-CR	Emergency brake lever to cross shaft rod—28"	1929	意外車制桿連橫軸桿
AA-2853-DR	Emergency brake lever to cross shaft rod—28 $\frac{3}{4}$ "	1929	意外車制桿連橫軸桿
AA-2853-G	Emergency brake lever to cross shaft rod—24 $\frac{1}{4}$ "	1930	意外車制桿連橫軸桿
AA-2853-H	Emergency brake lever to cross shaft rod—49 $\frac{3}{4}$ "—AA-157	1930	意外車制桿連橫軸桿
A-23827-S8	Pin	1930-31	針
A-23555	Cotter	1930-31	鎖針
AA-2864-AR	Emergency brake cross shaft to rear axle rod—59 $\frac{3}{4}$ "	1928-29	意外車制橫軸連後輪軸桿
AA-2864-B	Emergency brake cross shaft to rear axle rod—63 $\frac{3}{4}$ "	1930-31	意外車制橫軸連後輪軸桿
A-2461	Clevis	1928-31	U形鐵
A-23555	Cotter	1928-31	鎖針
A-21700	Nut	1928-31	螺絲帽
AA-4906-A	Emergency brake cross shaft bushing	1928-29	意外車制橫軸套
A-23822-S7	Pin	1928-31	針
A-2866	Emergency brake rod spring	1928-31	意外車制桿彈簧

Part No.	Name of Part	Year	貨名
A-20705-S1	Bolt	1928-31	螺絲
A-21702-S2	Nut	1928-31	螺絲帽
A-22217	Washer	1928-31	圈片
FRONT AXLE 前輪軸			
AA-3010	Front axle	1930-31	前輪軸
AA-3030-AR	Front spring perch	1928-29	前彈簧架
AA-3030-B	Front spring perch	1930-31	前彈簧架
A-23550	Cotter	1930-31	鎖針
A-21893	Nut	1930-31	螺絲帽
A-4020	Front spring perch bushing	1930-31	前彈簧架套
AA-3105-AR	Spindle assembly	1928-29	樞紐軸總成
AA-3105-B	Spindle assembly	1930-31	樞紐軸總成
AA-3109	Spindle bushing	1930-31	樞紐軸套
A-21943	Spindle nut	1930-31	樞紐軸螺絲帽
AA-3115-A	Spindle bolt—R. H.	1930-31	樞紐軸螺絲 右
AA-3116-A	Spindle bolt—L. H.	1930-31	樞紐軸螺絲 左
AA-3122-R	Spindle bolt locking pin	1928-29	樞紐軸螺絲鎖針
A-3122-C	Spindle bolt locking pin	1930-31	樞紐軸螺絲鎖針
A-21793-S1	Nut	1930-31	螺絲帽
A-22300	Washer	1930-31	圈片
AA-3123	Spindle bolt bearing assembly	1930-31	樞紐軸螺絲滑滾總成
AA-3124-R	Spindle bolt locking pin nut	1929	樞紐軸螺絲鎖針螺絲帽
AA-3130	Spindle arm—R. H.	1930-31	樞紐軸臂 右
AA-3131	Spindle arm—L. H.	1930-31	樞紐軸臂 左
A-21927	Nut	1930-31	螺絲帽
A-23552	Cotter	1930-31	鎖針
AA-3281	Spindle connecting rod tube	1928-31	樞紐軸接連桿管
A-3285	Spindle connecting rod end—R. H.	1930-31	樞紐軸接連桿夾 右
A-3286	Spindle connecting rod end—L. H.	1930-31	樞紐軸接連桿夾 左
A-20919	Bolt (spindle connecting rod adjusting end clamp)	1930-31	螺絲 (樞紐軸接連桿調節尼夾)
A-21745	Nut	1930-31	螺絲帽
A-23531	Cotter	1930-31	鎖針
AA-3405-B	Front radius rod	1930-31	前牛徑桿

REAR AXLE—WORM TYPE 後輪軸蝸齒式

†AA-4000-AR	Rear axle and drive shaft assembly— 7.25—1	1928-29	後輪軸及總槓總成
†AA-4000-BR	Rear axle and drive shaft assembly— 5.17—1	1928-29	後輪軸及總槓總成
‡AA-4000-ER	Rear axle and drive shaft assembly— 7.25—1	1928-29	後輪軸及總槓總成
‡AA-4000-FR	Rear axle and drive shaft assembly— 5.17—1	1928-29	後輪軸及總槓總成
†AA-4014-AR	Rear axle housing—R. H. and L. H.	1928	後輪軸殼 右及左

*When replacing previous type replace both levers.

**With four-speed transmission.

Part No.	Name of Part	Year	名貨
AA-4014-BR	Rear axle housing—R. H. and L. H.	1928-29	後輪軸殼 右及左
A-24452	Oil plug	1928-29	放油塞
A-24408	Lubricator fitting	1928-29	注油嘴
AA-4035-AR	Rear axle housing gasket—lower (same as TT-1009)	1928-29	後輪軸殼墊 下
AA-4036-R	Rear axle housing gasket—upper (same as TT-1008)	1928-29	後輪軸殼墊 上
A-21137	Bolt	1928-29	螺絲
A-21791-S3	Nut	1928-29	螺絲帽
A-23551	Cotter	1928-29	鎖針
A-21222-R	Rear axle housing cap (same as TT-1004)	1928-29	後輪軸殼帽
A-21222-R	Screw	1928-29	螺絲
A-24466	Plug	1928-29	塞
AA-4191-R	Rear axle housing cap gasket (same as TT-1005)	1928-29	後輪軸殼絲墊
AA-4205-AR	Differential gear case (same as TT-1028-B)	1928-29	分速齒輪殼
A-21137	Bolt	1928-29	螺絲
A-21791-S3	Nut	1928-29	螺絲帽
A-23531	Cotter	1928-29	鎖針
AA-4210-AR	Worm gear—7.25—1	1928-29	蟲齒輪
AA-4210-BR	Worm gear—5.17—1	1928-29	蟲齒輪
AA-4211-AR	Differential spider (same as TT-1033-B)	1928-29	分速齒輪架
AA-4215-AR	Differential pinion (same as TT-1032)	1928-29	分速小齒輪
AA-4221-AR	Differential bearing cone assembly	1928-29	分速齒輪錐形滑滾總成
AA-4222-BR	Differential bearing cup	1928-29	分速滑滾套
AA-4235-BR	Rear axle shaft	1928-29	後輪軸槓
A-21941	Nut	1928-29	螺絲帽
A-22421-R	Washer	1928-29	隔片
A-23566	Cotter	1928-29	鎖針
AA-4235-CR	Rear axle shaft	1928-29	後輪軸槓
TT-1027	Differential gear	1928-29	分速齒輪
TT-1031	Rear axle differential gear lock ring	1928-29	後輪軸分速齒輪鎖環
AA-4243-AR	Rear hub key	1928-29	後輪心鍵
AA-4245-AR	Rear axle shaft outer grease retainer assembly	1928-29	後輪軸槓外護油圈總成
AA-4505-BR	Torque tube	1928-29	總軸殼
A-21222-R	Screw	1928-29	螺絲
A-24405	Lubricator fitting	1928-29	注油嘴
A-4513-A	Universal joint housing cap—inner	1928-29	總關節殼帽 內
A-4520-BR	Universal joint housing cap—outer front	1928-29	總關節殼帽 外前
A-4520-C	Universal joint housing cap—outer rear	1928-29	總關節殼帽 外後
AA-4521-AR	Universal joint housing cap shim	1928-29	總關節殼帽片
A-4515-A	Universal joint housing inner cap gasket	1928-29	總關節殼內帽墊

*With emergency brakes.

†Without emergency brakes.

Part No. Name of Part Year 貨名

A-4516 Universal joint housing cap felt 1928-29 鐘關節殼帽絨
 A-20905 Bolt (universal joint housing cap) ... 1928-29 螺絲(鐘關節殼帽)
 A-21741-S8 .Nut 1928-29 螺絲帽

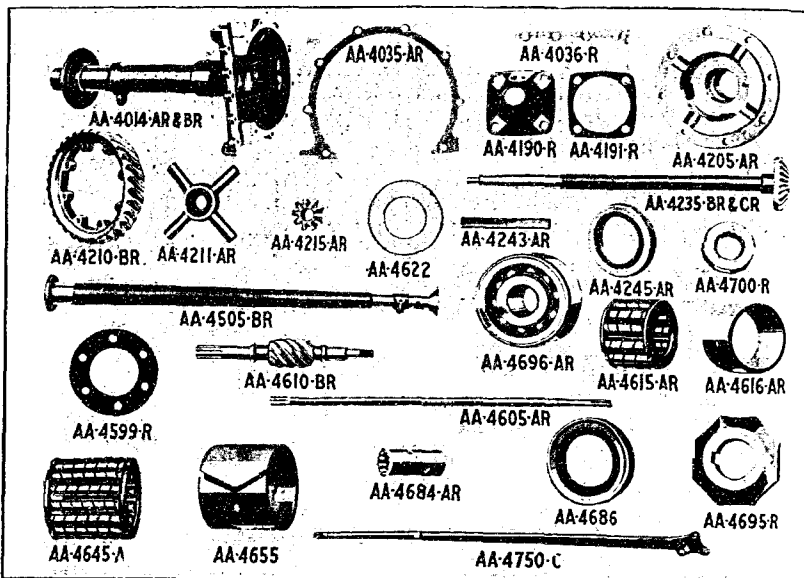

A-22245 Lock washer 1928-29 鎖環
 A-20931 Bolt (cap to transmission) 1928-29 螺絲(箱速傳力機)
 A-21745 Nut 1928-29 螺絲帽
 A-23534 Cotter 1928-29 鎖針
 A-20907 Bolt (cap coupling shaft rear support) 1928-29 (箱接軸後架)
 A-21745 Nut 1928-29 螺絲帽
 A-23534 Cotter 1928-29 鎖針
 AA-4599-R ... Torque tube flange gasket (same as TT-1037) 1928-29 鐘軸殼緣邊墊
 AA-4605-AR .. Drive shaft 1928-29 總槓
 AA-4610-AR .. Worm—7.25—1 1928-29 齒齒輪
 AA-4610-BR .. Worm—5.17—1 1928-29 齒齒輪
 AA-4615-AR .. Worm roller bearing assembly (same as TT-1046) 1928-29 齒齒輪槓子滑滾總成
 AA-4616-AR .. Worm roller bearing sleeve..... (same as TT-1048) 1928-29 齒齒輪槓子滑滾套管
 AA-4622-R ... Worm roller bearing retainer—front .. 1928-29 齒齒輪槓子滑滾隔片
 AA-4645-A ... Drive shaft roller bearing 1928-29 總槓槓子滑滾
 AA-4655 Drive shaft roller bearing sleeve 1928-29 總槓槓子滑滾套管

Part No.	Name of Part	Year	名貨
AA-4684-AR	..Drive shaft coupling (same as L-3403)	1928-29	總槓兩筒
A-23861-R	..Pin—short	1928-29	針 短
A-23860-R	..Pin	1928-29	針
A-2224S	...Washer	1928-29	圈片
A-23534	...Cotter	1928-29	鎖針
AA-4686	...Drive shaft grease retainer assembly	1928-29	總槓護油圈總成
AA-4695-R	...Worm thrust bearing retainer (same as TT-1053)	1928-29	蟲齒輪推進滑滾片
A-21941	...Nut	1928-29	螺絲帽
A-23566	...Cotter	1928-29	鎖針
A-23767-R	..Pin	1928-29	針
AA-4696-AR	..Worm thrust bearing assembly	1928-29	蟲齒輪推進滑滾總成
AA-4700-R	...Worm grease retainer assembly	1928-29	蟲齒輪護油圈總成
AA-4750-C	...Rear radius rod assembly—R. H.	1928-29	後半徑桿總成 右
AA-4751-C	...Rear radius rod assembly—L. H.	1928-29	後半徑桿總成 左
A-24404	...Lubricator fitting	1928-29	注油嘴
A-21300	...Bolt—front	1928-29	螺絲 前
A-21891	...Nut	1928-29	螺絲帽
A-23533	...Cotter	1928-29	鎖針
A-21301	...Bolt—rear	1928-29	螺絲 後
A-21891	...Nut	1928-29	螺絲帽
A-23550	...Cotter	1928-29	鎖針

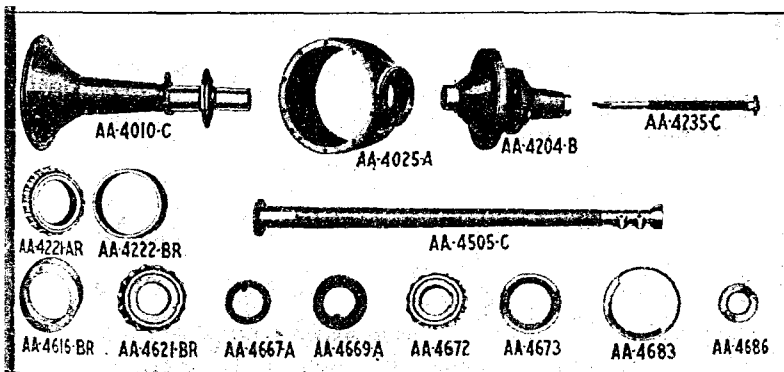

REAR AXLE—BEVEL GEAR TYPE—1928-29 後輪輪 斜面齒輪式

AA-4010-C	...Rear axle housing	1928-29	後輪輪殼
A-21162	...Bolt	1928-29	螺絲
A-24457	...Oil plug	1928-29	放油塞
A-24408	...Lubricator fitting	1928-29	注油嘴
AA-4025-A	...Rear axle differential housing	1928-29	後輪輪分速殼
AA-4035-B	...Rear axle housing gasket	1928-29	後輪輪殼墊
AA-1204-B	...Differential case assembly—malleable.	1928-29	分速殼總成

Part No.	Name of Part	Year	名貨
A-21145-R	Bolt	1928-29	螺絲
A-21791-S3	Nut	1928-29	螺絲帽
AA-4209-A	Driving gear and drive shaft (matched) (7.16—1)	1928-29	驅動齒輪及總槓
AA-4209-B	Driving gear and drive shaft (matched) (5.11—1)	1928-29	驅動齒輪及總槓
†A-21238-R	Bolt (driving gear)	1928-29	螺絲(驅動齒輪)
†A-21842-R	Nut	1928-29	螺絲帽
†A-23531	Cotter	1928-29	鎖針
AA-4211	Differential spider	1928-29	分速齒輪架
AA-4215-AR	Differential pinion	1928-29	分速小齒輪
AA-4221-AR	Differential bearing cone assembly	1928-29	分速錐形滑滾總成
AA-4222BR	Differential bearing cup	1928-29	分內滑滾套
AA-4235-CR	Rear axle shaft	1928-29	後輪軸槓
A-21941	Nut	1928-29	螺絲帽
A-23566	Cotter	1928-29	鎖針
AA-4243-AR	Rear hub key	1928-29	後輪心鍵
AA-4245-AR	Rear axle shaft grease retainer	1928-29	後輪軸預識油圈
AA-4505-C	Torque tube	1928-29	總軸殼
A-21277	Screw	1928-29	螺絲
A-24405	Lubricator fitting	1928-29	注油嘴
A-4513-A	Universal joint housing cap—inner— rear	1928-29	總關節殼帽 內 後
A-4515-A	Universal joint housing cap gasket— rear	1928-29	總關節殼帽墊 後
A-4520-C	Universal joint housing cap—outer— rear assy.	1928-29	總關節殼帽總成 外 後
AA-4521-R	Universal joint housing cap shim	1928-29	總關節殼帽片
A-4516	Universal joint housing cap felt	1928-29	總關節殼帽絨
A-20905	Bolt (universal joint housing cap)	1928-29	螺絲(總關節殼帽)
A-21741-S8	Nut	1928-29	螺絲帽
A-22245	Lock washer	1928-29	鎖環
A-30953	Bolt (cap to transmission)	1928-29	螺絲(帽連傳力機)
A-21745	Nut	1928-29	螺絲帽
A-23534	Cotter	1928-29	鎖針
A-20907	Bolt (sap to coupling shaft rear sup- port)	1928-29	螺絲(帽連接輪後架)
A-21745	Nut	1928-29	螺絲帽
A-23534	Cotter	1928-29	鎖針
A-23906-R	Driving pinion key	1928-29	驅動小齒輪鍵
AA-4616-BR	Driving pinion bearing cup	1928-29	驅動小齒輪滑滾套
AA-4621-BR	Driving pinion bearing cone assembly	1928-29	驅動小齒輪錐形滑滾總成
AA-4645-A	Drive shaft front bearing	1928-29	總槓前滑滾
AA-4655	Drive shaft front bearing sleeve	1928-29	總槓前滑滾套管
AA-4667-A	Drive shaft rear bearing adjusting nut washer	1928-29	總槓後滑滾調節螺絲帽 圈片
AA-4669-A	Drive shaft rear bearing nut retainer	1928-29	總槓後滑滾螺絲帽圈片
A-21952	Drive shaft rear bearing nut retaining nut	1928-29	總槓後滑滾螺絲帽鎖 絲帽
AA-4672	Drive shaft rear bearing cone assembly	1928-29	總槓後錐形滑滾總成

Part No.	Name of Part	Year	貨名
AA-4673	Drive shaft rear bearing cup	1928-29	驅動軸後滑滾套
AA-4683	Driving pinion oil baffle	1928-29	驅動小齒輪護油片
AA-4686	Drive shaft grease retainer assembly	1928-29	總槓護油網總成
AA-4750-C	Rear radius rod assembly—R. H.	1928-29	後半徑桿總成 右

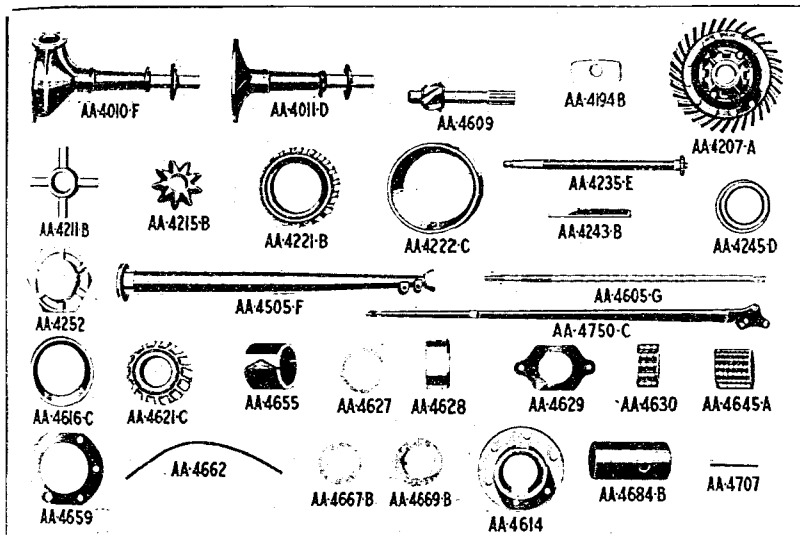

AA-4751-C	Rear radius rod assembly—L. H.	1928-29	後半徑桿總成 左
A-21300	Bolt—front	1928-29	螺絲 前
A-21301	Bolt—rear	1928-29	螺絲 後
A-21891	Nut	1928-29	螺絲帽
A-23553	Cotter	1928-29	鎖針
A-24404-S7	Lubricator fitting	1928-29	注油嘴

REAR AXLE—BEVEL GEAR TYPE—1930-31 後輪軸—斜齒輪式

AA-4000-K	Rear axle and drive shaft assembly (6.6-1)	1930-31	後輪軸及總槓總成
AA-4010-F	Rear axle housing assembly—R. H.	1930-31	後輪軸殼總成 右
AA-4011-D	Rear axle housing assembly—L. H.	1930-31	後輪軸殼總成 左
A-24452	Drain plug	1930-31	沖油塞
A-24452	Filler plug	1930-31	注油塞
A-21133-S1	Bolt	1930-31	螺絲
A-21793-S1	Nut	1930-31	螺絲帽
A-22300	Washer	1930-31	隔片
AA-4035-D	Rear axle housing gasket	1930-31	後輪軸殼墊
AA-4189	Driving gear thrust block pin	1930-31	驅動齒輪推進座針

Part No.	Name of Part	Year	貨名
AA-4194-B	Driving gear thrust block	1930-31	驅動齒輪推進座
†AA-4207-A	Differential gear case and driving gear assembly (6.6-1)	1930-31	分速齒輪殼及驅動齒輪總成
†AA-4207-B	Differential gear case and driving gear assembly—5.14-1	1930-31	分速齒輪殼及驅動齒輪總成
A-21168	Screw	1930-31	螺絲
AA-4211-B	Differential spider	1930-31	分速齒輪架
AA-4215-B	Differential pinion	1930-31	分速小齒輪
AA-4221-B	Differential bearing cone and roller assembly	1930-31	分速錐形及輓子滾滾棧成
AA-4222-C	Differential bearing cup	1930-31	分速滑滾套
AA-4235-E	Rear axle shaft	1930-31	後輪軸槓
A-23566	Cotter	1930-31	鎖針
AA-4243-B	Rear axle shaft key	1930-31	後輪軸槓鍵
AA-4245-D	Housing grease retainer assembly	1930-31	殼護油圈總成
AA-4252	Rear axle shaft nut	1930-31	後輪軸槓螺絲帽
AA-4505-F	Torque tube assembly	1930-31	總輪殼總成
A-24409	Lubricator fitting	1930-31	注油嘴
A-24461	Plug	1930-31	塞
A-21279	Screw	1930-31	螺絲
A-22355-S1	Lock washer	1930-31	鎖環
A-4513-A	Universal joint housing cap—inner	1930-31	總關節殼帽 內
A-4520-C	Universal joint housing cap—outer assembly	1930-31	總關節殼帽 外總成
A-4516	Universal joint housing cap felt	1930-31	總關節殼帽絨
A-4515-A	Universal joint housing gasket	1930-21	總關節殼墊
A-20963	Bolt (universal joint housing cap)—rear	1930-31	螺絲(總關節殼帽) 後
A-20907	Bolt (cap to coupling shaft)	1930-31	螺絲(新連接軸)
A-23534	Cotter	1930-31	鎖針
A-21745	Nut	1930-31	螺絲帽
AA-4605-G	Drive shaft	1930-31	總槓
AA-4609-A	Driving pinion and pilot bearing race assembly	1930-31	驅動小齒輪及滑滾槽棧成
AA-4609-B	Driving pinion and pilot bearing race assembly—5.14—1	1930-31	驅動小齒輪及滑滾槽棧成
AA-4614	Driving pinion bearing sleeve and bearing cups assembly	1930-31	
AA-4616-C	Driving pinion bearing cup	1930-31	驅動小齒輪滑滾套
AA-4621-C	Driving pinion bearing cone and roller assembly	1930-31	驅動小齒輪錐形及輓子滑滾棧成
AA-4626	Driving pinion pilot bearing inner race	1930-31	驅動小齒輪滑滾內槽
AA-4627	Driving pinion pilot bearing locking ring	1930-31	驅動小齒輪滑滾鎖環
AA-4628	Driving pinion pilot bearing outer race	1930-31	驅動小齒輪滑滾外槽
AA-4629	Driving pinion pilot bearing retainer	1930-31	驅動小齒輪滑滾圈片
A-23293	Rivet	1930-31	帽釘

†Includes both right and left halves of case.

Part No.	Name of Part	Year	貨名
AA-4630	Driving pinion pilot bearing roller assembly	1930-31	驅動小齒輪輦子滑滾總成
AA-4645-A	Drive shaft bearing assembly—front	1930-31	總槓滑滾總成 前
AA-4655	Driving shaft roller bearing sleeve—front	1930-31	驅動槓輦子滑滾套管 前
AA-4659	Driving pinion bearing sleeve shim (.005")	1930-31	驅動小齒輪滑滾套管片
AA-4661	Pinion bearing sleeve shim (.060")	1930-31	小齒輪滑滾套管片
AA-4662	Driving pinion bearing sleeve gasket	1930-31	驅動小齒輪滑滾套管墊
AA-4664	Pinion bearing sleeve shim (.070")	1930-31	小齒輪滑滾套管片
AA-4667-B	Driving pinion bearing thrust washer	1930-31	驅動小齒輪滑滾推進圓片
AA-4669-B	Driving pinion bearing nut retainer	1930-31	驅動小齒輪滑滾螺絲帽片
AA-4669-C	Driving pinion bearing nut retainer—use with driving pinion with 1/4" keyway	1931	驅動小齒輪滑滾螺絲帽片
AA-4684-B	Drive shaft coupling	1930-31	總槓聯筒
A-21956	Nut (driving pinion bearing)	1930-31	螺絲帽 (驅動小齒輪滑滾)
AA-4686	Drive shaft grease retainer assembly	1930-31	總槓護油圈總成
AA-4707	Drive shaft coupling pin	1930-31	總槓連針
AA-4750-C	Rear radius rod assembly—R. H.	1930-31	後半徑桿總成 右
AA-4751-C	Rear radius rod assembly—L. H.	1930-31	後半徑桿總成 左
A-24404-S7	Lubricator fitting	1930-31	注油嘴
A-21300	Bolt—front	1930-31	螺絲 前
A-21891	Nut	1930-31	螺絲帽
A-23533	Cotter	1930-31	鎖針
A-21301	Bolt—rear	1930-31	螺絲 後
A-21891	Nut	1930-31	螺絲帽
A-23533	Cotter	1930-31	鎖針
AA-4773	Rear radius rod bolt nut—rear upper—270A, 275A, 280A, 330A		後半徑桿螺絲帽 後上

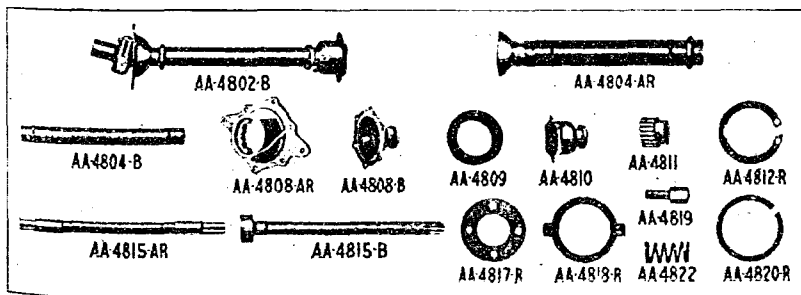

Do not use sleeve with one 1/4" hole to replace sleeve with two 5/16" holes.

Part No.	Name of Part	Year	貨名
----------	--------------	------	----

COUPLING SHAFT 接軸

AA-4802-B	Coupling shaft and housing assembly	1929-31	接軸及殼總成
AA-4802-C	Coupling shaft assembly—AA-157	1930-31	接軸總成
AA-4804-AR	Coupling shaft housing	1928-29	接軸殼
A-22438	Felt washer	1928-29	絨圈片
AA-4804-B	Coupling shaft housing	1929-31	接軸殼
AA-4804-C	Coupling shaft housing—AA-157	1930-31	接軸殼
AA-4808-AR	Coupling shaft rear support	1928-29	接軸後架
A-21223	Bolt	1928-29	螺絲
A-21839-S1	Nut	1928-29	螺絲帽
A-23534	Cotter	1928-29	鎖針
A-22337	Washer	1928-29	圈片
AA-4808-B	Coupling shaft housing rear support	1929-31	接軸殼後架
A-20963	Bolt	1929-31	螺絲
A-21745	Nut	1929-31	螺絲帽
A-23534	Cotter	1929-31	鎖針
AA-4809	Coupling shaft housing packing	1929-31	接軸殼蓋
AA-4810	Coupling shaft housing front support	1929-31	接軸殼前架
A-20718	Bolt	1929-31	螺絲
A-22217	Washer	1929-31	圈片
A-24405	Lubricator fitting	1929-31	注油嘴
AA-4811	Coupling shaft male gear	1929-31	接軸陽齒輪
AA-7095	Coupling shaft male gear retainer	1929-31	接軸陽齒輪殼
A-22245	Coupling shaft male gear washer	1929-31	接軸陽齒輪圈片
AA-4645-A	Coupling shaft roller bearing	1928-29	接軸轆子滾滾
A-22439-R	Washer	1928-29	圈片
AA-4655	Coupling shaft roller bearing sleeve	1928-29	接軸轆滾滾滾套管
AA-4812-R	Coupling shaft bearing retainer	1928-29	接軸滾滾殼
AA-4815-AR	Coupling shaft	1928-29	接軸
AA-4815-B	Coupling shaft	1929-31	接軸
AA-4815-C	Coupling shaft—AA-157	1930-31	接軸
AA-4817-R	Coupling shaft revolving thrust washer	1928-29	接軸旋轉壓力圈片
AA-4818-R	Coupling shaft stationary thrust washer	1928-29	接軸固定壓力圈片
AA-4819-R	Coupling shaft locating screw	1929-31	接軸螺絲
A-22300	Washer	1929-31	圈片
AA-4820-R	Coupling shaft thrust washer lock ring	1928-29	接軸壓力圈片鎖環
AA-4822	Coupling shaft thrust spring	1929-31	接軸壓力彈簧
AA-4826	Coupling shaft male gear screw	1929-31	接軸陽齒輪螺絲

DUAL HIGH 高複機

AA-4830-BR	Dual high front housing assembly	1928-29	高複前殼總成
AA-4830-CR	Dual high front housing	1928-29	高複前殼
A-6730-AR	Drain plug	1928	沖油塞

Part No.	Name of Part	Year	貨名
A-24457	Drain plug	1929	沖油塞
A-22424	Dual high front housing drain plug gasket	1928-29	高複前殼沖油塞墊
A-24461	Plug		塞
AA-4835-AR	Dual high rear housing	1928-29	高複後殼
AA-4835-BR	Dual high rear housing	1928-29	高複後殼
A-20904	Screw	1928-29	螺絲
A-22245	Washer	1928-29	圓片
A-22438	Felt washer	1928-29	絨圓片
AA-4837-BR	Dual high oil filler	1928-29	高複注油嘴
AA-4838-R	Dual high power take off cover	1928-29	高複去力機蓋
A-22330	Washer	1928-29	圓片
A-21220	Screw	1928-29	螺絲
AA-4839-R	Dual high power take off cover gasket	1928-29	高複去力機蓋墊
AA-4840-AR	Dual high housing gasket	1928-29	高複殼墊
AA-4840-BR	Dual high housing gasket	1928-29	高複殼墊
AA-4841-AR	Dual high oil filler plug	1928-29	高複注油塞
AA-4841-BR	Dual high oil filler plug	1928-29	高複注油塞
A-22424	Dual high oil filler plug gasket	1928-29	高複注油塞墊
AA-4808-AR	Dual high rear support	1928-29	高複後架
A-21223	Bolt	1928-29	螺絲
A-21839-S1	Nut	1928-29	螺絲帽
A-23531	Cotter	1928-29	鎖針
A-22337	Washer	1928-29	圓片
AA-4842-R	Dual high clutch—stationary	1928-29	高複傳力盒 固定式
AA-4843-R	Dual high rear spacing washer	1928-29	高複後隔片
AA-4844-R	Dual high oil level indicator	1928-29	高複指油表
AA-4848-R	Dual high driven shaft	1928-29	高複被驅軸
AA-4849-R	Dual high grease retainer sleeve	1928-29	高複護油圈套管
AA-4686	Dual high grease retainer assembly	1928-29	高複護油圈總成
AA-4851-R	Dual high planet carrier	1928-29	高複行星架
AA-4853-R	Dual high planet gear assembly	1928-29	高複行星齒輪總成
AA-4855-R	Dual high planet gear bushing	1928-29	高複行星齒輪套
AA-4856-R	Dual high planet gear pin	1928-29	高複行星齒輪針
AA-4857-R	Dual high planet gear pin retainer	1928-29	高複行星齒輪針管頭
AA-4862-R	Dual high internal gear and bushing assembly	1928-29	高複內齒輪及套總成
AA-4864-AR	Dual high internal gear bushing	1928-29	高複內齒輪套
AA-4870-AR	Dual high power take off gear	1928-29	高複去力機齒輪
AA-4870-BR	Dual high power take off driving gear	1928-29	高複去力機驅動齒輪
A-21951-R	Nut	1928-29	螺絲帽
A-23907	Key	1928-29	鍵
AA-4871-R	Dual high power take off nut lock	1928-29	高複去力機螺絲帽鎖
AA-4876-R	Dual high sun gear assembly	1928-29	高複太陽齒輪總成
AA-4878-AR	Dual high sun gear bushing	1928-29	高複太陽齒輪套
AA-4883-AR	Dual high sliding clutch	1928-29	高複滑動力盒
AA-4883-BR	Dual high sliding clutch	1928-29	高複滑動力盒
AA-4887-R	Dual high shifter yoke assembly	1928-29	高複更換齒輪叉總成

Part No.	Name of Part	Year	貨名
A-7233-A	Dual high shifter yoke plunger	1928-29	高複更換齒輪叉鎖柱
A-7234	Dual high shifter yoke plunger spring	1928-29	高複更換齒輪叉鎖柱彈簧
AA-4888-BR	Dual high shifter yoke	1928-29	高複更換齒輪叉
A-21156-R	Lock screw	1928-29	鎖螺絲
AA-4889-BR	Dual high shifter yoke shoe	1928-29	高複更換齒輪叉襯套
AA-4890-AR	Dual high shifter shaft	1928-29	高複更換齒輪軸
AA-4890-BR	Dual high shifter shaft	1928-29	高複更換齒輪軸
AA-4890-CR	Dual high shifter shaft	1928-29	高複更換齒輪軸
A-23826-R	Pin	1928-29	針

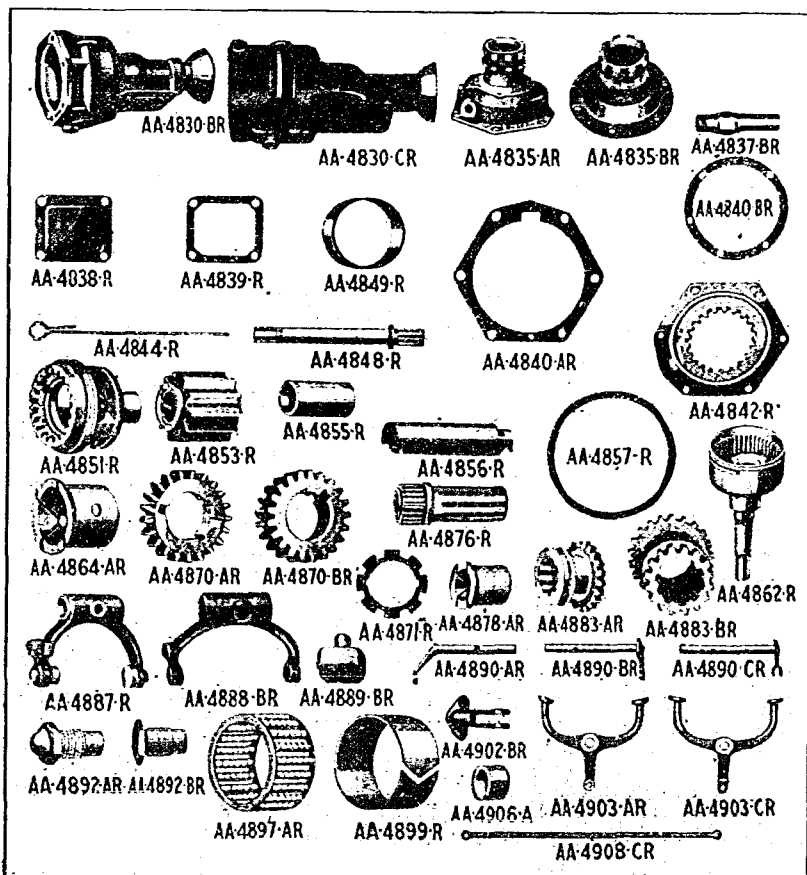

Part No.	Name of Part	Year	貨名
AA-4892-AR	Dual high shifter lock retainer	1928-29	高複更換齒輪鎖管頭
AA-4892-BR	Dual high shifter lock retainer	1928-29	高複更換齒輪鎖管頭
AA-4645-A	Dual high roller bearing	1928-29	高複槓子滑滾
A-22489-R	Washer	1928-29	圈片
AA-4655	Dual high roller bearing sleeve	1928-29	高複槓子滑滾套管
AA-4897-AR	Dual high intermediate bearing assembly	1928-29	高複中間滑滾總成
A-22441-R	Spacing washer	1928-29	間隔圈片
AA-4899-R	Dual high intermediate bearing sleeve	1928-29	高複中間滑滾管
AA-4902-BR	Dual high shifter bracket	1928-29	高複更換齒輪架
A-20755	Bolt	1928-29	螺絲
A-21701-S2	Nut	1928-29	螺絲帽
A-23515	Cotter	1928-29	鎖針
AA-4903-AR	Dual high shifter pedal assembly	1928-29	高複更換齒輪踏板總成
AA-4903-CR	Dual high shifter pedal assembly	1928-29	高複更換齒輪踏板總成
AA-4906-A	Dual high shifter bushing	1928-29	高複更換齒輪套
A-23890	Pin (dual high shifter)	1928-29	針(高複更換齒輪)
A-23533	Cotter	1928-29	鎖針
AA-4908-CR	Dual high shifter rod assembly	1928-29	高複更換齒輪桿總成

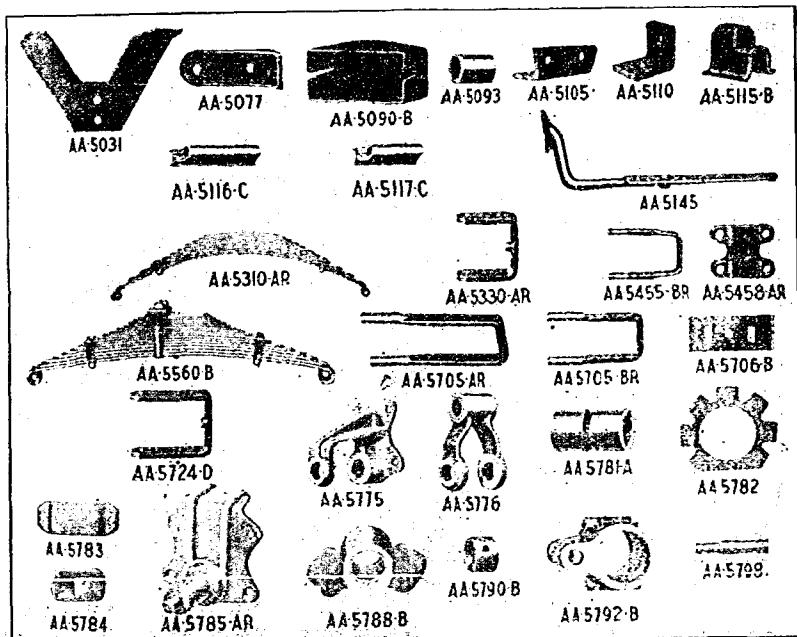

Part No.	Name of Part	Year	貨名
A-2461Clevis	1928-29	U形鐵
A-23822-S7Pin	1928-29	針
A-23530Cotter	1928-29	鎖針
A-21700Nut	1928-29	絲絲帽
A-24461Plug (dual high shifter lever)	1928-29	塞(複換換齒輪桿)

FRAME 車 框

AA-5005-AR	..Frame assembly	1928-29	車框總成
AA-5005-B	...Frame assembly—158 ¹⁹ / ₃₂ " long—AA-131	1930-31	車框總成
AA-5005-D	...Frame assembly—158 ⁵ / ₁₆ " long—AA-131	1931	車框總成
†AA-5006-AR	..Frame assembly—AA-157	1930	車框總成
AA-5008	...Frame assembly—AA-157	1931	車框總成
†AA-5013-AR	..Side member—R. H.—AA-157	1930	旁樑 右
AA-5013-B	...Side member—R. H.—AA-157	1931	旁樑 上
†AA-5014-AR	..Side member—L. H.—AA-157	1930	旁樑 左
AA-5014-B	...Side member—L. H.—AA-157	1931	旁樑 上
AA-5015-A	...Side member—R. H.	1928-31	旁樑 右
AA-5015-C	...Frame side member—R. H.—AA-131— with AA-5005-D	1931	車框旁樑 右
AA-5016-A	...Side member—L. H.	1928-31	旁樑 左
AA-5016-C	...Frame side member—L. H.—AA-131— with AA-5005-D	1931	車框旁樑 左
AA-5017Cross member assembly—No. 1—AA-157	1930-31	橫樑總成 第一
AA-5019-ACross member assembly—No. 1	1930-31	橫樑總成 第一
AA-5020-AR	..Cross member—No. 1	1928-29	第一橫樑
AA-5025-ACross member—No. 2	1928-31	第二橫樑
AA-5026-ACross member—No. 3	1928-31	第三橫樑
AA-5027Cross member—No. 2—AA-157	1930-31	第二橫樑
†AA-5028-AR	..Cross member—No. 3—AA-157	1930	第三橫樑
AA-5028-BCross member—No. 3—AA-157	1931	第三橫樑
AA-5030-AR	..Cross member—No. 4	1928-29	第四橫樑
AA-5030-CCross member—No. 4	1930-31	第四橫樑
AA-5031Cross member—No. 4 gusset	1928-31	第四橫樑節片
†Tapered frame.			
†AA-5032-AR	..Cross member—No. 4—AA-157	1930	第四橫樑
AA-5032-BCross member—No. 4—AA-157	1931	第四橫樑
AA-5035-ACross member—No. 5	1928-31	第五橫樑
A-5075Frame to body bracket—front	1928-31	車框連車身架 前
AA-5035-CFrame cross member—No. 5—with AA-5015, 16-C	1931	車框橫樑 第五
†AA-5036-AR	..Cross member—No. 5—AA-157	1930	第五橫樑
AA-5036-BCross member—No. 5—AA-157	1931	第五橫樑
AA-5042Engine rear support rest	1931	引擎後架座
AA-5077Frame to body bracket—rear	1928-31	車框連車身架 後
AA-5098-BEngine rear support—R. H.	1928-31	引擎後架 右

Part No.	Name of Part	Year	貨名
AA-5090-B	Engine rear support—L. H.	1928-31	引擎後架 左
*A-20782-S2	Bolt	1923-30	螺絲
A-20761-S2	Bolt	1930-31	螺絲
A-21701-S2	Nut	1928-31	螺絲帽
A-23515	Cotter	1928-31	螺釘
AA-5093	Engine rear support to frame spacer	1928-31	引擎後架連車框隔片
A-5100	Hood shelf support bracket on frame	1928-31	車框上緣蓋支架
A-23266	Rivet	1928-31	帽釘
AA-5105	Battery front support to frame bracket	1928-31	電池前架連車框架
AA-5110	Frame to running board shield bracket	1928-31	車框連登車板殼架
A-20556	Bolt	1928-29	螺絲
A-21664-S2	Nut	1928-29	螺絲帽
A-22151	Washer	1928-29	隔片
AA-5115-B	Frame side member spacer—rear— 88A, 89A, 185A, 187A, 199A, 242A	1928-31	車框旁探隔片 後
AA-5115-C	Frame side member spacer—rear— 3 15/32"—187A, 199A, 242A, 239A, 248A	1931	車框旁探隔片 後
AA-5116-C	Frame side member spacer—front— 88A, 89A, 187A, 199A—AA-131, 200A, 202A, 239A, 248A	1928-31	車框旁探隔片 前
AA-5117-D	Frame side member spacer—inter- mediate—88A, 185A, 187A, 199A, 242A, 248A	1928-31	車框旁探隔片 中
A-22371	Washer	1928-29	隔片
A-21147-S7	Bolt (Stake and Express body)	1928-29	螺絲(欄桿及快車式車身)
A-21793-S1	Nut (Stake and Express body)	1928-29	螺絲帽(欄桿及快車式車身)
A-22300	Washer (Stake and Express body)	1928-29	隔片(欄桿及快車式車身)
A-5125-A	Running board bracket—No. 1	1928-31	登車板架 第一
AA-5119-R	Frame side member spacer—front— 185A	1930-31	車框旁探隔片 前
AA-5120	Frame side member spacer—rear— 185B	1931	車框旁探隔片 後
AA-5123	Frame side member spacer—rear—R. H.—202-A	1930	車框旁探隔片 後 右
AA-5124	Frame side member spacer—rear—L. H.—202-A	1930	車框旁探隔片 後 左
§AA-5130-A	Running board bracket—No. 2	1928-31	登車板架 第二
†AA-5145	Running board bracket—No. 3—85-B, 215A, 195A, 210A, 242A	1928-31	登車板架 第三
A-20732	Bolt—85A	1928-29	螺絲
A-21701-S2	Nut—85A	1928-29	螺絲帽

†Tapered frame.

*When used to replace 1½" bolt also use A-22217 washers.

†No. 4 bracket on AA-157 with long running board 210-A and 197-A.

§No. 3 bracket on AA-157 with long running board and 197-A.

Part No.	Name of Part	Year	貨名
A-23516Cotter—85A	1928-29	鎖針
AA-5775	...Rear spring front shackle bracket	1928-31	後彈簧前鎖鉗架
A-23437Rivet	1928-31	帽釘
A-2504Front brake rod spring bracket	1928-31	前車制桿彈簧架
TOWING CLEVIS MODEL 229A			拖曳U形鐵 第二二九A式車身
AA-5179-B	...Towing clevis	1931	拖曳U形鐵
A-21281-S1	.Bolt	1931	螺絲
A-21877-S1	.Nut	1931	螺絲帽
A-22355-S1	.Washer	1931	圈片
AA-5180-B	...Towing clevis bar	1931	拖曳U形鐵橫桿
A-23468Rivet	1931	帽釘
AA-5181-B	...Towing clevis brace	1931	拖曳U形鐵支架
A-23468Rivet	1931	帽釘
AA-5182Towing clevis pin and chain assembly	1931	拖曳U形鐵針及鍊總成
A-22750Screw	1931	螺絲
MUFFLER			消聲器
AA-5230Muffler—AA-131—with 78" outlet pipe —AA-157	1930-31	消聲器
A-5230Muffler—AA-131—with 33" outlet pipe	1930-31	消聲
A-5251Muffler inlet pipe clamp	1930-31	消聲器入氣管鎖鐵
A-20955Bolt	1930-31	螺絲
A-21752Nut	1930-31	螺絲帽
AA-5253Muffler outlet pipe—78" long—AA-131	1930-31	消聲器出氣管
AA-5255-A	...Muffler outlet pipe—AA-157—133" long	1930-31	消聲器出氣管
AA-5255-B	...Muffler outlet pipe—50" long—AA-157	1930-31	消聲器出氣管
AA-5255-D	...Muffler outlet pipe—103" long—AA- 157	1930-31	消聲器出氣管
AA-5256-AR	..Muffler outlet pipe bracket	1928-29	消聲器出氣管架
A-20755Bolt (bracket to frame)	1928-29	螺絲(架連框)
A-21701-S2	.Nut	1928-29	螺絲帽
A-23515Cotter	1928-29	鎖針
AA-5256-C	...Muffler outlet pipe bracket—front— with AA-5255-B and D	1930-31	消聲器出氣管架
A-20763-S1	.Bolt (bracket to frame)	1930-31	螺絲(架連框)
A-20753-S1	.Bolt (bracket to pipe)	1930-31	螺絲(架連管)
A-21702-S1	.Nut	1930-31	螺絲帽
A-22217Lock washer	1930-31	鎖環
AA-5256-D	...Muffler outlet pipe bracket—front— with AA-5253	1931	消聲器出氣管架 前
A-20763-S1	.Bolt (bracket to frame)	1931	螺絲「架連框」
A-20753-S1	.Bolt (bracket to pipe)	1931	螺絲「架連管」
A-21702-S2	.Nut	1931	螺絲帽
A-22217Lockwasher	1931	鎖環
AA-5257-B	...Muffler outlet pipe bracket adapter— A-5230 AA-131	1930-31	消聲器出氣管架接合片
A-23372Rivet (adapter to frame)	1930-31	帽釘

Part No.	Name of Part	Year	貨名
A-5256-C	Muffler outlet pipe bracket—with A-5230 and AA-131	1930-31	消聲器出氣管架
A-20953	Bolt (bracket to adapter)	1930-31	螺絲「架連接合片」
A-21745	Nut	1930-31	螺絲帽
A-23534	Cotter	1930-31	鎖針
AA-5258	Muffler outlet pipe bracket—center—with AA-5255-D	1930-31	消聲器出氣管架 中
A-20970-S1	Bolt (bracket to frame)	1930-31	螺絲「架連框」
A-20935-S1	Bolt (bracket to pipe)	1930-31	螺絲「架連管」
A-21741-S2	Nut	1930-31	螺絲帽
A-22245	Lock washer	1930-31	鎖環
†AA-5259-A	Muffler outlet pipe to frame bracket—rear—AA-157	1930-31	消聲器出氣管連車框架 後
A-23534	Cotter	1930-31	鎖針
A-20905	Bolt (pipe bracket clamp)	1930-31	螺絲「管架鎖鐵」
A-21741-S2	Nut	1930-31	螺絲帽
A-22245	Lock washer	1930-31	鎖環
AA-5259-B	Muffler outlet pipe bracket—rear—with AA-5255-B	1930-31	消聲器出氣管架 後
A-20763-S1	Bolt (bracket to frame)	1930-31	螺絲「架連框」
A-20753-S1	Bolt (bracket to pipe)	1930-31	螺絲「架連管」
A-21702-S2	Nut	1930-31	螺絲帽
A-22217	Lock washer	1930-31	鎖環
A-5256-C	Muffler outlet pipe bracket—rear—with AA-5253 and AA-5255-D	1930-31	消聲器出氣管架 後
A-20969	Bolt (bracket to frame)	1930-31	螺絲「架連框」
A-21741-S2	Nut	1930-31	螺絲帽
A-22245	Lock washer	1930-31	鎖環

FRAME RIVETS

A-23262	1/4" x 3/4" oval hd. rivet	卵形帽釘
A-23266	1/4" x 13/16" rd. hd. rivet	圓頭帽釘
A-23371	5/16" x 1 1/16" rd. hd. rivet	圓頭帽釘
A-23372	5/16" x 7/8" rd. hd. rivet	圓頭帽釘
A-23377	5/16" x 13/16" rd. hd. rivet	圓頭帽釘
A-23384	5/16" x 15/16" rd. hd. rivet	圓頭帽釘
A-23435	3/8" x 1 1/2" button hd. rivet	鈕頭帽釘
A-23436	3/8" x 1" button hd. rivet	鈕頭帽釘
A-23437	3/8" x 1 1/8" button hd. rivet	鈕頭帽釘
A-23438	3/8" x 7/8" oval hd. rivet	卵形帽釘
A-23439	3/8" x 1 1/16" rd. hd. rivet	圓頭帽釘
A-23441	3/8" x 1 1/4" rd. hd. rivet	圓頭帽釘
A-23445	3/8" x 3/4" rd. hd. rivet	圓頭帽釘

FRONT SPRING 前 簧 彈

AA-5310-AR	Front spring assembly	1928-29	前彈簧總成
AA-5310-BR	Front spring assembly—18 leaf	1928-29	前彈簧總成 十八頁
AA-5310-C	Front spring assembly—13 leaf	1930-31	前彈簧總成 十三頁
AA-5310-D	Front spring—14 leaf	1930-31	前彈簧第一十四頁

Part No.	Name of Part	Year	貨名
AA-5313-AR	..Front spring leaf No. 1 assembly	1928-29	前彈簧第一頁總成
**AA-5313-BR	..Front spring leaf No. 1 assembly	1929	前彈簧第一頁總成
AA-5313-C	..Front spring leaf No. 1 assembly—13 leaf	1930-31	前彈簧第一頁總成
AA-5313-D	..Front spring leaf No. 1 assembly—14 leaf	1930-31	前彈簧第一頁總成
AA-5315-AR	..Front spring leaf No. 2	1928-29	前彈簧第二頁
**AA-5315-BR	..Front spring leaf No. 2	1929	前彈簧第二頁 十四頁
AA-5315-D	..Front spring leaf No. 2—14 leaf	1930-31	前彈簧第二頁 十四頁
AA-5316-AR	..Front spring leaf No. 3	1928-29	前彈簧第三頁
**AA-5316-BR	..Front spring leaf No. 3	1929	前彈簧第三頁
†AA-5316-C	..Front spring leaf No. 3	1930-31	前彈簧第三頁
AA-5317-AR	..Front spring leaf No. 4	1928-29	前彈簧第四頁
**AA-5317-BR	..Front spring leaf No. 4	1929	前彈簧第四頁
†AA-5317-C	..Front spring leaf No. 4	1930-31	前彈簧第四頁
AA-5318-AR	..Front spring leaf No. 5	1928-29	前彈簧第五頁
**AA-5318-BR	..Front spring leaf No. 5	1929	前彈簧第五頁
†AA-5318-C	..Front spring leaf No. 5	1930-31	前彈簧第五頁
AA-5319-AR	..Front spring leaf No. 6	1928-29	前彈簧第六頁
**AA-5319-BR	..Front spring leaf No. 6	1929	前彈簧第六頁
†AA-5319-C	..Front spring leaf No. 6	1930-31	前彈簧第六頁
AA-5320-AR	..Front spring leaf No. 7	1928-29	前彈簧第七頁
**AA-5320-BR	..Front spring leaf No. 7	1929	前彈簧第七頁
†AA-5320-C	..Front spring leaf No. 7	1930-31	前彈簧第七頁
AA-5321-AR	..Front spring leaf No. 8	1928-29	前彈簧第八頁
**AA-5321-BR	..Front spring leaf No. 8	1929	前彈簧第八頁
†AA-5321-C	..Front spring leaf No. 8	1930-31	前彈簧第八頁
AA-5322-AR	..Front spring leaf No. 9	1928-29	前彈簧第九頁
**AA-5322-BR	..Front spring leaf No. 9	1929	前彈簧第九頁
†AA-5322-C	..Front spring leaf No. 9	1930-31	前彈簧第九頁
AA-5323-AR	..Front spring leaf No. 10	1928-29	前彈簧第十頁
**AA-5323-BR	..Front spring leaf No. 10	1929	前彈簧第十頁
†AA-5323-C	..Front spring leaf No. 10	1930-31	前彈簧第十頁
AA-5324-AR	..Front spring leaf No. 11	1928-29	前彈簧第十一頁
**AA-5324-BR	..Front spring leaf No. 11	1929	前彈簧第十一頁
†AA-5324-C	..Front spring leaf No. 11	1930-31	前彈簧第十一頁
**AA-5325-AR	..Front spring leaf No. 12	1929	前彈簧第十二頁
†AA-5325-B	..Front spring leaf No. 12	1930-31	前彈簧第十二頁
**AA-5326-AR	..Front spring leaf No. 13	1929	前彈簧第十三頁
†AA-5326-B	..Front spring leaf No. 13	1930-31	前彈簧第十三頁
**AA-5327-AR	..Front spring leaf No. 14	1929	前彈簧第十四頁
AA-5327-B	..Front spring leaf No. 14—14 leaf	1930-31	前彈簧第十四頁 十四頁

*4 required with AA-5255-A, 2 required with AA-5255-B.

†With AA-5255-A.

††2 required with AA-5255-A—1 required with AA-5255-B.

**With 18 leaf spring.

†13 or 14 leaf spring.

Part No.	Name of Part	Year	貨名
A-5724-D	Front spring clamp—14 leaf	1930-31	前彈簧鎖鐵 十四頁
A-5724-C	Front spring clamp—13 leaf	1930-31	前彈簧鎖鐵 十三頁
**AA-5328-R	Front spring leaf No. 15	1929	前彈簧第十五頁
**AA-5329-R	Front spring leaf No. 16	1929	前彈簧第十六頁
**AA-5332-R	Front spring leaf No. 17	1929	前彈簧第十七頁
**AA-5333-R	Front spring leaf No. 18	1929	前彈簧第十八頁
A-5323	Front spring leaf No. 12	1928-29	前彈簧第十二頁
A-3034	Front spring bushing	1928-29	前彈簧套
A-4020	Front spring bushing—13 or 14 leaf	1930-31	前彈簧套 十三或十四頁
A-5330-B	Front spring clamp	1928-29	前彈簧鎖鐵
**AA-5330-BR	Front spring clamp	1928-29	前彈簧鎖鐵
A-20454	Bolt	1928-29	螺絲
A-20546	Bolt	1930-31	螺絲
A-21663-S2	Nut	1930-31	螺絲帽
**AA-5345-R	Front spring tie bolt	1928-29	前彈簧鎖絲螺
A-20731-R	Front spring tie bolt	1928-29	前彈簧鎖絲螺
A-20976	Front spring tie bolt—14 leaf	1930-31	前彈簧鎖絲螺 十四頁
A-21706	Front spring tie bolt nut	1928-29	前彈簧鎖絲螺帽
A-20942	Front spring tie bolt (13 leaf)	1930-31	前彈簧鎖絲螺 十三頁
A-21749-R	Front spring tie bolt nut	1930-31	前彈簧鎖絲螺帽
AA-5455-BR	Front spring clip	1928-29	前彈簧夾
**AA-5455-CR	Front spring clip	1928-29	前彈簧夾
AA-5455-D	Front spring clip—13 leaf	1930-31	前彈簧夾 十三頁
AA-5455-E	Front spring clip—14 leaf	1930-31	前彈簧夾 十四頁
AA-5456	Rear spring clip nut— $\frac{7}{8}$ "	1931	前彈簧夾螺絲帽
AA-5458-AR	Front spring clip bar	1928-29	前彈簧夾門
AA-5458-B	Front spring clip bar—13 leaf	1930-31	前彈簧夾門 十三頁
A-21663-S2	Nut	1930-31	螺絲帽
A-21839-S1	Nut	1928-31	螺絲帽
A-5458	Front spring clip bar	1928-29	前彈簧夾門
A-23531	Cotter	1928-31	鎖針
A-5465	Front spring hanger	1928-29	前彈簧吊架
A-5715	Front spring hanger	1930-31	前彈簧吊架
A-21794	Nut	1928-31	螺絲帽
A-23531	Cotter	1928-31	鎖針
A-5468	Front spring hanger bar	1928-31	前彈簧吊架門
A-24404-S7	Front spring lubricator fitting	1928-31	前彈簧注油嘴
AA-5461	Starting crank bearing	1930-31	搖車柄滑滾

REAR SPRING 後彈簧

AA-5560-B	Rear spring assembly—16 leaf	1928-31	後彈簧總成 十六頁
AA-5560-C	Rear spring assembly—13 leaf	1928-31	後彈簧總成 十三頁
AA-5560-E	Rear spring assembly—13 leaf—270A, 275A and 280A	1931	後彈簧總成 十三頁
AA-5560-F	Rear spring assembly 16 leaf—330A	1931	後彈簧總成 十六頁
AA-5563	Rear spring leaf No. 1 assembly	1928-31	後彈簧第一頁總成

**With 18 leaf spring.

Part No.	Name of Part	Year	貨名
AA-5565	Rear spring leaf No. 2	1928-31	後彈簧第二頁
AA-5566-A	Rear spring leaf No. 3—with AA-5560-B	1928-31	後彈簧第三頁
AA-5566-B	Rear spring leaf No. 3—with AA-5560-C	1928-31	後彈簧第三頁
AA-5567-A	Rear spring leaf No. 4—with AA-5560-B	1928-31	後彈簧第四頁
AA-5567-B	Rear spring leaf No. 4—with AA-5560-C	1928-31	後彈簧第四頁
AA-5568-B	Rear spring leaf No. 5	1928-31	後彈簧第五頁
AA-5569-B	Rear spring leaf No. 6	1928-31	後彈簧第六頁
AA-5570-B	Rear spring leaf No. 7	1928-31	後彈簧第七頁
AA-5571-D	Rear spring leaf No. 8—with AA-5560-B and C	1928-31	後彈簧第八頁
AA-5572-D	Rear spring leaf No. 9—with AA-5560-B and C	1928-31	後彈簧第九頁
AA-5573-B	Rear spring leaf No. 10	1928-31	後彈簧第十頁
AA-5574-B	Rear spring leaf No. 11—with AA-5560-B	1928-31	後彈簧第十一頁
A-5575-B	Rear spring leaf No. 11—with AA-5560-C	1928-31	後彈簧第十一頁
AA-5575-B	Rear spring leaf No. 12—with AA-5560-B	1928-31	後彈簧第十二頁
AA-5577-B	Rear spring leaf No. 12—with AA-5560-C	1928-31	後彈簧第十二頁
AA-5576-B	Rear spring leaf No. 13—with AA-5560-B	1928-31	後彈簧第十三頁
AA-5579	Rear spring leaf No. 13—with AA-5560-C	1928-31	後彈簧第十三頁
AA-5577-B	Rear spring leaf No. 14—with AA-5560-B	1928-31	後彈簧第十四頁
AA-5578	Rear spring leaf No. 15—with AA-5560-B	1928-31	後彈簧第十五頁
AA-5579	Rear spring leaf No. 16—with AA-5560-B	1928-31	後彈簧第十六頁
A-20735	Bolt (rear spring tie) with AA-5560-B	1928-31	螺絲「後彈簧鎖」
A-20772	Bolt (rear spring tie) (AA panel) with AA-5560-C	1930-31	螺絲「後彈簧鎖」
A-21702-S2	Nut	1928-31	螺絲帽
AA-5705-AR	Rear spring clip—with AA-5560-B	1928-29	後彈簧夾
AA-5705-BR	Rear spring clip—with AA-5560-C	1928-29	後彈簧夾
AA-5705-C	Rear spring clip—with AA-5560-B	1930-31	後彈簧夾
AA-5705-D	Rear spring clip—with AA-5560-C	1930-31	後彈簧夾
AA-5705-E	Spring clip—with AA-5560-E		彈簧夾
A-21895	Nut	1928-31	螺絲帽
A-22367	Lock washer	1928-31	鎖環
AA-5706-B	Rear spring clip bar spacer	1930-31	後彈簧夾門隔片
AA-5708	Rear spring clip bar	1930-31	後彈簧夾門
AA-5723	Rear spring clamp plate	1928	後彈簧鎖鐵片
AA-5724-D	Rear spring clamp	1928-31	後彈簧鎖鐵

Part No.	Name of Part	Year	貨名
AA-5724-E	Rear spring clamp	1928-31	後彈簧鎖鐵
AA-5724-G	Rear spring clamp—with AA-5560-B		後彈簧鎖鐵
AA-5724-H	Rear spring clamp—with AA-5560-C		後彈簧鎖鐵
A-20736	Bolt	1928-31	螺絲
A-21702-S2	Nut	1928-31	螺絲帽
A-24404-S7	Rear spring lubricator fitting	1928-31	後彈簧注油嘴
†AA-5775-A	Rear spring front shackle bracket	1928-30	後彈簧前鎖鏈架
AA-5775-B	Rear spring front shackle bracket— AA-157	1931	後彈簧前鎖鏈架
A-23437	Rivet	1928-31	帽釘
AA-5776	Rear spring shackle assembly—R. H.	1928-31	後彈簧鎖鏈總成 右
AA-5776-BR	Rear spring shackle—R. H.—5½" long		後彈簧鎖鏈 右
AA-5777	Rear spring shackle assembly—L. H.	1928-31	後彈簧鎖鏈總成 左
AA-5777-BR	Rear spring shackle—L. H.—6¾" long		後彈簧鎖鏈 左
A-21320-A	Bolt	1928-31	螺絲
A-21921	Nut	1928-31	螺絲帽
A-23552	Cotter	1928-31	鎖針
A-24404-S7	Lubricator fitting	1928-31	注油嘴
AA-5781-A	Rear spring leaf bushing	1928-31	後彈簧葉套
AA-5782	Rear spring upper shackle bolt lock	1928-31	後彈簧上鎖鏈螺絲鎖
AA-5783	Rear axle bumper	1928-31	後輪軸擋
A-20734-S1	Bolt	1928-31	螺絲
A-21707-S2	Nut	1928-31	螺絲帽
A-22217	Lock washer	1928-31	鎖環
AA-5784	Rear axle bumper washer	1928-31	後輪軸擋圈片
AA-5785-AR	Rear spring pivot bracket	1928-29	後彈簧旋桿架
†AA-5785-B	Rear spring pivot bracket	1928-30	後彈簧旋桿架
AA-5785-C	Rear spring pivot bracket—AA-157	1931	後彈簧旋桿架
A-23441	Rivet (side) upper	1928-31	帽釘「旁」上
A-23435	Rivet (side) lower	1928-31	帽釘「旁」下
A-23437	Rivet (bottom)	1928-29	帽釘「底」
AA-5788-D	Rear spring pivot seat assembly	1928-31	後彈簧旋桿座總成
A-24407	Lubricator fitting	1928-31	注油嘴
A-21921	Nut	1928-29	螺絲帽
A-21941	Nut	1928-31	螺絲帽
A-22410	Washer	1928-31	圈片
A-23566	Cotter	1928-31	鎖針
A-23436	Rivet—side	1928-29	帽釘 旁
AA-5790-AR	Rear spring pivot seat bushing	1928-29	後彈簧旋桿座套
AA-5790-B	Rear spring pivot seat bushing	1928-31	後彈簧旋桿座套
AA-5791	Rear spring shackle bushing	1928-31	後彈簧鎖鏈套
AA-5792-AR	Rear spring seat assembly—R. H.	1928-29	後彈簧座總成 右
†AA-5792-B	Rear spring seat assembly—R. H.	1928-30	後彈簧座總成 右
AA-5792-C	Rear spring seat assembly—R. H.— AA-157	1931	後彈簧座總成 右
AA-5793-AR	Rear spring seat assembly—L. H.	1928-29	後彈簧座總成 左
†AA-5793-B	Rear spring seat assembly—L. H.	1928-30	後彈簧座總成 左
AA-5793-C	Rear spring seat assembly—L. H.— AA-157	1931	後彈簧座總成 左
†AA-131, AA-157	tapered frame.		

Part No.	Name of Part	Year	貨名
A-21276	Bolt	1928-31	螺絲
A-21877-S1	Nut	1928-31	螺絲帽
A-22355-S1	Lock washer	1928-31	鎖環
A-24404-S7	Lubricator fitting	1928-31	注油嘴
AA-5798	Rear spring seat lock pin	1928-31	後彈簧座鎖針
A-21793-S1	Nut	1928-31	螺絲帽
A-22300	Lock washer	1930-31	鎖環
AA-5799	Rear spring seat pin	1928-31	後彈簧座針

TRANSMISSION—Four Speed 四速度傳力機

AA-7006	Trans. case	1929-31	傳力機殼
A-24452	Filler plug	1929-31	注油塞
A-24452	Drain plug	1929-31	放油塞
AA-7017	Trans. main drive gear	1929-31	傳力機總軸齒輪
AA-7025	Trans. main drive gear ball bearing	1929-31	傳力機總軸齒輪鋼珠滑滾
AA-7030	Trans. main drive gear bearing retain- er ring	1929-31	傳力機總軸齒輪滑滾滾鋼
AA-7043	Trans. main drive gear bearing oil baffle	1929-31	傳力機總軸齒輪滑滾滾油
AA-7045	Trans. main drive gear bearing snap ring	1929-31	傳力機總軸齒輪滑滾滾止
AA-7050	Trans. main drive gear bearing re- tainer	1929-31	傳力機總軸齒輪滑滾滾隔
A-20718	Screw	1929-31	螺絲
A-22317	Washer	1929-31	圈片
AA-7051	Trans. main drive gear bearing re- tainer gasket	1929-31	傳力機總軸齒輪滑滾滾隔
AA-7061	Transmission main shaft	1929-31	傳力機總軸
AA-7062	Trans. main shaft bearing washer	1929-31	傳力機總軸滑滾滾圈片
AA-7063	Trans. pilot bearing spacer	1929-31	傳力機滑滾滾隔片

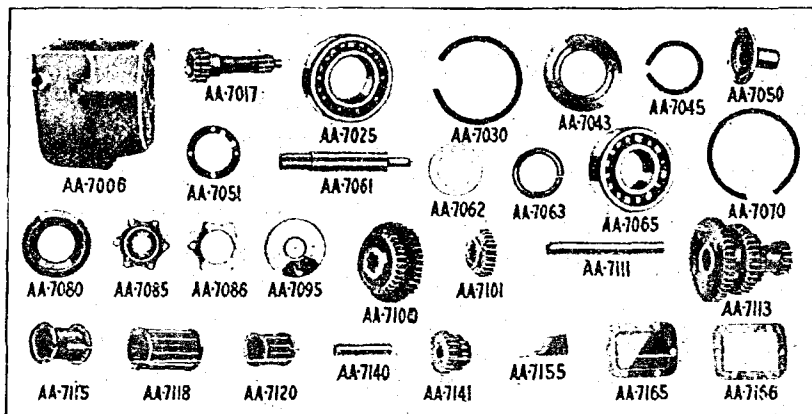

Part No.	Name of Part	Year	貨名
AA-7064	Transmission main shaft snap ring	1930-31	傳力機總軸位置環
AA-7065	Trans. main shaft ball bearing	1929-31	傳力機總軸鋼球滾滾
AA-7070	Trans. main shaft bearing retainer snap ring	1929-31	傳力機總軸滾滾限位位置環
AA-7080	Trans. main shaft bearing oil baffle	1929-31	傳力機總軸滾滾油護圈
AA-7084	Universal joint spider, bushing and ring assembly—in carton	1931	總關節架至及附總成
AA-7085	Trans. main shaft bearing retainer	1929-31	傳力機總軸滾滾限位片
A-20718	Screw	1929-31	螺絲
A-22217	Washer	1929-31	片圍
AA-7086	Trans. main shaft bearing retainer gasket		
AA-7090-AR	Universal joint assembly	1928-29	傳力機總軸滾滾限位墊
AA-7090-B	Universal joint assembly	1929-31	總關節總成
AA-7095	Universal joint knuckle retainer	1929-31	總關節保持片
AA-7100	Transmission low and second sliding gear	1929-31	傳力機慢速度及第二速度滑動齒輪
AA-7101	Transmission high and third sliding gear	1929-31	傳力機高速度及第三速度滑動齒輪
AA-7111	Transmission countershaft	1929-31	傳力機對動軸
AA-7113	Transmission countershaft gear	1929-31	傳力機對動軸齒輪
AA-7115	Transmission countershaft gear bearing spacer	1929-31	傳力機對動軸齒輪滾滾隔片
AA-7118	Transmission countershaft gear bearing	1929-31	傳力機對動軸齒輪滾滾
AA-7120	Transmission main shaft pilot bearing	1929-31	傳力機總軸滾滾
AA-7140	Transmission reverse idler shaft	1929-31	傳力機倒車怠動軸
AA-7141	Transmission reverse idler gear assembly	1929-31	傳力機倒車怠動齒輪總成
AA-7155	Countershaft and reverse idler shaft retainer	1929-31	對動軸及倒車怠動軸限位片
A-20985	Screw	1929-31	螺絲
A-22245	Washer	1929-31	片圍
AA-7165	Transmission power take off cover	1929-31	傳力機去力機蓋
A-20985	Screw	1929-31	螺絲
A-22245	Washer	1929-31	片圍
AA-7166	Transmission power take off cover gasket	1929-31	傳力機去力機蓋墊
GEAR SHIFT—FOUR-SPEED TRANSMISSION			
AA-7208	Gear shift latch trigger anti-rattler spring	1929-31	更換齒輪 四速度傳力機 更換齒輪制門消音彈片簧
AA-7209-B	Gear shift lever assembly	1929-31	更換齒輪桿總成
AA-7212	Gear shift lever latch rod	1929-31	更換齒輪桿制門插桿
AA-7213	Gear shift lever ball	1929-31	更換齒輪桿球
AA-7215	Gear shift lever latch trigger	1929-31	更換齒輪桿制門
AA-7216	Gear shift lever latch trigger screw	1929-31	更換齒輪桿制門螺絲
A-21577-S2	Nut	1929-31	螺絲帽
AA-7217	Gear shift lever latch rod nut	1929-31	更換齒輪桿制門插桿螺絲帽

*With 3 speed transmission.

†When used to replace AA-7209-AR also use AA-7220-B and AA-7221-B.

Part No.	Name of Part	Year	貨名
AA-7218	...Gear shift lever latch	1929-31	更換齒輪桿門
AA-7219	...Gear shift lever latch spring	1929-31	更換齒輪桿門彈簧
AA-7220-AR	...Gear shift lever cap	1929-31	更換齒輪桿門
AA-7220-B	...Gear shift housing cap—Use with threaded gear shift housing	1930-31	更換齒輪殼帽
AA-7221-AR	..Gear shift lever trunnion	1929-30	更換齒輪桿母螺絲
AA-7221-B	...Gear shift lever trunnion—Use with threaded gear shift housing	1930-31	更換齒輪桿母螺絲
AA-7222-AR	..Gear shift housing	1929-30	更換齒輪殼
AA-7222-B	...Gear shift housing	1929-31	更換齒輪殼

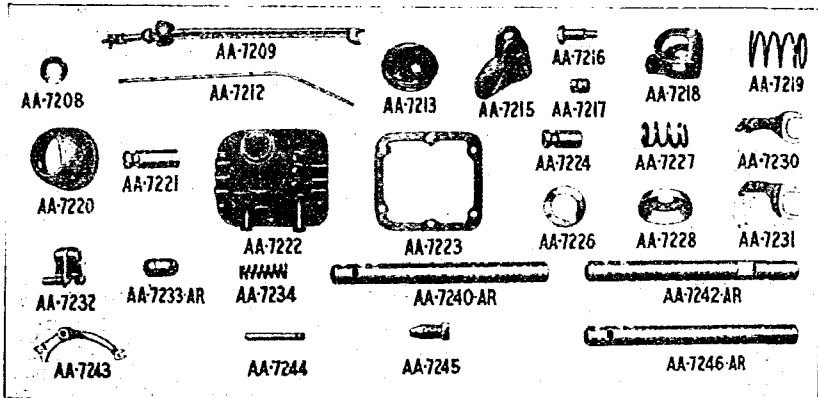

A-20904	...Screw	1929-31	螺絲
A-22245	...Washer	1929-31	圈片
AA-7223	...Gear shift housing gasket	1929-31	更換齒輪殼墊
AA-7224-R	...Gear shift housing pin	1929-31	更換齒輪殼針
AA-7226	...Gear shift lever latch spring washer	1929-31	更換齒輪桿門彈簧圈片
AA-7227	...Gear shift lever spring	1929-31	更換齒輪桿彈簧
AA-7228	...Gear shift lever spring seaf	1929-31	更換齒輪桿彈簧座
AA-7230	...Gear shifter fork—third and high	1929-31	更換齒輪叉 第三及高速度
AA-7231	...Gear shifter fork—first and second	1929-31	換更齒輪叉 第一及第二速度
AA-7232	...Reverse gear shifter shaft gate	1929-31	倒車更換齒輪軸門
AA-7233-AR	..Gear shifter shaft interlock	1929	更換齒輪軸互鎖
AA-7233-B	...Gear shifter shaft interlock	1930-31	更換齒輪軸互鎖
AA-7234	...Gear shifter shaft mesh lock spring	1929-31	更換齒輪軸齒合鎖彈簧
A-24500	...Ball (gear shift mesh lock)	1929-31	球「更換齒輪齒合鎖」
AA-7240-AR	..Gear shifter shaft—low and second	1929	更換齒輪軸 慢及第二速度
AA-7240-B	...Gear shifter shaft—low and second	1930-31	更換齒輪軸 慢及第二速度
AA-7242-AR	..Gear shifter shaft—reverse	1929	更換齒輪軸 倒車
AA-7242-B	...Gear shifter shaft—reverse	1930-31	更換齒輪軸 倒車

‡When used to replace AA-7222-AR also use AA-7220-B and AA-7221-B.

Part No.	Name of Part	Year	貨名
AA-7243	Reverse gear shifter fork	1929-31	倒車更換齒輪叉
AA-7244	Reverse gear shifter fork shaft	1929-31	倒車更換齒輪叉軸
A-23552	Cotter	1929-31	鎖針
AA-7245	Gear shifter fork lock screw	1929-31	更換齒輪叉鎖螺絲
AA-7246-AR	Gear shifter shaft assembly—third and high	1929	更換齒輪軸總成 第三及高速度
AA-7246-B	Gear shifter shaft assembly—3rd and high	1930-31	更換齒輪軸總成 第三及高速度

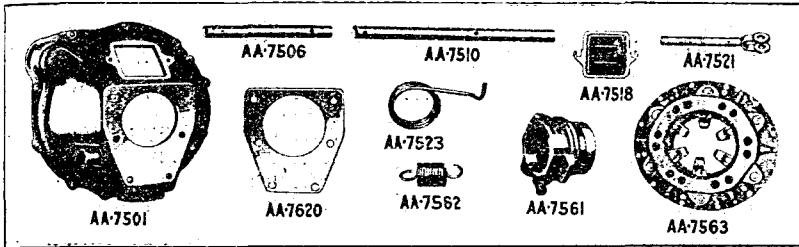

CLUTCH PARTS—FOUR-SPEED TRANSMISSION

傳力盒零件—四度速傳力機

AA-7501	Clutch housing assembly	1929-31	傳力盒殼總成
A-21243	Screw	1929-31	螺絲
A-22330	Washer	1929-31	隔片
AA-7506	Clutch and brake pedal shaft	1929-31	傳力盒及車制踏板軸
A-23791	Pin	1930-31	針
A-23530	Cotter	1930-31	針鎖
A-23781	Pin (clutch and brake pedal shaft collar)	1930-31	針「傳力盒及車制踏板軸管頭」
AA-7510	Clutch release shaft	1929-31	傳力盒放鬆軸
AA-7518	Clutch housing hand hole cover	1929-31	傳力盒殼手孔蓋
AA-7521	Clutch pedal to release arm rod	1929-31	傳力盒踏板連放鬆臂桿
AA-7523	Clutch pedal spring	1929-31	傳力盒踏板彈簧
AA-7549	Clutch disc facing	1929-31	傳力盒片面
A-22993	Rivet	1929-31	帽釘
AA-7550	Clutch disc assembly	1928-29	傳力盒片總成
AA-7556	Clutch spring	1928	傳力盒彈簧
AA-7561	Clutch release bearing hub	1929-31	傳力盒放鬆滑滾輪心
AA-7562	Clutch release bearing spring	1929-31	傳力盒放鬆滑滾彈簧
A-24408	Lubricator fitting (clutch release bearing) long	1929-31	注油嘴「傳力盒放鬆滑滾」長
A-24405	Lubricator fitting (clutch release bearing) short	1928-31	注油嘴「傳力盒放鬆滑滾」短
AA-7563	Clutch pressure plate and cover assembly	1928-31	傳力盒壓力片及蓋總成
AA-7620	Clutch housing gasket	1929-31	傳力盒殼墊

Part No.	Name of Part	Year	貨名
----------	--------------	------	----

RADIATOR 水箱

AA-8005-AR	Radiator—less shell	1930-31	水箱 無殼
AA-8005-B	Radiator—less shell—4 row—flat tube	1930-31	水箱 無殼
A-20968	Bolt (radiator to frame)	1930-31	螺絲「水箱連框」
A-8126-R	Radiator support shim	1930-31	水箱架片
AA-8133	Radiator rod (single)	1930-31	水箱桿「單」
A-21702-S2	Nut	1930-31	螺絲帽
A-22217	Washer	1930-31	隔片
AA-8139	Radiator rod (single) retainer on radiator	1930-31	水箱上水箱桿「單」隔片
A-20705-S1	Bolt	1930-31	螺絲
A-21702-S2	Nut	1930-31	螺絲帽
A-22217	Washer	1930-31	隔片
AA-8141	Radiator rod (single) retainer on dash	1930-31	表板上水箱桿「單」隔片
A-20562-S2	Bolt	1930-31	螺絲
A-21663-S2	Nut	1930-31	螺絲帽
A-22151	Washer	1930-31	隔片
AA-8200-A	Radiator shell—use with AA-8005-B	1930-31	水箱殼
AA-8200-B	Radiator shell (rustless steel)	1931	水箱殼「不銹鋼料」
AA-8212	Radiator name plate—with AA-8200-B	1928-31	水箱名片
AA-8260	Cylinder head outlet Hose	1930-31	汽缸頂放水皮管

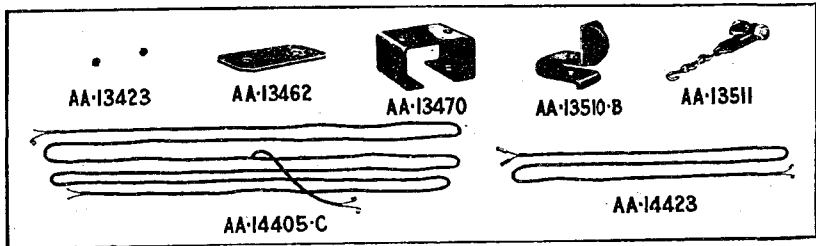

ELECTRICAL SYSTEM 電系

†A-13106-B	Rear license bracket—200A, 202A, 204A, 206A, 208A	1930-31	後執照架
AA-13423	Rear license bracket spacer block—200A, 202A, 204A, 206A, 208A	1930-31	後執照架隔塊
A-20656-S1	Bolt	1930-31	螺絲
A-21668-S2	Nut	1930-31	螺絲帽
A-22151	Lock washer	1930-31	鎖環
AA-13454	Rear lamp tapping plate—270A, 275A, 280A and 300A	1931	尾燈號音片
A-20665	Bolt (lamp to tapping plate)	1931	螺絲「燈連號音片」
A-22151	Washer	1931	隔片
AA-13462	Rear lamp bracket reinforcing plate—200A, 202A, 204A, 206A, 208A	1930-31	尾燈架增固片

Part No.	Name of Part	Year	貨名
AA-13469	Rear lamp bracket—285A and 290A	1931	尾燈架
A-22760	Screw (bracket to cross sill)	1931	螺絲「架連橫基」
A-22215	Washer	1931	隔片
AA-13470	Rear lamp bracket—200A, 202A, 204A, 206A, 208A	1930-31	尾燈架
A-20653-S2	Bolt	1930-31	螺絲
A-22151	Lock washer	1930-31	鎖環
AA-13471	Rear lamp spacer—270A, 275A, 280A and 300A—without tail gate	1931	尾燈隔片
AA-13472	Rear lamp spacer—300A—with tail gate	1931	尾燈隔片
A-14567-B	Rear lamp wire grommet	1930-31	尾燈電線管頭
A-14487	Rear lamp wire connector	1930-31	尾燈電線接連器
A-14588	Rear lamp wire clip—upper	1930-31	尾燈電線夾 上
A-14592	Rear lamp wire clip—lower	1930-31	尾燈電線夾 下
†Multiple disc clutch.			
AA-13510-B	Stop light switch operating finger	1929-31	停車燈開用手指運風
A-20579	Bolt	1929-31	螺絲
A-21663-S2	Nut	1929-31	螺絲帽
A-20764	Bolt (rear lamp support bracket to frame)	1928-29	螺絲「後燈支架連框」
A-21707-S1	Nut	1928-29	螺絲帽
A-22217	Washer	1928-29	隔片
AA-13511	Stop light switch chain and clamp assembly	1930-31	停車燈開關鍊及夾總成
A-20566-S8	Bolt	1930-31	螺絲
A-21663-S2	Nut	1930-31	螺絲帽
AA-13606	Rear lamp stud plate assembly—270A, 275A, 280A and 300A	1931	尾燈螺絲片總成
A-22715	Screw (plate to door)	1931	螺絲「片連門」
AA-13616	Rear lamp plunger plate assembly—270A, 275A, 280A and 300A	1931	尾燈鎖片總成
A-22715	Screw (plate to body)	1931	螺絲「片連車身」
†AA-14405-C	Stop and rear lamp wiring assembly	1928-31	停車燈及尾燈電線總成
AA-14423	Rear lamp extension wire assembly—AA-157	1930-31	尾燈加長電線總成
AA-14539	Rear lamp wire to door conduit—270A, 275A, 280A and 300A	1931	尾燈電線連門管
A-13472-B	Rear lamp bracket—85B and 195A	1931	尾燈架
A-20812-S2	Bolt (bracket to body)	1931	螺絲「架連車身」
A-21707-S2	Nut	1931	螺絲帽
A-22217	Lock washer	1931	鎖環
A-20631-S3	Screw (lamp to bracket)	1931	螺絲「燈連架」
A-22150	Washer	1931	隔片
A-13406-B	Rear license bracket—270A, 275A, 280A, 285A, 290A and 300A	1931	後執照架

Part No.	Name of Part	Year	貨名
FENDERS, RUNNING BOARDS AND SHIELDS 車翅登車板及防塵殼			
AA-16036	Front fender assembly with well—L. H.—229A and all Dump Trucks, 242A, 300A, 199A, 239A, 270A, 275A, 280A, 285A and 210A	1931	前車翅總成 連座 左
AA-16030	Front fender shield assembly—L. H.—229A and all Dump Trucks, 242A, 300A, 199A, 210A, 270A, 275A, 280A, 285A and 239A	1931	前車翅防塵殼總成 左
AA-16310	Rear fender assembly—R. H.—210A— with dual wheels	1931	後車翅總成 右
AA-16311	Rear fender assembly—L. H.—210A— with dual wheels	1931	後車翅總成 左
AA-16312	Rear fender assembly (dual) R. H.—195A, 197A, 280A, 285A and 300A	1931	後車翅總成「複輪」 右
AA-16313	Rear fender assembly (dual) L. H.—195A, 197A, 280A, 285A and 300A	1931	後車翅總成「複輪」 左
AA-16324	Rear fender to body anti-squeak—210A—with dual wheels	1931	後車翅連車身消音片
AA-16337-AR	Rear fender to wheel house panel spacer— $1\frac{1}{4}$ " long—195A, 197A—with dual wheels	1931	後車翅連車輪殼鑲板隔片
AA-16337-B	Rear fender bracket to wheelhouse panel spacer— $\frac{1}{4}$ " thick—85B, 229A, 290A, 195A, 197A, 210A, 275A, 280A, 285A and 300A—with dual wheels	1931	後車翅架車輪殼鑲板隔片
AA-16346	Rear fender to body anti-squeak	1928-31	後車翅連車身消音片
AA-16347-R	Rear fender to body anti-squeak	1928-31	後車翅連車身消音片
AA-16403	Rear fender assembly—242A, 199A	1931	後車翅總成
AA-16413	Rear fender assembly—R. H.—195A, 197A, 270A, 275A, 280A, 285A and 300A	1931	後車翅總成 右
AA-16414	Rear fender assembly—L. H.—195A, 197A, 270A, 275A, 280A, 285A and 300A	1931	後車翅總成 左
AA-16425-R	Rear fender to side panel spacer—R. H.—89A	1928-30	後車翅連旁邊鑲板隔片 右
AA-16426-R	Rear fender to side panel spacer—L. H.—89A	1928-31	後車翅連旁邊鑲板隔片 左
AA-16436-R	Rear fender to side panel spacer—R. H.—88A	1928-31	後車翅連旁邊鑲板隔片 右
AA-16437-R	Rear fender to side panel spacer—L. H.—88A	1928-31	後車翅連旁邊鑲板隔片 左
AA-16438-AR	Rear fender assembly—R. H.—85A, 88A, 89A	1928-31	後車翅總成 右
AA-16438-B	Rear fender assembly—R. H.—85B, 229A, AA-157 with long running boards except with dual wheels	1930-31	後車翅總成 右
AA-16438-CR	Rear fender assembly—R. H.—89A	1930	後車翅總成 右
AA-16439-AR	Rear fender assembly—L. H.—85A, 88A, 89A	1928-31	後車翅總成 左
AA-16439-B	Rear fender assembly—L. H.—85B, 229A, AA-157 with long running boards except with dual wheels	1930-31	後車翅總成 左

Part No.	Name of Part	Year	貨名
AA-16439-CR	Rear fender assembly—L. H.—89A	1930	後車翅總成 左
AA-16445-AR	Rear fender bracket—85A, 88A, 89A	1928-30	後車翅架
AA-16445-B	Rear fender bracket—85B, 229A, 290A	1930-31	後車翅架
AA-16458-B	Running board assembly—long—R. H.—85B, 195A, 229A, 270A, 285A, 290A, 300A	1930-31	登車板總成 長 右
AA-16459-AR	Running board assembly—long—85A, 89A	1928-31	登車板總成 長
AA-16459-B	Running board assembly—long—L. H.—85B, 195A, 229A, 270A, 285A, 290A, 300A	1930-31	登車板總成 長 左
AA-16468	Running board assembly—R. H.—AA-157—197A	1930-31	登車板總成 右
AA-16469	Running board assembly—L. H.—AA-157—197A	1930-31	登車板總成 左
AA-16500	Running board assembly—R. H.—197A, 210A	1931	登車板總成 右
AA-16501	Running board assembly—197A, 210A	1931	登車板總成
AA-16508	Running board assembly—R. H.—195A—with dual wheels	1931	登車板總成 右
AA-16509	Running board assembly—L. H.—195A—with dual wheels	1931	登車板總成 左
AA-16514-AR	Running board assembly—R. H.—AA chassis except 85A, 88A, 89A	1928-29	登車板總成 右
AA-16514-B	Running board assembly—R. H.—88A, 185B, 187A, 199A, 242A and all dump trucks	1930-31	登車板總成 右
AA-16515-AR	Running board assembly—L. H.—AA chassis except 85A, 88A, 89A	1928-29	登車板總成 左
AA-16515-B	Running board assembly—L. H.—88A, 185B, 187A, 199A, 242A and all dump trucks	1930-31	登車板總成 左
AA-16534	Running board shield—R. H.—300A, 195A, 229A, 270A, 275A, 280A and 285A	1931	登車板殼 右
AA-16535-AR	Running board shield—R. H.—long—88A, 89A	1928-31	登車板殼 右
AA-16535-B	Running board shield—R. H.—long—85B, 195A, 229A, 270A, 275A, 280A, 285A, 290A, 300A	1930-31	登車板殼 右 長
AA-16536-AR	Running board shield—L. H.—long—85A, 88A, 89A	1928-31	登車板殼 左 長
AA-16536-B	Running board shield—L. H.—long—85B, 195A, 229A, 270A, 275A, 280A, 285A, 290A, 300A	1930-31	登車板殼 左 長
AA-16585	Running board shield—R. H.—197A, 210A	1931	登車板殼 右
AA-16586	Running board shield—L. H.—197A, 210A	1931	登車板殼 左
AA-16598-AR	Running board shield—R. H.—AA chassis except 85A, 88A, 89A	1928-31	登車板殼 右
AA-16598-B	Running board shield—R. H.—88A, 185B, 187A, 199A, 242A and all dump trucks	1930-31	登車板殼 右

†When used to replace previous type also use A-14423-BR

Part No.	Name of Part	Year	貨名
AA-16599-AR	Running board shield—L. H.—AA chassis except 85A, 88A, 89A	1928-31	登車板殼 左
AA-16599-B	Running board shield—L. H.—88A, 185B, 187A, 199A, 242A and all dump trucks	1930-31	登車板殼 左
A-16540-B	Running board shield to frame anti-squeak front	1930-31	登車板殼連車樞消音片前
A-15641	Running board shield to body bracket anti-squeak	1930-31	登車板殼連車身架消音片
A-15642	Running board shield to front body bracket anti-squeak	1930-31	登車板殼連前車身架消音片

FENDER, RUNNING BOARD AND SHIELD BOLTS

車翅登車板及防塵殼螺絲

A-20537-S2	$\frac{1}{4}$ "—20 x $1\frac{1}{4}$ " carriage bolt	圓担螺絲
A-20538-S1	$\frac{1}{4}$ "—20 x $\frac{5}{8}$ " hex. hd. bolt	六角螺絲
A-20556-S1	$\frac{1}{4}$ "—20 x $\frac{3}{4}$ " carriage bolt	圓担螺絲
A-20560-S4	$\frac{1}{4}$ "—20 x $\frac{7}{8}$ " oval hd. mach. bolt	卵形螺絲
A-20571	$\frac{1}{4}$ "—20 x 2" carriage bolt	圓担螺絲
A-20594-S1	$\frac{1}{4}$ "—20 x $\frac{7}{8}$ " carriage bolt	圓担螺絲
A-20606-S3	$\frac{1}{4}$ "—20 x $\frac{9}{16}$ " spec. hd. ege. bolt	特別頭圓担螺絲
A-20705-S1	$\frac{5}{16}$ "—24 x $\frac{11}{16}$ " hex. hd. bolt	六角螺絲
A-20709	$\frac{5}{16}$ "—24 x $\frac{5}{8}$ " hex. hd. bolt	六角螺絲
A-20711-S1	$\frac{15}{16}$ "—18 x $\frac{3}{4}$ " carriage bolt	圓担螺絲
A-20718-S2	$\frac{5}{16}$ "—18 x $\frac{3}{4}$ " hex. hd. mach. bolt	六角螺絲
A-20721	$\frac{5}{16}$ "—18 x $2\frac{1}{4}$ " hex. hd. bolt	六角螺絲
A-20760-S1R	$\frac{9}{16}$ "—18 x $1\frac{3}{16}$ " spec. hd. bolt	特別頭螺絲
A-20761-S1R	$\frac{3}{16}$ "—18 x $\frac{3}{4}$ " spec. hd. bolt	特別頭螺絲
A-20763-S1	$\frac{5}{16}$ "—24 x $\frac{25}{32}$ " hex. hd. bolt	六角螺絲
A-20764	$\frac{5}{16}$ "—18 x $\frac{7}{8}$ " hex. hd. bolt	六角螺絲
A-20782-S2	$\frac{5}{16}$ "—24 x $1\frac{7}{8}$ " hex. hd. bolt	六角螺絲
A-20783	$\frac{5}{16}$ "—18 x $\frac{5}{8}$ " spec. step bolt	特別螺絲
A-20953	$\frac{3}{8}$ "—24 x $1\frac{7}{32}$ " hex. hd. bolt with cotter hole	六角螺絲有鎖針孔者
A-21741-S8	$\frac{3}{8}$ "—24 ($2\frac{1}{64}$ " x $\frac{9}{16}$ ") hex. nut	六角螺絲帽
A-22154-S8	$\frac{1}{4}$ " ($1\frac{1}{16}$ " x $\frac{3}{4}$ ") plain washer	平圈片
A-22245-S1	$\frac{3}{8}$ " (.401-.411) ($\frac{3}{32}$ " x $2\frac{1}{32}$ ") lock washer	鎖環

FENDER, RUNNING BOARD AND SHIELD NUTS

車翅登車板及防塵殼螺絲帽

A-21661	$\frac{1}{4}$ "—20 ($\frac{3}{16}$ " x $\frac{1}{4}$ ") sq. nut	四方螺帽
A-21663-S2	$\frac{1}{4}$ "—20 ($\frac{3}{16}$ " x $\frac{1}{4}$ ") hex. nut	六角螺帽
A-21664-S2	$\frac{1}{4}$ "—20 ($\frac{1}{4}$ " x $\frac{1}{2}$ ") carriage nut	圓担螺帽
A-21668-S2	$\frac{1}{4}$ "—20 ($\frac{3}{16}$ " x $\frac{1}{4}$ ") hex. nut	六角螺帽
A-21702-S2	$\frac{5}{16}$ "—24 ($1\frac{17}{64}$ " x $\frac{1}{2}$ ") hex. nut	六角螺帽
A-21705-S1	$\frac{5}{16}$ "—18 ($\frac{1}{4}$ " x $\frac{9}{16}$ ") square nut	四方螺帽
A-21707-S2	$\frac{3}{16}$ "—18 ($\frac{1}{4}$ " x $\frac{1}{2}$ ") hex. nut	六角螺帽

FENDER, RUNNING BOARD AND SHIELD SCREWS

車翅登車板及防塵殼螺絲釘

A-20604-S1	$\frac{1}{4}$ "—20 x $1\frac{3}{8}$ " hex. hd. bolt	六角螺絲
A-20763-S1	$\frac{5}{16}$ "—24 x $\frac{5}{8}$ " hex. hd. bolt	六角螺絲
A-22677	12 x 1 flat hd. wood screw	平頭木螺絲

Part No.	Name of Part	Year	貨名
FENDER, FUNNING BOARD AND SHIELD WASHERS			車翅登車板及防護板隔片
A-22150 $\frac{1}{4}$ " ($\frac{3}{64}$ " x $\frac{29}{64}$ ") lock washer.....		鎖環
A-22151 $\frac{1}{4}$ " ($\frac{1}{16}$ " x $\frac{35}{64}$ ") lock washer		鎖環
A-22166-S8 $\frac{1}{4}$ " ($\frac{1}{16}$ " x $\frac{3}{4}$ ") plain washer		平隔片
A-22217 $\frac{5}{16}$ " ($\frac{1}{16}$ " x $\frac{37}{64}$ ") lock washer		鎖環
A-22223-S2 $\frac{5}{16}$ " ($\frac{1}{16}$ " x $\frac{3}{4}$ ") plain washer.....		平隔片
TOOLS 用具			
AA-17019-B	..Tire iron	1928-31	鎖胎撬鐵
AA-17034Wheel nut wrench handle	1930-31	車輪螺帽板頂柄
AA-17035-B	..Wheel nut wrench	1930-31	車輪螺帽板頂
AA-17036-AR	..Starting crank and wire wheel wrench	1928-29	搖車柄及鋼線輪板頂
AA-17036-BR	..Starting crank and wire wheel wrench	1928-29	搖車柄及鋼線輪板頂
AA-17036-C	..Starting crank	1930-31	搖車柄
AA-17080Jack assembly	1928-31	扛車機總成
AA-17081Jack handle	1928-31	扛車機柄
SPEEDOMETER			速度表
AA-17261-AR	..Speedometer shaft casing	1928-30	速度表軸殼
AA-17261-C	..Speedometer shaft casing—AA-131...	1930-31	速度表軸殼
AA-17261-D	..Speedometer shaft casing—AA-157...	1930-31	速度表軸殼
AA-17262-A	..Speedometer shaft	1928-30	速度表軸
AA-17262-C	..Speedometer shaft—AA-131	1930-31	速度表軸
AA-17262-D	..Speedometer shaft—AA-157	1930-31	速度表軸
AA-17265-R	..Speedometer cable support	1928-29	速度表索架
AA-17266Speedometer cable grommet	1928-31	速度表索管頭
A-14585Speedometer cable clips—on frame— 157"	1930-31	車架上速度表索夾
AA-17269Speedometer driven gear bearing	1928-31	速度表被驅齒輪滾珠
AA-17271-BR	..Speedometer driven gear—used with AA-17277-BR	1928-29	速度表被驅齒輪
AA-17271-DR	..Speedometer driven gear (5.17-1, 5.14-1)	1928-29	速度表被驅齒輪
AA-17271-ER	..Speedometer driven gear (7.17-1)...	1928-29	速度表被驅齒輪
AA-17271-FR	..Speedometer driven gear—6.6-1	1929-30	速度表被驅齒輪
AA-17271-G	..Speedometer driven gear—6.6-1	1930-31	速度表被驅齒輪
AA-17271-H	..Speedometer driven gear—5.14-1	1930-31	速度表被驅齒輪
AA-17277-BR	..Speedometer drive cap and plug as- sembly	1928-29	速度表驅動帽及塞總成
A-20544-S8R	Screw (speedometer drive cap)	1928-29	螺絲[速度表驅動帽]
AA-17285-BR	..Speedometer driving gear	1928-29	速度表驅動齒輪
AA-17285-DR	..Speedometer driving gear (5.11-1 or 5.17-1)	1928-29	速度表驅動齒輪
AA-17285-ER	..Speedometer driving gear (7.17-1 or 7.25-1)	1928-29	速度表驅動齒輪
AA-17285-FR	..Speedometer driving gear—5.17-1 to run with AA-17271-D	1929-30	速度表驅動齒輪
AA-17285-G	..Speedometer driving gear—6.6-1 to run with AA-17271-AR and G	1930-31	速度表驅動齒輪

Part No.	Name of Part	Year	貨名
AA-17285-H	Speedometer driving gear—5.14—1 to run with AA-17271-H	1930-31	速度表驅動齒輪
AA-17286-AR	Speedometer drive gear retainer	1928-29	速度表驅動齒輪管頭
AA-17286-B	Speedometer drive gear retainer	1929-31	速度表驅動齒輪管頭
AA-17287	Speedometer driving gear thrust washer	1929-31	速度表驅動齒輪壓力圈片
REAR VIEW MIRROR			照後鏡
AA-17745-AR	Rear view mirror bracket—Closed Cab with platform body		照後鏡架
AA-17745-B	Rear view mirror bracket—82B—with Platform or Express Bodies	1928-31	照後鏡架
AA-17745-C	Rear view mirror bracket—when used to replace previous type also use A-17723A or B and A-17724-A and B		照後鏡架
FRONT BUMPER			前車擋
AA-17750-A	Front bumper assembly	1929-30	前車擋總成
AA-17750-B	Front bumper assembly	1930-31	前車擋總成
*AA-17752-AR	Front bumper arm—R. H.	1930	前車擋臂 右
AA-17752-B	Front bumper arm—R. H.	1930-31	前車擋臂 右
*AA-17753-AR	Front bumper arm—L. H.	1930	前車擋臂 左
AA-17753-B	Front bumper arm—L. H.	1930-31	前車擋臂 左
A-17766	Bumper arm stud—front	1930-31	車擋臂螺絲 前
A-17767	Bumper arm stud—rear	1930-31	車擋臂螺絲 後
A-21845	Nut	1930-31	螺絲帽
A-22330	Lock washer	1930-31	鎖環
AA-17754-BR	Front bumper arm—R. H.	1928-30	前車擋臂 右
AA-17755-BR	Front bumper arm—L. H.	1928-30	前車擋臂 左
*AA-17756-R	Bumper bar clamp back plate	1930-31	車擋橫片夾後片
*AA-17757-AR	Bumper bar	1930	車擋橫片
AA-17757-B	Front bumper bar	1930-31	前車擋橫片
A-21280-S1	Bolt (bar to arm)	1930-31	螺絲「橫片連臂」
A-21880-S1	Nut	1930-31	螺絲帽
A-22355-S1	Lock washer	1930-31	鎖環
A-21169-S1	Bolt (bar to back bar)	1930-31	螺絲「橫片連後片」
A-21787-S1	Nut	1930-31	螺絲帽
A-22300-S1	Lock washer	1930-31	鎖環
*AA-17760-AR	Bumper back bar	1930	車擋後片
*A-21877-S1	Nut (bumper bar clamp)	1930	螺絲帽「車擋橫片夾」
*A-22355-S1	Lock washer	1930	鎖環
AA-17760-B	Front bumper back bar	1930-31	前車擋後片
A-21219-S1	Bolt (bar to arm)	1930-31	螺絲「橫片連臂」
A-21845-S1	Nut	1930-31	螺絲帽
A-22330	Lock washer	1930-31	鎖環

*Double bar type bumper used on few trucks.
Do not stock these parts but order as required.

REAR BUMPER—Models 270A, 175A, 280A, 285A.

Part No.	Name of Part	Year	貨名
			後車擋一二七〇A等式車身
AA-17814-AR	Rear bumper assembly	1931	後車擋總成
AA-17814-B	Rear bumper assembly	1931	後車擋總成
AA-17758-B	End clamp assembly (with AA-17814-AR and B)	1931	尾夾總成
A-21877-S1	Nut		螺絲帽
A-22355-S1	Lock washer		鎖環
AA-17843-AR	Rear bumper arm—R. H.—with AA-17814-AR	1931	後車擋臂 右
AA-17844-AR	Rear bumper arm—L. H.—with AA-17814-AR	1931	後車擋臂 左
A-21304	Bolt (arm to frame—front)	1931	螺絲「臂連車框 前」
A-21895	Nut	1931	螺絲帽
A-22367	Lock washer	1931	鎖環
A-21245-S4	Bolt (arm to frame—center and arm to brace support)	1931	螺絲「臂連框 中及臂連帶架」
A-21845-S1	Nut	1931	螺絲帽
A-22330	Lock washer	1931	鎖環
A-21219-S4	Bolt (arm to frame—rear)	1931	螺絲「臂連框 後」
A-21845-S1	Nut	1931	螺絲帽
A-22330	Lock washer	1931	鎖環
AA-17843-B	Rear bumper arm—R. H.—with AA-17814-B	1931	後車擋臂 右
AA-17844-B	Rear bumper arm—L. H.—with AA-17814-B	1931	後車擋臂 左
A-21304	Bolt (arm to frame—front)	1931	螺絲「臂連框 前」
A-21895	Nut	1931	螺絲帽
A-22367	Lock washer	1931	鎖環
A-21249-S2	Bolt (arm to frame—center and rear)	1931	螺絲「臂連框 中及後
A-21845-S1	Nut	1931	螺絲帽
A-22330	Lock washer	1931	鎖環
†AA-17915-R	Bumper "U" clamp	1930	車擋U形夾
A-21793-S1	Nut	1930	螺絲帽
A-22300-S1	Washer	1930	隔片
†AA-17916-R	Bumper "U" plate	1930	車擋U形片
†A-17758-B	Bumper bar end clamp	1930	車擋橫片尾夾
AA-17920-R	Bumper end bolt	1930	車擋尾螺絲
†A-21798-S1	Nut	1930	螺絲帽
†A-22300-S1	Lock washer	1930	鎖環
†AA-17773-R	Front bumper cross bar	1930	前車擋橫片
†A-21219-S1	Bolt	1930	螺絲
†A-22330	Lock washer	1930	鎖環
AA-17925-AR	Rear bumper brace support—R. H.—with AA-17814-AR	1931	後車擋帶架 右
AA-17925-B	Rear bumper brace support—R. H.—with AA-17814-B	1931	後車擋帶架 右
AA-17926-AR	Rear bumper brace support—L. H.—with AA-17814-AR	1931	後車擋帶架 左
AA-17926-B	Rear bumper brace support—L. H.—with AA-17814-B	1931	後車擋帶架 左

Part No.	Name of Part	Year	貨名
AA-17927-R	Rear bumper arm to body support— with AA-17814-AR	1931	後車擋臂車連身架
AA-17928-AR	Rear bumper guard bar bracket—L. H.—with AA-17814-AR	1931	後車擋裙片架 左
AA-17928-B	Rear bumper guard bar bracket—L. H.—with AA-17814-B	1931	後車擋裙片架 左
AA-17929-AR	Rear bumper guard bar bracket—R. H.—with AA-17814-AR	1931	後車擋裙片架 右
AA-17929-B	Rear bumper guard bar bracket—R. H.—with AA-17814-B	1931	後車擋裙片架 右
AA-17930	Rear bumper guard bar with AA- 17814-AR and B	1931	後車擋裙片
AA-17931	Rear bumper end clamp spacer—with AA-17814-AR	1931	後車擋尾夾隔片
AA-17932	Rear bumper end bolt—with AA- 17814-AR and B	1931	後車擋尾夾螺絲
A-21881	Nut		螺絲帽
A-22355-S1	Lock washer		鎖環
AA-17933	Rear bumper bar clamp back plate— with AA-17814-B	1931	後車擋片夾後片
REAR BUMPER MODEL 330A			
AA-17950	Rear bumper assembly	1931	後車擋總成
AA-17955	Rear bumper arm—R. H.	1931	後車擋臂 右
AA-17956	Rear bumper arm—L. H.	1931	後車擋臂 左
A-21219-S4	Bolt (arm to frame)	1931	螺絲「臂連框」
A-21845-S1	Nut	1931	螺絲帽
A-22330-S1	Lock washer	1931	鎖環
AA-17959	Bumper bar outer support	1931	車擋片外架
A-21244	Bolt (support to floor sill)	1931	螺絲「架連地板基」
A-21840-S1	Nut	1931	螺絲帽
A-22330-S1	Lock washer	1931	鎖環
A-2311-S4	Bolt (support to outer bar)	1931	螺絲「架連外片」
AA-17960	Bumper bar—outer	1931	車擋橫片 外
A-21901-S2	Nut	1931	螺絲帽
A-22367-S2	Lock washer	1931	鎖環
AA-17963	Bumper bar—center	1931	車擋橫片 中
A-21311-S1	Bolt (center bar to outer bar)	1931	螺絲「中片連外片」
A-21901-S4	Nut	1931	螺絲帽
A-22367-S2	Lock washer	1931	鎖環
A-21312-S4	Bolt	1931	螺絲
A-21901-S4	Nut	1931	螺絲帽
A-22367-S2	Lock washer	1931	鎖環
AA-18008	Rear shock absorber and link	1931	後避震器及連柱
AA-18009	Rear shock absorber and link	1931	後避震器及連柱
AA-18015	Rear shock absorber assembly—R. H.	1931	後避震器總成 右
AA-18016	Rear shock absorber assembly—L. H.	1931	後避震器總成 左

‡Double bar type bumper used on few trucks.

Do not stock these parts but order as required.

Part No.	Name of Part	Year	貨名
A-21247	Bolt (shock absorber to frame)		螺絲避震器連框
AA-18052	Rear shock absorber arm	1931	後避震器臂
AA-18056	Rear shock absorber link and ball joint assembly	1931	後避震器連柱及球節總成
AA-18092	Rear axle shock absorber support assembly—R. H.	1931	後輪軸避震器架總成右
AA-18093	Rear axle shock absorber support assembly—L. H.	1931	後輪軸避震器架總成左

MISCELLANEOUS PARTS

Part No.	Name of Part	Year	貨名
AA-18047	Front shock absorber arm	1928-29	前避震器臂
AA-18330	Spare wheel lock assembly	1929-31	常備輪鎖總成
AA-18345	Spare wheel lock nut	1929-31	常備輪鎖螺絲帽

SPECIAL TOOLS 特別用具

5-z-1705	AA Hub puller		雙A輪心板
5-z-1705-1	AA Hub puller screw		雙A輪心板螺絲
5-z-1821	T-wrench for $5/16$ " hex. head screw		丁式頭六角螺絲用
5-z-1825	Socket wrench for gas gauge flange		汽油表邊凹板頭
5-z-1832	Open end offset wrench for camlockshaft nut		開尾板頭偏心鎖軸螺帽用
5-z-1833	Open end wrench for adjusting nut for drive pinion bearing		開尾板頭驅動小齒輪滑液調節螺帽用
5-z-1834	Hex. L-wrench for removing starter motor		六角L式板頭拆卸發動機用
5-z-1835	Brace wrench for oil pan screws		曲柄板油盤螺絲用
5-z-1845	T-wrench for $1/4$ " hex. head screw for oil pump cover		丁式板頭抽油機蓋二分六角頭螺絲用
5-z-1846	Brace wrench for $3/8$ " hex. head screws		曲柄板頭三分六角頭螺絲用
5-z-1860	Adapter used with AA hub puller for pulling A hubs		雙A輪心板接合器
5-z-1861	Clutch nut wrench		傳力盒螺絲板頭
5-z-1866	Vac-cup valve grinder		真空杯汽門磨
5-z-1867	Piston ring squeezer		活塞環捏器
5-z-1868	Connecting rod wrench		接連桿板頭
5-z-1900	Hex box wrench for removing crankshaft ratchet nut		六角箱板頭
5-z-1901	$45/64$ comb. L and T wrench for cyl. head nuts		汽缸頭螺絲板頭
5-z-2031	Star wrench for gas gauge		汽油表板頭
5-z-2038	Connecting rod wrench (for $21/32$ nut)		接連桿板頭
5-z-2065	Drive pinion bearing lock nut wrench		驅動小齒輪滑液鎖螺絲板頭
5-z-2794	Lock cylinder removing tool		拆卸車鎖圓筒器
5-z-2797	Pliers for fitting lock tumblers to key		各種小鉗用於安裝車鎖控制於鑰子

