

*

UMASS/AMHERST

*



312066 0333 2714 1

5901
Call
No 24913



**UNIVERSITY OF MASSACHUSETTS
LIBRARY**

LIBRARY
UNIVERSITY OF
MASSACHUSETTS
AMHERST, MASS.

F

638.05

G47

v. 29

Contents of this Number.

Amateurs	10
Bees in Clamps	14, 15
Bees in Court	18, 21
Bee-keepers, Amateur	10
Black Brood in New York	18
Clamps, Hutchinson's	14, 15
Clover, Sweet	9
Exposition, Buffalo	17
Girard Pabou	11, 12
Honey v. Sugar as Food	8, 9
Honey, Canded, Fowls on	12
Honey, To Sell	9
Legislation for Bee-keepers	9
Propolis	9
Queen-rearing in France	11
Secor's Report of N. B. K. A.	17
Snakes and Bees	10
Stings as a Remedy	8
Utter v. Utter	18, 21
Wintering, Doolittle on	15

Honey Column.

FANCY.—All sections to be well filled, combs straight, firmly attached to all four sides, the combs unsoiled by travel stain, or otherwise; all the cells sealed except an occasional cell, the outside surface of the wood well scraped of propolis.

A No. 1.—All sections well filled except the row of cells next to the wood; combs straight; one-eighth part of comb surface soiled, or the entire surface slightly soiled; the outside surface of the wood well scraped of propolis.

No. 1.—All sections well filled except the row of cells next to the wood; combs comparatively even; one-eighth part of comb surface soiled; or the entire surface slightly soiled.

No. 2.—Three-fourths of the total surface must be filled and sealed.

No. 3.—Must weigh at least half as much as a full weight section.

In addition to this the honey is to be classified according to color, using the terms white, amber, and dark; that is, there will be "fancy white," "No. 1 dark," etc.

CITY MARKETS.

ALBANY.—Honey market not so brisk as it was. We don't change quotations, but to move any amount we would have to shade our quotations. Extracted very dull, and prices are asking prices at present. White comb, 17; No. 1, 16; No. 2, 15; mixed, 13@14; buckwheat, 13@13½. Extracted, white, 8@8½; mixed, 7@7½; buckwheat, 6. **MACDOUGAL & Co.,**
Successors to CHAS. McCULLOCH & Co.,
Dec. 19. Albany, N. Y.

NEW YORK.—There is a good and steady demand for all grades of comb honey; but very little is coming into this market. If producers have any on hand, we advise marketing it at once. We quote: Fancy white comb, 15@16; No. 1, 14; No. 2, 12@13; buckwheat, 11@12. Beeswax, firm and in good demand at 28. No large demand for buckwheat extracted as yet. Some sales are being made at 5½.

FRANCIS H. LEGGETT & Co.,
Franklin, West Broadway, and Varick Sts.,
Dec. 17. New York City.

DETROIT.—Fancy white comb, 15@16; No. 1, 13@14; dark and amber, 10@12. Extracted white, 7½@8; dark and amber, 6@7. Beeswax, 26@28.
Dec. 22. **M. H. HUNT & SON,** Bell Branch, Mich.

NEW YORK.—Our market for comb honey is firm, with shipments coming in less frequent; demand is not what we can call good, but fair, and equal to the stock that is here and that is arriving. We quote: Fancy white, 17@18; A No. 1, 15@16; No. 1, 14@15; No. 2, 12@13; fancy buckwheat, 11@12; No. 1, 10@11; No. 2, 9@10. Extracted, white, 8@8½; light amber, 7@7½; buckwheat, 5½@6½. Beeswax, demand limited, 27@28.
Dec. 18. **CHAS. ISRAEL & BROS.,**
486-8 Canal St., New York City.

CINCINNATI.—The market for comb honey here is becoming a little bare, although higher prices are not obtainable. Fancy white comb sells for 16, lower grades do not want to sell at all. Extracted is selling slow, amber sells for 5½ and higher; fancy white clover brings 8@8½. Beeswax, 28. **C. H. W. WEBER,**
Dec. 26.

CHICAGO.—The honey market is dull. Extracted is lower; also amber comb, with fancy white steady, there being very little of the latter offered. Beeswax, 28. **R. A. BURNETT & Co.,**
Dec. 18. 163 South Water St., Chicago, Ill.

BOSTON.—We quote our market as follows: Fancy No. 1 white in cartons 17; A No. 1, 16; No. 1, 15@16, with a fairly good demand. Absolutely no call for dark honey this year. Extracted, white, 7½@8; light amber, 7@7½. Beeswax, 27.

BLAKE, SCOTT & LEE,
Dec. 18. 31, 33 Commercial St., Boston, Mass.

SAN FRANCISCO.—Fancy comb, 14; A No. 1, 13; No. 1, 12½; No. 2, 10½; No. 3, 8½. Extracted, light amber, 5-gallon tins, 2 tins to case, 6½; white, 7½.
Dec. 21. **GUGGENHIME & Co.**

NEW YORK.—Good demand continues for all grades of comb honey. We quote fancy white, 15@16; No. 1 white, 14; No. 2 white, 12@13; amber, 12; buckwheat, 10@11. Extracted in fairly good demand at 7½@8 for white, and 7 for amber; off grades and southern, in barrels, at 65@75 per gallon, according to quality. Not much demand for extracted buckwheat as yet. Some little selling at 5½@6. Beeswax firm at 28.
HILDRETH & SEGELKEN,
Dec. 22. 120, 122 West Broadway, New York.

WANTED.—Comb and extracted honey. State price kind, and quantity. **R. A. BURNETT & Co.,**
163 South Water St., Chicago, Ill.

FOR SALE.—20,000 lbs. extracted honey from alfalfa and light amber from Rocky Mountain bee-plant. Two cans, 120 lbs. net, \$8.40; also 5 and 10 lb. pails. In ordering state if you want white or amber.
M. P. RHODES, Las Animas, Col.

FOR SALE.—Extracted alfalfa honey, 9½c per lb.; light amber extracted, 8½c; in cans. Sample, 5c.
I. J. STRINGHAM, 105 Park Place, New York.

FOR SALE.—White alfalfa honey at \$8.50 per case of ten gallons, weighing 122 pounds net. Buyer to pay freight charges. **H. L. WEEMS, Lemoore, Cal.**

FOR SALE.—Choice alfalfa honey. Two cans, 120 lbs. net, whitest, \$9.00; tinted, partly from other bloom, \$8.40. Also small cans.

THE ARKANSAS VALLEY APIARIES,
OLIVER FOSTER, Prop., Las Animas, Bent Co., Colo.

FOR SALE.—Buckwheat extracted honey, in large or small quantities. Write for prices.
C. B. HOWARD, Romulus, N. Y.

FOR SALE.—Extracted honey from alfalfa; 60 lb. cans at 7 cts., and smaller cans.
D. S. JENKINS, Las Animas, Colo.

FACTS About Bees.

REVISED EDITION.

How to get
GILT-EDGED HONEY

Send 2c stamp to

THE A. I. ROOT CO.,
Medina, Ohio,
or F. Danzenbaker,
Box 66, Washington, D. C.

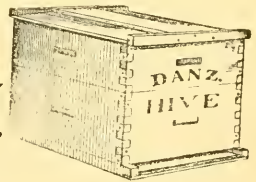

A Honey Market. Don't think that your crop is too large or too small to interest us. We have bought and sold five carloads already this season, and want more. We pay spot cash. Address, giving quantity, quality, and price.
Thos. C. Stanley & Son, Fairfield, Ill.

CHAS. ISRAEL & BROS.,

486, 488, 490 Canal St.,
Corner Watt Street, N. Y.

HONEY & BEESWAX.

Liberal Advances made on Consignments.
Wholesale Dealers and Commission Merchants.
Established 1875.

GRAND CLUBBING OFFERS.



Magazines and Post Fountain Pen
to the amount of \$9.00 for \$5.00.



Gleanings in Bee Culture.....	\$1 00
Review of Reviews (new).....	2 50
Success.....	1 00
McClure's.....	1 00
Pearson's.....	1 00
Post Fountain Pen.....	2 50
	\$9 00

All of these sent to
one or separate ad-
dresses one year for

\$5.00.

READ EVERYTHING ON THIS PAGE. ❄ Here are a few Sample Combinations.

SAMPLE COMBINATIONS.

Regular Price. Our Price

Gleanings, Review of Reviews (new), McClure's, and Success.....	\$5 50	\$3 50
" " " and Cosmopolitan.....	5 50	3 50
" " " Pearson's, and Cosmopolitan.....	5 50	3 25
" Success, McClure's, and Cosmopolitan.....	4 00	2 75
" " " and McClure's.....	4 00	2 75
" " " Cosmopolitan, and Pearson's.....	4 00	2 50
" " " and Cosmopolitan.....	3 00	2 00
" " " and Pearson's.....	3 00	2 00
" " " and McClure's.....	3 00	2 25
" " " and Munsey's.....	3 00	2 25
" " and Success.....	2 00	1 50
" " and Cosmopolitan.....	2 00	1 50
" " and Pearson's.....	2 00	1 50
" " and Woman's Home Companion.....	2 00	1 50

Other Combinations can be made from the Table Below. *Every order must include Gleanings.*

No. 1. * 25 cents.	No. 2. * 50 cents.	No. 3 * 75 cents.	No. 4 * \$1.00.	No. 5 * \$1.25.	No. 6. * \$1.50.
Am. Poultry Advo. Poultry Keeper. Rel. Poultry Jour. Poultry Monthly. Am. Poultry Jour. Farm Poultry Farm and Home. Farm & Fireside. Ag. Epitomist. Prairie Farmer.	Success. Woman's Home Companion. Ohio Farmer. Mich. Practica " Kansas " Indiana " Cosmopolitan Pearson's	Munsey's. McClure's. Rural N.-Yorker Nat'l Stockman and Farmer	Am. Gardening. Christian Herald Post Pen.	Rev. of Reviews. Country Gentle- man. Youths Compa'n <i>Orders for these three must be for new subscribers.</i>	Pacific Rural Press. Country Gentle- man (renewal).

*These prices are not the publishers' prices for these papers, but they are our special reduced prices when taken in connection with GLEANINGS. In many cases they are just one-half the regular rate.

How to get the Price for any or all of the Papers Named Above.

1. Gleanings in Bee Culture, one year, \$1.00.
2. If you want only one additional paper, add the price found in the top of the column in which that paper appears. For instance: Gleanings, and Success (2d col.) will cost you \$1.50.
3. If you want several papers in addition to Gleanings, each one may be had at the price named at the top of the column. For instance: Gleanings, Success (2nd col.) and Rural New-Yorker (3rd col.), will cost you \$2.25.
4. You may select as many papers from each column as you wish.
5. Every order sent us must include Gleanings.

CONDITIONS.—Offers subject to withdrawal Dec. 31, 1900. Subscriptions to the Review of Reviews, Youth's Companion, and Country Gentleman must be strictly new. New subscriptions sent for Success, Youth's Companion, or Gleanings will receive the balance of this year free. Neither the Review of Reviews or Post Fountain Pen will be sent in any combination amounting to less than \$2.50.

CHRISTMAS PRESENTS.—We will send all papers or pen to one or separate addresses as desired. In this way you can easily make desirable Christmas Presents.

THE A. I. ROOT CO., Medina, Ohio.

Special Notice!

Last winter's cut of basswood is the whitest it has been for many seasons. We are now making sections out of this new stock, and therefore are in a position to furnish you with the very finest quality in the market.

Lewis' - White - Polished - Sections - are - Perfect IN WORKMANSHIP AND COLOR.

Orders shipped immediately upon receipt. Five different styles of Bee-hives. A complete line of every thing needed in the apiary. Lewis Foundation-fastener, simplest and best machine for the purpose. Price, \$1.00, without lamp. Send for our catalog.

G. B. Lewis Co., Watertown, Wis., U.S.A.

BRANCHES.

G. B. Lewis Co., 19 So. Alabama St., Indianapolis, Indiana.
G. B. Lewis Co., 515 1st Avenue, N. E., Minneapolis, Minnesota.

AGENCIES.

L. C. Woodman, Grand Rapids, Michigan.
Fred Foulger & Sons, Ogden, Utah.
E. T. Abbott, St. Joseph, Missouri.
Special Southwestern Agent.

Biggest, Brightest, Best---The Ohio Farmer.

== Only 60 Cts. a Year.== Cleveland, O.== A 20-page Weekly.==

There is no other weekly farm paper published that has as large an actual list of paid-in-advance subscribers as THE OHIO FARMER has. Farmers read it and pay for it because it is clean, reliable, practical, and progressive. It is a 20-page weekly (often 24 pages) with the largest staff of editors and correspondents (all farmers) of any farm paper published; liberally illustrated every issue. Our subscription price is only 60 cents a year (52 copies), making it the cheapest, as well as the best, in America. We furnish free sample copies on request, also our illustrated premium list of useful articles, which we furnish at wholesale prices, or give free for clubs of subscribers. Send for these and clubbing rates with other papers, all at cost price.

**Our
Special Offer!**

For only \$1.10 we will send *The Ohio Farmer* and *Gleanings in Bee Culture* both one full year. *Gleanings in Bee Culture* costs you \$1.00, and you can get *The Ohio Farmer* one year by adding 10 cents. Subscriptions may be either new or renewal. Send all orders to

THE OHIO FARMER, - - - CLEVELAND, OHIO.

In writing advertisers please mention Gleanings.

24213

Wm. A. Selser, Honey Expert,

Office of the A. I. Root Company.

10 Vine St., Philadelphia, Pa.

BEST WHITE

ALFALFA HONEY

IN 60-POUND CANS.

We have a quantity of the finest white alfalfa honey in 60-pound cans at these prices: Sample by mail 8 cts.; two 60-pound cans, boxed, at 9 cts. a pound; 4 or more 60-pound cans, at 8½ cts., f. o. b., Chicago. Cash must accompany each order.

Remember, we are

**HEADQUARTERS IN CHICAGO
FOR BEE-SUPPLIES.**

We carry a full line of the best goods for bee-keepers, and would like to serve you. Give us a trial.

THE AMERICAN BEE JOURNAL

we issue every week. You should have it. A sample will be mailed free, and also our bee-supply catalog. Ask for them. Address

GEO. W. YORK & CO.,

118 Michigan St.

CHICAGO, ILL.

Bee Supplies.

Root's Goods

— at —

Root's Prices.

My stock is complete. My prices are right. Send for catalog, mailed free.

SEEDS.

I make a specialty of FIELD and GARDEN SEEDS. Send for my ILLUSTRATED CATALOG. My seeds are true and reliable, all tested by me personally.

C. H. W. WEBER, CINCINNATI, O.
2146 CENTRAL AVENUE.

HONEY-JARS.

One-pound square, \$5.00 a gross; with labels, \$5.60 a gross.

Cartons & Shipping-cases

for all sizes of sections. Our cartons are of a superior quality of cardboard, but cost no more than others. Sample free. Untested Italian queens, 60c. Tested, \$1.00. Catalog free.

I. J. Stringham, 105 Park Place, N. Y.

Apiaries at Glen Cove, L. I.

GLEANINGS

A JOURNAL DEVOTED TO BEES AND HONEY AND HOME INTERESTS.

BEE CULTURE

ILLUSTRATED
SEMI-MONTHLY
Published by THE A. I. ROOT CO.
\$1.00 PER YEAR MEDINA, OHIO.

VOL. XXIX.

JAN. 1, 1901.

No. 1.



H. G. QUIRIN thinks the loss of young queens results in many cases from the lack of young brood in the hives.—*Amer. Bee-keeper.*

“ALL CHEAP QUEENS are not inferior, but facilities and care necessary for the production of good queens are expensive,” is a wise word from Editor Hill.

IT MAY BE WELL to suggest that if J. Warren Arthur saves seed from the first crop of that short-tubed clover (p. 968), the chances will be better for short tubes in the progeny.

O. O. POPPLETON says that virgin queens caged and introduced upon removing the old queen do not lay nearly so soon as if they emerged from the cell among the bees.—*Amer. Bee-keeper.*

THE BROOD-NEST is placed near the entrance, says C. P. Dadant in *Revue Int.*, the better to protect the colony against the incursions of robbers, just as we build our forts on our borders rather than in the interior.

LEBRECHT WOLFF says in *Centralblatt* the honey-bee is the most intelligent of insects, as indicated by the size of its brain. The brain of the bee is $\frac{1}{14}$ of its entire body; that of the ant, $\frac{1}{256}$; May-bug, $\frac{1}{3520}$; water-bug, $\frac{1}{4200}$.

JOSEPH BETHKE reports in *American Bee Journal* that he put 56 colonies of bees in cellar Oct. 7, 1899, and took them out April 10, 1900, and they all came out strong in bees. That was 185 days' confinement—a trifle more than half a year.

EDITOR HUTCHINSON says there is no occasion for bleaching comb honey in his part of the world, for all the combs the bees build are white. Now I'd like to know whether, in Michigan, sections sealed white in June will remain white if left on the hive till August.

WITHOUT the possibility of collusion between the two, Thaddeus Smith, p. 969, and a writer in one of the Australian journals make the same objection to Mr. Pender's low esti-

mate of the amount of honey required to make a pound of wax. Yes, Mr. Editor, that's a good point for the experiment stations to settle.

PRIVATELY, I want to say to J. E. Crane, “When you try sugar and water in equal quantities for feeding (p. 970), don't forget to try a few colonies by pouring dry sugar in the feeder and then pouring wet water on top. The percolating idea has all passed away, and it's just possible the mixing-in-advance idea may go to keep it company.”

SUPPLEMENTING the good advice Bro. Doolittle gives farmers, p. 967, I should say, be sure to have hives big enough. An eight-frame hive may be the best thing for comb honey in the hands of a man who gives close attention to his bees; but with the man who gives little attention to his bees it would lead to too many cases of starvation.

IT IS SAID in *Bienen-Vater* that queens from unusually large queen-cells are no larger than those from normal cells. And I think Doolittle says the largest queens are no better than the medium ones. The most prolific queen I had the past summer was remarkable for small size. That doesn't say small queens are best, but that they may be good in spite of their size.

AT ONE TIME ye editor raised the question whether any considerable amount of propolis could be secured. Now that there's a possibility of a market for it, I may say that I think I might offer from 10 to 40 pounds every year. [I learn that Frank Benton actually sold 25 lbs of real propolis. I suppose if a demand should be made for that article, a considerable quantity of it could be gathered up.—Ed.]

A. I. ROOT has tackled a tough problem when he starts in on the “hired girl” question, page 972. On one point I'm with you, Bro. Root: Any one that isn't fit to sit at table with me isn't fit to stay in the house with me. In the *Christian Endeavor World* a story written by Chas. M. Sheldon is now running, in which a refined college graduate has become a hired girl. I'm anxious to know how she makes out.

CURIOUS how far out of the way one may be when at a distance. A writer in *Revue*

Eclectique says Americans have no guide but the eye in spacing frames, and space them $1\frac{5}{8}$ in summer and $1\frac{3}{8}$ in winter. [It is probable that the writer did not understand that the self-spacing frame is very largely used in the United States. A large percentage of the modern hives sold—at least of the number we sell—contain the self-spacing type.—ED.]

BOTTLING HONEY occupies some six or eight pages of last GLEANINGS, and then on p. 970 the editor coolly informs us that he has begun the subject. Say, Mr. Editor, are you going to drive all us comb-honey fellows to extraction? I must confess that, if you should go to arguing that it would be better for the country at large if every one should produce extracted rather than comb, it might be hard to meet the argument. [Yes, I have on the string several more articles on the matter of bottling honey, each touching on a different phase. When I went into the subject I little realized that there was so much in it that had never been exploited before the bee-keeping public.—ED.]

"WHILE SNOW-WHITE" is the time Doolittle says to take off sections, p. 968, just as if they would get dark by staying on. Bro. Doolittle, don't you know we are told that the dark color runs clear through the cappings? Yet I must confess that my bees are just as much out of order as yours, and in nearly all cases cap the honey snow-white, and later plaster it with the dark stuff. [The dark color does not always run clear through the cappings. I suppose you refer to a statement I have made. A large part of the travel-stained honey I have examined has shown the stain clear through. Whether this stain is due to the fact that the discoloration strikes through like ink through blotting-paper, or whether it is due to some other process, I can not say. It is very evident that, in the matter of travel-stain, there is a great difference in locality.—ED.]

SULPHURIC ACID makes dull-colored wax yellow (p. 971). How? Isn't it by operating on particles of dirt that wouldn't settle without the acid? I'm asking the question because I don't know. What I do know is that in this locality the dirt in an ordinary cake of wax cooled rapidly is enough to have a very decided effect on its color, and when cooled slowly the color is different. I remember distinctly being at a bee convention when it was held as a secret that slow cooling would clear wax, and I wasn't in the secret. If a beginner should to-day ask me how to get bright-looking wax, I should feel pretty sure of hitting the case nine times out of ten by saying, "Cool slowly." [I do not know, and I have not yet found any one, not even chemists, who can explain why sulphuric acid lightens the color of wax. It is not altogether a matter of dirt, by considerable. The acid has the effect of bleaching, and I am not sure but that is the only effect. Slow cooling certainly does allow the particles of dirt to settle out of the wax. But suppose you take a cake of dark wax, and break it in two in the middle. Melt one portion, and allow it to cool slowly over

hot water. Melt the other portion, and add a few drops of sulphuric acid in the water over which the wax is melted, and just note the difference in the effect.—ED.]

THE BELGIAN government pays annually \$5000 for bee-keepers' conferences or conventions. [And this money is well invested. I am looking forward to the time when our own government will see its way clear to appropriate at least \$500, or a tenth of the amount offered by the Belgian government, to help maintain a national bee-keepers' association. To my mind, Uncle Sam's best investments are not in great guns and big war-ships, but in the amount annually appropriated to maintain the Department of Agriculture that is now and has been doing such good work for the rural classes in the United States. When our Congressmen can see their way to go a little further to appropriate additional funds for the purpose of conventions of all sorts, calculated to help the people of this country to a better understanding of how to earn their daily bread, we shall be taking a step in advance. There are many people who read books and papers, but there is a large class who scarcely ever read any thing, and yet they would attend conventions and farmers' institutes. It is true that several of the States are doing considerable in this direction already; but there is room for more work in this line yet.—ED]



Close every entrance just $\frac{3}{4} \times 1$;
The sleet-mailed storm-king now doth roar;
At every crack he tries a vantage-ground to seize,
And force his presence on the clustered bees.

Utter lack of amity in Amity, apparently. See editorial notes of travel in the land of Goshen.

Rambler's article on amateurs is worthy of a second reading. The disparaging remarks we often hear about amateurs is owing to the fact that the word is wrongly used for novice or beginner. An amateur works for the love of it. Newton, Franklin, Humbolt, Herschel, and hosts of other men prominent in their lines, were amateurs. See article following.

According to a writer in the *Bulletin de la Somme*, Dr. Terc, of Vienna, treats rheumatism with bee-stings. He has tried his plan in 173 cases, making 39,000 stings. He claims to have had undoubted success. "And yet," says the writer, "one grumbles when stung once."

Mr. York speaks of a man whose application for life insurance was rejected because the doctor found sugar had passed the kidneys; and the question was whether or not it was

due to the sugar in honey or to common sugar. A good French writer now comes forward and recommends honey mixed with rye flour, the yolk of an egg, and a little butter, as a valuable aid in case of kidney troubles.

A writer in the *Bulletin de la Somme* urges bee-keepers in general to contribute for that journal in order to add to the general stock of information. For the benefit of those who fear they can not write good smooth French he says :

We have a large number of practical bee-keepers who have a good many bright ideas in their heads, and who could interest us by sending them to the *Bulletin*; but they fear they will be lacking in respect for the rules of grammar, and hence they refrain. But Editor Guerin is a scholar; and as he has worn his pants thin on the school-bench it will be to him a pleasure and a joy to reconcile their prose with the rules of grammar.

The same advice might be given here. The very thing that one writer would consider a trifling event might be the missing link in a very important chain that somebody else has been unable to link together. Yes, Mr. Guerin is a scholar, and is doing much for apiculture in France.

Mr. Maurice Conquaux, proprietor of *Le Miel* (The Honey), has just published a book entitled "Apiculture in France at the Beginning of the Twentieth Century." It is a history of apiculture in all the departments of France. One will find in it every thing concerning the flora; the names of apicultural societies; the names of apicultural writers and practitioners, and manufacturers of apicultural articles. One might wish for a similar work for this country; but owing to the vast size of the United States compared with France the work would be difficult of preparation in proportion.

REVIEW INTERNATIONALE.

The great task before the bee-keepers of Europe, as here, is to get their honey into market. Mr. Ulrich Gubler, a celebrated writer, says :

As everybody is complaining that honey does not sell, we should take every occasion to make known the qualities of this product. During winter there are often bazars or auctions to help along philanthropic work. Do not fail to contribute to their success by donating several sections of honey, neatly labeled. If buyers do not come to you, you must go to them. Don't you remember a trick resorted to by Mr. Smith, a manufacturer of shoe-blackening? Finding business slow he engaged several persons to visit certain stores and call for Smith's blackening. As these calls were repeated the merchants got their eyes opened and put the blackening forward; and as it was a really good article, Smith's success was assured. If bee-keepers and their friends while traveling would call for honey at hotels the proprietors would be compelled to buy it and put it on their tables.

RUCHER BELGE.

A writer says that, although all the changes have been rung in regard to honey as a medicine, yet its value, he thinks, is not well enough understood by those suffering from diseased kidneys, spleen, and pancreas. He suffered greatly from hereditary kidney trouble, but after reading an article in a German

paper he resolved to abstain from all dishes containing sugar. In a short time his troubles disappeared, and returned only when he used sugar; but meanwhile, he says, he used honey freely. Whether he was helped by the minus sugar or the plus honey or both might be a debatable question; but at all events he recommends honey highly in such cases, and urges that doctors make further use of it. As to stings, he says a person of his acquaintance was cured of tuberculosis by inhaling formic aldehyde, and was also cured of a persistent diarrhoea by the stings of bees applied to the abdomen. He says that the use of honey does not keep pace with its production in France. Many things conspire against it. For one thing, sugar, which is good for those whose organs are sound, is largely used in place of honey. Then the high price of honey at the groceries, together with its low grade, tends to drive away customers.

BRITISH BEE JOURNAL.

A writer makes a strong plea for a fund to protect bee-keepers from unjust legislation and attack; and he urges that not only enough be provided to meet each case after it arises, but a standing fund to be ready for any emergency. The wisdom of such a course has been fully demonstrated in this country by the National Bee-keepers' Association. It seems our British friends have nothing quite similar. See editorials.

The following paragraph by Mr. W. A. Vari-an, of Dublin, in regard to sweet clover, seems so pertinent and well written that I copy it just as it is.

Sweet clover, or Bokhara clover, as it is variously named in the United States, is a biennial. When grown from seed in the spring, it makes a fine growth for hay, or green feed for cattle in the late summer; but it does not flower in its first season after sowing. The second-year growth starts earlier than alfalfa (lucerne), so there is a good "bite" for stock before the latter shows. In fields where both are growing, these young plants look very much alike. The melilotus, however, will endure as much drouth as alfalfa, while it will do well on a much wetter soil than the latter. It cares nothing for the hard winters of the Western United States. I believe it was introduced into the States from Tartary as a dry-weather forage-plant for stock, but was not taken kindly to by the ranchmen, and has since spread as a weed all over the West, from Michigan to Colorado, during the past twenty-eight years. This result comes about because it sprouts in spite of the small attempts of the careless, slovenly farmer, and grows wild along the sides of roads, railways, and irrigation ditches. It also spreads over neglected corners and commons, apparently not caring how hard or poor the soil is, where the climate suits, for I have seen it growing as high as 5 ft. when in flower. The plant bears a great number of insignificant-looking bunches of little white flowers which give out a strong smell of honey, quite perceptible some distance away.

Concerning the good effects of propolis in certain diseases of animals I give the following for what it is worth, as it seems to be fathered by Mr. Gravenhorst's journal in the first place :

A landed proprietor reports in the *Deutsche Bienenfreund* that he requested a veterinary surgeon to prescribe for cattle suffering from the foot and mouth disease. The veterinary replied that no remedy was known to him. On the recommendation of a farmer, however, he tried propolis, with the following re-

sults. He says: I washed the feet (resp. claws) of the cattle affected, with propolisin solution, and gave each animal about one teaspoonful of the same on a piece of bread two days running. The results far exceeded my expectations. Not only did the animals eat their food next morning with relish, but the supply of milk increased again to its former quantity, and fever disappeared. Thus in several days I had quite got rid of the plague; and I am of the opin on that if propolisin is applied in good time, before the disease has been able to make much progress, the epidemic can be easily held in check.

▼

Snakes as enemies of bees is an old theme. Here is a practical illustration of the matter:

A bee-keeper gives an interesting account of a swarm which he noticed one day at the corner of a wood while out for a walk. He ran home to fetch his swarming-tackle, but was surprised to find on his return that the whole swarm was in a state of great excitement, and on closer inspection found that a ringed snake had crept into the middle of the cluster, where it had evidently thought to enjoy a hearty meal. Having, however, removed the snake (which was already by this time considerably injured by stings), the swarm settled down, was afterward hived, and has since developed into a satisfactory colony.



AMATEUR BEE-KEEPERS.

Their Usefulness.

BY RAMBLER.

When we mention the name of an amateur in any profession we usually convey with the name a disparaging remark. For instance, the amateur photographer, always snapping his camera in season and out of season, is termed a fiend. Probably the term "amateur" has fallen into disrepute just from the free use of the snap-shot camera. Any way, each individual trade is not given to praising its amateurs.

Let us give a few moments of attention to what relation amateurs bear to bee-keeping. I have a book on the table before me that gives a brief account of the first amateur bee-keeper—Samson, the son of Manoah. We can infer from Samson's conduct that he was naught but an amateur, for no *professional* bee-keeper from that day to this would be guilty of stalking off across the country to visit a Delilah. Some writers go so far as to claim that Samson invented the movable frame hive, from the supposition that the bees built the combs to the ribs of the defunct lion; and it was the comb attached to one of these ribs with which he sweetened himself. But, like all amateurs, he failed to get his idea patented, and thereby missed a great opportunity.

Coming down the stream of time, the next amateur of importance is the immortal Virgil. He left a distinct and lasting impress upon the industry; and no doubt the practical bee-keeper of his time derived great benefit from his researches.

I am inclined to put Huber in the amateur class. He was not dependent upon the indus-

try for his sustenance, and, owing to his infirmity, he had to turn the management over to other parties; and while some profit was made from the bees they were worked with the paramount idea of scientific research; and the results have been of the utmost value to bee-keepers. Cotemporary with Huber, and following in his footsteps, were many German investigators who were amateurs.

Crossing the ocean, in our own land we find the man we love to term the father of American bee-keeping—Langstroth. His invention of the movable-comb hive gave to the most crude bee-keeper a key with which to open the mysteries of the hive, and to enhance the profit of the same; and if he were the only amateur who has aided in developing the industry, that invention alone is enough to give lasting fame to the amateur.

Naturally, in due time the honey-extractor followed the invention of the movable frame, and this too was given to us by an amateur—Hruschka.

I may now get myself into trouble; but I am going to put A. I. Root into the class of amateur bee-keepers. A manufacturer of bee-keepers' supplies can have a large number of colonies of bees and still not be a professional, for he is not dependent upon his bees for his living. Then when said apiary is turned over entirely to other parties for management, and the owner goes off after greenhouses and gardening, of course he is an amateur bee-keeper. And what has amateur A. I. Root given to the fraternity? He gave us the pound section and the dollar queen. He has given us GLEANINGS IN BEE CULTURE and the "A B C of Bee Culture," the most popular up-to-date text-book, and the largest supply-manufactory in the world, where new things too numerous to mention are being tested and introduced, and bee-keepers are handling the industry with less manual labor than in former days.

Prof. A. J. Cook is another amateur, and has given us an excellent manual, and continues to give us good things from time to time in the journals.

George W. York, of the *American Bee Journal*, is another very useful amateur, and follows weekly in the steps of Samuel Wagner, its founder, and an amateur. In the same connection we place Thomas G. Newman, editor, author, and staunch defender of the rights of bee-keepers, and an amateur.

Arthur C. Miller, who gave us the hot-plate foundation-fastener, is an amateur, and may possibly soon give us another useful machine.

When I once met Mr. Danzenbaker he was an amateur bee-keeper. He will possibly now claim to be a professional, but I am sure he invented his hive while an amateur.

Crossing the ocean again, we find J. Mehring, a German, the first inventor of comb foundation. He was an amateur.

In England we find many amateurs, among them Cheshire, who gave us a fine work upon scientific and practical bee-keeping; and Mr. Thomas W. Cowan, editor of the *British Bee Journal*, and author of a very correct and comprehensive work on bees, also inventor of the Cowan honey-extractor.

There are probably many other useful amateurs; but from the foregoing the amateur bee-keeper shows up well for usefulness. May he continue to bless the fraternity.

QUEEN-REARING IN FRANCE.

Following American Methods; 314
Queens from One Hive; How
it was Done.

BY GIRAUD-PABOU.

I began bee culture in 1889. In 1892 I adopted the Dadant hive, a hive with frames $11\frac{1}{2} \times 16\frac{1}{2}$, 12 frames in a hive. In 1893 I harvested an average of 66 lbs. per colony. One hive gave us a crop of 143 lbs. It was then that I began to see the advantage of selecting breeders for queen-rearing. We subscribed to the *Revue Internationale*, of Bertrand, bought the "Hive and Honey-bee," and also subscribed for the *British Bee Journal*, which one of my sons was able to read. We finally dropped this paper to take *GLEANINGS*, and it was in the last-named magazine that we found our new method of queen-rearing, taken from different writers.



FIG. 1.—DOOLITTLE CELL-BUILDING; FIRST ATTEMPT.



FIG. 2.—DOOLITTLE CELL-BUILDING; LATER ATTEMPTS.

The past spring we tested several colonies to ascertain which one was most likely to raise a great number of queen-cells. The colony selected was placed in a hive holding 18 large frames, and divided in two by a partition of perforated zinc to keep the queen out of the compartment in which the queen cells were to be reared. The cells were made of artificial cups by the Doolittle method, with larvæ 24 hours old, and each provided with a little royal jelly, as we had noticed that they were less readily accepted when they were not provided with any jelly. The queen-rearing compartment was divided as follows: Against the perforated zinc, one comb of brood, next to this the frame upon which are fastened the slats bearing the cell-cups, as in the cut sent first, eighteen or twenty cells in two rows; next to this another comb of brood, then another frame bearing on five slats the cell cups taken from frame No. 2 as fast as they are sealed, each slat being numbered to take the cells in regular order. See photos sent with this letter. The fifth frame is again brood, and the others

are pollen and honey. The brood is renewed from time to time with brood taken from the same queen on the other side of the perforated partition. So this hive makes a continual hatching of queens possible, while it keeps up a hive full of bees, since it has a good queen laying. As soon as the cells are ready to hatch they are placed in cell-protectors and given to nuclei. Our nuclei are made to contain ten half frames such as are described in the "Hive and Honey-bee" (page 267, American edition) by Mr. Dadant, who used them himself when he reared queens for sale. We find them better than the same surface in large frames, and they can be joined together when the nuclei are either destroyed or enlarged.

CANDIED VS. BOTTLED LIQUID HONEY.

Figuring up the Profits on Bottled Honey; Answer to Mr. Aikin.

BY CHALON FOWLS.

And now remember, Mr. Aikin,
Nae kind of license out I'm takin';
Frae this time forth I do declare
I'se ne'er ride horse nor hissie mair.

—Robert Burns.

As suggested by the editor I will now "pay my respects to the Ridgpole (F)owl." It seems the sage of the Ridgpole must have been *Aikin* for a fight or he would not have started out gunning after Ohio poultry. He "puts up a good game too" as defense, but he



GIRAUD-PABOU AND WIFE READING GLEANINGS.

In this manner one single hive reared and brought to the hatching-point 314 queens, all from this single selected queen, during the season of 1900. Our first trials in this line were made in 1897, but we did not fully succeed until the summer of 1899. This year the result was superb. We have about 100 colonies, and make our own foundation, as we are unable to find anything but adulterated goods on this side of the ocean.

[The above was translated by C. P. Dadant, who says Mr. Giraud-Pabou has three sons with him, the youngest of whom is 16. They are in the mercantile business at Landreau, and their speciality in the bee business is queen-rearing.]

‡ The person holding the frames of completed queen-cells is a son of Mr. Pabou, and probably the one who achieved such remarkable results in queen-rearing. Even a Doolittle or a Pridgen might be proud of that batch of cells shown in Fig. 2.—ED.]

should have noticed that in my article on page 304 I disclaimed any intention of attacking his methods of marketing in Colorado.

I suppose in the "wild and woolly West" they have such great crops that, with the sparse population, there is a perpetual glut in the honey market, and no doubt 6 cts. a pound, or the price of sugar, is all it will bring; but the case is different down here. People are willing to pay something for flavor.

Now, Bro. Aikin, you may be safe clear up on the top round of the apiarian ladder with that owl so close; but he is an old enemy of the fowl tribe, and I have mounted up high enough to get a squint at him, but I shall urge my numerous family to get after you both.

You say he's peaceable; but I'm too old a Fowl to be fooled like that. I can see through his thin disguise, and I'm going for him with my gun and a *brimstone-pot*, for he's a *Miller*, and I always tell my friends to *beware of those*.

Now, I've no quarrel with you for selling candied alfalfa honey at whatever price you can in Colorado; but just wait till I catch Dr. Miller. He talked about selling candied honey in Ohio. Editor York said he ought to keep his fingers out of the pie, and I am afraid for our pie, for he looks as though he might have a bad mouth for it.

Now, Bro. Aikin, no doubt I am but a bungler in the use of language, and that is probably the reason I did not make myself understood in my article on page 304, and I want to make it plain now that I do not now and never did intend to criticize your methods of marketing in Colorado; and the opinion expressed by the New York man you mentioned is his sentiments and not mine. But when it comes to applying your methods, that are perfectly proper in your section, where the supply always exceeds the demand, to our section, where the demand exceeds the supply, then I protest that such a policy would not help us, but would be a real damage to our market. And now that we are discussing the subject I want to call attention to some misconceptions in your article. I did *not* say that your alfalfa honey would bring 25 cts. a pound in Oberlin, but I *did* call attention to the fact that Mr. Selser's fine bottled honey was selling for that; but that was clover, if I am correct, and I do not think that alfalfa honey would sell here or anywhere in this section at the highest price; and in saying this I mean no reflection on the quality of alfalfa honey, but just this: While alfalfa honey would bring the highest price in *your* market, clover and basswood would sell higher here, as the people are accustomed to the flavor, and regard with suspicion any thing different; so you see I could not buy your honey, for it would not do for my trade at all. I tried alfalfa honey of the best quality years ago, and know that nine out of ten of our people will take clover and basswood, even at a higher price, and I have been paying 10 cts. per pound for the latter in ton lots when I could get alfalfa honey at 8½.

Now a word about selling prices and commissions. I want you to understand that that "pesky stingy Fowls" is not getting rich bottling and selling honey—not by a long shot, but I am just making wages in buying and bottling honey in off years, with the idea of holding trade so as to have a good market for my honey when I do have a good crop; and if I had to sell at prices at which candied honey sells for, or such prices as obtain a thousand miles west, I should be in a worse fix than the Irishman in your cartoon, for I should not be able to get even bread for *my* Molly. Now it's my turn to do a little figuring.

The A. I. Root Co. and myself are selling at the same price to the trade; viz., \$2.25 per dozen for the No. 25 jar (one-pound size), and the grocers retail them at the uniform price of

25 cts. each. The best honey is worth 10 cts. per lb. at Medina (see p. 794); Root's No. 25 jars are \$7.00 per gross, about 5 cts. each, or a little more if you allow for breakage; then allowing, say, ¼ cent more for labels and freight from Medina on honey and jars makes 15¼ cents; cost of selling, 10 per cent of \$2.25, or nearly 2 cts. more, makes 17¼ cts. I will explain that I pay a drummer for a wholesale grocer 10 per cent to take orders for me in near-by counties, and I also sell some to wholesale grocers at about the same discount. But the largest share of my honey is sold to the grocers in my own county; and when hauled to the neighboring town and delivered from my wagon at each store I am sure that the extra 10 per cent is honestly earned. So in either case there is the cost of selling to be deducted, which makes it about as follows: Net price to grocers, 18¾ minus 17¼ equals 1½—a little over 1½ cts. per lb. for hauling the honey and jars from the depot and back again; unpacking and washing jars, liquefying, filling, sealing, and labeling, as described in the Dec. 15th GLEANINGS, after which the



FOWLS AND HIS FOWLS AFTER THE OWL(D) MAN.

jars are to be wrapped and boxed, tagged, and stenciled "Glass, this side up," so as to ship safely, and then there are the bills to make out before I can get my money back, and there is interest on the capital invested yet to account for, and, say; am I getting too much for my work?

It might be figured a little more in my favor, but not much. Perhaps you will say that your arrangement of prices would be better, as you would give the retailer only about half as much, and allow me 5 cts. a pound, which would give me a good profit after allowing for the work. But I will explain that, after trying both ways, I am satisfied that it pays to arrange it so that the retailer will have a good profit. If his margin is too small he will not care to handle it, but will very likely take glucose mixtures that will bring him 40 or 50 per cent profit. No doubt some would say the retail price, 25 cts. a pound, is too high; but it is no higher than comb honey when put up in the No. 25 jars, as the buyer gets a very fine self-sealing fruit-jar worth 4 or 5 cts.; besides, the price of pure honey should be higher than glucose mixtures. To illustrate: Be-

fore my prices were raised, the half pound glasses were retailed at 10 cts. each. The dealer's profit was much smaller than on the glucosed honey, and his customers would often say, "Why, this brand is labeled pure; but I don't believe it is, for it is all sold at the same price, and this other kind I as the

groceries, and sells very slowly at a low price; and while locality and the supply and demand have very much to do with it, that is not all the reason for good prices. General attractiveness counts with almost any thing. This is a great dairy region, and butter *sometimes* se'l's for 10 cts. per lb.; yet a fancy article,



READY FOR THE RAILS.



READY FOR THE STRAW.



READY FOR THE EARTH.



READY FOR THE WINTER.

WINTERING BEES IN CLAMPS; SEE NEXT PAGE.—*Bee-keepers' Review*.

formula printed right on it." No, the grocer's profit is not too large, and I am not alone in this opinion either, as is shown by the fact that able business men like Mr. Selser and The A. I. Root Co. have adopted this same policy; and, Bro. Aikin, the demand here in Ohio for choice honey, put up liquid in neat and attractive style, is *constantly increasing*, while candied honey is seldom seen in the

coming from some one who has a reputation of producing only the best, *always* brings 25 cts. a pound or more.

Oberlin, Ohio.

[I have concluded that it would be better for me to keep out of this mince pie or I'll be dreaming of owls, fowls, and all kinds of night-hawks. After all, both are right for their localities.—Ed.]

WINTERING BEES BY BURYING THEM IN CLAMPS.

Ventilation vs. no Ventilation; some Interesting Experiments.

BY W. Z. HUTCHINSON.

For many years I have wintered bees by burying them in the ground, much as farmers bury potatoes and other vegetables. I don't remember where I first got the idea, but I do remember having some correspondence on the subject with Mr. C. J. Robinson, of Richford, N. Y. He very persistently urged me to give no ventilation. He asserted that the bees would winter better with no ventilation—that the hibernation would be more perfect than in a "sea of oxygen." I was very loath to take this advice; and it was with many misgivings that I finally ventured to risk six colonies with no ventilation except that which would come through the earth. At the same time I buried a dozen other colonies, giving them ventilation by means of a four-inch tube laid along the bottom of the trench, and extending out into the outer air. There was also a similar tube at the top, extending from the bottom of the pit up through the earth some three or four feet. I remember that I had a thermometer hung, by means of a string, in this upper tube, and that I often climbed up and drew up the thermometer to learn the temperature. The outside temperature had very little effect upon that inside the pit. When the mercury stood at zero in the open air, the thermometer drawn up from the clamp showed 43°. It did not vary three degrees from this in all winter. The bees wintered perfectly in both clamps. It seemed as though they were just about the same as when set in the previous fall. The straw around them, and the hives and combs, were dry and clean, and free from mold. My belief in the ability of bees to pass the winter with no ventilation was greatly strengthened. The next winter I put 32 colonies into one clamp, and wintered them perfectly with no ventilation. This brought my confidence up to such a height that, the next winter, I put 96 colonies into one clamp, and *lost nearly all of them*. There were 16 hives that had live bees in them when dug out in the spring. These were weak in numbers, and several of them balled and killed their queens when they were set out. This was the most serious loss with which I ever met while in the bee-business. There was no dysentery. The combs were clean and dry and full of honey, but the bees had deserted the hives, and crawled all through the straw. Perhaps the heat generated by so great a number piled in such close quarters drove out the bees. Perhaps they went in search of air. They certainly went.

Since then I have several times wintered a dozen colonies in one clamp, and always with good success except in clay soil. Two or three times I have tried it there, and the bees wintered poorly, the hives and combs coming out in the spring reeking with mold and dampness. My successes have all been on a dry sandy hillside. With such a location I should

have no hesitancy, whatever, in putting any number up to 25 or 30 into a clamp. It is possible that a large number might winter all right if given sufficient ventilation, but I am without experience on that point.

The work of burying the bees is about as follows: First dig a trench wide and deep enough to allow the hives to be set down in till the tops of the hives are level with the surface of the earth. Put in a little straw and lay in two rails a foot apart. Set the hives in a row on these rails. Put some straw around the hives, and then lay some rails over the hives, putting some short pieces of rails across under the rails to support them. Next cover the hives liberally with straw, say to a depth of two feet, and then shovel on the earth to a depth of 18 inches. Sometimes I vary this by putting on only a few inches of earth, and then another layer of straw, and then a few more inches of earth, covering the whole with a light covering of manure.

I do not know that wintering bees in clamps has any advantages over that of wintering them in the cellar, and it is certainly considerably more work; but when one has a few colonies to winter at a place where there is no cellar, and experience has told him that indoor wintering is better than outdoor, he can successfully winter the bees by putting them in a clamp, if the soil and location are suitable. Don't winter in clay. Don't bury them where water will stand. Don't try wintering large numbers without ventilation; in fact, my experience is against large numbers, and I do not know that there is any objection to giving ventilation, even with small numbers, but I have never found it necessary.—*The Bee-keepers' Review*.



WHAT NEXT?

"Good afternoon, Mr. Doolittle. I have my bees all fixed for winter, and thought I would come over and ask what next I can best do (to be preparing in the best way) so I may be perfectly ready for next season when it comes."

"I am very glad indeed, friend Jones, to hear that you have your bees all ready for winter thus early (October 30), for many leave the matter of preparation for winter till cold weather comes, the last of November or fore part of December. And I am also glad that you wish to commence preparations for next season now; for it gives me assurance of your success. The ancient wise man said, 'Seest thou a man diligent in business? he shall stand before kings;' and the proverb is as applicable to these times as it was to his."

"But there are no kings in this country to stand before; and if there were, I should rather know all about what I can do during the winter to best advantage than to stand before a hundred kings."

"Well, I am not so sure about there being no kings in this country; for we often read about the 'money kings' of Wall Street. But we will drop that matter, and I will ask if you have your surplus arrangements all ready for next year."

"No. I have nothing but the bees ready. What would you do with the surplus arrangements?"

"My first work in preparing for the next season has always been to get around the supers to the hives which have been in use the past season, and scrape off all the propolis adhering to the separators, or any bits of comb that may be adhering to any part of the supers, so that the sections may fit in these supers just as well as they did when they were new. If you allow propolis to accumulate on all parts of the surplus arrangements for years, you will soon find that this will make a certain number of sections of the same size occupy more space than at first, this causing fuller, or, more properly speaking, heavier, sections of honey than formerly; besides, your keys, springs, or wedges, will not work well in tightening the sections together."

"I think that would be a good idea; but how is it best done?"

"My way is to take a cold day for this, working in a cold room, because at such times the propolis is very brittle, and will easily fly off; while in warmer weather it is more pliable, and will stick tenaciously to what it adheres to. Lay the separators down on some flat surface, and with a chisel, or other iron having sharp corners, go over the surface of the separators, allowing the chisel to lie flat on the separator, when, with a swift motion over the separator, the propolis is easily knocked off."

"I think I understand this part. What next about getting the supers ready?"

"All sections which are partly filled with honey should have the honey extracted from them (unless you think you will need it to feed in the spring), as very likely the honey now in them will not correspond as to color and flavor with that gathered next season to finish out the sections."

"But will it not spoil the combs to try to extract this honey during cold weather?"

"Yes, if you try to extract while cold; but it can be done nicely by fixing a shelf close to the ceiling of your room. Put the honey thereon and keep the room so warm that the mercury will stand at 90 to 100 degrees for three or four hours before you commence extracting. By placing the honey near the ceiling it does not require nearly as much fire to heat it as it would if placed on the floor or a bench."

"What is to be done with the sections after the honey is extracted from the combs?"

"They are to be used for 'baits' as they are called, to entice the bees to enter the supers very much sooner than they would were no comb given in the super."

"How are they arranged?"

"They are placed in the center of the super generally—one, two, four, or eight being used in each super, just in accord with the number

of partly filled sections you have in proportion to your colonies. Where a person has two, four, or eight to the colony it is best to so arrange these baits that one section having only foundation in it can come between each two baits. This causes the bees to commence work in the sections between as soon as they do on the baits, and leads them to commence soon on all of the sections in the super."

"What next?"

"The next work is to make up all the sections you think you will need during the season, furnishing each with a starter of comb foundation, or filling them entirely, as you can afford or think best. Then fill out each super having baits in it with these; and those having no baits in them, entirely."

"Do you use any supers without baits?"

"Yes. I put baits only in the first super that goes on any colony. When the bees are well at work in this first super it is generally raised up, and a super with no baits placed under it, and this causes the bees to work in the second super as well as they would were baits used."

"You speak of filling the sections with foundation at this time of the year, for using next season. Will not this foundation become hard and tough where so put in, so that the bees will not work on it as soon as they would on new? I think I have read something of this kind."

"There used to be great stress laid on using only foundation fresh from the mill, or that dipped in tepid water immediately before placing on the hive; but bee-keepers soon learned that the heat of the hive softened and made pliable any foundation, no matter how old, so the bees worked it readily, providing the foundation had not been in the light long enough to bleach and harden it."

"Again allow me to ask, what next?"

"Supposing your supers are all filled, as we have talked, you are to pack them away all nicely so they will be ready at a moment's notice, when the honey harvest arrives in June, 1901; and having this done I would next look over all empty hives which are stored away for future use; and if any repairs or cleaning is needed, this can be done, and they are stored away also, all in perfect readiness for the first swarms which issue."

"One question right here: You spoke of getting the supers ready, and filled with sections; but you did not tell how many I needed for each colony I have now. How many do you calculate are needed to each old colony in the spring?"

"After trying various numbers I settled down on 150 one pound sections for each old colony I had when I was preparing the sections during the winter. Probably all of these will not be filled one year in four; but if you try to get along with less, there is likely to come a 'down pour' of honey when you least expect it, and you will not be able to secure it all by not having sections enough. It is far better to have a few too many, always, than to be caught with not enough."

"Again, what next?"

"Having your hives in readiness, and pack-

ed away, look over every thing else you have stored away which you expect to use next season, and clean and repair things up generally, so that all and every thing will be in perfect order and readiness to be used at just the right time to secure the best results; and if you have more time left, get around your back volumes of bee-papers, and any bee-books you may have, and reread these, for you will scarcely read half an hour but you will run across some little kink you had forgotten to put in practice, which will prove, perhaps, more valuable, when put in practice, than very much you may now be using. No bee-keeper can afford to neglect posting himself up during the long evenings or days of the winter months, by reading all he can get hold of on the subject. It is the man who is *best posted* that makes the greatest success out of his calling."



OWING to the great crowd in our printing department, I am obliged to omit reports of the several conventions which I have attended during the last two or three weeks. In our next issue I hope to give brief reports of all the conventions.

THE PAN-AMERICAN EXPOSITION.

ON my recent trip eastward, Mr. Hutchinson and I, piloted by Mr. O. L. Hershisser, had the pleasure of visiting the grounds of the Pan-American Exposition. Most of the buildings were well up at the time of our visit, so that we could form some idea of what the great show will be when it is formally opened next season. While it will not be so large, of course, as the World's Fair at Chicago, yet in the matter of quality and variety of exhibits I think there is no question that it will very much excel it. Its nearness to the great source of power at Niagara Falls will make the electric displays something the world has never seen before. The framework of the electric tower was well up; and this structure alone, when completed, will extend hundreds of feet into the air; and at night, when ablaze with the cataract fires of the Niagara, will make the eighth wonder of the world. There will be electric fountains, lakelets, and lagoons, beautiful parks and gardens, all over the entire grounds.

My impression is, from what I have seen thus far, that the Pan-American will so excel the World's Fair in real novelty and variety, that one will go away feeling that he has seen more than the World's Fair had to offer. The only respect in which the Chicago exposition could be said to surpass the one at Buffalo is in the matter of size of buildings and grounds.

This is not a paid puff nor an advertisement; but I speak of it because there is a possibility

that the next convention of the National may again go to Buffalo next summer.

THE MAGNIFICENT SHOWING OF THE NATIONAL BEE-KEEPERS' ASSOCIATION FOR 1900.

THE Fourth Annual Report of the National Bee-keepers' Association has just been issued. It appears that 1900 has been a record-breaker in the matter of work done.

The General Manager first calls attention to the fact that the two bee-keepers' societies, the National Bee-keepers' Union and the United States Bee-keepers' Association, were amalgamated into what is now known as the National Bee-keepers' Association.

He next refers to the case of Utter v. Utter, the one between two brothers—one a fruit-grower and one a bee-keeper; how in the lower court, before a justice, the learned judge decided against the bee-keeper, and assessed him \$25.00 and costs; of the alarm which was expressed by bee-keepers and others over the effect of this decision, especially if it were left unchallenged. He therefore, with the concurrent judgment of the Board of Directors, ordered the case appealed to the county court. This involved a pledge of \$100 toward a favorable verdict, and also the expense of expert witnesses which he had sent to the scene of the trial.

During the year the General Manager compiled and published a 12-page pamphlet showing the value of bees as pollenizers and fruit-producers.

In 1899 the Association put up a fight against adulterated honey in Chicago. While the outcome of the suit at first was unfavorable, yet it appeared from the statements of Prof. Eaton and Commissioner Jones, of the Illinois State Pure-food Commission, at the Chicago convention, that this work had not been without its moral effect. As an indirect result of the fight made, newspapers all over Chicago said so much about the matter that a pure-food bill was drafted and enacted into law, the effects of which have been such as to practically wipe adulteration out of Chicago.

Mr. Secor acknowledges his thanks to the Division of Entomology, and especially to Prof. Frank Beuton, for the valuable services rendered at various times.

He refers to several cases of trouble arising between bee-keepers and city authorities; but copies of the celebrated Arkadelphia decision were sent, which no doubt had a restraining influence. Mr. E. T. Abbott, one of the Directors, was sent to the third annual convention of the pure-food congress, which took place in Washington, March 17, 1900.

The Hakes trial, to which a representative of the Association was sent, involved the prosecution of a dealer for selling adulterated honey. The court instructed the jury to render a verdict of guilty, which was done. The result of the verdict is such that Mr. Secor has no doubt it will have a wholesome effect in Michigan and in all other States where pure-food laws are in force.

The financial statement stands as follows:

RECEIPTS.

Bal. on hand as per last year's report	\$131.22
Rec'd from Mr. Newman.....	173.95
" " Dr. Mason, Sec.....	76.85
" " members direct	383.47

Total, 765.49

DISBURSEMENTS.

Paid Dr. Mason's expenses to Jackson, Mich.....\$	3.60
Freight on printed matter from Mr. Newman.....	4.25
Mr. Abbott attending Pure-food Congress.....	41.25
" Bees and Horticulture " pamphlet.....	12.00
Postal Cards and printing.....	16.25
Postage-stamps.....	39.30
2500 envelopes and printing same.....	8.00
This report—650 copies.....	12.00
Other printing.....	11.00
Salary of General Manager.....	76.69
Extra clerk hire.....	20.40
Bal. cash on hand.....	521.15

\$765.49

It appears from the foregoing that the Association, from a financial point of view, was amply equipped to enter into the fight that has resulted so happily in reversing the decision of the lower court in the case of Utter v. Utter. If it had accomplished no more, the bee-keepers all over this land, far and wide, might consider it worthy of its support; but it has done more. It has put up a fight against town councils, against disagreeable neighbors, and against adulteration. The showing for 1900 is simply magnificent; indeed, in the matter of actual results no organization, either past or present, has for one year equaled it, in my humble opinion. Every bee-keeper in the land should at once send in one dollar, thus in a substantial manner showing a merited appreciation.

BLACK BROOD IN NEW YORK UNDER CONTROL.

IN my recent trip through New York there seemed to be a general impression among bee-keepers that black and foul brood were under control. As a corroboration of this, the report of the Commissioner of Agriculture will be read with much interest. It is as follows:

The work of the Department of Agriculture by the four inspectors who have charge of diseases among bees has just closed for the season, and has been most satisfactory. Statistics convey only in part an idea of the labors performed by these experts. They have visited some of the fall fairs and other meeting places of apiarists, and their "missionary" work has awakened an interest which will stimulate the industry to more profitable proportions.

The sections of the State where foul brood has appeared are now known, and its control and extermination may be expected.

Number of apiaries visited.....	1,128
" " of colonies.....	30,372
" " found diseased.....	7,253
" " condemned for treatment or destruction.....	5,972
" " destroyed.....	1,281

C. A. WRETING,
Com. of Agriculture.

This goes to show that one inspector could not have done this work. The Wisconsin law, which has often been pointed to as a model, provides for only *one* inspector; but the New York law is flexible enough to permit the Commissioner of Agriculture to appoint as many inspectors as, in his judgment, the exigencies of the case require. Four inspectors were appointed last season, and this number was deemed sufficient to cover those portions of

the State where the disease had been raging. The very fact that 7253 diseased colonies were found, is pretty good evidence that a real danger was threatening the very life of bee-keeping in one of the best honey-producing States in the Union; and that it was found necessary to destroy over 1000 colonies is further evidence of the awful spread of the disease, and what it might have done had it not been brought under control. Of course, it will break out again next spring and summer; but the task of controlling it will be much easier than it was last season; and in the very near future I have reason to believe it will be stamped out. Fortunately the disease was confined to a narrow section in the eastern part of New York. I did not hear of any traces of it in the western or central portions of the State.

BEES IN COURT; THE CASE OF UTTER VS. UTTER; A VERDICT FOR THE BEES.

THE celebrated case of Utter v. Utter came off on the 17th, 18th, and 19th, at Goshen, N. Y., the county-seat of Orange Co. The case was a peculiarly hard-fought one; and after 25 or 30 witnesses had been examined on both sides the jury brought in a verdict, after being out about ten minutes, for the defendant, beaman Utter.

I need not say that the National Bee-keepers' Association took an active part in this case—one that seemed to involve the very life of bee-keeping in New York. It pledged \$100 to Bacon & Merritt, two of the leading attorneys of Orange County—lawyers who have been retained in some of the most important cases that have been tried in that vicinity.

The trial was originally set for the 13th, but was postponed to the 17th. A. I. Root and myself arrived in the little city on Saturday, the 15th. We found that Mr. Benton had preceded us, but would be back in time for the trial on Monday morning. On the 17th, Mr. O. L. Hershiser, an attorney and also a bee-keeper, came from Buffalo, and also W. F. Marks, of Chapinville, N. Y. These five came prepared to render expert testimony to the effect that bees do not and can not puncture sound fruit. Something over a dozen witnesses from the vicinity, as well as from New Jersey, had been called by bee-keeper J. W. Utter. Among them were nurserymen, fruit-men, and bee-keepers, so that, all in all, the defense represented two of the best attorneys in New York, and some 16 or 17 witnesses. The attorney for the plaintiff, Mr. Sanford, at the last moment, called upon a distinguished attorney, a Mr. Cane, to assist him, as he had probably found he would have to put up a hard fight to win. The battle royal began on Monday afternoon, and continued until Tuesday night, with the result as already stated.

There were many laughable incidents and some queer statements on the part of the witnesses for the plaintiff as to how the bees did and could puncture fruit; how they used their "horns" (antennæ) to make the holes, etc. In the lower court, several of the witnesses, so I am told, testified that the bees got up "on their hind legs" and *stung* the fruit; went off

and left the peach, and stung others; that a rotten spot at the points pierced by the stings would soon set in, and this would be subsequently visited by the bees. In the higher court, that same set of witnesses testified that the bees punctured the fruit with the "head end" and not with the "business" end. It was evident that the prosecution had realized the utter absurdity of the former statement. The plaintiff, fruit-man Utter, while on the stand went on to describe how the bee moved its head first to one side and then the other, and raised up on its legs and flopped its wings; that after this performance he found there was a hole. This was corroborated with some variation by his two sons. It was amusing to see the plaintiff try to mimic the bee, on the witness-stand, as he swayed his head from one side to the other, raised up on his legs, and flopped his arms. His motions were so Utterly ridiculous, and so contrary to the real acts and movements of bees, that every one in the court-room, including the jury, laughed, and laughed heartily. I sincerely believe that, if the jury had gone out at that supreme moment on the evidence then presented, we should have had a verdict in our favor, even without one word of rebuttal testimony.

Another witness, Mrs. W. H. Utter, the wife of the plaintiff, testified that the bees would alight on the fruit, and then with their "horns" make holes in the peaches. She stated that there were eight holes in one peach she examined, and that three bees were on it; that, after they left, there were three more holes, or eleven in all. Mr. Bacon, one of our attorneys, in his cross-examination, got at the facts something in this way:

"You say, Mrs. Utter, that there were three holes after three bees had visited that peach?"

"Yes."

"You say that the bees made these holes with their horns?"

"Yes, sir."

"Where were these horns located?"

"On the top of the head."

"Two prongs like this?" said he, putting his two hands over his head.

"Yes."

"And they took those two horns, and dug them right down into the peach, did they?"

"Yes."

"Well, now, Mrs. Utter, will you tell the jury how three bees, each with two horns, could make only *three* holes? Shouldn't there have been *six* holes?"

"Wy ah, wy-ah, wy-ah; they took those two horns and put them together, and then poked them into the peach."

"O—h!" said Mr. Bacon, with a wise look.

At this there was an uproar of laughter. When the jury and the audience had subsided, Mr. Bacon continued:

"You are sure the bees made these holes with their horns?"

"Yes."

"Well, don't you know that those are antennæ, or feelers?"*

Several had talked about the so-called "horns," and how bees make holes with the horns; but after the learned counsel had

shown the *Utter* absurdity of the horn theory, then the prosecution began to talk about the "jaws;" and some of the witnesses told how the bees ran their "bills" down into the peach—meaning, of course, the tongue. But the bill theory was untenable, and the rest of the testimony was then confined to the jaws, which, it was averred, were powerful enough to puncture the skin of peaches. The prosecution claimed, among other things, that after the bees had punctured the peaches the juice ran down on the limbs, causing them to wither and dry up. In the former trial it was maintained that the trees were utterly destroyed; and even in this trial the Peach Utter at first talked of the destruction of the trees, and claimed damage for the loss of trees and fruit. The defense, on the other side, showed by two good witnesses that the plaintiff, Mr. Utter, the fruit-man, had said to each of the affiants that these trees were going to die, and he would have to pull them up, and this was *before* the bees are alleged to have visited the fruit.

In this connection I might state that a great deal of testimony was produced on the subject of peach-trees with "wet feet," peach-trees with "curl," and peach-trees with the "yellows." From all the evidence, it seemed very clear that *something* was the matter with Peach Utter's trees before the bees ever came near them. It was admitted that the fruit was very early, and from the expert testimony of fruit-men it seemed to be pretty clear that the trees had been forced up, or borne too early, with the result that the fruit itself decayed prematurely, resulting in injury to the limbs of the trees. There was testimony produced showing that early peaches will very often develop rotten spots, even when kept away from the visitation of bees; that these spots, at first invisible, will be readily discovered by bees; and as the spots enlarge sometimes within the space of two or three hours, the bees often get the blame for doing a kind of mischief that clearly should not have been laid at their door.

I omitted to say that Peach Man Utter testified that he caught some bees from the peaches and put them in a box. These bees he liberated at different points, and he said that, in every case except one, they flew toward his brother's apiary. But the defense showed that there were six or eight apiaries all around Bee Utter's place, and that it proved nothing to say that the confined bees flew toward Utter's apiary. So there was no real proof that Bee Utter's bees were the only trespassers, if trespass there was.

I do not need to rehearse here the testimony that was introduced by expert bee-keepers, though I can not omit reference to the testimony of Prof. Frank Benton, Assistant Entomologist, Department of Agriculture, Washington, D. C. Prof. Benton had been sent by the National Bee-keepers' Association to render expert testimony on the mouth parts of

* I believe the witness was honest in believing that the antennæ, or feelers, were "horns;" and as they moved up and down, touching the peach, she erroneously assumed that they were puncturing the peaches. As to the three extra holes, she was evidently blinded by prejudice.

the bees, and he certainly was the star witness for the defense. He showed by live and dead specimens of bees, and also by charts which he had brought for the occasion, that in his opinion it was a physical impossibility for the bees to puncture fruit with their mandibles, or jaws; that the jaws of bees were very different from those of wasps and other insects having cutting edges or teeth. He chloroformed some live bees and then passed them around to the jury, after our attorneys had obtained consent from the court to do so. He showed them that the delicate tongue, so far from being a "bill" which could puncture a sound peach, was more like a camel's-hair brush; that it would be absurd to suppose that they could run this through the skin of any substance. He admitted that bees could tear by picking away at fiber, but denied the possibility of their *cutting* the skin of any fruit. The jaws, or mandibles, had smooth rounding edges, which, he showed by charts, were different in this respect from the jaws of a wasp, that has cutting edges or teeth; that the mandibles were made for forming plastic substances like wax; and even then the wax had to be brought to a temperature of about 90 degrees before such work could be performed.

The professor's testimony, so far from bearing evidence of prejudice, was what might be termed in legal phraseology "candied," the kind that weighs with a jury. There was no evasion, and no attempt on his part to make *all* of his testimony in favor of the bees. When asked whether he regarded the experiment of confining a few bees in a box with a peach as worth anything to prove that bees would not or could not puncture sound fruit, he said that, in his opinion, it did not count for much, as he doubted whether they would even help themselves to honey under like circumstances.

At the conclusion of the testimony for the defense the prosecution called Peach Utter back to the stand, and asked him whether the trees, the fruit of which the bees were alleged to have stung, causing the limbs to die, were alive and in good order. He said yes, in very good order. This testimony was produced, probably, to show that the trees did not have the "yellows" or "wet feet," as was claimed by the defense. But Mr. Bacon, in his final plea before the jury, called attention to the fact that the plaintiff *first* testified that his trees had been *destroyed*, and that now they were *good and sound*; and yet he desired compensation for the trees which he at first said were *destroyed*! Mr. Bacon made a strong plea, picking up all the important threads of evidence, and hurling them at the jury in a most forcible manner.

The attorney for the plaintiff, Mr. Cane, while he did not attack the testimony of Mr. Benton, turned his guns upon A. I. Root, shaking his fist in his face, and calling him the great "poo-bah" of the West. A. I. R. did not appear to relish the compliment; but the rest of us enjoyed the joke immensely, though there wasn't one of us who knew what "poo-bah" meant. We consoled A. I. by

saying that it signified something *big*, and told him not to feel bad.

Of course, no one could tell absolutely what the jury would do; but it seemed to be made up, if I could judge by their faces, of a lot of intelligent, thinking men.

The judge, in his charge, rehearsed very carefully and impartially the full case, and then said that the jury, in order to render a verdict for the plaintiff, must find that the bees of the defendant, and *his bees alone*, were the trespassers; and that it (the jury) should further give very careful consideration to expert testimony. The jury then retired, and in about ten minutes returned with a verdict of "no cause for action."

It will be interesting in this connection to give a few statements from some of the newspapers which, of course, in the personages of their reporters, looked on the case with an unprejudiced eye. The New York *Sun* for Dec. 19 contains this item:

The National Bee-keepers' Association secured many expert witnesses to prove that bees will not attack perfect fruit. Among them are Frank Benton, assistant entomologist of the United States Department of Agriculture, and A. I. and E. R. Root, of Medina, Ohio. Bee-keepers from all over the State are assembled, and will spend much money to win. Peach Tree Utter's case is tottering, so the local agriculturists say, and there is much rejoicing among the bee-keepers.

This shows that the National Bee-keepers' Association was regarded as a power on this particular occasion; for it will be noticed that the item goes on to state that Peach Tree Utter's case was beginning to totter; and this was before all the evidence had been introduced. On the next day this same paper referred to the evidence of Prof. Frank Benton in the following language:

The star witness for the defendant, however, was Prof. Frank Benton, an assistant entomologist of the United States Department of Agriculture. He had spent thirty years studying bees, and for that purpose spent four years in Austria, four in Germany, and several in Eastern countries, in pursuit of bee knowledge. He said that the tongue of the bee was soft and pliable, and could not puncture a peach. The inner tongue of the bee is spoon-shaped, and covered with hair. It can not become rigid. It laps its food, which is called nectar, and is fond of rotten peaches. Its feelers are soft, and can not pierce any substance that offers the least resistance. They are supposedly the organs of touch and smell by which bees recognize each other by the odor of the body. Sometimes they will meet and wind their feelers about each other. This is their method of shaking hands.

The Rochester *Democrat and Chronicle* for Dec. 21 contained this editorial item:

After hearing an abundance of expert testimony, a jury in Goshen, New York, has decided that honeybees do not injure peaches. It was admitted by all that bees are attracted to wounded or decaying peaches, and get some sweets from them, but are incapable of puncturing a sound peach. The deciding testimony was given by Prof. Frank Benton, assistant entomologist of the Department of Agriculture. He described the organs by which the bee secures food, and showed that they were soft, and unequal to the puncture of the hairy skin of the peach. A lawsuit between brothers was based upon the unfounded supposition that a bee can puncture the skin and induce decay. Some other insect or a bird is the probable cause of the injury that became the subject of complaint. It is well for the peach-growers of Western New York to understand this matter.

We have not room to give more clippings; but these are sufficient to show that the National Bee-keepers' Association exerted a powerful influence in the case, in that it enabled

Mr. Utter, the bee-man, to employ the best legal talent, and, in addition, furnish expert testimony on the bee side of the question, so that an unprejudiced jury, seeing and knowing the facts, would render a verdict accordingly.

This case was a hard-fought one from beginning to end. There was no lack of legal counsel on either side, and no lack of witnesses; but, thanks to the Association, we were able to show that the evidence adduced by the plaintiff was, for the most part, to put a most charitable construction on it, founded on misapprehension, ignorance, and prejudice. There is no doubt that some witnesses for the fruit-men actually believed that the bees did puncture sound fruit with their "horns or bills." If they did so believe, and if they heard our evidence, their belief must have been most severely shaken before they went away.



What doth the Lord require of thee but to do justly, and to love mercy, and to walk humbly with thy God? —MICAH 6:8.

I presume there has always been a great demand for men for office who will be *just*; but at present there seems to be greater need of men who can be trusted than ever before since the world began. Our text speaks of not only doing justly, but loving mercy, and walking humbly with God. Sometimes we feel as if we could get along very well if we could find men who would "do justly," to say nothing about mercy or having the fear of God in their hearts. The people who take lead in these shameful scenes of lynching excuse themselves by saying there is no justice to be obtained, and no redress to be secured by law; and when we notice the hundreds and thousands of dollars that are required to get one criminal punished by law, it does seem somewhat discouraging. The man Ruthven, whose life was full of crime, and who not only shot a policeman, but tried to shoot other people right and left in broad daylight in Cleveland, had to go through a long-drawn-out and expensive lawsuit before he could be found guilty and sentenced to death as he has been. No one questions, unless it is his own attorneys, the matter of his guilt. And, by the way, I can not quite understand how it is that lawyers will spend so much time and money to try to get such a man (with no money to pay them) out of the clutches of the law. Perhaps I had better stop here or I shall be finding fault, and criticising our courts, when I started out to do just the reverse.

In our last issue, on page 974, I expressed a fear that our colored friends could hardly expect protection from our laws—especially such protection as our white citizens have a right to expect. Since that was written I have had a pleasant experience along that line.

Just a week ago to-day, Dec. 15, I visited Goshen, Orange Co., N. Y., in the interest of bee-keepers in the suit between the Utter brothers; but as Ernest will tell you about this, I wish to speak about something else just now. Our suit was to be taken up at 9 o'clock on Monday morning, the 17th; and when all the parties were on hand we found there was another suit in ahead of us that they thought would occupy only an hour or two. However, it occupied almost the entire day. As we bee-keepers and fruit-growers wanted to be on hand promptly, we remained in the courtroom and witnessed the trial between an electric-railway company and a colored man who had been knocked down and thrown off the car by the motorman. During my busy life I have hardly found time to be present at court proceedings. In fact, I am not sure I ever attended unless I was called in as a witness, and just one time when I was on the jury for two days. Well, in this case the colored man sued the trolley company for damages. I very soon made up my mind that, even though he had been roughly handled, he stood no chance of getting any damages at all. Between Middletown and Goshen there is a park. I noticed it as I passed through, and saw the signs on the buildings of the different kinds of beer that were sold there in the summer time. By the way, that park (I have forgotten the name of it) or, rather, the buildings with inscriptions on them, are a disgrace to Orange Co. as well as to the whole State of New York. But as I say it I recognize that our own State of Ohio is cursed with any number of just such summer resorts. The row that brought this case before the court occurred on Sunday, as you might expect, and after some if not all the parties had been drinking. Green, the colored man, said under oath that he had had two glasses of beer and one glass of whisky. He claimed the motorman was drunk also, but this was not proved conclusively.

Near the park a second drunken man was permitted to get aboard. The conductor did not want to let him get on, but Green desired that he should. The conductor tried to put him off because of his profanity and obscenity. Green and his wife quieted him down and tried to get him to behave himself. When the drunken man had no money to pay his fare, the conductor again tried to put him off. This, of course, started the profanity once more. Green evidently tried to act as peace-maker, and says he volunteered to pay the fare for his friend; but the conductor evidently thought best to put him off. Being unable to do this he called the motorman to his aid. Green remonstrated, either by words or actions, and the motorman struck him with his trolley-crank, knocked him off on the ground, and laid bare his skull. He climbed back on the seat, however, and every thing went on pleasantly.

Let me pause right here to say that I was forced to admire the skill and ingenuity with which four lawyers went to work to bring out every little item of fact regarding the matter. More than a dozen witnesses were examined, and it was really wonderful to me to see how

the lawyers unraveled the conflicting testimony, and held all the facts in the case up before the light of day. A young lawyer who looked as if he might be a Christian, from his fairness and evident sincerity, strongly impressed me, and he gained his case. The jury, greatly to my surprise, gave Green a verdict of \$50.00 damages. The railway company had, as a matter of course, two bright and skillful attorneys. I admired them too, and I thanked God in my heart again and again for the lawyers of our land—that is, if those I heard that day were a fair specimen of the legal profession.

The judge, J. G. Beattie, of Warwick, N. Y., is an exceedingly able, fair-minded, and kind gentleman. I watched him with the keenest scrutiny to see if I could detect any bias on his part, either one way or the other. Ernest will give you a picture of him in due time. Now, then, for the point of my story.

The above are not the exact words, but as near as I can remember in substance; and during the whole trial not a word or suggestion was made by any witness or lawyer, by way of reflection on the colored people *because* they were colored. The State of New York certainly ignores color in the administration of law and justice. Long live the Empire State—in this one particular at least. Three colored people, if not four, had more or less to do with the affray, and there were a good many more colored people in the car, as it appeared from the witnesses; but although I kept expecting it every little while, not one word was dropped to indicate that the fracas was caused by a lot of drunken negroes on a car during a Sunday excursion.

By the way, I wonder if Sunday excursions do not always go with beer and drinking; and I wonder, too, if it is not true that, if we break down one, we shall break down the oth-



CLASS OF GIRLS LEARNING BEE-KEEPING.

The attorney for the railway company, in his opening words to the jury, said something like this:

"Gentlemen, let me impress on your minds, at the very outset, that the fact that this man is black, instead of white, must not in any way prejudice you against him one hair's breadth. He is in no way responsible for the color of his skin. He is, however, responsible, like all the rest of us, for his behavior and character before the world. Give him just as good a chance in your minds as you would give the whitest man that ever lived. He has just as good a right to life, liberty, and the pursuit of happiness, as any one of us. The only question is in regard to his behavior and general character."

er. If we stop Sunday excursions the beer-drinking will stop—at least to a great extent; and if we stop the sale of beer on Sunday, is it not true that we shall stop the Sunday excursions? This unfortunate man declared from his own testimony that he had had two glasses of beer and one of whisky. His wife said she had one glass of beer, and that was all. His colored comrade, who was at the bottom of the whole disturbance, had beer and whisky—we do not know how much; but we do know that when he felt in his pocket he could not find even a nickel left to pay his fare. How are we as a nation going to deal justly, love mercy, and walk humbly before God, while we run Sunday excursions, carry colored people and everybody else, then permit the brew-

ers to advertise on the buildings, and push their beer and whisky before these people by every art that wealth can command? Why, the wonder to me is there is not ever so much more free fighting than we have now. Permit me to say right here, even if it is outside of the line of my text, that throughout the trial between the bee-keepers and fruit-growers I was impressed in the same way, not only with the wisdom and fairness of Judge Beattie, but also by the skill and wisdom, and, as a rule, with the honesty, of the lawyers. One lawyer was undignified and uncourteous enough to call me names, and to pervert the truth of my statements, when I went there to help both the bee-keepers and the fruit-growers. I am told this thing is common; but, even if it is, I protest. In my opinion it is not only ungentlemanly, but I think it hurts any attorney to go out of his way to be uncourteous and uncivil to a witness who comes from a distance, and who has at least a fair reputation among men. This lawyer lost his case; and I should not be surprised if this one thing contributed largely to his prejudice.

In our last I told you I expected to have one or more of the cuts from that book describing the work among the colored people in Tuskegee, Ala. I wish to call your attention first to the beautiful picture of the apiary.

The building in the background is only one of the fine structures built for the institution, entirely by the colored people. The hives, you notice, are the Dovetailed eight-frame. They seem to be stationed on wooden planks nailed to substantial cleats or pieces of scantling. I should object to these planks unless the girls were very careful not to step on them, because the jar might arouse the bees. Another thing, in handling one of the hives unless the plank were very solid it would jar or disturb the next one.

How exceedingly natural it looks to see these women at work in the open air! In their warm climate I should think those hives would need some sort of shade. If they are kept painted white, however, they may do very well. In my last I suggested that it was probably Mrs. Booker Washington who taught the girls bee-keeping. The publishers of the book make the following comment in regard to the matter:

Mr. Thrasher tells us that Mrs. Washington does not have direct charge of the bee-keeping, which is in charge of the instructor in agriculture. She has su-

pervision, however, over all the young women at the institute, and assigns the women students to the different departments.

Boston, Dec. 14.

SMALL, MAYNARD & CO.

Here is the picture of Mrs. Washington herself, the woman whom Booker selected to be his comrade and helper through the great work he has undertaken. I wanted this picture because it shows so clearly how character stamps itself on the face of any one, even a colored woman. I can imagine this woman meeting among other women of the W. C. T. U., and giving the benefit of her education and expe-



MRS. BOOKER T. WASHINGTON.

rience. Just take a good look at her, and imagine what a power she has been and is going to be among the people of her race. I can not tell you here what is in the book, because I want you to read it for yourself; but I will give just one illustration. Somewhere she found a father and mother and a family of children; but the parents had never been married. Nobody could do any thing with them. They got along well enough, and didn't care. Mrs. Washington took the case

in hand, and she tells how she talked with them; how she managed to make the undertaking an easy one, and yet at the same time have them recognize the reverence and respect due to such a ceremony, as well as the effect of the example on the whole of their race. The ceremony was performed in her own parlor, she furnishing the sponge cake and lemonade and other things, to make it appear like a wedding.

If there was ever a work since the world began that means *out of the darkness, and into the light*, this work at Tuskegee is just that. We do not know the future of the colored the race; and, for that matter, we do not know future of the *white* race; and we do not know how the two races are going to get along together. But God knows, and we have his blessed promise that, if we "do justly and love mercy and walk humbly before God," "all things shall work together for good to those who love him."



My talk just now is going to be high-pressure poultry-raising rather than high-pressure gardening. It may be I shall have something to say about high-pressure bee-keeping before I get through. In the *Pacific Rural Press* of Nov. 3 a poultry experiment is reported by Prof. Dryden, of the Utah Experiment Station. First we have pictures of five very pretty Brown Leghorn pullets. There is nothing in the looks of any particular one of these pullets to indicate that she should be noticeably better than any other. The experiment was made to determine which hen would produce the most eggs for the same amount of food; or, in other words, to determine what the food cost, per dozen eggs. Well, with No. 70 the food alone cost over 13 cts. per dozen. No. 71, the food per dozen did not cost quite 4 cts. No. 72, the food cost not quite 4 cents per dozen eggs. No. 73 the cost of food was $3\frac{1}{2}$ cents per dozen eggs. No. 74 the cost of food was a little more than $6\frac{1}{2}$ cents per dozen eggs. Now, when eggs are sold at 12 cents per dozen, as they often are, No. 70 was sinking money for her owner every day in the year. Such a flock would bankrupt the owner; and even one such hen among the others spoils the credit of the whole flock. No one could tell any thing about it from her looks. The experiment was continued a whole year with all, so as to get a true general average.

Our brethren in the dairy business have been for some time, as our readers probably know, weeding out the worthless cows; and just within a short time back our friends in the poultry business have been sorting out the drones among their laying hens from the really profitable workers. For years and years they have been "breeding to feather," just as the bee-keepers have been breeding for yellow bands, and filling the bee-papers with adver-

tisements of their handsome bees produced by careful selection, working just for looks, or at least I *fear* this has been too often the case. I have protested and scolded, but still the thing has kept going on. Why, my dear friends, what would you think of a young *man* who would pick out a wife "just for looks"? Come to think of it, I do not know but some of them are guilty of that very thing—picking out a girl just because of her good looks, and then marrying her before he has had any time to find out whether she is a drone or worker. Well, there is one thing hopeful about the wife. She may start out as a drone, but become, by the grace of God, waked up, and make one of the best workers before she dies. Thank God, both you and I have seen such things happen, not only with the girls but with the boys.

Well, our bee-keeping friends, nearly if not quite all of them, know about the recent stir in hunting up queens that produce long-tongued workers. Ernest has told you that these workers with long tongues seem to come every time from colonies that excel all the others in securing large crops of honey. It is an easy matter with the bees, and it is an easy matter with the cows, to tell which ones are bringing in the dollars; and if you have only half a dozen hens, and not much to do, you can tell pretty well the biddy that lays the greatest number of eggs. But when pullets are kept by the dozens and hundreds, then how? Why, I see by looking over the poultry-papers that they are just having quite a big stir about what they call the "trap nest." This sort of nest holds the hen until her owner lets her out; or a modification of the above lets the hen go into a nest from one yard or house, and when she goes off she goes out into another yard or house. The owner can then tell at once which hens have laid eggs; but to know just exactly which hen does the laying, and exactly how many eggs she lays, each hen must be numbered. She has a very pretty little bracelet, not to wear on her wrist, but on her ankle. When she lays an egg I suppose she is allowed to cackle in the good old way. Then when her owner comes to let her out she daintily lifts her foot (I have not learned yet whether she deftly raises her skirt a little, but perhaps she will get to that after a while) until he can read the number on the aforesaid bracelet, and make a pencil-mark on the door of the trap nest. These pencil-marks (on a ruled card) constitute a memorandum to be footed up at the end of the season.

Now, this trap nest is revealing a great many queer things. Very few hens lay an egg a day, even for a week—at least some good authorities tell me so. Some hens do, it is true, in rare cases, lay an egg in the morning and another at night; but they do not lay one next day in that case. Very few hens lay seven days in a week—usually about six on the average. It spoils the couplet about Grimes' speckled hen. Perhaps I had better give it here. It should be sung to the tune of Old Lang Syne:

Whoever stole my speckled hen had better let 'er be;
She laid two eggs on every day, and Sunday she laid three.

Yes, the speckled hen herself is knocked out too. You see I have been visiting poultry-keepers lately; and if you are a poultry-man, may be I shall hunt you up when I get around on my bicycle. Instead of *speckled* hens nowadays the whole flock must be clear white, buff, black, or barred, like the Plymouth Rocks. But there must not be any sport in the way of feathers of a different color. I have just purchased two pullets and a rooster—White Plymouth Rocks. I got the rooster for \$2.00. He has a few cream-colored feathers or else he would have been worth \$5.00. His father was sold for \$30.00; but he had all the points, and every feather was up to the mark. Now, I do not care a cent about the feathers; but I do want a hen that lays an egg every day in the year, or as near to it as possible. I would hardly insist that she lay three eggs on Sunday; but if she would lay just one egg early in the morning it seems to me she would not be any the less orthodox on that account. At present I am getting two eggs a day, from one old hen and three pullets. I have not any particular need of a trap nest, because I know the egg that each hen lays; and yet I am curious about that trap-nest business; but when I scan the poultry-papers to see where I can buy one, I feel like objecting to the way the poultry people do things. Perhaps if I am going to mix in with their crowd I had better take things as I find them, and not go to crowding in my notions. What I object to is that nobody has a trap nest to sell; but most of them sell you directions how to make them, all the way from 15 cents up to \$2.00. Each man has a plan that sends all the other inventions in this line away out of sight; but he would not even give you a picture of it unless you plunk down the money. I do not know whether you have to sign a contract not to divulge the wonderful secret to your neighbors around or not. I sent fifteen cents to one fellow. His nest is something like a basket hung on a nail. When the hen steps on the edge of the basket to get into the nest, a lid flops down that holds her in. When she gets "through" she is expected to cackle, and her owner comes and lets her out and gives her credit. Now, why do not these enterprising poultry-journals send these inventors the two dollars, or a smaller sum, and then give the invention to all the world? One of the best poultry-journals, called the *Featherer*, has indeed illustrated, with excellent cuts, a very nice sort of trap nest; but I had to have a good laugh when I was reading it over. For instance, he says you must not make the nest in such a way that the folding doors will bump the biddy when she is getting on the nest, or she might take offense and refuse to "trade at that store." Again, "when the doors close they must not pinch her tail." The editor says she objects to that sort of treatment also. One thing I like about the trap nest is that the hens must be tamed so you can give them an encouraging pat on the back at any time. My two white pullets are already so tame they rather expect an encouraging word or a dainty morsel every time one goes near them. My white rooster, however, does not seem to fan-

cy too much "taffy" of that sort. When he thinks you have said enough he shows fight; and it does not make any difference who it is, even the boss of the ranch. When I was absent in York State he and Mrs. Root had several pitched battles. He decided to drive her out of the poultry-house, when she went near the nest to get the eggs, and I think he came pretty near doing it. When she brought them a dainty mash prepared by her own hands he knocked the dish out of her hands, and she was absolutely obliged to get a club in order to teach him to be respectful to his mistress. Do you begin to suspect that poultry is going to be my next hobby? Well, is it not a pretty good one, anyhow? The *Rural New-Yorker* says the eggs and meat produced each year in the United States in the poultry business are worth as much as the entire crop of wheat.

But let us now get back to this trap nest. I should not wonder if some good man or woman has been saying, "Well, I suppose there are some people who have nothing to do but to watch hens and take them off the nest, and count the eggs; but you do not catch *me* going into any such small business as that." But, just hold on, my friend. These hens that have a big record back of them are the ones we want for breeders. If they do not sit at all it does not matter, because the incubator as now made is a success. Yes, I know there has been lots of money wasted on incubators, and lots of people have been disappointed. But one of the girls in the office, right close to where I am sitting, uses an incubator that cost only \$5.00, and *she* makes a success of it. The fowls I have been speaking about were just purchased from her flock. Get a pullet with a good egg-record, and her chickens are likely to produce layers like their mother. These choice pullets, with a record by means of the trap nest, are worth anywhere from \$2.00 up. May be some of the poultry-keepers who know more about this than I do can tell how *much* some pullets are worth. At the Willow Crest poultry-yards at Goshen, N. Y., three or four days ago, I saw several hens valued at \$25.00 each; and I also examined a White Wyandotte rooster for which the firm recently paid \$125. Do you say "stuff and nonsense"? Why, look here, my friend. They have already got a lot of orders for eggs at \$5.00 a dozen. These eggs are to be from choice pullets *fathered* by this high-priced male bird. If you are going into the poultry business you can grow high-priced layers just as easily—in fact, easier—than to grow worthless stock. It costs a little more to start with. I can very well remember when the Light Brahmas were introduced somewhere down east, just a few years after we had had the long-legged Shanghais. The first Light Brahma eggs were sold at a dollar apiece. The orders were so far ahead that people came long distances, and boarded at the hotel until the egg was laid. The minute biddy dropped the choice egg, the owner handed over his dollar and started off home a happy man, and well he might be. In a few short weeks—perhaps I had better say months—he could have a *flock* of Light Brahmas of his own; and while he might not get a dollar

apiece for his eggs he could get several dollars a dozen. The advent of the Light Brahma gave the whole poultry business a boom, and added, I think I might say, millions to the wealth of the world.



BINDERS FOR GLEANINGS.

We can supply a very simple binder for GLEANINGS, called the Monitor, at 15 cents each, postpaid. These are made of tin in the form of two half-round tubes, between which the copies of GLEANINGS are placed as received. They are held securely in good shape, and you would find them a great convenience. Then we have a much better and more expensive binder which incloses in a cloth-bound cover the numbers as they arrive until the year's volume is complete. Price 60c; or with leather back and corners, 75c; by mail, 8c extra for postage.

GLEANINGS AND AMERICAN AGRICULTURIST.

A great many have written us within the past two weeks, inquiring if they can not, as usual, have the *American Agriculturist* or *Orange Judd Farmer*, or *N. E. Homestead*, clubbed with GLEANINGS for \$1.00. We have been compelled to reply no, because the publishers of these papers have withdrawn the special clubbing arrangement they formerly made, and that the best rate we can now offer on the two is \$1.50. Some have not taken the precaution to write, but have sent on their order for both papers with \$1.00. If we can get such through on the old rate we will do it; but we have scarcely a right to ask it after the arrangement has been withdrawn, and we no longer include the paper in our clubbing offers. Please make note of this, as we can not accept any more such combinations at the old rate.

Special Notices by A. I. Root.

ADVANCE IN PRICES ON MEDIUM, AND PEAVINE (OR MAMMOTH) RED CLOVERS.

Instead of \$5.50 per bushel, as in our catalog, the lowest price we possibly make at present writing, Jan. 1, is \$6.00 per bushel, sack included. Price for small quantity will be the same as given in our catalog.

THE BOOK, STODDARD'S NEW EGG-FARM.

Just about a year ago I became very much taken up with this book, and because of the big write up I gave it we have sold toward 100 copies; and to tell the truth, my friends, it is this very fact that troubles me. When I read the book I took it for granted that the author either had an egg-farm of his own where the work of caring for the poultry was managed by machinery, or that there were some institutions operated on some such plan scattered over the land. So far I have not been able to find any such establishment, neither have I been able to find an egg-farm anything like the one described there. I have written the O. Judd Co., the publishers of the book, and they have promised me to look into the matter and see why the author of the book does not answer me. If the plans outlined in the book are all on paper, and have never been demonstrated in actual practice, we who have purchased the book have a right to know it. I still think the book is a valuable one in exhorting, not only that poultry shall be cured and kept well by a large amount of outdoor exercise, but in teaching us that a like principle runs through the whole animal kingdom. I do not believe the book is a bit exaggerated in this respect, and I think poultrymen are fast accepting this great truth. We know *something* has been done in the way of using machinery to care for poultry, because many of the cuts in the book are from actual photos. Now, then, if any reader of GLEANINGS knows where Stoddard's system is in actual practice I wish he would write and let me know about it. I wish also I could get at least a postal card from each one of you who have purchased the book through my advice, telling what you think of it, and

state whether the purchase of the book was a good investment or not.

CLOVER FARMING, BY HENRY WALLACE.

The above is the title of a little book, paper covers, from the Wallace Publishing Co., Des Moines, Ia. It is a volume of 220 pages, and contains a very large amount of valuable matter. It discusses all the clovers; how to sow the seed, and when; enemies of the clover; and it discusses briefly the different varieties of clover, and certainly ought to be worth many times its price to any farmer who is interested in clover. I confess, however, I was somewhat disappointed at not finding a single hint that clover seed might be put in in the fall, and get root enough to winter over. There is a slight mention of crimson clover, but not very favorable. (While I write, Dec. 4, a most beautiful stand of crimson clover greets my eye just out of the window, over in the lot; and if this winters over—and I am sure it will—it will make the sixth season I have succeeded perfectly in carrying through crimson clover sown in August). Sweet clover is also noticed very briefly. Perhaps half a page is given to it out of the whole 220. There is just one paragraph, however, that partly atones for its very brief mention.

When, however, other grasses fail, it is found to have very considerable feeding value; and as a fertilizer, it is doubtful if it is exceeded or even equaled by any of the clovers.

Alsike clover is also briefly touched on, but the book does not accord it any thing like the value made out of it by the three recent writers in GLEANINGS. If the author could have talked a little more with some bee-keeper before his book was put out, I think he might have made it more valuable.

As it is the only book we have, devoted entirely to the clovers, we welcome it, and it ought to have a large sale. We can mail it from this office for 35 cents; or you can have it for 30 cts. shipped with other goods. The book is written in such a familiar, off-hand way, that if you once begin it you will be likely to want to read it through, even if you are not particularly interested in the growing of clover.

CONVENTION NOTICE.

The annual meeting of the New York State Association of Bee-keepers' Societies will be held in the Kirkwood, Geneva, N. Y., on Wed., Jan. 9, 1901, at 10 A. M., and continue through the afternoon and evening.
C. C. HOWARD, Sec'y,
W. F. MARKS, Pres. Romulus, N. Y.

HONEY FOR SALE.

Strictly pure extracted honey, in original five-gallon cans, as received from the apiary, 2 cans in case, 7½c per lb., f. o. b. Provo Utah; or if wanted East, 8c per lb., f. o. b. Chicago. Write S. T. Fish & Co., Chicago, Ill., who will ship from there. Honey guaranteed strictly pure.

W. M. M. ROYLANCE,
Wholesale Fruits and Produce,
Provo City, Utah.

Established 1885.

S. C. BROWN LEGHORNS.

I use well-striped breeding cocks Eggs, \$1.00. Cockerels, \$1.00 and up. Also Italian bees. Circular free.
H. M. MOYER, Shanesville, Pa.

The Modern Farmer and Busy Bee.

Emerson Taylor Abbott, Editor.

A live, up-to-date Farm Journal with a General Farm Department, Dairy, Horticulture, Live-stock, Poultry, Bees, Home and General News. The Editor has had practical experience in every department of farm work. To introduce the paper, it will be sent to New subscribers one year for 25c. Sample copies free. Best Advertising Medium in the Central West. Clubbed with *Gleanings* for \$1.00.

ADDRESS

Modern Farmer, St. Joseph, Mo.

A Great Combination.

Good reading for every member of the family at one-half price.

Gleanings in Bee Culture.....	Reg. price, \$1.00.
The Mich. Farmer (weekly)....	“ .60.
The N. Y. Tribune (weekly)....	“ 1.00.
Pearson's Magazine.....	“ 1.00.
People's Home Journal.....	“ 1.00.
The Poultry Journal.....	“ .50.

At regular price would cost.....\$5.10.

We will send any one the entire lot for \$2.50, each one a full year, all postage paid. Each publication is the best of its kind published. THE MICHIGAN FARMER is a large, popular farm, stock, and home journal, published at Detroit, Mich., has a large circulation, and is national in every way except in name. Send to them for a free sample copy. The other papers are all well known and popular. The offer is a rare bargain. Address all orders to this office.

THE MICHIGAN FARMER, Detroit, Mich.

HONEY QUEENS !!

I have them, as daily letters testify. Recent conclusions force the belief that the leather-colored strain of three-banders excel in honey-gathering. If you want Golden's my strain takes the lead of all others, and I have tried them all; 250 colonies for honey, and 200 strong nuclei that will winter over. I am prepared to send you a queen any day you may order. Tested or untested queens, \$1.00. Leather breeders, \$2.50. Owing to increased demand straight 5-band breeders are \$5.00 each.

W. H. LAWS, Beeville, Texas.

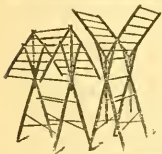

PUT THEM TOGETHER

in your own shop; easy to make, easy to sell. We do two-thirds the work, you get two-thirds of the money. Price of material, and full directions free. Exclusive territory. Address

D. S. Hall, Sou. Cabot, Vt.

For Sale. Forty-five colonies of bees in 10 frame hives, with honey enough for winter; 55 extracting-supers, with frames and drawn combs all wired; 33 empty hives; 36 supers with sections and foundation; 30 queen-excluding honey-boards; four-frame Excelsior extractor. In good basswood locality. All for \$150.00. One mile from Homer, Nebraska.

JAS. P. GOODWIN, Homer, Neb.

FOR SALE.—A 40-acre farm situated in the famous resort region of Peto-key, four miles from city. Farm is well adapted to gardening, fruit, dairy, or poultry. If purchased soon a good chance may be had to purchase cheap; garden and farm implements; good buildings; easy terms. Address

Box 493, Petoskey, Mich.

QUEENS. Warranted, November, \$1.00; dozen, \$9.00; tested, \$1.25; dozen, \$12.00. See late ads. Guaranteed.

J. B. CASE, Port Orange, Fla.

BELG. HARES

W. HAHMAN, Box 3, ALTOONA, PA.



Belgian Hares

I have some fine hares for sale at reasonable prices.

J. F. Moore, : Tiffin, Ohio.

\$18 Guaranteed for 10 Years. Frgt. Prepaid and Money Back if not Satisfactory.

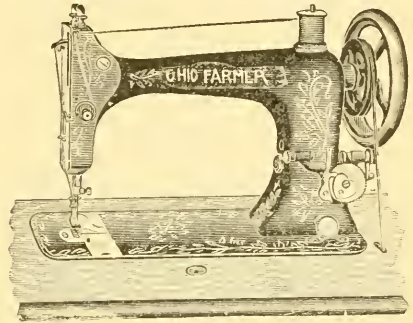

Send us \$18.00 and we will send you one of our NEW IMPROVED OHIO FARMER HIGH-ARM SEWING-MACHINES, freight prepaid. Use it for all kinds of work, and if not satisfactory you can return it in 90 days and we will refund your money and pay freight both ways.

All Guaranteed New Machines.

Self-setting needle; automatic bobbin-winder, with oak or walnut woodwork; new bent wood top; seven long skeleton drawers. Full and complete set of attachments and illustrated instruction book sent with each machine. Every machine we send out guaranteed to give ENTIRE SATISFACTION OR MONEY REFUNDED. We can furnish repairs or needles at any time. Remit by postoffice order, registered letter, New York draft, or express.

If you want the BEST sewing-machine made in the world at the LOWEST PRICE ever offered, send us your order.

Drop Head, \$20.00.

This is the same machine, except the cabinet, which is made so that head drops out of sight when not in use. Four drawers, Freight prepaid. With same attachments as the \$18.00 machine.

Our No. 2 Machines.

Have old-style top tension instead of the new side tension furnished on the others. Not quite as much work on them as the others, which accounts for the same lower price; but we guarantee them for the same time, furnish same attachments, and prepay freight.

High Arm No. 2, 5 Drawers, Only \$15.00.
Drop Head No. 2, 4 Drawers, Only \$16.50.

Send for our new illustrated catalog. Address

The Ohio Farmer, : : : Cleveland, Ohio.

NOTE.—We have known the publishers of the Ohio Farmer for many years. They are entirely responsible, and will fully make good their agreements.

THE A. I. ROOT COMPANY.

POULTRY-BOOK FREE. 64 pages, illust'd, with 3 mos. trial subscription to our paper, 10 cts.

Inland Poultry Journal, Indianapolis, Ind.

FOR SALE.—GLEANINGS from the first number, Feb. 1, 1873, up to date, inclusive of all numbers of the juvenile department, all in very good condition. Who wants them? THOS. WITTMAN, 52d and Jefferson Sts., West Philadelphia, Pa.

FOR SALE.—12,000 up-to-date poplar dovetailed sections in flat; 100 Hoffman hives and frames with bottoms and roofs painted; 200 supers for said hives. Will take part buckwheat extracted honey or bees in payment. D. E. FLOYD, Nelliston, N. Y.

FOR SALE.—Poultry, fruit, and bee ranch at Port Angeles, Wash. Finest opportunity in the world for the right man. Write now. GEO. V. SMITH.

In writing advertisers mention Gleanings.

Wants and Exchange.

Notices will be inserted under this head at 10¢ per line. You must say you want your ad in this department, or we will not be responsible for any error. You can have the notice as many lines as you please; but all over ten lines will cost you according to our regular rates. We cannot be responsible for dissatisfaction arising from these "swaps."

WANTED.—To exchange buckwheat extracted honey as cash, for 2d hand hives—Simplicity or 10 frame only. Have your neighbors got any, or store combs?
W. I. COGGSHALL,
West Groton, Tompkins Co., N. Y.

WANTED.—A position with a good bee-keeper, or will take entire charge for you; 15 years' experience. Good reference to give.
J. E. HENDERSON, Elm Grove, Ohio Co., W. Va.

WANTED.—A competent man to take charge of four or five hundred colonies. To the right man a good proposition will be made. Write, stating amount of experience, age, etc.
I. A. KING, Almond, San Diego Co., Cal.

WANTED.—Several bushels of Alsike clover seed. Who will sell me pure seed the cheapest?
DANIEL DANIELSON, Clarkson, S. D.

WANTED.—Two or three apiaries for cash; located in Colorado; write full particulars; first letters and lowest cash price; comb honey preferred.
THOS. C. STANLEY & SON, Fairfield, Ill.

WANTED.—Potatoes for cash, in sections where crop is large.
F. W. DEAN, New Milford, Pa.

WANTED.—To exchange 100-egg Buckeye Incubator for shotgun, or any thing useful to a bee-keeper.
J. WARREN ARTHUR, Beatty, O.

WANTED.—To exchange modern fire arms, for old flint lock guns, and old, antique dishes.
Address 216 Court St., Reading, Pa.

American Gardening

10 Sample Copies separate issues, 10 cents. Published at 136 Liberty Street, New York.

Root's Goods for California.

We have just received a large carload of sections, extractors, smokers, veils, etc., direct from the factory, and are prepared to supply bee-keepers with the same promptly. Do not send a long distance and pay high freights. Write for our prices.

M. R. MADARY, - Fresno, California.

Tour of All Mexico

in Pullman's finest Compartment Drawing Room, Library, Observation, and Dining Cars—all Vestibled—with the celebrated

Open-top Car "Chillilitli"

for Observation in the Mountains and Canyons, and Dining-car in the Tropics.

A delightful trip of 38 days with **Three Circle Tours in the Tropics of the South of Mexico, and a Visit to the Ruined Cities**

All exclusive features of these itineraries of leisurely travel and long stops. The Special Train starts Tuesday, January 22, from Chicago.

Tour of Puerto Rico.

SPECIAL PULLMAN CARS leave Chicago **Thursday, January 17, and Thursday, February 14, at 9:30 A. M.**, connecting with the splendid new steamships Ponce and San Juan sailing from New York the second day following. Individual Tickets sold for other sailing dates, alternate Saturdays.

Tickets Include All Expenses Everywhere.

These select limited parties will be under the special escort and management of THE AMERICAN TOURIST ASSOCIATION, Reau Campbell, General Manager, 1423 Marquette Building, Chicago.

Itineraries, Maps, and Tickets can be had on application to Agents of the Chicago, Milwaukee & St. Paul R'y.

WHERE TO LOCATE?

Why, in the Territory Traversed by the

Louisville & Nashville

RAILROAD.

THE

Great Central Southern Trunkline

IN

KENTUCKY, TENNESSEE, ALABAMA, MISSISSIPPI, FLORIDA.

WHERE

Farmers, Fruit-growers, Stock-raisers, Manufacturers, Investors, Speculators, and Money Lenders

will find the greatest chances in the United States to make "big money" by reason of the abundance and cheapness of

Land and Farms, Timber and Stone, Iron and Coal, Labor--Everything.

Free sites, financial assistance, and freedom from taxation for the manufacturer.

Land and farms at \$1.00 per acre and upwards, and 500,000 acres in West Florida that can be taken gratis under U. S. homestead laws.

Stockraising in the Gulf Coast District will make enormous profits.

Half-fare excursions the first and third Tuesdays of each month.

Let us know what you want, and we will tell you how to get it—but don't delay, as the country is filling up rapidly.

Printed matter, maps, and all information free.

Address **R. J. WEMYSS,**
Gen'l Immigration and Industrial Ag't,
LOUISVILLE, KY.

Mr. A. I. Root's Writings

of Grand Traverse territory and Leelanau County are descriptive of Michigan's most beautiful section reached most conveniently via the

Pere Marquette R. R.

For particulars address W. C. Tousey, D. . A., Toledo, Ohio.

Low Rates to the South.

Excursion tickets at reduced rates are now being sold by the Chicago, Milwaukee & St. Paul Railway to the prominent resorts in the South, including Jacksonville, Fla.; Mobile, Ala.; New Orleans, La.; Savannah, Ga.; El Paso, Tex., which are good for return passage at any time prior to June 1, 1901. Information regarding rates, routes, time, etc., can be obtained on application to any coupon-ticket agent of the Chicago, Milwaukee & St. Paul Railway.

New Smith Premiers Nos. 5 and 6.

The No. 6 takes paper 18½ inches wide and writes lines 16 inches long. The No. 5 takes paper 11 inches wide and writes lines 9½ inches long. These new machines in essential mechanical principles are the same as Models Nos. 2, 3 and 4—unequaled.

Write for Printed Matter Free.

The Smith Premier Typeewriter Co.

158 Prospect Street, Cleveland, Ohio.

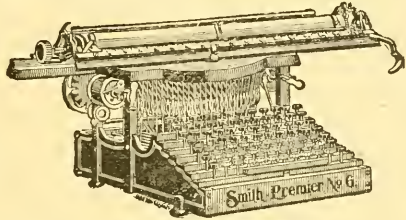

No Money in Advance

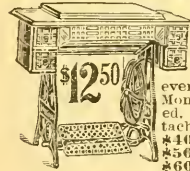

Our elegant New Jewel Drop-head Sewing Machine possessing all the latest improvements, high quality and thorough workmanship. Shipped direct at \$12.50, the lowest price ever known. 30 days' free trial. Money refunded if not as represented. Guaranteed 20 years. All attachments free. 125,000 sold.

\$10.00 Arlington for... \$14.50
\$50.00 " " " " \$17.00
\$60.00 Kenwood " " \$21.50

Other Machines at \$8.00, \$9.00 and \$10.50. Large illustrated catalogue and testimonials free. CASH BUYERS' UNION, 158-164 W. VanBuren St., B-345, Chicago

Union Combination Saw

For Ripping, Cross-cutting, Rabbling, Mitering, Grooving, Gaining, Boring, Scroll-sawing, Edge-moulding, Beading. Full line FOOT and HAND POWER machinery. Send for catalog A. SENECA FALLS MFG. CO. 44 Water St., Seneca Fs., N. Y.

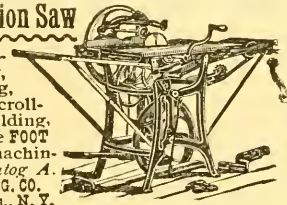

Improved Ohio Farmer REPAIR OUTFIT.

Our Price Only \$1.65.

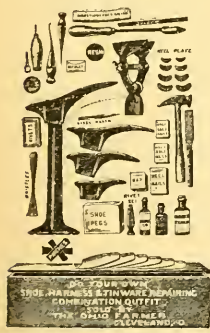

We have examined samples from all manufacturers, and believe this is the very best repair outfit on the market; easily worth \$1 more than those offered by stores and other papers. It contains 48 articles, all full size and first class, and we guarantee satisfaction or will refund money. Half-soles alone are worth 50c, and are not included in other outfits. It will soon pay for itself in repairing boots, shoes, rubbers, harness, and tinware.

Repair Outfit with Ohio Farmer one year for only \$2.15, or the Complete Outfit free for a club of 10 subscribers to the Oh'io Farmer. By freight.

Send for our illustrated premium list, giving wholesale prices on watches, sewing-machines, knives, and lots of other useful articles. Mention this paper.

The Ohio Farmer, : Cleveland, Ohio.

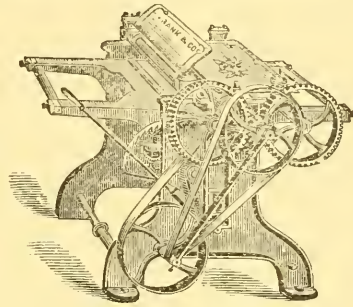

PLANERS

The above cut shows one of our small Planers, of which we make twelve different styles and sizes. Also large Planers, Band Saws, Buzz Planers, Moulders, Wood Lathes, and all kinds of

WOOD WORKING MACHINERY

Send for Catalogue.

The FRANK MACHINERY CO.
BUFFALO, N. Y.

The Power Question

—for farm use, dairies, creameries, cheese factories—anything requiring light power is best settled by buying one of these.

LEFFEL ENGINES.

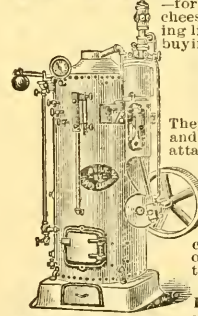

They are made in both horizontal and upright pattern, with engine attached to boilers. Being very simple and direct in construction they are economic of fuel and great developers of power. Best for cutting and grinding feed, sawing wood, pumping water, separating cream, churning, &c. Made of the best material throughout they are durable and long lived.

Send stamp for our Book on Engines and Power.

JAMES LEFFEL & CO., Box 89, Springfield, O.

FOR SALE.—Fox, coon, rabbit, and blood hounds, also game chickens.

E. IAS FOX, Hillsboro, Wis.

In writing advertisers please mention Gleanings.



LOTS OF EGGS MEANS LOTS OF MONEY.

If you can double the eggs you double the money. Green Cut Bone is the only thing which will double the egg product. It is easily secured, easy to prepare and feed and is cheap.

MANN'S NEW BONE CUTTERS

are the difference between profit and loss in the poultry business. Cut fine, fast and easy. Mann's Clover Cutters, Granite Crystal Grit and Swinging Feed Trays make the business profitable. Catalogue free. F. W. MANN CO., Box 87 MILFORD, MASS.



"Profitable Poultry Keeping

IN ALL ITS BRANCHES." This is the title and theme of our new Year Book. Contains 192 pages, 8x11 in.; 200 new and original illustrations of best poultry farms, buildings, etc., in the country. Deals with every phase of the poultry industry in an instructive and profit bringing way.

Treats also of the famous non-moisture, self-ventilating **CYPHERS INCUBATORS**, guaranteed to out-throw three or more tests or money refunded. Sent for 10c in stamps. Ask for book 74. Circulars and prices free. Address nearest office. **CYPHERS INCUBATOR CO.**, Chicago, W. yand, N. Y., Boston, Mass.



INVESTIGATE BEFORE YOU BUY.

We want our customers to be perfectly satisfied before they spend the money, investigate the claims of all incubators and then decide. We believe you will find that the

SURE HATCH INCUBATORS

AND COMMON SENSE FOLDING BROODERS are giving better satisfaction than any other made. It's because they are so simple, sensible and sure. They are built for busy people, who haven't time to fuss and bother. Our catalogue is FREE. We can't ask you to pay for it. Isn't it worth examining?

We Pay the Freight.

SURE HATCH INCUBATOR COMPANY, CLAY CENTER, NEBRASKA.

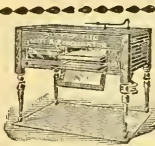

Our Incubators

have all the latest improvements, are sold at very low prices and guaranteed to please every customer. Send 6 cents for our 154 page catalogue, which contains full descriptions of our extensive line and tells how to raise poultry successfully. Plans for poultry and brooder houses.

Des Moines Incubator Co., Box 503, Des Moines, Ia.

Satisfaction guaranteed or money refunded on every

MARILLA

INCUBATOR & BROODER we sell. Are not those reasonable farmers that shows you how much faith we have in our machines. Either HOT WATER, or HOT AIR machines. A child can work them. Eleventh year on the market.

MARILLA INCUBATOR CO.

Catalogue 2c. Stamps. Box 62 Rose Hill N.Y.

ROOM AT THE TOP

Recognizing that there was "room at the top," we have issued not an ordinary catalogue but the



20th Century Poultry Book.

Contains the latest and best thought on the poultry question, from the egg through all its changes, to the market. No subject missed. Written from practical experience. The world renowned **Reliable Incubators and Brooders**, used all over the U. S. and in 51 foreign countries, receive deserved attention. Book mailed anywhere for 10c.

RELIABLE INC. & BROODER CO., Box B-49 Quincy, Ill.

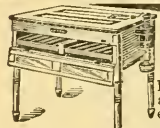

200-Egg Incubator for \$12.00

Perfect in construction and action. Hatches every fertile egg. Write for catalogue to-day. **GEO. H. STAHL, Quincy, Ill.**

1200 FERRETS FOR SALE. Small, medium, and large sized; some trained. First-class stock. New price list free.

N. A. KNAPP,

Rochester, Lorain County, Ohio.



Sharples Cream Separators - Profitable Dairying

A BASKET FULL OF EGGS

by using Ley's Poultry Condition Powders. Puts all fowls in a normal condition; destroys all disease germs; purifies the blood; is a tonic and nutrient. Price 25 cts. a pk.; 5 for \$1.00. Ley's Thoroughbred Minorca's Eggs, \$1.00 for 15. Also Thoroughbred Belgian Hares. **Geo. J. Ley, Florence, Cal.**

EASY EGG MONEY

A man can easily make money selling eggs if he can but get the eggs. He can get the eggs **sure**—twice as many, if he will feed his hens on Green Cut Bone. No better way to prepare it than with

ADAM'S GREEN BONE CUTTER

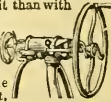

It cuts on the shear plate principle. Takes off a fine ribbon like piece, easily consumed by the chicks or fowls. No sharp splinters to injure throat. Turns easily. Only half-bearing cutter made. For hand or power. Catalogue No. 99 free. **W. J. ADAM, Joliet, Ill.**

DO YOU GET GOOD HATCHES?

Fertility and vitality depend upon the feeding ration. Feed cut green bone and get good hatches. Use the

HUMPHREY GREEN BONE AND VEGETABLE "CUTTER."

—the open hopper kind. No fuss nor bother. Guaranteed to cut more bone with less labor than any other. Money back if dissatisfied. Send for book containing egg record and blanks for a whole year.

HUMPHREY & SONS, Box 51 JOLIET, ILL.

SPRAYING

with our new patent **Kerosene Sprayers** is simple indeed. Kerosene emulsion made while pumping. 12 varieties sprayers, Bordeaux and Vermorel Nozzles, the "World's Best." **THE DEMING CO., SALEM, O.** Western Agents, Henion & Hubbell, Chicago. Catalogue and formulas free.



TREES Fruit and Ornamental, Shrubs, Roses, Vines, Plants, Bulbs, Seeds. The best by 47 years test. 1000 acres, 40 in Hardy Roses, 44 greenhouses in Everblooming Roses and Plants. Mail size postpaid, safe arrival guaranteed, larger by freight or express. Try us, our goods will please you and direct deal will save you money. Correspondence solicited. Valuable catalogue free.

STORRS & HARRISON CO., Box 223 Painesville, Ohio.



"Planet Jr. GIRDLING THE WORLD."

The "Planet Jr." Year Book for 1901, like its predecessors, will be the best catalogue of the season. Last year it took 350,000 copies to supply the demand. We have issued a like amount for this year and shall print subsequent editions as required. To those who know us we need only say that the new catalogue surpasses that of 1900. Sixteen full page half tone views made from original photographs will show how their farm at home and in foreign lands, illustrates fully the complete "Planet Jr." line, comprising Seed Drills, Wheel Hoes, Cultivators, Harrows, Two Horse Cultivators, and Sugar Beet Seeders and Cultivators. We mail this catalogue free upon request to everybody having crops of any kind to cultivate. We fit every case from the smallest garden to the largest farm. Prices greatly reduced for 1901.

S. L. ALLEN & CO., BOX 710-H, PHILADELPHIA, PA.
Two Gold Medals at Paris Exposition; Highest Award.

50c SEED DUE BILL FREE

Send us to-day, your name and address on a postal and we will mail you FREE our handsome illustrated Seed Catalog containing Due Bill and plan good for 50c worth of Flower or Vegetable Seeds FREE. Your selection to introduce

The Best Northern Grown Seeds direct from grower to planter, from Saginaw Valley Seed Gardens. Seed Potatoes, Vegetable, Flower, Field Seeds and Plants.

100,000 PACKAGES SEEDS FREE on above plan. Write quick, send names of neighbors who buy seeds. \$100 cash for best list. See the catalogue.

HARRY N. HAMMOND SEED CO.,
Box 69, BAY CITY, MICH
Formerly of Egheld.

212 For 14 Cents

We mail the following rare seed novelties.

1 pkg. Blue Blood Tomato Seed,	\$.15
1 " Northern Lemon Seed,	.15
1 " Mama's Favorite Onion Seed,	.10
1 " Emerald Green Cucumber Seed,	.10
1 " City Garden Beet Seed,	.10
1 " 13-Day Radish Seed,	.10
1 " La X. Market Lettuce Seed,	.15
3 " Brilliant Flower Seed,	.15

Worth \$1.00 for 14 Cents.

Above 10 packages rare novelties we will mail you free, together with our great illustrated Seed Catalog, telling all about

Salzer's Billion Dollar Grass
Also Choice Onion Seed, 60c. a lb.

Together with thousands of earliest vegetables and firm seeds, upon receipt of 14c. send **this notice.** When one plant Salzer's Seeds you will never do without.

JOHN A. SALZER SEED CO., LaCrosse, Wis.

OLDS' Seed Potatoes
Always Give Satisfaction.

18,000 bushels this year. Largest and best stock ever grown. Pat's Choice, Pingree, Vigorosa, Bovee, Ey. Mich., Ey. Ohio, Acme, McKinley, Carm. 3, Sir Walt. Cal., Livingston, etc. Pure Stock, Low Prices.

Olds' Field and Garden Seeds.
Quality the best; price as low as the cheapest. First Dried Seed Corn a specialty. Seed Oats, Barley, Rape, Millet, Clover, Field Peas, Vegetable and Flower Seeds. 40 p. illus. Catalog Free. L. L. OLDS, Drawer H, Clinton, W. S.

SEED DUE BILL FREE

To get new customers to test my seeds, I will mail my 1901 catalogue, filled with more Bargains than ever and a 10c Due Bill good for 10c worth of seeds for trial absolutely free. All the Best Seeds, Bulbs, Plants, Roses, Farm Seeds, Potatoes and many Novelties at lowest prices. Ginseng, the great money making plant. Giant Prize Tomatoes, 2 to be foot, Pan American Oats, sent on free to farmers, and two Free Passes to Pan American Exposition, Buffalo, N. Y. are offered, \$2,635 00 in cash premiums. Don't give your order until you see this new catalogue. You'll be Surprised at my bargains offered. Send postcard for catalogue to-day. It is FREE to all. Tell your friends to send too.

F. B. MILLS, Box 105, Roschill, Oneadaga Co., N. Y.

Ferry's SEEDS

Ferry's Seeds are known the country over as the most reliable Seeds that can be bought. Don't save a nickel on cheap seeds and lose a dollar on the harvest.

1901 Seed Annual free.

D. M. FERRY & CO.,
Detroit, Mich.

Pig-Tight HORSE-HIGH!

... BULL-STRONG ...

With our Duplex Automatic Ball Bearing Moven Wire Fence Machine, any farmer can make 100 styles, and from **50 to 70 rods a day** of the best and most practical fence on earth at a cost for the wire to make it of from **20 to 30c. per rod** We sell Ornamental Fence and Gates, Farm Fence and Gates, Plain, Barbed and Coiled Spring Wire direct to the farmer at wholesale prices. Catalogue free.

KITSELMAN BROS.,
Box D31, Muncie, Ind.

Longest Tongues.

For two years I have been advertising and selling a superior strain of bees. I knew that they were really superior, that they stored more honey than any other strain of bees with which I was acquainted, and that others who had tried them had the same report to make; I knew that they were gentle and hardy, as well as industrious, but just *why* they should store more honey I was unable to decide. It is possible that I do not now know why; but at last I have got a hint—they have *very long tongues*. The average length of bees' tongues is 16-100 of an inch, while these bees have tongues 23-100 of an inch in length. Only one other report has been made of bees having tongues of this length. This breeder, who has been furnishing me queens, has been breeding this strain of bees for more than 20 years, always selecting the best to breed from, and, for this reason, this trait, or peculiarity, that of having long tongues, must have become fairly well *fixed*—much more so than in that of some chance sport. The discovery of this reason for their superiority is the source of considerable satisfaction to me. Heretofore I could only assert that the bees were superior, that they would store more honey, but I could give no reason why, except that this trait had been developed by years of selection and careful breeding; now I can say why, or, at least, give a reasonable reason why.

I wish to repeat what I have already said several times; viz., that it is impossible for a

bee-keeper to invest a small sum of money to better advantage than by introducing this strain of bees into his apiary. It will repay him a hundred fold—perhaps a thousand fold. In addition to their known length of tongue, there are also the additional traits of hardiness and gentleness—something well worth considering.

To those who are thinking of trying this strain of bees, I would say, don't wait until next spring before sending in your order. Last spring, when I began sending out queens, there were orders on my books for nearly 200 queens. Orders are already coming in to be filled next spring. They will be filled in rotation; so, if you wish to get a queen next spring, send in your order this fall. The price of a queen is \$1.50; but safe arrival, safe introduction, purity of mating, and entire satisfaction are all guaranteed. The queen can be returned any time within two years, and the money refunded, and 50 cents additional sent to pay for the trouble.

The REVIEW for this year and next (two years) and one of these queens for only \$2.00. As soon as your order is received, the back numbers for this year will be sent, and your subscription put on the book to the end of 1901, and next spring the queen will be sent you.

I have many unsolicited testimonials as to the superiority of this strain of bees. Here is the last we received:

Mr. W. Z. Hutchinson:—

WOODLAND, ILLS., Nov. 20, 1900.

Can any more of those queens be purchased of you next season? The one I bought of you last June out-stripped every thing else in this vicinity. As a breeder, she certainly capped the climax of any thing that ever came under my observation in the bee-line. And her offspring—well, they are simply marvelous as workers. From her colony, in September, I extracted 65 lbs. of honey of the finest quality and, remember, the honey season here was a very poor one. There are a number of apiaries in this vicinity, and I do not know of one that will average 10 lbs. per colony. And I want to add right here that the cappings of the honey in this colony were of snowy whiteness; and, to-day, as I put this colony in winter quarters, I find the eight combs well filled and capped with that same snowy whiteness that was so conspicuous in the supers. I stand ready to challenge any apiarist in this locality to produce bees the equal of these as honey-gatherers. Two of my friends wish to get queens of this strain, and I certainly want more of them if they can be gotten.

Yours respectfully,

C. E. AURICK.

Address all Orders to

W. Z. HUTCHINSON. = FLINT, MICHIGAN.



BEE-HIVES AND HONEY-BOXES,

in car lots—wholesale or retail. Now is the time to get prices. We are the people who manufacture strictly first-class goods and sell them at prices that defy competition. Write us today.



Interstate Box & Manufacturing Co., Hudson, Wis.

In writing advertisers please mention Gleanings.

Notice.

◆ ◆ ◆ DO YOU WANT ◆ ◆ ◆
 Printed Stationery, Queen-cages, or Folding
 Cartons for your next season's honey crop?
 If so, here are a few prices which will hold
 good for a short time only. ◆ ◆ ◆ ◆

High-cut Melon Laid Envelopes, 6½×3½ at \$2.00
 per 1000. If you haven't use for that many will
 print and send by mail, postpaid, 100 for 50 cts.
 Round-corner Die-cut Cards 4½×2¾, \$1.80 per M.
 Letter-heads, 11×8½, \$2.00 per M.
 Folding Cartons, printed one side, \$3.20 per M.
 Sample for stamp.
 Polished Queen-cages, \$9.00 per M.
 We have on hand 2000 second-hand L-size brood-
 frames at \$1.00 to \$1.25 per 100, also 150 hives.
 If any readers of Gleanings would like a fine
 trio of Belgian Hares, will say that many will
 have some very fine imported and domestic ped-
 greeed stock. Also some cheap unpedigreed.
 We breed improved queen bees in season. Re-
 member that.
 Parkertown is now a money-order office, so
 please don't send stamps for goods if you can
 help it.

ADDRESS ALL ORDERS TO
 H. G. Quirin, Parkertown, Erie Co., Ohio.

Root's Bee-supplies for the South Atlantic States at Root's Prices.

Quick Shipments.
 Low Freight Rates.

We call your attention to our one-
 horse Winner Wagon.
 Star Force-feed Wheelbarrow Clo-
 ver Seeder.
 Pea-Threshers.
 Buffalo Pitts Harrows.
 We carry a full line of the most
 approved Farm Implements, etc.
 Send for catalog G.

Rawlings Implement Co.,
 209 S. Charles St.,
 Baltimore, Md.

1881

PAGE & LYON MFG. CO.

1900

We manufacture a full line of the latest
BEE-SUPPLIES.

Our motto is, "Perfect Goods and Prompt Shipment."

Send for our new free illustrated catalog.

PAGE & LYON MFG. CO., New London, Wisconsin.

NOW READY!

64-PAGE CATALOG OF EVERY THING BEE-KEEPERS NEED. Illustrated
 and fully described. Especially valuable to beginners for the information
 it contains. Send your address on a postal and get it now. Established 1884.

J. M. JENKINS, Wetumpka, Ala.

Our Advertisers.

Green Bone as an Egg-Maker.

At this time of year the poultryman wants eggs above every thing else. If his hens ever have an opportunity of showing what they can do, now is their chance, for eggs mean money during this and next month. It is hardly worth while at this time to go into the necessity of careful and judicious feeding in order to get a supply of eggs. Every poultryman realizes that the hen can lay eggs only when she has the necessary ingredients at her command, and that she must get these ingredients in her food. The leading poultry-raisers of the country (we do not know of a single exception) are a unit in saying that of all foods which can be given poultry, none has a better effect on the egg-basket, at a less expense, than cut green bone. Since the day when the original bone-cutter (the Mann) was put on the market, green bone has increased in popularity and has doubled the income of many a poultry-raiser. The Mann Bone cutter was the original, and is still the one most largely used. Its popularity is the best indication of its merit. Send to F. W. Mann Co., Milford, Mass., for new catalog and book on feeding.

The Swarthmore Cage is the most perfect nursery yet devised. It admits of practicing all methods of cell-getting, lessens manipulation, does away with all division and honey boards, may be placed like any comb in any hive, no small parts, all in one piece; acts as cell-protector, hatchery, nursery, and magazine; a single cell or all may be separated without cutting, or all may be allowed to hatch at once. The Swarthmore plug-cup is the simplest cell-cup of all—no delicate waxwork. Price, complete, by mail, with full directions, \$1.00.

The Swarthmore Apiaries, Swarthmore, Pa.
Send for queen circular—13th year. E. L. PRATT.

QUEENS ! QUEENS !

If any of the readers of Gleanings are looking out for their queens for 1901, remember The Jennie Atchley Co. are preparing to rear queens largely, and will try to be ready to fill orders promptly in any quantities. Write today for a catalog, giving queen-rearing, and full instruction how to manage apiaries for profit.

The Southland Queen

The Only Southern Bee-paper.

\$1.00 per year, together with a premium untested queen, to new subscribers.

You can send your subscription now, and get the queen-bee when you want her.

Bee-keepers' Supplies.

THE JENNIE ATCHLEY CO.,
Beville, Bee Co., Texas.

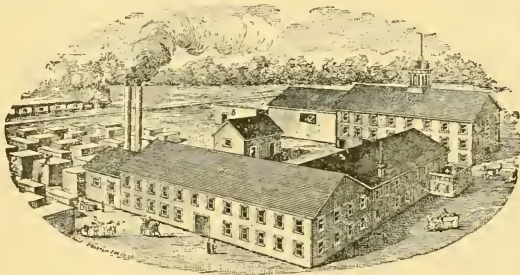

KRETCHMER M'F'G CO., Red Oak, Iowa.

BEE-SUPPLIES.

Best-equipped factory in the West; carry a large stock and greatest variety of every thing needed in the apiary, assuring BEST goods at the LOWEST prices, and prompt shipment. We want every bee-keeper to have our FREE ILLUSTRATED CATALOG, and read description of Alternating Hives, Ferguson Suppers, etc. Write at once for a catalog.

— AGENCIES: —

Trester Supply Co., 103 So. 11th St., Lincoln, Nebraska; C. C. Richards, 1223 17th St., Denver, Col.



BINGHAM SMOKER.

DEAR SIR:—Inclosed find \$1.75. Please send one brass Smoke-engine. I have one already. It is the best smoker I ever used.
Truly yours,
HENRY SCHMIDT, Hutto, Tex

MADE TO ORDER.

Bingham Brass Smokers

Made of sheet brass, which does not rust or burn out; should last a lifetime. You need one, but they cost 25 cts. more than tin of the same size. The little open cut shows our brass hinge put on the three larger sizes. No wonder Bingham's 4-inch smoke-engine goes without puffing, and does not drop inky drops. The perforated steel fire-grate has 381 holes to air the fuel and support the fire.

Heavy tin smoke-engine, 4-inch stove, per mail, \$1.50; 3½-inch, \$1.10; 3-inch, \$1.00; 2½-inch, 90c; 2-inch, 65c. Bingham smokers are the originals, and have all the improvements, and have been the standard of excellence for 22 years. Only three larger ones brass.

T. F. Bingham, : : Farwell, Mich.

Contents of this Number.

Bee and Fruit Men in Session.....51
 Bees and Fruit—Green on.....43
 Bee keepers, Value to of N. B. K. A.....54
 Black Brood, To Cure.....55
 Brown Seige.....52
 Buckwheat, Great Yield from.....53
 Clover, Sweet.....43
 Clover's in Wisconsin.....52
 Convention, Geneva.....55
 Convention, Ontario.....55
 Co-op ration, Aikin on.....46
 Dadant in Paris.....45
 Extracting outfit, Gilstrap's.....48
 Grafting with Pipette.....53
 Hives, Doolittle on.....51
 Honey, Bleaching Dark Extracted.....56
 Nevada, Honey from.....45
 Popperton, O. O.....47, 54
 Sections, Thin, Transparent.....53
 Sections, Use of Partly Filled.....43
 Section folder, Mittle's.....50
 Space, Proper Bee.....44
 Sugar, Beet v. Cane.....44
 Uniting in Winter.....53
 Utter Case, Va'ue of.....44
 Utter Trial, Personnel of.....53

Honey Column.

GRADING RULES.

FANCY.—All sections to be well filled, combs straight, firmly attached to all four sides, the combs unsoiled by travel stain, or otherwise; all the cells sealed except an occasional cell, the outside surface of the wood well scraped of propolis.

No. 1.—All sections well filled except the row of cells next to the wood; combs comparatively even; one-eighth part of comb surface soiled; or the entire surface slightly soiled, the outside surface of the wood well scraped of propolis.

No. 2.—Three-fourths of the total surface must be filled and sealed.

No. 3.—Must weigh at least half as much as a full weight section.

In addition to this the honey is to be classified according to color, using the terms white, amber, and dark; that is, there will be "fancy white," "No. 1 dark," etc.

CITY MARKETS.

BUFFALO.—Comb honey, fancy, 16@17c; A No. 1, 15@16; No. 1, 14@15; No. 2, 13@14; No. 3, 12@13. Extracted, white, 7@8; dark, 5½@6; beeswax, 28@30. The demand for honey since the holidays is pretty slow. I think honey is scarce enough so that it can be all marketed at about the prevailing prices.
 Jan. 8, 1901. W. C. TOWNSEND, Buffalo, N. Y.

ALBANY.—Honey market dull, and prices nominal. White comb, 15@16; mixed, 13@14; dark, 11@12. There is a good deal of complaint of honey hardening in comb; and when it does, consumers think it is not pure, and it injures the sale. Extracted market quiet; white, 8@8½; mixed, 7@7½; dark, 5½@6.

MACDUGAL & Co.,
 Successors to CHAS. McCULLOCH & Co.,

Jan. 11. Albany, N. Y.

NEW YORK.—Both comb and extracted honey market, dull and featureless. No New York State white comb honey on the market to speak of, but some buckwheat to be had. We quote: Fancy white, 15@16; A No. 1, 14@15; No. 1, 14@15; No. 2, 12@13; fancy buckwheat, 11; No. 1, 10; No. 2, 9. Extracted, white, 8; light amber, 7@7½; amber, 6@6½; buckwheat, 5½@6. Beeswax, dull but firm, 27@28.

CHAS. ISRAEL & BROS.
 486-8 Canal St., New York City.
 Jan. 11.

PHILADELPHIA.—As we predicted some weeks ago, the cars of California honey in comb have been unloaded, and pushed to get returns, and market broke down. We quote: Fancy comb, 15; No. 1, 13@14. Extracted white, 7; amber, 6. Beeswax, 28. We are producers of honey, do not handle on commission.

WM. A. SELSER.
 10 Vine St., Philadelphia, Pa.
 Jan. 11.

NEW YORK.—The demand for all grades of comb honey still continues to be very brisk. Our receipts are rather light. We quote: Fancy white comb, 15@16; No. 1, 13@14; No. 2, 12½@13½; buckwheat, 10@11. There is but a small demand as yet for buckwheat extracted. Some small sales are reported as low as 5½. Beeswax is in good demand, and firm at 28.

FRANCIS H. LEGGETT & Co.,
 Franklin, West Broadway, and Varick Sts.,
 Jan. 11. New York City.

DENVER.—Demand not very active. Fancy white, \$3 25 per case of 24 sections; No. 1, \$3.00. Extracted white, 7½@8. Beeswax, 22@25

THE COLORADO HONEY PRODUCERS ASS'N.
 1410 Market St.

WANTED.—Comb and extracted honey. State price, kind, and quantity. R. A. BURNETT & Co.,
 163 South Water St., Chicago, Ill.

FOR SALE.—Light amber extracted honey, in barrels, 7½ a lb.; buckwheat, in kegs, 6c per lb.
 I. J. STRINGHAM, 105 Park Place, New York.

FOR SALE.—Choice alfalfa honey. Two cans, 120 lbs. net, whitest, \$9 00; tinted, partly from other bloom, \$8.40. Also small cans.

THE ARKANSAS VALLEY APIARIES,
 OLIVER FOSTER, Prop., Las Animas, Bent Co., Colo.

FOR SALE.—Extracted honey from alfalfa; 60-lb. cans at 7 cts., and smaller cans.
 D. S. JENKINS, Las Animas, Colo.

A Honey Market. Don't think that your crop is too large or too small to interest us. We have bought and sold five carloads already this season, and want more. We pay spot cash. Address, giving quantity, quality, and price.
 Thos. C. Stanley & Son, Fairfield, Ill.

CHAS. ISRAEL & BROS.,

486, 488, 490 Canal St.,
 Corner Watt Street, N. Y.

HONEY & BEESWAX.

Liberal Advances made on Consignments.
 Wholesale Dealers and Commission Merchants.
 Established 1875.

HONEY FOR SALE.

Strictly pure extracted honey, in original five-gallon cans, as received from the apiary, 2 cans in case, 7½c per lb., f. o. b. Provo Utah; or if wanted East, 8c per lb. f. o. b. Chicago. Write S. T. Fish & Co., Chicago, Ill., who will ship from there. Honey guaranteed strictly pure.

W. M. ROYLANCE,
 Wholesale Fruits and Produce,
 Provo City, Utah.
 Established 1885.

ROCKY FORD CANTALOUPE SEED, grown by one of the best melon-growers in Colorado. The seed is all right. Supply limited. Speak soon. I will supply this seed at 65 cts. per lb., post-paid, in the United States.
 H. F. HAGEN, Rocky Ford, Colo.

HIVES. The HUBBARD HIVE leads them all. Easy to operate, and bees store more honey in them than any other hive.
 Hubbard Hive Co., Fort Wayne, Ind.

FACTS About Bees.

REVISED EDITION.
 How to get
GILT-EDGED HONEY
 Send 2c stamp to

THE A. I. ROOT CO.,
 Medina, Ohio,
 or F. Danzenbaker,
 Box 66, Washington, D. C.

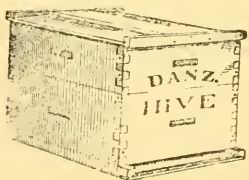

Revised Price List of Garden Seeds for January 15, 1901.

PLEASE NOTICE that any or all seeds mentioned below are sold in five-cent packages, postpaid, by mail. For ten papers ordered at one time, 40 cents; 100 papers, \$3.50. Of course, scarce and high priced seed will necessitate making a very small amount of seed in a package; but by far the greater part of them contain a full half ounce of good fresh seeds. By comparing these packages with those you get of any of the seedsmen you will notice the liberal amounts we furnish for only 5 cts. It is true, we do not give presents or cash prizes; but we believe the most intelligent people of the present day would prefer to have their money's worth of what they ordered rather than to compete for a prize. The five-cent packages are sent postpaid; but the price of all other seeds does not include postage; therefore, when you order seed by the ounce or pound, allow postage thus: 9 cts. per lb.; 5 cts. per $\frac{1}{2}$ lb., or 1 ct. per oz. Peas and beans by the pint and quart must also have 8 cts. per pint or 15 cts. per quart; for corn, add 12 cts. per quart for postage. Postage to Canada is double the above rates. One-fourth ounce, pound, or peck will be sold at ounce, pound, or peck rates unless otherwise specified. In the enumeration below no description of the seeds is given, you may notice. Our larger catalog will be mailed on application.

ASPARAGUS.

Asparagus, Palmetto. Oz. 5c; lb. 40c.

BUSH BEANS.

Burpee's Bush Lima. Pt. 15c; qt. 30c; $\frac{1}{2}$ pk. \$1.00; Wood's Improved Bush Lima. Pt. 20c; qt. 35c; pk. \$2.00.

Davis Wax Bean. Pt., 12c; qt., 20c; 4 qts., 75c; pk. \$1.25; bushel, \$4.75.

White Kidney, Large. Pt. 8c; qt. 15c; pk. \$1.00; bu., \$3.50.

Red Kidney Beans. Same prices as white.

York State Marrow. The standard field bean. Qt. 10c; pk. 75c; bushel, \$2.75.

Banner Field Beans. Qt. 10c; pk. 70c; bushel, \$2.75.

POLE BEANS.

Extra-Early Lima Beans. $\frac{1}{4}$ pt. 8c; qt. 25c; pk. \$1.90. King of the Garden Lima. $\frac{1}{2}$ pt. 8c; qt. 25c; pk. \$1.90.

All of our beans will be furnished in 5-cent packages; but where they are to go by mail, postpaid, of course the above packages will have to be quite small. If wanted by mail, add 8c per pt. or 15c per qt. for postage.

BEETS.

Eclipse. Oz. 5c; lb. 30c; 5 lbs. \$1.25.

Long Red Mangel. Oz. 5c; lb. 20c; 5 lbs. 90c; 10 lbs. \$1.60; 20 lbs. or more, 15c per lb.

Golden Tankard Mangel. Oz. 5c; lb. 20c; 5 lbs. 90c; 10 lbs. \$1.60; 20 lbs. or over, 15c per lb.

STANDARD SUGAR BEETS.

Lane's Imperial Sugar. Oz. 5c; lb. 20c; 5 lbs. 75c; 10 lbs. or more, 20c per lb.

French White Sugar Red-top. Same price as Lane's.

CABBAGE.

Select, Very Early Jersey Wakefield. Oz. 20c; lb. \$2.50.

Henderson's Early Summer. Oz. 10c; lb. \$1.25.

Fottler's Brunswick. Oz. 10c; lb. \$1.25.

Burpee's Sure-head. Oz. 10c; lb. \$1.25.

Excelsior Flat Dutch. Oz. 10c; lb. \$1.25.

Perfection Drumhead Savoy. Oz. 10c; lb. \$1.25.

Large Red Drumhead. Oz. 10c; lb. \$1.25.

CARROTS.

Early French Forcing. Oz. 5c; lb. 40c.

Orange Danvers, Half Long. Oz. 5c; lb. 35c; 5 lbs. \$1.50.

CAULIFLOWER.

Henderson's Early Snowball. $\frac{1}{2}$ oz. 25c; $\frac{3}{4}$ oz. 40c; oz. \$1.50.

CELERY.

Henderson's White Plume. Oz. 10c; lb. \$1.50.

Golden Self-blanching Celery. Oz. 15c; lb. \$1.75.

New Rose. Oz. 10c; lb. \$1.00.

Giant Paschal. Oz. 10c; lb. \$1.00.

Dwarf Golden Heart. Oz. 10c; lb. \$1.00.

CORN (for table use).

Corn we sell at 5c per half-pint package; but at this price purchasers must pay postage, which is 3c for each half-pint. If wanted in larger quantities the price (where no price is given) will be, pt. 7c; qt. 10c; pk. 65c; bu. \$2.25.

Kendel's Early Giant Sweet Corn.

Ford's Early Sweet.

Stowell's Evergreen. Pt. 5c; qt. 8c; pk. 50c; bu. \$1.75.

Late Mammoth Sugar.

Country Gentleman, or Improved Shoepeg.

Sweet Corn for fodder. Pk. 40c; bu. \$1.50.

CORN SALAD.

Oz. 5c; lb. 40c.

CRESS.

Extra Curled, or Pepper Grass. Oz. 5c; lb. 40c.

Water Cress, true. Oz. 25c; lb. \$2.50.

CUCUMBER.

Early Frame. Oz. 5c; lb. 35c.

Improved Early White Spine, or Arlington. Oz. 5c; lb. 35c.

Green Prolific, or Boston Pickle. Oz. 5c; lb. 35c.

LETTUCE.

Grand Rapids Lettuce. Oz. 5c; lb. 50c; 5 lbs. \$2.00.

Boston Market (or White-seeded Tennis-ball). Oz. 5c; lb. 50c.

Henderson's New York. Oz. 5c; lb. 50c.

MELONS, MUSK.

Casaba, or Persian Muskmelon. Oz. 5c; lb. 35c.

Banana. Oz. 5c; lb. 35c.

Extra Early Citron. Oz. 5c; lb. 35c.

Emerald Gem. Oz. 5c; lb. 35c.

Miller's Cream, or Osage. Oz. 5c; lb. 35c.

Paul Rose Muskmelon. Oz. 8c; lb. 60c.

Rucky Ford Canteloune Muskmelon. The same that so many people enjoyed at the Omaha exposition. Pkt. 5c; oz. 8c; 1 lb. 60c.

MELONS, WATER.

Phinney's Early. Oz. 5c; lb. 30c.

Landreth's Boss. Oz. 5c; lb. 30c.

Sweetheart. Oz. 5c; lb. 25c.

ONIONS.

A leaflet on "Growing Onions to Bunch up" will be mailed on application.

Yellow Globe Danvers. Oz. 8c; lb. 75c; 5 lbs. \$3.25.

Large Red Wethersfield. Oz. 8c; lb. 75c; 5 lbs. \$3.25.

Pritzaker. Oz. 20c; lb. \$1.75.

White Victoria. Oz. 20c; lb. \$2.50.

American (Extra Early) Pearl. Oz. 25c; $\frac{1}{2}$ lb. \$1.75; lb. \$3.25.

Extra Early Red. Oz. 8c; $\frac{1}{2}$ lb. 30c; lb. \$1.00.

Bermuda (true Tenerife). Oz. 25c; lb. \$3.00.

Giant Gibraltar Onion.

Price of seed, 20c per ounce; \$2.50 per lb.

ONION-SETS.

By mail, 10 cents per quart extra.

Winter or Egyptian. Qt. 10c; pk. 50; bu. \$1.50.

Top or Acorn. Qt. 20c; pk. \$1.00; bu. \$3.50.

White Multiplier. Same price as Acorn.

PARSNIP.

Improved Guernsey. Oz. 5c; lb. 25c; 10 lbs. \$2.00.

PARSLEY.

Fine Curled or Double. Oz. 5c; lb. 35c.

PEAS.

Alaska. $\frac{1}{2}$ pt. 8c; qt. 20c; pk. \$1.25; bu. \$4.50.

American Wonder. Qt. 20c; pk. \$1.25; bu. \$4.50.

Premium Gem. $\frac{1}{2}$ pt. 5c; pk. \$1.25; bu. \$4.50.

Stratagem. $\frac{1}{2}$ pt. 8c; qt. 20c; pk. \$1.25; bu. \$4.50.

Champion of England. Pt. 10c; qt. 15c; pk. \$1.00; bu. \$3.50.

Canadian Field. Pk. 40c; bu. \$1.50.

Peas by mail will be at same rate as beans for postage.

PEPPERS.

Sweet Spanish. $\frac{1}{4}$ oz. 8c; oz. 20c.

Bullnose. $\frac{1}{4}$ oz. 5c; oz. 12c.

Cayenne. $\frac{1}{4}$ oz. 8c; oz. 15c.

PUMPKIN.

Early Sugar. Oz. 5c; lb. 30c.

Field Pumpkin. Oz. 5c; lb. 15c.

RHUBARB.

Myatt's Victoria. Oz. 5c; lb. 75c.

Roots, 10c each; 50c for 10; \$3.50 per 100. *Small roots postpaid by mail at above prices.*

RADISHES.

Early Scarlet Globe. Oz. 5c; lb. 40c.

Wood's Early Frame. Oz. 5c; lb. 40c.

Beckert's Chartier. Oz. 5c; lb. 40c.

Chinese Rose Winter. Oz. 5c; lb. 40c.

SALSIFY, OR OYSTER PLANT.

New Mammoth. Oz. 10c; lb. \$1.00.

SPINACH.

Bloodsdales Extra Curled. Oz. 5c; lb. 20c; 5 lbs. 75c.

SQUASH.

Giant Summer Crookneck. Oz. 5c; lb. 40c.
Hubbard. Oz. 5c; lb. 50c; 5 lbs. \$2.25; 10 lbs. \$4.00

TOMATO.

Go'ten Queen. Pkt. 5c; oz. 15c; lb. \$2.00.
Ignotum Tomato. ½ oz. 8c; oz. 15c; lb. \$1.50.
Livingston's Beauty. Oz. 12c; lb. \$1.75.
Earliest-in-the-world Tomato. ¼ oz. 10c; ½ oz. 15c; ¾ oz. 20c; oz. 50c.
Fordhook First. Oz. 20c; lb. \$2.75.
Dwarf Champion. Oz. 12c; lb. \$1.75.
Buckeye State. Oz. 15c; lb. \$1.75.
Livingston's New Stone Tomato. Oz. 15c; lb. \$2.25.
Trophy Tomato. Oz. 10c; lb. 75c.
Pearshaped Tomatoes. Oz. 20c; lb. \$2.50.

TURNIP.

Yellow Aberdeen. Oz. 5c; lb. 25c.
White Egg. Oz. 5c; lb. 30c.
Breadstone. Oz. 5c; lb. 30c.
Purple-top White-globe. Oz. 5c; lb. 30c; 5 lbs. \$1.25.

BEST PRESENT PRICES ON THE CLOVERS, AND SEEDS OF OTHER HONEY-PLANTS.

Alsike 1 lb., by mail, 30 cts.; by express or freight, 1 lb., 20 cts.; peck, \$2.25; ½ bu., \$4.25; bu., \$8.00.

Alsike is very scarce, and we have had difficulty in finding any at any price. We have, however, just secured 30 bushels of an extra-fine lot of seed grown by a bee keeper; but it cost us so nearly \$8.00 a bushel that it is almost swapping one dollar for another to sell it at that. When this lot of seed is sold out I do not know where we are going to get any more. Better put in your orders now if you want it, so as to have it on hand when the right time to sow it comes.

Alfalfa, or Lucerne. Same price as Alsike above.
Medium White Dutch, and Peavine or Mammoth Red Clovers. Bu., \$7.00; ½ bu., \$3.75; pk., \$2.00; 1 lb., 15 cts.; 1 lb. by mail, 25 cts.

Sweet Clover. 100 lbs at 5 cts. per lb.; 10 lbs. or more, 6 cts.; 1 lb. by mail, 18 cts.

The above prices on sweet clover are for immediate orders. We can not tell how long these very low prices will hold.

Japanese Buckwheat. Two-bushel bag, \$1.50; bu., \$5 cts.; ½ bu., 45 cts.; peck, 25 cts.; lb. by mail, 15 cts.

Seed Potatoes.

We will ship potatoes any time during the winter to any point further south than we are, at our risk of freezing; or we will set aside all potatoes sold, and keep them in an excellent cellar and ship them in good order after April 1. If you have not the very best kind of cellar you had better let us keep them for you. We have done it for years without a failure, and we can keep them without sprouting until April 1.

TABLE OF PRICES.

NAME.	1 lb. by mail.		8 lbs. by mail.		½ peck.		Peck.		½ bushel.		1 Bushel.		Barrel—11 pk.
	1 lb.	8 lbs.	8 lbs.	½ peck.	Peck.	½ bushel.	1 Bushel.	Barrel—11 pk.					
Varieties are in order as regards time of maturing; earliest first, next earliest second, and so on.													
Red Bliss Triumph.....	18	40	35	40	40	75	1.25	3.00					
*White Bliss Triumph.....	25	50	35	50	50	85	1.50	3.50					
Early Ohio.....	25	50	35	50	50	85	1.50	3.50					
Early Trumbull.....	25	50	35	50	50	85	1.50	3.50					
Bovee.....	25	50	35	50	50	85	1.50	3.50					
Early Vermont.....	15	35	20	35	35	60	1.00	2.50					
New Queen.....	15	35	20	35	35	60	1.00	2.50					
Lee's Favorite.....	15	35	20	35	35	60	1.00	2.50					
Freeman.....	18	40	30	40	40	75	1.25	3.00					
Two-ti th Century.....	25	50	35	50	50	85	1.50	3.50					
State of Maine.....	18	35	20	35	35	60	1.00	2.50					
Manley's Commercial.....	18	40	30	40	40	75	1.25	3.00					
Corman No. 3.....	15	35	20	35	35	60	1.00	2.50					
Sir Walter Raleigh.....	15	35	20	35	35	60	1.00	2.50					
New Russet.....	15	35	20	35	35	60	1.00	2.50					
N.....	15	35	20	35	35	60	1.00	2.50					

* This is the same thing as Junior Prince.

Seconds of any of the above will be (while they last) half the price of firsts, with the understanding that the seconds not only contain the small potatoes but

those that are scabby, prongy, or cut in digging. The scabby ones are just as good for seed if treated in the usual way with corrosive sublimate, but they are a little more trouble.

Seed Potatoes as Premiums.

Any one sending \$1.00 for GLEANINGS, and asking for no other premium, may have 25 cents' worth of potatoes. And any one who is a subscriber, and who sends us \$1.00 and one new name may have 50 cents' worth of potatoes; but if the potatoes are wanted by mail the subscriber must pay postage. Please notice we give potatoes as premiums, but we can not afford to give postage-stamps. A descriptive sheet of the above varieties will be mailed on application.

Early Ohio and the New Russet, Michigan grown, can be shipped at above prices from Traverse City, Mich., when our customers are nearer that point.

HUBBARD SQUASH SEED.

Last season we had some trouble about seed being true to name; but every complaint has been fixed up so far as we know. This year we have a splendid lot of seed—the handsomest I ever saw—grown by one of our bee-keepers, from seed furnished by ourselves. The seed was not removed from the squashes until the middle of the winter. You will notice by Gregory that such seed is very much plumper, and superior to that taken out in the fall. Good Hubbard squashes are never a glut in the market—at least I never heard of such being the case. See very low prices above.

Cold-Frame or Hot-Bed Sash at Lower Prices.

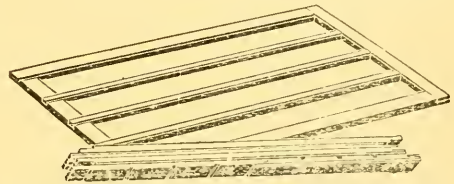

The sash are of the regular size, 3 ft. 4 inches by 6 ft., for four rows of glass 8 inches wide. If any prefer larger glass we will furnish sash for 3 rows of 11 inch glass at the same price.

These sash are usually shipped from here knocked down at a low rate of freight, and they can be put together by anybody. If done securely they are just as strong as the regular sash. They are 1 3/4 in. thick, outside bars about 3 inches wide, and inside ones about 1 1/4. The bars are grooved to slip the glass in place. If a light of glass is broken, move them up close and slide another in from the bottom end. If any prefer the bars rabbeted to set glass in putty, we will make them so on request.

Price of one sash, in the flat, for sample, without glass, 70 cts.; 5 in the flat, 65 cts. each; 10 in the flat, 60 cts. each. Glass, 8x10, just right for the above, \$2.75 per box of 9 lights.

Sash put up, no glass or paint, 10 cts. each extra; 10 cts. each extra for each coat of paint, and \$1.00 each extra for glass s-t in place, making the sash put up, painted two coats, and filled with glass, at \$1.95 each in lots of 5. The risk and freight charges are so much more shipped put up with glass that we do not recommend you to order this way, and we can not well pack less than 5 sash.

We would not advise shipping a less number than five; but if you take our advice you will have all your glass sash shipped in the flat. In this case they go as fourth-class freight; whereas, all complete they will have to go as first-class, and some roads rate them as double first-class.

The new white bush bean, the Prize-winner.

During the past season we grew two crops (ripe and dry) of these on the same ground. Quality and yield were both ahead of any white beans we know of.

This was fully described on pages 930 and 938 GLEANINGS for Dec. 1. We have just secured from the grower enough so that we can make the following very reasonable prices: ½ pint, 12c; pint, 20c; quart, 35c; peck, \$1.25; ½ bushel, \$2.25.

The A. I. Root Co., Medina, O.

Italian Bees.

WM. A. SELSER,

10 Vine Street,

Philadelphia, Pa.

Office of The A. I. Root Co.

I am booking orders now for spring shipment of Thoroughbred Italian Bees and Queens. My two apiaries kept for breeding are situated on high sandy soil—are strong with young bees and brood, when queens at my other apiaries have just commenced laying—never known any disease. Send in your orders now to insure prompt shipment when season opens. Full colonies, with queen in shipping-case, \$6.00; 3-frame nucleus, with queen in shipping-case, \$3.00. In lots of 10 to 25 full colonies or nuclei, 10 per cent off. As our specialty is Full Colonies and Nuclei, we do not care to send single queens before May.

BEST WHITE

ALFALFA HONEY

IN 60-POUND CANS.

We have a quantity of the finest white alfalfa honey in 60-pound cans at these prices:

Sample by mail 8 cts.; two 60 pound cans, boxed, at 9 cts. a pound; 4 or more 60 pound cans, at 8½ cts., f. o. b., Chicago. Cash must accompany each order.

Remember, we are

HEADQUARTERS IN CHICAGO FOR BEE-SUPPLIES.

We carry a full line of the best goods for bee-keepers, and would like to serve you. Give us a trial.

THE AMERICAN BEE JOURNAL

we issue every week. You should have it. A sample will be mailed free, and also our bee-supply catalog. Ask for them. Address

GEO. W. YORK & CO.,

118 Michigan St.

CHICAGO, ILL.

Bee Supplies.

Root's Goods

— at —

Root's Prices.

My stock is complete. My prices are right. Send for catalog, mailed free.

SEEDS.

I make a specialty of FIELD and GARDEN SEEDS. Send for my ILLUSTRATED CATALOG. My seeds are true and reliable, all tested by me personally.

C. H. W. WEBER, CINCINNATI, O.

2146 CENTRAL AVENUE.

I. J. Stringham, 105 Park Place, New York City.

Keeps in stock a full line of modern appliances for bee-keepers.

COMB FOUNDATION

is one of our specialties. If you expect to use any quantity get our prices. Catalog free. Apiaries at Glen Cove, Long Island.

I. J. Stringham, 105 Park Place, New York City.

GLEANINGS IN BEE CULTURE

A JOURNAL DEVOTED TO BEES AND HOME-INTERESTS.

ILLUSTRATED SEMI-MONTHLY

Published by THE A. I. ROOT CO.
\$1.00 PER YEAR MEDINA, OHIO.

VOL. XXIX

JAN. 15, 1901.

No. 2.



ISN'T THAT a foul proceeding for Fowls to go fowling after such fowls as owls and Millers the way he does on page 13?

CLARIFYING extracted honey is urged in *Deutsche Bienenzucht*. Heat slowly to not more than 145°, so as to melt all the granules; then let cool slowly; the more slowly, the brighter the honey. Some people will say slow cooling makes no difference, but I'm only giving it as I find it.

THE UNCAPPING-FORK continues to be vaunted in the German bee-journals as superior to an uncapping-knife. Has any one tried it in this country, or does it work well only in the German language? it is now made with adjustable forks or needles, so that, if one is broken, it may be replaced. Price, with 4 extra needles, 33 cts.

MORE PROGRESS in bee culture has been made in the past 60 years than in the entire previous history of the world. In 1842 appeared the Dzierzon theory; in 1851 Langstroth gave us movable combs; in 1857 Johann Mehring comb foundation; in 1865 Hruschka the honey-extractor; Hannemann the queen-excluder, when? Then there's the smoker, sections, etc.; when and by whom were they? It's well for us at the beginning of the new century to make an inventory of our blessings, and to be thankful for them.

DOOLITTLE is reported in *Deutsche Bienenzucht* as distinguishing between drone cells and store-cells (unterscheidet geradezu Drohnerzellen und Vorratszellen). In proof of this he is quoted as saying (GLEANINGS, p. 438) that store-cells "den Drohnerzellen an Groesse gleichen" (resemble drone-cells in size). Doolittle's exact words were, "store comb, which is of the drone size of cell." I hardly think he meant to teach that a drone-cell differs from a store-cell except as to its use. [This is a good example, showing how American ideas are sometimes perverted simply because the language is misunderstood.—ED.]

SWEET CLOVER in Ireland is reported as growing 5 ft. high, p. 9. Now some one report what it can do in this country, say out west, where it isn't thickly settled, and where it has room to grow. [Sweet clover grows right here in Medina, along the sides of the roads, a great deal more than 5 feet high. I have not measured it, but I am sure I have seen it along the road for a quarter of a mile a great deal higher than I could possibly reach.—A. I. R.]

C. A. GREEN, editor of Green's *Fruit-Grower*, says: "But as regards bees injuring fruit, there is no doubt in my mind that this is a fallacy which should be corrected by the agricultural and horticultural press throughout the country. Make it plain to all inquirers that bees do not injure fruit, but that they are the friends of fruit-growers." [This is most important testimony, coming as it does from a representative of the fruit-growing interest. When we get right down to it there is no real antagonism between the two interests, fruit and bees.—ED.]

IF I UNDERSTAND rightly, Doolittle advises, p. 16, to extract partly filled sections, and use them for bait without having the bees clean them out. Now, will there not be particles of candied honey in those sections? and will that not hasten candying in them when filled? [It does not seem to me that Mr. Doolittle really meant this; for among practical bee-keepers it has always been laid down as a rule that unfinished sections, when extracted, should be cleaned out by the bees, else there will be particles of candied honey in the sections when they are filled the second time.—ED.]

ACCORDING to the report in *American Bee Journal*, all but one member of the National convention voted in favor of the reform spelling used in that paper. Now, was that an "unbiast" vote, or were all those sensible people hoodooed by that man York? [If I remember correctly there was a large number who did not vote on either side. If there was any "hoodooing" it was by that man Mason. But, nevertheless, I believe in short spelling, but do not see how it is practicable to carry it into effect at the present time in our own establishment.—ED.]

BRO. A. I., you speak of a young man "picking out a girl just because of her good looks," p. 24. Well, now, that isn't as bad as it might be; for when a fellow's over head and ears in love with a girl she's the best-looking girl in the world to him, no matter how homely others may think her. Don't you remember? I do. [Yes, doctor, I *do* remember. The girl I am thinking about was "all the world to me," and for that matter she is yet—or at least I tell her so almost every day.—A. I. R.]

THAT UTTER-UTTER decision is alone worth more than all the money that has been put into the N. B. K. A. treasury. So was the adulteration fight in Chicago. Now, my friends, who are not yet members, don't you think you can afford to put in a dollar each to help on the good work? A lot more good can be done by the Association if it has a full treasury. I just suggest it to you. [In my humble judgment the decision of the Utter trial was worth more—vastly more—than that of the celebrated Arkadelphia case, important as that was. If the decision in the first named had been against us, and left there, bee-keeping might have been wiped out of many fruit sections of the United States. The Arkadelphia case related only to bees in towns and villages; and if that had gone against us it would have wiped bee-keeping out of the great centers of population only, but would not have affected it in the least in the great areas of country half a mile and more from those centers. Why, it seems to me that the results of the Utter trial are worth thousands and thousands of dollars. If the National Bee-keepers' Union, the United States Bee-keepers' Union, or the North American Bee-keepers' Association, now all merged into one, had never done any more, we could still feel that the money that has been put into the several treasuries was well invested.—ED]

FRESH WARNING is given in the *British Bee Journal* against the use of beet sugar made in imitation of Demerara cane sugar. A London daily has an article on "Beet Sugar and Arsenic," in which it is said that "in course of manufacture of the white granulated grades of sugar, considerable quantities of sulphuric acid are used" to clean the vacuum-pans, "wash" the sugar white, and give it the proper "bloom." The *British Bee Journal* has steadily insisted that beet sugar is bad for bees. A large part of granulated sugar in this country is from beets. Can our experiment stations tell us about its purity? also its wholesomeness for bees? [In our recent convention at Traverse City, Mich., Prof. Rankin, of the Michigan Agricultural College, emphasized very particularly the fact that sugar from beets is exactly the same thing as sugar from cane, and no chemist can tell a particle of difference. He said the idea that beet sugar was not as good for bees as cane sugar is all foolishness. You may be aware that I have taken the same ground for years. Our sugar makers, with their great costly plants, and wonderful skill that has come through ages of experience, manufacture sugar that is

almost absolutely chemically pure, no matter what they make it of. Prof. Rankin said that the greater part of the sugar now in the markets of the world is made from beets.—A. I. R.]

GOOD THING that Rambler champions amateur bee-keepers, p. 10. An amateur may or may not be a novice. He generally knows less than the professional, but he may know more. We owe a big debt to amateurs. But I protest against Rambler's classing among amateur bee-keepers a man who doesn't keep bees at all. Still worse: how could you, Rambler, say "of course" A. I. Root is an amateur bee-keeper when he turns over his bees to others and goes off after greenhouses and gardening? He *was* an amateur, a fact greatly to the profit of bee-keeping, and at present you may put him into almost any class of bee-keepers you like, but not among amateurs. He is an amateur florist, an amateur gardener, just now an amateur poultry-raiser, and I don't know what next; and when A. I. is an amateur in any thing he is an amateur of the most pronounced type. [Now look here, doctor; I appeal to the good people of that convention at Traverse City whether I did not rank fairly with the best scientific bee-keepers of the age—at least when I attended that convention. Why, several times I was rated as the great "poo-bah" in bee culture—yes, and not only in Michigan but in York State too.—A. I. R.]

A. J. FISHER sends a tough conundrum. With old comb $1\frac{1}{8}$ thick, and $\frac{1}{8}$ added for cappings, spaced $1\frac{3}{8}$, there is only $\frac{3}{8}$ between combs; then he flings this at me: "If you began anew, would you space $1\frac{3}{8}$ or $1\frac{1}{2}$?" I don't know, but I think not. I'd space $1\frac{1}{8}$, unless swayed from it by its being too much out of fashion. It does seem that $1\frac{1}{2}$ ought to give a better chance for proper clustering in winter. [Now look here, doctor; why do you back down, for you have formerly believed that $1\frac{3}{8}$ was the right spacing? Don't you remember that, out of 49 measurements of comb naturally built in straw hives, Weyprecht found that the distance was $1\frac{3}{8}$ from center to center? and that Berlepsch, in 49 measurements, verified this result? Old comb $1\frac{1}{8}$ thick must be 25 years old; and we may safely say there is not more than one comb in ten thousand—no, nor in five hundred thousand—that will be that old. Then, again, Mr. Fisher is assuming that $\frac{3}{8}$ is too small a space for bees between combs. There are some who believe that $\frac{3}{8}$ is the right bee-space, and we certainly know that that spacing is by no means impracticable. No, sir, 'e, doctor; don't you countenance wider than $1\frac{3}{8}$. If any thing, make it a shade less. And don't you know, too, that if the frames are $1\frac{3}{8}$ wide, propolis will increase the spacing? The older the comb, or the older the frame, the wider will be the spacing. Leaving theory entirely out of the account, practical experience in hundreds of thousands of self-spacing frames has shown that $1\frac{3}{8}$ is not too narrow. And one more fact: Narrow spacing has a tendency to keep out drone comb and drone-rearing.—ED.]



Again the weather is as mild
As balmy April's breath;
The sun shines down on pleasant fields
Scarce touched by winter's death.

AMERICAN BEE JOURNAL.

The chief feature of interest in the issue for Jan. 3 is Mr. Dadant's review of the international bee keepers' congress in Paris last September. Although the congress was interesting, Mr. D. thinks more beneficial results have been achieved in national meetings in this country. There were 15 different nations represented, 24 foreign associations, and 35 French. The various representatives understood French except two or three; but the different topics were placed in the hands of committees with foreign chairmen to control the discussions. Mr. Dadant says that, although these men who occupied the chair in turn were very familiar with French, they still showed in their speech that it was a tongue foreign to them. At the door Mr. Dadant was required to register his name, and show his credentials before entering. This was the only method that could be used to compel members to help sustain the institution by paying a membership fee. Otherwise, they said, a number of people, who could enjoy the meetings, would come and listen, and even discuss and vote, and would go home without having subscribed a cent toward defraying expenses. Mr. Dadant says he has heard it deplored that there are bee-keepers at each convention in this country who take advantage of the meetings without helping in a pecuniary way. There were about 150 delegates present, and Mr. Dadant says he was impressed by the great number of doctors, teachers, and clergymen whom he met. The clergy are distinguished there by their clothing. He says he never met a pleasanter set of men than the clergy. It was the opinion of the majority that the destruction of drone comb, and replacing it by worker comb, was desirable, and a motion to recommend it was passed. This was opposed by one man who said he weighed 5 hives with many drones, and 5 hives with few drones. The 5 with many drones increased 116 kilograms, and the 5 with few drones increased 123 kilograms. This shows a difference of 16½ lbs. in favor of few drones. Mr. Dadant comments:

The gentleman did not think that this difference is sufficient to condemn the drones, and thinks they are advantageous in keeping the brood warm. He did not stop to note that, before these drones could keep the other brood warm, they had to be kept warm themselves while in brood, and that, too, at a time when the bees are not numerous, and the weather is cooler than during the honey crop; and that if there had been workers reared instead of drones they would be just as likely to be able to keep the brood warm if the weather became cold enough to necessitate this.

It was asserted by some that bees change worker comb to drone comb when all the

drone comb has been removed, but Mr. Dadant entirely disbelieves this. He attributes the apparent change, not to the bees, but the sagging of the cells in combs of foundation, caused by heat. He says he has seen this in a few instances.

Foul brood was discussed. Mr. Dadant says he thinks that in Europe as well as in America many so called cases of foul brood are only chilled brood. One French bee-keeper told him that he had had foul brood, but it disappeared without his doing any thing with it. One speaker asserted that foul brood is not so bad a disease as reported, and one man ridiculed all the writers who advise such strong measures against it; but the interruptions and laughing of the majority showed him that he had no hope of convincing them. Several leading men, on the other hand, recommended fire and boiling water as the only sure remedies for this dreadful scourge.

In coming home, to pass away idle hours the passengers got up an evening entertainment at which each one was required to say or sing something for the entertainment of the others, under the payment of \$1.00 into the sailors' orphans' fund, and they had Mr. Dadant down on the program for a talk on bees. The few words he spoke led to more questions than he could have answered in a week, and some of them were decidedly foolish. This is mentioned as showing the general ignorance among the masses on the subject of bees.

A fine view of the president of the congress, Mr. Gaston Bonnier, is given. I have long felt interested in the work of this man, and it may not be beyond the bounds of possibility to give a short sketch of him, together with his portrait, in these columns.

An interesting letter appears from Mr. J. T. Hammersmark, written at Reno, Nevada. That State figures but little in print so far as bees are concerned. It is the State of great extremes in some respects. It has an area of 110,700 square miles (more than twice that of Illinois), with a population of only 42,000, or the thirty sixth part of that of Chicago alone. The chief crop for honey there is alfalfa, as we all know. One is always sure of a crop, although it may not be more than 40 or 50 lbs. per colony. The writer says the average crop for 20 years would not be less than 100 lbs. per colony. He says some have asked him whether alfalfa honey is of good flavor. He replies that alfalfa honey of that region is preferred to that of California by buyers. In his estimation it comes next to pure white-clover honey. We have had a great deal of Nevada honey here at the Home of the Honey-bees, and have so far placed it at the head of every thing else in the honey line. If it could not be had for less, the writer would call it cheap at 40 cts. a pound for extracted, and will willingly pay that. We are not aware however, of any difference in the same kind of honey, whether raised in Colorado, Nevada, or California. One of the drawbacks suffered by the people of Nevada is thus described by Mr. Hammersmark:

Think of a ride on the cars from Chicago, for instance, from three to four days, first through our fertile neighboring States, then over the vast desert of waste land and mountains of the far West. However, this would not be so bad if the railroad company did not charge you a small fortune to get there. Then our freight charges are something awful. Suppose I order a carload of bee-fixtures from the East to be laid down in Reno, Nevada. My goods go no further than Reno, but the company charges me with freight to San Francisco, and then back freight again to Reno. Of course, they are the big fish and I am of the little fish, and during the present state of political corruption, and as long as the men who make our laws can be bought and bribed to do as the big fish dictate, regardless of the rights of the people, the little fish must either submit to their robbery and be swallowed alive, or keep out of their way. There are hopes, however, that such things will some day be modified, for the people will not always be silent.

Comment is needless.

The writer says alfalfa is cut there in its best bloom for honey. The past season the bees did not work more than seven or eight days on each crop before it was cut. It is of the sweet-clover order. It commences to bloom about July 1, and will bloom for ten weeks or more if not cut. "What a lot of sweet could be produced from 1000 acres of alfalfa raised for seed!" Mr. York gives his readers a fine picture of Mr. Hammersmark and his little son, one of the finest-looking boys I ever saw.



CO OPERATIVE ORGANIZED WORK.

Its Benefits Demonstrated; Conditions Demand Co-operation; the Colorado Honey-producers' Association; an Information Scheme.

BY R. C. AIKIN.

It is now time that we begin to think about what we are to do in the way of perfecting the organizing of bee-keepers. We need to co-operate in a way (or ways) not yet touched. I propose here to follow out more in detail the lines touched upon in my essay before the National Association at Chicago in August last.

I will again refer to the matter of marketing small fruits as practiced here at Loveland. I have before mentioned the matter, but we have since passed through another fruit season, and the results growing out of the system we practice are a good illustration of some of the points I wish to get before the bee-keeping public.

Before the fruit-growers organized, every man shipped for himself or sold to the local stores, and they each shipped separately. There was no system. I did not know what my neighbor was doing, nor he of me. We were just as likely to ship all the same day to the same town and same firm. You see one

house might be badly overloaded, and another house or market have none. Such things result in a glut, demoralized prices, and spoiled berries. Somebody loses heavily, dealers are disgusted, hard feelings are engendered, and it is unsatisfactory all around.

Besides other difficulties, the individual growers were not all posted as to reliable firms, or the methods of doing business, the needs of this and that about putting up the fruit, what trains best to ship on, etc. As a result, there were rascally firms that never paid, things were going wrong here and there, and very many discouragements.

The people organized, and a buying and selling agent was employed. The people report to the agent the prospective need of boxes and crates, and these are ordered in car lots, all being regular, and a good supply on hand. The growers produce the berries, and deliver them at certain hours at the depot, each grower's number on the crates, and there the grower's trouble ends. The agent takes the fruit; ships, collects, and pays over the money when the returns are in. The agent begins to hunt up and book his customers before the fruit comes on, so that, when it does begin to come, he knows just where to place it. He keeps in touch, daily, with all the consuming territory—mail, telephone, and telegraph keep him posted as to supply and demand in the various markets, so that there is an equal distribution.

He also has the commercial rating of the houses, besides knowing personally very many of them and what to expect of them. All this brings the business to a system, and there is economy in distribution, in collecting; in every way the business is more satisfactory. The poor widow with her few rows of berries and half a dozen crates to market, gets her product sold just as quickly, just as safely, and at the same expense or commission, as the wealthiest grower in the whole country. I produce some fruit; and were I obliged to market for myself I should have to quit the fruit, for I can not leave my bee and honey work to putter with a few crates of berries; but by the aid of the association system my berries are put into the agent's hands, and I have no more bother but to draw my pay by and by.

As I have repeatedly said in print, and by word of mouth, our commercial systems *demand* and *must have* co-operation. Sending our products so far and into the hands of perfect strangers, trusting strangers to get the goods transported, etc., all demand that we get all done by co-operation and a *complete system*. A little community doing business by itself, and having no dealings with the outside world, has little or no need of all this organizing; but the more far-reaching, the more we need organized effort. Do not get scared at the thought of organizing, and cry "trust." There are right and wrong motives. A robbing trust is the rascal's machinery; but a trust to facilitate and improve our methods is a grand and a good thing—our weapon of defense against robbers, and a mutual help and protection. The Loveland Fruit-growers' Association is no robber's scheme. Without

this combine, many who now market fruit with profit would be out of the business, and many who now have fruit to eat would not have it.

Now let us apply the ideas to honey-producers. An aparian organization must necessarily be much more extensive and far reaching, because our products are from widely distributed territory, and are sent over great dis-

ter should be by and with the others. When a few of us in a county or State have, by hard study and work, wrought out a good thing, why not all fall in and use the results of this knowledge and experience, instead of groping along over the same ground?

We have in Colorado a marketing association known as "The Colorado Honey-producers' Association." This is a corporation

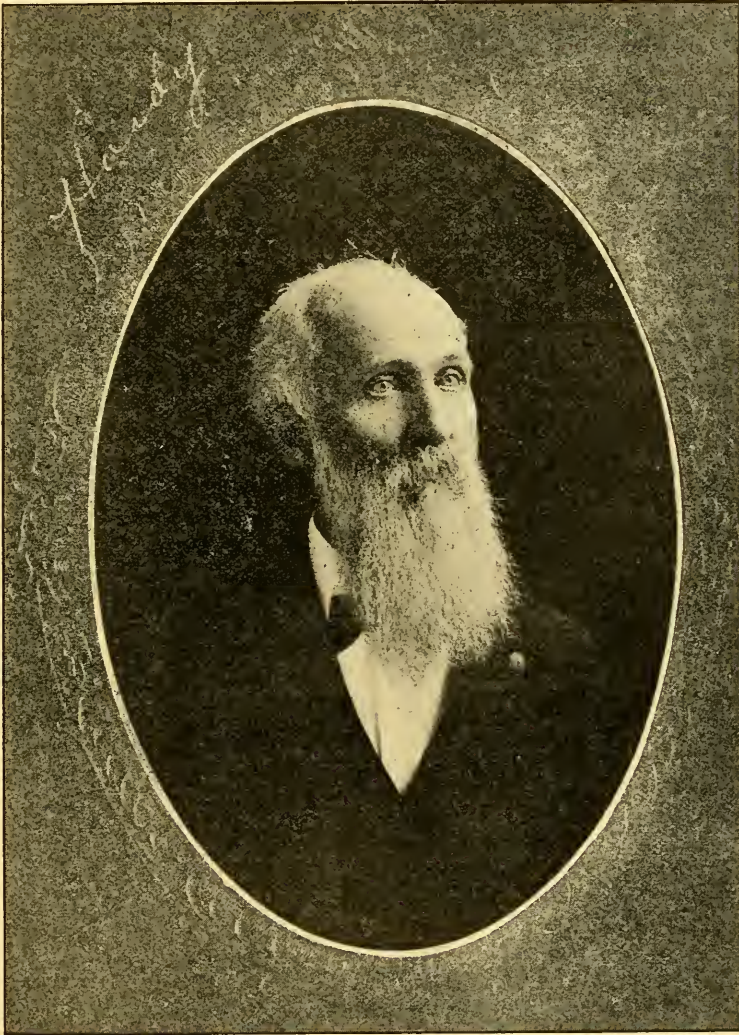

O. O. POPPLETON.—SEE EDITORIALS.

tances. A big crop of honey in the Atlantic and Pacific States means competition to the interior, and *vice versa*. Loveland small fruits seldom go out of the State; but my honey may go to Boston. A county organization is a good thing; a State is better; but a national co operation is *by far* better than either. The former *can* operate separately, but the lat-

doing business under the laws of our State. The statutes provide that any organization or association doing business *for profit* must *incorporate*. Of course, we expected to do business for profit, so we incorporated.

Right here I want to protest against a common idea that seems to be in the minds of many—that we should not organize for profit,

but that we should simply co-operate for mutual benefit, without salary or any such thing as pay. Let all such know that it is possible for a few people to perform "a labor of love" to aid their brethren; but to keep it up very long will wear out both the patience and pocketbook of the laborer. The Bible teaches us that, in the matter of moral and spiritual things, "the laborer is worthy of his hire," and never once hints that service should not receive compensation, though we are led to the thought that a labor of love and good will receive its reward—if not in this world, in the one to come. It is Bible teaching, and, as well, a *common duty*, that we recompense our brother for service rendered. The gist of this is, let *business* enter into all organization and co-operation.

Our Honey-producers' Association is a business concern on business principles. The object is to co-operate to the business advantage of those concerned. Those concerned are all the honey producers of the State. True, not all of our producers are members of the company, but they may and should be. Those who are outside the company, and even those who are *working against* it, receive benefit because of it. Remember what I have told you about our Loveland Fruit-growers' Association, and the benefits growing out of it, as compared with the demoralized condition before organizing. The Colorado Honey-producers' Association, imperfect and incomplete as it is, and hampered and injured in its work by jealous and suspicious persons who ought to be lending a helping hand, makes it possible to market more systematically and thoroughly our product, and both directly and indirectly benefit the State's producers.

The company business manager is in touch with nearly all the producers in the State, and with every producing part of the State. If there is a crop in one valley and none in some other, our manager knows somewhat of it. If honey is wanted, he knows where it is. He makes it *his business* to know, as far as possible, the crop prospects in the whole United States, and all this information he applies to the protection and benefit of the industry in the State, and in particular to those who support him by moral and financial help. It takes thought and energy, time and money, to do this work; but in the end it pays the producer and works him no hardship.

We will admit that our organization has reduced the profits, probably, of a few middlemen (I am not objecting to a middleman, he is a *necessity* in our business); but it has very much benefited the *producers*. One thing is *absolutely fundamental and necessary to the welfare and upbuilding of the nation and its business*; it is, the *prosperity of the producers*. I wish these ideas could be in bold relief, in letters of blood before our politicians and rulers and law makers, till they would never forget them. Break down the producer, and you destroy our prosperity, *middlemen and all*; build up the producer, and you unavoidably build up the dependencies.

I will, in my next, enter into the plans I have in mind for organizing the bee-keepers

all over our nation into a co-operative business concern. That we should do this I have not the least doubt. Economy and justice demand it. Duty to ourselves and others makes it a necessity. We shall have neglected a very important duty if we leave this work undone.

Before closing I want to call attention to a work done this summer and fall by our Mr. F. L. Thompson. It illustrates somewhat the benefits of organization and co-operation, is the beginning (and only a beginning) of what should be carried out all over our land. Mr. Thompson's work was this:

He conceived the idea of getting reports from producers all over the State, as to amount of old honey carried over from last year, together with prices it was selling at; how the bees wintered, and prospects for a crop, both as to condition of bees and other features; from time to time the progress of the flow, the harvesting of crop, prices crop was held at, and when sales made, price obtained, etc. From reports sent to him, Mr. T. compiled results, and mailed the same to the reporters in the various locations. It is too soon yet, while I am writing this, to know the benefits derived from the work; but no doubt it has done much good. This is merely a modest beginning—just a start. Mr. Thompson can not devote a life to this kind of work unless helped. The whole country ought to be covered with this *report*, thoroughly organized, and the work *paid* for.

I shall, in forthcoming articles, outline some plans for consideration and discussion, out of which may grow great good to our industry.



EXTRACTING-OUTFIT.

Conveniences at an Extracting-yard.

BY W. A. H. GILSTRAP.

With the producer of extracted honey, a matter of no small consideration is the house and appliances by which the apiarist is enabled to put his product into marketable condition. Having had an experience of eleven years in fourteen home and out-apiaries run for extracted honey, in whole or in part, and having assisted others in extracting, possibly my views will be worth something to others.

Perhaps the first thing to mention is the cart or wheelbarrow. This is a matter of location, to a great extent. On very uneven ground the cart is out of the question. If you want the hives to be in a few nearly straight rows, tracks may be laid and cars run on the same at slight outlay of labor providing the lay of the ground is favorable. But the general appearance of different hive locations should be guarded against to avoid the loss of queens. On soft ground the broad face of an ordinary gang-plow wheel is the most

satisfactory for a wheelbarrow of any thing I have tried. My preference is to have the wheel slightly under the load, leaving just enough weight on the handles to keep the wheelbarrow steady when in motion.

If the extracting-house is not to be used for other purposes, a building 8x16 feet is large enough for one or two men. Gravitation should be used when we can do so.

My preference is to excavate sufficiently from one end of the house so the honey can run from the extractor through a pipe which empties into a McIntyre strainer on the tank. Another pipe should carry the honey from the uncapping-box to the strainer. A door should be in each end of the house, or in the side near the end. The screen used to ventilate the house should extend several inches above the windows and a bee space from the wall, thus forming good bee-escapes.

is a question in my mind whether a two-frame machine would not suit most people better. The baskets rest plump against the irons, which keeps them true. It is light, and far more effective than many might dream.

In this country we get our honey ripened in the hives so well that there is usually no need of a tank for that purpose. But we must let the honey settle to supply the demand of our exacting market. To let the honey run through those play strainers which come with the extractors might do—no one, perhaps, has the patience to find out. How such men as Messrs. France and Cogshall can sell honey right from the extractor is a kink we have not learned yet.

If we are to handle honey by gravitation as much as possible it follows that, in most places we need a shallow tank. This year I made one of galvanized iron, two feet wide, two high, and four feet long. The distinguishing feature about it, which must not be patented, is a double bottom. Strips of heavy galvanized iron were soldered securely to the lower bottom—such strips as are used to fasten sheet iron together for shipment. These strips are bent to strengthen the bottom. After the second bottom is put in, strips of galvanized iron six inches by two feet are first riveted in, and then soldered. Of course the corners of the upper bottom are cut away. The accompanying diagram will probably make it clear. To hold it in shape it should be crated. The tank is nailed to the crating at different points near the top; but the crating does not quite reach the bottom. Between the bottoms there is a space of about 1½ inches which can be filled with water at every corner. During the late fall flow, when honey granulates so quickly, you can warm this water by an oil-stove, or by wood fire in furnace under tank, and it is much more convenient than digging honey out of the tank and melting up elsewhere, as I have frequently been forced to do. The tank may also be used for liquefying honey at other times. A round tank could be made with the same distinguishing feature; but I like this form better.

Whatever the style of tank, a platform scale should be under the honey-gate; and when you draw off 60 pounds net, take the can off the scales and it will be just right.

Grayson, Cal., Nov. 27.

[Referring to the hoop or circle against which the baskets swing in Cowan extractors, I would say that we could make it eight-sided or six-sided, so that the baskets would strike against the flat surface rather than at the corners, but we had never supposed this would be any advantage. We will take the matter under consideration, however, and if, after testing, the change is found advisable, we will adopt it. We are always glad to get suggestions, for it is only by taking the advice and experience of practical men that we can make an article that meets the demands of severe and prolonged usage.

The great majority of producers run the honey from the extractor into a large tank, or reservoir, not alone for the purpose of allow-

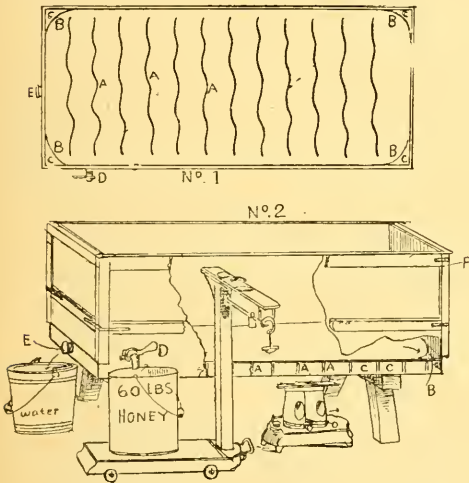

This top view of the tank is to illustrate the appearance before the upper bottom is in.

- A, A, A, supporting-strips soldered to bottom.
 - B, B, B, B, corner pieces from top of tank to upper bottom, or floor.
 - C, C, C, C, opening from top of tank to reservoir at bottom.
 - D, honey-gate.
 - E, screw-cap to draw water out of reservoir.
- NO. 2. DIAGRAM.
- A, galvanized iron braces.
 - B, first bottom, and space between.
 - C, clipped covers in first bottom.
 - D, honey-gate.
 - E, water-cock or cap.
 - F, crating to support tank.

Among the various extractors I have used, the Cowan line suit me best. For rapid work, give me the six-frame size. But a man dreads to look at one after he extracts a few tons of honey with it—at least a medium or small man does. It means hard work to run one. Another defect is, the baskets swing against a circle, which has a tendency to bulge the baskets and rack them; and it also is trying on the combs. I extracted several carloads of honey with one of this size, and then sold it. With slight repair it can make several season's run yet. Where there is much moving to do, the four-frame size suits me better. There

ing the honey to evaporate but also to allow particles of dirt and sediment to precipitate down so that, when the honey is drawn off, it will be clear and limpid. Mr. Coggs shall, I know, does run the honey into pails, and from the pails directly into kegs. But it should be remembered that a large part of his honey is buckwheat and buckwheat mixed. If there were slight particles of sediment scattered through the honey it would not show; and as this sediment consists only of pollen grains and minute particles of wax it does no harm. If Mr. Coggs shall were located where you are, and producing *white* honey he certainly would have to depend on precipitation to clarify his honey or else use some sort of strainer. Here it is again—the matter of locality.

Our artist has made a little mistake in the engraving. Instead of showing the 60 pound *pail* he should have shown the 60 pound *square can*; for after the honey has stood long enough to precipitate sediment, it is run into the regular marketing packages—namely, square cans.

If nothing prevents, I hope to make a run through California during the extracting season, my plans having been modified by the fact that my brother-in-law, Mr. Boyden, went in my stead to Cuba and Florida.—Ed.]

MINTLE'S LIGHTNING SECTION-FOLDER.

BY E. R. ROOT.

Some little time ago Mr. J. R. Mintle, of Glenwood, Iowa, sent us one of his section-folders to test. A careful trial showed that it is probably the fastest machine that has ever been built; and while our experts with the



MINTLE SECTION-FOLDER.

Hubbard press can fold sections just as rapidly as they can on the Mintle, yet I am strongly of the opinion that, if they were equally expert with the last named, they would reach a greater speed. An objection to it is, that it is more liable to break sections than the Hubbard. This liability is due to the fact that the section is folded with a *blow*, whereas the

Hubbard press brings a gradual squeeze, forcing the dovetails together.

The machine is certainly very ingeniously

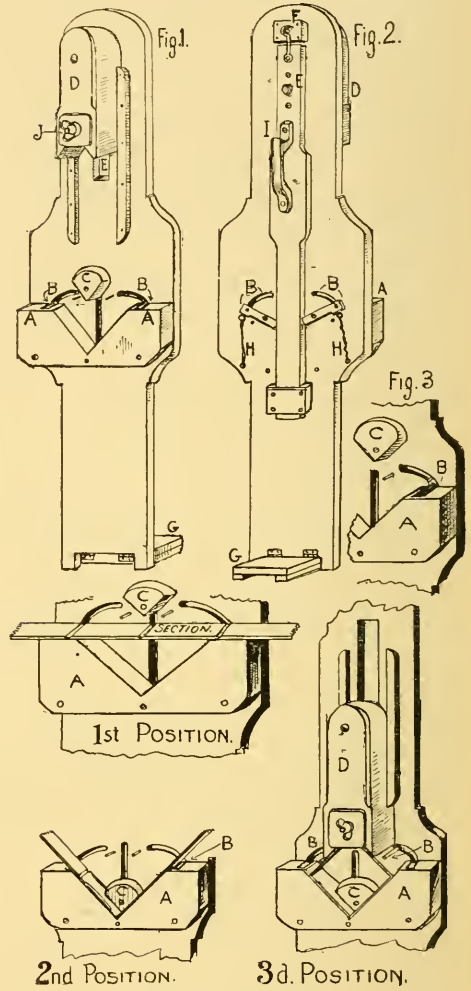

FIG. 1.—FRONT VIEW.

- A—Bed block.
- B, B—Slots and movable pins.
- C—Sliding forming-block.
- D—Movable head-block.
- G—Foot-hold.
- J—Adjustable plate.

FIG. 2.—BACK VIEW.

- A—Bed-block.
- B—Slots and back view of B pin holder.
- E—Movable lever for working C and D.
- F—Stop-block with hook to fasten lever E.
- G—Foot hold.
- H—Elastic springs.
- I—Handle.

First position, section in position on bed-block, with C above, ready to descend.

Second position, first fold produced by C. Notice at B the pins in cavity of bed-block and ready to rise in slot.

Third position, pins B B. rising and following direction of slots, force the rest of the section forward, where it is met, and the dovetail locked by the descent of D. As the lever returns to its first position the block C, in its ascent, throws off the formed section if the machine is inclined forward a trifle.

constructed, and to be understood and appreciated it needs to be seen. Still, our artist has succeeded in making a set of engravings that show its manner of construction, as well as its exact *modus operandi*.

The operator sits down in a chair, as shown in the small engraving, with a pile of section-blanks in his lap. He picks up a blank, puts it in the machine as shown, and with the left hand brings down the slide with a blow. As the block D comes down, the corner block C precedes it, crowding the section down into position. The fingers BB then draw the two ends together, bringing them almost in contact, when the block D bangs the ends together. As D moves up it picks up the section and gives it a toss into a basket. The whole thing is done so quickly that its exact manner of operation can not be seen. All one sees is the sections being spit out of the machine as fast as the hand can move up and down.

Mr. Mintle writes us that he has overcome the defect of breaking sections by substituting a lever movement for the hammer action; but the improved machine I have not yet seen, and therefore can not certify as to its merits.

There is another objection; and that is, it is considerably more complicated than the Hubbard, requiring a very nice adjustment of all the parts. And then there is the danger that it will get out of order. The Hubbard has only two moving parts, and can be operated by any man, woman, or child without instruction and without experience; nor can it possibly, with ordinary usage, get out of order. Its speed, while probably not as great as that of the Mintle, would probably come within 25 per cent of it, and it might equal it.



REGARDING BEE HIVES.

A rap at the door, and on opening it I find Mr. Jones, who says, "Good evening, Mr. Doolittle. The evenings seem so long now that I thought I would run over a little while and have a chat with you."

"Glad you came, Bro. Jones. And what is the chat to be about? for I see by your looks that you have something on your mind."

"Well, you know I found two swarms of bees in the woods this fall; and if they winter through I wish to get them into hives in the spring, as a start for an apiary. I want to make the hives this winter, and I was wondering what size would be best for them."

"When I first commenced keeping bees, Langstroth, Quinby, Gallup, and others recommended a hive holding about 2000 cubic inches as the right size; and if you expect to make only a box, without any frames in it, I should say that the size recommended by 'the fathers' would not be very bad for you, especially if you calculate to go into the busi-

ness for only a little honey for your own use."

"But I think I wish to use frame hives. What number of frames did the Langstroth hive take or hold?"

"Mr. Langstroth made and advocated a hive holding ten frames, about 16½ by 8½ inside measure, which would give about 2175 cubic inches inside the frames, or 1450 square inches of comb."

"Well, was that all right?"

"As the size of the brood chamber has much to do with the average yield of section honey, perhaps it would be well to look into the matter a little."

"Section honey! Why, is that different from the box honey of the past?"

"It is just the same, only the box honey of the past was honey stored in boxes holding two or more combs, and weighing from four to fifteen pounds, while the section honey of today is stored in little boxes or sections, each one of which holds only a single comb, the section box and all weighing only about a pound."

"I think I understand. But how are you going to look into the matter of hives?"

"To look properly into the matter of hives we must begin with the queen, or mother-bee, only one of which is allowed with each colony of bees, except at times of after-swarms."

"What has the queen got to do with the matter?"

"The queen is the mother of all the bees there are in a colony, hence lays all of the eggs from which the bees are produced. As a rule she will not occupy more than 800 square inches of comb for any length of time; therefore you will see that, if you use ten Langstroth frames, you will have 650 square inches of comb filled with honey and pollen."

"Well, what if I do? Isn't that all right?"

"If you want honey only for family use, this may be all right; but from your wishing to start with frame hives I took it for granted that you wished to produce honey for market. In case we have a new swarm in such a hive we shall have from 500 to 600 square inches of comb, filled with the best of honey, which would be from 25 to 30 pounds. So each year you would have this nice honey in your hives, instead of having it in the sections, and turning it into cash."

"But would not the bees need this for wintering?"

"In case of a very poor season such large hives sometimes have honey for wintering when smaller ones do not; but with the small ones, very few lack in stores, when there is a yield of honey sufficient to have any stored in sections. When a shortage does occur, the bees can be fed sugar syrup, which is fully as good for winter stores as honey."

"But how about the pollen you mentioned a while ago?"

"In order not to get any pollen in our sections it is best to allow 200 square inches of comb for that, and the honey the bees always will have in the upper corners of the combs. So allowing this we have 1000 square inches of comb, or about 1500 cubic inches, as the right size for the brood-chamber, regardless of what

style of frame is used; and this is the size I have used mostly during the past 30 years."

"What number of Langstroth frames will give that size of brood chamber?"

"About $7\frac{1}{2}$; and where I use the Langstroth frame I use only seven in some hives and eight in others."

"But do you have two different sizes of hives?"

"No. As, occasionally, a queen will occupy ten L. frames with brood I make all the L. hives I use to hold ten frames; and by the use of dummies the hive can be contracted down from a ten-frame hive to one holding only five or six, if the queen is only equal to such a number of combs."

"What is a dummy?"

"I make them of inch lumber—rough hemlock or the cheapest pine being as good as any thing for this. The lumber is cut the same dimensions as the outside of the frames less the top-bar, and then the top-bar to a frame is nailed to it. Thus the dummy hangs in the hive in place of one frame."

"And these boards are used to take the place of the frames the queen does not fill with brood?"

"Yes. All frames which she does not have filled with brood at the beginning of the honey-flow are taken out, and their places filled with these boards; and in this way even a four-frame colony can be made to contribute something toward our crop of comb honey; though better results accordingly can be secured from the colony whose queen will keep 7, 8, 9, or 10 combs occupied with brood immediately preceding the honey harvest."

"You have spoken several times about the honey harvest. What do you mean by that? I thought bees could get honey at any time when the weather was pleasant."

"In this thought you erred, especially in this locality. Our first honey comes from the willow. The next from fruit-bloom; but neither of these generally yields more than the bees need to carry on brood-rearing properly. After fruit-bloom we have a period during which little or no honey is gathered, lasting from fifteen days to three weeks, no matter what the weather is, as there are no honey producing flowers in bloom at that time. About the middle of June the white clover opens sufficiently for the bees to begin storing from that, where white clover is abundant."

"But our land is kept so constantly under the plow that we have little here."

"You are right in this, and so we do not calculate much on white clover for surplus. But basswood yields honey (or nectar) in large quantities, as a rule, and for this we calculate and plan, and at the opening of basswood is the time to use the dummies, as we talked about."

"Whew! Is that nine the clock is striking? How short the evening has been! I told Mrs. Jones I would be home before nine, and I must be going. Good night."



ALSIKE AND OTHER CLOVERS IN WISCONSIN; ALSO SOMETHING ABOUT PROPOLIS.

Mr. Root.:—Since the clover symposium was published I have received a number of inquiries regarding the alsike, two of them from Oregon. I am pleased to see so much interest in this the best of the clover family.

Our second crop (after-growth) here in Northern Wisconsin this season made a heavier hay crop than the first crop, the weather being more favorable the latter part of the season. Our bees worked diligently on the second crop from Aug. 1 until the alsike was harvested the latter part of September. No other plant yields nectar for so long a time, except, perhaps, sweet clover. We sometimes get a splendid catch of clover by sowing in August, as A. I. Root has written of the Traverse region. I have some sown Sept. 12 that appears to be still growing under six inches of snow; but there is no frost in the ground.

We often read in the bee-journals of large yields of honey in different sections of the country. There are, perhaps, localities where they secure greater yields of honey per colony than we do here; but when it comes to big yields of propolis I claim the championship for our bees. At the close of summer they plaster every crack and crevice, fasten brood-frames and sections together solid, glue the cover fast to the hive, so that we need a strong chisel to pry them apart. The plant from which our bees collect propolis is dwarf birch, *Betula glandulosa*. I have frequently watched his beeship gather his load from the resinous dots on the birch. I have also seen them gather propolis from some of the thorough-worts, *Eupatorium*. WM. ROBINSON.

Chapman, Wis., Dec. 4.

BROOM SEDGE AS A SUBSTITUTE FOR THE BROOM; ALSO FOR BRUSHING BEES OFF THE COMBS.

While traveling through Tennessee I noticed a peculiar kind of tall grass, and asked a resident of that State what it was. He told me it was broom sedge, and that it grew in wornout fields.

Last winter, while remaining at a hotel for two days, on the shore of St. Andrews Bay, I noticed a large field of broom sedge near, and that there were brooms in every room made from it. On talking with my landlady in reference to it she said, "I have enough gathered before heavy frosts come to make a year's supply of brooms, and I make them only as I need them."

It was quite cool while I was there, but I went out to the field during the warmest part of the day, and gathered sedge, and tied it up into brooms which I took home. A northern friend, seeing them, remarked, "I don't see why people here do not make brooms the usual way, and put them upon the market."

THE winter thus far has been comparatively mild.

The stems of the sedge are wrapped with twine, which forms the handle; and my landlady said she could not sweep with a wooden-handled broom, on account of her rheumatism, but she could with one of these. Every room had a fireplace, and the floors were bare, and the brooms were fine in sweeping up litter into the fire. When I returned to my home in the North I brought in my trunk a short-handled broom, and it is the nicest brush I ever had to brush the bees from combs. I'm surprised that Southern bee-keepers have not used them for this purpose, and told us about them.

The landlord formerly kept a good many bees, but of late years they had not done well. His bees were in tall box hives, made of the heavy southern pine, and he had tried movable-frame hives, but he did not like them, as his bees did best in box hives. He gave his bees little attention, as his family preferred Florida syrup to honey.

MRS. L. HARRISON.

St. Andrews Bay, Florida.

[Now, Mrs. H., do you see the prospect of starting you in an industrial business? Perhaps you had better turn the broom-making task over to Booker T. Washington, and let the colored women who have the apiary at Tuskegee, Ala., manufacture brooms for bee-keepers.—A. I. R.]

A GOOD REPORT FROM BUCKWHEAT.

My bees averaged about 60 lbs. of buckwheat extracted honey this year. S. J. SNYDER.
Venice Center, N. Y., Dec. 7.

[The above is given because so many people inquire what amount of honey they may expect if they sow an acre or several acres of buckwheat. In our locality it has been many long years since we have had anything like the above, or even half as much. If friend Snyder had told us how many colonies of bees he had in one place we could tell better about it; and very likely this large yield was made where there were hundreds of acres within range of the bees' flight.—A. I. R.]

UNITING BEES IN WINTER.

Please tell in GLEANINGS how to double up colonies for winter. Is it not necessary to use a *double* screen between the two colonies during the night? I used a single screen, with the result that, in the morning, I found over a quart of dead bees above the screen, and nearly a quart below. There had been a fierce battle. That was in August.

Vancouver, Wash. G. W. MINKLER.

[It is not usually necessary to have even a single screen, let alone a double one. Of course, a great deal depends on what kind of bees you propose to unite. If they are cross hybrids or Cyprians, one may have a good deal of difficulty. In such cases I would place the two clusters of bees, one on each side of the hive; close them up quietly, and then go back in fifteen or twenty minutes and open them very quietly; and if there is no fighting, let

them go. But if there seem to be "wars and rumors of wars" I would smoke them pretty thoroughly with tobacco smoke; but be careful not to overdo it. After that they will usually unite quite peaceably. With our ordinary Italians we scarcely ever have any trouble. We simply place two lots of bees together, and close the hive up.—ED.]



NEXT issue will have 16 extra pages.

THE weather all over the country has been exceedingly mild. This will mean good wintering.

WE have quantities of reading-matter on hand that has been lying over from issue to issue simply because we have not been able to find room for it. A little later on we shall be able to get it before our readers. Our printers say we never before had so much "good stuff" on hand as now, and I think they are right.

MR. HERSCHISER, at the Geneva convention, in speaking of the tall thin section, mentioned one fact that I had not thought of before; namely, that the thinner the box the more transparent and beautiful the honey. Mr. H. has had long and extended experience in the matter of honey exhibits, and expressed himself as generally favoring the tall box.

THE PERSONNEL OF THE UTTER TRIAL.

WE find it impossible to show in this issue the *personnel* of those who took an active part in the celebrated Utter trial at Goshen, N. Y., the engravings having arrived too late; but in our next issue we will give you pictures of Bacon & Merritt, of the judge who presided at the trial, of the star witness, Frank Benton, entomologist from the Division of Entomology, Washington, D. C., and of the defendant bee-keeper Mr. J. W. Utter. Our printing department has been taxed to its utmost to finish up the latest edition of our A B C book, of 500 pages, and now that is out of the way we shall be able to get out extra pages for GLEANINGS. Just now we have on hand enough matter, some of it in type, to make complete two or three extra numbers. In our next we will begin the subject of bottling honey.

GRAFTING CELLS WITH A MEDICINE-DROPPER.

A CORRESPONDENT suggests the use of an ordinary medicine-dropper, or pipette, or what some call a fountain-pen filler, for the purpose of handling royal jelly. If some one else has suggested such a device, I do not now recall it; but I feel confident that royal jelly could be handled this way easily. Its manner

of use would be something as follows : Squeeze the rubber bulb, insert the glass point in the royal food, allow the bulb to expand, when the food will be taken up into the glass tube ; then for the purpose of grafting, squeeze the bulb a trifle, and a small drop would be exuded into a cell cup. This operation could be easily repeated on cell cup after cell cup. It looks pretty in theory, but it may be poor in practice.

SHALL THERE BE A JOINT MEETING OF BEE AND FRUIT MEN ?

The suggestion was made at the Geneva convention that the National Bee-keepers' Association meet at the Pan-American Exposition at the same time as the American Pomological Society ; that now a great interest having been stimulated in the matter as to whether bees puncture fruit, it would be of great importance to have a joint session of the bee and fruit men, of one day, say, at which time the two interests could discuss these matters dispassionately, with the view of getting at the actual facts.

The place as to where the next meeting of the National Bee-keepers' Association will hold its convention has not been decided as yet. There was a rumor, apparently unfounded, that the Grand Army of the Republic had completed arrangements for holding its next encampment at Denver, and that a rate of a cent a mile had been secured ; but in some of the later papers I see this has been contradicted.

WHAT THE NATIONAL BEE-KEEPERS' ASSOCIATION DID FOR BEE-KEEPERS.

The following letter, received, from a subscriber who, I judge, has not been a member of this Association, explains itself :

Mr Root.—I wish to congratulate you on the interest you have taken, and the results obtained, in regard to the Utter vs. Uter bee-suit. Hurrah for the National Bee-keepers' Association ! I am glad my eyes have been opened sufficiently to cause me to send in my name and a dollar to General Manager Seacor asking to become a member of the very best order bee-keepers ever had. I wonder if bee men in general realize what the results of the Utter suit means to them, and what it would have meant had the opposite decision been the result. I learned of the result through the *Rural New-Yorker*. Suppose, for once, that the lower court's decision had been sustained ; where would bee-keepers stand ? All the ignorant fruit growers in the country would have ground us into the earth, and we should have had to grin and bear it. So, again, I say, "Hurrah for the National Bee-keepers' Association !" It has laid the cornerstone of a very solid foundation upon which we, as bee-keepers, can build our hopes in regard to having our rights protected.

Kingston, N. Y., Dec 31. AARON SNYDER.

There ought to be five thousand more bee-keepers who would see and feel the same way. What could we do if we had such a membership ? But with only five hundred we have been able to bring about a verdict in favor of the bees that will be worth to the bee-keepers of this land thousands of dollars. Already, as I understand it, a case that was about to be tried, of a similar nature, was dismissed as soon as it was known how the Utter trial had been decided at Goshen. We do not know how many more cases would have sprung up if the verdict had been for the fruit-men.

But I wish it distinctly understood that this was not only a case of bees versus fruit, but a case which showed that the two interests, so far from being antagonistic, are in entire harmony with each other ; that fruit, at least, is dependent for its proper fertilization, to a great extent, on the work of the bee.

I would suggest that our subscribers send in short articles for their local agricultural papers, giving the result of the trial at Goshen, N. Y. Let us spread the news far and wide.

Strange as it may seem, and yet not very strange, the progressive fruit-men, with perhaps one or two exceptions, are very much pleased with the verdict.

O. O. POPPLETON.

ON page 47 of this issue we are able to present a very natural likeness of our old friend and correspondent—Mr. O. O. Poppleton, of Stuart, Florida. There are very few bee-keepers in the United States who have had a more extended and more varied experience in different climates than our friend. He is familiar with the conditions necessary to success in bee culture in Iowa, Florida, and in Cuba.

The first we know of him as a bee-keeper was in Iowa. Here he began the business moderately, but made the few he did keep yield large averages. But poor health on the part of his wife finally compelled him to seek a more favorable climate, which he found in Florida. Here he engaged in his favorite pursuit, but at this time it appears that he took up with what is known as the "Long Idea" hive. The frames were 12 inches square, and anywhere from 20 to 24 frames to the hive. Instead of piling the hives one on top of another, on the tiering-up plan, the hive proper was extended in a horizontal line. If the bees required 10 or 12 frames of brood they were allowed to have them. Then the surplus frames were placed on either side of the brood. But the Long Idea is primarily intended for the production of *extracted* honey. Mr. Poppleton himself believes that the hive first devised by Mr. Langstroth 50 years ago has not been improved upon, so far as shape and proportion of frames are concerned, for the production of *comb* honey. But the production of *extracted* honey is so different, he thinks it is doubtful if the same style of hive and frame can be best for both. While he is using a special extracting hive, frames 12 inches square, yet if he were going to start over he would keep the same depth but lengthen the frames 2 inches. This would more nearly approximate the proportions of the Jumbo frame, or what is in reality the Langstroth, but $2\frac{1}{8}$ inches deeper.

Mr. Poppleton is a practical, conservative bee-keeper. While not a voluminous writer, yet what he does write always finds its way into the bee-journals. My father once said, when he had the editorial management of this journal, "Whenever you see any thing from that man Poppleton" (showing me manuscript he had just received from him), "just hand it right in to the printers. It is *always* good copy. He is sound and practical." During

the time I have had charge of the bee department, I have found this statement literally true.

During all the years since he first began keeping bees, Mr. Poppleton has been a close student, and exceedingly careful in drawing conclusions—so much so that the Root Co. has at various times had him conduct experiments in advance of the season at the North, because we knew we could rely on whatever he said.

Mr. Poppleton last season was rather more fortunate than most bee-keepers, for he had a large crop of honey. Whether this was due to his locality or to his careful management, I can not say; but I am inclined to believe that the latter has very much to do with it.

THE STATE CONVENTION OF NEW YORK— SPRAYING DURING BLOOMING-TIME.

I HAVE just come from a very important meeting of the New York State Association of Bee-keepers' Societies. I will not attempt at this time to give a report, but merely state that two professors from the Geneva Experiment Station were present, and gave us some most valuable proof to the effect that spraying during blooming-time is not only detrimental to the development of pollen, but does most decidedly cut down the output of fruit. But more of this anon.

BLACK BROOD, AND HOW TO CURE.

I had quite a talk with the New York foul-brood inspectors, and from them I received further assurance that black brood was being rapidly brought under control, although they admitted there were some sections where the disease had done some destructive work the past season, and that it would probably break out again the coming season. But the most interesting fact to me was that the McEvoy treatment, such as has been prescribed for *foul* brood would, when carefully administered, also cure *black* brood. Mr. Stewart believed that the reason the treatment had proved a failure was because the bee-keepers in some cases had not been careful enough to disinfect their persons and clothing, and had been a little careless in letting bees get at diseased combs or infected honey. He did not believe the disease was any more difficult to cure than foul brood. The first symptoms of black brood, he explained, were usually a yellow spot about the center of the coil of the larva. In some cases the whole grub would have a yellowish cast. The larva would appear to act as if something was the matter with it—wiggle and squirm around. The spot would grow larger until the whole larva was yellow. It would then die and turn brown. The dead matter would not rope. It might string out a quarter of an inch or so, but never like foul brood. Black brood has a sour, yeasty smell. Another important characteristic was that the larvae of black brood usually died before being capped, while in foul brood the reverse was true.

As to pickled brood, it looked very much like black brood, but the dead matter was more watery. At times there would be a fungus or mold on it which is never found on black brood.

THE ONTARIO BEE KEEPERS' CONVENTION AT NIAGARA FALLS.

As I have already stated, this was not largely attended, but the discussions and general interest were of the very best. I arrived one day late, just in time to hear the report of Wm. McEvoy, Inspector of Apiaries. From that report I have made a digest as follows:

During 1900 he visited bee yards in 13 counties. He inspected 100 apiaries, and found foul brood in 33 of them, and dead brood of other kinds in many others which had been mistaken for foul brood. The first thing he did when he entered a locality was to pick out the best bee keeper in it and get him to take him from place to place so that he could see how he managed the business, and, if required, would make a valuable witness. He did this for the last ten years, and kept up a correspondence with the most of them, and by this means he always knew pretty well how all were getting on at the curing. At this work he burned a good deal of midnight oil, and sometimes he wrote all night and part of the next morning. Sometimes death and sickness in families delayed the curing; and in all places where he found this to be the case he went and did the curing himself.

Since he was first appointed inspector, Mr. McEvoy has had thousands of diseased colonies cured of foul brood, and very many apiaries that were once in a bad state with foul brood have not only been cured but have given some of the largest average yields of honey of any ever taken in the Province of Ontario. One of the treated apiaries gave an average of 200 pounds of clover and basswood honey per colony, and 50 per cent increase in bees, and had plenty of clover and basswood honey left in the hives to winter the bees. This yield was taken in a locality where no buckwheat was grown.

Every bee-keeper visited during the past season treated him in the most courteous and generous way.

I regret that I am unable to give even a passing mention of the other valuable papers that were read. But there was one paper or address from Dr. Fletcher, of the Experiment Farm, Ottawa, that was listened to with the closest attention, more especially as it related to a vital subject; namely, the question of bees in orchards, and whether they injure fruit or not. He said that the subject had doubtless been discussed by the council, owing to the great lawsuits which were now attracting the attention of the bee-keepers in the United States and Canada. The case of Mr. Sparling, which had only yesterday been given in his favor, and the case of the Utter brothers, of Amity, N. Y., had been watched carefully, as it was thought that these would be taken as precedents. He pointed out the advantage of every member of the Association keeping well posted in all matters bearing directly upon the subject of whether it is possible for bees to injure fruit or not. It had been claimed in both of these cases that several things which every bee-keeper knew were utterly impossible had been done. He was neither a bee-keeper nor a fruit-grower, but he

was keenly interested in finding out what were the actual facts with regard to the alleged injuries to fruits by insects. He had studied the matter carefully for a great many years, and from all he had been able to see and learn from the writings of reliable observers there had been no case of actual injury to uninjured fruit proved which was undoubtedly due in the first case to bees. He showed a diagram of the mouth parts of the bee and the wasp, and explained the use of each. He was under the impression that nearly all of the injuries attributed to bees were begun in the first place by wasps, ants, or some other insect or bird.

The question was by no means a new one—it had been studied for a great many years, and he believed that there was a great deal of ignorance about the whole question which ought to have been solved before this, either by bee-keepers or the students of insect life. However, from all that he had been able to read he believed that entomologists were almost all of the opinion that bees were not responsible for the injuries sometimes attributed to them.

He read from the *Rural New-Yorker* of November 10th an article entitled "Do Bees Injure Fruit?" which was written by Prof. Slingerland, of Cornell University, one of the very first practical entomologists in the United States. This article detailed some very careful experiments which were carried out by the Agricultural Department at Aurora, Illinois, by which colonies of bees were kept in a closed building so that they were brought to the stages of hunger, thirst, and starvation by artificial conditions, but could not be induced in any instance to attack the fruit exposed unless it was first punctured or injured in some other way.

He thought that every member of the Beekeepers' Association should read this article, and should be in position to speak definitely with his neighbors and those with whom he came in contact on this question.

These tests were continued for many weeks, and the conclusion drawn by Prof. Slingerland was that the experiments showed that honey-bees are not only unable to penetrate the skin of fruits, but they also appear to be unable, even when impelled by the direst necessity, to penetrate the films surrounding grapes, even after the skin has been removed.

One of the contentions with regard to bees being a nuisance was that bees stung pickers in fruit gardens, and worried horses when they went to the trough to drink. His own opinion was that, although many people were afraid of bees, and often made them sting by hitting at them, bees never sting except in self-defense or in defense of their hives.

Again, it was claimed by many that the bees stung the fruit, and that this induced decay. This he believed was entirely erroneous; and although he had not tried any experiment he would certainly suppose that the formic acid which forms the poison of the bee's sting would have exactly the opposite effect, and would preserve the fruit rather than cause it to decay. It is well known that wasps preserve the caterpillars and other insects which

they stored up for their young by stinging them, and that insects stung by wasps remained alive, but in a perfectly torpid condition, for several weeks. The formic acid of a bee's sting is almost identical, chemically, with chloroform, so that practically the food of wasps was chloroformed and remained as fresh food for the grubs of the wasps for a long time, owing to the antiseptic properties of the poison.

An interesting feature of this address was an explanation of many of the devices found in flowers as the means provided by nature to secure cross fertilization. Some of the more prominent methods by which certain insects, particularly those which, like the honey-bee, fly rapidly from plant to plant, were illustrated by means of excellent diagrams showing the different forms of flowers and their parts; that the stamens and pistils, the two essential organs in many plants, were not ripe at the same time; and experiments were mentioned by which it was proved that it is more advantageous for a flower to be fertilized by pollen from another flower, or from the same kind of flower, but on a different plant, than it is if its own pollen were used. It was even stated that some flowers are actually sterile to their own pollen.

He urged bee-keepers to strive to put themselves in the position of being able to give definite opinions on such important questions as this one which had now come up, and pointed out that it was one which concerned every one of them; that as a society they should band themselves together for mutual protection, not against fruit-growers or any one else, but simply to be able to speak positively, and give the actual truth with regard to these and similar matters. He was quite sure that bees did not injure fruit, however ripe it might be, unless the skin was actually cracked beforehand, either with their mandibles or tongues or stings. Many of the enlightened fruit-growers know only too well the enormous advantage of having bees near their orchards, and some actually keep bees in their orchards simply for the benefit of bees working on the flowers. He felt sure that fuller knowledge of the actual habits of the bees would bring about a better understanding between fruit-growers, and would be of enormous advantage, both to them and bee-keepers, whose interests were identically the same.

In our next issue I hope to give a report of another paper read at this convention—experiments in wintering, showing comparative losses between outdoor and indoor wintering.

G. N. L., Conn.—We know of no way of bleaching colored extracted honey. If you desire a light-colored article for pharmaceutical purposes, the only thing to do is to buy the light colored honey in the first place. The whitest honey in the world is that from willow-herb. This is almost absolutely water-white. The next lightest is the mountain sage, and the next in order is basswood, then clover.



Who is he that overcometh the world but he that believeth that Jesus is the Son of God?—1. JOHN 5:5.

The relation in which the father and mother stand to each other is the foundation of every home. It is the cornerstone. No true home can be built securely, and stand securely, without perfect harmony between the father and mother—or, if you choose, between the husband and wife. No matter what the parents may say to the children, their words will have but little weight or effect unless these words correspond with the conduct. The home should be harmony—harmony between the parents, and harmony between the children; and, more important still, if any thing, harmony between parents and children. Sometimes when Mrs. Root and I see *our* children each one taking up different departments in our business, and all being satisfied and contented to work together—I do not wish to boast, dear friends, for God knows how little I have to boast of; but I do thank God every day of my life for the peace and harmony in which all the members of our family work together. As our children get married, and have homes of their own, this same harmony seems to take in and include the new members also; but, dear friends, I wish to tell you that this has not been done without much hard work. Many fervent and earnest prayers have been offered up, and much struggle and fighting against our own inclinations and impulses. Some of you may think it is *easy* for *me* to be gentle and kind. You are mistaken. The only reason why I take this subject up just now is because I am so deeply concerned and so *very* anxious about the members of different homes of which I know; and the thought that perhaps I may help you by some chapters in my own experience is what calls me to take up this talk to-day.

In Our Homes for Nov. 1 I told of the happy time Mrs. Root and I had together on that farm in the woods. I told you that, although we were about sixty years old, and had brought up a family of children, we enjoyed our outing in the woods as much as we enjoyed being together when we were both in our teens. I told you of the great *flood* of joy and peace that seemed to spread like a mantle over me. Some of you may ask, "How long did it last?" Well, it ought to have lasted the rest of my life. Yes, it may last from now on, during the rest of our lives, providing we both grasp the beautiful thought in the text I have chosen; yes, if even *one* of the parents gets hold of the great truth in that great text, the other will pretty surely come along.

Several times in this eventful life of mine I have heard husbands tell how impossible it was to get along in peace and quietness with *such* a wife—I was going to say, such a wife as God had given him, and I still think that is about the way to put it. Yes, I have heard wives too (not so many of them), but a *few*

women have told me how impossible it was for them to live with such husbands as God had given them. Sometimes when the dear Savior lifts me up so I can get a glimpse of the mount of transfiguration, I feel almost as if I could live in at least *tolerable* peace and harmony with almost any woman. I feel that, through the spirit of Christ Jesus, I might *win* her out of her fretful and unlovely ways into peace and harmony. Yes, I have urged and enjoined unhappy wives to *try* to win their husbands by love and gentleness away from evil and vicious habits. Mind you, dear brother or sister, I am not boasting of what *I* can do or would do as a peacemaker; but I am boasting of what the spirit of *Christ Jesus* may do.

Well, after we got back home from that pleasant trip away off in the woods, the Holy Spirit did seem to follow us. We were happy in talking over our experience, and in telling the children about it; and, for the time, we were very patient and kind to each other. I began to think the rest of our lives was really to be a long honeymoon. For one thing, my health was better while I was in the Traverse region. This may be owing largely, however, to the fact that I was away from business cares. Please do not imagine that Mrs. Root and I are ever in the habit of quarreling. We sometimes scold each other, but mostly in pleasantry. Our lives are very busy ones—at least they have always been so thus far. When there was so much to do, and so much to see to, some things would be neglected more or less. As an illustration, it has always been my habit to have tools, baskets, and every thing else, put under shelter before a rain. Very few people seem to think it worth while to take care of tools and implements as I do. It is not so much the value of things as it is getting in the habit of letting go to ruin and waste things that in the aggregate cost a great deal of money. Well, Mrs. Root is a very neat housekeeper. She does not like to have her domain lumbered up with things of uncertain or no value. Sometimes she pushes them outdoors to get rid of them; then when I am not feeling very well I sometimes scold. Perhaps I blame her for something she did not do; and she, being tired like myself, does not reply just as kindly and lovingly as we used to talk to each other during that holiday up in the woods.

Perhaps somebody may say, "Why, Mr. Root, husbands and wives *always* talk to each other in that way. They do not mean any thing, and it is all right." But I happen to know by experience that it is *not* all right or best for *me*. After I have scolded about some unimportant matter, and perhaps brought on myself replies that are not always gentle and kind, I discover that the gentle, loving spirit of Christ Jesus has been driven out of my heart. My happiness is gone, and it is not an easy matter to get it back again. Sometimes it takes me quite a little spell to get back into the straight and narrow path where peace and happiness reign. I am fortunate in at least this one respect: Whenever I am feeling sorry I spoke cross or hastily, and come up to Mrs.

Root and put my arm about her lovingly, she always forgets and forgives. Yes, thank God, she is *always* ready at any time to go *more* than half way. Sometimes when others are around, and I do not wish to attract observation, I simply lay my hand quietly over hers. She understands it, and we two start out to meet life's conflicts once more, *hand in hand*. Some of you may think it is hardly worth while to be so very careful about such little disagreements as I have mentioned. As I think it over, and watch humanity, I have decided it is one of the most important things in this world, that this perfect peace and harmony, this full understanding, this tender relation between father and mother, shall never lapse for a single instant. You may have to pray most earnestly for the influences of the Holy Spirit to keep you from making a mistake and doing harm, but it can be done.*

After I had been home a few weeks my old trouble from malaria came back. I caught cold—I do not know exactly how. It settled in my throat, teeth, and ears. I had toothache, earache, and sore throat all together. I could not stand drafts, and had to be bundled up. I had just got my new poultry-house fixed very nicely with a floor of dry dust. Mrs. Root admired the dry dust with me, but she did not like to have it tracked into the house on her carpets. One day when I was suffering from my "compound" maladies, I forgot and walked through the house, leaving dry dust at every step (at least she says I did). Well, when she began to remonstrate, in no very gentle terms, perhaps, I had partly opened my mouth to say that a little dust on the carpet was a trifling matter compared with some other things; and then I thought of adding that she made a great deal of *fuss* about a little matter. Then Satan added (I know it was Satan, because the observation or the suggestion he made bore his ear-marks so plainly), "If I were you I would just tell her that she makes herself miserable, and everybody else, by chasing around with a brush and dust-pan, and making such a row about a little dust." I really hope Mrs. Root will not read this. I am going to keep it away from her if I can, because I do not know but she will bristle up (like our big white rooster), ready for a fight when she finds out that I ever tolerated for one brief moment even the thought of saying any thing so unkind and unreasonable. But I did *not* say it, thank God, and, in fact, I did

Every little while somebody takes the ground that people who commit suicide are insane. I can not agree with them. A few days ago a girl in her teens was planning to go to a party. Her whole mind was taken up with parties, and her mother had objected because of her youth, and because of the character of those she was meeting. Her mother told her she could not consent to let her go. The girl declared she *would* go. When the mother would not relent the girl became very angry, and told her mother, in a passion, that she would be sorry. While still in anger she procured and drank carbonic acid. Such cases are getting to be alarmingly frequent—yes, even suicide among boys and girls. The struggle between the mother and daughter started in regard to a comparatively trifling matter. Satan, as I have suggested, seems to be getting a new hold on humanity right along this line. Let us beware how we invite his presence for a single moment in unkind thoughts, or, worse still, in letting those thoughts *get into words*.

not say any thing at all. I will tell you what kept me from saying any thing, even if I *was* groaning with toothache and earache together. Permit me to digress a little.

Every fall, as soon as the flies are surely gone, our screen-doors are taken off and carried up into the attic. It is up two flights of stairs, and one of them is pretty narrow. The doors are rather heavy too—some of them. Huber has always done this work, but he is off at school now, you know. Well, I told Mrs. Root I would send one of the men over from the factory; but I kept forgetting it. One day when I came home she said, "Dear husband, you can not guess who took off all the screen-doors and put them safely away in the attic, the screws tied to each door so they won't be lost, every thing all nice and straight."

"No, I do not believe I can guess. Who did it?"

She came up close to me so I could easily get hold of her if I wanted to, and replied, with an arch look, "It was the woman you *love* who did it."

I would not tell this, dear friends, if it were not that it gives you a glimpse of our usual relation to each other better than any thing else I can think of. I suppose she will scold like every thing when she sees it in print; but I will try to explain to her that I have taken the liberty of repeating such words only because I am sure it will do good in *many* homes where GLEANINGS is read. She said it because she *knew* it was *true*. Dear me! haven't I told her so enough times during the years we have lived together so she might be *sure* of it? Let us now hitch our two stories together.

This matter about the screen-doors happened some two or three days before that of the dusty carpet. When I came in suffering with the cold in my head, I presume I was tired out with many cares over at the factory, and attending to correspondence when I hardly felt able to do so; but when those unkind and uncalculated-for words came into my mind, all of a sudden the transaction of the screen-doors came before me. Dear reader, was it not the voice of Christ Jesus that said, "Gently, gently, child. Remember, she to whom you are about to speak is 'the woman you love.' Surely, you do not feel unkind or even unpleasant toward *her*?"

I had been praying that the dear Savior would help me to bear patiently whatever little crosses I might be called on to bear. I had prayed that the influences of his Spirit might be near me and keep me from inconsistencies; yes, every day of my life, almost, I pray for this one thing. My prayer was answered. I did not say a word. I presume I might have scraped up grace enough to beg her pardon for being thoughtless, and promised to be more careful. I certainly did not feel unkind, but I was worried and wearied. I hurried to my resting-place, and after about half an hour's sleep I was myself again.

The father and mother should strive above all things to be *consistent* before the children. It is right and proper that the children should

see you give the mother a kind word and perhaps a loving touch ; but if you should, later in the day, or the next day, scold and give her pain by harsh words, it would be inconsistent. The average boy or girl might say, and with reason, "Well, I do not think pa cares so very much about ma after all. If he is going to scold just a little while after, in the way he has been doing, he had better leave off the first part of it. He had better either be *less* kind and gentle at times if he is going to get cross so soon, and not be so changeable."

Yes, even children notice inconsistencies like these ; but even if their childish hearts do revolt they will learn to copy it after just a little while. They get an idea it is the *proper thing* to do to talk "pretty" when you want a favor, and then be cross and unkind when you feel like it. It is hard work for me to be even-tempered and always the same ; and sometimes I feel like giving up and saying I can not do it ; but for the dear Savior's sake I will keep trying. When I can keep in mind that I am a pupil, and that he is the teacher, that he is to lead and I am simply to follow, *then* I come out conqueror.

After the words I have mentioned, spoken in jest and pleasantry about the screen-door, it occurred to me there was something in the Bible that seemed a little like it. I found it in the 20th chapter of John. In fact, John, in several places, in speaking of himself, instead of using the pronoun *I*, says, "that disciple whom Jesus loved." I have often wondered at these words. It would seem to indicate that there were certain ones for whom Jesus cherished a particular regard. Somewhere else he says, "If ye love me, keep my commandments ;" and we might infer that John had been unusually ready to hear his words and obey, as nearly as he could, to the letter. John was a disciple particularly loved by the Savior, and he seems so sure of it that he does not hesitate to say as much, only he does not tell us outright that he was the one. Again, in the story of Lazarus, Mary says to him, "Lord, behold he whom thou lovest is sick." From this we learn that Jesus loved particularly the brother, Lazarus. It was so well known, that Mary did not hesitate to speak of her brother in that way—"he whom thou lovest." The very thought of it thrills my heart through and through. Sometimes when I have been pleading for Christ, especially when I at first dreaded to undertake the task, *after* I have finished there has come a feeling that Jesus loves me ; and these thoughts or thrills are some of the very most precious things in all my religious experience. Mary simply said that he whom Jesus loved was sick. She did not add any thing further. We read further in that story that Jesus paid but little attention, apparently, to the message. He did not go immediately, as she had a right to expect he would ; neither did he say the word, and command that Lazarus should be made well. We do not know God's plans, neither do we know why he allows suffering and sickness ; but we *may* know that he hears and remembers, especially those whom he loves.

Years ago I heard a revival minister tell of

an old colored man who used to pray, when his enemies tried him severely, something after this fashion : "Lord, your property is in danger. Come and look after it." There was a sort of assurance in this old colored man's mind—we might almost call it audacity—for thinking that God regarded *him* as his property. Recently in a very trying experience, when I felt a good deal at sea as to what I ought to do, I remembered this illustration, and I breathed an inward prayer something like it. There came to me at once a sense of relief. It seemed as though the great Father above heard it and answered it : "Yes, dear child, you *are* my property. I will keep you from the snares of the evil one." After that there was a peaceful feeling of rest and contentment that caused me to feel that I was in the hands of Him whom even the winds and the waves obey. I think that Christians sometimes need that assurance. It rests them, and prepares them for life's conflicts ; and they may have it if they are ready to put aside self and to let the spirit of Jesus rule. I like this new phrase that has come up—"What would Jesus do?" or, "I will promise to do as Jesus would do, as nearly as I can, to the best of my judgment and understanding." What a world this would be if we could meet and deal with people who are united for a purpose or on a common platform and living such a life as this ! Some time ago I was in a home where the father and a son, the latter almost man grown, did not get along well together. The boy was very much needed at home. In fact, there was more property and business than the father could well manage ; but, unfortunately, both father and son were considerably set in their ways. The father laughingly said that he feared the trouble was, the boy was so much of "a chip off the old block." The poor mother stood midway between them. She did all she could to be a *mediator*. She was loyal to the *husband* and also loyal to her *boy*, and yet *they* were widely apart. The boy left his home and went away off. I have had more or less talk with all three of the parties. I begged the father to put self aside and let Jesus rule ; but I do not think he felt quite ready to do so. The good mother would have gladly acquiesced in *my* remedy for the trouble (for *all* troubles), for she would do almost any thing to have her boy at home. I do not know whether the boy is ready as yet to do "as Jesus would do," as nearly as he can judge, or not ; but with his mother's help I think he could be easily persuaded.

Oh what a beautiful and lovely home is that where Jesus rules and is over all ! Through him come harmony and peace and joy ; for where Jesus rules, Satan can not get in even a finger. We must accept him, as in the language of our text, as the Son of God. We must believe that God sent him as his messenger from heaven to earth, to heal all these troubles, and to bring peace and good will into every home. In fact, the very last words of the Old Testament are a prophecy to the effect that "he shall turn the heart of the fathers to the children, and the heart of the children to the fathers."

Temperance.

TEMPERANCE AND GOVERNMENT, OR TEMPERANCE IN GOVERNMENT.

The following editorial, which we clip from the Cleveland *Daily News and Herald*, is to me the best boiled-down temperance talk I ever heard in my life. It goes to the root of the matter without fear or favor, letting it hit where it may. See if you do not agree with me.

ORGANIZE, AND STOP THE DISGRACE.

Civilization becomes the agent of the Devil when it goes into a country inhabited by "heathen," with a sword in one hand and a whisky-bottle in the other.

England, as ex-President Harrison would say, has been looking for "consumers" for several centuries. Slaves, opium, and rum are some of the products which England has dealt in. China was debauched so that traders might make great fortunes in the sale of opium. Ships loaded with beer and whisky followed the American army to the Philippine Islands.

The United States has no right in morals, or, so far as we can see, in law, to engage in the liquor business. Yet we are told by Senators from the floor of Congress that this government has licensed hundreds of saloons in the city of Manila. If this is so the government should be compelled to revoke those licenses by the enraged public sentiment of the people of this Christian country.

Americans do not want, and they will not tolerate, drunken armies led by drunken officers. Nor will the mothers and the fathers in America permit the government, which their sons are fighting for in far distant lands, to destroy those sons with beer and whisky—Filipino bullets are deadly enough.

Men and women who love their country, and who are unwilling to see the further degradation of the Filipinos under the American flag, no matter whether the Constitution has followed the flag or not, should organize and bombard Washington so furiously and persistently as to compel the authorities to put a stop to the liquor traffic in Manila and elsewhere on the islands.

The Senators from Ohio Messrs. Foraker and Hanna, are powerful men. They know how to carry elections, to influence public sentiment, and to persuade public authorities. Let them both be plainly told what the people of Ohio want them to do—what the people of Ohio demand that they shall do. They will not decline to act; they would hardly dare to decline, even were they averse to taking a fresh burden upon themselves. Let the people, men and women, of other States organize for vigorous, tireless, and intelligent action. Let the authorities in Washington feel the pressure of an outraged and disquieted public sentiment.

The Anti-Saloon League in Ohio and the great Women's Christian Temperance Union, as well as all good citizens should enlist for the war. The Filipino war is small and unimportant compared with the "commercialism" which debauches the young American soldiers as well as the "heathens" whom these patriotic soldiers are attempting to civilize at the point of the bayonet. If expansion, the hunt for consumers for American products, means to farther in the souls and bodies of young men and Malay savages, the sooner this country begins to contract the better.

The issue is live and pressing. Everywhere in this country the people should act. Delegations of strong, able men should be sent to Washington from every city and village in the whole country. Republicans and Democrats should stand shoulder to shoulder. Compel public men to take their stand upon one side or the other. Drive this government out of the liquor business. Take the whisky-bottle out of the hand of civilization. Give to the Filipinos that benevolent assimilation which does not first make them drunk.

Now, dear brother or sister, if the above strikes you as it does me, give the editor who had the courage to write it such support and encouragement as he deserves. Subscribe for his paper, either daily or weekly. Show this temperance editorial to your friends; and if you want more copies of it, write me and I will furnish you free of charge, postpaid, as many as anybody will distribute to his friends, or where it will be read.

Special Notices by A. I. Root.

CAULIFLOWER SEED—H. A. MARCH'S LATEST AND BEST—THE MATTITUCK ERBURT.

For years past we have been furnishing H. A. March's strain of Snowball cauliflower seed. The best evidence of its good qualities and reliability is the increased orders from year to year, and the fact that so many of our old customers will not take any other. Well, friend March has just got out something that he thinks is an improvement on the Snowball. Here is what he says in regard to it:

MR. ROOT—I send you to-day 5 lbs. of selected Early Jersey Wakefield cabbage seed; also 1 lb. of cauliflower seed. I am willing to wager my reputation as a cauliflower-seed raiser that it is the very best pound of cauliflower seed in America to-day. Every seed, with good care, will make a head. At the head of this sheet is a photo of six of them piled up against a wheelbarrow turned up edgewise. You can see what they are like. Those six heads, trimmed as you see them, brought the scales down at 60 lbs. You may recommend the seed with perfect confidence. It heads with Snowball, but larger. Here in our moist climate the leaves cover the heads so well that there is no need of tying up. We call it the Mattituck Erfurt. The stock seed was imported from Erfurt three years ago, through a man at Mattituck, L. I., at a cost of \$8.00 per ounce. Fidalgo, Wash., Dec. 3. H. A. MARCH.



SIX HEADS OF MARCH'S CAULIFLOWER

The pound of seed referred to in the above will be sold, while it lasts, at the regular price of the Snowball; viz., packet, 5 cts.; ½ ounce, 25 cts.; ¼ ounce, 40 cts.; 1 ounce, \$1.50.

Early cauliflower brings tremendous prices; therefore it is a good plan to start a few plants right away. March's strain of Early Jersey Wakefield cabbage is also equally well known. The 5 lbs. referred to above will be sold in 5-cent packets; per ounce, 20 cts.; per lb., \$2.50. The cabbage is so very hardy that it is a good plan to have some of the seed put in right away. You can transplant them into cold frames, and get them almost ready to head up before they go into the open ground, thus getting ahead of anybody else on early cabbage.

GRAND RAPIDS LETTUCE SEED—THE IMPORTANCE OF HAVING THE VERY BEST.

Some time ago, while discussing this matter of the best strains of seed, Eugene Davis, the originator of the Grand Rapids lettuce, sent me by request a small quantity of the best seed he could grow or procure. He also sent a small quantity to Thomas Slack, who writes as follows in regard to it:

I was just fortunate enough to have sown a section in the greenhouse last year with Davis' seed, as I was short of plants. A good many seeds did not come up until last spring, when the ground was dry, so I saved every one and set them out for seed, and got about three quarts; and the price you paid for your first seed (\$100.00 per lb.) would not buy it until I grow more. You can not understand how differently we feel this winter from last—hardly a spotted plant in the whole house, and each section turning out 35 to 40 boxes of first-class stuff instead of 15 to 20 boxes of very poor stuff as it did last winter. Price is 50 cents instead of 25. If you want a little seed to grow seed from in the spring, I think I can spare you a little. No charge, but it is not for sale.

Waterloo, Quebec, Dec. 27.

THOS. SLACK.

Now, friends, it does seem too bad that either friend Davis, Thomas Slack, who writes the above, or your humble servant A. I. Root, can not, one or all of them, personally superintend growing some choice Grand Rapids lettuce seed. Let's see—we shall have to call

it "Gilt-edged stock seed." The California-grown seed which we have been selling for a year past is far in advance of most of that on the market; but still it is not up to what we have just been writing and talking about, seed saved from carefully selected heads or plants. Eugene Davis has none to spare, and friend Slack says in closing that what little he has *is not for sale*. We have about 2 ounces left, sent us by Mr. Davis; and while it lasts we will let those have it, who wish, in five cent packets, putting only a few seeds in each. When you order, just say you want a packet of that "gilt-edged stock seed." You can, from this little packet, grow quite a good lot of seed during the coming year. As friend Slack seems to know better than anybody else exactly what is wanted, I suggest that he go right to work and grow seed enough so he can offer it for sale next fall.

A VISIT TO FLORIDA.

Providence permitting, some time during the month of February I shall make a hurried trip to Florida; and those of our readers who would like to have me make a brief call on them can drop me a postal. I can not promise to see all of you, but I will arrange my trip so as to take in as many as possible. I am planning to start about Feb. 1.—A. I. R.

A RARE COMBINATION

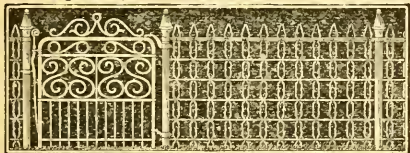

HARTMAN STEEL ROD PICKET FENCE.
Best and handsomest for lawns, parks, cemeteries, school grounds — anything. Send for our free catalogue—know more about it.
HARTMAN M'FG. CO., BOX 80 ELLWOOD CITY, PA.
Or Room 40, 309 Broadway, New York City.

IT MENDS BREAKS

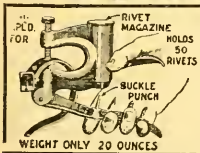

ON THE SPOT.
The Premium combined riveter, rivet magazine and buckle punch is a complete repairing outfit for harness, belting, etc. Carry it in your pocket; holds 50 rivets and is always ready. Makes a perfect clinch. Price only \$1, including a year's subscription to the "Differen" dairy paper—devoted to money making dairying, not theories. Send for free sample copy. We want agents for quick selling novelties. Write for terms. You can make big money. Agreeable work.
DRAPER PUB. & SUPPLY CO., CHICAGO, ILLINOIS.

Strawberry-plants.

I have a large supply of Lady Thompson, Excelsior, and Crescent plants. A limited supply of Bismarck, Clyde, Barton's Eclipse, Brunette, Gertrude, Brandwine, Wm. Belt, Bubach, Haverland, Gandy, and Warfield, \$2.00 per 1000, f. o. b. here, or 70 cts. per 100, postpaid. Satisfaction guaranteed.

J. P. LEA, Fayetteville, Arkansas.

WANTED.—A competent man to start and manage an apiary, that can soon be developed into some 50 colonies; every convenience; no apiary near; 3 miles from Jacksonville P. O. Plenty of bee trees. Only a few colored people have hives.

H. TURNER, Matthews, Duval Co., Fla.

60 COLONIES BEES FOR SALE; \$1.00 per colony; 70 empty hives, one honey-extractor for Am. frame, etc.
P. R. McLAUGHLIN, Shiloh, O.

FOR SALE.—Fox, coon, rabbit, and blood hounds; also game chickens.
ELIAS FOX, Hillsboro, Wis.

Italian Queens for early shipment from the South; are reared in full colonies by the best methods known to queen-breeders. Spring prices—full colonies, \$6.00. two frame nucleus without queen, \$1.50; three-frame nucleus without queen, \$2.00. Add price of queen wanted to price of nucleus. Tested queen \$2.00; untested, \$1.00; six for \$5.00; 12 for \$9.00. Liberal discounts on large orders. Combs built on full sheets of foundation in wired Hoffman frames. Shipments to the North by New York, Baltimore, Philadelphia, or Boston steamer via Savannah, Ga.

CHRISTIAN & HALL, Meldrim, Ga.

HONEY QUEENS!!

I have them, as daily letters testify. Recent conclusions force the belief that the leather-colored strain of three-handers excels in honey-gathering. If you want Golden my strain takes the lead of all others, and I have tried them all; 250 colonies for honey, and 200 strong nuclei that will winter over. I am prepared to send you a queen any day you may order. Tested or untested queens, \$1.00. Leather breeders, \$2.50. Owing to increased demand straight 5-band breeders are \$5.00 each.
W. H. LAWS, Beeville, Texas.

SUPERIOR QUEENS.

Bee-keepers, here is your chance to get queens of a superior strain for business, beauty, and prolificness. According to measurements by The A. I. Root Co., I have the noted long-tongued bees. I have also the Doolittle and Pridden strain which I am offering at reduced prices. I want 10,000 new names in this, the new century to whom I will mail my catalog for 1901, which explains it all. To introduce my queens I give free a \$3.00 breeder to every 100 names. I make tested and choice breeders a special v. Write to-day for price list.
PORTER A. M. FEATHERS,
(Superior Queen-bred'r),
Oak Hill Volusia Co., Florida.

PRICE OF Lone Star Queens



AFTER APRIL 1ST.
1 tested queen.....\$1 50
3 tested queens..... 3 75
1 untested queen... 2 00
3 untested queens 2 00
We have both the golden and leather color from imported mothers at same price.
Agent for Root's goods.

G F. DAVIDSON, Fairview, Wilson Co., Texas.

READY FOR 1901.

We are again ready to furnish our superior strains of Bees and Queens for 1901. We have the best stock of bees that money and skill can procure, as our numerous testimonials prove. We guarantee satisfaction. Let us have your orders. **WE WANT** your name and address for our circular giving valuable information, also a description and prices of queens. We have 800 queens wintered over for spring orders, among them 50 fine Golden breeders.

Prices, either Golden, 3-banders, or Holy Lands.
Untested—June, July, Aug. and Sept.—1 75c; 6 \$4.25. Untested—all other months—1, \$1.00; 6 \$5.00. Tested, 1, \$1.25; 6, \$6.75. Sel. Tested, each, \$2.01. Breeders, \$3.00 and \$5.00 each. Discount in quantities, and premiums given away to our customers. Address

O. P. HYDE & SON, Hutto, Texas.

Angora Goats. Handsome pets; profitable stock. Large new circular for stamp.
FDW. W. COLE & CO., Kenton, Ohio.

CRU-HED OYSTER SHELLS for poultry; 100 lbs., 60 cts.; 200 lbs., \$1.00
WISE & CO.,
Wholesale Grocers, Butler, Ohio.

WANTED.—Potatoes for cash, in sections where crop is large.
F. W. DEAN, New Milford, Pa.

FOR SALE.—Clover and buckwheat extracted honey.
E. D. TOWNSEND, Hubbardston, Mich.

Wants and Exchange.

Notices will be inserted under this head at 10c per line. You must say you want your ad in this department, or we will not be responsible for any error. You can have the notice as many lines as you please; but all over ten lines will cost you according to our regular rates. We can not be responsible for dissatisfaction arising from these "swaps."

WANTED.—To exchange buckwheat extracted honey as cash, for 2d hand hives—Simplicity or 10-frame only. Have your neighbors got any, or store combs?
W. I. COGGSHALL,
West Groton, Tompkins Co., N. Y.

WANTED.—A position with a good bee-keeper, or will take entire charge for you; 15 years' experience. Good reference to give.
J. E. HENDERSON, Elm Grove, Ohio Co., W. Va.

WANTED.—A competent man to take charge of four or five hundred colonies. To the right man a good proposition will be made. Write, stating amount of experience, age, etc.
I. A. KING, Almond, San Diego Co., Cal.

WANTED.—Two or three apiaries for cash; located in Colorado; write full particulars; first letters and lowest cash price; comb honey preferred.
THOS. C. STANLEY & SON, Fairfield, Ill.

WANTED.—To exchange modern fire arms, for old flint-lock guns, and old, antique dishes.
Address 216 Court St., Reading, Pa.

WANTED.—To exchange Danznbaker complete hives and Ideal cleated separators, for piano, organ, feed-cutter, feed-mill, 18-inch pony planer, or any thing I can use.
F. G. BASS, Front Royal, Va.

WANTED.—To exchange 12 000 up to date poplar dovetailed sections in flat; 100 Hoffman hives and frames with bottoms and roofs painted; 200 supers for said hives, for buckwheat extracted honey or bees.
D. E. FLOYD, Nelliston, N. Y.

WANTED.—An experienced man with family to take charge of my bees, poultry, and farm; work to be done on shares. Address
JOHN IFFT, Zelenople, Pa.

American Gardening

10 Sample Copies separate issues, 10 cents. Published at 136 Liberty Street, New York.

1200 FERRETS. All sizes; some trained; first-class stock. New price list free.
N. A. Knapp, Rochester Lorain Co., Ohio.

Tour of All Mexico

in Pullman's finest Compartment Drawing Room, Library, Observation, and Dining Cars—all Vestibuled—with the celebrated

Open-t p Car "Chililitli"

for Observation in the Mountains and Canyons, and Dining-car in the Tropics.

A delightful trip of 38 days with **Three Circle Tours in the Tropics** of the South of Mexico, and a **Visit to the Ruined Cities**

All exclusive features of these itineraries of leisurely travel and long stops. The Special Train starts Tuesday, January 22, from Chicago.

Tour of Puerto Rico.

SPECIAL PULLMAN CARS leave Chicago **Thursday, January 17, and Thursday, February 14, at 9:30 A. M.**, connecting with the splendid new steamships Ponce and San Juan sailing from New York the second day following. Individual Tickets sold for other sailing dates, alternate Saturdays.

Tickets Include All Expenses Everywhere.

These select limited parties will be under the special escort and management of **THE AMERICAN TOUR ST ASSOCIATION**, Reau Campbell, General Manager, 1423 Marquette Building, Chicago.

Itineraries, Maps, and Tickets can be had on application to Agents of the Chicago, Milwaukee & St. Paul R'y.

WHERE TO LOCATE?

Why, in the Territory Traversed by the

Louisville & Nashville

RAILROAD.

THE

Great Central Southern Trunkline

IN

KENTUCKY, TENNESSEE,

ALABAMA,

MISSISSIPPI, FLORIDA.

WHERE

**Farmers, Fruit-growers,
Stock-raisers, Manufacturers,
Investors, Speculators,
and Money Lenders**

will find the greatest chances in the United States to make "big money" by reason of the abundance and cheapness of

**Land and Farms,
Timber and Stone,
Iron and Coal,
Labor--Everything.**

Free sites, financial assistance, and freedom from taxation for the manufacturer.

Land and farms at \$1.00 per acre and upwards, and 500,000 acres in West Florida that can be taken gratis under U. S. homestead laws.

Stockraising in the Gulf Coast District will make enormous profits.

Half fare excursions the first and third Tuesdays of each month.

Let us know what you want, and we will tell you how to get it—but don't delay, as the country is filling up rapidly.

Printed matter, maps, and all information free.

Address **R. J. WEMYSS,**
Gen'l Immigration and Industrial Ag't,
LOUISVILLE, KY.

Mr. A. I. Root's Writings

of Grand Traverse territory and Leelanau County are descriptive of Michigan's most beautiful section reached most conveniently via the

Pere Marquette R. R.

For particulars address W. C. Tousey, D. P. A., Toledo, Ohio.

Low Rates to the South.

Excursion tickets at reduced rates are now being sold by the Chicago, Milwaukee & St. Paul Railway to the prominent resorts in the South, including Jacksonville, Fla.; Mobile, Ala.; New Orleans, La.; Savannah, Ga.; El Paso, Tex., which are good for return passage at any time prior to June 1, 1901. Information regarding rates, routes, time, etc., can be obtained on application to any coupon-ticket agent of the Chicago, Milwaukee & St. Paul Railway.

No Money in Advance

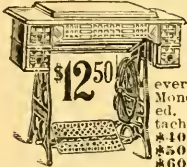

Our elegant New Jewel Drop-head sewing Machine possessing all the latest improvements, high quality and thorough workmanship. Shipped direct at \$12.50, the lowest price ever known, 30 days' free trial. Money refunded if not as represented. Guaranteed 20 years. All attachments free. 125,000 sold.

\$10.00 Arlington for... \$14.50
 \$50.00 " " " " \$17.00
 \$60.00 Kenwood " " \$21.50

Other Machines at \$8.00, \$9.00 and \$10.50
 Large illustrated catalogue and testimonials Free.
 CASH BUYERS' UNION, 158-164 W. Van Buren St., B-345, Chicago

\$18

Guaranteed for 10 Years.
 Frgt. Prepaid and Money Back if not Satisfactory.

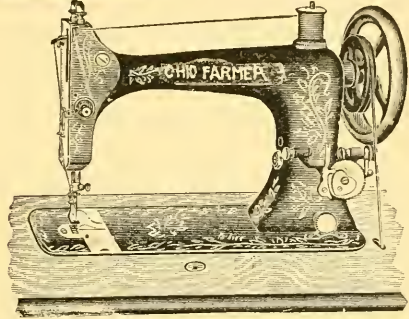

Send us \$18.00 and we will send you one of our NEW IMPROVED OHIO FARMER HIGH-ARM SEWING-MACHINES, freight prepaid. Use it for all kinds of work, and if not satisfactory you can return it in 90 days and we will refund your money and pay freight both ways.

All Guaranteed New Machines.

Self-setting needle; automatic bobbin-winder, with oak or walnut woodwork; new bent wood top; seven long skeleton drawers. Full and complete set of attachments and illustrated instruction book sent with each machine. Every machine we send out guaranteed to give ENTIRE SATISFACTION OR MONEY REFUNDED. We can furnish repairs or needles at any time. Remit by postoffice order, registered letter, New York draft, or express

If you want the BEST sewing-machine made in the world at the LOWEST PRICE ever offered, send us your order.

Drop Head, \$20.00.

This is the same machine, except the cabinet, which is made so that head drops out of sight when not in use. Four drawers. Freight prepaid. With same attachments as the \$18.00 machine.

Our No. 2 Machines.

Have old-style top tension instead of the new side tension furnished on the others. Not quite as much work on them as the others, which accounts for the lower price; but we guarantee them for the same time, furnish same attachments, and prepay freight.

High Arm No. 2, 5 Drawers, Only \$15.00.
 Drop Head No. 2, 4 Drawers, Only \$16.50.

Send for our new illustrated catalog. Address

The Ohio Farmer, : : : Cleveland, Ohio

NOTE.—We have known the publishers of the Ohio Farmer for many years. They are entirely responsible, and will fully make good their agreements.

THE A. I. ROOT COMPANY.

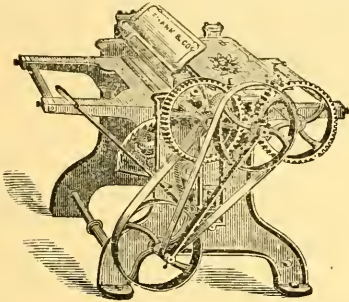

PLANERS

The above cut shows one of our small Planers, of which we make twelve different styles and sizes. Also large Planers, Band Saws, Buzz Planers, Moulders, Wood Lathes, and all kinds of

WOOD WORKING MACHINERY

Send for Catalogue.

The FRANK MACHINERY CO.
 BUFFALO, N. Y.

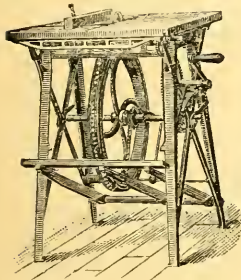

Barnes' Hand and Foot Power Machinery.

This cut represents our combined circular saw, which is made for beekeepers' use in the construction of their hives, sections, boxes, etc. Machines on trial. Send for illustrated catalogue and prices.

W. F. & John Barnes Co.,
 545 Ruby St.,
 Rockford, Ill.

Union Combination Saw

For Ripping, Cross-cutting, Rabbering, Mitering, Grooving, Gaining, Boring, Scroll-sawing, Edge-moulding, Beading. Full line FOOT and HAND POWER machinery. Send for catalog A. SENECA FALLS MFG. CO. 44 Water St., Seneca Falls, N. Y.

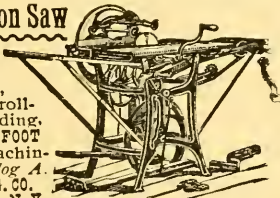

POULTRY-BOOK FREE. 64 pages, illust'd, with 3 mos. trial subscription to our paper, 10 cts. Inland Poultry Journal, Indianapolis, Ind.

In writing advertisers please mention Gleanings.

BELG. HARES

W. HAHMAN, Box 3, ALTOONA, PA.

Belgian Hares

I have some fine hares for sale at reasonable prices.



J. F. Moore, : Tiffin, Ohio.

New Smith Premiers Nos. 5 and 6.

The No. 6 takes paper 18½ inches wide and writes lines 16 inches long. The No. 5 takes paper 11 inches wide and writes lines 9½ inches long. These new machines in essential mechanical principles are the same as Models Nos. 2, 3 and 4—unequaled.

Write for Printed Matter Free.

**The Smith Premier
Typeewriter Co.**

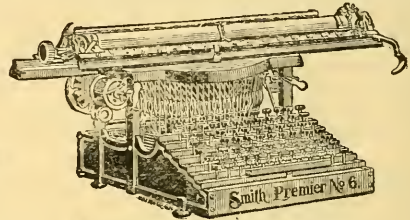

158 Prospect Street, Cleveland, Ohio.

Biggest, Brightest, Best---The Ohio Farmer.

== Only 60 Cts. a Year. == Cleveland, O. == A 20-page Weekly. ==

There is no other weekly farm paper published that has as large an actual list of paid-in-advance subscribers as THE OHIO FARMER has. Farmers read it and pay for it because it is clean, reliable, practical, and progressive. It is a 20-page weekly (often 24 pages) with the largest staff of editors and correspondents (all farmers) of any farm paper published; liberally illustrated every issue. Our subscription price is only 60 cents a year (52 copies), making it the cheapest, as well as the best, in America. We furnish free sample copies on request, also our illustrated premium list of useful articles, which we furnish at wholesale prices, or give free for clubs of subscribers. Send for these and clubbing rates with other papers, all at cost price.

**Our
Special Offer!**

For only \$1.10 we will send *The Ohio Farmer* and *Gleanings in Bee Culture* both one full year. *Gleanings in Bee Culture* costs you \$1.00, and you can get *The Ohio Farmer* one year by adding 10 cents. Subscriptions may be either new or renewal. Send all orders to

THE OHIO FARMER, - - - CLEVELAND, OHIO.

A Great Combination.

Good reading for every member of the family at one-half price.

Cleanings in Bee Culture.....	Reg. price, \$1.00.
The Mich. Farmer (weekly)....	.. 60.
The N Y Tribune (weekly)....	.. 1.01.
Pearson's Magazine.....	.. 1.00.
People's Home Journal.....	.. 1.00.
The Poultry Journal.....	.. .50.

At regular price would cost.....\$5 10.

We will send any one the entire lot for \$2.50 each one a full year, all postage paid. Each publication is the best of its kind published. THE MICHIGAN FARMER is a large, popular farm, stock, and home journal, published at Detroit, Mich., has a large circulation, and is national in every way except in name. Send to them for a free sample copy. The other papers are all well known and popular. The offer is a rare bargain. Address all orders to this office.

THE MICHIGAN FARMER, Detroit, Mich.

S. C. BROWN LECHORNS.

I use well-striped breeding cocks, Eggs, \$1.00. Cockerels, \$1.00 and my Als. Italian bees. Circular free. H. M. MOYER, Shanesville, Pa.

The Modern Farmer and Busy Bee.

Emerson Taylor Abbott, Editor.

A live, up to-date Farm Journal with a General Farm Department, Dairy, Horticulture, Live-stock, Poultry, Bees, Home and General News. The Editor has had practical experience in every department of farm work. To introduce the paper, it will be sent to New subscribers one year for 25c. Sample copies free. Best Advertising Medium in the Central West. Clubbed with *Gleanings* for \$1.00.

ADDRESS

Modern Farmer. St. Joseph, Mo.

QUEENS. Warranted, November, \$1.00; dozen, \$9.00; tested, \$1.25; dozen, \$12.00 See late ads. Guaranteed.
J. B. CASE, Port Orange, Fla.

In writing advertisers please mention Gleanings.

Always Fresh.
Always the Best.



FERRY'S SEEDS

are sold everywhere.
1901 Seed Annual free.
D. M. FERRY & CO., DETROIT, MICH.

For Sale! A splendid little fruit and bee-farm, in the midst of about half a dozen of the finest summer resorts in Northern Michigan, will be sold at less than one-half its value. Farm contains 16 acres with 1500 choice fruit-trees, nearly all in bearing, 5 to 7 years old, consisting of 300 cherry (mostly sweet), 250 pear, 250 peach, 300 plum, and 400 apple trees, all of them of the most profitable varieties. Also 1½ acres in strawberries, 2 acres in raspberries, 3 acres in clover, and the rest under cultivation for gardening purposes. The soil of the best; 3½ miles from Traverse City (a town of about 12,000 inhabitants, at the head of Grand Traverse Bay, with the largest State buildings in the State), 40 rods from a good school, and good graveled roads all over this part of the country; markets good, climate healthy. The buildings all new, and well built and finished, consisting of house with 7 rooms, upright 16x24, 1½-story, with good cellar, stone wall, full size of this part of house; wing part one-story, dining-room, kitchen and wood-shed 16x36 with soft water in the kitchen. Barn, 16-foot posts, 30x32; hen-house, 12-foot posts, 12x24. All buildings on stone foundation. Plenty of good water. Terms: \$3000; \$1000 down, balance to suit purchaser. Will also sell all of my personals, among them 40 colonies of Italian bees in chaff hives; team of horses, cow, one spring and one lumber wagon, and all other farming tools.

Address **J. P. Berg, Box 8, Traverse City, Mich.**

**Improved Ohio Farmer
REPAIR OUTFIT.**
Our Price Only \$1.65.

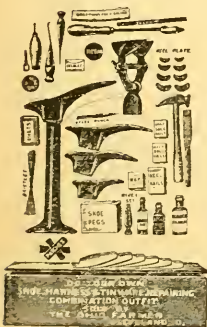

We have examined samples from all manufacturers, and believe this is the very best repair outfit on the market; easily worth \$1 more than those offered by stores and other papers. It contains 48 articles, all full size and first class, and we guarantee satisfaction or will refund money. Half-soles alone are worth 50c, and are not included in other outfits. It will soon pay for itself in repairing boots, shoes, rubbers, harness, and tinware.

Repair Outfit with Ohio Farmer one year for only \$2.15, or the Complete Outfit free for a club of 10 subscribers to the Ohio Farmer. By freight.

Send for our illustrated premium list, giving wholesale prices on watches, sewing-machines, knives, and lots of other useful articles. Mention this paper.

The Ohio Farmer, : Cleveland, Ohio.

SEED DUE BILL FREE

To get new customers to test my Seeds, I will mail my 1901 catalogue, filled with more bargains than ever and a Due Bill good for 10c worth of seeds for trial absolutely free. All the Best Seeds, Bulbs, Plants, Roses, Farm Seeds, Potatoes and many Novelties at lowest prices. Gluseng, the great money making plant. Giant Prize Tomatoes, 2 to the foot, Pan American Oats, sent out free to farmers, and two Free Passes to Pan American Exposition, Buffalo, N. Y. are offered. \$2,635.00 cash premium. Don't give your order until you see this new catalogue. You'll be Surprised at my bargains offered. Send postcard catalogue today. It is FREE to all. Tell your friends to send too. **F. B. MILLS, Box 105, Roschill, Oneadaga Co., N. Y.**

**Maule's (35 new things for 1901)
Seed Catalogue**

You should, by all means, have this most modern catalogue of modern things. It is brimful and overflowing with good things in vegetable, farm and flower seeds, flowering plants, fruits, bulbs, etc. It contains 35 novelties in vegetables and flowers never offered before, has 136 large pages, seven handsome colored plates and hundreds of illustrations. It gives practical, up-to-date cultural directions and offers many cash prizes. The first edition alone costs over \$30,000, so while we send it free to all customers, we must ask others to send 10 cents for it, which amount they may deduct from their first order. You will make a mistake if you do not write to-day for this the Novelty Seed Book of the year. Address, **WM. HENRY MAULE, Philadelphia.**



BIG APPLES
WE OFFER TRUE TO NAME.
375,000 Apple, Standard and Dwarf Pear, Cherry and Plum Trees, Japan Plums a Specialty.
Save half your money by buying direct to the producer. Let us price your list of wants. Send for our free catalogue of fruit or ornamental trees, also copy of Green's Fruit Grower.
Green's Nursery Co., Rochester, N. Y.
For 10c. we will mail two plants of our Red Cross Currant.



Extra Early Admiral Dewey
Originated and introduced by
HARRY N. HAMMOND SEED CO.
(Formerly of Finland) Box 69, Ray City, Mich.
Largest growers of Seed Potatoes in America. The Dewey is the most wonderful New Potato. Its merits are fully described in Hammond's 1901 Catalog. Free for the asking. Address as above. Write to-day. 20 other varieties of potatoes. Also Vegetable and Flower Seeds.

Sharples Cream Separators - Profitable Dairying.

In writing advertisers please mention Gleanings.

SEEDS VEGETABLE and FLOWER. Everything in the Nursery and Florist's line. Direct deal with us will insure you the best and save you money. Mail size postpaid, larger by freight or express, safe arrival and satisfaction guaranteed. Try us. A valuable 168 page Catalog for the asking. 47 cents, 1000 acres, 41 greenhouses.

THE STORRS & HARRISON CO., Box 222, Painesville, Ohio

NOTHING CAN COMPARE WITH IT.

When it comes to an all-round handy and useful garden tool, nothing compares with this "Planet Jr." No. 25 Hill and Drill Seeder and Double Wheel Hoe, Cultivator and Plow. It is made to fit the man who has a good sized garden, yet not quite enough to justify owning a separate wheel hoe. As a drill it does all our famous "Planet Jr." No. 4 does. As a wheel hoe it is identical with our "Planet Jr." No. 12. Has 11 1/2 in. wheels, cultivates between the rows, or on each side of the row, throws dirt to or from the row, hills up, plows, marks out, etc. Easily and quickly changed from one to the other. We give this tool the strongest possible recommendation.

You should have one of the 350,000 copies of our new 1901 catalogue. It is better than ever. Tells all about our full line of Seed Drills, Wheel Hoes, Cultivators, Harrows, Two Horse Cultivators, Sugar Beet Seeders and Cultivators, and our reduced prices for Europe and in foreign countries. Mailed free. They are used at home and in foreign countries. Mailed free.

S. L. Allen & Co., Box 710-H, Philadelphia, Pa.
Two Gold Medals at Paris Exposition; Highest Award



BURPEE'S FARM ANNUAL 1901 FOR
"QUARTER-CENTURY EDITION"

A Grand New Book of two hundred and twenty pages. Entirely rewritten at our famous FORDHOOK FARMS—the largest Trial Grounds in America. New Directions for culture, New Leaflets, New Novelties of unusual merit in both Vegetables and Flowers, Elegant New Colored Plates. The Quarter-Century's Record of Progress, New Cash Prizes, and other New Features. The largest, most complete, and BEST SEED CATALOGUE ever published. Mailed for ten cents, which is less than cost per copy. Name this paper, send ten cents (silver or stamps) and with this great catalogue we shall send a 15-cent packet of either Burbank's Unique Floral Novelty or Burpee's wonderful, new, dwarf, meaty, bright-red, earliest Tomato,—"Quarter-Century."

Should you object to paying ten cents for a seed catalogue (even though it is worth a dollar), then write a postal card for Burpee's "SEED-SENSE" for 1901,—a "strictly business" catalogue of ninety pages.

W. ATLEE BURPEE & CO., PHILADELPHIA, PA.

MONEY IN CABBAGE

IF YOU PLANT
The Right Seeds.

My new Seed Book tells all about the best varieties of Cabbage and everything of interest in seeds; how to grow them for profit, etc.

Write to-day **FREE** this Paper and will send you a sample package of Buckbee's New Century Cabbage. The BEST ON EARTH, together with Beautiful and Instructive Seed and Plant Book.

H. W. BUCKBEE,
Rockford Seed Farms,
Box 614 Rockford, Ill.



"SALZER'S SEEDS WILL MAKE YOU RICH"

This is a daring statement, but Salzer's seeds bear it out every time.

Combination Corn.
Greatest corn on earth. Will positively revolutionize corn growing.

Billion Dollar Grass.
Greatest marvel of the age; 12 tons of hay per acre. First crop six weeks after sowing.

What Is It?
Catalogue tells.

FOR 10c. STAMPS and this NOTICE we mail you seed catalog, 10 Grain Samples including 24 lbs. also Swift (80 bu. per A.) Oats, (250 bu. hhd. per A.) Rye, Bar. y. (175 bu. per A.) Peas, etc. Worth \$10. to get a start.

John A. Salzer Seed Co. La Crosse, Wis.



SPRAYING

with our new patent
KEROSENE SPRAYERS is simple indeed. Kerosene Emulsion made while pumping. 12 varieties sprayers, Bordeaux and Vermorel Nozzles, the World's Best.

THE DEMING CO. Salem, O.
Western Agents, Henion & Hubbell, Chicago. Catalog, formulas free



Egg Record Book Free.

Our new free catalogue contains a 12-page egg record, enabling you to keep track of what your hens do. It also describes the

Humphrey Green Bone and Vegetable Cutter guaranteed to cut more bone in less time and with less labor than any other cutter made. Your money back if you're not satisfied.

Read our **GUARANTEE**

Humphrey & Sons, Box 51, Joliet, Ills.



In writing advertisers please mention Gleanings.



"Profitable Poultry Keeping

IN ALL ITS BRANCHES. This is the title and theme of our new Year Book. Contains 122 pages, 8x11 in.; 200 new and original illustrations of best poultry farms, buildings, etc., in the country. Deals with every phase of the poultry industry in an instructive and profit bringing way. Treats also of the famous non-moisture, self-ventilating and regulating **CYPHERS INCUBATORS**, guaranteed to out-perform three or more tests of money refunded. Sent for 10c in stamps. Ask for book 74 Circular and prices free. Address nearest office. **CYPHERS INCUBATOR CO.**, Chicago, Weymouth, N. Y., Boston, Mass.



INVESTIGATE BEFORE YOU BUY.

We want our customers to be perfectly satisfied before they spend the money. Investigate the claims of all incubators and then decide. We believe you will find that the **SURE HATCH INCUBATORS**

AND COMMON SENSE FOLDING BROODERS are giving better satisfaction than any other made. It's because they are so simple, sensible and sure. They are built for busy people, who haven't time to fuss and bother. Our catalogue is FREE. We don't ask you to pay for it. Isn't it worth examining?

SURE HATCH INCUBATOR COMPANY, CLAY CENTER, NEBRASKA.

Strong, Healthy Chicks

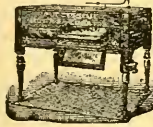

are hatched by our incubators, and more of them than hens can hatch. Why? Because our regulator never fails to keep the heat just right. Catalogue printed in 5 languages gives full descriptions, illustrations and prices, and much information for poultry raisers. Sent for 6 cents. **DES MOINES INCUBATOR CO.**, Box 503, Des Moines, Ia.

YOU OUGHT TO KNOW



everything between the covers of our

20th CENTURY POULTRY BOOK in order to be successful in the poultry business. It tells everything necessary and no more. It's a compend of poultry knowledge. Among other things it fully describes

Reliable Incubators and Brooders, which are known and used all over the world. We mail the book for 10 cents as long as they last. Hurry your order in at once.

Reliable Incubator & Brooder Co., Box B-49 Quincy, Ills.

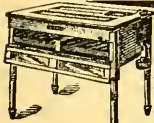

200-Egg Incubator for \$12.00

Perfect in construction and action. Hatches every fertile egg. Write for catalogue to-day. **GEO. H. STAHL, Quincy, Ill.**

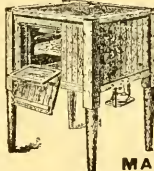

MARILLA.

That's the name which means highest excellence in Incubators and Brooders—the most perfect regulation of temperature and moisture. Hot air or hot water. Send 2c for catalogue and guarantee. Your money back if you are not satisfied.

MARILLA INCUBATOR CO., Box 62, Rose Hill, N. Y.

EASY EGG MONEY

A man can easily make money selling eggs if he can but get the eggs. He can get the eggs **sure**—twice as many, if he will feed his hens on **Green Cut Bone**. No better way to prepare it than with

ADAM'S CUTTER

It cuts on the shear plate principle. Takes off a fine ribbon like piece, easily consumed by the chicks or fowls. No sharp splinters to injure throat. Turns easily. Only ball-bearing cutter made. For hand or power. Catalogue N. 39 free. **W. J. ADAM, Joliet, Ill.**

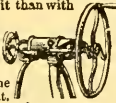

Highest Price FOR EGGS

comes in the winter when eggs are scarce. **Green Cut Bone** prepared by **Mann's New Bone Cutter** makes hens lay at any time. It doubles the egg product. **Mann's Granite Crystal Grit, Clover Cutter and Swinging Feed Tray** mean hen comfort and hen profit. Catalogue free. **F. W. MANN CO. Box 37, Milford, Mass.**

GREIDER'S POULTRY

always do well. 50 standard varieties. Handsomest poultry book of the season for 8c stamps. Full of money-making hints. My birds are winners. **B. H. GREIDER, Florin, Pa.**

AT ANY TIME—

summer time or winter time, the **BEST POWER** for all purposes on the farm, in the dairy, creamery or cheese factory, is a

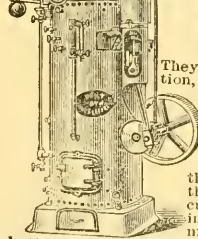

LEFFEL ENGINE.

They are very simple in construction, and easy to run and keep in order. Are very economic of fuel, are easy steamers and great power developers. They are made both horizontal and upright with engine mounted on boiler. Everything is made of best material throughout. They are ideal for cutting and grinding feed, sawing wood, pumping water, running cream separators, churns, butter workers, etc. **JAMES LEFFEL & CO., Box 89, Springfield, O.**

A BASKET FULL OF EGGS

by using **Ley's Poultry Condition Powders**. Puts all fowls in a normal condition; destroys all disease germs; purifies the blood; is a tonic and nutrient. Price 25 cts. a pk.; 5 for \$1.00. **Ley's Thoroughbred Minorca's Eggs, \$1.00 for 12.** Also **Thoroughbred Belgian Hares.** **Geo. J. Ley, Florence, Cal.**



BULL-STRONG!

....PIG-TIGHT.... An Illinois farmer said that after harvest he had fully 200 bushels of loose oats on the ground that he could not secure any benefit from, because the fence around the field would not turn logs. Figure the loss for yourself. He also said, all this would have been saved if he had used the **Kitselman Woven Wire Coiled Spring Fence**, and the value would have gone a long way towards paying cost of the fence. With the **Duplex Machine** any farmer can make it himself at the actual cost of the wire. Catalogue free for the asking. **KITSELMAN BROS.**, Box D31, Muncie, Ind.

Three Times as Much!

I have recently returned from a trip through New York, where I attended a series of bee-keepers' institutes, or conventions. While at Romulus and Auburn, several bee-keepers told me of the wonderful performances of the bees from a queen that I had sold Thos. Broderick, of Moravia. Mr. Broderick had reared queens from this queen for both himself and a few friends, and nothing in those parts had equaled this strain of bees. Wishing to have the particulars direct from Mr. Broderick himself, I wrote and asked him if he would be so kind as to give them to me. Here is his reply:

MORAVIA, N. Y., Dec. 31, 1900.

Mr. W. Z. Hutchinson, Flint, Mich.

Dear Sir:—It is with pleasure that I write concerning the queen that I purchased of you three years ago, as I have reasons to believe her one of the most remarkable queens ever possessed by any bee keeper in this part of the country.

At the end of the first season, as you may remember, I wrote you my appreciation of this queen, but I will now go more into detail. Upon receiving the queen, May 24, 1898, I gave her to a colony that scarcely covered four Gallup combs. She built up that colony and gave me 140 well-filled sections, mostly from buckwheat. This I considered remarkable, as, previous to that time, 75 lbs was the very best yield that I had ever been able to take from my best colonies.

In the fall, after preparing my colonies for winter, by some accident the super containing the absorbent was knocked out of place, thereby letting the heat of the cluster pass out of doors all winter. They were protected from the wind by a shock of corn fodder, and in this way they passed three months without a flight. They came through the winter somewhat reduced in numbers; but, again the colony built up and gave me a crop of 96 lbs. of well-filled sections.

The past season this colony gave me 48 lbs. of comb honey, which I consider good considering the age of the queen (four years) and the very poor season.

It was in the season of 1899 that I reared the first queens from this queen. The past season the colony from one of those young queens gave me a crop of 174 sections which tipped the beam at 176½ lbs. The only thing that I did to this colony in the way of manage-

ment was that, some time in May, I robbed it of a comb of honey and replaced it with an empty comb. This queen was the only one of this stock that passed the winter in a full colony, all of the others being given to artificial colonies that were formed late in the season. They all wintered finely, although each colony occupied only some five or six Gallup combs.

The past season they all built up and gave me on an average 90 lbs. each of comb honey. My best colony gave me a crop that was *three times as large as that produced by the best colonies of my neighbors.*

Queens of this strain occupy every comb in the hive, and it makes no difference whether the combs are the Gallup, the Quinby, or the hive a two story Langstroth. The bees never crowd these queens if given plenty of room. The bees are as gentle as one could wish; cap their honey as white as any bees cap it; and, as workers—well, I can't explain it. It is needless to say that this strain of bees will be in evidence in my apiary as long as I keep bees. You are at liberty to publish this if you wish.

THOS. BRODERICK.

To those who are thinking of trying this strain of bees, I would say, don't wait until next spring before sending in your order. Last spring, when I began sending out queens, there were orders on my books for nearly 200 queens. Orders are already coming in to be filled next spring. They will be filled in rotation; so, if you wish to get a queen next spring, send in your order this fall. The price of a queen is \$1.50; but safe arrival, safe introduction, purity of mating, and entire satisfaction are all guaranteed. The queen can be returned any time within two years, and the money refunded, and 50 cents additional sent to pay for the trouble.

The REVIEW for this year and the back numbers for 1900 (two years) and one of these queens for only \$2.00. As soon as your order is received, the back numbers for last year will be sent, and your subscription put on the book to the end of 1901, and next spring the queen will be sent you.

Address all Orders to

W. Z. HUTCHINSON, = FLINT, MICHIGAN.

Marshfield Manufacturing Company.

Our specialty is making SECTIONS, and they are the best in the market. Wisconsin Basswood is the right kind for them. We have a full line of BEE SUPPLIES. Write for FREE illustrated catalog and price list.

Marshfield Manufacturing Company, Marshfield, Wisconsin.



BEE-HIVES AND HONEY-BOXES,

in car lots—wholesale or retail. Now is the time to get prices. We are the people who manufacture strictly first-class goods and sell them at prices that defy competition. Write us today.

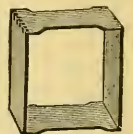

Interstate Box & Manufacturing Co., Hudson, Wis.

Notice.

◆ ◆ ◆ DO YOU WANT ◆ ◆ ◆

Printed Stationery, Queen-cages, or Folding Cartons for your next season's honey crop? If so, here are a few prices which will hold good for a short time only. ◆ ◆ ◆ ◆

High-cut Melon Laid Envelopes, $6\frac{1}{2} \times 3\frac{1}{8}$ at \$2.00 per 1000. If you haven't use for that many will print and send by mail, postpaid, 100 for 50 cts.

Round-corner Die-cut Cards $4\frac{3}{8} \times 2\frac{3}{4}$, \$1.80 per M. Letter-heads, $11 \times 8\frac{1}{2}$, \$2.00 per M.

Folding Cartons, printed one side, \$3.20 per M. Sample for stamp.

Polished Queen-cages, \$9.00 per M.

We have on hand 2000 second hand L-size brood-frames at \$1.00 to \$1.25 per 100, also 150 hives.

If any readers of Gleanings would like a fine trio of Belgian Hares, will say that we have some very fine imported and domestic pedigree stock. Also some cheap unpedigreed.

We breed improved queen bees in season. Remember that.

Parkertown is now a money-order office, so please don't send stamps for goods if you can help it.

ADDRESS ALL ORDERS TO

H. G. Quirin, Parkertown, Erie Co., Ohio.

Root's Bee-supplies for the South Atlantic States at Root's Prices.

Quick Shipments.
Low Freight Rates.

We call your attention to our one-horse Winner Wagon.

Star Force-feed Wheelbarrow Clover Seeder.

Pea-Threshers.

Buffalo Pitts Harrows.

We carry a full line of the most approved Farm Implements, etc.

Send for catalog G.

Rawlings Implement Co.,

209 S. Charles St.,

Baltimore, Md.

1881

PAGE & LYON MFG. CO.

1900

We manufacture a full line of the latest
BEE-SUPPLIES.

Our motto is, "Perfect Goods and Prompt Shipment."

Send for our new free illustrated catalog.

PAGE & LYON MFG. CO., New London, Wisconsin.

NOW READY!

64-PAGE CATALOG OF EVERY THING BEE-KEEPERS NEED. Illustrated and fully described. Especially valuable to beginners for the information it contains. Send your address on a postal and get it now. Established 1884.

J. M. JENKINS, Wetumpka, Ala.

Our Advertisers.

We take pleasure in calling the attention of our readers to the advertising pages of this number. In these pages you will find many whose advertisements are new in GLEANINGS. We take every precaution to keep out any unreliable concern, so you will find those who advertise with us are the very best in their respective lines. It will pay you to write for their catalogs; and when you do this be sure to mention GLEANINGS IN BEE CULTURE. If you desire catalogs from three or more whose names are found in our paper you may send your request to us and we will get them for you. This will save you writing to so many. Be sure to give the full names and addresses of all whose catalogs you desire.

TYPEWRITERS.

Do you want a typewriter? Then write the Smith Premier Typewriter Co., 158 Prospect St., Cleveland, Ohio, for their catalog. See page 64. We use only these machines in our office, and have for the past ten years.

FARM AND GARDEN TOOLS.

Do you want first class work done on your farm or garden? If so, you will be interested in the catalog of S. I. Allen & Co., Box 710, H. Philadelphia, Pa. Their tools are sold all over the world. We can supply with our goods when desired.

ENGINES.

We used to manufacture small engines ourselves; but the large manufacturers are able to do this much more advantageously than we, so we discontinued this some years ago. We still get a good many inquiries, however, and we take pleasure in referring any and all who need a first-class engine, large or small, to Jas. Leffel & Co., Box 89, Springfield, Ohio. See page 67

Get the Best Queens.

Evansville, Ind., Sept. 27th, 1900.
The Jennie Atchley Co., Beeville, Bee Co., Texas;
Dear Friends:—It gives me great pleasure to forward you this unsolicited testimonial regarding the merits of Atchley queens. The three (3) dozen queens purchased of you have made an excellent record for themselves. Not an Atchley queen among the twenty colonies lost during the severe drouth in July. I have bought queens from many breeders; and although the present crop is exceedingly short, the tiers of supers show where the Atchley queens are, and speak volumes for your method of queen-rearing. I find the progeny to be very gentle, strong winged, uniformly marked, long-lived, of large size, and, last but not least, the best honey-gatherers I ever had. I shall want 100 more next season.
 Yours fraternally, J. C. WALLENMEYER.

Prices for Queens.

Tested \$1.50 each; \$8.00 for 6, or \$15.00 per dozen. Untested, February, March, April, and May, \$1.00 each; \$5.00 per 6, or \$9.00 per dozen. Fine breeders, \$5.00 each. We have as good bees and queens as money and labor produce. We breed three-hand Italians, Golden Carniolans, Cyprians, and Holy-Lands, in their purity, bred in separate yards 5 to 20 miles apart. If you want the best, call for Atchley's improved strains. Safe arrival guaranteed. Send for a sample copy of "The Southland Queen," the only southern bee-paper, \$1.00 per year. To new subscribers we offer as a premium a nice untested queen in order to get our paper introduced. Catalog, giving queen-rearing and management of apiaries for profit, FREE.

**THE JENNIE ATCHLEY CO.,
 Beeville, Bee Co., Texas.**

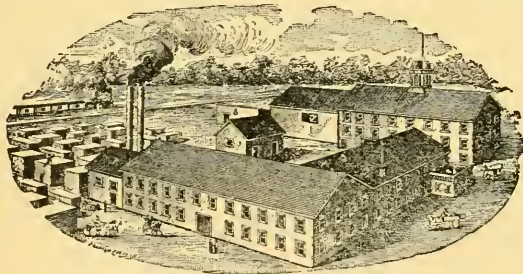

KRETCHMER M'FG CO., Red Oak, Iowa.

BEE-SUPPLIES.

Best-equipped factory in the West; carry a large stock and greatest variety of every thing needed in the apiary, assuring BEST goods at the LOWEST prices, and prompt shipment. We want every bee-keeper to have our FREE ILLUSTRATED CATALOG, and read description of Alternating Hives, Ferguson Supers, etc. Write at once for a catalog.

— AGENCIES: —

Trester Supply Co., 103 So. 11th St., Lincoln, Nebraska; C. C. Richards, 1223 17th St., Denver, Col.



BINGHAM SMOKER.

DEAR SIR:—Inclosed find \$1.75. Please send one brass Smoke-engine. I have one already. It is the best smoker I ever used. Truly yours,
 HENRY SCHMIDT, Hutto, Tex

MADE TO ORDER.

Bingham Brass Smokers

Made of sheet brass, which does not rust or burn out; should last a lifetime. You need one, but they cost 25 cts. more than tin of the same size. The little open cut shows our brass hinge put on the three larger sizes. No wonder Bingham's 4-inch smoke-engine goes without puffing, and does not drop inkly drops. The perforated steel fire-grate has 381 holes to air the fuel and support the fire.
 Heavy tin smoke-engine, 4-inch stove, per mail, \$1.50; 3½-inch, \$1.10; 3-inch, \$1.00; 2½-inch, 90c; 2-inch, 65c. Bingham smokers are the originals, and have all the improvements, and have been the standard of excellence for 22 years. Only three larger ones brass.

T. F. Bingham, : : Farwell, Mich.

Contents of this Number.

Bees, Weight Can Carry..... 80
 Belgian Hares, Morrison on..... 84
 Belgian hare Business Dead..... 81
 Breeding-stock..... 85
 Brood chambers, Shallow..... 88, 89
 Cans v. Barrels..... 81
 Chickens, Visit to Mapes' Yard..... 108
 Clipping Wings, Barber's Plan..... 85
 Clover and Snow..... 79
 Combs 25 Years Old..... 80
 Counties, Dry, of Ohio..... 107
 Cuba, Disadvantages of..... 90
 Do little in Arkansas..... 102
 Eggs in Winter..... 109
 Honey, To Load on Wagons..... 101
 Honey-bottling Symposium..... 93
 Map of Honey Centers..... 83
 Negroes Position of..... 107
 Officer of N. B. K. A..... 102
 Organization, Co-operative..... 82
 Pollen in Shallow Brood-chambers..... 100
 Pulse Rate in Colorado..... 101
 Sage, Rambler on..... 81
 Salve from Propolis..... 101
 Spraying, Prof. Beach on..... 103
 Stings, Immunity from..... 79
 Sugar as Food..... 80
 Sulphuric Acid in Refining Wax..... 101
 Surplus Arrangement, Adjustable..... 99
 Swarms, Artificial Brushed..... 86
 Symposium on Bottling Honey..... 93
 Tipping..... 82
 Tongues, Charton's Measurement..... 80
 Tongues, Rankin's Measurements..... 84
 Tongues, To Measure..... 101
 Utter Trial, Personnel of..... 91
 Wax, To Prevent Cracking..... 79
 Wintering at Ontario Convention..... 102
 Wintering in the South..... 90
 Wintering under Snow..... 01

Honey Column.

GRADING RULES.

FANCY.—All sections to be well filled, combs straight, firmly attached to all four sides, the combs unsoiled by travel stain, or otherwise; all the cells sealed except an occasional cell, the outside surface of the wood well scraped of propolis.
 A No. 1.—All sections well filled except the row of cells next to the wood; combs straight; one-eighth part of comb surface soiled, or the entire surface slightly soiled, the outside surface of the wood well scraped of propolis.
 No. 1.—All sections well filled except the row of cells next to the wood; combs comparatively even; one-eighth part of comb surface soiled; or the entire surface slightly soiled.
 No. 2.—Three-fourths of the total surface must be filled and sealed.
 No. 3.—Must weigh at least half as much as a full weight section.
 In addition to this the honey is to be classified according to color, using the terms white, amber, and dark; that is, there will be "fancy white," "No. 1 dark," etc.

CITY MARKETS.

DENVER.—Demand not very active. Fancy white, \$3.25 per case of 24 sections; No. 1, \$3.00; No. 2, \$2.75. Extracted white, 7½@8. Beeswax, 22@25.
 THE COLORADO HONEY PRODUCERS' ASS'N.
 Jan. 23. 1440 Market St.

BUFFALO.—The honey market is very dull. I think if prices were lower it would not increase the demand very much. It is a time of the year when honey always moves slowly. Fancy white comb, 16@17; A No. 1, 15@16; No. 1, 14@15; No. 2, 13@14; No. 3, 12@13; buckwheat, 10@12. Extracted, white, 7@8; dark, 6@6½. Beeswax, 28@30.
 Jan. 21. W. C. TOWNSEND, Buffalo, N. Y.

NEW YORK.—The supply in hand for all grades of comb honey seems equal to the demand, which at present is but moderate. We quote: Fancy white comb, 15@16; No. 1, 13@14; No. 2, 12@12½; buckwheat, 10@11. Buckwheat extracted, 5½@5½. Beeswax, 28.
 FRANCIS H. LEGGETT & Co.,
 Franklin, West Broadway, and Varick Sts.,
 Jan. 19. New York City.

BOSTON.—We quote our market as follows: Fancy No. 1 white in cartons 17; A No. 1, 16; No. 1, 15@16, with a fairly good demand. Absolutely no call for dark honey this year. Extracted, white, 8@8½; light amber, 7½@8. Beeswax, 27.
 BLAKE, SCOTT & LEE,
 Jan. 18. 31, 33 Commercial St., Boston, Mass.

CHICAGO.—Honey is selling slowly. This applies to all grades, with the exceptions of white-clover and basswood comb honey. It sells readily at 16, providing it grades number one or better. All other kinds of white comb honey sell at from 14 to 15, and candied white comb honey at from 8 to 10; travel-stained and off grades, comb, 13@14; amber, 12@13; amber extracted, 7@7½; dark and buckwheat, 9@10; white, 7½@8; basswood and white clover bring the outside prices; buckwheat and other dark grades, 6@6½. Beeswax, 28.
 R. A. BURNETT & Co.,
 Jan. 19. 163 South Water St., Chicago, Ill.

DETROIT.—Fancy white comb, 15@16; No. 1, 13@14. Extracted white, 7@7½; dark and amber, 6@6½. Beeswax, 26@27.
 M. H. HUNT & SON, Bell Branch, Mich.
 Jan. 19.

CINCINNATI.—Market very quiet. No change in prices. Fancy white comb sells for 16. Extracted dark, sells for 5½, and better grades bring 6½ to 7½; fancy white table honey brings from 8 to 9.
 C. H. W. WEBER.
 Jan. 16.

SCHENECTADY.—Market was very quiet during the holidays, but we note an improved demand again for comb honey, with prices unchanged. Extracted continues selling very slowly, and producers are getting anxious to sell, and are willing to accept a lower price than they would early in the season.
 C. McCULLOCH, Schenectady, N. Y.
 Jan. 21.

ALBANY.—Honey market quiet, with light stocks of honey. Prices nominal. White clover, 16@17; mixed, 13@14; buckwheat, 11@12. Extracted white, 7½@8; mixed, 7@7½; buckwheat, 5½@6.
 MACDOUGAL & Co.,
 Successors to CHAS. McCULLOCH & Co.,
 Albany, N. Y.
 Jan. 21.

PHILADELPHIA.—As we predicted some weeks ago, the cars of California honey in comb have been unloaded, and pushed to get returns, and market broke down. We quote: Fancy comb, 15; No. 1, 13@14. Extracted white, 7; amber, 6. Beeswax, 28. We are producers of honey, do not handle on commission.
 WM. A. SELSER,
 Jan. 24. 10 Vine St., Philadelphia, Pa.

NEW YORK.—Demand for comb and extracted honey is very dull. We quote: Fancy white, 15@16; A No. 1, 14@15; No. 1, 14@15; No. 2, 12@13; fancy buckwheat, 11; No. 1, 10; No. 2, 9. Extracted, white, 8; light amber, 7@7½; amber, 6@6½; buckwheat, 5½@6. There is no great stock of either white or buckwheat comb honey on hand; but the extracted buckwheat is plentiful, with prices ranging from 5 to 6c, with little demand. Beeswax, 26@28.
 CHAS. ISRAEL & BROS.,
 Jan. 25. 486 8 Canal St., New York City.

SAN FRANCISCO.—Fancy comb, 14; A No. 1, 12; No. 1, 9½; No. 2, 7½. Extracted white, 7; light amber, 6½.
 GUGGENHIME & Co.
 Jan. 22.

FOR SALE.—20,000 lbs. extracted honey from alfalfa and light amber from Rocky Mountain bee-plant. Two cans, 120 lbs. net, \$8.40; also 5 and 10 lb. pails. In ordering state if you want white or amber.
 M. P. RHOADS, Las Animas, Col.

WANTED.—Comb and extracted honey. State price, kind, and quantity.
 R. A. BURNETT & Co.,
 163 South Water St., Chicago, Ill.

FOR SALE.—Light amber extracted honey, in barrels, 7½c a lb.; buckwheat, in kegs, 6¢ per lb.
 I. J. STRINGHAM, 105 Park Place, New York.

FOR SALE.—Choice alfalfa honey. Two cans, 120 lbs. net, whitest, \$9.00; tinted, partly from other bloom, \$8.40. Also small cans.

THE ARKANSAS VALLEY APIARIES,
 OLIVER FOSTER, Prop., Las Animas, Bent Co., Colo.

FOR SALE.—Extracted honey from alfalfa; 60-lb. cans at 7 cts., and smaller cans.
 D. S. JENKINS, Las Animas, Colo.

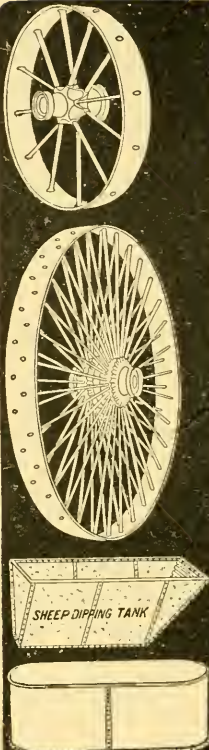

“ELECTRIC” GOODS.

Thousands of farmers all over the country know that the name “Electric” stands for the highest quality, the greatest durability, the lowest price. Everything put out of our factory carries the reputation of being “as good as money can buy.”

Electric Metal Wheels
of all sizes and varieties, to fit any axle on any vehicle or farm implement. Either direct or staggered oval steel spokes.

Electric Handy Wagon,
the neatest, strongest, most durable, easiest to load wagon made. Metal wheels, any width of tire, any height from 24 to 56 inches. Best angle steel hounds.

Tanks of All Kinds.
Sheep Dipping Tanks, Watering Tanks and Feed Troughs of all shapes and sizes.

Trucks
for engines, water tanks, etc. Send for our new catalogue. We ship our goods everywhere and guarantee to save you money.

Electric Wheel Co.,
Box 95, Quincy, Ills.

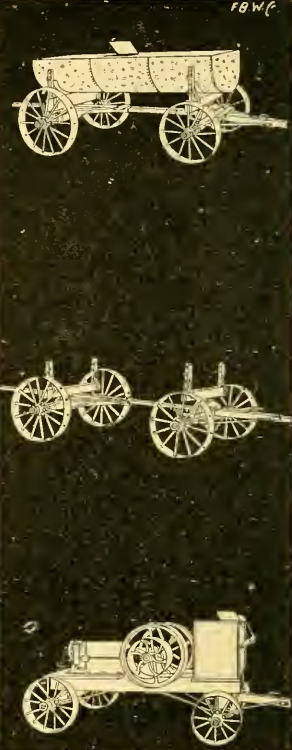

In writing advertisers please mention Gleanings.

\$1.75 FOR ONLY 75c.

THE NATIONAL MAGAZINE—over 100 pages choicest reading matter, replete with the finest illustrations, and in all respects the equal of Munsey's, McClure's, and that class. THE HOME MAGAZINE—a 20-page story, fashion, and fancy-work magazine for the home, size of the Ladies' Home Journal. Both the above magazines a full year, and a 25c seed due bill and our seed catalog and newspaper catalog, all for 75 cts. if you will order at once, and at the same time send us 10 good names of people that buy garden seeds. A. I. Root will tell you we are square and do as we agree.

C. M. Goodspeed, Skaneateles, N. Y.

I AM NOW booking orders for my superior queens, reared from best stock. My increasing trade proves that they please.
J. B. CASE, Port Orange, Fla.

Bee and Poultry Supplies.... } Fine barred Plymouth Rock eggs, \$1.10 for 15; oyster shells, 65c per cwt. All kinds of bee- and poultry supplies. Get catalog. **G. Rutzahn, Menallen, Pa.**

OUR CATALOG of varieties and prices of Small-fruit Plants, Dahlia Bulbs, S. C. W. and B. Leghorns, B. P. Rocks Berry Crates and Baskets, ready Feb. 1. Send for it before ordering.
H. H. AULTFATHER, Pinerva, Ohio.

HONEY FOR SALE.

Strictly pure extracted honey, in original five-gallon cans, as received from the apiary, 2 cans in case, 7½c per lb., f. o. b. Provo Utah; or if wanted East, 8c per lb. f. o. b. Chicago. Write S. T. Fish & Co., Chicago, Ill., who will ship from there. Honey guaranteed strictly pure.

W. M. M. ROYLANCE,
Wholesale Fruits and Produce,
Provo City, Utah.

Established 1885.

Tour of All Mexico

in Pullman's finest Compartment Drawing Room, Library, Observation, and Dining Cars—all Vestibuled—with the celebrated

Open-top Car "Chillitli"

for Observation in the Mountains and Canyons, and Dining-car in the Tropics.

A delightful trip of 38 days with **Three Circle Tours in the Tropics** of the South of Mexico, and a **Visit to the Ruined Cities.**

All exclusive features of these itineraries of leisurely travel and long stops. The Special Train starts Tuesday, January 22, from Chicago.

Tour of Puerto Rico.

SPECIAL PULLMAN CARS leave Chicago **Thursday, January 17,** and **Thursday, February 14,** at 9:30 A. M., connecting with the splendid new steamships Ponce and San Juan sailing from New York the second day following. Individual Tickets sold for other sailing dates, alternate Saturdays.

Tickets Include All Expenses Everywhere.

These select limited parties will be under the special escort and management of **THE AMERICAN TOURIST ASSOCIATION,** Reau Campbell, General Manager, 1423 Marquette Building, Chicago.

Itineraries, Maps, and Tickets can be had on application to Agents of the Chicago, Milwaukee & St. Paul R'y.

NOW READY!

64-PAGE CATALOG OF EVERY THING BEE-KEEPERS NEED. Illustrated and fully described. Especially valuable to beginners for the information it contains. Send your address on a postal and get it now. Established 1884.

J. M. JENKINS, Wetumpka, Ala.

A Bear in the Apiary.

I have just lost an entire apiary of 52 colonies by bear. I had the very good fortune to kill a very large one *right in the midst of the wreckage*. I have a very good 5x8 picture of this *Bear, in the apiary he destroyed*. This is the greatest novelty in the way of an apiarian view I have ever seen. I will send you one of these pictures for 35 cts. postpaid, or as a premium for each half dozen queens ordered.

Don't forget that my specialty is the best *queens* from the *best stock* that it is possible to procure, and that my *motto* is *promptness*. I also handle The A. I. Root Co.'s supplies at their prices, plus 55 cts. per 100 lbs. to pay carload freight. Send for price list.



W. O. VICTOR, WHARTON, TEXAS.

QUEEN SPECIALIST.

Notice.

◆ ◆ ◆ DO YOU WANT ◆ ◆ ◆
Printed Stationery, Queen-cages, or Folding Cartons for your next season's honey crop? If so, here are a few prices which will hold good for a short time only. ◆ ◆ ◆ ◆

High-cut Melon Laid Envelopes, 6½×8¾ at \$2.00 per 1000. If you haven't use for that many will print and send by mail, postpaid, 100 for 50 cts.

Round-corner Die-cut Cards 4½×2¾, \$1.80 per M.

Letter-heads, 11×8½, \$2.00 per M.

Folding Cartons, printed one side, \$3.20 per M. Sample for stamp.

Polished Queen-cages, \$9.00 per M.

We have on hand 2000 second hand L-size brood-frames at \$1.00 to \$1.25 per 100, also 150 hives.

If any readers of Gleanings would like a fine trio of Belgian Hares, will say that we have some very fine imported and domestic pedigreed stock. Also some cheap unpedigreed.

We breed improved queen bees in season. Remember that.

Parkertown is now a money-order office, so please can't send stamps for goods if you can help it.

ADDRESS ALL ORDERS TO

H. G. Quirin, Parkertown, Erie Co., Ohio.

I. J. Stringham, 105 Park Place, New York City.

Keeps in stock a full line of modern appliances for bee keepers.

COMB FOUNDATION

is one of our specialties. If you expect to use any quantity get our prices. Catalog free. Apiaries at Glen Cove, Long Island.

I. J. Stringham, 105 Park Place, New York City.

Italian Bees.

WM. A. SELSER,

10 Vine Street,

Philadelphia, Pa.

Office of The A. I. Root Co.

I am booking orders now for spring shipment of Thoroughbred Italian Bees and Queens. My two apiaries kept for breeding are situated on high sandy soil—are strong with young bees and brood, when queens at my other apiaries have just commenced laying—never known any disease. Send in your orders now to insure prompt shipment when season opens. Full colonies, with queen in shipping-case, \$6.00; 3-frame nucleus, with queen in shipping-case, \$3.00. In lots of 10 to 25 full colonies or nuclei, 10 per cent off. As our specialty is Full Colonies and Nuclei, we do not care to send single queens before May.



C. B. Lewis Co.,

Man'f'rs of Bee-keepers' Supplies,
Watertown, Wis., U. S. A.

Our Improved Langstroth Simplicity Hive. We show here a cut of our Langstroth Simplicity Hive, the style which you will find described on page 3 of our new catalog. It is one of our oldest styles, and is considered the simplest and best hive for general use ever manufactured. We are confident it will suit a large number of beekeepers who wish a good and serviceable hive but do not care for so-called up-to-date devices. We manufacture four other styles. Watch our next adv't for cut of our Wisconsin hives.

Our 1901 Catalog is now ready. If you received our 1900 edition you will receive our new one. If you did not, kindly send your address, and a copy will be mailed you.

BRANCH: 19 Sou. Alabama St., Indianapolis, Indiana.
AGENTS: L. C. Woodman, Grand Rapids, Mich;
Fred Foulger & Sons, Ogden, Utah; Colo. Honey-producers' Association, Denver, Col.; E. T. Abbott, St. Joseph, Missouri, Special Southwestern Agent.

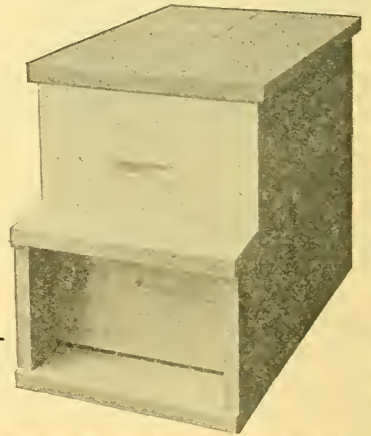

Bee-supplies !



C. H. W. WEBER,

2146-2148 CENTRAL AVENUE,

CINCINNATI, O.

NEW and complete stock of Root's goods at Root's prices for 1901 now at hand.

I am their representative for Cincinnati and surrounding territories. Our convenient R. R. facilities enable us to ship at short notice to any direction. You save freight by having goods shipped from this point.

Before buying elsewhere write for my catalog and prices, which will be mailed you free of charge upon application. The goods I handle have gained a wide reputation on account of A No. 1 quality and lowest prices.

GLEANINGS IN BEE CULTURE

A JOURNAL DEVOTED
TO BEES
AND HONEY
AND HOME
INTERESTS.

ILLUSTRATED
SEMI-MONTHLY

Published by THE A. ROOT CO.
\$1.00 PER YEAR MEDINA, OHIO.

VOL. XXIX.

FEB. 1, 1901.

No. 3.



STENOG says, p. 45, he will willingly pay 40 cts. a pound for extracted Nevada alfalfa honey. He's likely to get the Nevada output.

WHEN HAULING BEES, tacks sprinkled on the platform, even two to a hive, will keep the hives from slipping about, says F. A. Gemmill, in *Review*. That may do pretty well in place of cleats nailed on the platform. [A capital idea.—ED.]

I'VE USED lots of dummies such as Bro. Doolittle describes, p. 52, an inch thick, and like them. But I now use dummies $\frac{1}{4}$ or $\frac{3}{8}$ inch thick, cleated at the ends, and like them better. In some cases it may take more, but they're nicer to handle, and sometimes one can be used where the thicker could not.

TO PREVENT cracks in a cake of wax, *Le Rucher Belge* recommends that, when cooling, it be covered with a cover having a hole in the middle, so that the center of the surface will cool first. A good way is to put the dish of melted wax in the stove oven at night when the fire begins to go down, and leave it there all night.

SOMETIMES you put candied honey or bees-wax in the oven of the cook stove to leave there over night. You're sure you'll remember to take it out when you start the fire in the morning, but never think of it again till that dreadful smell greets your nostrils. To prevent such a catastrophe, put the stove-handle in the oven at night, then you can't well forget it in the morning. [Doctor, you talk as if you had been having some very recent experience. If so, we will profit by it.—ED.]

HERE'S THE WAY C. A. Hatch managed 10-frame hives for comb honey, as given in *Review*: When time for supers came, he put the frames with eggs and unsealed larvæ at the outsides; and the season being short these outside combs were not emptied for honey till it was over; and as the bees didn't want to store right in the middle of the brood-nest, the surplus all went into the super. [At first

thought, this strikes me as being a most excellent suggestion for either 10 or 8 frame hives; but, of course, in some localities and under some conditions it might not give very satisfactory results; but I should suppose it would work very nicely.—ED.]

SHALL EXTRACTING-COMBS be given to the bees to clean in the fall? is asked in *Revue Internationale*. Most of the repliers say no, if the combs are kept in a dry place. The sticky combs are less troubled with moths, and the bees will occupy them more promptly the next season. But it must be remembered that candied honey is in favor in Europe more than here, and the residue of honey in the combs left over winter hastens candying the next year. If you don't want candied honey in sections, let the bees clean dry in the fall all unfinished sections that are to be given to the bees the next year. [Here, again, locality has every thing to do with the matter.—ED.]

ACCORDING to German journals, Dr. J. Langer investigated 164 bee-keepers, and found 11 of them immune to bee-poison from the start; 126 became immune after a time; and 27 remained as sensitive as ever. Some lost their immunity each winter, and sometimes suddenly through sickness. [I have never yet run across a case of one who was immune from the start—that is to say, one on whom there was no swelling after the first sting. But I have known of instances where it would seem as if certain people could never keep bees, owing to the fact that the poison, in spite of the repeated doses of it, seems to act as disastrously as at first, not only producing swelling, but causing a sickness bordering hard on the dangerous.—ED.]

IRA BARBER says in *Review* that, when there is not enough snow on the ground to prevent freezing 2 or 3 feet deep, there will be no surplus from white clover. If snow covers the unfrozen ground all winter, the clover yields nectar whether the ground be wet or dry. That looks reasonable; but how about buckwheat? Like white clover it may bloom and not yield, but it has no roots the previous winter. [Snow probably does have a very decided influence on the growth of clover and its subsequent behavior the following season. In our locality we count on a large amount of

snow as being very favorable to the growth of white clover. A severe winter, with little or no snow, and with very little rain, is apt to be followed by a season of little or no clover; but, like every thing else in beedom, there are a good many exceptions to general rules.—ED.]

WE MAY SAFELY SAY that not more than one comb in 500,000 will be 25 years old, say you, Mr. Editor, p. 44. Been at the saloon again, eh? Wait somewhere from two to five years and you'll find that many right here in Marengo, if the number of combs in the country doesn't exceed a billion. [Yes, but you are one in ten thousand. In all my travels all over the country, doctor, I never ran across a man who had as many old combs as you have. The combs are not usually discarded because of age, but because of being either naturally built and so many drone cells, or because the frames have gone out of date, and their owners want newer fixtures. No, sir; I will stick to my original statement, that not more than one comb in half a million will be 25 years old. Of course, I have to except from this box hives and every thing that does not make use of movable frames.—ED.]

A. CHARTON, who invented the Charton glossometer in 1892, gives in *Revue Eclectique* some figures that seem to indicate that bees store in proportion to the length of tongue. In 1897, 6 colonies, during 37 days, made the following gains, weights being given in kilograms, and measurements in millimeters. A colony with tongues measuring

7.4mm	weighing	12k	gained	0.0
7.9mm	"	11.5k	"	0.5k
8.1mm	"	13k	"	0.5k
9.2mm	"	12.5k	"	0.5k
9.4mm	"	11.5k	"	5.5k
9.5mm	"	12k	"	6.0k.

In 1900, two swarms of same date were compared. With tongues 9.5mm one swarm gained 47.3 lbs.; with tongues 7.3mm one swarm gained 33.7 lbs. And yet the short-tongued was a tenth heavier at the start than the other. [See answer to Prof. Rankin, in this issue, on the relation of the length of tongues to the amount of yield.—ED.]

SUGAR as a ration for soldiers has had quite a boom in Germany. J Crepieux-Jamin reports in *Revue Internationale* that he has given it a trial on a cycling-trip and finds it good to fill in between the morning and the evening meal, but finds honey still better. With honey there is less thirst and clamminess in the mouth. After using sugar on the wheel Aug. 11 and 12, here's his dietary for Aug. 13: "Usual breakfast at 8. At 10:30, 60 gr. (about 2 1/2 oz.) honey. At noon, 70 gr. honey. At 2, 60 gr. At 4, 60 gr., and, having slight thirst, a cup of tea. Supper at 7.30. Excellent condition, good appetite, clear head."

[In all my cycling experience, and it has been quite an extended one, I never made a test of any form of sweet, much less one with honey. In preparing for a long run I have made it my rule to eat in the morning, on starting out, a generous quantity of oatmeal and milk; at noon a good ration of beefsteak

and other solid food; and at night every thing I could find on the table that was good. If I could finish my ride with a strong appetite, I was all right; but in some of my later experiences my longest rides were completed with little or no appetite, and that was followed by a breakdown. While I believe most emphatically in honey, yet I think a cyclist needs something that is far stronger as a food.—ED.]

SYLVIAIC, in *Revue Eclectique*, scouts the idea of a bee carrying a load weighing more than its own body. He says it can not carry more than its honey sac will hold, and gives figures to show that its heaviest load of nectar can not exceed one-fifth the weight of its body in its normal condition. [I suppose Sylviaic never saw a bee carry away one of its fellows that had outlived its usefulness. The wing power of a bee is certainly great enough to carry its own weight of honey; but I think myself it is doubtful whether they ever carry more than half their weight in nectar. Prof. B. F. Koons, of the Connecticut Agricultural College, found, by numerous measurements that he had made, that bees could carry half their own weight in nectar; but ordinarily the average load is about one-fourth their weight. If I mistake not, these results were corroborated very closely by Prof. Gillette and Prof. Lazenby, the former of the Colorado Experiment Station, and the latter of the Ohio Experiment Station.—ED.]

LET UP, Mr. Editor, and I'll take back what I said, p. 44, and say $1\frac{3}{8}$ is the right distance for spacing. Yes, for Hoffmans, $1\frac{1}{4}$ or less. Of course, I might reply to Weyprecht's measurements that Doolittle measured the same way and got $1\frac{1}{2}$; but I don't want to have any words with you about it. I'm willing to say to A. J. Fisher that, when his combs get to be 25 years old, he can increase the spacing; but as to saying that $\frac{3}{8}$ is space enough—I draw the line right there. I won't say that for you or any other man. Why, $\frac{1}{4}$ is the spacing between combs of honey, even when crowded. Would you ask the bees to do with less room between combs of brood? [Don't you remember the time, doctor, when I was measuring spaces between comb surfaces, and how I found in very many instances the space was only $\frac{1}{8}$? It seemed to me as if half the measurements were of this spacing. Why, yes, if the bees are content with $\frac{1}{8}$, why not let them have it under certain peculiar conditions?—ED.]



I should like to ask Mr. Bonney or any other person who has tried his method of introducing queens if he has ever had any trouble from the queen killing the bees that are put in the cage with her. I tried that plan several years ago, and the queen made a vicious

and deadly attack upon every bee I put into the cage.

If you are interested in census matters, will you observe this about Los Angeles? In 1890 the city had a population of 50,000. In the last census (1900), 102,000. A little more than doubled its growth in ten years. Prospects for the future, great. Transcontinental railroads are heading this way; new harbor at San Pedro; a great oil industry; a wonderland.

Here is another argument for tin cans instead of barrels for honey. Freight rates on honey in tin cans cased, from California to the East, \$1.10 per 100 lbs. On honey in barrels, \$1.30 per 100 lbs. On honey in glass, \$1.30 per 100 lbs. Observe honey in barrels and glass is in the same class. The railroad companies evidently know where the greatest risks are.

Long-tongued bees are now the order of the day, and a desirable improvement where red clover is grown or where there are other long-tubed flowers; but here in California, where the flower-tubes are all comparatively shallow, I think the long tongue is not so much called for; but if extra length of tongue insures extra working ability we will take the long tongues. It is a healthy feature of the honey business when the value of the queen is looked after.

The bee-keepers in California, from Oregon to Mexico, have taken their harps from the willows, where they have hung for the past three years, and now they are harping a merry chorus, and all because the rains have fallen at the proper intervals. The hills and valleys are being clothed in green, and ere another month passes millions of flowers will be in bloom. Bee-men begin to talk about ordering cans for their prospective crop. Dealers are ordering carloads of supplies. If you wish to study the magic power of a raindrop, come to California.

Returning to Los Angeles I find the Belgian-hare business, which was booming nine months ago, dead as a door nail. A number of breeders have gone out of business; others are going out, or wishing they were out. As many predicted, as soon as the demand for fancy stock at fancy prices ceased it became a non-paying business. Those who believed Belgian-hare meat would compete successfully with beef, mutton, and pork have run up against a disappointment. It will not compete; and if there was ever a chance for such competition it would have been known long ago in England and on the continent, where the Belgian hare has been bred for years. Glad I did not go into the business.

Remarks are in order in what Mr. Shiber says about his experience with California sage honey, page 959. All hands in the transaction, from the producer to Mr. Shiber, may have been honest in their statements about there being sage honey. The trouble lay in the fact that it was not *all* sage honey. Pure sage honey will continue in a liquid state two and even three years, and perhaps longer. I speak of honey under my own observation. There

are, however, many localities where honey from other flowers is gathered at the same time, and it all goes under the title of sage honey. In fact, dealers are so-reckless in the use of titles that much honey is sold under the name of sage that never was produced from a sage blossom. A grocer near me has a fine lot of comb honey piled up in attractive form on his shelves. The caption across the top reads, "New White-sage Honey." New in January, and it was produced in the northern portion of the State in an alfalfa district! It is the same with honey from the orange. Tons of orange honey is sold as such when it came from an entirely different source. An amusing label was found a few years ago upon some honey in the hands of an enterprising grocer. It was, "Pure California White-clover Honey." The amusing part comes in when you consider that there is scarcely an acre of white clover in Southern California. The fact in this matter of fictitious titles to honey on sale in groceries is that the grocer will put on any name that sounds well, suits the popular taste, and will sell his honey. The bee-keeper is innocent of any such chicanery.



The ruler of one-fourth our race,
Whose drum-beat sounded round the globe,
At last lays earthly honors down,
Old England's flag her robe.
For four and sixty years she's ruled
With woman's gentle sway;
The nations mourn the loss of her—
Hail Edward VII. to-day.



AMERICAN BEE JOURNAL.

For a New Year's present Mr. York received the destruction of his office by its being flooded by twenty fire-engines. The floor above was burned out. Fortunately the forms for the issue for Jan. 3 were in the hands of the printer, and these were not injured nor that issue. The loss is, of course, considerable, and the inconvenience great. The issue for Jan. 10 shows no signs of the calamity. Ten firms were in the building, and all suffered loss, the total amount of which will be toward \$100,000. Now is the time to help Mr. York by sending in arrearages, etc.



In speaking of the experimental apiary in the Garden of Luxembourg, Paris, Mr. Dandant says:

It was a disappointment. The spot is unique, for an apiary in the heart of one of the largest cities in the world. It is a very quiet corner, among the trees, the shrubs, and the flowers, in the aristocratic garden of the palace of the French senate, and the bees fly back and forth unmolested and busy. But there are only a few hives, in a rather dilapidated condition, and it is evident that no pains are taken with them. The keeper very kindly permitted us to look at every thing. We found half a dozen different practical hives, rotting without occupants, while half a dozen straw skeps and two or three odd patents seemed the only

experimental feature. I enquired for an observation hive, and he showed me a hive with eight or nine frames with glass all around. What one could observe with such a hive is more than I could say. I was told that lessons in bee culture were given every two weeks, in this place, during the summer. I doubt that any experiments of value are ever made there. France can afford something better.

Mr. Dadant ascended the Eiffel Tower with his daughter and Mr. Calvert. After reaching the third platform, 1000 feet high, the view below flattens out. The monuments, the hills, the white ribbon of the Seine, seem only like a living map. The houses make a sea of red tiles, the river is a silver thread, and the parks are green spots here and there.

The wretched habit of tipping waiters, which is showing its hydra head in this country, is thus graphically described by Mr. Dadant:

I earnestly hope that we are not going to take the habit of "tipping" the waiters and servants as they do over there. It is sickening. You eat dinner—tip. You ride half a mile and discharge the cabman, pay—and—tip. You go to the theater, buy your ticket, and tip the ushers. You leave the hotel, tip the servants, the boot-black, the chamber-maid, the porter. Tip, tip, tip. Luckily they do not expect silver in every case, and this is the principal use of coppers. Two cents, three cents, make a very passable tip. If you give a dime, you get a smile. If you give a quarter, you get a fine bow. But if you give nothing, you had best not look behind, for a look of contempt will follow you till you are out of sight.



CO-OPERATIVE ORGANIZATION.

Plans Outlined; Intelligence Bureau; Why Simple Co-operation Fails; Business must be at the Bottom; Government's Duty.

BY R. C. AIKIN.

The first work in organizing is to make a head. From a head, or central place and body, go out and spread to all the people the benefits. We can not begin at the out edges and build in to the center, but the center first and then the outer parts.

My plan is that there be a business organization for the whole nation, with a general head at some stated place. In conjunction with this head will be branch offices in all the principal producing districts, and a system of communication between the central office and all the branches. This contemplates that no producing territory be left out—all must be constantly in touch with the central. Also the consuming districts must be in touch with the central office, that the needs of the consumer may be known too. We may call this phase of the plan an "intelligence organization."

It shall be the business of the central office to keep constantly in communication with all branches, and the branch manager shall distribute all necessary information to the individual producers. Each local or branch office shall report to the central the conditions of stock in spring, the progress of honey-flows, the harvesting of the crops, the movement of the honey, prices obtained, etc., and the central shall in turn give to the branches reports of all compiled.

The object of this reporting is that all concerned may know about the prevailing conditions. Just this fall, buyers were making quite an effort to make producers believe there was a large crop—at least enough so that they could buy all they needed, at moderate prices. The average buyer *can*, if he *tries*, know better than the average producer whether there is a good crop or not; but the producers, being informed by means of the intelligence department of the organization, will make quotations and sales more in accord with the prevailing conditions.

But with the completing of the intelligence machinery the work is not much more than well begun. There is need of a complete and extensive business organization. The central office need not be a warehouse, but the branch offices should be regular depots or places for handling honey, wax, and supplies. To illustrate, we will suppose the Root establishment is the head office. They, of all those connected with apicultural matters, are in a position to know of the flows, of harvests, and the moving of the crop to market. The California marketing association (have forgotten its name), "The Colorado Honey-producers' Association," and many others that are yet to be organized, each reporting to Medina office the amount of honey in sight, and kind and quality, can keep the central posted as to what is going on.

Now, the central should have a list of all honey-dealers in every city and town of importance all over the country, and these dealers could find out by applying to central where they could get the needed supply. The general manager at Medina could bring together the buyer and producer, and thus there could and would be a much more equal and intelligent distribution. Not only this, but the price would be more even and just.

There should be a branch office and depot and packing-house in every large city or distributing center. Denver, Omaha, Kansas City, St. Joseph, Chicago, St. Louis, etc., should each have a depot for handling the product of the territory tributary. There should be storage depots in every heavy producing district, and in all cases have storage rooms as near as may be to the producing field. The object is twofold at least—to save freights by enabling producers to deliver in person by wagon where it can be so done, and that there may be accumulated enough at one point to make it possible to ship in car lots.

All honey to be transported to distant markets should go in carloads, both for economy in freights and safe shipping. It is possible for wheat-speculators to gamble, buying and

selling when they do not have a bushel of wheat in their bins; but it is no way for a man to sell honey when he has not the goods where he can lay his hands on them and deliver at once. Many producers think we can agree to co-operate, then when a car of honey is contracted let each individual deliver his goods at the shipping point, and so load a car, and no need of a warehouse. I want to point out to each and every reader why this plan can not be made a *general* success.

once, and provision should be made for such. Circumstances may almost or quite compel some to sell for spot cash.

Then there are others who would prefer to put their honey in on commission. On this plan they may be able to get more money, for there is no questioning the idea that, if one buys outright, putting cash into goods, the margin must be absolutely safe, hence a less price will be paid, so that the risks may be fully covered; but on commission the producer helps carry the risks, and so of right ought to get more pay in the end. With a plan of this kind—both outright buying and commission, the business can be more mutual and also co-operative. It will bring together the greatest number of those who ought to be in the association.

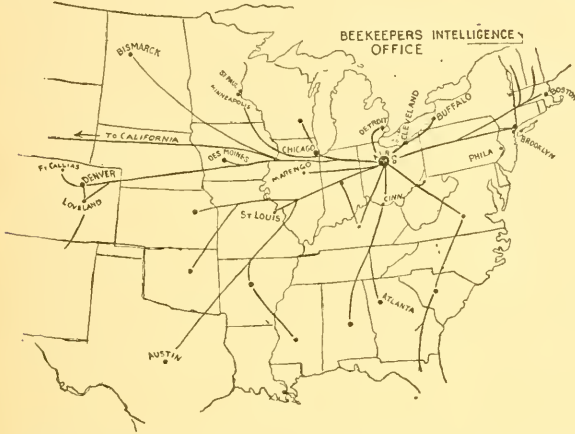

When you and I, brethren, make purchases we do not like to buy "out of sight and unseen." People's idea of what the goods ought to be, differ; and there is always a suspicion that, when delivery is made, there may be something wrong, the buyer not getting what he paid or bargained for. A minimum carload of honey is 30 000 pounds; and if ten or twenty producers are to deliver that much honey at a given place on a certain day of the week, almost invariably some one or more fail. It may be sickness, bad roads, bad weather, carelessness, or something; or it may be some one has had a better offer on the honey from some other source, and the high bidder gets it. All these and many more reasons I could set forth make such a scheme very untrustworthy and unsatisfactory. Such plans usually cause the early demise of the co-operative concern, and the disgust and dissatisfaction of the co-operators.

One of the very first things to be accomplished is to get the producers together and co-operating. Get a general knowledge of crop prospects, and of its gathering in. Let the central office determine if the crop will probably equal the demand or otherwise, and indicate to branch offices about prices that ought to prevail. In doing this the head office should get very frequent reports of the crops, and of the kind and grade, and when it

will be available to ship. Remember, it is never available for shipment until delivered in warehouse.

The head office should be fully informed of the stock in hands of the various dealers in all principal markets, and so would know about how soon any given point could use a car or two. When honey is needed or wanted, there

are several reasons the business should be neither all co-operative nor all outright buying and selling, but a combination of both methods. Some will want to sell honey outright, get cash, and be done with it at

There must be storage centers, and there must be provision to supply cash to the producers when they deliver the goods. Do not forget the financial part of the matter. Cash must be on demand when goods are delivered in storage. If the plan contemplates a co-operative business, then the producer should not receive all his money *down*. Enough should be withheld so that there be no loss when the honey is marketed; but if the plan is to be an outright buying and selling, then the pay should be in full at delivery of stuff.

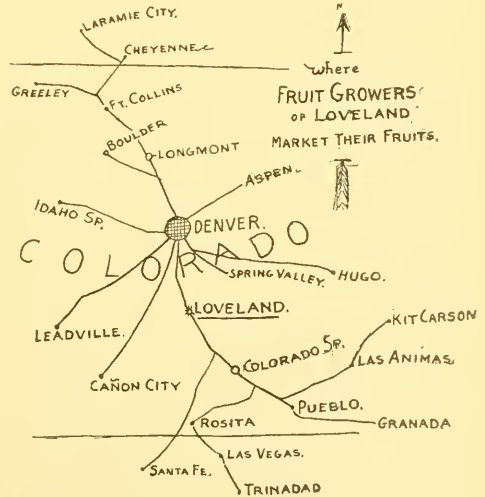

would be no difficulty in pointing out to buyers where it can be had, and sellers to where there is a buyer.

This looks like a big undertaking, and it is quite large, I admit; but that it will abun-

dantly pay I have no doubt. It surely ought to give us better prices, better and more equal distribution, should increase the consumption of honey, should cheapen the distribution, and, all things considered, be a benefit to both producer and consumer.

Such an undertaking as this is really the business of government (I am not bringing in any politics), and should include the distribution of all products. Management by the government would insure its being more equal and general. Some will say there would be too much jobbery; but to such I need but say that there is plenty of jobbery now in the distribution of products, and it would be hard indeed for a government distributing agency all in one concern to beat the producer out of any more than he loses now under present methods. One of the arguments in favor of combines and trusts is that one management can do the work cheaper and better than several, and the argument is good.

What is the use of two warehouses and agents where one can do all? But, why argue? It needs only a little common sense and thought to prove that government should do this work; but she does not, and we as interested producers should do it until such time as we can get government to take it off our hands.



MEASUREMENTS OF TONGUES AT THE MICHIGAN AGRICULTURAL COLLEGE.

The Direct Relation of Long Tongues to Large Yields of Honey.

BY JOHN M. RANKIN.

A short time ago two cages of bees were sent to me from J. H. Gerbracht, Spring Grove, Illinois, for measurement. Cage No. 1 was a sample from a colony that stored 240 pounds surplus, and were a strain of his own breeding. Cage No. 2 was from a five-banded strain that stored 135 pounds of surplus honey during the past season. The measurements of ten bees from each cage are as follows:

Cage No. 1.—Lengths of tongues were as follows: 6, 5.9, 6, 5.8, 6, 6, 5.9, 6, 5.8, 5.7. Average length, 5.9 millimeters.

Cage No. 2.—Lengths of tongues were as follows: 4.5, 5, 4.8, 4.7, 4.8, 5, 6, 5.5, 4.5, 4.3. Average length, 4.9 millimeters.

It will be seen that the measurements are very irregular, probably owing to the fact that the bees were of all ages, as Mr. Gerbracht says that he ran them into the cage just as they came. These colonies were on a double stand, with the entrances only a few inches apart. This will easily account for the one long tongued bee in the cage with the five-banded ones, as they doubtless worked from one hive to another to a certain extent. One experiment, of course, does not absolutely

prove any thing; but after many cases of this kind I am sure that the difference of length of tongue goes with the corresponding difference in honey production, other things being equal. The more work I do along this line the more certain I am that there is nothing in bee culture to-day that furnishes the opportunity for improvement that is offered along this line of improving the strains of our bees. I am confident that there are tons of honey going to waste every year simply because the bees have not the *ability* to gather it. As I have said before, it probably will not be practical for every bee-keeper to run an experiment station of his own, but he can well afford to pay more attention to this phase of improvement, and select his breeding stock from his best workers, even if they are not the highest-colored bees in his yard.

Agricultural College, Mich., Dec. 7.

[Yes, you are just right. It does look more than ever as if the difference in the length of tongue is in direct ratio to the corresponding yields of honey, other things being equal. But I was particularly interested in the measurements you made of the tongues of those bees that gathered 240 lbs., and the tongue-measurements we made of those *very same* bees. In GLEANINGS for December 1, page 924, the tongue measurements of Mr. Gerbracht's best workers average .19. Your average for the same bees is 5.9 millimeters, which, figured out in hundredths, is 23 plus. But you measured the entire length after it was dissected, and we measured that portion of the tongue that will stick out from the end of the mandibles. It appears, then, according to your average and our average that there is a difference of .04. Of course, you understand that this does not signify that your experiment was wrong and ours right, but that we measured from one point and you from another; yet, unless cleared up to the average reader, this is somewhat confusing. Your average tongue-length for the five-banded bees was 4.9 millimeters, which, when converted into hundredths, gives .19 plus a very small fraction; or by our own way of measuring 15 plus. That strain of five-banders, to say the least, would hardly be worth cultivating. As I have said before, the breeder evidently worked for bands, and got bands and nothing else.

Regarding the direct relation of tongue-length to yields of honey, a very interesting corroboration of this is given in Dr. Miller's Straws in this issue; but the reader will notice that the average of the measurements of A. Charton are considerably in excess of the average of the measurements of myself and even of Prof. Rankin. This goes to show that Mr. C. is measuring from another point. Surely it's high time we got together and measured from one point, all of us. But for purposes of comparison we have got enough so far to show that the increase in the yield of honey is almost in direct ratio to the increase in the length of tongue. I have been talking this up for the last six months, and it is no little satisfaction to know that my impressions along these lines have been proven by those who

have gone before me in this tongue-measuring business.—ED.]

ABOUT CLIPPING QUEENS.

A Good Record.

BY MRS. A. J. BARBER.

I have noticed in several of the bee-papers lately, items about clipping queens' wings, and how to do it. I did not suppose there were so many ways of doing it, and I was surprised that, of all the different plans described, none used mine. Perhaps many are doing so; but as none of them have told about it (perhaps thinking it too simple to need description) I will tell how I have been doing it for the last five or six years. It seems so much easier and more satisfactory than any other way that I never think of trying any other method.

When I find the queen I rest the comb on the edge of the hive and hold the upper end of it in such a way that the comb slants a little away from me. When I can get the queen near the center of the comb I start her toward the upper end of it; and by following her with my scissors I slip the blade under her wing as she runs, and take it off smooth and clean in much less time than it would take me to catch her in my fingers. One soon gets used to following her motions with the hand, and after a few trials the clipping can be done nicely without even touching the queen except with the scissors. I don't believe they know what has happened, or that any thing has happened, judging by their actions. One needs a pair of embroidery scissors, and they should be keen and sharp.

One day last spring I found and clipped 31 queens before noon.

I have had but one accident, and that was several years ago when I was nervous, and a little afraid of the bees. That time I cut both wings and legs.

I tried the pocket-knife method, but had to turn my queen loose on a comb, and clip her with the scissors after all.

I think it much easier and better to clip all the wings across straight, about half their length. As I do not sell queens, nor keep them for exhibition purposes, I like to clip them close enough to insure their being found easily when a swarm comes out. I usually have a boy watching, and it doesn't pay to leave a queen's wings long enough so that she can make any use of them or the boy will not find her.

I don't see why so many are troubled with swarms clustering before returning to the hive to look for their queen. I don't remember ever having had them do so but twice. Usually they are coming back by the time the queen is caged and the new hive put in place of the old one. Perhaps different strains of bees have different habits. When mine cluster I am always reasonably sure that they have met a young queen from some other place or hive, and treat them accordingly.

Mancos, Colo., Nov. 17.

[Your method is all right for women with a delicate touch and steady nerves. But imagine a man, who is so bungling that he can't thread a needle, trying to clip a queen's wings while free on the comb, with a pair of embroidery scissors! Why, he would probably decapitate the best queen he had. The average man, if I am any judge, would better first catch the queen and then clip.

But do I understand that you clip *both* pairs of wings for the purpose of better identification during swarming time? Of course, if you seldom pick up a queen for any purpose then it wouldn't matter much if all the wings were cropped.

But, say; your record of finding and clipping 31 queens in one forenoon is not bad. I doubt it, in the case of strong colonies, as I take it yours were, it has been surpassed.—ED.]

VALUE OF BREEDING-STOCK.

Can a Queen be Worth \$200? The Question of Inbreeding.

BY H. L. JEFFREY.

Mr. Root:—On page 848, Nov. 1, you note Moore's bees with $\frac{23}{100}$ tongue, and then you refer to the editor of the *American Bee-keeper* calling the \$200 queens an advertising scheme. Now just look at this picture, not at the bees. When Mercury, the Jersey bull, was what would be called along in years, but actually in his prime, and where his value was really known, \$75.00 was offered for his service, and why? His worth was in his ability to stamp the blood qualities. Hold your hands up in holy horror; for, 23 times out of 32, his pedigree ran back on to the cow Alpha and her bull mate. Now, then, you will (or I should say that others will) say that there is quite a difference between a queen-bee and a valuable Jersey or any other bull. Is there? Not one bit. The queen, if any thing, is the more valuable of the two. First, she is shorter lived; second, the ability to increase indefinitely the reproductive ability is more than 1000 to 1, and why? Just take off your hat, and get ready to say, "That's not so!" Well, I'll prove it, and back it by more than 20 years' test in facts.

The workers of a queen are the result of the influence of the drone she mates with. Most will say, "Not wholly so." I say positively they are, every time. For convenience admit it as a fact. Now, then, the queens from that queen are the direct and full sisters to those workers, the progeny of that queen. Those young queens being the sisters of those workers possess the same qualities as the workers, their sisters; consequently the drones of those queens possess the imparting powers of qualities possessed by the drone that was the father of the workers and queens from that first-mentioned queen; consequently the superior starting queen is just as valuable as the superior imprinting bull. From the bull we obtain the perpetuating power of his qualities; from the queen we obtain daughters to perpetuate

the imprinting qualities of the drone that she originally mated with.

This is not an uncommon illustration of the atavistic (or alternate) generation influence that is understood by a few of the most thorough investigating breeders of all kinds of stock.

Now, then, to go one step further, if you have that \$200 queen in 1901, from her raise more queens. In the most isolated place you can find, place one, two, or three of her daughters raised in 1900; from them raise drones in abundance. With those drones let the young queens mate raised in 1901; and from the earliest raised and so mated raise drones in another apiary, and mate queens raised from themselves, and from the old queen raise more queens to mate with the drones from these daughters of the \$200 queen. You will say that is too much *in-breeding*; but I shall laugh at that bugbear of the in-breeding whoop or howl. Then you raise drones from this strong in-bred stock, and let queens from worthless indigent stock mate with them, and see the results in the next three or four generations. Advise J. P. Moore and others with those \$200 daughters to raise drones from them just as early as they can, and note the results from the young queen given a chance to mate with them, and see if the drone influence doesn't tell more than 16 to 1.

But look at this: That superior queen in an apiary of 100 colonies, the hives of which her daughters preside over, give an average of 5 lbs. more honey than the general run of bees. The money her daughters put in those 100 hives is 500 lbs., or an equivalent of \$60, at 12 cts per lb. If an ordinary breeding queen is worth \$5.00, then that superior queen is really worth \$65.00, for the reason that she is worth just as much as her influence produces dollars and cents more than another; therefore, if your choice queen has furnished for the numerous customers only 400 queens, her actual worth is not less than \$240. If from her in 1901 you raise 1000 queens to disseminate, her actual value is to the bee-keepers not less than 10 times the \$60, or \$600. Such things are facts, and are positive; so is the natural law of 1 from 2, and 3 remains; or 8 from 2 and 10 is the result. Subtraction does multiply in the laws of nature, positively.

Woodbury, Conn., Dec. 1.

[I had always supposed that in-breeding was in all cases undesirable. I know that nature, in the case of many flowers, makes a studied attempt to avoid it. Some flowers are sterile to their own pollen. Others have the male organs only, while other specimens of the same species have the female organs only. In still other plants, while they have both the essential organs they are not both ripe at the same time. Even in the animal kingdom we find similar efforts to avoid in-breeding. If it were not for nature's abhorrence of the mixing of the same blood, drones and queens would mate in the hive instead of in the air. In the breeding of high-blooded stock there may be an exception to this rule; and if so, I

should like to get more light, especially from stock-raisers.

Mr. Jeffrey's point on why a queen may be worth \$200 is well taken. If a rooster is worth a hundred dollars, or even a thousand, why should not an extra breeding queen be valuable for a like reason?—ED]

THE BELGIAN-HARE BUSINESS.

A Fair Statement; Extravagant Statements; Bees and Rabbits Not a Good Combination.

BY W. K. MORRISON.

There have been so many conflicting accounts of the Belgian-hare business that a word from one who has a little knowledge and practical experience in the pursuit may prove acceptable just now. The word *hare* is misleading to begin with. It is only an overgrown variety of the common domestic rabbit, such as we are all familiar with. In its native country, Belgium, it is known as the Flemish rabbit—an appropriate name.

I mention this because Prof. Van Deman, in a recent number of the *Rural New-Yorker*, said that the Belgian hare is a hare, and would not breed with the rabbit, and that the Australian rabbit is a different animal entirely. Surely Prof. Van Deman can have had no experience with rabbits; for if he will only allow his Belgian hares a good deal of freedom and scanty fare, in a short time he will have rabbits that can not be distinguished from the rabbits of Australia. And, what is more, this is how the Australian rabbits did originate, simply by the running wild of the ordinary domestic rabbit belonging to the early settlers.

It may be well to state here that the rabbit in Australia is not the pest that it is often represented to be by the newspaper press. On the contrary, a great industry has arisen in canned rabbit; and now right here in Bermuda we can buy one whole Australian rabbit, canned, for 24 cents; and, besides, the skins are in demand for felt. I saw by a recent number of Cook's *Poultry Journal* that one firm in Melbourne had sent last year to England 5,000,000 rabbits, canned or frozen, and that many of the farmers were making money in the business of raising them, so they can not be said to be a pest. I have no doubt that the Australians will make money out of the rabbit industry. Perhaps it is a better business than digging gold out of placers.

Some eight years ago I wrote an article on the subject for the *American Agriculturist*, in which I warned its readers against the amazing statements of interested parties who printed all sorts of fairy tales to induce people to buy their stock. If the warning was needed then it seems to be much more necessary now. In the long run these entrancing statements will injure the rabbit business, when more moderate statements might give rise to a good business for a number of people.

So far as my experience goes, rabbits require a great deal of care—*more so than poultry*—as each grown rabbit has to be attended to individually. They require pretty much the

same food as a cow. To get them fat, and to make them grow well, they have to be fed a little grain of some kind. To do their very best the breeding stock ought to have green feed twice a day, and a little grain once a day. The reader will thus see that rabbits require more care than chickens. Their feed does not cost quite so much, but they lay no eggs, neither is their manure valuable.

Some of the people concerned in promoting the industry make a great ado about the extraordinary fecundity of the rabbit; but this is not so important as it appears to the unobservant. A doe rabbit can just manage to produce 40 young in a year; but a hen will lay 160 eggs in a year just as easily—a proportion of four to one in favor of the hen. Both rabbits and hens breed at the same age—five months or thereabouts.

I have always understood that the Belgian-rabbit raisers were mostly market-gardeners and the like who feed their stock on weeds and refuse vegetables very largely, and I have no doubt, they find it profitable in this way; but if a raiser has to buy feed for his rabbits I am afraid he would not make money at it. I suspect, also, that Americans require education in acquiring a taste for rabbit flesh.

Some time ago there was an account of the Belgian-rabbit trade in the *Journal of the British Board of Agriculture* that throws some light on the subject. It states:

The annual shipment of rabbit carcasses to England is 2,200,000, of the total value of \$1,117,000. The average weight of the Belgian rabbit is given as varying from 6 to 8 lbs., which just agrees with my own experience. Of course, they can be got much larger. For market purposes they are killed at 4 or 5 months, when the average weight is 3½ lbs. "The rabbits thus bred are kept in cages or boxes. When in cages, they are placed immediately on the ground; ashes are usually scattered on the spot covered, then a layer of loose stones is placed on the ashes, and finally the stones are covered with straw. This method keeps the cage in a sanitary condition, and is excellent for fattening rabbits for the market."

All I can add to this is amen! It agrees with my views exactly, and the rabbits I have now are kept on this plan, though I never knew that it was a Belgian plan. My experience is that pure-bred rabbits are hard to breed. I mean they have few young in a litter, and they are apt to die in the most unexpected manner, and this experience tallies with that of others.

For all practical purposes I think a cross of the lop-eared kind with the Belgians would be most profitable for market purposes. But if any of your readers are actually thinking of going in for the new business in a scientific and professional manner, I would advise them to get the best book which I believe has been printed on the subject, and which looks at it from a dollar-and-cents point of view. This is the title of the book:

"The Wild Rabbit in a New Aspect; or, Rabbit-warrens that pay. A record of recent experiments conducted on the estate of the

Right Honorable the Earl of Wharncliffe, at Wortley Hall. By James Simpson."

The author received a gold medal for his experiments in this field. The price of the book is \$1.25, and the publishers are Wm. Blackwood & Son, Edinburgh, Scotland.

The other books that I have seen on the subject are fanciers' books, not studying the rabbit for profit. From what I know of the business I am safe in saying it will not suit bee-keepers. The two pursuits of bees and rabbits would hardly dovetail, the latter requiring so much of the bee keeper's time as to keep him from his legitimate sphere—the apiary. The rabbit business is more of a craze than a business, and it will be some time before it becomes a *real* business. I incline to the view that what bee-keepers want is a greater cultivation of field crops that yield good honey in large quantity. I mean such crops as alfalfa and buckwheat. I can mention three other crops that are as great and important as the two just mentioned—sainfoin, field beans, and rape. These *are* great crops in every sense of the word, and by and by will occupy a large space in American farming; and it is the duty of bee-keepers and bee-papers to boom them. If the average bee-keeper would read up on these crops I am sure he will agree with me that, when these crops become the fashion, bee-keeping will yield a much more certain income than it does now. I believe the bee-papers could do much to boom these crops into popularity. They need only a little persistent booming to get them started. It is honey-flowers the American bee-keeper lacks. He should try to encourage floral crops among his neighbor farmers. Skill and bees will do the rest, and he has these now.

Warwick East, Bermuda, Nov. 7.

ARTIFICIAL BRUSHED SWARMS.

Objection to Artificial Swarming Before the Natural Swarming Impulse Comes on.

BY C. DAVENPORT.

I read Mr. Stachelhausen's article, page 840, with much interest, as I have largely practiced artificial swarming for a number of years. Our experience does not coincide in all respects; but we are a long way apart, and the difference in our locality probably accounts for much of it. As I understand it, his practice is to swarm colonies at the beginning of the main flow, if they are strong enough, without regard to whether they have started queen-cells or not. It is far from my intention to criticise any thing Mr. S. says; but here I do not consider it profitable to swarm colonies before they contract the swarming fever, no matter how strong they are, especially when running for comb honey; for with a large yard, or on a range well stocked, a good many strong colonies will not swarm naturally; and such colonies will store more surplus than they would if artificially swarmed, except, possibly, if the flow were very short, and they were hived in a shallow brood chamber, and given supers of drawn or partly drawn comb.

Under these conditions I have secured fully as much, perhaps more, from strong colonies swarmed before they contracted the swarming fever than would have been the case without swarming; but the drawn comb formed a very important part as to the results; for a colony that has not contracted the swarming fever is not prepared to build comb, as is one that has. This is a very interesting fact that any one can verify by looking at a colony preparing to swarm, and that has cells well under way. The wax formation between the segments can be seen on a large number of the bees, which shows that they are expecting and preparing to build a large amount of comb in the near future. This wax secretion can be seen on a large number of bees in any strong colony during warm weather, whether they are preparing to swarm or not, but to a much greater extent in colonies that have preparations for swarming well under way; and when a colony which has not got its wax-works well under way, if I may use such a term, is artificially swarmed, they do less satisfactory section work here than one that has; and in quite a per cent of the colonies I have swarmed before they had the swarming fever, the queens sulked, or, for some reason, refused to lay until considerable comb below was built and filled with white honey, which should have gone into the sections. Why a queen that has just been laying profusely should, under these conditions, in some cases, refuse to begin work again in less time than one that has slacked up laying in anticipation of swarming, is something I can not understand. It would be natural to infer that it would be the other way. And, again, I have in numerous cases had the bees themselves sulk and refuse to do much work for a number of days when all the brood was taken away.

Mr. S. does not seem to attach much importance to the fact of his leaving a frame of brood; but when I have artificially swarmed colonies before they had made any preparation to swarm, I have secured much better results by leaving them permanently two frames of brood, but after a colony has once contracted the swarming fever, nothing can be relied on to cure it, barring a sudden cessation of the flow, except the removal of all the brood—that is, when the full force is kept together.

THE USE AND ABUSE OF SHALLOW BROOD-CHAMBERS IN THE PRODUCTION OF COMB HONEY.

I notice more experience is called for from those who have used shallow brood-chambers for comb honey. I commenced using these a number of years ago, and have been gradually increasing their use since; and, under certain conditions, considerably more surplus honey can be obtained with them than can be from full-depth ones; but it is done at the expense of increase and with less stores in the brood-chambers. When increase is not desired, and in a locality like mine, where the conditions are such that swarming does not naturally occur, or has to be done before the main flow commences, or is well under way, I con-

sider their use very profitable; for, as editorially stated, a swarm hived in one of these shallow brood-chambers must of necessity store most of the honey in the sections. My practice is to hive two swarms in each of these shallow hives; and the amount of section work these allied forces will do in a good flow is surprising; but during the hard work of the main flow their strength rapidly decreases, and there is not brood-chamber room enough in one of these shallow hives to allow the strength of a normal colony to be kept up. After the main flow these colonies will, as a rule, be practically without stores in the brood-chamber, and weak in bees; but the pile of filled sections accounts for the hosts that have vanished.

One of the problems with me is to keep down increase; and these shallow brood-chambers solve the matter in a most satisfactory manner, for the increase is, so to speak, turned into filled sections. Soon after the white flow I unite enough of these shallow chambers to make good strong colonies for the fall flow, if there is any. By the use of zinc the queen is, in those united, kept confined to the lower story; so when the fall flow commences, these upper stories can be removed and shaken free from bees. These colonies are then in excellent shape to do section work again through the fall flow; or I sometimes run them for extracted honey in the fall. After this last flow the bees in these hives are united with the weakest colonies in frame hives. By this means I am able to have all colonies in frame hives strong in bees for winter. In theory I do not intend to winter any colonies in these shallow hives; but if, on account of sales or winter losses, it is desired to do so, two sections are left together during the fall flow, which they are allowed to fill up for winter stores. As a rule there will be but a small amount of honey in the removed sections. What there is, is used for fall and spring feeding, and the combs are removed and rendered into wax. While the wax is no small item, when a large number of these hives are used on the plan I practice, the combs are not removed for the profit there is in the wax itself, for I have obtained much better results by using these shallow hives empty, or without combs or foundation to hive swarms in; but I have not space to explain why, for I wish to point out that, under some conditions, the use of these hives might not be as profitable as would that of full depth.

In localities where swarming naturally occurs, or can be profitably done artificially some time before the main flow commences, so that at least part of the brood-chamber room could be filled with comb and brood before the real flow commenced, probably as much if not more section work would be done by using full-depth brood-chambers, for these would allow the force of the colony to be kept up to full strength, and still not allow any more room for honey to be stored below than would be the case with shallow chambers under conditions such as they are in in my locality; or if increase were desired at some expense of surplus, I would not think of using these shal-

low chaubers, for, as I have explained, colonies in them are, at the end of the main flow, unless it is of unusually short duration, weak in bees, and short of stores, and the latter condition would be present if the flow were short. Of course, feeding could be done to overcome this; but one of these sections is too small to contain stores and allow a colony to build up or even hold its own. So with feeding, two sections would have to be used, which would make a full (or more than full) depth brood-chamber, and the work and expense of feeding would, I think, more than offset the extra amount of surplus that could be obtained by using one shallow section during the main flow.

Southern Minn.

[You have aroused a curiosity in me to know more about your shallow brood-chambers. What kind do you use? style of frame and the depth of it? Then you say there are other things in this connection that you would refer to but can not for lack of space. I hope you will in another article or two cover all of this ground.—ED.]

HIVING SWARMS ON SHALLOW BROOD-CHAMBERS NOT SATISFACTORY.

BY E. F. ATWATER.

I have had some experience with the methods of producing comb honey by hiving natural and artificial swarms in contracted brood-nests, as practiced by Harry Lathrop, Danzenbaker, Stachelhausen, and others. In this locality we have a long, slow flow from sweet clover, followed by goldenrod, at no time rapid, commencing about June 1st to 13th, and lasting well into September. In such localities I am firmly convinced that the above methods do not pay. To illustrate, the past summer I hived a strong natural swarm in a single section of the Heddon hive. The frames contained foundation starters $\frac{1}{2}$ inch wide. The hive was put on the old stand. The three Ideal supers were taken from the parent colony and placed on the swarm. Work in the supers went on for about two weeks. By that time the colony was so weakened by loss of old bees that super work was almost entirely discontinued. A little over half as much comb honey was taken from this colony as from colonies of like strength that did not swarm. Had the swarm been hived on full sheets of foundation, the results might have been much better, as enough bees would have been reared to gather the late summer and fall crops.

About June 15, 1889, I shook two colonies having cells built for swarming. Each colony was given a frame of unsealed brood, according to Danzenbaker's method. Supers were taken from the old hives, and put on the new swarms. Both colonies swarmed out about 10 A. M. the next day. The swarms were returned. One colony settled down to work, completing about 40 sections. The other loafed during the best part of the season, completing about 30 sections. Now compare these yields with the average from that yard, of over 60 lbs. per colony.

A strong colony having made no preparations for swarming was shaken on starters, and given a frame of drone brood. They gave less than 40 completed sections in a yard where the average was 60 lbs.

Swarms hived on starters in a single Heddon brood-nest, or in a Langstroth hive contracted to five or six frames, have invariably stored pollen in the sections, regardless of the use of a honey-board. Despite the arguments of S. A. Deacon in the *American Bee Journal*, and others. I know that I secure far better results in comb honey by hiving natural or artificial swarms on full sheets of foundation, because, as I have said before, I have a honey-flow lasting from 8 to 10 or even 12 weeks; and, furthermore, pollen in the sections is the greatest objection to the use of a very shallow hive.

I have had little opportunity for experiment during the past season, as less than three per cent of the colonies swarmed. You say, Mr. Editor, that "putting the bees on starters has decidedly a tendency to check swarming;" but I have shown that sometimes it serves to hasten swarming, apparently making the bees the more determined to swarm.

Yankton, S. D., Nov. 24.

[Your conditions, friend Atwater, are perhaps a little peculiar. In your first paragraph you speak of having hived a swarm in a single section of the Heddon hive on half-inch starters, and then placed thereon three Ideal supers. You say the work in the supers went on for two weeks, and about that time the colony was so weakened by the loss of old bees that the super work was almost entirely discontinued. A little lower down you speak of preferring to hive on full sheets of foundation in a contracted brood-nest. Now, I fail to see how, if you had done this in the case under consideration, the swarm would have been any better off. You say that in about two weeks' time the colony was weakened by the loss of old bees. Even if you had hived the swarm on full sheets of foundation it would have taken a month, at the least calculation, to have gotten a force of field bees, so that your remedy would not have helped the matter at all. If, however, the colony had not swarmed, and they could have had the new blood, or, rather, a new force of field bees from the brood in the parent colony, then I can see how work might have continued in that super.

In your locality I should say it was an advantage not to have any swarming. While that is true of any locality to a great extent, yet it seems to be particularly so for yours. The only argument, then, it seems to me, that you advance against shallow brood-chambers is in the pollen going up into the sections. We have had a great many reports of this with brood-chambers as shallow as the Heddon; but only two, so far, I believe, were brood-chambers 7 inches deep. I am not advocating shallow hives; but we must be sure not to let one swallow make a summer, or base our conclusion on the work of three or four colonies.

I still think that hiving on starters has a tendency to discourage swarming. Any swarm,

when newly hived, is liable to swarm out again, no matter what the conditions. But if we can make them once stick for a day or two, we can hold them.—ED]

WINTERING BEES IN THE SOUTH.

BY J. W. JACKSON.

Some time ago some one from the South asked GLEANINGS why it did not tell how to winter bees in the South. The substance of the reply, as well as I recollect was that the same conditions did not apply; in other words, that the winters are so mild in the South that there is no such thing as wintering.

Wintering here is not of such moment as it is at the North, but still it should have some attention. Opelousas is only $6\frac{1}{2}$ or 7 degrees north of the Tropic of Cancer; but it gets very cold here sometimes in the winter, comparatively. The thermometer may drop in a day from 75° or 80° to 25° Fahr., and then the bees, small colonies especially, when left as they were in the summer, suffer from the cold. After a cold night of a cold "snap" I have seen apparently a quart of dead bees lying at the entrance of an upright triangular hive. Wintering here, then, would consist in protecting the bees against these sudden and extreme changes of the weather.

Winter before last—the coldest one on record—the thermometer went down to 5° or 6° Fahr.; ice floated past New Orleans for the first time in a hundred years. Of course, many unprotected or insufficiently protected bees were destroyed. During the winter of 1888 there was no ice at all, and no frost (hoar frost) after November. Corn planted in February came up in five days. China-trees, usually in full bloom about the 10th of April, were in full bloom then the first of March; on the 3d of March there was a freeze that caught the advanced vegetation, killed the young corn, and killed the limbs of many China and even peach trees, to the body of the tree. Bees necessarily suffered.

Bees, then, should have some protection in winter. I use the gable-end cover on my hives, for summer ventilation. About the last of October I put oilcloth on the tops of the frames, to protect the bees against the cold air of the nights and cloudy days passing through the cover; I also reversed the bottom-board (Danzenbaker) so as to have the $\frac{3}{8}$ -inch side up and the $\frac{7}{8}$ -inch side down, and contracted the entrance according to the strength of the colony. The weakest colonies I reduced in space with division-boards. So far this has been all that was necessary. But I have ready, for the cold snaps that may come, an oilcloth sack or box for each hive, to protect its inmates during the existence of the snap—sometimes a day or several days, a week, and possibly longer. I use the ten-frame Langstroth hive, and I find that oilcloth 46 inches wide is very good in size. I cut a strip off 23 inches wide. It is then 46 inches long. It runs lengthwise of the hive, making top and ends of the sack or box. I mark it so the top is 23 inches, and the ends each $11\frac{1}{2}$ inches. Then

I cut another strip $11\frac{1}{2}$ inches wide, and divide it in the middle. Each piece is $11\frac{1}{2} \times 23$, and makes the sides, the ends of the top piece uniting with the ends of the side pieces. The sewing can be quickly done on a machine. When a cold snap comes I propose to drop or place a sack over each hive while it lasts.

This year I have some bees, gotten late in the season, that have not two sets of combs. Others have two sets, and were working in the upper story. One had even three boxes. With these I put the upper story on the bottom-board, laid on it a honey-board, and put the brood-chamber on top. I think they will winter better in that condition.

On Saturday, Dec. 1, the weather was so mild that I saw many bees out after sundown. Opelousas, La.

CUBA.

A few Plain Facts for Those who Think of Going There.

BY THE AMERICAN TRAMP.

It is quite a while since I had the pleasure of writing to GLEANINGS; but after reading Mr. Osburn's article on page 915 I should like to give my view of conditions here, and ask him for some information.

I think a man with a little money had better stay out of Cuba, no matter how much push and perseverance he has. A good doctor or dentist who has a good paying practice here, or some one holding a government or other good paying job, if his personal habits are not too extravagant, can afford to go into bee-keeping here.

Mr. Osburn says the price of every thing is high. I think this should read, "The price of every thing we buy is high, and what we have to sell is worth nothing."

Let us take honey. The price of the best honey at the present writing is 40 cents per gallon, Spanish gold. This is equal to 36 cents American. It costs the bee-keepers here, on an average, \$3 00 for freight and cartage on the empty and full hogshead of honey (100 gallons). This brings the price down to 33 cents per gallon, or $2\frac{3}{4}$ cents per pound. Now, the cost of living here is more than double what it is in the United States; so, compared with the bee-keepers of America, as we have to live by our product, we are getting the very high price of $1\frac{3}{4}$ cents per pound for honey.

In the same issue of GLEANINGS I see Mr. Aikin criticised for selling his honey for 6 cents. He'd better sell out up there and come to Cuba, where he can get the very high price of $1\frac{3}{4}$ cents per pound, taking the price of living here into consideration.

I have not overdrawn this, as there are plenty of every-day staples that we have to pay not only double for, but four times as much as they cost in the United States. If Mr. Osburn calls 3 cents a pound a high price for honey, will he in his next article please rise and tell us what he would call a low price?

Artemisa, Cuba.

THE PERSONNEL OF THE UTTER TRIAL.

BY E. R. ROOT.

As promised in our last issue, I take pleasure in introducing to you some of those who took a conspicuous part in the celebrated case of Utter v. Utter at Goshen, N. Y., a case that involved new principles in law; and has, since the trial, been heralded, on account of its novelty, over the entire United States.



HENRY BACON, THE ATTORNEY WHO MADE THE PLEA BEFORE THE JURY.

The National Bee-keepers' Association, together with Mr. Utter, employed as attorneys the firm of Bacon & Merritt, of Goshen.



JOSEPH MERRITT, ONE OF THE ATTORNEYS IN THE DEFENSE.

This firm has been engaged in active practice for sixteen years, and I was told by numerous residents that they were the best lawyers in the county, and that we had made no mistake in having them to defend bee-keepers and their interests. They had been retained in some important railroad cases; and very recently had won in a celebrated drainage case involving something like \$15,000.

The next personage to whom I introduce you is Judge John J. Beattie, of Warwick, N. Y., who presided at the Utter trial. As already stated, he was as fair a judge as ever sat on the bench. If he had any prejudice or leaning for one side or the other it could not be discovered. He has held his position for two terms, and is now on his third term. Of him it is said that the evil-doers of the county hold him in wholesome fear; that he has always tempered his decisions with justice and mercy. He is a man of large physique, of commanding presence, a kindly, benevolent face, and every inch a judge.



JOHN J. BEATTIE, THE JUDGE WHO PRESIDED.

The defendant, Mr. J. W. Utter, has been engaged in keeping bees and raising fruit for a good many years. Unfortunately, there has been a difficulty between him and his brother, Mr. W. H. Utter, the plaintiff, over the settlement of their mother's estate; and during the years that have since elapsed there has been more or less trouble between them, culminating in this celebrated suit with which our readers are now so familiar. From all the evidence that I heard in the court, and from what I could hear from local residents, it appeared that Peach Utter had it "in" for his brother, and continued to annoy him on every occasion.

What appeared to be a family feud resulted finally in bringing out a test case—a case that, in the language of the lawyers, had up to that time never been adjudicated, and therefore involved the introduction of new principles.

But the star witness in the case, on the side of the bees, at least, was acknowledged by all to be Prof. Frank Benton, Assistant Entomologist of the Department of Agriculture, Washington. Probably no other bee-keeper in the world has had so wide and diversified an experience in different climates, in different countries, and with different species and races of bees, as Frank Benton. His earliest experience with bees began in Michigan, where he was born and reared. We next hear of him as a student at the Agricultural College, at Lansing, Mich. He was known as a close, careful student, and an accomplished linguist. These qualifications especially fitted him for the trip with D. A. Jones in 1879 and '80 through the Orient, for new races of bees; and as a result, Cyprian, Syrian, and Palestine bees were introduced in the United States and Canada. Later on, Mr. Benton made tours to India alone, after the celebrated *Apis dorsata*, captured them, if I mistake not, but was not successful in getting them alive to the United States. Subsequently we find him in Germany managing a series of out-apiaries a thousand miles or more apart. About this time he was engaged in sending queens of the various races to the United States, prominent

I am correct, they were not bees worth propagating as compared with other races. A few years ago he came back to his native land,

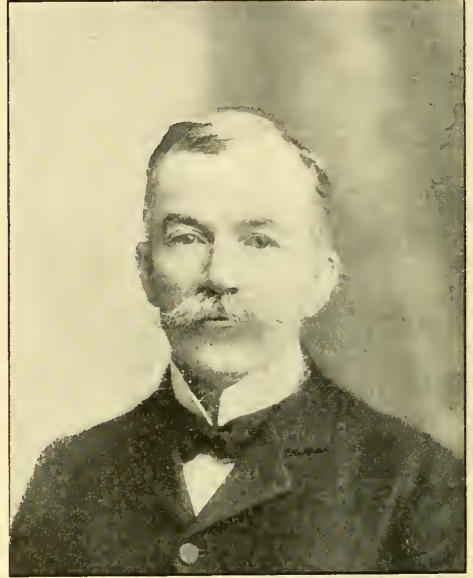

PROF. FRANK BENTON, THE STAR WITNESS.



J. W. UTTER, THE DEFENDANT.

among which were those of the Carniolan race.

At some time in his career, I do not know just when, he made his way down into the northern part of Africa, studied the Tunisian bees in their native habitat, but concluded, if

finally entering the service of this government.

As a witness in this celebrated case of Utter v. Utter he gave incontrovertible evidence; and while the attorneys for the plaintiff made vigorous attempts to break down the testimony of many of the other witnesses on the defense, when they came to Prof. Benton they very wisely concluded that they had run up against one who could neither be scared nor shaken.

During the last few weeks there have been numerous clippings from agricultural and daily papers sent us, concerning the Utter trial. The case was so new, involving as it did so many new principles, that it gave the reporters free scope with the pen. It would make "mighty interesting reading" if we could publish all the various accounts, but space forbids. I can not, however, pass by one in rhyme that has been going the rounds of the press. Leaving out entirely supplementary matter in prose, the account in stanzas reads as follows:

"Peach Tree" Utter took no ease
When he learned his brother's bees
Ate the peaches on his trees,
And caused them all to rot.
"By," says he, "the Holy Grail
I'll git upon the criters' trail
An' kitch a couple by the tail."
But, b' gosh, their tails were hot.

Further yet than eye could see,
Daily o'er the verdant lea
Flew the busy little bee,
Humming merrily i's song.
"Peach T. ee" then experimented
Till he had a cage invented,
When his nature stern relented,
And he chuckled, loud and long.

Jeffry Utter and his fellows
 Claim the peaches all had "yellows,"
 E'en though William loudly bellows
 That, b'gosh, it warn't so.
 And all the country roundabout
 Is twist a "holler and a shout,"
 While they're waitin' to find out,
 'Cause they're anxious fur to know.

Our Honey-Bottling Symposium.

How to Wash the Bottles ; Filling with Hot Honey
 or Cold ; Bottles with Corks or Self-sealing
 Tops ; Temperature of the Honey to be
 Bottled.

BY G. A. DEADMAN.

There are comparatively few bee-keepers who know much about bottling honey ; at least it is so in "this locality." It pays, not only from the standpoint of advance in price, but also in increased demand for our product.

honey was in them, so we now do this before filling, and when still moist from the washing. It is for this reason we do not let them dry in the sun, but as soon as washed place them inside or in a shady place.

Before washing, a boy examines and removes any scales of glass that may be adhering to them. He does this with a screw-driver or some such thing, and hands them to the party who does the washing. Some bottles do not require this, but others do, and especially the 1-lb. jelly-bottles, which we prefer to all others. I have given my order in advance, specifying particularly that they be free from these scales ; but occasionally we find them, and I feel safer to go over them all before washing. I say *before washing*, for they are much more difficult to remove when wet. I know some pay no attention to these ; but I do not like the thought of the possibility of any one getting a piece in the mouth or throat, as the consequences may be serious.

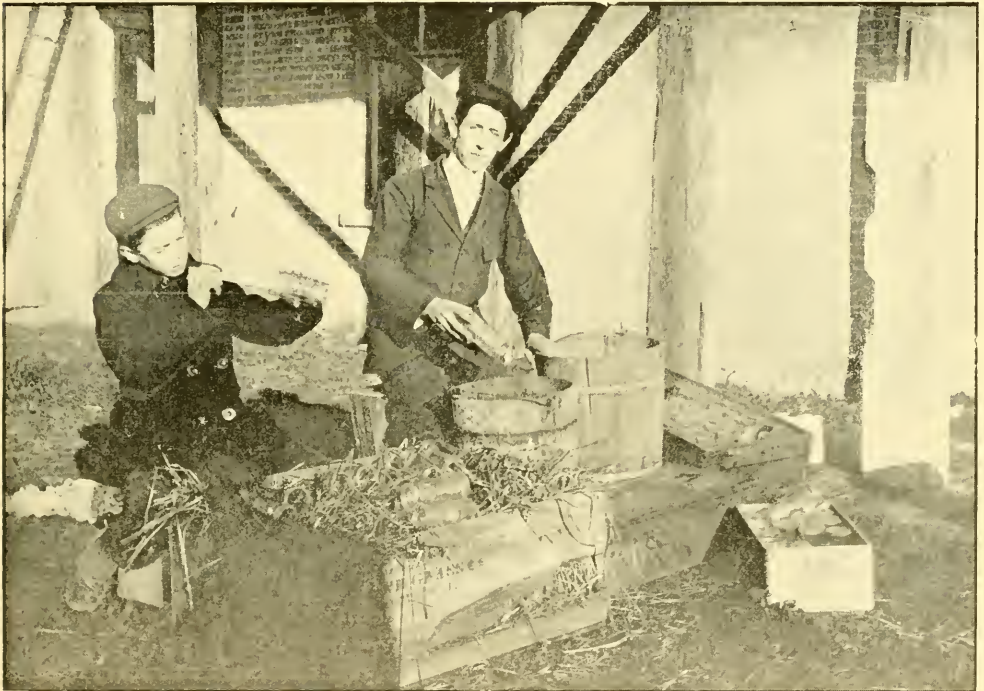

WASHING AND CLEANING THE BOTTLES.

It is not so difficult as some may imagine, nor so slow as many might suppose. The first thing is to have your bottles all cleaned and ready, and the best time to do this is the day before filling. Not only are they less in the way, but in better condition for wiping before labeling.

Formerly we would wipe them after being filled, just before wrapping them, previous to packing them. We found, however, that they were then much harder to polish after the hot

In washing, it is easier and better to use plenty of water, and three pails are preferable to two. It is for this reason we prefer doing this work near a well. It is an easy matter for two persons to examine and clean six gross or more in a day, which is as many as you will fill in the same time.

Next in order is the filling. We always warm the honey before doing this. To keep it from granulating is not the only reason. It would be too slow work otherwise. The tem-

perature we prefer is 170° F., and we never want it more than 180°, believing that, if much hotter than this, the flavor is injured; and if allowed to come near the boiling point the honey is darkened as well. The round all-glass dairy thermometer is best for this purpose. We suspend it by a string from the top of the can so it is always ready for examination.

The question is now, when and how shall we heat the honey? The kitchen stove will do, but we do not recommend doing it there. As we bottle all our honey in the back shop of our drugstore, we prefer warming it outside, and as near the back door as we can get, until this year, when we used a sugar-kettle having sufficient water in to surround the honey nicely. The objection is, a waste of fuel, and the annoyance from smoke. Not long ago some

ble stove we can warm the honey as fast as we can fill 1-lb. bottles or smaller. As it takes about an hour to get the first lot ready by starting at 7 o'clock, the honey will be ready by 8. We can then take off 40 lbs. every half-hour, which means one hour for this quantity when using two tins. This would be from 700 to 800 1-lb. bottles in a day. If the honey is granulated it is absolutely necessary to stand it in water; and then two boilers on a cook-stove would be better. You do not require to use water if the honey is sufficiently liquid to pour. Though honey is strained as it comes from the extractor, we do this again through thin cheese-cloth on the can we fill from. Keep the honey on the stove covered also, if for no other reason than to preserve the aroma. When filling 1-lb. bottles we take the tare of each, using a double-beam scale



MR. DEADMAN AND BOYS BOTTLING HONEY.

one (unlike those we read about who live in Muskoka) walked off with our kettle; and when looking for it, or something to take its place, I found on a heap of old iron the readily movable stove seen in the picture. I have been glad more than once that my kettle was stolen, as this stove is so much better. It is nothing more than the oven part of an old-fashioned cook-stove. There are no legs and no bottom, so we set it on the ground and move it where we please. Two lots of honey are warmed at one time; and as the pipe is at the back, and not, as with box stoves, at the end, it warms with equal rapidity. This is an advantage in itself. With this readily mov-

able stove we can warm the honey as fast as we can fill 1-lb. bottles or smaller. We can then guarantee each bottle to hold this quantity. We are careful, however, not to give much over this. Half an ounce over on each bottle would mean 156 lbs. when filling 5000, as we did one year. Then you may meet some merchants who will say you are charging too high; and when beginning on the price of the honey, and the cost of the bottles, they will make no allowance for overweight. The quart gems (wine measure) that we used this season, would not hold 3 lbs., so we filled without weighing, and sold them as quarts. One-pint gems hold a little over 1½ lbs.; but as the 1-lb. screw-top straight jelly-bottles look nearly as large we

now use very few of the former. We usually fill the quart when getting behind with the 1-lb., as it would require two or three stoves to warm the honey fast enough to keep one filling them. The bottles to be filled are piled up behind the one who does the wiping and labeling. They are then handed to the one who does the filling, who, in turn, gives them to the person who covers and puts them away. If a child is to do the labeling it is best to have the bottles wiped beforehand. They will then be encouraged by easily keeping ahead. If short of help, label also beforehand, but it makes less handling when all is done at the same time. We always use gummed labels, and we moisten the gum by placing them in a folded cloth kept wet. This is better than doing it with the tongue. We think the label looks better when placed about half way between the center and top. Never put it across the center of a bottle. We prefer a label going across rather than one up and down, believing the former shows the honey off better. Have "Pure Honey" in clear bold type; next the directions small, and then the name and address in clear type below. Many labels in use have directions about the honey granulating, etc., and read, "This honey *will* granulate." Now, as we do not expect our bottled honey to do this, but at the same time wish to educate and provide against a possible chance of its doing so, we say on the label, "*Should* this honey granulate it can be liquefied by placing the bottle in a warm oven or in the reservoir of the stove." The tin covers for the 1 lb. bottles have a cardboard inside. We have never known the honey to leak unless the bottle was faulty. We are careful, however, not to allow the hot honey to touch the cover, and therefore do not roll them in paper until next day, when they are placed away ready for packing.

As a customer will invariably prefer a bottle with a cover rather than one with a cork, and as they can be bought so cheaply, we see no reason for using the latter. Should you wish to do so I would soak the corks for a few hours before using, unless you wish to seal while hot. Soaking them not only gathers up any cork dust found in the crevices of large corks, but makes them fit much better. They must be allowed to dry before sealing, should you wish to do this. We prefer pure beeswax for this purpose. Have it kept hot, and invert the bottle, holding it perpendicularly when placing in the wax. You may require to dip the second time. Before sealing, cut

off any projecting cork with a sharp thin-bladed knife. If you wet the corks first they easily pound in level, using a wooden mallet.

If you wish something cheaper than beeswax, then combine equal parts of resin with about one-fifth tallow. A little vermilion will improve the color. If I were using corked bottles I would have a label with my address, etc., made especially for the purpose, and stick it on; but so long as the public prefer, and I can buy 1-lb. bottles, such as I have described, and have a profit on them at four cents each, I shall never bother with those requiring corks. There are other sizes of the same make; but as the smaller sizes cost near-

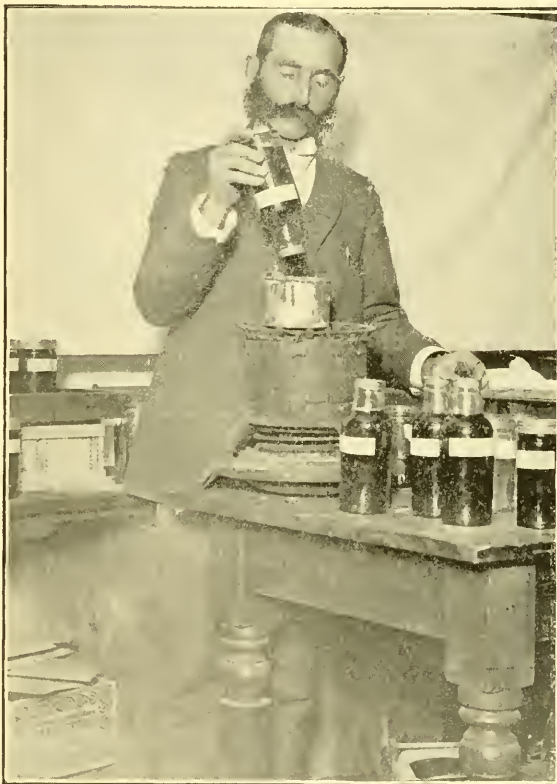

SEALING THE BOTTLES.

ly as much I prefer the 1-lb., and always the "straight." There is another make that's shorter, a little larger at the bottom than at the top, and that have a projection near the top. They not only do not look as well, but are more difficult to pack so as to keep from breaking. The straight ones ship well, and are easy to pack, having had only one broken out of 5000 shipped one season.

We use only warm water for washing the bottles when it is too cold to be comfortable without. On a hot day the cold water is preferred, but on a cold day the warm is better. Never wash them in the house unless you are

obliged to. Only the water that is used for the first rinsing is changed, as it, of course, needs changing most. The one that was used for the second rinsing now takes first place, and the one for the final rinsing the second place, so that we always have the clean water for the last rinsing. With the "readily movable" stove it will warm as fast as required.

As to wiping the bottles, this is done only on the outside. After standing for an hour or so to drain over night, the hot honey will attend to the inside. In wiping, all that is necessary is to hold the bottle in one hand, then with the other hand and a soft towel encircle as much of the bottle as you can, and go from

The latter is preferable. When folding in the ends, always begin where the paper ends.

They are now not only ready for delivery or shipment, but if there is any leakage the paper will show it. Before doing this we go over the covers and see that all are reasonably tight. If those with cardboard covers have been properly put on they will not require tightening — not so, however, with the fruit-jars. I think having all this done at one time is better than having to give them a "bath" before being able to fill an order, and they will look just as "fresh and clean" after three months as they do the day they are wrapped. I have had occasion to liquefy

some that had granulated in the bottle, but I never do it from choice. Unless one had extensive appliances for heating, it would be altogether too slow. Then one can only guess at the temperature; and the filling is not only slower, but it is impossible to be accurate.

I decidedly object to handling hot bottles, whether for cleaning or labeling. They get warm, it is true, when bottling the honey hot; but it is not until they are placed away after covering.

We prefer, when warming the honey, to have one more tin than the number on the stove, so as to have one ready to put on immediately when one is taken off. We prefer to have about 40 lbs in each, except when beginning, when we have about half as much in one, till we get a start. Any tins will do for this purpose. Ours are round, holding fully 50 lbs.; have handles to lift off with, and are made of heavy tin. The 60-lbs., same as you store your honey in, will do, but I prefer the top all open.

I omitted to mention that, when filling without weighing, you should have your bottles a little fuller than you wish them when cold, as the honey occupies more space when hot.

Brussels, Ont., Can.

BOTTLING HONEY.

The Right Kind of Honey for the Purpose; Mixing Honey to Secure a Flavor; Why Honey Should be Heated in the Bottles.

BY EARL C. WALKER.

Before proceeding to describe the various steps in the process of bottling honey, allow me, Mr. Editor, to say a few words concerning the honey which is to be bottled; for, aft-



TAKING THE TEMPERATURE.

top to bottom, then turn the bottle around and do the other side the same way. This is all that is required. When filling, have a towel and water handy so that only clean hands touch the bottles. They will then not require any more wiping. The papers we use for wrapping are old newspapers, which can be had from newsdealers for two or three cents per pound. A thin bladed honey knife is the best for cutting to desired size. Wrap as soon as cold, and before any dust can gather on them. There are two ways of doing this. One is by folding as you would a parcel, and the other by rolling the bottle in the paper.

er all, more depends upon the grade and quality of the honey than upon the manner in which it is put up.

Bottled honey is, as a rule, purchased by a class of customers who demand a fancy article, and are able and willing to pay a fancy price for it. This being true, only a first-class article should be bottled. A great majority of the people who eat this bottled honey never see the package or jar in which it was bought. The cook empties the honey, and sends it to the table; if it is good, and tickles the palates of those who eat it, they demand more of the same kind; but if it is an inferior article, with a rank flavor, they want no more of this or any other kind, for they either decide that they don't *like* honey, or that it is impossible to obtain a good or pure article.

But not only should the honey, to be bottled, be of fine flavor, but it should be light in color. Dark honey looks bad in glass, and is a drag on the market. Recently I tried to sell some bottled honey to a fancy grocer. He said no; he wanted none, for it would not sell. "Why," said he, "I have honey in just such jars as those, which I have had on hand for years." I asked to see some of the honey he referred to, and was shown several jars of very dark honey on which were the labels of Chas. F. Muth. They were out on the counter, too, in plain view, but no one wanted to buy such honey.

Now, if *dark* honey, put up by a man with such a great and good reputation, would not sell in jars, how can any of *us* hope to dispose of cheap goods in fancy jars, and at fancy prices? This grocer would not buy any of my fancy honey, but agreed to take two dozen jars on trial, with the understanding that I would take them back if he could not sell them. In less than two weeks he ordered more, and he is still a customer.

Now as to mixing the different varieties of honey to secure a standard flavor. I know many practice this, but I think it is a poor practice. Why not label the different kinds and flavors, and thus educate the public taste? The sooner the public learns that there are different kinds and flavors of honey, the better. Many people who are fond of *clover* honey can not bear the taste of basswood or poplar, or *vice versa*; nor can they stand a mixture of them. There is no more excuse for mixing the different kinds of honey than there would be for mixing all the different kinds of jelly to get a standard flavor. Better label each *kind*, and let the customer choose that which he likes best. This is no theory with me, but it has been demonstrated by experience in bottling and selling honey.

A gilt-edged article of extracted honey should be put up in a neat and attractive package. I have used mostly the Ponder and Muth jars, but I am now trying a new kind, a self-sealing jam-jar with a glass lid and rubber ring, which saves the trouble of waxing corks.

But, regardless of what kind of jar is used, the process of bottling is practically the same. The first thing to be done is to thoroughly wash the jars and remove the fine glass splinters or slivers which are so often found pro-

jecting from the interior surface of the same. The jars are then drained and dried. They are then ready to be filled with honey.

The jars are filled from a large tin tank filter with a good-sized honey gate. If the weather is cold, and the honey is thick and stiff, it should be warmed before being placed in the large tank, for it will then flow rapidly from the honey-gate into the jars, and save a great deal of time.

When the honey is being poured from the cans into the tank, and when it is being drawn from the tank into the jars, it becomes mixed with air, and filled with bubbles. If you doubt this, take one of the jars you have just filled and hold it up to the light. You will see that the honey is filled with hundreds of little beads (or bubbles) of air. Now, it is this air in the honey which helps it to granulate. You may seal it up as tight as you please; and if these air-bubbles are left in, it will *candy* as soon as it is exposed to cold. To drive out all of these air-beads I place the jars in large tin trays of water, which are heated to 175 or 180°. Any greater degree of heat will injure the flavor of the honey, and tend to *darken* it.

The trays used are made of galvanized iron, and are about 5 inches deep, and large enough to hold conveniently about 40 jars. A gasoline-burner keeps the water at the right temperature.

After the honey is thoroughly heated, and all the air is expelled, the jars should be sealed at once, before being allowed to cool. The corks are sunken slightly below the top edges of the jars, and then covered with melted wax. In this way they are hermetically sealed, and will all be sold before they will granulate. I have kept clover honey, sealed in this way, two years, and there were no signs of *candy*-ing. When the corks were drawn, the air could be heard hissing in, thus proving that, when the jars cooled, a vacuum was produced.

The above, Mr. Editor, will answer your question as to the reason for heating the honey *after* it has been placed in the jars. This is a little "wrinkle," but an important one.

If self-sealing jars, mentioned in the beginning of this article, are used, no waxing of corks is needed, as the rubber ring and glass lid make an air-tight seal.

If the regular honey-jars with corks are used, a tinfoil cap adds greatly to their attractiveness. The method for putting these on is so simple that it need hardly be described. The method that Chas. F. Muth used, as described by him in his catalog of years ago, is as good as any.

The last thing of all to be done is to put on the labels. I use a dark-blue label printed in gold. The dark label is not as easily soiled as a light-colored one; and then by contrast the honey looks lighter in color with the dark labels.

An attractive label is a great help in selling the honey, and then it is an advertisement for the producer.

I use dextrine to stick the labels on the jars; and by spreading it over both surfaces of the labels they will never curl up or come off.

The bottling of honey is an important subject, and I am anxious to read your symposium, and learn how others do it.

New Albany, Ind., Dec. 14.

BOTTLING HONEY.

Size and Construction of Vats for Heating the Bottles of Honey; Tumblers vs. Jars or Bottles.

BY WALTER S. POWDER.

Bottling honey, with me, is done according to the time we have to devote to the work, making a sort of fill-in job of it. For instance, we wash a batch of jars one day, and fill and cork them at another time, and so forth, although we try to get a good stock ready in the fall before granulation starts. In washing jars we use a vat containing five gallons of clean water. Take one jar at a time, and with the jar half full of water shake and then rinse the outside of the jar. We now invert them till well drained, and then place them right side up and allow them to stand till dry. In heating the filled jars we use a two-burner gas stove which stands eight inches above the floor. We like the low-down stove because it is very convenient in lifting off sixty-pound cans of honey or heavy pails of beeswax.

For heating jars we use vats made of galvanized iron, $11 \times 18\frac{1}{2}$ and $5\frac{1}{2}$ deep. Heavy handles are riveted at each end, and we find this a very convenient size to handle. In the bottom we place thin boards with narrow cleats secured to the under side to prevent the jars from touching the metal. As many of these vats can be used as business may require. They hold 28 one-pound jars, 40 eight-ounce jars, or 54 five-ounce jars. On a two-burner gas-stove we use two vats at a time. If we wish to melt honey in five-gallon cans we use a vat covering two burners, and melt two cans at once. If we used Mason jars or tumblers we would then have vats made especially for them. If we did not use gas for fuel we would then use a gasoline-stove, because we must have a fire that can be easily regulated.

I have no doubt that a tumbler is a very desirable receptacle for honey in Mr. Fowls' locality; and the fact that a tumbler is still a useful article after its contents have been used is worth considering; but I have often wondered if the consumer takes this into consideration. I abandoned the tumbler because I learned that I was competing with a tumbler exactly like one I was using, and containing a thin slice of comb honey and a whole lot of glucose mixture. The jars are not convenient for such adulterated goods, and to my knowledge I have never seen them used for any but pure honey.

We cork all jars immediately after filling and before heating. I prefer the cork to fit easily; but if they are properly steamed, quite a large cork can be inserted in a small-mouthed jar by hand. On one-pound jars I use a label covering one side of the jar and a foil cap over the cork. This side label consists of

a guarantee of purity, and directions how to liquefy in case the contents should granulate. On the smaller jars we use a round gummed label over the cork and a slender label around the neck.

Indianapolis, Ind., Jan. 9.

[It has been our practice to pour the honey into the jars when cold, and then heat the jars with the honey in the vats of water, of the kind described by Walter S. Powder. After looking over the various methods this seemed the more practicable for our conditions and circumstances; and now it would appear that it is *altogether the best method* in that it may (I don't know positively) preserve the honey in a liquid condition longer than when the honey is poured into the jars while hot. I had never thought of it before; but if jars are filled with either cold or even hot honey, and corked, innumerable small bubbles of air would be scattered, I should suppose, all through the honey. Whether this is true or not, these would necessarily disappear if the honey were *heated gradually, and then corked*. I had not thought of it before, that air in honey will hasten granulation; but our own experience leads me to believe that the theory of Mr. Walker is correct. We have taken some of the honey that we bottled during the past fall, placed it outdoors in the cold air, to be subject to all sorts of variation, from 70 degrees down to zero, or nearly so, and yet it has remained clear. Mr. Fowls, in his article on bottling honey, described how he heated the honey in the first place, poured it into the jars hot, and then sealed. In one of his previous articles he tells how he goes around and gathers up all the jars in the local groceries where the honey is candied, takes the bottles that are cloudy, and gives them, in exchange, bottles of clear honey. Now, I don't know, but it strikes me if he were following the plan that Mr. Powder, Mr. Walker, and ourselves use he would not have to go into this kind of exchange business.

Mr. C. H. W. Weber, of Cincinnati, who has been doing a large business in bottling, and who bought out C. F. Muth & Son, told me of a valuable little kink, and that is, in the method of inserting corks. The jars are filled, and then the corks are laid loosely on top of the bottles, or just barely entered, we will say. After half a gross of the bottles are so prepared he goes around with a mallet having a rubber face, and drives these corks clear down into the mouth of the bottle. One or two blows force the corks clear down; and it is done so quickly that it leaves all other methods of forcing corks down clear in the shade. Some insert them by means of the weight of the body on the hand. Others use a lever. But this wastes time as well as requiring a great deal of strength.

Mr. Weber did not tell us where he got his mallets with rubber noses; but here is a suggestion: Take a common wooden mallet and put on each of its faces one of these new-fangled rubber heels, such as you can buy at any shoestore for a few cents. These rubber heels are about half an inch thick, and are secured

to the shoe by means of three or four nails whose heads are countersunk into the rubber.

In all the articles, reference is made to the use of beeswax for smearing over the corks to make a hermetic sealing; but we have found, and our experience seems to be that of a number of others, that a mixture of paraffine, beeswax, and resin, equal parts, makes a much better sealing than pure beeswax. The mixture will spread evenly over the cork, without cracking or leaving air-bubbles, while the wax alone is liable to do both.

Mr. Pouders and Mr. Walker's method of bottling is almost exactly the same as the one we use here at the Home of the Honey-bees, with this difference, that we use steam, which is much more convenient.

I wish to indorse particularly, one of the points made by all three of the writers in this symposium; and that is, the importance of getting all the particles of glass off that cling to the inside of the bottles.—ED]



AN ADJUSTABLE SURPLUS ARRANGEMENT.

Returning home from the postoffice last night I found Mr. Smith and Mrs. D. in the sitting-room awaiting my return. Upon passing the usual salutations, and remarking about the nice winter weather, Mr. Smith launches out thus:

"A friend of mine, who keeps bees, told me to-day that you had a surplus arrangement for comb honey that you could enlarge or contract at will to suit the size of the colony or the season of the year, and I have come over to have a little talk with you about it—that is, if you have no patent on it, and feel free to tell me about it."

"Relative to your last point, I never even thought of getting a patent on anything I ever made or planned. And as to telling any one about the things I use, and how I use them, it is something I have been at for the past thirty years, and it always gives me pleasure if I can help any one in any way."

"Thank you. And now how is that surplus arrangement made?"

"All that is necessary is to make the wide frames, which hold the sections, so they will fit the top of the hive and allow the hood or cap to the hive to rest down over them, for this arrangement is best used with a hive that has a cap or hood. However, it can be used by putting a wide shade-board over it. Get all the pieces out true and square, after which nail them over a true square form, so that each wide frame will fit true and square against its neighbor, for this surplus arrangement is made out of a number of wide frames."

"Do you use separators on these wide frames?"

"Yes. I advise using separators on or in

any surplus arrangement, for after thirty years of experience I am led to believe that a strictly fancy article of comb honey can not be secured in any other way."

"Can this arrangement be used on the tiering-up plan?"

"Yes, it can be so used by making both tops and bottoms a plump one-fourth inch narrower than the ends. If to be used only one tier high, then have the top the thickness of the tin separator wider than the ends, for the separator is to be nailed to the ends."

"Do you use tin for separators?"

"Yes. After using several kinds of material for separators, I prefer tin to any thing else."

"But doesn't the tin kink and warp when it is nailed to the wide frames? I could never nail it so but that it would."

"The nailing-on of this tin has much to do with our liking or disliking this plan for a surplus arrangement. The first year or two, to prevent the kinking you speak of, I used a hand vise, so arranged that I could pry over one end of the wide frame, after having nailed the tin at the other, thus stretching the tin so tightly that it would fairly ring when hit a little. While thus working one day I noticed that in drawing the tin very taut I often sprang the top and bottom of the frame out or in, as the case might be, and from this I soon had a way of putting on tin perfectly every time. I made a form a trifle shorter than the frame was long, outside measure, this form being perfectly true and square, which gave advantage over the vise method, for with that the frame was sometimes drawn out of true. Next I made a block the size of the inside of the frame, except a little shorter, and of the same thickness as the ends to the frames. To use it I sprang or bent the top and bottom bar a little outward, thus shortening it, until it went into the form, when I laid the tin separator in the proper place, placed a straight-edge on top of the tin, and on this a heavy weight. I now had the tin just where I wished it, with all kinks and bulges taken out, when it was nailed fast to the wide frame. Upon removing the frame from the form, the top and bottom sprang back into place again, thus drawing the separator as tight as a drum-head."

"I am very glad you explained this to me so fully, as it will help me much in nailing separators to wide frames. But having the separators and wide frames all in readiness, what is the next move?"

"They are now to be filled with sections, the same having starters in them, or filled with foundation, as you can afford, while it is best, if possible, to have at least two wide frames filled with bait sections, for each hive you expect to work for comb honey."

"Bait sections! What are those?"

"Simply sections left over from the previous year, that are half or more filled with comb, but which were not sufficiently filled with honey to be salable. These are called baits, because they entice the bees to commence work in the sections much sooner than they otherwise would, because bees will go to work

filling empty comb before they will build new."

"Thanks again. This is something that I never knew about before, and I often wished I knew of some way of getting the bees to work in the surplus arrangement sooner. But having the wide frames all filled and in readiness, what next?"

"The wide frames are to be keyed together. I have tried almost all ways of keying these wide frames together, using in clamps, etc., all of which I did not like, as I wished for a plan that would allow of my using as few or as many wide frames on a hive as I pleased, according to the season and the strength of the colony, from two up to twelve. By most of the other plans we must give just so much room or none, no matter what the season or what the strength of the colony."

"But what keeps the bees from going out at the sides of the wide frames and sections, whether keyed or otherwise?"

"A thin board is gotten out the same size as the wide frame, outside measure, this board having a cleat nailed at either end, so as to keep it from warping or twisting away from the sections or wide frame. In each end of this cleated board a wire nail is driven, and two of these boards are used with each surplus arrangement."

"I see. These boards are to come flat up against the outside of each outside wide frame."

"Exactly. And to hold the number of wide frames together, pressed right up tightly to each other, as in a vise, a coiled wire spring is used, prepared by tying a suitable length of string to one end of the spring. The spring is now hooked over the nail in the end of one of the boards, and, after stretching the spring sufficiently, the string is wound around the nail on the other board on the opposite side, when, with a spring fixed in the same way on the other end, we have the number of wide frames we wish to use, all tightly clamped into a surplus arrangement, which can be handled as a whole, no matter whether the wide frames number two, three, four, or a dozen. And they give all the lateral movement required, so as to use the number to the hive which the apiarist may desire. And they can be taken off as one surplus arrangement, or each wide frame separately, tiered up, reversed, interchanged, etc., according to the views of the most exacting."

"Well, this is quite a scheme, and I am glad I came over, for I now understand better how to work for what I want. But allow me one more question before I go."

"Certainly."

"Do you use any honey-board with this surplus arrangement?"

"When not enough wide frames are on to cover the top of the hive, something must be used to cover the remaining portion. Otherwise I use no honey-board of any kind, unless I contract the hive so that the queen is liable to enter the sections and fill them with brood. In this case I use a queen-excluding honey-board, which keeps her below, no matter how small the brood chamber."

"What do you use to cover the remaining portion of the top of the hive, when only a few wide frames are used?"

"Where a cap or hood is used over all, I use a piece of enameled cloth, or an old bee quilt; and where no hood is used I have pieces of board of different sizes, to suit a certain number of wide frames, these pieces covering that portion not covered with the number of frames used. But the quilts and the hood are best for this arrangement."

"Well, I must be going. Good night."

"Good night."



POLLEN IN THE SECTIONS OF SHALLOW BROOD CHAMBERS.

Mr. Editor:—Will you kindly permit me to reply to Messrs. A. J. S. & Bro., of Virginia, who write me they have decided to use the Dünzenbaker super arrangements but say there seems to be trouble about the story of pollen in the sections, with shallow brood-chambers? If I can guarantee there will be no such trouble they will reduce their old hives to fit my fixtures. I infer this "trouble" has been brought to their notice, as it has to that of others, by Dr. Miller's *S'raw* in GLEANINGS; and I desire to say to them and others whom it may concern, that there is nothing of the kind with proper or even ordinary management. The 10 frames, 7½ inches deep, of my hive, contain a trifle more comb surface than the eight frame D-vetailed hives, which gives ample room for pollen, and brood of average queens during the honey-flow.

Bees naturally store pollen at the side of and beneath the brood-nest in the coolest part of the hive, and the honey above the brood in the warmest part of the hive, but never store honey beneath the brood or in cells that have a drop of honey in first, but will store honey in cells partly filled with pollen. In case the brood-nest becomes gorged with honey before the supers are put on, or they are put on too long before the flow begins, there might be a few cells of pollen stored in the sections; but I have not lost a dollar on that account in ten years. I have in that time raised and sold thousands of sections from my hives, without any show of pollen in the sections.

Bees gather very little pollen during the white-honey flow. If supers are put on at the right time, and made nearly air-tight by waxed-paper mats or enameled sheets, with ample covering to retain the bee heat, and render the super the warmest part of the hive, the bees will store their honey there, where it ripens soonest, and store pollen in the cooler part of the brood-nest.

Thousands of shallow seven-inch frames were used with full satisfaction, before I ever tried them, by such men as Dr. G. L. Tinker, New Philadelphia, O.; Dr. Geo. W. Brodbeck,

Los Angeles, Cal.; C. H. Dibbern, Milan, Ill.; M. M. Baldrige, St. Charles, Ill.; Wm. L. Ewing, Vincennes, Ind.; Z. T. Hawk, Audubon, Ia.; H. Bandy, Clinton, Mich.; M. J. Bundy, Angola, N. Y.

F. DANZENBAKER.

Washington, D. C.

[The presence of pollen in Dr. Miller's case may be more a matter of locality than of improper management. However that may be, we hear little of this kind of trouble in connection with the 7-inch brood frames.—ED.]

CARRYING COMB HONEY ON WAGONS — HOW SHOULD IT BE LOADED?

Friend Root:—In regard to loading honey, page 883, I am of the opinion you are correct. I have hauled a good many bees and considerable honey, both in sections and extracting-frames, and have always loaded lengthwise of the wagon, spring or no spring, and have never broken a comb when crossing bridges, culverts, or ditches. The jar is entirely lengthwise; also in stopping and starting the team; and even the ruts often let both wheels drop at the same time. But the rule is with ruts, there is not much of a drop, for the descent and ascent are gradual; and when there is a drop of one wheel in a single rut, the bump is more downward than sidewise.

Hillsboro, Wis., Nov. 26. ELIAS FOX.

MAKING SALVE FROM PROPOLIS.

On page 921, Dec. 1, Mr. Holtermann speaks of making salve by heating propolis and sweet oil. I tried to mix propolis and sweet oil by heating. I stirred it on the stove until I was tired, then took it off the stove and stirred it until it was cold. I then had a solid piece of propolis lying in clear sweet oil. The only way that I have been able to mix propolis and sweet oil is by pulverizing the propolis and then rubbing the oil and propolis together.

MAGGIE M. JOHNSTON.

Malvern, Iowa, Dec. 15.

WINTERING UNDER SNOW.

The place I have selected for my apiary is the most convenient in every respect. But there is one thing that might prove to be a drawback—that is, in severe winters the snow drifts four and five feet deep, and packs so hard it would nearly hold a horse. Would bees (weak colonies as well as strong) live under this snow until it melts?

Troutdale, Ore., Dec. 4. F. E. BATES.

[I think your bees would winter all right.—ED.]

PULSE RATE IN COLORADO.

Mr. Editor:—In your issue for Nov. 15 you say you wouldn't live in Colorado if you were paid for it, because your pulse rate is so high here. I venture the opinion that your health would be greatly improved by a year's residence here. Your pulse rate becomes high here because of deficient lung capacity, which would certainly expand, and then the pulse rate would return to its normal state.

S. W. MORRISON, M. D.

Ignacio, Col., Nov. 24.



J. M., Utah.—It is impossible for us to give you proportionately the amount of sulphuric acid to use in water for refining wax, as so much depends on the condition of the wax, its color, whether it is in the form of old combs or wax cakes; but I would use about a spoonful of sulphuric acid to about a quarter of a pail of water. Put the kettle on the stove; and when the water is hot, put in the wax. After it is thoroughly melted, set the kettle on the back of the stove and allow it to stand over a low fire for half an hour, but not long enough to let the wax cool. Then drip off the wax carefully into receptacles. If the wax has not attained through the process the proper color, the next time use a little more acid; and if the wax after refining smells a little of the acid, use less.

W. B. P., Cal.—If the combs that you transferred into Hoffman frames are crooked, you can still straighten them. Such combs should be placed in a warm room or in the sunshine, after which they should be laid on a flat board, and then forced back into position again with the palms of the hands, or even with another flat board placed on top. Yes, you could get the bees to draw out foundation in the upper story in the manner you suggest. To do this, take out a frame of brood from below with the queen and bees; put this in the upper story, and then place between the two stories a perforated zinc honey-board. The bees will gradually work upward. When the brood is hatched out, if it is along in the fall they will desert the lower combs for the upper ones. If it is during the honey-flow the combs below will be filled with honey, which can be taken out and extracted, after which they may be straightened or put into the solar wax-extractor to be rendered up into wax.

O. P. H., Texas.—We do not sell the apparatus for measuring bees' tongues. It consists simply of a machinist's steel rule that you can get at any large hardware store, one, two, or three inches long, having on one side an inch marked off into hundredths. This, together with an ordinary 15 cent or 20 cent magnifying-glass, 10 cents' worth of chloroform, and two darning-needles, constitute all the apparatus that is needed. Catch a few bees whose tongues you desire to measure; put a few drops of chloroform on a common handkerchief, and place it directly over the wire cloth of the cage; and when the bees are stupefied, cut off the head of one bee, lay it with the tongue stretched out on the rule graduated to hundredths. Stretch the tongue as far as it will go, by pressing upon the head or face of the bee. Count off the hundredths from the point where the tongue leaves the mouth to its end. This is a very simple operation, and any one with a little skill and patience should be able to do the work as well as an expert.



MILD weather, la grippe among men, and good wintering among bees.

SIXTEEN extra pages this time, and more to follow in our next. We still have on hand a large amount of good available matter that is still waiting a place in our columns.

DOOLITTLE IN ARKANSAS.

FOR some weeks past, our old Borodino correspondent has been sojourning at Ft. Smith, Ark. He has rented a farm of 135 acres at Ursulo for a term of five years. In a letter just received from him he says he enjoys the sunny South during winter, but has concluded that, on the whole, he is better off at his old home at Borodino, N. Y. It appears from this that the bee-keepers of the Empire State can still claim one among their number whose writings are, perhaps, as familiar as those of any writer on bee-lore in all beedom.

THE OFFICIARY OF THE NATIONAL ASSOCIATION.

MR. ARTHUR C. MILLER, of Providence, R. I., in referring to the editorial in Jan. 1st GLEANINGS, in which mention is made of the good work of the National Bee-keepers' Association, says no statement is made as to where in the United States the Association has its head, who its general manager is, or who any of its officers are, nor how, when, and where outsiders can get into it, and thus receive the benefits of the organization. I have looked up the editorial in question, and find that I must plead guilty to the charge; but I have said so much about General Manager Secor, and about sending \$1.00 to him, I supposed that every one would certainly know all about the organization, and all I needed to do was to make bee-keepers see and know that the Association was doing something, and a very important something too.

Perhaps it would be well to keep a *standing* notice in our columns, giving the names of the officers, or at least the General Manager and the executive board, and here they are:

E. R. Root, President, Medina, O.; R. C. Aikin, Vice-president, Loveland, Colo.; Eugene Secor, General Manager, Forest City, Iowa.

To get into the organization, and thus be entitled to its benefits, at the same assisting in the good work, send \$1.00 to the General Manager as above named. This will entitle you to membership for one year, securing for you protection against dishonest commission men, against town councils and disagreeable neighbors, and at the same time giving you the additional benefits resulting from the fight against adulteration. It should be understood that one who is not a member can not justly expect the protection of the Association unless he joins *before* he gets into trou-

ble. There may be cases in which a large principle is involved, where it may be necessary to defend some one who was not at the time a member of the organization; but these cases are rare.

INDOOR V. OUTDOOR WINTERING AS DISCUSSED AT THE ONTARIO CONVENTION AT NIAGARA FALLS.

AT one of the sessions we listened to a valuable address by Prof. John Fixter, of the Ottawa Experiment Station. In this he detailed an interesting series of experiments that had been conducted under his direction for four, five, and six winters by the station, on the various methods of wintering bees indoors, underground, and even outdoors. A series of colonies of average strength in common Dove-tailed hives were set apart in pairs, and prepared in various ways as follows:

Experiment No. 1. He had put two hives in a cellar under a dwelling. Under the back end of each hive was placed a three-inch block by means of which the hive was raised so as to insure free ventilation. The regular outdoor covers were removed, and replaced by cushions made of chaff, 4 inches thick, and long enough and wide enough to lap over the hive all around about two inches. The temperature of the cellar varied from 46 to 47. The bees were very quiet all winter, only a sort of hum being noticeable at times; and at such times cold air was let in by opening slides in the doors of the cellar at night, and closing them in the morning. The average loss of stores for a period of six years was 11 lbs. 1½ ounces.

Experiment No. 2. Two colonies were put into the cellar, having the covers and bottoms on just as they were out in the bee-yard. They were watched for dampness to compare the amount of honey consumed. During December and January the bees in both hives made considerable noise. Drops of water were noticed along the entrances of both hives. The colonies were removed from the cellar in the spring in fair condition, but the combs were slightly moldy. The average consumption of stores for six years was 13 lbs. 1¼ ounces.

Experiment No. 3. Two other colonies were placed in a root house. The covers were removed, and replaced by large chaff cushions. Between the bottom-boards and the hive proper were inserted four blocks, two inches high, one at each corner. The house was opened frequently, to put in and take out vegetables. The temperature varied from 38 to 40. The bees made considerable noise. Along in March the hives showed signs of dysentery, dampness, and mold. The average consumption of stores for four years was 14 lbs. 4 ounces.

Experiment No. 4. Two colonies were prepared by being raised off the bottom-boards two inches. The covers were removed, and in their places were put chaff cushions. Hives were then put into a pit 3 ft. wide, 3 ft. deep, and 10 ft. long. At each end of this trench there was a ventilator. This pit was then covered with cedar poles: over these a layer of

straw, and over all a foot of soil. Arrangements were made for taking the temperature during the winter. The mercury showed 38 to 39 degrees F. The loss of stores during the four years was 11 lbs. 4½ ounces.

Experiment No. 5. Two colonies were prepared for the house-apiary, having chaff cushions on top with a space of two inches between the hive-body and the bottom-board. The hives were removed a foot from the wall, and covered above and all around with a double thickness of sacking, and outside of this was a foot of cut straw. The average loss of winter stores was 15 lbs. 15 ounces for a period of four years.

Experiment No. 6. Two colonies were put into a cellar with the bottoms of the hives left just as they were brought in from the beeyard. The covers were removed, and nothing was left on except the quilts sealed down with propolis. The entrances were left wide open. During the entire winter the bees remained perfectly dry. The average loss of stores was 11 lbs. 7½ ounces for four years.

Experiment No. 7. Two colonies were put into the cellar, covers were removed, and chaff cushions put on top. The front of the hive was tilted up with a three inch block placed between the bottom-board and brood-chamber, making an entrance 3 in. across the whole front. The bees thus prepared wintered the best of any, showed no uneasiness of any kind during the whole winter, and came out in the spring in excellent condition. The average loss during a period of four years was 10 lbs. 8¾ ounces.

Experiment No. 8. Two colonies were left on their summer stands with extra packing all around their sides and on top. The cover was removed, and replaced by chaff cushions. No flying took place from Nov. 12 till April 7. On the 15th of April the hives were taken out of the packing-case, and found to be deserted. The frames were dry and clean, and had an abundance of sealed stores. The average loss in weight, including live bees during six years of trial, was 19 lbs. 1½ ounces. During only two seasons did the bees come out in fair condition.

Prof. Fixter's conclusion was that, in the locality where he tried the experiments, where the temperature would go below 15 below zero, outdoor wintering was wasteful and expensive, both in stores and bees, and he would recommend wintering in the cellar. The average loss from good indoor cellar wintering in stores was about 11 lbs., while the average loss of the outdoor-wintered colonies, even when they came through alive, was almost twice as much, or 19 lbs. The experiment in the root-cellar showed that, while bees can winter in a room or repository subject to frequent disturbance, yet they will do much better in a quiet cellar.

At the conclusion of the professor's interesting address a lively discussion followed. While the majority seemed to favor indoor wintering, some among this number, prominently among whom was Mr. Darling, took the ground that it is a bad practice to leave the bees in the cellar too long. Mr. J. B.

Hall, a bee-keeper of large experience, and whose opinion is valued most highly by the Ontario Bee-keepers' Association, winters both indoors and outdoors. He seemed to feel that, although outdoor-wintered bees consumed more stores, yet they were enough stronger to make up for the extra consumption of food. Had it not been for Mr. Hall I should have drawn the conclusion that for Canada, at least, indoor wintering was the only method. But when Mr. Hall said he wintered half of his bees one way and half the other, the inference was that what was gained in one case was offset by greater strength and vigor of bees in the other.

There is one thing certain: Indoor wintering, where it is very cold, causes a very much smaller consumption of stores than outdoors. Now, then, is it true that outdoor-wintered bees are always stronger in spite of the extra consumption of stores?

SPRAYING FRUIT WHILE IN BLOOM; VALUABLE EXPERIMENTS CONDUCTED AT THE GENEVA EXPERIMENT STATION, N. Y.

At the convention of the New York State Association of Bee-keepers' Societies, held in Geneva on the 9th of January, we had the very great pleasure of listening to an address by Prof. S. A. Beach, of the Geneva Experiment Station, detailing a very interesting series of experiments that were instituted to determine the advantage, if any, of spraying trees *while in full bloom*. These investigations had been requested by a certain class who believed that spraying during the time that the trees are in full flower was essential to the best development, growth, and maturing of the fruit. Prof. Beach called attention to the fact that a certain manufacturer of spraying-outfits, had sent circulars broadcast over the country, advocating and urging the administering of poisonous mixtures during the time that bees work on trees. Then there were also some among the fruit-growers of New York who advocated spraying at such times, but who could not carry into effect such practice because a law had been enacted in 1898, making it a misdemeanor for any one to spray during the time the trees were in bloom. Some of the fruit-growers (not all) sought on several occasions to have this law repealed; but being foiled they finally secured the passage of an amendment which provided that trees might be sprayed during blooming-time for *experimental* purposes. The object of this amendment (and it appears the bee-keepers did not object to it) was to determine whether there was any advantage in spraying when the trees were in full bloom, irrespective of any damage that might accrue to the bee-keeper. As a result of this amendment a series of experiments was begun at Geneva, and also at Cornell.

In the conducting of the experiments, Prof. Beach stated that several questions were kept in mind: What was the effect of spraying while the trees were in bloom? did the spraying at such times affect the blossoms? did it kill the pollen? and if not, did it affect the setting or the development of the fruit? what part did the bees play in the matter?

Some bee-keepers, he stated, were inclined to make sweeping assertions, to the effect that no fruit could set without the agency of the bees. This was altogether too strong a statement. That bees did play a most important part in the fertilization of some kinds of fruit-trees could not be denied. That question might be considered settled.

In the experiments that had been conducted, it was found that the blossoms that were sprayed just at the time they were in full bloom were either killed or injured. If the spraying were administered only during the blooming-time the poisonous mixtures did not go to the right spot, in a good many cases, for the simple reason that no cluster of apple-blossoms, for example, opened out at one and the same time. Some blossoms would be closed, and impervious to the effect of the spraying-liquids; and if no more spraying were administered after blooming-time, then those blossoms that were not open would not receive the benefit, and the fruit-eating insects would then get in their work. The professor brought out the point clearly, that if spraying were applied before blooming and after, the leaf-eating insects in the first case, and the fruit eating insects in the other, would be destroyed.

He further showed that the spraying-mixtures are exceedingly harmful to the development and growth of the delicate pollen. Some pollen was gathered and taken into the laboratory and mixed with a thin syrup, then afterward a quantity of spraying-liquid was applied, of about the strength that is used in spraying trees. It was found in every case that the pollen failed to grow. Then the spraying-liquid was reduced 50 per cent, and still mixed with pollen and syrup which had been prepared, and still the pollen grains failed to grow in most cases. The professor said he was decidedly of the opinion that spraying during blooming-time was exceedingly harmful to the delicate reproductive organs, and to the pollen itself in the flowers of the fruit-trees. He referred to a certain Mr. Kellogg who had tried spraying strawberries while they were in bloom, and much to his sorrow. He mentioned a number of instances of fruit-men who formerly had believed that spraying during blooming-time was the correct practice, but had now been completely converted.

In the experiments that were conducted in four orchards located in different parts of the State, a certain set of trees were set apart and sprayed while in bloom, and only then, and others were not sprayed. Even though the bloom was exceedingly abundant, it was found that those trees that were *not* sprayed during blooming-time yielded from a third to a bushel and a half more of fruit. In some cases they sprayed a half of one tree *several times* during blooming time, leaving the other side of the tree not sprayed. There was a marked difference in the setting of the fruit on the two sides of the trees, and that difference was decidedly in favor of the side not sprayed. Experiments were conducted in fruit-orchards in different parts of the State; and in one instance, at least (the professor

would not give the name) a certain fruit-man who believed that spraying during blooming-time was the right thing to do, estimated, after he had sprayed his whole orchard at such time, that he had lost nearly a thousand dollars. He had had enough of that business.

The professor stated, however, that there was one instance when spraying right during blooming-time might prove to be advantageous; and that was, to kill the apple-scab that might come on at just that time; but even in such a case it has not yet been proved that spraying before and after bloom may not be equally efficient. But, generally speaking, the conclusion seemed to be that spraying during blooming-time was not only wasteful but decidedly harmful as well, cutting down the supply of fruit to an extent that, if generally practiced, would amount to thousands of dollars to the fruit-men all over the State.

On the evening of the first day we listened to an excellent address from another professor of the same station—Prof. V. H. Lowe. The experiments that had been conducted under his direction were for the purpose of determining the value of insects in pollinizing fruit-blossoms. A certain set of nine small pear-trees (it was not practicable to use large ones) were enveloped in a hood of sheeting. This hood was large enough to slip down over the whole tree, something in the form of a bag—the bag tied at its bottom around the trunk of the tree. The object of this was to keep out insects, ants, bees, or any thing that might assist in pollinizing the blossoms. For the purpose of ventilation, some windows were made in the sheeting, and the openings covered with a fine netting. On all of these trees so covered, there was a large number of buds, and all the conditions were favorable for a good crop, except that the flight of insects was entirely cut off. Now, then, for the results: Out of the whole lot of trees covered, there was just one fruit. On another set of trees not covered there were 145. In the other case, where it was not practicable to envelop the whole tree, one large limb, for instance, would be inclosed in the bag, the mouth of the bag being tied around the trunk of the limb. In one such instance there were 2483 buds of an apple-tree that were thus covered with the sheeting. Out of that number just one fruit matured. There was plenty of fruit on other portions of the tree where the limbs were not covered. In one case, where the sheeting broke open so that insects could get in, there were 13 perfect fruits from 818 buds. It was clearly shown that bees or other insects play a most important part in the pollination of average fruit-trees. When the professor was asked how much of this pollination was attributable to bees and how much to other insects, he said he could not tell; but Mr. O. L. Herschiser, in referring to a similar set of experiments made some years ago at the Michigan Agricultural College, showing the same results, said that the bees were altogether the earliest insects out; that at the time the average fruit-tree is in bloom it is too early in the spring for other insects to be of any value. In his opinion the covering of the limbs or the

covering of the whole tree as explained by Prof. Lowe (with the result that little or no fruit had set) showed clearly that the bees, and they alone, did the mixing of the pollen.

At the conclusion of both addresses, both professors were given a most hearty vote of thanks for the interesting and valuable testimony they had produced; and this testimony was the more valuable because both men began these experiments at the solicitation of the fruit men, anxious to show that spraying during blooming-time was not detrimental but decidedly advantageous. Verily the bees in York State have been and are being vindicated on every hand.

President Marks said he had made the statement that 95 per cent of the bee men of the State were also fruit-growers. He wished it understood that a large number, yes, the majority of fruit-growers, acknowledged that the bees were their best friends; that it was only a few of the fruit-men who were at variance with the bee-keepers; that there was no real fight between bee keepers and fruit-growers.



The effectual fervent prayer of a righteous man availeth much.—JAMES 5:16.

Dear friend, do you know of somebody who is very kind, accommodating, skillful, and helpful in every way when he feels just like it; but when he does not happen to feel just like it he can be as contrary, disobliging, and vexatious as he is at other times good-tempered? I suppose such people are all over the world. When you take them just right, or when they happen to feel like it, they are most estimable people and valuable citizens. At other times they are so contrary, disobliging, and *ugly* (to get right down to it), that it is hard work to live near them and be obliged to have any thing to do with them.* May be you remember having got hold of a certain hired man or girl who was of this sort. When she or he first began work you wondered how it was that he changed places so often, and

* Sometimes a man is wanted for a particular job—often times something of very great importance. The question is, "Who can do it?" Finally we hit upon a man who would fill the bill exactly, providing he took a notion to. Sometimes the question comes up before a committee. This man is peculiar. If the right person should present the subject to him when he happened to be in one of his accommodating moods he might fall in with it and do it to our entire satisfaction. Again, if somebody he did not like should present the matter, or he did not happen to be in an "accommodating mood," he would refuse to have any thing to do with it, and, may be, declare flatly it could not be done. A great many times I have met just such contingencies. It is not only in business matters, but in temperance work, and in various greatly needed reforms. We can not say we will have nothing to do with one who is so changeable (and we might almost say untruthful); for sometimes it seems as if the world could hardly get along without them. All we can do is to make the best of circumstances and of the people we meet. Earnest prayer and patient labor are the two things needed, and a broad charity for those who are beset with these human infirmities and weaknesses. May God help us.

yet was so reasonable in his charges. As time passed, and you became a little better acquainted, little by little this person began to show out his moods and streaks and inconsistencies, and then the secret was out. What are you going to do with such people? Somebody said a while ago she would not have a girl on the premises who would tell deliberate falsehoods. But, my friend, you can not very well lay down rules. I have sometimes thought these people I have described did not really *mean* to tell a falsehood, and that, in fact, it hardly ought to be called a falsehood. Your hired girl or man gets one of these streaks, and declares the thing you want done can not be done. You explain fully what is wanted, and tell him you could do it yourself easily if you had time. But, unfortunately, a bad spirit has got hold of the otherwise usually skillful and ready helper. He insists it can not be done, gets contrary, and pretends he did not understand just what you wanted. The result is, wasted time and loss of property. There is a controversy or conflict between you two, and the hired man comes out ahead. May be it is the hired woman or hired girl who comes out ahead. In one of our Home Papers recently I expressed a dislike for the term "hired girl;" and just as I expressed a dislike for it a writer suggested that we say "housemaid." The woman of the house is the housekeeper, or housewife, if you choose. Her helper is the housemaid. Well, now, this housemaid, or hired man, as the case may be, thinks he is telling the truth when he said he did the best he could. If you question him, perhaps he will insist that he did the best he could, and furthermore declare, perhaps, that the thing you wanted can not be done. May be by this time you are sufficiently stirred up so you drop other important duties, and go to work and show him just how easily the thing can be done if one goes about it in the right way; or perhaps you call in somebody else who has not "got his back up" on this particular matter, and let your hired help see you are right. Is he convinced, and does he beg your pardon? Generally speaking, he does not. He is still contrary; and this is one of the sad phases of humanity. Perhaps somebody puts in right here, "Get rid of him." But, my dear friend, this same person has many grand good qualities, and he has many lovable traits. He can do things that nobody else can do or has learned to do. You can not afford to let him go, unless, indeed, you let the same spirit into your heart that has found a lodging-place in his, and "cut off your nose to spite your face." I beg pardon for such a piece of slang, but it just hits the spot. Perhaps some of you say, "Well, Bro. Root, what would *you* do? or what *do* you do under such circumstances?" In the first place, I try to keep my temper. If you lose your temper you have stepped down from the throne where reason holds sway. You are standing exactly on the same level with your contrary man. "He that ruleth his own spirit is greater than he that taketh a city." But if you get stirred up you can not take any city at all; in fact, you can not

capture one single commonplace individual. The man who allows himself to get angry is like one who has let go of the lines with a runaway horse—yes, even when even his very life *depends* on a firm steady hand. Therefore do not let your opponent see he has vexed you. Very likely that is just what he is trying to do. When you have got the contrary spirit all out of your heart, then you are ready for our text, especially the latter part of it—"the effectual fervent prayer of a righteous man availeth much." *Pray* for the man who vexes you. Some of you, especially those who do not believe in prayer, may say, "Why, Bro. Root, the whole thing is preposterous, to pray for a man who has spoiled your property, wasted your time, and then looks you fairly in the face, and *lies*."

I know, dear friends, it is demanding a good deal of humanity—especially untrained humanity. It is easy enough to read over the words, "Pray for those that despitefully use you" when you are not in conflict with somebody; but to ask a man, right when he is greatly vexed, to stop and to try to pray for the man who acts in the way I have described, is a pretty hard thing to do. I know, because I have tried it; but, O dear friends! it is the *only* road from earth to heaven; it is the *only* way to save the world from sin. Our text says the prayer of a *righteous* man availeth much. If you are contrary, ugly, and untruthful, like your hired man, there is no promise that the prayer will avail; and, oh dear me! I have come now to the saddest part of my talk.

When I was trying to describe to you the contrary hired man or housemaid it kept forcing itself on me that I was almost unconsciously describing my poor self, or at least a part of myself that *too often* comes in sight. While I think of it I can only say, "May God have mercy on *me* a sinner."

If I, then, am ready to acknowledge that I am one of the contrary sort—one thing at one time and another thing at another—what right have I to expect my prayers shall amount to any thing? Well, in one sense I have not any right; but the dear book says (thank God) that Christ Jesus came into the world, not to save the righteous, but to bring *sinners* to repentance. We read, too, "Him that cometh to me I will in no wise cast out," and this includes sinners like me and everybody else. Now, then, dear brother or sister, do not turn off your housemaid because she has a fashion of behaving as I have described. Pray for her—pray that the spirit of Christ Jesus may get into her heart and drive out this spirit of Satan. Do not forget to include yourself and your own heart in this plea to the great Father above. When you are off by yourself in your own closet, where none but God can hear, you can say, if you choose, "O God, have mercy on *both of us*. Help me to set a good example; help me to forget these unpleasant acts and untruthful words; and may the Holy Spirit rule and *guide* both of us." O dear friends, you do not know how such prayers help. I have seen men and women transformed in just a little while. Yes,

I have been so astonished at the result of such prayers that I have gone off by myself again and again, just to thank the dear Savior, and to ask him to forgive my want of faith—to forgive me for not having faith to believe that such blundering prayers from a heart already stumbling and blundering so *far* out of the straight and narrow path should avail so much. Oh how I do like those two words, "avail-eth much"!

Suppose you have forgotten yourself, and ordered your impudent, untruthful hired man off the premises. Would it have made him behave any better with his next employer? I do not believe it would, especially if you are a professing Christian. He would have gone away soured against all the world—professing Christians especially. Years ago I had a man working for me whom I had taken from our county jail. In just a few days there was a fight started between him and one of our regular men. I got between them, and, after a good deal of hard work, had the two shaking hands, and begging pardon for the misunderstanding. He told me afterward that he had been in lots of fights during his life, but he never before saw a fight end in that way; and I am afraid his experience is too much like that of a good many others.

Our text enjoins us to confess our faults one to another. Of course, the man who employs some one to work for him must preserve proper dignity. If your hired man sees that you are afraid of him when he gets contrary, he may undertake, especially if he is one of the ignorant sort, to take advantage of you. The matter should be settled in the outset that you are to direct things and he is to work according to directions. If he is a reasonable man he will agree to this; but, sad to say, it is not the hired man and the housemaid alone who are sometimes one thing and sometimes another. We have neighbors who act in the way I have described; yes, we have sisters and brothers *in the church* who seem to forget themselves, and think it no very serious thing to be contrary; and, oh dear me! I almost forgot to say that we have employers who will be pleased with work at one time and at another time get into a mood so they would not be pleased with any thing, and scold and make a fuss when every thing is all right. Yes, there are housewives who are this way. There are policemen and sheriffs who let a man go scot free at one time, and then take him up at some other time for a very trifling offense as their mood changes. And we really can not stop with policemen and sheriffs. I have seen judges on the bench, who, because they were prejudiced against a certain one who was in their power, would so far forget themselves and their—I almost said *sacred* calling, for the man who is chosen to hold the property and sometimes the life of a fellow-being in his hands does have a high and sacred duty and a great responsibility on his shoulders. Yes, even judges on the bench, I am sorry to say, sometimes let little personal spites or prejudice for or against certain persons warp and bias their decision. May I suggest that not only the governors of our

States, but even the President himself, does, at times, show, let us say, "human weakness" in the direction I have been talking about. May God help us, not only in dealing with the hired man and the housemaid, but in whatever we have to do with the affairs of the town, city, State, and nation. May we also remember that the fervent effectual prayer of a righteous man availeth much.

Dear friends, as we step out into this new century we have certainly one thing to rejoice about and to thank God for—the decision of both House and Senate in regard to beer among the soldiers. For a time it seemed as if those in power were all against us; but we are, as a rule, a praying people. I knew of the fervent prayers of righteous men and women that were ascending to the great throne of Him who judges all the earth, and in view of this I ought not to have been surprised when some of our great officials in Washington said they would vote for the abolition of beer, not because they *believed* it was best, but because of the *importunities* of the people. Truly the fervent prayer of a righteous man does avail much, not only in humble places but at the very head of our government. Let us have faith, and let us believe that, if we follow the teachings of God's holy word, we shall prevail, not only in the home and on the farm, but at the very head of the government of this nation.

In closing, permit me to quote some beautiful words that came from the Bible Truth Depot, Williamsport, Pa.:

When you are forgotten or neglected, or purposely set at naught, and you smile inwardly, glorying in the insult or the oversight—that is *victory*.

When your good is evil spoken of, when your wishes are crossed, your tastes offended, your advice disregarded, your opinions ridiculed, and you take it all in patient, loving silence—that is *victory*.

When you are content with any food, any raiment, any climate, any society, any solitude, any interruption—that is *victory*.

When you can bear with any discord, any annoyance, any irregularity, unpunctuality (of which you are not the cause)—that is *victory*.

When you can stand face to face with folly, extravagance, spiritual insensibility, contradiction of sinners, persecution, and endure it all as Jesus endured it—that is *victory*.

When you never care to refer to yourself in conversation, nor to record your good works, nor to seek after commendation, when you can truly "love to be unknown"—that is *victory*.

PLACING THE NEGRO ON THE SAME FOOTING WITH WHITES.

I have been accused of this in our two last issues; but permit me to plead not guilty. All I undertook to do was this: To hold the colored people responsible for their behavior, which is something they *can* help, but not hold them responsible for the color of their skin, which is something they can *not* help. Where I spoke of having a colored man or woman sit down with me at my table, I suppose I gave the most offense to some of my good friends in the South. My position was and is that behavior should decide whether he is fit to sit at the table, and not color. Who-

ever works for me, outdoors or in my home, I shall try to teach good manners, truth, and righteousness; and if having a person sit down with me at the table, say once a day, would help in lifting him up, I should be willing to put up with whatever inconvenience it might cost. If he persistently refused to be decent and respectable, I presume I should give up the experiment. Quite a number of letters have come, protesting against what I have written along this line. Just *two* have ordered their journals stopped. But there is one other subscriber who said he had decided to take GLEANINGS another year just *because* of my defense of the colored people; so at present writing we have lost only one subscriber. The *Country Gentleman* was so well pleased with my treatment of the hired girl that the editor copied my article entire, and here is what he says at the conclusion of it:

One of the editors of the *Country Gentleman* has employed only colored servants for fifteen or twenty years; and it is fair to add that in all the number there has never been one that was not scrupulously honest.

Perhaps the colored help mentioned in the above were brought up in the North. And then another fact seems to stare us in the face right here. It makes a difference as to whom the colored help (or white help either, for that matter) is working for. Some employers would discourage any form of dishonesty at the very outset, and I am sorry to say there are others who would without meaning it tend to encourage it.

In regard to Tuskegee, so large and influential a periodical as the *Outlook* has just employed Booker T. Washington to write them a series of articles in regard to his industrial school and his lifework.

Now, dear friends, I am sorry to have even *one* of our readers order his journal stopped because of any thing I may do or say; but when I feel sure that I am doing "as Jesus would do" I do not know how I can change my views or teachings.

Temperance.

The following from State Superintendent P. A. Baker will certainly be of interest to all Ohio people, and it ought to interest, and I rather think will, everybody else, no matter what State he lives in, especially if he is interested in the matter of getting rid of the saloons.

I presume you have heard of the splendid victory we won last week at Lebanon in putting out 14 saloons, thus adding another county-seat to our temperance belt, making six county-seats in Ohio without saloons. I believe we can make Warren County a dry one in a short time.

The six county-seats referred to in the above are as follows: Lebanon (Warren Co.); Bellefontaine (Logan Co.); Cadiz (Harrison Co.); Jefferson (Ashtabula Co.); and last, but not least, Medina (Medina Co.). Now can't somebody tell us of another county-seat that is almost ready to be included in the roll of honor?



Some of you will remember that in November, 1897, I gave a picture of a hen and chickens, entitled "The Youthful Mother," the White Leghorn pullet that commenced laying when she was 4 months and 16 days old, and in 5 months and 21 days she was the mother of a brood of chickens. I said then I should like an oil painting of the hen and chickens to hang up where I could see it every day. A lady who reads GLEANINGS volunteered to make the picture. It is in our dining-room, where I see it and feel happy several times a day. Well, this youthful mother belonged to O. W. Mapes, of Middletown, N. Y., the "electric hen-man." Ever since reading this story I have had a great desire to visit the electric hen-farm. After I had promised to attend the Utter trial it occurred to me this egg-farm might be somewhere in that part of York State. Sure enough, Middletown is in Orange Co., the same one where the unbrotherly brothers live, just one station away from Goshen. So I started off a day or two ahead of the time for the trial, and, finding we had a bee-keeper in Middletown, I proceeded to look him up. Somehow I had several streaks of good luck during that visit. Mr. C. Belding is not only a bee-keeper, but a gardener and florist, and has been all his life. Just now his boys (like mine) are taking charge of the greenhouse and other business, and letting him take things easy. Friend B. knew all about the electric egg-farm, and kindly volunteered to take me there with his horse and buggy.

Although Orange Co. is one of the richest ones in the State of New York, it contains some stony and hilly ground that is almost unfit for any thing unless it is an egg-farm. All around among these stones and hills Mr. Mapes several years ago started his egg-farm. Little houses to the number of 50 or more are scattered all through among the rocks and hills. For three or four years he had communication with each house by means of electricity. As many of the little buildings are so far away from home, and out among the wilds, it becomes quite necessary to shut the pullets up nights on account of wild "varmints" as they used to express it in olden times. Electric wires open the houses all at once, every morning, and shut the doors every night after the last straggler has got inside. These same wires open the feed-boxes and close them. Now, I do not exactly understand whether it is the same wire or an extra one that does this.

Stoddard and many other good authorities claim, you know, that fowls, to do their best, must have just what they *need* in the way of food, and not all that they will *eat* if they can get it all day long. More than one poultryman, however, has found out that it is a big job to give several thousand chickens just so much and no more. After working the machinery

for three or four years, Mr. Mapes has dropped it; and now as he goes around to the houses every morning to carry feed and water, he lets the chickens out and then makes another trip every night to gather the eggs and shut the hens up. He is satisfied that as good results are secured by giving the chickens all they will eat all day long—that is, certain kinds of food, and food that is just right. Perhaps the expense of the apparatus, and keeping it up, has something to do with it. He has made a great many exhaustive experiments—among others, one in regard to the matter of exercise, the point on which Stoddard lays so much stress. He confined a hen under a peach-basket where she could have no exercise at all except to turn around, and she laid 84 eggs, if I remember correctly, without missing many days. Of course, he gave her the best kind of rations, and supplied every thing as well as he could *except* exercise. I believe, however, he places a value on a reasonable amount of exercise, for his fowl-houses are something like 6 or 8 rods apart all over the farm. With this arrangement all the chickens go "home" to roost. I forgot to ask if he did not have a few gossiping hens that went gadding all over town, stirring up musses and jealousies. Oh! by the way, roosters never quarrel when there are no hens around. In fact, he had thirty or forty in one pen, and they were as brotherly as could be. The hens stir up jealousy and hatred. Come to think of it, I do not think this is true of boys and girls. How is it, young people? Thank God, we are a notch or two higher up in the scale than chickens.

Mr. Mapes keeps almost entirely White Leghorns, like the picture of the pullet I gave you. He gets from 5 to 8 cts. a dozen more for his eggs because the purchaser knows exactly what day they were laid. Every case is sent to New York city, with a certificate that the eggs were laid on such a day, and consequently there are never any bad ones or stale ones. Very likely *you* can not do it unless, indeed, you have as good a reputation for truthfulness as Mr. Mapes has.

Although it was a cold freezing day, as our trip was taken along toward noon, when the sun was warmest, the brooder-houses where the young pullets were kept were opened, and they were allowed to jump, run, and fly over the fields, up hill and down. The brooder buildings were closer together than those for laying hens. I should think that perhaps a hundred half-grown chicks were in each building. A lamp with an ingenious hot-water brooder kept the chickens warm. I expressed a fear they would take cold by going out into the frosty air after being around the hot-water pipes; but the way they cut up and ran there did not seem to be much danger; besides, they had lived in that way till they were fully feathered out, and were as handsome as white doves, and about the same size. You see, if a chick felt cold or tired it could go back into the brooder whenever it felt so disposed. As a rule, each chick goes back into its own home like a bee out of its hive. But their owner said if they got mixed up somewhat it did not

matter. I think he sells the manure to tanners.

Some of his methods for saving time made me think of our veteran friend Doolittle when somebody was asking about being so careful about killing a bee. Friend Doolittle suggested that a man's time was of too much value to wait for one or two bees to get out of the way. Well, Mr. Mapes cures sitting hens by putting them in a rough cage in the upper part of the poultry-house. He does not make any provision for food or water. It would make a great deal of extra trouble, and he says they get over the sitting fever rather *better* for their fast of 48 hours. Fifty fowls have four nests to lay in. I asked him if there would not be too many in one nest. He said they were sometimes even "two or three deep" when laying, but he did not think it mattered. When I asked what kind of nest-egg he used he looked at me in surprise.

"Why, what do you suppose I want of a nest-egg?"

I ventured to suggest, timidly, that they would lay more eggs. I do not remember just his reply, but it was somewhat to the effect that when they were ready to lay the eggs must be put somewhere. Now, I hope I am not presuming, in disagreeing with such good authority as Mr. Mapes; but when one of your biddies plays a trick on you, and slips off by herself, and fixes up a real nice nest, doesn't she get that nest full quicker than if she had to lay in some conspicuous nest occupied by several other hens? Right here in the middle of January, during two or three warm days one of my pullets strayed into a sunny place in an unused open shed, and made a most elaborate nest, and laid an egg in it. I saw her skulking around out of my sight, and I was pretty sure that was just what she was up to. I feel a good deal disappointed because the weather is so cold she can not get off so as to use that nest again to day, for I think she would work harder, and lay more eggs, if she thought she was managing things all on the sly.

Friend Mapes urged us, on our way home, to look in at a plate-glass window on a particular street. What do you think we saw? Why, some 20 or 30 White Wyandotte pullets, the handsomest chickens I think I ever saw anywhere. A beautiful placard right over their heads, plain enough to be read clear across the street, was something like this:

"We were hatched during fair time, last fall. We have been fed all our lives on Mapes balanced ration for poultry. In fact, we have never had any other food. Aren't we beauties?"

And they seemed to be just as happy there in that window during that cold winter day as if they were out in the green fields chasing grasshoppers. The above was an advertisement for a certain firm, I know; but I think such advertisements are all right. Mr. Mapes uses this poultry food very largely in all his operations, and he has a theory that the proper amount of this food, with every thing else kept away, will cure the roup; and this I think he has demonstrated several times.*

Chickens, like human beings, depend largely for their health and happiness on having plenty of pure wholesome food instead of being obliged to drink stagnant water and eat all kinds of filth, as they have to do when they are starved to it.

I feel a little sorry because I am having so much to say about poultry just now, to the exclusion of so many other important matters; but somehow the spirit seems to move me in just that particular direction this winter, and I believe I have got hold of some valuable facts.

Oh, yes! I described to Mr. Mapes my underground tunnel warmed by exhaust steam, and asked him what he thought of getting eggs in winter by having the ground under the poultry-houses dry, and warmed by steam, or even running smoke and hot air through drain-tile or sewer pipe a foot under ground. He said that, with what experience he had had, he was quite well satisfied this arrangement would give an abundance of eggs when the weather was very cold and the price away up. With exhaust steam, as we use it, he said there was no question about it; but if one had to fire up, and keep a little fire going to warm the ground under a range of poultry-houses, only a test would decide whether it would pay for the *cost of fuel* and some one to look after the fire.



"HIGH PRESSURE"—EGGS.

A short time ago every one was wanting eggs, and there were none to be had. There were none at the stores, but there were a few skillful poultry-keepers who were getting eggs every day. The price ran up to 18, 20, 22, 24, and finally to 26 cts. a dozen; and I am told some people paid 30 cts. a dozen rather than go without eggs entirely. There were two reasons why the hens did not lay. The old ones had not finished moulting, and the young ones had not commenced laying, and it was too cold weather. I made some investigations as to how the skillful ones managed to have eggs at such a time. It was usually a flock of poultry where *women* had the management, and I talked with these skillful women about it. Finally an idea came into my head. A few years ago while visiting friend Boardman at East Townsend, O., he invited me out to visit his hot-beds. This was in the middle of winter; but when he raised one of the sashes, instead of seeing Grand Rapids lettuce and vegetables I saw some fine-looking chickens scratching and having a fine time there under the glass, even if it was almost zero outside. The fowls could go from the warm house right out under the glass.

*If you want to know more about this balanced ration for poultry, address L. R. Wallace, Middletown, N. Y.

Now, if you will turn to your A B C book and find the winter view of our own apiary, under the head of "Wintering," you will notice a row of hot-beds running from the factory over toward my residence. This row of hot-beds is right over the pipe that carries the exhaust steam to warm our house. Over near the evergreens there is a hot-bed 12x28 feet. I raised the sashes on this high enough to stand under, making a close warm north wall. You will notice the apiarist has passageways about 6 feet wide so he can get through the line of hot-beds. In order to let the poultry get from one bed to another I made some underground tunnels right beside the exhaust-steam pipe. When I told Mrs. Root of my plan she said, "You will never get chickens to go down into burrows under ground in that way. It might do for wild animals."

Well, I did have some trouble in educating the biddies; but after I scattered corn through that tunnel, and then cut off their rations until they had to go in there or go hungry, they learned the trick; and now my Brown Leghorns will dive down into that underground passage and out at the other side quicker than a wink. In fact, during very severe weather the underground tunnels have become a favorite place to scratch in and keep warm.

Just as soon as I got the thing rigged, and the fowls had learned how to use it, my pullets all began to lay. You see the ground in these tunnels is perfectly dry—not only as dry as dust, but as warm as dry dust baked in an oven. I have talked with several poultry-men about having steam-pipes, or even flues, a foot or more under ground, right under a line of greenhouses. Just common tiles will do, and you can send either exhaust steam or even smoke, on the plan of fire hot-beds described in the tomato book. This will keep the ground dry and warm. You do not need to have a fire in it every day. When the ground is once thoroughly warmed up it keeps nice and dry for several days, especially if protected so that no rain or snow can get on it. Glass sash does this beautifully. I have talked with several poultry-raisers in regard to this method of keeping the ground warm and dry under a range of houses. They all declare it would be tiptop. The only objection is the expense. Well, with the exhaust steam here that is available, there is no expense except the cost of the apparatus; and with high-priced fowls—that is, where there is a range of houses—the expense of fire enough to warm up the ground under the chickens' feet need not be great. We are told again and again that poultry can not stand dampness; and that dry earth or dry dust is the best remedy for insect enemies and disease. Dry warm earth to scratch in is the natural thing for chickens; and a lot of dry leaves scattered right on the dry warm ground seems to be just the thing. Poultry manure is never offensive, and there never come any bad smells from it, if it drops into the *drydust*. I was particularly struck with this in visiting poultry-ranches in Florida. The dry clean sand that covers the ground everywhere seemed to take care of the droppings so they were never offensive to

the sight. Well, as soon as I can get a hen to sit I am going to try my hand at raising chickens in those dry underground tunnels. As soon as they can run about I think it will be safe to let them take exercise right under those glass sashes, even if it is zero outside of the glass a foot above their backs—that is, when they are alongside of this warm steam-pipe. One of the beds is to be filled with Grand Rapids lettuce. When the chickens are small we will let them run right among the lettuce-plants. I have before remarked I believe it would pay to grow Grand Rapids lettuce just for poultry and nothing else. This winter I propose to make a test of it. If the lettuce brings a big price we will sell it, giving the chickens the refuse. If there should be no great demand for it, then we will turn our lettuce into eggs, just as the farmer turns his corn into pork before he sells it.

Now while we are getting eggs all the time as I have described, a larger number of fowls in the poultry-house and in the barn (and this is a good warm place also) did not lay an egg during December or January. But, of course, they do not have the warm underground tunnel to run into.



SYRUP-CANS.

We are putting in a stock of a carload of cans of 1-qt., 1/2-gallon, 1 and 5 gallon capacity. To those wanting cans for syrup we can furnish the one-gallon size, 100 in a box or crate at \$10.00 per 100; 500 or over at \$9.00; 1/2-gallon size at \$8.00 per 100; 500 lots at \$7.25; 1/4-gallon at \$7.00 per 100; 500 lots at \$6.25. These cans all have a 1 1/2-inch screw cap, with tin seal, with rubber gasket. We have a supply of 1/2-gallon cans with 2-inch lever seal, which we offer, to close out, at \$1.00 per .00 less than above; i. e., \$6.00 per 100; 500 at \$5.25. These are perfect, and seal just as tight as any; but we are discontinuing this style, and therefore offer them, to close out, at above special price.

RECORD SAP-SPOUTS.

We can supply the Record sap-spouts at \$1.00 per 100, or \$9.00 per 1000. Sap buckets we do not keep in stock, but we can supply them, shipped direct from the factory in Conneaut, O., at the following low prices:

	10 qt.	12 qt.	15 qt.
I C bright tin	per 100.....13 00	14 00	16 00
I X " "	" " " " " " " " " " " "	15 00	16 00 18 00
Galvanized iron	" " " " " " " " " " " "	" " " "	18 00 20 00
Best charcoal tin add	" " " " " " " " " " " "	1 50	1 50 1 50

CLIMAX POULTRY-NETTING.

Our new contract for Climax wire poultry-netting for this season will enable us to offer it for shipment either from here, Chicago, or Georgetown, Conn., at the following very low prices per roll, 150 feet long, 2-inch mesh:

12 inch,	65c per roll.
18 " "	1 00 " "
24 " "	1 30 " "
30 " "	1 65 " "
36 " "	2 00 " "
48 " "	2 60 " "
60 " "	3 30 " "
72 " "	4 00 " "

We have 3/4-inch staples for same, at 8c per lb. Climax netting is much stronger than other brands of No. 19 netting, and w 1 roll out flat and smooth. It is made with 3-strand rope-selvages, and is galvanized after being twisted. It is warranted to last for 25 years in any ordinary exposure.

60-POUND HONEY-CANS AT SPECIAL PRICES.

We have secured in Buffalo, N. Y., a choice lot of second-hand 5-gallon honey-cans, put up two in a case. We are assured that they have been cleaned inside and out with steam, and thoroughly dried before they were repacked in the boxes. We offer them in lots of 10 cases at 50c per case; 50-case lots at 45c per case; 100 or more cases in one order, 42c. Where cans have been properly handled they should be just as good to use a second time for honey as the first, and this price is less than two-thirds what new cans cost at present. There are about 1000 cases in the lot, and they should not last long at this price.

EXTRACTED HONEY.

We have on hand the following lots of extracted honey, which we offer while they last at price annexed:

Lot.	Quantity.	Source.	Price per lb. case or bbl lots
No. 68	18 cases	Cotton	7c
" 75	25 bbls	Basswood	8½c
" 79	1 case	Cotton	7½c
" 80	6 kegs	Buckwheat	6½c
" 85	4 kegs	Buckwheat	6½c
" 88	6 cases	Amber Calif.	7c
" 89	73 "	Light amber California	8½c
" 90	2 "	Buckwheat	7c
" 93	2 "	Buckwheat	7c
" 94	6 "	Goldenrod	7½c
" 95	18 "	Clover	9c
" 96	2 lbs	Ratan vine	7c
" 97	19 cases	Mesquite and horsemint	7½c

BUSINESS AT THIS DATE.

While business was rather quiet through the fall we have had plenty to do since Dec. 1, and are already somewhat behind on our carload shipments. With the several cars we are working on as we go to press we have shipped twenty cars of bee-keepers' supplies, a half of them being exported, and the other half going in various directions. We have orders entered for ten cars more, and others expected before these are completed. Mr. Danzenbaker has been developing such a trade in his hive that he has thought best to put in a carload of stock in Washington, D. C., where those in the East and South can order of him direct. In this connection we might say that the Danzenbaker hive for comb honey is becoming more popular each year, especially in the East.

Special Notices by A. I. Root.

WANTED—SWEET-CLOVER SEED.

If any of you have any, send us a sample and tell us how much you have and what you want for it.

RICE POPCORN, EXTRA FINE.

We can furnish a very superior article of rice popcorn, either for popping or planting, as you choose, for 10 cts. per quart, 60 cts. per peck, or \$2.25 per bushel. If wanted by mail, add 15 cts. per quart for postage.

STRAWBERRY-PLANTS, VEGETABLE PLANTS, ETC.

With all the other business we have on hand at the present time, we are, somewhat reluctantly obliged to give up dealing in plants. We shall grow choice strawberries, mainly in order to test new varieties, and may offer them for sale at the proper season in tens and hundreds. For any larger quantity, we take pleasure in referring you to Flansburgh & Peirson, of Leslie, Mich. We have just printed for them 15,000 very pretty catalogs of strawberry-plants, seed potatoes, etc. Better send for their catalog, anyhow; and if you send them an order I am sure they will give satisfaction. We have never received any nicer plants than those we had from the above firm.

ADVANCE IN THE PRICE OF CLOVERS.

All of the clovers except white—namely, alsike, alfalfa, white Dutch, medium, peavine, or mammoth, are worth now, bushel, \$8.00; half bushel, \$4.25; peck, \$2.25; 1 lb., 20 cents; 1 pound by mail, 30 cents. The above prices take the place of all other previous quotations; and we can not guarantee them except for

immediate orders as soon as this reaches you. Prices are going up so rapidly it is almost impossible to guarantee quotations one day ahead. Now, then, this is rather bad for the people who are obliged to buy; but it offers a splendid chance for those who are prepared to grow clover seed. If farmers need to make a fair living at three or four dollars a bushel, what should they be able to do at present prices?

STODDARD'S NEW EGG-FARM.

The above book seems to be getting your humble servant into trouble. While many who have purchased it report that, all together, they think it worth what it cost, there are quite a good many who rather lost confidence in A. I. Root when they came to see the book he gave such a tremendous recommendation. Well, friends I first wish to humbly beg pardon. I supposed that such a plant for growing chickens by machinery was in actual operation; but since I have not found it, all you who did not get the worth of your money may mail the book back and I will extend GLEANINGS to the amount you paid for it, and after this I will go slower in recommending nice chicken-books, even if they are full of pictures.

THE PLANET JR. CATALOG FOR 1901.

It seems to me that every one engaged in market-gardening, etc., should send for one of these catalogs, just to look at the pictures. The photos of the grounds of successful high-pressure gardeners ought to be worth a great deal in the way of an object-lesson for one to look at. It shows what crops are possible, and also shows the importance of getting your ground in excellent condition. It gives you glimpses of successful work that you might have to travel a thousand miles or more to see otherwise, describing all the latest improved tools for both man and horse power. We can furnish you the catalog on application, and we can also furnish the tools described in it. As a work of art this new catalog is a gem. It contains half tone pictures of 28 different farms, and gardens to illustrate how these tools are used on growing crops. See advertisement of S. L. Allen & Co., Philadelphia, Pa., on page 117.

THE AMERICAN COFFEE-BERRY, OR EARLY SOJA BEAN.

We have received two communications recently in regard to the value of the above for food. On page 157, 1900, Mrs. Axtell says: "We like them very much; we like the taste of them, and then they are so beneficial to our health. They seem to be nutritious and very laxative. Until using them Mr. A. had to use cathartics every day; now, scarcely ever." Now, this is an important matter where wholesome food can be made to take the place of medicines. In our next we will give a report of where eight bushels of mature beans were grown on ¼ acre, on poor soil in our neighborhood, and that with ordinary culture. We have secured the crop, and offer it for sale as follows: Pint, 10 cts.; quart, 15; peck, 75; bushel, \$2.50. If wanted by mail, add 15 cts. per quart for postage. Remember, these beans are just as good for coffee as they ever were. Mrs. Axtell suggests using a fourth of real coffee; then you have the coffee taste together with the nourishing properties of the soja bean. Our experiment stations tell us there is scarcely any thing grown with the amount of nutrition in so small a compass as the soja bean. The crop we offer for sale was planted May 15, and the beans were matured and harvested Sept. 5. Soja beans, same as above, only longer in maturing, peck, 60c; bushel, \$2.00.

OFF FOR FLORIDA.

Providence permitting, I expect to leave home Feb. 4, to be gone until about March 1. Will the friends who usually correspond with me direct in regard to gardening, fruit, etc., please bear this in mind?

CONVENTION NOTICE.

The Wisconsin State Bee-keepers' Association will hold its 17th annual convention at the State Capitol, Madison, Wis., Feb. 5th and 6th.

E. R. Root, editor of *Gleanings in Bee Culture*, will present his stereopticon views on the evening of February 5th. These we know to be highly entertaining as well as instructive, and to be appreciated they must be seen. Since Mr. Root presented these at the Na-

tional Convention he has obtained many new slides which will prove to be instructive and interesting to fruit-growers as well as to bee-keepers.

G. W. York, editor of *American Bee Journal*, and so well and favorably known to many of the Wisconsin bee-keepers, will also be present.

A general discussion will follow each topic, and a free use of question-box and answers will be a prominent and valuable feature.

Excursion rates, within 200 miles of Madison, one and one-third fare for round trip, ticket purchased February 4, 5, or 6 good to February 9. Tickets in Wisconsin, over 200 miles from Madison, same rate if purchased February 4, good to February 9.

N. E. FRANCE, Pres.
ADA L. PICKARD, Sec'y,
Richland Center, Wis.

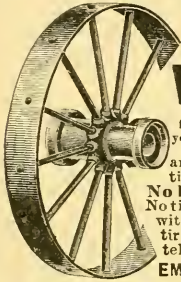

STEEL WHEELS

for your **FARM WAGONS**

any size wanted, any width of tire. Hubs to fit any axle. No blacksmith's bills to pay. No tires to reset. Fit your old wagon with low steel wheels with wide tires at low price. Our catalogue tells you how to do it. Address **EMPIRE MFG. CO., Quincy, Ill.**

For Sale! A splendid little fruit and bee-farm, in the midst of about half a dozen of the finest summer resorts in Northern Michigan, will be sold at less than one-half its value. Farm contains 16 acres with 1500 choice fruit-trees, nearly all in bearing, 5 to 7 years old, consisting of 300 cherry (mostly sweet), 250 pear, 250 peach, 300 plum, and 400 apple trees, all of them of the most profitable varieties. Also 1½ acres in strawberries, 2 acres in raspberries, 3 acres in clover, and the rest under cultivation for gardening purposes. The soil of the best; 3½ miles from Traverse City (a town of about 12,000 inhabitants, at the head of Grand Traverse Bay, with the largest State buildings in the State), 40 rods from a good school, and good graveled roads all over this part of the country; markets good, climate healthy. The buildings all new, and well built and finished, consisting of house with 7 rooms, upright 16x24, 1½-story, with good cellar, stone wall, full size of this part of house; wing part one-story, dining-room, kitchen and wood-shed 16x36 with soft water in the kitchen. Barn, 16-foot posts, 30x32; hen-house, 12-foot posts, 12x24. All buildings on stone foundation. Plenty of good water. Terms: \$3000; \$1000 down, balance to suit purchaser. Will also sell all of my personals, among them 40 colonies of Italian bees in chaff hives, team of horses, cow, one spring and one lumber wagon, and all other farming tools. Address **J. P. Berg, Box 8, Traverse City Mich.**

Strawberry-plants.

I have a large supply of Lady Thompson, Excelsior, and Crescent plants. A limited supply of Bismarck, Clyde, Barton's Eclipse, Brunette, Gertrude, Brandywine, Wm. Belt, Bubach, Haverland, Gandy, and Warfield, \$2.00 per 1000, f. o. b. here, or 70 cts. per 100, postpaid. Satisfaction guaranteed.

J. P. LEA, Fayetteville, Arkansas.

HONEY QUEENS !!

I have them, as daily letters testify. Recent conclusions force the belief that the leather-colored strain of three-handers excels in honey-gathering. If you want Golden's my strain takes the lead of all others, and I have tried them all; 250 colonies for honey, and 200 strong nuclei that will winter over. I am prepared to send you a queen any day you may order. Tested or untested queens, \$1.00. Leather breeders, \$2.50. Owing to increased demand straight 5-band breeders are \$5.00 each. **W. H. LAWS, Beville, Texas.**

SPRAYING FRUIT-TREES.

The question of spraying fruit-trees to prevent the depredations of insect pests and fungus diseases is no longer an experiment but a necessity.

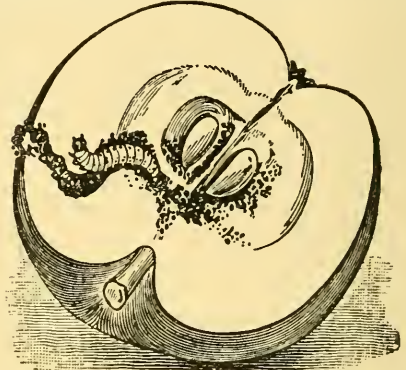

Our readers will do well to write Wm. Stanl, Quincy, Ill., and get his catalog describing twenty-one styles of Spraying Outfits and full treatise on spraying the different fruit and vegetable crops, which contains much valuable information, and may be had for the asking.

PRICE OF

Lone Star Queens

AFTER APRIL 1ST.

- 1 tested queen.....\$1 50
- 3 tested queens..... 3 75
- 1 untested queen... 75
- 3 untested queens 2 00

We have both the golden and leather color from imported mothers at same price. Agent for Root's goods.



G. F. DAVIDSON, Fairview, Wilson Co., Texas.

Italian Queens for early shipment from the South; are reared in full colonies by the best methods known to queen-breeders. Spring prices—full colonies, \$6.00; two frame nucleus without queen, \$1.50; three-frame nucleus without queen, \$2.00. Add price of queen wanted to price of nucleus. Tested queen, \$2.00; untested, \$1.00; six for \$5.00; 12 for \$9.00. Liberal discounts on large orders. Combs built on full sheets of foundation in wired Hoffman frames. Shipments to the North by New York, Baltimore, Philadelphia, or Boston steamer via Savannah, Ga. **CHRISTIAN & HALL, Meldrim, Ga.**

READY FOR 1901.

We are again ready to furnish our superior strains of Bees and Queens for 1901. We have the best stock of bees that money and skill can procure, as our numerous testimonials prove. We guarantee satisfaction. Let us have your orders. **WE WANT** your name and address for our circular giving valuable information, also description and prices of queens. We have 800 queens wintered over for spring orders, among them 50 fine Golden breeders.

Prices, either Golden, 3-banders, or Holy Lands.

Untested—June, July, Aug., and Sept.—1 75c; 6, \$4.25. Untested—all other months—1, \$1.00; 6, \$5.00. Tested, 1, \$1.25; 6, \$6.75. Sel. Tested, each, \$2.00. Breeders, \$3.00 and \$5.00 each. Discount in quantities, and premiums given away to our customers. Address

O. P. HYDE & SON, Hutto, Texas.

All This Nice Printing only \$1.	100 sheets paper, ruled, 100 envelopes, No. 6, 100 neat cards,	LITHO PRINT, Box 5, Swarthmore, Penn. E. L. Pratt.
	SENT POSTPAID BY EARLY MAIL.	

In writing advertisers mention Gleanings.

Wants and Exchange.

Notices will be inserted under this head at 10c per line. You must say you want your ad. in this department, or we will not be responsible for any error. You can have the notice as many lines as you please; but all over ten lines will cost you according to our regular rates. We cannot be responsible for dissatisfaction arising from these "swaps."

WANTED.—To exchange buckwheat extracted honey as cash, for 2d hand hives—Simplicity or 10-frame only. Have your neighbors got any, or store combs?
W. L. COGSHALL,
West Groton, Tompkins Co., N. Y.

WANTED.—A position with a good bee-keeper, or will take entire charge for you; 15 years' experience. Good reference to give.
J. E. HENDERSON, Elm Grove, Ohio Co., W. Va.

WANTED.—A competent man to take charge of four or five hundred colonies. To the right man a good proposition will be made. Write, stating amount of experience, age, etc.
I. A. KING, Almond, San Diego Co., Cal.

WANTED.—Two or three apiaries for cash; located in Colorado; write full particulars; first letters and lowest cash price; comb honey preferred.
THOS. C. STANLEY & SON, Fairfield, Ill.

WANTED.—To exchange modern firearms for old flint-lock guns, and old antique dishes.
Address 216 Court St., Reading, Pa.

WANTED.—A refined girl or widow woman, a house-keeper in small family, one interested in bee-keeping preferred. Address
ELIAS FOX, Hillsboro, Wis.

WANTED.—Business. Could act as agent, local or traveling, prefer local; must furnish good clear references; would like a little hustle to it. Write, stating terms, and get references to
A. R. BODGE, Dexter, Maine.

WANTED.—A number of good strong colonies of Italian bees with good quantity of stores and young queens, in healthy condition, for spring delivery. Hoffman frames in 8 or 10 frame L. or Danz. hives preferred.
W. HABMAN, box 3, Altoona, Pa.

WANTED.—To exchange 25 or 30 new 8-frame hives—never used—with Hoffman frames and division-boards, for any kind of bees. Correspondence requested.
F. L. REHN, Collingdale, Del. Co., Pa.

WANTED.—Man about 25 or 30 years of age, for ranch. Must be a good hand with team. Steady work to a good man.
P. CLEGG, New Windsor, Col.

WANTED.—To exchange 50,000 No. 1 polished sections, for beeswax.
W. H. NORTON, Skowhegan, Me.

WANTED.—To buy an apiary in Colorado or Arizona.
B. HOWARD, Hayt's Corners, N. Y.

WANTED.—To exchange Belgian hives for any thing useful to an apiarist. Good healthy stock; good color. Domestic, \$1.50 per pair; pedigree, \$3.00 per pair.
RALPH P. DALY, Lockport, N. Y.

Low Rates West and Northwest.

On February 12th and on each Tuesday until April 30th, the Chicago, Milwaukee & St. Paul Railway will sell one-way second-class tickets at the following very low rates:

To Montana points,	- - - - -	\$25 00
To North Pacific Coast points,	- - - - -	30 00
To California,	- - - - -	30 00

These tickets will be good on all trains, and purchasers will have choice of six routes and eight trains via St. Paul, and two routes and three trains via Missouri River each Tuesday. The route of the famous Pioneer Limited trains and the U. S. Government Fast Mail trains.

All ticket Agents sell tickets via the Chicago, Milwaukee & St. Paul Railway, or for further information address F. A. Miller, General Passenger Agent, Old Colony Building, Chicago.

WHERE TO LOCATE?

Why, in the Territory Traversed by the

Louisville & Nashville

RAILROAD.

THE

Great Central Southern Trunkline

IN

KENTUCKY, TENNESSEE,

ALABAMA,

MISSISSIPPI, FLORIDA.

WHERE

**Farmers, Fruit-growers,
Stock-raisers, Manufacturers,
Investors, Speculators,
and Money Lenders**

will find the greatest chances in the United States to make "big money" by reason of the abundance and cheapness of

**Land and Farms,
Timber and Stone,
Iron and Coal,
Labor--Everything.**

Free sites, financial assistance, and freedom from taxation for the manufacturer.

Land and farms at \$1.00 per acre and upwards, and 500,000 acres in West Florida that can be taken gratis under U. S. homestead laws.

Stockraising in the Gulf Coast District will make enormous profits.

Hall fare excursions the first and third Tuesdays of each month.

Let us know what you want, and we will tell you how to get it—but don't delay, as the country is filling up rapidly.

Printed matter, maps, and all information free.

Address
R. J. WEMYSS,
Gen'l Immigration and Industrial Ag't,
LOUISVILLE, KY.

Mr. A. I. Root's Writings

of Grand Traverse territory and Leelanau County are descriptive of Michigan's most beautiful section reached most conveniently via the

Pere Marquette R. R.

For particulars address W. C. Tousey, D. P. A., Toledo, Ohio.

Career and Character of Abraham Lincoln.

An address by Joseph Choate, Ambassador to Great Britain, on the career and character of Abraham Lincoln—his early life—his early struggles with the world—his character as developed in the later years of his life and his administration, which placed his name so high on the world's roll of honor and fame, has been published by the Chicago, Milwaukee & St. Paul Railway, and may be had by sending six (6) cents in postage to F. A. Miller, General Passenger Agent, Chicago, Ill.

New Smith Premiers Nos. 5 and 6.

The No. 6 takes paper 18½ inches wide and writes lines 16 inches long. The No. 5 takes paper 11 inches wide and writes lines 9½ inches long. These new machines in essential mechanical principles are the same as Models Nos. 2, 3 and 4—unequaled.

Write for Printed Matter Free.

**The Smith Premier
Typewriter Co.**

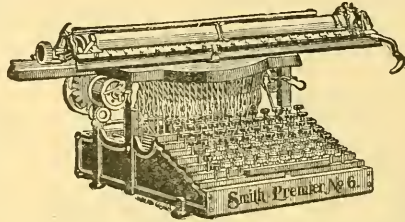

158 Prospect Street, Cleveland, Ohio.

Biggest, Brightest, Best---The Ohio Farmer.

== Only 60 Cts. a Year. == Cleveland, O. == A 20-page Weekly. ==

There is no other weekly farm paper published that has as large an actual list of paid-in-advance subscribers as THE OHIO FARMER has. Farmers read it and pay for it because it is clean, reliable, practical, and progressive. It is a 20-page weekly (often 24 pages) with the largest staff of editors and correspondents (all farmers) of any farm paper published; liberally illustrated every issue. Our subscription price is only 60 cents a year (52 copies), making it the cheapest, as well as the best, in America. We furnish free sample copies on request, also our illustrated premium list of useful articles, which we furnish at wholesale prices, or give free for clubs of subscribers. Send for these and clubbing rates with other papers, all at cost price.

Our Special Offer!

For only \$1.10 we will send *The Ohio Farmer* and *Gleanings in Bee Culture* both one full year. *Gleanings in Bee Culture* costs you \$1.00, and you can get *The Ohio Farmer* one year by adding 10 cents. Subscriptions may be either new or renewal. Send all orders to

THE OHIO FARMER, - - - CLEVELAND, OHIO.

SPRAYING

with our new patent
Kerosene Sprayers
is simple indeed. Kerosene emulsion made while pumping. 12 varieties sprayers, Bordeaux and Vermorel Nozzles, the "World's Best."
THE DEMING CO., SALEM, O.
Western Agents, Hemion & Hubbell, Chicago. Catalogue and formulas free.

American Gardening

10 Sample Copies, separate issues, 10 cents. Published at 136 Liberty Street, New York.

POULTRY-BOOK FREE.

64 pages, illust'd, with 3 mos. trial subscription to our paper, 10 cts.
Inland Poultry Journal, Indianapolis, Ind.

A BASKET FULL OF EGGS

by using Ley's Poultry Condition Powders. Puts all fowls in a normal condition; destroys all disease germs; purifies the blood; is a tonic and nutrient. Price 25 cts. a pk.; 5 for \$1.00. Ley's Thoroughbred Minorca's Eggs, \$1.00 for 13. Also Thoroughbred Belgian Hares. **Ceo. J. Ley, Florence, Cal.**

CRUSHED OYSTER SHELLS

for poultry; 100 lbs., 60 cts.; 200 lbs., \$1.00
WISE & CO.,
Wholesale Grocers, Butler, Ohio.

For Sale.

A fruit and sugar-beet farm, 24½ acres, six acres fruit, six-roomed brick house, 60 rods from central school, postoffice, and store; 3½ miles from Springville. Located in center of large alfalfa district. For further particulars, address **W. A. WARTHEN, Springville, Utah.**

1200 FERRETS.

All sizes; some trained; first-class stock. New price list free. **N. A. Knapp, Rochester, Lorain Co., Ohio.**

If You Raise Sheep

you need the great semi-monthly **Wool Markets and Sheep**, devoted to the breeding and care of sheep and the marketing of wool. It helps you make money, 50 cents a year, including liberal premium. We want agents for publications and use all novelties. Samples free. **Draper Pub. & Supply Co., Chicago, Ill.**

50 VARIETIES.

I breed fine poultry on one of the best equipped poultry farms in the world. Send 8c in stamps for new 1901 Book, telling all about 50 varieties, with special prices on fowls and eggs. **B. H. CREIDER, Florin, Pa.**
In writing to advertisers, mention Gleanings.

\$18 Guaranteed for 10 Years.
Frgt. Prepaid and Money
Back if not Satisfactory.

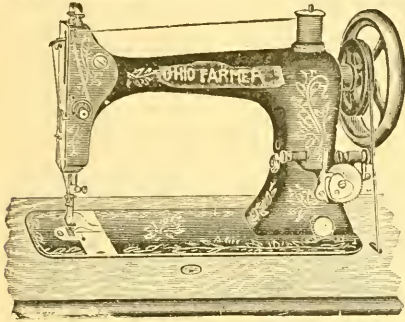

Send us \$18.00 and we will send you one of our NEW IMPROVED OHIO FARMER HIGH-ARM SEWING-MACHINES, freight prepaid. Use it for all kinds of work, and if not satisfactory you can return it in 90 days and we will refund your money and pay freight both ways.

All Guaranteed New Machines.

Self-setting needle; automatic bobbin-winder, with oak or walnut woodwork; new bent wood top; seven long skeleton drawers. Full and complete set of attachments and illustrated instruction book sent with each machine. Every machine we send out guaranteed to give ENTIRE SATISFACTION OR MONEY REFUNDED. We can furnish repairs or needles at any time. Remit by postoffice order, registered letter, New York draft, or express.

If you want the *BEST* sewing-machine made in the world at the *LOWEST PRICE* ever offered, send us your order.

Drop Head, \$20.00.

This is the same machine, except the cabinet, which is made so that head drops out of sight when not in use. Four drawers. Freight prepaid. With same attachments as the \$18.00 machine.

Our No. 2 Machines.

Have old-style top tension instead of the new side tension furnished on the others. Not quite as much work on them as the others, which accounts for the lower price; but we guarantee them for the same time, furnish same attachments, and prepay freight.

- High Arm No. 2. 5 Drawers. Only \$15.00.
- Drop Head No. 2. 4 Drawers. Only \$16.50.

Send for our new illustrated catalog. Address

The Ohio Farmer, : : : Cleveland, Ohio

NOTE.—We have known the publishers of the Ohio Farmer for many years. They are entirely responsible, and will fully make good their agreements.

THE A. I. ROOT COMPANY.

The Modern Farmer and Busy Bee.

Emerson Taylor Abbott, Editor.

A live, up-to-date Farm Journal with a General Farm Department, Dairy, Horticulture, Live-stock, Poultry, Bees, Home and General News. The Editor has had practical experience in every department of farm work. To introduce the paper, it will be sent to New subscribers one year for 25c. Sample copies free. Best Advertising Medium in the Central West. Clubbed with *Gleanings* for \$1.00.

ADDRESS

Modern Farmer, St. Joseph, Mo.

No Money in Advance

Our elegant New Jewel Drop-head Sewing Machine possessing all the latest improvements, high quality and thorough workmanship. Shipped direct at \$12.50, the lowest price ever known. 30 days' free trial. Money refunded if not as represented. Guaranteed 20 years. All attachments free. 125,000 sold.

- \$10.00 Arlington for... \$14.50
- \$50.00 " " " " " " \$17.00
- \$60.00 Kenwood " " " " " " \$21.50

Other Machines at \$8.00, \$9.00 and \$10.50

Large illustrated catalogue and testimonials Free. CASH BUYERS' UNION, 158-164 W. VanBuren St., B-345, Chicago

The Power Question

—for farm use, dairies, creameries, cheese factories—anything requiring light power, is best settled by buying one of these

LEFFEL ENGINES.

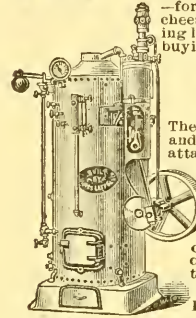

They are made in both horizontal and upright pattern, with engine attached to boilers. Being very simple and direct in construction they are economic of fuel and great developers of power. Best for cutting and grinding feed, sawing wood, pumping water, separating cream, churning, &c. Made of the best material in which they are durable and long lived.

Send stamp for our Book on Engines and Power.

JAMES LEFFEL & CO., Box 89, Springfield, O.

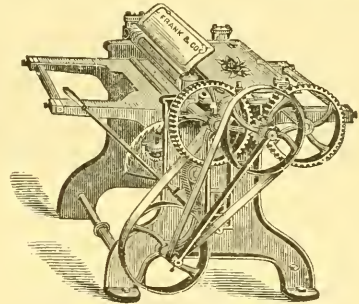

PLANERS

The above cut shows one of our small Planers, of which we make twelve different styles and sizes. Also large Planers, Band Saws, Buzz Planers, Moulders, Wood Lathes, and all kinds of

WOOD WORKING MACHINERY

Send for Catalogue.

The FRANK MACHINERY CO.

BUFFALO, N. Y.

Union Combination Saw

For Ripping, Cross-cutting, Rabbling, Mitering, Grooving, Gaining, Boring, Scroll-sawing, Edge-moulding, Beading. Full line FOOT and HAND POWER machinery. Send for catalog A. SENECA FALLS MFG. CO. 44 Water St., Seneca F., N. Y.

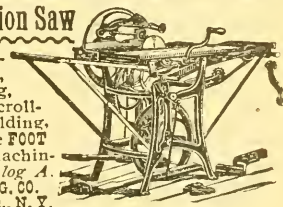

In writing mention *Gleanings*.

DEAL DIRECT with the Makers.



When you buy a carriage, buggy or harness. Choose from the biggest stock and fullest assortment, and pay only the cost of making, with but one moderate profit added. Our plan of selling direct from the factory insures satisfaction—your money back if you're dissatisfied with your purchase—and enables you to **save the dealer's profit.**

Our complete illustrated catalogue, showing many styles of high grade vehicles, harness, robes, blankets and horse equipments, with detailed descriptions of each, mailed free. Write for it and learn how cheaply you can buy when the jobber's and dealer's profits are cut off.

THE COLUMBUS CARRIAGE AND HARNESS CO., Box 772, Columbus, O.



No. 304 Buggy. Price \$38.30 with leather quarter top.

No. 240. Single Strap Buggy Harness. Price \$7.95.

YOUR MONEY'S WORTH.

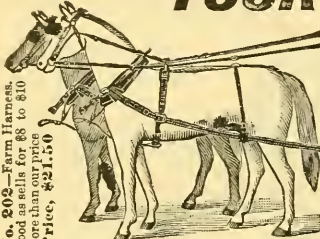

You have a right to expect that, because you are entitled to it. To do this we sell all goods direct from our factory to the consumer at wholesale prices. The advantages of this plan are many and obvious. This plan has built us up until we are now the largest manufacturers of vehicles and harness in the world selling to consumers exclusively. We make 178 styles of vehicles and 65 styles of harness. The buyer takes no risk on our plan as we ship our goods anywhere for examination and guarantee safe arrival.

Send at once for a copy of our large illustrated catalogue—FREE.

Elkhart Carriage & Harness Manfg. Co., Elkhart Indiana.

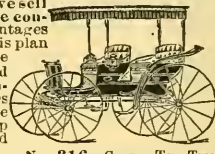

No. 302—Farm Harness. Good as sells for \$8 to \$10 more than our price. Price, \$21.50

No. 316—Canopy Top, Two-seated Carriage with side curtains, storm apron, sun shade, lamps, fenders, pole or shafts, \$65. Same as sell for \$85 to \$90 more.

Makes The Lawn Beautiful.

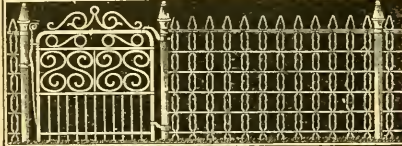

HARTMAN STEEL ROD LAWN FENCE adds to the attractiveness and value of the home. Strong and durable, keeps out everything but the sunshine. Unequaled for School Lawns, Church Enclosures, Parks, Cemeteries, Private Lots, etc. Catalogue free.

HARTMAN M'FG CO., BOX 80 ELLWOOD CITY, PA.
Or Room 40, 309 Broadway, New York City.

\$29.75



Take a Short Cut

Buy direct from the manufacturers. Save retailer's large profit. We make strong, finely finished, reliable VEHICLES, HARNESS and SADDLES. The kind that stand hard use in all sorts of weather. BEST MATERIALS, STYLES and WORKMANSHIP. SATISFACTION GUARANTEED.

We ship C. O. D. for examination. YOU TAKE NO RISK.

\$45 Top Buggy, \$29.75 \$18 Double Farm Harness \$12.00
\$60 Surrey, \$47.50 \$25 Road Cart, \$9.00 and up. Single Buggy Harness, \$4.25 & up.
\$50 Spring Wagon \$32.50 New Catalogue & Testimonials free. All grades of Team, Double Buggy and Surrey Harness.

CASH BUYERS' UNION, 158 W. Van Buren St. B-345, Chicago

Improved Ohio Farmer REPAIR OUTFIT.

Our Price Only \$1.65.



We have examined samples from all manufacturers, and believe this is the very best repair outfit on the market; easily worth \$1 more than those offered by stores and other papers. It contains 48 articles, all full size and first class, and we guarantee satisfaction or will refund money. Half-soles alone are worth 50c, and are not included in other outfits. It will soon pay for itself in repairing boots, shoes, rubbers, harness, and tinware.

Repair Outfit with Ohio Farmer one year for only \$2.15, or the Complete Outfit free for a club of 10 subscriptions to the Ohio Farmer. By freight.

Send for our illustrated premium list, giving wholesale prices on watches, sewing-machines, knives, and lots of other useful articles. Mention this paper.

THE OHIO FARMER, CLEVELAND, O.

Pig-Tight



HORSE-HIGH!

... BULL-STRONG ...

With our Duplex Automatic Ball Bearing Woven Wire Fence Machine, any farmer can make 100 styles, and from **50 to 70 rods a day** of the best and most practical fence on earth at a cost for the wire to make it of from **20 to 30c. per rod**. We sell Ornamental Fence and Gates, Plain Fence and Gates, Plain, Barbed and Coiled Spring Wire direct to the farmer at wholesale prices. Catalogue free.

KITSELMAN BROS.,
Box D31, Muncie, Ind.



Belgian Hares

I have some fine hares for sale at reasonable prices.

J. F. Moore, : Tiffin, Ohio.

The Ohio Farmer, : Cleveland, Ohio.

SEED DUE BILL FREE

To get new customers to test my Seeds, I will mail my 1901 catalogue, filled with more Bargains than ever and a 10c Due Bill good for 10c worth of seeds for trial absolutely free. All the Best Seeds, Bulbs, Plants, Roses, Farm Seeds, Potatoes and many Novelties at lowest prices. Gluseng, the great money making plant. Giant Prize Tomatoes, 2 to the foot, Pan American Oats, sent on free to farmers, and two Free Passes to Pan American Exposition, Buffalo, N. Y. are offered. \$2,635.00 in cash premiums. Don't give your order until you see this new catalogue. You'll be surprised at my bargain offers. Send posts for catalogue today. It is FREE to all. Tell your friends to send too. F. B. MILLS, Box 105, Roschill, Onondaga Co., N. Y.

Trees

375,000
at Bargain Prices

Apple, Standard and Dwarf Pear, Cherry, Peach and Plum trees, Japan Plums a specialty. Save half your money by buying direct of producer. Our free catalogue of fruit or ornamental trees will tell you how and why. Let us price your list of wants.

We will mail two plants of
For 10c our Red Cross Currant,
GREEN'S NURSERY CO.,
Rochester, N. Y.

OLDS' BIG THREE



Pat's Choice—Late—Introduced in 1900. Heaviest yielder—Handsomest—Best quality. **Vigorosa**—Medium early—Introduced in 1897—Most profitable. Outyields any other early. **King**—Extra early—Introduced in 1899.—Smooth, Handsome, Prolific. All other leading varieties—Fine stock, low prices. Catalog free, shows full line. Also field and garden seeds. Send to-day.

L. L. OLDS, Drawer H, Clinton, Wis.

Angora Goats. Handsome pets; profitable stock. Large new circular for stamp. **EDW. W. COLE & CO., Kenton, Ohio.**

THE FASHION FLOWER OF THE DAY

Is the beautiful sweet pea. Recognizing the popularity of this garden favorite, we offer for 1901 five new and handsome sorts, for 5 2-cent stamps, together with a copy of our new seed book, the most modern catalogue of modern times. It is so costly a production we cannot afford to gratuitously distribute it. (Postage alone is 5 cents.) We send it postpaid for 10 cents, together with one packet of each of these:

5 Grand New Sweet Peas.

<p>Navy Blue. The best to date, Gorgeous. Unique and distinct. America. White striped carmine. Royal Rose. A blushing beauty. Salopian. Intense scarlet.</p>	<p>Five separate packets.</p> <p style="font-size: 2em;">ONLY 10c.</p>
---	---

With our new seed book free.

Features of our new catalogue for 1901 are 126 pages (9520 square inches of reading and illustrations) 7 handsome colored plates. A list of novelties in vegetable, farm and flower seeds to be had nowhere else this year, **35 new sorts now offered for the first time**, and a complete list of standard seeds, bulbs, plants, fruits, etc., Other features, full cultural directions and many cash prizes. If you want an up-to-date garden and the best you ever had you must plant Maule's Seeds. Send 10 cents for catalogue and these new sweet peas to-day. Address,

WM. HENRY MAULE,
1711 Filbert Street, Philadelphia.

FERRY'S SEEDS

You know what you're planting when you plant Ferry's Seeds. If you buy cheap seeds you can't be sure. Take no chances—get Ferry's. Dealers everywhere sell them. Write for 1901 Seed Annual—mailed free.

D. M. FERRY & CO.,
Detroit, Mich.



Easy and Profitable Gardening.

The thoughts of back-breaking, hand hoeing and weeding prevents many a man from making money out of a garden. The easier, surer and better way is to use one of our "Planet Jr." Double Wheel Hoes. They cultivate perfectly all garden crops, astride or between the rows. Throw the dirt to or from the row; cultivate the middles; break up the crust and level the surface. They plow, turning furrow either right or left, hill up and furrow out. Have attachments for all this work. Adjustable to any width of row. Strong, durable and lasting. Every attachment of best hardened polished steel. Then, too, they are so easy to handle; children use them readily.

Our 1901 Catalogue (edition 350,000) illustrates and fully describes these and our full line of "Planet Jr." Hill and Drill Seeders, Wheel Hoes, Horse Hoes, Cultivators, etc. Prices greatly reduced for 1901. But send and get a free copy of the catalogue and learn all about "Planet Jr." and how they are used at home and in foreign countries.

S. L. ALLEN & CO., BOX 710 H, PHILADELPHIA, PA.
Two Gold Medals at Paris Exposition; Highest Award.

In writing advertisers please mention Gleanings.

ROUGH RIDER,
SEN. DUNLAP,
and other
CUMBERLAND RASPBERRY,
KING OF MICHIGAN POTATO.

STRAWBERRIES

100 Varieties.

HEADQUARTERS FOR HIGH GRADE

Plants and Seed Potatoes.

Descriptive Catalogue Free to All.

FLANSBURGH & PEIRSON, Leslie, Mich.



PEACH

Grand lot of trees, free from borers, aphids, scale, yellows, etc. Large stock of Pear, Plum, Cherry, Apple, Quince, etc. Immense supply of small fruits. Headquarters for Ornamental Trees, Shrubs, Plants, Bulbs, Seeds.

40 acres hardy Roses, 44 greenhouses of Palms, Ferns, Ficus, Roses, Geraniums, etc. Mail size postpaid. Direct deal will save you money. Try us. Elegant catalogue free. 47 Years, 1000 Acres.

THE STORRS & HARRISON CO., Box 224 Painesville, O.

BURPEE'S SEED-SENSE FOR 1901

is mailed FREE to all.

A Bright Business Catalogue of ninety pages that tells plain truth about BEST SEEDS that Grow. Write a postal card to-day, or send ten cents (stamps or silver) for BURPEE'S QUARTER-CENTURY FARM ANNUAL,—a New Book of 220 pages fully worth a dollar. W. ATLEE BURPEE & CO., PHILADELPHIA, PA.

SEEDS

BUCKBEE'S SEEDS SUCCEED!

SPECIAL OFFER:

Made to Build New Business. A trial will make you our permanent customer.

Prize Collection Radish, 17 varieties; Lettuce, 12 kinds; Tomatoes, 11 the finest; Turnip, 7 splendid; Onion, 8 best varieties—55 varieties in all. GUARANTEED TO PLEASE.

Write to-day; Mention this Paper.

SEND 10 CENTS

to cover postage and packing and receive this valuable collection of Seeds postpaid, together with my new instructive, Beautiful Seed and Plant Book, tells all about the Best varieties of Seeds, Plants, etc.

H. W. Buckbee ROCKFORD SEED FARMS,
Box 611 ROCKFORD, ILL.



HAMMOND'S Mammoth Tomato.

Michigan tomato seed is best on earth. Hammond's Mammoth made a specimen last year weighing 5 1/2 lbs. Largest tomato that grows. Hammond's Earliest Tomato on Earth has eclipsed all others in earliness. Hammond's Great Tall Tree, Hammond's Dwarf Tree, Hammond's Golden Beauty, and Hammond's Prolific Bush are novelties of wonderful merit. Handsome illustrated catalog of Tomatoes, \$1000 in prizes for 1901, and all leading varieties of Potatoes, Field, Flower and Vegetable Seeds mailed FREE on request.

HARRY N. HAMMOND SEED CO.

Box 69, Bay City, Mich.

Formerly of Fifield.

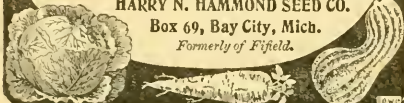

SALZER'S SEEDS RICH!

WILL MAKE YOU RICH!



BROMUS INERMIS

Greatest Permanent Grass of the Century.

Nothing like it on earth to-day that we know of and we have scoured the world over to find its equal. Grows where all others kill and burn up from excessive heat and lack of sufficient moisture. Grows where all others winter kill and freeze out 3 to 7 tons of magnificent hay per acre and lots of pasturage besides.

\$1.20 and up a Barrel.

Largest potato and vegetable growers. Choicest, rarest, heaviest yielding stock.

Catalogue Tells.

For 10 Cents and this Notice

our big catalogue will be mailed you free, together with 10 sample packages of the 80 lb. Spectiz Wonder, the 40c Spring Wheat, the Billion Bull-r Grass with its 12 tons of hay per acre, the Peasant—a startling food, the Victoria Rape Marvyl, the astonishing 250 bushel per acre, Cats, etc. In all 10 packages fully worth \$10 to get a start for 10c in stamps. Send to-day.

JOHN A. SALZER SEED CO., LA CROSSE, WIS.

LOTS OF EGGS

The sure result of feeding Green Cut Bone. You can cut it fast, fine and easier with the original MANN'S NEW BONE CUTTER than in any other way. Doubles the egg crop winter and summer. Next to this and ahead of all others is Mann's Clover Cutter, that does cut—not a playing. Grit and Feed Trays too. Catalogue Free. F. W. MANN CO., Box 37, Milford, Mass.





"Profitable Poultry Keeping

IN ALL ITS BRANCHES. This is the title and theme of our new Year Book. Contains 192 pages, 8x11 in.; 200 new and original illustrations of best poultry farms, buildings, etc., in the country. Deals with every phase of the poultry industry in an instructive and profit bringing way. Treats also of the famous non-moisture, self-ventilating and self-regulating **CYPHERS INCUBATORS**, guaranteed to out-perform three or more tests or money refunded. Sent for 10c in stamps. Ask for book 74 Circular and prices free. Address nearest office. **CYPHERS INCUBATOR CO.**, Chicago, Weymouth, N. Y., Boston, Mass.



INVESTIGATE BEFORE YOU BUY.

We want our customers to be perfectly satisfied before they spend the money. Investigate the claims of all incubators and then decide. We believe you will find that the **SURE HATCH INCUBATORS** AND COMMON SENSE FOLDING BROODERS are giving better satisfaction than any other made. It's because they are so simple, sensible and sure. They are built for busy people, who haven't time to fuss and bother. Our catalogue is FREE. We don't ask you to pay for it. Isn't it worth examining?

SURE HATCH INCUBATOR COMPANY, CLAY CENTER, NEBRASKA.

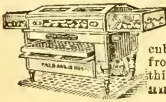

A PRACTICAL POULTRY BOOK

One which covers every detail of the industry from incubation to market is our **20th CENTURY CATALOGUE**. It will teach you from the practical experience of others what it would take you ten years to learn. Among other things it tells about the latest improvements in the world famous **Reliable Incubators and Brooders**. Sent for 10c to pay postage. **Reliable Inc. & Brdr. Co.** Box B-49 Quincy, Ill.

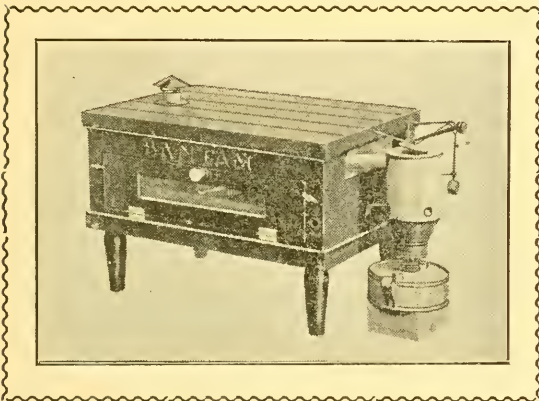

BIDDIES & BEES. MAKE THEM BOTH PAY.

50-egg Bantam. Self-regulating.

Holds 50 ordinary-size eggs. No sitting up nights. 20 minutes' attention in twenty-four hours will operate it. Sold on

30 Days' Trial for \$5.00

Over 15 000 in use, and thousands hatching 50 chicks from 50 eggs. You can do as well. Either hot-water or hot-air heating. We have a brooder to go with it for \$3.00. Our catalogue of valuable information, and describing incubators and brooders of all sizes and prices—all on trial—sent for the asking if you mention this paper.

Buckeye Incubator Co., Springfield, Ohio.

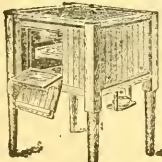

Satisfaction guaranteed or money refunded on every

MARILLA

INCUBATOR & BROODER

we sell. Are not those reasonable terms? That shows you how much faith we have in our machines. Either **HOT WATER** or **HOT AIR** machines. A child can work them. Eleventh year on the market.

MARILLA INCUBATOR CO.

Catalogue 2c. Stamps, Box 62 Rose Hill N.Y.



THERE IS NO INCUBATOR

which has been more successful than the SUCCESSFUL. You hear about them everywhere. The reason is that they do their work so well. Send 6c in stamps for new 154 p. book, printed in 5 languages, describing our successful incubators and Brooders. They deserve their name. **Des Moines Incubator Co., Box 503, Des Moines, Iowa.**

If You Want A Bone Cutter

one that is sold on a guarantee to cut more bone in less time and with less labor than any other bone cutter made, you want the

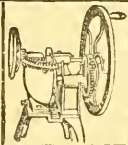

HUMPHREY Green Bone and Vegetable CUTTER

It's the only one making such a guarantee good. It is a rapid vegetable cutter, too. Send at once for our handsome catalogue, containing blanks for egg record for a whole year. **IT IS FREE.**

HUMPHREY & SONS, Box 51, Joliet, Illinois.

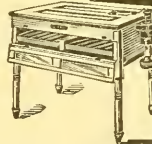

200-Egg Incubator for \$12.00

Perfect in construction and action. Hatches every fertile egg. Write for catalogue to-day. **GEO. H. STAHL, Quincy, Ill.**

EASY EGG MONEY

A man can easily make money selling eggs if he can but get them eggs. He can get the eggs **sure**—twice as many, if he will feed his hens on **Green Cut Bone**. No better way to prepare it than with

ADAM'S CUTTER GREEN BONE

It cuts on the shear plate principle. Takes off a fine ribbon like piece, easily consumed by the chicks or fowls. No sharp splinters to injure throat. Turns easily. Only ball-bearing cutter made. For hand or power. Catalogue No. 39 free. **W. J. ADAM, Joliet, Ill.**

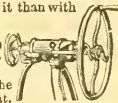

S. C. BROWN LECHORNS. I use well-striped breeding cocks Eggs, \$1.00. Cockerels, \$1.00 and up. Also Italian hens. Circular free. **H. M. MOYER, Shanésville, Pa.**

Three Times as Much!

I have recently returned from a trip through New York, where I attended a series of bee-keepers' institutes, or conventions. While at Romulus and Auburn, several bee-keepers told me of the wonderful performances of the bees from a queen that I had sold Thos. Broderick, of Moravia. Mr. Broderick had reared queens from this queen for both himself and a few friends, and nothing in those parts had equaled this strain of bees. Wishing to have the particulars direct from Mr. Broderick himself, I wrote and asked him if he would be so kind as to give them to me. Here is his reply:

MORAVIA, N. Y., Dec. 31, 1900.

Mr. W. Z. Hutchinson, Flint, Mich.

Dear Sir:—It is with pleasure that I write concerning the queen that I purchased of you three years ago, as I have reason to believe her one of the most remarkable queens ever possessed by any bee keeper in this part of the country.

At the end of the first season, as you may remember, I wrote you my appreciation of this queen, but I will now go more into detail. Upon receiving the queen, May 24, 1898, I gave her to a colony that scarcely covered four Gallup combs. She built up that colony and gave me 140 well-filled sections, mostly from buckwheat. This I considered remarkable, as, previous to that time, 75 lbs. was the very best yield that I had ever been able to take from my best colonies.

In the fall, after preparing my colonies for winter, by some accident the super containing the absorbent was knocked out of place, thereby letting the heat of the cluster pass out of doors all winter. They were protected from the wind by a shock of corn fodder, and in this way they passed three months without a flight. They came through the winter somewhat reduced in numbers; but, again the colony built up and gave me a crop of 96 lbs. of well-filled sections.

The past season this colony gave me 48 lbs. of comb honey, which I consider good considering the age of the queen (four years) and the very poor season.

It was in the season of 1899 that I reared the first queens from this queen. The past season the colony from one of those young queens gave me a crop of 174 sections which tipped the beam at 176½ lbs. The only thing that I did to this colony in the way of manage-

ment was that, some time in May, I robbed it of a comb of honey and replaced it with an empty comb. This queen was the only one of this stock that passed the winter in a full colony, all of the others being given to artificial colonies that were formed late in the season. They all wintered finely, although each colony occupied only some five or six Gallup combs.

The past season they all built up and gave me on an average 90 lbs. each of comb honey. My best colony gave me a crop that was *three times as large as that produced by the best colonies of my neighbors.*

Queens of this strain occupy every comb in the hive, and it makes no difference whether the combs are the Gallup, the Quinby, or the hive a two story Langstroth. The bees never crowd these queens if given plenty of room. The bees are as gentle as one could wish; cap their honey as white as any bees cap it; and, as workers—well, I can't explain it. It is needless to say that this strain of bees will be in evidence in my apiary as long as I keep bees. You are at liberty to publish this if you wish.

THOS. BRODERICK.

To those who are thinking of trying this strain of bees, I would say, don't wait until next spring before sending in your order. Last spring, when I began sending out queens, there were orders on my books for nearly 200 queens. Orders are already coming in to be filled next spring. They will be filled in rotation; so, if you wish to get a queen next spring, send in your order this fall. The price of a queen is \$1.50; but safe arrival, safe introduction, purity of mating, and entire satisfaction are all guaranteed. The queen can be returned any time within two years, and the money refunded, and 50 cents additional sent to pay for the trouble.

The REVIEW for this year and the back numbers for 1900 (two years) and one of these queens for only \$2.00. As soon as your order is received, the back numbers for last year will be sent, and your subscription put on the book to the end of 1901, and next spring the queen will be sent you.

Address all Orders to

W. Z. HUTCHINSON, = FLINT, MICHIGAN.

Marshfield Manufacturing Company.

Our specialty is making SECTIONS, and they are the best in the market. Wisconsin basswood is the right kind for them. We have a full line of BEE-SUPPLIES. Write for FREE illustrated catalog and price list.

Marshfield Manufacturing Company, Marshfield, Wisconsin.



BEE-HIVES AND HONEY-BOXES,

in car lots—wholesale or retail. Now is the time to get prices. We are the people who manufacture strictly first-class goods and sell them at prices that defy competition. Write us today.



Interstate Box & Manufacturing Co., Hudson, Wis.

1881

PAGE & LYON MFG. CO.

1900

We manufacture a full line of the latest BEE-SUPPLIES.

Our motto is, "Perfect Goods and Prompt Shipment."

Send for our new free illustrated catalog.

PAGE & LYON MFG. CO., New London, Wisconsin.

Fred W. Muth & Co.

Fred W. Muth. Chas. J. Hauck. P. W. J. Hauck.



One Minute Please!

We beg to announce that we have gone into the bee-supply and honey business. Being *practical bee-keepers who understand the supply business thoroughly*, and know pretty well the wants of the bee-keepers, the firm will give its exclusive attention to the bee-supply business, and the promotion of the sale of honey in this vicinity.

After visiting all the important manufacturers we have selected a line that will give the best of satisfaction. Our location, adjoining the suspension bridge, is most central, and, being only four blocks south from the Fountain Square, is right down in the business part of the city, and especially handy for our Kentucky friends. Our facilities for prompt service are perfect. Our prices are consistent with good business judgment. Our catalog has many good features. Send us your name so we can mail you one.



FRED W. MUTH & CO.,

S-W. Cor. Front and Walnut,

CINCINNATI, OHIO.

A Honey Market. Don't think that your crop is too large or too small to interest us. We have bought and sold five carloads already this season, and want more. We pay spot cash. Address, giving quantity, quality, and price.

Thos. C. Stanley & Son, Fairfield, Ill.

CHAS. ISRAEL & BROS.,

486, 488, 490 Canal St.,
Corner Watt Street, N. Y.

HONEY & BEESWAX.

Liberal Advances made on Consignments.
Wholesale Dealers and Commission Merchants.
Established 1875.

FOR SALE.—Clover and buckwheat extracted honey.
E. D. TOWNSEND, Hubbardston, Mich.

FIRE SALE

OF BEE BOOKS!

On January 1st there was a severe fire in our building, burning out entirely four floors above us. The water that was thrown on the fire came down through our floor damaging our stock of books, printing-office, etc. Some of the books were wet slightly, but enough so that they could hardly be sent out as perfect. These are the ones that we wish to offer. The reading pages of all are perfect, only the covers being a little soiled. Here they are, with prices postpaid:

Prof. Cook's "Bee-keeper's Guide," only 60c.

Doolittle's Scientific Queen-rearing, only 50c.

Newman's "Bees and Honey," only 40c.

They are all cloth bound, and latest editions. If you want a year's subscription to the old *Weekly American Bee Journal*, with any of the above books, add 75 cts. to your order. This is a SPECIAL OFFER, and will last only so long as the slightly damaged books last. Better order AT ONCE if you want a bargain. Remember we are

Headquarters for

Bee-keepers' Supplies !!

Catalog and sample copy of the AMERICAN BEE JOURNAL, FREE. Ask for them. Address

George W. York & Co.,

144-146 Erie St., Chicago, Ill.

Root's Goods for California.

We have just received a large carload of sections, extractors, smokers, veils, etc., direct from the factory, and are prepared to supply bee-keepers with the same promptly. Do not send a long distance and pay high freights. Write for our prices.

M. R. MADARY, - Fresno, California.

BOOKS.

Write for price on any book you want.
M. T. WRIGHT, MEDINA, OHIO.
Reference, The A. I. Root Co.

FOR SALE.—3000 pounds fancy comb honey. Write for prices.
WILLIAM MORRIS,
Las Animas, Col.

WANTED.—To exchange for a gun, bicycle, or incubator, a gold-plated watch.
O. E. ERICKSON, Bloomer, Wis.

Our Advertisers.

SPRAYING.

When you are considering the matter of sprayers you should not forget to write for the catalog of Deming & Co., Salem, O.

NURSERY STOCK.

A catalog of 168 pages, full of valuable information regarding vegetable and flower seeds and nursery stock may be had of our old friends the Storrs & Harrison Co., Box 222, Painesville, O. See what they say on page 118.

FENCES.

We have frequent inquiries for fencing for lawns, parks, cemeteries, etc.; and while we are dealers ourselves, we suggest to persons needing such material that they write for catalog and prices to Hartman Mfg. Co., Box 80, Ellwood City, Pa.; and to Kitselman Bros., Box D31 Muncie, Ind. See the advertisements with illustrations in this issue of GLEANINGS.

CARRIAGES AND HARNESSSES.

Are you in need of a carriage or harness? It will pay you to look over the advertisement of Elkhart Carriage and Harness Mfg Co., Elkhart, Ind., and Columbus Carriage and Harness Co., Box 772, Columbus, Ohio. You will find them on pages 116 Both of these concerns issue handsome catalogs which may be had on application to them if you mention GLEANINGS.

THE BANTAM INCUBATOR

Since my chicken talk quite a few have asked where the incubator was made, used by one of our office girls. It is the "Bantam," advertised in this issue. Quite a few of the small-sized incubators have reported 50 chickens from 50 eggs; but a letter just placed in my hands "breaks the record." One of their patrons got (with the Bantam) 51 chickens from 50 eggs. One of the eggs was very large and had a double yolk.

Get the Best Queens.

Evansville, Ind., Sept. 27th, 1900.

The Jennie Atchley Co., Beville, Bee Co., Texas:
Dear Friends:—It gives me great pleasure to forward you this unsolicited testimonial regarding the merits of Atchley queens. The three (3) dozen queens purchased of you have made an excellent record for themselves. Not an Atchley queen among the twenty colonies lost during the severe drouth in July. I have bought queens from many breeders; and although the present crop is exceedingly short, the tiers of supers show where the Atchley queens are, and speak volumes for your method of queen-rearing. I find the progeny to be very gentle, strong winged, uniformly marked, long-lived, of large size, and, last but not least, the best honey-gatherers I ever had. I shall want 100 more next season.

Yours fraternally, J. C. WALLENMEYER.

Prices for Queens.

Tested, \$1.50 each; \$8.00 for 6, or \$15.00 per dozen. Untested, February, March, April, and May, \$1.00 each; \$5.00 per 6, or \$9.00 per dozen. Fine breeders, \$5.00 each. We have as good bees and queens as money and labor produce. We breed three-band Italians, Golden, Carniolans, Cyprians, and Holy-Lands, in their purity, bred in separate yards 5 to 20 miles apart. If you want the best, call for Atchley's improved strains. Safe arrival guaranteed. Send for a sample copy of "The Southland Queen," the only southern bee-paper, \$1.00 per year. To new subscribers we offer as a premium a nice untested queen in order to get our paper introduced. Catalog, giving queen-rearing and management of apiaries for profit, FREE.

THE JENNIE ATCHLEY CO., Beville, Bee Co., Texas.

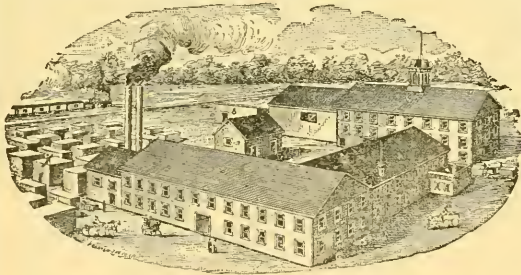

KRETCHMER M'FG CO., Red Oak, Iowa.

BEE-SUPPLIES.

Best-equipped factory in the West; carry a large stock and greatest variety of every thing needed in the apiary, assuring BEST goods at the LOWEST prices, and prompt shipment. We want every bee-keeper to have our FREE ILLUSTRATED CATALOG, and read description of Alternating Hives, Ferguson Suppers, etc. Write at once for a catalog.

AGENCIES:

Trester Supply Co., 103 So. 11th St., Lincoln, Nebraska; C. C. Richards, 1223 17th St., Denver, Col.



BINGHAM SMOKER.

DEAR SIR:—Inclosed find \$1.75. Please send one brass Smoke-engine. I have one already. It is the best smoker I ever used. Truly yours,
HENRY SCHMIDT, Hutto, Tex

MADE TO ORDER.

Bingham Brass Smokers

Made of sheet brass, which does not rust or burn out; should last a lifetime. You need one, but they cost 25 cts. more than tin of the same size. The little open cut shows our brass hinge put on the three larger sizes. No wonder Bingham's 4-inch smoke-engine goes without puffing, and does not drop inkly drops. The perforated steel fire-grate has 381 holes to air the fuel and support the fire. Heavy tin smoke-engine, 4-inch stove, per mail, \$1.50; 3½-inch, \$1.10; 3 inch, \$1.00; 2½-inch, 90c; 2-inch, 65c. Bingham smokers are the originals, and have all the improvements, and have been the standard of excellence for 22 years. Only three larger ones brass.

T. F. Bingham, : : Farwell, Mich.

Contents of this Number.

Apple-blossoms, Honey from Good.....150
 Bees Freezing to Death, Doolittle on.....146
 Bees on Shares in California.....143
 Bees, Large, in Philippines.....133
 Combs, Old, for Brood-rearing.....111
 Convention in Grand Traverse.....155
 Cuba, Boyden in.....134
 Cuba, Howe on.....135
 Cuba, Luaces on.....136
 Dzierzon, Services of.....132
 Eggs Unfertilized, and Drones.....148
 Exposition, Pan-American.....133
 France, N. E. at Madison.....150
 Fumigating Queens.....136
 Ginseng Culture, Difficulties of.....160
 Glossometer, To Make.....147
 Grape Fruit in Florida.....159
 Hall, J. B.....151
 Honey Candying in Uncleaned Sections.....136
 Honey, Retailing.....140
 Humbugs, Dunning Letters.....161
 Jaws of Bees and Wasps.....152
 Legislation, Foul-brood, Needed in Michigan.....153
 Legislation, Pure food.....132
 Legislation, Vicious, in Wisconsin.....151
 Old Grimes—Poem by Miller.....142
 Planter, Acme.....159
 Potato-planter, Grand Traverse.....157
 Questions from a Beginner.....148
 Rambler Resumes Rambles.....143
 Representatives of Michigan.....153
 Royal Jelly in Medicine-dropper.....150
 Sections Relative Weights of.....147, 148
 Soja Bean in Ohio.....159
 Trap Nests.....160
 Wax, Adulteration of in Europe.....132
 Wintering in Cellar.....149
 Wintering, Indoor and Outdoor.....132

Honey Column.

GRADING RULES.

FANCY.—All sections to be well filled, combs straight, firmly attached to all four sides, the combs unsouled by travel-taint, or otherwise; all the cells sealed except an occasional cell, the outside surface of the wood well scraped of propolis.
 A No. 1.—All sections well filled except the row of cells next to the wood; combs straight; one-eighth part of comb surface souled, or the entire surface slightly souled; the outside surface of the wood well scraped of propolis.
 No. 1.—All sections well filled except the row of cells next to the wood; combs comparatively even; one-eighth part of comb surface souled; or the entire surface slightly souled.
 No. 2.—Three-fourths of the total surface must be filled and sealed.
 No. 3.—Must weigh at least half as much as a full weight section.
 In addition to this the honey is to be classified according to color, using the terms white, amber, and dark; that is, there will be "fancy white," "No. 1 dark," etc.

CITY MARKETS.

CINCINNATI.—The market for comb honey is becoming bare, although the prices did not change. Fancy white comb is still selling for 16. No demand for darker grades. Extracted in fair demand; dark sells for 5½, better grades from 6½ to 8; only white clover brings from 8½ to 9. Beeswax, 28.
 Feb. 9. C. H. W. WEBER.

BOSTON.—We quote our market as follows: Fancy No. 1 white in cartons 17; A No. 1, 16; No. 1, 15@16, with a fairly good demand. Absolutely no call for dark honey this year. Extracted, white, 8@8½; light amber, 7½@8. Beeswax, 27.
 BLAKE SCOTT & LEE,
 Feb. 2. 31, 33 Commercial St., Boston, Mass.

NEW YORK.—Demand for comb and extracted honey is very dull. We quote: Fancy white, 15@16; A No. 1, 14@15; No. 1, 14@15; No. 2, 12@13; fancy buckwheat, 11; No. 1, 10; No. 2, 9. Extracted, white, 8; light amber, 7@7½; amber, 6@6½; buckwheat, 5½@6. There is no great stock of either white or buckwheat comb honey on hand; but the extracted buckwheat is plentiful, with prices ranging from 5 to 6c, with little demand. Beeswax, 26@28.

CHAS. ISRAEL & BROS.
 Jan. 25. 486-8 Canal St., New York City.

PHILADELPHIA.—As we predicted some weeks ago, the cars of California honey in comb have been unloaded, and pushed to get returns, and market broke down. We quote: Fancy comb, 15; No. 1, 13@14. Extracted white, 7; amber, 6. Beeswax, 28. We are producers of honey, do not handle on commission.
 W. M. A. SELSER,
 Jan. 24. 10 Vine St., Philadelphia, Pa.

SAN FRANCISCO.—Fancy comb, 14; A No. 1, 12; No. 1, 9½; No. 2, 7½. Extracted white, 7; light amber, 6½.
 Jan. 22. GUGGENHIME & CO.

FOR SALE.—20,000 lbs. extracted honey from alfalfa and light amber from Rocky Mountain bee-plant. Two cans, 120 lbs. net, \$8 40; also 5 and 10 lb. pails. In ordering state if you want white or amber.
 M. P. RHOADS, Las Animas, Col.

WANTED.—Comb and extracted honey. State price, kind, and quantity.
 R. A. BURNETT & Co.,
 163 South Water St., Chicago, Ill.

FOR SALE.—Choice alfalfa honey. Two cans, 120 lbs. net, whitest, \$9 00; tinted, partly from other bloom, \$8 40. Also small cans.
 THE ARKANSAS VALLEY APIARIES,
 OLIVER FOSTER, Prop., Las Animas, Bent Co., Colo.

FOR SALE.—Extracted honey from alfalfa; 60-lb cans at 7 cts., and smaller cans.
 D. S. JENKINS, Las Animas Colo

FOR SALE.—I have a few 160-lb. kegs of well-ripened buckwheat honey left which I will sell at 5½c per lb. by the keg, f. o. b. Special price on the lot.
 N. L. STEVENS, Venice, N. Y.

FOR SALE.—3000 pounds fancy comb honey. Write for prices.
 WILLIAM MORRIS,
 Las Animas, Col.

A Honey Market. Don't think that your crop is too large or too small to interest us. We have bought and sold five carloads already this season, and want more. We pay spot cash. Address, giving quantity, quality, and price.
 THOS. C. STANLEY & SON, Fairfield, Ill.

CHAS. ISRAEL & BROS.,
 486, 488, 490 Canal St.,
 Corner Watt Street, N. Y.
HONEY & BEESWAX.
 Liberal Advances made on Consignments.
 Wholesale Dealers and Commission Merchants.
 Established 1875.

PURE MAPLE SYRUP.
 MEDINA is the home of the honey bee and also the home of the MAPLE TREE, and the maple tree produces sap in the spring, which is boiled down and makes the finest flavored sweet in existence when you get it pure. One of our customers called it "Delicious Nectar." We have pure maple syrup to sell to the trade in several sizes of packages. Write for prices to
 R. E. FRENCH, - MEDINA, OHIO.
 Reference, The A. I. Root Company.

Strawberry-plants.
 I have a large supply of Lady Thompson, Excelsior, and Crescent plants. A limited supply of Bismarck, Clyde, Barton's Eclipse, Brunette, Gertrude, Brandywine, Wm. Belt, Bubach, Haverland, Gandy, and Warfield, \$2.00 per 1000, f. o. b. here, or 70 cts. per 100, postpaid. Satisfaction guaranteed.
 J. P. LEA, Fayetteville, Arkansas.

WANTED.—50 customers for great big strong farm-raised Bared Plymouth Rock cockerels, at \$1.00 each; from high-scoring and most fashionable strains.
 H. N. MUSSER, Blachleysville, Ohio.

FIRE SALE

OF BEE BOOKS!

On January 1st there was a severe fire in our building, burning out entirely four floors above us. The water that was thrown on the fire came down through our floor damaging our stock of books, printing-office, etc. Some of the books were wet slightly, but enough so that they could hardly be sent out as perfect. These are the ones that we wish to offer. The reading pages of all are perfect, only the covers being a little soiled. Here they are, with prices postpaid:

Prof Cook's "Bee-keeper's Guide," only 60c.
Doolittle's Scientific Queen-rearing, only 50c.
Newman's "Bees and Honey," only 40c.

They are all cloth bound, and latest editions. If you want a year's subscription to the old **Weekly American Bee Journal**, with any of the above books, add 75 cts. to your order. This is a **SPECIAL OFFER**, and will last only so long as the slightly damaged books last. Better order AT ONCE if you want a bargain. Remember we are

Headquarters for

Bee-keepers' Supplies !!

Catalog and sample copy of the **AMERICAN BEE JOURNAL**, FREE. Ask for them. Address

George W. York & Co.,
144-146 Erie St., Chicago, Ill.

WE WANT

to sell you bee-supplies. Our line is all new and complete. Send for our illustrated catalog. It will convince you that our Dovetailed hive is the best on the market. Our prices are right and our service is prompt.

Fred W. Muth & Co.,
Cincinnati, Ohio.

S-W. Cor. Front
and Walnut Sts.

Dittmer's Foundation !!!

Retail---Wholesale---Jobbing.

I use a PROCESS that produces EVERY ESSENTIAL necessary to make it the BEST and MOST desirable in all respects. My PROCESS and AUTOMATIC MACHINES are my own inventions, which enable me to **SELL FOUNDATION and WORK WAX INTO FOUNDATION FOR CASH**, at prices that are the lowest. Catalog giving

FULL LINE OF SUPPLIES

with prices and samples, free on application. **BEE SWAX WANTED.**

GUS. DITTMER, AUGUSTA, WIS.

FLOWER GARDEN VEGETABLE FOR 25 CTS.

To introduce our seeds to new homes we offer:

1 pkt. fragrant carnations,	1 pkt. German pansies,
1 pkt. sweet peas, our new	1 pkt. poppy, mixed,
white beauty,	1 pkt. new giant hollow-
1 pkt. foxglove, mixed,	hocks, mixed,
1 pkt. nasturtiums, mixed,	1 pkt. asters, mixed,
1 pkt. prize wax bean,	1 pkt. cucumber, mixed,
1 pkt. June 21 sweet corn,	1 pkt. new scarlet radish,
1 pkt. Edgewater tomato,	1 pkt. best summer squash
1 pkt. best winter squash,	1 pkt. Edgewater beet,
1 pkt. long keeping celery,	1 pkt. Edgewater parsnip.

All the above full packages for 25c, and a 10c Due Bill Free if you name this paper.

Cash prizes for our splendid novelties, nameless wax bean, and the Lawrence popcorn. Particulars in catalog. Write for it. Address

C. M. GOODSPEED, Skaneateles, N. Y.

HONEY QUEENS !!

I have them, as daily letters testify. Recent conclusions force the belief that the leather-colored strain of three-handers excels in honey-gathering. If you want Golden's my strain takes the lead of all others, and I have tried them all; 250 colonies for honey, and 200 strong nuclei that will winter over. I am prepared to send you a queen any day you may order. Tested or untested queens, \$1.00. Leather breeders, \$2.50. Owing to increased demand straight 5-hand breeders are \$5.00 each. **W. H. LAWS, Beeville, Texas.**

READY FOR 1901.

We are again ready to furnish our superior strains of Bees and Queens for 1901. We have the best stock of bees that money and skill can procure, as our numerous testimonials prove. We guarantee satisfaction. Let us have your orders. **WE WANT** your name and address for our circular giving valuable information, also description and prices of queens. We have 800 queens wintered over for spring orders, among them 50 fine Golden breeders.

Prices, either Golden, 3-banders, or Holy Lands.

Untested—June, July, Aug., and Sept.—1 75c; 6, \$4.25. Untested—all other months—1, \$1.00; 6, \$5.00. Tested, 1, \$1.25; 6, \$6.75. Sel. Tested, each, \$2.00. Breeders, \$3.00 and \$5.00 each. Discount in quantities, and premiums given away to our customers. Address

O. P. HYDE & SON, Hutto, Texas.

Italian Queens for early shipment from the South; are reared in full colonies by the best methods known to queen-breeders. Spring prices—full colonies, \$6.00; two frame nucleus without queen, \$1.50; three-frame nucleus without queen, \$2.00. Add price of queen wanted to price of nucleus. Tested queen, \$2.00; untested, \$1.00; six for \$5.00; 12 for \$9.00. Liberal discounts on large orders. Combs built on full sheets of foundation in wired Hoffman frames. Shipments to the North by New York, Baltimore, Philadelphia, or Boston steamer via Savannah, Ga. **CHRISTIAN & HALL, Meldrim, Ga.**

Dixie Superior Queens

Ten thousand names wanted. To each I mail my catalog for 1901, of high-grade long-tongued strain, which will explain how I give \$3.00 breeders free. I breed only best queens; so if you want your money's worth, write for free catalog. Notice former advts.

PORTER A. M. FEATHERS,
(Superior Queen-breeder),
Oak Hill, Volusia Co., Florida.

Don't Forget that I am booking orders for my strain of **Business Bees** that have been bred for working qualities for years, and have made some of the largest yields on record. Write for circular.

J. B. CASE, Port Orange, Fla.

Bee-keepers' Supplies !!

Root's Goods. Sold cheap. Bee book given with order. Send for list explaining Barred Rock chickens and Belgian hares. Pedigreed stock.

W. D. Soper, R. D. 3, Jackson, Mich.

NOW READY!

64-PAGE CATALOG OF EVERY THING BEE-KEEPERS NEED. Illustrated and fully described. Especially valuable to beginners for the information it contains. Send your address on a postal and get it now. Established 1884.

J. M. JENKINS, Wetumpka, Ala.

QUEENS?

Improved Golden and Leather-colored Italians is what we rear — 13 years' experience enables us to furnish Superior Stock.

Humboldt, Neb., Aug. 5th, 1900.

Mr H. G. Quirin. Dear Sir:—The colony containing the queen you sent me has already stored over 400 lbs. of honey (mostly comb) for this season, and will yet store quite a considerable before the season closes. It would take \$100 to buy this queen. I have another one from you which I think will turn out equally as well. Bees from your queens certainly do work on white clover. I can tell, as they are the only bees of their kind in my locality. Hereafter when I want more queens I shall know where to get them.

Yours truly, J. L. GANDY.

At present we have two very valuable breeders which will be used for the coming season. One is a breeder from Root's \$200.00 red clover queen. We are now booking orders for April, May, and June delivery at the following prices:

Warranted Stock, \$1.00 each; 6, \$5.00.
Tested Queens, \$1.50 each; 6, \$8.00.
Select Tested, \$2.00 each; 6, \$10.50.

Why not let us book your order for one or half a dozen of these **Superior Queens?** We guarantee safe delivery. You take no risk. Remember queen-bees is our specialty in summer time. For a short time we will allow **20 per cent discount** on Folding Cartons, and printed stationery. Parkertown is a money-order office, so please do not send stamps if you can help it.

H. G. Quirin, Parkertown, Ohio.

A Bear in the Apiary.

I have just lost an entire apiary of 52 colonies by bear. I had the very good fortune to kill a very large one *right in the midst of the wreckage*. I have a very good 5x8 picture of this *Bear, in the apiary he destroyed*. This is the greatest novelty in the way of an apiarian view I have ever seen. I will send you one of these pictures for 35 cts. postpaid, or as a premium for each half dozen queens ordered.

Don't forget that my specialty is the best *queens* from the *best stock* that it is possible to procure, and that my *motto is promptness*. I also handle The A. I. Root Co.'s supplies at their prices, plus 55 cts. per 100 lbs. to pay carload freight. Send for price list.

W. O. VICTOR, WHARTON, TEXAS.

QUEEN SPECIALIST.

I. J. Stringham, 105 Park Place, New York City.

Keeps in stock a full line of modern appliances for bee-keepers.

COMB FOUNDATION

is one of our specialties. If you expect to use any quantity get our prices. Catalog free. Apiaries at Glen Cove, Long Island.

I. J. Stringham, 105 Park Place, New York City.

Notice!



THE A. I. ROOT CO.

wish to announce that they have from their branch at 10 Vine St., Philadelphia, Pa., direct steamboat connections and very low rates of freight to the following States: Massachusetts, Rhode Island, Connecticut, New Jersey, Delaware, North Carolina, South Carolina, Georgia, Florida. As this is a branch of the factory, prices are the same. Full colonies of Italian Bees, \$6.00. Special discount in large quantities.



G. B. Lewis Co.,

Man'f'rs of Bee-keepers' Supplies,
Watertown, Wis., U. S. A.

The cut shown below is our packing case. It protects goods while in the hands of the railroad company so that you will receive every article in just as good condition as when they left factory.

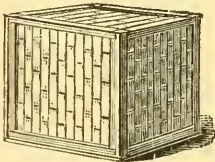

Our Wisconsin Hive.

We consider this one of the best hives in the market. It is similar in construction to the Improved Langstroth Simplicity shown in the previous issue, but includes some of the new-style devices which are preferred by some. It has the thick reversible bottom, and the supers are arranged so that the bottom can be wedged up from the end as well as the side. The body contains Hoffman frames, metal rabbets, and division-boards. See page 5 of our new catalog. We manufacture four other styles of hives. If you have not received our new catalog, send for one. It's free.

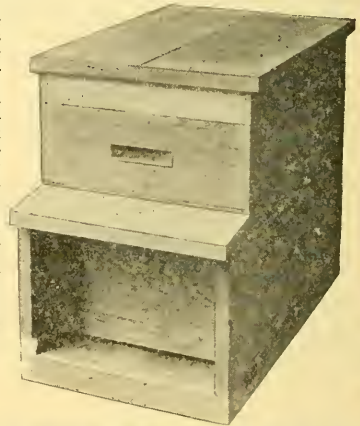

BRANCH: 19 Son. Alabama St., Indianapolis, Indiana
AGENCIES: L. C. Woodman, Grand Rapids, Mich.
Fred Foulger & Sons, Ogden, Utah; Colo. Honey-producers' Association, Denver, Col.; E. T. Abbot, St. Joseph, Missouri, Special Southwestern Agent.

BEE-SUPPLIES!

ROOT'S GOODS
AT
ROOT'S PRICES

C. H. W. Weber, Cincinnati, Ohio.
2146-2148 Central Ave.

A NEW and complete stock for 1901 now on hand. I am The Root Company's representative for Cincinnati and surrounding territories. . . . You save TIME and FREIGHT CHARGES by having goods shipped from here. Convenience of railroad facilities here enables me to do so. Before buying elsewhere, write for my prices and catalog, which will be mailed you free of charge.

GLEANINGS IN BEE CULTURE

A JOURNAL DEVOTED TO BEES AND HONEY AND HOME INTERESTS.

ILLUSTRATED SEMI-MONTHLY

Published by THE A. ROOT CO.
\$1.00 PER YEAR MEDINA, OHIO.

VOL. XXIX.

FEB. 15, 1901.

No. 4.



EDITOR GERSTUNG, of the *Deutsche Bienenzeitung*, has a sample of linden honey from latitude 60° north. Like that from high mountains, it has intense aroma, without losing any of its pleasant taste.

THE CENTRALVEREIN for Bohemian beesmen insures its members free of cost against loss by fire up to a certain limit, and by payment of 1¼ cts. per colony against damages arising from trouble with bees.

YOU ADVISE heating extracted honey gradually, Mr. Editor, to clear it of bubbles, p. 98. The Germans say cool slowly. Both may do better than either alone; the idea being to keep the honey hot long enough for the bubbles to rise, without having it so hot as to injure the honey.

DZIERZON has used with satisfaction in spring, when bees are flying daily, as a stimulant for brood-rearing, skim milk sweetened, less sweetening being necessary when the bees have fairly started. The milk may be fed in combs or feeders, outside or in the hive. If too much is given there will be curd in the hive.

ILLUSTRIERTE MONATSBLETTER FUER BIENENZUCHT is the title of a new German bee-journal edited and published by Theodor Weippl, who has ably edited the well-known *Bienen-Valer* heretofore. In appearance it takes high rank, and, unlike most of the German bee-journals, it is entirely independent of any bee-keepers' society.

ALOIS ALFONSUS, so favorably known among German bee-keepers, is the new editor of *Bienen-Valer*. He starts out well in his inaugural by urgently advising beginners to get a text-book, saying a bee-journal is by no means intended to supplant a text-book, but to supplement it. That's sound doctrine, either in German or English, Herr Alfonsus.

DR. LEISTER is reported in German journals to have subsisted mainly on white bread and ½ to ½ lb. honey daily for six months. He

exercised severely and was well nourished, finding candied honey best for his purpose. [The opinion is gaining ground very rapidly that sugars are food, and that they conduce to strength and endurance, and that an excess of them tends to an excess of fat.—ED.]

THE EDITOR of *Le Rucher Belge* has been measuring some old combs, and endorses Editor Root's views as to their being all right for brood. But he says bees prefer new comb, and so do queens. Others have said the same thing. I don't understand it. Give my bees old black comb and new comb side by side, and they'll prefer the old every time, whether for brood or honey.

ARTHUR C. MILLER thinks uncapping-forks are no new thing, having been mentioned several times in old issues of bee-journals. Yes, I've used such a fork for years—learned it of M. M. Baldridge. But I used it to uncap for the bees, not for the extractor. Such a fork scratches; but, if I understand rightly, the German fork slices off the cappings as well as or better than a knife.

THAT HEADING on p. 89 is hardly fair to shallow brood-chambers. E. F. Atwater's experience would probably have been the same in a deep chamber. I agree with you, Mr. Editor—no, I don't—I go further than you, and say that putting a colony on starters not only discourages but almost invariably prevents swarming. Desertion may occur at first; but that's another thing, and may be prevented by penning the queen in the hive.

TO FRIGHTEN away robbers, it is recommended in *Leipziger Bztg.* to put a looking-glass before the entrance. [It depends on how bad the robbers are. I have seen the time when nothing in the world would stop their onslaught but a good piece of wood wedged tightly in the entrance. If the case were a mild one I should not be surprised if a mirror might accomplish something, for the robber would apparently be rushing right toward another bee that it supposes is about to grab and pull it down.—ED.]

THE PORTER ESCAPE should not be forgotten, in summing up inventions, says Arthur C. Miller, referring to a Straw on p. 43. That Straw, friend Miller, was not intended to ex-

haust the list; only to introduce the subject in hopes that some one more competent would take it up. It might not be of any practical value, but it would at least be interesting to see a full list of all improvements in the past 60 years, with names and dates as far as possible. [No, indeed; the Porter bee escape should not be omitted; for in the saving of time, and in the saving of disagreeable work, no other invention of recent times has accomplished as much. Say: I do not know but it would be a good idea to have a list of all the great and important inventions relating to bee-keeping. I'll try to prepare such a list, and then submit it for revision.—ED.]

DR. JOHANN DZIERZON, the beloved altmeister of German bee-keepers, was 90 years old on his last birthday, Jan. 16. He is still vigorous, and made a strong address at the last great German convention. As evidence of the high esteem in which he is held, the January numbers of German bee-journals contain many pages concerning him. But Dr. Dzierzon belongs not to Germany alone; he is too great for that. He belongs to us, and to the whole world. No other man living has done so much for bee-keeping. Long may he live! [Is not your last sentence, doctor, a little strong? I am a great admirer of Dr. Dzierzon, and believe he has done much for the advancement of scientific apiculture; but to say that no other man living has done as much for bee culture would be questioned by many bee-keepers.—ED.]

ABOUT THREE YEARS ago (GLEANINGS, Vol. 26, p. 292), a Stray Straw said, "Bro. Ritchey and I believe in breeding for long tongues, even if some editors don't;" and the footnote said, "But some of us have not seen those bees yet with long tongues, notwithstanding all the talk about them." Then a little later (p. 502) the same footnoter said, "Are you really sure, doctor, that some Italians have longer tongues than others?" That same footnoter is now the craziest of the crazy on long tongues. And yet some people say no progress is being made. [Look here, doctor; you do not need to go back into old ancient literature. It may give you a great deal of satisfaction, but it may not please other folks. But I have the same opinion that I always had about a glossometer; that is to say, I do not take much stock in that way of measuring bees' tongues.—ED.]

AT A CONVENTION reported in *Revue Internationale*, M. Seiler showed a bottle of concentrated chemical preparation used by adulterators to give the proper odor to adulterated wax and honey. If one can judge by the foreign journals, America does not take the lead in the adulteration of honey, and is far in the rear in adulterating beeswax. [So far as I can remember, never even a taint of suspicion has ever rested on the makers of foundation in the United States as to the purity of their product. The paraffine and ceresin foundations were very unsatisfactory to those who tried them. Perhaps they might be used if the frames were excessively wired. After all, the general consensus of opinion of those who are in position

to know is, that genuine beeswax is the cheapest in the long run. Economy in foundation will not come by cheapening the product from which the product is made, but rather in reducing the excess of wax now in the cell bottoms or septa. While we have made great improvements in this one respect, there is still room for more improvement.—ED.]

"IS IT TRUE that outdoor-wintered bees are always stronger in spite of the extra consumption of stores?" p. 103. Not "always," but I'm afraid they generally are. Let me give my guess in the matter. A weak colony suffers from severe cold more than a strong one, as a greater *proportion* of its bees form the outer crust. A strong colony suffers more in the average cellar than outdoors, in spite of the more favorable temperature of the cellar, because the air is impure in the cellar and pure outdoors. [I would suggest that our readers watch this matter of outdoor and indoor wintered bees very carefully this coming spring. Take count of the amount of stores consumed per colony by the outdoor and indoor bees; then see which ones are the first to go into the supers, or, better still, which produce the most honey. But, look here: Suppose the bees of an indoor colony have long tongues, and the indoor colony, of the same strength, has short-tongued bees. Well, at all events it would do no harm to take observations, for it is only by a general comparison extending over several years that we can get at the truth of this matter.—ED.]



We wait, impatient, for mild Summer's reign
To bring the flowers so nice.
Then turn, perspiring, from those flowers
To bless these blocks of ice.

AMERICAN BEE JOURNAL.

At the last session of the Illinois State Beekeepers' Association a paper from Mr. Geo. W. York, the editor, was read. His subject was "Pure-food Legislation." Concerning the reason that laws on this matter and others concerning the public health are not properly enforced, Mr. York well says:

Another very important requirement to the successful results of pure-food legislation is honest officials—officers who know no better than to enforce laws just as they find them, without fear or favor. No law ever enforced itself, and never will. The reason, almost invariably, why prohibition doesn't prohibit is because of officials who don't officiate honestly and fearlessly. I believe, however, that the present pure-food commission of Illinois are all right, but that the fatal weakness is in the law itself.

But so long as the "dear people" persist in electing, as their State lawmakers, saloon keepers, pothouse politicians, gamblers, and frauds, just so long may they expect to have weak laws—laws that fail at the most crucial time, because they were evaded with that intention. The people must act honestly and decently themselves in the selection of their lawmakers and public officers; then, and not until then, need they expect that good laws will be furnished and properly enforced.

The following letter, relative to the big bees of the Philippines, was sent to us by Mr. J. M. Woodhouse, of Dubuque, Ia. It was written by his son N. E. Woodhouse, an American soldier in the Philippines. As it contains much of interest in regard to the big bees of that place it is given here entire. It will be noticed that Jumbo despises any house smaller than outdoors, and has no idea of what "benevolent assimilation" means.

Dear Father :—I have something to tell you which I know will interest you. On the 18th a large swarm of bees came here and lit on a tree about 40 ft. from the ground. They were the first I had seen here, and I was determined to have them; so I got a ladder that reached them, fixed an old rough box in readiness, and put on two pairs of gloves, and some mosquito-bar over my face, and took a rice-bag up, slipped it up over the bunch, crowded them off the limb, and got them almost all into the bag, closed the bag, and brought them down as smoothly as could be. About 200 natives had gathered to watch the operation, but were very careful to keep away. They never saw any thing like that; and the soldiers thought they were going to see some fun, but did not see it. I could not get them into the box out of the bag, so I lit here, and I went on the alighting-board, and they went up into the tree again. I went up and brought them down the next day, but could not get them into the hive. They went back into the tree, and yesterday they left and went close to the hospital, and went into an old building. I cut a round hole in a box and slipped it up over the bunch, crowded them loose from where they hung, put a board over the hole, and had them in a nice comfortable home with honey to eat, which I had bought out of the sales commissary. To-night I took the paper out of the entrance at sundown and gave them their liberty, and they immediately came out and lit up under the eaves of the church. I believe they will go to work there.

All that I used to know about having bees in the United States has failed to work here; i. e., so far as I had the wherewith to work with. They simply will not stay in a box. They are a beautiful bee, considerably larger than the Italian. Instead of having the yellow stripe they have a silvery-white stripe with the black.

If I could have got them to work in the common box I would have made a movable-frame hive and reared some more queens and sent the queens back to you; but I guess I shall have to give it up for the present.

N. E. WOODHOUSE.

Gray, P. I., Oct. 20, 1900.



THE PAN-AMERICAN EXPOSITION.

Something of What it will Be, from the Standpoint of the Bee-keeper.

BY OREL L. HERSHISER.

[The following letter is in answer to one I wrote to Mr. Hershiser, stating that I was receiving a good many inquiries, and also that a number of clippings had been sent us, but that I disliked to take any thing of this kind at second hand, and hoped that Mr. Hershiser himself, superintendent of the apiarian exhibit, would give us full particulars from his own pen. In response to this he has sent me the following letter—Ed.]

My dear Mr. Root :—Answering your note of January 25, regarding the Pan-American, the whole matter might be summed up in a single statement, to the effect that there will be here presented greater opportunities for instruction, amusement, and the cultivation of

taste for the beautiful, than have ever before been afforded at an exposition in the western hemisphere, and, according to the statements of persons well qualified to judge, the architectural and landscape effects of the Pan-American will make it the high-water mark of the expositions of the world. This is a broad statement, but one which the facts support; and when we consider the elegant symmetry that has been studiously observed in the grouping of the buildings and laying-out of the grounds, the pleasing and harmonious color effects of the exteriors as well as the interiors of the buildings, the novel and beautiful Spanish architecture, and the elegant landscape, the claim seems to be merited.

Judging from present indications the apiarian exhibit will not be least among the many novel and instructive attractions. It promises to eclipse every thing in this line ever attempted, and this notwithstanding the general shortage in honey production in many localities within the United States and Canada during the past two years.

This exhibit will be a veritable wonderland, not only for apiarists but for that larger class of users and consumers of honey. It is designed to make this exhibit educational as well as entertaining, to the end that the fallacies affecting the pursuit of apiculture may be, as far as possible, rectified. A model apiary will be in operation to show, in a practical way, just how both comb and extracted honey are produced. Exhibits showing the relation of bees to horticulture will be a prominent feature, and the mistake of spraying fruit-trees when in bloom will be demonstrated, as well as the absolute necessity of the presence of bees during the season of bloom in order to make horticulture, in any sense, a paying pursuit. Vast quantities of both comb and extracted honey, prepared in the most attractive and appropriate forms for market, will be shown. It is safe to say that this most interesting feature of the exhibit will include the nectarous products of all valuable honey-plants to be found within the Americas and the island possessions of the United States. There will be a complete and exhaustive display of manufactures in which honey forms a component part, and beeswax and the many and various manufactures therefrom. A distinctive exhibit of honey-plants, as a part of the general outdoor-growing horticultural and floral exhibits, is contemplated. There will be several large and attractive exhibits of apiarian supplies, comprising specimens of all approved hives and every tool, device, and preparation needed in the pursuit of apiculture.

Several State and Provincial exhibits are already assured, and others are under advisement. It may also be stated that individuals, no matter where situated within the Americas, have an opportunity to exhibit their apiarian manufactures and products. One person in this class proposes to install an exhibit comprising a carload of 30,000 pounds of comb honey, and it is expected that there will be others of great magnitude, especially from localities noted for large production of honey

of a standard and uniform grade, as is the case with the alfalfa of Colorado, the sage of California, and the basswood of Wisconsin. Many of these, as well as some State exhibits, will be of the present season's honey harvest, and will not be installed before the middle of July to the middle of August; but application for space should be made early, in order that it may be provided.

Apiculture is accorded a prominent place in the exposition, and a special building, in an excellent location, will be provided for the apicultural exhibits, the extent and size of which will be commensurate with the needs and desires of the bee-keepers who will exhibit. Mr. F. A. Converse, Superintendent of live stock, dairy, and agricultural products, is deeply interested in this important branch of rural husbandry, and the apiarists are most fortunate that their interests have fallen under his excellent supervision.

1106 D. S. Morgan Building, Buffalo, N. Y.

GLIMPSES OF CUBA AND CUBAN BEE-KEEPING.

BY A. L. BOYDEN.

For some time past the readers of GLEANINGS have seen frequent articles by different writers with reference to the state of bee-keeping in Cuba. These articles have fired me with a desire to visit that country, and see for myself the conditions as they exist there, not only with reference to bee-keeping, but relating to other industries as well.

Accordingly, on the morning of Dec. 20 the steamer *Curityba* brought me in sight of Matanzas, 60 miles east of Havana, a beautiful city of 75,000 inhabitants. I found very few



BRIDGE AT MATANZAS.

Americans in Matanzas, and experienced some little difficulty the first day or two in making my wants known. I soon found my way to the store of Thos. D. Crews, formerly of Florida, now a merchant in that place, and he gave me much valuable information. After visiting him I took a stroll about the city. I first went out on the roof of the hotel "Paris," from which point I could see all of the city and surrounding country very well indeed. A great many of the buildings are provided with

means of access to the roofs. The roofs are made of brick or tile, mainly of the latter. I found one of the railway stations, and the yard adjoining, very similar to those in our large cities of the Northern States. The streets of the city are very narrow, though not as narrow as those in Havana, and the sidewalks are in proportion, being only eighteen to twenty-four inches wide in many places. The windows of the dwelling-houses, stores, and hotels are tall and wide, with no glass, but simply closed shutters or inside blinds, which are folded back in the daytime. These windows are all provided with grates or bars, giving the buildings quite the appearance of a jail or prison. Most of the houses are built right up to the walk, there being no yard in front at all, so one passing along the sidewalk looks directly into the sitting-room or parlor of these houses.

The city lies at the intersection of two rivers, and has several fine bridges. Toward the west lies a series of hills which are very beautiful. I found the streets well lighted with electric lights, but the lighting of dwellings and many public buildings is very inferior.

I found no apiaries located near the city; but on going out to Ceiba Mocha, nine miles distant, I found a number of Americans who had recently embarked in this pursuit. Here I found the apiary of Thos. D. Crews, also that of W. B. Cilley, and several others of smaller beginnings.

I am told that Ceiba Mocha, prior to the late war, was a prosperous village of some 8000 people. Now it is said to contain 800 inhabitants, though I could scarcely believe that this number were to be found in the place. Near the railway station is a typical Cuban apiary of some 500 box hives. These hives are made of four boards about 12×30 inches long, nailed together, forming a tall box. The ends are left entirely open. These boxes, instead of standing on the end, which would make them look somewhat like the old "American" hive, are laid down on the side, resting on blocks a few inches above the ground or on low benches. The sight of these hives, filled from end to end with combs, and well covered by bees was enough to give a bee-keeper a touch of the "bee-fever."

I found that the surplus is obtained by cutting out the combs of honey from each end, perhaps one-third of the distance from the end toward the center. The brood, naturally, is in the center of the hive, so the combs in the end contain very little brood as a rule. With a smoker or pail of smoking wood the bees are driven back from one end so that the combs are cut out with very little difficulty from one end, and later on they are cut from the opposite end.

In this apiary there is a sort of honey-house in which I found a large trough hollowed out of a log, and a press in which the honey is pressed out of the combs. If there is any brood or pollen in the combs, that has to be mashed up with the rest. No effort is made in these box-hive apiaries to put up a nice article of strained honey where extractors, of course, are unknown. The honey is put up

in tierces of about 100 gallons, loaded on to two-wheeled ox-carts, and hauled to the nearest market. I took a snap-shot of this yard, but, unfortunately, the tropical vegetation was so heavy that the picture does not show the hives sufficiently clear to reproduce.

Near the apiary of Mr. Crews, which is managed by Mr. Frierson, is another large box-hive yard. In company with several American bee-keepers, some of whom could speak Spanish, we visited this yard, wanting to get another picture to show the readers of GLEANINGS. The same conditions existed here—a very heavy foliage—and I secured no picture sufficiently good to half-tone. I had quite an amusing experience, however, in trying to get this picture. My interpreter told our Cuban friend what I desired, and he gave his consent to have me photograph the yard. It appears that he did not understand the matter very well, and when I went to the lower end of the yard to snap my kodak he came rushing up, gesticulating wildly and talking vociferously. The bees were getting roused up at this point; and as I did not understand his Spanish I concluded that he was afraid I would get stung. Being a bee keeper myself, I determined to take my chances, and so held my ground until I had made two exposures (both failures, however), and then went back to the upper end of the yard where the rest of the company were. When I got there I found I had offended this man very much indeed, for he thought I had come with some sort of music-box to entice his bees away. It is reported that he lost a large number a year or two ago in the same way, and he is very suspicious of any thing he does not understand now. We tried to explain the matter to him, but did not succeed in pacifying him.

I found a large amount of honey is shipped from Matanzas every year. The production of strained honey naturally results in a large accumulation of wax, and these box-hive men are reported to receive about as much for their wax as they do for their honey.

In our next issue I will give a view of Independence Street, in Cardenas, and how I spent Christmas with the mosquitoes.

Medina, O., Feb. 10.

CUBA.

Locations; Climate; Social Life, etc.

BY HARRY HOWE.

Very frequently I am asked by bee-keepers in regard to locating in Cuba. In my opinion Cuba is the place to raise honey; but one must expect to put up with things that he would not in the States. If I were not sure that Cuba is all right I would not be making contracts for years ahead, as I am in renting locations, etc. There are, however, several reasons why I always advise my correspondents not to come. First, one can not do a thing until he can speak the language. A bee-keeper must of necessity locate at some distance from the places where he could have

American neighbors, for all of those places are already overstocked with bees. Besides, one does not like to depend on some neighbor to do all of his business for some months. So if one wants to come here he must either learn the language first, or get a place with some other American while he is learning it. The chances for that are not very good, for all of us have a waiting-list of considerable length, to say nothing of always having some personal friend in view for the next opening.

There are several chances to work for Cubans, but one must know Spanish.

Then there is the climate. While the winters are fine, the summers are not. Men from Texas or Florida, for instance, get along pretty well with it, but men from the North are apt to have a hard time the first summer. I got it so bad I had to go to New York and lie up in a hospital several weeks (this from "bicycle heart"). Heart disease is very prevalent among the natives, but consumption takes the worst hold. Then there are the malarial fevers which also get the northern men. For these reasons, no one with either heart or lung trouble should try to live here in summer. The winters are fine for both, for the air is then generally dry and clear.

I say nothing of yellow fever, for there is no danger of that in the country, nor to men of regular habits if they do get it.

Then comes the trouble to find locations. For instance, one of my yards is just piling in the honey, while one eight miles away is not much more than making a living at present; yet four months ago, when I located the last one, that location looked to be the better of the two.

A stranger coming here would find it very hard to get a good place. This fall one man came from the States with some bees which he took to a place he had heard called a good one. After he had been there a while he found there were 2000 colonies within three miles of him. The location was good, but badly overstocked.

No one seems to know what is on even the next farm. He must go and look for himself before he knows whether there are bees or not.

Then there is no social life here. A man must be able to amuse himself in some other way to be happy. When I say no social life, I mean for us stray Americans. Society is very exclusive, and it is only by a long residence here, or by some accident, that one gets into it; and when he does, it is so different from northern ways that one has to learn anew.

But if one is prepared to enjoy nature, if he knows some botany, entomology, or geology, he can be perfectly happy here. Where one can go out every day and find a bug or a plant or a fossil not down in the books he can be sure of enough to keep him busy, and he can get honey. One friend has already this season 75,000 lbs. from 500 colonies, and the season is only about half over. Another started with 32 in April, now has 170, and 20,000 lbs. of honey. But, again, white honey, the finest in the world, brings only 3½ cts. here now.

Here location is every thing, men something, and hives nothing as factors in big crops.

Artemisa, Cuba, Jan. 20.

CUBA FOR BEES AND HONEY.

A Favorable Statement.

BY ROBT. L. LUACES.

For some time past I have been finding articles on Cuba as a bee country; foul brood in Cuba; Cuban honey in the American markets, etc., that are sure to create the impression that bee-keeping here is bad business, and growing worse from day to day. Now, all this is not so. The value of Cuban honey exported for the six months from July 1 to Dec. 31, 1899, amounted to \$19,506. Of this, half went to Germany and half to France and the United States. These data are taken from official reports, and show that Cuban honey finds its market in Europe and not in the United States, so American bee-keepers need not fear competition from Cuba in their home markets.

In GLEANINGS for April 1, 1900, page 260, Mr. Harry Howe gives his experience in looking up a location, coming to the conclusion that these are few and all taken up; also that bees are scarce, and foul brood plentiful. On page 261 Mr. Geo. Rockenbaugh, Jr., goes on to say that Cuba as a bee country is done for; foul brood has killed it, and gives doleful accounts of prices and railroads. Mr. F. H. Somerford gives us a funny story, and sums up his experience, saying Cuba is no better than Texas.

Now, I will ask the readers of GLEANINGS to take into consideration the following: None of the gentlemen I have mentioned, according to their own statements, have been more than 30 miles away from Havana, and, of course, they can speak of the different places where they are; but it is straining a little to judge all Cuba by what small portion of it they have seen. Mr. R. forgets to say that the prices he gives are mostly in Spanish silver, and Mr. S. ought not to expect big crops from places that, from their own saying, are overstocked, overeaten by cattle, and full of all kinds of broods and worms.

I live fully 300 miles from Havana, at Puerto Principe; and the bee-keeper whom I can't show in one day's ride on horseback more good locations than he can use is hard to please. Bees don't cost here \$5.00 to \$6.00 per colony in log gums, but from \$1.25 to \$1.50 (Spanish silver). Land does not cost an enormous rental for a few yards. My apiary of 69 hives is situated 3500 meters from the city limits on half a caballeria (some 16 acres) of land that costs me in rental \$20.00 currency a year. I have never seen foul brood here, nor heard of it. Moths are plentiful, as in all warm climates. Since September 20 we here have been hard at work extracting royal palm and Indian-vine honey, and since Nov. 1 the pure white aguinaldo (or campanilla, as we call it here), is in full swing.

This part of Cuba has always been noted as

a honey-producer; and although the late war did lots of harm, the industry of bee-keeping is fast coming to the front again; and with improved methods, hives, and extractors, we shall soon beat our own record.

Puerto Principe, Cuba, Dec. 31.

TWO ITEMS.

Fumigation of Queens in the Foreign Mails; Honey Candying in Uncleaned Sections.

BY G. M. DOOLITTLE.

On reaching home from my six weeks' absence in the "Sunny South" I am pleased to see that the National Bee-keepers' Association won the Utter-Utter suit, which was a *glorious victory* for our pursuit, and one which will go down to all time as a precedent to any who ignorantly or maliciously wish to attack the bee-industry. And, so far as I know, the bee-keepers have won in all litigations which have been started against them, ever since we organized ourselves into a body to show to the world that we have *natural* rights in this world as well as others. In view of these results, the strange thing is that, out of about 300,000 bee-keepers in the United States and Canada, less than 600 seem to care enough about these achievements to send in a dollar and join their names and destinies with us. Come, you 299,400 on the outside, wake up to your privileges.

But this was not what I started to write about. From some facts which have come to me lately, it would seem that the time is at hand when the N. B. K. A. can help the bee-keepers of the world along the line of a "new departure." Our pursuit would probably have never risen to the prominence it now enjoys had this country never had any other bees than the black bee of our fathers; for, in my estimation, the importation of the different races of bees we have in this country to-day (outside of the black bee) has been one of the incentives which have raised our pursuit from where it was forty years ago to the eminence it now enjoys. And, if I see clearly, there is something that stands directly in the way of any further improvement of the bees of the world by way of importing choice stock from the Orient to us, and of our exporting our choice stock over to them. All importers and exporters have found out, sooner or later, that, while some shipments of bees have gone through in apparently perfect condition, other shipments have arrived at destination *all dead*; and we have wondered at this, for, so far as we could see, the same pains and carefulness were used on the latter as on the former. A year ago last summer I was filling a large order from Jamaica for queens, sending from six to twelve a week. Up to 35 or 40, every one went through in perfect condition, when all at once one shipment went through with every bee dead. I had the cages all returned to me; and as soon as I looked at them I came to the conclusion that the mails containing this shipment had been fumigated, as the bees all had their tongues protruding.

On writing the matter up I found, as I surmised, that the mails had been fumigated at that time on account of the yellow-fever scare that was then on. As no more were lost that year I paid but little further attention to the matter, as I thought such a scare would not happen very often, and when it did I should be likely to know of the matter through the papers, so I could withhold any shipment of queens until it was over. But I am now awakened from this reverie by lately receiving word from a shipment of queens to Australia, all of which went through dead. Among other things in the letter are these words: "If there had been a chance of any of them coming through alive they were deprived of it by the process of *fumigation* which all mails coming from America to New South Wales have to undergo now;" and that this state of affairs is becoming quite common can be seen by turning to p. 242 of the *Southland Queen*, where it will be found that the Atchley Co. lost a whole shipment sent to New Zealand; and as the health officers of all countries are becoming more alert with each passing year, the mails will be fumigated more and more till our choice queens will have no show whatever in the foreign mails unless some special privileges are granted by way of a separate pouch for queens, or something of the kind.

The question now is, Can the National Beekeepers' Association take any action in this matter which will help any? or can Prof. Benton use any influence with those at the head of the foreign-mails department at Washington? Unless something is done, successful exporting or importing of queens through the mails will soon be a thing of the past.

The other item to which I wish to call attention is found in *Sray Straws*, page 43, Jan. 15, and reads as follows: "If I understand rightly, Doolittle advises, p. 16, to extract partly filled sections, and use them for bait without having the bees clean them out. Now, will there not be particles of candied honey in those sections? and will that not hasten candying in them when filled?" This part is by Dr. Miller. Then the editor adds, "It does not seem to me that Mr. Doolittle really meant this; for among practical bee-keepers it has always been laid down as a rule that unfinished sections, when extracted, should be cleaned out by the bees, else there will be particles of candied honey in the sections when they are filled the second time."

To the good doctor I wish to reply as follows: First, he understood me correctly or rightly, and I have been in the habit of thus using sections for the past 15 years. Second, there may or there may not be particles of candied honey in those sections. If the sections contained honey which would candy in the comb before spring, had not the bulk of the honey been extracted from them, the honey remaining in the cells after extracting will candy somewhat, after the extracting process. If the bulk would not have candied when left without extracting, that remaining in the combs after extracting will be free from candied particles when the baits are set on the hives. Third, after several experiments I can

not find that particles of candied honey, put with freshly gathered honey, hasten the candying of the mass, on the principle that "a little leaven leavens the whole lump." I have tried this several times, but so far have succeeded in getting honey to granulate or candy only when every thing was just right for it to do so, just the same as honey used to candy for our fathers, or before we "smarties" got to "fooling" with it. I know that some honey will candy sooner than other kinds, both in the comb and out; but so far as I have experimented I could never hurry the slow candying kind by putting a little of the quicker-candying kind with it. Could you, doctor?

And to our good editor I wish to say that many fallacies are often indorsed by "practical bee-keepers" simply because some one has announced such fallacy to be a fact. Does Bro. E. R. Root remember when nearly every practical bee-keeper in our land was loud in "laying it down as a rule" that none but comb foundation "*fresh from the mill*" should be put in section boxes, because, if other than fresh, the bees would not work it until a part of the honey season had passed away, because the old was so hard and dry-looking? After I experimented in this matter, and announced that such a theory was a fallacy, and that foundation three years old proved to be soft and pliable looking and otherwise, just so soon as a degree of heat sufficient to work wax was brought to bear on it in the hive or surplus arrangement, and that my bees actually worked foundation from three to five years old just as readily as they did that only one week old, this old rule, "laid down by practical bee-keepers," was as silent as the grave, and has hardly been heard of since. And so will be this other, regarding "particles of candied honey in the sections when they are filled the second time," when we as candid apiarists take time to look into the matter, instead of taking for granted what is told us. Take a section of candied honey and set it in your surplus arrangement on the hive with other sections, and allow it to remain there till the rest are filled, and you will find the honey in it liquid like the rest. Quinby told us 45 years ago that combs of honey, candied solid during winter, would all liquefy during the following summer if left in the hive with the bees, the heat of the bees and the summer doing the work, and I have proven the same true time and time again; and, further, that, if put up in the loft of a building where the sun on the roof maintained a high temperature, the liquefying would be done long before fall. Now, then, as soon as those sections having particles of granulated honey in them are on the hives, and the temperature rises to a point where brood can be reared, or wax worked, they all dissolve, and the bees lick every thing dry and clean, as they always do before putting any honey in any cell. And those combs are just as free from particles of granulated honey as they would have been had the bees licked them dry the fall before; at least, reason and *experiments* covering almost a score of years tell me that such is the case here in Central New York; and as for the

honey in such sections candying any sooner, no matter whether licked in the fall or in the spring, than does the honey in those filled from starters of foundation, or those filled with foundation, years of close observation has failed to show any difference. Therefore I adhere to using all partly filled sections again, instead of destroying them, as was the common advice a decade ago, and placing sections in the supers as baits from which the honey has been extracted, without giving them to the bees to clean up, other than what they do after the sections are put on the hives for the next season's crop. And I advised accordingly, as the labor thus saved is an item worth looking after. If any disagree, all they have to do is to give the matter a thorough trial, and then govern themselves accordingly. Borodino, N. Y.

[Yes, Mr. Doolittle, I remember how you were almost alone at one time in asserting that old foundation was as readily worked by the bees as new. At the present time there are very few bee-keepers, who are familiar with recent literature pertaining to the industry, who would pay half a cent difference for new foundation over old. But your *other* statement about unfinished sections—well, if it came from any one but you I should be inclined to say he was wrong—all wrong; and even now, in the face of evidence that I have listened to at the various conventions I have attended during the last three months, I can not help feeling that you are mistaken for once, even admitting that you have been a pioneer sometimes in dispelling and showing up the fallacy of old exploded beliefs and notions. If there is any one thing that comb-honey producers have come to regard as an accepted fact, it is, that it is poor policy to place in supers unfinished sections containing honey of the previous year except for baits. They have insisted that it was their experience, so far as I can remember, that such sections, when finished, were inferior-looking in the first place, and very apt to have candied honey; and now for you to come in and pronounce this a heresy—well, I will keep still until I can gather fresh ammunition. In the mean time, let us have short pithy reports on this matter. Our space is getting to be so crowded that we can not just now find room for a dozen or so long articles on this subject; but as long as Doolittle stands sponsor for the statement that unfinished sections of the previous year may be used and still furnish, when finished, a good grade of comb honey, we must think an experiment; for if he is right, then we are throwing away dollars and dollars; and if he is wrong, let us bury him out of sight with evidence.

Regarding the mailing of bees to foreign countries, Mr. D. has probably discovered the real cause of all the bees arriving dead at certain times when at other times they would go through in good order. This may be a proper subject for the National Bee-keepers' Association to take hold of; but we know how difficult it is to get something from even our own government, and we know it is more difficult

to get a concession from a foreign government, especially when the interests of bee-keepers in the case in question are so small. Mr. W. S. Pender, of West Maitland, Australia, did, however, secure a very important concession, in that bees might go to Australia, not at letter rates, but at parcels-post rates. Mr. Pender is the editor of the *Australian Bee Journal*, and doubtless he can interest himself in a matter that is to our mutual interest. If he will "pull the wires" on the other side we will "pull the strings" on this side; at all events, I have this day, as President of the N. B. K. A., written a letter to our Postoffice Department, asking if some special provision can not be made by which bees will be exempt from fumigation while in transit.—ED.]

EXTRACTED HONEY FOR THE POOR.

Relative Cost of Glass and Tin in Four and Five Pound Lots for Honey; a Strong Plea for the Small Glass Package; Fowls out after the Owl.

BY CHALON FOWLS.

No doubt but ye are the people, and wisdom shall die with you, but I have understanding as well as you. Job 12: 2, 3.

Notwithstanding the alleged foolishness of those who put up honey in glass (according to Mr. Aikin's article on page 955), I will attempt an answer in behalf of the many foolish fellows here in the East who put up honey in that way. As I see it, Bro. Aikin's benevolence gun is aimed too high. He should commence nearer home. He says his sympathies are with the poor laborer. Me too; but, hold on. "Charity begins at home;" and the kind that would cut down the meager wages of the bee-keepers of our land, and give it to other laborers, I should call misdirected. Mr. Aikin moralizes at considerable length, trying to prove the foolishness of those who persist in buying articles put up in glass; but that need not trouble us. We should try to supply what the *buyer wants*; and, as mentioned in another article, my experience has been that they want honey in glass in preference to tin, even at a higher price. In fact, liquid honey in glass has practically driven candied honey in tin out of the market, excepting the five-gallon square cans as sold at wholesale.

At the Chicago convention, President Root reported that a number of prominent producers are now bottling their own product. Of course, this means they think it will sell better this way than candied. Now, I will leave the readers of GLEANINGS to judge whether these people "are decidedly lacking in push and business ability." While I may be lacking in these requisites it strikes me that it takes more "push" and a higher order of "business ability" to build up such a trade as Mr. Selser has at his prices than to sell in a crude condition at half price, or at the price of sugar.

Again, Mr. Aikin tries to make out that I am cheating my customers in that I am making them pay for a worthless glass package

with the honey. Not a bit of it. I am giving them a more useful package than he is, and fully as cheap in proportion to the size. He says his 4-lb. pail costs from 5 to 7 cts. each, while one-quarter Mason jars holding 3 lbs. usually cost here less than 4 cts. each; and half-gallon jars about 5 cts. There is no question as to the relative usefulness of the two, in this locality at least, for good self-sealing fruit-jars are always in demand; but lard-pails are not sold except when filled with lard or other shortening, and they are often seen in rubbish-heaps where they have been thrown away. It may be said that some people use square bottles that are worthless after the honey is used; but Aikin should turn his gun upon them instead of me. Some of his statements I can heartily agree with. He says, "display can

paying out. We see the same thing with other things. A grocer could sell but little candy if obliged to sell in 5 or 10 lb. lots. The people want 5 or 10 cents' worth at a time, and are willing to pay more than pound or five-pound rates for it too.

And now at the risk of repetition I wish to say that all this talk about cheap honey for the masses, honey at the price of sugar, etc., is a direct blow at the interests of the honey-producers of our land. Choice honey is a luxury, and must always remain so, for the reason that its flavor comes from the flowers, and must be gathered by the bees, and can be got in no other way. Of course, I know of grades of honey must be sold cheap, but they should be classed as cooking honey, and not put up for table use at all.



What in the world does our Colorado friend mean when he says it would be "more honorable" (putting up so it could be sold low)? Does he mean that putting up liquid in small packages, making more cost, is thus making it a luxury, and that it is less honorable to produce a luxury than a necessity? If he means that, I'll tell Dr. Miller that Aikin hints that raising and selling comb honey is dishonorable. And now until I am convinced that it is dishonorable to offer a luxury for sale, I shall probably still continue to bottle choice honey in the best style I know how, so as to supply the demand

not be ignored," and that "we want the cheapest neat and serviceable package we can get;" but I would add, consistent with general utility. In this locality a good self-sealing fruit-jar meets this requirement better than a tin pail.

Some of the statements in Mr. Aikin's article show what a difference locality may make, even in markets. Two years ago, when we had a good crop, I put up some fine clover honey in half-gallon Mason fruit-jars at \$6.00 a dozen. The grocer sold them at 60 cts. each, and, according to Mr. Aikin's experience, the "common every-day man" should have bought them; but, no; they would buy the little half-pound glasses at double price. The large packages at half the price per pound of the small ones did not "meet the needs of the poor," and were not a "good business proposition," for they did not sell well, probably for the same reason that 2-lb. sections do not sell as well as one-pound.

Mr. Aikin speaks of putting up his honey in large packages so that it is a rare thing, for him to sell single pounds. While that may do for him, it is certainly the wrong policy here. Choice honey is regarded as a luxury, and rightly, too; and after the necessities are bought, such as flour, sugar, etc., the people want a chance to buy a few cents' worth of some delicacy; and it's not "How much honey can I get?" but, "How cheap can I get a little?" They don't regard the quantity they are getting as much as the money they are

for something that is nice, and looks nice too. But I see by the cartoon on p. 976 the kind of trade that Aikin wants to get; and when he comes to Oberlin with his cheap methods, cheap goods, and cheap prices, he will get the cheap trade, and the Buckeyes will call his store, "Aikin's Honey Racket Store." Oberlin, Ohio.

THE RELATION OF BEES TO FRUIT.

Why Some Fruit Bursts Open; a Valuable Series of Experiments Conducted by the Connecticut Board of Agriculture.

BY H. L. JEFFREY.

In GLEANINGS for Oct. 1 I notice the mention of the Utter v. Utter case, and I will give you two or three points brought out by my research for our Connecticut Board of Agriculture. Because of complaints in Connecticut to the Board of Agriculture about the damage to peaches and grapes by bees in 1881, I was requested to investigate the subject for the benefit of the Board. Not only the damage but the benefits done by the bees was to be looked into with thoroughness, and a report to be given when called for. I have been studying the pros and cons to this day. The work was entered into with a will, with a cooperation on all sides. Mr. J. H. Hale, of South Glastonbury, furnished me with quite a variety of strawberry-plants; also raspberries,

grapevines, and peach-trees. Mr. P. M. Auger, State Pomologist (now deceased), also contributed trees and plants, while alive. A great many yards of cheese cloth and mosquito-net were used to cover trees and plants while in bloom to keep the bees away from the bloom to find out what the benefits were.

This part of the work showed two strong points. They were very conclusive evidence on the relative merits of varieties. A list would take up too much room.

Some varieties fruited to the extent that it would furnish material to argue that berries would set crops of fruit without the aid of the bees, and other varieties would not set even the apology of berries when covered up, and it was just the same when cultivated under glass. The Early Alexander peach is a very strong evidence of the need of the bees, and others that will set fruit without the aid of bees gave very strong evidence that the varieties by which they were fertilized very strongly influenced the flavor of the fruit. Very sweet varieties of strawberries, when fertilized by the sour varieties, furnished fruit with better shipping and keeping qualities, in quite a good number of varieties. All these tests were made on a variety of soils and in different places.

The influence of a rainy time after a very dry time in a great many instances caused the juice of sweet varieties of both peaches and grapes to force the juice out through the pores of the skin at the stem. This caused the bees, during the scarcity of honey, to collect the juice that was forced out around the stem.

In such very thin-skin varieties of peaches as the Mountain Rose, and most of the very sweet white varieties, I have seen a good heavy shower that came just at the right time as the fruit came to maturity, and a few hours of very bright sunshine caused the pulp to expand so that the skin cracked in places, and the bees would gather the juice. The bees were not alone in these deprecations, but were helped by the wasps and hornets. These peaches that were by the laws of nature, and uncontrollable by man, put in a damaged condition, would not be of any practical value to ship or for any thing else except immediate use. That such results were produced in the way mentioned was proved in localities where a hose and irrigation could be resorted to under quite similar circumstances to test the evidence apparent from natural causes.

With varieties of grapes that were of the more tender skinned and sweet varieties, such as the Green Mountain, Moore's Diamond, and the varieties having foreign blood, like Rodger's Hybrids, quite often a thorough soaking of the soil would make a separation of the grape at the peduncle, or stem, so that the juice oozed out. In some cases cutting back the green growth would cause the same result. I have also seen the same result in peach-trees when loaded with fruit, and a sudden wind storm broke down some of the branches. The roots were pumping sap to their full extent. The fruit on the remaining limbs could not properly appropriate the sap, and that caused the bursting of the skin or the

stretching of it till the juice oozed through the pores, making it an easy prey for the wasps, hornets, and bees. Cases like what I have given are so numerous in the memoranda of the 19 years of research, that, were I to give you one out of a hundred, it would more than fill one copy of GLEANINGS. Even Mr. James H. Hale, probably one of the very largest peach-growers in the world, has published, over his signature, that, even if he positively knew that bees did destroy peaches, he would not resort to legal redress with a bee-keeper, because he knows, or thinks he knows, his *indebtedness* to the bees for their work of fertilizing the bloom.

Woodbury, Conn., Nov. 30.

[These experiments are exceedingly valuable, not because the results found were new, but because they confirm a long line of other experiments that have been conducted at various times and places. I think we may set it down as a fact that the most progressive fruit-growers are very warm friends of the bees, because they know and realize the valuable service they render in spring, when no other insects are about. The statement of Mr. J. H. Hale, in the last paragraph, is very important, coming as it does from one of the largest fruit-growers in the world.—Ed.]

RETAILING HONEY.

A Disturbance Among the Fowls and the Owls.
The Package Question: Retailing without Packages.

BY NIGHT HAWK.

Mr. Editor:—In GLEANINGS, page 14, you have announced your conclusion to keep out of the pie to avoid "dreaming of owls, fowls, and all kinds of night-hawks." Were you "ludin' at" me when you refer to night-hawks? At any rate, I am anxious to have a hand in this pie contest, whether chicken-pie, owl-pie, or Harry Howe's favorite pumpkin-pie.

The arguments between our friends, Aikin and Fowls, nicely show the best side out for each of the methods. One wishes to sell large quantities at as low figures as possible to increase consumption near home, packing in low-priced packages, etc. The other takes extra care to get his honey into the most attractive shape, which means high prices at retail, and a cut-down of amounts consumed per capita.

You say both are right for their localities—meaning, I presume, with their own quality of honey; but how would our owl man fare in Oberlin, using his methods with the same honey that the good brother Fowls makes the consumer pay 25 cts. a pound for? Aikin could buy for 10 cts. if Fowls can, and deliver it in the cheap package for 12½ cts. Then the question would be, "Will Oberlin people pay two prices for the sale of the fancy glass bottle and red ribbon?" If they will, they are built on different lines from Pennsylvania Dutchmen; and if the good Oberlin brother

should go to Colorado with his plan he would not sell a bottle—would know better than to try it.

This becoming accustomed to one kind of honey, and not liking any other, is a factor to be taken into consideration by the honey-salesman, as I have found out to my cost. In this neck of the woods I am selling, on the average, ten pounds of good old candied black buckwheat extracted to one of fancy white—a very fine article too.

The package question was the sticker, but it has been solved so easily! and I don't object to giving it away to the bee-keeping fraternity. As you know, Mr. Editor, I always was generous that way, and so here it is: No package at all, for I can sell more honey without packages than with. How? I just take my samples into the first house I come to, and ask for a dish to give them a sample of fine honey. The lady wishes to know the price, of course. The price is, say, 12½ cts. per pound; but if she will furnish a pail to bring it in, and take ten pounds, it will be only a dollar. That is a very "fetching" plea to start in with; but after getting half a dozen pails to carry, there is an added force to it. The neighbors all think it a good bargain, as that array of tinware testifies. If some one doesn't happen to have the pail, as a special favor I promise to deliver it in a paper oyster-pail—ten pounds, pail and all, and that's about the cost—ten cents per pound for the paper package, and it works all right.

There you are, Mr. Editor, and I hope it may help some bee-keeper to dispose of his crop to advantage, and also give some lover of honey a chance to obtain the purest and best sweet known to mankind, at a reasonable price, without being obliged to pay for any "fancy fixin's" or unnecessary commissions. Sarpe, Pa.

[Your plan of selling is similar to that employed so successfully by Dan White, of New London, Ohio. He sells all he can produce, and more too.—Ed.]

OLD COMBS FOR BROOD-REARING.

Should Old Combs be Thrown Away, and New Ones be Drawn from Foundation?

BY W. T. STEPHENSON.

On page 908 Dr. Miller, referring to an item in the *Review*, written by me, in which I describe combs 12 years old as being considerably less in diameter than new comb, says that he has combs 25 years old, and yet the cells are no smaller, so far as he can see. In writing the item for the *Review* I put the adverb "least" before "12," but the printer failed to put it in. These combs may have been older than 12 years, for aught I know. I will describe more fully. I bought the colony from a neighbor some years ago. The hive was badly dilapidated then, and the combs had been transferred from, may be, a bee-tree, to that hive; so those combs are possibly 25 years old or more.

Dr. M. says his side walls (of the cells) were not perceptibly thickened after having 25 years' accumulation of cocoons plastered on them. The comb I was speaking of had the side walls thickened, and that to no slight degree. Indeed, there were cocoons enough on the inside of the cells to make them perfectly round. The cells looked like so many gimlet-holes. Well, doctor, it's too bad; but I melted those remarkable combs into beeswax last season, but (believe me) if I had any of it both you and Mr. Root should have a piece to examine and see if the septum had eight or ten layers of cocoons where the sides have one or two.

I melted the comb in a solar extractor, and after the wax was all rendered the shape of the cell was still perfect. The outside or first cocoons were the shape of the cells; and little by little, as more were added, it became round.

Mr. Editor, you suggest that, if the diameter of the cells becomes too small to suit the bees, they will remove the cocoons from the sides of the cell and leave the septum until it accumulates eight times as many cocoons. I thought you said that bees' mandibles were not suitable for biting skins of fruit. If so, how are they going to bite through the cocoons? They are surely slicker and tougher than any peach. You might say they would commence at the top of the cell; but I don't believe their mandibles are delicate enough to separate the cocoons from the sides of the cell. Why is it that the bees would peel the cocoons from the sides of the cell and leave the septum? Do you think it is desirable to the bees to have cocoons on the septum?

Besides the toughness and slickness of the cocoons, the concave shape of the cells, it seems to me, would be quite a drawback. To prove what I have said in regard to old combs producing smaller bees, I will say that I have transferred the colony spoken of, and the bees are a good deal larger than before..

New Columbia, Ill.

[It is very easy for one to draw wrong conclusions and wrong inferences; and especially is this true, it seems to me, in the case before us. You say that the comb that you were speaking of had the "side walls thickened, and that to no slight degree;" that there were cocoons enough on the inside to make the cells perfectly round. Now let me ask, Did you count the cocoons in the side walls or did you take a micrometer and measure the thickness of the side walls in some of these old combs, and also the walls of combs, we will say three or four years old, and in which brood had been reared as many seasons? If you did not then you might easily be deceived. To depend on the eye alone is too much like guesswork.

You say the cells look like so many gimlet-holes. So do those of any brood comb, even if it is not more than three or four years old. The bees generally thicken the top edges, making a circular rim, giving the cell itself the appearance of a round hole.

You did not, so far as I can see from what

you have written, take out the cocoons and count them one by one. This I did in the case of the comb Dr. Miller sent me, which was 25 years old, and the cell walls were not thicker than those of ordinary comb, nor were there more than two thicknesses of cocoons in the walls. If the bees kept on packing in cocoons, and every cocoon was left in for 25 years, those same cells would hardly let in an ant, to say nothing about letting in a bee.

You refer to melting up these old combs in a solar wax-extractor. Any comb, even if it be not more than three or four years old, when melted under such conditions, will show the perfect shape of the cocoons after the wax is melted away.

I did say that bees' jaws were not suitable for biting the skins of fruits, and I still adhere to the statement. While the bees seem to lack the power of biting through chitinous substances, yet they will unravel and pull to pieces any filament or fabric just as we can with our fingers unravel and pull to pieces the strongest hemp rope if we take time enough. If you will examine under a strong magnifier the filament of a cocoon you will see it is made up of a web. These individual webs can be easily unraveled and pulled away by the bees, and it would be a very easy trick to remove the cocoons in that way. But the skin of a peach or grape has quite a different texture and surface. Nothing short of cutting instruments would pierce them.

Again, you say that, after you removed the old combs and put in new ones, the newly hatched bees were a good deal larger. Let me ask again, Did you test these and the other bees with perforated zinc? and is it not a fact that you expected the bees to be larger, and hence wrongly inferred that they were larger after you saw them? I do not mean to accuse you of carelessness, and certainly not of misrepresentation; but unless one depends on something besides his eyes for gauging sizes involving differences of one or two thousandths of an inch he is pretty sure to make decidedly wrong guesses.

This is a very important matter; and if you are right and we are wrong it will be quite a point for the foundation-makers of the country. All we would have to say would be that combs would have to be renewed once in ten years, and this would mean the selling of tons of foundation where none is sold now.

I do not wish to be positive. You may be right and I wrong; but I am showing how you *might* be mistaken in your conclusions. While I am open to conviction, yet I hope you or any one else will help us to get down to the actual facts; but in the mean time it does not seem to me that Nature would make so egregious a blunder as to pinch growing bees in combs 15 or 25 years old. We are accustomed to saying that Nature works in harmony with herself; and I still believe that, when we gather in all the facts, we shall find that the useless cocoons are removed as soon as they have a tendency to reduce the diameter of the cells.

And here is one more fact: If it were true that the size of bees varies according to the

age of the comb in which they are reared, then we should have no end of trouble in the use of perforated zinc. One make of zinc that would let one lot of bees through easily, would almost if not quite bar other lots. But, so far as I know, when the perforations are $\frac{1.65}{1.00}$ wide, or a trifle more than $\frac{5}{8}$, in figures we can understand, the zinc answers all requirements with all bee-keepers in every climate and under any conditions. If your conclusions were correct this would be far from the fact.

I should be pleased to receive samples from any one having combs which he *knows* to be 20 or 25 years old. Mail us a piece two or three inches square. Send a card telling about the comb, its age, and, if you can, mature bees that have hatched from such comb. Let us investigate this matter without prejudice, with the simple idea of getting at the truth.—[E.]

OLD GRIMES.

BY ARTHUR C. MILLER.

Old Grimes's not dead; that good old man
We'll often hear him more;
He sometimes wears an old gray coat
All homes down before.

His heart is open as the day;
His feelings, if you knew,
Are oft inclined to lead astray
His common sense of view.

When'er he hears the pipe of queen,
His steps are quickly turned
Into that path which we have seen
He's "beaten" out and learned.

Kind fun he ever pokes at all;
He lives not to malign;
His thoughts are slow, inclined to fall
To tools of olden time.

He lives in land of Setting Sun;
And, though his hives are new,
Uncaps his honey with a knife
As "daddy" used to do.

Unharm'd by stings of bees astute,
He stumbles gently o'er
The bives, excluders, traps, and things
Strew'd in that path he told of.

But good old Grimes is not at rest;
He's heard the news from town,
So takes his pen and does his best
To bring inventors down.

He modest profit seeks to find
To pay for bread and butter;
He has no notion in his mind
To spend it on uncapper.

His neighbors, by its proper use,
Find decrease in their labor;
He, giving license to his views,
Grows "adjusting" and "excluder."

His knowledge of the modern ways
He keeps from public view;
But makes a noise these latter days
Of what other folks may do.

His worldly goods he never threw
Away on any fancy;
He says we cut, adjust, and slice,
With things that's quite expensive.

Though much disturbed by honeyed cares,
And fears of tools not mellow,
Just everybody says he is
A jolly young "old fellow."

RAMBLE NO. 181.

Dame Fortune; Keeping Bees on Shares; the Barber Method of Producing Comb Honey.

BY RAMBLER.

[It is with a great deal of pleasure that I announce that Rambler is to begin his series of illustrated articles which were discontinued some three years ago owing to the pressure of other duties and some changes in his plans. He is now in position to resume the series, and the first one begins where the others left off, and is given herewith.—ED.]

"Why, Mr. Rambler! how do you do? Glad to see you. Sit down here on this hive in the shade of the fig-tree, and let's have a talk. Le'me see—it's been two or three years since I put my optics on you. But, Rambler, you look awful bad—sick, are you? No? Pushed that wheel a little too lively—sandy roads? No? Got into a scrimmage with a teamster? Hat-brim tore? No? Ran off that pesky river bridge, got lost, and came near starving on those alkali plains?"

"O Mr. McCubbin! it is worse than all that. Heigh-ho! hum—worse, worse."

"Worse? why, land alive! you didn't get run over by a railroad train? coat-sleeves ripped, pants tore—too bad—no? What! struck by lightning in yesterday's unusual thunder-storm?"

"Worse, Mr. McCubbin—worse, worse."

"Land o'Goshen! Rambler, what have you been through—a thrashing machine, a rock-pulverizer, a—"

"O my friend McCubbin! it's worse than all that—worse, worse, my dear McCubbin; I've been jilted."

"Ha! ha! Rambler. I might have known it. How sad, dejected, and how disconsolate you look! seedy as a haystack, and forlorn; too bad, too bad. But, hey now; was it a grass widder that got away with that heart o'yours?"

"Well, now, McCubbin, that's too bad; indeed, it is a bad way to let your mind wander into such trivial channels. Why, I could stand such jilts as you speak of twice a week, and still smile. But, McCubbin, I have been jilted by Dame Fortune. You see, I worked happily and hopefully in building up a nice apiary, every thing new and up-to-date. It was located in a quiet cosy nook in the Cahuenga Hills. I could cast my eyes down the canyon, and in the distance see the restless waters of the Pacific Ocean, while all around me were the everlasting hills. The bluejays were my companions and regular boarders. The mockingbird mocked, and in the deep silence of the night a distant coyote would send his multitudinous carol down the canyon; but, heigh-ho! those pleasant pictures are blasted.

"You see, my friend, I had just gotten my new apiary into shape to make at least \$1000 a year out of it when there fell to our lot in Southern California two dry seasons, and now we are facing another. See, see, Bro. McCubbin, these emaciated features, these bepatched pants, these protruding elbows; and, alas! I am but a type of many bee-men in that portion of the State. But, Bro. M., I will not

complain, for I have a good share of my bees left, while many have lost all they had. These are sad years for the bee men of Southern California. The circumstance is beyond our ken, and we lay it to the fickleness of Dame Fortune."

"Beg your pardon. I might have known that women would have paid no attention to such a forlorn chap; but if you had got that \$1000 a year you'd had to do the jilting—hey, Rambler?"



RAMBLER TURNS UP AT M'CUBBIN'S APIARY.

"Bro. McCubbin, let's talk about something more agreeable. I wish to tell you that I have again decided to try to woo Dame Fortune, and I have traveled all of these weary 250 miles, and here I am in this alfalfa country; and now what can you do for me?"

"Why, Rambler, you are just the man I have wanted to see. I am just so full of business that I can not attend to my bees, and you are just the man to do it. You see, I own a 160-acre timber-ranch a few miles north, and two fruit-ranches. In fact, I am a rancher, bee-keeper, housekeeper, painter, paper-hanger, stock-dealer, real-estate agent, insurance agent, book-keeper, honey-dealer, etc. Then you know I lost my wife two years ago, and I have these two little children to care for, and I sometimes call this my orphanage. You can

readily see that I can not do very much with bees."

"Sure enough, Mr. McCubbin. Truly you have your hands full. I think it would be highly conducive to your peace of mind to allow me to work your bees. How many colonies have you?"

"At this Reedley ranch I have about 40 colonies. I will attend to these and work them for increase. I have one of Doolittle's \$5.00 queens. You know in our raisin trade here we have the celebrated London layers. Well, in order to be up to date I call this Doolittle queen my Dublin layer, and will requeen my apiaries from her. And say, Rambler, I believe Doolittle is the best all-round bee-keeper and queen breeder in America."

"Pshaw! McCubbin, do you really think so? I think you had better revise that statement a little."

"Well, I don't. I mean every word of it. Why, what have you against Doolittle?"

"Oh! not much. I was only thinking it would sound better to say he is the best all-round bee-keeper on earth."

"That's so, Rambler—that's so; that hits his case exactly—on earth. Why in time didn't I think of that? Well, as I was saying, I have 115 colonies at the peach orchard, 3½ miles south, and 105 three miles further on, in an alkali-weed patch. Now, these two apiaries, with a total of 220 colonies, are at your service. I think these, with now and then a few miles spin on your wheel, will give you all the recreation you need. And now suppose we swap ideas as to the terms of management. Now let your ideas loose first."

"Well, Bro. McCubbin, my idea is for you to let me have all of the honey and—"

"You? You have all of the honey? well, well. I must say you have an eye for No. 1. Want to make up for lost time, hey? And, Rambler, what am I to get?"

"Why, my dear McCubbin, you are to have the increase."

"Well, well! who ever worked bees that way? Did you ever do it yourself, Rambler?"

"Certainly. I worked an apiary for Mr. Wheeler, of Riverside, Cal., and the agreement was that I should have all of the honey, and make as much increase as I deemed judicious."

"But, Rambler, how many colonies did you manage that way?"

"Ahem—ahem—m-z-z-z-z—it seems sort of chilly under this fig-tree—le'me see—what did you remark, Mr. McCubbin?"

"Why, I want to know how many colonies you managed for all of the honey, less a judicious increase."

"Why—ahem—z-z-z-z—getting cool and cloudy; d'ye think it'll rain?"

"Well, now, see here, Rambler. I want to know how many colonies of bees you managed under those peculiar rates."

"Well, if you must know all about it, I managed one swarm, more or less—did well too; got 127 lbs. of honey, and increased to three, and it was not much of a honey year either. The same plan applied to your 220 colonies would give you nearly 700. All you

have to do is to furnish the hives, the bees, and I will do the rest."

"Now, Rambler, I think your remark more or less covers up something; but I am not going into any such scheme as that. I want honey instead of bees; and unless we can make arrangements with that in view you might as well pick up your duds and travel."

"Heigh-ho! all right, McCubbin; it is again the voice of Dame Fortune calling, 'Move on, move on.' I am so used to that command, it seems as though my weary limbs would never find rest. But, see here; you have not let any of your ideas loose. I am listening."

"My ideas will be few and to the point. When I rent or let an apiary I do not believe in making a complicated contract. I give the lessee half of the honey, each party to furnish his own packages for the honey. I must have all of the increase, and will provide hives for the same, the lessee to make as little increase as he deems judicious. How does that strike you?"

"Why, it strikes me as would a fountain of ice-cold soda on a hot summer's day. Your plan is about the one I have operated in the past; but in addition to half of the honey I must have half of the wax. That is quite an item sometimes. I have known bee-keepers to ignore this very important product, and allow scores of pounds to go to waste. The careful bee keeper saves every scrap of old combs and scrapings of hives and frames, and in so doing he adds to his revenue. I am pleased with your 'judicious increase' provision, for it must be understood that, when I work bees for extracted honey, I will so manage them that but few swarms will issue. If you wish to make a considerable increase by natural swarming I should have something for hiving the swarms. I know of parties who have received fifty cents a swarm for such work."

"Rambler, I am not anxious for increase; therefore, if it is agreeable to you we will fix the terms at half the honey and half of the wax, and go it as light as you please with swarms. Furthermore, I have a few supers with sections I had left over from last season, which I should like to work in, and I think it can be done without interfering with the swarming. The way I manage in the production of comb honey is to put on the extracting-supers; and when the bees get vigorously working in them I take them off and put on the comb honey supers, and the bees just fill the sections in no time. You observe the sections are in broad frames, double tier, and occupy the same space as the extracting-super."

"Why, Bro. McCubbin, that is Mrs. Barber's plan as she described it in GLEANINGS. Did you learn it from her?"

"Oh, no! I have practiced that plan for several years, and I believe Mr. Brodbeck, of Los Angeles, told me some time ago that he indulged in such practice. I think the idea has been mentioned in print; but you see it has taken a lady to make the idea attract attention."

"But, see here, McCubbin. It seems to me

you use rather thin sections— $4\frac{1}{4} \times 4\frac{1}{4} \times 1\frac{1}{2}$; are they not short weight?"

"They are a trifle short; but you see I use no separators, and get better weight on that account; and then grocers sell them by the piece and not by the pound. But this is the last lot I have; and since I am letting my bees on shares, and the lessee, like yourself, for instance, desires to work for extracted honey, I

INGS; but it seems that comb honey is passing in Central California. Five years ago nearly all of your bee-men were for comb honey, and now I find the extractor in almost universal use."

"Yes, that is so. Our best comb honey has a dark tinge, and will not sell so well as the white grades. We have a ready sale for our extracted honey, and last season dealers were

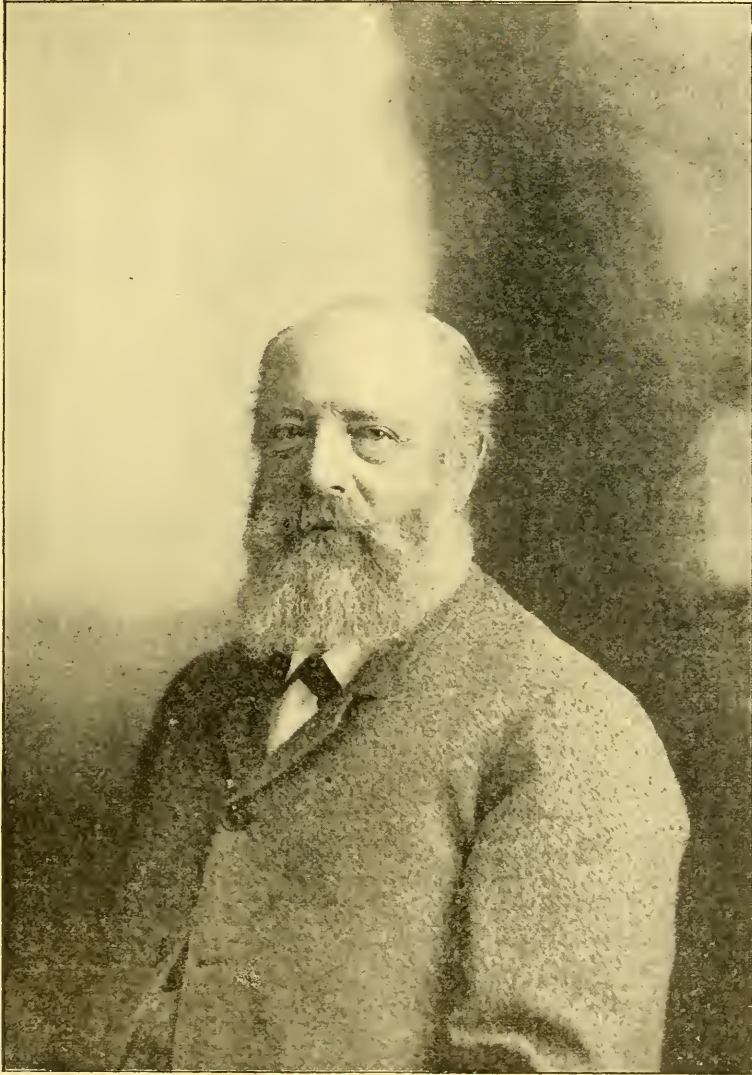

J. B. HALL, WOODSTOCK, ONTARIO, CANADA.—SEE EDITORIALS.

Courtesy of American Bee-keeper.

shall have to comply with the new order of management. But I tell you, Rambler, I love to work for comb honey."

"That is evident from your fixtures; and I remember that photo I secured of yourself and your comb honey some six years ago at Selma, and which made a fine illustration in GLEAN-

chasing around after our product, and it sold at a good price. Oh, no! it was no trick at all to sell honey last year. But, Rambler, you look awful hungry. Come right into the house and we will have some supper. Here, Bruce and Grace, pick up all these things you have on the floor. Children must play, you know,

and I let them have full swing here in the house with my bee-hive material. Now, Rambler, how would a few pancakes strike you?"

"Bro. McCubbin, I'm speechless."



COLONIES OF BEES FREEZING TO DEATH.

"Good morning, Mr. Doolittle. Pretty cold outside this morning."

"Yes, it is, neighbor Smith. Take this big rocking-chair and draw up by the fire."

"Thank you, I will do so. And now I want to talk a little while with you about bees freezing to death."

"I am agreeable. But what set you to thinking about this matter?"

"This awful cold, after reading last night in an old bee-paper that some thought that bees froze to death, one writer asserting that any one who has handled bees knows that too cold weather makes them perfectly stiff and apparently lifeless."

"Did you believe what you read?"

"Well, enough so that I went and looked at one colony, and I found them apparently lifeless, as he said they would be. But this colony was in a single-walled hive, and the writer in the paper said that if bees were in other than thoroughly packed chaff hives they should be taken to warmer quarters if zero cold lasts longer than four or five days, else they might freeze; and this is why I came over this morning. Would you carry these bees into the cellar?"

"It would have been a good plan to carry such colonies as were in single-walled hives into the cellar from the middle to the latter part of last November; but I consider that which you read as fallacious, and think a little talk over this matter will convince you that there is nothing in the matter further than theory."

"I am glad to hear you say this, as I had no place where I could put the bees just now. But why should bees not freeze when other animals, which are poorly protected, do so?"

"While it is possible to freeze nearly all animal life by exposure to a very low temperature, the bees seem capable, with plenty of stores near at hand, to stand any amount of cold so long as food remains within easy reach."

"But I saw some bees in the hive I opened this morning, on the outside of the bunch of bees, that were so stiff they did not wiggle when I poked them with a lead-pencil."

"To be sure, the bees on the outside of the cluster may become somewhat stiffened with cold; but those within are nearly as brisk and lively as in summer."

"What proof have you of this assertion?"

"M. Quinby, than whom there is no better authority, knew this to be a fact when he said in his 'Mysteries of Bee-keeping Explained,'

that the bees inside the cluster, on a zero morning, could fly as readily as in July, should the cluster be thrown apart. Mr. Quinby wrote this more than 35 years ago."

"Well, suppose the zero weather had held on four or five days, that being the length of time the writer allowed in the old bee-paper."

"This part was made very plain by that veteran bee-keeper of thirty years ago, Elisha Gallup, now of California. When speaking of a winter in Upper Canada he says, 'the thermometer for sixty days in succession was not above 10° below zero, and for eight of these days the mercury was frozen; yet my bees, in box hives, with a two inch hole at the top and the bottom, plastered up tight, came through in excellent condition.' This you can find in Vol. V. of the *American Bee Journal*, page 33, unless my memory has given me the slip."

"Whew! Mercury frozen! That is ahead of any thing we ever get here, is it not?"

"Yes. But while bees here in Central New York were never put to so severe a test as the above, yet, a few years ago, the mercury went as low as 37° below zero; still, so far as I could see, it did not affect the bees in the least."

"How can they resist such cold?"

"By eating honey, or 'burning it as fuel,' as one writer puts it."

"I wonder how much heat they can get up in that way."

"From experiments conducted with a self-registering thermometer I have found that when it is 20° below zero in the outside air, a temperature of 46° above zero is maintained within the hive close to the outside of the cluster of bees, while the center of the cluster gave a warmth of 63° at the same time, showing that they were far from freezing."

"Well, I declare! Have you made any other tests?"

"To test more thoroughly this matter of bees freezing, I took a colony one evening when the mercury stood at 10 below zero, and suspended the hive about two feet from the bottom-board, taking off all covering from the top of the hive, so they were the same as if hung in the open air, as the colony was so small that it did not touch the hive at any point. They were left thus all night, during which the mercury went as low as 16 degrees below zero, yet the next morning the bees were all right, though I really expected to find them dead. Since then I have come to the conclusion that the freezing of a colony of bees when in a normal condition is an impossibility, and that the finding of bees dead and frozen only proves that the freezing was an effect coming after death produced by some other cause than zero cold, such as starvation, bee-diarrrhea, caused by long confinement, etc."

"But you would not advise swinging all colonies from their bottom-boards during winter?"

"No, sir; and I would advise putting all colonies in *this section*, or north of 40, north latitude, into chaff hives, or into the cellar during winter, as they winter much better

that way, even though they never freeze to death."

"How time has flown! It is time I were doing my noonday chores. Good morning."

"Good morning. Come again when you wish something further."

[We have never found a cluster of bees dead unless the food supply had been eaten away from the cluster for two or three inches. I reason that the outside of cluster becoming chilled stiff prevents the cluster from moving over to the stores, and hence they starve to death. But we must not infer that, because bees can stand cold, they do not need any protection. They should have plenty of it.—ED.]



HOW TO MAKE A GLOSSOMETER.

I think Dr. Miller has hit on the right principle in the construction of glossometers. The figure here represents a cut of such an instrument as I would construct.

The dotted line shows the wire cloth. The depth at one end should be $\frac{1}{4}$ inch, decreasing toward the other end to nothing. The

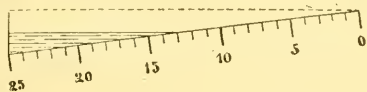

bottom should be divided by well-marked lines across in 25 parts, as shown in the scale under the cut of the instrument. The wire cloth should be straight, and for that purpose the instrument should not be more than $\frac{3}{4}$ inch wide inside, otherwise bulged places in the wire cloth could not be avoided.

Put the instrument in an empty super on the hive; fill it with syrup or honey; level it, which is easily done by observing whether the syrup is flush all over with the cloth.

When the bees have helped themselves to all they can take, note, before disturbing the instrument, to which division the remaining syrup reaches. If it reaches to the 17th division, as shown in the cut of the scale above, the length of their tongues, or at least the space between the wire cloth and the level of the syrup, would be $\frac{17}{100}$ inch.

The above is merely an illustration of the principle. For instance, the deeper end might be $\frac{35}{100}$ inch instead of $\frac{1}{4}$, and the other end $\frac{10}{100}$ instead of nothing. The divisions would then read from $\frac{10}{100}$ to $\frac{35}{100}$ instead of from 0 to $\frac{25}{100}$ of an inch.

With the longer-tongues subject, the size of bees will necessarily be brought out again; for the maximum length of tongue that can

be reached will be greater in the larger strain of bees.

ADRIAN GETAZ.

Knoxville, Tenn.

[Dr. Miller proposed something like this a short time ago. While the principle is all right, yet I doubt very much whether you could get the measurement as easily and quickly as by the way I have described in GLEANINGS. Of course, it might show more exactly the actual reach of the bees. In the matter of breeding, it is not so important to know the actual reach as it is to know the comparative length of tongues between the bees of one queen and the bees of another. Those of you who believe in that kind of glossometer, make one and send in your report; but in the mean time I think I can measure ten lots of bees while you are measuring one lot. Sometimes we have four or five cages to measure in a day, from bee-keepers in different parts of the country; and if we were to use a plan like that shown above, it would make an all day's job, where now the work can be done inside of an hour; and for comparative results it is just as good.—ED.]

RELATIVE WEIGHTS OF TALL AND SQUARE SECTIONS WHEN FILLED WITH HONEY.

I wish to run one of my apiaries this coming season for comb honey, and will you kindly assist me in deciding what to adopt by answering the following questions?

My preference is the plain tall section, one holding a guaranteed pound, or a little over, but not less.

1. Will the Danz. $4 \times 5 \times 1\frac{3}{8}$ section meet this requirement?

2. Will the Danz. $4 \times 5 \times 1\frac{3}{8}$, when filled, average as heavy as the $4\frac{1}{4} \times 4\frac{1}{4}$ old beeway section?

3. How would the $5 \times 4\frac{1}{4} \times 1\frac{5}{8}$ do? Can you furnish them, also cartons for same? What super can they be used in, 10-frame size?

CHARLES STEIGER.

Spring, Ill., Jan. 18.

[1. It depends on how full the sections are filled. Unless they are completed clear out to the wood, nearly every cell sealed, they will fall short about an ounce of making a pound. All the so-called pound sections are scant pounds. There is no market that seems to want a section that runs a little over. Every salesman says he would prefer to have the box run a little under rather than a little over a pound. If you desire a 4×5 section to average a pound year in and year out, with the seasons as they run, cells sealed clear out to the wood, the sections should be $1\frac{1}{2}$ in. wide, but then you would be troubled with overweights so much that the trade would object.

2. Yes, the regular Danzenbaker section will average as heavy as the $4\frac{1}{4} \times 4\frac{1}{4} \times 1\frac{3}{8}$; or, in other words, if the old-style $4\frac{1}{4}$ section with beeways was heavy enough to meet your requirements, then the Danzenbaker $4 \times 5 \times 1\frac{3}{8}$ will be.

3. The $4\frac{1}{4} \times 5 \times 1\frac{5}{8}$ would run altogether too heavy—over a pound. If you adopt a $4\frac{1}{4} \times 5$ better have it $1\frac{1}{4}$ in. thick, then you

would not be troubled with over-weights. Yes, the $5 \times 4\frac{1}{4} \times 1\frac{3}{8}$ or $4\frac{1}{4} \times 5 \times 1\frac{1}{4}$ can be furnished by us or any of the manufacturers. The $1\frac{3}{8}$ inch sections of our 4×5 or $4\frac{1}{4} \times 5$ can be used in any ten-frame super, providing the right section-holders are used, and providing, too, those ten-frame supers are deep enough. We make super arrangements for both.—ED.]

RELATIVE WEIGHTS OF VARIOUS SIZES OF SECTIONS WHEN FILLED WITH HONEY.

In reviewing the last volume of GLEANINGS I find on page 357 your estimates in regard to different sizes of sections, also Dr. Miller's average weights. I was a little curious to know how the $3\frac{3}{8} \times 5 \times 1\frac{1}{2}$ compared in weight; so, having two crates of 24 sections each of buckwheat honey I weighed them and found that the crates weighed just alike, 21 lbs. each, net, which would make 14 oz. per section. That makes .17 more than Dr. Miller's $4\frac{1}{4} \times 4\frac{1}{4} \times 1\frac{1}{2}$. Now, as the Danz., or $4 \times 5 \times 1\frac{3}{8}$, figures out only $\frac{1}{5}$ of a cubic inch more than the $3\frac{3}{8} \times 5 \times 1\frac{1}{2}$ I can not see how it is going to hold very much more.

Your estimate of $\frac{7}{12}$ oz. per cubic inch agrees with my weights of the $3\frac{3}{8} \times 5 \times 1\frac{1}{2}$ as well as Dr. Miller's $4\frac{1}{4} \times 4\frac{1}{4} \times 1\frac{1}{2}$. If we figure the $4 \times 5 \times 1\frac{3}{8}$ on the same basis it would weigh 14.3 oz. I do not know what the majority of bee-keepers like best, but my preference would be for a section holding as nearly one pound as possible.

Suppose you use a section $4 \times 5 \times 1\frac{1}{2}$; that would give 26.718 cu. in.; if we allow $\frac{7}{12}$ oz. per cubic inch it would give 15.58 oz. of honey. Such a section would work in an eight-frame super all right by using the Danz. holder and cleat, using 6 rows of 4 each, the same as the $4\frac{1}{4} \times 4\frac{1}{4} \times 1\frac{1}{2}$.

I believe that, the nearer we come to selling what we pretend to sell, the better. When I am selling butter in 1-lb. prints I would not think of selling my print for 14 oz. I know I should be the loser by so doing, as my customers would look up another man who would give them full weights. The simile is not well drawn, as we can make the 1-lb. print of butter exact, but can not the 1 lb. section of honey. If the $4 \times 5 \times 1\frac{3}{8}$, when well filled, hold 16 oz., that is all that is necessary. But, do they?

Since I commenced to write this I thought I would see if there was any difference in the weight of buckwheat and basswood. In selecting several boxes of each as near the same as possible I found that the buckwheat gave quicker weight, about $\frac{1}{2}$ oz. This does not prove that the buckwheat was heavier, however. The weights stood 14 oz. light; $14\frac{1}{2}$ oz. dark.

On page 53 S. J. Snyder reports 60 lbs extracted buckwheat. My bees averaged 31 $3\frac{3}{8} \times 5 \times 1\frac{1}{2}$ sections, and filled their brood-chamber full. I had eight colonies, and there were 22 acres of buckwheat in reach of them.

W. W. SHEPARD.

Wayland, N. Y., Jan. 23.

[You will find many of your questions answered in the footnote to Charles Steiger's ar-

ticle just preceding; and in addition I would state that we figure to have the $3\frac{3}{8} \times 5 \times 1\frac{1}{2}$ plain hold approximately the same amount of honey as the $4\frac{1}{4}$ square by $1\frac{1}{2}$ or the $4 \times 5 \times 1\frac{3}{8}$ plain; but in actual results there is a slight difference. The 4×5 runs a trifle heavier, while $3\frac{3}{8} \times 5$ and the $4\frac{1}{4} \times 4\frac{1}{4}$ both run about the same; but the $4\frac{1}{4}$ plain and the $4\frac{1}{4}$ beeway section ($1\frac{3}{8}$ wide) do not hold exactly the same amount, the beeway holding a trifle more.

Referring to the weight of different kinds of honey, there may be a difference. The buckwheat honey that I have seen in New York is, as it is extracted, very thick, and, for the same cubic contents of comb, I should suppose it would run a little heavier than clover or basswood.—ED.]

UNFERTILIZED EGGS AND DRONES.

1. What good reasons have we to believe that the unfertilized egg produces the drone?
2. Why is it that a colony of bees rarely ever makes any comb during dog days?
3. Does a colony ever winter drones? If so, why?

JAMES L. FRANKLIN.

Redbush, Ky., Jan. 13.

[1. The long series of experiments conducted by Dr. Dzierzon went to show conclusively that the unfertilized egg produced the drone. Further than that, every-day observation shows that virgin queens and laying workers, if they lay at all, lay eggs that produce drones; but even then it might be said, "How do we know that those laying workers and virgins had not been fertilized?" There are plenty of cases where virgin queens without wings have laid eggs that produced only drones.

2. I do not know exactly what you mean by "dog days," but I presume you mean during August, when little or no honey comes in. Comb-building never takes place unless there is a supply of food coming in from feeders in the hive, or from natural sources in the fields. The answer to your question, then, is that comb is not built because there is no incoming of food.

3. Yes, but not generally. There are liable to be in any strong healthy colony a few drones that are wintering over.—ED.]

QUESTIONS FROM A BEGINNER.

1. Can a reason be given why one colony will store well in a super, while an adjoining colony does not and can not be induced to go into the super, colonies apparently equal? In one instance they were working well in the super and suddenly quit work.

2. Do you recommend destroying queen-cells with the object of preventing swarming? Is not this practice liable to result in queenless colonies? Several colonies on which this was practiced became queenless, though I can not tell definitely the cause.

3. What is the approved practice in increasing colonies and preventing swarming?

4. When is the best time to requeen?

5. When is the earliest that breeders can

supply queens? or can wintered-over queens be obtained?

[1. No positive reason can be assigned, unless it be, perhaps, that one colony has bees that have long tongues, and another has those with short ones. If there is anything in long tongues, then I should be inclined to believe that one colony had bees that were better workers, simply because they were physically able to gather honey when the others could not.

2. Yes, it is a good plan to destroy queen-cells in colonies where you desire to prevent swarming, and where the stock is such that you do not care to breed from it; but if the bees of that colony are extra good workers, and of good blood, then I would save the cells. There is not much danger of a colony becoming queenless from the practice of cutting out cells or destroying them. If the old queen should happen to fail, or go out with a swarm, there would be enough young larvæ or eggs from which some cells would be reared and a queen raised.

3. There is no way except artificial swarming or dividing. Where increase is desired I would by all means prefer to get it by dividing, as being much more convenient.

4. Usually after the honey season, when queens are the cheapest. But the best time to rear queens is when plenty of swarming-cells can be obtained from good colonies during the height of the honey-flow. It is always difficult to rear queens when no honey is coming in, and I would advise the beginner, if he can not afford to buy queens, to requeen at some time in the year when honey is coming in slowly.

5. In the North, about May 15 or June 1. Breeders in the extreme South can furnish queens almost any month in the year.—ED.]

CELLAR WINTERING; DOES NOISE DISTURB BEES?

1. Can you tell me some simple way to remove wax from utensils?

2. If bees have their last fly for the fall on Nov. 1, how long can they be confined, and still come out alive and healthy, last brood hatched about Oct. 15?

3. About how many pounds of stores will it take to feed an average colony of bees from Sept. 10 to April 15, bees to be deposited about Nov. 15, and taken out about April 15?

4. Do you consider pollen in cells topped off with honey, and capped, as sealed winter stores?

5. My bees are in a large cellar under a house where a large family of noisy young folks live, and they have dances or parties occasionally. Will the noise disturb the bees, or will they become accustomed to it?

6. I winter my bees a quarter of a mile from their summer stand. If I take the bees out of the cellar, and haul them to their summer stand before I let them loose, will they soil the combs or the inside of the hive? or should I set them out near the cellar and let them have a fly, and haul them that night? In the latter

case, would any of the bees go back to the cellar location? GEO. F. HANEGAN.

Hersey, Wisconsin.

1. To immerse the article smeared with propolis in boiling hot water is the most satisfactory way of cleaning it. Scraping can be used, but it is at best a very messy and tedious job. Propolis on the fingers may be removed by using a little gasoline or weak lye, ether, or alcohol. The first named is the most convenient for the average bee-keeper.

2. If bees are put up properly they will stand confinement from Nov. 1 till May 1. A good deal depends, however, on the mode of packing if outdoors, the kind of cellar if indoors, or whether the hives have plenty of bottom ventilation. No definite statement on this point can be made, as sometimes colonies prepared in the best manner possible, with the best of food, will die in spite of us.

3. From your other questions I should assume that you refer to indoor or cellar wintering. There have been various figures given that ran all the way from 4 to 15 pounds as the amount of stores consumed; but I should call it good wintering if a good average colony consumed from 7 to 10 pounds in the cellar; if outdoors, we should have to add from $\frac{1}{3}$ to $\frac{1}{2}$ to these amounts. If the climate were very cold, and the protection poor, we would have to double the figures.

4. There is no objection to a little pollen in the combs. There was a time when it was advised to see that all combs were free of pollen. But very little attention is paid to the matter now.

5. This is a question that is a little hard to answer; but we know that bees are wintered successfully under a living-room; but just how much noise the bees will stand, I can not say; but my impression is, they will take a great deal when they become accustomed to it. But as a rule we would say the less jar and noise the better. I have been in bee-cellars, and have noticed that when some one stomped on the floor above, the bees would give forth in unison a peculiar sharp quick "z-z-z" sound. Then I tried shouting, and obtained the same response. Once I shouted so long that finally the bees began to come out at the entrances to see what the rumpus was; so I conclude that an excessive or unusual amount of noise upstairs, like romping or jumping, would disturb the bees, with the result that they would become uneasy, consume too much food, and thus bring on dysentery.

At this present time we are wintering some of our colonies in a cellar under our machine-shop; but there is no more noise under this room than under an ordinary living-room where there are children romping around.

6. I would advise you to carry your bees from the cellar direct to their permanent stands. I can see no object in putting them down for a fly near the house, and then moving them again. Whenever bees are set out of the cellar, they are pretty apt to void their feces all over every thing. Especially is this noticeable on snow or white clothes hung out to dry.—ED.]



CALIFORNIA had 9 inches of rain up to the morning of the 5th, which, according to a correspondent, means about 75 carloads of honey by the first of August. I suppose the Californians will be hoping that the Coloradoans and the eastern bee-keepers will have a failure of the honey crop. For three years California has had almost a total failure, and now she is to be blessed with a big crop, it seems.

At the Madison convention a good deal was said in reference to the matter of low prices during a year of large supply. Mr. F. France said it was often a good paying investment to hold honey over until the following year, especially when prices were ruling low and everybody had a plenty. One year he had 50,000 lbs. of honey. Everybody was selling it, and selling it cheap. He held his over, and next year there was a scarcity; then he unloaded his crop, and, as he said, made the "very best investment" he ever made in his life.

"BUT 'T WAS A GLORIOUS VICTORY."

Sum people that go to law for dammiges sumtimes get more than the want.—*Josh Billings.*

JUST as this form is going to press I have received information that the plaintiff, or, as he is called, Fruitman Utter, has decided not to carry his case to a higher court, and he has settled by paying all the costs, which can hardly be less than \$500 or \$600. Thanks to the National Bee-keepers' Association, the defense was so strong that the other side knew there was absolutely no show for them. We met the enemy and whipped him so hard that he knew there would be nothing left of him if he attempted to put up another fight. 'Tis well. Hip, hip, hurrah for the Association! Such a victory ought to appeal to every one of our subscribers who is not a member. Send in a dollar to General Manager Secor, Forest City, Ia., and have a hand in this glorious work. There are more battles to fight, and we need your help, and—*you may need ours.*

PRESIDENT FRANCE AND THE WISCONSIN CONVENTION.

I HAVE just returned from attendance at the Wisconsin State Bee-keepers' Convention, held in Madison on the 5th and 6th. Owing to the very poor year the general attendance was not so large as formerly; but lack of attendance was fully made up in the character of the discussions and the interesting side talks by Pres. France, who not only knows how to "talk bees" but to steer discussion. Mr. France is both President of the Wisconsin State Bee-keepers' Association, and foul-brood inspector for the State. For the last two or three years he has been sent by the State to lecture on bee-keeping at farmers' institutes; and from what I saw and heard of

him I should say he was *the* right man in the right place.

PICKING UP ROYAL JELLY WITH A MEDICINE-DROPPER.

Mr. Arthur C. Miller, who has been experimenting in this matter, writes us as follows:

Mr. Root:—In your editorials for Jan. 15 you referred to the use of medicine-droppers for gathering and distributing royal jelly, and you asked if any of your readers had tried it. During last summer I made several attempts to use the droppers for that purpose, but it was a failure every time; the food would distribute itself all over the inside of the tube, and would not come out again. I also made some attempts to remove larvae by placing over them a glass tube, and then by placing my finger over the end of the tube I expected to lift them with the food in which they lay. It did not work. I also tried a medicine-dropper with a specially large end, and Miss Larva promptly shot up to the top, with, of course, fatal results. With a tube of the right air capacity, and having a rubber diaphragm over the top, and with an opening *exactly right*, we may be able to succeed. I believe that the matter is worth further investigation.

Providence, R. I., Jan. 31. ARTHUR C. MILLER.

APPLE-BLOSSOM HONEY AND ITS QUALITY.

FOR several years the article that appeared in the A B C of Bee Culture referred to the quality of apple-blossom honey as being very inferior; but in the last edition, that of 1900, this item was changed, and the honey from apple-blossoms is now spoken of as having a very fine flavor. Mr. R. J. Fox, of Naick, Mass., has recently sent us another sample of apple-blossom honey—the pure genuine article. It is light in color, heavy in body, and most delicious in flavor. To my notion, alfalfa stands at the head in point of flavor; white clover and basswood next; but between white clover and genuine apple-blossom I do not know which I prefer. The flavor of the apple-tree honey has the same beautiful delicate aroma that one smells when going through an apple-orchard in the height of bloom.

A. I. Root says he does not know how he came to class apple honey as dark and poorly flavored; but some one has since suggested that perhaps the honey he tested, and which he supposed was from apple-blossoms, was honey from peach-trees—a honey that is not nearly so good as that from apple.

THE FOOL POLICY OF SMALL PRODUCERS; LOW PRICES.

THE editor of the *American Bee Journal*, at the Wisconsin convention, in explaining why the prices of comb honey are often put down, told how the small dealer would rush his honey off to market, bring it to the grocer, and sell it at whatever price he was offered. Well, this grocer would, later, needing more honey, go to a commission man and inquire the price of honey, but he would be met with a figure two or three cents above what he had just paid the small producer. Oh, no! he would not pay that price, for he could buy at a much lower price. The commission man, not willing to lose a sale, cuts the price down to the price of the small producer, with the result that prices *fall all along the line.*

Mr. York urged that all the producers, whether large or small, should first get their prices from recognized honey-buyers or com-

mission men—yes, take a good bee-paper and consult its price current; then, knowing the ruling figures, not to sell lower. He had no objections to producers selling to grocers direct, but he had no patience with the fool policy of some of the small producers who would rush off and sell the first of their crop at two-thirds the regular market price, thus smashing prices right and left.

HALL'S WIT AND McEVROY'S "BLARNEY."

MR. J. B. HALL, of Woodstock, Ont., Canada, whose picture appears elsewhere in this issue, is one of the live spirits of Canadian conventions. From what little I could gather from the Canadians themselves it would seem to me that a convention without Hall would be pretty nearly like Hamlet with Hamlet left out. This year I think he said he could not afford to be present. As soon as the officers knew this they immediately wired him that he "must come, expenses guaranteed," and so we had the pleasure of Mr. Hall's presence. He has an inimitable vein of spontaneous good humor that bubbles over every now and then. Never long-winded, he has a happy faculty of telling sound hard facts from a long experience, in a few words that delight and edify every one.



WM. McEVROY, FOUL BROOD INSPECTOR.

—*Canadian Bee Journal.*

At the close of Wm. McEvoy's report as foul-brood inspector, Mr. Hall, in commenting on the inspector and his work, spoke of him after this fashion: "He can get along with cross old men and crooked old women. It is his Irish blarney that gets him through." I did not hear any of this "blarney" that our facetious friend tells about; but on every hand I learned that Mr. McEvoy's success lay in the fact that, while he *rigidly enforced the foul-brood law*, he did it in such a nice splen-

did sort of way that, so far from being the cause of offense, he was invariably invited to "call again."

VICIOUS LEGISLATION IN WISCONSIN.

DURING the session of the Wisconsin convention we learned that a bill had been introduced in the Legislature, then in session, had been printed, passed to its second reading, was then in the hands of the House committee for recommendation. The bill starts out with a very innocent preamble, but winds up with the provision that whenever an apiarist finds it necessary, by increase in the number of bees, or lack of pasturage, to move his bees to some other locality or township, he shall pay a tax of \$1.00 per colony per month during the time that such bees are in the new location. As bees are liable to be kept at their out-yards some four months, it would mean that many bee-keepers would have to pay \$4.00 for every colony of bees kept out of their immediate locality. This would amount to the practical prohibition of much of the out-yard business.

But the bill was drafted by some one who evidently did not know his business, for it provided that such tax could be collected when the bees were run "for the purpose of extracted honey." If any one desired to move his bees to a field where they would be run for *comb* honey, or for the purpose of raising bees or queens, the law could not touch him. It was suggested that possibly some one had foul brood taken to his locality, and to prevent the further spread of that disease he had had this bill introduced; but it was later learned that it really was fathered by a bee-keeper who had a few bees, and who had a little spite against a man who had moved some other bees to his locality; and for the purpose of "getting even" with this neighbor he proposed to handicap the bee-keeping interests *of the entire State*.

The matter was thoroughly discussed at the convention, and was condemned on every side. A resolution was passed condemning it as a piece of vicious legislation. A committee was also appointed, consisting of Pres. France and two others, who were to wait on the committee of the House that had the bill in charge; and before I came away, Pres. France had gained the ears of two or three of the committee, and explained the whole animus that was back of it. The "other side," however, had in the mean time learned of the action of the convention, and were going to put up a fight; but at the last talk I had with Pres. France he said, "I shall stay until the bill is killed."

Pres. France had a good deal to do in securing the passage of the very excellent foul-brood law now in force in Wisconsin. He is familiar with legislative tricks, and knows thoroughly how to pull the legislative wires; and I think the bee-keepers of Wisconsin may feel sure that he will not allow the interests of the State to be jeopardized in any such manner; but for fear he may not be able to kill the measure in the committee it will be well to write to the representatives and senators, protesting against the measure.

THE JAWS OF A BEE AND A WASP.

At the trial of Utter v. Utter, Prof. Frank Benton, when called on to take the stand, produced a chart showing the mandibles of a bee and those of a wasp. He explained that he had some specimens of bees and wasps from which the drawings had been made; that he had a magnifier, and would give the jury an opportunity, if they desired it, to compare the real things themselves with the drawings, if they desired to verify the diagrams. Of these I have had a photo reproduction made in zinc, and the same are shown herewith. The lower

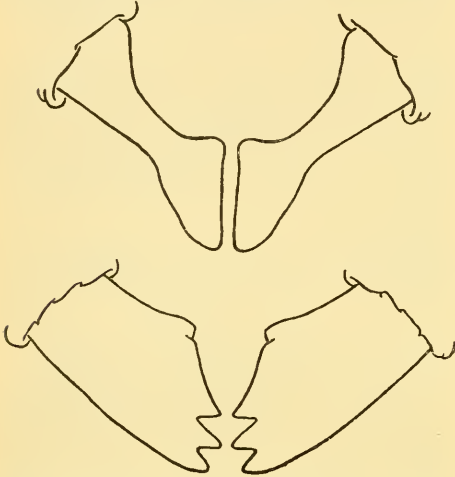

diagram shows the jaws, or mandibles, of the wasp, an insect that is especially fitted, as will be seen from the notched portions, for cutting and gnawing. The upper drawing shows the jaws of a worker bee. It will be noticed that these last are perfectly smooth and rounding on the edges, and are shaped for forming plastic substances, such as wax, at a temperature of 90 degrees. In the opinion of Prof. Benton it was a physical impossibility for a worker bee to do any cutting or puncturing of the skins of either sound grapes or peaches; that these jaws, so far from making incisions, would slide laterally over the smooth surface of the fruit without being able to catch hold; but not so the jaws of the wasp; owing to their special construction, they would work right through the skin of any fruit without any effort; that he had seen them in this very act. He had also seen bumble-bees cut through the delicate corolla-tubes of some kinds of flowers, but never a honey-bee.

It needs only a good magnifier to prove all the professor's statements so far as the general structure of the jaws of bees and wasps was concerned; and all this talk about bees having teeth, sharp cutting edges, and the like, can be disproved at any time by any one if he has ordinary candor and ordinary skill, without taking the *ipse dixit* of any one else.

In this connection it might be well to note that the prosecution, when Prof. Benton admitted that the jaws of the bee were powerful, tried to draw the inference that the bees could

pinch a hole through the skin of a fruit; but the professor and other witnesses showed that, while they might be able to exert a powerful squeeze, yet it would be impossible, owing to the structure of their jaws, to get hold of the skin of the fruit, unless, forsooth, it had already been cut into, or cracked or torn open. If the skin were torn so that they could get hold of it, they could then pull it and probably make the opening larger; but they could no more cut a hole in the surface of a peach than a man could with one hand grab hold of a cannon-ball 15 or 16 inches in diameter.

We expected the prosecution to ask how it was bees could make holes in quilts. But this could easily have been answered by the fact that, while bees could not cut, they could *unravel* fiber, tearing away piece by piece until they made a hole, in the same way that we can with our fingers pick to pieces a rope.

NEEDED FOUL-BROOD LEGISLATION IN MICHIGAN; ATTENTION, MICHIGAN BEE-KEEPERS!

FOR two or three years back it has been plain to most progressive bee-keepers in Michigan that foul brood, instead of being brought under control, was spreading throughout the State, and that, too, in spite of the fact that there is already a law on the statute-books, which, at the time it was framed, was supposed would prevent the spread of the disease; but this law, if I remember correctly, applies only to counties, and lacks the very important provision by which it *can be properly enforced*. At all events, it is very certain that, in spite of this law, the disease is making progress, and the most progressive bee-keepers of Michigan believe that a new one should be drafted, somewhat on the line of the Wisconsin measure.

A short time ago the editor of the *Bee-keepers' Review* wrote me, asking if it were not possible for the National Bee-keepers' Association to send Hon. George E. Hilton down to the Michigan legislature—one who has been a member of the House of Representatives of Michigan for two terms—for the purpose of steering (or, if you please, lobbying) the bill through both houses. He added, furthermore, that Mr. Hilton was President of the Michigan State Bee-keepers' Association—a bee keeper of extended experience, one who is acquainted with men, and knows how to pull legislative strings at the right time and place. I replied, stating that, so far as I knew, the National Association had never before interested itself in any measure that related to legislation in any particular State; but that I saw no reason why it could not do so, and that I would lay the matter before General Manager Secor, who in turn would probably refer it to the Board of Directors. The former apparently coincided with my view, for he sent a circular letter to all the directors, suggesting that whenever bee-keepers of any State, through their State organization, desire to pass a foul-brood law, there be appropriated from the funds of the National Association a sum not to exceed, say, \$25, this sum to be used to defray the expenses of a skilled lobbyist in the

interest of a reasonable and fair measure. Just what action the Board of Directors will take, perhaps I ought not to forecast; but I believe they will approve of the suggestion; and if they do, the sum of \$25, or whatever is voted, together with a similar sum assessed on any State bee-keepers' association, would go a long way toward paying the expenses of some one to engineer a bill through both houses of any State. As there was not time to get an action in this case from the Association, Mr. Hutchinson and I have agreed to be responsible for a sum not to exceed \$30 toward defraying the expenses of Mr. Hilton.

A great deal of preliminary work had already been done by Mr. Rankin and Mr. Hutchinson; and accordingly last Monday, the time appearing to be ripe, Mr. Hilton went down to Lansing, and stayed there talking to the members of both houses, showing the urgent need of the measure advocated by the Michigan Bee-keepers' Association. So far he has received very favorable assurances from a number of the members of the House, and also of the Senate. The bill has been carefully framed by Mr. Hilton and by Senator Helme.

Toward the close of the Madison convention Mr. Hutchinson, who was with us, suggested that on my return trip home I go by way of Lansing; that he thought that, as an official of the National Bee-keepers' Association, I might have some influence with the legislators at Lansing. The more I thought of this, the more it seemed to me it was the thing to do, especially as it would cost the Association nothing. Accordingly, the morning of the 7th found us at Lansing, where we met Mr. Hilton, who had come to meet Mr. Hutchinson. He was greatly pleased at meeting us both, and expressed the conviction that we had come at the opportune time. He took us to the capitol and there introduced us to prominent members of both Houses, putting great emphasis upon the fact that one of us was "president" and the other "director" of the National Bee-keepers' Association; that the National organization was very much interested in the passage of this bill.

There is a possibility at the present time that the bill may pass both the House and the Senate; but before this can take place a great deal of work needs to be done by bee-keepers in various portions of the State of Michigan, writing to their Senators and Representatives. This work should be undertaken at once.

As sure as fate the bill will never pass unless every Michigan bee-keeper writes at once to his Representative and Senator. Write anyhow, whether you know how to write a business or a legislative letter. If some of you do not know how to spell or punctuate, write just the same, and that right speedily. For fear some may not know who their Representatives are, I have appended a list of the House from each county and district. You will certainly know what county you belong in. Pick out your county and write to your man, not at his postoffice, but at the House of Representatives, Lansing, urging him to support Senator Helme's foul-brood bill should it come over to the House. Say further that the interests of fruit growers and the interests of bee-keepers are at stake; that many of the fruit blossoms would not be fertilized but for the bees; that the bee-keeping industry of Michigan represents something like two millions of dollars, and that you hope he will not only see his way clear to vote for the bill, but to work for it. Impress upon him that a great industry is threatened, and that something must be done, and done at once. If you know any one who has a "political pull," and who would be willing to help you, get him to write also. The letter should be addressed, not to the postoffice of the several Representatives, but to the House of Representatives, Lansing, Mich.

Then there should be a letter sent to your Senator. Find out first who he is. This information you can get from any one who is at all up on politics, then write him on the lines above suggested.

Perhaps I am taking a good deal of space for the bee-keepers of one State; if so I am suggesting possibilities and lines of work for other States.

C. Spencer Adams, Van Buren Co.

Robert Alward, Ottawa Co.

Dr. J. W. Ames, Washtenaw Co.

Silas L. Ballentine, St. Clair Co.

Horace T. Barnaby, Jr., Kent Co.

Leo and Baumgaertner, Saginaw Co.

Jacob Bauman, Wayne Co.

Earl B. Bolton, Alpena District.

John E. Bunker, Bay Co.

William B. Byrd, Calhoun Co.

Norris H. Branch, Jackson Co.

David E. Burns, Kent Co.

William B. Bushnell, Branch Co.

Charles J. Byrns, Marquette Co.

Thomas G. Campbell, Midland District.

John J. Carton, Genesee Co.

William Chandler, Chippewa District.

Ira G. Chapman, Macomb Co.

Shenlan J. Colby, Wayne Co.

John H. Combs, Lenawee Co.

Alvah H. Corwin, Oseola District.

William L. Curtis, Cheboygan District.

Orville Dennis, Westford District.

Edward N. Dingley, Kalamazoo Co.

James D. In. St. Clair Co.

Charles Dupont, Wayne Co.

Michael S. Doyle, Clinton Co.

Dexter M. Ferry, Jr., Wayne Co.

William J. Foster, Calhoun Co.

James S. B. French, Monroe Co.

James J. G-e-e, Muskegon Co.

Leo H. Gillette, Berrien Co.

Jester A. Goodrich, Hillsdale Co.

John R. Gordon, Marquette Co.

C. A. Hallenbeck, Eaton Co.

Sherman T. Handy, Dickinson District.

Anson R. Hardy, Ingham Co.

Charles I. Harley, Mason Co.

Ernest W. Hastings, Grand Traverse Dis.

Lawton T. Hemans, Ingham Co.

John Henry, Saginaw Co.

John W. Holmes, Gratiot Co.

Fred A. Hunt, Wayne Co.

William A. Hurst, Wayne Co.

Angus W. Kerr, Houghton Co.

Charles B. Kidder, Lapeer Co.

William Kirk, Tuscola Co.

Luther C. Kanouse, Livingston Co.

C. H. L. Lauboy, Montcalm Co.

Warrin B. Laffer, Montrose Co.

John Lane, Berrien Co.

Berry J. Lowrey, Montcalm Co.

Luke Luzers, Ottawa Co.

Herman Marks, Wayne Co.

Fredrick C. Martindale, Wayne Co.

George T. Mason, Shiawassee Co.

L. H. McCall, Eaton Co.

Geo. P. McCullum, Delta District.

Du-can McFarlane, Wayne Co.

William McKay, Tuscola Co.

John McK. Ionia Co.

James S. Monroe, Gogebic District.

Franklin Moore, St. Clair Co.

J. J. Murdoch, Huron Co.

Christopher Murphy, Sanilac Co.

Edward P. Nash, Kent Co.

Frank S. Neal, Wayne Co.

B. A. Nevins, Allegan Co.

Frank A. O'born, Kalamazoo Co.

John J. Perkins, Barry Co.

Herbert E. Powell, Ionia Co.

F. S. Randall, Oshtemo Co.

J. Herbert Read, Muniee Co.

William A. Reed, Jackson Co.

Arthur L. Rich, Newaygo Co.

John M. Riegel, Bay Co.

James L. Robinson, Cass Co.

Lincoln Rodgers, Muskegon Co.

George W. Ruff, Houghton Co.

Asa T. Sanderson, Saginaw Co.

Andrew J. Scott, Saginaw Co.

Theodore D. Seeley, Oakland Co.

Albert E. Sharpe, Ionia District.

Newton C. Spencer, Menominee Co.

Alvah G. Stone, Lenawee Co.

H. C. Stumpfenhagen, Washtenaw Co.

Wm. D. Totten, Antrim District.

Henry B. Vandereock, Kent Co.

Jacob J. Van Zereen, Kent Co.

Theodosius Wade, Allegan Co.

Edward A. Walker, Genesee Co.

Newton O. Ward, Mecosta Co.

I. R. Waterbury, Oakland Co.

James E. Weter, Macomb Co.

Charles P. Wheeler, St. Joseph Co.

Byron C. Whitaker, Washtenaw Co.

Geo. W. Willis, Bay Co.

Mark Willis, Sanilac Co.

Henry D. Wright, Isabella Co.



Watch and pray, that ye enter not into temptation.—MATT. 26:41.

In our last I alluded one or more times to the fact that this spirit of being contrary and disobliging is more apt to show itself after we become quite well acquainted. Years ago I used to hear a sort of adage that "familiarity breeds contempt." Dear friends, this should not be. It is a sad reflection on humanity—yes, on every one of us, when we assent to any such proposition as this. If the adage means that we should avoid getting so well acquainted that we waste time in trifling, perhaps it might answer; but God forbid that we should show less of a gentle Christian spirit and common courtesy *because* we are quite well acquainted. Yet it is true, I know, that with young married people, after the honeymoon is over, as they become acquainted and adjust themselves to the intimate relations of the home and family circle, it is very apt to be the case that they begin gradually to show out little disagreeable traits that were kept out of sight during the days of courting and the honeymoon. Somebody has suggested that one of the comforts of a home is that you can scold when you do not like things. Now, I do not like that either. While you are reading these words I expect to be away off from my home, and much of the time a guest in other homes. When we go away from home on a visit, everybody knows we must be gentle, kind, and courteous. Did you ever have a visitor that was cross and crabbed? Why, he would be turned out of doors, almost. When somebody invites you to come and make his home yours for a little time, you put on your very best behavior. If there is disorder in the new home you would not think of noticing it. If the children's faces are dirty you say to the good wife you well know how impossible it is to keep children clean all the time—that is, if she speaks about their faces *first*. You would not speak about it first for the world. If she begins to apologize because the bread was overdone, and browned in baking, you make haste to tell her that is just the way you like it baked, and beg for the brownest portions. Now, I can do this truthfully. I do not know just how it is with you. I do not mean you should be untruthful; but I do mean that you should, or, rather, that you *do* use such courtesy and good nature, even when things are wrong, that the whole wide world expects of you. I need not go any further. You all know how it is; and I have many times thought it did me good to get away from home and practice for several weeks in being pleasant, smiling, good-natured all the while. I remember after one trip I took to California, I told them in prayer-meeting (when I got home), that, during that trip, my naturally impatient temper seemed to have disappeared entirely. It was altogether out

of sight. Why, I had really forgotten how to scold. I learned it again, however, when I got into the harness of business cares once more.

Now, why can not men and women be as pleasant and good natured, as even-tempered, always the same, in their own home, amid the every-day cares, as when they are abroad and invited guests. In the Pilgrim's Progress we are introduced to a character of whom it was said he was "a saint abroad but a devil at home." Oh dear me! this hits *me* again. I take some comfort, however, in thinking it does not hit me as badly as it did a few years ago. Mrs. Root herself told me recently (in confidence), that I certainly was growing in grace; that the fashion that had followed me all my life, of being harsh and severe when things went wrong, was certainly getting into the background, and that I was growing more gentle and lovable. She did not use these words, but it was something to that effect. Now may God give me grace to keep on watching and praying as in the language of our text.

A few days ago, when I was over home a signature was wanted in a hurry. It was necessary to use ink—a pencil would not do. In this day and age of typewriters, pen and ink are not so much used as formerly, and Mrs. Root flew around to find a pen and a bottle of ink. The latter was soon found; but even when it was tipped up on one corner there was scarcely ink enough to moisten the pen; and when the point of the pen was moistened it would not write. I presume it was too old and rusty. I do not know whether I commenced or not; but it came right to my tongue's end to say, "Well, I wonder if it takes all this time and fuss to get just a pen and ink." But it was so long before the pen and ink were forthcoming that I began to get impatient again, and came pretty near saying, "Well, now, this is a pretty state of affairs, if it takes *half an hour* to find a pen, and ink enough just to write one's name." I am sure I did not make the latter remark, and I rather think I did not say any thing. Perhaps I groaned a little inwardly to think I could not have the privilege of speaking out my mind. Shall I tell you why I could not, here in this "free country" of ours, express my thoughts? Well, just now Mrs. Root and I are the only inmates of our very pretty comfortable home. If this convenient home does not afford a pen and ink it is the fault of us two; and as I was the *grumbler* it could not be *my* fault, so it must be *her* fault—the fault of "the woman you love." There it was again. More than that, this ugly speech would dishonor Christ Jesus our Lord and Savior—he who spake to his followers the words of our text. May be you say again, "O Mr. Root! you are making a big fuss about trifling matters. These things happen everywhere, and no good wife or husband lays them up or feels particularly hurt. Wait a minute. Not many years ago a man rushed into the house and asked his wife for a pen and ink to sign some contract. They had the same kind of "racket" I have been telling you about. The husband became

impatient at the delay, and talked a good deal as I thought of talking. He finally said, as nearly as we could make out:

"Well, this is the dumdest place I ever heard of when anybody happens to want just such a trifling thing as a pen and ink."

I presume he said something more in the same strain. He declares he used the word "dumdest;" but his wife says she understood him to use a word much like it, but a great deal worse. It resulted in a separation. She left his home and went back to her friends, and he said she could stay away until she got ready to come back. Then the neighbors took sides. Just as soon as I heard of it I said, "No, no! they must never separate for any such trifling misunderstanding as that." But they had got a going, other things had been brought up, and some good friends of mine were foolish enough to think the parties should stay separate. But they didn't, and they lived together nicely and pleasantly for years after that. Now, I need not multiply cases like this. You all know of them. Suppose I should get around and call on you. God knows it would delight my heart to make a brief call on every one who reads these Home Papers—that is, if they *want* to see me. Now, suppose, when at your home, I should happen to want a pen and ink, and that the good wife should have a little trouble in finding them—what would you think of me? or, rather, what would you *do* with me if I should blurt out—well, the things I had in mind when Mrs. Root was doing the very best she knew how? Or suppose I should say it was the worst place I ever found in all my travels to find so simple a thing as a pen and ink. I do not *know* what you would do; but I should expect you to "fire me out" of the front gate, and I might think I got off cheaply even then.

You see I am discussing pretty much the point I did in my Home talk just before this. What is the reason we can not preserve the same gentlemanly, courteous, and Christian-like demeanor before our wives and children that we do when in the home of a stranger? It *can* be done, dear friends. It *must* be done if we expect to be accepted as followers of Christ Jesus. Temptations come to us in different ways, I am very well aware. There are some people who seem to find it easy to be courteous, smiling, and slow and deliberate under all circumstances; but, unfortunately, these people are not, as a usual thing, *pushers*. The present day demands men and women who are *pushers*—who will, for instance, push the saloon, that is encroaching on their neighborhood, completely out of existence. If we have any severe words to use for anybody, let us use them against the saloon-keeper or the midnight assassin. Don't let them come into sight before or toward the woman and the children you love. Let us remember the example we are setting. Let us watch and pray that we enter not into temptation. Our grievances and trials, many of them, are imaginary. In studying up the matter of family relations of the two Utter brothers I was impressed with this. I am *sure* their griev-

ances are largely imaginary. We had one illustration before a bee-keepers' convention that I have once or twice alluded to. A rich man located near a bee-keeper. The bees annoyed him, and he told his neighbor he would have to move them out of the way. A big quarrel started. The two were at swords' points. They made arrangements to go to law, and there was a great long string of grievances on both sides—at least I suppose there was. The quarrel was growing and increasing every day; but, all unbeknown to the two men, something *besides* a quarrel had been going on and "increasing every day." The rich man had a son, and the bee keeper had a daughter; but the two men had their heads so full of the quarrel and lawsuit they did not seem to know, either one of them, that the young people had become acquainted. I can imagine this boy and girl informing their respective parents (and perhaps they did it, too, with downcast eyes), that they had better soften down a little, for it would look bad to have a lawsuit and a wedding going on so near the same time. Well, these parents had Christian grace enough—or suppose we say good common sense enough—to bury the hatchet, shake hands over the yawning chasm of discontent, and settle down together and be friends and neighbors. I often think of this because it illustrates so clearly that there was no need in the first place of a quarrel. Their reasons for disagreement (like Electropoise (?)) was all imaginary. It was just Satan's work, every bit of it, and two good bright business men could not see it was *he* who was pulling the wool over their eyes. Could not the outcome have been brought about, all the same, even if there had not been any boy or girl in the question? Yes, surely. The love of Jesus Christ ought to accomplish just *exactly* this result every time; and the love of Jesus Christ in the hearts of the two parties who were looking for pen and ink was fully adequate to scatter discord in a second of time. May God help us to bring about that glad day when his kingdom shall come, and his will be done on earth as it is in heaven; and may he help us all to "watch and pray" against the temptation that is sure to come; yes, for the temptation that *will* surely invade even "our homes."



THE MICHIGAN BEE-KEEPERS' CONVENTION.

When we go into a railway dining room or even lunch-room we expect, as a rule, to pay bigger prices than almost anywhere else. Well, this in one sense is all right. The eatables are usually first-class, they have to pay high rents for the location, and they must also keep every thing ready with plenty of waiters to serve promptly the crowd that rushes in from the train. Well, in view of this it

was a rather pleasant surprise to me to find a very pretty lunch-room at the Pere Marquette station in Toledo, every thing nice, and prices as low as you would find them on almost any street in Toledo or any other city. As in the ticket office, they had pleasant capable *women* to wait on customers. This Pere Marquette depot in Toledo is, by the way, a model institution all around. Even the *baggage-man* is pleasant, quick, and good-natured when passengers are in a hurry to catch a train at some other depot.

I reached Traverse City just in time to be one of the first at the convention. I went a little ahead of time, thinking I could have a chat with the early comers. To my surprise there was not only quite a lot of the men-folks but half a dozen women also. It happened the train was late that brought President Hilton, so we had a very pleasant social for two hours or more while we waited for him. Perhaps some of you may think it a little strange when I tell you that I have not even yet got over my bashfulness as a boy so it is easy for me to take the lead in getting acquainted; but under the circumstances I felt that it rather devolved on me to take the lead; and I assure you I found some extra nice people. A little later Bro. Hutchinson photographed the whole crowd out in front of the hall. It is not only a most excellent picture, but there is one feature of it that is novel. He "took" us during a snowstorm, and you can see the flakes all over our clothing, and the beautiful white snow down about our feet.

In shaking hands with the ladies I met a very bright, vivacious woman who looked so exceedingly pleasant I wondered if I had not met her before. A little later I found out *why* she felt already acquainted with one she had never seen until that day. Two or three years before, she got hold of our A B C book, and she got the bee-fever for sure. She told me she studied the book day and night. She got some bees, and enjoyed working with them in verifying the statements in the book, as she never enjoyed any thing before in all her life. Of course, her friends laughed at her, and predicted failures, etc.; but she is one of the energetic kind, and when she gets started on something, especially something she likes, there is no give up about it. Well, almost while she was a novice—a beginner, in fact—she secured from one hive in one season *ten 24-pound cases of comb honey*. I believe the sections did not all weigh quite a pound; but there was pretty well toward 240 lbs. of comb honey from that one hive that one season. She is up near my ranch that I told you about, and the bees commenced on apple-bloom. I have not told you much about the apples in the Traverse region, but it is bound to be a great apple country. The bees commenced on apple-bloom, and she actually had some work done in sections. Then raspberry followed right on, then clover, then basswood and willow-herb; and the wild raspberry, if I am correct, gave honey more or less, clear on through the whole season. In fact, I saw honey-bees on the raspberry-blossoms when I was chopping in the woods in October. Per-

haps I have not remembered all the different sources, but that season there was honey right along from apple-bloom until frost killed the wild flowers, and a good strong flow at that. This one colony that did so well was one of 18—that is, she had 18 in the spring to start with. Well, the 18 and their increase gave, if I am correct, over 3000 lbs. of honey, mostly comb. Do you wonder she was anxious to see the man who wrote the A B C book, or that she felt *acquainted* with him without being introduced? I think this big yield was three years ago. I questioned her a good deal about it. Did other bee-keepers notice that the season was anything remarkable? I rather think not. None of the bee-keepers at the convention did any thing like what Mrs. Jackson did. Was it the season, the locality, or the bee-keeper? I do not quite remember, but I think Mrs. Jackson is a farmer's wife, and the mother of several children; but her *enthusiasm* was what brought the honey crop. And this thing has happened, not only with bees but with fruit, with poultry, and with almost all other rural industries. A beginner, comparatively, with enthusiasm and plenty of help in the way of good books and periodicals, often outstrips the veterans. Yes, and it is a sad fact that some of these veterans can not, to save their lives, do over again what they did when they were just learning. The seasons may not be as good as they used to be 15 or 20 years ago—that is, this may have something to do with it; but failures are more often because we lose enthusiasm than because nature has withheld her rewards.

The photo I mentioned contains a picture of Mrs. Jackson with all the rest. It will be mailed to any one for 75 cts. Address W. Z. Hutchinson, Flint, Mich.

Prof. Rankin, of the Agricultural College at Lansing, gave us quite a little help, especially in the matter of foul brood; and it is a sad fact that foul brood is pretty well scattered through many parts of Michigan. Just a few years ago, somebody, whose name I do not remember, moved a carload of bees up into the Traverse region, and these bees were affected with foul brood. When he discovered how great was the task of eradicating it he went away and left them to scatter through the woods, and damage the industry in that locality for years to come. The transaction was no profit to himself, but a great calamity to that part of the State. May be you think I am a little rough when I say that the man who deliberately does a thing of this kind ought to go to the penitentiary. They are already discussing better laws and energetic measures for the suppression of foul brood. We had some sad stories, I tell you, of what it may do in a locality when allowed to go on unchecked.

Mrs. Jackson has promised to give me a report of her big yield of honey, but I am afraid she has not as much enthusiasm in writing for the journals as she has for getting crops of honey.

The next meeting is to be held at Petosky. The date is not yet decided on. I asked if it was not a mistake to keep the State conven-

tion so much in that corner of the State for three years in succession. But somebody said it was the best point for honey in the whole State, and there were more bee-keepers there; and, besides, when it was put to vote, that was the decision. Of course that would be natural, for nearly all present lived not far away from there.

At the convention I was bantered not a little about my ranch in the woods, eight miles north of Traverse City. After the convention was over I went up there in company with Mr. Hilbert, and we commenced clearing off a place for the cottage. I was greatly anxious to know if I could keep warm and feel well at work out in the woods in winter time. Well, toward night I was ready to swing my hat and praise God because the experiment seemed a complete success. I worked all day in the open air, and enjoyed it hugely. But we were a mile and a half from home. Of course, friend Hilbert's ponies took us flying; but I was so warm and comfortable I declared I did not need the great big outside overcoat that I had when I came up in the morning. Mr. Hilbert, however, constituted himself my guardian, and insisted on my putting it on; but I was so exceedingly warm and comfortable without it, I fear I did not button it up very well. I had planned for another outing in the woods next day—in fact, had hired some extra help; but along in the night I was taken with a coughing-spell that came pretty near waking up the rest of the family as well as myself, and I reluctantly gave up my work in the woods in winter. Now, I firmly believe I should not have caught any cold if I had managed right, or if there had been a little bit of cabin or some warm place where I could have stayed in the woods over night. I became so much interested in the work that I did not have a nap all day long at all; then in going home we had to go over hills, and the wind that blew from over across the lake was pretty fierce and cold. If I can just get over in that little bit of dense woods in among the hills, and stay there, I feel sure I shall be all right, winter and summer; and when I get to be too old to be of any use anywhere else, that is where Mrs. Root and I are going to stay until—we get tired out and want to come home.

I have spoken to you once or twice about the little girl that I found digging those Early Rose potatoes. She and I have become fast friends since then. One day at the dinner-table her mother remarked:

"Alice says she wishes Mr Root would stay here, and live right here with us always."

At this remark Alice colored up somewhat and hung her head, while the rest laughed and asked her *why* she wanted me to stay there always. Miss Erna (the young lady who carried one end of the pole for marking the potatoes) suggested it was because her father, Mr. Hilbert, was so much pleasanter when I was around. This made another laugh, and finally Alice was urged to tell just why. She only said we might all guess; and when we guessed right she would tell us—not before. Nobody could guess. I told her we

should have to let the readers of GLEANINGS guess why Alice wanted Mr. Root to live at their house *always*. By the way, we had a joke on Alice a few days later. She came home from school one day and marched into the dining-room with a book in her hand which she picked off from the table where her father and I had left it. As she held it up she said, "Why, what a funny book this must be!"

Her sister then put in, "Why, Alice, what is the book about? Read us the title."

"Why, it reads, 'Farmers with Green Manners.'"

At first nobody caught on, and I was saying to myself, "What in the world does the child mean—'Farmers with Green Manners'?"

But somehow the title sounded a little familiar. Then friend Hilbert began to shake. One after another they caught on. It was the O. Judd Co.'s excellent work entitled "Farming with Green Manures." And, by the way, friend Hilbert has been reading the book over and over, and building some tremendous air-castles on this subject. He says that next year, instead of taking four or five acres to grow a thousand bushels of potatoes, he is going to follow the teachings of that book and get a thousand bushels from one acre. I think I will have to tell the O. Judd Co. of this joke in regard to the title of their book. May be it will furnish somebody a subject on which to write a *new* book on agriculture.



THE GRAND TRAVERSE HAND POTATO-PLANTER.

On page 817, Oct. 15, I described the hand potato-planter used in the great potato locality round about the Grand Traverse region. Let me repeat, there are quite a number of hand potato-planters, somewhat similar to this, on the market, or that have been peddled around, especially the one with a tin tube to drop the potatoes in at the top. Now, this tube arrangement is not what is wanted at all. I was induced to buy one of an agent, and so was friend Hilbert; but they are not worth any thing at all. To push the implement down, even into mellow ground, you want your *foot right on it* as in the figure. In the first place, you want your ground marked both ways; and I would use the chain arrangement as pictured and described on p. 975, Dec. 15. You can plant your potatoes, with little extra expense, so as to cultivate both ways; but whether you decide to cultivate both ways or not, I would mark the ground both ways. By the way, at a recent visit at friend Hilbert's, one of his daughters, a bright young lady of 14, remarked that the picture was not just right. She said there ought to be a boy at one end and a girl at the other, and the girl would represent herself, for she carried one end of the pole to mark their potatoes last

season ; and, in fact, a boy and girl will mark just about as well as a team of horses. They don't tramp down your nice ground as horses do. Well, after you get a planter there is a special knack or trick in using it just right. The directions below will make it plain.

DIRECTIONS FOR THE ACME HAND POTATO PLANTER.

Take the planter in the right hand, with lever pointing ahead. With the left hand reach into the sack and select the seed required. Don't stoop, but raise the planter to meet the hand. Drop the seed into the hopper. Steadily lower the planter to the mark ; step on the hopper, not on the lever, and with the left foot press the planter into ground, then step ahead with the same foot, at the same time pushing forward the handle, which releases the seed ; drag the right foot over the hill in bringing it forward ; this brings you to the next hill. While planting the seed, the left hand has gone to the sack to secure seed for the next hill. In planting with the left hand, reverse these directions. If these directions are followed, the operator will move ahead at every motion.



PLANTING POTATOES WITH THE ACME PLANTER.

Now, please do not think you know a much better way. The manufacturers of the implement have spent much time, and have watched the machine while it planted thousands of acres. Let me say again that Mr. Hilbert's boy, when he was 17 years old, planted two acres of potatoes all alone in one day ; and the work was done well. I saw acres that had been planted with this machine. This implement was invented in the Grand Traverse region, and everybody there uses it.

I wish to call attention to the concluding sentence of the directions. Almost fifty years ago, when my brother and myself were boys, we were planting corn by hand, with a hoe. I

think there were four of us—two men and two boys. Well, my brother, about 18 years old, walked right away from the rest of the planters, and did his work just as well as the grown-up men did theirs. I was of an inquiring disposition then, just as I am now, and I insisted on finding out the whys and wherefores. He laughingly explained to the rest of us that we stood still and took both hands to dig a place to put the corn. Now, he pulled away dirt enough to leave a cavity, with his hoe in his *right* hand, while he picked the corn out of his pocket with the *left* hand. In fact, he had trained his two hands so that they worked independently. One did one thing, and the other did another thing. In that way he could walk right along and do his work just as well as we did ours. Of course, it took a little more strength and a little more brains to keep every thing going. I soon learned the trick ; but the two old men could not get out of their old ruts. I think my father afterward turned them off and let his two boys finish the corn planting.

Now, I have seen this same thing a thousand times through life. A good many grown up people, strong able men and women, will think they are going to be killed or injured in some way if you insist that they teach their two hands so one will do one thing at the same time that the other does something else. When I get hold of a boy or girl who is teachable, and will catch on to the idea that such a one can do ever so much more work by keeping both hands busy, such a boy or girl gets promoted. Those who can not learn the trick of thus saving time and money soon get out of a job. Now, with this potato-planter you have got to learn to do just this thing—that is, learn the trick of keeping not only both *hands* but both *feet* busy at work all the time. Of course, you must have your potatoes cut and located at the ends of the rows ; and then you will have to find out by experiment just how many will go across the lot, so that you do not unnecessarily carry potatoes across the field and then carry the same ones right back. If your field is very large, have some potatoes located along the line through the middle of the field as well as at the outsides.

I forgot to add in the proper place, that, where the ground was nice and mellow, my brother and I covered the corn with a motion of the foot. The old men I alluded to stood still to dig a place for the corn, stood still while they counted out so many kernels, and stood still *again* until they hoed some dirt over the grain, and flattened the top of the hill with the hoe. Of course, this planting of corn by hand is all out of date now. I mention the matter only by way of illustration. This hand potato-planter and one man will plant almost as many acres as you can plant with a man and team, and our best machines want a boy besides. The machine planter will, of course, work in ground not as thoroughly fitted as it needs to be for hand planting. But I do not believe the machines will give any better results, after having looked the matter over very thoroughly.

Please notice you do not have to stoop over

at all to put the potato in the planter. Just raise the planter with your right hand until the opening (right where the man in the picture is resting his foot) comes so the left hand can take the potato out of the bag and put it in the planter, both hands working together.

The following additional description is taken from our 1901 price list:

While in the region of Grand Traverse Bay last fall I found the principal crop for miles around was potatoes, the soil and climate being especially adapted to this crop; and I was both surprised and pleased to find that the planting was done almost entirely by hand, with an implement invented and manufactured in that locality. A bright boy, 18 years old, with whom I became acquainted, informed me that he had with this machine planted *two acres* in one day himself. The ground is fitted in the usual way with ordinary farming-tools; but after that (see *Gleanings*, Dec. 15, page 975), both marking and planting are done by hand. The following, which I take from the manufacturer's circular, I think is a fair statement of the merits of the machine. The cut adjoining explains the way in which the machine is made; but we can furnish a larger cut with descriptive circulars, showing just how the planter is to be used, on application.

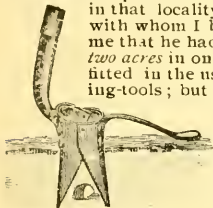

HOW IT WORKS.

"The Acme hand potato-planter makes the holes, and drops and covers at one operation. Once over the field does the work.

"It makes planting easier. The erect position; the carrying of the seed on the shoulder; the ease with which it can be changed from one shoulder to the other, make this part of farmwork much less disagreeable. 'Almost as easy as walking.'

"Ten pounds of seed will plant thirty rods of row if five bushels of seed is used to the acre. This will average only five pounds if the seed is distributed at intervals of thirty rods.

"It plants better. It is very important in planting potatoes that they be placed in moist soil, and covered before the soil dries out. Ordinarily the holes are made, or furrows turned in if a horse is used, and the soil exposed to the hot sun for the day. The soil soon dries out. Next the sets are dropped, and perhaps they are left to blister in the sun; they are then covered at unequal depths. The dry ground absorbs the moisture that may be left in the seed, and the result is—no crop.

"With the Acme hand planter the seed is planted at a uniform depth directly into the moist soil, where it can not dry out or blister, nor is the soil disturbed. The success of the planting is thus assured.

"The implement is light, weighing but 2½ pounds, but strong and durable. We have a planter in our office that has planted for eleven seasons. It was then brought in to be repaired!"

GROWING THE SOJA BEAN (OR AMERICAN COFFEE BERRY) IN NORTHERN OHIO.

Learning that the writer whose communication appears below had grown successfully quite a crop of fully matured soja beans, I wrote him for particulars, and he furnishes the following:

We plowed the ground May 10th, and harrowed it thoroughly. We had some seed raised from a packet of American coffee-berry purchased of you. The strip we planted was so poor we were certain it would not pay to plant it to corn. We applied acid phosphate, or South Carolina rock, at the rate of 250 lbs. per acre. It was drilled in with a grain-drill with fertilizer attachment. We then marked it in rows 30 inches apart, and drilled the beans in by hand after the fashion of early peas—i. e., about an inch apart in the row. We went over them with a weeder just before they were through the ground. After they were up we cultivated them thoroughly as deep and close to rows as possible, until they were about three inches high. From there on we gave them shallow cultivation, and just kept the ground nice and fine on top as long as we could get between the rows. They grow very rapidly, covering the ground completely. They

root so deeply that drouth does not seem to affect them; they even grow and produce well when planted in among the corn. We planted the beans May 15, and harvested them Sept. 5. We drove along each row with a mowing machine, and cut them; then followed, put them in bunches, and left them to cure for about a week. We used a common thrashing-machine to thrash them, removing all but one row of concaves, running very slowly, and always keeping the cylinder nearly full to avoid throwing beans all over the barn. The quarter acre yielded about 8 bushels. The soil was a mixture of clay and sand. J. McQUEEN, Baltic, O.

Now, this is interesting, for the soja bean has met with favor everywhere. It not only makes excellent hay and feed, but for plowing under to enrich the ground there is probably no plant known that is its superior. Our experiment station goes further, and informs us that where the crop is taken off the ground completely, for hay or seed, the soil on which it grew has been benefited for almost any other crop. We can furnish a leaflet on application, telling more about this new forage plant.

GRAPE FRUIT IN FLORIDA; HOW MUCH MAY THE CROP BE WORTH ON A SINGLE TREE?

I noticed your call for a report about grape fruit, and was surprised not to see a good item or two, in your last issue, on the subject. Let me say 12 boxes is nowhere. There are trees in DeSoto Co. here in South Florida that have on them this year very nearly 100 boxes to a tree—standard orange-boxes. There have been 50.00 fruit picked from one tree. The 100-box trees are about 60 years of age. The trunks are about 2½ feet in diameter, and the trees are nearly 50 feet high. Now, don't get excited, or want to come here to find a Klondike, for we Floridians have enough young grape-fruit groves set out to reduce prices in a few years so everybody can eat the fruit.

If no one else sends in a full detailed account of this fruit, I will do so on request, or will answer inquiries by mail. Florida will soon rival Michigan in celery-growing. If you happen along this winter, drop off at Sanford and see successful celery-growers. Lakemont, Fla., Dec. 14. C. W. BROWN.

GRAPE FRUIT AT \$12.00 A BOX.

On page 923, M. W. Shepherd says a gentleman living near Sarasota, Fla. sold 12 boxes of grape fruit from one tree, and received \$12.00 per box. This may be possible, and we will not question the gentleman's veracity; but at the same time we don't want the whole country flocking down on us to raise \$12.00 grape fruit. They might be disappointed. True, it is a profitable crop for Florida where it is not too cold. The usual price is about \$7.00 per box for best sizes, and they will sometimes bear a box at five-years-old bud. They are nature's own tonic, besides being most delicious eating. N. O. PENNY.

Nathan, Fla., Dec. 8.

I confess it occurred to me, when I first saw the above statement, that \$12.00 was a big price, for we used to buy grape fruit for less than half that amount; but I supposed it had probably increased in popularity, and that the price had gone up. Very likely friend Shepherd can explain. Very large and fine fruit brings better prices, of course, than the kind that is often sent north.

HOW TO GROW COLD-FRAME LETTUCE IN NEW JERSEY; STARTING OUR PLANTS IN THE SEED BED.

About the 10th of August we prepare our ground by taking a small piece of sandy loam or soil, and plow it about three inches deep, and then take an iron rake and pulverize the soil until the lumps and trash are removed and the soil is nice and fine, and then we broadcast, and then rake them in lightly and sprinkle with water, and then take boards and cover the beds so they will be about six inches from the ground, for we can not get the seed to sprout without covering. Leave the boards on until the seed is up, and then remove the covering just before sunset; and if the

weather is cool it is better for the plants; for if the sun is hot it will need a little care to keep from burning.

TRANSPLANTING TO COLD-FRAMES.

About the first of September is the time to prepare the bed for transplanting. Clear the ground of all trash, and get the soil the same as for sowing the seed, and then take fish guano and broadcast over the soil, and then work the guano well in the soil; then leave it until about the 10th of September. Transplant your plants to this bed by setting the plants 8 inches each way, and then the plants do not need much care except a little watering if the weather should be dry, until frost, and then the sash must be put on at night to keep the frost from frothing the plants. About the 10th of November it is ready for the market, and will bring from 3 to 5 cts. per head; and to grow it nicely it should grow nearly natural. We can not grow hot-house lettuce with us for it gets lousy, so that the lice kill it. It is not a success. GILBERT M. SHUTE.
Clarksboro, N. J., Dec. 15.

GINSENG CULTURE.

Since I have invested quite a little money in plants, and have utterly failed to make even one plant grow, I have been criticised rather severely because we have declined advertisements pertaining to the ginseng industry. I have recently written to the people at our experiment station in regard to it, and here is what Prof. Green says:

Mr. A. I. Root:—I do not know much about ginseng culture, although there is a man not far from here who is experimenting along that line. We have done nothing with it, but have thought we might commence experiments with it next spring. The man referred to has had more trouble with insects and diseases than he has had in getting the plants to grow. It is certainly not the kind of business that every one can expect to succeed in, because the plants are not only difficult to grow, but seem to be quite subject to disease.

W. J. GREEN, Horticulturist.

Wooster, O., Dec. 13.

Now, friends, every thing of this sort should be first tested and tried by the experiment stations of our different States. When they tell us there is a reasonable prospect of success in it, then is the time to invest, and not before. The trouble mentioned is exactly the one that I have found. Insects and fungi seem to finish up the plants, no matter what kind of soil and treatment I gave them.

TRAP NESTS, AND SOMETHING ABOUT POULTRY, IN GENERAL.

Mr. A. I. Root:—I have been a constant reader of GLEANINGS for more than twenty years. I like your Home Papers and believe that I am a better man to-day from reading and trying to follow the precepts given therein. I also like your high pressure gardening; but when I tell you that I have been a "chicken fancier" for more than forty years you will have some idea of the pleasure it gave me to read your article on high pressure poultry-raising in your Jan. 1st issue. Now, can't you "walk around the stairs" and devise a trap nest that anybody can make without paying a royalty? I attended the poultry show in Philadelphia, and was quite surprised at the number of bee-keepers I met—the same people I had been meeting for years at bee-keepers' conventions, and never dreamed that they had the hen fever; but you know the old saw, "birds of a feather will flock together." I have been called a fool with a big D because I paid \$3.00 for a setting of eggs; but my wife and children have sat down to many a good dinner of roast chicken, fried chicken, broiled chicken, stewed chicken, chicken potpie, and omelets, custards, eggs boiled, fried, etc.; whereas the wife and children of the man who called me a fool did not have either, because the tavern-keeper got more of his money than I paid for my fancy eggs. From one setting of eggs I once sold \$40 worth of chickens, and I sold only four and kept six for myself. Now don't forget the trap nest. Let the gardeners and bee-keepers rest for a while, and talk chicken. Ashbourne, Pa., Jan. 10. W. E. FLOWER.

Over twenty years ago, in our first bee-hive factory up on the street there used to be a central stairway on the first floor. When I wanted to study up something on hives I used to walk around this stairway while I worked out the problem, and the readers of GLEANINGS then got hold of the expression our friend uses in his kind letter. When they wanted me to help them out on something they had been planning they used to say, "Bro. Root, walk around the stairs and think it over."

In response to the above kind invitation I have sent for all the patent nests, and directions for making the same, that I could find advertised. I have before expressed my opinion in regard to selling secrets or plans for making any thing for a certain amount of money. I have advised the inventors and manufacturers of trap nests to patent them if they like, but, instead of selling rights, sell the nests for so much, set up or in the flat. The objection made to this by many of them is that they can buy cheap pine boxes at the groceries, that answer every purpose of a patent nest, with a little fixing over. To illustrate: One of the best patent nests I have yet gotten hold of (and it cost me \$2.00 for the right and patent directions to make) is something like this: Get any kind of box at the grocery (for five or ten cents), big enough for a hen's nest. Stand it on end—that is, so its longest way is up and down; then cut a round or oval hole through one side of the box, with its lower edge just a little above the bottom, just right for the hen to step up a little as she goes into the nest. Now put this where the hen has been laying. Such a nest suits her first rate, for it is inclosed all around, and tolerably dark. She has just room enough to get in and out. The box should be large enough so she can turn around comfortably on the nest, but not too large. Of course, there is nothing to patent on such a nest. Well, the door is a swinging door. It is like the door that shuts over a common padlock to keep the rain and snow out. Suppose you cut a piece of wood about the shape of a pumpkin seed. Make a hole through where the point is, and put in a screw. Hang this over the hole of your hen's nest, and it makes a door. But you do not want this door to close the opening entirely. Cut away a little of one side so the hen can put her head in and see the nest she is familiar with. Yes, make the opening large enough so if she crowds a little it will swing off to one side. Well, now, this is very simple. Nobody can claim a patent on such a nest; and the patented feature comes in on the latch to *fasten* the door as it drops back after she has got inside.

Now, there is no end of door-latches, and nobody could get a patent on the simple idea of having the door fasten itself whenever it swings down. But there might be a peculiar latch for the special purpose, that would be patentable. A very pretty pamphlet goes with the nest I have described, which contains considerable information in regard to the whole business of making and using trap nests. You can make a home-made nest, such as I have described, without buying a patent from any-

body ; or you can procure for \$2.00 a right to use the patent nest, including a sample door and latch, by mail, postpaid.

Another trap nest that has been found to work very nicely by the Maine Experiment Station is described in their reports.

The Cyphers incubator people furnish a nest, ready made, for \$1 50, which they recommend very highly.

Perhaps one of the simplest trap nests is described in the back part of a book furnished by the O. Judd Co., entitled, "Low-cost Poultry-houses," 25 cents. We can send this book from our office if our friends want it.

The "Advance" trap nest furnished by W. Darling, South Setauket, L. I., is \$1.50. I have not seen this, but I should think it would work all right.

A prominent agricultural writer furnishes a little pamphlet describing a trap nest, or a nest that can be easily arranged so as to trap the hen when she uses it, together with a new hatching system, for \$1.00. This trap nest amounts to the same thing as the one described in the book I have mentioned, sold by the O. Judd Co. ; but I think the one in the book is much the simpler and easier to make.

As we have now about finished the subject of trap nests I wish to say something about the "new hatching system," or the "natural-hen incubator," for it amounts to the same thing. I wrote up the natural-hen incubator something over one year ago. The invention of the writer mentioned above is a nest made out of a drygoods box, such as I have described, with a little poultry-netting yard, so the sitting hen can not get away from her eggs very far, and no other hen nor any thing else can get to her nest to bother her. Food and water are provided, of course, in this poultry-netting yard. This device, you will see, is simply a modification of the natural-hen incubator, only the latter is made by having a lot of hens' nests and a lot of yards all in compact form. Now, although the vendors of these devices would persuade us that they are entirely new, the thing is *not* new at all. I find both pictured and described in the book entitled "Profits in Poultry," sold by the O. Judd Co., and the book has been in our book-list for more than ten years. In fact, I found both devices pictured and described in an old edition as far back as 1886. Both parties who sell this yarded sitting-hen arrangement tell doleful stories about the loss of money and loss of eggs with incubators ; and no doubt it is true one can, in almost any neighborhood, find incubators that have been purchased and laid aside ; but even if this is true, their efforts to make it appear that everybody who buys an incubator is humbugged are very far from the truth. Sitting hens may be very good where you can get enough to stock a sitting-hen incubator on short notice.

But let me touch on one point that the sitting-hen men seem to overlook. I have been waiting all winter to get a sitting hen. I have told the neighbors right and left I would pay almost any price for a hen that wanted to sit. But all the hens in our neighborhood seem to

have quit the business. Had I known this I would have bought a \$5.00 incubator in December, and had some chickens to play with all winter. Of course, I do not know how *many* (we must not count our chickens before they are hatched, you know) ; but I feel sure I might have had a few. Will our good friend (the agricultural writer) and that other fellow in that same line of business (Natural-hen Incubator Co., of Columbus, Neb.), tell us how we are to get sitting hens to stock their machines, for that institution advertises that a 100-egg incubator can be made on their plan for \$2.00? This may be true, but I think the \$2.00 would have to be stretched pretty well ; and after the machine is made, eight or ten hens must be forthcoming that *want to sit*, before the thing can be started.

Now, even though it is out of my line of business somewhat, I protest against this plan of asking people for a dollar for the information contained in a little bit of pamphlet or on a single sheet of paper. The pamphlets or sheets of paper can be printed for a cent each or less ; and when you *get* the information, almost invariably the very thing is found in our books that have been before the world for years past.

By the way, I have not seen any mention in any of the poultry books or journals of the fact that an electric light is the best thing in the world for testing eggs. With a fifty-candle-power lamp, shaded and arranged just right, you can see every thing inside of an egg. I have not had a chance yet to test it with eggs from an incubator. One more item: All the books and journals recommend a scratching shed, and most of them say this shed should be open to the sun and air whenever the weather permits ; and cloth frames are recommended in place of glass when the weather is not bad. The cloth is cheaper, gives light enough, and also gives just about as much air through it as the poultry ought to have. Now, the cheapest way in the world to move the cloth according to the weather is by having it roll up, on the plan described in our tomato-book.

Humbugs and Swindles.

DUNNING LETTERS, FOR SOMETHING YOU DID NOT ORDER AND DID NOT HAVE.

It seems the swindling fraternity are finding new tricks for the new century. One of the latest is to threaten people with a suit at law unless they send the swindlers a certain sum of money forthwith. Several of the letters have already been mailed to us, asking us if they had not better pay the amount (two or three dollars as the case may be) in order to keep out of trouble. This threatening letter is usually sent to somebody who answered an advertisement some time ago, and perhaps sent a small sum of money for the advertised nostrum. Let me say, first, that nobody can collect or will undertake to collect any money from you for something you did not order and did not have. Another thing, these letters are

skillfully gotten up so as to appear to be *bona-fide* type-written productions, when they are nothing but printed circulars in letter form. These rascals print them by the thousands, and mail them for a cent each, knowing that every little while they will get hold of somebody who is foolish enough to be frightened by their threats of "United States courts," etc. One such medicine firm, whose letter is now before me, is the Hospitaline Remedy Co., of New York. The man it was sent to is Henry F. Buck, of Buckskin, Mich. He says he was foolish enough to send them money in advance for the medicine he had, about a year ago; but it never did him a particle of good—just money thrown away; and now they are trying to blackmail him for some *more* money. A similar letter came to a relative of mine, a widow. Her husband purchased some medicine of a firm several years ago, but he paid for it at the time, as a matter of course. Instead of handing over any money in answer to such threats, just mail all such letters to us and we will show the parties up.

The dunning letter Mr. Buck sends us does not have his name, nor that of anybody else, for that matter. His name was on the outside of the envelope, where the letter was addressed to him.



NATIONAL BEE-KEEPERS' ASSOCIATION.

OBJECT:—Defense of the rights of bee-keepers; prosecution of dishonest commission men and glucose adulterators; but only members are entitled to protection.

OFFICERS:—E. R. Root, President, Medina, O.; R. C. Aikin, Vice-president, Loveland, Col.; Dr. A. B. Mason, Secretary, 3512 Monroe St., Sta. B, Toledo, O.; Eugene Secor, Gen'l Manager, Forest City, Ia.

FEES:—Annual membership fee \$1.00 Remittances may be sent here or to General Manager as above.

OUR CATALOG FOR 1901.

Owing to delay in the completion of the present edition of the A B C of Bee Culture and other printing about the beginning of the new year, we are a little late in getting out our catalog. We have already mailed a copy to the readers of GLEANINGS, and expect to get around to our larger list of applicants by the first of March or soon after. We have printed 10,000 catalogs for Geo. W. York & Co., who have just moved to 141-146 Erie St., about five blocks further north than the old location; also 12,000 for Jos. Nysewander, Des Moines, Iowa. Catalogs for other dealers will be distributed within the next two weeks. If you have not received your catalog yet, send for it; and if you know of others in your neighborhood interested in bees, or like 'y' to be, send us their names and we shall be pleased to send them a copy.

SECOND-HAND MACHINERY.

We have on hand quite a number of second-hand machines which might be of use to some of our readers if they knew of them. We have several machines for cutting the slots in sections, section-holder bottoms, or separators. One is a single-head machine, hand-feed, which sells new for \$25.00. This is just as good as new for service, and we offer it complete with wood frame for \$12.50 just half price. We have also two or three double-head feed machines which sell new for \$75.00. One or two of these machines are almost new, and just as good for service, and we offer them at \$40.00 each. A third was slightly damaged by a fire,

but is in good shape. We offer this one at \$30.00. We have also several saw-tables for ripping, worth from \$10.00 to \$20.00 in present condition. Further particulars on application, to those interested. Last, but not least, we are just installing a new machine for dovetailing our hives both sides at once, with which we expect to do the work much more rapidly and very accurately. It will be hard to improve very much upon the work we have been doing on our present machine, which will be for sale as soon as the new one is installed and accepted. The old machine is practically as good as ever, and is capable of dovetailing nearly 1000 hives a day, and doing it in the excellent manner which has given our Dovetailed hive an enviable reputation. We would not build a new one like it for less than \$500; but we will sell this one for much less. We shall be pleased to hear from any one interested, when we will give further particulars and price.

REMOVAL NOTICE.

In our last issue, in the department of Pickings, we referred to the fire and water loss at the office of the *American Bee Journal*, on the first day of the year. The publishers have put forth a notice which we are pleased to put before our readers:

Beginning Feb. 1st, our place of business will be at 141 and 146 Erie Street, instead of 118 Michigan Street. Our correspondents, and customers who are in the habit of calling at our office, will please note this change in location.

After our loss and general disturbance here, caused by the fire in this building on Jan. 1st, we concluded it would be best for us to seek another location. We had little trouble in finding what we think will suit us exactly.

The new place is on the first or ground floor—so there will be no more stairs to climb, as is the case here. Also, there will be no need for a freight elevator at the rear, on which we have had to load and unload all our goods the past eight years. This will save considerable handling. We shall have a larger floor space at our new location, so we shall be able to have every thing on one floor instead of on two as has been the case here a part of the time.

Our new office—141 and 146 Erie Street—is just a few short city blocks (about 100 rods) due north of the Chicago & Northwestern Railway Passenger Station on Wells Street. We shall be about midway between Wells Street and Franklin Street on Erie Street.

We think now none of our friends who come to the city will experience any difficulty in finding us.

Come and see us in our new business home—after Feb. 1st. GEORGE W. YORK & CO.

The change, we anticipate, will be better in every way. There is no great loss without some small gain.

Special Notices by A. I. Root.

OFF FOR FLORIDA.

To-day, Feb. 4, during a big snowstorm, I start out for the sunny South, to meet the friends once more, or at least a part of them, with whom I had such a pleasant acquaintance six years ago.

JAPANESE BUCKWHEAT—ADVANCE IN PRICE.

Although we have sold 100 bushels or more at 75 cts. a bushel, it has now gone up so we should be glad to buy at that price or a little more. Under the circumstances the lowest price we can offer it is, two-bushel bag \$2.00. For smaller quantities see our new seed catalog just out.

ADVANCE IN SWEET CLOVER.

Instead of 100 lbs. at 5 cts., as heretofore, after this date we shall have to make the price 100 lbs. at 7 cts.; 10 lbs. or less at 8 cts. By mail, 1 lb. will be 20 cts. The above is for sweet-clover seed with the hulls on. Hulled seed, sometimes called Bokhara, will be 3 cts. per lb. more than the above prices. As there are a good many more seeds of the hulled in a pound you can not tell exactly which is the cheaper in the end.

HENDERSON'S BUSH LIMA BEANS.

When all other beans are so well up in price, it is a little refreshing to know that we are enabled to furnish Henderson's bush lima, 1 pint, 8 cts.; quart, 15 cts.; peck, \$1.00; bushel, \$3.50. This is the earliest lima a known, and they are wonderfully productive. So far as I know they will grow and ripen any-

where. The principal objection is that it is more trouble to pick and shell them than the large bush lima.

DWARF PROLIFIC GERMAN BLACK-SEEDED WAX BEANS.

This is a long name, I know, for one kind of bean; but if you plant some of them I think you will say they are worthy of the long name. You may remember I gave them a write-up last August. They are not only the best quality of wax beans I ever got hold of, but they are extra early, and so exceedingly prolific that a few hills will give a family beans right along every day, and the pods keep tender until there are good-sized beans inside of them. Ten cents' worth of seed will make a patch big enough to furnish a good-sized family with beans—that is, if they are well cared for in good ground. Prices: ½ pint, 8 cts.; pint, 12; quart, 20. If wanted by mail, add at the rate of 15 cts. per quart for postage. There has never been a rusty pod, so far as we have grown them.

DREER'S VEGETABLES UNDER GLASS.

Our friends may remember I gave the above book a pretty good write-up some four years ago when it first came out, and it has had a big sale; in fact, a new edition is just out. This new edition has over 100 pages, and lots of beautiful half-tone pictures. Every person who takes any interest at all in gardening under glass should have this very valuable book, especially since the price is only 25 cts. postpaid. On page 63, in treating of growing cucumbers under glass, we have a picture of a bee-hive with the bees going out and in; and here is what is said in regard to it:

"The cucumber-grower has no more useful ally than the honey-bee; and the same industrious, unpaid laborer will do good service among tomato-blossoms. Every New England gardener has one or more swarms of bees, and a hive is carried into the forcing-house soon after the cucumbers are planted, so that the bees may be ready to visit the first blossoms.

"The cucumber (like other plants of its tribe) bears two kinds of blossoms on the same vine. One sort has stamens and the other a pistil. It is necessary for the pollen of the former to be carried to the latter. The work was formerly done by hand, with a camel's hair-brush until it was found that the same result could be obtained more easily and cheaply through the agency of bees. The little insects are also more certain to find and fertilize all the cucumber-blossoms than even an expert human operator."

Such a statement as the above, from a book like this, ought to settle the matter in regard to the importance of bees to the gardener, or fruit-grower, for that matter.

SOME NEW BOOKS BY THE O. JUDD CO.

I have been reviewing the poultry-books of late, and I find several I can recommend. First, "Pocket-money Poultry," by Myra V. Norys. Written by a woman especially for women. The book is written in such a charming style it is intensely fascinating, and, in fact, it is full of delightful pleasantries. Besides this, it is really a gem of art in its beautiful pictures. These are almost worth the price of the book, let alone the reading. Such a book really ought to be cloth bound, but I find it is advertised only in paper. It has 171 pages, full of pictures, 50 cts.

"Low-cost Poultry-houses." This I have mentioned elsewhere. It has 48 pages, fully illustrated; 25 cts.

Then we have two books on building houses—"Modern House Plans for Everybody;" price \$1.00; fully illustrated. It gives plans and specifications, with full details for houses costing all the way from \$250 up to \$8000. The \$250 house is the one we are talking about for our ranch in the woods.

The other book is "Cottage Houses for Village and Country Homes." It gives detailed estimates of materials and their cost, with each plan; price \$1.00. These two latter should go together.

Then we have "Farm Appliances," another book fully illustrated, brimful of short cuts for farmers and others. This is a nicely bound book with nearly 250 illustrations; price only 50 cts.

"Farm Conveniences" is a still larger book, better bound, made up of the best ideas from the experiences of many practical men; 200 engravings; price \$1.00.

We can mail any of the above books promptly from our office, postpaid, at the prices given.

KIND WORDS FROM OUR CUSTOMERS.

KIND WORDS FOR GLEANINGS.

Don't ever stop sending GLEANINGS to me until you get orders to do so. I have read it the past 25 years, and expect to as long as I live. If I get behind a little at any time I will make it all right. E. BEDELL.
Lake Helen, Fla., Jan. 23.

[It is because of the number of letters like the above that we continue GLEANINGS until we are desired to stop it. In other words, more people complain when their journal is stopped without orders than when it is continued without orders. In view of this, will not our friends please tell us on a postal when GLEANINGS is wanted no longer?]

SOME KIND WORDS IN VERY TRUTH.

My husband died Sept. 18, 1900. Perhaps it may encourage you to know that your Home talks greatly helped to strengthen his spiritual life. I read your talk on the prodigal son a few days before God called him home. God had led you to speak of things that had often perplexed my husband, and we both rejoiced that the Holy Spirit's influence led you to deal with that subject just then. I have written "my husband died" I should have said he "entered into life." May God still own and bless your labor for his kingdom. JEMIMA M. BENTON.

Durham, Ont., Can., Jan. 14.

[May God be praised for the above words. Success in business or any thing else that the world has to offer can not compare with the thought that one has been instrumental in God's hands in leading some other fellow-being out of darkness and into the light.]

I am especially indebted to Bro. A. I. Root, and desire to inform him that I am now free from any desire and love for tobacco, which lasted for nearly a year after I gave up its use. I also wish him to know that the parties referred to in one of my letters about a year ago—the one a traveling man and the other an express messenger, particular friends of mine, who had given up the use of tobacco through the indirect influence of Bro. A. I., are continuing in the good habit, much to my surprise, as they are exposed to special temptations. The one must also sell cigars, together with groceries, and the other through the environment of railroad life and night work.

Marion, O., Dec. 24.

LOUIS SCHERFF.

THE TOBACCO HABIT, ETC.

Friend A. I. Root:—The way you have been hammering away on tobacco all these years is certainly commendable. A pioneer of this county some years ago met with a series of financial reverses, which left him in a very gloomy condition. He sat around smoking and worrying until he went insane. Friends took him to Stockton to put him in the State Insane Asylum. Before taking him to the asylum they were advised to take him to a water-cure institution, which they did. As nearly as I can remember his words were, "They put me in cold water and then hot. They steamed me and soaked me. When I came to I was in a bath-tub. The tobacco soaked out of my system showed in the water around the edge of the tub. It may not look reasonable, but it is so."

"I suppose that broke your tobacco habit?"

"Yes, for a while. I had no special desires or appetites, any more than a babe. I had it all to learn over. Afterward I saw other men using tobacco, and thought I'd like to try it. It tasted good, and I got in the habit of using it again."

He is now an inveterate smoker. Many who consider them-elves temples of the living God are in no better condition to-day. Strange!

Yours for pure air, clean bodies, furniture, floors, etc. W. A. H. GILSTRAP.

Grayson, Cal.

Mr. Root:—I am very much interested in your Home talks. When I began reading your paper I was using tobacco—had been chewing for some ten years, but I am free from the stuff. Now I have no desire for it. I rejoice that I can lay aside the filthy stuff and spend the money for such a nice clean paper as GLEANINGS. I certainly wish you and your company a great success. May you be ever ready to say a few words to encourage some one to rid his pockets of the filthy weed. Lift up the hands that hang down, and strengthen the feeble knees. J. B. OVERFELT.
Gogginsville, Va.

Allow me to thank Bro. A. I. Root for so clean a periodical as GLEANINGS. D. F. BASSETT.
Beloit, Wis., Dec. 12.

GLEANINGS AS AN ADVERTISING MEDIUM.

I have now an apiarist on my place in Volusia Co., in answer to my advertisement in your journal more than a year ago. HATTON TURNER.
Mathews, Fla., Jan. 14.

CAYENNE PEPPER AS A REMEDY FOR GRIP AND COLDS; SEE PAGE 853.

In the summer of 1899 a friend of mine who is a member of the Ralston Club told me cayenne pepper was good for the grip. But to take it either in butter or milk did not come up to my idea of taking medicine, so I emptied some quinine capsules and filled them with pepper. Since then I have purchased some three-grain empty capsules and filled them with cayenne pepper and have taken it in this form ever since. Now, whenever I get a chill or have that burning heavy feeling, or in any way feel a cold coming on, I take one of those capsules just before going to bed; and although it sometimes feels pretty hot in the region of the stomach, yet in the morning I am quite myself again. Both my self and all our family stopped every cold, both last winter and this, in this way. I do not give this in any argumentative spirit; but if you get as much benefit from it as I have I shall be only too glad to tell you of it. HENRY PILLAR, JR., The Woodlands, French Creek, B. C. Can., Nov. 21.

CONVENTION NOTICE.

The annual convention of the California State Beekeepers' Association will be held in the Chamber of Commerce, at Los Angeles, on the 25th and 26th of Feb., 1901. The convention will be called to order at 1:30 P. M., on the 25th. Several valuable papers have been promised, and we expect an interesting convention. J. F. MCINTYRE, Sec'y., Fillmore, Cal.

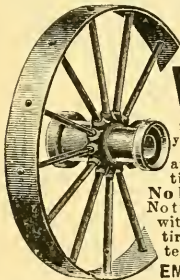

STEEL WHEELS
for your **FARM WAGONS**

any size wanted, any width of tire. Hubs to fit any axle. No blacksmith's bills to pay. No tires to reset. Fit your old wagon with low steel wheels with wide tires at low price. Our catalogue tells you how to do it. Address **EMPIRE MFG. CO., Quincy, Ill.**

LAWNS, PARKS, CEMETERIES

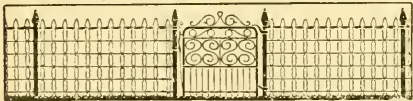

and all enclosures are both protected and beautified by using this **HARTMAN STEEL ROD LAWN FENCE.** Strong, serviceable and lasts indefinitely. Catalogue mailed free. **HARTMAN M'FG CO., BOX 86, ELLWOOD CITY, PA.** Or Room 40, 309 Broadway, New York City.

Maple Sugar and Syrup.

We are again prepared to furnish choice Medina County maple sugar and syrup. Do not fail to get our prices. It is too early to name prices at this writing, but we will quote by letter on application.

THE A. I. ROOT CO., Medina, O.

FOR SALE—Apiary in Arkansas Valley, Colo.—175 colonies, Baldwin 2-st ry hives, comb honey. Address **Oliver Foster Las Animas, Bent Co., Colo.**

FOR SALE—Some fine comb and extracted honey. Comb in 3 3/8x5 and 4x5 sections; extracted in 60-lb. cans. All fine Spanish needle. **L. WERNER, Box 387, Edwardsville, Ill.**

Popular Books at Popular Prices.

- Black Rock.** By Ralph Connor; 50,000 sold; authorized edition; formerly 50c; my price 25c—by mail, postpaid, 35c.
- An English Woman's Love Letters.** Authorized edition, 25c; by mail, 32c.
- Elizabeth and Her German Garden.** 25c; by mail 32c.
- Eben Holden, Alice of Olo Vincennes To Have and to Hold, Master Christian,** and other regular \$1 50 books, \$1.10 each; by mail, \$1.24
- Walks and Talks in the Geological Field.** By Alexander Winchell; revised edition for Chautauqua Circle; paper, print, and binding the best; 853 pages; regular price \$1.10; limited supply at 35c; mail 39c. Five other Chautauqua books, same quality, same price (35c, or 49c post-paid) while present stock lasts—only a few copies of some titles. List for asking.
- Your Money Back** if you return at once any unsatisfactory book bought of me.
- Reference.** The A. I. Root Co. (for whom I worked 10 years). Books inclosed with shipments from them if desired.

M. T. WRIGHT, Medina, Ohio.

LONE STAR APIARIES

C. F. Davidson & Sons, Props.

Breeders of fine Italian queens. Established in 1885. Write for Circular.

C. F. Davidson & Sons, Fairview, Texas.

SPRAYING FRUIT-TREES.

The question of spraying fruit-trees to prevent the depredations of insect pests and fungus diseases is no longer an experiment but a necessity.

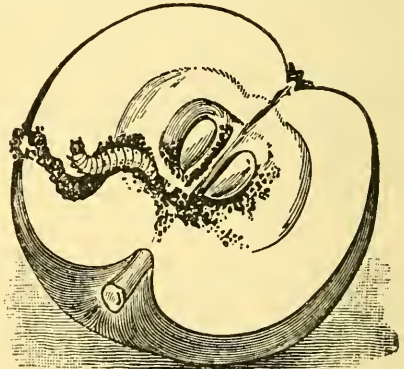

Our readers will do well to write Wm. Stanl. Quincy, Ill., and get his catalog describing twenty-one styles of Spraying Outfits and full treatise on spraying the different fruit and vegetable crops, which contains much valuable information, and may be had for the asking.

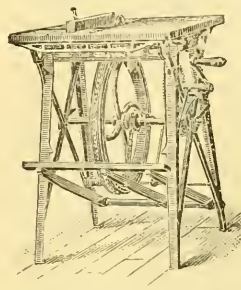

Barnes' Hand and Foot Power Machinery.

This cut represents our combined circular saw, which is made for beekeepers' use in the construction of their hives, sections, boxes, etc. **Machines on trial.** Send for illustrated catalogue and prices.

W. F. & John Barnes Co., 545 Ruby St., Rockford, Ill.

WANTED.—a healthy sober young man in large apiary. Address **JOHN NIPPERT, P. O. Box 1051, Phoenix, Arizona.**

Wants and Exchange.

Notices will be inserted under this head at 10c per line. You must say you want your ad. in this department, or we will not be responsible for any error. You can have the notice as many lines as you please; but all over ten lines will cost you according to our regular rates. We cannot be responsible for dissatisfaction arising from these "swaps."

WANTED.—A competent man to take charge of four or five hundred colonies. To the right man a good proposition will be made. Write, stating amount of experience, age, etc.
I. A. KING, Almond, San Diego Co., Cal.

WANTED.—Two or three apiaries for cash; located in Colorado; write full particulars; first letters and lowest cash price; comb honey preferred.
THOS. C. STANLEY & SON, Fairfield, Ill.

WANTED.—A refined girl or widow woman, a house-keeper in small family, one interested in bee-keeping preferred. Address
ELIAS FOX, Hillshoro, Wis.

WANTED.—A number of good strong colonies of Italian bees with good quantity of stores and young queens, in healthy condition, for spring delivery. Hoffman frames in 8 or 10 frame L, or Danz, hives preferred. W. HAHMAN, box 3, Altoona, Pa.

WANTED.—To exchange 50,000 No. 1 polished sections, for beeswax.
W. H. NORTON, Skowhegan, Me.

WANTED.—Extracted honey, onions, cabbage; cash or trade.
G. ROUTHANN Menallen, Pa.

WANTED.—By a practical bee keeper, an apiary to rent, or will work for salary. Must not be farther east than Colorado.
VIRGIL SIREN, North Yakima, Washington.

WANTED.—To exchange bicycles and tandems, gasoline engines (new and 2d hand), 1 to 20 horsepower), for wood and metal working machinery of all kinds.
ROBERT B. GEDYE, LaSalle, Ill.

WANTED.—400 2d-hand 5 gallon cans, crated 2 in a case—cans used but once preferred—for extracted honey. E. D. TOWNSEND, Hubbardston, Mich.

WANTED.—To exchange two No. 5 Novice honey-extractors, good as new, for bees.
E. W. BROWN, Box 102, Morton Park, Cook Co., Ill.

WANTED.—A good farm-hand of good moral character; a good position for the right man. No one using tobacco or profane language need apply. State age and wages expected. Address
P. E. TWINING, Kipton, Lorain Co., Ohio.

WANTED.—A young man of several years' experience to help care for six apiaries the coming season. Give reference, habits, and salary expected.
R. T. SINNETT, Mesilla Park, New Mexico.

WANTED.—To buy some blue-thistle seed.
WELCH WILBUR, Helena, S. C.

WANTED.—A renter for 60 colonies of bees, or will sell the whole to some good man. I can not attend to them as they should be. I have a neighbor who has 40 colonies who also wants to let out on shares. He is only three miles from me. Single man preferred.
R. J. MATHEWS Rosedale, Miss.

WANTED.—Man of 45 (mechanic); no bad habits; experienced in fruit and vegetable growing, also bee-keeping; handy with poultry, wants a situation; shares or otherwise, or to manage apiary with privilege to buy and do work for part pay.
BEE KEEPER, 925 W. California Ave., Chicago, Ill.

WANTED.—A good sober, orderly bee-man; one who understands queen rearing thoroughly and general work in the apiary, and healthy. I should wish him free from tobacco habit, as tobacco and its effects nauseate. Wish him to commence work at once.
M. H. MENDLESON, Ventura, Cal.

WANTED.—A position with a bee keeper in the Middle States; one who has some other side issue. I have manipulated bees for 12 years, and can take full charge of 100 colonies.
JOHN F. DIAMOND, Fly Mountain, N. Y.

\$18 Guaranteed for 10 Years.
Frgt. Prepaid and Money
Back if not Satisfactory.

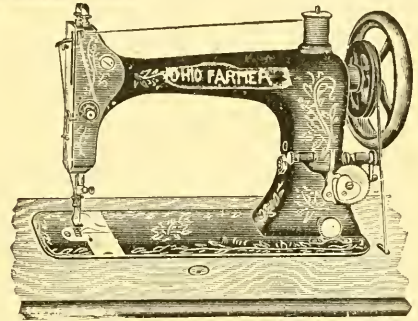

Send us \$18.00 and we will send you one of our NEW IMPROVED OHIO FARMER HIGH-ARM SEWING-MACHINES, freight prepaid. Use it for all kinds of work, and if not satisfactory you can return it in 90 days and we will refund your money and pay freight both ways.

All Guaranteed New Machines.

Self-setting needle; automatic bobbin-winder, with oak or walnut woodwork; new bent wood top; seven long skeleton drawers. Full and complete set of attachments and illustrated instruction book sent with each machine. Every machine we send out guaranteed to give ENTIRE SATISFACTION OR MONEY REFUNDED. We can furnish repairs or needles at any time. Remit by postoffice order, registered letter, New York draft, or express.

If you want the BEST sewing-machine made in the world at the LOWEST PRICE ever offered, send us your order.

Drop Head, \$20.00.

This is the same machine, except the cabinet, which is made so that head drops out of sight when not in use. Four drawers. Freight prepaid. With same attachments as the \$18.00 machine.

Our No. 2 Machines.

Have old-style top tension instead of the new side tension furnished on the others. Not quite as much work on them as the others, which accounts for the lower price; but we guarantee them for the same time, furnish same attachments, and prepay freight.

High Arm No. 2, 5 Drawers, Only \$15.00.
Drop Head No. 2, 4 Drawers, Only \$16.50.

Send for our new illustrated catalog. Address

The Ohio Farmer, : : : Cleveland, Ohio

NOTE.—We have known the publishers of the Ohio Farmer for many years. They are entirely responsible, and will fully make good their agreements.
THE A. I. ROOT COMPANY.

The Modern Farmer and Busy Bee.

Emerson Taylor Abbott, Editor.

A live, up-to-date Farm Journal with a General Farm Department, Dairy, Horticulture, Live-stock, Poultry, Bees, Home and General News. The Editor has had practical experience in every department of farm work. To introduce the paper, it will be sent to New subscribers one year for 25c. Sample copies free. Best Advertising Medium in the Central West. Clubbed with *Gleanings* for \$1.00.

ADDRESS

Modern Farmer, St. Joseph, Mo.

Union Combination Saw

For Riping, Cross-cutting, Rabbeting, Mitering, Grooving, Gaining, Boring, Scroll-sawing, Edge-moulding, Beading. Full line FOOT and HAND POWER machinery. Send for catalog A. SENECA FALLS MFG. CO., 44 Water St., Seneca Fd., N. Y.

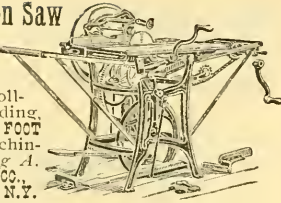

AT ANY TIME--

summer time or winter time, the **BEST POWER** for all purposes on the farm, in the dairy, creamery or cheese factory, is a

LEFFEL ENGINE.

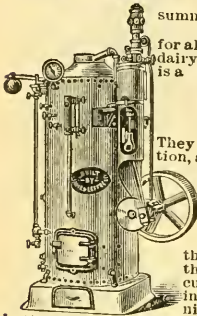

They are very simple in construction, and easy to run and keep in order. Are very economic of fuel, are easy steamers and great power developers. They are made both horizontal and upright with engine mounted on boiler. Everything is made of best material throughout. They are ideal for cutting and grinding feed, sawing wood, pumping water, running cream separators, churns, butter workers, etc. Send stamp for Book on Power. **JAMES LEFFEL & CO., Box 89, Springfield, O.**

\$29.25



Don't Pay a Cent

of profit to agent or dealer when you can with equal safety, satisfaction and guarantee buy direct from manufacturers and save by the cost. Our Vehicles are built for hard wear. Best materials throughout. New styles, Approved Workmanship. Unqualified guarantee. \$29.25 and upwards. Our Harness and Saddles comprise a complete line of standard work \$4.25 upwards. In no event place your order without writing for our Free Catalogue containing valuable suggestions to the vehicle & harness buyer. **CASH BUYERS' UNION, (Inc.)** 158 W. Van Buren St., B-345, Chicago, Ills.

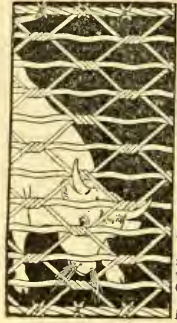

BULL-STRONG!

....PIG-TIGHT....

An Illinois farmer said that after harvest he had fully 200 bushels of loose oats on the ground that he could not secure any benefit from, because the fence around the field would not turn hogs. Figure the loss for yourself. He also said, all this would have been saved if he had used the Kitzelman Woven Wire **Coiled Spring Fence**, and the value would have gone a long way towards paying cost of the fence. With the **Duplex Machine** any farmer can make it himself at the actual cost of the wire. Catalogue free for the asking. **KITZELMAN BROS.** Box D31. Muncie, Ind.

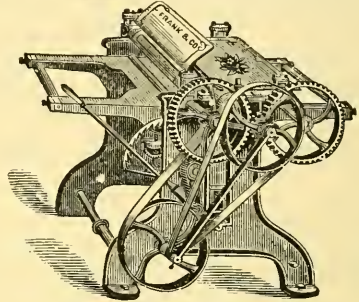

PLANERS

The above cut shows one of our small Planers, of which we make twelve different styles and sizes. Also large Planers, Band Saws, Buzz Planers, Moulders, Wood Lathes, and all kinds of

WOOD WORKING MACHINERY

Send for Catalogue.

The FRANK MACHINERY CO.
BUFFALO, N. Y.

New Smith Premiers Nos. 5 and 6.

The No. 6 takes paper 18½ inches wide and writes lines 16 inches long. The No. 5 takes paper 11 inches wide and writes lines 9½ inches long. These new machines in essential mechanical principles are the same as Models Nos. 2, 3 and 4—unequaled.

Write for Printed Matter Free.

The Smith Premier Typewriter Co.

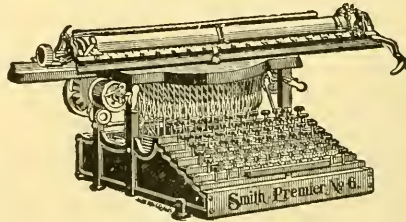

158 Prospect Street, Cleveland, Ohio.

ROUGH RIDER, SEN. DUNLAP, and other CUMBERLAND RASPBERRY, KING OF MICHIGAN POTATO.

STRAWBERRIES
100 Varieties.

HEADQUARTERS FOR HIGH GRADE **Plants and Seed Potatoes.**

Descriptive Catalogue Free to All.

FLANSBURGH & PEIRSON, Leslie, Mich.

In writing advertisers please mention Gleanings.

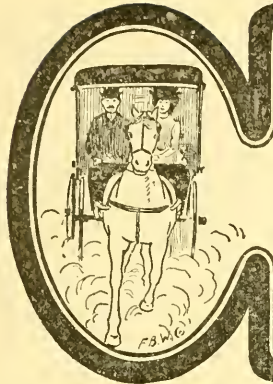

THE BEST BUGGY THAT COMES DOWN THE PIKE

When you buy a vehicle you want one that you can be proud of. At the same time you want to buy it at a reasonable price. The famous

Split Hickory Vehicles

are sold to you direct from the factory, at a saving of 1/3 of the price charged by dealers or agents. Moreover, the Split Hickory Buggies and Carriages are built right in every particular. Every little detail is correct. There are dozens of special features about them, which add to their beauty, comfort, safety and durability—features found on no other make. Test yourself on quality as well as prices. Send for our free illustrated book on vehicles—it puts in black and white things you ought to know. We can save you money on harness, too. We ship on approval and guarantee satisfaction. Don't keep it if you don't like it.

OHIO CARRIAGE MANUFACTURING CO., 27 West Broad St., Columbus, Ohio.

No 707—Extension Top Surrey, with double fenders. Complete with side curtains, aprons, lamps and poles or shafts. Price, \$40. As good as sells for \$40 more. selection in the country as we make 178 styles of vehicles and 63 styles of harness. Catalogue free.

Your Whole Family Would Be Satisfied

with one of these surreys. They are handsome, strong, stylish, easy riding and durable. Selling on our plan you can examine it thoroughly before you are required to buy it.

WE HAVE NO AGENTS but sell all goods direct from our factory to the purchaser at wholesale prices. We are the largest manufacturers of vehicles and harness in the world selling to the consumer exclusively. We have pursued this plan successfully for 23 years. You assume no risk as we ship our goods anywhere for examination and guarantee safe arrival. Largest and best styles of harness. Catalogue free.

ELKHART CARRIAGE AND HARNESS MANUFACTURING CO., ELKHART, INDIANA.

No. 180—Double Buggy Harness, with nickel trimmings. Price complete with collars and hitch straps, \$22. As good as sells for \$30.

You get the Profits

Under our plan of selling carriages, buggies and harness, you get the profits. The jobber and retailer are cut out. By dealing direct with our factory, you pay only the cost of making with a moderate profit added; and you take your choice from the biggest stock and fullest assortment. Our plan of

Selling Carriages Direct

insures satisfaction — your money back if you are dissatisfied. Our complete illustrated catalogue, showing many styles of high grade vehicles, harness robes, blankets and horse equipments, with detailed descriptions of each, mailed free.

THE COLUMBUS CARRIAGE and HARNESS CO., P. O. Box 772, Columbus, O.

**No. 240
Single Strap
Buggy Harness
Price \$7.95**

No. 3034, Price \$38.30
with leather quarter top.

NOTHING CAN COMPARE WITH IT.

When it comes to an all-round handy and useful garden tool, nothing compares with this "Planet Jr." No. 25 Hill and Drill Seeder and Double Wheel Hoe, Cultivator and Plow. It is made to fit the man who has a good sized garden, yet not quite enough to justify owning a separate wheel hoe. As a drill it does all our famous "Planet Jr." No. 4 does. As a wheel hoe it is identical with our "Planet Jr." No. 12. Has 11 1/2 in. wheels, cultivates between the rows, or on each side of the row, throws dirt to or from the row, hills up, plows, marks out, etc. Easily and quickly changed from one to the other. We give this tool the strongest possible recommendation.

You should have one of the 350,000 copies of our new 1901 catalogue. It is better than ever. Tells all about our full line of Seed Drills, Wheel Hoes, Cultivators, Harrows, Two Horse Cultivators, Sugar Beet Seeders and Cultivators, and our reduced prices for 1901. Illustrates by photographic views how they are used at home and in foreign countries. Mailed free.

S. L. Allen & Co., Box 710-H, Philadelphia, Pa.
Two Gold Medals at Paris Exposition; Highest Award

FARM NOVELTIES

Do You Want to Try

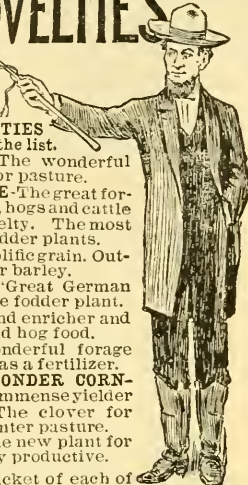

the best NEW VARIETIES of Farm Seeds! Read the list.
BROMUS INERMIS-The wonderful new grass for hay or pasture.
DWARF ESSEX RAPE-The great forage plant for sheep, hogs and cattle.
ENCILARIA-A novelty. The most productive of all fodder plants.
SPILTZ-The new prolific grain. Out-yields wheat, rye or barley.
SOJA BEANS-The "Great German Coffee Berry." A fine fodder plant.
COW PEAS-Great land enricher and productive cattle and hog food.
SAND VETCH-A wonderful forage plant and valuable as a fertilizer.
NEW CENTURY WONDER CORN-Stools like wheat. Immense yielder.
GIANT SPURRY-"The clover for sandy land," for winter pasture.
ZEA-A most valuable new plant for feeding green. Very productive.

A good sized trial packet of each of the above 10 varieties and a circular describing them and telling how to grow, cure and feed, sent postpaid for only 12 cents. Large, 100 page, beautifully illustrated catalogue FREE, if you mention this paper, no matter whether you order above seeds or not. We refer by permission to the editor of this paper. Established 30 years.

IOWA SEED CO., DES MOINES, IOWA.

SEED DUE BILL FREE

To get new customers to test my Seeds, I will mail my 1901 catalogue, filled with more Bargains than ever and a 10c Due Bill good for 10c worth of seeds for trial absolutely free. All the best Seeds, Bulbs, Plants, Roses, Farm Seeds, Potatoes and many Novelties at lowest prices. Ginseng, the great money making plant, Giant Prize Tomatoes, 2 to the foot, Pan American Oats, sent on free to farmers, and two Free Passes to Pan American Exposition, Buffalo, N. Y. are offered. \$2,635 00 in cash premiums. Don't give your order until you see this new catalogue. You'll be Surprised at my bargain offers. Send posts for catalogue today. It is FREE to all. Tell your friends to send too.
 F. B. MILLS, Box 105, Roachville, Onondaga Co., N. Y.



EVERGREENS

Hardy sorts. Nursery grown for wind-breaks, ornaments and hedges. Priced \$1 to \$10 per 100-50 Great Bargains to select from. Write at once for free Catalogue and Bargain Sheet. Local Agents wanted.
 D. Hill, Evergreen Specialist, Dundee, Ill.



SPECIAL offer, only 10c

25 EVERBLOOMING BULBS

Grand assorted colors. No flower is more easily grown. Come into flower quickly after planting and remain in bloom throughout the season, producing a perfect blaze of highly colored blossoms.

The above GRAND ASSORTMENT together with my New Instructive Seed and Plant Book, which tells all about THE BEST varieties of seeds and plants.

Send 10 cents for mailing.
H. W. BUCKBEE,
 Rockford Seed Farms.
 Box 614,
 ROCKFORD, ILLS.

HAMMOND'S
 Michigan Northern-Grown Onion Seed.
 I sold 56,000 lbs. of this seed in 1899. My customers report yields of 450 to 1,205 bushels of onions per acre from this seed. Some of them intimate that this seed is worth \$2 to \$4 per lb. more than the California grown seed sold by anybody. I guarantee this seed to be new and freshly grown. We have seed of all the leading and standard varieties. We make special prices on large lots. Onion sets of all varieties. Buy direct from the grower. Catalogue extended and illustrated—free.
HARRY N. HAMMOND SEED CO.
 Box 69, Bay City, Mich.
 Formerly of E. Field.

Ferry's SEEDS

Ferry's Seeds are known the country over as the most reliable Seeds that can be bought. Don't save a nickel on cheap seeds and lose a dollar on the harvest.

1901 Seed Annual free.
D. M. FERRY & CO.,
 Detroit, Mich.

BIG APPLES
 WE OFFER TRUE TO NAME.
 375,000 Apple, Standard and Dwarf Pear, Cherry and Plum Trees.
 Japan Plums a Specialty.
 Save half your money by buying direct of the producer. Let us price your list of wants. Send for our free catalogue of fruit or ornamental trees, also copy of Green's Fruit Grower.
 Green's Nursery Co., Rochester, N. Y.
 For 19c, we will mail two plants of our Red Cross Currant.

OUR CATALOG of varieties and prices of Small-fruit Plants, Dahlia Bulbs, S. C. W. and B. Leghorns, B. P. Rocks Berry Crates and Baskets, ready Feb. 1. Send for it before ordering.
H. H. AULTFATHER, Minerva, Ohio.

FOR SALE.—Wonderful, Black Cow, and Ram's Horn, or Big Black Eye cow peas and soja beans, 20 cts per qt.; \$1.25 per bu. by express, except Ram's Horn, which are \$2.25 per bu., not prepaid. Address
E. R. MILLER, Hearing, Norfolk Co., Va.



The Popular CAROLINA POPLAR.

Just the tree for city planting—Thrives where others fail—Resists smoke and gas as the salamander fire. No tree furnishes quicker shade; 75,000 of them, beautiful trees, 6 to 8, 8 to 10, 10 to 12 and 12 to 15 feet. Immense stock of all other Shade Trees, Shrubs and Roses. Hundreds of thousands of Fruit Trees, Small Fruits, Grape Vines, Plants, Seeds. Valuable Catalogue free. Correspondence solicited. Write us your wants if you would procure the best at bottom prices. 47 YEARS. 44 GREENHOUSES. 1000 ACRES.

THE STORRS & HARRISON CO., Box 225, Painesville, Ohio.

BURPEE'S FARM ANNUAL FOR 1901

"QUARTER-CENTURY EDITION"

A Grand New Book of two hundred and twenty pages. Entirely rewritten at our famous FORDHOOK FARMS—the largest Trial Grounds in America. New Directions for culture, New Leaflets, New Novelties of unusual merit in both Vegetables and Flowers, Elegant New Colored Plates. The Quarter-Century's Record of Progress, New Cash Prizes, and other New Features. The largest, most complete, and BEST SEED CATALOGUE ever published. Mailed for ten cents, which is less than cost per copy. Name this paper, send ten cents (silver or stamps) and with this great catalogue we shall send a 15-cent packet of either Burbank's Unique Floral Novelty or Burpee's wonderful, new, dwarf, meaty, bright-red, earliest Tomato,—"Quarter-Century."

Should you object to paying ten cents for a seed catalogue (even though it is worth a dollar), then write a postal card for Burpee's "SEED-SENSE" for 1901,—a "strictly business" catalogue of ninety pages.

W. ATLEE BURPEE & CO., PHILADELPHIA, PA.



BIG STRAWBERRY GIVEN AWAY.

We will mail you six plants of Corsican, biggest strawberry on earth, if you will send us 15c. for one new subscription to

GREEN'S FRUIT GROWER and Home Companion for six months. Established twenty years ago. It has 60,000 subscribers who say it's the best family fruit journal in America. Send for free sample copy.

Green's Fruit Grower, Rochester, N. Y.

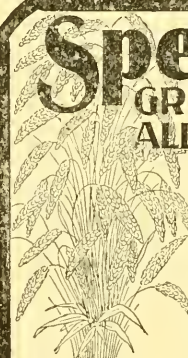

Speltz

GREATEST OF ALL CEREALS

Speltz started the Famine World in 1900; it will capture every heart in 1901, with its \$9 bu. of grain and 4 tons of hay, equal to Timothy, per acre. Get the genuine, buy of Salzer, the introducer.

Combination Corn is one of the greatest things of the century. It is early and an enormously, fabulously big yielder, a sort bound to revolutionize corn growing.

Salzer's Vegetable Seeds. The beauty about Salzer's vegetable seed is, that they never fail. They sprout, grow and produce. They are of such high vitality they burch at droughts, rains and the elements, taking 1st prizes everywhere. We warrant this.

For 14 Cents and This Notice we send 7 packages of rare, choice, fine, splendid vegetable novelties and 3 packages of brilliantly beautiful flower seeds, all worth \$1, and our big catalog for only 14c and this Notice, in order to gain 250,000 new customers in 1901, or for 10c, 10 rare farm seed samples, fully worth \$10.00 to get a start and our great catalogue.

JOHN A. SALZER SEED CO., LA GROSSE, WIS.

Maule's (35 new things for 1901) Seed Catalogue

You should, by all means, have this most modern catalogue of modern times. It is brimful and overflowing with good things in vegetable, farm and flower seeds, flowering plants, fruits, bulbs, etc. It contains 35 novelties in vegetables and flowers never offered before, has 136 large pages, seven handsome colored plates and hundreds of illustrations. It gives practical, up-to-date cultural directions and offers many cash prizes. The first edition alone costs over \$30,000, so while we send it free to all customers, we must ask others to send 10 cents for it, which amount they may deduct from their first order. You will make a mistake if you do not write to-day for this the Novelty Seed Book of the year. Address,

WM. HENRY MAULE, Philadelphia.

American Gardening

10 Sample Copies, separate issues, 10 cents. Published at 136 Liberty Street, New York.

For Sale. A fruit and sugar-beet farm, 24½ acres, six acres fruit, six-roomed brick house, 60 rods from central school, postoffice, and store; 3½ miles from Springville. Located in center of large alfalfa district. For further particulars, address W. A. WARTHEN, Springville, Utah.

Mr. A. I. Root's Writings

of Grand Traverse territory and Leelanau County are descriptive of Michigan's most beautiful section reached most conveniently via the

Pere Marquette R. R.

For particulars address W. C. Tousey, D. P. A., Toledo, Ohio.

Career and Character of Abraham Lincoln.

An address by Joseph Choate, Ambassador to Great Britain, on the career and character of Abraham Lincoln—his early life—his early struggles with the world—his character as developed in the later years of his life and his administration, which placed his name so high on the world's roll of honor and fame, has been published by the Chicago, Milwaukee & St. Paul Railway, and may be had by sending six (6) cents in postage to F. A. Miller, General Passenger Agent, Chicago, Ill.



"Electric"
applied to either
Wheels or Wagons
is a guarantee of excellence. The public knows this fact. In 4 years we sold 320,000 Electric Steel Wheels and 20,000 Electric Handy Wags. We make wheels to fit any wagon. Illustrated Catalog F. E. Electric Wheel Co., Box 95, Quincy, Ills.



SPRAYING

with our new patent
KEROSENE SPRAYERS
is simple indeed. Kerosene Emulsion made while pumping. 12 varieties sprayers, Bordeaux and Vermorel Nozzles, the World's Best.
THE DEMING CO. Salem, O.
Western Agents, Henion & Hubbell, Chicago. Catalog, formulas free.

SEND NO MONEY—but

order any of our Sewing Machines sent C. O. D., on 30 days' trial. If you don't find them superior to any other offered at the same or higher prices or are dissatisfied for any reason, return them at our expense and we refund your money and freight charges. For \$14.50 we can sell you a better machine than those advertised elsewhere at higher price, but we would rather sell you better Quality and Give Satisfaction. Our elegant Arlington Jewel drop head, \$12.50. Our No. 9 Ball Bearing Arlington, 5 drawer, drop head, \$15.45. Write for large illustrated catalogue **FREE. CASH BUYERS' UNION** (Inc.), 158-164 W. Van Buren St., B-345, Chicago



BIG CUT IN DRUGS

Direct to Consumers.

Our Hand-some Catalog Free, costing over \$2 each, contains 144 pages, with 1500 illustrations and 15,000 articles listed, on which we guarantee to save you from 15 to 75%. Most complete book of its kind. Sent for 10c to pay cost of mailing, which will be refunded with first order. Valuable book of reference and ought to be in every household. Get it; keep it handy.
Heller Chemical Co., Dept 49, Chicago.
"The Only Mail Order Drug House in the World."

Angora Goats. Handsome pets; profitable stock. FDW. W. COLE & CO., Kenton, Ohio.

1200 FERRETS. All sizes; some trained; first-class stock. New price list free. N. A. Knapp, Rochester, Lorain Co., Ohio.

All This Nice Printing only \$1.	100 sheets paper, ruled,	LITHO PRINT, Box 5, Swarthmore, Penn.
	100 envelopes, No. 6,	
	100 neat cards,	
	SENT POSTPAID BY EARLY MAIL.	E. L. Pratt.

HENS EAT BUGS.



because they need animal food. Feed cut bone and get eggs when eggs are eggs. The **HUMPHREY Green Bone and Vegetable CUTTER** is guaranteed to cut more bone in less time and with less labor than any other cutter made. Get your money back if not perfectly satisfied. It's a rapid vegetable cutter, too. Send for handsome catalog containing egg record blanks for a whole year. Every poultry keeper should get it. It's free.
Humphrey & Sons, Box 51, Joliet, Ills.

HEN'S EGGS are worth more than twice as much in winter as in summer. You can have plenty of eggs all winter if you feed **Green Cut Bone**. To prepare it nothing equals the **GREEN BONE ADAM CUTTER**. It's the only bone cutter made with ball bearings. This makes it run easier than any other. Cuts hard and soft bone without choking. Easy to keep clean for it cleans itself. Made for hand and power. Send for free catalogue No. 59 **W. J. ADAM, Joliet, Ill.**

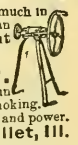

THE BEST EGG FOOD for laying hens is **Green Cut Bone**. Nothing equals **MANN'S NEW BONE CUTTERS** for preparing bone. Cut fast, fine and turn easy. Mann's Clover Cutter cuts clover the best and fastest. Swinging Feed Trays, Granite Crystal Grit, &c. Illustrated catalogue free. **F. W. MANN CO., Box 37, Milford, Mass.**



COMMERCIAL POULTRY

is a semi-monthly journal, telling how to raise and market poultry so as to make the most money. 50 cents a year, including valuable premium. Trial 4 times 10c., stamps or silver. Sample copy free. We want agents for publications and novelties.
DRAPER PUB. & SUPPLY CO., Chicago, Ill.



GREIDER'S POULTRY

always do well. 50 standard varieties. Handsomest poultry book of the season for 8c. stamps. Full of money-making hints. My birds are winners.
B. H. GREIDER, Florin, Pa.

EGGS \$1.00 for 15 best Brown Leghorn or B. P. Rocks. Illustrated descriptive egg-circular free. H. B. GEER, Nashville, Tenn.

S. C. BROWN LEGHORNS. I use well-striped breeding cocks. Eggs, \$1.00. Cockerels, \$1.00 and up. Also Italian bees. Circular free. H. M. MOYER, Shanesville, Pa.

POULTRY-BOOK FREE. 64 pages, illust'd, with subscription to our paper, 10 cts. Inland Poultry Journal, Indianapolis, Ind.

A BASKET FULL OF EGGS by using Ley's Poultry Condition Powders. Puts all fowls in a normal condition; destroys all disease germs; purifies the blood; is a tonic and nutrient. Price 25 cts. a pk.; 5 for \$1.00. Ley's Thoroughbred Minorca's Eggs, \$1.00 for 13. Also Thoroughbred Belgian Hares. **Geo. J. Ley, Florence, Cal.**

CRUSHED OYSTER SHELLS for poultry; 100 lbs., 60 cts.; 200 lbs., \$1.00. **WISE & CO.,** Wholesale Grocers, Butler, Ohio.

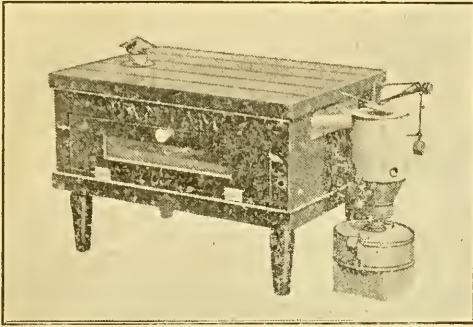

BIDDIES & BEES. MAKE THEM BOTH PAY.

50-egg Bantam. Self-regulating.

Holds 50 ordinary - size eggs.
No sitting up nights. 20 minutes' attention in twenty-four hours will operate it. Sold on

30 Days' Trial for \$5.00

Over 15 000 in use, and thousands hatching 50 chicks from 50 eggs. You can do as well. Either hot-water or hot-air heating. We have a brooder to go with it for \$3.00. Our catalog of valuable information, and describing incubators and brooders of all sizes and prices—all on trial—sent for the asking if you mention this paper.

Buckeye Incubator Co., Springfield, Ohio



"Profitable Poultry Keeping

IN ALL ITS BRANCHES." This is the title and theme of our new Year Book. Contains 192 pages, 8x11 in.; 200 new and original illustrations of best poultry farms, buildings, etc. in the country. Deals with every phase of the poultry industry in an instructive and profit bringing way. Treats also of the famous non-moisture, self-ventilating and regulating **CYPHERS INCUBATORS**, hatch any other in three or more tests or money refunded. Sent for 10c in stamps. Ask for book 74 Circular and prices free. Address nearest office. **CYPHERS INCUBATOR CO.**, Chicago, Wayland, N. Y., Boston, Mass.



INVESTIGATE BEFORE YOU BUY.

We want our customers to be perfectly satisfied before they spend the money. Investigate the claims of all incubators and then decide. We believe you will find that the

SURE HATCH INCUBATORS

AND COMMON SENSE FOLDING BROODERS are giving better satisfaction than any other made. It's because they are so simple, sensible and sure. They are built for busy people, who haven't time to fuss and bother. Our catalogue is FREE. We can't ask you to pay for it. Isn't it worth examining?

SURE HATCH INCUBATOR COMPANY, CLAY CENTER, NEBRASKA.



A PRACTICAL POULTRY BOOK

One which covers every detail of the industry from incubation to market is our **20th CENTURY CATALOGUE**. It will teach you from the practical experience of others what it would take you ten years to learn. Among other things it tells about the latest improvements in the world famous **Reliable Incubators and Brooders**. Sent for 10c to pay postage. **Reliable Inc. & Brdr. Co. Box B - 49 Quincy, Ill.**



INCUBATOR ON TRIAL

The Perfected Von Culin.

Successful result of 25 years' experience. Scientifically correct, practically perfect. Non-explosive metal lamps. Double and packed walls. Perfect regulation of heat and ventilation. Made of best materials, and highest quality of workmanship and finish.

PRICES \$7.00 AND UP.

SATISFACTION GUARANTEED OR NO PAY. We make Brooders, Bee Hives & Supplies. Catalog and Price List sent Free.

THE W. T. FALCONER MFG. CO.,
Dept. 73. **Jamestown, N. Y.**



Our Incubators

have all the latest improvements, are sold at very low prices and guaranteed to please every customer. Send 6 cents for our 154 page catalogue, which contains full descriptions of our extensive line and tells how to raise poultry successfully. Plans for poultry and brooder houses.

Des Moines Incubator Co., Box 503, Des Moines, Ia.

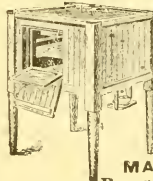

MARILLA.

That's the name which means highest excellence in Incubators and Brooders—the most perfect regulation of temperature and moisture. Hot air or hot water. Send 2c for catalogue and guarantee. Your money back if you are not satisfied.

MARILLA INCUBATOR CO.,
Box 62, **Rose Hill, N. Y.**

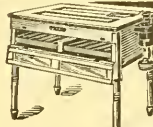

200-Egg Incubator for \$12.00

Perfect in construction and action. Hatches every fertile egg. Write for catalogue to-day. **GEO. H. STAHL, Quincy, Ill.**

Wake up Bee-Keepers,

To the Changed Conditions.

I have many times advised my readers to keep more bees. We are often asked what will mix the most successfully with bee-keeping, and I have replied, and still say, "a few more bees." In my eastern trip I met quite a number of men who are making money keeping bees—not simply making a living, but laying up money. All of these men, with no exception, keep bees in large numbers, scattering them around the country—perhaps 100 colonies in a place. It isn't profitable to put only a few in a place—there must be enough in each yard to make a day's work when the apiary is visited.

Mr. H. L. McLallen, a former pupil of Mr. W. L. Coggshall, but now the owner of several hundred colonies, made a very bright remark at the Romulus institute. He said: "We can't produce so much honey per colony as we did years ago, but we can make more money. The reason is that we can keep more bees with less labor." The reason of the lessened yield per colony is the cutting off of natural resources, such as clover and bass-wood, but the improved methods that enable us to manage a greater number of colonies, the short cuts, if we will only recognize and practice them, really gives us advantages over our predecessors. It is in the discovery and practice of short cuts that we must look for our financial salvation. A great many processes that may be employed at a profit in a home apiary, are totally out of place in an out-apiary. The swarming problem, for instance, must be solved by a different process in an out-yard. The honey-extractor is the most satisfactory solution. Give the bees plenty of empty comb in which to store honey, and swarming is practically ended. Years ago extracted honey was of slow sale at a low price, but its use by bakers and other manufacturers has placed the demand upon a firm basis, and, at present, I know of no more hopeful field for the apiarist than the production of extracted honey on a large scale.

Keep a lot of bees, scatter them around the country, and don't use up all your profits in useless manipulations. I wish to see bee-keepers prosperous, and I believe I have never given them better advice than I am giving them now. Let me repeat it: Keep hundreds of colonies, scatter them around the country, 100 in a place, produce extracted honey, study short cuts as though your life depended upon it. Personally, let me ask you to give this matter your careful, serious thought. Not only this, but write to me on this subject. Especially would I like to hear from men who have had experience along these lines. Men who have made but an indifferent success with only one apiary, but have made money with several apiaries, or those who have tried running several apiaries and failed, if there are any such, could tell an interesting and instructive story. Let me hear from you. Those who have had experience with both few and many bees are especially invited to write. If I have drawn any incorrect conclusions, or omitted any important factors, I shall be glad to have these defects pointed out. For the best article on this subject, received before March 1st, I will pay \$5.00. For any article that I think well enough of to use, but to which the first prize is not awarded, I will send the writer the REVIEW one year and a queen of the Superior Stock. The establishing and managing of out apiaries might, very properly, form the latter part of the article.—*Editorial in January Review.*

Remember that the REVIEW is \$1.00 a year, but I send 12 back numbers free of charge. For \$2.00 I send the back numbers, the REVIEW for 1901, and a queen of the Superior Stock.

W. Z. Hutchinson, Flint, Mich.

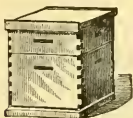

BEE-HIVES AND HONEY-BOXES,

in car lots—wholesale or retail. Now is the time to get prices. We are the people who manufacture strictly first-class goods and sell them at prices that defy competition. Write us today.

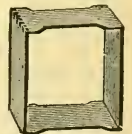

Interstate Box & Manufacturing Co., Hudson, Wis.

Marshfield Manufacturing Company.

Our specialty is making SECTIONS, and they are the best in the market. Wisconsin basswood is the right kind for them. We have a full line of BEE-SUPPLIES. Write for FREE illustrated catalog and price list.

Marshfield Manufacturing Company, Marshfield, Wisconsin.

1881

PAGE & LYON MFG. CO.

1900

We manufacture a full line of the latest BEE-SUPPLIES.

Our motto is, "Perfect Goods and Prompt Shipment."

Send for our new free illustrated catalog.

PAGE & LYON MFG. CO., New London, Wisconsin.

Improved Ohio Farmer REPAIR OUTFIT.

Our Price Only \$1.65.

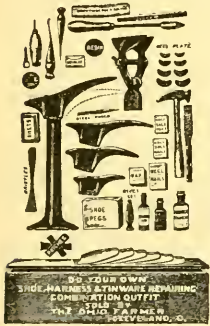

We have examined samples from all manufacturers, and believe this is the very best repair outfit on the market; easily worth \$1 more than those offered by stores and other papers. It contains 48 articles, all full size and first class, and we guarantee satisfaction or will refund money. Half-sole alone are worth 50c, and are not included in other outfits. It will soon pay for itself in repairing boots, shoes, rubbers, harness, and tinware.

Repair Outfit with Ohio Farmer one year for only \$2.15, or the Complete Outfit free for a club of 10 subscriptions to the Ohio Farmer. By freight.

Send for our illustrated premium list, giving wholesale prices on watches, sewing-machines, knives, and lots of other useful articles. Mention this paper.

The Ohio Farmer, : Cleveland, Ohio.

Low Rates West and Northwest.

On February 12th and on each Tuesday until April 30th, the Chicago Milwaukee & St. Paul Railway will sell one-way second-class tickets at the following very low rates:

To Montana points, - - - -	\$25 00
To North Pacific Coast points, - - - -	30 00
To California, - - - -	30 00

These tickets will be good on all trains, and purchasers will have choice of six routes and eight trains via St. Paul, and two routes and three trains via Missouri River each Tuesday. The route of the famous Pioneer Limited trains and the U. S. Government Fast Mail trains.

All ticket Agents sell tickets via the Chicago, Milwaukee & St. Paul Railway, or for further information address F. A. Miller, General Passenger Agent, Old Colony Building, Chicago.



Belgian Hares

I have some fine hares for sale at reasonable prices.

J. F. Moore, : Tiffin, Ohio.

WHERE TO LOCATE?

Why, in the Territory Traversed by the

Louisville & Nashville RAILROAD.

THE
Great Central Southern Trunkline
IN
KENTUCKY, TENNESSEE,
ALABAMA,
MISSISSIPPI, FLORIDA.

WHERE
Farmers, Fruit-growers,
Stock-raisers, Manufacturers,
Investors, Speculators,
and Money Lenders

will find the greatest chances in the United States to make "big money" by reason of the abundance and cheapness of

Land and Farms,
Timber and Stone,
Iron and Coal,
Labor--Everything.

Free sites, financial assistance, and freedom from taxation for the manufacturer.

Land and farms at \$1.00 per acre and upwards, and 500,000 acres in West Florida that can be taken gratis under U. S. homestead laws.

Stockraising in the Gulf Coast District will make enormous profits.

Half-fare excursions the first and third Tuesdays of each month.

Let us know what you want, and we will tell you how to get it—but don't delay, as the country is filling up rapidly.

Printed matter, maps, and all information free.

Address **R. J. WEMYSS,**
Gen'l Immigration and Industrial Ag't,
LOUISVILLE, KY.

Our Advertisers.

BURPEE'S QUARTER-CENTURY FARM ANNUAL.

This is another catalog (see advertisement in this issue) that contains a vast amount of valuable information besides the pictures. Burpee, you will remember, gave us the bush lima bean, the Rocky Ford muskmelon, or the one that gave birth to it, and a whole string of other exceedingly valuable well-known vegetables. When he recommends a thing you may be sure it is worthy of at least a trial, and I wish we could say the same of all other seedsmen.

POULTRY-KEEPING IN ALL ITS BRANCHES.

The above is the title of a catalog sent out by the Cyphers Incubator Co. See advertisement in this issue. Now, this catalog, or book, we had better say, was revelation to me. In fact, it was one of my happy surprises. I have visited some of the big poultry-farms recently, but I confess I did not dream, until I got hold of this book, of the *magnitude* that the poultry business has reached at the present day. A few years ago we used to hear that "hen-farms" were a failure; lots of men had sunk money in incubators and expensive buildings, but nobody ever got it back again. The pictures alone in this book tell us that men *have* got their money back, and are getting it back. Not only have we views of chickens, but of ducks and geese by the thousand. There may be poultry-books with such beautiful pictures, but I have not seen them. If you are at all interested in poultry-keeping, and if you want to know what this great country of ours is doing along this line, you can well afford to send 10 cents for this wonderful achievement, not only in the way of poultry-keeping, but in beauty of print and half tone work, as well. These unique half-tones show over 60 of America's largest and most successful poultry-plants, in luding duck-ranges, broiler-farms, winter chicken and rooster farms, besides the yards of numerous breeders of standard poultry.

Get the Best Queens.

Evansville, Ind., Sept. 27th, 1900.

The Jennie Atchley Co., Beeville, Bee Co., Texas.

Dear Friends:—It gives me great pleasure to forward you this unsolicited testimonial regarding the merits of Atchley queens. The three (3) dozen queens purchased of you have made an excellent record for themselves. Not an Atchley queen among the twenty colonies lost during the severe drouth in July. I have bought queens from many breeders; and although the present crop is exceedingly short, the tiers of supers show where the Atchley queens are, and speak volumes for your method of queen-rearing. I find the progeny to be very gentle, strong winged, uniformly marked, long-lived, of large size, and last, but not least, the best honey-gatherers I ever had. I shall want 100 more next season.

Yours fraternally, J. C. WALLENMEYER.

Prices for Queens.

Tested, \$1.50 each; \$8 00 for 6, or \$15 00 per dozen. Untested, February, March, April, and May, \$1 00 each; \$5.00 per 6, or \$9 00 per dozen. Fine breeders, \$5 00 each. We have as good bees and queens as money and labor produce. We breed three-band Italians, Goldens, Carniolans, Cyprians, and Holy-Lands, in their purity, bred in separate yards 5 to 20 miles apart. If you want the *best*, call for Atchley's improved strains. Safe arrival guaranteed. Send for a sample copy of "The Southland Queen," the only southern bee-paper. \$1 00 per year. To new subscribers we offer as a premium a nice untested queen in order to get our paper introduced. Catalog, giving queen-rearing and management of apiaries for profit, FREE.

**THE JENNIE ATCHLEY CO.,
Beeville, Bee Co., Texas.**

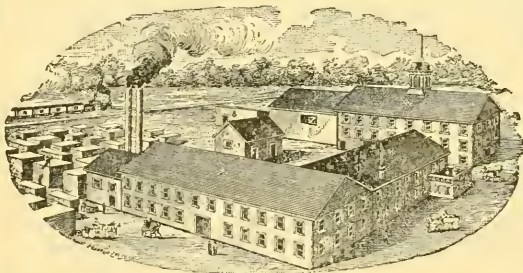

KRETCHMER M'F'G CO., Red Oak, Iowa.

BEE-SUPPLIES.

Best-equipped factory in the West; carry a large stock and greatest variety of every thing needed in the apiary, assuring BEST goods at the LOWEST prices, and prompt shipment. We want every bee-keeper to have our FREE ILLUSTRATED CATALOG, and read description of Alternating Hives, Ferguson Supers, etc. *Write at once for a catalog.*

— AGENCIES: —

Trester Supply Co., 103 So. 11th St., Lincoln, Nebraska; C. C. Richards, 1223 17th St., Denver, Col.



BINGHAM SMOKER.

DEAR SIR:—Inclosed find \$1.75. Please send one brass Smoke-engine. I have one already. It is the best smoker I ever used. Truly yours,
HENRY SCHMIDT, Hutto, Tex

MADE TO ORDER.

Bingham Brass Smokers

Made of sheet brass, which does not rust or burn out; should last a lifetime. You need one, but they cost 25 cts. more than tin of the same size. The little open cut shows our brass hinge put on the three larger sizes. No wonder Bingham's 4-inch smoke-engine goes without puffing, and does not drop inky drops. The perforated steel fire-grate has 381 holes to air the fuel and support the fire. Heavy tin smoke-engine, 4-inch stove, per mail, \$1.50; 3½-inch, \$1.10; 3-inch, \$1.00; 2½-inch, 90c; 2-inch, 65c. Bingham smokers are the originals, and have all the improvements, and have been the standard of excellence for 22 years. Only three larger ones brass.

T. F. Bingham, : : Farwell, Mich.

Contents of this Number.

Air, Fresh, for Bees, Ira Barber on.....	184
Apple-bloom, Honey from.....	190
Barrels, France on.....	195
Bees, Preparing for Apple-bloom.....	190
Bees, York's Suggestion.....	195
California Crop for 1901.....	194
California Rains.....	192
Combs from Foul-broody Colony.....	183
Editor in Florida.....	196
Honey in Mason Jars, Marketing.....	194
Honey, Bottling and Selling.....	187
Honey, to Liquefy.....	188
Honey, to Sell.....	189
Introducing Dipped Queens.....	184
Italians and Black Brood.....	183
Michigan Foul-brood Bill.....	194
Paraffining Barrels.....	195
Peach-orchard, McCubbin's.....	186
Rambler at McCubbin's.....	185
Smoking Bees with Cloth.....	184
Spraying During Bloom.....	193
Sugar, Cane v. Beet.....	192
Tinfoiling.....	187
Tongues, Measuring.....	193
Wintering, Indoor, in Medina.....	195
Wintering, Questions on.....	193

Honey Column.

GRADING RULES.

FANCY.—All sections to be well filled, combs straight, firmly attached to all four sides, the combs unsoiled by travel-stain, or otherwise; all the cells sealed except an occasional cell, the outside surface of the wood well scraped of propolis.

NO. 1.—All sections well filled except the row of cells next to the wood; combs straight; one-eighth part of comb surface soiled, or the entire surface slightly soiled; the outside surface of the wood well scraped of propolis.

NO. 2.—All sections well filled except the row of cells next to the wood; combs comparatively even; one-eighth part of comb surface soiled, or the entire surface slightly soiled.

NO. 3.—Three-fourths of the total surface must be filled and sealed.

NO. 4.—Must weigh at least half as much as a full-weight section.

In addition to this the honey is to be classified according to color, using the terms white, amber, and dark; that is, there will be "fancy white," "No. 1 dark," etc.

CITY MARKETS.

BOSTON.—We quote our market as follows: Fancy No. 1 white in cartons, 17; A No. 1, 16; No. 1, 15@16; with a fairly good demand. Absolutely no call for dark honey this year. Extracted, white, 8@8½; light amber, 7½@8. Beeswax, 27.

BLAKE, SCOTT & LEE,

Feb. 19. 31, 33 Commercial St., Boston, Mass.

CHICAGO.—Fancy white comb, 16; No. 1 white, 14@15; fancy amber, 12@13; No. 1 amber, 10@11; fancy dark, 10; No. 1 dark, 8@9. White extracted, 7¼@8; amber, 6½@7¼; dark, 6@6½. Beeswax, 28.

R. A. BURNETT & Co.,

Feb. 19. 163 South Water St., Chicago, Ill.

CINCINNATI.—The market for comb honey is becoming bare, although the prices did not change. Fancy white comb is still selling for 16. No demand for darker grades. Extracted in fair demand; dark sells for 5½, better grades from 6½ to 8; only fancy white clover brings from 8½ to 9.

C. H. W. WEBER,

Feb. 18. 2146-8 Central Ave., Cincinnati, Ohio.

SCHENECTADY.—The market has been very quiet for the past two weeks, but we note an improvement already with the beginning of Lent—having made a large sale the opening day. We quote white clover, comb, 14@16; buckwheat, 11@12, dark extracted, 5@6.

Feb. 20. C. McCULLOCH, Schenectady, N. Y.

NEW YORK.—Comb honey is being well cleaned up on our market. The demand has lessened to quite an extent on account, we presume, of the high prices which have been ruling. Fancy white still brings 13@16; No. 1 white, 13@14; amber, 11@12; buckwheat, 10. Extracted rather light and not much doing. California white honey at 7½@8; light amber, 7; Southern, 6@7 per gallon; buckwheat, 5@5½. Beeswax steady at 28.

HILDRETH & SEGELKEN,

Feb. 19. 120, 122 West Broadway, New York.

MILWAUKEE.—Since our last report this market has maintained a very quiet place, and the demand for honey has not been very active, and the main reason is because the supply of fancy stock is wanting, and the lower grades do not meet with good favor. But there is a little better demand existing now, and especially for the extracted shipments of either. Fancy section or extracted white will meet a good market. We can now quote fancy 1-lb. sections 17@18: A No. 1, 15@16; No. 1, 15@16; No. 1 amber, 13@15. Extracted white, in barrels, cans, pails, and kegs, 9@9½; amber, 7½@8. Beeswax, 26@28. A. V. BISHOP & Co., Feb. 18. Milwaukee, Wis.

NEW YORK.—The market for both extracted and comb honey is rather dull. We quote fancy white comb, 15; No. 1, 14; No. 2, 12; buckwheat, 10. Buckwheat extracted, 5½. Beeswax, 28.

FRANCIS H. LEGGETT & Co.,

Franklin, West Broadway, and Varick Sts., Feb. 18. New York City.

NEW YORK.—Demand for comb honey is slacking off with stock pretty well cleaned up, with the exception of a few lots of white Colorado offering on the market. We quote: Fancy white, 15@16; A No. 1, 15; No. 1, 14@15; No. 2, 11@12; fancy buckwheat, 10@11; No. 1, 10; No. 2, 9. Extracted honey not in as much demand as there should be at this season of the year. Extracted white clover and basswood, 7@8; light amber clover, 7@7½; amber and buckwheat, 5@5½. Beeswax, demand dull, but from 26@28.

CHAS. ISRAEL & BROS.

Feb. 25. 486-8 Canal St., New York City.

FOR SALE.—20,000 lbs. extracted honey from alfalfa and light amber from Rocky Mountain bee-plant. Two cans, 120 lbs. net, \$8.40; also 5 and 10 lb. pails. In ordering state if you want white or amber.

M. P. RHOADS, Las Animas, Col.

WANTED.—Comb and extracted honey. State price, kind, and quantity. R. A. BURNETT & Co., 163 South Water St., Chicago, Ill.

FOR SALE.—Choice alfalfa honey. Two cans, 120 lbs. net, whitest, \$9.00; tinted, partly from other bloom, \$8.40. Also small cans.

THE ARKANSAS VALLEY APIARIES,

OLIVER FOSTER, Prop., Las Animas, Bent Co., Colo.

FOR SALE.—Extracted honey from alfalfa; 60-lb cans at 7 cts., and smaller cans.

D. S. JENKINS, Las Animas Colo

FOR SALE.—3000 pounds fancy comb honey. Write for prices. WILLIAM MORRIS, Las Animas, Col.

A Honey Market. Don't think that your crop is too large or too small to interest us. We have bought and sold five carloads already this season, and want more. We pay spot cash. Address, giving quantity, quality, and price. Thos. C. Stanley & Son, Fairfield, Ill.

CHAS. ISRAEL & BROS.,

486, 488, 490 Canal St.,
Corner Watt Street, N. Y.

HONEY & BEESWAX.

Liberal Advances made on Consignments,
Wholesale Dealers and Commission Merchants.
Established 1875.

PURE MAPLE SYRUP.

MEDINA is the home of the honey bee and also the home of the MAPLE TREE, and the maple tree produces sap in the spring, which is boiled down and makes the finest flavored sweet in existence when you get it pure. One of our customers called it "Delicious Nectar." We have pure maple syrup to sell to the trade in several sizes of packages. Write for prices to

R. E. FRENCH, - MEDINA, OHIO.

Reference, The A. I. Root Company.

\$200 RED-CLOVER QUEEN.

OFFER NO. 35.

ON SEPTEMBER 1st last we announced that we finally had a red-clover queen fully equal to the one we had years ago. The colony of this queen has given one of the most remarkable showings on red clover of any bees we have ever had. The queen in question is an imported one, and therefore of the genuine pure leather-colored Italian stock. We sent out daughters from her all the season. But we did not discover her value until the clover season, second growth, came on, and then her colony so out-distanced all the other 450 that she attracted attention at once.

It must be understood that these queens are not golden yellow, neither are their bees of the five-banded stock. They are simply leather-colored Italians, whose mother came direct from Italy.

Since the notice appeared regarding this queen we have hardly been able to supply all of the queens that were wanted from this stock. Many daughters of this queen we sent out before we knew her value, and it now transpires that some of the finest bees in the land are from queens we sent out early. We are now booking orders for the coming season, and make the following offer, but no queens will be furnished except those who subscribe for Gleanings, and only one with each year's subscription. All arrearages must be paid to the end of this year. Gleanings for 1901 and one untested red-clover queen, \$2.00; Gleanings one year and a tested red-clover queen, \$4.00; a select tested red-clover queen and Gleanings one year for \$6.00. We will begin mailing these queens in June, 1901. Orders are already being entered, and the same will be filled in rotation. Do not neglect to improve this opportunity and get some choice stock, and send your order early so you may get the queen correspondingly early in the season. We are using every precaution to winter this queen safely, but reserve the right in case of her loss this winter to substitute from other select tested stock of this strain which we are holding in reserve, or to give the subscriber the benefit of any of our other clubbing offers if desired.

The A. I. Root Company. Medina. Ohio.

NOW READY!

64-PAGE CATALOG OF EVERY THING BEE-KEEPERS NEED. Illustrated and fully described. Especially valuable to beginners for the information it contains. Send your address on a postal card get it now. Established 1884.

J. M. JENKINS, Wetumpka, Ala.

QUEENS?

Improved Golden and Leather-colored Italians is what we rear — 13 years' experience enables us to furnish Superior Stock.

Humboldt, Neb., Aug. 5th, 1900.

*My H. G. Quirin. Dear Sir:—*The colony containing the queen you sent me has already stored over 400 lbs. of honey (mostly comb) for this season, and will yet store quite a considerable before the season closes. It would take \$100 to buy this queen. I have another one from you which I think will turn out equally as well. Bees from your queens certainly do work on white clover. I can tell, as they are the only bees of their kind in my locality. Hereafter when I want more queens I shall know where to get them.

Yours truly, J. L. GANDY.

At present we have two very valuable breeders which will be used for the coming season. One is a breeder from Root's \$200.00 red-clover queen. We are now booking orders for April, May, and June delivery at the following prices:

Warranted Stock, \$1.00 each; 6, \$5.00.
Tested Queens, \$1.50 each; 6, \$8.00.
Select Tested, \$2.00 each; 6, \$10.50.

Why not let us book your order for one or half a dozen of these **Superior Queens?** We guarantee safe delivery. You take no risk. Remember queen-bees is our specialty in summer time. For a short time we will allow **20 per cent discount** on Folding Cartons, and printed stationery. Parkertown is a money-order office, so please do not send stamps if you can help it.

H. G. Quirin, Parkertown, Ohio.

A Bear in the Apiary.

I have just lost an entire apiary of 52 colonies by bear. I had the very good fortune to kill a very large one *right in the midst of the wreckage.* I have a very good 5x8 picture of this *Bear, in the apiary he destroyed.* This is the greatest novelty in the way of an apiarian view I have ever seen. I will send you one of these pictures for 35 cts. postpaid, or as a premium for each half dozen queens ordered.

Don't forget that my specialty is the best *queens* from the *best stock* that it is possible to procure, and that my *motto is promptness.* I also handle The A. I. Root Co.'s supplies at their prices, plus 55 cts. per 100 lbs. to pay carload freight. Send for price list.

W. O. VICTOR, WHARTON, TEXAS.

QUEEN SPECIALIST.

I. J. Stringham, 105 Park Place, New York City.

Keeps in stock a full line of modern appliances for bee-keepers.

COMB FOUNDATION

is one of our specialties. If you expect to use any quantity get our prices. Catalog free. Apiaries at Glen Cove, Long Island.

I. J. Stringham, 105 Park Place, New York City.

Notice!



THE A. I. ROOT CO.

wish to announce that they have from their branch at 10 Vine St., Philadelphia, Pa., direct steamboat connections and very low rates of freight to the following States: Massachusetts, Rhode Island, Connecticut, New Jersey, Delaware, North Carolina, South Carolina, Georgia, Florida. As this is a branch of the factory, prices are the same. Full colonies of Italian Bees, \$6.00. Special discount in large quantities.



G. B. Lewis Co.,

Man'f'rs of Bee-keepers' Supplies,
Watertown, Wis., U. S. A.

The cut shown below is our packing-case. It protects goods while in the hands of the railroad company so that you will receive every article in just as good condition as when they left factory.

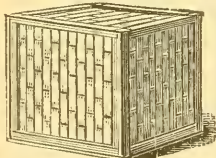

Our Wisconsin Hive.

We consider this one of the best hives in the market. It is similar in construction to the Improved Langstroth Simplicity shown in the previous issue, but includes some of the new-style devices which are preferred by some. It has the thick reversible bottom, and the supers are arranged so that the bottom can be wedged up from the end as well as the side. The body contains Hoffman frames, metal rabbets, and division-boards. See page 5 of our new catalog. We manufacture four other styles of hives. If you have not received our new catalog, send for one. It's free.

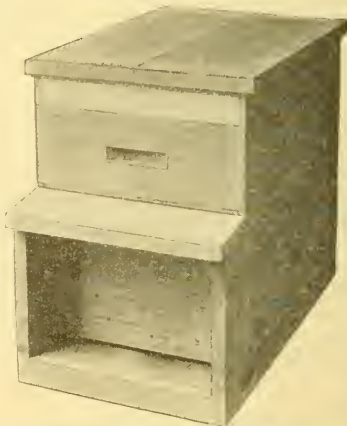

BRANCH: 19 Sou. Alabama St., Indianapolis, Indiana.
AGENCIES: L. C. Woodman, Grand Rapids, Mich.;
Fred Foulger & Sons, Ogden, Utah; Colo. Honey-
producers' Association, Denver, Col.; E. T. Abbott,
St. Joseph, Missouri, Special Southwestern Agent.

BEE-SUPPLIES!

ROOT'S GOODS
AT
ROOT'S PRICES

C. H. W. Weber, Cincinnati, Ohio.
2146-2148 Central Ave.

A NEW and complete stock for 1901 now on hand. I am The Root Company's representative for Cincinnati and surrounding territories. . . . You save TIME and FREIGHT CHARGES by having goods shipped from here. Convenience of railroad facilities here enables me to do so. Before buying elsewhere, write for my prices and catalog, which will be mailed you free of charge.

GLEANINGS

A JOURNAL
DEVOTED
TO BEES
AND HONEY
AND HOME
INTERESTS.

BEE CULTURE

ILLUSTRATED
SEMI-MONTHLY

Published by THE A. ROOT CO.
\$1.00 PER YEAR MEDINA, OHIO.

VOL. XXIX.

MARCH 1, 1901.

No. 5.



DOOLITTLE'S TEACHINGS sound like good sense in French as well as English. "Bee-keeping for Farmers," GLEANINGS, 967, is translated in full in *Le Progres Apicole*.

THE *Bienenwirtschaftliches Centralblatt* says Rudolph Dathe has the largest apiary in Germany, with 451 colonies, the next six in order containing 380, 300, 285, 210, 170, and 150 each.

IN THIS LOCALITY prospects look bright for the coming harvest. (The bee-keeper that can't see any bright prospect ahead isn't very much of a bee-keeper.) White clover was in good condition when winter set in, and there has been a good blanket of snow for several weeks, with a prospect of continuance.

HERE'S A KINK worth thinking about that Editor Hutchinson lets out on W. L. (ighting) Coggshall: When uncapping for the extractor, *slice deep*. Takes ever so much less time than the usual way, the honey can be drained from the cappings, and it takes no more wax to build out the cells than the bees will secrete anyway.

ONCE got myself into trouble, not with the Dadants, but with one of their friends, by speaking jokingly of those miserable frog-eaters down at Hamilton. (As a matter of fact I am exceedingly partial to frog-legs.) I hope to reinstate myself in the good graces of their belligerent defender by quoting an expression from that bright new periodical, *L'Apiculture Pratique*: "The bee-keepers of the whole world owe to the Messrs. Dadant a tribute of profound gratitude" Which sentiment I heartily indorse.

EDITOR HUTCHINSON says Italians are much less susceptible to black brood than blacks or hybrids. The Australians say Italians are safer against foul brood. [Two inspectors who attended the State convention at Geneva, N. Y., stated that, for some reason, the Italians seemed much more able to resist black brood. They could assign no cause for it, but

the fact was nevertheless true. I believe, though, it was suggested that, as black bees, including hybrids, are more inclined to rob than the pure yellow Italians, the former in the stealing expeditions would carry to their colonies germs of infection when the Italians, content to work in the fields, would gather the pure non-infected nectar from the flowers. —ED.]

THE CHICAGO BEE-KEEPERS' ASSOCIATION, as reported in *American Bee Journal*, urges the N. B. K. A. to provide local associations with printed matter to help boom the N. B. K. A. Now, why didn't some one think of that before? With all the bee-journals and the local societies booming it, why ought not the membership this year to reach 1000? A thousand members! Hip, hip—but perhaps we better wait till we reach the thousand. [A good idea; and I would suggest that the General Manager, if he deems it proper, prepare a circular or booklet, giving the objects of the Association, and what it has accomplished during the period of its existence. I think it would be proper to include the work of the old Union, as that is now a part of the new organization, the N. B. K. A. The organization has a great record and it should be known. —ED.]

INSPECTOR MCEVOY says in *Review* that it is perfectly safe to give to a healthy colony combs taken from a foul-broody colony if such combs *never had brood in them*, and if they have been *licked clean and dry* by the foul-broody bees. [I remember our friend McEvoy making that statement in convention; but assuming that he is correct, the advice would be a little dangerous to beginners and to bee-keepers of experience who are a little careless in their ways of working. It takes good strong eyes sometimes to detect the presence of a cocoon or cocoons in brood-combs. Methinks it would be safer for the average bee-keeper to render up *all* combs from foul-broody hives. We must not forget that a line of procedure that would be safe for an expert inspector like Mr. McEvoy might be unsafe for *some* bee-keepers. For example, I can handle with a fair degree of safety a razor or a loaded revolver, and I can give my ten-year-

old boy full directions on how to handle either; but do you think I would trust him to carry out my directions? Not I.—ED.]

IRA BARBER says in *Review* that the only thing necessary to keep cellared bees from becoming uneasy toward spring "is to keep all fresh air from reaching them, by banking thoroughly from the outside, and be sure that it is kept there air-tight." Looks reasonable, doesn't it? that a sniff of spring air should make them want to get out where there's more of it. But how do you account for another thing? When they get uneasy with the outside temperature at 45° or 50°, and the cellar is left wide open all night, they are very quiet in the morning, and don't offer to fly out, even if full daylight shines in. If a little fresh air leaking through the walls makes them uneasy, why doesn't a whole flood of it make them worse? [Ever since the article came out in the *Review* I have been cogitating on it not a little. I had already formulated some thoughts on this phase of the wintering question, and I would therefore refer you to an editorial in this issue.—ED.]

E. GIRAUD-PABOU, in *Revue Electrique*, gives the following as his sole means of introducing queens: Roll the queen in a spoonful of honey. When thoroughly smeared, drop her between two combs of brood so close together that she can not fall to the bottom; smoke, and close the hive. The queen may be introduced the evening of the same day the queen is removed, and up to the ninth day after. No need to destroy queen-cells. [Some years ago there used to be more talk about dipping queens (to be introduced) in honey than now. If I remember correctly, some valuable queens were lost by such procedure. Perhaps it might be well to call on those who have had experience, and who could tell us why they abandoned the practice. I have introduced queens by that plan myself, and I do not remember that I ever lost a queen where the colony was surely queenless. But the meanest stock to introduce a queen to is one having cells pretty well advanced, and almost ready to hatch. A still meaner one is one having a young virgin. Kill that virgin, and they are still mean. Well, let us have reports from those who have tried the honey-dipping process of introducing.—ED.]

COMMENT 315, in the latest A B C, says my plan of placing 4 hives in a group is more economical of room than S. E. Miller's plan with 5 in a group. Then you ask in a footnote, Mr. Editor, "If the hives in the several groups on the S. E. M. plan were placed only 3 inches apart, and the space gained closed up between the several groups, is it not true S. E.'s plan would accommodate more hives in a given area than your plan?" I suppose you want an answer to that question, and it is, "No." Look at the figures I send you, and you will see that, when your conditions are fulfilled, S. E.'s plan still takes 5 per cent more room than mine. [I have examined Dr. Miller's figures, and must admit that he is right; but the difference is so very, very slight, that it practically amounts to "six of

one and half a dozen of another." I am not sure but I should prefer the C. C. in place of the S. E. plan, for the simple reason that the entrances would all be pointing in one direction, while in the S. E. way the entrances of one set of hives are at right angles with the entrances of another set in the same group. It is desirable to direct the flight of bees, as far as possible, in one direction, so that there may be an alleyway for the bees and one for the bee-keeper. Encountering the flight of busy workers is annoying, both to the bees and to their owner.—ED.]

HERE'S SOMETHING to give "aid and comfort" to Mrs. Barber and ye editor. Devauchelle says in *L'Apiculteur* that the only way to set bees to work at once in sections, and also the best way for the bee-keeper to employ with profit, is to put on first an extracting-super, and when this is nearly filled to put a section-super under it. [Yes, indeed; like other mortals I like to read what suits my way of thinking. Over and over again I have had stubborn colonies of Italians that would not go into the supers, boiling over with strength, clover out in profusion, and yet they would stay in the brood-nest and cram every available cell before going above. I have given such colonies supers of shallow extracting-combs when they rushed above; and after they got well going in these combs I took these supers off and gave them, instead, supers of sections with full sheets of foundation. The habit of going above being once established, caused those bees to occupy at once quarters that they had refused to occupy before. I am sure the principle is all right when working with Italians, and in localities where the honey-flow is not strong enough to force the bees above with a mighty rush.—ED.]

COGGSHALL puffs smoke into his extracting-supers, and flops a cloth up and down to make the smoke go in. I tried it with no great success. I suspect it doesn't work as well on supers of sections as on his supers of extracting-combs. [Yes, sir, I saw Mr. Coggs hall and one of his men, by means of the floppcloth smoker act, drive about two-thirds of the bees out of something like 30 or 40 different extracting-supers. From three to five floppings of the cloth would accomplish the result in a surprisingly small amount of time. The rest of the bees were disengaged by a peculiar trembling shaking motion, combs being shaken *in* the hive and not in front of the entrance. In some cases there would be half a dozen bees left on the combs; but these persistent chaps were quickly dislodged with the Coggs hall bee-brush. You say it does not work as well on supers of sections as on supers of extracting-combs. I suppose you refer to the old-style sections; and if so, right you are. In the ordinary beeway sections there is a little space at each corner, the top not being cut away. It is in these spaces that the bees lodge and pile up. In supers of no beeways, or plain sections, the bees are dislodged much more easily; and easier still from plain extracting-combs.—ED.]

RAMBLE 182.

Alfalfa in California; Extracting Methods Discussed; a Practical Method of Hive-record Keeping.

BY RAMBLER.

"Now, Mr. Rambler, if you feel like it this morning we will hitch my old white horse Bonares to the top buggy, and you and I and the children will visit the apiaries, and you can see the lay of the land and various other matters."

"I am ready any time, Mr. McCubbin; but I can tell you before we start that I do not like the lay of the land. This San Joaquin Valley is a great prairie, and I do not like a dead-level country—it is too monotonous. I was raised in the hill country of New York where the roads wound around the hills. Those roads were just charming with their change of scenery. Even in Southern California our roads lead into the hills and to the grand mountains; but the mountains here are in the dim distance. There is nothing distinctive in such a level country; and where the roads just follow land sections, and form squares, a ranch house might as well be a peg on the map, and other ranch houses just so many more pegs. I am sure I shall be lonesome without the hills."

"Oh! well, Rambler, you will soon get used to this level condition of the country, and like it. You can wheel anywhere here, and have no hills to contend with. We will now go to our first apiary, which is out three and a half miles on my raisin and alfalfa ranch, which I rent, reserving the bees for more skillful hands—like yours, for instance."



COMBINATION HONEY-HOUSE AND RESIDENCE.

"Thank you, Mr. McCubbin; but I fear my hands will not be very skillful here, for I am satisfied that the conditions are entirely different here from those I have been familiar with, and I shall, with your advice, have to learn the trade anew. It seems that I am traded around into various portions of this great

State, and I shall be a dull scholar indeed if I do not learn a few new wrinkles in bee-keeping. Now, you are familiar with this country, and know every foot of land between Reedley and Traver; what are the conditions of alfalfa growth here? and is the country generally adapted to its cultivation?"

"No, Mr. Rambler, there are only certain districts that are adapted to alfalfa culture. Here is a district about two miles wide and ten in length, or 20 square miles, well adapted to the growth of alfalfa. East of us the land is heavy, like adobe; and, though alfalfa will grow upon it, it does not thrive as upon this more porous soil, and it is sown mostly to wheat. Then west of us is a portion not adapted to alfalfa; but when we get over to Selma, 13 miles west, there is quite an extensive acreage where alfalfa does well. So far as I know, it runs in spots all through the valley. The hindrances are sometimes adobe, sometimes alkali, and again too sandy and porous, and not water enough for irrigation."

"Mr. McCubbin, I should like to ask how many acres of alfalfa are in this twenty square miles."

"I know the country well, and think I can answer your question quite correctly. There is fully 5000 acres, or well toward eight square miles. The remainder is occupied with fruit-orchards, vineyards, grain-fields, etc."

"You may think I am figuring down quite fine, Mr. McCubbin; but do you know how many colonies of bees are owned in this area?"

"I think I can answer that quite closely. I am acquainted with all of the bee-men, and the number of colonies is not far from 1500."

"Then, Mr. McCubbin, there is about one colony to every three and one-third acres of alfalfa. Do you call that crowding in too many bees for the pasturage?"

"Well, as the fellow said, that depends. If we were sure of an alfalfa yield every season, there might be more crowded upon the pasture; but some seasons the alfalfa fails to secrete nectar; and when that happens there are too many bees, and a small crop is the result. I think the pasture is overcrowded around my out-apiary three and a half miles from what you will call your home apiary. There are fully 900 colonies on 1000 acres, and in another year the number will run up to a thousand, or a colony to every acre, and that is getting them in too thick."

"You say, Mr. McCubbin, that you scarcely ever have a failure of a honey crop. What do you depend upon if the alfalfa fails? I believe you have no sage here."

"You are right, Mr. Rambler. We have no sage here. There is some over on the foothills of the Coast Range of mountains, on the

west side of the valley ; but that is fifty miles from us. Here in the valley we have a good fruit-bloom. After that there is a precarious yield from yellow sweet clover, which grows plentifully along the ditches ; then there is an alkali weed, also sweet clover just getting a footing ; also wild sunflower and a camphor-weed which come up by the hundred acres in our grain-fields, and give a good flow of honey until into October. Well, here we are. This is what I call my twenty-acre ranch, and it was my home until after my wife died. You will observe that the apiary is pleasantly located under the peach-trees, and here is the cabin you can occupy. One end is a honey-house and the other a living-room. Your work-shop can be under those fig-trees. You can hardly imagine what a grateful shade those fig-trees make when the mercury gets up to 115° or 120° in the shade."

"Whew, Mr. McCubbin ! but I am afraid I shall melt if the sun pours down calorically at that rate. Then see here ; it seems to me that this extracting-house is some distance from

work the bees ; do as you like ; if you prefer to lift your honey in concentrated form in cans, then that is the proper way. All I ask is to have the work well done. The conditions are not as to the *how*."

"I notice, Mr. McCubbin, that you have cards tacked upon the hives. How do you use them?"

"You observe, Mr. Rambler, that when I am working with the bees I note down upon the card the conditions as they arise during the season. At the close of the honey-yield I transfer the record on the cards to my permanent record-book. Now, I can turn to my record and tell the condition of any colony, and the amount of honey it has produced, and its value. For instance, here is hive 63, 1889. The first ruled columns are for the dates when the caps were put on and when full ; then space for comments, then more columns for weight and grades of extracted and comb honey, and the value. I was producing comb honey mostly when this record was kept, and had three grades : fancy, No. 1, No. 2, and



M'CUBBIN'S PEACH ORCHARD APIARY.

the apiary ; and do you have to wheel all of the honey in here, lift it up these steps and into this close dark room? Why, I believe it is a tenth of a mile out to the far side of the apiary."

"That's the way we do it, Rambler. You see we work on Aikin's plan—take the combs home to extract."

"Yes, yes ! I see, Mr. McCubbin ; but your plan is worse than Aikin's—he uses a horse, while you make a horse of yourself ; and, land o' Goshen ! what a heavy wheelbarrow this is ! Say, my friend, if you want a wheelbarrow, light and well made, send to The A. I. Root Co. for a Daisy. It is just the thing for an apiary. I speak from experience, for I have one in my up-to-date apiary down south. But, really, Mr. McCubbin, I believe if you have no objections—yes, and I believe even if you do have objections—I shall build one of our cheap Southern California extracting-houses right out under the shade of one of those peach-trees, and right among the bees."

"All right, Rambler. You are the one to

the record for extracted honey was whether it was taken from the cap or brood-chamber. If a colony was unusually cross through the entire season, the queen was marked for supersedure ; and you will see by this record that the season runs clear into October. You will also note that the record gives a better general yield in 1896 than in 1889."

"Well, Bro. McCubbin, you have your record worked down fine. My plan is to lump the whole crop, and then strike an average for each colony. There are always a few that will show a better record than the rest, and these I always reserve to breed from."

"Yes, Rambler ; every man has his way of doing things, and we will not quarrel over methods as long as you get the honey. When you come here to live in this combination honey-house and residence you can look every thing over at your leisure. And now we will go to the out-apiary, three and a half miles further along. Come, Bruce and Grace, hustle into the wagon with Rambler and we will be off."

The apiary shown in the photo is comfortably shaded with peach-trees, and contains 150 colonies, but is roomy enough for 200. An alfalfa-field is in the foreground. The something in the distance that looks like a haystack is the dense foliage of umbrella-trees around a farmhouse.

THE ART OF BOTTLING AND SELLING HONEY.

Does Not Pay to Bottle a Poor Grade; Package must be Useful when Empty; the Lard-bucket not a Good Seller; Importance of Tinfoiling; an Excellent Article.

BY J. C. WALLENMEYER.

Having had an experience of eight years in bottling a dozen different kinds of honey in a dozen different kinds of packages or containers, I thought I would give the benefit of my somewhat varied experience to the readers of GLEANINGS that they might possibly profit by avoiding the usual mistakes of beginners in using unsalable packages.

I have bottled honey from alfalfa, basswood, willow-herb, white clover, California sage, Florida mangrove, saw and cabbage palmetto, wild aster, and smartweed (or heartsease) mixed; dry-weather honey-vine, and fall flowers. For containers I have used pint and quart Masons, costing 50 and 60 cts. per dozen, 5 and 8 oz., and 1 and 2 lb. square flint-glass jars, costing \$5.70 and \$7.50 per gross (corks included); 13 and 16 oz. jelly-glasses; ½-gallon fruit-tablet jars costing 5 cts. each; lard-buckets; glass bowls, and Root's No. 25 round flint-glass one-pound jars—quite a variety to select from.

I found Root's No. 25 jar the best and quickest seller of all, because, after being emptied, it could be used as a self-sealer for jelly, preserves, jams, etc.; only flint-glass jars should be used, as they show the honey off to perfection. Amber honey will sell nearly as well in quart Masons on account of the universal use

of the package; but it is hard to sell 3 lbs. of honey to every-day consumers. Most people prefer a small cheap package. Our market demands a honey of light or light amber color, heavy body, mild flavor, and fine bouquet or aroma. It does not pay to bottle a poor grade of honey. The people generally get accustomed to the kind of honey produced in their own locality. I found this out to my sorrow when I tried to sell three barrels of mangrove and palmetto honey from Florida, although I thought it fine indeed. This matter of selection is very important. If you happen to run short of honey, and must buy, procure an article as near like your own as possible. I have found, just as friend Pouder says, that patrons grow suspicious when they get different honey. I find honey from white clover, dry-weather honey-vine, and fall flowers, to give the best satisfaction for bottling, in my locality. Briefly stated, there are three essentials for success in bottling honey:

1. Best quality of well-ripened honey.
2. Neat, attractive package, useful when empty.



FIG. 1.—J. C. WALLENMEYER AND HIS LIQUEFYING APPARATUS.

3. Aggressive selling methods.

You might have the very finest honey ; but if it is not put up attractively it will not sell. You might have a poor article put up in a showy, gaudy, labeled package, but no one will buy a second time. Again, you may have a fine article of heavy body and fine flavor, put up in the right kind of package ; but if you leave it at home, what good will it do? Be up to date ; be aggressive ; talk honey everywhere you go. I built up an enormous trade in the fall of 1894 with a well-ripened crop of honey from dry-weather vine and fall flowers. I controlled at that time a large portion of the drug trade in Evansville, and probably half of the grocery trade. I bought 5 bbls. of Root's No. 25 1-lb jars and one gross each of the 5-oz. and 8 oz. square flint Muth jars, and 5 gross of 1-lb. and 3 gross of 2-lb. Muth jars, all at one time. I had every kind of package to please the most fastidious. I sold both the 1-lb. square and round jars at \$2.00 per dozen, to retail at 20 cts. The 5 bbls. of Root's No. 25 jars were gone in a jiffy, while I have nearly all the 5 and 8 oz. jars yet. These I use at fairs to give away as samples. I often sold a dozen of the round jars to housewives who wanted a set for jelly, etc., but never sold more than one or two of the square jars at one time to any lady. They are considered worthless when empty, although my wife likes them for small pickles and catsup. I use the No. 50 label, costing \$1.75 per 1000 for both round and square 1-lb. jars. This label

is showy, and will not soil easily in fly-time. I find the 2-lb. square jar an easy seller to parties who mix their own cough medicine every winter.

I have now dwelt at length on the merits of various packages, as I think it a very important item to help sell our honey. I forgot to say my worst-selling package was the tin lard-bucket, Mr. R. C. Aikin notwithstanding. They may be all right to sell to old customers ; but the main objection is that people can not see the contents unless it is opened. To get new customers to buy your honey, invest 5 cts. in a "glass show-case." As honey is not a staple, instruct the grocer to place conspicuously, and you will have the pleasure of selling both "show-case" and honey at the same time.

HOW TO LIQUEFY ; HOW TO WASH THE BOTTLES.

We will now proceed to the process of bottling. Have your honey liquefied, if candied, holding the same at 150° for two or three hours. By using a gasoline-stove you can regulate to a degree, almost. Be sure not to over-heat it. It will stand 170 to 180 for a short time, but I prefer not to risk losing the aroma and injuring the delicate flavor. If you are compelled to buy honey, always buy in 60-lb. tin cans, as they are more convenient to handle. While you are liquefying your honey, wash your bottles, using clear soft water with sal-soda and shot to remove dirt and particles of glass if new. Then rinse in clear water, and place bottom upward in racks to drain. This will make flint jars clear and sparkling. I did use a ten-gallon filling-can, bought of friend Muth, but now prefer to use my extractor (with cross-arm and basket removed), raised to a convenient height. I prefer to bottle honey hot, as it runs quicker, retains its aroma, and will stay liquid longer than if bottled cold. Have the rack containing empty jars at your left. Place the pan under the honey-gate to catch any drippings. You will soon learn how to cut off the flow just right the first time. Pass the jar to an assistant at the right, who presses the cork (cost 75 cts. per gross) in the mouth, then dips the jar into melted wax and paraffine, half of each. A second as-



FIG. 2.—FILLING THE JARS, AND CAPPING.

sistant puts on the tinfoil (costs 75 cts. per gross) in place; winds a capping-strap around the jar with the right hand; then holds the jar with the left hand, running the head up and down on the strap until the cap is nicely smoothed down. A pasteboard, about 12×20, covered with dextrine (costs 10 cts. per lb.) is covered with labels in front of the operator. She lays the jar down flat, deftly catches the label by the corner, removes it from the board, attaches it to the center of the jar, smoothing it out with a soft cloth; then she places the jar in the case at the right, holding a dozen each.

After a little practice, three persons can easily fill, cork, wax, tinfoil, label, and pack 800 lbs. a day, and not spill a drop of honey, by this method. The corks used for honey-jars are seconds, and ought to be covered with wax to effect an air-tight sealing while the honey is hot.

HOW TO SELL THE BOTTLED GOODS.

Now, then, we are ready to sell. Tog up a bit; for if you will notice you will see that all successful salesmen are well dressed and well groomed. Take a sample jar of each kind, and go to your grocer. If he is busy, see if he has any honey in sight. Don't attempt to sell to him while he is busy. If he is not, tell him you have a fine article of honey, fine flavor, and good body; that the crop of honey is very short this year, and you will not have very much to sell. If you tell him you have five tons he will expect to get it for nothing. Hold your jar to the light; turn it upside down to show how thick it is; talk honey,

talk business, and stick right to him. Have one price for everybody. It will pay you to allow a good margin of profit, and he will then try to make more sales than if he made a very small per cent of profit. But be sure to have your honey placed where every one can see it on entering the store, as people hardly ever ask for honey unless they see it. I visited friend Poudler several times, and the steady stream of customers was evidence that he understands the art of bottling and selling honey to perfection.

Remember, in conclusion, that he who tooteth not his own horn, the same shall not be tooted.

LIQUEFYING-APPARATUS—SEE FIG. 1.

In presenting to the readers of GLEANINGS a photo of my liquefying-apparatus I have tried to make it conform as nearly as possible to the requirements of the average bee-keeper. Although I usually liquefy on a gasoline-range, the cut shows 500 lbs. of candied honey liquefying, without interfering with the preparation of meals. Two 60-lb. cans are placed in two common wash-boilers, then filled with water, and heated gradually. After all the honey in the can is liquefied it is drawn off into a Root's Novice extractor-can (with the baskets and crank removed), by means of a rubber hose, the can being covered to prevent foreign substances lodging therein. I had a Muth ten-gallon filling-can, but I like the extractor better as it has a much larger honey-gate, which is very essential in rapid filling. If the honey is cold, the flow can not be cut off a third as fast; therefore with hon-



FIG. 3.—LABELING AND TINFOILING WITH A CAPPING-STRAP (TINFOILING SHOWN AT LEFT).

ey at about 140 to 150° Fa., and a large honey-gate, we attain the maximum of rapidity in filling. Besides, I found, at least in my experience, that, in filling with cold honey, a large number of air-bubbles formed, thus preventing our getting the desired amount in the bottles. It would also run over the sides when heated to the right degree.

Of course, no one would attempt to seal until the bubbles had risen to the surface, which they will do in a few minutes with hot honey. If the honey is then sealed, and either dipped or corks sunk, and any kind of good sealing-wax poured on, thus effecting a hermetical sealing, the honey contracts when it gets cold, thus causing the much-talked-of vacuum, especially if a tinfoil cap is properly applied, making it absolutely air-tight.

I found, only the other day, 2-lb. Muth jars which had been waxed, that candied, while others on the same shelf, sold to the grocer the same day (Oct. 5, 1900), were nice and clear on account of the tinfoil cap. I find that if, after sealing, the jars are left in a warm room, thus preventing the too sudden cooling of the wax on the corks, we shall have no cracks. If one-half paraffine is added to the wax it will not crack nearly as easily, besides being much cheaper.

WASHING THE BOTTLES WITH SHOT.

In regard to the washing of bottles, I had a good laugh over Mr. Deadman's picture of the little boy punching the little pieces of glass out of the bottles, especially new ones. I used to do the same thing. But how much nicer, and far more easy, and quicker, to take about 3 or 4 oz. of No. 6 shot, and the bottle half full of warm soft water! A few shakes, turn the bottle, then pass to helper, who rinses in clean cold water, and we have a clear sparkling jar which is then set upside down in a large tray to drain.

I think Mr. Deadman's label is not in proportion to the size of his jar. It is too small and insignificant. If using jars like the No. 25 and the No. 100, where it is impossible to cover the top with wax, I now pour into each a large tablespoonful of beeswax and paraffine, right on top of the heated honey, which, when cooled, effects the air-tight sealing. This is an additional inducement to my patrons, as they thus secure a nice piece of wax to slick up their irons for laundry work; while, if put on the cork, it prevents the cork from breaking to pieces while being drawn out the first time.

If I am compelled to reliquefy any bottles of honey (which is very rare) I always set the jars in vats of water deep enough to come up to the necks, as I have seen honey scorch in the lower half of a jar while the upper half was yet candied.

I would say in conclusion to those readers of GLEANINGS who have no honey to bottle, better order a few cans of extracted, and a barrel of the No. 100 or No. 25 jars of The A. I. Root Co., and canvass your nearest town. You will be surprised how easy it is to sell a barrel put up in this neat, useful, and attractive package. It pays to work up a trade in a bad season, for, if you sell no honey in a bad

season, how can you expect to sell three or four tons when you have not previously worked up a foundation for the disposal of your coming crop? I believe this bottled-honey symposium will be the means of showing beekeepers how a large part of our crop can be disposed of, thereby increasing the demand for our product.

Evansville, Ind.

[I would say to our readers that J. C. Wallenmeyer was first known to the bee-keeping world as the author of the song "Queen Jeanette." I think it was dedicated to his "best girl," who subsequently went into partnership with him; and, if I may judge by the picture, she is his best helper in a business which he has been developing for years.

One can readily see by the way Mr. W. writes that he has had a large experience in bottling honey, and is familiar with all its various little details.

It is interesting to note that both he and Mr. Chalon Fowls prefer gasoline-stoves for liquefying honey, for the simple reason that the heat can be more easily controlled. The ordinary cook-stove, using coal or wood, is liable to overheat the honey, and that means either a loss in profits or loss in subsequent trade.

While Mr. Wallenmeyer has covered nearly every detail of the work, yet his familiarity with some features of it is such that he has left us groping a little in the dark. In Fig. 3, for instance, we see what appears to be a method of tin-foiling by means of a leather strap. One end of this strap is fastened to the wall, the other end being held in the left hand. From the description, I judge that the strap goes clear around the neck of the bottle, and that the bottle is slid back and forth, the friction of the strap around the neck causing the edge of the tinfoil to be smoothed out neat and workmanlike. There, I fear I am guessing; at all events, I hope Mr. W. will, in his next article, go into details in the matter of tin-foiling.

Referring to Fig. 1, I assume that the rubber tubing reaching from the wash-boilers to the extractor is a siphon by which the honey is delivered from the square cans to the filling-tank. If I am not right, Mr. W. will please correct.—E.D.]



SECURING HONEY FROM APPLE-BLOOM.

"Good morning, Bro. Doolittle. I came over from Massachusetts (by letter) to have a little chat with you about securing honey from apple-bloom; because, for the last few years, apple-bloom has furnished an abundance of nectar in this locality."

"So it does with us some years; but the rule is that the bees do not secure much from this source on account of high winds, or cold,

cloudy, rainy weather, which usually appears at just the time the bloom is at its best."

"Well, because this is so with you it is no sign that it is with all the rest of the United States and Canada. I know the readers of GLEANINGS would be interested in knowing how to get our bees in the best condition to secure honey from apple-blossoms, and I come to draw you out on this subject."

"The apple-bloom comes so early in the season that it requires more skill to secure many bees in time for a harvest from this source than from any of the later sources."

"This I believe, and that is just the reason I came over to see you and have a chat on this subject."

"In order to produce good results in honey, the first requisite is plenty of bees when the honey harvest arrives, for, whatever else we may have, success can not be obtained without plenty of bees. Again, as hinted at before, these bees must be on hand in time for the honey harvest, else they become merely consumers instead of producers. Many keeping bees are more often working on the consuming plan than otherwise, and, for this reason, tell us the truth when they say 'bee-keeping does not pay.' Our first step, then, is to produce plenty of bees in time for the harvest from apple-bloom."

"Exactly; and that is just what I wish to know, if you can tell me."

"Well, I will do the best I can. But, as I said at the outset, it will require much skill to secure plenty of bees in time for a harvest of honey from apple bloom. From practical experience I find that it takes about six weeks to build up an ordinary colony in the spring to where they are ready to produce honey to the best advantage. As apple-bloom comes from the 20th to the 25th of May we shall have to commence operations to stimulate brood rearing about the tenth of April."

"Isn't that pretty early?"

"Yes, it is early in the season, but not early if we are to be ready for the bloom; and because it is so early in the season is why so much skill will be required."

"I suppose you are right, here. But how about stimulating? How is this done?"

"I have tried many plans of stimulative feeding, both in the open air and in the hive, but finally gave them all up as not being of sufficient advantage to cover the cost of labor and feed."

"Yes, but there are many ways of stimulating, I am told."

"Well, there are ways besides feeding liquid sweets, but not many that have any advantage in them over allowing the bees to take their own course; and unless great care is used, the plan I am about to describe may prove of little value; or, worse still, an actual loss; and my advice to you would be to try it on only a few colonies till you are sure you can make a success of it."

"I will try to remember this if you will hurry up a little in telling what you know."

"When I have decided that it is time to commence active operations for an early harvest, I go to each colony and look it over,

clipping all queens' wings that were not clipped the previous season, and equalizing stores so that I know each colony has enough honey to carry it three weeks without fear of starvation. This last is important, for brood-rearing will not go on to any great extent early in the season where starvation stares the colony in the face."

"Do you find much brood in the hives as early as the 10th of April?"

"If we have had the usual amount of warm weather there will be brood in four combs with each good colony, and it is not best to try to work other than good colonies at this time of the year. The two center combs will contain the largest amount of brood, and I now reverse the position of these combs by placing the two outside combs of brood in the center, which brings the combs having the most brood in them on the outside. Thus, while the colony has no more brood than it had before, the queen finds plenty of empty cells in the center of the brood-nest, in combs having some brood in them, and she at once fills these combs with eggs, so that in a few days they will contain more brood than those which were moved to the outside, while the bees have fed and taken care of this as well as though its position had not been changed. Thus quite a gain has been made in regard to increasing the brood."

"This seems plain, and I do not see how any one could fail thus far. But what next?"

"In about eight days, if the weather will admit, these selected hives are gone over again, and this time a frame of honey is taken from the outside of the cluster, and the cappings of the cells broken by passing a knife flatwise over them, when the brood-nest is separated in the center, and this frame of honey thus prepared placed therein. The removing of this honey, to place it around the outside of the brood, causes great activity in the hive, the queen being fed to a greater extent, and the heat of the hive being kept up so that no brood suffers, even should a cold snap of a day or two occur. Where many err and make a failure here is in giving an empty comb in the center of the brood instead of a frame of mutilated honey. With the frame of comb the bees 'draw up' for a cold snap, and thus the extreme outside brood is left to perish."

"In going over this time, do you do any thing besides inserting this frame of mutilated honey?"

"Yes. As I go over these colonies each time I am careful to know that each has abundant honey to last at least two weeks; for if we wish to obtain the largest amount of brood possible, the bees must never feel the necessity of feeding the brood sparingly on account of scanty stores. It is also necessary to know that there are no cracks or open places at the top of the hive to let the warm air pass out, but tuck all up as nicely as you would fix your bed on a cold winter's night."

"Well, there is something in this getting ready for an early yield of honey—more than I thought. But what next?"

"After seven days more have elapsed I again go over these hives and insert another

frame of honey in the center of the brood-nest, prepared as before. Then in five or six days more the brood in the frames first 'thrown' to the outside will have largely hatched, and these, being on the outside, will be more slowly filled than those in the center, so that a very great gain can now be made by again reversing the brood-nest, which is now accordingly done. The brood is now hatching quite rapidly, and another frame of honey, prepared as at first, can be given two or three days later, for in these frames of prepared honey lies the greatest secret of successful brood-rearing, early in the season. In about a week more we go over these colonies again, this time putting in two frames of prepared honey unless the hard maple and willow are now yielding honey sufficient to cause great activity, in which case frames of empty comb will answer our purpose just as well."

"But by this time you must have brood in all the combs but the last put in."

"Yes; where only an eight or nine frame hive is used, this will conclude the stimulating process; for as soon as our frames are full of brood we have accomplished our object, only that we see to it that there are sufficient stores in sight so that the bees do not slacken in brood-rearing and allow the combs to become bare of brood before the apple blooms, which they will rarely do if they have sufficient stores, and no long-drawn-out cold or stormy time occurs."

"With the stimulating process over, what next?"

"As soon as sufficient bees have hatched so that they can protect the brood without its being so warmly tucked up, the surplus arrangement is to be put on, so that your dish will be right side up to catch the honey when the apple-blossoms secrete it."

"I am pleased to have had this chat with you, and will say good-by."

"Good-by; and may you be prospered by having good weather through apple-bloom this year; for if you are not, all labor in building the colonies up to meet it will be in vain."

Just as I had said good-by, along came a letter from one styling himself "Illinois," with these questions, which I will answer here at his request.

"Will the divided colony, or the colony in the box hive, swarm when transferred by the Heddon short method? What I have reference to is this: Will the remaining bees in the box hive cast a swarm before the 21 days are up?"

"No, not if the box hive is moved to a new stand, as it is intended it should be."

"Is it best to use medium brood or light brood foundation when using wired frames?"

"I have always used the light brood when using wired frames, as such costs less in proportion to the surface filled, and is just as good where wired frames are used."

"Should extracted honey be put in 60-pound cans direct from the extractor?"

"I should say no. It should be allowed to stand a week or more to clarify, in large tanks, when the clear thick honey should be

drawn from the bottom of the tank into the cans. If any hold different views, the readers of GLEANINGS would be pleased to hear from them."



ENCOURAGING RAINS IN CALIFORNIA.

All Southern California is rejoicing over the splendid rains for the past three months. Here at Riverside we have now had 10 inches; and as the rule is for us to get as much after Feb. 1st as we do before that date, it is not at all improbable that we shall have as fine bee-pasturage as we did in the summer of 1895, when I averaged 100 lbs. comb honey to the colony. The way our rains have come this winter insures a pretty fair crop, I think, even if we should not get any more. The 10 inches we have been blessed with has almost entirely come in a gentle fall that stayed where it fell, and the ground, even on the hill and mountain sides, is so thoroughly soaked that beemen are most hopeful. The good year referred to was preceded by 16 $\frac{1}{4}$ inches. In the past three years of failure there has been a total rainfall for all the time of only 17 $\frac{1}{2}$ inches, and now it seems quite probable that we shall get as much this winter as during those three years. At any rate the amount we have had up to this 7th day of February, and the way in which it has come, give us great encouragement for the season soon to commence.

G. K. HUBBARD.

Riverside, Cal., Feb. 7.

BEE-T VS. CANE SUGAR.

Now something else—GLEANINGS, page 44, regarding beet sugar. I am informed that a great deal of sulphuric acid is made from pyrites from Spain, and that arsenic is a component to quite an extent, and is not eliminated in the manufacture. This was the cause of the poisoning by beer which caused such a stir in Britain a short time ago. You can easily see how such a state of affairs could make trouble in beet sugar. I think your father's information is faulty, still I may not quite comprehend its drift. It by no means follows that, because two substances are alike chemically, they are alike in properties. Take, for instance, cane sugar and milk sugar, just alike chemically, but quite different in many characteristics; or try to use oil turpentine for oil lemon, both identical in chemical composition. Or call to mind the characteristics of the red, black, white, and flaky forms of phosphorus, and a late statement says that arsenic and phosphorus are identical. It is constantly asserted that jelly-making and fruit-preserving can not be successfully carried on with beet sugar. Personally I dislike beet sugar, and so far have readily distinguished it. The sugar made at the Rocky Ford plant is nearer to cane sugar than any other I have seen, in

taste. I have for twenty years held that glucose syrups are destructive to health. I can see nothing yet to make me think otherwise, and chemically some of these syrups are quite pure. The important question is their effect on the animal or human organism.

Denver, Colo., Jan. 23. T. LITTLE.

[I believed at the time, that A. I. R.'s statement concerning beet and cane sugar was a little too strong. Still, in defense of what Mr. Rankin said, I would say this: That we have fed our bees on beet sugar for the last ten years, and our percentage of winter loss is as low as or lower than that of any one else I know of. It averages only between two and three per cent, and in extremely hard winters it may run up as high as ten or fifteen. Only one winter in the last fifteen years, that I remember, did our loss reach the high figure named. I have repeatedly tasted samples of cane and beet sugar from the best factories; and had I not known that one was from one source and the other from another, I should have never suspected any difference; and even when the samples were mixed *incognito* I could not tell which was which. Of course, there might be a trace of sulphuric acid or some other deleterious drugs. But the proof of the pudding is in the eating, or, rather, I should say, beet sugar for a winter food—and we have bought from factories everywhere during the last ten or fifteen years—has given us results that could scarcely be better. On the other hand, *before* beet sugar was on the market, and we used exclusively cane, we had some bad results in wintering. It would hardly be fair to attribute these results to the sugar, however, for at that time the art of wintering had not been brought down to as fine a point as now.—ED.]

QUESTIONS ON WINTERING, FROM A BEGINNER.

I am just getting a start with bees, and should like to ask you a few questions concerning their care, and especially wintering.

1. Will bees winter all right here in West Virginia on summer stands, with another hive made just large enough to slip down over the eight-frame Dovetailed hive, thus making a wall of two inches all around, where the hives are set on the ground as near as possible?

2. Would it be better to winter in the cellar, where the mercury gives only 10° below zero for two weeks or so? During a whole winter there will be a week of zero weather, and then a month of open weather. Which would you advise—wintering on summer stands with wintering-cases or in the cellar?

3. Will a colony of bees winter on 30 lbs. of syrup made from granulated sugar?

4. Will the moth-worm destroy a strong colony of bees in the movable-frame hive if they are not destroyed in some way, or will the bees destroy them?

5. Will snow smother the bees if it falls 10 or 12 in. deep, and is not removed from the entrance, and lies for ten days or two weeks?

WILLIAM D. KEPHART.

Rohr, W. Va., Jan. 22.

[1. Yes, bees ought to winter in your climate very nicely when they are in winter-cases.

2. No. I would not recommend cellar wintering in your locality. When there is any considerable amount of open weather, the outdoor plan would prove the more satisfactory.

3. Yes.

4. In modern bee-keeping the moth-worm is no more feared than the wolf in the great centers of population. If the moth-worm makes way with the bees, you may be sure the owner either does not know very much about his business, or at least neglects it. But Italian bees, no matter what their strength is, will defend themselves against moths of any kind.

5. Not much danger of it. Unless the snow heaps up five or six feet deep, there will be very little danger of smothering.—ED.]

SPRAYING DURING BLOOM, DESTRUCTIVE TO BEES AS WELL AS TO THE FRUIT.

Mr. Editor:—You told us on page 103 about spraying fruit-trees while in bloom, and the effects. Can you tell us in your next what effect it had on the bees? C. M. HERBERT.

Salina, Utah, Feb. 7.

[The experiment related in GLEANINGS was not for the purpose of finding out whether the spraying of fruit-trees during blooming-time killed the bees, but to determine whether spraying at such times was injurious to the pollen and its development, and, in general, to the setting of the fruit. The experiment was conducted from the standpoint of the fruit-grower, because it is universally conceded, among all bee-keepers who are in position to know, that spraying during the time of bloom destroys bees by the thousands. Sometimes whole apiaries are so decimated that but few colonies are left from which to make an increase after the spraying season is over. Many instances of this kind are on record. Now, we know positively that spraying during fruit-bloom is detrimental to both bee-life and to the fruit-grower; and as soon as fruit-growers themselves discover that they are losing money, the practice will be discontinued. It is now in order to educate the fruit-growers by calling their attention to the facts.—ED.]

MEASURING BEES' TONGUES.

Friend Root:—In my "tin-can" article I omitted to say that I get from $\frac{1}{2}$ to $1\frac{1}{2}$ c per lb. above the barrel quotations for my honey. In carrying the cans I place my hands under either end of the case. This throws considerable of the weight directly upon the body, which makes it a lighter job.

I finished cellaring my bees Nov. 22—151.

While measuring bees' tongues, why not measure the tongue of the bumble-bee and make comparisons, then there will be no guesswork as to the necessary length. I will send you some of my bees in the spring or before.

ELIAS FOX.

Hillsboro, Wis., Dec. 10.

MARKETING HONEY IN MASON JARS.

R. C. Aikin's article, page 955, prompts me to write some of my experience and make a few remarks anent the retail business of extracted honey. I began tentatively some 18 years ago to retail extracted honey in divers kind of packages. I soon perceived and found that, for my locality, the Mason pint fruit-jar was the thing. As long as glass fruit-jars shall be used, I believe they will sell as honey-packages, for the obvious reason that, when empty, they are worth very nearly as much as new jars, and are used again in all families. I never used or thought well of honey-bottles, useless when emptied of honey. I have discouraged the use of tumblers, as they are too small. A pint, 1½ lbs., is small enough. I have a gross of tumblers in a box; have had them four or five years; had a few calls from grocers for tumblers, but put them off one way or another.

I sell to about 100 grocery dealers, in nine or ten towns, about 250 dozen pints a year. Price now, \$2.25 a dozen, cash down. Until last spring I sold both for cash, or on commission at 15 cts. more, to be paid on next trip, or about 60 days. I warrant the honey every way, and secure the dealer against all losses on account of honey candying, getting shabby, dauby, etc.; take up and exchange, and would buy back if required. I have done and do that yet, on account of prejudice, and to inspire confidence in both myself and my honey. My success is gratifying. Many are getting educated in regard to both extracted and candied honey. Of course, I have a nice explanatory label on every jar.

While it is well to cater to public taste and demand in these matters, I believe we ought to and can also educate and form those tastes and demands in a measure, being careful not to indulge the public too much in matters of niceties and quantities. Why, they would buy honey a penny's worth at a time, or require half-pound or five-cent sections if you would start them that way. Your polishing sections, both before and after being filled, then enclosed in a nice pictured cardboard case, etc., is, in my opinion, an unnecessary and burdensome thing. I sell, also, many hundreds of pounds in common tin pails, 1, 2, and 4 qts., 3, 5, and 10 lbs., at 30 and 50 cts., and \$1.00 respectively. I use largely, as store-cans, second-hand lard-cans. They must not be filled too full, else they will not handle well in melting the honey. A. MOTTAZ.

Utica, Ill., Dec. 22.

[I think there is no question but the Mason jar—an article that is in demand in almost every household—is the most common package for extracted honey in the rural districts; and when one buys such a jar of honey he is not paying for a package that will be of no use to him in the future. The same is true, but to a lesser extent, of jelly-tumblers. These are cheap and very handy, and can be made to hold honey on the plan described by Chalou Fowls, on page 961, Dec. 15th issue. But in selecting a package for the local honey market we must bear in mind locality. Selsler,

Pouder, Tweed, and a number of others who use Muth jars, or bottles of similar shape, cater to an extra-fancy city trade. Some of this is represented by the poorer class who want only a dime's worth of honey at a time; and other portions belong to the "upper ten" that want something fancy. With the last named the cost of the package cuts no figure. They seek something that is attractive in appearance, irrespective of price. The question of package, then, should be decided by local conditions.—ED.]



WE have been having steady cold weather, with scarcely any warming up, for about three weeks. We see by the papers that a large amount of snow has fallen all over the Northern States. As I have before stated, heavy snowfalls generally indicate a good crop of white clover.

WE are receiving more matter, I fear, than we shall ever find room for—matter that is "good stuff," and worth publishing. Although our two last issues were enlarged 16 pages, and although we shall continue to print extra pages for some time to come, it now looks as if we should never find room for all we have on hand and which we should like to publish. If any of our good friends get impatient, let them write and we will return the manuscript. It is not possible to print articles always in turn, as some things would be out of date unless given insertion at once; and even as it is I fear some up-to-date matter is held until it is out of date.

THE CALIFORNIA CROP FOR 1901.

Mr. M. H. MENDLESON says we eastern bee-keepers need not be alarmed by the glowing prospects of honey in California. While, undoubtedly, there will be a heavy honey-flow, there are not a quarter, he says, of the bees there were formerly, to gather the crop. He does not think, therefore, that California honey will be very much in evidence in the eastern markets, even this year, as the local consumption will probably take care of all there is produced.

THE MICHIGAN FOUL-BROOD BILL.

THIS measure, about which so much was said in our last issue, has, as I am informed by Hon. Geo. E. Hilton, passed the Senate, and is now in the hands of the State Affairs committee of the House. Mr. Hilton has seen the members of this committee, and also the Speaker of the House, and writes that he has the promise of their support. He says, moreover, he will stay and see the Ways and Means committee, to whom the bill will next be reported, and that, if he can get both committees to agree to offer a favorable report, we may expect it to pass.

In the meantime, our subscribers in Michigan will remember to write not only once, but write again if necessary, to their members of the House. See last GLEANINGS.

YORK'S PATENT DOUBLE-ACTING BEES.

WHILE we were on the cars *en route* to the Wisconsin convention, Mr. York poked fun at Mr. Hutchinson and myself on this matter of measuring bees' tongues. Mr. Rankin, you are aware, measures the whole tongue, while we measure from the mandibles to the end of the tongue. When Mr. Hutchinson and I were discussing which was the *right* way, Mr. York facetiously remarked that he had a plan that was better than either; and that was, to measure from the end of the bee's tongue to the end of the sting. There could be no confusion if we measured thus. And he proposed, further, that Hutchinson and I go into the business of breeding bees that could suck up nectar from "both ends" at one time, something like a patent double-acting double-plunger pump.

GOOD INDOOR WINTERING AT THE HOME OF THE HONEY-BEES.

WE are wintering 38 colonies in a compartment 8 feet square, in the center of the basement of our machine-shop, which is 36×96. The floor above is 7 inches thick, and is supported at intervals of 9 feet by means of 12-inch walls running lengthwise through the basement. Between two of the inner walls is the bee-room referred to, 8 feet square. At one end of the room is a board partition, and the other end is composed of several thicknesses of heavy matting and carpeting. There is no provision for ventilation, and the only air that can get into the compartment is through the matting referred to. Notwithstanding the rumble and noise above, of machine tools, the constant walking to and fro, the dropping of heavy pieces of steel, and notwithstanding the bees have been absolutely left alone, examination for the first time to-day, Feb. 21, showed that the bees were wintering well. They were perfectly quiet, and there were not enough dead bees on the floor to fill even a half pint cup. Examination of clusters under the frames shows the bees to be healthy and prosperous, not even one colony showing any signs of uneasiness. It will be observed that this compartment for the bees is in the center of a large basement in which are located pipes, iron rods, and two or three carloads of potatoes. It is necessary that the potatoes should be as cold as possible and not freeze, so it is the practice of our boys to open and close the windows in the general basement. There is plenty of fresh air in the outer room; and this air, being warmed up, finally percolates through the matting into the room referred to. The temperature of the bee-room is 48 degrees F.

It may be there is something in Ira Barber's statement that indoor-wintered bees should not receive direct infusions of air from outdoors. In our case, if they get it at all, it has to pass through a long passageway, where it

is warmed to about 40 or 45. It then reaches the bees. See Straw in this issue, referring to Ira Barber's method of wintering.

E. FRANCE'S BARREL TALK; HOW TO TEST A BARREL FOR LEAKAGE.

PRES. FRANCE, at the Wisconsin convention, told how to test a barrel, into which it is proposed to put honey, for leakage. In the first place, he explained that there should be good cooerage; that the staves should be made of sound kiln-dried stuff, and that nothing but *iron* hoops (not wooden ones) should be used. The barrels should then be placed, not in the cellar, but in a good dry room. Just before they are filled the hoops should be driven down as far as they will go. To test for leakage, proceed as follows: Drive one of the bungs in, and then, with the mouth placed tightly over the other bunghole, breathe in air as long as you can stand it. The lungs should be re-filled through the nose, and then the air should be expelled through the mouth into the barrel until considerable pressure is made. Quickly slide the palm of the hand over the opening, and then listen for any hissing. If the barrel leaks at any point the air can be heard coming out. When you have found the spot, or think you have, dip the fingers in water and rub them along at the point of the supposed leak. If the air is working its way out, bubbles will form. The hoops should then be driven until the crack closes, and the operation repeated until no air escapes. If the barrel holds air for a considerable length of time, the pressure not going down perceptibly, it may then be known that the barrel is tight.

Mr. France explained that it is bad policy to pour water into a barrel to see if it leaks, as that causes the staves to swell and temporarily close a leak, and then when the staves dry out again, and the barrel is filled with honey, the leak appears when the barrel is full of honey. It should be borne in mind, he said, that the staves of a barrel will sometimes shrink, notwithstanding the barrel is full of honey.

He further explained that, while he is a user of barrels, yet for the *average bee-keeper* he would recommend *tin cans*, because there are only a few people who know how to make a good barrel, and few who know a good barrel from a poor one.

HOW TO PARAFFINE A BARREL.

In this connection it was Mr. E. D. Och-sner, a practical bee-keeper of Wisconsin, who explained that there was a great waste of honey if barrels are not paraffined on the inside; that one scarcely realizes the loss if he does not weigh the barrels before filling them with honey, and after they are emptied. The barrels, he said, should be made good and tight first, and then should be paraffined on the inside by pouring hot paraffine in the bung, closing it, rolling the barrel around, and then standing it on one end, and then on the other, so that every portion of the inside should be coated. The bung should be driven out, allowing the surplus paraffine to run into the pan whence it was poured.



TRAVELS IN THE SOUTH.

Although I have been over the Louisville & Nashville between Cincinnati and New Orleans toward a dozen times in years past, I enjoy the trip each time almost as much as I did at first. With modern improvements we can get on a fast train at Cincinnati at 6 P.M. and reach New Orleans the next evening. To do this the train stops only at large cities. Meals are served on board. This saves time, but I have often objected to the extra cost. Last evening I noticed on the bill of fare, "Armour's Chicken Tomales, 20 cents." In San Francisco or in Arizona, Mexican tomares (pronounced *-mal-e*) are a common thing. They are made of pounded corn, chicken meat, etc., with plenty of peppers (chili), and served hot; but it was a new thing on a Pullman car—a new thing that *Armour* should run opposition to the Indians in their manufacture. I didn't suppose a tomale would make any thing like a meal, and so I ordered other things with it; but, to my astonishment, for the 20 cents four tomares, smoking hot, done up in *corn-husks* in true Indian fashion, came on a plate. They made a pretty good square meal of meat and vegetables; and although Armour had put in rather more chipped beef than *chicken*, it certainly made a very nice, appetizing, and *low-priced* addition to the *menu*.

When I left Ohio, every thing was white with snow and frost; but as I opened my eyes this morning the full moon was shining on bare fields—not quite green fields, but the hills were covered with the green foliage of the evergreen-trees. The scenery along about Blount Springs and Birmingham, when illumined by the morning sun, is especially fascinating. The rocky hills are not only covered with beautiful pines and cedars, but by sparkling cascades and rapids leaping from rock to rock along the railway. I always enjoy watching a stream, because it tells when we are climbing up or going down. At one point we went up what seemed to me a pretty steep grade for more than a mile. It seemed like going over the Rocky Mountains. As we get further south the hills gradually change to level timber land and swamp, and, finally, to great expanses of canebrake and tall swamp grasses, higher than one's head, with bodies of water interspersed, until we begin to get views of the great ocean itself, or rather, perhaps, the great Gulf of Mexico. Of course, the cotton-fields, sugar-cane, and other southern crops are a novelty to the Northerner.

Through the swamps and wet woods the palmetto surprises and delights one who sees it for the first time; also the beautiful Spanish moss that usually comes into view at about the same time. The lumber industry continues to grow, much as it was a dozen years ago or more, but on even a larger scale in many

places. The supply of nice trees for timber and boards holds out better than in Michigan, seemingly; and then all along in the low wet woods, where water always stands nearly one foot deep, is found the beautiful cypress. For building greenhouses, and for making hot-bed sash, there is no wood in the world like cypress. The heat, dampness, cold-without-and-hot-within conditions that rot and twist every other timber seem to have little or no effect on this clear straight-grained wood. I have sometimes thought that it is because it grows *in* the water is the reason that wet and heat never harm it. Greenhouse rafters (or sash-bars) are often furnished of cypress, 20 or even 30 feet long, without a knot or flaw of any kind.

At New Orleans I left the L. & N. to take a trip up the Illinois Central toward Jackson, Miss., to visit Mr. Day, the author of the tomato book. At Ruddock Station, a town built by the Ruddock Cypress Co., there is quite a little village with its streets all water, or, perhaps I should say, water and water-plants. A great sawmill is located in a cypress swamp, and the town is for the wives and children of the workmen. Of course, the houses are all on piles, as are the plank sidewalks too, for that matter. I at first wondered why they had streets at all; but it would hardly look businesslike if they didn't have spaces where one could imagine streets might sometimes be needed; but then, where is the earth (topped with gravel) to come from? Well, over near the mill they are starting streets by dumping sawdust into the water where the streets are to be. I began wondering why it is that the children didn't tumble off those plank walks, and go plump into the water. Perhaps they learn by "intuition" (the *girl* babies, any way) not to fall "overboard."

One often wonders at the queer names of railroad towns. The L. & N. has one called "Pine Barrens." I wondered at this somewhat, especially as it is in *Florida*, where they have so many spread-eagle names. It looks truthful and honest, any way—*painfully* honest—if they ever have a real-estate boom for that locality. On the Illinois Central there is a station called "Gulletts." I have thought many of the names of new places sounded as if the people were really hard up for a name at christening time. Hadn't some one better write a *book*, or at least an article, on "naming new towns"? Perhaps the U. S. Post-office Department might take the matter up jointly with the companies that are building new railroads.

Well, my good friend Day is still growing tomatoes, and using the cloth-covered beds, as he was nine years ago, and of late he uses the beds the fore part of the winter for growing the finest *cabbage plants* I ever saw. Cabbage is so hardy the cloth is all the protection he ever needs in his locality. Last season, from plants grown by this new method he not only grew the first cabbage, but the *finest* new cabbage, sent off to market; and, as a result, he got as high as \$8.00 a crate for some of it.

I wonder if I dare tell a little *story* about those nice cabbages. One of friend Day's

boys got to smoking cigarettes. His father told him if he would break right square off he would send him to the State Agricultural College. The boy went one year, and was not only cured of the bad habit, but he put his schooling in practice, grew the cabbages, and from the sale of them got money enough to go back to college again.

I was remarkably impressed with the very neat and tidy appearance of every thing about the "Day" home. Even the poultry-house was as clean and neat "as a parlor," or pretty nearly that, when you compare it with most chicken-roosts. Just before I came away my friend explained it. Some time ago I described how Terry had cleaned up all of the trash and every thing unsightly, and moved all the old rubbish, not only back in the lots, but put it over back of a hill where it could not be seen at all from the house. I think Mrs. Day had something to do with cleaning up around the Day home. Well, it made me ashamed of our home. I had given a little "lecture" on the subject, and Mrs. Root had pointed out the unsightly things, but it was "put off" again and again. Mr. Day says there is money in such a "slicking-up." He says now if he wants a stick or board of a certain size or kind, instead of hunting all over the premises for it he just goes over where they are all put away, nicely sorted, and puts his hand right on the very best thing there is on the premises for that particular purpose.

The names of places in the western part of Florida are certainly unlike names of places anywhere else, and they have always been to me attractive and almost musical. I suppose they are Indian names, and I should be very glad to know the meaning of, say, Wewahitchka, Apalachicola, etc. Of course, these names are rather long; but the place where I now sit writing is called Iola. This is short enough, and very pretty—*ever* so much to be preferred to—well, we will say Vanburen, a name that is used in almost every State in the Union.

Before daylight Saturday morning, Feb. 9, the man who came down to the boat for the mail at Marchand's Landing escorted me into Mr. Marchand's home—yes, right into his bedroom, and astonished us all by saying to the sleeping man:

"Mr. Marchand, this is A. I. Root, the man you said you expected." and, having done his duty, the postman marched off, leaving me to shake hands with a man before he had his clothes on, and almost before he was awake. Mr. Shepherd, the apiarist, was hustled out of bed after about the same fashion, and then we went out among the bees and talked bees.

The Marchand apiary has so many things to commend it I will describe it somewhat in detail. Between 200 and 300 hives are arranged in double rows so as to form a sort of hollow square. The operator stands between the two rows, and hive-entrances all point outward, so he is never obstructing the flight by getting before the entrance of any hive. The stands to hold the hives are a sort of bench, say 16 feet long. The hives rest on boards 6 inches by 16 feet, set up edgewise, and nailed to stakes. The hives are supported just high

enough from the ground to make it easy to work without stooping; and I want to say to you that, after looking over quite a number of hives, I don't believe I want any more down flat on the ground. The long stand (16 ft.) has some objections, such as jarring the next hives, getting around each hive, etc.; but the ease with which the whole apiary may be lined up level, and rows straight, I think compensates for all the other. I expect to give you some kodak views of it all, later. At present the hives have no shade over them, for every bit of sunshine is wanted from now on until very warm weather. When shade is wanted, loose boards are to be placed on rafters just high enough to clear the head. Mr. Marchand uses only fixed bottom-boards, and his plan of feeding is, I believe, about the cheapest and simplest that can be gotten up. A third strip of board runs the whole length of the hive-stand I have described, placed so if any hive is moved a little forward the back end will drop enough on the strip so as to be a little lower than the front or entrance end. Now pour in a pint or quart of syrup right on the projecting entrance, just after the bees have stopped flying at dark, and your feeding is done. No harm is done if the hives are left this way, providing the back end is lifted up and pulled back before a shower comes. When you want to lift any hive from the stand, do so by placing the back end against your body, and right here comes in the need of hand-holes on sides as well as ends of all hives. Marchand and Shepherd both say the wooden handles projecting from the hives are not wanted in their apiary, and I quite agree with them. We want no projections, to prevent stacking hives up tight and snug, if we can possibly avoid it. All hand-holes should slant a little up as the cut goes deeper, and the sharp corner of the board on the under side of the hand-hole should be cut down or beveled off. This apiary has hives all numbered; but the number is on the stand, under the back end of the hive, and not on the hive itself. Mr. Marchand has quite a lot of eight-frame Dovetailed hives with sides of half-inch boards instead of $\frac{3}{8}$. Why are not these just as good for this climate, thus saving both freight and lumber? Large amounts of pollen were carried in, and quite a little new honey, the day I was there. Mr. M. has another out-apiary, like the one I have described, and the two contain about 500 colonies. When I asked if 250 or even 200 in one spot were not too many, Mr. Marchand said he one year got over 125 lbs. per colony right through an apiary of over 200, and that he has never gone below an average yield of 50 lbs. per colony—usually 75 or more.

As there is no church or Sunday-school nearer than Wewahitchka, 15 miles distant, I took a boat again at night, and reached destination just as I saw some children starting for Sunday-school with their Bibles in their hands. I asked if I could not leave my valise inside their gate and go with them. I had before seen bee-hives in their yard, and when I learned that Mr. Thomas Spencer, their father, was superintendent, I consented to wait a little

and walk along with him. One minute I felt a little lonely and almost homesick because I was a stranger in a strange land; but the next minute I was — almost one of the family. A little later I was astonished to hear that I was expected to "preach" in the evening; and before I could correct the statement the friends were introducing me as *Rev. A. I. Root*. After my talk in the evening the pastor remarked that, even if it was as I said in my introduction, I was no preacher, and never had, and surely never *would* even *try* to preach a sermon, he felt, notwithstanding, they had listened to a very good sermon from a business man's standpoint, and told in a business man's language.

I shall always remember with pleasure the way in which the people of four different churches in Wewahitchka unite and work together in all Christian work. It rejoices my heart, also, to know they have a law, well enforced, that keeps saloons out of all the small towns in Florida, and perhaps this is the reason they have so many good men and women working together in harmony. Now, Florida should speedily get a similar law that will stop the cigarette business among *blacks* as well as *whites*, for it is getting a fearful hold, even among the small boys of both colors.

Alderman & Roberts have the largest number of colonies in one spot I ever saw or heard of. In 1891, *680* stands of bees, all in Mr. Roberts' dooryard, gathered an average per colony of 65 lbs. More than *22 tons* of honey was brought in to that one spot, in one season, and all collected from flowers within the range of the bees' flight. Can the world furnish a parallel? At that time there were no other apiaries near; but now there are several within three or four miles that will likely make another yield like that improbable. There may be other points out in the swamp equally good, but the apiary would have to be situated on a platform of boards, above high water; and Mr. Alderman says that, during the dull season, when nobody is around, the bears would be almost sure to destroy an apiary so located.

During the great yield I have mentioned, a single colony, one of that 680, brought in 18 lbs. in one day. Only one was placed on the scales, and that one was probably no better than many others. The source was mostly from a tree called tupelo, and this tupelo honey *never candies*.

Much time and honey have been spent, and very likely much wasted, on arrangements for extracting honey, and doing it rapidly. Mr. Roberts has, perhaps, one of the best-arranged extracting-houses, for his has been gradually arranged as *real practical work* seemed to indicate it should be. With his apparatus, and ten people, mostly his children if I am correct, they have extracted ten barrels (perhaps two tons) in a day.

Sometimes when I meet with such earnest, honest, and kind Christian men and women, in whose every thought and word the love of God shines forth, I rejoice that God has permitted me to live, and know this kind of people. I found such friends at Wewahitchka.

Mr. Isabel, of Wewahitchka, has a very neat and pretty apiary. The hives are set on stands, much as I have described; the ground is raked clean and level, and it is really a pleasure to walk around through it. As we came up he said he had a queer case of robbing. It was still going on quietly, but the robbers were coming out and running up the front of the hive before taking wing, but heavily laden. The bees belonging to the hive either didn't know their stores were going off, or didn't have spunk enough to fight. Mr. Isabel sprinkled flour on the robbers (*a la Utter*), and hastily watched the entrances to all the 200 or more hives. In about a minute I called, "Here they are, boys;" and all hands came to see the dusty white bees scramble in with their huge loads. In a minute more we "swapped" places with the hives. The loaded robbers rushed in as they had been doing, as soon as we got the hives in place; but, lo and behold! they were taking their stores into the very hive they took them out of! One can imagine how they rushed out and in, rubbing their eyes to be sure they were awake, and may be scratching their little heads in perplexity to know what had happened. At any rate, in 15 minutes both colonies were quiet, and apparently normal. The colony that wouldn't protect themselves, of course received quite an accession of bees, and, very likely, bees that knew how to fight. I wish we might invent a similar plan to wake up mayors and policemen that can't see the ruin saloon-keepers are doing by violating the law, unhindered, right under their very noses.

The Apalachicola River has been for a week on a rampage. For a hundred miles or more the water is pouring over the banks at intervals on either side, and going off into the swamps and woods, but still the water keeps up. Like other large rivers on low flat ground, the sediment brought down for centuries past has raised the river bed and banks above the surrounding country, and now it is breaking out into new channels. It looks odd to see streams pouring out of a big river, all along, instead of emptying into it. Such freshets are common almost every spring, and whenever there is much rain. When we bee-keepers were all together one day Mr. Alderman told

A PRETTY GOOD FISH STORY.

He had a nice garden with a good tight close picket fence about it, to keep out the chickens. One night the river came up suddenly, and while the yellow water was pouring in at the garden gate, which had been left open, he noticed a school of good-sized catfish pouring in at the garden gate with the water. After they all got in, and the water had settled down a little, the folks went out in a boat, swung the gate shut, and fastened it securely. The small fish slipped out between the pickets, but the big ones were captured in such numbers they had catfish enough for all the town for a long while. We all had a big laugh, I assure you; but Mr. A. declared it was true, and he is a *very* good man, and as honest and steady as the day is long.

SPRAYING FRUIT-TREES.

The question of spraying fruit-trees to prevent the depredations of insect pests and fungus diseases is no longer an experiment but a necessity.

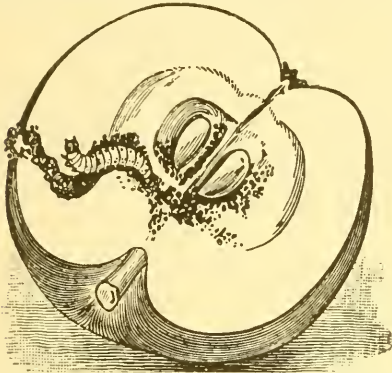

Our readers will do well to write Wm. Stahl, Quincy, Ill., and get his catalog describing twenty-one styles of Spraying Outfits and full treatise on spraying the different fruit and vegetable crops, which contains much valuable information, and may be had for the asking.

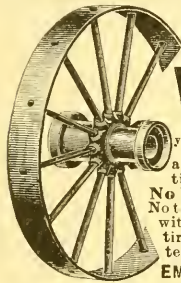

STEEL WHEELS

for your **FARM WAGONS**
any size wanted, any width of tire. Hubs to fit any axle. No blacksmith's bills to pay. No tires to select. Fit your old wagon with low steel wheels with wide tires at low price. Our catalogue tells you how to do it. Address **EMPIRE MFG. CO., Quincy, Ill.**

\$50.00 POP CORN.

100 seeds of this wonderful new Pop Corn for 25c and chance to compete for our cash prizes. Seed Due Bill good for 25c worth of other goods **FREE** with every order for Pop Corn. First prize winner last year raised at the rate of 188 bushels per acre. We will pay \$50 for its equal in quality. Handsome seed catalog and free presents with every offer.

C. M. Goodspeed, Skaneateles, N. Y.

Popular Books at Popular Prices.

Black Rock. By Ralph Connor; 50,000 sold; authorized edition; formerly 50c; my price 25c—by mail, postpaid, 33c.

An English Woman's Love Letters. Authorized edition, 25c; by mail, 32c.

Elizabeth and Her German Garden. 25c; by mail 32c.
Eben Holden, Alice of Old Vincennes To Have and to Hold, Master Christian, and other regular \$1.50 books, \$1.10 each; by mail, \$1.24.

Walks and Talks in the Geological Field. By Alexander Winchell; revised edition for Chautauqua Circle; paper, print, and binding the best; 353 pages; regular price \$1.00; limited supply at 35c; mail 49c. Five other Chautauqua books, same quality, same price (35c, or 49c postpaid) while present stock lasts—only a few copies of some titles. List for asking.

Your Money Back if you return at once any unsatisfactory book bought of me.

Reference. The A. I. Root Co. (for whom I worked 10 years). Books inclosed with shipments from them if desired.

M. T. WRIGHT, Medina, Ohio.

Honey Queens.

Have you noticed the change in my P. O. address? Did you know I am seeking to give my customers the best service possible?

Did you know that I have as good or better queens than can be bought elsewhere? Many have found this out, and continue my best customers. Golden and leather colored honey queens, bred in separate apiaries. Bees, nuclei, and full colonies for sale.

Price of queens—March and April—tested or untested, each, \$1.00; 6 for \$5.00; \$10.00 per dozen. Breeders, \$2.50 to \$5.00 each.

— ADDRESS —

W. H. LAWS, BEEVILLE, TEXAS.

LONE STAR APIARIES

C. F. Davidson & Sons, Props.

Breeders of fine Italian queens. Established in 1885. Write for Circular.

C. F. Davidson & Sons, Fairview, Texas.

Golden or 5-banded; 3-band Italians.

Some Points.

We have been extensively producing honey for the last ten years, hence know the value of good queens. During all this time we have made a close study of queen-rearing, and now run over 500 nuclei, hence we know how to rear good QUEENS. During the last two years we have spared neither time, money, or skill in procuring and breeding up our strains of bees. We have bought queens from almost all who have claimed to have superior stock. We have taken them, tested them, and crossed them to each other and to our already fine stock of bees, and we now have the finest strains in the United States. WE GUARANTEE ALL QUEENS to be large, prolific, and well developed, to give entire satisfaction, and to arrive at your postoffice in good shape.

We have wintered over 800 fine queens, and our prices will be: Tested, \$1.25; select tested, \$2.60; breeders, \$3.00 to \$5.00 each; untested queens, March 15, \$1.00; after June 1st, 75c. Discounts in quantities, and valuable premiums given away to customers. Send a postal for large circular; tells all about our queens, methods, etc.; gives valuable information to every one.

N. B.—Motto, "High-grade queens, prompt service."

O. P. HYDE & SON, Hutto, Texas.

EARLY QUEENS FROM THE SOUTH

We are rearing queens now in full colonies by the best methods known. Tested queen, \$2.00. Untested, \$1.00; 6, \$5.00; 12, \$9.00. Full colonies, \$6.00; 3-frame \$2.00; 2-frame, \$1.50. Add price of queen to nucleus wanted. Write for discount on large orders, and circular. Satisfaction guaranteed.

Christian & Hall, Meldrim, Georgia.

PACIFIC QUEENS.

Wanted.—Addresses, especially on Pacific Coast, for my circular of best queens, and club rates on bee papers.

W. A. H. GILSTRAP, GRAYSON, CAL.

Don't Forget that I am booking orders for my strain of **Business Bees** that have been bred for working qualities for years, and have made some of the largest yields on record. Write for circular.

J. B. CASE, Port Orange, Fla.

Maple Sugar and Syrup.

We are again prepared to furnish choice Medina County maple sugar and syrup. Do not fail to get our prices. It is too early to name prices at this writing, but we will quote by letter on application.

THE A. I. ROOT CO., Medina, O.



NATIONAL BEE-KEEPERS' ASSOCIATION.

OBJECT:—Defense of the rights of bee-keepers; prosecution of dishonest commission men and glucose adulterators; but only members are entitled to protection.

OFFICERS:—E. R. Root, President, Medina, O.; R. C. Aikin, Vice-president, Loveland, Col.; Dr. A. B. Mason, Secretary, 3512 Monroe St., Sta. B, Toledo, O.; Eugene Secor, Gen'l Manager, Forest City, Ia.

FEES:—Annual membership fee \$1.00. Remittances may be sent here or to General Manager as above.

EXTRACTED HONEY.

We still have on hand several large lots of choice extracted honey in barrels and 60-lb. cans. We want to close this out this month and will make low prices. Let us know what grade and quantity you want, and we will name prices.

WIRE POULTRY-NETTING.

We call attention to the very low prices on Climax netting named in this department a month ago. We are prepared to supply it promptly, either from here, Chicago, or Georgetown, Ct. Send for catalog of netting and fencing if interested.

BEESSWAX WANTED.

Until further notice we will pay 28 cts. cash, 30 cts. in trade, for average wax delivered here. It takes a large quantity to keep us supplied at this season of the year. Shipments have been coming in freely, but we can use all that may be received. Be sure to mark your shipment so that it can be identified on arrival here.

CHOICE SECOND-HAND 60-LB. HONEY-CANS.

A month ago we called attention to a choice lot of second-hand honey-cans now stored in Buffalo, N. Y., and which we offered for sale at these prices: 10 cases of two cans each, 50 cts. per case; 50 cases at 45 cts.; 100 cases or more at 42 cts. It is desirable to move the rest of this lot as soon as possible; and if you wish to take advantage of this offer, let us hear from you at once. We have received a 100-box lot here, and find them excellent value for the money—practically as good as new.

BUSINESS AT THIS DATE.

As we go to press we are shipping from four to six carloads of bee-supplies a week, but are still about twelve cars behind. There is a favorable outlook in many localities, which promises much better honey crops than previous recent years. The prospects in Southern California are especially promising; but there are scarcely a fourth of the bees left there compared with three years ago. Texas is also expecting a larger yield, judging from the quantity of supplies being sold there. Colorado is also booming as usual. By getting some outside help in printing this issue we are enabled to rush out our catalogs more promptly, and we expect soon to cover our list of names with a new catalog.

DRONE-SIZE COMB-FOUNDATION.

Having a demand in England for medium brood foundation, drone size, for extracting combs, we have completed attachments for our foundation-mill cutting-machine so we are now prepared to supply comb-foundation mills, drone size, in rolls 2½ inches in diameter, at 20 per cent advance on regular worker size, viz., \$30.00 for 6-inch; \$36.00 for 10-inch; \$42.00 for 12-inch, or \$50.00 for 14-inch. We are also prepared to furnish drone foundation in medium-brood weight and thin super weight at 5 cts. per pound advance over price of regular worker size. There may be some who wish to experiment with drone foundation, and if there proves to be sufficient demand we may arrange to stock it at various distributing points at regular prices. For the present it can be obtained from here only.

FIRE SALE

OF BEE BOOKS!

On January 1st there was a severe fire in our building, burning out entirely four floors above us. The water that was thrown on the fire came down through our floor damaging our stock of books, printing-office, etc. Some of the books were wet slightly, but enough so that they could hardly be sent out as perfect. These are the ones that we wish to offer. The reading pages of all are perfect, only the covers being a little soiled. Here they are, with prices, postpaid:

Prof. Cook's "Bee-keeper's Guide," only 60c.
Doolittle's "Scientific Queen-rearing," only 50c.
Newman's "Bees and Honey," only 40c.

They are all cloth bound, and latest editions. If you want a year's subscription to the old **Weekly American Bee Journal**, with any of the above books, add 75 cts. to your order. This is a **SPECIAL OFFER**, and will last only so long as the slightly damaged books last. Better order **AT ONCE** if you want a bargain. Remember we are

Headquarters for

Bee-keepers' Supplies !!

Catalog and sample copy of the **AMERICAN BEE JOURNAL**, FREE. Ask for them. Address

George W. York & Co.,
144-146 Eric St., Chicago, Ill.

WE WANT

to sell you bee-supplies. Our line is all new and complete. Send for our illustrated catalog. It will convince you that our Dovetailed hive is the best on the market. Our prices are right and our service is prompt.

Fred W. Muth & Co.,
5-W, Cor. Front and Walnut Sts. Cincinnati, Ohio.

Dittmer's Foundation !!!

Retail---Wholesale---Jobbing.

I use a PROCESS that produces EVERY ESSENTIAL necessary to make it the BEST and MOST desirable in all respects. My PROCESS and AUTOMATIC MACHINES are my own inventions, which enable me to SELL FOUNDATION, and WORK WAX INTO FOUNDATION FOR CASH, at prices that are the lowest. Catalog giving

FULL LINE OF SUPPLIES

with prices and samples, free on application. BEESSWAX WANTED.

GUS. DITTMER, AUGUSTA, WIS.

Wants and Exchange.

Notices will be inserted under this head at 10c per line. You must say you want your ad. in this department, or we will not be responsible for any error. You can have the notice as many lines as you please; but all over ten lines will cost you according to our regular rates. We cannot be responsible for dissatisfaction arising from these "swaps."

WANTED.—A competent man to take charge of four or five hundred colonies. To the right man a good proposition will be made. Write, stating amount of experience, age, etc.

I. A. KING, Almond, San Diego Co., Cal.

WANTED.—Two or three apiaries for cash; located in Colorado; write full particulars; first letters and lowest cash price; comb honey preferred.

THOS. C. STANLEY & SON, Fairfield, Ill.

WANTED.—A refined girl or widow woman, as house-keeper in small family, one interested in bee-keeping preferred. Address

ELIAS FOX, Hillsboro, Wis.

WANTED.—To exchange bicycles and tandems, gas-oline-engines (new and 2d hand, 1 to 20 horse-power), for wood and metal working machinery of all kinds.

ROBERT B. GEDYE, LaSalle, Ill.

WANTED.—To exchange two No. 5 Novice honey-extractors, good as new, for bees.

E. W. BROWN, Box 102, Morton Park, Cook Co., Ill.

WANTED.—A young man of several years' experience to help care for six apiaries the coming season. Give reference, habits, and salary expected.

R. T. STINNETT, Mesilla Park, New Mexico.

WANTED.—A renter for 60 colonies of bees, or will sell the whole to some good man. I can not attend to them as they should be. I have a neighbor who has 40 colonies who also wants to let out on shares. He is only three miles from me. Single man preferred.

R. J. MATHEWS, Rosedale, Miss.

WANTED.—Man of 45 (mechanic); no bad habits; experienced in fruit and vegetable growing, also bee-keeping; handy with poultry, wants a situation; shares or otherwise, or to manage apiary with privilege to buy and do work for part pay.

BEE KEEPER, 925 W. California Ave., Chicago, Ill.

WANTED.—Experienced man on bees. Fine country; only 3 hours from Washington, D. C.

F. G. BASS, Front Royal, Virginia.

WANTED.—Man to work in apiary, and to make himself generally useful.

CHAS. ADAMS, Greeley, Colorado.

WANTED.—To exchange 12,000 berry-boxes, low-Hallock wine-measure quart, in flat, good condition, for Cowan reversible extractor, any size, or good incubator. J. D. BIXBY, Grooms, Sar. Co., N. Y.

WANTED.—A healthy sober young man in large apiary. Address

JOHN NIPPERT,
P. O. Box 1051, Phoenix, Arizona.

FOR SALE.—500 Dov'd-all-around, $3\frac{1}{2} \times 6 \times 2$, sawed, basswood sections—flush all-around—for \$1.50.

THOS. WITTMAN, 52d & Jeff. Sts., W. Phila., Pa.

Root's Goods for California.

We have just received a large carload of sections, extractors, smokers, veils, etc., direct from the factory, and are prepared to supply bee-keepers with the same promptly. Do not send a long distance and pay high freights. Write for our prices.

M. R. MADARY, - Fresno, California.

OUR CATALOG of varieties and prices of Small-fruit Plants, Dahlia Bulbs, S. C. W. and B. Leghorns, B. P. Rocks, Berry Crates and Baskets, ready Feb. 1. Send for it before ordering.

H. H. AULTFATHER, Minerva, Ohio.

\$18 Guaranteed for 10 Years.
Frgt. Prepaid and Money
Back if not Satisfactory.

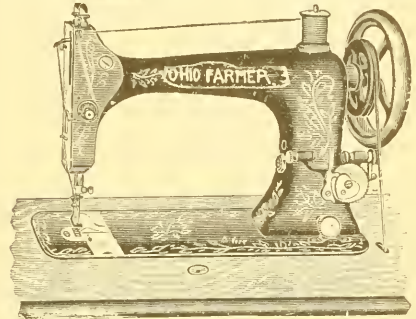

Send us \$18.00 and we will send you one of our NEW IMPROVED OHIO FARMER HIGH-ARM SEWING-MACHINES, freight prepaid. Use it for all kinds of work, and if not satisfactory you can return it in 90 days and we will refund your money and pay freight both ways.

All Guaranteed New Machines.

Self-setting needle; automatic bobbin-winder, with oak or walnut woodwork; new bent wood top; seven long skeleton drawers. Full and complete set of attachments and illustrated instruction book sent with each machine. Every machine we send out guaranteed to give ENTIRE SATISFACTION OR MONEY REFUNDED. We can furnish repairs or needles at any time. Remit by postoffice order, registered letter, New York draft, or express.

If you want the BEST sewing-machine made in the world at the LOWEST PRICE ever offered, send us your order.

Drop Head, \$20.00.

This is the same machine, except the cabinet, which is made so that head drops out of sight when not in use. Four drawers. Freight prepaid. With same attachments as the \$18.00 machine.

Our No. 2 Machines.

Have old-style top tension instead of the new side tension furnished on the others. Not quite as much work on them as the others, which accounts for the lower price; but we guarantee them for the same time, furnish same attachments, and prepay freight.

High Arm No. 2, 5 Drawers. Only \$15.00.

Drop Head No. 2, 4 Drawers. Only \$16.50.

Send for our new illustrated catalog. Address

The Ohio Farmer, : : : Cleveland, Ohio.

NOTE.—We have known the publishers of the Ohio Farmer for many years. They are entirely responsible, and will fully make good their agreements.

THE A. I. ROOT COMPANY.

The Modern Farmer and Busy Bee.

Emerson Taylor Abbott, Editor.

A live, up-to-date Farm Journal with a General Farm Department, Dairy, Horticulture, Live-stock, Poultry, Bees, Home and General News. The Editor has had practical experience in every department of farm work. To introduce the paper, it will be sent to New subscribers one year for 25c. Sample copies free. Best Advertising Medium in the Central West. Clubbed with *Gleanings* for \$1.00.

ADDRESS

Modern Farmer, St. Joseph, Mo

New Smith Premiers Nos. 5 and 6.

The No. 6 takes paper 18½ inches wide and writes lines 16 inches long. The No. 5 takes paper 11 inches wide and writes lines 9½ inches long. These new machines in essential mechanical principles are the same as Models Nos. 2, 3 and 4—unequaled.

Write for Printed Matter Free.

**The Smith Premier
Typewriter Co.**

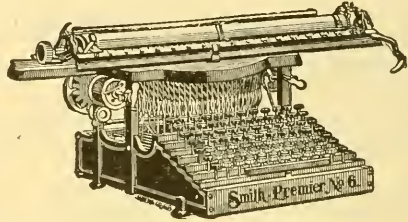

158 Prospect Street, Cleveland, Ohio.

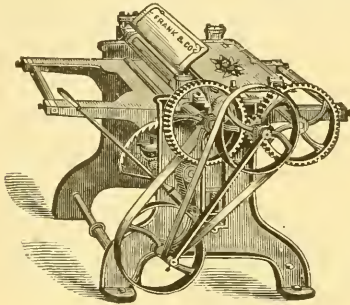

PLANERS

The above cut shows one of our small Planers, of which we make twelve different styles and sizes. Also large Planers, Band Saws, Buzz Planers, Moulders, Wood Lathes, and all kinds of

WOOD WORKING MACHINERY

Send for Catalogue.

The FRANK MACHINERY CO.
BUFFALO, N. Y.

Sweet-Potato Seed.

Sound bright stock of the best varieties. Special rates by express. Descriptive price list free. Address

L. H. Mahan, Box 143, Terre Haute, Ind.

Union Combination Saw

For Ripping, Cross-cutting, Rabbiting, Mitering, Grooving, Gaining, Boring, Scroll-sawing, Edge-moulding, Beading. Full line FOOT and HAND POWER machinery. Send for catalog A. SENECA FALLS MFG. CO. 44 Water St., Seneca Fd., N.Y.

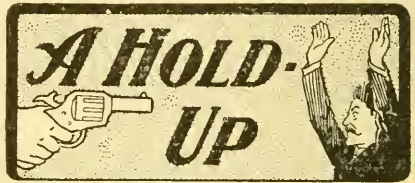

*Is not always the work
of a highwayman.*

When a dealer charges you from 35 to 50 per cent more for a carriage or harness than we would charge you direct for the same, or better, you are certainly being held up. This however, is not the dealers fault. He must live, but why at your expense? We sell our vehicles at factory prices and save you both the jobber's and dealer's profit. We do still better; we send our vehicles on to **Days Free Trial**. Try it before you buy.

If not wholly satisfactory return it at our expense. Write to-day for our free illustrated catalogue.



Kalamazoo Carriage & Harness Co.,
Box 22, Kalamazoo, Mich.

Career and Character of Abraham Lincoln.

An address by Joseph Choate, Ambassador to Great Britain, on the career and character of Abraham Lincoln—his early life—his early struggles with the world—his character as developed in the later years of his life and his administration, which placed his name so high on the world's roll of honor and fame, has been published by the Chicago, Milwaukee & St. Paul Railway, and may be had by sending six (6) cents in postage to F. A. Miller, General Passenger Agent, Chicago, Ill.

FOR SALE.—Apiary in Arkansas Valley, Colo.—175 colonies, Baldwin 2-story hives, comb honey. Address Oliver Foster, Las Animas, Bent Co., Colo.

SPLIT HICKORY

**YOU CAN BEND IT
BUT YOU CANT BREAK IT.**

You can't afford to buy a "shoddy" vehicle, when you can get a famous Split Hickory—made right all the way through—for less money than a dealer will charge you for an inferior job. We ship vehicles and harness direct from factory to anyone

Anywhere on Approval

and save you 1/4 the cost. Don't confuse us with cheap "supply houses," but send for catalog, note our prices and examine the output of our factories. We finish and trim to suit your taste.

Ohio Carriage Mfg. Co., 27 W. Broad St., Columbus, O.



SAVE \$8 ON A HARNESS!

We are the largest manufacturers of harness and carriages in the world selling to the consumer exclusively.

We Have no Agents, Dealers or Middlemen.

We sell you direct from our factory at wholesale prices and save you all additional expense. We ship anywhere for examination. A guarantee and warrant everything. This Elegant Farm Harness for \$21.50. Many customers who have bought it report that they have saved from \$8 to \$10 in buying this harness from us. For full description of this and about 65 other styles of harness and 173 styles of vehicles see our new Illustrated Catalogue. Your name on a postal card will get it.

Elkhart Carriage and Harness Mfg. Co.,

G. B. PRATT, Secy.

ELKHART, INDIANA.

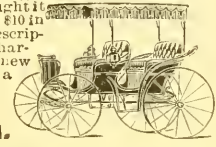
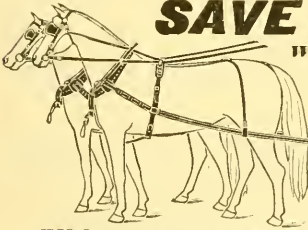

DEAL DIRECT with the Makers.



No. 3034 Buggy. Price \$38.30 with leather quarter top.

When you buy a carriage, buggy or harness, choose from the biggest stock and fullest assortment, and pay only the cost of making, with but one moderate profit added. Our plan of selling direct from the factory insures satisfaction—your money back if you're dissatisfied with your purchase—and enables you to

save the dealer's profit.

Our complete illustrated catalogue, showing many styles of high grade vehicles, harness, robes, blankets and horse equipments, with detailed descriptions of each, mailed free. Write for it and learn how cheaply you can buy when the jobber's and dealer's profits are cut off.

THE COLUMBUS CARRIAGE AND HARNESS CO., Box 772, Columbus, O.

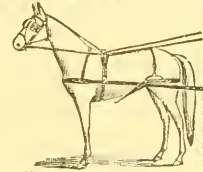

No. 240 Single Strap Buggy Harness. Price \$7.95.

"KEEP OFF THE GRASS"



That unsightly sign will not be needed if you have the **HARTMAN STEEL ROD LAWN FENCE.** Keeps off everything but sunshine and rain. Best for Lawns, Schools, Churches, Cemeteries, etc. Steel Posts and Gates. Catalogue free. **HARTMAN MFG. CO.,** Box 80, Ellwood City, Pa. Or Room 10, 309 Broadway, New York City.

Don't Pay a Cent



of profit to agent or dealer when you can with equal safety, satisfaction and guarantee buy direct from manufacturers and save half the cost. Our Vehicles are built for hard wear. Best materials throughout. New styles. Approved Workmanship. Unqualified guarantee. \$29.25 and upwards. Our Harness and Saddles comprise a complete line of standard work \$4.25 upwards. In no event place your order without writing for our Free Catalogue containing valuable suggestions to the vehicle & harness buyer.

CASH BUYERS' UNION, (Inc.)
158 W. Van Buren St., B-345, Chicago, Ills.

The Power Question

—for farm use, dairies, creameries, cheese factories—anything requiring light power, is best settled by buying one of these

LEFFEL ENGINES.

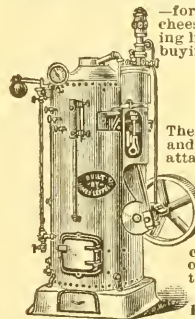

They are made in both horizontal and upright pattern, with engine attached to boilers. Being very simple and direct in construction they are economic of fuel and great developers of power. Best for cutting and grinding feed, sawing wood, pumping water, separating cream, churning, &c. Made of the best material throughout they are durable and long lived.

Send stamp for our Book on Engines and Power.

JAMES LEFFEL & CO., Box 89, Springfield, O.

FOR SALE CHEAP.—100 nearly new second-hand Hilton chaff hives. Hives are at Wallin, Benzie Co., Mich. For particulars inquire of
L. C. WOODMAN, Grand Rapids, Mich.

THE FASHION FLOWER OF THE DAY

Is the beautiful sweet pea. Recognizing the popularity of this garden favorite, we offer for 1901 five new and handsome sorts, for 5 2-cent stamps, together with a copy of our new seed book, the most modern catalogue of modern times. It is so costly a production we cannot afford to gratuitously distribute it. (Postage alone is 5 cents.) We send it postpaid for 10 cents together with one packet of each of these:

5 Grand New Sweet Peas.

Navy Blue. The best to date.	} Five separate packets.
Gorgeous. Unique and distinct.	
American. White striped carnine.	
Royal Rose. A blushing beauty.	
Salopian. Intense scarlet.	

With our new seed book free.

Features of our new catalogue for 1901 are 136 pages (9520 square inches of reading and illustrations) 7 handsome colored plates. A list of novelties in vegetable, farm and flower seeds to be had nowhere else this year. **35 new sorts now offered for the first time**, and a complete list of standard seeds, bulbs, plants, fruits, etc. Other features, full cultural directions and many cash prizes. If you want an up-to-date garden and the best you ever had you must plant Maule's Seeds. Send 10 cents for catalogue and these new sweet peas to-day. Address,

WM. HENRY MAULE,
1711 Filbert Street, Philadelphia.



SEED POTATOES
\$1.50 a Barrel and up.

Michigan Northern Grown are always the best. 20 best varieties. Blight proof, enormous yields, highest quality, lowest prices. Sold in any quantity, one pound to a car load. Catalogue free on request.

Harry N. Hammond Seed Co
Box 69, Bay City, Mich.
Formerly of Elfield.
Largest growers of seed potatoes in America.

Trees

375,000
at Bargain Prices

Apple, Standard and Dwarf Pear, Cherry, Peach and Plum trees. Japan Plums a specialty. Save half your money by buying direct of producer. Our free catalogue of fruit or ornamental trees will tell you how and why. Let us price your list of wants.

For 10c we will mail two plants of our Red Cross Curran.

GREEN'S NURSERY CO.,
Rochester, N. Y.

SEED DUE BILL FREE

To get new customers to test my Seeds, I will mail my 1901 catalogue, filled with more Bargains than ever and a 10c Due Bill good for 10c worth of Seeds for trial absolutely free. All the Best Seeds, Bulbs, Plants, Roses, Farm Seeds, Potatoes and many Novelties at lowest prices. Gluseng, the great money making plant. Giant Prize Tomatoes, 2 to the foot, Pan American Oats, sent on free to farmers, and two Free Passes to Pan American Exposition, Buffalo, N. Y. are offered. \$2,635.00 in cash premiums! Don't give your order until you see this new catalogue. You'll be Surprised at my bargain offers. Send postals for catalogue to-day. It is FREE to all. Tell your friends to send too.

F. B. MILLS, Box 105, Rosehill, Onondaga Co., N. Y.



SEEDS, PLANTS, ROSES, Bulbs, Vines, Shrubs, Fruit and Ornamental Trees. The best by 47 years test. 1000 acres, 40 in Hardy Roses, 44 Green-houses of Plants and Ever-blooming Roses. Mail size postpaid, safe arrival guaranteed. Try us, our goods will please you and direct deal will save you money. Write for valuable catalogue, free.

The Storrs & Harrison Co.,
Box 226 Palmsville, Ohio.

OLDS The Seed Potato Man

grows his own potatoes and guarantees them true to name. Has all standard sorts and the very best of the tested new varieties at the lowest prices.

Olds' Field and Garden Seeds are of equal merit as to purity and quality. Leading farm seeds of best varieties. Also vegetable and flower seeds. Why not buy seeds direct from the grower? Catalogue free.

L. L. OLDS, Drawer H, CLINTON, WIS.



Mention this Paper.

EVERGREENS

Hardy sorts. Nursery grown for wind-breaks, ornament and hedges. Prepaid \$1 to \$10 per 100-50 Great Bargains to select from. Write at once for free Catalogue and Bargain Sheet. Local Agents wanted.

D. Hill, Evergreen, Dundee, Ill.

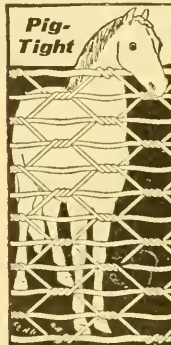

Pig-Tight

HORSE-HIGH!

... BULL-STRONG ...

With our Duplex Automatic Ball Bearing Woven Wire Fence Machine, any farmer can make 100 Styles, and from **50 to 70 rods a day** of the best and most practical fence on earth at a cost for the Wire to make it of from **20 to 30c. per rod** We sell Ornamental Fence and Gates, Farm Fence and Gates. Plain, Barbed and **Coiled Spring Wire** direct to the farmer at wholesale prices. Catalogue free.

KITSELMAN BROS.
Box D31, Muncie, Ind.



SPRAYING

with our new patent **Kerosene Sprayers** is simple indeed. Kerosene emulsion made while pumping. 12 varieties sprayers, Bordeaux and Vermorel Nozzles, the "World's Best."

THE DEMING CO., SALEM, O.
Western Agents, Henion & Hubbell, Chicago. Catalogue and formulas free.

BURPEE'S SEED-SENSE FOR 1901

is mailed FREE to all.

A Bright Business Catalogue of ninety pages that tells plain truth about **BEST SEEDS that Grow.** Write a postal card to-day, or send ten cents (stamps or silver) for **BURPEE'S QUARTER-CENTURY FARM ANNUAL**,—a New Book of 220 pages fully worth a dollar. **W. ATLEE BURPEE & CO., PHILADELPHIA, PA.**



Easy and Profitable Gardening.

The thoughts of back-breaking, hard hoeing and weeding prevents many a man from making money out of a garden. The easier, surer and better way is to use one of our "Planet Jr." Double Wheel Hoes. They cultivate perfectly all garden crops, astride or between the rows. Throw the dirt to or from the row; cultivate the middles; break up the crust and level the surface. They plow, turning furrow either right or left, hill up and furrow out. Have attachments for all this work. Adjustable to any width of row. Strong, durable and lasting. Every attachment of best hardened polished steel. Then, too, they are so easy to handle; children use them readily.

Our 1901 Catalogue (edition 250,000) illustrates and fully describes these and our full line of "Planet Jr." Hill and Drill Seeders, Wheel Hoes, Horse Hoes, Cultivators, Two-Horse Cultivators, Sugar Beet Seeders and Cultivators, etc. Prices greatly reduced for 1901. But send and get a free copy of the catalogue and learn all about "Planet Jr.," and how they are used at home and in foreign countries.

S. L. ALLEN & CO., BOX 710 H, PHILADELPHIA, PA.

Two Gold Medals at Paris Exposition; Highest Award.

ROUGH RIDER,
SEN. DUNLAP,
and other

STRAWBERRIES

100 Varieties.

CUMBERLAND RASPBERRY,
KING OF MICHIGAN POTATO.

HEADQUARTERS FOR HIGH GRADE

Plants and Seed Potatoes.

Descriptive Catalogue Free to All.

FLANSBURGH & PEIRSON, Leslie, Mich.

BIG STRAWBERRY GIVEN AWAY.

We will mail you six plants of Corsican, biggest strawberry on earth, if you will send us 15c. for one new subscription to

GREEN'S FRUIT GROWER and Home Companion for six months. Established twenty years ago. It has 60,000 subscribers who say it's the best family fruit journal in America. Send for free sample copy.

Green's Fruit Grower, Rochester, N. Y.

SALZER'S SEEDS RICH! WILL MAKE YOU RICH!

Billion \$ Grass.
Marvelous grass, wonderful grain, fit for all soil, every condition, every state in the Union. Will yield 12 tons of rich hay and lots and lots of pasture besides. "What is it?" It's the heaviest yielding grass this side of the stars; will make you rich. First crop 6 weaslers' wince. Everybody is asking: "What is it?" Catalogue tells.

Combination Corn.
Greatest golden yellow dent corn of the age. Seed dirt cheap. Will make you rich to plant. Will revolutionize corn growing.

Speltz, Rape and Pea oat.
Three perfect crops. Speltz yields 80 bu. of grain and 4 tons of hay per acre; Rape 25 tons green food and Pea oat 8 tons of perfect food per acre.

Bromus Inermis.
Great & permanent grass of the century. Nothing like it on earth to-day and we have scoured the world for its equal. 4 to 7 tons of hay per acre.

Vegetable Seeds.
Largest growers.
Onion seed 60c lb.

For 10c Stamps and this Notice, we mail big illustrated Seed Catalog and 10 grain samples, including above, also Speltz (80 bu. per A.), Oats (200 bu. per A.), Rape, Barley (175 bu. per A.), Pea oat etc. worth \$10 for a stack.

JOHN A. SALZER SEED CO., LA CROSSE, WIS.

Always Fresh.
Always the Best.

FERRY'S SEEDS

are sold everywhere.
1901 Seed Annual free.
D. M. FERRY & CO., DETROIT, MICH.

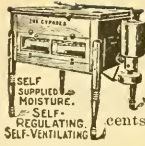

You Can't Afford to Guess

at results in the poultry business. If you fail to raise the chicks, you simply have no business. The way to be absolutely sure about getting the chicks is to employ a **Cyphers Incubator** in your hatching. We guarantee them to last 10 years and to outbatch any incubator made. The best way to know about it is to read our 224 page (8x11 in.) book, "Profitable Poultry Keeping." Has 250 illustrations and covers the entire subject. We send it for 10 cents in stamps. Ask for book 74. Circulars mailed free. Address nearest office. **CYPHERS INCUBATOR CO.** Chicago, Ill., Wayland, N. Y., Boston, Mass.

Mr. A. I. Root's Writings

of Grand Traverse territory and Leelanau County are descriptive of Michigan's most beautiful section reached most conveniently via the

Pere Marquette R. R.

For particulars address W. C. Tousey, D. P. A., Toledo, Ohio.

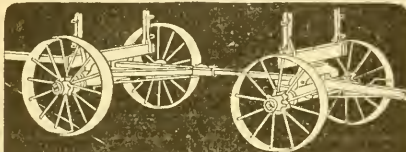

ELECTRIC HANDY WAGON.

When you buy a wagon, buy one that will last you a life time, without costing more for repairs than it is worth. Get one that is easy to load and easy to draw. That's the Electric—the best made wagon in the world. Steel wheels (24 to 56 inches high) widetires, straight or stagger spokes. Send for handsome catalogue of steel wheels, wagons and other implements at money-saving prices.

ELECTRIC WHEEL CO., Box 95 QUINCY, ILLINOIS.

When Your Harness Breaks

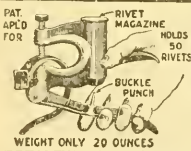

You want something that will fix it on the spot. The

PREMIUM

Combined Riveter, Rivet Magazine and Buckle Punch

is the handiest contrivance you ever saw. Makes a perfect clinch. Holds 50 rivets. Carry it in your pocket. Price \$1, including one year's subscription to

WOOL MARKETS AND SHEEP semi-monthly. The leading authority on all sheep questions.

Liberal terms to agents. We have other publications and novelties. **DRAPER PUB. & SUPPLY CO., CHICAGO, ILLINOIS.**

SEND NO MONEY—but

order any of our Sewing Machines sent C. O. D., on 30 days' trial. If you don't find them superior to any other offered at the same or higher prices or are dissatisfied for any reason, return them at our expense and we refund your money and freight charges. For \$10.50 we can sell you a better machine than those advertised elsewhere at higher price, but we would rather sell you better Quality and Give Satisfaction. Our elegant **Arlington Jewel** drop head, #12.50. Our No. 9 **Ball Bearing** Arlington, 5 drawer, drop head, #15.45. Write for large illustrated catalogue FREE. **CASH BUYERS' UNION, (Inc.)** 158-164 W. Van Buren St., B 345, Chicago

Help the Hens

and They'll Help You.

Cut green bone supplies just the element needed for winter egg production. The

HUMPHREY Green Bone and Vegetable Cutter will cut more bone in less time and with less labor than any other cutter made. We make a positive guarantee on this. Your money back if you want it. Send for our free catalogue and egg record book. **HUMPHREY & SONS, Box 51, JOLIET, ILL.**

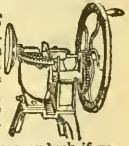

HENS LAY double the eggs when fed on Green Cut Bone.

MANN'S NEW BONE CUTTERS prepare bone in the best and cheapest way. Cut fast, fine, turn easy. Mann's Clover Cutters, newest, fastest, 85¢ and \$1.00. Mann's Swinging Feed Tray and Granite Crystal Grit make the business profitable. Catalog free. **F. W. MANN CO., Box 37 Milford, Mass.**



50 VARIETIES.

I breed fine poultry on one of the best equipped poultry farms in the world. Send 3¢ in stamps for a new 1001 Book, telling all about 50 varieties, with special prices on fowls and eggs. **B. H. CREIDER, Florin, Pa.**

EGGS

\$1.00 for 15 best Brown Leghorn or B. P Rocks. Illustrated descriptive egg-circular free. **H. B. GEER, Nashville, Tenn**

S. C. BROWN LECHORNS.

I use well-striped breeding cocks. Eggs, \$1.00. Cockerels, \$1.00 and up. Also Italian bees. Circular free. **H. M. MOYER, Shanesville, Pa.**

POULTRY-BOOK FREE. 64 pages, illust'd, with trial on our paper, 10 cts. **Inland Poultry Journal, Indianapolis, Ind.**

A BASKET FULL OF EGGS

by using **Ley's Poultry Condition Powders.** Puts all fowls in a normal condition; destroys all disease germs; purifies the blood; is a tonic and nutrient. Price 25 cts. a pk.; 5 for \$1.00. **Ley's Thoroughbred Minorca's Eggs, \$1.00 for 13.** Also Thoroughbred Belgian Hares. **Ceo. J. Ley, Florence, Cal.**

CRUSHED OYSTER SHELLS for poultry; 100 lbs., 60 cts.; 200 lbs., \$1.00 **WISE & CO.,** Wholesale Grocers, Butler, Ohio.

Angora Goats. Handsome pets; profitable stock. Large new circular for free. **EDW. W. COLE & CO., Kenton, Ohio.**

1200 FERRETS. All sizes; some trained; first-class stock. New price list free. **N. A. Knapp, Rochester, Lorain Co., Ohio.**

FOR SALE CHEAP.—Twelve acres of very fertile land with eight-room dwelling, cellar, and cellar-house, barn, store-house, and orchard—well watered, 100 Heddon bee-hives complete, 25 or 30 colonies of Italian bees. A bargain. **C. M. THORNTON, Osage, Ill.**



Direct to Consumers. Our Handsome Catalog Free, costing over \$2 each, contains 144 pages, with 1500 illustrations and 15,000 articles listed, on which we guarantee to save you from 15 to 75%. Most complete book of its kind. Sent for 10c to pay cost of mailing, which will be refunded with first order. Valuable book of reference and ought to be in every household. Get it—keep it handy. **Heiler Chemical Co., Dept 40, Chicago.** "The Only Mail Order Drug House in the World."

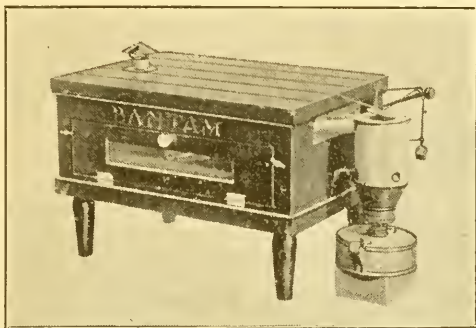

BIDDIES & BEES.

MAKE THEM BOTH PAY.

50-egg Bantam. Self-regulating.

Holds 50 ordinary - size eggs. No sitting up nights. 20 minutes' attention in twenty-four hours will operate it. Sold on

30 Days' Trial for \$5.00

Over 15 000 in use, and thousands hatching 50 chicks from 50 eggs. You can do as well. Either hot-water or hot-air heating. We have a brooder to go with it for \$3.00. Our catalog of valuable information, and describing incubators and brooders of all sizes and prices—all on *trial*—sent for the asking if you mention this paper.

Buckeye Incubator Co., Springfield, Ohio.

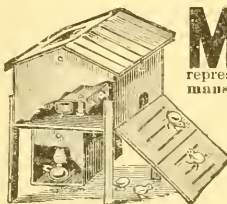

MARILLA INCUBATORS and BROODERS

represent in their construction the best material, best workmanship and finish and the best general plans we know how to bring together in such a machine. For this reason we say to our customers that if they are not found exactly as represented and don't do all we claim for them after a thorough trial, it is no sale. Eleventh year on the market. We make both Hot Water and Hot Air—take your choice. So simple a child can run it. Send 2c. in stamps for catalogue.

MARILLA INCUBATOR CO., BOX 62 ROSE HILL, N. Y.

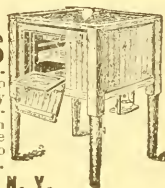

We Pay the Freight.

INVESTIGATE BEFORE YOU BUY.

We want our customers to be perfectly satisfied before they spend their money. Investigate the claims of all incubators and then decide. We believe you will find that the

SURE HATCH INCUBATORS

AND COMMON SENSE FOLDING BROODERS are giving better satisfaction than any other made. It's because they are so simple, sensible and sure. They are built for busy people, who haven't time to fuss and bother. Our catalogue is FREE. We don't ask you to pay for it. Isn't it worth examining?

SURE HATCH INCUBATOR COMPANY, CLAY CENTER, NEBRASKA.

INCUBATOR ON TRIAL

The Perfected Von Culin.

Successful result of 25 years' experience. Scientifically correct, practically perfect. Non-explosive metal lamps. Double and packed walls. Perfect regulation of heat and ventilation. Made of best materials, and highest quality of workmanship and finish.

PRICES \$7.00 AND UP.

SATISFACTION GUARANTEED OR NO PAY. We make Brooders, Bee Hives & Supplies. Catalog and Price List sent Free.

THE W. T. FALCONER MFG. CO.,
Dept. 73. Jamestown, N. Y.

Strong, Healthy Chicks



are hatched by our incubators, and more of them than men can hatch. Why? Because our regulator never fails to keep the heat just right. Catalogue printed in 5 languages gives full descriptions, illustrations and prices, and much information for poultry raisers. Sent for 6 cents.

DES MOINES INCUBATOR CO.,
Box 503 Des Moines, Ia.

ROOM AT THE TOP Recognizing that there was "room at the top," we have issued not an ordinary catalogue but the



20th Century Poultry Book.

Contains the latest and best thought on the poultry question, from the egg through all its changes, to the market. No subject missed. Written from practical experience. The world renowned Reliable Incubators and Brooders, used all over the U. S. and in 51 foreign countries, receive deserved attention. Book mailed anywhere for 10c. RELIABLE INC. & BROODER CO., Box B-49 Quincy, Ill.

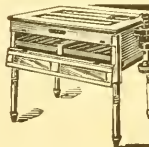

200-Egg Incubator for \$12.00

Perfect in construction and action. Hatches every fertile egg. Write for catalogue to-day. GEO. H. STAHL, Quincy, Ill.

Wake up Bee-Keepers,

To the Changed Conditions.

I have many times advised my readers to keep more bees. We are often asked what will mix the most successfully with bee-keeping, and I have replied, and still say, "a few more bees." In my eastern trip I met quite a number of men who are making money keeping bees—not simply making a living, but laying up money. All of these men, with no exception, keep bees in large numbers, scattering them around the country—perhaps 100 colonies in a place. It isn't profitable to put only a few in a place—there must be enough in each yard to make a day's work when the apiary is visited.

Mr. H. L. McLallen, a former pupil of Mr. W. L. Coggshall, but now the owner of several hundred colonies, made a very bright remark at the Romulus institute. He said: "We can't produce so much honey per colony as we did years ago, but we can make more money. The reason is that we can keep more bees with less labor." The reason of the lessened yield per colony is the cutting off of natural resources, such as clover and basswood, but the improved methods that enable us to manage a greater number of colonies, the short cuts, if we will only recognize and practice them, really gives us advantages over our predecessors. It is in the discovery and practice of short cuts that we must look for our financial salvation. A great many processes that may be employed at a profit in a home apiary, are totally out of place in an out-apiary. The swarming problem, for instance, must be solved by a different process in an out-yard. The honey-extractor is the most satisfactory solution. Give the bees plenty of empty comb in which to store honey, and swarming is practically ended. Years ago extracted honey was of slow sale at a low price, but its use by bakers and other manufacturers has placed the demand upon a firm basis, and, at present, I know of no more hopeful field for the apiarist than the production of extracted honey on a large scale.

Keep a lot of bees, scatter them around the country, and don't use up all your profits in useless manipulations. I wish to see bee-keepers prosperous, and believe I have never given them better advice than I am giving them now. Let me repeat it: Keep hundreds of colonies, scatter them around the country, 100 in a place, produce extracted honey, study short cuts as though your life depended upon it. Personally, let me ask you to give this matter your careful, serious thought. Not only this, but write to me on this subject. Especially would I like to hear from men who have had experience along these lines. Men who have made but an indifferent success with only one apiary, but have made money with several apiaries, or those who have tried running several apiaries and failed, if there are any such, could tell an interesting and instructive story. Let me hear from you. Those who have had experience with both few and many bees are especially invited to write. If I have drawn any incorrect conclusions, or omitted any important factors, I shall be glad to have these defects pointed out. For the best article on this subject, received before March 1st, I will pay \$5.00. For any article that I think well enough of to use, but to which the first prize is not awarded, I will send the writer the REVIEW one year and a queen of the Superior Stock. The establishing and managing of out-apiaries might, very properly, form the latter part of the article.—*Editorial in January Review.*

Remember that the REVIEW is \$1.00 a year, but I send 12 back numbers free of charge. For \$2.00 I send the back numbers, the REVIEW for 1901, and a queen of the Superior Stock.

W. Z. Hutchinson, Flint, Mich.



BEE-HIVES AND HONEY-BOXES,

in car lots—wholesale or retail. Now is the time to get prices. We are the people who manufacture strictly first-class goods and sell them at prices that defy competition. Write us today.



Interstate Box & Manufacturing Co., Hudson, Wis.

Marshfield Manufacturing Company.

Our specialty is making SECTIONS, and they are the best in the market. Wisconsin basswood is the right kind for them. We have a full line of BEE-SUPPLIES. Write for FREE illustrated catalog and price list.

Marshfield Manufacturing Company, Marshfield, Wisconsin.

1881

PAGE & LYON MFG. CO.

1900

We manufacture a full line of the latest BEE-SUPPLIES.

Our motto is, "Perfect Goods and Prompt Shipment."

Send for our new free illustrated catalog.

PAGE & LYON MFG. CO., New London, Wisconsin.

Improved Ohio Farmer REPAIR OUTFIT.

Our Price Only \$1.65.

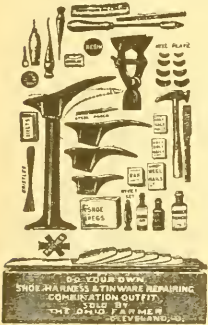

We have examined samples from all manufacturers, and believe this is the very best repair outfit on the market; easily worth \$1 more than those offered by stores and other papers. It contains 48 articles, all full size and first class, and we guarantee satisfaction or will refund money. Half-soles alone are worth 50c, and are not included in other outfits. It will soon pay for itself in repairing boots, shoes, rubbers, harness, and tinware.

Repair Outfit with Ohio Farmer one year for only \$2.15, or the Complete Outfit free for a club of 10 subscribers to the Ohio Farmer. By freight.

Send for our illustrated premium list, giving wholesale prices on watches, sewing-machines, knives, and lots of other useful articles. Mention this paper.

The Ohio Farmer ; Cleveland, Ohio.

Low Rates West and Northwest.

On February 12th, and on each Tuesday until April 30th, the Chicago, Milwaukee & St. Paul Railway will sell one-way second-class tickets at the following very low rates:

To Montana points,	- - - -	\$25 00
To North Pacific Coast points,	- - - -	30 00
To California,	- - - -	30 00

These tickets will be good on all trains, and purchasers will have choice of six routes and eight trains via St. Paul, and two routes and three trains via Missouri River each Tuesday. The route of the famous Pioneer Limited trains and the U. S. Government Fast Mail trains.

All ticket Agents sell tickets via the Chicago, Milwaukee & St. Paul Railway, or for further information address F. A. Miller, General Passenger Agent, Old Colony Building, Chicago.



Belgian Hares

I have some fine hares for sale at reasonable prices.

J. F. Moore, : Tiffin, Ohio.

WHERE TO LOCATE?

Why, in the Territory Traversed by the

Louisville & Nashville RAILROAD.

THE
Great Central Southern Trunkline
IN
KENTUCKY, TENNESSEE,
ALABAMA,
MISSISSIPPI, FLORIDA.

WHERE

Farmers, Fruit-growers,
Stock-raisers, Manufacturers,
Investors, Speculators,
and Money Lenders

will find the greatest chances in the United States to make "big money" by reason of the abundance and cheapness of

Land and Farms,
Timber and Stone,
Iron and Coal,
Labor--Everything.

Free sites, financial assistance, and freedom from taxation for the manufacturer.

Land and farms at \$1.00 per acre and upwards, and 500,000 acres in West Florida that can be taken gratis under U. S. homestead laws.

Stockraising in the Gulf Coast District will make enormous profits.

Half-fare excursions the first and third Tuesdays of each month.

Let us know what you want, and we will tell you how to get it—but don't delay, as the country is filling up rapidly.

Printed matter, maps, and all information free.

Address
R. J. WEMYSS,
Gen'l Immigration and Industrial Ag't,
LOUISVILLE, KY.

Our Advertisers.

SWEET-POTATO SEED.

See what L. H. Mahan, Box 143, Terre Haute, Ind. says on page 202.

BELGIAN HARES.

We do not keep them, but you can get them of J. F. Moore, Tiffin, Ohio. See page 209.

SPLIT HICKORY.

What about it? See what the Ohio Carriage Mfg. Co., 27 W. Broad St., Columbus, O., say on page 203.

PLANTS.

By some mistake our regular bee-supply catalog, in referring to our other catalogs, mentions a plant catalog. We do not issue such a catalog now, and our friends will do well to write to some of our advertisers. Flausburgh & Peirson, whose advertisement is found on page 205, can probably supply about all we have listed heretofore.

HUNGRY HOGS.

The John A. Salsler Seed Company, of La Crosse, Wis., the great farm-seed growers, have some splendid seed sorts to cure the hunger of the hogs, and make them happy, fat, healthy, and contented. In their Peaoat, a perfect food, in the green state, or in their Giant Incarnat Clover, or Sand Vetch, or Cow Peas, or Rape, they have heavy cropping, quick producing foods, that tempt the appetite of the swine, or cow, or sheep, or poultry, or horse. Every mouthful of this food seems to give contentment and adds flesh and fat. Their great catalog tells all about it. Have you seen a copy? If not, send for one to-day, inclosing 5 cents postage.

Get the Best Queens.

Evansville, Ind., Sept. 27th, 1900.

The Jennie Atchley Co., Beeville, Bee Co., Texas.

Dear Friends:—It gives me great pleasure to forward you this unsolicited testimonial regarding the merits of Atchley queens. The three (3) dozen queens purchased of you have made an excellent record for themselves. Not an Atchley queen among the twenty colonies lost during the severe drouth in July. I have bought queens from many breeders; and although the present crop is exceedingly short, the tiers of supers show where the Atchley queens are, and speak volumes for your method of queen-rearing. I find the progeny to be very gentle, strong-winged, uniformly marked, long-lived, of large size, and last, but not least, the best honey-gatherers I ever had. I shall want 100 more next season.

Yours fraternally, J. C. WALLENMEYER.

Prices for Queens.

Tested, \$1.50 each; \$8.00 for 6, or \$15.00 per dozen. Untested, February, March, April, and May, \$1.00 each; \$5.00 per 6, or \$9.00 per dozen. Fine breeders, \$5.00 each. We have as good bees and queens as money and labor produce. We breed three-band Italians, Goldens, Carniolans, Cyprians, and Holy-Lands, in their purity, bred in separate yards 5 to 20 miles apart. If you want the best, call for Atchley's improved strains. Safe arrival guaranteed. Send for a sample copy of "The Southland Queen," the only southern bee-paper. \$1.00 per year. To new subscribers we offer as a premium a nice untested queen in order to get our paper introduced. Catalog, giving queen-rearing and management of apiaries for profit, FREE.

**THE JENNIE ATCHLEY CO.,
Beeville, Bee Co., Texas.**

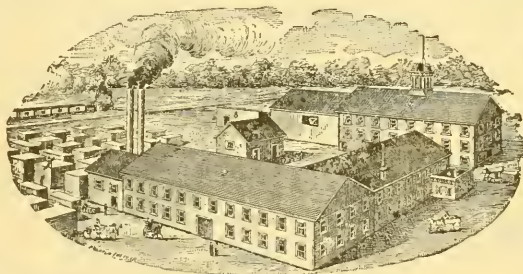

KRETCHMER M'F'G CO., Red Oak, Iowa.

BEE-SUPPLIES.

Best-equipped factory in the West; carry a large stock and greatest variety of every thing needed in the apiary, assuring BEST goods at the LOWEST prices, and prompt shipment. We want every bee-keeper to have our FREE ILLUSTRATED CATALOG, and read description of Alternating Hives, Ferguson Supers, etc. *Write at once for a catalog.*

— AGENCIES: —

Trester Supply Co., 103 So. 11th St., Lincoln, Nebraska; C. C. Richards, 1223 17th St., Denver, Col.

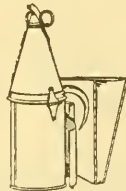

BINGHAM SMOKER.

DEAR SIR:—Inclosed find \$1.75. Please send one brass Smoke-engine. I have one already. It is the best smoker I ever used. Truly yours,
HENRY SCHMIDT, Hutto, Tex

MADE TO ORDER.

Bingham Brass Smokers

Made of sheet brass, which does not rust or burn out; should last a lifetime. You need one, but they cost 25 cts. more than tin of the same size. The little open cut shows our brass hinge put on the three larger sizes. No wonder Bingham's 4-inch smoke-engine goes without puffing, and does not drop inky drops. The perforated steel fire-grate has 381 holes to air the fuel and support the fire. Heavy tin smoke engine, 4-inch stove, per mail, \$1.50; 3½-inch, \$1.10; 3-inch, \$1.00; 2½-inch, 90c; 2-inch, 65c. Bingham smokers are the originals, and have all the improvements, and have been the standard of excellence for 22 years. Only three larger ones brass.

T. F. Bingham, : : Farwell, Mich.

Sheet Music.

Blue and the Gray (song or march),
 Girl I Loved in
 Sunny Tennessee,
 Just as the Sun
 Went Down, My Little Georgia Rose, and many others, at 25 cts. each, by mail postpaid.

Books at reasonable prices. See my "ad." in *Gleanings*, March 1. Ask for list of popular new books. Reference, The A. I. Root Co.

M. T. WRIGHT, Medina, O.

FIRE SALE OF BEE BOOKS!

On January 1st there was a severe fire in our building, burning out entirely four floors above us. The water that was thrown on the fire came down through our floor damaging our stock of books, printing-office, etc. Some of the books were wet & ightly, but enough so that they could hardly be sent out as perfect. These are the ones that we wish to offer. The reading pages of all are perfect, only the covers being a little soiled. Here they are, with prices postpaid:

Prof. Cook's "Bee-keeper's Guide," only 60c.
 Doolittle's Scientific Queen-rearing, only 50c.
 Newman's "Bees and Honey," only 40c.

They are all cloth bound, and latest editions. If you want a year's subscription to the old *Weekly American Bee Journal*, with any of the above books, add 75 cts. to your order. This is a SPECIAL OFFER, and will last only so long as the slightly damaged books last. Better order AT ONCE if you want a bargain. Remember we are

Headquarters for

Bee-keepers' Supplies!!

Catalog and sample copy of the AMERICAN BEE JOURNAL, FREE. Ask for them. Address

George W. York & Co.,
 144-146 Erie St., Chicago, Ill.

Bee-keepers' Supplies!!!

Root's Goods. Sold cheap. Bee-book given with order. Send for list explaining Barred Rock chickens and Belgian hares. Pedigreed stock.

W. D. Soper, R. D. 3, Jackson, Mich.

FOR SALE.—50 good strong Italian and Hybrid colonies of bees, all in new up-to-date 8-frame dovetailed hives, painted two coats of white. Will sell for \$2 per colony.
EARL BAKER,
 1438 W. Bancroft Toledo, O.

FOR SALE. One 10 h-p engine and boiler (up-right boiler), one 18 inch planer, one Root saw-table, 30 ft. line-shafting, hanger pulleys and belting. Will take \$250. J. W. Bittenbender, Knoxville, Ia.

Sea Shells, Palms, Rare Plants.

A sample box of sea shells, 10 cts. Larger boxes 25 and 50 cts. The above is an inexpensive way to take a little trip to the sea-shore.

Resurrection Plants, 10 cts. each. A great novelty. Spanish Moss, 10 cts. for large package.

Water Hyacinths, 10 cts. each. Easily grown. Palmetto Palms, 10 cts. each. Palmetto Palm Seed, 10 cts. per packet. Air Plants 15 cts each, Banana Plants, 20 cts. each. Orange Blossoms in Feb., March, and April, 10 cts. per box. Florida's sweetest flowers.

Every thing postpaid at list price. All plants large and healthy. Letters answered. PREMIUM with every 50-cent order. Refer to A. I. Root.

F. CHARLES GIFFORD, Vero, Fla.

Golden or 5-banded; 3-band Italians.

Some Points.

We have been extensively producing honey for the last ten years, hence know the value of good queens. During all this time we have made a close study of queen-rearing, and now run over 500 nuclei, hence we know how to rear good QUEENS. During the last two years we have spared neither time, money, nor skill in procuring and breeding up our strains of bees. We have bought queens from almost all who have claimed to have superior stock. We have taken them, tested them, and crossed them to each other and to our already fine stock of bees, and we now have the finest strains in the United States. WE GUARANTEE ALL QUEENS to be large, prolific, and well developed, to give entire satisfaction, and to arrive at your postoffice in good shape.

We have wintered over 800 fine queens, and our prices will be: Tested, \$1.25; select tested, \$2.00; breeders, \$3.00 to \$5.00 each; untested queens, March 15, \$1.00; after June 1st, 75c. Discounts in quantities, and valuable premiums given away to customers. Your subscription paid one year to the *Progressive Bee-keeper* upon receipt of your first order for one-half dozen queens. Send a postal for large circular; tells all about our queens, methods, etc.; gives valuable information to every one.

N. B.—Motto, "High-grade queens, prompt service."

O. P. HYDE & SON, Hutto, Texas.

PACIFIC QUEENS.

Wanted.—Addresses, especially on Pacific Coast, for my circular of best queens, and club rates on bee papers.

W. A. H. GILSTRAP, GRAYSON, CAL.

Long-Tongued Yellow Queens.

"The cage of bees is received. The tongue-reach is 19-hundredths. This is very good."

The A. I. Root Co., per E. R. Root.

The above is from my best breeding queen. Her mother is also long tongued. *It runs in the family.*

These are my 5-band or Golden strain that have been bred for business for years. Queens, untested, \$1.00; 6, \$5.00; dozen \$9.00. Fine tested, \$1.50; 6, \$8.00. Select tested, \$2.00. Breeding, \$3.00 to \$5.00. I am printing a limited number of circulars with Florida views—5c ones—free. An extra one with different views for 5c stamp. Better get one at once.

J. B. CASE, Port Orange, Fla.

EARLY QUEENS FROM THE SOUTH

We are rearing queens now in full colonies by the best methods known. Tested queen, \$2.00. Untested, \$1.00; 6, 5.00; 12, \$9.00. Full colonies, \$6.00; 3-frame \$2.00; 2-frame, \$1.50. Add price of queen to nucleus wanted. Write for discount on large orders, and circular. Satisfaction guaranteed.

Christian & Hall, Meldrim, Georgia.

CHAS. ISRAEL & BROS.,

426, 488, 490 Canal St.,
 Corner Watt Street, N. Y.

HONEY & BEESWAX.

Liberal Advances made on Consignments.
 Wholesale Dealers and Commission Merchants.
 Established 1875.

A Honey Market. Don't think that your crop is too large or too small to interest us. We have bought and sold five carloads already this season, and want more. We pay spot cash. Address, giving quantity, quality, and price.

Thos. C. Stanley & Son, Fairfield, Ill.

FOR SALE.—Apiary of 90 colonies, Dove'd hives, \$225; farm of 57 acres 750; together or separate; also horses, cows, etc.; basswoods at different elevations and in sheltered coves give a crop of honey every year; never knew any bee-disease around. Cause for selling, accident. For particulars address

JOHN HAMMOND, Buena Vista, Scioto Co., Ohio.

Climax Poultry-netting.

Galvanized after Woven.
Made from Cold-drawn
Steel Wire. . . .

Warranted to Last Twenty-five Years in Ordinary Exposure.

Tensile Strength
Greater than Other
Brands of No. 19 Netting.

"Climax" Poultry-netting and Fencing are the Climax of Perfection. . .

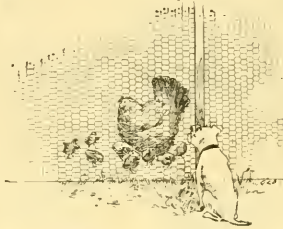

"SO NEAR, YET SO FAR."

Climax Netting has 3-strand Selvages.

The demand for fence netting or fabric made from wire, for the purpose of restraining domestic animals and fowls, has grown to vast proportions, and, like every thing else, the mode of manufacturing the same has undergone important changes. After testing many different makes we have purchased a large stock of the "Climax" netting, which is practically the G. & B. netting improved. The same being far superior to the product of recent years or inexperienced manufacture of to-day. It is a well-known fact that frequently ordinary steel wire is heated in the process of manufacture, and, when finished, is soft, and possesses a low degree of tensile strength and elasticity. Although wire of this kind is more easily manipulated in manufacturing, it is also true that the netting is more easily bent out of shape. All wire used in the "Climax" netting is manufactured by a patent process described as "cold drawn" steel wire. By this process the wire is not heated to a point that will detract in the least from the tensile strength, and, when woven, forms a fabric capable of withstanding a much greater strain than other brands of netting made from No. 19 wire or heavier. "Climax" poultry-netting therefore possesses an exclusive advantage, in point of the superiority of its wire, over all others.

Another notable feature of the "Climax" netting is the long twist in the meshes. With a long twist the wires are laid side by side for a greater distance, thereby making it much more rigid and strong. The meshes are uniform, and three-strand selvages contribute to the strength where usually required most.

"CLIMAX" POULTRY-NETTING.

Because the selvages are perfectly uniform in length and also equal in body, "Climax" poultry-netting will roll out flat and straight, and smooth as a carpet or

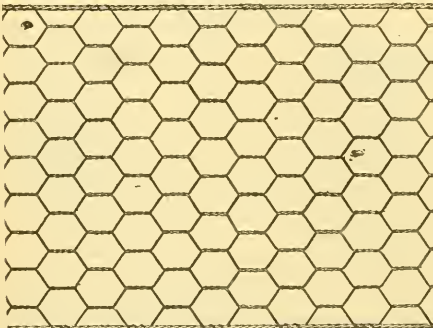

oil-cloth. For this reason it can easily be fastened to posts without hard stretching. It will, when put on,

remain flat and straight, and therefore be free from unsightly appearance that marks a netting that bulges in the fabric.

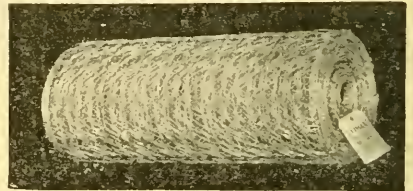

150-FOOT BALE OF "CLIMAX" NETTING READY FOR SHIPMENT.

PRICE OF 2-INCH MESH "CLIMAX" POULTRY-NETTING.	
12 inches wide, per roll of 150 running feet.....	\$.65
18 " " " " " " " " " " " "	1.00
24 " " " " " " " " " " " "	1.30
30 " " " " " " " " " " " "	1.65
36 " " " " " " " " " " " "	2.00
48 " " " " " " " " " " " "	2.60
60 " " " " " " " " " " " "	3.30
72 " " " " " " " " " " " "	4.00

Staples for the above, $\frac{3}{4}$ and 1 inch, 8c per lb. Five per cent off on 5 rolls; 10 per cent off on 10 rolls or more. Prices F. O. B. cars Medina, New York, or Chicago, whichever point is nearest or most convenient to you.

"CLIMAX" SHEEP AND HOG FENCING.

THREE STRAND TWISTED SELVAGES. SOLD ONLY IN FULL BALES, 20 RODS (330 FEET) LONG.

The "Climax" meets the demand for a strong and durable fencing for sheep and hogs. Each strand of wire is capable of sustaining a strain of at least 300 pounds, thus being amply strong for any ordinary requirements. The meshes are small enough (3x4 in., instead of 3x6 in. formerly), to stop small animals, while the shape of the mesh affords sufficient rigidity to the fabric to prevent sagging between the posts; also animals can not bend the fencing to crawl under. Being galvanized after weaving, the coating will withstand the action of the atmosphere for at least 25 years. In addition the wires are soldered where twisted, which unites them and combines the strength of all. It is the best material ever offered for the purpose at as low a price.

23 inches (7 $\frac{1}{2}$ meshes) wide, per roll 20 rods, \$5.60
50 inches (16 meshes) wide, per roll 20 rods, 10.50
F. O. B. cars Chicago or New York.

We will mail free on request our 28-page netting and fencing catalog of other sizes of poultry-netting, also cottage-fencing, farm-gates, etc.

THE A. I. ROOT CO., Medina, Ohio.

Contents of this Number.

Absorbents v. Sealed Covers241
 Beer Poisoned by Glucose230
 Bees and Allalfa Hay.....211
 Bees, Long-tongued, Are they Wanted?.....220
 Broom-Seed.....241
 Clover, Yellow Sweet.....217
 Combs, Loading Cross-wise.....211, 243
 Communioners, Pure-food.....246
 Contraction, and Belgian Hares.....225
 Cough Medicine, Honey.....242
 Cover, Brodbeck's.....232
 Cuba, Glimpses of.....228
 Dominica, Morrison in.....235
 Drones, Number Needed per Colony.....242
 Dzierzon as an Inventor.....219
 Entrance-contractor, Pole's.....2-8
 Extractors with Double Pockets243
 Feeding Back for Comb Honey.....242
 Forming Nuclei.....226
 Foul-brood Law, California247
 Foundation on a Curve.....243
 Foundation, Thin, for Brood-frames.....223
 Frame, Movable, Inventor of.....219
 Gleanings Family.....242
 Glossometer, Swarthmore's.....233
 Glucose as a Poison.....230
 Heat, Effects of.....231
 Hives, Elevated.....218
 Hiving on Drawn Combs.....239
 Honey, Bottling.....230
 Honey, Extracted, from Dark Combs.....242
 Honey, Selling Extracted.....232
 House apiary and Shop Combined237
 Medicine dropper a Success.....241
 Partnership in Bees238
 Poison of Sting, Antidote for.....238
 Pullen, Too Much.....236
 Queens Mated in Confinement.....218, 247
 Questions Answered.....244
 Rambler at Work.....231
 Sections, Size of.....220, 246
 Strainer, Kuehne's.....239
 Sugar, Beet v. Cane.....218, 245
 Swarming, To Prevent235
 Tank, Gil-trap's.....243
 Tongues, Long, and Longevity.....234
 Top-bars, Origin of Wide and Thick.....227
 Uncapping, How Deep?.....239
 Wiley on Glucose.....230
 Wintering, Indoor.....246
 Wintering, Que-tion-ov.....240

Honey Column.

GRADING-RULES.

FANCY.—All sections to be well filled, combs straight, firmly attached to all four sides, the combs unsoiled by travel-stain, or otherwise; all the cells sealed except an occasional cell, the outside surface of the wood well scraped of propolis.
 A No. 1.—All sections well filled except the row of cells next to the wood; combs straight; one-eighth part of comb surface soiled, or the entire surface slightly soiled; the outside surface of the wood well scraped of propolis.
 No. 1.—All sections well filled except the row of cells next to the wood; combs comparatively even; one-eighth part of comb surface soiled, or the entire surface slightly soiled.
 No. 2.—Three-fourths of the total surface must be filled and sealed.
 No. 3.—Must weigh at least half as much as a full-weight section.
 In addition to this the honey is to be classified according to color, using the terms white, amber, and dark; that is, there will be "Fancy White," "No. 1 Dark," etc.

CITY MARKETS.

SAN FRANCISCO. — Fancy comb, 12½; A No. 1, 11; No. 1, 9½; No. 2, 8; No. 3, 7. Extracted, light amber, 5½; amber, 5. GUGGENHIME & Co.

CHICAGO.—Fancy white comb honey sells readily at 16; but all other grades are weak at the following range of prices: No. 1 white, 14@15; fancy amber, 12@13; fair amber grades, 10@11; buckwheat fancy, 10; off grades, 8@9. Extracted white, ranges from 7 @8 amber grades, 6½@7½; buckwheat, 5½@6; Southern dark, 5@6. Beeswax in demand at 30.
 R. A. BURNETT & Co.,
 163 South Water St., Chicago, Ill.

PHILADELPHIA.—Honey selling freely, but sufficient supply to fill the demand. Job lots of comb honey selling at buyers' offers. We quote No. 1 comb, 13@14; no fancy in market; amber, 10@11. Extracted white, 8; amber, 6@7. We are producers of honey—do not handle on commission. WM. A. SELSER,
 Mar. 9. 10 Vine St., Philadelphia, Pa.

ALBANY.—Honey, quiet, with light stock. White comb, 15@16; mixed, 13@14; buckwheat, 11@12; amber, 11@12. Extracted, buckwheat, 5@5½; mixed, 6@6½; clover, 7@8. MACDUGAL & Co.,
 Successors to CHAS. McCULLOCH & Co.,
 Mar. 9. Albany, N. Y.

CINCINNATI.—The demand for comb honey is nearly over. The stock also well cleaned up. Fancy white brings 16c. Extracted is in fair demand; dark sells for 5½; better grades bring 6 to 7½; fancy white clover from 8½ to 9. C. H. W. WEBER,
 Mar. 9. 2146-8 Central Ave., Cincinnati, Ohio.

BUFFALO.—Honey is selling very slow in our market. Prices steady and I think we can clean up before the new crop, at or near these prices. Fancy comb, 15@16; A No. 1, 14@15; No. 1, 13@14; No. 2, 12@13; No. 3, 11@12; No. 1 dark, 10@11; No. 2 dark, 8@9. Beeswax, yellow, 29@30; dark, 24@26
 W. C. TOWNSEND, Buffalo, N. Y.
 Feb. 27.

COLUMBUS.—Honey market very quiet; fancy Western white, selling at 17; amber, 14.
 Mar. 8. EVANS & TURNER.

DETROIT.—Fancy white comb, 15@16; No. 1, 14@15. dark and amber, 10@13. Extracted white, 6½@7; dark and amber, 5½@6. Beeswax, 27@28.
 Mar. 8. M. H. HUNT & SON, Bell Branch, Mich.

FOR SALE.—20,000 lbs. extracted honey from alfalfa and light amber from Rocky Mountain bee-plant. Two cans, 120 lbs. net, \$8 40; also 5 and 10 lb palls. In ordering state if you want white or amber.
 M. P. RHOADS, Las Animas, Col.

WANTED.—Comb and extracted honey. State price, kind, and quantity. R. A. BURNETT & Co.,
 163 South Water St., Chicago, Ill.

FOR SALE.—Choice alfalfa honey. Two cans, 120 lbs. net, whitest, \$9 00; tinted, partly from other bloom, \$8 40. Also small cans.
 THE ARKANSAS VALLEY APIARIES,
 OLIVER FOSTER, Prop., Las Animas, Bent Co., Colo.

FOR SALE.—Extracted honey from alfalfa; 60-lb. cans at 7 cts., and smaller cans.
 D. S. JENKINS, Las Animas, Colo.

FOR SALE.—3000 pounds fancy comb honey. Write for prices. WILLIAM MORRIS,
 Las Animas, Col.

Wanted! HONEY, WAX, MAPLE SUGAR, SYRUP, AND POPCORN.
 A. L. JENKS, 42 W. Market St., Buffalo, N. Y.

PURE MAPLE SYRUP.

MEDINA is the home of the honey-bee and also the home of the MAPLE-TREE, and the maple-tree produces sap in the spring, which is boiled down and makes the finest flavored sweet in existence when you get it pure. One of our customers called it "Delicious Nectar." We have pure maple syrup to sell to the trade in several sizes of packages. Write for prices to

R. E. FRENCH, - MEDINA, OHIO.
 Reference, The A. I. Root Company.

Notice!



THE A. I. ROOT CO.

wish to announce that they have from their branch at 10 Vine St., Philadelphia, Pa., direct steamboat connections and very low rates of freight to the following States: Massachusetts, Rhode Island, Connecticut, New Jersey, Delaware, North Carolina, South Carolina, Georgia, Florida. As this is a branch of the factory, prices are the same. Full colonies of Italian Bees, \$6.00. Special discount in large quantities.

C. B. Lewis Company,

Watertown, Wis., U. S. A.

FIVE ✨ DIFFERENT ✨ STYLES ✨ OF ✨ BEE-HIVES.

We will furnish you
with the finest bee-
keepers' supplies in
the World.



Send us your Orders
and we will fill 'em
promptly. Send for
Catalog.

LEWIS' • WHITE • POLISHED • SECTIONS • ARE • PERFECT.

BRANCH: G. B. Lewis Company, 19 South Alabama Street, Indianapolis, Indiana.
AGENCIES: L. C. Woodman, Grand Rapids, Michigan; Fred W. Muth & Co., Southwest Cor. Walnut & Front Sts., Cincinnati, Ohio; Fred Foulger & Sons, Ogden, Utah; Colorado Honey-producers' Association, Denver, Col.; Grand Junction Fruit-growers' Association, Grand Junction, Colorado; Robert Halley, Montrose, Colorado; Pierce Seed and Produce Company, Pueblo, Colorado; E. T. Abbott, St. Joseph, Missouri, Special Southwestern Agent.

BEE-SUPPLIES!

ROOT'S GOODS
AT
ROOT'S PRICES

C. H. W. Weber, Cincinnati, Ohio.

2146-2148 Central Ave.

A NEW and complete stock for 1901 now on hand. I am The Root Company's representative for Cincinnati and surrounding territories. . . . You save TIME and FREIGHT CHARGES by having goods shipped from here. Convenience of railroad facilities here enables me to do so. Before buying elsewhere, write for my prices and catalog, which will be mailed you free of charge.

GLEANINGS

A JOURNAL DEVOTED TO BEES AND HONEY AND HOME INTERESTS.

BEE CULTURE

ILLUSTRATED SEMI-MONTHLY

Published by THE A. ROOT CO.
\$1.00 PER YEAR MEDINA, OHIO.

VOL. XXIX.

MARCH 15, 1901.

No. 6.



THE SECRET, most likely, of the large membership of bee-keepers' societies in Germany lies in the fact that the bee-keeper gets back *directly* the worth of his money in the way of reduced price of bee-journals and in other ways. New York bee-keepers seem to be following somewhat the same plan, and I'm wondering whether it may not be partly due to the fact that a man by the name of Greiner happened to select Germany as the land of his birth.

E. S. LOVESY says, in *The Rocky Mountain Bee Journal*, that last year sweet clover yielded nothing except along the water-courses. That's the first report I've seen saying sweet clover failed to yield nectar anywhere. [This reminds me that *The Rocky Mountain Bee Journal* is a very creditable publication—nicely printed, and the general subject-matter is good. We wish our newly arrived cotemporary success; and we see no reason why Colorado alone could not give a fair support to a bee-journal.—ED]

"THE MEANEST STOCK to introduce a queen to is one having cells almost ready to hatch," quoth ye editor, p. 184. Must have forgotten just then about laying workers. [Y-e-s—but, a colony with fertile workers is not, in a sense, queenless, is it? for it has one or more (drone-laying) queens, or what they think are queens. It is usually not possible to introduce another queen to a colony already having one or what they regard as one. When I made the statement in question I had in mind a colony that was queenless—entirely so.—ED]

DR. PAUCHET, *La Nature* says, replaces cod-liver oil with butyroniel, composed of two parts of fresh butter and one part of honey, beaten together. He says it is more readily accepted by children, a thing not hard to believe. [I remember my mother used to give me honey and butter when I had a cold. If there is any virtue in such a combination it might be a good idea for us parents to give

our children bread and butter and honey, and lots of it. "Honey and butter shall he eat," the good Book says, and its advice is always good.—ED]

SWEET CLOVER, says H. M. Jameson, of California, in *The Ruralist*, "blooms here the first season, and continues for several seasons . . . The yellow variety abounds here, but the bees never touch it." Three things in that statement are at variance with previous reports. Does the same thing hold true in all parts of California? If its life history is so much hurried up that it blooms a year sooner than elsewhere, one would think it ought then to die as an annual instead of being prolonged as a perennial.

I AGREE heartily with Rambler, p. 185, in thinking a dead-level country is too monotonous. When I came from among the mountains to a prairie State I couldn't stand the level, so I got a spot right on a hill and built a home on it; and if you were to be set down here blindfolded you couldn't tell whether you were in Illinois or Pennsylvania. I'd want good pay to agree to spend the rest of my life on a level (although I'm trying my level best to live "on the level"), or anywhere where the dwellings were thicker than one to every ten acres.

SPRING being at hand, let me remind those whose bees work a little on red clover, and who are trying to grow red clover with short tubes, that, if they can get seed from the *first* crop, they will stand a better chance of success, for just at that time bumble-bees are too scarce to fertilize many blossoms, and so a larger *proportion* of seed in the first crop may be of the desired kind than in the second crop. Of course, there may be a larger quantity of short-tubed seed in the second crop, but it will be mixed with a still larger quantity of seed that you don't want.

"WHY IS IT that the bees would peel the cocoons from the sides of the cell and leave the septum?" says W. T. Stephenson, p. 141, evidently thinking that the same thickness of cocoons is on the walls as on the septum. I think I can show you a good many old combs with the septum $\frac{1}{8}$ in. thick. Now, suppose the same amount of cocoons on the cell walls;

that would leave the cells measuring 13 to the inch instead of 5 to the inch, and it would take $6\frac{3}{4}$ of the bees to weigh as much as a common bee. Were your workers as small as that, friend Stephenson? [Yes, yes; you are correct. I had not thought of putting the matter in that light.—ED.]

A. I. ROOT is a convert to the plan of having hives "supported just high enough from the ground to make it easy to work without stooping," p. 197. In some parts of the South I think there are special reasons for having hives thus raised on account of ants, other enemies, or water. I infer friend Root prefers it on the score of comfort, and he has a very small following. More than 30 pictures of hives in actual use are given in A B C, and only one of the pictures shows the hives thus raised, and that's in South America. One who works much at bees will sooner or later come to prefer to work at them sitting, and the ground is the place for that. If raised to work with ease standing, the ease is gone when three to five supers are added.

IT MAY BE that beet sugar is just as good as cane sugar, p. 193, but I confess to a little uneasiness so long as it is insisted across the water that beet sugar is bad for bees. They're not all fools over there; there are some bright men in England and Germany, but I don't remember to have seen one of them contradict the statement that beet sugar is inferior to cane. I only wish we could know just what the truth is. It's a thing no chemist can settle as a chemist, remember that. Can we look to the experiment stations for an answer? [No, indeed. Among the intelligent bee-keepers across the water there are no fools. In scientific investigations they are usually ahead of us; but I am inclined to believe they have made out too bad a case for the beet sugar.—ED.]

YOU SEEM TO LEAN toward Ira Barber's view, Mr. Editor, p. 195, but you don't answer my question. If it stirs up the bees so much to have just a little fresh air leak into the cellar, how is it that it quiets them down to have the whole cellar flooded with it? [In the same way that giving swill to pigs stops their squealing. If the pigs get to expecting the swill they will squeal until they get it. Then they are satisfied. But that does not signify that they will not squeal at the next swilling-time. I do not know that this hits the case exactly, but it struck me that *perhaps*, after one infusion of air, the bees are satisfied; and then, discovering that roaring will bring on more fresh air, they will roar. Perhaps bees do not reason like pigs; but when robbing-time comes on we do know they will show greater sagacity.—ED.]

IT STRIKES ME that the Rambler-McCubbin plan of having all increase go to the owner of the bees is a bright one. Then there's no temptation on the part of the bee keeper to overdo the matter of increase. [Rambler referred to this disposition of increase, in an article, about a year ago. It struck me as being so equitable that I incorporated the feature in a provisional contract in "Bees on

Shares" in the new edition of our A B C book. The operator, if he understands his business, will, on this plan, bend every energy toward keeping down increase; because, if he is to make any thing, he will have to realize his profits from *honey* and not from bees. If he were to share equally in the increase and honey, the probabilities are that both operator and owner would not make as much in the end as on the other plan.—ED.]

SOME LETTERS lately sent to GLEANINGS show an irrepressible desire to be honest, and to sell a section for no more than its actual weight, and at the same time there goes with it the belief that a certain size of section can be found so that there will never be more than a range of an ounce between the heaviest and lightest weights. Friends, that's all a myth. The average weight of one year will differ from that of another; they will vary in the same year; and you'll find no reasonable size that will not give a variation of three or four ounces between the heaviest section of a heavy year and the lightest section of a light year. [Yes, you are right. Then why should we place so much stress on sections holding a pound? and why should we not rather sell by the piece, and thus avoid all the figuring and waste of time?—ED.]

MATING QUEENS in confinement, that dead, decayed thing that has been carried out and buried, comes up smiling in *Review* for a rehearing, and Hutchy seems to think there may be something in it. And—must I make the humiliating confession?—I'm a believer in it myself. Listen: If you had a cage a mile high, a mile long, and a mile wide, there would be no trouble about having queens mate in it. A smaller cage might do, the practical question being *how* small. Well, J. S. Davitte has found the answer to that question, and he says the cage must be 30 feet in diameter and 30 feet high. He had 100 queens mated thus in one year. The way he manages—but I'm sure the editor or Stenog will tell you all about it. [Your Straws came after I had prepared an editorial on this subject; and you will note that I, too, believe that there is something in it. But I am afraid A. I. R., when he comes home from Florida, will hold up his hands in horror; but if he thinks I have been carried away by a new old fad I shall have the satisfaction of knowing I am in good company.—ED.]

PROF. COMSTOCK, the able entomologist of Cornell University, sees no reason, from the structure of the mouth-parts of a honey-bee, why it should not be able to bite into a grape or peach. Prof. Cook says, in *American Bee Journal*, that he does not wonder at this statement, but that the practical question is not whether bees *can* bite grapes, but whether they *do*. And it has been proven over and over again, that, when a cluster of grapes is given to bees in a time of scarcity, some of the grapes punctured with a pin, the bees promptly clean out the punctured grapes but never bite into the sound ones. My view of the case may not be scientific, but I have a lingering suspicion that it is a physical im-

possibility for a bee to bite into a peach or grape. [I think your suspicion is well founded. I have examined the mouth-parts of several different insects, and it seems to me those of any one of them are better adapted for cutting or puncturing fruit than those of the bees. From what I know of bees they would cut and slash through the skins of fruit during a dearth of honey if they could. They have no more conscientious scruples about wading into the nice preserves of the housewife than the highway robber has for stealing my watch.—ED.]

YOU SAY, Mr. Editor, that bees will start in an extracting-super when they wouldn't in sections, and when this is replaced by a section super they'll start promptly in the latter. I don't doubt it in the least. But that still leaves it an open question with me whether the plan is advisable. Now please answer two questions: How many days after the extracting super is given before they will start work in the sections? Do you *know* that they would not start just as soon in bait sections if these are given in place of the extracting-super? [I have found that many of our pure Italian colonies were very stubborn about going into sections, even when I gave them "baits;" but by giving them a shallow super of extracting-combs all drawn out, I could induce most of them to start upward at once. When they have stored a little honey above, and become accustomed to going above, which would take anywhere from one to two days, I would take this extracting-super off, and give them, instead, sections with full sheets of foundation. The habit of going above seemed to be so strong that those same bees that had been stubborn before would now go right into the sections. I did not allow any such colonies so treated to store very much honey in extracting-combs. As soon as the bees entered them and began to store a little honey I would take them off and give them to other stubborn colonies. Thus one set of extracting-combs might answer for four or five colonies, but usually not more than two.—ED.]

SO YOU THINK I rate a little too highly the value of Dzierzon's contributions to bee culture, Mr. Editor. Possibly, but that's my honest conviction. You have grown up under the full light of the Dzierzon theory, and is it not just possible that it is a little difficult for you to realize just what it would be to have that light totally extinguished? Perhaps, too, you may not give full force to the fact that Dzierzon gave the movable frame to a large part of the bee-keeping world. I do not think of any one living man who has done more for bee-keeping than those two things. [Dzierzon gave the movable frame? Why, doctor, it must be you have forgotten. If you are basing your authority on Cheshire, I am afraid you are misled. What Cheshire says concerning Dzierzon, and his connection with the movable frame, is contradicted by Charles Dadant and L. Stachelhausen. Samuel Wagner, than whom there is no better authority, says in the *American Bee Journal*, page 14, Vol. I., that "Dzierzon did not invent a movable frame; that he only improved a method

for handling movable *combs*;" that Della Rocca, as you will see by reference to the authorities, devised a method for using movable *bars* to which combs were built; but in all these cases it was necessary to cut the combs away from the sides of the hive as well as from the bottom, before they could be taken out. Dzierzon improved on this by using bars in a top-opening hive. Later on, Berlepsch invented a movable frame, but not till after Langstroth had patented and brought out his invention. But for argument's sake, assuming that Berlepsch was prior, you will see that the Langstroth invention made a practicable movable frame, which the Berlepsch was not. Before we could give credit to Dzierzon for the invention of movable frames we should have to mention the names of Munn, of England; Debeauboys, of France; and Propokovitsch, of Russia. But if any one is to be credited for the invention of movable frames before Langstroth, that honor should be extended to Huber, who did make a closed-end frame that was a great improvement on any of the frames ever invented until the Langstroth came out. The Quinby, the Heddon, and the Danzenbaker are, practically, modifications of the original Huber. For my authorities I would refer you to the *American Bee Journal*, Vol. I., for 1861, page 14. There you will find a most interesting and valuable article by Wagner. While it is admitted by this writer that Dzierzon's improvement on the movable bar "received general acceptance and approval in Europe," yet he limits this invention to "bars," and not "frames," as you will see. Now turn to GLEANINGS for May 15, 1888, pages 379-381; then, if you care to, turn to Dadant's *Langstroth Revised*, from pages 137 to 144. But I would not detract from the glory that Dzierzon has won in his great discovery of parthenogenesis. That alone is enough to make him great in the mind of any intelligent bee-keeper. But as long as it is generally conceded now, both in Europe and America, that Langstroth was the first to bring out a *practicable* movable frame I think we ought to concede that honor to him.—ED.]



A strange commingling of the weather now—
Fogs, rain, zero, then more snow;
Then slush, then mud, then icy walk,
And all within a day or so.

L'APICULTURE PRATIQUE.

This is a new French bee journal published in Mr. Dadant's native department (Haute-Marne) in France. The first number is before us. It presents a fine appearance, and gives an account of Mr. Dadant's visit to his old home. From it we also learn that the Minister of Agriculture of Hungary has just created a special school for the study of apiculture.

The course comprises theory and practice in an apiary having hives of all systems, an experimental field for testing honey-yielding plants, and a laboratory for different kinds of honey and wax.

Mr. Voironot, "the most active, the most ardent, and the most intelligent propagator of movable-frame apiculture in France or Belgium," died recently at Ludie, France. Mr. V. was one of the most voluminous writers on apiculture that ever lived, and his productions were highly esteemed. His death will cause a large vacancy among bee-keepers.

BRITISH BEE-JOURNAL.

The discussion as to the size of sections has lately assumed interesting proportions in England. That a thinner and taller section seems to be demanded there is evident after reading several letters from prominent British bee-keepers. Mr. R. M. Lamb is one of the most active persons in the agitation of this question. In the issue for Feb. 7 he says:

In the previous article, after noticing how Mr. Cowan supported my view as to the natural thickness of honey comb I ought also to have given the following quotation from The A. I. Root Company's catalog for 1900 (page 6):—"A tall section holding approximately a pound weight permits of the use of a thinner comb—a comb more nearly approaching combs in nature. Thin combs are said to be filled sooner and are far better filled, and it is also thought that honey ripens better in them." I can hardly think these statements would have been inserted if they had not the support of some successful bee-keepers. This catalog, I may say, came into my hands only at the beginning of this winter, and in it I have found several ways in which my experience has been strikingly similar to those of many of our brethren over the water.

In the next issue Mr. F. W. L. Sladen, a bee-keeper well known on both sides of the water, writes:

I have been following the discussion on the size of sections started in your pages by the Rev. R. M. Lamb, with much interest. I see that Mr. Lamb now advocates not only a *thinner comb* in the section, but also a *larger and taller section* than our present $4\frac{1}{4}$ inch by $4\frac{1}{2}$ inch section.

Having been for some time interested in the question of tall v. square sections, I last year gave the tall sections a trial, and selected for this purpose Root's "Ideal" plain sections, which measure $3\frac{3}{4}$ in. by 5 in. by $1\frac{1}{2}$ in. These sections have a thin comb, as recommended by Mr. Lamb, but when finished they weigh only about $13\frac{1}{2}$ oz. Owing to the bad season I got only a few of these sections finished, but every one who saw them thought them much better looking than the ordinary $4\frac{1}{2}$ -in. square sections.

Further down Mr. Sladen says:

I agree with Mr. Lamb in his further demand for a taller section.

For a better presentation of this matter, see page 246, written by the editor.

SOUTHLAND QUEEN.

Dr. Howard Gilmore asks:

I notice *Gleanings* is making lots of fuss about long-tongued bees. I don't know whether they will beat others here or not. We do not have any red clover for them to reach. Our cotton-blossoms are large, and brasswood is not very deep. What do you think about that strain, Bro. A.? Are they any better for us here in the sunny South than any other good Italian bees? If they are I should like to try them a fall, as I like to have the best.

The editor replies:

Our notion is that, if bees' tongues can be bred a thousandth of an inch longer than nature intended, they can be bred with tongues a foot long. It is our opinion that there is a great big nonsense lurking around long-tongued bees. We do not think there are any better bees in the world than those we have in Texas, and they never saw red clover. . . . We think some soils will grow red clover with shallower nectar-cells than others.

One is inclined to think that the "nonsense" that lurks around long-tongued bees is in the mind of those who do not consider the matter of locality. As for the length of bees' tongues, Nature never had any intention concerning them any more than she did when she made a pig with a snout a foot long, and yet enabled man to breed that snout down to a mere vestige of its original comeliness. But it does not follow that the tongue of a bee can be lengthened a foot simply because a half can be added to its average length, nor would that be desirable. The movement for longer tongues is simply to get the red-clover crop of the North, which now is practically all wasted. The bees, no one claims, would be any better except on that account. If anybody can get along with a 14-foot ladder to get on his 14 foot house, all right; but if others have houses 20 feet high they are entitled to a longer ladder. A bee with a tongue-reach of $\frac{1}{3}$ inch would, we are morally certain, add greatly to the yield of honey in the Northern States, and that, too, of a quality so good that all other honeys would have to be compared with it for a standard, except that from other clovers.



BOTTLING HONEY.

Washing the Jars; Packing for Shipment, etc.

BY CHALON FOWLS.

In my former article on bottling I did not describe the process of washing the jars, so I will do so now.

We generally run them through water twice, using merely tepid water first and hotter water last, so as to avoid breaking the glass by too sudden changes. When there is sand sticking to the inside of the jars, our folks use a swab or rag tied on a stick when washing the first time. Some might like a woven-wire pot-cleaner to shake around inside and loosen the sand; but our folks will have none of it. After the jars are rinsed they are turned bottom up on two or more thicknesses of crash toweling for half an hour or more, when they are ready for use. The towels take up the water like a sponge, so that they get dry quicker; besides, there is no water streaming down on the floor.

Perhaps it might not be amiss to give my method of packing for shipment. Shipping-cases can be bought with some kinds of jars; but the 1-lb. cans come cheaper by the barrel,



and, at the grocerirs, I can get boxes which I saw up and make over if too large. I prefer the latter plan, as I can make wages doing the work in winter. The boxes are made large to give room under the jars for two or more inches of packing, and something springy should be used—planer shavings, for instance, putting some pieces of shingles or pasteboard over the packing to set the jars on so they will not work down through so as to get to the bottom. In this way the honey-jars ride on a sort of springy cushion, and I have never had any complaints of broken jars when so packed. The tops of the boxes are stenciled "Glass, this side up," and the shipping-tags tacked on top; and the railroad men will keep them right side up, because they want the tags on top, where they can be seen. I pack not less than two dozen in a box, and put in four dozen when the orders call for that

much. Each jar is wrapped well with paper before packing. I use old newspapers for the purpose.

In the picture my daughter is seen at my left, wrapping tumblers, while I come next, packing, and my boy Arba is nailing on covers at my right. It will be seen, by looking at the open box in the picture, that every other tumbler is placed bottom up. By packing in this way they keep in place, and no packing is needed between them. If more honey is put up than is ordered, it should be kept, preferably, in a warm room; but if it must be stored in a cold room it should either be packed ready for shipment or else covered up closely in boxes to prevent their getting too cold and then sweating when placed in a warm store, thus making the labels come off.

Since writing the foregoing, GLEANINGS for Feb. 1st has come to hand.



PREPARING HONEY FOR SHIPMENT.

On reading over the symposium in that issue, I see there is one point that should be explained more fully, in justice to the method advocated by Mr. Deadman and myself. If the honey is kept quite hot, say at 160°, during the process of filling the bottles or glasses, it will be found that the bubbles will all rise to the top in a very short time. Now, I contend that, as this takes place before it has time to cool, it makes no difference at all about its candying afterward. There will be an air-space at the top, just as in canned fruit, so the result is the same by either method.

I see the editor infers by my former articles that I am put to some trouble in exchanging jars at the grocer's on account of their getting caudied. I will explain that, since we have improved our methods of putting up, the exchange business is done away with. I no longer need to exchange, although I still agree to. In fact, *only one jar* has been exchanged during the past year.

Oberlin, Ohio.

[In reference to the matter in your last two paragraphs concerning pouring honey hot and honey cold into glass jars, you are probably right in saying that the bubbles will rise to the top, where they will do no harm. So we shall have to conclude that the question whether we shall pour hot or cold honey into the jars is rather one of convenience than one of difference in results.—ED]

RETAILING EXTRACTED HONEY.

Bottled Goods v. Those Put up in 8-lb. Pails for \$1.00; a Valuable Article.

BY THOS. SLACK.

I have been a good deal interested in the articles you have published from time to time on putting up and *marketing* extracted honey, etc. This is a very important point in any business, for it is of little use manufacturing or producing a nice article and then realizing only half price for it. R. C. Aikin comes nearer my idea of the right thing than any of the rest, but I differ with all of them in one or two points, although it may seem rather cheeky for me to say so, as many of your correspondents sell tons where I sell hundreds; but I doubt very much if they could sell any more than I can on the ground I cover with my market-wagon, some 21 miles in three directions each week in the summer. My sales have *always* been limited by the amount of honey I could produce or buy at a low enough price to pay handling. Candied honey can be sold to a limited amount here; but liquid honey sells as ten to one against candied. Most of my customers are farmers, mechanics, or laborers (no stores), or people who have to earn their own living, and a fancy price can not be looked for—about 12½ cents a pound. One year I sold at 10 cents.

Bottling hot or bottling cold will never trouble me, as I have no use for either. I give my ideas from my standpoint here for this section, and I do not think it differs much

from any good farming section with good villages or small towns scattered around it. I never touch comb honey to sell. Loss from breaking down just wipes the profits clean out. I never sell a *single* pound of extracted honey. My unit in selling is \$1.00. If a customer asks, "How much is your honey this fall?" I say, "Eight pounds for \$1.00, pail included." Perhaps, if a stranger to me, they will say, "I want only one or two pounds." I explain to them I can not very well carry conveniences for weighing on my wagon, and I have it all weighed up in pails nicely labeled, a card explaining that the honey will likely candy in cold weather, but that it can be brought to a liquid state again without hurting the flavor, and telling how to do so. Pasted on the pail it prevents the trouble Mr. Aikin speaks of, of losing a customer because his liquid honey candied. If possible, have them taste the honey, and do not have any that is not fit or a pleasure to taste. If the customer wants honey I very seldom miss selling him a pail. I used to put the honey up 8 lbs. net, the pails to be returned when empty; but this did not work well. After losing about 125 pails one summer I set my thinker to work, and struck the following plan: Weigh up 8 lbs. gross for \$1.00, the pail a legal tender for 10 cts. if returned in good order. This works perfectly—no friction, no loss. I do not believe in putting up honey in glass or selling by the pound, for the following reasons: Too costly and too much bother for one thing; but more particularly because, if a person buys a bottle or a tumbler of honey, the price is pretty high including the glass. Now, very few families (about one in twenty, not to be wild, probably nearer one in one hundred) eat honey. I do not mean to say they do not taste it, but they do not look upon it as food, something to nourish the body with. If they buy a nice white section of honey, that sacred thing is put aside against company coming. If a tumbler, it is put aside as a nice thing in case of colds, etc. The children must not touch it. Come and try to sell them some honey. "Thank you, not any to-day; we have some on hand," and you do not sell them any until some one of the family has a cold or company does come. With a pail in hand there is a feeling of plenty. As I heard a man say once, "I do not suppose I can or do drink more milk out of a pan in the milk-room than I can out of a tumbler in the house, but all the same I like to drink out of the pan. There is a sense of freedom about it that suits." The children want some honey with their biscuits; there is plenty, and they have it. It is put on day after day, until, halloo! the bottom of the pail is reached! They have acquired a taste for honey (the older people as well), and got into the habit of eating it, and another pail must be bought, adding much to their comfort and good health, and profit to the seller. I believe, and feel quite sure, that I can sell more good extracted honey at 8 lbs. for \$1.00 than I can for 10 cts. a pound. As A. I. R. once said, "If there is one thing I excel in it is being able to employ a lot of help and make them earn their wages."

Now, if there is one thing I am good at it is being able to sell any *good* article I have at a *good* price, and hold my customers; and one thing I have found out is, don't bother your customers much in making change. Take whole coin, not cents. It is easier to get \$1.00 for honey from one man than 50 cts. from two. I can sell a good many more cucumbers or cabbage at 3 for 25 cts. than I can at 8 cts. each. I do not mean to say that any stranger can go in and sell on these lines anywhere; but a *good* man with *good* goods, if he is a *good* salesman, can do it. You must have the confidence of your customers. It takes fair and square dealing, and time to get that, and when you have it, *keep it*, as you will find it profitable, both for your pocket and your soul—for your pocket, for it enables you to sell; for your soul, for, to keep their confidence, you must have clean hands and a straight tongue, and so a good conscience.

Waterloo, P. Q., Dec. 26.

[There is a great deal of sound truth in what you say, friend Slack; and, by the way, you are not so *slack* a man as your name would seem to indicate, for apparently you have given attention to even the small details.

But a policy that would be advisable for your locality might not be a good one to follow in another. If you were to move to Oberlin, Ohio, you would find a very large class of customers who would buy in small "drips," but who would not take any honey if it were put up in pails requiring the expenditure of a *whole dollar*. Some of the poor people of that town, I fancy, would look at the dollar, and then look at the pail of honey; and if they could not buy a dime's worth of your goods put up in glass they would go away with the shining dollar and leave you in possession of the honey.—ED.]

THIN FOUNDATION FOR BROOD-FRAMES.

A Scheme of Wiring; the Economy of Using Thin Foundation in Place of the Ordinary Heavier Standard Grades in the Brood-nest; Square v. Tall Sections; Greasy Sections.

BY WM. M. WHITNEY.

Mr. Root:—Last year I commenced experimenting with extra-thin surplus foundation for brood comb, and promised to give an account of results as soon as my experiments warranted doing so, which promise, I believe, may now be redeemed.

I hand you a photo of sample of brood comb made from such foundation, using 13 sheets to the pound, Langstroth size. Truer, better-built comb I've never seen. No. 1 is a frame of solid honey from top to bottom, taken from the brood-chamber. No. 2 are frames of comb from which the honey has been extracted, and have been used for brood. No. 3 is simply a frame of foundation showing the line

of wire. The frames are the staple-spaced, groove and wedge, thick top-bar. The only difficulty experienced was in two or three instances where the wedges were too thin to fasten the foundation securely, which, by inadvertence, were overlooked.

You will find on the next page a diagram marked No. 4, showing the method of wiring. The hooks are made of slim nails, or brads, of the proper length, driven from the outside, excepting in the top-bar, where they are driven from the under side at the outer edge of the foundation-groove. After the nailing is done, the hooks are made with a pair of small round pliers. The wire is run from the spool, placed upon a spindle to hold it stationary, commencing at No. 1. and following the course of the arrows as shown in the drawing, the whole work being done more rapidly than I've been able to do it in any other way.

The method of wiring is not new with me, but was obtained from my very dear friend Henry Bosworth, of Newbury, Geauga Co., O., who always produced most perfect comb, and did all his work about his apiary in the neatest and most approved manner. In his death, which occurred several months ago, the fraternity lost one of the most practical bee-keepers



I have ever known. I always felt doubly paid whenever it was my good fortune to visit his place and observe his work.

Other methods of wiring may be as good, perhaps, but this suits me. After the wiring is done, the manner of putting in the foundation is as follows:

Set the frame top down, with foundation-groove next to you. Hook the wire from the center of the top-bar, aided by a slight pressure upon the bottom-bar to loosen the wire. Slip the foundation into the groove, and hook the wire, at the same time turning the hook so that the side and wire shall press against the foundation, thus making a smooth surface. Turn the frame around and press the wedge in place, and the work is done.

You will notice that by this operation there is a pair of diagonal or bracing wires on either side of the foundation. Now, if these wires are drawn taut, and the foundation securely wedged, there will be little or no need of imbedding the wire, as the bees will build over it all right. The spur-wheel often pricks too deep, and leaves a ragged line along the wire, which is a cause of the tearing-down of foun-

vation. I do not mean to say that bees will not, under other conditions, tear down foundation, for they sometimes do; but this is a fruitful source of this mischief, of which we hear complaint.

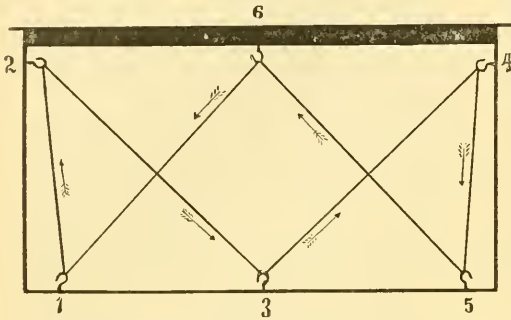

Wiring thus, holds the foundation in place until the bees shall have fastened it; and if there is any expansion, there is no danger of buckling; hence even, straight comb is the result.

Care should be taken in placing the frames in the hive. It would not be advisable to put such foundation in the center of a hive of a populous colony during very hot weather, as there might be danger of its breaking down before it had become securely fastened; but it would be all right at the sides and in the second story, or in building up a weak colony anywhere. I have had no trouble in hiving new swarms on such foundation.

Now, it will be readily seen that, if 13 sheets to the pound can be successfully used, it will be very much to the advantage of bee-keepers to use such instead of 6 to 8 sheets, as has been the custom, notwithstanding the price is slightly higher. When bee-keepers come to understand that 2 lbs of foundation is sufficient to fill 3 hives, instead of 3 lbs. being required to fill 2, much more foundation in full sheets, and fewer starters, will be used, and less drone comb produced; thus everybody connected with the business will be benefited.

I've also been experimenting along the line of comb honey production, which has given me much satisfaction. The standard $4\frac{1}{4}$ and $4x5x1\frac{3}{4}$ beeway sections, with and without separators, were used. As this has not been a favorable season for honey in this locality—surplus coming late and very slowly—better results have been obtained without than with separators, excepting where they were perforated with $\frac{5}{16}$ holes. With solid wood separators, bees built brace-comb, more or less, in nearly all the hives, thus injuring cappings; but with perforations, say five to each side of the section, the comb was built as true as if a straight-edge had been used. A photo of samples of such are herewith inclosed. Neither photos of brood comb nor sections show as well as the originals. Sections in lower row are capped as white as snowflakes; but next above are what are known as *greasy cappings*, all from the same case.

In my experiments with the surplus chamber, two of the most populous colonies were

selected to test the matter of greasy sections. Cases containing 32 sections each were placed over the brood-chamber with the winter cushions kept on all summer, an air-space of about three inches being left around the section-case, as the hives are what is known as the two-story chaff, with packing inclosing the first story only, leaving the second story simply an outside shell of thin material.

The season, as before remarked, has been a slow one, and the center of the case, as a matter of course, being first occupied, was completed before much if any attention was given to the outside rows of sections. After the fall honey-flow began, much quick work was done. Through the center of the cases every section, excepting at the extreme ends, was capped *greasy*, not travel-stained, but *thoroughly greasy* in appearance; but the outside sections were capped as white as one could wish to see. The inside sections were much heavier, the honey being very thick and waxy, and very fine.

One thing further, and I'll not tax your patience longer. With such a season as we have had this year, the $4\frac{1}{4}$ section is filled and capped more completely than the $4x5x1\frac{3}{4}$, as shown in the photo, all of which were used with perforated separators. With a flush flow there would be, probably, little if any difference. This is my first experience with $4x5$ sections. I have some handsome specimens, and like them very much, barely balancing the scales at a pound each. I think such as I have with beeway space, with perforated separators, preferable to the plain with fence. On submitting them for inspection by the side of standard $4\frac{1}{4}$ to several ladies, at different

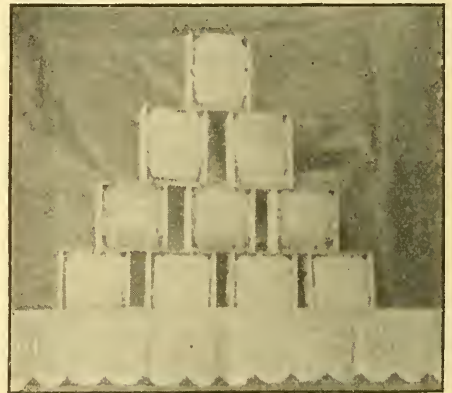

times, the unanimous verdict was in favor of the square section; "and they look so much nicer when placed on the table."

While we obtain theories and hints from the books and journals, which are absolutely necessary to success, we acquire more positive knowledge by careful work in the apiary than anywhere else. It is to be hoped that careful bee-keepers will do a little experimenting

along economic lines, not with a view to cheapening the quality of products, as is too often the case in many lines of manufacture, but to learn how to obtain best results with the smallest outlay of capital, remembering, however, that, as a rule, the best material is economical if intelligently applied.

Kankakee, Ill., Nov. 23.

[I have long entertained the idea that the time would come when we could use the same foundation that is ordinarily used in sections, in brood frames. The only difficulty, hitherto, has been that such a light weight has a tendency to stretch during the time of drawing out, causing drone in place of worker-cells. The solution of this difficulty is in the use of some sort of wiring or stays by which the foundation may be kept from stretching. The A. I. Root Co. has been working on this problem, and is still considering it, and it hopes in the future to be able to turn out an extra-thin foundation, having incorporated in the wax, either before or after milling, a very fine grade of wire in the foundation, the wires being placed about two inches apart, and in such a manner as to hang perpendicularly when the foundation is suspended in the brood-frame. It will take time and patience to work out the problem; but when it is, bee-keepers will be able, for the same money, to use 3 lbs. of foundation in place of two as now; and I am not sure but they can do so now if they follow out carefully the plan suggested by Mr. Whitney above. But it will be very necessary to follow him very carefully, otherwise there will be a great many drone-cells in the finished combs.

The scheme of wiring is very similar to the one we advocated and used, known as the Keeney plan, but which we finally abandoned because the foundation had a tendency to bulge in the diamonds made by the intersecting wires. We concluded at the time, it was better to use either parallel horizontal or parallel perpendicular wires.

The only plan by which such method of diagonal wiring may be made practical on so light a grade of wax, is to let the foundation hang free from the wires, *without imbedding*; and even then it must be put outside of the center of the brood-nest. If friend Whitney were to have these diagonal wires imbedded into the light-weight foundation he speaks of he would have trouble in the way of bulging at every diamond or intersection of the wires. If the frames hang true, the bees will do their own imbedding as the comb is drawn out into shape, and the result would be beautiful flat slabs of comb.

Referring to tall v. square sections, I am of the opinion that, if those beeway sections had had four openings, Mr. Whitney would have found the result in favor of the tall box. Or if he had used plain sections, both square and tall, with fences, the difference would still have been in favor of the tall box; but under the conditions named, I should suppose that the square one would be filled just as well at least.

There is no denying the fact that a square comb, when cut out, looks better on the plate

than the tall one; but when the honey reaches that stage in its history, it has been sold. It is not how the honey looks on the *plate*, but how it looks on the market *before* it is sold.

In conclusion I desire to say that this article, in my opinion, especially that part relating to the use of foundation, is very valuable, and it is high time that bee-keepers were considering whether they could not save many dollars by using the lighter-weight wax in the brood-nest.—ED.]

CONTRACTION, AND BELGIAN HARES.

BY W. A. H. GILSTRAP.

In GLEANINGS, page 874, last year, you say in a footnote to Mr. Norton's article concerning contraction, "Now, it would be folly, it seems to me, to drop the discussion at this point, and I should be glad to hear from a number of our readers who have been working along these lines."

At the time, it seemed to me there were some good points coming out about contraction. But you have crowded out information on that point with some things that may be of more value, or the subject of contraction does not attract the attention that I think it should. Most writers seem to think contraction of the brood-nest should be practiced only with a short honey-flow when managed for sections. I have had no experience with such conditions, but have derived considerable benefit from contraction nevertheless.

To understand the subject well we should make a careful study of our range and honey-flow, not only as regards honey stored, but in connection with swarming and building up for another season.

The San Joaquin Valley, which is in the central part of the State, is about 250 miles long by perhaps 50 miles or more in width. Much of it is worthless for bees. Where we get honey it usually runs as follows: Honey enough to promote swarming from about the middle of April till the middle of May; then a honey-dearth for a month, after which the honey-flow may commence in earnest, but oftener it is light at first and increases until August, and usually quits about the last of September. Of course, there are exceptions as to localities and seasons.

My plan with the Heddon hive is this: Leave plenty of stores in the fall. In the spring, place a case of empty combs, except one comb which should contain brood, on the lower story. By repeating this as often as necessary, until early in August, it is possible to keep swarming down, and have stronger colonies, than by any other method I have ever tried.

During the last week in August a wood-and-zinc queen-excluder is placed on the lower story, and a case of combs containing no brood, or only foundation, is put on the excluder. The bees are shaken on the ground in front of the hive from the cases that contain the brood, and may contain the queen, while the rest of the combs can be sufficiently cleared by smoking to take to the

extracting-house. A week later I extract from the hive again, or at least look for queen-cells, but do not find them started in many hives. It will be remembered that the two lower stories need not be examined, which is quite an item with such strong colonies. If ten-frame L. hives are receiving much honey at the time, it would astonish the natives to see how the honey "just grows" in those Heddon hives.

I never tried inverting brood to get queen-cells torn down, and do not believe it would work. Once while destroying cells I noticed one, quite small, which had no more downward tendency than a drone-cell. I thought it was a queen-cell, and gave it a pinch to see, which revealed a lank young queen of surprising length for so small a cell. For experiment she was given to a nucleus, and proved to be an average queen for laying. Inversion would not have cost her any thing, and such cases are frequent. Early in the summer it might be different.

Of course, these contracted colonies winter in our climate with less stores than others do, and have ample time to build up for the honey-crop. If properly cared for, not one per cent of them should swarm.

If you come around next September I shall try to convince you that the Draper (Dadant) bar is not big enough for a brood-chamber, and not the right shape.

Last fall I did not contract any. Egg-laying was reduced by requeening, and it seemed better to leave the rest strong for queen-rearing operations in the spring.

Now, if I can run the bees out of an L. hive into a box or "any old thing" I shall owe thanks to Mr. Lathrop and several others, if it gives the advantages of contraction. The objections which Mr. Massie raises to inversion in Tophet (p. 608, last August) do not apply to this locality.

BELGIAN HARES.

Lately I have been feeling very guilty about what I said on page 607 about Belgian hares. The "limited experience" referred to was for a few weeks last winter. Last summer I purchased a lot on the strength of that experience, and the almost universal fake claims of breeders—men I could safely believe (?). As an example, they are claimed to dress five pounds at five months old. As they are so big it is natural to believe such whopping statements. In fact, however, they weigh about half that amount.

The notice they get in Dec. 15th GLEANINGS, p. 977, is truly amusing. If the Secretary of Agriculture would pay express charges on a fine pair of hares it would be a pleasure for me to send him a pair for experiment. He would be apt to find so much difficulty in raising them that his fears would vanish about their increase when unprotected by man.

If I can make honorable exchange for something I can use I'll quit the business; if not, you can depend on my eating out. They should be good pets, but will never supplant poodle-dog worship. As food they can not be produced cheap enough. I can't learn where their tough hides sell for any thing. The

stories of water-mouth, death from heat neglect, and eating of young by the does; broken legs, lop ears, bowel complaints, and what not that breeders talk to each other about would surprise an outsider. To make these facts public might cause some folks to cry, "Great is Diana of the Ephesians!" for the space of half an hour, for their income would be jeopardized.

When I think of Belgian hares my next thought is, *fake!* and this is a valley with a record of 17 pups at a litter, and one cow produced four calves which grew off finely. The locality is all right.

Grayson, Cal., Jan. 1.

[If I understand, your method of contraction is not contraction as it is ordinarily understood. First, you practice expansion, running the bees up to their greatest possible strength. Then you contract, not by cutting down the size of the brood-chamber, but by restricting the egg-laying of the queen, and giving the bees, in lieu of cases of brood and honey, those containing either empty combs or frames of foundation.

Belgian hares are getting the black eye all along the line; and while they are now being condemned right and left I can not help feeling that the trend of discussion and opinion is going just as much to one extreme as it did in the other extreme in extolling their merits to the skies. I have been at the homes of bee-keepers where Belgian hares were reared for table use, and they had been so reared for a number of years.

In time this industry, like all others, will seek its legitimate level; but in the mean time I think we must conclude that, as a rule, where the growing of Belgian hares would pay, the rearing of poultry would yield a larger revenue, because from them we get not only the meat but the eggs.—ED.]

FORMING NUCLEI.

Helpful Hints from a Practical Man.

BY C. F. BENDER.

Although a professional bee-keeper and an interested reader of GLEANINGS I have never yet contributed any thing; but in looking over the volume for this year I see several places where I should have liked to put in a word if I could have done so at the proper time. As I seldom have time for much writing, I will, with your permission, write on several subjects in one article.

1. When I made my nuclei this summer, in spite of the fact that I left them shut up two days I saw so many bees going back to the old stands that I began to fear I should lose all my nuclei. Just for an experiment I moved one of the old hives about four feet back, and was more than pleased with the result. The bees that had no other home would, of course, enter the nearest hive, which was their own; while those returning from the nuclei would make a few circles and return to their new home when they found the old one no longer there. Just

try this next time you are troubled by the bees returning, and you will see them do just as I have said. This method has saved me \$20, this summer alone.

2. In extracting, instead of elevating the extractor on a box I have a box sunk in the floor of my honey house (open side up, of course), large enough to hold two 60-lb. cans or a three-gallon pail, and covered with a tight trap door sunk flush with the floor. When ready to extract I remove the trap-door, place the honey-gate of the extractor over the box, and set the cans under it. This is very handy where one has an extractor with a large space under the reel (mine holds 200 pounds), because the extractor is just high enough to be handy when standing on the floor.

3. In preparing outdoor colonies for winter, where the hives are on or near the ground I proceed as follows: Rip out sticks from $\frac{7}{8}$ lumber, 20 inches long and one inch wide. Take 7 pieces of lath, each 2 feet long; place one of the sticks at each end, and nail the lath to them, spacing the lath equally, and leave the sticks projecting one inch above and below. This makes a hurdle, or frame, 2 feet long and 20 inches wide. To protect the hives, take three of these lath hurdles and place them on edge to form three sides of a square. Tie the sticks together at the corners, and fasten across the front of the hive (which is to be left unprotected), by running strong twine across at top and bottom. Fill the space around and under the hive with leaves or straw pressed in tightly, and also cover the top of the hive eight inches deep; or, better, put on a superful of coarse sawdust, using burlap over the frames. These lath protectors may be taken apart and stacked up during the summer, or used for chicken-coops by putting in another side and a cover. With hives facing the South, and thus protected, I seldom or never lose a good colony. This may be an old method, for it is a very simple and good one; but I have never seen it described.

4. Speaking of feeders, by far the best one for me is made of a box about 7×9 inches inside, and 3 inches deep, with a single piece of board, cleated, for a cover. An entrance is cut in one end and placed tightly against the front of the hive, so no bees can enter except from the hive. A wooden butter-dish is placed in this box, and filled with feed. Of course, this feeder can be used only in warm weather.

These little boxes can be very cheaply made from scraps, if one has a foot-power saw, and they are the most convenient feeder I ever used. The division-board feeder is excellent, but costs at least three times as much to make.

5. The editor recommends hand-hole sawdust for smoker fuel. I used it for some time, and liked it very well until I discovered by accident that the smoke from it is almost as pungent as cayenne pepper. Just make a hot fire with it, and take a sniff at the nozzle of the smoker. If you are a humane man you will never use it again. This may seem like a small matter to some, but I think it is wrong to cause unnecessary pain, even to the lower animals, and most especially to the bees.

Newman, III.

THE ORIGIN OF WIDE AND THICK TOP-BARS.

Width Essential, but Thickness Unnecessary and Wasteful.

S. T. PETTIT.

In GLEANINGS, page 798, Dr. Miller gives the width of his top-bars, and I am glad of it. He and you have said so much about deep top-bars that I had come to think you reckon on the deep feature as the chief factor in preventing burr and brace combs, while in reality it cuts no figure at all in that line. It is the width of the top-bar, or, rather, the $\frac{1}{4}$ -inch space that does the work—governs the whole matter, practically so.

Mr. Root, I know you want facts, even if they do seem to cut deep; then don't be startled at this statement, for I am telling you an important fact that will stand the severest tests.

Years ago I wrote this matter up, but it was passed over as a thing of naught, while deep top-bars have been unduly lauded, and bee-keepers have suffered. In order to secure the necessary rigidity I make mine $\frac{5}{8}$ inch thick; but I'd much rather have them only $\frac{1}{8}$ thick, if it were possible to have them of that thickness, or, rather, of that thinness, having the necessary rigidity.

I hope you will allow me to disabuse the minds of your readers upon this important matter, and possibly some one may invent the top-bar above indicated. Indeed, thin top-bars, whether the space is right or wrong, will have less burr and brace comb than thick ones; and then there are also other advantages. Let us notice the gain in space.

The difference between $\frac{5}{8}$ and $\frac{1}{8}$ is $\frac{1}{2}$ inch, which in the different kinds of hives now in use amounts to from 1600 to 2000 or more cells to each hive. The saving of that space in each hive is a matter worthy our best consideration. Another gain, the bees more readily enter the sections and stick more closely on cool nights. When I think of the thousands of deep top-bars you turn out annually, and the consequent loss to your patrons, I can not help feeling troubled about it. You are welcome to the honor of evolving the deep feature, but you will hardly claim the wide feature. I have written the above in a dogmatic, querulous style, in order to catch your attention and hope to succeed.

And now, Bro. Root, let us step into the 20th century with a top-bar possessing the nearest approach to perfection ever used; that is, one wide enough to form a $\frac{1}{4}$ -inch space between them, and as thin as possible, having the necessary rigidity. Such is the top-bar of the 20th century, whether you lead the way or not. The deep feature must go. I wish to say a word about bottom-bars, if you will.

They should be $\frac{3}{4}$ inch wide, and about $\frac{1}{4}$ thick. A wider one, when being lifted out and replaced, is hard on the bees, and may injure the queen; and, besides that, the bees are more likely to sting; and, more: Wide bottom-bars are more likely to catch and choke the hive with dead bees in winter; but if they are narrower, the bees are more likely to build

comb under them when using deep entrances. The end-bars are of the same width as the top-bars. Of course, the width of both depends upon the spacing of the frames. Mine are $1\frac{3}{8}$ in. from center to center. About 25 years ago I made measurements in all the old hives I could find in my neighborhood, and I found that that spacing was chosen and adopted by the bees when nature was working according to her own sweet will, and I believe they made no mistake in that.

Aylmer West, Ont., Can., Jan. 5.

[While, perhaps, I started the ball a rolling for wide and deep top-bars in this country, yet we of the Root Co. do not claim any thing of originality for them. When I attended one of the conventions in Canada, some ten or twelve years ago, I had quite a little talk with Mr. J. B. Hall, who incidentally happened to mention that, with wide and deep top-bars, he had no trouble from burr-combs. Dr. Miller was greatly struck with the idea; and after some extended correspondence with the doctor we decided that we would launch forth for the ensuing season the new top bars.

While width is certainly essential, and it is also necessary to have a spacing about $\frac{1}{4}$ inch between the top-bars, thickness does of itself play a somewhat important part—at least according to my experience and observation. I not only judge by what I have seen in our own apiaries here at the Home of the Honey-bees, but from what I have seen at other yards in several different States. We first tried top-bars that were wide, and only $\frac{1}{4}$ inch thick. We had trouble from such bars sagging, and the building of burr and brace combs. We next tried the wide bars, $\frac{7}{8}$ inch thick and $1\frac{1}{8}$ wide. Burr-combs disappeared almost entirely; and even when these frames might be called old they were still practically free from the nuisance. As a few of our customers objected to "sawlogs" for top-bars, we, a year or so afterward, reduced the thickness of the bars to $\frac{5}{8}$, keeping the width the same. We soon discovered that brace-combs were more plentiful by the use of such bars than when they were full $\frac{7}{8}$ deep. Then there came the objection to having a bar so shallow. We finally went back to the full $\frac{7}{8}$ -inch deep and $1\frac{1}{8}$ wide top-bar, with wedge for securing the foundation; and this has given the best satisfaction of any thing we ever tried.

When we first launched these on the market, we were met by the statement that the bees would not fill the supers so well over them. But here, again, careful observation convinced us that they did not offer any real hindrance to the bees. It was Doolittle who, when these new bars were put forth, condemned them, saying that the bees needed the burr and brace combs as "ladders" to get up into the supers; that thick top-bars would be the means of cutting down the surplus. But in later years I see he advocates thick and wide top-bars as the thing. As it is no disgrace for one to change his opinion on evidence, Mr. Doolittle, when he saw his error, was frank enough to admit it.

I think you are exactly correct in what you say about the width of the top-bar. If it is too narrow, the bees will build the combs past the bar; and if too wide they will build the comb within $\frac{1}{4}$ inch of it, and leave a nice hiding-place for queens, besides rendering the comb less stable because of there being no bottom attachments. Three-fourths of an inch is a very nice golden mean, and accomplishes the results most perfectly. The last few years we have been using them that width, and feel that we have no reason to change.—Ed.]

GLIMPSES OF CUBA AND CUBAN BEE-KEEPING.

BY A. L. BOYDEN.

When I wrote my previous article, which appeared in the Feb. 15th GLEANINGS, I intended to follow it with this article March 1st, but was too busy to get my copy ready in time.

After visiting Matanzas I next crossed by rail to Cardenas. This was my first experience with Cuban railways. Here I found three classes of tickets are sold—first, second, and third; and, instead of a car devoted entirely to the mails, as we find in the United States, the mails were carried in a small compartment in the second-class cars. As I went into the depot at Matanzas I noticed a great many people were carrying chickens, having them tied by the legs, and a great many boarded the train with these. I bought a railroad guide at the window, and in this I found a paragraph in the rules to the effect that no first-class passenger should carry more than one rooster. This was quite amusing to me.



INDEPENDENCIA ST., CARDENAS, CUBA.

I reached Cardenas after little delay, and the only Americans I found on my trip were some showmen who were going to exhibit in Cardenas the following day. On my arrival I was met at the depot by Mr. Hamel and Mr. L. S. Houston, and was soon shown to the hotel La Isla de Cuba. I found very good accommodations there, but unlike any thing I had ever seen before. On my arrival at this place at one o'clock I was asked if I had had break-

fast. This seemed strange to me, but I found that their breakfast was from ten to twelve.

In the afternoon I walked up Independencia St., the leading street in the place, as shown below. Except for the height of the buildings, this street is not so very much unlike some of our American streets. It is quite wide, and the sidewalks are much wider than many in Matanzas.

When I went down to dinner that night I noticed that there were some mosquitoes about. I sat down to the dinner-table alone, and very soon the mosquitoes discovered that there was but little hair on the top of my head. I had got along in Cuba very well so far, but I was simply obliged to cut my dinner short and beat a retreat. The mosquitoes would give me no rest whatever. I consider this the worst difficulty I found in Cuba. Later on in the evening I went to my room, and, as the beds are provided with mosquito-bars, I passed a very comfortable night.

Early next morning I called at the office of Mr. J. B. Hamel. He had just returned from a trip in the interior. This gentleman, I am told, has been in Cuba some 25 years or more. He is interested in various enterprises, among which is the production and sale of honey, and later he has taken up the sale of bee-keepers' supplies as well. In the afternoon we drove out to his apiary, about three miles from the city, where I found several hundred colonies in frame hives. The harvest was just coming on, and it gave me a great deal of enthusiasm to open the hives and see the combs so well filled. We returned to the city late in the afternoon, and I went to the hotel for dinner. I determined that this time I should not be beaten by the mosquitoes, so I went down to the dining-room with my hat on, and kept it on during the entire evening. I don't want the readers to get the impression that these mosquitoes were more ferocious than ordinary, but I should say that they were very fond of Americans, and perhaps I am more sensitive than the average American in this matter. I do not mind a dozen or fifteen bee-stings very much, but I prefer to be excused when it comes to mosquitoes.

This being the evening of Dec. 24th, it appeared very early that the people were preparing for their Christmas festivities. I was told that the custom prevails there of having their Christmas dinner or feast on the evening or night of the 24th, and, as nearly as I can judge, many of the people do not go to bed at all that night—at least I remember a very troubled sleep, for it seemed to me that I never heard more noise all night long than I heard there. Very late in the night I got up, and, looking out, saw a band of people marching by to some kind of music, and not long after I saw another of the same. It appears that opposing companies are made up for some purpose—just what, I could not discover, although it occurred to me each was trying to outdo the other in the amount of noise it made. Instead of turkeys for their feast, as we have here in the North, roast pig is the principal article. I am told that every family who can afford it has the roast pig: I did not

discover that the giving of presents was as common there as it is here, although this practice prevails to some extent.

Dec. 25th I left Cardenas for Havana, and reached that place late on Christmas evening. After some delay I found my way to the hotel La Isla de Cuba, fronting the Central Park, and during my stay here, of some ten days, I found this a most pleasant location.

Early on the morning of the 26th I engaged an interpreter, and together we started out to find my bee-keeping friends.

Readers of GLEANINGS will remember very well some articles in years past, from the pen of Fred Craycraft, formerly of Indiana, and later from Florida, and still later from Cuba. If I remember rightly, his first article appeared as long ago as 1882, in JUVENILE GLEANINGS. Mr. Craycraft is now chief clerk of the Record Department of the Cuban customs service. Before the war he had a large apiary, which was entirely destroyed at that time, and, while he has not lost his love for bee-keeping, he has recently taken the above-named position, as it is more remunerative.

I soon found my way to the custom-house, and within a few minutes after finding him it seemed quite impossible to realize that I had not known him before. He seemed exactly like an old acquaintance. This, I presume, comes about because I had known him by correspondence as well as his writings, and, in fact, it does not take two bee-keepers very long to get acquainted, anyway. Later in the day I met Mr. F. H. de Beche, who was also a bee-keeper before the war, now engaged in one of the leading houses in Havana, and a partner with Mr. Craycraft in an apiary recently established a few miles out of the city. These men found a little leisure time outside of their regular duties, and last fall decided to start an apiary. They ordered about 25 nuclei with queens from Florida as a starter. Being very successful with this lot they ordered another, and still another; and when I visited the apiary they had some 200 or 300 colonies.

In the afternoon of this day I visited the office and warehouse of Bridat, Mont, Ros & Co., large exporters of tobacco and honey.

Of my visit there and to the apiaries of W. W. Somerford and Harry Howe, both of whom the readers of GLEANINGS remember, I will write in my next.

HOW DEEP SHALL THE UNCAPPING-KNIFE SHAVE?

Coggsshall's Statement Criticised; Unwholesomeness of Commercial Glucose.

BY E. H. SCHAEFFLE.

Extracting-time will soon be here; in fact, the hills are covered with wild flowers at this writing, Feb. 23, in the lower part of the State. Here the bees have been shut in for a month past, during a continuous rain that shows no sign of abating. About once a week the bees get a chance to rush out and go to the alders, and come home laden with pollen. We are

hoping that this old-time rain will give us an abundance of bloom, and that the weather will be favorable while it is in bloom, which it has not been for years past. But, to go back to extracting.

We are all interested in securing the largest results from our bees, and for this reason I want to "agree to disagree" with Mr. Cogshall when he states that "In extracting, the knife should cut deep, so as to give the bees an opportunity to use up their surplus wax, which would otherwise go to waste." This is the first time I have ever known the bee to be charged with wastefulness, and I wish, in its defense, to state that the bee does not carry its surplus wax about in its pockets, ready to shake it loose like a chicken shedding feathers, when it has no further use for it. On the contrary, all raisers of comb honey know how difficult it is to get the bee to make comb, save when the honey is coming in with a rush. At that time a large number of bees are kept in the hive clustering in idleness, consuming large amounts of honey that they may "sweat wax," and this right in the heart of the flow. Now, I contend that every pound of wax made at this time costs many more pounds of honey; and the less wax the bees have to build, the more honey will be gathered. How about it, brother bee-keepers?

The manufacturers, bottlers, and retailers of glucose assure us that glucose is healthful, and to be preferred to sugar. The following, from *The Medical Record* of Dec. 15, proves the contrary:

The English victims of poisoning in beer now number more than sixty dead and more than one thousand ill. It has been completely established that the cause of the poisoning is arsenic in the sulphuric acid used in the manufacture of glucose which the English brewers use in the place of malt and hops in the manufacture of cheap beer. An analysis shows that some beers contain arsenic sufficient to kill a persistent drinker, as much as one sixth of a grain being found in a pint. The fact that arsenic is a cumulative poison makes it the more dangerous.

I have tasted glucose, bottled in San Francisco, and bearing the label "Los Angeles Orange-blossom Honey, Guaranteed Absolutely Pure," that was unadulterated (with honey) glucose. So very strong is its taste of sulphuric acid and brass that it could not be retained in the mouth. Now, if a teaspoonful of glucose in a pint of beer will kill a man, how long will it take the straight article, with a piece of comb honey inserted as a bait, to do the same work?

Murphys, Cal., Feb. 23.

[The statement of *The Medical Record* is quite in line with some tests I made on myself some years ago. For experimental purposes we purchased a small quantity of commercial glucose—the very same article that is used so largely for adulterating. I sampled this stuff repeatedly, taking sometimes a whole spoonful. It came very near inducing vomiting several times as a result of this tasting, and I was sick for two weeks. My whole digestive apparatus had become disarranged; and no one can make me believe it was not the poison in the glucose—the sulphuric acid, the arsenic, and every thing else that is used

in its manufacture. The greed of the manufacturers is so great they do not stop to clarify the cheaper grades they put out. By paying enough, one can get a good grade; but the mixers do not find the better goods so profitable, and therefore use the very cheapest because it "looks all right."

I was very sorry to see in the *Ohio Merchant* an admission from Prof. H. W. Wiley, Chief Chemist of the U. S. Department of Agriculture, as to the wholesomeness of glucose. While I indorse most heartily every thing he said in the article, there is one statement that I feel sure will do harm, because I do not think it can be true of the ordinary glucose—such stuff as is used for adulterating. He says in the article on page 24 of the periodical above mentioned:

There is a distinction to be drawn between injurious and harmless adulterants. Certain falsifications have no bad effect upon the health of the consumer—as, for example, glucose, which is one of the most largely employed of all adulterants. Glucose is not at all unwholesome. It is prepared from India corn, and something like ten pounds of it are manufactured annually in the United States for every man, woman, and child in the country. There can be no objection to it, except that it pretends to be what it is not.

What Prof. Wiley doubtless alludes to is chemically pure glucose. The manufacturers of the stuff have probably sent him some for his inspection—the very best glucose that they can make, and from this he might base his statement as to its wholesomeness. But if he will, as did ourselves, go to the concerns that make a business of adulterating their wares with glucose, and analyze such an article, I feel positive he will find poison enough in it, in the way of arsenic and sulphuric acid, to upset the stomach of a pig. It is this vile glucose that is used so much in honey; and when these glucose-mixers masquerade their decoctions under the names of "Strictly Pure Honey," "Farmers' Honey," "Bees' Honey," and a dozen other honest names, the over-suspicious public conclude that, if *these* are honey, they will never buy another ounce, nor will they. It is this feature of the glucose business that disgusts consumers with all kinds of honey, and that is proving to be so damaging to the honey business of the United States.

I hope Prof. Wiley, whom I believe to be a friend of bee-keepers, and one who has done much for the cause of pure food, will have occasion to modify the statement, because he has before spoken of the wholesomeness of the syrup from corn.

Further on in the same article he says, "Maple syrup, so called, is nearly always falsified with other substances, and over 40 per cent of the strained honey sold is impure." This last statement is a little too strong. In some cities it is possibly true; but I doubt if there is anywhere in Ohio, under our present law and our present food commissioners, a place where there is even one per cent of glucosed honey; and Chicago, once the very hotbed of adulteration, has been compelled, on account of the new food commissioners, and the new law, to go out of the business, and sell only pure syrups and honeys.—ED]

RAMBLE NO. 183.

Life in a California Out-apiary; Effects of Heat on Hives, Covers, etc.

BY RAMBLER.

"Now while we are about it, Mr. Rambler, we will skip over to the out-apiary three and a half miles from here. Of course, you know that an out-apiary does not have all of the conveniences of a home apiary; but this one of mine will do; it is good for more or less honey. Here we are passing a creamery, as you will see by the milk-house and the silos. Such places mean a large acreage of alfalfa."

"I have noticed, Mr. McCubbin, that a large number of cattle seem to be crowded upon what I should call a small acreage. Here, you say, is an 80 acre alfalfa-field. How many cattle will that sustain?"

"Well, Mr. Rambler, if a good stand of alfalfa is secured in all parts of the field, and it is irrigated properly, the 80 will sustain 300 head of cattle; and, aside from running cattle for dairying, it is quite profitable to breed the cattle for beef. You can not help noticing that all the cattle in this country are sleek and plump, and ready for the shambles."

"Yes, I have noticed that; and the more pronounced, perhaps, for I have seen such emaciated and starving cattle during the dry seasons in the South; and another thing, Mr. McCubbin, I have not seen poor emaciated horses here; they are all plump and frisky—in fact, too fat for speed. And here we are at your out-apiary. What sort of crop do you call this around here?"

"That, Mr. Rambler, is an alkali weed. It grows rank, you observe, and, in its season, the bees get a little honey from it. Then there is a prickly alkali weed that gives a little honey."

"But, dear me! Mr. McCubbin, this is a desolate place—not a house within a mile; not a tree for shade; weeds, weeds; and if you have any hot weather it will strike right in here. There is nothing cheerful about this place."

"Oh! you will soon get used to the condition of things; and as to hot weather, it is only a matter of 115° or 120° when it gets down to it. When I first came here I declared that I would not work when the temperature got above 100; but when it did come I found myself working right along with the rest of the people."

"Mr. McCubbin, I notice you have quite a number of loose-jointed hives in your apiaries. See here. This hive wee-waws at least two inches out of square. Then just look at this cover. The top is made of four narrow strips, and no battens over the gaping cracks; and this one I am holding is rather loose-jointed. Jimmy Jericho! a bee-keeper down south would be ashamed to meet a looking-glass if he had such hives as that."

"Ha, ha! Why, Rambler, that hive and that cover are the desire of my heart. You see, when you place such a super on a hive you have to look all around it to see if it is on

right. That, Mr. Rambler, teaches you to be circumspect; and if you are in relation to hives you will be in relation to bees and other things. Then these hive-bodies cost me but five cents each. I buy up all of the coal-oil cases I can, and a case makes a hive-body; and a case that is not fit to make a body will make a cover; and any thing that is not fit to make a cover will make a bottom; and any portion not fit for a bottom I use for kindling-wood."

"And do you have much kindling-wood out of it, Mr. McCubbin?"

"Well, no; kindling-wood is rather scarce around here; but, as I was going to say, a two-story hive with cover and bottom cost me about 20 cents without the frames. The latter I get cut at a planing-mill, and I suppose you think that covers with three big cracks across the top will leak when the rain comes; but, keep your eye on 'em, Rambler, and you will learn something about covers."



"JUST LOOK AT THIS COVER."

"But, see here, Mr. McCubbin; it distresses me greatly to look at this cover. I suppose you have a hammer here. I will nail it into some shape. Then, this hive-body with 'This will not explode' printed on the outside needs a little nailing, for it does look a little as though there had been an explosion inside of it."

"I do not keep hammers lying around loose, Mr. Rambler; but here is a harrow-tooth with which I do my nailing."

"Land o'Goshen! harrow-tooth! Who can drive nails with a harrow-tooth? No wonder your hives are wee-waw, and covers see saw. Why, down south if a bee-keeper had only an ax and a harrow-tooth for a kit of tools he'd be ashamed to meet a—"

"Yes, yes; but, see here, Rambler; you have lived too long in the South. Those fel-

lows down there have spoiled you. Next we know you'll want the whole earth. Who wants a better tool to drive a nail with than a good harrow-tooth?"

Mr. McCubbin and I discussed these matters, both in a happy frame of mind; and, though we differed on some points, there were enough upon which we did agree so we found we could work harmoniously for the production of honey; and as the cover question is under discussion between us, and is a question



AN APIARY IN A WEED-PATCH; A MULE MIRAGE.

of no mean importance, I wish to give some ideas in that line that I have gleaned from connection with many bee-keepers.

First, I show you a half-tone of our out-apiary. It is located in the midst of a rank growth of alkali weeds. A good share of the covers on these hives are of the cracked kind; but between the covers and the frames, a grain-sack is spread. One would naturally suppose that such a cover, or combination of sack and cover, would leak like a sieve. Later in the season, after 24 hours of steady downpour of rain, I went out to examine these wonderful covers and their capacity for turning water into the hive. To my surprise I found the bees on deck, ready for business as soon as I turned back the sack. The cracks in the cover had swelled tight, and only a little of the water from the first hour of rain had penetrated the hive. The sack was soaking wet; but as there was ample ventilation above, as soon as the cover dried and the cracks opened, the sack soon dried, and all was well with the bees.

The out-apiary is also provided with a honey-house with a cover in keeping with the cover on the hives; but when you consider that, all through the working season, there is no rain, tight covers to hives and houses are not the most essential thing. This is also the country of the mirage. In the case of this apiary it is a mule mirage. These mules were much interested in bee-keeping and photography, and, though the apiary was in their pasture lot, a couple of strands of barbed wire kept them at proper distance. When working alone in the apiary under the hot sun of Central California it was a pleasure to have

occasionally the companionship of a mule mirage.

From the comparing of notes with a good number of bee-keepers I know they prefer a tight even-fitting cover; but how to get it is the next question.

A few years ago the Higginsville cover received some attention, and it may be a good cover for some localities; but for this country, and made with a thin edge as I have used them, it is a failure, for that thin edge soon warps, leaving an opening several inches in length.

A whole-board cover, with clamps at the ends, is probably the cover most extensively used; but these will warp, and especially when made wide enough for a ten-frame hive. Redwood covers hold their shape in this country better than pine or any other variety of wood. Wide lumber is expensive, and the crying want is for something cheap and perfect.

Mr. Brodbeck, of Los Angeles, uses a cover which he assures me will not warp, and, to his mind, is near perfection. It is not, however, any cheaper than the ordinary wide covers, for it is made by resawing a wide board into boards $\frac{3}{8}$ inch thick, and placing between them $\frac{3}{8}$ -inch cross-pieces, making in reality a combination cover and shade-board, and it can be used either side up. The accompanying cut will show the method of construction.

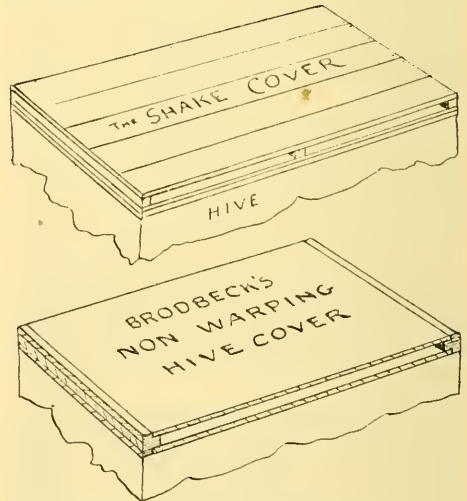

Another very good cheap non-warpable cover is made as follows: As previously mentioned, redwood, so plentiful on this coast, is not so liable to warp as other woods. Redwood shakes are used extensively for covering buildings, making raisin-trays, etc. They are sawed about $\frac{3}{8}$ inch thick, and 4 inches wide. Cut these the desired length for the cover;

provide three pieces of board $\frac{7}{8}$ inch square, as long as you desire the width of the cover, one at each end and one in the center. If your cover is to be 12 inches wide, nail three shakes, crowding them close together, to the end and center pieces. Then nail another set over the first, breaking joints. This will necessitate splitting a shake. When these are nailed on firmly, turn the cross-strips up and nail another set on that side, single layer, but breaking joints with the ones below. This makes a light durable cover; and I am told by J. H. Miller, of Los Angeles, who uses them, that they do not get out of shape.

The cover is much in appearance like Brodbeck's, but it is cheaper. This cover also acts as shade-board as well as cover; and in Central California, although the heat is sometimes great, there are practically no shade-boards used; and in the location where I spent the summer there are no stones on the hives. A very sufficient reason is in the fact that there is not a stone large enough to throw at a dog, in an area of many square miles.

[All through Colorado I saw the effect of the dry climate and the dazzling sun on hive-covers and hive-bodies. Even the very best of hives, made in the best factories, would have a fashion of pulling apart, nails sticking out, and boards checking and warping in a manner that would make one who had seen these goods before they left the factory almost weep. One can scarcely realize the effect of such a climate until he has seen the work of the elements with his own eyes.

In a warm climate a good dashing rain will do very little harm to a colony of bees, even if the water pours right down through on to them; and I suppose the purpose of a hive in California is not so much to keep out rain as it is to shut out the direct rays of the sun, and to afford a receptacle in which the bees may be held for the purpose of moving from one place to another. At such times it is important to have the hive reasonably strong and tight. The few bees that might escape from a hive loaded, with a lot of other hives on a wagon, *en route* over the mountain roads, would be apt to make a bad mess of the whole load in case they should get at the horses.

In the department of Special Notices in this issue will be found a description of a new hive-cover that The A. I. Root Co. has recently adopted for excessively hot climates, or climates that are severe on lumber, causing it to shrink and swell badly. A paper protection to cover up the big cracks in cover-boards will, I believe, come more and more into general use.

We have made covers on special order for various bee-keepers, on the plan of the Brodbeck and "shake" hive-covers. These covers, when covered with a special grade of roofing paper, will prove to be very serviceable in any locality; will be proof against extremes of heat from the sun, and the cold of our northern States during winter. This question of cover is something that will have to be decided largely by conditions and locality. It may be said, however, that a cover that will

stand a hot dry climate would also be serviceable for any other climate.—ED.]

SWARTHMORE'S GLOSSOMETER.

How to Measure the Tongues of a Whole Colony of Bees.

BY SWARTHMORE.

It is a sort of meter that I have devised, constructed as follows: A dish of tin is balanced in a box just like a compass, by use of wire nails and solder, strips of brass, etc. The top of the dish is covered with hard wood nailed on firmly. In the middle of this cover is bored a one-inch hole, which is covered on its under side with wire cloth. Off to one side is a float of cork having a piece of strap steel attached to its under side, in the middle. A small hole is pierced through the pan cover, and a knitting-needle is pushed down into the cork until it strikes the steel plate. A dial is constructed above the pan-cover, upon which is adjusted a recording hand, and the knitting-needle then fits into a little impression close to its center in such a way that the rise and fall of the cork will force the needle up and down, and, being at such a long lever-

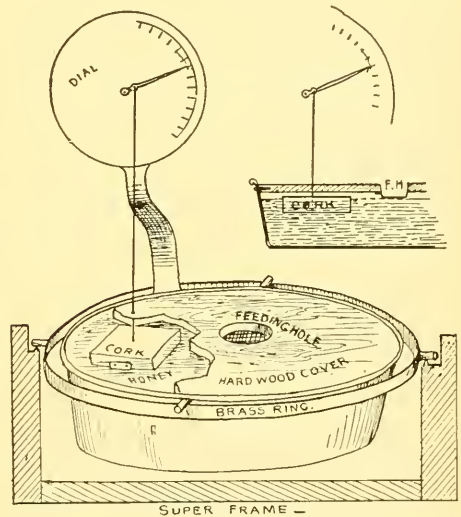

age, the hundredth part of an inch will make an eighth or more at the end of the hand.

Fill the tin pan with thin honey and allow it to stand long enough to soak the cork thoroughly, then place the instrument on top of the frames of the colony to be measured, and cover all with an upper story. The bees will suck up the syrup through the meshes of the wire, and the cork will gradually sink. The needle will, of course, follow; and by lines on the dial the hundredths may be plainly seen. Move the instrument from hive to hive.

I have found among my golden-all-over stock, reared this season, bees with extreme length of tongue—from .23 to .25 $\frac{1}{2}$. By re-

peated tests with the wire-cage method I find that the full length of tongue is put out by the bees through the wire.

[The general scheme of your measuring-device is very ingenious; but after all it would measure only the longest tongued bees in a colony. There is a slight variation in tongue-reach in bees of the same colony, and this variation is more with the bees of some queens than with others. But for real accuracy I question whether so much machinery would give the results as satisfactorily as a more simple device. For instance, the dial pointer would have to be very nicely balanced on a delicate hair-spring, with a slight tendency to move toward the zero-point. Then the string or thread reaching from the top of the needle to the point in the dial might vary a trifle in length. Any fibrous filament will vary in length according to the weather; and while it might be possible for you to use a fine wire, yet the stiffness of it would destroy to a certain extent the freedom of movement of the pointer on the dial.

You say that, by repeated test by the wire-cloth method, you find that the whole length of the tongue is put out by the bees through the wire cloth. From a physiological point of view I do not see how this is possible, any more than it is possible for us to stick our tongues the entire length clear out of our mouths. But perhaps you measure from one point of view, and we from another; and, again, your wire cloth may be sufficiently coarse so that a bee can actually stick its nose or mandibles *down through* the meshes. This would add somewhat to the tongue-reach. If so, this would hardly be a fair comparison, for the corolla-tubes of red clover that I have examined would not admit any portion of the mandibles with the tongue.—ED.]

.....

PRACTICAL IMPROVEMENT.

Longevity vs. Long Tongues.

BY J. O. GRIMSLEY.

An invalid is not expected to be very impressive in the discussion of even the most interesting subjects; but I, for one, am like the good old woman at a camp-meeting, especially when I am devouring (mentally) the last few copies of GLEANINGS. I "get full, and must have a say." But you all are not around to hear the expressions of approval, and to see the accompanying smile, and I have to resort to the columns of GLEANINGS.

MEASURING TONGUES.

Well, that's business. Seems to me I said something once before on the same subject. But, oh what a crank I am on long tongues! Long-tongued women are an—an—abomination; long-tongued bees, the ideal of the bee-keeper. But, had you thought how queer the people are? We have a long and tedious road ahead, and the by-paths are numerous, and catch many travelers. The most prominent by-path has a large sign marked, "Color;"

another says "Gentleness;" another, "Comb-building," and besides these we find various signs. However, to those looking ahead—in the straight and narrow way—is visible, in unmistakable letters, the ideal, "Long tongues."

In the first place, The A. I. Root Co. will not—can not, in fact—sell even a majority of the queens sold in the United States. If they could, then they could afford to say, "No queens will be sold which are not from a breeder whose workers have a reach of at least $\frac{2}{100}$ inch, and no breeding queen will be sold whose workers show a reach of less than $\frac{1}{100}$ or $\frac{2}{100}$ inch."

The various queen-breeders have their customers. In order to be successful at any business a man must "cater to the whims" of his patrons, who generally have ideas of their own, and it is no small undertaking to set their heads straight on their shoulders. For that reason most of the queen-breeders are making a specialty of golden Italians.

Now, don't understand me to say that yellow bees do not have long tongues. From personal experience I can't say, having given them only a limited trial, and I do not feel justified in condemning them unless I know. In fact, I can not see why they should not be well developed in that point. Why not? They are color sports; and if they have a tendency to sport in one point, why not in another? But for a success with long tongues we should not let color or any thing else be in the way. Line breeding—from both drone and queen—will eventually establish a long tongue, and then if there are undesirable traits they can be bred out by selection.

Now, who is going to do that? The Root Co. can't do it by themselves, neither can any other breeder or small number of breeders. I mean that it can't be done in any reasonable length of time.

Those who *buy* queens must put their shoulder to the wheels, and demand queens from long-tongued stock. Or, let's see; can't the breeders take one step forward by breeding from long-tongued stock, and "talking it" to their customers? Why not?

But there is another thing that puzzles me to some extent. It is plain to me that some bees—I will say strains of bees—are longer-lived than others, and it seems to me that short-lived long-tongued bees would be no better than long-lived medium-tongued bees, especially during a continued or even an average honey-flow. Now, how are we to determine whether a strain of bees are short-lived or long-lived? But may be I am carrying my quiz too far. However, there is a point to consider. In talking about long-tongued bees we notice that they are often called "red-clover bees," which is, in a sense, misleading. It is true that red clover would become a leading honey-plant if we had a strain of bees with tongues that would reach the nectar; but there are certainly hundreds of other nectar-secreting flowers that are barely out of reach at present, and would furnish honey if we had the long-tongued bees. For that reason I think the term "red clover" should be

dropped. Well, for a fact many bee-keepers that are not right to the front in every thing kind o' look on the term "red-clover queen" as being a synonym for "humbug."

Let color do her best, and gentleness have its day; but rest assured that the bee-keeping world is making the grandest stride in its history by falling in line with the long-tongue movement.

Beeville, Tenn.

PREVENTION OF SWARMING.

More about those "Brushed Swarms;" Large Hives and Under what Conditions they will Check or Curtail Swarming.

BY L. STACHELHAUSEN.

In *Stray Straws*, Nov. 15, Dr. C. C. Miller says that my article, p. 840, is not plain enough where I said, "Some time the next day. . . the lower story of the brood-chamber is removed." In the third line of that article I said, "For my management a two-story brood-chamber is needed." In fact, I use two $5\frac{3}{4}$ -inch ten-frame supers as a brood-chamber. If a swarm is brushed I give at first two such supers with frames—containing starters only—because the bees will stay better and will cluster more readily if the hive is large enough for the swarm. I remove one of these stories the next day, because the swarm will build all worker-cells if the brood-chamber is small. Besides this I give a brood-comb when the swarm is framed, and remove it the next day. This brood-comb is not absolutely necessary, but the bees will sooner cluster around this comb, and will conduct themselves quieter. When the bees are not very much inclined to swarm, this brood-comb can remain in the hive; but some years I have to remove the brood-combs the same evening or the next morning, or the whole colony will sometimes swarm out and abscond if nobody is present to rehive it.

All this is of minor importance, and according to circumstances we can proceed differently. The essential part of the management is, that the colony is brought into the condition of a swarm; and the purpose of so doing is, first, to avoid all natural swarming (an important item for out-apiaries); and, second, to fix the colony at the proper time in the best condition for storing honey in the supers. The plan is very similar to that described by H. Lathrop, pages 684 and 872, and by A. Norton, page 873. In the *Progressive*, F. L. Thompson describes another very similar way.

By an experience of many years I know how to avoid the absconding of these swarms as described above. The plan described by A. C. Miller, in the *Review*, and mentioned in *GLEANINGS*, page 921, is essentially the same as that described by me, and differs in details only. So far as I know, the first bee-keeper who recommended the forming of swarms by brushing the bees from the combs into a new hive, and setting this hive on the stand of the parent colony, or on a new stand, was the late C. J. H. Gravenhorst, in Germany, well known to the older readers of *GLEAN-*

INGS, for which journal he has written many interesting articles. We have only changed his method according to our hives, and utilized it for the production of comb honey in sections.

I have to mention again an advantage of this management. By using large brood-chambers, or by enlarging smaller ones by giving shallow extracting-supers at the right time, we can prevent swarming to a certain extent; and my observation during about 18 years is the same as Mr. Lathrop's—that from year to year the bees will be less inclined to swarm, if large hives are used in this way. This advantage of large hives is doubted by some bee-keepers, some of them going as far as to say this non-swarming theory is a farce. The fact is, some years and some localities are so favorable for brood-rearing, and consequently for swarming, that even a colony worked for extracted honey in a very large hive filled with combs will occasionally swarm. If I find so much brood in a certain hive that a simple calculation will show that the queen must have laid 3000 or more eggs daily on an average for 21 days, I know at once that this colony will probably swarm, no matter how many supers I add. Only the commencement of a very good and fast honey-flow will prevent swarming in such colonies.

To explain this it would be necessary to give a whole theory on swarming. Here I will say that a colony will swarm under the same circumstances as soon as the number of eggs laid daily by the queen remains the same, or is diminishing from any cause. As long as this number is increasing, no swarm need be expected. See *GLEANINGS*, 1899, p. 926. If, in my out-apiaries, I find too much brood in my hives, I brush my colonies at once from the brood-combs and give them starters only. With colonies worked for extracted honey this is necessary only in extremely good years. With colonies worked for comb honey I do this brushing as soon as the main honey-flow commences, for the purpose of getting the colony in the best condition to start to work in the sections, and at the same time prevent swarming.

If large hives are used to prevent swarming, we have to consider that a large hive should contain a large number of empty cells in which the queen can lay eggs. I know that a colony in a large hive only half filled with combs may swarm, especially if the queen is old. It is not the large hive itself that prevents swarming; but the large number of empty cells available for the queen will prevent swarming, and even this is true to a reasonable extent only, as mentioned above.

Converse, Texas, Dec. 12.

DOMINICA, THE SWITZERLAND OF THE WEST INDIES.

BY W. K. MORRISON.

St. Pierre, Martinique, was the next stopping-place of our steamer the *Solent*, of the West India Royal Mail. Ever since reading Pere Labat's book on the West Indies, and

Lafcadio Hearn's splendid "Two Years in the French West Indies," I have been anxious to visit Martinique, and now my wish was to be gratified. Before us lay the high peaks of the land of Josephine, the Creole Empress who held in herself the destinies of Napoleon and of France. Fort de France we could see in the distance, with the everlasting three-masted American schooner anchored in the offing to indicate the nearness of a more progressive civilization than that of France. I fancied I could see Trios Islets, the birthplace and childhood home of Josephine. Looking at the high peaks of Martinique, and musing inwardly on the somber aspect of the Morne Pelee, I thought, "What a land for romance, especially in the days when old Spain, France, and Britain fought desperate sea-fights for the possession of the new world!" Near by, Admiral Rodney smashed the whole French fleet which had eluded him to assist Washington at Yorktown. Quite near we could see, from the deck of the Solent, Diamond Rock, famous in story as His Majesty's ship Diamond. It was taken by the British fleet, and guns and sailors placed on it, conducted as a man-o'-war, and uniformly annoyed the French. Nowadays when the British fleet sail by, Diamond Rock is saluted with all the elaborateness of naval etiquette.

As our stay was to be short, I made haste to get on *terra firma*, and marched up and down the streets of St. Pierre. The shops and stores are good, and many of the houses are handsome and spacious, and thoroughly French. None of the storekeepers could speak English, and, try as I could, I could not purchase a single picture of the place. Even Josephine's statue seems to be unphotographed. I called on a photographer, but he had none but portraits of uninteresting people. He was a dentist and clock-fixer as well as photographer. The stores are excellent, however, and well stocked with the latest French conceptions. The streets are beautifully paved, and streams of water run down them all, to carry off effluvia. The streets are lighted by electricity; and a comical street-car, carrying eight persons drawn by a branded mule, solemnly does the duty of a trolley car. I visited the cathedral, and saw the ebony worshippers at their devotions—poor black women probably trying to console themselves for the loss of a dear child, though they had to work hard to find it bread. I came away saying to myself, "It's all French." Then our good ship Solent, with 50 English tourists, headed straight for Dominica, the Switzerland of the West Indies, only three hours distant. Ere long we could see its dim outline, and then nearer, till we could see the giant peaks, the tops hidden by the clouds. Columbus, who discovered Dominica, in trying to describe to Queen Isabella the configuration of the land, took a piece of paper, and, crumpling it in his hand, laid it on the table as an illustration of Dominica's outline, and this well conveys the idea of serrated peaks and jagged crests; but it by no means conveys to the mind any idea of the somber grandeur of this tropical paradise.

Soon we reached Roseau, the chief town of the island; but before reaching it I noted, by the spy-glass, that the flags on shore were all at half-mast; and on conveying this news to my fellow-passengers all said, "The Queen is dead," and a damper was put on the spirits of all on board. Getting nearer we could hear the church-bells tolling, which caused a further depression.

I was soon ashore, safely ensconced at Mrs. Ogilvey's hotel, whence I purposed to explore and define the possibilities and capabilities of Dominica as a bee country. But I will defer my account to the next issue.



TOO MUCH POLLEN.

A knock at the door. Mrs. D. requests that I open it, as she is very busy with her hands in the dough, kneading what is to be the bread for dinner. So I go and open the door. There I find a man who says he has come across Skaneateles Lake on the ice to see me. I invite him in, and he says his name is Wilbur.

"But were you not afraid to cross the ice? Do you not know that the ice is always treacherous on that lake? and that there is scarcely a year, when it freezes over, but one or more are drowned from venturing on it?" are the first questions I ask.

"I was not aware that the ice on Skaneateles Lake was any more treacherous than on any other lake. What makes it so?"

"Skaneateles Lake is made up largely from springs which come up under the surface of the water; and as these springs throw up warmer water than that in the lake proper will average, ice does not form so thick over these springs, and is constantly getting thinner, as soon as our zero weather has passed by; and, not knowing where these springs are, the traveler walks on these thin places, only to drop in when least expected; and, unless help comes to the rescue soon, or the traveler has a long pole in his hand so it will catch on the unbroken ice, drowning is the result."

"Thank you for the information. I will take a pole with me when I go back, as it is thawing quite rapidly. But I came over to see you regarding some combs which have too much pollen in them, according to my way of thinking. Is there any way of removing pollen from combs?"

"In some localities bees store so much pollen in their combs that it seems to some that it would be better to have it removed. But I hardly think there is any locality where too much pollen is really stored."

"Could not a machine be invented for its removal?"

"Possibly. I was once at a bee convention where a man offered as high as \$25 for a machine to remove pollen from the combs, but I never knew of such machine being invented."

"If there is no machine for removing it, is there not some other way of getting rid of it?"

"Some advise making combs containing much pollen into wax, and then have the wax worked into comb foundation, putting the same into the hives for the bees to draw out into comb again; but all such advice seems to me to be a damage rather than a help."

"Perhaps you do not have much pollen here, and so do not know what it is to have combs almost solid with pollen."

"In this locality we get large quantities of pollen, probably as much as is gathered in any place in the United States; yet I have never melted up a comb on that account, neither did I ever have any thrown out by the bees, as others claim they have, unless said pollen had become moldy."

"When does your pollen come?"

"With me there are two different periods that bees store very much more pollen than is worked up by the nurse-bees into chyle for the young brood. One is during the bloom of the hard maple, and the other during white-clover bloom. I have had combs of pollen gathered during the yield from hard maple, which weighed as high as four pounds."

"That is like some I have. And if there is no machine to take it out of the cells, and you do not wish to melt the combs, how do you get rid of it?"

"At such times as this I work as follows: Whenever the bees gather so much as to crowd the queen I take it away for the time being, substituting empty combs for those taken away."

"If there come a few rainy or windy days at this time, I find that this pollen is all exhausted, so that the cells are once more empty or filled with eggs, as it takes large quantities of food for the numerous brood at this season of the year."

"But where you take away such combs full of pollen, what do you do with it? That is what has puzzled me, for it soon gets wormy."

"After apple-bloom there is little for the bees to work on for some two or three weeks, and the surplus pollen is all soon used up and more needed, when I set back that which was removed, and thus brood-rearing is kept up more effectually than by feeding syrup, honey, or any of the many plans for stimulative feeding, and costs very much less by way of outlay in either cash or labor. I consider plenty of pollen in the combs during the period of scarcity between apple and clover, or in any other time of scarcity, to be of great advantage."

"Well, I had never thought that these combs of pollen could be turned to advantage, and I now see my mistake. But how about that which comes from clover?"

"The pollen gathered during white-clover bloom is treated differently from that gathered early. That gathered early rarely ever has honey placed on top of it, while that from clover is placed in the cells till they are nearly three fourths full, when the remaining portion of the cell is filled with honey and sealed over so as to preserve it against a time of need the next spring, or some future time. During

summer, as I find combs containing much pollen in this preserved state, they are hung away in my room for storing combs, and sulphured as occasion may require, to kill the larvae of the wax-moth, which are sure to injure such combs much if not thus treated."

"If this pollen is covered with honey, and the cells sealed over, as you state, how do you tell them from combs of solid honey?"

"Combs containing pollen under honey are readily distinguished from those without by holding them up before a strong light and looking through them, especially if the combs are somewhat new. Then combs containing pollen of any amount are not so heavy according to their appearance as those solid with honey. Taking the two together I have no trouble in ascertaining those containing enough pollen to bother with."

"What do you do with these combs after storing them away?"

"When spring opens I again take the opportunity of placing such combs on hand, which contain pollen under honey, near the brood, and in doing so break the capping to the cells where they come next to the brood, by passing a knife flatwise over them, and find that there is nothing which will stimulate very early brood-rearing equal to this. This answers a very much better purpose to stimulate brood-rearing at this time of the year than the feeding of rye or oat meal, as some recommend. In this way all pollen is used up to far better advantage than by melting up the combs or by inventing a machine to remove it from the combs."

"That looks reasonable, and I have quite changed my views in this matter."

"The successful apiarist is the one who always studies hard to turn every thing that comes along so it will forward his pursuit, either directly or indirectly. Let us look wisely into all of the little matters which come along, and then we shall prosper."



A HOUSE-APIARY AND WORK-SHOP COMBINED; QUESTIONS FOR GLEANINGS.

Would it be practicable to put up a building that would accommodate 100 colonies of bees for summer and winter, and also use one end for a honey-house? The writer's idea was to put up a building, say 65 feet long and 10 feet wide, and use 15 feet at one end as a honey-room, and have the other 50 feet used for the bees two tiers high on each side, and the building double-walled, and packed with sawdust with an entrance through the side for each hive.

The advantages of such a building, if practicable, would be numerous, such as shade for bees and apiarist in summer; practically no walking or carrying honey, no packing and

unpacking hives in spring and fall; every hive perfectly dry and warm at all times, and the satisfaction of being able to lock up your hives, bees, and all, should you desire to go away for a day or two—no double-walled hives to make, no winter-cases, no grass to cut, and very few if any angry bees to bother the apiarist.

Would there be any loss of bees worth speaking of if there were an alighting-board, say one foot wide, run along the whole building, and the front of the building at every third hive painted a different color? Hives, of course, would have to be placed close together for economy of space inside. Would the different colors in painting referred to above be an advantage or not?

Would a building like this not give something of the uniform temperature of the cellar, coupled with the advantages of outdoor wintering?
A. L.

[Such a building would be, I think, entirely practicable; indeed, we came very near constructing such a one at our outyard last fall, and probably will do so the coming season.

Of course, it is very important that the walls be double, and the space between packed with sawdust or shavings.

There should be a separate alighting-board for each entrance, and it would be better if they were of varied design to better enable the bees to find their several entrances. I would, for the same purpose, use the different colors of paint.

So far as uniformity of temperature is concerned it could not be as even as in a cellar entirely under ground.

Hives inside should be movable, and exactly like those outdoors, and should rest on shelves the same as is shown in the house-apiary used by F. A. Salisbury, described in the A B C of Bee Culture. Indeed, you will do well to follow this plan clear through, except that the building be double-walled.

The work-shop part can be added on the end, and extended as far as desired.—Ed.]

ANTIDOTE FOR THE AROMA OF BEE-STING POISON.

I want an antidote for the poisonous aroma (if that is a proper phrase) given off from honey-comb. I have handled bees and combs for a good many years. I have been stung thousands of times with no ill effects. Late last season my eyes, face, and ears began to swell whenever I handled combs for a few hours. My eyelids are affected the most, swelling nearly shut, and remaining so for several days. I have never heard of a similar experience—perhaps you have. If there is an antidote or preventive known that can be suggested, I want it.
H. C. MOREHOUSE.

Boulder, Colo., Feb. 9.

[It was the Rev. L. L. Langstroth who, some ten years ago, related a similar experience, as to how he suffered from swelling, or an itching sensation, when in the spring or early summer he began work with the bees;

but at the time no one else had been similarly troubled; but in later years our Mr. Spafford, who was employed by us to fill two or three different orders from a large homeopathic-supply house for 10,000 bee-stings each, complained that, on the last thousand stings he pulled, his face and eyes began to smart. There was a swelling and a general tingling sensation all over. The aroma of the poison affected him quite seriously, making him sick, so that he had to give up the job. It would appear that, when one gets a large quantity of this poison in his system, the *very aroma* of it later on seems to affect him.

As to a remedy or antidote I do not know of any thing that would give you relief; but very possibly a homeopathic physician—one who makes use of bee-sting poison known as *Apis mellifica*, might give you an antidote that would afford relief.—Ed.]

POOLE'S ENTRANCE-CONTRACTOR.

I send you another small article which I consider to be handy in the apiary. It is a contrivance to contract the entrance of a hive in cold weather, or in the spring or fall. They are also good when the bees are inclined to rob. The entrance of the contractor can be made larger or smaller. JEROME POOLE.

Rockport, Mass., Jan. 23.

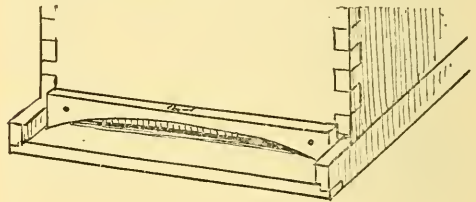

FIG. 1.

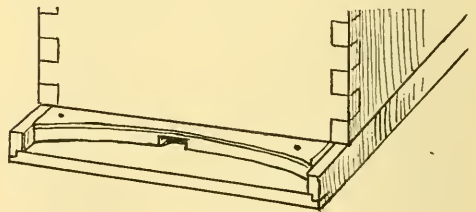

FIG. 2.

[The contractor, when put on as shown in Fig. 1, gives the greatest width of entrance. When placed as shown in Fig. 2, the smallest opening is given. This is something that any one can whittle out during these winter days.—Ed.]

PARTNERSHIP IN KEEPING BEES, IN WHICH ONE OF THE PARTIES IS A NOVICE AND THE OTHER AN EXPERT BEE-KEEPER.

A friend of mine and myself are thinking of going to Colorado and engaging in the bee business, in partnership. He has had little or no experience in handling bees. I have had thirteen years of practical experience with them. What do you think he ought to put in

the business, extra, against my experience, this same extra to be divided equally between us if we should ever dissolve partnership? I write you, as I believe your judgment to be good in such matters.

Ottawa, Kan.

J. Q. ADAMS.

[It is a little hard to give an answer; but perhaps we can arrive at a solution something in this way: Unskilled labor, in the case under consideration, should be placed, perhaps, at half of that of skilled. For instance, in Colorado, if a good experienced bee-keeper can earn \$2 00 a day, a man who is learning the business ought not to have more than \$1, if as much as that. But assuming that the beginner will be gathering experience and becoming more and more competent, we may assume that his labor will average at about half of the labor of the expert. Now, then, to your question. If the wages of an expert bee-keeper in dollars and cents—one who understands his business—is rated at \$2 a day in Colorado, then your friend, considering that you are an expert, should receive half of the proceeds of the apiary less \$1 per day for time actually spent by yourself.

A good deal of labor in an apiary that an expert would have to perform, the novice could do, such as lifting and carrying combs, brushing bees off the combs, turning the crank of the extractor; but, on the other hand, it should be considered that the unskilled labor would be worth perhaps \$1 less per day, and possibly in some cases more than that without the skilled labor placed in co-operation. If your friend agrees to this kind of division then each of you should share equally in the expenses and the profits.—E.D.]

HIVING ON DRAWN COMBS.

Dr. C. C. Miller:—Owing to the extraordinarily poor seasons for the last three years, and the gradual dwindling away of many colonies, I am left with a large number of the ordinary-sized Hoffman brood-combs on my hands. It is possible that next season may surprise us by being a good one, and that I may have many swarms. Will you please advise us through GLEANINGS how drawn brood-combs may be used to the best advantage in hiving swarms? My practice has been heretofore, in the days when the seasons were good enough for the bees to swarm, to use brood-frames with starters of foundation, about four frames to a ten-frame Dovetailed hive; fill up the rest of the brood-nest with dummies, and put on the sections; but this season I shall have plenty of old brood-frames to use. Please advise how you would use them in hiving swarms to best advantage, giving details.

BEN AVON.

[Dr. Miller replies:]

Using brood-combs fully drawn out, in place of foundation, need not call for a great deal of change in management, at least in the management you have been using. Whatever necessity you may have felt for limiting the frames of foundation to four when hiving a swarm, that necessity is emphasized when

combs are used; for if the hive were filled with combs the bees would prefer to store in them in place of the super. Let the swarm be put on four combs; fill the dummies and place it on the old stand, with the mother colony close beside it, the super being transferred to the swarm. A week later move the mother colony to a new stand. Ten days after the time of swarming, four more combs may be put in the center of the brood-nest if it is an eight-frame hive. If it is a ten-frame hive, give three combs, putting on each side of these three combs two of the filled combs. Ten days later still, put three more combs in the center of the hive.

I do not speak with authority, as I have not used ten-frame hives for some years, and it may be that it would be all right to give five combs at first and the other five ten days later.

C. C. MILLER.

Marango, Ill., Jan. 28.

A SIMPLE WAY TO STRAIN THE HONEY AS IT COMES FROM THE EXTRACTOR.

In the article of W. A. H. Gilstrap, Jan. 15, page 48, I see that he does not know how "Messrs. France and Coggshall can sell honey right from the extractor." Well, I do not know either; but I will tell how I do it.

I am using two cans, made as per illustration, to hold 5 gallons each. These are used under the extractor, one at a time. Each can has a strainer on top (an old-fashioned flour sifter, but finer wire), and a honey-gate at the bottom. As soon as the can is full, it is set up on a box, high enough to put a square can under the honey-gate of the can, and the honey is started to run into the

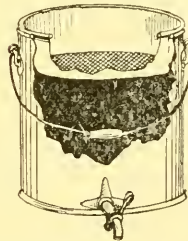

lower can, when I go on extracting into the second can. In this way I do not need to watch, to keep the honey from running over, as it will do by filling from a tank, especially when one's mind is on something else at the time. I like this arrangement, especially for out-apiaries, as I can take home the honey as soon as extracted, and am not compelled to leave it in a tank unprotected on the desert or mountain range. I know of one bee-keeper, who has his honey-house at an elevation, who found his honey at the foot of the hill, losing several tons of honey, as some one had fired a rifle-ball through his tank, and in this way liberated the honey. This might have been great fun for the hunter, but certainly not for said bee keeper, who lost the larger part of his crop.

M. R. KUEHNE.

Pomona, Cal., Jan. 19.

[Your honey-strainer is doubtless a very serviceable and useful implement; but while it will separate out all the coarse particles of wax, propolis, bee-legs, pieces of wood, etc., it would not, I should suppose, catch the finer particles that will pass right through a sieve. These can be separated out only by gravity or

precipitation, while the honey was stored in a large settling-tank, after which drawing it off into square cans or barrels. But clarifying honey by precipitation is not necessary unless the honey is very light in color, and is used for bottling purposes.

I should like to receive an article from some of our large extracted-honey producers in this matter of clarifying extracted honey for market. Which is the more practicable—straining the honey *a la* Kuehne, or clarifying it by means of precipitation? And, by the way, this question of producing a crystalline extracted honey has not been very much discussed. Tell us the whole story.—ED.]

QUESTIONS ON WINTERING BEES.

Please answer the following questions, through GLEANINGS:

1. How large an entrance, and of what dimensions, should bees have that are wintered on their summer stands, without any packing except on top? Would it make any difference if they were wintered on closed-end brood-frames or in double-walled hives so far as the entrance is concerned?

2. How many pounds of comb honey would a colony average in an average locality, supposing it to be in good condition every spring, and not throw out any swarms? Make an estimate.

3. If I should give my honey a good sulphuring on taking it from the hives, would I have to sulphur it again?

4. What do you think of closed-end brood-frames the size of the Langstroth, for comb honey? Would they handle easily?

5. I have been troubled with my new swarms leaving their new hives and going to the woods. Could I prevent this by tacking "perforated zinc" over the entrance?

6. How would you manage outyards for comb honey when there is no one to watch for swarms? It seems to me if the entrance were covered with perforated zinc the queen would have to be replaced by a new one every two years or so, or she would be superseded by a young queen that could not get out of the hive to be fertilized.

I see you think it necessary, in cold climates, to winter bees in double-walled or chaff hives. I know of a man who has wintered his bees, for the past 20 years, in single-walled hives. He lays two sticks crosswise of the brood-frames, throws some old cloths over the sticks, packs them down tight, and his bees are ready for winter. His bees are protected from the cold winds by a windbreak of evergreens. They are in the best condition in the spring of any bees I know of, and we have quite a severe winter here too. The weather has played about zero for a spell of two weeks or more sometimes.

BEGINNER.

Ashtabula Co., O.

[1. For outdoor wintering, an entrance $\frac{3}{8} \times 8$ inches for an average strong colony is about right. For a weaker colony, a shorter entrance in proportion should be used. Closed-end frames are certainly a protection, but the use

of them would probably make no difference as to the size of the entrance.

2. It is pretty hard to give an average, as every thing depends on locality; but in Ohio, from 10 to 50 lbs., or, we will say, an average of 40 lbs. if we take a series of ten years.

3. Probably not.

4. A good deal depends on the style of the closed-end frames. One like the Danzenbaker would do very nicely in a hive as deep as the Langstroth; but one like the Heddon would not answer unless there were plenty of end play.

5. Clipping the wings of the queen, or using entrance-guards, would prevent swarms from going to the woods.

6. Different plans are used. Some clip the queen's wings; but this is unsatisfactory. Some use a hive so large that the brood-nests can not be cramped for room; but if the locality is not favorable, little if any comb honey would be secured. Some cage the queen or remove her entirely, and then destroy the cells in nine days and again in nine days. No one general plan can be recommended, because so much depends on the locality and the individual.

Queens would not be replaced if the colonies were looked after. The zinc should be removed after the honey season, and be kept off till it comes on again. It is true, bees can be wintered in single-walled hives outdoors in cold localities. There are exceptions to all good rules. In the case referred to, the wind-breaks are over half the battle. Of two things, good windbreaks or double-walled hives, I think I would take the former.—ED.]

BEES AND ALFALFA HAY.

Do the bees lessen the value of alfalfa hay in any way by gathering nectar from its bloom before being cut for hay? Some of the cattle-raisers and ranchmen claim we should not keep bees, as they take for every pound of honey gathered from the alfalfa-bloom just that many pounds of fat off their beef cattle. While I do not think this is the case, I should be glad to have it explained by those in position to know the facts. J. E. PRYOR.

Egalite, Colo., Jan. 28.

[The claim of the cattle-men is most silly and absurd. Show them a copy of the A B C book, and refer them to the article on fruit-blossoms, where there is any amount of proof to show that bees do a great deal of good in the setting and perfecting of most fruit. If they are of value to fruit they certainly would be, to say the least, not harmful to the growth of alfalfa hay. But here is a fact, and it stands uncontradicted: The first seed crop of red clover is usually not nearly as good as the second one, for the simple reason that the bees do not get at the blossoms of the first crop. Here is another fact: The farmers of Australia were not able to grow red-clover seed until they imported bees. When they did so they could grow seed as well as we can here in America. It should be remembered that red clover and alfalfa are very near rela-

tives. If the bees were taken away from the alfalfa-fields entirely, you can tell your ranchmen that they would not be able to do very much in the way of growing alfalfa seed — Ed.]

THE MEDICINE-DROPPER A SUCCESS FOR PICKING UP ROYAL JELLY.

We notice what is said in a recent issue of GLEANINGS in regard to using a dropper for supplying queen-cells with royal jelly. I will say that it will work to perfection, as we have used several for the past five years. In looking over nuclei we generally have one or more with us; and when we come across a queen-cell containing royal jelly, and which would have to be destroyed anyway, we just fill the dropper. Sometimes it takes five or six cells to fill a dropper; occasionally two will do. With a dropper supplied with the royal food one can prime cells in just a third of the time it requires with a quill; besides, the jelly can be kept in a dropper for several days; but we prefer it fresh.

Parkertown, O., Feb. 9. H. G. QUIRIN.

[I am glad to get this report, as I could not see any reason why a medicine-dropper would not handle the royal jelly much more rapidly, and deposit the exact quantity desired in each cell-cup. But A. C. Miller's experience was not so favorable.—Ed.]

AN EXPERIENCE RESULTING IN FAVOR OF ABSORBENTS AS AGAINST SEALED COVERS FOR OUTDOOR WINTERING.

Mr. Editor.—I noticed in your Dec. 15th issue you request those in a position to do so to observe the conditions in which sealed covers and absorbents give best results. I winter my bees in tenement chaff hives, and I find they winter best, "in this locality," by removing the covers; then lay on some sticks or corncobs, and cover with burlap and chaff. I have sometimes put on a deep super or hive-body filled with chaff, then put on the cover; but even this seems to be a detriment, as it prevents the moisture from passing off.

With sealed covers in chaff hives, as soon as it becomes cold the combs become moldy, frost gathers on the inside of the hives, then when there is a thaw the frost melts, runs down over the combs, and stands in puddles on the bottom boards.

I get best results in wintering by having the hives face the south or west, as the bees often fly on warm afternoons, toward spring, when those facing east do not. I also find it a good idea to take off the covers and stir up the chaff on such days.

INDOOR VS. OUTDOOR WINTERED BEES.

The majority of the large bee-keepers of this county winter their bees in the cellar; but I have heard some of them speak as though they were dissatisfied with that plan, and were looking with longing eyes toward outdoor wintering.

From some of Dr. Miller's writings I mistrust he feels something the same way. I think if he would try my plan of wintering he

would find they would live through in good order, and be ahead of those wintered in the cellar at the beginning of the honey-flow. Is not at least a part of the extra food needed for outdoor wintering used in rearing brood before bees can be taken from the cellar safely? Salem, N. Y. EARL Y. SAFFORD.

[There seems to be a growing apprehension among those who winter indoors, that, even though indoor bees consume less stores, yet the outdoor bees may be enough more vigorous to make up for the extra consumption of stores. I should be pleased to get further reports.—Ed.]

THE USE OF THE BROOM SEDGE FOR BRUSHING BEES IN THE SOUTH.

Mrs. L. Harrison, in telling of southern broom sedge, p. 52, says, "I'm surprised that southern bee-keepers have not used them for this purpose, and told us about them." I suppose by "us" she means northern bee-keepers. Now, I should like to say that southern bee keepers have used brooms of this kind for many years. Bees have been kept on our place, 6 miles east of Washington, N. C., for the last 60 or 75 years by my father and grandfather and myself. I have often seen my father, as far back as I can remember, use a broom of this kind.

Washington, N. C. J. R. PINKHAM.

LOADING CROSSWISE OR LENGTHWISE; GOOD PROOF.

E. R. Root.—I was surprised when I read your editorial in GLEANINGS for Nov. 15 on how to load honey on a wagon, as I supposed everybody thought the combs should run *across* the wagon and not lengthwise. I notice Mr. Hutchinson, in the *Review*, thinks it should be loaded the same as you say. There is no need of breaking honey that is fastened firmly to the wood, and properly crated, no matter which way it is loaded; but in hauling hives of bees or loose combs one has to be more careful. I moved an outyard last fall about one mile, but left over one hundred extracting-supers till I had more time. I moved the supers last week with a spring wagon; and as there isn't room in a common wagon-box to place two rows crosswise, I set one row of supers with combs running crosswise and one with combs running lengthwise of wagon. When I came to unload I found several combs broken in the row that was loaded lengthwise, but none in the supers that were loaded crosswise. That's the way it always works "in this locality," no matter what kind of roads. H. H. PORTER.

Baraboo, Wis., Dec. 20.

LOADING COMB HONEY ON A WAGON.

Dr. Miller's directions as to the right way to load comb honey on a wagon are correct, and will apply to all kinds of roads. When the roads are bad and the ruts deep, the chances are a hundred to one against there being two holes, one in each rut, *exactly* opposite one another, such as would produce a forward and

downward jolt. When, as is nearly always the case, only one wheel falls in a hole or strikes an obstruction, the result is a *side* jolt; and to guard against these the combs must be placed *across* the wagon. The only exception I can see to this rule would be in the case of a very steep hill; but by driving very carefully and slowly there would be but very little danger if any. My yards are 10 and 15 miles from the railroad, and I have hauled comb honey over as rough roads as can be found anywhere. I use springs under the load, and the broken sections have never amounted to any thing, the breakage being confined to those that were not well attached to the wood.

GUSTAVE GROSS.

Lake Mills, Wis., Jan. 7.

GLEANINGS FAMILY A PICKED COMPANY;
GLEANINGS AS AN ADVERTISING ME-
DIUM.

I have received so many letters in answer to my request for information which you were so kind as to insert in a recent number of your paper that I find it utterly impossible to answer them all. I desire to thank my many unknown friends for their kind invitations to come to their neighborhoods, but of course I can go to but one place, and now I am in more of a quandary than ever as to where I had best locate. I have letters before me from people living in Wisconsin on the north to Florida on the south, and from New Jersey on the east to Utah on the west. It strikes me that your paper must have a wide and general circulation, and hence must surely be a good advertising medium. I have before me several offers of good apiaries and other property; and as I am not ready to buy I would suggest to the owners that they advertise it in GLEANINGS, as I am satisfied they will soon find a buyer. Judging by the kindly spirit pervading all these letters I believe the GLEANINGS family is "picked company."

HENRY DETMERS.

Carlsbad, N. M., Dec. 15.

EXTRACTED HONEY FROM DARK COMBS.

Is it an established fact that dark combs impart a dark color to the honey stored in them, as I understand Mr. Chalon Fowls to state? See page 960, Dec. 15, top of right-hand column.

R. J. FOX.

Natick, Mass.

[I know there are some who say that old dark combs should not be used if one wishes to get a first-class article of white extracted honey. If they (the combs) do have any effect, the darkening is almost imperceptible. If one wishes to put a fine article of extracted honey on the market, or for exhibition purposes, or for a fancy trade, it would, perhaps, be better to have such honey stored in combs not more than three or four years old. I say it would *perhaps*. I do not know. I myself am inclined to believe that for *ordinary* marketing purposes old dark combs would answer as well as newer ones for the production of extracted honey. Of course, some combs might be stained by pollen, or they might come

from hives on which bees had recently wintered. Such combs, of course, could not furnish a first-class article of extracted honey.—ED.]

HOW MANY DRONES DOES A COLONY RE-
QUIRE?

How many drones do I need per colony? Perhaps the question is not plain. It is like this: I bought a few colonies of bees, and their increase has been put in hives where I used full sheets of brood foundation, so they have no drone comb whatever. Since reading your paper I have made up my mind that it is not a good plan to inbreed, so I am going to buy a few colonies of well-bred bees to raise drones from. I have 60 old colonies now. How many shall I buy to furnish drones?

A SUBSCRIBER.

Fort Lupton, Col., Jan. 28.

[I would pay no attention to the matter of drones, if you are working your bees for the production of honey. Even if you are rearing queens, one or two colonies of choice stock could rear all the drones you require. One great advantage of comb foundation is that it restricts the useless rearing of a lot of drones, that are only consumers. The ordinary apiary, consisting of hives containing combs built off from foundation, even if there is not a drone-cell, *apparently*, in the hives, would have all the drones it needs for the fertilization of its queens during swarming time, or any other time, in fact, when bees can fly.—ED.]

HONEY COUGH MEDICINE.

Friend Root:—Why don't some of your great doctors tell us how to medicate honey for coughs, colds, and throat and lung troubles, and perhaps flavor too?

Dexter, Me.

A. R. BODGE.

[You will find quite a number of recipes for honey cough preparations in our regular honey-leaflet, and under the heading of "Honey-cooking Recipes," in our A B C book. As these recipes were selected by C. C. Miller, an M. D., they are probably the very best known.—ED.]

FREEDING BACK FOR COMB HONEY; CONDI-
TIONS UNDER WHICH IT MAY BE
PRACTICED.

Will you tell me what per cent of extracted honey fed back can be obtained sealed in boxes, if none going into the brood-combs is taken into consideration, said boxes filled with foundation?

F. H. CYRENIUS.

Oswego, N. Y.

[It is impossible to give an estimate of the percentage, as so much depends on the kind of honey fed back, the time of year, the kind of bees used, and the man. Mr. Hutchinson, who has had much experience, says it is important to get the right kind of colonies. Some stocks are away ahead of others; and in general the black bees are the best; the next best are hybrids, and the poorest are Italians. The combs in the brood-nest must

be new, or comparatively so, as old combs have a tendency to stain the sections above. The honey to be fed should be thinned by water to about the consistency of raw nectar. The hotter the weather, the better; and if there is ever a time when separators are needed it is in feeding back, because at such time bees are more liable to bulge the combs than when the honey comes from natural sources. Mr. Hutchinson's estimate is that, under the right conditions, and with the proper amount of experience, one will get back two-thirds of the honey fed before it is diluted. There are times when one might possibly get as much as 90 per cent; but I have seen reports from those who have lost as much as 50 per cent. Where all this excess of honey went to can not be definitely determined; but probably a large portion of it was consumed by the bees, and another portion was converted into wax. As a general rule, the average person had better let feeding back alone unless there is no demand for extracted honey, and a good demand for comb honey. There are times when it pays, and pays well; but as a rule, but little is gained.—ED.]

PUTTING FOUNDATION INTO SECTIONS ON A CURVE.

I use the $3\frac{5}{8} \times 5$ section with top and bottom starters put in with a hot-plate arrangement. To counteract the propensity of the long and narrow top starter to swing and fall out I give it a slight curve as I drop it from the hot plate on to the outstretched flat section. This stiffens it and enables it to support its own weight without becoming detached, even if lying on its side. This may be an old story to you. It would probably occur to everybody who puts in starters with a hot plate, but I have never seen it mentioned, and it is quite a help to me. G. COLLIER.

Warsaw, N. Y., Jan. 24.

[I should hardly suppose that the plan you propose would be practicable, for the simple reason that the combs would be inclined to follow the curve of the foundation itself, one side being slightly concave and the other a little convex. I think if you were to try the plan on a larger scale you would find it objectionable.—ED.]

A SCHEME FOR MAKING DOUBLE-POCKET HONEY-EXTRACTORS.

Having just read W. A. H. Gilstrap's article, p. 48, Jan. 15, with what you say in the footnote in regard to improvement in construction of extractors, I wish to add a word. As I have used a four-frame Cowan extractor for the past three years, I can say that an eight-sided hoop for the baskets would be a great improvement, especially in the West, where we have so much thick honey. My comb-baskets have had to be overhauled and resoldered several times each season, and make me no end of trouble.

I conceived an idea for the construction of a comb-basket last summer. I don't know whether it's new or not. It is original with me at least; i. e., to make a basket double,

holding two combs face to face, operated by a sheet of tin, so that, when the extractor is turned, the contents of one side of each comb are thrown against the tin partition instead of the extractor side. Get up two baskets side by side, with, say, an inch space between the two faces, and then set up a piece of tin between the two faces, and you will see the idea, I think.

By this plan a four-frame extractor would need to be but little larger than a two-frame as now made. The four-frame, as now made, is too heavy for one man to handle, and is hard to start and stop.

L. B. BELL.

Camp Verde, A. T.

[The scheme of making double-pocket honey-extractors has been carried into general practice by the Goold, Shapley & Muir Co., of Brantford, Canada, for a number of years. It can be adapted to extractors of the Cowan type; in fact, we have an order on hand now for an extractor of that kind.—ED.]

GILSTRAP'S TANK; ITS OBJECT FURTHER EXPLAINED.

Mr. Root:—Your footnote on page 49 calls for an explanation. My honey is *not white*. It ranges from saffron color to quite dark.

The principal object of a tank here, *decidedly*, is to give those "minute particles of wax" time to rise before being canned, for rise they will in spite of you. If the honey is put into cans before this scum (small pieces of wax) rises, the dealers refuse to buy the honey—that's all.

W. A. H. GILSTRAP.

Grayson, Cal., Jan. 29.

COMBS CROSSWISE OR PARALLEL WITH THE ENTRANCE.

Why should the brood frames run from front to rear? I have tried in two colonies, each half of the hive. The result was, they removed the brood-nest to the rear of both colonies at the same time. Even the queen-cups were found where the comb ran sidewise in the rear of the colonies. My boxes are 14×22 , $9\frac{1}{2}$ deep inside; frames 8×13 . I have half an inch below the brood-frames. That should give room enough to carry the dead bees out. I think it is a good point for beekeepers, on account of the cold wind that strikes the bottom-board, and goes up directly between the brood-frames, and chills the brood. Will you please mention this in GLEANINGS? Where can I find the royal jelly to put into the queen-cups? My bees are Italians. H. F. MEESE.

Rock Island, Ill., Feb. 25.

[This question, whether brood-frames should run at right angles to the entrance, or whether the edges shall point toward it, is one that was discussed years ago. It was the general consensus of opinion then that while, theoretically, there might be an advantage in having the combs crosswise of the entrance, yet, practically, colonies on frames running in the opposite direction did just as well, year in and year out. So far as the position of brood is

concerned in the late spring and early summer it will be placed at that end of the hive that is remote from the entrance, whether the frames are crosswise or in line with it. With wide deep entrances, it is perhaps a slight advantage to have the edges of the combs pointing toward the entrances, as the flying bees during the height of the honey-flow will fly through the entrance and alight on the cluster, just under the frames. If the honey is being stored on the right they will steer their flight toward the right, then pass directly upward. If combs are crosswise, the bees will be compelled to climb over from one frame to the other or else go to the side of the hive and then on to a frame where honey is stored. But Doolittle says flying bees do not generally deposit any honey; that they give it to nurse-bees which, in turn, transfer it to the combs. Taking it all in all, I think we may safely conclude that, between the two different ways of placing combs, it is about six of one and half a dozen of the other.

Royal jelly is found only in queen-cells. A cell well drawn out, and a good fat larva in it a day or two before it is capped, will contain royal jelly of about the right consistency.—*Ed.]*



M. S., Minn.—Your trouble with frost getting through the hives will be remedied by putting winter-cases over them, or packing them in some way with straw, chaff, or saw-dust. Put outside of the packing-material, of course, something that would shed rain or snow. In your locality the bees should either be in the cellar or packed as described.

W. I. F. H., Pa.—If you have a superabundance of drones at this time of the year in your hives, I should suppose, from what you say, that you have either a drone-layer or a laying worker. Cyprian bees are better workers than Italians, but they are very cross; still, with the right degree of caution they can be handled. The best record of Cyprian bees is 750 lbs. from one colony.

C. L. L., Wis.—There is a great difference in honey about candying. Some honeys will candy within a few weeks or months, and others will remain clear for two years. At one time it was considered an infallible proof that if honey candied it was therefore pure; but it is now known that this is no test, for some pure honeys will remain clear for two or three years without any treatment whatever, under certain conditions.

J. S., Kan.—If your bees are short of stores, give them lumps of candy made by mixing granulated sugar, or, better, powdered sugar, and honey into a stiff dough, mixing in sugar till the dough is quite hard. Lay two lumps of this, about as large as the fist, over the frames of the colony. Cover the whole with

a quilt or cushion, as the bees will fail to take the feed unless it is properly covered and protected. If you can get a nice grade of rock candy, free from coloring-matter or flavoring extracts, you can give this instead.

J. C. D., Pa.—Without knowing more about your locality, it is hard to say whether you should winter outdoors or indoors. If you have considerable zero weather, and most of the winter there is snow and a temperature below 32°, I would advise indoor wintering; but if you have but little zero weather lasting, say, a week, and a great deal of open weather, and a general range of temperature at freezing and above, I would recommend wintering in double-walled hives. For indoor wintering, a good dry cellar is about as good as any thing you can have; but the temperature in it should not be much above 50 nor below 40. While you can use a stove sometimes to raise the temperature, the general practice is to use none.

G. W. A., Mass—It is not wise to give bees liquid feed during mid-winter or late in the fall. If you have not combs of sealed stores, better give them cakes of candy. The first warm day you had better remove the feeder containing the syrup, close the brood-nest down to as small a capacity as possible, then lay on top of the frames pieces of rock candy made of cane sugar. The bees will winter very nicely on such candy, and get along far better than if you try to give them syrupy feed now. While the bees can eat a great many of the flavored candies, it will be far better for you to give them that which is pure, and free from flavoring and coloring matter as much as possible. For directions concerning how to make candy or winter feed, see our A B C of Bee Culture. Next spring, when you get settled warm weather, then you can feed syrup.

H. P. L., Ill.—As to which is the best honey-plant to grow when *honey alone* is considered, it is a hard question to answer. Locality has every thing to do with the matter. If it were in Colorado I think I would unhesitatingly recommend alfalfa. If for Ohio, I think I would name the Simpson, or spider plant; if it were California, the mountain sage; if Utah, sweet clover. Speaking of this, it might be well to state that sweet clover will grow in a greater number of localities than perhaps any other known honey-plant; and while it is difficult to make it grow as a plant when you want it to grow, yet it will spring up spontaneously in patches where nothing else will sprout.

But it should be well understood that no one can afford to grow *any honey-plant* for honey alone. The only ones that will do for artificial pasturage are those that are useful for either grain or hay as well as honey. Of these the principal ones I would name, then, would be alfalfa, buckwheat, and alsike.

BEES AND GRAPES; BEES NOT GUILTY.

J. A. H., Ohio.—Through the courtesy of Prof. W. J. Green, of the Ohio Experiment Station, Wooster, I have been permitted to see two letters which you wrote him in reference to alleged damages by bees to grapes.

From your letters I judge you to be a man of candor, and open to conviction; and, if so, I hope you will give some of the facts, that I am able to present, some consideration.

By our Feb. 1st issue of GLEANINGS IN BEE CULTURE, page 91, you will see there has just been litigated at Goshen, N. Y., a case that involved new principles in law—a case involving the question whether bees can or do puncture fruit. You will not only see that the case was a peculiarly hard-fought one, and attracted attention far and wide, but that *the bees were adjudged not guilty*.

I would call attention to an editorial in our journal in our issue for Feb. 15, page 152; a copy of which we send you; to another editorial on page 150 of the same issue; also to the following back numbers of our journal containing marked articles: Oct. 1, 1900; Nov. 15, 1896; Jan. 1, 1897.

You will find an article in the Feb. 15th issue, from H. L. Jeffrey, detailing some experiments that were conducted at the Connecticut Agricultural College.

If you will kindly take time to read the references you will see that bees have not yet been caught in the act of puncturing fruit. Some contend that it is a physical impossibility, owing to the structure of the mouth parts. Again, in every case, if I am correct, of alleged puncture or stinging we have found that birds or some kinds of insects, not bees, have first made the incisions, and that bees afterward helped on in the work of destruction. But as we bee-keepers affirm that fruit that has been punctured by birds or insects is worthless or practically so, and while we admit that bees are annoying at times, we deny that they are the original cause of destruction to fruit.

You will see by the marked items referred to above that I have personally seen the Cape May warbler in the act of puncturing fruit. The beak of this bird is very small and needle-like, and, as a general rule, the punctures are on the top side of the bunches as they hang on the vines. They will even hunt out the baskets of grapes that have already been picked and punctured them. There are about a dozen other birds that are special adepts in this practice. As they get in their bad work early in the morning, usually before any one is up, the bees come in later, run their tongues down into the small holes made by the birds, and suck the berries almost dry, and being observed at work over the punctures *get the credit for doing the whole mischief*. Now, to convince yourself that bees do not make fresh incisions, I would call attention to the fact that three or four, yes, five or six, will be circling around one hole, sometimes standing on top of each other, all running their tongues down into that same hole. If they could make fresh incisions, they would not crowd and jostle each other as they do; but each bee would make for itself a hole where it could work without being hampered in its efforts to extract the juices.

Believing you to be a candid man, as I have stated, and open to conviction, I should be very glad to respond to a telegram next summer or fall, when you find the bees punctur-

ing the grapes; and while I shall not deny that they will feed upon broken, cracked, or punctured fruit, I think I can show you, if you will go out with me in the morning, that a bird or some insect is the original cause of the mischief.

Should you desire further information, I would refer you to Assistant Entomologist Prof. Frank Benton, of the Department of Agriculture, Washington, D. C. He has made this one subject a very thorough and exhaustive study. You will also find that all of the various experiment stations in the land that have gone into this matter at all have completely exonerated the bees.



NATIONAL BEE-KEEPERS' ASSOCIATION.

OBJECT:—Defense of the rights of bee-keepers; prosecution of dishonest commission men and glucose adulterators; but only members are entitled to protection.

OFFICERS:—E. R. Root, President, Medina, O.; R. C. Aikin, Vice-president, Loveland, Col.; Dr. A. B. Mason, Secretary, 3512 Monroe St., Sta. B, Toledo, O.; Eugene Secor, Gen'l Manager, Forest City, Ia.

FEES:—Annual membership fee \$1.00. Remittances may be sent here or to General Manager as above.

WE have just received notice that the father of Geo. W. York, editor of the *American Bee Journal*, died very suddenly at his home in Randolph, Ohio, March 4th. We extend to Mr. York our sympathies.

THE whole month of February was made up of what we would call here in the North delightful winter weather. In our locality the temperature never went below zero, and seldom did it go above freezing. If such weather should continue till the first of April we may expect an early spring.

CANE AND BEET SUGAR.

WANTED—an article on beet and cane sugar, from some one who is in position to tell us about the relative food value to human beings as well as to bees, and how much cane sugar there is on the market as compared with beet; if it is possible to buy a genuine cane sugar; and if so, how the one may be detected from the other by an ordinary bee-keeper. This article must come from some one who is in position to get information direct from both cane and beet sugar factories.

A CORRECTION.

By a strange oversight and an inexcusable blunder on my part, I find that on page 102, in giving a list of the officers of the National Bee-keepers' Association, I omitted the name of Secretary Dr. A. B. Mason, Station B, Toledo, O. When I dictated the list I supposed I was giving the entire officary, and was utterly ignorant of the omission until a

friend called my attention to it. Dr. A. B. Mason has been one of the most active in the support of the old Union, and latterly of the Association, of any member or officer we have ever had. It was he who drafted the constitution of the present organization, which, under its excellent provisions, is doing such good work. He served as president for two terms, and as secretary continuously for several years.

One can readily see that it was an oversight, as the notice at the head of this column was published in the very next issue following this unfortunate oversight, and again in the March 1st number.

SOMETHING TO LEARN IN INDOOR WINTERING.

THE bees under the machine-shop, of which I spoke in our last issue, are still doing very nicely. The more I think of it, the more I believe there is much to learn on this subject of indoor wintering. The fact that Ira Barber says he succeeds under conditions that seem to be utterly at variance with the experience of others, should merit sufficient attention to see if harmony can not finally be made out of all the conflict of opinion. If I remember correctly Mr. Barber maintains that even a high temperature is not detrimental, but that a fresh infusion of air direct from outdoors causes the bees uneasiness, hence they get out of the hives, and consequently losses occur on the cellar bottom. Our bees get no air except from the outer or main cellar, and the number of dead bees on the floor of the bee-cellar is surprisingly small.

JUDGING OF THE CIRCULATION OF A PERIODICAL; ADVERTISING IN GLEANINGS.

ONE can often judge of the circulation of a periodical by the class and amount of advertising seen in its pages. The subscription-list of GLEANINGS has been having a steady and healthy growth, and a very good proof of this is afforded by the large amount of clean advertising that will be found in our columns. The advertisers of the country are in the habit of keeping returns of every periodical they advertise in; and if such medium does not bring in a large list of applications, or enough to bring down the cost of each name to 10 or 25 cts., that medium is dropped from the list, and only those used which are able to show value received for the money invested. The large amount of advertising we now have shows that our advertisers have tried our columns, and find that it pays to keep in them. We have some who have been with us, not only many months but years.

PURE-FOOD COMMISSIONERS, AND HOW THEY CAN HELP BEE-KEEPERS.

THE following letter, addressed to H. G. Acklin, President of the Minnesota State Bee-keepers' Association, will be read with special interest by all the bee-keepers of that State, and we are glad to place it before our readers:

Mr. H. G. Acklin:—If the bee interests of Minnesota will advise this office of all violations of the law

relative to honey that come under their observation it will enable us to be of greater service to this industry than we can possibly otherwise.

Any information of this kind received could only be used by us in ferretting out and making up a case of our own.

It is, and will be, the purpose of this Department to protect as far as possible all products that are pure. With the co-operation of our friends we hope to guard our pure foods from competition of spurious articles.

Very truly yours,

W. W. P. McCONNELL,

Dairy and Food Commissioner.

St. Paul, Minn., Feb. 21.

Would there were more dairy and food commissioners who felt the same interest in the purity of the product of the hive. We have another good one in Illinois, and one in Ohio; but we need more. Most of these public servants would be glad to carry out the requests of bee-keepers; and I would suggest that our subscribers of the several States write to their commissioners, asking for assistance in the matter of prosecuting the adulterators of honey. A letter addressed to the Food Commissioner at your State capital will probably find your man.

THE LOGIC OF THE TIMES — TALL SECTIONS V. SQUARE ONES.

AS will be seen in Pickings in this issue, it appears that the tall and thin sections are receiving considerable attention from our British cousins. So far as I have been able to discover, their experience with regard to tall thin boxes is very strongly in line with the statements of those in this country who have given these special goods careful and extended trial. Our own orders from Great Britain, instead of being now so much for the 4¼ square, full 2 inches thick, are beginning to show a tendency toward the tall thin boxes, either four-bee-way or plain. And, by the way, our British cousins were a long way ahead of us in discovering that sections with four openings were considerably better than those with simple openings at top and bottom. As they recognize the value of direct communication side-wise as well as up and down, so they were quick to perceive the advantages of the plain section and fence system. The time was, and that not ten years ago, to say the least, when square boxes, with one or two exceptions, were used almost exclusively throughout the United States, and now many bee-keepers right and left are beginning to see that there is money in the tall and thin boxes. I know of one particular case where a bee-keeper opposed the introduction of these new things, and particularly the tall section; but I learned recently that the hard logic of a cent or two difference in his own market, in favor of the tall box as against his own square section, convinced him that he could not afford to use the old-style one, and compelled him to use the very things which he had decried and despised. He is not saying any thing—he is keeping still and "sawing wood;" that is to say, he is buying tall sections, re-equipping his supers, and proposes to be on a level with his neighbors who have been getting a higher price than he.

Of course there are markets where no discrimination is made in price in the two kinds

of sections; but, if I mistake not, sooner or later the tall ones will be found the first ones to sell.

FERTILIZING QUEENS IN CONFINEMENT.

WHILE W. Z. Hutchinson and myself were riding on the cars *en route* to one of the conventions, he produced a manuscript; and as he did so he said he did not know but I would think he was foolish, but he was shortly to publish an article on the subject of fertilization of queens in confinement, and, what was more, he believed that, while the scheme had hitherto been considered visionary and impracticable, yet it had been abandoned prematurely. He had quite accidentally run across a man who, some ten years ago, had been successful in fertilizing 100 queens in confinement. Strangely enough this party never said any thing about it, in print.

To make a long story short, he read to me the manuscript, and then, with a look of inquiry on his face, he wished to know what I thought of the plan.

"Why," said I, "I am inclined to think there is something in it."

The article has, since our conversation, been published in *The Bee-keepers' Review* for February, and the man who succeeded in getting 100 queens fertilized is Mr. J. S. Daviett, of Aragon, Ga. In brief, the plan involves the erection of a large tent 30 feet in diameter and 30 feet high, the covering being of mosquito-netting. Mr. D. writes:

Colonies of bees well supplied with drones were placed close up against the wall of the tent, on the outside, each colony being allowed two entrances. One entrance opened outside of the tent, and was contracted so that neither queens nor drones could pass, but allowed the workers to pass out and in, and work in the fields in the usual manner. The other entrance opened into the tent, and was large enough for the passage of a queen or drone; but it was kept closed or darkened for about a week after the colony was placed in position. This was done for the purpose of educating the workers to use the outside entrance. The drones were not allowed to use the outer entrance at any time, nor to enter the tent (except from 11:00 A. M. until 1:30 P. M. After the drones had learned the bounds of the tent, they seemed contented, and made a very pretty school flying in the top of the tent. And I wish to say right here that the *drones* are the main feature of this problem. Once you get them *quiet* and *reconciled* to fly in the top of the tent, the problem is solved. Nine times out of ten the queen will not reach the top of the tent before receiving the most prompt and gushing attention. After I got the drones under control I had no difficulty. I simply turned in the queens from the hives they were in, just the same as I turned in the drones. I one year reared about 100 queens and had them mated in this tent. A queen would leave the mouth of the hive, and return in about five minutes, apparently mated; and in three or four days would be laying; and the progeny of all queens thus mated showed the same markings as the workers of the colonies from which the drones were taken.

It appears that Prof. N. W. McLain, several years ago, tried about the same plan, but succeeded only partially, and, what was more, the results at the time were regarded by the fraternity as a failure. But Prof. McLain still believes that a little further experiment would enable him to make the scheme work; but the following year the State Experiment Station at Aurora, Ill., was discontinued, and no further experiments along that line were conducted by any one, so far as is known, except, per-

haps, by this Mr. Daviett, who has up to this time kept his candle under a bushel.

Prof. McLain attributed his failure to the fact that the drones were either not fully developed, or impotent from some cause. Like Mr. Daviett, he had no trouble in getting the drones accustomed to their narrow quarters.

Mr. Daviett, as will be noted, accustoms the worker-bees to flying out in the open air. This compelled them to become familiar with the outer entrances. Then when they were flying thickest, about 11 o'clock on up to 2, he opened the inner entrance, and allowed the drones and queen to intermingle in the enclosure. But the queens were not allowed to enter until the drones, as I understand it, had become content and flew around inside without bumping their heads against the netting, and that, when they were thus content, they would meet the queens half way. Mr. Daviett does not tell how his drones were brought to the proper sexual condition; but perhaps from the fact that they were allowed to go and come from their hives at will, to feed in the hive, and thus reach the condition of maturity and potency, he was able to succeed where the professor failed.

Mr. Hutchinson, in commenting on this matter of fertilizing queens in confinement, makes this very sensible remark: "Do not let us lose our heads with enthusiasm, nor toss the matter aside with contempt and ridicule"—a remark that I most heartily indorse. It has happened before that a plan or process which was abandoned after repeated trials has, years afterward, been resurrected and shown to be a perfect success. For instance, the attempt to harden india-rubber was continued till success was despaired of. By mere chance, however, as it would seem, some rubber was melted in a kettle that had some sulphur in it, and, lo! the secret was laid bare. Many such instances might be adduced.

While Mr. Hutchinson and I were discussing the merits of the plan of fertilizing queens in confinement, he said he hoped The A. I. Root Co. would think enough of it to give it a trial. I can only say this: We will talk it over among ourselves; and if the other members of our company feel that there is any hope of success we will put up such a tent.

It hardly needs to be said that the greatest bar to the breeding of long-tongued bees, hitherto, has been in the fact that we have been unable to control the fertilization of select stock. If fertilization of queens can be controlled, great possibilities are before us.

To-day, March 12, I am home again in Medina, and will answer the great pile of letters awaiting me, as speedily as possible. I shall have some wonderful things to tell you in our next, in the line of high-pressure gardening; and to be ready to take advantage of it this season you had better sow at once some seed of self-blanching celery, or make sure in some way you can have some good nice plants ready as soon as the weather will permit of setting them out. I will tell you "what to do" and how to do it, later.—A. I. R.



And they come to Jesus, and see him that was possessed with the devil, and had the legion, sitting, and clothed, and in his right mind; and they were afraid. —MARK 5 : 15.

In closing my talk Sunday evening at Wehahitchka I said something like this :

"Dear friends, inasmuch as you are all entire strangers to me I may be able to say some things to you that your respective pastors would hesitate to say, even if they entirely agree with me. For instance, I can speak very plainly in regard to the use of cigarettes, for I do not know whether this boy or that one uses them or not; but your pastor probably knows all about it. You might think him personal, and be offended; but you will not be offended with me, I am sure."

Then I pleaded with the young boys who have not commenced it, and told them what a very simple thing it is to let them alone, compared with breaking off after the habit is once formed. I had heard of a boy in that very locality, who absolutely could *not* break off, and the doctors told his friends if they wanted to save his life he must be watched *day and night*; and this very thing they are now doing if I understood correctly. I then asked how many in the audience had passed through the experience of breaking away from an evil habit.

The next day I had a talk on this matter with Mr. H. B. Buder, of Ilio Landing. Mr. B. is now postmaster, boat agent, merchant, farmer, bee-keeper, and a very good man as every one in that locality will admit. I had heard, however, that he had not always been thus, and that he had passed through a remarkable experience. He finally himself told me that, for a great part of his life, he had not only used tobacco, but drank also. His regular business is watchmaker and jeweler; in fact, he became an expert, and earned enough money to have been well off, but it all went for the things I have mentioned, and evil companions. First his nerves began to give way. He could not adjust a hairspring, and perform other delicate work about a watch. He had always been an expert in all athletic games; but even his wonderful constitution could not stand it. He studied the matter over, and, like a sensible being, said, "Get thee behind me, Satan." He broke away from every thing, and accepted Christ as his Savior, and united with the church.

Now, here is the point of my story. When I asked him how big a job it was to break right square off from stimulants he said something like this :

"Mr. Root, you may be surprised to hear it, and my experience may be very unusual; but it *wasn't any task at all*. I have never wanted either drink or tobacco one minute since I quit. Getting off the load of a guilty conscience, which I had carried for years, was such a relief that I never *thought* of going

back. I wouldn't touch either of them again for all of the money in the world. I have met my old comrades at our annual conventions (for I still attend some of them), but it wasn't a bit hard for me to say, 'No, gentlemen, I don't drink or smoke.' If they say, 'Why, do you mean to say you have turned pious?' I reply, 'That is just what I have done; and if you will come along with me, and do the same, you will declare right away it is the most sensible thing any one can do.'"

The above is not exactly his own words, but the substance of them. When I asked if I might publish what he had told me, he replied :

"To be sure, you may, Mr. Root. I am ready to stand up before all the world as a humble follower of the Lord Jesus Christ; and there is nothing I enjoy more than using my influence for him as far as it will go."

As a matter of course, soon after our friend started out in the new life he married a good woman, and they two now make a very pleasant home for travelers stopping over night or waiting for boats.

The reason why, or at least one great reason why, friend B. has had no awful battle with his old bad habits is that he made a full and complete surrender. He never *looked back* after he had turned heavenward; nay, let us put it still stronger—he never *thought* of looking back; then the "old man," with his legion of evil ways, was *gone*, and in his stead was the new creature "sitting and clothed, and in his right mind." No wonder they were afraid.

Special Notices by A. I. Root.

WHITE DUTCH CLOVER SEED—ADVANCE IN PRICE.

The best present figures are: Bushel, \$10.00; $\frac{1}{2}$ bushel, \$5.25; peck, \$2.75; 1 lb., 20 cts.; 1 lb. by mail, 30 cts.

PRICE OF THE NEW POTATO-PLANTER.

By an oversight no price was given in our Feb. 15th issue of the potato-planter described and illustrated. It is only 75 cts.; and as it weighs only $2\frac{1}{2}$ lbs it can be sent by mail for only 45 cts.; but it had better be sent by express, or, better still, by freight with other goods.

SWEET CLOVER SEED—ANOTHER ADVANCE IN PRICE.

The best price we can possibly make at the present date is, 100 lbs., 10 cts per lb.; 10 lbs. or more, 12 cts. per lb.; single pound, 15 cts.; single pound by mail, 25 cts. The above is for seeds with the hulls on. Seed with hulls off will be 5 cts. per lb. more than the above prices.

THE NEW CAULIFLOWER SEED—THE MATTIUCK ERFURT.

After the notice given in our Jan. 15th issue concerning this new cauliflower, a tremendous demand sprang up. For a time we were out of seed, and unable to fill orders; but by considerable persuasion we secured the last bit of seed friend March had left, and can still supply it in 5-cent packets, or $\frac{1}{2}$ -ounce packets at 25 cts.; $\frac{1}{4}$ -ounce, 40 cts.

GLASS ADVANCED AGAIN.

We are again obliged to mark up the price of 8x10 glass for greenhouse sash to \$3.60 per box of 90 lights or 50 sq. feet, and a like advance will apply to all special sizes or strips which we can not obtain cut from waste. Strips over 16 inches long to 20 inches are worth \$1.20 per box by the latest prices received.

Tailor-Made Suits, Wrappers, Chairs, Tea Sets, and a Hundred Other Valuable Premiums ALL FREE!



Ladies' Pat. Corset-Belt Wrappers
FREE for selling only 1 dozen Holdfast Skirt Supporters.

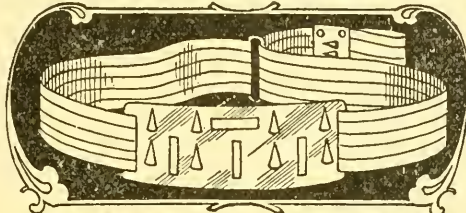

NO MONEY REQUIRED

These handsome and useful premiums given ABSOLUTELY FREE to you for introducing to your friends our great "HOLDFAST" Waist and Skirt Supporter which is the only automatic supporter yet invented. Requires no sewing on of hooks, buttons or anything else. All that is necessary is to put the Supporter on, and "it does the rest." It is what everybody is looking for. Every lady and girl in the land needs one. Every Supporter sold brings two more customers. They only cost 55 Cents, so are within reach of everyone. We do not ask you to invest one cent of your money. If you would like to get one or more of our handsome premiums for using a few moments of your time in our interest, all that is necessary to do is to write, saying you would like to earn a premium. We will then send you, charges paid, the Supporters. When you have sold them you send us the money and obtain your premium which we send to you, freight charges prepaid, anywhere in the United States, so, from first to last, you do not invest a penny of your own money.

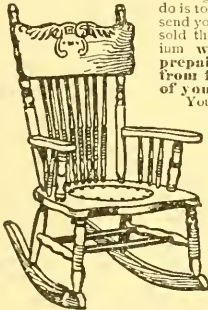

Oak Chair
FREE for selling only 1 dozen Holdfast Skirt Supporters.



Ladies' Tailor-Made Suit
FREE for selling only 4 dozen Holdfast Skirt Supporters.

You take no risk. We trust you with our goods and take back what you can't sell. We have premiums for selling one-half dozen up to one gross. We send a large premium list with first lot, containing 100 offers, all useful as well as ornamental; and we wish you especially to note that when you have earned the premium it is sent to you prepaid, if you live in the United States, so you are actually out only your time. Such an offer has never been made before.

Better write us today and be the first to show the great invention in your town. Note—If you would like to see our Supporter before ordering a quantity, we will send you one, postage paid, on receipt of 35 cents in stamps.



32-Piece Tea Set
FREE for selling only 2 dozen Holdfast Skirt Supporters.

Address this way:

All Freight Prepaid to You **THE COLVER CO.** Dept. 14, 815 Schiller Bldg., Chicago



\$29.25
Don't Pay a Cent of profit to agent or dealer when you can with equal safety, satisfaction and guarantee buy direct from manufacturers and save half the cost. Our Vehicles are built for hard wear. Best materials throughout. New styles. Approved Workmanship. Unqualified guarantee, \$29.25 and upwards. Our Harness and Saddles comprise a complete line of standard work \$4.25 upwards. In no event place your order without writing for our Free Catalogue containing valuable suggestions to the vehicle & harness buyer
CASH BUYERS' UNION, (Inc.)
158 W. Van Buren St., B-345, Chicago, Ills.

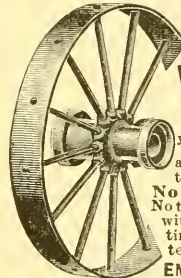

STEEL WHEELS

for your **FARM WAGONS**
any size wanted, any width of tire. Hubs to fit any axle. No blacksmith's bills to pay. No tires to reset. Fit your old wagon with low steel wheels with wide tires at low price. Our catalogue tells you how to do it. Address **EMPIRE MFG. CO., Quincy, Ill.**



PAGE

When a Tree Falls

across a wire fence, when a bull or a runaway team run into it, how much benefit is a quarter inch cross wire? Isn't it a damage? Think of it. **Page Fence Co., Box S, Adrian, Mich.**

BETTER THAN WOOD.

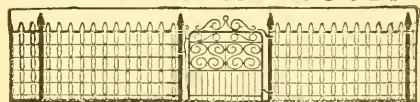

Costs less; looks better; lasts longer.
HARTMAN STEEL ROD LAWN FENCE will neither rot nor burn.
HARTMAN MFG. CO., Box 80, Ellwood City, Pa.
Or Room 40, 209 Broadway, New York City.

\$1,000.00 IN CASH

will be given to Subscribers of **Agricultural Epitomist** making the largest yield from one quart of "EPITOMIST PRIZE" White Dent Corn.

The prizes to be awarded in the following named amounts and paid December 1, 1901

\$250.00 for largest yield	\$50.00 for 4th largest yield	\$10.00 for 7th largest yield
\$150.00 " 2d "	\$25.00 " 5th "	50 prizes, \$5.00 each \$250
\$100.00 " 3d "	\$15.00 " 6th "	50 " \$3.00 " \$150



Natural Size, 10 inches in length; 7 1-2 inches in circumference; weight, 17 ounces.

MAKING A TOTAL OF \$1,000.00

Those contesting for one of these Prizes must send affidavit of yield with sample of corn, when mailing report; also report mode of cultivation and fertilization.

ONE QUART "EPITOMIST PRIZE"

....OF....

White Dent Corn

with careful cultivation will grow enough seed to plant two hundred acres of land—**200 ACRES.**

This is a variety of corn of remarkable characteristics. It produced last year on the Epitomist Experiment Farm eighty bushels to the acre under exceedingly unfavorable conditions. The land on which it grew was of medium fertility only: the cut worms mowed it down, until there was, at one time, an intention of plowing it up, and owing to natural conditions which we could not control, it received but one plowing. Corn that will produce eighty bushels to the acre under such conditions is exceptionally valuable. The length of the ears is from ten to twelve inches, the circumference is seven and a half inches and sometimes more; the cob is small and completely covered with grain; the grain will average a half inch in depth and same in width, and is unusually thick; the weight of grain and cob averages something over a pound, and there is evidently per cent of grain. The "EPITOMIST PRIZE" WHITE DENT is an early variety that will mature anywhere within the corn belt, and to those who appreciate the value of corn fodder, it recommends itself, as it produces a luxuriant growth of stalk, many of which in our fields, were fifteen feet high. It is certainly the best variety of corn that we have ever grown or seen grown, and there is every indication that it contains an unusual per cent of protein, and the higher the per cent of protein the more valuable the corn. We have never seen stock of all kinds that was fed almost exclusively on corn, do as well as our stock has done upon the Epitomist Farm.

The Epitomist Experiment Station,

is without doubt the most beautiful spot in the State of Indiana. Over \$100,000 has been spent in improvements on this Experiment Farm, where **Agricultural Epitomist** is edited and printed amid the activities of real farm life. Its beauty of scenery and perfect climate, with its pure spring waters, are hard to surpass in any locality. We have at this Experiment Farm of 650 acres, all the different soils found in Indiana or in almost any other State, as well as the varied conditions requiring drainage, irrigating, enriching, etc., all to be included in our experiments which will be written up in the **Epitomist** from month to month. It is our purpose to experiment in all lines of Agriculture, Horticulture, Live Stock, Dairying, and Poultry Raising, and as the growing of this variety of Corn which we have named "EPITOMIST PRIZE" is the result of one of our first and most successful experiments we are not only going to give **Epitomist** readers some of the seed of this variety to raise, but \$1,000 in prizes the same to be awarded as described above.



Every subscriber to the **Epitomist** is entitled to participate in this contest. All we require is that you send 50 cents for one year's subscription to the **Epitomist** and 50 cents to pay for postage, packing, etc.—**70 cents all told**—upon receipt of which we will enter your subscription and send you one quart of "EPITOMIST PRIZE" WHITE DENT CORN by mail, postage prepaid.

FREE

READ Carefully how to get the seed. Plan Carefully how to get the Prize.

THIS EAR OF CORN

represents an average ear of "EPITOMIST PRIZE" WHITE DENT CORN and is taken from actual nature without history. The crop was grown this past season of 1900 at the Epitomist Experiment Station, and we feel that the remarkable results obtained justify us in expecting subscribers to derive unusual benefit therefrom.

Address **AGRICULTURAL EPITOMIST** Box 318

Epitomist Experiment Station, SPENCER, IND
This Contest is for EPITOMIST Subscribers Only.

SPRAYING FRUIT-TREES.

The question of spraying fruit-trees to prevent the depredations of insect pests and fungus diseases is no longer an experiment but a necessity.

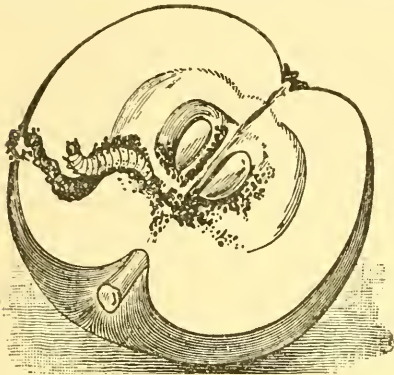

Our readers will do well to write Wm. Stahl, Quincy, Ill., and get his catalog describing twenty-one styles of Spraying Outfits and full treatise on spraying the different fruit and vegetable crops, which contains much valuable information, and may be had for the asking.

\$50.00 POP CORN.

100 seeds of this wonderful new Pop Corn for 25c and chance to compete for our cash prizes. Seed Due Bill good for 25c worth of other goods FREE with every order for Pop Corn. First-prize winner last year raised at the rate of 188 bushels per acre. We will pay \$50 for its equal in quality. Handsome seed catalog and free presents with every offer.

C. M. Goodspeed, Skaneateles, N. Y.

LONE STAR APIARIES

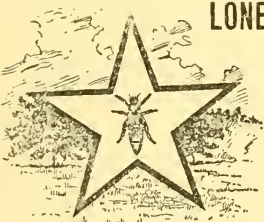

G. F. Davidson & Sons, Props.

Breeders of fine Italian Queens. Established in 1885. Write for circular.

G. F. Davidson & Sons, Fairview, Texas.

QUEENS BY RETURN MAIL.

The Choicest of Tested Italian Queens \$1 each.

Large yellow queens, healthy and prolific; workers the best of honey-gatherers. Safe arrival and satisfaction guaranteed in every case. Send for price list.

J. W. K. Shaw & Co., Loreauville, La.

I AM NOW BOOKING ORDERS for my Superior queens, including three long-tongued strains, also the five-banded strains; all young; no inferior-looking queens sent to customers. Descriptive price list will be sent for postal. Untested queens: Sweet Heart, \$1.25; 6, \$7.00. A. I. Root red clover, \$1.25; 6, \$7.00. Steffy's red clover, \$1.00; 6, \$5.50. Five-banded, \$1.00; 6, \$5.50. Always state in your order which kind is wanted. Save this adv't as it will not appear again soon. SEWARD STEFFY, Bishopville, Ohio.

FOR SALE CHEAP.—100 nearly new second-hand Hilton chaff hives. Hives are at Wallin, Benzie Co., Mich. For particulars inquire of L. C. WOODMAN, Grand Rapids, Mich.

Honey Queens.

Have you noticed the change in my P. O. address? Did you know I am seeking to give my customers the best service possible?

Did you know that I have as good or better queens than can be bought elsewhere? Many have found this out, and continue my best customers. Golden and leather colored honey queens, bred in separate apiaries. Bees, nuclei, and full colonies for sale.

Price of queens—March and April—tested or untested, each \$1.00; 6 for \$5.00; \$10.00 per dozen. Breeders, \$2.50 to \$5.00 each.

— ADDRESS —

W. H. LAWS, BEEVILLE, TEXAS.

\$18 Guaranteed for 10 Years. Frgt. Prepaid and Money Back if not Satisfactory.

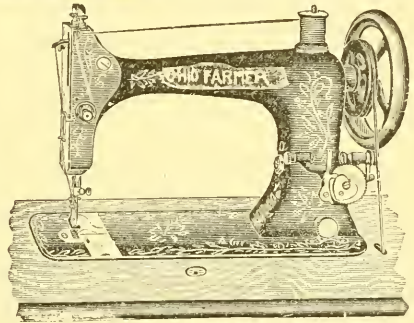

Send us \$18.00 and we will send you one of our NEW IMPROVED OHIO FARMER HIGH-ARM SEWING-MACHINES, freight prepaid. Use it for all kinds of work, and if not satisfactory you can return it in 90 days and we will refund your money and pay freight both ways.

All Guaranteed New Machines.

Self-setting needle; automatic bobbin-winder, with oak or walnut woodwork; new bent wood top; seven long skeleton drawers. Full and complete set of attachments and illustrated instruction book sent with each machine. Every machine we send out guaranteed to give ENTIRE SATISFACTION OR MONEY REFUNDED. We can furnish repairs or needles at any time. Remit by postoffice order, registered letter, New York draft, or express.

If you want the BEST sewing-machine made in the world at the LOWEST PRICE ever offered, send us your order.

Drop Head, \$20.00.

This is the same machine, except the cabinet, which is made so that head drops out of sight when not in use. Four drawers. Freight prepaid. With same attachments as the \$18.00 machine.

Our No. 2 Machines.

Have old-style top tension instead of the new side tension furnished on the others. Not quite as much work on them as the others, which accounts for the lower price; but we guarantee them for the same time, furnish same attachments, and prepay freight.

High Arm No. 2. 5 Drawers. Only \$15.00.
Drop Head No. 2. 4 Drawers. Only \$16.50.

Send for our new illustrated catalog. Address

The Ohio Farmer, : : : Cleveland, Ohio.

NOTE.—We have known the publishers of the Ohio Farmer for many years. They are entirely responsible, and will fully make good their agreements.

THE A. I. ROOT COMPANY.



CELERY-GROWING BY SUB-IRRIGATION, NEAR
SANFORD, FLA.

One of the principal reasons for my recent trip was to look up and write up the new industry of celery and lettuce growing in different parts of Florida. That State is a land of wonderful contrasts. Perhaps not one acre in a thousand there is made any use of at all. While stopping with a friend, he made a remark to the effect that he had, the day before, closed a deal for 1000 acres of land. I stopped in surprise, and, looking at him, said:

"Do you mean that *you* have actually purchased a thousand acres of land?"

"That is what I said, and I was thinking of going out to look it over, or a part of it, for I have not yet seen it myself."

"Do you mind telling me about how much an acre it cost you?"

"Well, probably the greater part of it cost 50 cts. an acre — some of it considerably more than that."

So you see it did not take very much money after all to become the owner of a thousand acres. I was still more astonished when I saw land right adjoining the new purchase that had had fine crops of sugar cane, corn, and other Florida crops. It was dark sandy loam, beautiful to work, and it seemed to me it ought to be worth \$40 or \$50 an acre almost anywhere. Well, right in this very region were orange-groves which, before the frost, could not have been bought for \$1000 an acre, and there is no reason in the world why this same land, that was sold at 50 cts. an acre might not soon be worth \$1000 an acre providing the seasons in the future should finally settle down something as they were before the great freeze six years ago. Well, right where the great yields of celery were made I am going to tell you about, and are being made, there are *hundreds* of deserted plantations. Beautiful homes, or what were such but a few years ago, yes, almost *princely* residences, are now going to ruin. The owners became discouraged because of the freezes, and moved away. For miles and miles in any direction you can see only desolation and ruin. Now for the other side.

Six years ago I told you about the artesian wells of Florida. All around Sanford, for miles in almost any direction, one can get artesian water by going down from 50 to 150 feet. I saw four-inch pipes six years ago pouring out a full stream.

Well, these pipes have been running during all the last six years, and I found them running just the same on my last visit. Nobody even takes the pains to turn the valve and shut off the water. When I spoke about the supply being exhausted they stared at me in astonishment.

One of our first visits was to C. F. Williams, of Sanford. Mr. W. commenced last summer

by clearing off two acres of palmetto or hammock land. There were so many palmetto stumps, and they were so large, he could not well burn them, so he bought some of the cheap land adjoining his own, and tumbled the rubbish over on to it. I spoke about burying the great stumps, as we do boulders here in the North; but he said when land cost only from \$2.50 to \$5.00 an acre it was cheaper to dump the rubbish on a piece of land bought for the purpose than to waste time and money in trying to bury it. The two acres were all cleared off by hand work, or "grubbed out," as they call it. This may have cost about \$50 an acre. Then open ditches were made all around the outside, and at right angles through the middle. In fact, these open ditches were only two or three rods apart, if I remember correctly, and they were in depth something like 15 or 18 inches. An outlet was secured so that the whole plantation could be thoroughly drained so the ditches would be dry enough to walk in. Of course, all ditches must slope a little toward the outlet, and the sides must be sloping enough (bottom flat), so when soaking wet they don't cave in. Now, with their black porous sandy loam, we might think this was underdrainage enough. Not so, however. Either tiles or wooden boxes were put through these beds between the open ditches, say every 10 or 12 feet. Some people use tiles, and others use V-shaped troughs, with the apex uppermost; and these tiles or wooden boxes were a little above the bottom of the open ditches. The idea is, to be able to let off every bit of water whenever the soil shall become water-soaked by tremendous rains or by artificial flooding, as I shall explain. These tiles and wooden boxes also serve to let air come in through the roots of the celery-plants.

Now, at some point in the garden—perhaps right in the center—a four-inch iron pipe is driven down until it will run out full of water. I think a four-inch stream will irrigate two acres easily. Thus, you see, whenever there is a lack of rain, or the light soil becomes too dry, the valve of the four-inch pipe is opened, the outlet to the open ditches closed up, and the whole plantation allowed to fill up with water until it rises by capillary attraction so the celery-plants are sufficiently watered. The common way of bleaching is with boards. Some growers plant the celery in a single row, say 2½ feet apart. Others have a double row, the plants standing only about 6 inches from each other. At the proper stage of growth one-foot cypress boards are put up at each side in the usual way. Now, Mr. Williams has got on to "the new celery culture." Instead of one row or two rows he plants *seven rows* of celery side by side, so the plants are only six inches apart from center to center. Then boards are put each side of these seven rows. The plants are then made to grow with such rank luxuriance that they bleach each other. Considerable quantities of stable manure are used first. I was not able to determine just how much. The plants are coaxed, not only by water, alternating with perfect drainage, but by constant

stirring of the soil; and, furthermore, the most stimulating fertilizers are applied at every stage of the growth until the plants fill the entire space so that no implement can get between them. Then they are pushed by water and drainage.

The fertilizer most used at this garden was bought of Wilson & Toomer, Jacksonville, Fla. They call it Peruvian vegetable manure. Mr. Williams said it was the next thing to Peruvian guano. The cost of fertilizers for an acre of celery, or at least the cost to him, as he figured it, was \$150, perhaps more. Lots of work, and lots of money, you say. Yes, my friends, there is no high-pressure gardening without money and work. Now for the result.

I saw one of these beds containing 350 sq. feet where the crop had just been harvested, and shipped to New York. I suppose the owner of the garden was as much surprised as anybody to receive a check for \$39.00. This amount was above the freight, mind you, for the celery grown on 350 square feet. He said one of his friends figured up that the yield was at the rate of \$5000 per acre. He had been too busy to do the figuring—in fact, did not care particularly about it. Now, the question that has come up thousands of times before faced me once more. I looked at this energetic young gardener and said, "Mr. Williams, is it possible for you to manage a whole acre (of course hiring all the help you need) so as to make a result something like this little bed which you have here, of less than two square rods?"

He smiled as he replied, "Mr. Root, that is the question I am asking myself. Just come this way and see what I am doing along that line."

To my great joy and surprise he showed me a bed, 7 rows wide, perhaps 12 rods long, nearly ready to be banked up, with every plant a model one, and just like its neighbor. Next to this bed was one with plants a little smaller, then another with plants smaller still, and so on down, step by step. He had evidently tried to put not only just the same amount of fertilizer but the same amount of *brains* on every square foot that he did with his first experiment. The astonishing thing about it was there were no poor spots or small or indifferent plants, and I found by questioning that he had sorted his plants, and graded them, before putting them out. All of one size were put in a certain bed; then if a plant, or a dozen or two of them, got to lagging behind he took them up and put better ones in their places, thus *insisting* on a perfect, even stand.

Now, then, why in the world do not the poor people in Florida, and everywhere else, get a little bit of ground, say half an acre, and go to work and do what I have been describing? I was tempted to say it is because they actually *can* not do it, but I think I had better say it is because they *will* not. As I write I am looking out on a piece of low rich ground that is generally too wet, and I have been wondering whether even I myself have the grit and determination to do what I saw that

young man do down there in Florida. You see, human nature has such a constant tendency to backslide, and go down hill, there is only one in a thousand or one in ten thousand who will be up and on the alert to *push* things in the way I have described.

Now, this wonderful revelation—and that is just what it was to me—does not apply to celery alone. Wonderful crops of lettuce are grown in just the same way, or in much the same way, and I do not know but it brings almost as much money; and thousands of other crops can be grown, getting more from an acre than ordinarily grows on ten acres—yes, getting as much from a single acre on high-pressure gardening as thousands of farmers get from a *hundred acres*.

Florida has the advantage of us in having this artesian water, without stint or limit. Then there are no frosts, that I know of, that interfere with celery. The crop needs no covering. I forgot to say the variety grown is the Golden Self-blanching, known now all over the world.

Now, I hope you will all go to work and make a trial of at least a few rods by sub-irrigation. You can certainly get enough water to fill up the open ditches when it does not rain enough; and when you get something extra nice, may be I will get around to look it over.

The question naturally comes up, "Why these open ditches instead of good-sized tiles?" Well, as nearly as I can understand it the open ditches are to enable you to see when the plants have water enough, and to be sure they do not get too much. I am under the impression they give better drainage and better aeration than any other plan. In our most expensive greenhouses I notice they are placing tiles under all the beds only three or four feet apart, letting them reach over into the paths, so that in case anybody does overwater any sort of stuff, the water immediately runs away and thus we avoid danger from standing water.

The plan I have given above succeeds. I should be afraid to try some other way until I knew by experiment that it is just as good as the one I have given. The great secret is *feeding* the plants from the very beginning to the end. Old well-rotted stable manure has always been our cheapest and most effective fertilizer. But please remember that, if you are going to get a crop worth \$25 or more to the square rod, you must hunt up the very best and most concentrated fertilizer that can possibly be found, suitable for the particular crop in your own locality, and apply it without stint.

Mr. H. H. Chappell has also about two acres adjoining the above, almost if not quite as good as I have described. He was not at home at the time, but his good wife showed us around, and answered our many questions.

There are similar enterprises scattered off for miles in every direction. Not many of them, however, are up to such a standard of excellence as the one I have just described. In fact, I am sorry to say some are only making sad failures.

You get the Profits



No. 3034. Price \$38.30 with leather quarter top.

Under our plan of selling carriages, buggies and harness, you get the profits. The jobber and retailer are cut out. By dealing direct with our factory, you pay only the cost of making with a moderate profit added; and you take your choice from the biggest stock and fullest assortment. Our plan of

Selling Carriages Direct

insures satisfaction — your money back if you are dissatisfied. Our complete illustrated catalogue, showing many styles of high grade vehicles, harness, robes, blankets and horse equipments, with detailed descriptions of each, mailed free.

THE COLUMBUS CARRIAGE and HARNESS CO., P. O. Box 772, Columbus, O.



No. 240 Single Strap Buggy Harness Price \$7.95



LIKE A SORE THUMB.

Our low prices and our Ten Days Trial plan are "forever in the way" of the local dealer. He doesn't like us—naturally —because we let our customers take a vehicle and use it 10 days before deciding whether they will keep it or not, and because we sell you better goods for less money than he possibly can. There are two or three profits on the goods he sells—the dealer's, the jobber's, the manufacturer's. We make our own goods and add but one small profit. In style, finish and material you won't find the equal of our vehicles for the money anywhere. Send for big, free catalogue and particulars of our 10 days trial plan. We make harness too

KALAMAZOO CARRIAGE AND HARNESS CO., Box 22, Kalamazoo, Mich

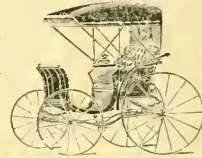

FROM MANUFACTURER TO USER

MANUFACTURERS OF THE **FAMOUS SPLIT HICKORY VEHICLES, AND HARNESS.**

Anyone—Anywhere

Our vehicles and harness are shipped to any point in the United States on approval, and for comparison with any other goods. We are willing to take chances on pleasing you. Are you willing to save money without taking any chances? Our **Split Hickory Vehicles** are right in style, in quality and in price. Write for our new catalogue and prices on seventy-six (76) different styles in vehicles and large assortment of harness. Buy direct from us, and save all dealers' commissions and profits. We are manufacturers of the famous Split Hickory Vehicles

Ohio Carriage Manufacturing Company
27 W. Broad St., COLUMBUS, OHIO.

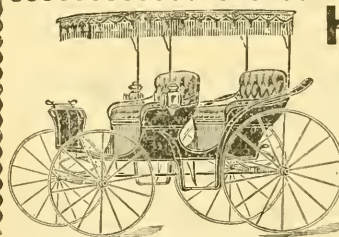

No. 717—Canopy top surrey with oil burner lamps. Price complete with pole or shafts \$75. Same as sells for \$35 more than our price

HOW MUCH CAN I SAVE?

This is a question that every man should ask himself when it comes to a business proposition. For instance, we manufacture vehicles and harness and sell them to you direct from our factory at wholesale prices. On this plan the saving to you is **about 35 per cent;** that is, you would have to pay a

local dealer or agent about that much more than you pay us for the same quality of goods. **is not this item worth saving?** We make 178 styles of vehicles and 65 styles of harness and are the largest manufacturers of vehicles and harness in the world selling to the consumer exclusively. We make every article we sell and ship our goods anywhere for examination and guarantee safe arrival. You have the advantage of large selection, newest designs, latest styles, &c. Above all you have a guarantee of quality at a reasonable price. **144-page illustrated catalogue FREE.**

ELKHART CARRIAGE & HARNESS MANUFACTURING CO., Elkhart, Indiana.



No. 130—Double Buggy harness, with nickel trimmings. Complete with collars, \$22. As good as sells for \$30.

Improved Ohio Farmer REPAIR OUTFIT.

Our Price Only \$1.65.

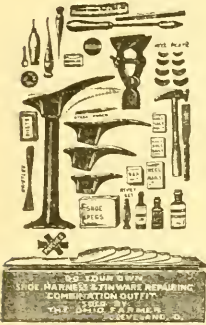

We have examined samples from all manufacturers, and believe this is the very best repair outfit on the market; easily worth \$1 more than those offered by stores and other papers. It contains 48 articles, all full size and first class, and we guarantee satisfaction or will refund money. Half-soles alone are worth 50c, and are not included in other outfits. It will soon pay for itself in repairing boots, shoes, rubbers, harness, and tinware.

Repair Outfit with Ohio Farmer one year for only \$2.15, or the Complete Outfit free for a club of 10 subscriptions to the Ohio Farmer. By freight.

Send for our illustrated premium list, giving wholesale prices on watches, sewing-machines, knives, and lots of other useful articles. Mention this paper.

The Ohio Farmer ; Cleveland, Ohio.

Home-seekers' Excursions.

On the first and third Tuesdays of each month the Chicago, Milwaukee & St. Paul R'y will sell round-trip excursion tickets from Chicago, Milwaukee, and other points on its line to a great many points in South Dakota, North Dakota, and other western and north-western States at about one fare. Take a trip West and see the wonderful crops, and what an amount of good land can be purchased for a little money. Further information as to rates, routes, prices of farm lands, etc., may be obtained by addressing F. A. Miller, General Passenger Agent, Chicago, Ill.

Mr. A. I. Root's Writings

of Grand Traverse territory and Leelanau County are descriptive of Michigan's most beautiful section reached most conveniently via the

Pere Marquette R. R.

For particulars address W. C. Touzey, D. P. A., Toledo, Ohio.

WHERE TO LOCATE?

Why, in the Territory Traversed by the

Louisville & Nashville RAILROAD.

THE

Great Central Southern Trunkline

IN

KENTUCKY, TENNESSEE,

ALABAMA,

MISSISSIPPI, FLORIDA.

WHERE

Farmers, Fruit-growers,
Stock-raisers, Manufacturers,
Investors, Speculators,
and Money Lenders

will find the greatest chances in the United States to make "big money" by reason of the abundance and cheapness of

Land and Farms,
Timber and Stone,
Iron and Coal,
Labor--Everything.

Free sites, financial assistance, and freedom from taxation for the manufacturer.

Land and farms at \$1.00 per acre and upwards, and 500,000 acres in West Florida that can be taken gratis under U. S. homestead laws.

Stock-raising in the Gulf Coast District will make enormous profits.

Half-fare excursions the first and third Tuesdays of each month.

Let us know what you want, and we will tell you how to get it—but don't delay, as the country is filling up rapidly.

Printed matter, maps, and all information free.

Address

R. J. WEMYSS,
Gen'l Immigration and Industrial Ag't,
LOUISVILLE, KY.

New Smith Premiers Nos. 5 and 6.

The No. 6 takes paper 18½ inches wide and writes lines 16 inches long. The No. 5 takes paper 11 inches wide and writes lines 9½ inches long. These new machines in essential mechanical principles are the same as Models Nos. 2, 3 and 4—unequaled.

Write for Printed Matter Free.

**The Smith Premier
Typewriter Co.**

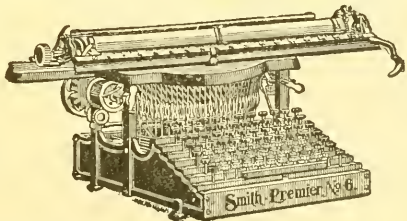

158 Prospect Street, Cleveland, Ohio.

ROUGH RIDER,
SEN. DUNLAP,
and other
CUMBERLAND RASPBERRY,
KING OF MICHIGAN POTATO.

STRAWBERRIES

100 Varieties.

Plants and Seed Potatoes.

Descriptive Catalogue Free to All.

FLANSBURGH & PEIRSON, Leslie, Mich.



BIG STRAWBERRY
GIVEN AWAY.

We will mail you six plants of Corsican, biggest strawberry on earth, if you will send us 15c. for one new subscription to

GREEN'S FRUIT GROWER
and Home Companion for six months. Established twenty years ago. It has 60,000 subscribers who say it's the best family fruit journal in America. Send for free sample copy.

Green's Fruit Grower,
Rochester, N. Y.

Maule's (35 new things for 1901)
Seed Catalogue

You should, by all means, have this **most modern catalogue of modern times.** It is brimful and overflowing with good things in vegetable, farm and flower seeds, flowering plants, fruits, bulbs, etc. **It contains 35 novelties in vegetables and flowers never offered before,** has 136 large pages, seven handsome colored plates and hundreds of illustrations. It gives practical, up-to-date cultural directions and offers many cash prizes. The first edition alone costs over \$30,000, so while we send it free to all customers, we must ask others to send 10 cents for it, which amount they may deduct from their first order. You will make a mistake if you do not write to-day for this the Novelty Seed Book of the year. Address,

WM. HENRY MAULE, Philadelphia.

SEED OATS

45c a Bu. and up.

The cleanest, heaviest, best yielding oats are Michigan Northern Crown, Hammond's English Wonder, Czar of Russia, Michigan Wonder and Mortgage Lifter, the four best varieties. Rust proof, stiff straw, have yielded 150 bu. per acre. Catalog describing these oats and all other farm seeds free on request.

Harry N. Hammond Seed Co.,

Formerly of E. Field.

Box 69, Bay City, Mich.

Sweet-Potato Seed.

Sound bright stock of the best varieties. Special rates by express. Descriptive price list free. Address

L. H. Mahan, Box 143, Terre Haute, Ind.

BULL-STRONG!

....**PIG-TIGHT**....

An Illinois farmer said that after harvest he had fully 200 bushels of loose oats on the ground that he could not secure any benefit from, because the fence round the field would not turn hogs. Figure the loss for yourself. He also said, all this would have been saved if he had used the Kitzelman Woven Wire **Coiled Spring Fence**, and the value would have gone a long way towards paying cost of the fence.

With the **Duplex Machine** any farmer can make it himself at the actual cost of the wire. Catalogue free for the asking.

KITZELMAN BROS.,
Box 231, Muncie, Ind.

Maple Sugar and Syrup.

We are again prepared to furnish choice Medina County maple sugar and syrup. Do not fail to get our prices. It is too early to name prices at this writing, but we will quote by letter on application.

THE A. I. ROOT CO., Medina, O.

AT ANY TIME--

summer time or winter time, the **BEST POWER** for all purposes on the farm, in the dairy, creamery or cheese factory, is a

LEFFEL ENGINE.

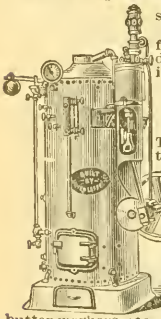

They are very simple in construction, and easy to run and keep in order. Are very economic of fuel, are easy steamers and great power developers. They are made both horizontal and upright with engine mounted on boiler. Everything is made of best material throughout. They are ideal for cutting and grinding feed, sawing wood, pumping water, running cream separators, churns, butter workers, etc.

Send stamp for Book on Power.
JAMES LEFFEL & CO., Box 89, Springfield, O.

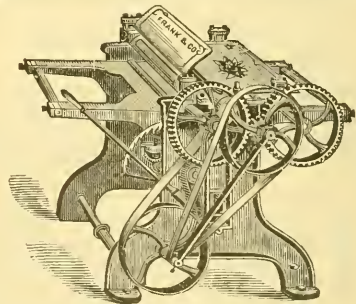

PLANERS

The above cut shows one of our small Planers, of which we make twelve different styles and sizes. Also large Planers, Band Saws, Buzz Planers, Moulders, Wood Lathes, and all kinds of

WOOD WORKING MACHINERY

Send for Catalogue.

The FRANK MACHINERY CO.

BUFFALO, N. Y.



PEEP OF DAY Sweet Corn.

Ready for the table 10 days ahead of any other variety.
Sweet as honey and very productive.

For 10 cents we will mail you a package of this corn, sufficient to plant thirty hills; our catalogue for 1901 which is full of good things of proven merit, and our interesting booklet, **SEED TRUTH**, which contains information of vital importance to every seed buyer, no matter where he gets his seeds.

Order at Once as this Offer will NOT Appear Again.

Northrup, King & Co. Seed Growers,
MINNEAPOLIS, MINN

BURPEE'S FARM ANNUAL FOR 1901

"QUARTER-CENTURY EDITION"

A Grand New Book of two hundred and twenty pages. Entirely rewritten at our famous FORDHOOK FARMS—the largest Trial Grounds in America. New Directions for culture, New Leaflets, New Novelties of unusual merit in both Vegetables and Flowers, Elegant New Colored Plates. The Quarter-Century's Record of Progress, New Cash Prizes, and other New Features. **The largest, most complete, and BEST SEED CATALOGUE** ever published. Mailed for ten cents, which is less than cost per copy. Name this paper, send ten cents (silver or stamps) and with this great catalogue we shall send a 15-cent packet of either Burbank's *Unique Floral Novelty* or Burpee's wonderful, new, dwarf, meaty, bright-red, earliest Tomato,—"Quarter-Century."

Should you object to paying ten cents for a seed catalogue (even though it is worth a dollar), then write a postal card for Burpee's "SEED-SENSE" for 1901,—a "strictly business" catalogue of ninety pages.

W. ATLEE BURPEE & CO., PHILADELPHIA, PA.

242

For 14 Cents

We mail the following rare seed novelties.

1 pkg. Blue Blood Tomato Seed,	\$.15
1 .. Northern Lemon Seed,	.15
1 .. Mama's Favorite Onion Seed,	.10
1 .. Emerald Green Cucumber Seed,	.10
1 .. City Garden Beef Seed,	.10
1 .. 13-Day Radish Seed,	.10
1 .. La X. Market Lettuce Seed,	.15
3 .. Brilliant Flower Seed,	.15

Worth \$1.00 for 14 Cents.

Above 10 packages rare novelties we will mail you free, together with our great Illustrated Seed Catalog, telling all about **Salzer's Billion Dollar Grass** Also Choice Onion Seed, 60c. a lb. Together with thousands of earliest vegetables and farm seeds, upon receipt of 14c. and this notice. When one you plant Salzer's Seeds you will never do without.

JOHN A. SALZER SEED CO., LaCrosse, Wis.

Ferry's SEEDS

Ferry's Seeds are known the country over as the most reliable Seeds that can be bought. Don't save a nickel on cheap seeds and lose a dollar on the harvest.

1901 Seed Annual free.

D. M. FERRY & CO.,
Detroit, Mich.

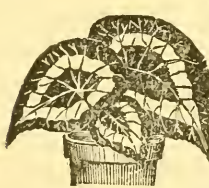

SEEDS, PLANTS,
Roses, Bulbs, Vines, Shrubs, Fruit and Ornamental Trees. The best by 47 years test, 1000 acres, 40 in Hardy Roses, 44 Greenhouses of Plants and Everblooming Roses. Mail size post paid, safe arrival guaranteed. Try us, our goods will please you and direct deal will save you money. Valuable 168-page Catalogue Free.

THE STORRS & HARRISON CO.,
Box 227 PAINSVILLE, OHIO.

SEED DUE BILL FREE

To get new customers to test my Seeds, I will mail my 1901 catalogue, filled with more Bargains than ever and a 10c Due Bill good for 10c worth of seeds for trial absolutely free. All the Best Seeds, Bulbs, Plants, Roses, Farm Seeds, Potatoes and many Novelties at lowest prices. Glueing, the great money making plant. Giant Prize Tomatoes, 2 to the foot, Pan American Oats, sent on trees to farmers, and two Free Passes to Pan American Exposition, Buffalo, N. Y. are offered. \$2,635.00 in cash premiums. Don't give your order until you see this new catalogue. You'll be Surprised at my bargain offers. Send post for catalogue to-day. It is FREE to all. Tell your friends to send too.

F. B. MILLS, Box 105, Roschill, Onondaga Co., N. Y.

In writing advertisers please mention Gleanings



THE WHEEL OF TIME

for all time is the

Metal Wheel.

We make them in all sizes and varieties to fit ANY AXLE. Any height, any width of tire desired. Our wheels are either direct or stagger spoked. Can FIT YOUR WAGON perfectly without change.

NO BREAKING DOWN.

No drying out. No resetting tires. Cheap because they endure. Send for catalogue and prices. Free upon request.

Electric Wheel Co.
Box 95 Quincy, Ills.



EASY SPRAYING

No sprayer made gives better service than the Century Barrel Sprayer. Submerged brass cylinder, brass ball valves, moving plunger packing; automatic agitator. For ease of operation, durability, free water way it is unequalled. Never scorches foliage. Send for catalogue of full line of pumps and sprayers.

THE DIMING CO., Salem, O.
Western Agents, Henion & Hubbell, Chicago

SEND NO MONEY—but order any of our Sewing Machines sent C. O. D., on 30 days' trial. If you don't find them superior to any other offered at the same or higher prices or are dissatisfied for any reason, return them at our expense and we refund your money and freight charges. For \$10.50 we can sell you a better machine than those advertised elsewhere at higher price, but we would rather sell you better Quality and Give Satisfaction. Our elegant Arlington Jewel drop head.

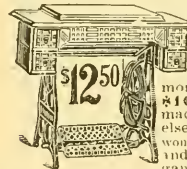

\$12.50. Our No. 9 Ball Bearing Arlington, 5 drawer, drop head, \$15.45. Write for large illustrated catalogue FREE. **CASH BUYERS' UNION, (Inc.)** 158-164 W. Van Buren St., B-345, Chicago

Big Cut in Prices
Big Cut in Prices

Direct to Consumers.
Our Handsome Catalog Free, costing over 42 each, contains 144 pages, with 1500 illustrations and 15,000 articles listed, on which we guarantee to save you from 10 to 75%. Most complete book of the kind. Send for 10c to pay cost of mailing, which will be refunded with first order. Valuable book of reference and ought to be in every household, for it is kept handy.
Heller Chemical Co., Dept. 49, Chicago.
"The Only Mail Order Drug House in the World."

SEED CORN

75c a Bu. and up.

Michigan Northern Crown is the earliest and produces largest crops. Hammond's Sixty Day Flint, American Pride Early Yellow Dent and Thoroughbred White Dent are the 3 famous varieties to-day. American Pride made 197 bu. shelled corn per acre. Fifteen other sorts. Catalog fully describing these wonderful crops and other seeds sent free on request.

HARRY N. HAMMOND SEED CO.,

Formerly of Fiftihs

Box 69, Bay City, Mich.

Union Combination Saw

For Ripping, Cross-cutting, Rabbeting, Mitering, Grooving, Gaining, Boring, Scroll-sawing, Edge-moulding, Beading. Full line FOOT and HAND POWER machinery. Send for catalog A. **SENECA FALLS MFG. CO.,** 44 Water St., Seneca Falls, N. Y.

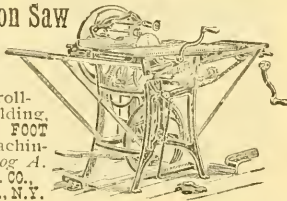

In writing advertisers please mention Gleanings.

YOU OUGHT TO KNOW



everything between the covers of our **20th CENTURY POULTRY BOOK** in order to best succeed in the poultry business. It tells everything necessary and no more. It's a compend of poultry knowledge. Among other things it fully describes

Reliable Incubators and Brooders, which are known and used all over the world. We mail the book for 10 cents as long as they last. Hurry your order in at once.
Reliable Incubator & Brooder Co., Box B-49 Quincy, Ills.



THERE IS NO INCUBATOR

which has been more successful than the SUCCESSFUL. You hear about them everywhere. The reason is that they do their work so well. Send 6c in stamps

for new 154 p. book, printed in 5 languages, describing our successful Incubators and Brooders. They deserve their name.
Des Moines Incubator Co., Box 503, Des Moines, Iowa.

DO YOU GET GOOD HATCHES?
Fertility and vitality depend upon the feeding ration. Feed cut green bone and get good hatches. Use the **HUMPHREY Green Bone and Vegetable ..CUTTER..**
—the open hopper kind. No fuss nor bother. Guaranteed to cut more bone with less labor than any other. Money back if dissatisfied. Send for book containing egg record and blanks for a whole year.
HUMPHREY & SONS, Box 51 JOLIET, ILL.

GREIDER'S POULTRY
always do well. 50 standard varieties. Handsome poultry book of the season for 8c stamps. Full of money-making hints. My birds are winners.
B. H. GREIDER, Florin, Pa.

S. C. BROWN LECHORNS.
I use well-striped breeding cocks. Eggs, \$1.00. Cockerels, \$1.00 and up. Also Italian breds. Circular free.
H. M. MOYER, Shanesville, Pa.

A BASKET FULL OF EGGS
by using Ley's Poultry Condition Powders. Puts all fowls in a normal condition; destroys all disease germs; purifies the blood; is a tonic and nutrient. Price 25 cts. a pk.; 5 for \$1.00. Ley's Thoroughbred Minorca's Eggs, \$1.00 for 13. Also Thoroughbred Belgian Hares. **Geo. J. Ley, Florence, Cal.**

POULTRY-BOOK FREE. 64 pages, illust'd, with 3 mos. trial subscription to our paper, 10 cts. Belgian hare book, 25 cts. **Inland Poultry Journal, Indianapolis, Ind.**

1200 FERRETS. All sizes; some trained; first-class stock. New price list free. **N. A. Knapp, Rochester, Lorain Co., Ohio.**

Belgian Hares
I have some fine hares for sale at reasonable prices.
J. F. Moore, Tiffin, Ohio.



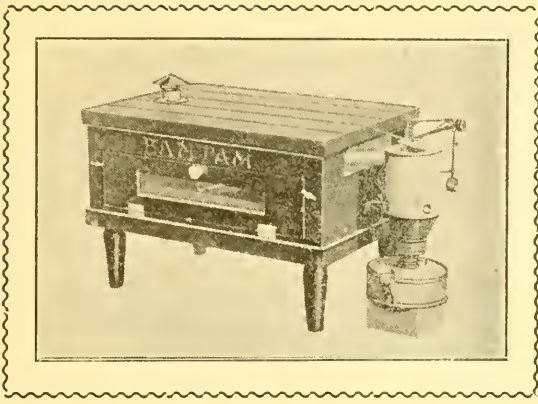

BIDDIES & BEES.
MAKE THEM BOTH PAY.

50-egg Bantam. Self-regulating.

Holds 50 ordinary - size eggs. No sitting up nights. 20 minutes' attention in twenty-four hours will operate it. Sold on

30 Days' Trial for \$5.00

Over 15 000 in use, and thousands hatching 50 chicks from 50 eggs. You can do as well. Either hot-water or hot-air heating. We have a brooder to go with it for \$3.00. Our catalog of valuable information, and describing incubators and brooders of all sizes and prices—all on trial—sent for the asking if you mention this paper.

Buckeye Incubator Co., Springfield, Ohio.

INVESTIGATE BEFORE YOU BUY.
We want our customers to be perfectly satisfied before they spend the money. Investigate the claims of all incubators and then decide. We believe you will find that the

SURE HATCH INCUBATORS
AND COMMON SENSE FOLDING BROODERS are giving better satisfaction than any other made. It's because they are so simple, sensible and sure. They are built for busy people, who haven't time to fuss and bother. Our catalogue is FREE. We don't ask you to pay for it. Isn't it worth examining?

SURE HATCH INCUBATOR COMPANY, CLAY CENTER, NEBRASKA.

We Pay the Freight.

You Can't Afford to Guess

at results in the poultry business. If you fail to raise the chicks, you simply have no business. The way to be absolutely sure about getting the chicks is to employ a Cyphers Incubator in your hatching. We guarantee them to last 10 years and to out hatch any incubator made. The best way to know about it is to read our 224 page (8x11 in.) book, "Profitable Poultry Keeping." Has 250 illustrations and covers the entire subject. We send it for 10 cents in stamps. Ask for book 74. Circulars mailed free. Address nearest office.

CYPHERS INCUBATOR CO. Chicago, Ill., Wayland, N. Y., Boston, Mass.

They Never Fail

You cannot afford to risk good eggs in a poor incubator or good chicks in a poor brooder. There is no need of doing it. The

MARILLA
Incubators and Brooders

never disappoint. They are made of such good material, in such a thorough manner, and have so perfect a system of regulating heat and moisture that they are absolutely certain in results. They are sold on a positive guarantee. Your money back if you want it. Send two cents for catalogue and learn why they are the leaders. Twelve years' success behind them.

Marilla Incubator Co. Box 62, Rose Hill, N. Y.

200-Egg Incubator for \$12.00

Perfect in construction and action. Hatches every fertile egg. Write for catalogue to-day.

GEO. H. STAHL, Quincy, Ill.

INCUBATOR ON TRIAL

The Perfected Von Culin.

Successful result of 25 years' experience. Scientifically correct, practically perfect. Non-explosive metal lamps. Double and packed walls. Perfect regulation of heat and ventilation. Made of best materials, and highest quality of workmanship and finish.

PRICES \$7.00 AND UP.

SATISFACTION GUARANTEED OR NO PAY. We make Brooders, Bee Hives & Supplies. Catalog and Price List sent Free.

THE W. T. FALCONER MFG. CO.,
Dept. 73. **Jamestown, N. Y.**

DOOLITTLE SAYS

"I think that I never read one number of any bee-paper from which I obtained so many precious things to think about, to store up for future experiments, as I did in the Bee-keepers' Review for January. Surely the Review begins the 20th century in grand style and practicality."

Gazelle, Cal., Feb. 12, 1901.

Friend Hutchinson:—Your article in the January Review, "How Coggshall Extracts," is worth more to me than several times the price of the paper for a year.

A. A. BROWN.

Remember, the Review is \$1.00 a year, but I send 12 back numbers (of my own choosing) free of charge. For \$2.00 I send the back numbers, the Review for 1901, and a queen of the Superior Stock.

W. Z. HUTCHINTON, Flint, Mich.

NOW READY!

64-PAGE CATALOG OF EVERY THING BEE-KEEPERS NEED. Illustrated and fully described. Especially valuable to beginners for the information it contains. Send your address on a postal card and get it now. Established 1884.

J. M. JENKINS, Wetumpka, Ala.

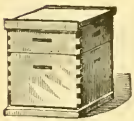

BEE-HIVES AND HONEY-BOXES,

in car lots—wholesale or retail. Now is the time to get prices. We are the people who manufacture strictly first-class goods and sell them at prices that defy competition. Write us today.

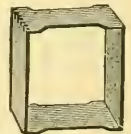

Interstate Box & Manufacturing Co., Hudson, Wis.

I. J. Stringham, 105 Park Place, New York City.

Keeps in stock a full line of modern appliances for bee-keepers.

COMB FOUNDATION

is one of our specialties. If you expect to use any quantity get our prices. Catalog free. Apiaries at Glen Cove, Long Island.

I. J. Stringham, 105 Park Place, New York City.

1881

PAGE & LYON MFG. CO.

1900

**We manufacture a full line of the latest
BEE-SUPPLIES.**

Our motto is, "Perfect Goods and Prompt Shipment."

Send for our new free illustrated catalog.

PAGE & LYON MFG. CO., New London, Wisconsin.

Marshfield Manufacturing Company.

Our specialty is making SECTIONS, and they are the best in the market. Wisconsin basswood is the right kind for them. We have a full line of BEE-SUPPLIES. Write for FREE illustrated catalog and price list.

Marshfield Manufacturing Company, Marshfield, Wisconsin.

QUEENS?

Improved Golden and Leather-colored Italians is what we rear - 13 years' experience enables us to furnish Superior Stock.

TESTIMONIAL.

Humboldt, Neb., Aug. 5th, 1900.

Mr H. G. Quirin. Dear Sir:—The colony containing the queen you sent me has already stored over 400 lbs. of honey (mostly comb) for this season, and will yet store quite a considerable before the season closes. It would take \$100 to buy this queen. I have another one from you which I think will turn out equally as well. Bees from your queens certainly do work on red clover. I can tell, as they are the only bees of their kind in my locality. Hereafter when I want more queens I shall know where to get them.

Yours truly, J. L. GANDY.

At present we have two very valuable breeders which will be used for the coming season. One is a breeder from Root's \$200.00 red clover queen. Large orders will be shipped from the South during April. We are now booking orders for April, May, and June delivery at the following prices:

**Warranted Stock, \$1.00 each; 6, \$5.00.
Tested Queens, \$1.50 each; 6, \$8.00.
Select Tested, \$2.00 each; 6, \$10.50.**

Why not let us book your order for one or half a dozen of these **Superior Queens?** We guarantee safe delivery. You take no risk. Remember queen-bees in our specialty in summer time. For a short time we will allow **20 per cent discount** on Folding Cartons, and printed stationery. Parkertown is a money-order office, so please do not send stamps if you can help it.

H. G. Quirin, Parkertown, Ohio.

Albino Queens. If you want the most prolific queens; if you want the gentlest bees; if you want the best honey-gatherers you ever saw, try my Albinos. Untested queens, \$1.00; tested, \$1.50.
J. D. GIVENS, Lisbon, Texas.

LONG-TONGUED QUEENS!

YARD NO. 1.

By special arrangements with THE A. I. ROOT CO. to furnish them queens, I have secured their assistance in procuring the finest breeding queens that a thorough knowledge of the bees of the country and money can procure. Among them is a *select daughter of their \$200 queen that they refuse to quote me prices on.* This queen shows every superior quality of her mother. Her bees show an actual reach of 21-100 of an inch; are large, gentle, and beautiful to look upon.

MR. E. R. ROOT SAYS: "You have as fine bees as there are in the United States; and with a direct cross of their breeders you should be able to produce queens whose bees show a reach of 25-100 of an inch."

Send for descriptive price list. Watch this space, and don't forget my long tongue stock is the best that money and knowledge can procure.

Prices: Untested queen, \$1.00; 6, \$5.00. Tested queen, \$1.50; 6, \$8.00. Fifty select breeders from long tongued strains, \$2.50 to \$5.00 each.

IMPORTED ITALIAN STOCK.

APIARY NO. 2.

Imported Queens, Daughters and Grand-daughters.

GOLDEN, OR 5-BANDED ITALIAN.

APIARY NO. 3.

Breeders, select tested, tested, and untested queens.

REMEMBER the bear picture goes as a premium on six queens. 1901 untested queens will be ready to mail March 25 to April 1st. Send in your order at once, and get in on the ground floor. Breeders, select tested, and tested queens go by return mail.

**W. O. VICTOR, WHARTON, TEXAS.
QUEEN SPECIALIST.**

FOR SALE.—150 colonies of bees, with fixtures, house with contents, two lots and five acres of land in incorporate limits; fine team, buggy, cutter, etc.; also Marlin rifle and shotgun.
ELIAS FOX, Hillsboro, Wis.

WE WANT

to sell you bee-supplies. Our line is all new and complete. Send for our illustrated catalog. It will convince you that our Dovetailed hive is the best on the market. Our prices are right and our service is prompt.

Fred W. Muth & Co.,

S-W. Cor. Front and Walnut Sts. Cincinnati, Ohio.

Dittmer's Foundation !!!

Retail---Wholesale---Jobbing.

I use a PROCESS that produces EVERY ESSENTIAL necessary to make it the BEST and most desirable in all respects. My PROCESS and AUTOMATIC MACHINES are my own inventions, which enable me to SELL FOUNDATION, and WORK WAX INTO FOUNDATION FOR CASH, at prices that are the lowest. Catalog giving

FULL LINE OF SUPPLIES

with prices and samples, free on application. BEESWAX WANTED.

GUS. DITTMER. AUGUSTA, WIS.

Get the Best Queens.

Evansville, Ind., Sept. 27th, 1900.

The Jennie Atchley Co., Beeville, Bee Co., Texas:

Dear Friends:—It gives me great pleasure to forward you this unsolicited testimonial regarding the merits of Atchley queens. The three (3) dozen queens purchased of you have made an excellent record for themselves. Not an Atchley queen among the twenty colonies lost during the severe drouth in July. I have bought queens from many breeders; and although the present crop is exceedingly short, the tiers of supers show where the Atchley queens are, and speak volumes for your method of queen-rearing. I find the progeny to be very gentle, strong winged, uniformly marked, long-lived, of large size, and last, but not least, the best honey-gatherers I ever had. I shall want 100 more next season.

Yours fraternally, J. C. WALLENMEYER.

Prices for Queens.

Tested, \$1.50 each; \$3.00 for 6, or \$15.00 per dozen. Untested, February, March, April and May, \$1.00 each; \$5.00 per 6, or \$9.00 per dozen. Fine breeders, \$5.00 each. We have as good bees and queens as money and labor produce. We breed three-band Italians, Golden, Carniolans, Cyprians, and Holy-Lands, in their purity, bred in separate yards 5 to 20 miles apart. If you want the best, call for Atchley's improved strains. Safe arrival guaranteed. Send for a sample copy of "The Southland Queen," the only southern bee-paper, \$1.00 per year. To new subscribers we offer as a premium a nice untested queen in order to get our paper introduced. Catalog, giving queen-rearing and management of apiaries for profit, FREE.

THE JENNIE ATCHLEY CO., Beeville, Bee Co., Texas.

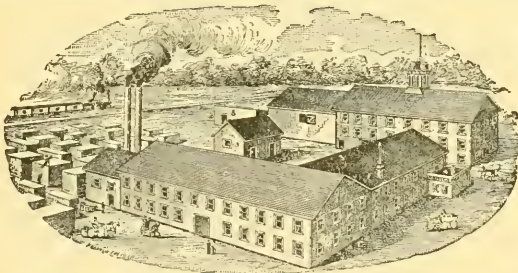

KRETCHMER M'FG CO., Red Oak, Iowa.

BEE-SUPPLIES.

Best-equipped factory in the West; carry a large stock and greatest variety of every thing needed in the apiary, assuring BEST goods at the LOWEST prices, and prompt shipment. We want every bee-keeper to have our FREE ILLUSTRATED CATALOG, and read description of Alternating Hives, Ferguson Supers, etc. Write at once for a catalog.

— AGENCIES: —

Trester Supply Co., 103 So. 11th St., Lincoln, Nebraska; C. C. Richards, 1223 17th St., Denver, Col.



BINGHAM SMOKER.

DEAR SIR:—Inclosed find \$1.75. Please send one brass Smoke-engine. I have one already. It is the best smoker I ever used. Truly yours, HENRY SCHMIDT, Hutto

MADE TO ORDER.

Bingham Brass Smokers

Made of sheet brass, which does not rust or burn out; should last a lifetime. You need one, but they cost 25 cts. more than tin of the same size. The little open cut shows our brass hinge put on the three larger sizes. No wonder Bingham's 4-inch smoke-engine goes without puffing, and does not drop inky drops. The perforated steel fire-grate has 381 holes to air the fuel and support the fire.

Heavy tin smoke-engine, 4-inch stove per mail, \$1.50; 3½-inch, \$1.10; 3-inch, \$1.00; 2½-inch, 90c; 2-inch, 65c. Bingham smokers are the originals, and have all the improvements, and have been the standard of excellence for 22 years. Only three larger ones brass.

T. F. Bingham, : : Farwell, Mich.

\$200 RED-CLOVER QUEEN.

OFFER NO. 35.

ON SEPTEMBER 1st last we announced that we finally had a red-clover queen fully equal to the one we had years ago. The colony of this queen has given one of the most remarkable showings on red clover of any bees we have ever had. The queen in question is an imported one, and therefore of the genuine pure leather-colored Italian stock. We sent out daughters from her all the season. But we did not discover her value until the clover season, second growth, came on, and then her colony so out-distanced all the other 450 that she attracted attention at once.

It must be understood that these queens are not golden yellow, neither are their bees of the five-banded stock. They are simply leather-colored Italians, whose mother came direct from Italy.

Since the notice appeared regarding this queen we have hardly been able to supply all of the queens that were wanted from this stock. Many daughters of this queen we sent out before we knew her value, and it now transpires that some of the finest bees in the land are from queens we sent out early. We are now booking orders for the coming season, and make the following offer, but no queens will be furnished except those who subscribe for Gleanings, and only one with each year's subscription. All arrearages must be paid to the end of last year. Gleanings for 1901 and one untested red-clover queen, \$2.00; Gleanings one year and a tested red-clover queen, \$4.00; a select tested red-clover queen and Gleanings one year for \$6.00. We will begin mailing these queens in June, 1901. Orders are already being entered, and the same will be filled in rotation. Do not neglect to improve this opportunity and get some choice stock, and send your order early so you may get the queen correspondingly early in the season. We are using every precaution to winter this queen safely, but reserve the right in case of her loss this winter to substitute from other select tested stock of this strain which we are holding in reserve, or to give the subscriber the benefit of any of our other clubbing offers if desired.

We can not enter orders for queens until remittance is received, unless you have a credit on our books, or you send references. To do otherwise would be an injustice to those who are sending cash with order.

The A. I. Root Company, Medina, Ohio.

Wants and Exchange.

Notices will be inserted under this head at 10c per line. You must say you want your ad. in this department, or we will not be responsible for any error. You can have the notice as many lines as you please; but all over ten lines will cost you according to our regular rates. We cannot be responsible for dissatisfaction arising from these "swaps."

WANTED.—Two or three apiaries for cash; located in Colorado; write full particulars; first letters and lowest cash price; comb honey preferred.
THOS. C. STANLEY & SON, Fairfield, Ill.

WANTED.—To exchange bicycles and tandems, gasoline-engines (new and 2d hand, 1 to 20 horsepower) for wood and metal working machinery of all kinds.
ROBERT B. GEDYE, LaSalle, Ill.

WANTED.—Boy about 17 or 18 years of age, to work in garden, one who can drive horses; state wages expected.
D. SPIERS, Oglesby, La Salle Co., Ill.

WANTED.—A renter for 60 colonies of bees, or will sell the whole to some good man. I can not attend to them as they should be. I have a neighbor who has 40 colonies who also wants to let out on shares. He is only three miles from me. Single man preferred.
R. J. MATHEWS, Rosedale, Miss.

WANTED.—To exchange for beeswax or 4 3/4 sections, pedigreed Belgian hares. Breeding age and good color. Will exchange at a low price until April 1st.
RALPH B. DALY,
Lockport, Niagara Co., New York.

WANTED.—To exchange 12,000 berry-boxes, low-Hallock wine-measure quart, in flat, good condition, for Cowan reversible extractor, any size, or good incubator. J. D. BIXBY, Grooms, Sar. Co., N. Y.

WANTED.—To exchange two No. 5 Novice honey-extractors, good as new, for bees in any kind of hives or shipping-boxes, with or without brood-combs. Make offer.
E. W. BROWN,
Box 102, Morton Park, Cook Co., Ill.

WANTED.—To exchange a Marlin repeater rifle and reloading tools for bees or offers. Send 2c stamp for terms.
ROBT. J. CARY, Norwalk, Conn.

WANTED.—To exchange a farm of 58 acres — good buildings, fruit, and water, level, no waste land — for bees and location. Florida preferred.
J. O. MUNSON, E Lansing, N. Y.

WANTED.—To exchange a Blickensderfer typewriter, in No. 1 condition, for bees.
GEO. SHIBER, Franklinville, N. Y.

WANTED.—From 25 to 50 3-frame nuclei of Italian bees with warranted or tested queens on L. frames. Must be delivered in May or first of June. Also want to buy 100 or 200 colonies in box or any style of cheap hives. Also want to exchange a 12-in. Vandevort foundation mill for cash or white or buff Wyandott eggs.
GARFIELD BOOMHOWER, Gallupville, N. Y.

WANTED.—Large apiary in good basswood location in Wisconsin. Also a man to take permanent charge of same on shares with a guaranteed income.
H. W. FUNK, Normal, Ill.

WANTED.—A handy, trustworthy young man to assist in apiary work and learn improved methods. Tact rather than experience required. Address with recommendations.
ARKANSAS VALLEY APIARIES, Las Animas, Col.

WANTED.—To exchange the best low-priced typewriter on the market; good as new, used only two months.
H. LATHROP,
Agent U. S. Ex. Co., Brownstown, Wis.

WANTED.—To exchange one saw-mandrel and two saws — one rip and one cutoff — all new; also small fruit-plant, for quart berry-baskets or any thing I can use in the photographing business. Write for particulars, stating what you have.
P. D. MILLER, Grapeville, Pa.

WANTED.—To exchange fine old violin for guitar or bicycle.
A. P. WILKEY, Dixon, Ky.

WANTED.—To exchange 7-light acetylene machine (\$35.00) for 3 frame nucleus, Cowan extractor, and hives in flat. Give particulars to
DR. BALL, Essex, Conn.

WANTED.—To exchange 20 new 8-frame Dov. hives (never used) with Hoffman frames, for chickens or any kind of bees.
F. L. REHN, Collingdale, Delaware, Co., Pa.

WANTED.—A location for a custom saw and feed mill. Address
WM. S. AMMON, 216 Court St. Reading, Pa.

WANTED.—Who wants my 30 years' experience in 7 months, at \$18.00 a month and board, to work at bees, and work on farm when there is no work at bees. Must have some experience with bees, and temperate. For willing and competent man I will endeavor to secure a winter job in Cuba. Write experience to
W. L. COGGSHALL,
West Grotton, Tompkins Co., N. Y.

WANTED.—Trio Black Minorcas, cockerel and pullets. State price.
J. B. ENOS, M. D., Charleroi, Pa. Lock Box 4.

Angora Goats. Handsome pets; profitable stock. Large new circular for
EDW. W. COLE & CO., Kenton, Ohio.

WANTED.—To sell my entire and complete apiary, consisting of bees, hives, foundation, sections, shipping-cases etc (Root's goods). Every thing new and in Al condition. A big bargain will be offered, as I must sell. Write for particulars.
E. B. FOSTER, 506 W. Warren St., Bucyrus, O.

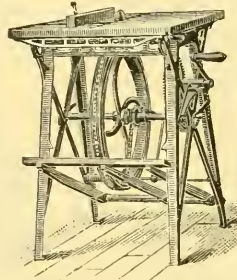

Barnes' Hand and Foot Power Machinery.

This cut represents our combined circular saw, which is made for beekeepers' use in the construction of their hives, sections, boxes, etc. **Machines on trial.** Send for illustrated catalogue and prices.

W. F. & John Barnes Co.,
545 Ruby St.,
Rockford, - - Ill.

The Modern Farmer and Busy Bee.

Emerson Taylor Abbott, Editor.

A live, up to-date Farm Journal with a General Farm Department, Dairy, Horticulture, Live-stock, Poultry, Bees, Home and General News. The Editor has had practical experience in every department of farm work. To introduce the paper, it will be sent to New subscribers one year for 25c. Sample copies free. Best Advertising Medium in the Central West. Clubbed with *Gleanings* for \$1 00.

ADDRESS

Modern Farmer, St. Joseph, Mo

Black and Hybrid Queens for Sale.

We have about 90 young black and hybrid queens for sale at 40c each, or six for \$2.00. *Safe delivery insured.* Orders filled at once.

SWINSON & BOARDMAN, Macou, Ga.

Contents of this Number.

Apiaries on Roofs.....275
 Average, A Large.....294
 Bees and Fruit in Farm Papers.....295
 Bees Dying of Old Age.....292
 Bees, Long-tongued, Why Wanted.....286
 Clover and Tong-tongued Bees.....295
 Comb, Black, How to Render.....296
 Combs, Melting up Old.....276
 Cook's Review of A B C Book.....297
 Crop of Honey, Increasing.....289
 Cuban Bee-keeping.....283
 Cyprians, Doolittle on.....275
 Extractor, Cart-wheel.....288
 Florida Matter, by Editor.....299
 Foul-brood Law, California.....296
 Frames, Wiring.....287
 Gemmill Hatch Machine.....290
 Gifford, Shooting of.....281
 Hicks and the Weather.....302
 Honey as Freight in Canada.....274
 Honey, Chunk, in the South.....284
 Honey-houses, Portable.....287
 Mo'd on Hives in Winter.....292
 National Bee-keepers' Association, Fowls on.....200
 Pecan Industry.....302
 Presses, Wax, German.....281
 Queens, Caging.....294
 Queen-rearing, Streunous.....291
 Rambler at Fray's.....287
 Rambler, Poem on.....275
 Smoker, Passage's Double-blast.....293
 Spraying During Bloom.....281
 Stand for Painting Hives.....288
 Symposium on Melting Combs.....276
 Tongues, Possible Disappointments.....295
 Wander-wagon.....288
 Wax-extractor, Fray's.....276
 Wax-press, Hatch-Gemmill.....278
 Yazoo Region.....275

Honey Column.

GRADING-RULES.

FANCY.—All sections to be well filled, combs straight, firmly attached to all four sides, the combs unsoiled by travel stain, or otherwise; all the cells sealed except an occasional cell, the outside surface of the wood well scraped of propolis.
 No. 1.—All sections well filled except the row of cells next to the wood; combs straight; one-eighth part of comb surface soiled, or the entire surface slightly soiled; the outside surface of the wood well scraped of propolis.
 No. 2.—All sections well filled except the row of cells next to the wood; combs comparatively even; one-eighth part of comb surface soiled, or the entire surface slightly soiled.
 No. 3.—Three-fourths of the total surface must be filled and sealed.
 No. 4.—Must weigh at least half as much as a full-weight section.
 In addition to this the honey is to be classified according to color, using the terms white, amber, and dark; that is, there will be "Fancy White," "No. 1 Dark," etc.

CITY MARKETS.

BOSTON.—We quote our market as follows: Fancy No. 1 white in cartons 17; A No. 1, 16; No. 1, 15@16, with a fairly good demand. Absolutely no call for dark honey this year. Extracted, white, 8@8½; light amber, 7½@8. Demand is good, with light stocks. Beeswax, 27. BLAKE, SCOTT & LEE, Mar. 12. 31, 33 Commercial St., Boston, Mass.

MILWAUKEE.—This market on honey is almost inactive because the stock here offered for sale is generally of such a quality that our trade will not buy. The white section or fancy grade of comb is wanted, and any shippers of this grade will get good values on such now, and we can quote fancy 1-lb. sections 17@18; A No. 1, 16@17. The lower grades are entirely nominal. Extracted white, in barrels, kegs, or cans, 8@10; dark, in same, 7½@8. Beeswax, 28. A. V. BISHOP & Co., Mar. 19. Milwaukee, Wis.

CINCINNATI.—The demand for comb honey is nearly over. The stock also well cleaned up. Fancy white brings 16c. Extracted is in fair demand; dark sells for 5½; better grades bring 6 to 7½; fancy white clover from 8½ to 9. C. H. W. WEBER, Mar. 19. 2146-8 Central Ave., Cincinnati, Ohio.

NEW YORK.—Comb honey is pretty well cleaned up. There are a few odds and ends lying about, but are not desirable goods. The demand is about over; however, there could be some nice lots placed if they could be had. We quote fancy, 15@16; No. 1, 13@14; No. 2, 11@12; fancy buckwheat, 10@11; No. 1, 9@10; No. 2, 8@9. Extracted honey has been moving freely. The buckwheat extracted market is about over, with a little stock on hand. Prices: New York State white, 7@8; light amber 7@7½; amber and buckwheat, 5@5½. Beeswax steady, 27@28. CHAS. ISRAEL & BROS., Mar. 21. 486 8 Canal St., New York City.

PHILADELPHIA.—We find quite a lot of comb honey being held back that is now pushed on the market, and the demand is growing less every day. New extracted honey will soon arrive from the South with good prospects. No fancy comb honey in this market. We quote No. 1 white, 14@15; amber, 12@13; buckwheat, 11. Extracted, 8. We are producers of honey—do not handle on commission. WM. A. SELSER, Mar. 20. 10 Vine St., Philadelphia, Pa.

NEW YORK.—Our market is virtually bare of comb honey, and there is a fair demand for all grades. Fancy white is still selling readily at from 15@16; No. 1 white, 13@14; amber, 12@13; buckwheat, 10@11, according to quality and style of package. We certainly would advise bee-keepers, who have any comb honey to dispose of, to send it to market now. As to extracted, the market is quiet and inactive, and a certain amount will have to be carried over again. Prices are declining somewhat, and if the honey is not moved in large lots concessions will have to be made. We quote California white, 7@7½; light amber, 6½@7; other grades and Southern, 6@6½ per gallon. Beeswax very firm at 28@28½ and for exceptionally fine yellow, 29. HILDRETH & SEGLKEN, Mar. 19. 120, 122 West Broadway, New York.

CHICAGO.—The choice grades of white comb honey sells at 16c, with supply about equal to demand. All other grades are slow of sale at the following range of prices: Fair grades of white, 14@15; best ambers, 12@13; mixed colors, 10@11; buckwheat, 9@10. Extracted white ranges from 7@8; amber, 6½@7½; buckwheat, 5½@6½. All of the extracted is governed by quality and flavor in the range of prices. The lowest figure in either of the colors applies to the sour or off flavored and unripened. Beeswax, 30c. R. A. BURNETT & Co., Mar. 19. 163 South Water St., Chicago, Ill.

NEW YORK.—There is but a very small stock of all grades of comb honey in this market. We quote as follows: Fancy white, 15; No. 1, 14; No. 2, 12@13; mixed, 10@11; buckwheat, 10. Buckwheat extracted, 5½@5½. Beeswax, firm, 27@28. FRANCIS H. LEGGETT & Co., Franklin, West Broadway, and Varick Sts., Mar. 19. New York City.

DETROIT.—Fancy white comb, 14@15; No. 1, 13@14; dark and amber, 10@12. Extracted white, 6½@7; dark and amber, 5@6. Beeswax, 27@28. M. H. HUNT & SON, Bell Branch, Mich. Mar. 21.

SAN FRANCISCO.—Fancy comb, white, 14; A No. 1, 13; No. 1, light amber, 12½; No. 2, 11; No. 3, 10. Mar. 11. GUGGENHIME & Co.

DENVER.—Market practically cleaned up of comb honey. Extracted slow; amber, 6½@7; white, 7@8. Beeswax, 22@26.

THE COLORADO HONEY PRODUCERS' ASS'N. Mar. 21. 1440 Market St.

FOR SALE.—20,000 lbs. extracted honey from alfalfa and light amber from Rocky Mountain bee-plant. Two cans, 120 lbs. net, \$8.40; also 5 and 10 lb. pails. In ordering state if you want white or amber. M. P. RHOADS, Las Animas, Col.

WANTED.—Comb and extracted honey. State price, kind, and quantity. R. A. BURNETT & Co., 163 South Water St., Chicago, Ill.

FOR SALE.—Choice alfalfa honey. Two cans, 120 lbs. net, whitest, \$9.00; tinted, partly from other bloom, \$8.40. Also small cans.

THE ARKANSAS VALLEY APIARIES, OLIVER FOSTER, Prop., Las Animas, Bent Co., Colo.

Notice!



THE A. I. ROOT CO.

wish to announce that they have from their branch at 10 Vine St., Philadelphia, Pa., direct steamboat connections and very low rates of freight to the following States: Massachusetts, Rhode Island, Connecticut, New Jersey, Delaware, North Carolina, South Carolina, Georgia, Florida. As this is a branch of the factory, prices are the same. Full colonies of Italian Bees. \$6.00. Special discount in large quantities.

G. B. Lewis Company,

Watertown, Wis., U. S. A.

FIVE ✨ DIFFERENT ✨ STYLES ✨ OF ✨ BEE-HIVES.

We will furnish you
with the finest bee-
keepers' supplies in
the World.



Send us your Orders
and we will fill 'em
promptly. Send for
Catalog.

LEWIS' • WHITE • POLISHED • SECTIONS • ARE • PERFECT.

BRANCH: G. B. Lewis Company, 19 South Alabama Street, Indianapolis, Indiana.
AGENCIES: I. C. Woodman, Grand Rapids, Michigan; Fred W. Muth & Co., Southwest Cor. Walnut & Front Sts., Cincinnati, Ohio; Fred Foulger & Sons, Ogden, Utah; Colorado Honey-producers' Association, Denver, Col.; Grand Junction Fruit-growers' Association, Grand Junction, Colorado; Robert Halley, Montrose, Colorado; Pierce Seed and Produce Company, Pueblo, Colorado; E. T. Abbott, St. Joseph, Missouri, Special Southwestern Agent.

BEE-SUPPLIES!

ROOT'S GOODS
AT
ROOT'S PRICES

C. H. W. Weber, Cincinnati, Ohio.
2146-2148 Central Ave.

A NEW and complete stock for 1901 now on hand. I am The Root Company's representative for Cincinnati and surrounding territories. . . . You save TIME and FREIGHT CHARGES by having goods shipped from here. Convenience of railroad facilities here enables me to do so. Before buying elsewhere, write for my prices and catalog, which will be mailed you free of charge.

GLEANINGS IN BEE CULTURE

A JOURNAL DEVOTED
TO BEES AND HONEY
AND HOME INTERESTS.

ILLUSTRATED
SEMI-MONTHLY

Published by THE A. I. ROOT CO.
\$1.00 PER YEAR © MEDINA, OHIO.

VOL. XXIX.

APRIL 1, 1901.

No. 7.



IF S. T. PETTIT wants to reform the thick top-bar, let him commence nearer home and straighten out J. B. Hall, the chap that began it.

MARCH 6 it was 3° above zero. To-day, the 18th, it is 65 above; and as I am writing this, Philo and Fred are taking the bees out of the cellar.

NOVICES should understand that the bees spoken of at bottom of p. 240 as working on red clover are bumble-bees. [Yes, yes, yes; this was a piece of careless proof-reading on my part. The word *bumble* should have been inserted before the word *bees*.—ED.]

I WOULD SAY to Beginner, page 240, don't trust entrance-guards or clipped wings to prevent swarms going to the woods. Either one will prevent the queen going away, but she will surely be killed a few days later. [You are correct, according to my experience.—ED.]

ALFALFA, buckwheat, and alsike are given as the principal plants for honey in addition to their other value for planting. Ought not sweet clover to be added in localities where its value as a forage-plant is known? And are not those localities constantly on the increase?

SOME WILL LIKE Poole's entrance-contractor, p. 238, and some will prefer the simpler plan of Langstroth—two triangular blocks, with three unequal sides. By placing these in different positions, and by taking them away all together, the entrance can be made of eight different dimensions.

GRAVENHORST'S *Bienenzeitung* gives a picture of Alberti's wander-wagon for migratory bee-keeping. It is really a house-apiary on wheels; contains 50 colonies, and costs \$150. When the harvest is better elsewhere than where you are, close the entrances at night, hitch on two stout horses, move to the better place, open the entrances, and the bees are ready for work in the morning. Extractor,

etc., are inside the wagon, and the bees remain the year round. [Dr. Miller sent us a print which we have had re-engraved. It is reproduced on page 288.—ED.]

THE QUESTION has been raised as to who first gave to the public grafting or inoculating larvæ in queen-cells. F. Goeken speaks in *Centralblatt* of what I suppose is the same thing (*das Umlarven* or *Larvieren der Bienenstoecke*), and says it was given in 1866 by Mehren, the inventor of comb foundation.

HONEY MAY BE thick and of fine flavor when extracted, so that it will not become thin or sour afterward; but it may nevertheless become flavorless, because extracted too soon—not retaining its flavor like that left longer on the hives. So says F. L. Thompson in *Progressive*; and if he is correct the matter is well worth considering.

THE QUESTION is asked, p. 240, "If I should give my honey a good sulphuring on taking it from the hives, would I have to sulphur it again?" If you have Italian blood it will hardly be necessary to sulphur it then or later. In any case, sulphuring on first taking off will do little or no good; but if moth's eggs are there it will need sulphuring later. Sulphur will not kill the eggs, but bisulphide of carbon may.

I BELIEVE I was among the first to urge measuring tongues in the English tongue (I think the French began it), but J. O. Grimsley is right in thinking that we must not go so wild as to consider tongue length alone. Some long-tongued bees may be lazy or short-lived. The question is not how deep a bee can dive, so much as how much does it actually store? [See editorial elsewhere on this subject.—ED.]

IF THE YOUNG PEOPLE who read GLEANINGS will read "bottom-bar" for "top-bar," p. 228, second column, second line, it may save them from thinking that something is wrong with their understanding. [Yes, indeed. I had the correction marked in the proof, but it did not get into type until quite a number of impressions had been run off. Fortunately, most of the journals went out with the correct reading.—ED.]

"SOME WHO ARE very fond of candied extracted honey care very little about comb honey. Personally, I much prefer it in this form to comb honey."—*C. Davenport in Amer. Bee Journal*. "Now, how can a man talk that way?" will probably be the mental comment of many a one who reads that. But facts are stubborn things. I have a niece who will not eat comb honey, but is very fond of candied extracted, and it is possible there may be so many cases of this kind not suspected, that it would make quite a market for candied honey.

THE GRAND TRUNK RAILWAY, says the *Canadian Bee Journal*, has issued notice that hereafter comb honey will not be accepted as freight because too fragile. Considering that its fragility is put to a severer test by express than by freight, that decision is a little rough on the Grand Trunk bee-keepers. [The Ontario Bee-keepers' Association had better get after the Grand Trunk Railway. No such move has been contemplated on this side of the line; and the right kind of pressure, if brought to bear from three or four of Canada's best bee-keepers, would result in getting the ruling rescinded, I believe.—ED.]

YOU ARE RIGHT, Mr. Editor, that there are places where Thos. Slack's plan of selling, p. 222, would not work. There is this to be said about it, however, that where there is any thing like an equal chance between his plan and the small-package plan, the Slack plan should have the preference as being *best for the buyer*. Small packages, glassed sections, and all that sort of thing, have their places, but we should especially favor what will give the public the most honey for its money without making the producer lose by it. [I say amen to this; and that is why I am in favor of selling sections by the piece when they are properly graded. See answer to Straw elsewhere.—ED.]

WHILE WORKING on the problem of getting thin foundation to work in brood-frames, as mentioned in footnote, p. 225, it might be well to consider the possibility of imbedding wooden splints. I have an idea that a very small splint would answer. Of course, it must be first saturated with wax. [It may be that the wooden-splint idea would be the best solution of the problem—no, it can not be, if the manufacturer can only put very fine wire into the foundation at the factory. Wires can be imbedded by electricity at a rate that is a thousand times faster than the using of splints; but I am willing to concede that splints may be more practicable under present conditions when the foundation is not wired as it leaves the mill.—ED.]

PROF. COOK has written in the *American Bee Journal* some criticisms on Root's A B C which show plainly that he has not had in hand the latest edition. Some will say this is unfair. I say so too; but the unfairness is on the part of the publishers of the A B C. How can Prof. Cook be expected to get into print a comment on the very latest edition if the publishers persist in getting out a new edition every Saturday afternoon? [Serious-

ly, the A B C might now almost be called an annual. The last edition followed the previous one by about 15 months; and the edition now just out may all be disposed of in a year and a half, notwithstanding there were 8000 copies in this edition, of which 3000 have already been sold.—ED.]

DISCUSSIONS in *Canadian Bee Journal* show a difference of opinion as to getting bees out of cellar early. Some say the saving of honey in the cellar is more than balanced by the earlier brood of those taken out early, those taken out very early outstripping those taken out later. Others say that those taken out early make a spurt at the start, but later on fall behind. Wish that we could know something for sure, and know that we knew it for sure. [Ever since I attended the convention of the Ontario Bee-keepers' Association at Niagara Falls this question has been playing in my mind. Two or three at that convention urged that it was important to get the bees out early, and no one seemed to dissent from the proposition. I am going to keep our bees in the cellar very late just to see what the effect will be.—ED.]

I STUDIED over that footnote on page 219 for some time, and then I said, "I've always thought of its needing a week or so to let bees have extracting-supers before changing for sections; but Ernest says it needs only a day or two. He also says it beats baits for pure Italians that are stubborn about going into supers with baits. If what he says is true, I've got to capitulate." After a minute I added, "But our bees are never stubborn about going into baits." My wife replied, "May be you don't watch 'em down close enough." I gave her one of my crushing looks as I said, "What does a woman know about bees?" [Next summer, doctor, you try some extracting-supers. Leave them on only a day or two at most, or until the bees get up into them. Then take them off and clap on the comb-honey supers without the baits. I can not remember exactly, but I think I have used one extracting-super as a puller on half a dozen different colonies, and it was not full then. This was an extreme case, but I desired to see what could be done when one wished to pull bees upward, without running too much for extracted.—ED.]

SPEAKING OF the variation in sections, p. 218, Mr. Editor, your first question is right to the point, "Why place so much stress on sections holding a pound?" the answer being that there is no section always holding a pound; but your second question, "Why not sell by the piece?" is off, the answer being that it would not be entirely fair to sell at the same price sections that vary so greatly in weight. [But you will not forget, doctor, that those who advocate selling by the piece recommend and practice very careful grading, both as to filling and weight. Mr. Niver, who always sells by the piece, so grades his sections that they will vary scarcely an ounce at the outside; and think of the time saved, and the convenience to the grocer, and yet no one is robbed. It is the general practice with the

average grocer, when a certain article figures to a half-cent, to give himself the benefit of that amount. If he makes a mistake, as some of them do, he is liable to cheat his customer out of two or three cents. Selling by the piece when sections are carefully graded will, I believe, give the average customer more honest value for his money than selling by the weight.—ED.]

A FEW YEARS AGO I asked in GLEANINGS whether there was any objection to having bottom-bars as wide as top-bars, as I hesitated about using them. No one raised any objection, but now that I have in nearly all my hives bottom-bars $1\frac{1}{2}$ wide, S. T. Pettit and ye editor say they're all wrong. Well, I think I've tried them long enough to know how they work in this locality. To Bro. Pettit, I say that his objection that they choke with dead bees is valid, although I don't know that I've suffered from that cause; but I don't think I ever hurt a bee or a queen by lifting or replacing a frame. To ye editor I say that, with $1\frac{1}{2}$ bottom-bars, I can show combs beautifully built down to the bottom—he may remember that he saw them—and with $\frac{3}{4}$ bottom-bars they are not so good. But I took a different plan with the wide bottom-bars. [Yes, I remember your showing me those wide bottom-bars; and I remember, too, that you succeeded in getting your combs clear down to them by the use of splints; but in the item on this point in our last issue I was thinking of the average bee-keeper, a class to whom the manufacturer has to cater rather than to the special ones who will take time to work out all these various little problems.—ED.]

RAMBLER.

BY ARTHUR C. MILLER.

There dwells a Rambler, lank and long,
Beside the raging sea;
He roams and sings from morn till night—
No bee more blithe than he,
And this the burden of his song
Forever seems to be:
"I ramble here and ramble there,
And tell of what I see."

"Thou'rt welcome, friend," cries Innocence;
"Come in and feast with me;
We'll chat of bees and traps and things
That full of wonder be."
He talks and talks, and shows his traps
Which Rambler likes to see,
But sees with eyes brimful of mirth
Rich fun there's sure to be.

The Rambler smiles and passes on
With songs across the lea,
"I love my wheel, I love this life,
I love the busy bee;
I love, 'bove all, confiding man
Who, while I take my tea,
Tells me of things he wots not of,
That's copy unto me."

We love him 'spite his ancient clothes,
With trousers bagged at knee,
And camera and umbrella too,
And eyes so full of glee.
Long may he ramble 'mongst us all,
And flirt with busy bee;
But let Dame Nature quite alone,
For fickle jade is she.

Providence, March 5, 1901.



Don't kill the pretty bumble-bees
That hum around the barn;
They'll bring the price of clover down,
But ne'er a person harm.

AMERICAN BEE JOURNAL.

In speaking of the Cyprian bees, the *Twentieth Century Farmer* says:

The next breed of bees imported came from the island of Cyprus. They are called Cyprians, a name not always used for bees. The Cyprians hold the world's record for the amount of honey gathered by one colony in a single season. Mr. Doolittle, of New York State, a well-known apiarist, took 1000 pounds of extracted honey from one colony of Cyprian bees one year. They have one serious fault—they are very nervous, and will defend their stores of honey to the death. They can not be subdued by smoke. When aroused the only way to conquer them is with a mild dose of chloroform. On account of their disposition they have not become popular.

Mr. Doolittle says, concerning this:

The above reminds me of the man who puked up three black crows, of ancient time, while the truth was that "he threw up something as black as a crow, and told his neighbor so."

My greatest yield of extracted honey from a single colony of bees was in 1877, when one colony gave me the large yield of 566 pounds, besides producing enough to winter on—or about 35 pounds more. So that the total gathered by this colony was not far from 600 pounds, all told—that is, above what they consumed while gathering, or during the summer months. But this was before any Cyprian bees were imported into this country, the bees doing the gathering of this 600 pounds being those best of all bees, *all things considered*—the Italians.

Does that "Twentieth Century" bear the ear-marks of A. D. or B. C.?

Roof apiaries are coming on top—naturally. Mr. York gives a fine view of one in Chicago, belonging to G. E. Purple. The latter says:

The roof as a place to keep bees has its advantages as well as disadvantages. Things in its favor are that the bees are up out of the way, and there is no fear of their disturbing anyone (I have never heard any complaints against mine). The roof being nearly level, and covered with clean gravel, there is nothing to hinder the bees, and when they swarm it is easy to find the queen. (I clip all my queens.)

In 1899 Mr. Purple secured about 3200 lbs. of extracted honey in this way, probably all taken from the little dooryards of that great city.

Some time ago the Yazoo region in Mississippi had a boom for bee-keepers. Mr. Daniel Wurth says of it:

The Yazoo Valley, in Mississippi, is a very unhealthy part of the country. I was sick there all summer with chills. It is also a very poor honey locality, as it rains too much. My advice to bee-keepers is to stay away from there. The great bee-keeper who was the cause of my moving there has rendered his 250 colonies into wax. About once in six or seven years they have a good honey-flow from the willows along the Mississippi River, and there are only a few places where that is plentiful.

Our Symposium on the Melting-up of Old Combs.

The Various Methods and Devices Carefully Considered.

THE FERRIS COMBINATION WAX-EXTRACTOR.

BY C. G. FERRIS.

Our first illustration, Fig. 1, shows six cords of combs cut from the frames, and photographed to show the result of what is known as black brood, pickled brood, or foul brood becoming mixed in among the lot. These combs have been accumulating for the past 25 years, and have been used in producing extracted honey exclusively.

To eradicate the disease and transform this huge pile of combs into choice wax as shown in Fig. 7, I call your attention to my large three-basket steam wax-extractor as shown in Fig. 2. This machine is made to take one or more long narrow baskets—see Fig. 4—on the same general principle as frames that we use in our hives. By being made in this manner the frames of comb can be put directly into the basket in clusters or handfuls of six each without breaking or otherwise changing them. Another advantage in being made in this way is, the live steam has a better chance to penetrate than if made to hold eight or ten combs. A basket holding four frames of comb on this principle would be rendered quicker than the one holding six or eight, and the advantage would be with the lighter bas-

ket, taking into consideration the handling. The first basket in Fig. 2 has been cut away to show the follower and press in actual position. After using until the refuse becomes objectionable, or after we have put into the baskets

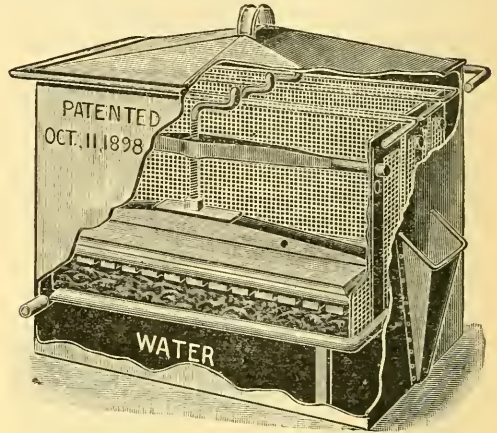

FIG. 2.—THREE-BASKET EXTRACTOR.

about sixty combs of ordinary size, put on the follower as shown in No. 3, at 14; adjust the screw and holder, at 11, and give the pressure desired. On a test of 64 combs that were badly worm-eaten, and heavy with pollen, I secured the following results:

Carefully steamed out 9 lbs. of wax. Pressure applied, and pressed out 8 lbs. 14 oz.



FIG. 1.—SIX CORDS OF COMBS RENDERED IN FOUR DAYS. WAX SHOWN IN FIG. 7.

Any one can do the same under the same conditions. Follower, screw, and bar can easily be removed, and are removed when combs are

and, when full pressure is applied, forcing the honey rapidly out without any discoloration whatever.

Section Fig. 3 shows the machine cut through the center, apparently. Fig. 2 shows the extension handles for handling the tank. In Fig. 3, steam and odor escape to the stove at 6 and 7; water is supplied to the extractor at 8 and 9; drip pan is at 5; 13, refuse; 14, follower; 11, iron bar and screw; 12, basket; 15, release of bar from baskets.

The baskets are made in a most substantial way of extra heavy galvanized wire cloth, all in one piece, united and soldered at the ends to galvanized band iron. All are interchangeable and self-spacing—as much so as our frames. AA shows the holes in one end for receiving press; see Fig. 4.

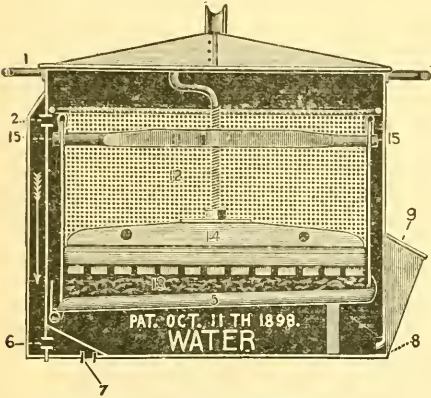

FIG. 3.—LONGITUDINAL.

being rendered. Two motions place ready for use, and the same removes it from position when not needed.

Four baskets should be used with this machine. While one or more are taken to be cleaned, the extra one takes its place, so the

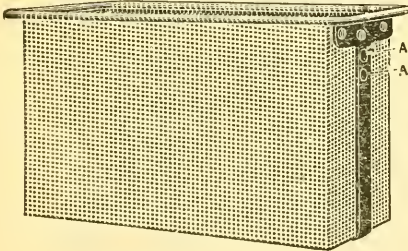

FIG. 4.—BASKET.

rendering can be carried on indefinitely. It can also be used to great advantage in pressing the honey from uncappings. As they accumulate they are to be put into the baskets,

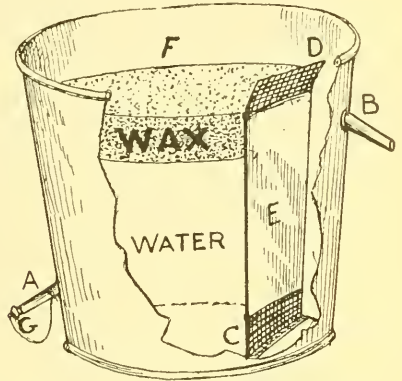

FIG. 8.—G. C. FERRIS WAX-BUCKET.

The wax cakes, after coming from the extractor, are of all sizes and all shapes, due largely, of course, to the abundance of water used in rendering. The wax at this stage somewhat resembles dark maple sugar, having a coarse granular appearance. We now scrape all sediment from the bottom of the cakes, and clean the tin buckets by placing them in the oven of the stove long enough to get them piping hot, when, with a clean piece of burlap, they are wiped clean easily. This is important, as the wax will not be clean should the buckets be dirty.

By a very simple contrivance as shown in Fig. 6, and illustrated more fully in Fig. 8, we take these irregular, off-colored cakes referred to, and, after cleaning out the baskets and extractor, we again prepare as for rendering wax. We place the wax-refiner as shown in Fig. 6, at 1, and bucket, so the wax flows through 1 to 2.

When 2 is full it should be taken away and another put in its place. Wax in

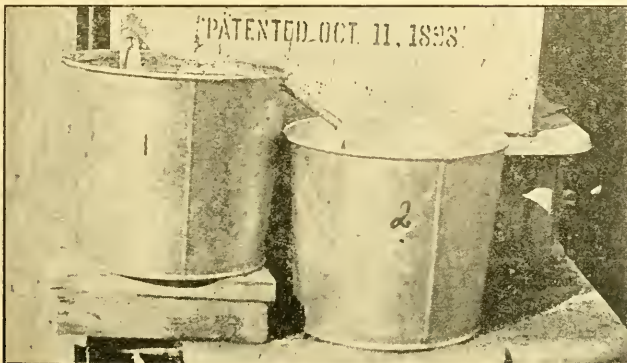

FIG. 6.—WAX REFINER AND BUCKET IN SHAPE.

irregular cakes should be put direct into the baskets, and then run rapidly into the wax-refiner at 1, and into 2, as given above. Cooling bodies contract so after filling the buckets full we do not try to empty them of wax until they cool sufficiently to almost drop out, as they will after a time. The results are shown in No. 7, in having nice even cakes of choice wax ready for crating. While rendering combs as shown in Fig. 1, many of them were white drone combs, and new foundation that had not been brooded in. Those were put to one side with the intention of having a choice quality of wax that would command a higher price than ordinary. When the old combs and the new had

THE HATCH-GEMMILL WAX-PRESS.

Why a Detached Press is to be Preferred to a Combined Steam and Wax Press.

BY F. A. GEMMILL.

Some years ago I had occasion to melt up a large quantity of old brood-combs, varying in age from five to fifteen years; and, as a result, have had considerable experience in rendering such in order to secure the greatest amount of wax therefrom, with the least possible loss of time, labor, and expense.

The Dadant (or gunny-sack) plan, probably best known to your readers, was the one first used. Next came the solar system, *a la* Board-

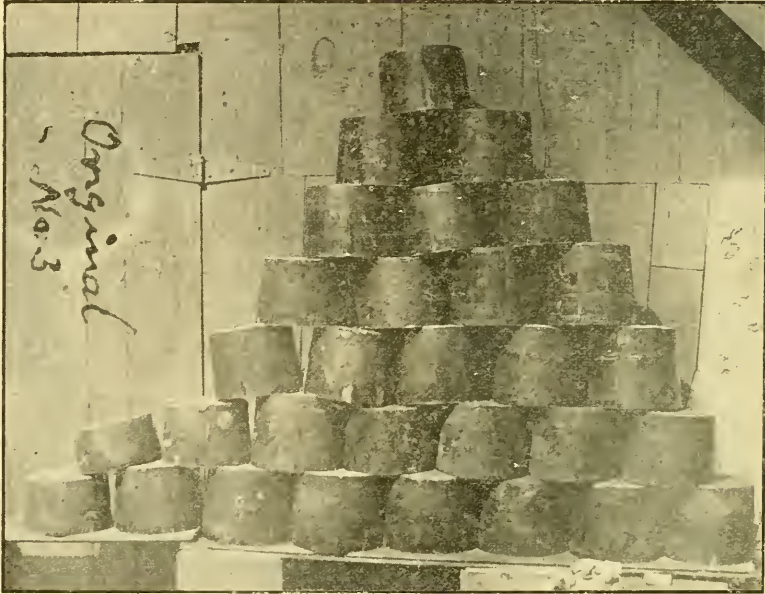

FIG. 7.—WAX RENDERED FROM SIX CORDS OF COMB.

been refined, there was no difference between the two lots. This is sufficient to show its value used in connection with any steam wax-extractor.

South Columbia, N. Y.

[Mr. Ferris' experiment, showing the saving effected by a press, is somewhat startling in its results. It would look as if the old-fashioned steam-extractors took, under certain conditions, only 50 per cent of the wax in the old combs. *In the experiment under consideration, the press actually saved 9 lbs. of wax, nearly. At an average price of 25 cts. per lb., this would be \$2 25.* At this rate, how long would it take to pay for a press, either as a part of the steamer or as a separate machine like the Gemmill-Hatch press? Referring to this last machine, I have asked Mr. Gemmill to tell of his experiments in detail, which he does.—ED.]

man—a capital method for uncappings, and combs containing few cocoons, and little or no pollen.

Later the Doolittle arrangement, combining pressure while the combs were still immersed in boiling water, and manipulated out of doors, was discouraged by a friend of mine, and I therefore next tried the Swiss steam or Ferris system, all of which satisfied me that much wax was being lost for want of proper and economical plans to secure it from such combs as described. The Salisbury method of treating the refuse or cocoons with acid did not get a trial, for the reason that I could not readily arrange for so doing. After considering the results of my experiments, I concluded to use pressure in some form, and finally adopted a modification of the Cary-Hatch or cheese-press process, as illustrated and described on page 315 of 52d thousand of A B C book, published by the Root Co., with some improve-

ments by myself; while Mr. Chrysler, the present manufacturer of the press in Canada, has made some additions to the form and follower, which are considered by some an advantage.

I have no desire to underestimate the results or attainments of others with their own inventions or apparatus for securing the desired ends; but for my own purpose the so-called Hatch-Gemmill press is all that is claimed for it, and I am pleased to have the indorsement of the above statement by our mutual friend Mr. J. B. Hall, of Woodstock, one of Canada's best apiarists. What do you think of such a man, when he actually proposed to remain away from the Ontario bee-keepers' meeting, held at Niagara Falls, in order to melt up combs by this system, knowing full well that he could not be spared, and had to be telegraphed for to present himself? Why, one would naturally conclude attending conventions was a more disagreeable matter than rendering combs, under such circumstances.

I think it has been generally conceded in the past, that, if as much wax could be secured from old combs as would fill a similar set of frames full of foundation, it paid to melt up all defective or unusable combs rather than continue their use.

My experiments, carried on by the various methods first enumerated, forced me to conclude I had not been getting much more, or about a half or two thirds at most, and not as rapidly or cheaply as I desired, and concluded to use high pressure exclusively as soon as the combs were brought to a sharp boil, and at once, but leisurely, transferred to the press, since which time my own average has been 3 lbs. of wax from a set of 8 Langstroth frames, while Mr. Hall has succeeded in securing from $3\frac{3}{4}$ to $4\frac{1}{2}$ from 8 Quinby combs, according to age, of as beautiful yellow wax as one would wish to see, for the reason that it had been forced through the refuse and quilt, and consequently strained at once to perfection.

I am quite well aware that objections have been raised to the use of this press as illustrated and described, for the reason that the cheeses, or slumgum, would cake or "freeze," or chill before pressure could be applied; but I can assure the readers of GLEANINGS that any one who allows such a thing to take place is a poor manipulator, and not possessed of much that goes to make a successful bee-keeper; and it does not require a lightning operator either.

Here is Mr. Hall's answer to that objection: "With me the slumgum cheeses do not cake, much less 'freeze'; nor does the wax splatter about."

I say amen to his statements. The only precaution that has been taken to avoid such an accident is, to first fill the press with boiling water, allowing the mats and faces to become water-soaked before commencing operations. This, however, is made to prevent the possible absorption, and, at the same time, expedite the removal of any wax from the press after removing the cheeses.

The quilt or material (no bags are employed) for confining the supply to be pressed is

composed of linen screen, a coarse kind of cheese-cloth, and it may be doubled if one so desires it, although one thickness appears to be strong enough. This article costs but 15 cents per yard, and should be about 54 inches square, and is much to be preferred to gunny sacking, as the refuse is much more easily and rapidly removed when cool. A good plan is to have two or more such quilts for convenience in working expeditiously.

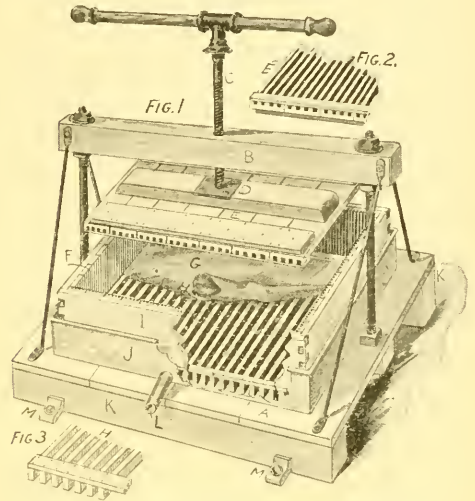

FIG. 1.—HATCH-GEMMILL WAX-PRESS.

- Fig. 1.—A—Bed, little higher at back end.
 B—Bean for screw and braces.
 C—Hand-screw and lever.
 D—Iron plate on follower.
 E—Slotted bottom of follower.
 F—Slotted sides of case.
 G—Cheese-cloth or burlap.
 H—Slotted bars on bottom-piece.
 I—Case.
 J—Galvanized tank.
 K, K—Heavy wood foundations.
 L—Spout.
 M, M—Braces running through K K to bolt to floor.

Fig. 2.—Part of the follower turned bottom side up, showing E.

Fig. 3.—Detail part of bottom part showing construction of H.

I have been asked why a press of such design or modification is superior to a wax-extractor like the Ferris, having a *press inside of the extractor*. To be candid, I have never used the Ferris except by the methods given by the inventor, with the follower, and can not at this writing speak of the results likely to be obtained, where high pressure, such as I have been using with the press, was used with that machine.

I have, however, several reasons for preferring my own hobby. First, I have found it necessary to fasten securely the press to the floor of the honey-house in order that the proper pressure may be applied.

Second, it has not been found necessary in either the case with Mr. Hall or myself to use steam or any particular kind of receptacle for melting the old combs, as an old boiler or several smaller tin pans answer admirably, and

the contents of one of the latter can be transferred in lots to the press while the others are heating for future use.

Third, much less fuel is required by such management; and the danger of fire or accident is not as great as where pressure is used while the material is still on the stove.

Fourth, I prefer that the back end of the press be raised two inches higher than the front, as by this means the water and liberated wax run directly into the pan in front, thereby leaving much less wax to be removed after the refuse has been taken therefrom.

Fifth, the only other article for securing the wax by pressure, that I have seen, is operated with steam, but is far too small in capacity for those requiring to melt up a large quantity of combs, so that I consider it but a toy as at present manufactured in Canada.

No claim is made that this article is the best of its kind manufactured. I trust, also, that future experiments may still further improve the methods now in vogue for securing the best results in wax rendering, and that those making such will allow their fellow bee-keepers any advantage thus realized, as I believe in helping one another as much as possible in this important part of apiculture. My only desire is that my mite in this direction will be of as much benefit to others as my friend Hall and myself have found it.

Stratford, Ont., Can., Feb. 4.

[As Mr. Chrysler is the maker of the Gemmill machine, and has made some improvements, I asked him to tell of them, and how he uses the machine. Mr. C. writes:]

THE GEMMILL-HATCH MACHINE

as Made and Used

BY W. A. CHRYSLER.

In December, 1899, I purchased of Mr. Gemmill a sample of his wax press, and he very generously encouraged me to manufacture them for the trade. I found after a trial it needed some better way of liberating the melted wax that would collect in the form and above the cheese while pressing. This wax had to be cooled and hardened with cold water poured into the form, to be successfully removed, causing much loss of time, and making it necessary to rewarm before commencing to press again. I made the form a little larger, and placed fluted or grooved pieces of wood, within grooves running up and down, all around its sides (on the inside) to drain all melted wax that might collect and come from the top of the cheese. This done it was not necessary to retain the rolling slatted mat that was used on top of the cheese. The follower was made fluted on its under side to conduct all melted wax to the outsides. To prevent the canvas from sometimes squeezing up between the form and follower, two strips of wood, $\frac{3}{8} \times \frac{3}{8}$, were nailed across and crosswise of the flutes, or grooves, at their ends, to press the canvas far enough down to be sure of not hindering the wax from passing away.

The form needs to be made strong at the corners or it will burst out from the pressure. With dovetailed corners like the hives, and well crossnailed, I think it would be sufficient. The press, as is now perfected, I think stands head and shoulders above any other that has been placed before the public, for rapid work, and at the same time getting more wax out of a given amount of old combs.

The *modus operandi* of the Gemmill wax-press, as operated by myself, is as follows: It will be supposed you have arrangements for melting up a large quantity of combs. If you have two stoves and large pans the full size of their tops, you can keep them busy melting, for the capacity of the press for doing rapid work is limited only by the inability to melt fast enough; and only one man need be engaged.

Have your press securely fastened to the floor with platform slightly higher at the back, your combs melting (in water of course), and a good-sized pail of water to be heated to the boiling-point when you are about ready to begin to press. When that time comes, place a cork in the outlet of the pan of the press. The lower rack, the form in place, with canvas inside and follower on top, take the pail of boiling water, pour into the form, and thoroughly wet and heat all surfaces that will be exposed to wax. After about five minutes the water may be drawn off. Your melted combs being ready (boiling-point), you remove the follower to one side, and spread the canvas over the form; place a receptacle to catch the wax from the pan. Now dip your melted product into the canvas in the form. Dip it full; then fold in the overlapping edges of the canvas, drawing taut, so as not to have any surplus canvas in the way of wrinkles near the form. Now place the follower on top and slowly screw down. Give it a little time to drain off. When you have screwed down fairly tight, leave it for two minutes (your time can well be employed in putting more old combs to melt), then give another turn at the screw, and another wait of two minutes. The wax will be running slowly; but it is as pure gold, and can be counted as net gain, for you have already obtained more than other processes furnished.

When screwed down as tight as possible, and drained, loosen the screw; draw pan, form, and all forward from under the press beam, letting the forward edge rest on a box, or strips arranged of suitable height to support; put one foot on the follower, and with both hands draw up the form. Remove the follower. The cheese containing the refuse will be hot; but take hold of some loose edges at such places as will allow you to carry it where you wish to deposit by letting go all but one hand. The refuse will usually all fall out clean. Give it a shake, hurry back, replace, and repeat as before.

Chatham, Ont.

[It appears that there are two methods of rendering up old combs—one using steam in connection with the press, pressure being exerted on the refuse *while it is surrounded by*

hot steam, and still in the extractor; and the other, pressing the refuse after it is taken from the boiler or extractor. To the last named, objection has been made that the refuse chills or cools, or, as some have expressed it, "freezes," before a full pressure can be exerted. Regarding this I talked with Mr. J. B. Hall, who is a user of the Gemmill press, and he said there need be no danger of

the slumgum chilling if a man understood his business, and worked rapidly; and, besides, said he, "These little screws inside of the ordinary steam wax-extractors are too small. I want something on which I can work the entire strength of my arms and body. With the Gemmill press and its powerful screw and frame I can exert a much heavier pressure. Those other things are only toys."

I have been surprised that we here in America have

hitherto made comparatively little use of the principle of the steam and screw wax-press combined. Even Mr. Ferris did not employ

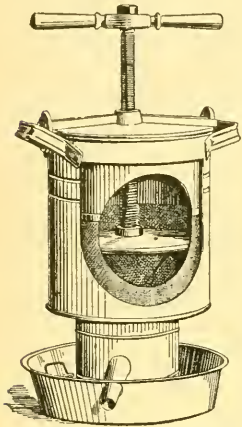

FIG. 10 — GOOLD, SHAPLEY & MUIR'S WAX-PRESS.*

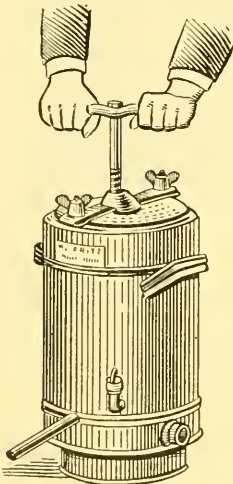

FIG. 12.—CARL FRITZ'S STEAM WAX-EXTRACTOR.

it originally; but, discovering its advantage, he adopted the feature in his extractor, and is now using it, I believe, in all his late machines. The Goold, Shapley & Muir wax-

* I understand that the company are about to put out an improved machine. For further particulars, write them at Brantford, Ont.

press was one of the first advertised on this continent, and is illustrated in Fig. 10. This machine was put out during the winter of 1899 or 1900. Knowing that Mr. Holtermann had something to do with the design of this machine, I wrote him, asking where he got the idea. In reply he said he thought he obtained it from a German catalog. Wishing to know more about the principle, and how extensively it had been used, I wrote to some of my German friends, and in response received a lot of back numbers of old German and French bee-journals and German catalogs. In Figs. 10, 11, 12, 13, 14, and 15 I have reproduced some of the cuts that are shown in the publications above referred to. The earliest mention of these machines to which I have been referred is the "History of the Steam Wax Press," in the *Bienenwirtschaftliche Centralblatt* for 1892, No. 22. Another early reference given to me of a similar machine is in the *Leipziger Bienenzeitung*, 1893, page 203. It is claimed in this that Haeckel, in Schlath, Württemberg, Germany, was the inventor of the steam and screw wax-press. Still another reference is to the combined steam and wax presses described in Witzgall's "The Book of the Bees." This is a most

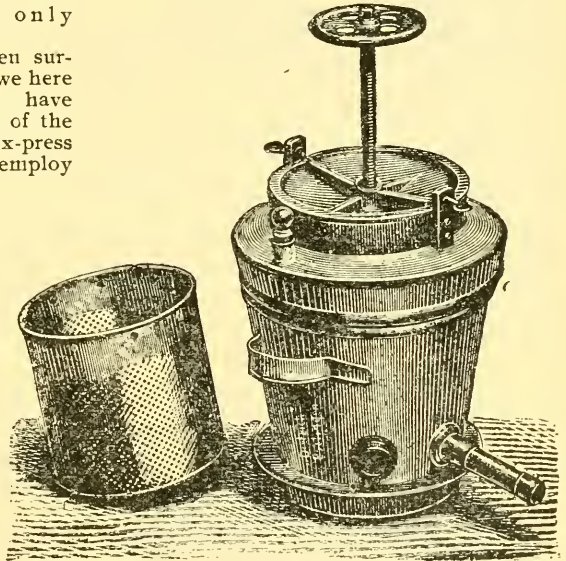

FIG. 13.—THE DIETRICH STEAM WAX-PRESS.

magnificent work of 540 pages, and is published in Stuttgart, Germany, by Eugene Ullmer. The book was written in 1897. Concerning the combined steam and screw wax-presses, and their use in Germany, the author says:

We will describe here only the Dietrich apparatus, as the essential principles of it are the same as those of all the others. It consists of an outer receptacle or jacket, having fastened near the bottom a tube for the purpose of allowing the melted wax to run out. Fastened to the top of this outer receptacle is a peculiarly shaped cover made of cast iron. Through the middle of it passes a screw with a wheel on the upper end to turn it. Inside of the outer vessel is a cylinder

pierced with holes. This is to contain the fragments of wax to be melted. On the lower end of the screw is a disk fitting exactly into the perforated cylinder. The space between the inner cylinder and the outer one is designed for the generation of steam. Through the upper orifice pour warm or even hot water, and place the apparatus on the stove. Pour in enough

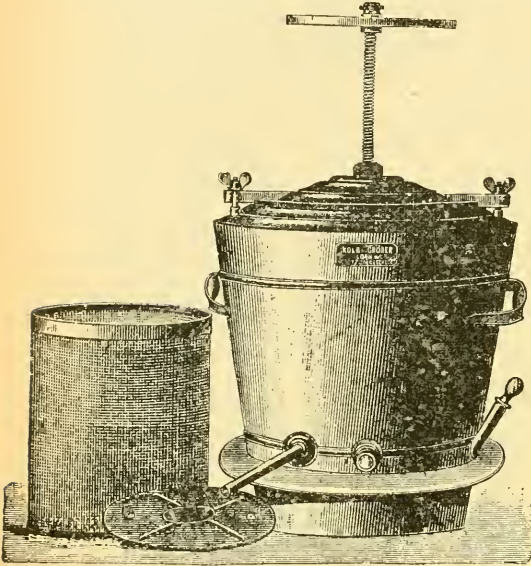

FIG. 14.—KOLB & GROBER STEAM WAX-PRESS.

water to come up to the top of the glass observation-hole. The steam soon causes the wax to melt, which runs out into a vessel beneath, which is partly filled with cold water. . . . For more extensive bee-keepers the steam wax press is to be recommended, such as is offered for sale by Kolb & Grober, in L. rch.

This description will answer for any of the other presses shown on this page.

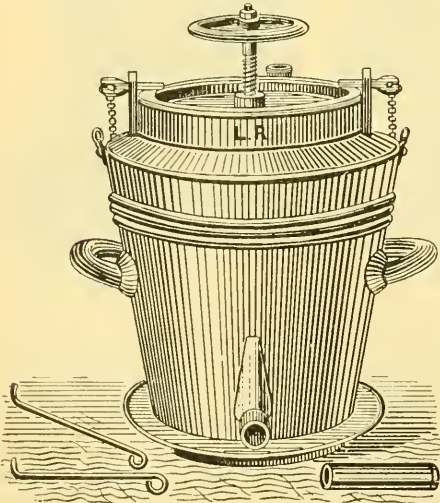

FIG. 11.—ROBERT-AUBERT STEAM WAX-PRESS (FRENCH).

Another writer in a French journal, *L'Apiculteur*, says:

The solar extractor gives nice wax, but there remains a good deal of wax in the refuse. Among the small wax extractors, one of the best is one operated by steam with a press. One of these implements, furnished by the house of Robert-Aubert, is placed on a stove, with hot water between the two sides, and on the inside there is a small receptacle pierced like a skimmer. It is there that the wax melts and is pressed. But the process is very long, and it is infinitely better to melt the slumgum in a simple boiler, and then dip out the melted wax with a dipper and pour it into a sack fitted to the inner receptacle, which is heated to the boiling point of water. It is then pressed, and the sack removed to take out the dross, or slumgum, and then begin again. In working thus with this apparatus there is but very little wax left in the slumgum.

I said I was surprised that here in America we had hitherto made comparatively little use of the screw press in the ordinary steam wax-extractors. I am the more surprised, because the Europeans seem to have utilized the combination for nearly ten years. The fact that so many machines are made, as will be seen by the illustrations (and these illustrations include only a very few of the great variety), would seem to indicate that the principle, when rightly applied, is good. I have had some experience in having the piles of slumgum chill in a wax-press of the Cary-Hatch principle while I was getting ready to put on the squeeze; but, as Mr. Hall says, there is probably no need, if one works right, of hav-

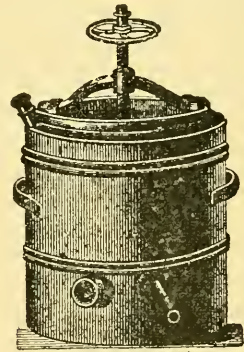

FIG. 15.—ROTHSCHUETZ WAX-PRESS.

ing this pile of refuse, or slumgum, just from the boiler, and hot, chilled before the screw is turned down. I am very sure it is true that the average man would drizzle wax from the boiler on the stove to the wax press on the floor; and for this reason, if for no other, the combined machines would have the preference.

From what I can judge from the illustrations I conclude that some of the German machines at least are mere toys compared with the Ferris. The great trouble with the first-named machines is that they are too small. Then while they are standing on the stove I do not see how sufficient pressure can be applied unless another person takes hold of the handles while the operator himself turns down the screw.

I omitted to explain that the tops of all the German machines are of cast iron. For the purpose of standing the strain of the screw, some of these cast-iron tops rest on gaskets

that are imbedded in the top of the steam-extractors. It is thus possible to make them steam tight at the top.

When the slumgum has been "cooked" enough, the free wax runs off and out of the spout, then pressure (not before) is applied, squeezing the melted wax out of the slumgum like water out of a sponge.

It will be noticed that, after the wax has been put under pressure, this slumgum must be emptied from the basket. In the mean time the basket cools from being opened, because it must be dumped, and then be refilled with old combs. Mr. Ferris overcomes this trouble by having *extra* baskets, of just about the right size and shape to take in Langstroth combs; and when one set of baskets or one basket, we will say, has had the squeeze applied, it is quickly lifted out of the steamer and another one put in its place, and the "cooking" goes merrily on. In the mean time the basket removed is dumped, filled with combs, and stands ready to take the place of the next basket that is ready to be dumped.

As to which is the better principle, the Hatch-Gemmill method or that employed by these others as illustrated, using a screw in connection with the steam wax extractor, I can not say from experience; but I have illustrated the various machines so that one can use whichever device he prefers. But I am sure of this much: That it pays, and pays well, to put all the slumgum from old combs in a press of some kind before throwing it away. A good press ought to pay for itself in one day's time; yes, and I should not be surprised if it would do so in *one hour's time*. I do not know of any better way for a bee-keeper to make good wages than for him to make a wax-press or buy one. See editorials, elsewhere.—ED.]

GLIMPSES OF CUBA AND CUBAN BEE KEEPING.

BY A. L. BOYDEN.

On the afternoon of Dec. 26, in company with Mr. Craycraft, we called at the office of Bridat, Mont, Ros & Co., and fortunately found Mr. Bridat engaged in conversation with one of our American bee-keepers, W. W. Somerford, whose name is familiar to our readers. I had never met either of these gentlemen before, but had soon arranged with Mr.

Somerford to make a trip to his place, which is near El Caimito, about thirty-five miles on the stone road southwest of Havana. I then went down to the warehouse with Mr. Bridat, and saw some of the honey he had taken in recently, about 336,000 lbs. This was put up in tierces, being about 100 gallons each. You may imagine that it requires a very substantial barrel to hold such a weight of honey. In one corner of the room was a pile of beeswax, and, on inquiry, Mr. Bridat replied that there was about \$10 000 worth. The sight of the contents of this warehouse gave me my



BELFLOWER, OR AGUINALDO.

first real idea of the extent of Cuban bee-keeping.

The following day I spent in Havana in company with Messrs. Craycraft, de Beche, and Penfield, the latter gentleman having an apiary at San Nicholas, where he has produced some very fine comb honey, which I shall allude to in a later article.

The morning of Dec. 28 found me on my way to Caimito. I took the train as far as Mariano, thence by stage to Somerford's. I found Mr. S. busily engaged putting up a tent in which to extract honey. On my arrival he insisted upon dropping his work, and we at once went to the house to talk as only bee-keepers can. Toward evening we started out on our wheels down the stone road to Punta Brava to visit the Du Sac apiary, managed by Harry Osborn, son of the late A. W. Osborn. On our way down there we met a younger brother of W. W., Mr. Frank Somerford, and, after a short consultation, he agreed to remain over night and go with us out to the apiary of Harry

Howe on the next day. We started down to Osborn's, where I saw the steam extractor and the famous Cuban apiary which have more than once been described in GLEANINGS. We visited with friend Osborn, ate oranges, and then all three rode up to Punta Brava for supper. After supper we visited Pedro Luis Garcia Zamara and his partner, Sr. Alfreda Felipe, and later we rode out in the moonlight to see the apiary of Fontanilla Bros., merchants and bee-keepers. While I could not see this very well by moonlight, it appeared to me that it was well kept, and that it must be in the hands of a very progressive apiarist. We finally returned to Somerford's late in the evening, and prepared for our trip to Howe's the following day.

Our trip down to Artemisa along the stone road was without event. On my way down there I halted our party of four, made up of W. W. and Frank Somerford, Harry Osborn, and myself, to take a shot at the aguinaldo, or bellflower, which is here shown. This is not a very satisfactory picture, but it will show the profusion of the bloom. The plant grows wild, and is found running over walls, hedges, and in every conceivable place. It does not, however, grow in every locality, for, while it is profuse in one place, within a mile or two there may be almost none, so one must not expect to find in Cuba that every locality is a good one for bee-keepers.

On our arrival at Howe's we found Mr. Glen Moe, of Candelaria, with Mr. Howe, and Mr. Harry Beaver. The latter is managing an apiary situated a few miles from Artemisa, for Mr. W. L. Coggsall, of West Groton, N. Y. They were busily engaged in extracting; but on our arrival they discontinued their work, and soon our party of seven was on the way down to Artemisa for dinner. I shall never forget the cocoanut dessert we had at that Cuban dinner. My morning ride had made me very hungry, and gave me a keen relish for this. After dinner we visited in turn the apiaries of W. L. Coggsall and C. F. Hochstein, known to readers of GLEANINGS as "The American Tramp."

While the Cuban stone road rather surpasses the average American road for bicycling, I do not think I ever undertook to make a trip of four miles over as rough ground as that trip of four miles in the woods to Hochstein's. I had warned the boys that I was not much of a bicycle-rider; but they, evidently, were determined to see what I could do, and, very fortunately for me, I happened to be pretty steady that day, and succeeded rather better than some who were more used to the route than I. We found Mr. Hochstein busy extracting. The season thus far had not come up to his expectations, though he was inclined to believe the locality was more at fault. We passed several hours very pleasantly with him, and his family of wife, son, and daughter. My chief regret during my visit in Cuba was that I was necessarily obliged to hurry from one place to another, and could scarcely keep all my appointments or stay with my friends as long as I desired.

My next will contain a view of the apiary of

F. O. Somerford, of Catalina, who has been in Cuba some ten or eleven years, and perhaps been engaged in bee culture as long as, or longer than, any other American there.

.....

SPRAYING DURING BLOOM.

Not Recommended by the New York Experiment Station, nor Sanctioned by Green's Fruit Grower.

BY E. R. ROOT.

This will be about the season for spraying; and the following, taken from *Green's Fruit Grower* for March, 1901, is most timely and valuable. It is true, that we published an account of the same experiments on page 103; yet this evidence, sanctioned as it is by one of the leading fruit-papers of the land, should have great weight with fruit-growers who are inclined to regard all testimony offered by bee-keepers as biased and one-sided evidence; but here we have something that comes from one of their *own organs*. If they won't believe this, they would not accept any evidence. So valuable do we consider it that we are printing this in the form of a leaflet, and will furnish it to the bee-keepers at the mere cost of postage and wrapping. We suggest that bee-keepers in all fruit-growing regions distribute these by the hundred. We will, therefore, send them out postage paid at the following rates: 10 for 1 cent; 100, 5 cts.; 500, 15 cts.

SHALL WE SPRAY TREES WHEN IN BLOSSOM?

In the coming time, to insure success in fruit-growing the fruit-grower will be obliged to manage his orchard in accord with scientific principles. Perhaps farmers with little scientific knowledge will be able to manage an acre or two so as to produce all the fruit required for home consumption; but to grow fruit for market so as to be able to compete with those who grow fine, first-class fruit, he will be obliged to know enough of entomology to know what poisons to use to destroy the different species of insects and also when to apply those poisons to effect greatest results, and at the same time do the least harm to the trees or fruits. He will also need to know enough of fungology to be able to combat the different kinds with remedies, when those remedies will be most effectual. As it happens, most of the insect enemies come into act we life with the first warm days of spring. A few warm days will hatch the eggs in which the insects have passed the winter, or cause the larvae, which have spent the winter in pupae, to leave their winter abodes and commence crawling over the tree or plant on which they have wintered, in search of the tender leaves which form their most appropriate food. The instinct of the maternal parent guides her to deposit her egg close to suitable food for the young larvae. Hence we learn that some of the most formidable insect enemies of the fruit culturist—the bud-worm, the case-bearer, the apple-leaf folder, the leaf-crumpler, and several others a little less destructive, are ready to enter the opening bud and commence eating before it is fully expanded, and those very formidable enemies, the tent-caterpillar and the canker-worm, soon follow. There is no period in the life of those insects when they can be so easily destroyed by arsenical poisons as when they first begin to feed. A weak mixture of arsenic will then destroy them while a much stronger mixture may fail to do so when they have attained to larger growth. It is evident, then, that apple-trees should be sprayed with Paris green, or other forms of arsenic, when the buds first begin to swell, certainly when the leaves begin to unfold. As many kinds of fungi commence to grow with the first warm days of spring, Bordeaux mixture can be profitably mixed with the arsenical poison.

A few years ago, from a mistaken idea of the time when the codling-moth first lays her eggs, orchardists,

feared that if they waited until the apple-blossoms fell, it would be too late to destroy the larvae, sprayed their trees while in blossom, and bee-keepers complained that their bees were poisoned, and prevailed upon our Legislature to pass a law forbidding spraying while trees are in blossom. Many orchardists felt greatly aggrieved by this law, asserting that they were forbidden to spray just when spraying would do the most good, and that they must sacrifice their apple-crop upon their own land, for the benefit of the bee-keeper, who had no claim upon their orchard as a bee-pasture. More recently, a careful observation of the habits of the codling-moth led to the discovery that she does not deposit her eggs immediately after the blossom falls, but several days later, and that instead of placing them in the calyx, or blossom end of the fruit, as had always been supposed, she lays them upon the side of the young apple, gluing them to the rind, and that when the egg hatches the larvæ crawl over the fruit in search of a place of concealment which they generally find in the partially closed calyx. This seems to show that there is no occasion for haste in spraying immediately after the blossoms fall, but that any time before the calyx closes will answer when the little cup may be filled with the poisoned water ready to give the worm an inhospitable welcome to its first meal.

Still more recent investigations show that it is not only not necessary to spray for the codling-worm when the trees are in blossom, but that it is a positive detriment to the fruit to spray at such a time. At the late meeting of the Western New York Horticultural Society, Prof. S. A. Beach, of the New York State Experiment Station at Geneva, detailed some experiments he had made in spraying apple-trees, when in bloom, with Paris green. He experimented in two orchards in Ontario County and two in Niagara County. Had sprayed some trees in all of the orchards and left others contiguous without spraying. All the trees were very full of blossoms. On the trees sprayed, but few apples set, a very large proportion of the blossoms falling, apparently, before the fruit set in, while on those not sprayed a very large crop of fruit grew. To make the test still more conclusive he selected trees very full of blossoms alike on both sides, and sprayed one side of each tree, leaving the other side unsprayed. The result was, on those sides sprayed, the fruit set very sparsely, while on the opposite side, not sprayed, a heavy burden of fruit grew. Prof. Beach came to the conclusion that, where you fairly hit an apple blossom with Paris green strong enough to kill insects, you will pretty certainly kill the blossom. The organs of reproduction in fruit-blossoms, when fully exposed, are very tender and easily killed. A slight frost or a long cold rain will often leave an orchard, covered with blossoms, with little or no fruit. If these experiments shall be confirmed we shall confess that the Legislature "budded better than it knew;" that while protecting the lives of the bees it prevented fruit-growers from destroying their fruit.

CHUNK HONEY IN THE SOUTH.

Peculiarities of the Southern Markets; When free Communication in Comb honey Supers is Needed; Importance of Protecting Comb honey Supers with Double Walls; Baits and their Real Purposes

BY ADRIAN GETAZ.

Several articles have appeared in bee-journals lately concerning chunk honey—that is, honey cut out from the combs or sections, and sold in buckets or other receptacles.

There has been some misunderstanding on the subject. The fact is, throughout the South the honey is almost altogether sold that way. In the North the honey, as well as most of the other farm products, is sold to the grocers, and the retailing to the customers is done by them. In the South, the farm products, vegetables, fruits, poultry, honey, and even dressed pork, sausage, cornmeal, sorghum molasses, and cider are bought on the public market by the farmers and gardeners, and re-

tailed out directly to the consumers, who come also to the market—that is, the majority of them. What is left after the market hours (12 o'clock generally) is either peddled from house to house during the afternoon or sold to the grocers and shippers for whatever they will give for it.

Honey is sold that way. Most people buy it that way in preference—some because they think the nice, white, and well sandpapered sections seen in a few of the groceries are "manufactured honey." The majority of consumers calculate that, in buying sections, they have to pay for the wood, and, besides that, the sections are not always full weight by any means; so they buy now and then a "bucket" of chunk honey. Generally, also, the vender "throws in" a pound or two; that is, if the honey weighs, for instance, 21½ lbs. he will "let it go" for an even 20 lbs. So you see it is a question of "locality" altogether.

That party in Texas who shipped some chunk honey North some time ago was evidently ignorant of the fact that the Northern markets require comb honey to be in sections altogether, and thought that, provided the honey be good, the kind of package and shape could not make much difference.

As to the chunk-honey system being a good one, I say no; and it is only a question of time when the comb honey of the South will be sold also in section boxes.

The question has been raised whether more honey could be secured in large boxes than in sections, supposing that both are furnished with foundation. It depends on the conditions of the colonies and on the hives used. Years ago it was argued that free communication between the sections or large boxes was necessary so the bees can cluster in them. It was also argued that it was necessary to use shallow frames in the brood-nest; otherwise the honey in the brood combs above the brood would prevent the bees from entering the sections.

When I began bee-keeping with rather small single-walled hives I found it so, more or less. Since I have larger hives and larger colonies, and have the supers protected by outer cases and some packing, I find it different. It is a question of warmth altogether. If your supers are warm enough during the night, as well as during the day, to permit comb-building and other bee-work to go on freely and uninterruptedly, you will find that it makes but little difference whether you use separators or not—that is, so far as the rapidity of bee-working is concerned. You will find that they will begin almost as soon without bait sections as with them, and that the honey contained in the upper part of the brood-combs does not cut any figure at all.

But the supers must be warm enough, otherwise the result would be different. If they are not warm enough, some bait sections will induce part of the cluster to move upstairs, and enable the bees to carry on and extend gradually the comb-building. If the supers are not warm enough, it is better that free communication should be had between the

sections, so a cluster can be formed, and comb-building carried on inside of that cluster. Don't misunderstand me when I say that bait sections are not necessary in a warm super. They are not necessary *as bait*—that is, to induce the bees to come and work in the supers; but they are of the greatest value as furnishing room to store honey at the beginning of the flow.

It is this way: When there is but very little gathered in the field, the secretion of wax is small accordingly. When a flow of honey comes, the secretion of wax, somehow or other, increases in proportion, but not at once. It takes perhaps five or six days to establish the secretion and make a good start at comb-building. During these five or six days but little honey will be gathered, simply because there is no room to put it in; but if you have drawn comb, or sections partly built up, honey will be stored in them and you will gain that much. More than that, during these few days, if the bees have no other room they will cram all they can in the brood-nest, cramp the queen in her egg-laying, and finally swarm—at least, very often.

Knoxville, Tenn.

[I wish to place special emphasis on the last three paragraphs of this excellent article. The matter of protecting comb-honey supers does not receive nearly the attention that it ought. Often the great heat from the sun and the coolness of the night have a depressing (not to say drive-away) effect in the supers. Not a little has been said about this; but the great mass of producers pay very little attention to it. Quite a few use and insist on using double hives or large deep covers that telescope over the whole top of the hive. Mr. Danzenbaker has long used and advocated a double-walled super, or what is practically such; and on top of the sections he recommends, and will have for his own use, a paraffine-paper mat—this mat having on top of it layers of news paper for additional protection. One of the secrets of his success in producing such fine well filled comb honey is the protection which he is very particular to have, and there is no denying that, when his directions are followed to the very letter, some great results have been secured. I fancy, therefore, that Mr. Danzenbaker will say *amen* to every thing Mr. Getaz says on this matter of protection.—E.D.]

LONG-TONGUED ITALIAN BEES.

Why we Want Them.

[The following, clipped from the *Michigan Farmer*, strikes a heavy blow, indirectly, in favor of the very thing bee-keepers have been working for in the way of long-tongued bees:]

Will our farmers ever learn what harm they are doing themselves and the agriculture and horticulture of the State by allowing the destruction of bumble-bees on their farms? They have been told repeatedly that the bumble-bee is the only thing under heaven or among men that can pollinize the red clover so it will produce a crop of seed, and yet they go

on destroying the best friend they have on earth, and allow it to be done by their sons or hired men. And then they poke their hands down into their pockets and pay about \$6.00 per bushel for clover seed raised where bumble-bees have not all been destroyed. They do not seem to realize that so small a thing as a bumble-bee can fill so important a place.

The bumble-bee is about the only insect with tongue long enough to reach the red clover. The honey-bee can not do it. The honey bee can reach the mammoth clover. This accounts for the large yield of seed sometimes secured from this variety when situated where many bees are kept. One man reported a yield of 12 bushels per acre from a field near 100 colonies of bees.

We have not space to tell you all about this subject, or how the people of New Zealand had to send to this country for bumble-bees before they could raise clover seed. A word to the wise should be sufficient. Then how shall the destruction of these our best friends be stopped? How many farmers who read this article will step out and boldly nail up a notice on the barn reading like this: "Bumble-bees must not be molested on this farm"? A notice of this nature should do some good in calling the attention of thoughtless persons to this important subject.

The reason the old queen-bee is often seen about the barn or sheds in the spring is that she builds her nest in a mouse-nest, and, not finding one suitable in the field, she betakes herself to the barn. This will be particularly true in a wet spring when the mouse-nests in the field are too wet and unsuitable for her purpose, and it is then that she should not be molested, as the shelter of the buildings is just what is needed at such a time. This was very noticeable about 17 years ago when we had it so very wet all the fore part of the season, which made it impossible to build in the mouse-nests in the field. This caused almost a whole-ale destruction of the bumble bee family, from which they have never fully recovered.

They tried to make their nests about the barns or stables, but were knocked down and killed through fear that they might sting some one or sting the horses. But they are very peaceable if left alone. The year it was so wet there was a large nest not over two feet from our heads where we went into the stable, and where we had to open and shut the door, but no one was stung by them. So let us all do all we can to protect the beautiful summer queen when she comes in the spring, dressed in rich colors of black and gold. We should all see in her a beauty and value we have never seen before, and realize more fully the important part she fills in perpetuating our greatest source of fertility—clover.

J. A. PEARCE.

[The above may be putting the value of bumble bees rather strongly, but I am inclined to think our friend is not far out of the way.—A. I. R.]

J. B., Ga.—Regarding the various ways of extracting pollen from the brood-combs, I would say that the most satisfactory way that I know of is to soak the combs over night in a tub of water. The next morning put them in a honey-extractor and throw the pollen out. This plan has been advocated by quite a number; and, if the pollen is not too old or packed too hard, it will come out quite readily.

J. R., Tenn.—Referring to "inky drops" and the prevention of same, we can only say that no smoker will prevent them entirely, but some smokers with a curved snout will prevent the creosote, for that is what the inky drops are, from running out of the combs on to the brood. The nuisance can be abated by using the right kind of fuel, of hard wood or any kind of wood that has very little pitch in it. Avoid using propolized rags, fine shavings, or sawdust. Chips of hard wood, even basswood, will do very well. The smoker we sent you is as proof against inky drops as any smoker that is made.

RAMBLE 184

Portable Honey-Houses; Wiring Frames; Revolving Stand for Painting Hives; Cart wheel Sun Wax-extractor, etc

BY RAMBLER.

Riding across the fields from the out-apiary one day with Mr. McCubbin he called my attention to a small white building about two miles south, and said, "That is Mr. Fray's portable honey-house, and he must be at work in his apiary below the McClanahan ranch."

I was immediately interested in this feature of bee-keeping, and the next afternoon found me mounted on my wheel with my large camera strapped to the handle-bars, and headed for the Fray apiary. I was fortunate enough to find Mr. Fray and his wife extracting honey. I had never met him, and had heard only a few days previous that he was an extensive bee-keeper. Some way I had imbibed the idea that he was an out-of-date, a sort of way-

A two-frame Cowan extractor occupied a central position in the house, and the occupants were uncapping combs. That is what the work is ordinarily called; but Mr. Fray had a brand-new term, up-to-date, and very appropriate. He said they were skinning the combs; and there is no getting around the fact that, when we get through using the knife on a comb, it does look as though it was skinned; but I have an idea that bee-keepers will persist in using the unwieldy term "uncapping."

The photo shows the construction of the house. The open sides are covered with wire cloth; and the blinds, when elevated, form a protection from the sun's rays. The honey runs from the extractor into the can shown at the side of the house. This has the appearance of being a double can. The upper portion is the strainer. Common wire cloth is used. Sometimes attention is so intense upon "skinning" combs and extracting that the strainer and can are forgotten, and the streaks

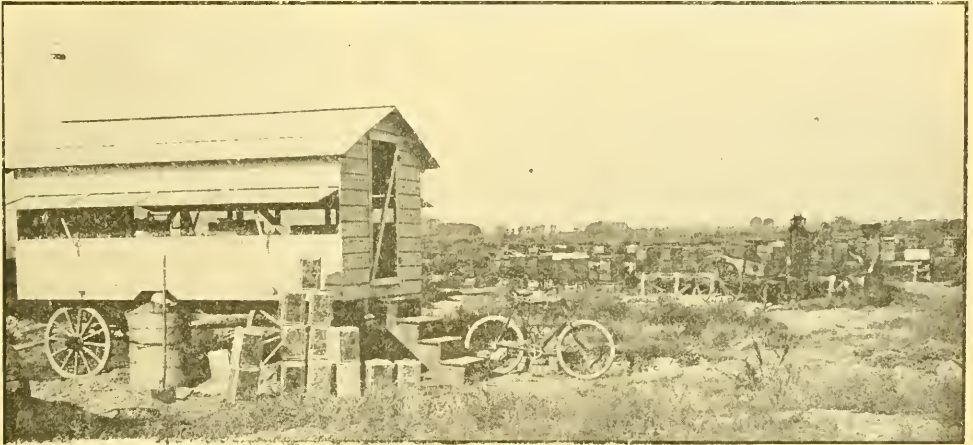

R. B. FRAY'S APIARY AND PORTABLE HONEY-HOUSE.

back bee-keeper—had not even improved up to the point of nailing hives together with a harrow-tooth; but when I approached his neatly painted honey-house on wheels, I saw stenciled in various places on the sides of the house these words, "Grand View Apiary," "Queen of the Valley," and other names appropriate to bee-keeping (I didn't think to ask Mr. Fray if he applied "Queen of the Valley" to his house or to his wife. As the latter was putting in some good licks with the uncapping knife I am sure she deserved the name).

Putting these items together, as I approached the house I came to the conclusion that there was an up-to-date bee-man inside. The bees were a little inquisitive, and I made haste to get inside the building. I calmly and consecutively introduced myself as the fellow who was slinging honey in the McCubbin apiaries, and we forthwith commenced discussing the probabilities of the honey crop, prices, etc.

down the sides of the can show where sweetness is wasted.

I suggested that a larger tank would save this waste, and also allow the honey to clear before being drawn into cans; "and," said I, "that is the way we do down south. We have tanks that hold all the way from one to ten tons."

"Oh! you are from the south, then?" said Mr. Fray. "They have had a hard time down there I hear, owing to dry seasons."

"Yes, Mr. Fray, they have, that's sure—no honey, and a great loss of bees."

"Oh! by the way," said Mr. Fray, "do you know that fellow down there they call the Rambler?"

"Why, yes, Mr. Fray; I have seen him at the conventions, and a regular old duffer he is too."

"Just as I expected," said Mr. Fray; "and these chaps that are always writing, and snapping their cameras at everybody, don't know any more about bees than you and I do!"

"That's so, Mr. Fray; but, by the way, I have a camera on my wheel, and I should really like to get a photo of your house and apiary."

"All right, sir; that is just what I want. I have been wishing some one would come along

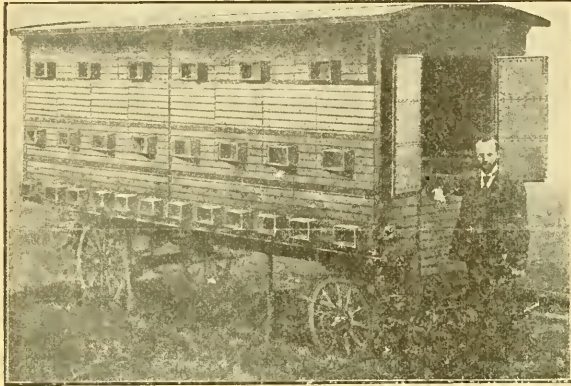

ALBERTI'S WANDER-WAGON.—SEE STRAWS.

that could take a photo. But, say" (and he sort o' froze his eyes on me); "blamed if I don't believe you are the Rambler."

This suspicion and discovery had happened several times before in my travels, and we all had a little jolly over the matter, and after that the photo.

Mr. Fray owns some 400 colonies of bees in four or five apiaries, and he thinks he could not manage them without the use of his portable honey-house. All through the extracting season he moves his house from apiary to apiary, and extracts the honey as the bees

other parties, and the bees were being transferred to nice new painted ten-frame hives. The ordinary flat cover is used, and no rags, and upon this point Mr. Fray and I were in perfect accord. He was inclined to think that a cover made of two pieces of inch board, with grooves and strip painted, in the center, is less liable to warp than when made of a whole board. As before stated, this climate is trying upon covers and the corners of the hive. In order to hold the latter from twisting out, Mr. Fray uses a little clamp made of hoop iron, extensively used on fruit-boxes, which is nailed to each corner to advantage.

I afterward called at Mr. Fray's headquarters, and found his appliances all in the order of genius and convenience. His frames were all wired, and with a little different kink from the ordinary.

When the frame is nailed together, fine wire nails are driven through the bottom and end bars, as shown by the diagram 'No. 1. Afterward the points of the nails are turned up in the form of hooks.

The first operation in wiring a frame is to form a loop on the end of the wire. Hold said loop in the jaws of a pair of pliers, and give it a neat twisting, with the simple little tool shown in Fig. 2. Fig. 1 shows how the wire is applied.

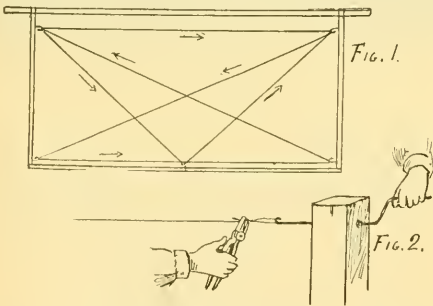

WAY OF WIRING FRAMES AND TWISTING LOOPS.



REVOLVING STAND FOR PAINTING HIVES.

gather it. Two persons can usually take care of the above number of colonies in this valley. For wheeling honey from the apiary to the house Mr. Fray uses a large two-wheeled cart shown in the photo, and upon which he can pile several supers, greatly facilitating the work.

From the appearance of the apiary shown, one would think that Mr. Fray was sparing of the paint-brush; but it is not so, for the hives shown were eight frame hives purchased from

Another new idea I found at this busy headquarters was in the economical painting of hives. The hive is mounted upon a revolving platform. The paint-pail rests on a little shelf in front, and all sides of the hive can be painted without moving from the one position.

New ideas stick out quite prominently in the construction of his sun wax extractor, and it is a genuine novelty. An old wagon-wheel and half of the axle, that have seen their best days, are used for a foundation. The end of

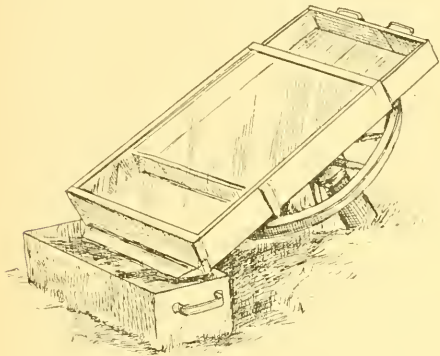

CART-WHEEL, SUN WAX-EXTRACTOR.

the axle is planted firmly in the ground, and the wheel upon it is free to revolve. The extractor is mounted upon the wheel, and a light pressure in either direction moves the extractor and contents in direct range of the sun.

It is also so constructed that the filling with cappings or the removal of the wax can be affected without removing the glass cover. The way it is worked is shown in the drawing.

In conclusion I would say that, should any bee-keeper call upon Mr. Fray, he will be used courteously; and should the call be made during the extracting season he will be found "skinning" combs at the old stand.

[I have been surprised over and over again in my travels over the country to find here and there a bee keeper extensively engaged in the business, well read, progressive and energetic, and yet unknown as such to the bee-papers or to their readers. Were it not for the fact that they subscribe for all the best of them, they could not be up to date. While I have been fortunate in finding a few of these fellows, Mr. Rambler has found a good many more. So far in my experience they have been perfectly willing to give us of their ideas, but are very little inclined to "write for the press" either because they think they "can not write," or because they are too modest to do so.

Elsewhere Dr. Miller refers to a portable house-apiary. While Mr. Fray's is a honey and extracting house on wheels, the German wagon combines the extracting-house and the house-apiary in one. I suspect that, some time in the future, we shall use portable house-apiaries and portable honey-houses in a way that we would not dream as possible now. Elsewhere in this issue I have also shown that the Germans are prior in the use of steam wax presses. I know they have been many years ahead of us in the use of portable house-apiaries, of which Mr. Alberti's wander-wagon is a good example. By the by, the name "wander-wagon" is very express-

ive in English, for I suppose it does do a great deal of wandering—not aimlessly, perhaps, but into fields where "mellifluous sweetness" would go to waste except for the presence of the wanderer. One objection to these portable apiaries in the United States is the frequently bad condition of the roads.

We have for years used in our paint-shop the revolving table for the painting of our hives. The plan is all right.

The method of wiring is quite similar to the Keeney method which we used some years ago, but which we have since abandoned for the horizontal wiring which we like better.—
ED.]

INCREASING THE HONEY CROP.

Red Clover, etc.

BY F. GREINER.

Three ways present themselves to the progressive bee-keeper by which he may hope to attain better results, reap greater profits from his apiaries, and thus better his condition generally.

1. He may adopt better methods. We all aim to do that.

2. He may improve his stock of bees. Many bee keepers work along this line, and some improvement has been made. But it would seem to me that we have made no more than just a beginning in this direction.

3 The last, and as difficult a way as any, is to provide our bees with better pasturage, introduce superior honey-plants, and improve the honey-plants already present, in such a way as to make certain but inaccessible sweet treasures accessible to our bees.

The moving of our bees into buckwheat-fields may be regarded as an effort in this direction. Also the scattering of sweet-clover seed along roadsides, etc.; but scarcely any attempt is being made to change the flowering-tubes of certain honey-plants to adapt them to our bees. The honey-plant which, above all others, presents itself to us for this improvement is the common red clover. Several years ago I ventured to make the assertion in *Farm and Fireside*, "Should we succeed in procuring a bee able to extract all the honey or nectar from the red clover, honey would become so plentiful that it could and would largely take the place of sugar for sweetening many articles of food, and that it could then be produced cheaper than cane or beet sugar." I believe this now; and the same result would be attainable by shortening the blossom-tubes of the clover. But this kind of work will of necessity have to be consigned to experts in such work. Perhaps our experiment stations may help along this line. Mr. Hasty says that he has not been very successful so far. Mr. Wuest, of Germany, a botanist of reputation, writes in the *Leipziger Bienen Zeitung* of his experiments in the same directions. I believe it will interest the readers of GLEANINGS to hear what he has to say. He writes in substance:

"There are many plants which secrete nec-

tar abundantly; but on account of the peculiar shape of their blossoms this honey can not be reached by the honey-bee unless the atmospheric conditions are very favorable to honey secretion, causing the sweet secretions to rise high enough to become accessible to the bees. It is then possible that they may have a good harvest from such a source, although they can appropriate but a small portion of the secretion. Sometimes a cunning little beetle cuts through the corolla of certain flowers near the bases where the nectar is hidden, to obtain the same. When, afterward, this oozes out through the opening, the bees find it and make regular visits. These observations have been verified by Dr. Muller, Vogel, and others.

"The abundant honey secretion of red clover (*Trifolium pratense*), and a pea variety (*Vicia villosa*) induced me to experiment with these to obtain new varieties by hybridizing varieties which might have blossoms with accessible nectar-glands. The crossing of the red clover with *Trifolium repens* and *Trifolium hybridum* gave me several new varieties with sufficiently short tubes; but in other respects as forage-plants they were inferior to the red clover.

"There are a multitude of varieties of the clovers scattered all over the world. We need to select only the proper one for crossing with the red variety. The scheme is not without a promising future.

"By crossing the *Vicia villosa* with suitable varieties I have obtained several crosses that meet all my expectations. The flowering-tubes are shorter and wider, so that our common bees can reach the nectar-secreting glands without difficulty. As foraging-plants they are superior to the parental stock. I think I shall be able to furnish some seed in the near future through a seed-house, as I am not in the business myself."

I am aware of the efforts now being made to produce long-tongued bees. The evidence produced so far might almost lead us to say, the longer their tongues the more honey the bees will store. I shall be slow to accept this as a fact. It stands to reason that a bee with a tongue only $\frac{13}{100}$ inch long can not gather as much honey from red clover as one with a tongue $\frac{25}{100}$ inch long, or almost twice as long; but I have often examined red-clover blossoms, and it seemed to me that, even with a tongue $\frac{1}{4}$ inch long, the nectar in the red clover could not be reached. I believe it would be well for us to concentrate some of our energies upon the production of short-tubed clovers, and thus shorten the route at each end.

Naples, N. Y.

[I have more hopes of lengthening bees' tongues than of shortening the corolla-tubes of clover; yet I would by no means disparage any effort looking toward the latter. See editorials.—E.D.]

THE NATIONAL BEE-KEEPERS' ASSOCIATION.

An Interview with Mr. Smith Concerning it.

BY CHALON FOWLS.

I have been thinking lately of the pressing need at this time of bee-keepers standing together for their protection in their mutual interests. If they don't, they are likely to be defrauded of their rightful reward of their honest toil. I believe that the National Bee-keepers' Association, if properly supported, can now do a great work toward putting the business of honey-production on a paying basis. So I resolved to appoint myself a committee of one to stir up the brethren on the subject, and here is an account of the first interview.

"Good morning, Mr. Smith."

"Why, good morning, Mr. Fowls. Come right in. Glad to see you and have a talk. Well, what's the last hobby? You generally have something, even in the winter."

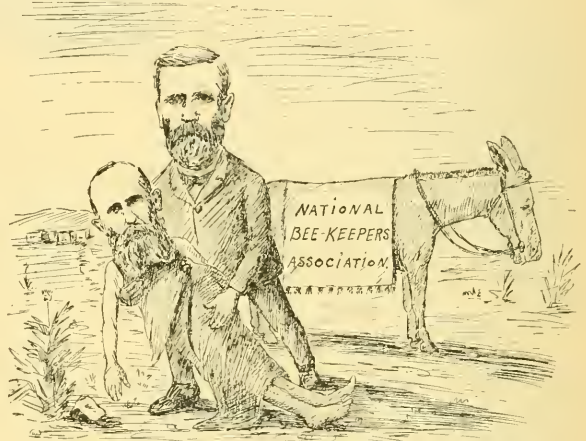

THE GOOD SAMARITAN AND THE MAN WHO WAS WOUNDED AND LEFT HALF DEAD.

"Well, Mr. Smith, I came over to see if I couldn't get you to join our National Bee-keepers' Association. We are doing a kind of work now that I feel you would like to have a share in."

"Of course, I am interested in any good work, Mr. Fowls. What is it?"

"Why, just this: A brother bee-keeper was in trouble. He was beaten in court because of ignorance, prejudice, and spite. Being a poor man he could not afford to appeal the case, as the expense would be too great. Then our Association came to his aid, and, like the good Samaritan, helped him by paying his expenses, and in other ways, thus setting him on his feet again. Was not that a good work?"

"Oh! I see. You refer to the lawsuit of the Utter brothers. Yes, that is a good work, not only that it helped the man by the verdict giving him the protection of the law in his business, but it will help all the rest of us in the business by establishing a valuable prece-

dent in law. But if I join now I shall be too late to help, anyhow."

"Oh! but the case may be carried up still higher; and, besides that, if there is a large increase in membership, and consequently a larger sum in the treasury, we shall be in a better position to protect bee-keepers' interests in other ways."

"Well, you can send in my name for membership, and here is the dollar. It will be ready, if needed, to help carry on the fight; but if not, it can go to replace one of those already taken out. It goes to pay for a *real service* in either case, for we don't want to be at the mercy of every ignorant fruit-grower who may want to go to law with us."

Oberlin, O.

[For the information of some of our friends who may not be able to understand the picture, I would explain that Secor, our genial General Manager, is represented as the "good Samaritan," and the man whom he is helping, and about to put on the faithful animal that will carry him safely out of trouble, is Mr. Utter. In the light of past events there is more of truth than fancy in the picture, and I hope those of our readers who have not yet joined the Association will do so at once. Send \$1.00 to Eugene Secor, Forest City, Iowa, and thus help along the good work. It may be that you will be the man to fall among thieves. —Ed.]

STRENUOUS QUEEN-REARING.

Read before the California State Bee-keepers' Association.

BY J. H. MARTIN.

In these twentieth-century days we hear much about strenuous living and working. I suppose strenuous is only another term for high pressure, and we have had high-pressure farming, high-pressure poultry-rearing, high-pressure commercialism, and high-pressure many other things; but I have never heard much of high-pressure bee-keeping.

High pressure is, however, too much out of date to apply to twentieth-century bee-keeping, and "strenuous" is the term; and I have an idea that, to commence at the root of the matter, we need a more strenuous queen-rearing.

Let us consider the subject. During the past season I found a strain of bees in the apiaries I was managing that were so far superior to the rest that, had the bees all been bred from the queen of that colony, our honey crop would have been increased by several tons.

The discovery that this strain were such good rustlers for honey was not made until the season was well advanced; and now, in order to get the full benefit from that strain, it must be gradually diffused through the whole apiary.

When I find a strain of bees like those mentioned I am impatient to get the whole apiary up to that standard, and the need of queens when I want them, and the lack of time to

rear them when my energies are devoted to the extractor or at other work. In fact, I am strenuous at something else, and need an extra-strenuous plan to supply the queens.

I think every bee-keeper present has observed that not one apiary in a hundred is properly queened, and I think we all have a dim suspicion that our own apiaries are not up to the standard we desire. We hear of golden-yellow queens, leather color, long tongues, and even \$100 queens. To make a good start we should like one of those \$100 queens; but after considering the lank condition of our purse we finally conclude to send for a dollar queen, and that is about as far as we get this year; but next year, if we have a big crop of honey, we will do better. Our dollar queen may be either good, bad, or indifferent; and, whichever it is, we do not get much out of her.

Then you know that queen-rearing has become a great science of late years. Alley's plan used to be good enough for me; but now it is dipping-sticks, tooth-picks, transfer of royal jelly, transfer of larvæ, and putteration until your head swims. Oh, it is so strenuous!

But I see light at last. When I read Pridgen's plan of making queen-cells by the peck and queens by the quart, a great load seemed to be lifted from my mind, and I formulated the following more strenuous plans for queen-rearing.

In the first place, every bee-keeper needs the very best queens that can be reared—best in hardiness, prolificness, and notably in the honey-gathering qualities of her progeny.

In the second place, there are but few bee-keepers who have the combination of qualities that will insure their success in modern strenuous scientific queen-rearing. Now, my plan is that a certain number of bee-keepers in a given locality turn their queen-rearing over to an expert in that line of work. A contribution from each bee-keeper interested would enable the expert to commence operations with the best available stock. Each bee-keeper in the district should agree to take a certain number of queens per annum; and, having a definite number of queens to rear, and a large number of them, the expert could rear them at a minimum cost to the bee-keeper, and at the same time with a good profit to himself.

A person devoting his entire attention to queen-rearing will strive to improve his stock, and his patrons will receive the full benefit, or the patrons in this case would have an influence in keeping the stock up to an approved grade.

Our usual plan is to send for a breeding-queen and rear daughters, granddaughters, and great-granddaughters from her, and trust to a promiscuous mating with our drones.

Our expert could be so located as to control the mating of queens with selected drones, and the bee-keepers in the district would get queens only one removal from the original, or daughters, and from the very best stock in the country. In our present haphazard way we dilute the blood too much by the many re-

moves from the original stock, and this would be entirely avoided through our expert queen-rearing station.

This plan is in line with the division of labor which at present is recognized as the most effective way for accomplishing great results; and the question is, "Are the bee keepers ready for this advance in their methods of management?"

I will leave the question to you for solution, believing that, if it is put into practice, the honey-producing power of our apiaries will be advanced many fold.



BEE'S DYING OF OLD AGE; SO-CALLED MOLD ON THE HIVES DURING WINTER; IMPORTANCE OF HAVING HIVES NEAR THE GROUND.

A knock at the door; and, opening it, I find the mail brought by a neighbor, as I often send for it (a distance of nearly a mile to our postoffice) when I am too tired or busy to go myself. "Many thanks" is what I say as the neighbor passes on his way. In opening the letters I find one from Maine, wishing me to engage in conversation with him in GLEANINGS something after this fashion:

"Can you tell me what ails my bees? I find nearly a quart of dead ones under one hive. This hive has plenty of honey in it, but there appears to be a slight mold on the combs."

"From the description you give I should say that there was nothing ailing them more than is the common lot of all bees under like conditions."

"What do you mean by like conditions?"

"My idea is that the colony of which you speak was composed largely of old bees last October, which, as soon as the cold weather of winter came on, died from lack of necessary vigor for enduring such weather as we have had during the past month of February, a month in which it has not thawed a particle in the shade during the whole of it, while from zero to 12° has often been registered. And, to make it more severe, we have had a very high wind more than three-fourths of the time, with the air so filled with snow that we have all the way from two to ten feet of snow in our roads, which has obstructed travel to that extent that we have had only two mails during some of the weeks."

"But, just think! a whole quart from this one colony."

"A quart of bees is quite a large number to die by the first of March; but in cases where there are no bees hatched after the first of September, as is often the case in this locality, especially after a dry summer as was the last, a large mortality may be expected before the bees have a chance at 'house-cleaning' in the spring."

"Well, I did not suppose bees ever died like that unless there was some disease that carried them off."

"Oh, yes! they frequently do, as all familiar with the bee-literature of the past well know. But there is something here that you have overlooked, which is that dead bees make a much greater show than live ones, as their legs and wings are rigid, causing them to lie loosely in a measure or dish, or on the bottom-board to the hive, thus leading the beholder to think there has been a very great loss, when in reality it is not so great after all."

"Well, I hope it is as you say, and that the colony will pull through all right. But how about the mold?"

"Regarding this, from the idea I have gained from your description I do not think it will do any harm, even if you have not been deceived in this matter, which I think is very likely to be the case; for during winter, when frost forms about the inside of the hive, the vapor from the bees, together with the congealing of it in the remote parts of the hive, gives a bluish-white appearance to the surface of the combs, which, by the inexperienced, is often mistaken for mold."

"I hardly think I could be mistaken in this. Do you?"

"Well, perhaps not; but I have had novices repeatedly come to me during the winter season of the year, declaring that the combs in their hives were 'all moldy,' and asking what they should do. I told them that I did not think their combs were moldy, but could not convince them that they were not right till I had taken them to the apiary and shown them combs in my hives having the same appearance, which, after a close inspection, showed no real mold. Yes, and some apirists who were not novices have had to be convinced in this way, W. S. Pender, of Australia, being one among this latter number. With him I even had to take the combs out of the hive and let him rub them and smell of them before he would be convinced."

"You may be right here, and I will find out for certain the next time I look at this colony, even if I have to pursue the same course Mr. Pender did. But I should have stated that the colony we have been talking about was in a rough bee-house, the hive being packed with buckwheat chaff. Is this right?"

"This is all right providing you have it so arranged that the bees can fly should there come warm days in winter. If no arrangement has been made so that the colony can thus fly, the putting-away of bees in this way is faulty."

"But bees in the cellar have no chance for a flight."

"I know they do not. But here the case is very different. In the cellar the temperature is kept some 12 to 15 degrees above the freezing-point, so the bees consume very little of their stores to use as fuel, consequently they do not consume more honey than their bodies can hold the excrement from while they sojourn in the cellar. But left in an outdoor bee house, no matter how well packed, they

must 'burn' much of the stores used to keep them warm; hence a large accumulation of excrement, which, with no chance of voiding, brings on uneasiness, resulting in the breaking of the cluster, bee-diarrhea, and death, where no opportunity for flight is presented. Bees placed in any room which goes below the freezing point, with no chance of flying during the winter, are not nearly so well off as if left on their summer stands."

"I had not thought of this part. This colony of bees is near the ground, and I thought that the trouble might lie here. What do you think about this?"

"I think you need have no fears on this account, for none of my hives are raised over three inches from the ground, where wintered outdoors, nor have they been during the past 28 years."

"But is it not well to have them higher than that? Some of mine are set up 18 to 20 inches high."

"There are a few reasons for preferring them higher than this, but not nearly as many, nor as valid ones, as there are for having hives rest near the ground."

"Will you give me some of the reasons for having them rest so low as three inches?"

"The greatest reason of all for having hives near the ground is that, in the spring of the year, one bee is worth more than ten later on when the hive is filled with bees, and the weather is almost warm enough for the perfecting of brood without any bees at all; and the placing of hives up from the ground is one of the greatest death traps for bees in early spring which can be invented."

"I do not see how."

"In early spring the bees are very active, looking toward the oncoming season, and often go out in search of pollen and water when it is so cold that, should a cloud suddenly come over the sun, they can scarcely get home before becoming benumbed with the cold. Then we have high winds at this season, which, in addition to cool weather, very nearly tire them out before reaching their hive with their loads of water or pollen. When they thus come home, if the hive is high up from the ground, the wind carries them down, or they miss the entrance to the hive, and fall under it, in the shade, never to rise again; while with the hive placed low, and with an entrance-board reaching to the ground, so they can not possibly fall under the hive, they are enabled to travel up and into the hive, when they are too much chilled to fly further. I have seen scores and hundreds of dead bees under and about hives standing high, which had died with pollen on their legs, while with hives placed low scarcely a dead bee could be found. But it is getting late, and I have still more letters to open, so I will say come again at any time when you have more questions."

[While I agree (generally do), with all you say, I particularly indorse your last paragraph. We have our hives on low hive-stands, four inches high; but these stands have a slanting alighting front board of easy slope, reaching from the ground to the en-

trance. Formerly our stands had *perpendicular* fronts without alighting-boards (we have some yet). It was and is apparent that, in the spring, with such stands, there is quite a loss from bees not being able to get into the hives. This was particularly noticeable last spring when we had the opportunity for direct comparison. Yes, sir; it pays to have good alighting-boards that afford an easy ingress to the hives.—Ed.]



A DOUBLE-BLAST SMOKER.

The bellows consists of one long board and two short ones mitered together, and hinged to the long board at the center with a piece of leather or sheepskin, fastened to the long board at A, Fig. 2, by both glue and tacks, and in the same way to the opposite short one at B, thus making an air-tight connection between the two compartments of the bellows. There should also be a staple in each side, driven into the long board and the strengthening-block, where the short boards meet, to hold the bellows from spreading apart and

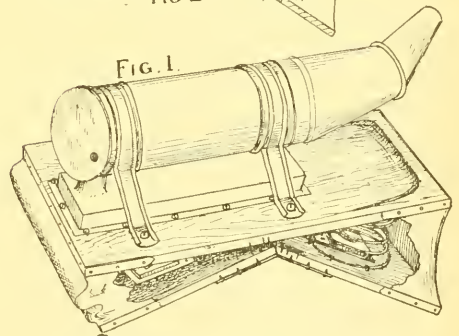
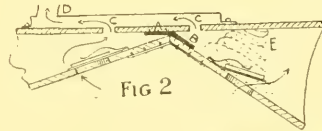

PASSAGE'S DOUBLE-BLAST SMOKER.

loosening the leather hinge. A coil spring is in the end of the bellows, held in the hand, and a small spring on each valve on the long board; and although the blast may not be quite as strong as on some others you can throw a cloud of smoke five or six feet, which is far enough for all practical purposes, and that continually, for the least pressure on the bellows sends the air through the fire-barrel; and when you let up, the air starts from the other side. There should be a $\frac{1}{4}$ -inch hole in the back end of the fire-barrel for a draft. It also keeps it from sucking smoke into the bellows. If you want the fire to go out, put a little plug into the hole and it will do so in a very few minutes. I prefer it to the intermittent, because I can get more smoke just where

I want it, and keep it coming there easier than with any other, as the least pressure on the bellows keeps it coming. BENJ. PASSAGE.
Stark, Mich., Jan. 3.

[Mr. Passage sent us one of his smokers to try. The blast, I should say, is not continuous, but a rapid series of little whiffs; that is to say, there are two blasts to every movement of the fingers instead of one, as in the ordinary style of smoker. But the blasts are so much weaker that for myself I should prefer a single blast, as the slow movement of a large bellows furnishing a long-range stream of smoke, is, to me, more satisfactory than the intermittent short whiffs of a double bellows.

Another objection is the weight of such a bellows. It strikes me that, some seven or eight years ago, we illustrated something similar to this, but just now I can not give the place.—ED.]

CAGING QUEENS TO PREVENT SWARMING.

Will you please give me a little light on caging queens to prevent having a lot of consumers only, instead of honey-gatherers? What are the greatest objections to the plan? Our honey here comes only from the bloom of fruit and almond, and, of course, comes very early, and doesn't last long. J. UMHOLTZ.
Los Gatos, Cal.

[The practice of caging queens for the purpose of preventing swarming is carried on successfully by only a very few bee-keepers, comparatively; and even these few acknowledge that it involves a great deal of work. In the first place, there are many bee-keepers who, after having tried it, believe that colonies with caged queens, or colonies without queens, do not work with the same energy and vim as those that have been allowed to swarm once. It seems to be pretty generally agreed that the one-swarm plan results in more honey. But there are localities where it is not desirable to have a lot of consumers after the honey-flow is over; and in such the caging or removal of the queens has the advantage that it cuts down the force of consumers when there is nothing for them to do.

The *modus operandi* is as follows: Just at the approach of the honey-flow, and before the bees begin to swarm, the queens of all the colonies in the yard are caged. Any flat wire-cloth cage may be used—something that can be slipped down between the frames or on top of the frames under the hive-cover or quilt. These cages may or may not be provisioned with Good candy. Ordinarily I would recommend supplying them with food. But the bees will take care of the queens, feeding them through the wire cloth, food or no food. I have had queens which I had forgotten, caged for three months over the brood-frames, and yet the bees were taking care of them. So much for caging.

All cells, if any, at the time of caging must be destroyed. In eight days more the cells must be destroyed again, and again in eight days. Not a cell must be missed; and to make a sure job, it is, perhaps, better to shake

all the bees off the frames, and then destroy the cells, as they can be easily seen. But this destruction of cells every eight days involves an enormous amount of work. While, of course, it renders unnecessary the attendance of an apiarist during the swarming season, yet the owner of the bees must go down to the yard and spend practically a whole day in the apiary, looking over the combs and destroying the cells. A week hence he must go through the operation again. As this work must necessarily be done during the height of the honey-flow, it comes when the bee-keeper can the least afford the time. Be that as it may, he has, perhaps, saved the expense of a man in the yard, and saved the expense of rearing a lot of useless consumers when they can be of no use to him after the honey-flow. After the swarming season, queens may be released by simply opening the cage. Of course, five or ten per cent of them may be killed. If the queens are valuable, I would recommend introducing in the regular way.—ED.]

A TERRIBLE AFFAIR.

H. T. Gifford was shot Feb. 16th by C. D. Reed, a renter. There had been some dissatisfaction about the crops, but no heated words for over three weeks. Reed used a shot-gun loaded with No. 4 shot, and fired without warning, at a distance of 50 feet. Mr. Gifford was unarmed, and was pumping water for his horse. He saw Reed when he aimed, and threw his head and body behind the pump and platform. This saved his life, but he is badly wounded. He is 62 years old, and most highly respected by the residents of Indian River, as well as in his native State, Vermont.
Vero, Fla., Feb. 22. MRS. F. C. PRANGE.

PROSPECTS GOOD, BUT FEW BEES IN CALIFORNIA.

Don't put the producers of honey on nettles over the prospects of a big honey crop in California. The season may be good, but where are the bees to store the honey? The empty hives echo, "where?" I would gladly sell 150 good clean empties in the southern part of the State at 10 cts. each—some never used. H. I. MORSE.

Palo Alto, Cal., March 5.

A LARGE AVERAGE PER COLONY FROM A BEE-KEEPER OVER 75 YEARS OLD.

My father, J. H. Meloy, of Wyeville, Wis., during the season of 1900 produced from 42 colonies 8960 lbs., an average of 213½ lbs. per colony, and increased by natural swarming to 61 colonies. All had plenty of stores left for winter, not extracting any from the brood-chamber. Previous years we kept about 200 colonies; but being in the 75th year of his age he is not able to care for as many.

He says this is the largest average yield he remembers getting. It was gathered mostly from goldenrod and buckwheat. Did any one ever do better? I have more bees, but my average was not as large. E. L. MELOY.

Tomah, Wis.



NATIONAL BEE-KEEPERS' ASSOCIATION.

OBJECT:—To promote and protect the interests of its members; to prevent the adulteration of honey.

OFFICERS:—E. R. Root, President, Medina, O.; R. C. Aikin, Vice-president Loveland, Col.; Dr. A. B. Mason, Secretary, 3512 Monroe St., Sta. B, Toledo, O.; Eugene Secor, Gen'l Manager, Forest City, Ia.

BOARD OF DIRECTORS:—E. Whitcomb, Friend, Neb.; W. Z. Hutchinson, Flint, Mich.; A. I. Root, Medina, O.; E. T. Abbott, St. Joseph, Mo.; P. H. Elwood, Starkville, N. Y.; E. R. Root, Medina, O.; T. G. Newman, San Francisco, Cal.; G. M. Doolittle, Borodino, N. Y.; W. F. Marks, Chapinville, N. Y.; J. M. Hambaugh, Escondido Cal.; C. P. Dadant, Hamilton, Ill.; C. C. Miller, Marengo Ill.

FEES:—Annual membership fee, \$1.00. Remittances may be sent here or to General Manager as above.

IN our issue for March 15, page 246, I referred to H. G. Acklin as if he were President of the Minnesota State Bee keepers' Association. Mr. Acklin writes that this is a mistake, and that Mr. Wm. Russell is President, and that he hopes I will make the correction, which I cheerfully do.

GLEANINGS ENLARGED.

THE large amount of advertising and of excellent matter that has been coming in of late, has made it necessary to nearly double the size of GLEANINGS. For several issues back we have been giving 16, and last issue 20 extra pages. This number has 16 extra pages again. The great variety of the illustrations that we are and have been giving will enable those of our busy readers to take in a great deal of valuable information at a few glances. For example, I take several illustrated papers, and find that I can almost keep track of the war news in different parts of the world by reading scarcely a line except those that appear at the bottom of the pictures. The history of the old civil war is pretty faithfully told by the pictures alone in the old numbers of *Harper's Weekly*, published from 1861 to 1866.

BEEES AND FRUIT IN THE FARM PAPERS.

IN the last issue of the *Farm Journal* there is a very full and comprehensive report of the matter we printed on page 152, concerning the jaws of worker-bees and those of wasps, and the inability of the former to puncture the skin of sound fruit. The illustrations have been reproduced, and the whole matter has been given very strong prominence in this most influential farm paper. It has a subscription-list of over half a million; and such matter going before farmers and fruit-growers and bee-keepers will prove to be of inestimable value. Besides the article in the *Farm Journal*, some articles of a similar nature have been published in other agricultural papers, with the result that the decision of the celebrated trial at Goshen, completely exonerating the bees, has gone far and wide over the land. The National Bee-keepers' Association has more work of this kind, and it should re-

ceive the substantial encouragement of bee-keepers everywhere. Let those who have not renewed their membership do so at once; and those who have never joined, let them get into line with a dollar bill. Such splendid results as were secured at Goshen can not be secured without somebody paying for them. Send a dollar to Eugene Secor, Forest City, Iowa.

CLOVER AND LONG-TONGUED BEES; HOW LONG MUST BE THE TONGUE-REACH?

FRIEDEMANN GREINER, on page 289 of this issue, expresses some doubt as to whether bees having a tongue-reach of $\frac{1}{4}$ inch would be able to get a very large percentage of the honey from red-clover blossoms; perhaps he is right, but late last fall we secured some red-clover heads that seemed to be fair specimens of heads in the height of the season, although they might not have been. The measurement of the corolla-tubes of these heads showed a variation of from $\frac{1}{8}$ to $\frac{3}{8}$ inch. The greatest lengths were in the very center or top of the head, and would comprise in number only about one quarter, I should judge at a rough estimate, of the number of the shorter tubes, ranging from $\frac{1}{8}$ to $\frac{1}{4}$ inch in depth. I reasoned this way: That if we could breed bees having a tongue-reach of $\frac{1}{4}$ inch, we should be able to get all the nectar out of $\frac{3}{4}$ of all the tubes, and a very large percentage of the nectar in the tubes $\frac{3}{8}$ inch long or more. If the clover heads that we measured last fall were a fair average, and if my rough estimate is reasonably correct, then bees with a tongue-reach of $\frac{1}{4}$ inch ought to be able to get three-fourths of the honey, I should say, from the heads of ordinary red clover.

While I believe we ought to work toward a red clover with shorter tubes, yet knowing as I do the tendency of all varieties to revert back to the original types, especially of the clovers, my hopes are not as strong in this direction as they are in the lengthening of bees' tongues. Here is the difficulty, as I view it, with the red clovers: Suppose half of the farmers have sown the short-tubed variety. The farmers in the other half of the vicinity sow the red clover of their fathers. The bees would mingle the pollen of the older with the newer type, with the result that the last named would work backward toward its old length of tubes.

While there would be the same tendency to sport backward in the case of bees, yet it seems to me we can control our bees better than we can control the clovers of the farmers in our vicinity.

BEEES WITH LONG TONGUES; POSSIBLE AND PROBABLE DISAPPOINTMENTS.

A YEAR or so ago there seemed to be a great rage for five-banded or yellow bees; and now nearly all the breeders in the country are advertising long-tongued stock. This is right and proper. But there is danger that many who get queens of this blood will be disappointed, and in the end the whole business will be condemned. It is hardly probable that even a large percentage of the queens

from long-tongued stock will be duplicates of their mothers. The young queen may have been mated to a drone whose bees would be of the short-tongued kind.

It is only proper to sound a note of warning that the general bee-keeping public must not be disappointed if they get some untested queens that do not come up to their expectations. The breeder who sells an untested mother of long-reach stock sells her for just what she is—a queen that has not yet been tested. If none of her bees have hatched, there is no possibility of knowing what the length of her bees' tongues will be.

Again, we are not positively sure that the amount of honey a colony will gather is in direct proportion to the length of the tongues of its bees. There have been a number of reports that seem to point that way; but this season's experiments may show that the yield of honey is dependent on some other important characteristic. In any case, let's not lose our heads.

Unfortunately, the buying of queens, even from the best of breeders, is something of a lottery; but if one will pay enough, and get *tested* stock, he then has some reasonable assurance of getting what he orders. The A. I. Root Co. will, if desired, sell tested queens whose bees will have a tongue reach of a certain specified length—the longer the reach, the higher the price, of course; and I have no doubt that other breeders will do the same, providing they learn how to measure the bees' tongues, or get some one who knows how to do it for them. We will undertake to measure the tongues of any bees of our subscribers for ten cents per cage of one dozen bees. Our Mr. Robert G. Calvert, who does the measuring, very rarely knows whose bees he is measuring. He brings in his report, and I send it out just as I get it from him. Sometimes I measure the bees myself, but more often he does it.

OLD BLACK COMBS AND HOW TO RENDER; THE USE AND ABUSE OF THE SOLAR WAX-EXTRACTOR.

OWING to the prevalence of brood diseases in many localities, such as foul brood, black brood, and pickled brood, many bee-keepers have been casting about for some simple, efficient, and reliable method by which old combs, diseased or of doubtful infection, may be safely and economically rendered, at the same time getting *all* the wax out. Elsewhere in this issue I have presented the very latest and best methods that have been in vogue, not only in this but other countries as well.

In every apiary, besides combs that are possibly infected there are scores and scores of crooked combs, combs with a large number of drone-cells, combs that have been disfigured from cell-cutting, and combs that to some may be too old to get a really nice article of extracted honey, or too old to get full-sized bees. While I believe this last statement is erroneous, yet there are some who believe in , and for that reason would prefer to melt

up all such. It comes to pass, then, that, in every well-regulated apiary, in the course of a few years there will be a very large percentage of old combs that for one reason or another ought to be rendered up. To put these in the solar wax extractor is a long job, and necessarily wasteful in its results, for sun heat will get only a part of the wax out of such combs, as I know by experience. We could put them through the solar machines and afterward put the refuse into steam wax-presses, or we could put them in boiling water, pressing out afterward, *a la* Gemmill. But better, far better, not use the solar wax-extractor for old combs at all. Such machines are useful only in the handling of new wax, like burr-combs and new combs. While we still sell solar wax-extractors, and are glad to see the sale increase, yet it is only fair to say that their use is limited. For the handling of *old black* combs, steam or hot water, and a *good press*, should be used—otherwise there will be an enormous waste. Mr. Ferris gives a set of figures in favor of a press that are something of an eye-opener; and from some tests we have made here at the Home of the Honey-bees I do not believe his figures are very far out of the way.

THE NEW CALIFORNIA FOUL-BROOD LAW.

WHILE the bee-keepers of Michigan have been and are now working for a foul-brood law, the bee-keepers of California, through their State Bee-keepers' Association, have not been idle. A year ago the California State Bee-keepers' Association, writes Mr. McIntyre, appointed a committee to draft a new bill for the suppression of foul brood. This was done, and a copy sent to every bee-keeper in the State, with the request to either see or write his Senator and Assemblyman, asking their support. The bill was placed in the hands of the Hon. Robert M. Clark, of Ventura Co., who, although a man only 21 years old, yet, on account of his energy and ability, was thought to be the man to see the measure through. The bill passed the House, but the Senate proposed to amend it; but Mr. Clark, on being informed that the bee-keepers opposed the amendment, insisted, even at the risk of defeating the bill, on its passage just as it came from the House. The Senate receded, and the bill became a law without amendment.

This law provides for county inspectors, who shall be appointed by the Board of Supervisors, and who shall receive \$3.00 a day and expenses. In this respect the measure is very similar to the one now in force in Michigan, and which it is intended to repeal, substituting the proposed law providing for a State inspector. It was found in Michigan that the *county* law was largely inoperative, as no one felt personally responsible for ferreting out the disease wherever it might exist. But we must remember that the counties in California are as large as some of our Eastern States, and what might not be operative for Michigan would be just the thing for California. According to the California law there is no limit to the funds that may be used for the

suppression of foul brood, and I suspect that one man in one of the California counties, at least Ventura, would have all he could do. The full text of the law reads :

AN ACT

To Promote the Apicultural Interests of the State of California by providing County Inspectors of Apiaries, and defining their duties, and providing for their compensation, and repealing the act entitled "An Act to authorize the Board of Supervisors of the several counties of this State to appoint Inspectors of Apiaries, and provide for their compensation, and defining their duties, and for the further protection of Bee Culture," Approved March 13, 1883.

THE PEOPLE OF THE STATE OF CALIFORNIA, represented in Senate and Assembly, do enact as follows:

SECTION 1. Whenever a petition is presented to the Board of Supervisors of any county, signed by ten or more persons, each of whom is a property-holder resident of the county, and possessor of an apiary, or place where bees are kept, stating that certain or all apiaries within the county are infected with the disease known as "foul brood," or any other disease which is infectious or contagious in its nature, and injurious to the bees, their eggs, or larvae, and praying that an inspector be appointed by them, whose duty it shall be to supervise the treatment of said bees and apiaries as herein provided, the Board of Supervisors shall, within twenty days thereafter, appoint a suitable person, who shall be a skilled bee-keeper, Inspector of Apiaries. Upon petition of ten persons, each of whom is a resident property-holder, and possessor of an apiary, the Board of Supervisors may remove said Inspector for cause, after a hearing of the petition.

SECTION 2. It shall be the duty of the Inspector of each county to cause an inspection to be made, when he deems it necessary, of any or every apiary, or other place within his jurisdiction in which bees are kept; and if found infected with foul brood, or any other infectious or contagious disease injurious to the bees, or their eggs or larvae, he shall notify the owner or owners, person or persons, in charge, or in possession of said apiaries, or places where bees are kept, that the same are infected with foul brood, or any other disease infectious or contagious in its nature, and injurious to bees, their eggs, or larvae, and he shall require such person or persons to eradicate and remove such disease or cause of contagion within a certain time to be specified. Said notice may be served upon the person or persons, or either of them, owning or having charge, or having possession of such infected apiaries, or places where bees are kept, by any Inspector, or by any person deputized by the said Inspector for that purpose, or they may be served in the same manner as a summons in a civil action. Any and all such apiaries, or places where bees are kept, found infected with foul brood, or any other infectious or contagious disease, are hereby adjudged and declared to be a public nuisance; and whenever any such nuisance shall exist at any place within his jurisdiction, or on the property of any non-resident, or on any property the owner or owners of which can not be found by the Inspector, after diligent search, within the county, or upon the property of any owner or owners upon whom notice aforesaid has been served, and who shall refuse or neglect to abate the same within the time specified, it shall be the duty of the Inspector to abate the same, either by treating the disease, or by destroying the infected hives, together with their combs and bees therein.

The expense thereof shall be a county charge, and the Board of Supervisors shall allow and pay the same out of the general fund of the county.

SECTION 3. It shall be the duty of the County Inspector of Apiaries to keep a record of his official acts and doings, and make a monthly report thereof to the Board of Supervisors; and the Board of Supervisors may withhold warrants for salary of said Inspector until such time as said report is made.

SECTION 4. The salary of the County Inspector of Apiaries shall be three dollars per day when actually engaged in the performance of his duties.

SECTION 5. An Act entitled "An Act to authorize the Board of Supervisors of the several counties of this State to appoint Inspectors of Apiaries, and provide for their compensation, and defining their duties, and for the further protection of Bee Culture," approved March 13, 1883, is hereby repealed.

SECTION 6. This act shall take effect and be in force from and after its passage.

PROF. COOK'S REVIEW OF THE A B C BOOK.

In the columns of *The American Bee Journal* Prof. Cook has given a review of "Dadant's Langstroth" and "Cowan's Honey-bee," and now follows with a review of the "A B C of Bee Culture." In his usual kindly manner he says at the outset, "Without doubt this book has exerted a wider influence upon the bee-keeping world than any others ever written. Even its rivals can only be joyous in its extensive sale, as they know that, wherever it goes, it goes to help and bless." Coming as those words do from one who is himself the author and publisher of a leading rival work, the publishers of the A B C would be hardly human if they did not feel a warming of the heart at their utterance.

He then proceeds to point out passages in which he thinks he has reason to believe there is error, although admitting the possibility that in some cases he may be wrong. Some of these may properly deserve consideration and correction: in others there may be occasion to take exception to Prof. Cook's exceptions.

First, it is proper to call attention to the fact that the criticisms are not based on the edition issued last January, as one would suppose, but on the *old* edition—the one put out nearly two years ago. As it is, much that Prof. Cook criticises is not in the new book at all, such matter having been either re-written or stricken out altogether.

As to the first error pointed out, there is no error in the book, but the error consists in very careless reading on the part of the reviewer—a carelessness that is hardly excusable, for one expects extreme carefulness on the part of one who points out the errors of others. The A B C, page 2, in discussing what is to be done with second swarms that issue, says in effect that they must be watched, climbed after, and hived. This sentence is *immediately* followed by another which says, "If one thinks this too much trouble, he should prevent having after-swarms as I advise under that head." He ignores the fact that the watching and climbing refers only to swarms that *have* issued, to say nothing of the fact that it would be an impossibility to prevent the issuing of a swarm after the swarm has actually issued. He goes on to give the Heddon as the best method of preventing second swarms. In the edition just out of the press the very next sentence refers to the place where, among other methods of preventing after-swarms, the Heddon plan is given more fully and correctly than it is given by the reviewer. If careless reading is inexcusable on the part of a critic, still less is careless quotation when the exact words are pretended to be given inside quotation-marks. In answer to the question as to what shall be done with a second swarm that has issued, the A B C says, "Candidly, I don't know of any better way than," etc. "Candidly, I don't know any better way to prevent second swarms than," etc., is the way Prof. Cook quotes it. We feel sure that he will say there is no sufficient excuse for interjecting the words "to prevent second swarms" in a direct quotation

where they were neither written nor thought by the author of the book.

Prof. Cook objects to the statement that alfalfa honey is probably superior in quality to any other. He claims to be something of a judge of honey, and thinks alfalfa no better than clover, linden, sage, and perhaps others. It is a matter, not of judgment, but of taste. The best judge *might* prefer a flavor that no one else would fancy. The criticism, however, is a valid one. In matters which appeal entirely to taste, it is unwise to make sweeping statements.

Speaking of alfalfa the A B C says it takes about three years to get it to its best yield. Prof. Cook makes the pleasant correction that in California the maximum yield is often got the very first year in the later cuttings.

The reviewer thinks it is putting it too strong to hint that bees gather from the dry hay. The simple truth is told that "one man reports so much sweet in it that he has seen bees by the thousand working on the dry hay in the spring."

Speaking of this matter, Prof. Cook says, "This is putting it altogether too strong. Still, I do not think that too much can be said in favor of alfalfa, for it is a marvelous crop." The good professor will probably indulge in a quiet smile when he sees these two sentences side by side. "You are saying altogether too much for alfalfa," and "You can not say too much for alfalfa." Which is one to believe?

Prof. Cook objects to the definition of digestion given by the author, saying, "This is given as a question [what can be meant by that?], but he was not happy in his selection of authority." Not all will agree as to this, seeing the authority selected was no less than the able and careful T. W. Cowan. Prof. Cook teaches that "digestion is rendering the food osmotic."

Our reviewer says "malpighian" should be "malpighian." So it is in the latest edition, and one would hardly suppose an older edition should be the one reviewed. But his correction needs further correction, neither the book nor the critic being right, for "malpighian" should be "Malpighian."

The A B C says, "The blacks are also easier to shake off combs in extracting time, and for that reason alone some prefer them, or hybrids, to pure Italians, which can hardly be shaken off." Prof. Cook says, "I have very little trouble to fell at one shake every Italian bee from the comb if the latter fully fills the frame." If Prof. Cook can shake *every* bee from the frame at *one* shake, he will confer a lasting favor on some of the veterans if he will make the process known. In spite of their shaking off so easily, he considers they stick tighter than the blacks, and prefers them on that account, for the best men stick closest to their homes. There are times when one wants bees to stick by their comb, and then he will prefer the tighter grip of the Italians; but at times when one wants bees to shake off, as in the case mentioned, will one not prefer that the bees he is trying to shake off shall shake off rather than to stick on?

Prof. Cook says, instead of Mr. Benton spending years in India he "was in India only a few days." In relation to this point I have a letter from Mr. Benton, who says, "I left Cyprus for India in December, 1880; returned to Cyprus in May of the following year—absent just *five* months." While the statement in the A B C was not strictly correct, Prof. Cook is no nearer the truth, for he has gone clear to the other extreme.

He thinks it unfortunate that the A B C uses the term "worm" and "grub" as synonymous with larva. That criticism is worth considering, at least so far as to avoid calling a bee a worm during its early life. Whether much more than that could be accomplished is questionable. To his credit be it said that Prof. Cook is consistent in that he does not speak of wax-worms, but calls them larvæ or caterpillars. It is feared that, if a bee-keeper were to say that caterpillars had eaten up his combs, he might be laughed at. It is very likely, too, that for many years to come good scholars will say that wormy apples have worms in them. Moreover, when no entomologists are around, an insect-larva is a worm, for so the dictionary says. So is a larva of any insect a grub, by the same authority.

Instead of pollen and honey partially digested being fed to larvæ, Prof. Cook says it is pollen perfectly digested, with or without the addition of honey. When doctors disagree, who shall decide?

Prof. Cook objects to calling "viper's bugloss" blue thistle. He says it belongs to the borage family, is no thistle at all, and is like borage in being no serious pest—all of which he should have noticed is already told in A B C. But blue thistle is one of its popular names, so given in the dictionary.

He thinks drones from laying workers are as large as any, and it is likely that is true when they are reared in drone-cells.

"It is very doubtful indeed that unimpregnated eggs will ever produce workers," says the reviewer. It is not said in A B C that they ever will.

He thinks the word fecundate or impregnate should be used rather than fertilize. According to the dictionary, either is right.

Referring to feeding at night, Prof. Cook says, "Our author recommends this night work to prevent robbing." If he will read *carefully*, he will see that it is not recommended, only reported as being accomplished, and that feeding *toward* night is recommended.

Prof. Cook believes the A B C wrong in teaching that honey from apple-bloom has a strong rank taste like that from cherry-blossoms. He may be right; but this, like some other points to which he refers, was corrected in the edition just out.

In conclusion, we fear that Prof. Cook, overburdened with work like some of the rest of us, has not taken the pains to ascertain whether he himself is always correct upon all points. He is a pleasant writer—one whom the fraternity regards as authority; and whatever else we may say of him, he is actuated by the kindest of motives—a spirit that esteems others better than oneself.



Then said Jesus, Father, forgive them for they know not what they do.—LUKE 23:34.

The last state of that man is worse than the first.—MATT. 12:45.

I saw a statement recently in the papers, to the effect that three-fourths of the men in the United States use tobacco more or less. In my recent trip through the South I was impressed that something of the kind is true, especially if we include the colored people. Since my trip through the Southern States six years ago, there has been a very great increase in the use of tobacco among the blacks, and, I fear, among the whites, especially the poor classes that are least able to afford it. When so many are against me, Satan sometimes suggests I had better give it up and "let the world wag." But the voice of Christ Jesus says, "Not so." He was content, when here on earth, to work day and night, almost, without being weary, even though the multitudes were almost *all* against him. Some skeptical writer has said that Jesus never had more than a mere handful of followers, comparatively, at any time; that he was disappointed at every turn, and that his whole plan and his lifework were a failure. Dear me! Did it never occur to this poor foolish writer that he was only stating what the prophet Isaiah said, only in a different way? "He was despised and rejected of men; a man of sorrows, and acquainted with grief."

I might be disheartened and discouraged were it not for the constant stream of kind and encouraging letters that come in the mails every day—not only from men and women, but even children have told me how much good these Home Papers have done them. It seems as if human language could not be framed into sentences more touching and pathetic; and I would answer these kind letters as fast as they come, thanking the writers for their (as it sometimes seems to me) extravagant praise of my poor efforts, did time permit. But if I did this, as I feel prompted to do, I should not have time to write the Home Papers nor to advise and suggest to the hundreds who are in trouble. Therefore I have faith, even though compared with the great outside world I seem to be but a little speck or a mere bubble in a great wide sea. My Home Paper in the last issue was cut short for want of space; but I have something more to say right along in that same line. A few hours after having that talk with Mr. Buder I was thrown in company with the postmaster of Wewahitchka; in fact, we rode together one whole day on the steamer. Alluding to my talk on Sunday evening, he said something like this:

"Mr. Root, you struck a point that is needed right here in the South more than any other one thing I know of. In fact, you little dream of the harm tobacco is doing among the old and the young, male and female. I

keep a store, as you know, as well as the post-office. There is quite a class all around us who work from hand to mouth. Yes, it is worse than that. When a man gets a job, before he can go to work he tells his employer he has got to have something to buy victuals with. He can not work until he has had a good square meal. This is more or less true of the whites as well as of the blacks, but more often, of course, of the blacks; and an employer has very often to give a man an order on the store before he can get him to go to work. The orders come to me every day, reading, for instance, like this: 'Let Mr. — have \$1.50 worth of groceries, and charge it to my account.' Then I say, 'All right, Mr. —, what do you want for the \$1.50?' The reply is almost invariably something like this: 'Well, let me see. You may give me 50 cents' worth of tobacco.' 'Here is your tobacco—what next?' 'Well, I guess I will have to have 25 cents' worth of snuff.' There, you see, Mr. Root, half of the \$1.50 that he was to have for absolute necessities for his family goes for tobacco and snuff, and the rest for food. You may think this is an exaggeration; but I tell you it is a fair statement of affairs, not only in our locality, but almost all through the South. Half if not more of all these poor people earn goes for the very thing that keeps them down, behindhand, and crippled physically and intellectually."

I did not have the courage to tell the postmaster while he was talking that, if I were in his place, I would refuse to touch, taste, or handle, or have any thing to do with the accursed traffic. His answer, very likely, would have been that it would simply turn the trade to the other store across the way, without diminishing the amount of tobacco in any respect whatever. Well, even if this were true it would be starting to break the ground, even if it did nothing more. And, may the Lord be praised, we have an object-lesson right here in *our* town, that has been standing before the faces and eyes of all the people for fifteen or twenty years. A young man united with the Congregational Church. He was soundly and thoroughly converted. At the time, he owned a grocery store. He went to his pastor and to myself, in great trouble. With tears in his eyes he told us that he would lose money if he stopped the sale of tobacco. But his pastor and I both assured him that the Lord would take care of him. From that time to this he has positively refused to have any thing to do with tobacco in any shape or manner. His store is to-day the largest and finest in our town, and has been taking the lead during all the years that are past. His strict integrity is so well known that people telephone him from the right and the left to bring this, that, and the other, without even asking the price. His establishment *almost* makes no mistakes. People are not annoyed by being dunned months afterward for things they bought and paid cash for. His store is a clean and pleasant place for ladies to enter; and I think that even his rivals in business must acknowledge the statement I make is true.

Six years ago I told you about a boy I met

who was enthusiastic about building a boat—a boat that would carry him away out on the St. John's River, and enable him to see something of the world. I found that boy had grown to be a man, and had a wife and baby. To meet my appointments, and save time, I hired him to take me twenty miles to an adjoining town. We had lots of time to visit, and talk over matters. I always enjoy these confidential talks during my buggy-rides. I talked with this young man about his financial affairs. He greatly needed a little capital to get a start with. But he smoked a pipe a great part of the twenty miles. He had been reading GLEANINGS, so he knew what I thought of such things. Then he commenced with a sort of apology. This opened the way for me to speak freely. He said his wife felt so bad about it that he did break off once for three months, but that he wanted the tobacco just as much at the end of that time as at the beginning, and so he resumed the use of the weed, a slave to tobacco while he was little if any more than 21 years of age, with a baby to bring up in the footsteps of its father. He said his tobacco cost him about 50 cents a month—\$6.00 a year, and no more.

Said I, "Charley, if you keep on using just \$6.00 a year, and no more, that amount of money would buy a nice farm before you are as old as I am. But let me tell you Satan will not let his subjects off in that way. You tried to break off, and couldn't. You yielded to Satan. You have acknowledged him as master, and yourself as the slave—the *abject* slave. He gives the orders, and you obey them. He will say, 'A little more tobacco; and a little more; and a little more.' He is saying it already. This very afternoon you are using more tobacco than 50 cents a month will pay for. There will never be a minute in your life when it will be easier for you to break off and declare yourself a free man than at this very time. Satan is riveting your chains every day."

When I bade him good-by as he started back home, I went up close to him and begged him to remember our talk on tobacco. I told him particularly to remember that, through Jesus Christ, the great burden-bearer of all humanity, he could be a free man, unfettered and unshackled.

It seems a little funny, but a few days later I employed another man to take his horse and buggy to carry me from Oakland to Orlando. He, too, began to apologize for using tobacco, especially as he was a member of the church, and a good Christian man. Then he told me the following story. Oh how I wish it could be told in every home, in every pulpit in our land! yes, I will gladly send you printed copies of this story by the hundred or thousand if you will help me scatter them everywhere. I presume the man would not object to having his name given if it helps humanity, even if he does love tobacco. As nearly as I can remember, the pathetic story he told was something like this:

"Mr. Root, I once broke off from tobacco, and you may be astonished to know that I broke off without a bit of trouble. I was a

professing Christian, and the thing lay heavily on my conscience. It worried me day and night to think that I was setting an example before my family of growing boys that I knew was bad. The habit kept increasing. Finally I went down on my knees before God, and begged him to give me strength and grace for the ordeal that lay before me. The prayer was answered then and there. Deliverance came. For more than a year I was without tobacco in any shape or form. You will hardly believe me, but I declare to you it is true, *I did not want it one minute, day or night.* I rejoiced in my freedom. I urged others to do likewise. I was a clean man, redeemed and *emancipated* by the Lord Jesus Christ."

Oh what a testimony! No wonder I thought of Mr. Buder; yes, and did I not think of how even *A. I. Root* was, years ago, delivered from a fearful thing in just exactly the same way? O ye of little faith! wherefore do ye doubt? But my story is not ended. Now listen to what my friend told me:

"Mr. Root, after I had been freed from the terrible bondage for more than a year I was put on the jury. I was kept there several days. It was very monotonous, and we all became very tired. Every one of the other eleven jurymen was chewing and spitting almost constantly. The judge was chewing and spitting. Lawyers on both sides were chewing and spitting. Almost everybody in the courtroom was using tobacco. Every little while somebody would say, 'Have some tobacco with the rest of us to pass away the time. You need not use it after you get through court unless you choose.' Then I began to listen to the tempter. May God forgive me. I trifled with temptation, and took a chew. In an instant the old appetite opened up like a great cataract. It swept me off my feet, as it were. I chewed and chewed with the rest of them, and I have been using tobacco ever since. May God help me; but it seems as if I could *not* break off now."

It was almost a plaintive wail as he put some more of the stuff into his mouth. I said to him:

"My friend, do you remember that strange passage in Matthew, where Christ says that the condition of a man who has gone back to evil ways after casting them aside for awhile is worse than before he attempted to put the evil spirit out? The evil spirit comes back and brings seven other evil spirits with him."

"Oh! yes, Mr. Root, I do remember it. I have often thought of it, and I am that man. I see it clearly."

Let us now go back to the judge and jury, lawyers, and other officers of county and State. In Florida the whole crew were using tobacco. Is this an extreme case, or is tobacco *king* in like manner in all the other States of this Union? Is it true of the capitals of our States as well as of our county seats? How is it in the capitol building at Washington? When a man is accused of a crime, and the laws of our land accord him a fair and impartial trial, does he come before a body of his fellow-men who are clean men, pure in heart, with brains undimmed by a drug of any sort? or does he

sit before a tribunal of tobacco-chewers and tobacco-smokers? Is it the clearest heads the land can furnish who judge him, or is *tobacco* once more the *king* over all? I know this sounds hard and severe. I know many good men—yes, and some good women, will think I am a fanatic, and will say I spoil the good I might do by pushing things to such extremes. Dear friends, I do know it is the almost universal fashion for officers of the law, and, in fact, for public men in almost any capacity, to think they must smoke and chew just as soon as they are elected to office.* I have told you that our own county commissioners seem to think they would not be respected or considered fit for office unless they learned to use tobacco straightway as soon as they are installed into office, even though they have got along all their lives until past middle age without it, and even been hostile to its use. Let me digress a little.

At Lakeland, Fla., the train was an hour or more late. I did not wish to sit in the waiting-room; in fact, the ladies filled the room pretty well, any way. I wanted to be out in the open air. There was one seat outside that would hold three persons comfortably. Two traveling men sat there smoking and talking. I finally took one end of the seat and turned my back toward them. In the open air I could stand the smoke very well; but the series of oaths and curses while the men were discussing pleasantly and good-naturedly some common topic fairly made my blood curdle. The situation was nothing new to me. Everywhere in traveling I had to put up with smoking and swearing. We are told our churches are running down. Our ministers have always found it a little difficult to get the members to come to prayer-meeting, and more difficult still to get those who are there to stand up boldly and *testify* for Christ Jesus. Now, these traveling men had no hesitation at all in taking the sacred name of Christ Jesus on their lips in tones that could be plainly heard by men or women. *They* were not backward in "testifying"—testifying to what? Their love for the Redeemer? O my God! what a thought! They seemed to take pride in testifying to the world and to all around that they *belonged* to Satan; that they hated religion, the Bible, and Christian people. Why *else* should they curse and swear?

A little way from the depot, near an electric light, another crowd of people were waiting for a coming train. They were sitting on trunks and baggage. I found a seat out there. I wanted to go to Braidentown the next day, and I was a little uncertain about where to take the boat. Two of the traveling men very kindly explained the whole matter to me,

showing me how I could save time and considerable money. As the matter was a little complicated, they, with exceeding kindness, mapped it out for me, told me how to find the persons I wanted, and how to get back as soon as possible. They were very kind and pleasant people. I think one was a physician, because the other called him "doctor." Both smoked their cigars, and cursed and swore—not because they were displeased with any thing, but because it was the fashion. Has the use of tobacco any thing to do with this matter of profane swearing? When you are out among men, use your eyes and ears, and see what you think about it. Everybody knows—and the man who uses tobacco, perhaps better than any one else—that the use of the drug is not conducive to a high state of spirituality. It is a stepping-stone to drink; it is a stepping-stone to cursing and swearing; it is a stepping-stone to crime and suicide. My good friend, would you want to see your own boy learn to use tobacco? Our departed friend C. F. Muth and I once had a long talk (I think his wife and daughters were present). He had been bantering me. As our talk closed he looked very sober. He said to the rest of them, "Bro Root is right. His way is the *better* way. His way is the *safe* way." In your better moments you will agree with me; and if so, dear friends, why do you use tobacco, and drink and swear? Why do you commence any thing so repulsive to good breeding, to good manners, and to purity? *Why* do you set the example before boys who are growing up? This boy I have told you about, who has a wife and baby, and is not yet 21, learned to use tobacco because he saw the judges, the lawyers, and the doctors setting him the example.

It is not *bad* men alone who learn to smoke and chew. I have told you these traveling men are some of the pleasantest and kindest people in the world. Very often the conductor or the ticket agent is unable (or unwilling to trouble himself) to give one the information desired; but a traveling man will pull out a folder from his pocket, or a railway guide, and spend a lot of his time in figuring the thing out. Yes, he will often go to another traveling man, and he will not give up until he makes you understand just the difficulty in making the point you wish, at the least expense. He will tell you which hotels are best; that you want to make a bargain beforehand to get low rates; he will tell you the good men in a certain town to go to. Then when you try to express your thanks for the pains he has taken he says that is what we are in the world for—to help each other. His behavior is *Christianlike*. If he knew you did not like swearing he would stop while you are around; but if you do not say any thing his blasphemy and profanity, and sometimes obscenity, are such that you are prompted to think only the prince of the powers of darkness could have studied up any thing so awfully low and bad. These men do not *know* what they are doing. They have not got hold of the spirit of true Christianity—that is, the great bulk of them have not. Here and there

* Alexander MacLaren, in a recent number of the *Sunday School Times* says:

"We to day are sinking into an abyss because of our admiration for the military type of hero; and there is not such an immense difference between the mob that rejected Jesus and applauded Barabbas and the mobs that shout round a successful soldier and scoff at the law of Christ if applied to politics."

And if this same successful soldier or military hero smokes a cigar, straightway almost every American boy thinks that this, of course, is the way to be a man. God forbid that this state of affairs should continue.

we find a converted commercial traveler holding up the cross of Christ Jesus, and fighting his way against fearful odds. Oh how I do love to get hold of such a man, and put in my feeble voice to back him up!

At that place called Flora Home the landlord sat before the fire, puffing his pipe, with every thing in disorder all around him. A traveling man, with jovial good nature, gave him a short sharp sermon. He told him his pipe would be the ruin of him, body and soul, unless he gave it up. A bystander assured the stranger that ruin it was, then, for he would *never* let go of his pipe, even hardly long enough to sleep. When they found there were two "pious" people in the crowd they stared at us in evident surprise. Why, it brightened me up, and made me forget I was sick, to find somebody who could, good-naturedly, give the sleepy tobacco-soaked crowd a *shaking-up*. Now, in thinking this matter all over, I am forced to the conclusion that these people who are setting such bad examples, and who are going thus headlong down to ruin, do *not* realize or *know* what they are doing. In one sense they are crucifying again the Savior who meekly gave his life for wicked men. But I think it can be said of them, as Jesus said of his persecutors away back there in the dark ages, "Father, forgive them, for they know not what they do." And these good friends—for I have reason to call them so—these good friends of mine that I met and talked with, when they smoke and drink and swear, really, in the language of our text, "know not what they do." The great wide world needs teachers; it needs ministers of the gospel, and laymen who are not *afraid* to show their colors, to speak out and plead for Christ Jesus. For some reason we can but dimly understand, God has laid the responsibility on us all; and even though I myself sometimes feel discouraged to think there are so few who are with me, and so many on the other side, especially in this matter of tobacco, yet when I find, after many days, the good fruit that my feeble words have brought forth, then I get new courage, and go on my way rejoicing. May the Holy Spirit bless these words I have written; and may they find lodgment in human hearts, and bear fruit.

After dictating the above, a friend handed me the following, clipped from a prominent agricultural paper for 1899:

Tobacco manufactured in the United States during October was 24,951,914 pounds, an increase of 6,271,078 over the same month in 1898. The cigar production for last month was 471,800,050, an increase of 75,771,117 over the corresponding month of last year. The small cigars not included in these figures numbered 79,918,150, the greatest on record. Every other class of tobacco production shows a material increase, which is encouraging.

The above is called "encouraging;" but to *whom* is it so? If we divide the world into two classes—those who would be encouraged by such statistics and those who would be discouraged—on which side should we find the virtuous, mainly, and on which side the criminal, depraved, unthinking, indifferent, and those who use their columns for the propagation of such a gospel of degradation?



HICKS' ALMANAC, AND PROTECTING ORANGE-TREES.

As soon as I got South I began to hear Hicks quoted. In fact, one of our bee-keepers where I stayed over night had just invested between \$27 and \$28 in protecting some orange-trees because Hicks said there would be a severe freeze on a certain Saturday night. I happened to be there that Saturday night, and the weather was almost as warm as in June. Mosquitoes were lively, and the fireflies were flitting about after dark. My friend thought that probably the cold wave would get along a little later; but, although I was in the neighborhood several days, there was nothing of the sort—not even a trace of frost. He finally made a remark something like this:

"I told father I did not believe Hicks knew any better than anybody else what would happen six months ahead; but he was so sure that Hicks was sound and scientific that I went and invested all that money for protection. I now wish I had my money back in my pocket."

I asked to see just what Hicks said in his almanac; and for once in his life he had been unguarded enough to say right out in plain words that a severe blizzard would come at just about that time. Later on, in another part of Florida another bee-keeper insisted that Hicks *correctly* predicted a very severe freeze. I asked to see the prediction, and it read something like this:

"On the 13th, 14th, and 15th, Vulcan will be in the ascendancy; so, look out."

Now, if that means there is going to be a severe frost, then Hicks hit it; but if the riddle about "Vulcan" means one thing at one time and something else at another time, I do not regard it as very clearcut prophecy.

THE PECAN INDUSTRY OF THE SOUTH.

When at friend Day's, in Silver Springs, Miss., I found him quite enthusiastic about growing pecans. He had a number of trees that cost him all the way from a few cents up to choice budded paper-shell stock that cost \$1.50 each tree. He had also learned the art of budding this difficult tree, and showed me with considerable pride the shoots from buds he had set. Paper-shell pecans often bring extravagant prices—if I am correct, somewhere from 25, 50, 75 cts., and even \$1.00 a pound for large nuts with soft shells and finely flavored meats. Friend Alderman, of Wewahitchka, has had the fever for some years. In fact, he showed me a tree grown from a nut that he himself planted 27 years ago. This tree is now three feet in diameter about two feet above the ground. It is 50 feet high, and the branches have a spread of fully 50 feet. The trees bear annually barrels of nuts. Nobody had kept account of how many. I found some under the trees that were very nice eating, in the fore part of February. The tree

now stands in a rather deserted place, and a great part of the nuts are gathered, as the wind shakes them off, by the children, and, I fear, some by the pigs. The pecan-tree is quite hardy. Frost does no harm to it anywhere in the South. It has no insect enemies, and it is almost an ever-bearer—that is, choice budded stock. All over Florida, north and south, I saw more or less pecan-trees; and as they are closely related to the hickory tree, I am not sure but they could be grown clear up here in Ohio. Who can tell me more about it?

When I left River Junction, and went down the Apalachicola River, the river was high and the banks overflowing, as I told you on page 198. Well, it was very easy for the steamer to go down stream. In fact, between 8 o'clock at night, and before light the next morning, we made about 130 miles. But to get back to the railway once more it took all together about two days. These river steamers are not very reliable in their methods of transportation. They told me that they carried the U. S. mail, and had to be pretty nearly on time; but on that occasion the mail remained uncalled for something more than 24 hours. After reaching the railway my next stop was a place a few miles out of Palatka, called Flora Home. That is a very pretty name, is it not? Well, some of you may have seen for two years past the advertisements of a little paradise on earth, just starting up in Florida. Some newspaper firm in Chicago sent out the advertisements and circulars. To make a long story short, they told how fast town lots were being taken up, and that if you hustled you might possibly get one of the beautiful places. For a small consideration they would plant trees for you, so when you came to build your house in the beautiful growing village you would be greeted by green trees, shrubbery, etc., all your own. Quite a lot of Medina people got the fever a year ago, and a few went down there. I noticed in the circular some photos of magnificent residences that I supposed were a part of the town of Flora Home; but after I got on the train I noticed the circulars did not exactly say that. It said, "Views of typical Florida homes."

I reached the place after dark. The depot was certainly just what the real-estate men had photographed, but it looked a little cheap, even by moonlight. But that did not matter. I inquired for a hotel, and somebody pointed toward a light in the distance. I looked for a sidewalk, and finally pulled my feet, one after the other, through the sand. The hotel was a cheap frame house. The waiting-room and office was full of men, all smoking pipes until the air was thick with tobacco smoke. After some trouble I found which one of the fellows with the pipes was the landlord. He said I could have a bed if I would sleep with another man, and that every bed but this one had two occupants already. I asked if there was no other hotel in the place, or any place where any one could get a whole bed. For some reason or other they seemed to think I was rather green. They told me I would have to

take up with the half of the bed offered me, or sit in a chair by the fire. I went up to bed, being careful to close the door to keep out the smoke which was fast filling every cranny upstairs as well as down. I wanted a window open, but the three other occupants objected. They all had bad colds like myself. The bedroom was just large enough to contain the two beds. The three big men were soon snoring away, each one taking a breath that seemed to me required a large part of the air in that little room. If I opened the door the tobacco smoke would pour in, to say nothing about the bad language that came up from the crowd below playing cards just at the foot of the stairway. I was sick already, and, to cut the matter short, I do not believe I would recommend Flora Home as just the place for an invalid, no matter what the promoters of the new tropical town may tell you in their printed circulars.

As soon as it was light I got out of that—well, you may call it what you like—and started to look up some of the beautiful homes and gardens that the circulars told about. After some inquiry I found the nearest garden was about half a mile out of town. The man had, perhaps, half an acre under cultivation. There was a very pretty little peach-orchard with trees just coming into bloom. There was a little patch of strawberries also in bloom, and some fair-looking Grand Rapids lettuce in a bed covered with cloth; but as nobody seemed to be stirring in or around the house, even though the sun was up quite a distance, I did not have a chance to talk about the possibilities of the locality. At the depot I met a poor fellow, homesick and desolate enough. He had been attracted to Flora Home by the published statements, and was disappointed enough to find a vast difference between newspaper yarns and reality. One of the statements was that there were over fifty houses already built in the village, and many more started. I do not think there were half a dozen buildings, including the hotel, that might be said to be in the town. But a circle a mile in diameter might, perhaps, include fifteen or twenty buildings of some sort; and an area two miles across might include fifty buildings of some sort. The greater part of the land, like a great part of Florida, is sand so soft and yielding that it is a hard matter for one on foot, or even a horse and wagon, to get anywhere with any sort of load. Now, somebody who has real estate to sell around Flora Home might make a much better statement than I have done, and tell the truth; but I have tried to tell it carefully and honestly.

Before going further with travels I wish to say something under the head of

HEALTH NOTES,

or, perhaps we had better say, health notes while traveling. Sometimes I think it is something of a cross to bear, that I am obliged to be so exceedingly careful about what I eat and drink, especially when away from home; and at other times I am led to think there may be a providence in it. It enables me to be more helpful to those who like to follow me

in my researches after God's truths. As an illustration, wherever I am, wherever I stop, I generally make inquiries, almost the first thing, about the water closets. In the average hotel here in the North, we have warm and convenient closets, not only inside of the building, but, in newer hotels, on each separate floor. A great many times when I ask for a sleeping-room near the closet, I can have it without any trouble; and when I can find a nice clean bath-room, wash-room, and closet combined, near my sleeping-apartment, I feel quite happy.

In the South, the hotels, especially the older ones, pay very little attention to the health and comfort of their guests, in the line of closets. At hotels where they charge \$2 00 or \$2 50 a day, when you ask about the closet they will point away off across the garden. I am not finding any fault with private homes, mind you, for I found very comfortable arrangements of this kind everywhere I stopped during my recent trip. Let me give you a glimpse of one hotel where they charge \$2 50 a day. I was expecting to get breakfast there; but when I inquired for a closet the landlord told me to go into the kitchen, and then the cook would show me the way. The cook was a colored man. I do not blame him for being black, but I do blame him for being filthy-looking, and for having about the filthiest and *nastiest*-looking kitchen I ever saw on the face of the earth. To add to it all, he was smoking the nastiest tobacco I ever smelled in my life, with an equally nasty pipe. The cooking-room was thick with tobacco smoke; and as he leaned over his culinary work he kept on puffing. It seemed to me he was *trying* to blow the smoke into the stuff he was cooking. The closet the pointed out was equally filthy. I did not get any breakfast at that hotel; but I was intending to do so, and should have done so had not mere chance led me through the kitchen.

Now, I do not know but there is a providence in this matter. In fact, I begin to think that perhaps the great Father's plan is to send me back behind the scenes of the dining-rooms and other places. You know I have often gone through saloons and into their back apartments, just because this infirmity of mine *sent* me there. After this visit I have told you of, especially where colored men have charge of the cooking, I have been suspicious a good many times of the food brought. Some of these colored cooks, that run the whole ranch without having anybody to look after them, might *poison* you with their filth, and I do not know that they would care much if they did. I say this after sizing up several of these chaps as well as I could.

Now, some of my friends have felt much hurt, and some of you have stopped taking GLEANINGS because of my defense of the colored people. May be you will feel better when I say right here I do not believe colored men—and, for that matter, perhaps a good many colored women might be put in with them—should be *allowed* to cook without some competent white man or woman to superintend their work. I spoke about sitting

down to the table with a colored man or woman. On the Louisville & Nashville Railway, both going and coming, I became acquainted with two colored porters. One of them had charge of the buffet cooking; and I would just as soon sit down to a meal with either of these men as not. They were bright, intelligent, skillful, neat, and clean. But the average negro of the South, especially the tobacco-using blacks, are not fit to sit down with me nor to do the cooking for me or for my family. They might be washed up and civilized. But somebody would have to stand over them a good while. Now, this is a more serious matter than it seems. People die every little while from something the doctors call ptomaine poisoning. This poisoning, if I understand it, is from either animal or vegetable food in a certain stage of decay. While at River Junction I noticed a very bad taste in my mouth. Now please bear with me a little, friends, because I am going to touch on a point that concerns not only health but perhaps *life itself*. My mouth not only tasted bad, but the eructations of gas that came up from my stomach, or belchings of wind, some might call it, were "just awful." The emanations from a frog-pond in dog days were nothing compared with it. The smell and taste were more like rotten eggs. I felt fearful of the result. I thought if I had a good square meal of wholesome food the foul mass would probably be carried away and passed through the bowels; but for two or three days I carried with me that awful foul breath. I thought of the ptomaine poisoning, and I believe yet it was a mild form of it, caused by something I ate at some hotel or on some steamer where these filthy colored people did all the work. I meditated taking an emetic or something that would make me throw the stuff up; but I hoped Nature would take care of it after her own fashion. Well she did, and I am going to tell you how.

In about three days my stomach seemed to have regained its normal state; but when this poison got into the bowels it first produced diarrhea and then dysentery. My experience in Flora Home, shut up with three big men in a little tight bedroom, with tobacco smoke coming up from below, did not help Nature to get rid of the poison. I was sick all night. During the day I felt pretty well, and got off at a station called Favorita. My friend A. F. Brown lived six or seven miles out in the woods. Favorita is a very pretty name, but there are no houses there, nor is there a station. I do not know that there is even a platform. You just get off the cars, and step into the sand. A boy was there with a buckboard, waiting for the mail. I could not tell friend Brown what day I would be there, so he could not be at the train for me. I could not have ridden my wheel out to my friend's nor even gone on foot, for, besides the sand, there were long stretches of road that were all under water. In fact, it came almost up to our feet as we sat in the buckboard.

Just before reaching Bulow—and, by the way, that is not a town either, but just a post-office in the woods—we passed through some

of the most beautiful tropical forest I ever saw in my life anywhere. Both cabbage and saw palmetto were thriving in most wonderful luxuriance. The ground was so rich that every thing grew with surprising tropical luxuriance. The driver informed me that that was Mr. Brown's property. He said it extended nearly a mile.

At length we came out of the woods and drove up before what I should call a fine old castle. It was made of Florida wood, however, instead of stone. My friend rapped at the door, but no one answered. He said he thought Mr. Brown was out after ducks, but would be in soon. The postoffice was a mile further on, and no one lived anywhere near. I decided to stay and await my friend's return. As I knew him quite well I made myself at home, and built a big fire in the open fireplace, and after blowing a big shell to announce my presence I began to look around a little. The more I explored the great building, the more I was astonished. Mr. Brown is not a married man—in fact, he lives all alone. What was he doing in such a great house, with its furnishing of books, paintings, heavy expensive curtains, and all the paraphernalia of a rich man's castle? A beautiful porch with expensive ornamental carvings graced the front of the house. A pair of broad doors opened up at the foot of a broad stairway. Half way up there was a landing, and the stairs curved gracefully to the right and to the left. On this landing was a pair of storks that startled one by their lifelike appearance, with heads about level with your own. Between them was an expensive antique vase, and costly ornaments met one at every turn. There were out buildings without number, and for every purpose imaginable. There were acres of grapes to furnish wine to fill the spacious wine cellars. There had been acres of orange-groves, but they had gone into a decline.

It was getting dark, and still no one came near. It looked as if I might be called on to pass the night alone in the wilderness in that great castle. Something said to me the secret of these things in this place was that the house, for some reason or other, had the reputation of being "haunted." Mr. Brown was just the chap for such a place. The more spirits and hobgoblins the house contained, the better it would suit him, especially if he got a very low rent.

After reading various books in the choice library, just as I began to think I should have to investigate the larder and get along for the night as best I could, I heard voices; and, wasn't there a hand-shaking? Mr. Brown had a friend with him, and they had some of the handsomest ducks, fat and plump, that ever delighted any hunter's heart; and my friend soon convinced us that he had learned how to cook during all his days of bachelorhood. Four or five years before, the doctors told Mr. Brown he had but a few weeks to live. One of his lungs was gone with consumption, and the other was badly diseased. In fact, the sunken lung has now caved in, as it were, and the other one has developed so as to do double duty. When the doctors gave him up he went

where he could get the salt breezes from the ocean, and live mostly in the open air. When he goes to bed he has the windows wide open, winter and summer, virtually sleeping outdoors.

During the night I had evidence that poison that has been forced down into the bowels is not in a very much *better* place than having it in the stomach. I had a great deal of distress; but I felt sure that, by a strictly lean-meat diet (my old remedy, you know), I should be all right in a day or so. The second night, I had an attack of dysentery so severe that I feared I should never live through it. Mr. Brown and I were alone, a mile from anybody else, and many miles from a doctor. I managed to get out by the fire, and scraped up strength enough to pick up a stick of wood and strike on a door and wake Mr. Brown up. He recommended my old water-cure treatment. He said he got it from GLEANINGS, and it had done very much in helping him back to life after the doctors said he had got to die. I told him I had tried it very thoroughly just before going to bed, but it did not seem to reach the spot. He got me some water, just as hot as I could bear my hand in, and necessity became the mother of invention. I discovered then, for the first time in my life, how to get water further through the intestines than I had been able to get it before. Let me beg your pardon, dear friends, for speaking plainly, for I am sure it is a matter that may save life in an emergency. In order to get the hot water clear along the intestines to the seat of the pain, or poison, if you choose, while using the hot-water enema in the way we are familiar with, I first stood on my feet, then bent my body so as to bring my head as near my feet as I could. This brought the intestines below where the water is introduced, and I felt it slowly working down until it reached the foreign matter that Nature was trying to get rid of. By changing my position the water all came away. I did this repeatedly, and the pain gradually subsided so I could go to sleep. You may be sure I did some earnest praying for help when suffering that night. My prayer was heard and answered in the way indicated above. But I declared then and there, that, if God would spare me till morning, and I was able to travel, I would take a bee-line for home. However, in the morning friend Brown persuaded me to go and see a doctor first and ask him if he thought I was able to go on my trip. So we two started for the nearest physician. At first I felt as if I could hardly sit in my seat; but the sun came up, the mockingbirds were singing, the salt breezes were coming from off across the ocean, the tropical scenery was all around me, and little by little I began to straighten up. When we got near the doctor's, toward noon, I said:

"Why, friend Brown, I do not believe I *want* any doctor after all. If I have the right kind of food, and take care of myself, I think I can go on with my trip."

Again and again when in distress have my prayers been answered in the same or some similar way as outlined above.

Golden or 5-banded; 3-band Italians.

Some Points.

We have been extensively producing honey for the last ten years, hence know the value of good queens. During all this time we have made a close study of queen-rearing, and now run over 500 nuclei, hence we know how to rear good QUEENS. During the last two years we have spared neither time, money, nor skill in procuring and breeding up our strains of bees. We have bought queens from almost all who have claimed to have superior stock. We have taken them, tested them, and crossed them to each other and to our already fine stock of bees, and we now have the finest strains in the United States. WE GUARANTEE ALL QUEENS to be large, prolific, and well developed, to give entire satisfaction, and to arrive at your postoffice in good shape.

We have wintered over 800 fine queens, and our prices will be: Tested, \$1.25; select tested, \$2.00; breeders, \$3.00 to \$5.00 each; untested queens, March 15, \$1.00; after June 1st, 75c. Discounts in quantities, and valuable premiums given away to customers. Your subscription paid one year to the *Progressive Bee keeper* upon receipt of your first order for one-half dozen queens. Send a postal for large circular; tells all about ourqueens, methods, etc.; gives valuable information to every one.

N. B.—Motto "High-grade queens, prompt service."
O. P. HYDE & SON, Hutto, Texas.

Long-Tongued Yellow Queens.

"The cage of bees is received. The tongue-reach is 19-hundredths. This is very good."

The A. I. Root Co., per E. R. Root.

The above is from my best breeding queen. Her mother is also long tongued. *It runs in the family.*

These are my 5-band or Golden strain that have been bred for business for years. Queens, untested, \$1.00; 6, \$5.00; dozen \$9.00. Fine tested, \$1.50; 6, \$8.00. Select tested, \$2.00. Breeding, \$3.00 to \$5.00. I am printing a limited number of circulars with Florida views—nice ones—free. An extra one with different views for 5c stamp. Better get one at once.

J. B. CASE, Port Orange, Fla.

EARLY QUEENS FROM THE SOUTH

We are rearing queens now in full colonies by the best method known. Tested queen, \$2.00. Untested, \$1.00; 6, \$5.00; 12, \$9.00. Full colonies, \$6.00; 3 frame \$2.00; 2-frame, \$1.50. Add price of queen to nucleus wanted. Write for discount on large orders, and circular. Satisfaction guaranteed.

Christian & Hall, Meldrim, Georgia.

Honey Queens.

Have you noticed the change in my P. O. address?

Did you know I am seeking to give my customers the best service possible?

Did you know that I have as good or better queens than can be bought elsewhere? Many have found this out, and continue my best customers. Golden and leather colored honey queens, bred in separate apiaries. Bees, nuclei, and full colonies for sale.

Price of queens—March and April—tested or untested, each \$1.00; 6 for \$5.00; \$10.00 per dozen. Breeders, \$2.50 to \$5.00 each.

— ADDRESS —

W. H. LAWS, BEEVILLE, TEXAS.

Take Notice.

We are headquarters for the Albino bees—the best in the world. If you are looking for the bee that will gather the most honey, and the gentlest in handling, buy the Albino. We can furnish others, but orders stand 50 to 1 in favor of the Albino. I manufacture and furnish supplies generally. Send for prices.

S. VALENTINE, Hagerstown, Md.

SEE Special Low Clubbing Offers on Page 308.

LONE STAR APIARIES



G. F. Davidson & Sons, Props.

Breeders of fine Italian Queens. Established in 1885. Write for circular.

G. F. Davidson & Sons, Fairview, Texas.

QUEENS BY RETURN MAIL.

The Choicest of Tested Italian Queens \$1 each.

Large yellow queens, healthy and prolific; workers the best of honey-gatherers. Safe arrival and satisfaction guaranteed in every case. Send for price list.

J. W. K. Shaw & Co., Loreauville, La.

Albino Queens.

If you want the most prolific queens; if you want the gentlest bees;

if you want the best honey-gatherers you ever saw, try my Albinos. Untested queens, \$1.00; tested, \$1.50.

J. D. GIVENS, Lisbon, Texas.

QUEENS.—Golden Italians; unexcelled for business, beauty, and gentleness; bred from the best of stock obtainable. Untested, \$1.00 each; 6, \$5.00. Tested, \$1.50 each. H. C. TRIESCH, JR., Dyer, Ark.

Fruit Packages of All Kinds.

— ALSO —

BEE-KEEPERS' SUPPLIES. . .

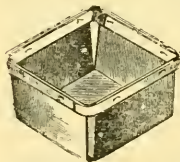

Order your supplies now before the busy season catches you. Price list free. Address

BERLIN FRUIT-BOX COMPANY, Berlin Heights, Erie County, Ohio.

D. COOLEY & CO., DEALERS IN BEE-KEEPERS' SUPPLIES, KENDALL, MICHIGAN.

Root's Goods at Root's Prices. : : Catalog free.

FOR SALE.—150 colonies of bees, with fixtures, house with contents, two lots and five acres of land in incorporate limits; fine team, buggy, cutter, etc.; also Marlin rifle and shotgun.

ELIAS FOX, Hillsboro, Wis.

WANTED.—To sell my entire and complete apiary, consisting of bees, hives, foundation, sections, shipping-cases etc (Root's goods). Every thing new and in Al condition. A big bargain will be offered, as I must sell. Write for particulars.

E. B. FOSTER, 506 W. Warren St., Bucyrus, O.

FOR SALE—Apiary of 90 colonies, Dove'd hives, \$22; farm of 57 acres \$750; together or separate; also horses, cows, etc.; basswoods at different elevations and in sheltered coves give a crop of honey every year; never knew any bee-disease around. Cause for selling, accident. For particulars address JOHN HAMMOND, Buena Vista, Scioto Co., Ohio.

BEAUTIFUL CALIFORNIA WILD FLOWER SEED. . . .

Golden Poppy, Mariposa Lily, etc., 4 packets 25c; 10, 50c; 16 75c. This ad. will not appear again.

BOX 23, Glendale, California.

SPRAYING FRUIT-TREES.

The question of spraying fruit-trees to prevent the depredations of insect pests and fungus diseases is no longer an experiment but a necessity.

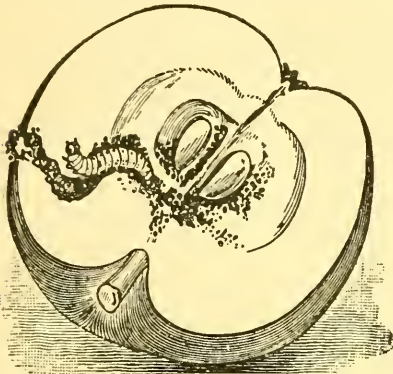

Our readers will do well to write Wm. Stahl, Quincy, Ill., and get his catalog describing twenty-one styles of Spraying Outfits and full treatise on spraying the different fruit and vegetable crops, which contains much valuable information, and may be had for the asking.

Sweet-Potato Seed.

Sound bright stock of the best varieties. Special rates by express. Descriptive price list free. Address

L. H. Mahan, Box 143, Terre Haute, Ind.

"KEEP OFF THE GRASS"

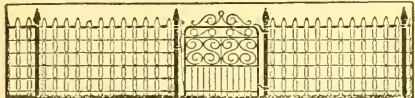

That unsightly sign will not be needed if you have the **HARTMAN STEEL ROD LAWN FENCE.** Keeps off everything but sunshine and rain. Best for Lawns, Schools, Churches, Cemeteries, etc. Steel Posts and Gates. Catalogue free. **HARTMAN MFG. CO.,** Box 80, Pittwood City, Pa. Or Room 46, 309 Broadway, New York City.

"Electric"
 applied to either
 Wheels or Wagons

is a guarantee of excellence. The public appreciates this fact. In 4 years we sold 320 000 Electric Steel Wheels and 30 000 Electric Handy Wagons. We make wheels to fit any wagon. Illustrated Catalog FREE.
Electric Wheel Co., Box 95, Quincy, Ills.

Union Combination Saw

For Ripping, Cross-cutting, Rabbeting, Mitering, Grooving, Gaining, Boring, Scroll-sawing, Edge-moulding, Beading. Full line FOOT and HAND POWER machinery. Send for catalog A.
SENECA FALLS MFG. CO.,
 44 Water St., Seneca Falls, N. Y.

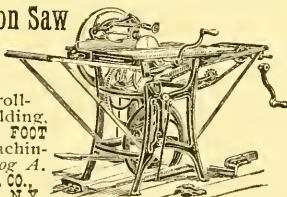

SEE Special Low Clubbing Offers on Page 308.

SPRAYING
 with our new patent
KEROSENE SPRAYERS
 is simple indeed. Kerosene Emulsion made while pumping. 12 varieties sprayers, Bordeaux and Vermorel Nozzles, the World's Best. **THE DEMING CO.,** Salem, O. Western Agents, Henion & Hubbell, Chicago. Catalog, formulas free

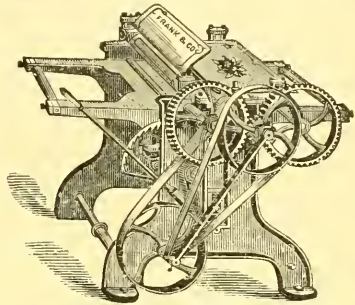

PLANERS

The above cut shows one of our small Planers, of which we make twelve different styles and sizes. Also large Planers, Band Saws, Buzz Planers, Moulders, Wood Lathes, and all kinds of

WOOD WORKING MACHINERY

Send for Catalogue.

The FRANK MACHINERY CO.

BUFFALO, N. Y.

The Power Question

—for farm use, dairies, creameries, cheese factories—anything requiring light power, is best settled by buying one of these

LEFFEL ENGINES.

They are made in both horizontal and upright pattern, with engine attached to boilers. Being very simple and direct in construction they are economic of fuel and great developers of power. Best for cutting and grinding feed, sawing wood, pumping water, separating cream, churning, &c. Made of the best material throughout they are durable and long lived.

Send stamp for our Book on Engines and Power.
JAMES LEFFEL & CO., Box 89, Springfield, O.

SEND NO MONEY—but

order any of our Sewing Machines sent C. O. D., on 30 days' trial. If you don't find them superior to any other offered at the same or higher prices or are dissatisfied for any reason, return them at our expense and we will refund you money and freight charges. For \$12.50 we can sell you a better machine than those advertised elsewhere at higher price, but we would rather sell you better Quality and Give Satisfaction. Our elegant Arlington Jewel-drop head, \$12.50. Our No. 9 Ball Bearing Arlington, 5 drawer, drop head, \$15.45. Write for large illustrated catalogue FREE. **CASH BUYERS' UNION, (Inc.)** 158-164 W. Van Buren St., B-345, Chicago

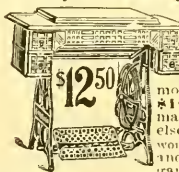



SECTIONS.

No withstanding the fact that we have been shipping sections recently to the number of a million or more a week, we still have on hand a reserve stock of upward of four million, and have a capacity for making eighty to one hundred thousand a day of ten hours. We have also a plentiful supply of choice white dry basswood of 1900 cut, as well as a million feet of new basswood cut the past winter right near us in Ohio, some of it the choicest lumber we ever had. The winter has been most favorable for cutting, and we have secured so much that we ran short of piling room, and had to stop shipment of large lots to be piled and seasoned elsewhere. We have been even more strict than usual in grading our sections, so that our No. 1 quality are unsurpassed; and the No. 2, of which we have a large stock, are unusually good—better than the best sections of a few years ago, yet 50 cents per thousand cheaper than the No. 1. Many will prefer them at the lower price.

BRASS SMOKERS

We are prepared to furnish smokers of brass, not only in the three larger sizes of Bingham but also the Crane and Corneil at 25 cents each more than the price of tin. We have not listed brass smokers in our catalog because we are not yet satisfied that they are as good as those made of tin except perhaps in localities on the sea coast where the salt air causes the ordinary tin smokers to rust out too soon. Out of hundreds of tin smokers sent every year in the mail we have had less damaged than we have had among the few brass that have been sent out. We take this as rather conclusive evidence that the brass smokers are not as strong as the tin. With careful usage they may not burn or rust out as quickly, but we have generally found that the tin fire-cup will last as long as the bellows under ordinary conditions, and therefore there is no need of a more durable material in the fire-cup. Better go slow on brass smokers till we know more about them.

BUSINESS AT THIS DATE.

We have made more carload shipments to date than in any year heretofore. Since the beginning of the season, about the middle of Dec., 1900 we have shipped sixty two carloads of 30 000 lbs or more each. Ten of these have been boxes, sixteen more have been hives, sections, etc., exported, and thirty-six to various points in this country. During the past week five cars have gone to various points on the Pacific coast, containing in all over a million sections and ten thousand shipping-cases. The demand for honey extractors this season has been something phenomenal, and an enlarged force of workers in this department has been working long over time for weeks, and still we are somewhat behind. California alone has taken one hundred and thirty-four extractors so far this year, sixty-five of these being four and six frame, with ball bearings. If this may be taken as an indication of the yield of honey we may look out for California this year. The latest reports from there are that late rains are lacking, and the honey yield may thereby be cut short or greatly reduced.

SPECIAL LOW CLUBBING OFFERS ON GLEANINGS.

New readers who may see this issue for the first time, and old ones who have perhaps been subscribers, and have dropped out in the meantime, will be interested in the following special clubbing offers that we are prepared to make:

OFFER NO. 21.

For 25c we will send GLEANINGS 6 months' trial subscription to new subscribers.

OFFER NO. 22.

For \$1.00 we will send GLEANINGS for one year and an untested Italian queen valued at 75 cents; but at this low price we reserve the right to send queen some time in July when we have a choice supply.

OFFER NO. 23.

For 50c we will send GLEANINGS from the time your subscription is received till January 1, 1902, so that the

sooner you send in your order the more numbers you will get.

OFFER NO. 24.

If you order \$10.00 worth of goods from our catalog at regular prices, paying cash for them, for 50 cents more you can have GLEANINGS for one year.

OFFER NO. 25.

For \$1.00 we will send GLEANINGS one year and a Clark smoker, postage 2c extra. Or, for \$1.25 we will send the Corneil smoker, postage 25c extra.

OFFER NO. 26.

For \$1.75 we will send GLEANINGS one year and our cyclopedia on bees, the A B C of Bee Culture, 1901 edition, of 500 pages.

CLUBBING OFFERS.

We will send the *Review of Reviews* or *Youth's Companion* new subscribers only, and a subscription to GLEANINGS, for \$2.25. Or for \$1.50 we will furnish GLEANINGS and any one of the following-named magazines or papers:

Success, Woman's Home Companion, Ohio Farmer, Michigan Farmer, Practical Farmer, Kansas Farmer, Indiana Farmer, Cosmopolitan, and Pierson's Magazine.

Subscriptions to *Review of Reviews* and *Youth's Companion* must be strictly new.

Old as well as new subscribers may take advantage of these several offers, but all arrears or back subscriptions must first be paid at \$1.00 a year. Refer to these offers by number to avoid mistakes.

Special Notices by A. I. Root.

WANTED, WHITE MULTIPLIER ONIONS AND SHALLOTS.

If any of the friends have either of the above kinds of onions I wish they would let me know how many, and what they will take for them. Better still, send a sample by mail, then there will be no mistake.

WANTED—SEED OF THE BLUE THISTLE OR CHAPMAN HONEY-PLANT.

If any of the readers of GLEANINGS can give us a few seeds, even to get a start, of this honey-plant, we will pay him a reasonable price for them. We also want some motherwort seed. Who has any?

YELLOW SWEET CLOVER.

As our supply is quite limited we can furnish this seed only in 5 cent packages. M. M. Baldrige, of St. Charles, Ill., an authority on sweet clover, says the yellow is quite different in many respects from the white.

ROOTED CUTTINGS AND OTHER GREENHOUSE PLANTS.

If you are at all interested in these things it will pay you to send to S. W. Pike, St. Charles, Ill., for his little catalog. After you have learned to handle rooted cuttings successfully in this way, you can get, for a few cents, plants that would cost dollars when they are grown up big. There are several nice things in our little greenhouse I should like to tell you about if space permitted.

CABBAGE, CAULIFLOWER, AND ALLIED VEGETABLES.

This is the title of another excellent book from the O. Judd Co., just out. It not only tells all about growing cabbage from seed to harvest, but also includes cauliflower, broccoli, collards, Brussels sprouts, kale, or borecole, and kohlrabi. These latter varieties of cabbage are largely grown in the South. The latter part of the book tells all about injurious insects, and fungous diseases of those plants. The book contains 125 pages, cloth-bound, and is fully up to date in every respect. Price 50c. It can be mailed from this office.

THE NEW HAND (75c) POTATO PLANTER.

When I returned from Florida I asked how the potato-planters were selling. They told me they had sold a few; and I began to think that perhaps I had overestimated the value of the implement. Pretty soon, however, our friends began to call for them, and now at this time, March 29, it seems as though almost every order included a potato-planter. The factory has sent us a gross and a quarter; but the present demand indicates that we shall need all of them. Special circular in regard to preparing the ground, using the tool, etc., mailed on application.

BASSWOOD OR LINDEN TREES.

Now is the time to set them out. One foot and under, each, 5 cts.; 10, 30 cts.; 100, \$2.00. By mail, 8 cts., 3), and \$2.25 respectively. We are at present sold out of the larger sizes, 3, 4, and 5 feet; but we have plenty from one to two feet. These will be, each, 8 cts.; 10, 50 cts.; 100, \$3.00. If wanted by mail, 12 cts., 65 cts., and \$3.75 respectively.

SEED POTATOES.

At this date, April 1, our potatoes are all in beautiful condition—not a potato sprouted. As some of the early kinds are nearly out, in ordering these perhaps you had better state if you can use some other kinds in case the kind you order is sold out. Our Early Ohio and Bovee are Michigan grown, and these have for years had a special reputation, as *Northern grown seed-potatoes*.

TABLE OF PRICES.

NAME.	1 lb. by mail.		3 lbs. by mail.		Half Peck.	Peck.	Half Bushel.	Bushel.	Barrel, 11 pks.
	%	%	%	%					
Red Bliss Triumph.....	15	35	45	50	75	1.25	3.00		
*White Bliss Triumph.....	15	35	45	50	75	1.50	3.50		
Early Ohio.....	15	35	45	50	75	1.00	2.50		
Early Trumbull.....	15	35	45	50	75	1.50	3.50		
Bovee.....	15	35	45	50	75	1.25	3.00		
Early Vermont.....	15	35	45	50	75	1.00	2.50		
New Queen.....	15	35	45	50	75	1.00	2.50		
Lee's Favorite.....	15	35	45	50	75	1.00	2.50		
Freeman.....	15	35	45	50	75	1.25	3.00		
Twentieth Century.....	15	35	45	50	75	1.50	3.50		
State of Maine.....	15	35	45	50	75	1.00	2.50		
Man's Commercial.....	15	35	45	50	75	1.25	3.00		
Carman No. 3.....	15	35	45	50	75	1.00	2.50		
Sir Walter Raleigh.....	15	35	45	50	75	1.00	2.50		
New Russet.....	15	35	45	50	75	1.00	2.50		
New Craig.....	15	35	45	50	75	1.00	2.50		

* This is the same thing as Junior Price.

Early Ohio and the New Russet, Michigan grown, can be shipped at above prices from Traverse City, Mich., when our customers are nearer that point.

EARLY OHIO POTATOES.

I have just purchased from a grower in Michigan a carload of extra-nice Early Ohio potatoes—the celebrated Red River stock. A year ago we paid Vaughan, of Chicago, \$3.00 a barrel (freight and all) for 30 or 40 barrels of this stock of Early Ohio potatoes in order to fill the orders we got along in March, April, and May—that is, after our own stock was exhausted. We sold these for \$3.50 a barrel. We did not make much, it is true; but we never had a complaint from them. We planted the same stock (Red River) on our creek-bottom grounds, and grew the finest crop of Early Ohios we ever had—nice shape, free from scab, extra early, good quality. And, by the by, the early Ohios were about as early, with one exception, as any potato we grew, and the yield was little, if any, behind. That one exception was the Bliss Triumph. But the latter blighted when the Early Ohio did not, so that the yield, although a little earlier, was much smaller. Now, we bought these Michigan grown Early Ohios by the carload so we can let you have them at the low price of \$1.00 per bushel, or \$2.50 per barrel of 11 pecks; ½ bushel will be 60 cts.; peck, 35 cts. There will be a few seconds, at \$1.75 per barrel. As we have always been sold short of Early Ohios ever since we have been in the seed-potato business, we expect to be this year, so you had better send in your orders at once. This same kind of potatoes can be shipped from Leslie, Mich., or Traverse City, Mich., when you are nearer the above points than to Medina, Ohio.

OTHER POTATOES FOR SEED.

At present writing, April 1, we are practically sold out of all seconds of early potatoes, except a few Early Ohio, as mentioned above. We have, however, seconds of Maule's Commercial, Carman No. 3, Sir Walter Raleigh, and New Russet. Of the firsts we have a fair stock of almost every thing except New Queen and Lee's Favorite. These two are entire y out. We have only a limited quantity of all kinds of early and extra early potatoes except Early Ohio, as mentioned above; and my candid opinion is, there is not a much better extra-early potato known at present than the Early Ohio, especially the strain we offer for sale, and such as we grew last year.

Any one sending \$1.00 for GLEANINGS, and asking for no other premium, may have 25 cents' worth of potatoes. And any one who is a subscriber, and who

sends us \$1.00 and one new name, may have 50 cents' worth of potatoes; but if the potatoes are wanted by mail the subscriber must pay postage.

SWEET POTATOES—THE NEW VARIETIES, ETC.

The number of varieties of sweet potatoes that have come out in the past two or three years, with high-sounding names, such as Gold Coin, General Grant, etc., especially when these new things are only well-known varieties under different names, has led to so much confusion that I've really spent hours in trying to untangle the matter and decide which is which. We have grown plants for sale for years, and I have tested most of the new things offered, enough to say what is really valuable or different from what we have already. I have finally settled down on four different kinds: A sweet potato and a yam with vines, and a sweet potato and a yam without vines.

First we have the old well-known yellow Jersey sweet potato. Yellow Nansemond and Yellow Carolina are only two more names for the same thing.

Then we have the Early Peabody Red yam. This is also the same thing as the Red Bermuda.

Then we have two vineless sweet potatoes—first the Vineless sweet potato, or General Grant, and this is round-leaved like the old-fashioned sweet potato.

Lastly we have the Vineless or Bunch yam, also known extensively as Gold Coin. This last is cut-leaved, and has a foliage entirely different from any thing heretofore known in the sweet-potato line.

I hope the above will enable you to straighten the matter out, and decide what you want. There are other varieties in the lists (nearly a dozen), but I think they might all be classed under some one of the four I have mentioned. I can not tell you which is best. One suits one locality, and another suits another.

In regard to prices, the Yellow Jersey is the cheapest of all. Our price will be, ½ peck, 25 cts.; peck, 40; ½ bushel, 75; bushel, \$1.25; barrel of 3 bushels \$2.75.

All the others will be, ½ peck, 35 cts.; peck, 60; ½ bushel, \$1.00; bushel, \$1.75; barrel, \$4.50.

Of the Early Jersey, we will send 1 lb. by mail post-paid for 20 cts.; 3 lbs., 50 cts. Of the others, 1 lb. by mail, post-paid, 25 cts.; 3 lbs., 60.

Plants of any of the above will be ready about May 1. The price will be by mail, 10 plants, 15 cts.; 100 60 cts. By express, 1000, \$3.00.

Sweet Potatoes and All About How to Grow Them. A little book by Waldo F. Brown, 10 cts. The above book will be sent free of charge to every one who buys 50 cents' worth or more of sweet potatoes or plants.

ARTIFICIAL EAR-DRUMS AND OTHER REMEDIES FOR DEAFNESS.

The Rural New Yorker says:

"The world seems to be filled with so-called cures and remedies for deafness just now."

To which I may add that these remedies, or at least a great part of them, do no good whatever. There are a good many bee-keepers who are more or less deaf, and in my travels I have taken pains to inquire about the remedies. Artificial ear-drums and other advertised appliances have been purchased and tried, in great numbers; but instead of the buyer getting any benefit, these ear-drums have done harm instead of good. I have had one experience of my own along this line. It is bad enough to rob people who are well and sound; but the man who goes deliberately to work to steal from a deaf man, and, after getting his money, do him harm instead of good—well, to put it mildly he should not be allowed advertising space in a respectable family newspaper.

HIGH-PRESSURE POULTRY, AND HIGH-PRESSURE EGG-LAYING.

There, didn't I tell you I could manage hens so as to make them lay in winter? It is not winter just now, but it is winter weather, even if it is March 22. We have just six pullets and one rooster. On Monday, March 18, they laid four eggs; Tuesday, five eggs; Wednesday, six eggs; Thursday, seven eggs. There were six eggs laid in the trap-nests; the seventh, without any shell, was dropped the night before on the dust-shelf under the roost. We might say this seventh egg was laid the day before; but every one of the six pullets laid an egg apiece in the trap-nests the day before. Mrs. Root says the neighbors' hens came over on the sly and laid an egg just to give me a chance to make a big report; and although that is possible, I do not think it probable. Is it not possible for a hen to lay an egg every day, and once in a while one in the night besides? Friday they laid six eggs again, an egg apiece.

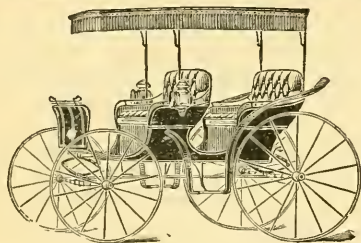

No. 717 Flat-bottom Surrey. Price with pole or shafts, \$75.00. As fine as retails for \$35.00 to \$40.00 more than our price. We make 43 styles of Surreys and Traps.

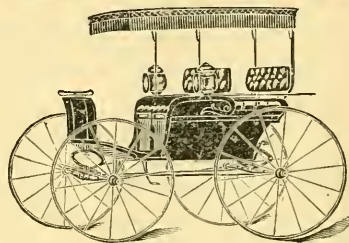

No. 212 Canopy-top Trap Price with pole or shafts, \$80.00. As fine in every way as usually sells for \$35.00 more than our price.

It Stands to Reason That there is Money Saved in Buying Direct from the Manufacturer.

The profits between the manufacturer and consumer are large. We Save You These Profits. We are the largest manufacturers of Vehicles and Harness in the world selling to the consumer exclusively. For 28 years we have conducted business on this plan. We guarantee to give you much better quality for the same money, or the same quality for less money than the dealer, jobber, or supply agent.

We Ship Anywhere for Examination and Comparison, Guaranteeing a Safe Delivery. We have no Agents.

We make 178 styles of vehicles and 65 styles of harness. Our large catalog shows every vehicle and harness we make, and gives prices. IT'S FREE.

Elkhart Carriage and Harness Manufacturing Co., Elkhart, Indiana.

W. B. Pratt, Secretary.

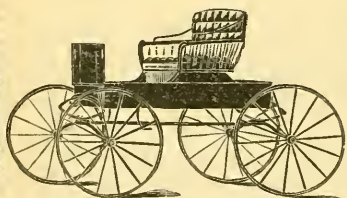

No. 232 Wagon.—Has High arched axles, 34 and 36 inch wheels, with $\frac{3}{8}$ in. solid rubber tires. Bailey body loops, rubber-covered steps and open head springs. Price \$65.00. As good as usually sells for \$25.00 to \$40.00 more than our price.



No. 47½ Single-strap Harness; nickel or imitation rubber trimmings. Price \$9.50. As fine as sells for \$13 to \$15.

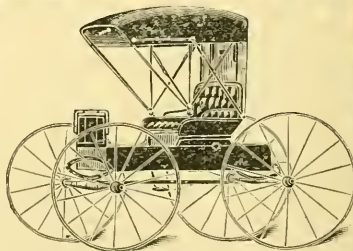

No. 292 leather cover top-buggy, with Bailey loops, long distance axles, open head springs, and rubber-covered steps. Price \$47.00. Same in every way as retails for \$75.00.



DEAL DIRECT with the Makers.

When you buy a carriage, buggy or harness. Choose from the biggest stock and fullest assortment, and pay only the cost of making, with but one moderate profit added. Our plan of selling direct from the factory insures satisfaction—your money back if you're dissatisfied with your purchase—and enables you to **save the dealer's profit.**

No. 3034 Buggy. Price \$38.30 with leather quarter top.

Our complete illustrated catalogue, showing many styles of high grade vehicles, harness, robes, blankets and horse equipments, with detailed descriptions of each, mailed free. Write for it and learn how cheaply you can buy when the jobber's and dealer's profits are cut off.



No. 240. Single Strap Buggy Harness. Price \$7.95.

THE COLUMBUS CARRIAGE AND HARNESS CO., Box 772, Columbus, O.



THE WHOLE WORLD ADMIRES Split Hickory Vehicles,

and the best of it is, the closer you examine them, the better you like them. They are built right all the way through and they have a hundred special features—"little things" that add to their comfort, safety and durability found on no other. We sell

DIRECT FROM THE FACTORY

You save all agent's profits. We ship on approval. You don't keep it unless you think it a bargain. Send for our Vehicle and Harness catalogue. It will save you money.

OHIO CARRIAGE MANUFACTURING CO.,
27 W. Broad Street, Columbus, Ohio.

AN EARLY TABLE LUXURY



NORTHROP KING & CO.
STERLING CUCUMBER
BEST FOR ALL PURPOSES

N. K. & Co.'s "STERLING" Cucumber is

- 1st. The earliest white spine Cucumber, suitable for table, market or shipping purposes, under all conditions of culture, whether under glass or in open ground.
- 2d. It is one of the greatest producers of all varieties; and at all stages of growth is the handsomest and most attractive of all sorts.
- 3d. It is of a very deep green color, which it retains during a much longer period of growth than any other variety, while in symmetry of form it is so regular, so uniformly one like the other, as to create comment wherever they are seen.
- 4th. The quality is superb, being exceedingly brittle and crisp. The flavor is delicate and entirely devoid of the bitter taste so frequently noticeable in other varieties.
- 5th. As a shipping cucumber the "Sterling" cannot be surpassed, as it holds up in color and quality better than any other variety.

FOR ONLY 10 CENTS

we will mail a packet containing sufficient seed of this superb cucumber to abundantly supply the average family. Also a copy of our catalogue of Northern Grown tested seeds, and our new booklet "Seed Truth," which tells how to buy seeds right, no matter where you get them. Send now, as this offer will not appear again.

NORTHROP, KING & CO.
Seed Growers
MINNEAPOLIS, MINN.



HOW TO BUY A \$75.00 BUGGY

Follow instructions carefully.

- 1st. Send for our large free catalog of vehicles and harness.
- 2nd. Select the rig you want and order it on our 10 Days Free Trial.
- 3rd. After trying it, if perfectly satisfied that it is the best bargain you ever saw for the money, draw \$75 out of the bank, give your wife \$27 for pin-money and send us the \$48 and you will have the best \$75 rig you ever saw. Your wife's \$27 is the two profits—dealer's and jobber's—you save in buying from the factory. Write for our large illustrated catalogue and follow directions carefully.



Kalamazoo Carriage and Harness Co.,
Box 22, Kalamazoo, Mich.



Don't Pay a Cent

of profit to agent or dealer when you can with equal safety, satisfaction and guarantee buy direct from manufacturers and save half the cost. Our Vehicles are built for hard wear. Best materials throughout. New styles. Approved Workmanship. Unqualified guarantee. \$29.25 and upwards. Our Harness and Saddles comprise a complete line of standard work \$4.25 upwards. In no event place your order without writing for our Free Catalogue containing valuable suggestions to the vehicle & harness buyer

CASH BUYERS' UNION, (Inc.)
158 W. Van Buren St., B-345, Chicago, Ills.

FOR SALE CHEAP.—100 nearly new second-hand Hilton chaff hives. Hives are at Wallin, Benzler Co., Mich. For particulars inquire of L. C. WOODMAN, Grand Rapids, Mich.

Wants and Exchange.

Notices will be inserted under this head at 10c per line. You must say you want your ad. in this department, or we will not be responsible for any error. You can have the notice as many lines as you please; but all over ten lines will cost you according to our regular rates. We cannot be responsible for dissatisfaction arising from these "swaps."

WANTED.—To exchange bicycles and tandems, gasoline engines (new and 2d hand, 1 to 20 horsepower), for wood and metal working machinery of all kinds.
ROBERT B. GEDYE, LaSalle, Ill.

WANTED.—A renter for 60 colonies of bees, or will sell the whole to some good man. I can not attend to them as they should be. I have a neighbor who has 40 colonies who also wants to let out on shares. He is only three miles from me. Single man preferred.
R. J. MATHEWS, Rosedale, Miss.

WANTED.—To exchange two No. 5 Novice honey-extractors, good as new, for bees in any kind of hives or shipping-boxes, with or without brood-combs. Make offer.
E. W. BROWN,
Box 102, Morton Park, Cook Co., Ill.

WANTED.—To exchange a Marlin repeater rifle and reloading tools for bees or offers. Send 2c stamp for terms.
ROBT. J. CARY, Norwalk, Conn.

WANTED.—To exchange a farm of 58 acres—good buildings, fruit, and water, level, no waste land—for bees and location. Florida preferred.
J. O. MUNSON, E. Lansing, N. Y.

WANTED.—Large apiary in good basswood location in Wisconsin. Also a man to take permanent charge of same on shares with a guaranteed income.
H. W. FUNK, Normal, Ill.

WANTED.—A handy, trustworthy young man to assist in apiary work and learn improved methods. Tact rather than experience required. Address with recommendations.
ARKANSAS VALLEY APIARIES, Las Animas, Col.

WANTED.—A location for a custom saw and feed mill. Address
WM. S. AMMON, 216 Court St., Reading, Pa.

WANTED.—Who wants my 30 years' experience in 7 months, at \$18.00 a month and board, to work at bees, and work on farm when there is no work at bees. Must have some experience with bees, and temperate. For willing and competent man I will endeavor to secure a winter job in Cuba. Write experience to
W. L. COGGSHALL,
West Groton, Tompkins Co., N. Y.

WANTED.—By an experienced bee keeper, a position as apiarist, or will work a large apiary on shares in the basswood belt of Wisconsin, Michigan, or York State. Best of references. No tobacco or whiskey.
F. W. DEAN, New Milford, Susq. Co., Pa.

WANTED.—Young man for apiary, greenhouse, and general work. Married man preferred. Experience not as necessary as industry, reliability, and willingness to learn.
J. A. GREEN, Ottawa, Ill.

WANTED.—To exchange a trunk-maker's cutter for cutting tin and sheet iron, cost \$35 good as new, for typewriter.
J. B. MASON, Mechanic Falls, Me.

WANTED.—To exchange a gentleman's solid gold watch, 22 rifle, and eggs from egg-laying strain of W. P. Rock and S. C. B. Leghorn chickens, for nuclei, queens, etc.
O. P. HIPPER,
Rural Route No. 1, La Junta, Col.

WANTED.—To pay cash for a number of strong colonies of Italian or hybrid bees with young queens on L. frames. Address
L. H. ROBEY, Worthington, W. Va.

WANTED.—To buy or exchange for a lot of good extracting combs—L. size.
H. LATHROP, Browntown, Wis.

WANTED.—Bees by the pound.
D. McLAREN, Alliston, Ontario, Canada.

WANTED.—To exchange 500 L. frames (comb) for bees.
J. H. STANFORD, Larrabee, Cher. Co., Ia.

WANTED.—Fifty colonies Italian bees in 10 frame Dov'd hives; Hoffman wired frames
CHAS. D. HANDEL, Savanna, Ill.

WANTED.—An experienced apiarist to take charge of 100 hives of bees on salary or on shares, in Otero Co., Col. Do not apply unless best references as to character and ability can be furnished.
Address DR. W. W. BULETTE, Pueblo, Col.

WANTED.—ALL TO KNOW that I sell my hives and Root's goods at Root's prices, and will pay \$50 in three cash prizes for the best white honey exhibited at the Pan-American Exposition at Buffalo this year, produced in Danzenbaker hives in New York State; also the same for the three best lots outside of New York State. Specific information given on application.
F. DANZENBAKER,
Box 66, Washington D. C.

WANTED.—To sell or rent my entire apiaries of 250 colonies, and fixtures to work for extracted honey, located in one of the best basswood belts of southwest Wisconsin, town of 500 inhabitants. Good schools and churches. Located on W. W. R. R. Also good, new 8-room house, and 2 acre block. Must sell on account of health.
A. J. McCARTY, Viola, Wis.

WANTED.—To sell ten-frame Simplicity hives, brood-frames, combs, Barnes' s/w, extractor, etc., both new and second hand, at half price. Also surveyor's transit. For particulars, address
A. N. CLARK, Agricultural College, Mich.

FOR SALE. One 10 h-p engine and boiler (up-right boiler), one 18 inch planer, one Root saw-table, 30 ft. line-shafting, hanger pulleys and belting. Will take \$250.
J. W. BITTENBENDER, Knoxville, Ia.

1901—Golden Italian Queens—1901

Untested—April, May, and June—\$1.00 each, or \$11.00 per dozen; after June, 50c each, or \$5.00 per dozen. Tested queens, half more. Breeding queens \$3.00 and \$4.00 each. W. P. Rock eggs from 91-scoring birds at \$1.10 per 15. Cocks, \$1.00 each.

GEORGE W. COOK, - SPRING HILL, KANSAS.

CHAS. ISRAEL & BROS.,

486, 488, 490 Canal St.,
Corner Watt Street, N. Y.

HONEY & BEESWAX.

Liberal Advances made on Consignments.
Wholesale Dealers and Commission Merchants.
Established 1875.

15 Swarms of Italian and Hybrid Bees For Sale.

In Dovetailed chaff hives, nearly new. The hives are 8 frame, L. size. Will be sold cheap, as I am unable to look after them.

CHAS. A. MONROE, S. Shaftsbury, Vt.

EGGS

\$1 00 for 15 best Brown Leghorn or B. P. Rocks. Illustrated descriptive egg circular free. H. B. GEER, Nashville, Tenn.

FOR SALE.—Extracted honey from alfalfa; 60-lb. cans at 7 cts., and smaller cans.
D. S. JENKINS, Las Animas, Colo.

FOR SALE.—300 pounds fancy comb honey. Write for prices.
WILLIAM MORRIS,
Las Animas, Col.

FOR SALE.—Nice comb honey in 3 $\frac{3}{8}$ x5 and 5x4 sections. Extracted in 60 lb. can, 2 in a case; nice Spanish-needle honey. Address
LOU S. WERNER, Edwardsville, Ill. Box 387.

SEE Special Low Clubbing Offers on page 308.

The Modern Farmer and Busy Bee.

Emerson Taylor Abbott, Editor.

A live, up-to-date Farm Journal with a General Farm Department, Dairy, Horticulture, Live-stock, Poultry, Bees, Home and General News. The Editor has had practical experience in every department of farm work. To introduce the paper, it will be sent to New subscribers one year for 25c. Sample copies free. Best Advertising Medium in the Central West. Clubbed with *Gleanings* for \$1 00.

ADDRESS

Modern Farmer, St. Joseph, Mo.

Carman No. 3 & Sir Walter Raleigh Potatoes.

Bushel, 80c; barrel, \$2 25. Choice white Wyandotte and White P. Rock eggs, \$1.00 per 15. Gibraltar and Pritzetaker onions and other vegetable plants. Circulars free. CHRISTIAN WECKESSER, Marshallville, O.

Black and Hybrid Queens for Sale.

We have about 90 young black and hybrid queens for sale at 40c each, or six for \$2.00. *Safe delivery insured.* Orders filled at once.

SWINSON & BOARDMAN, Macon, Ga.

Root's Goods for California.

We have just received a large carload of sections, extractors, smokers, veils, etc., direct from the factory, and are prepared to supply bee-keepers with the same promptly. Do not send a long distance and pay high freights. Write for our prices.

M. R. MADARY, - Fresno, California.

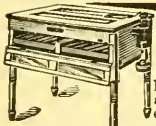

**200-Egg Incubator
for \$12.00**

Perfect in construction and action. Hatches every fertile egg. Write for catalogue-to-day.
GEO. H. STAHL, Quincy, Ill.

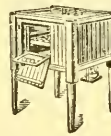

SELF-REGULATING

We have a perfect system of regulating temperature and moisture.

MARILLA INCUBATORS and **BROODERS** are guaranteed. Your money back if you want it. Send 2c stamp for catalog
MARILLA INCUBATOR CO., Box 62 Rose Hill, N.Y.

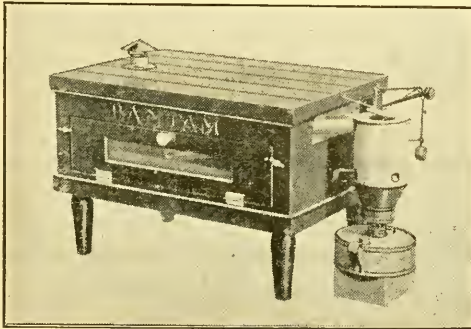

BIDDIES ^{AND} BEES.
MAKE THEM BOTH PAY.

50-egg Bantam. Self regulating.

Holds 50 ordinary-size eggs. No sitting up nights. 20 minutes' attention in twenty-four hours will operate it. Sold on

30 Days' Trial for \$5.00

Over 15 000 in use, and thousands hatching 50 chicks from 50 eggs. You can do as well. Either hot-water or hot-air heating. We have a brooder to go with it for \$3.00. Our catalog of valuable information, and describing incubators and brooders of all sizes and prices—all on trial—sent for the asking if you mention this paper.

Buckeye Incubator Co., Springfield, Ohio.

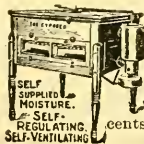

You Can't Afford to Guess

at results in the poultry business. If you fail to raise the chicks, you simply have no business. The way to be absolutely sure about getting the chicks is to employ a **Cyphers Incubator** in your hatching. We guarantee them to last 10 years and to out hatch any incubator made. The best way to know about it is to read our 224 page, (8x11 in.) book, "**Profitable Poultry Keeping.**" Has 250 illustrations and covers the entire subject. We send it for 10 cents in stamps. Ask for book 74. Circulars mailed free. Address nearest office.

CYPHERS INCUBATOR CO. Chicago, Ill., Wayland, N. Y., Boston, Mass.



STEEL WHEELS

for your **FARM WAGONS**

any size wanted, any width of tire. Hubs to fit any axle. No blacksmith's bills to pay. No tires to reset. Fit your old wagon with low steel wheels with wide tires at low price. Our catalogue tells you how to do it. Address **EMPIRE MFG. CO., Quincy, Ill.**



Our Incubators

have all the latest improvements, are sold at very low prices and guaranteed to please every customer. Send 6 cents for our 164 page catalogue which contains full descriptions of our extensive line and tells how to raise poultry successfully. Plans for poultry and brooder houses.

Des Moines Incubator Co., Box 503, Des Moines, Ia.

ROOM AT THE TOP

Recognizing that there was "room at the top," we have issued not an ordinary catalogue but the



20th Century Poultry Book.

Contains the latest and best thought on the poultry question, from the egg through all its changes, to the market. No subject missed. Written from practical experience. The world renowned **Reliable Incubators and Brooders**, used all over the U. S. and in 51 foreign countries, receive deserved attention. Book mailed anywhere for 10c.

RELIABLE INC. & BROODER CO., Box B-49 Quincy, Ill.



HORSE-HIGH!

... BULL-STRONG ...

With our **Duplex Automatic Ball Bearing Woven Wire Fence Machine**, any farmer can make 100 styles, and from **50 to 70 rods a day** of the best and most practical fence on earth at a cost for the wire to make it of from **20 to 30c. per rod**. We sell **Ornamental Fence and Gates, Plain, Barbed and Coiled Spring Wire** direct to the farmer at wholesale prices. Catalogue free.

KITSELMAN BROS., Box D31, Muncie, Ind.



GREEN RAPE

costs **25 cents per TON**

Greatest, Cheapest Food on Earth for Sheep, Swine, Cattle, Poultry, etc.

Will be worth \$100 to you to read what Salzer's catalogue says about rape.

Billion Dollar Grass

will positively make you rich; 12 tons of hay and lots of pasture per acre, also Bromus, Pecos, Speltz (400 bu. corn, 250 bu. oats per ac.) etc., etc.

For this Notice and 10c. we mail Big catalogue and 10 Farm Seed Novelties, fully worth \$10 to get a start.

For 14c. 7 splendid vegetable and 3 brilliant lower seed packages and catalogue.

JOHN A. SALZER SEED CO., LA CROSSE, WIS.

THE FASHION FLOWER OF THE DAY

Is the beautiful sweet pea. Recognizing the popularity of this garden favorite, we offer for 1901 five new and handsome sorts, for 2-cent stamps, together with a copy of our new seed book, the most modern catalogue of modern times. It is so costly a production we cannot afford to gratuitously distribute it. (Postage alone is 5 cents.) We send it postpaid for 10 cents together with one packet of each of these:

5 Grand New Sweet Peas.

Navy Blue. The best to date.	} Five separate packets.
Gorgeous. Unique and distinct.	
American. White striped carmine.	
Royal Rose. A blushing beauty.	
Salopian. Intense scarlet.	

ONLY 10c.

With our new seed book free.

Features of our new catalogue for 1901 are 136 pages (9 3/4 square inches of reading and illustrations) 7 handsome colored plates. A list of novelties in vegetable, farm and flower seeds to be had nowhere else this year, **35 new sorts now offered for the first time**, and a complete list of standard seeds, bulls, plants, fruits, etc., etc. Other features, full cultural directions and many cash prizes. If you want an up-to-date garden and the best you ever had you must plant Maule's Seeds. Send 10 cents for catalogue and these new sweet peas to-day. Address,

WM. HENRY MAULE,
1711 Filbert Street, Philadelphia.

I. J. Stringham, 105 Park Place, New York City.

Keeps in stock a full line of modern appliances for bee-keepers.

COMB FOUNDATION

is one of our specialties. If you expect to use any quantity get our prices. Catalogue free. Apiaries at Glen Cove, Long Island.

I. J. Stringham, 105 Park Place, New York City.

\$50.00 POP CORN.

100 seeds of this wonderful new Pop Corn for 25c and chance to compete for our cash prizes. Seed Due Bill good for 25c worth of other goods **FREE** with every order for Pop Corn. First prize winner last year raised at the rate of 188 bushels per acre. We will pay \$50 for its equal in quality. Handsome seed catalog and free presents with every offer.

C. M. Coodspeed, Skaneateles, N. Y.



Don't Brag About

a wire fence until you have used and abused it. Ours have been Used and Abused for 15 years.

Page Fence Co., Box S, Adrian, Mich.



50 VARIETIES.

I breed fine poultry on one of the best equipped poultry farms in the world. Send 8c in stamps for new 1901 Book, telling all about 50 varieties, with special prices on fowls and eggs.

B. H. GREIDER, Florin, Pa.

S. C. BROWN LECHORNS.

I use well-striped breeding cocks. Eggs, \$1.00. Cockerels, \$1.00 and up. Also Italian bees. Circular free.

H. M. MOYER, SHANESVILLE, PA.

1200 FERRETS. All sizes; some trained; first-class stock. New price list free. N. A. Knapp, Rochester Lorain Co., Ohio.



Belgian Hares

I have some fine hares for sale at reasonable prices.

J. F. Moore, Tiffin, Ohio.

SEE Special Low Clubbing Offers on Page 308.

Mr. A. I. Root's Writings

of Grand Traverse territory and Leelanau County are descriptive of Michigan's most beautiful section reached most conveniently via the

Pere Marquette R. R.

For particulars address W. C. Touzey, D. P. A., Toledo, Ohio.

TWENTY MILLIONS IN GOLD FROM ALASKA DURING THE YEAR 1900.

Five millions of this came from the Nome district. Government officials estimate the output from the Nome district will be doubled the coming season. The Bluestone, Kougarak, and Pilgrim Rivers have been found very rich. There is hardly a creek from Port Clarence to Norton Sound in which the precious metal is not found, and hundreds of creeks unprospected. A rich strike has been made on the Yellow River, a tributary of the Kuskokwim.

For full information regarding routes, steamship accommodations, and rates to all points in Alaska, address C. N. Souther, General Agent, Passenger Department, C. M. & St. P. R'y, 95 Adams St., Chicago.

Home-seekers' Excursions.

On the first and third Tuesdays of each month the Chicago, Milwaukee & St. Paul R'y will sell round-trip excursion tickets from Chicago, Milwaukee, and other points on its line to a great many points in South Dakota, North Dakota, and other western and north-western States at about one fare. Take a trip West and see the wonderful crops, and what an amount of good land can be purchased for a little money. Further information as to rates, routes, prices of farm lands, etc., may be obtained by addressing F. A. Miller, General Passenger Agent, Chicago, Ill.

POULTRY-BOOK FREE. 64 pages, illust'd, with 3 mos. trial subscription to our paper, 10 cts. Belgian hare book, 25 cts. Inland Poultry Journal Indianapolis, Ind.

BURPEE'S SEED-SENSE FOR 1901

is mailed **FREE** to all. A Bright Business Catalogue of ninety pages that tells plain truth about **BEST SEEDS** that Grow. Write a postal card to-day, or send ten cents (stamps or silver) for **BURPEE'S QUARTER-CENTURY FARM ANNUAL**,—a New Book of 220 pages fully worth a dollar. W. ATLEE BURPEE & CO., PHILADELPHIA, PA.

New Smith Premiers Nos. 5 and 6.

The No. 6 takes paper 18½ inches wide and writes lines 16 inches long. The No. 5 takes paper 11 inches wide and writes lines 9½ inches long. These new machines in essential mechanical principles are the same as Models Nos. 2, 3 and 4—unequaled.

Write for Printed Matter Free.

The **Smith Premier**
Typewriter Co.

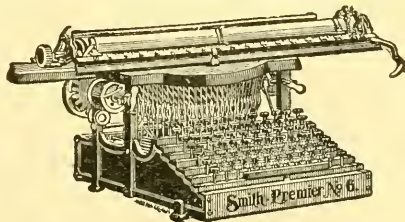

158 Prospect Street, Cleveland, Ohio.

In writing advertisers please mention Gleanings.

Some Good Things

That have appeared in the Bee-keepers' Review for the present year are as follows:

A Visit to the Coggshalls.

The editor visited the Coggshalls last winter, and in the January Review he gives the gist of the methods that have enabled these men to build beautiful homes (of which pictures are given) and put thousands of dollars in the bank. W. L. Coggshall says it is the best "write-up" that has ever been given of their business.

The Frontispiece.

A special feature of the Review is the beautiful frontispiece that it gives each month. This month it gives a characteristic California scene—snow capped mountain peaks in the distance, valleys and orange-groves in the middle distance, and a great irrigation-reservoir in the foreground.

Fertilization of Queens in Confinement.

The special feature of the February Review is an illustrated article by J. S. Davitte, telling how he secured the mating of 100 queens in confinement. Full particulars are given.

Working According to Locality, and Killing the Queens Each Summer.

The March Review has an article on this subject, and I think it one of the best, if not *the* best article, that has ever appeared in the Review. The methods described are probably not adapted to all localities, but the thoroughness with which the writer, S. D. Chapman, of Mancelona, Mich., has studied out the conditions of his locality, and devised a system of management adapted to the conditions, is a most interesting and encouraging object-lesson.

Wake up, Bee-keepers, to the Changed Conditions.

In the March issue is commenced a series of articles from men who have made money by "Keeping More Bees." You can do the same. I consider these articles the most timely and helpful of any the Review has published. They will be continued into the April, and possibly into the May, Review.

Three Editors.

The frontispiece of this issue is from an 8x10 photograph, taken last February, at Madison, Wis., and shows the editors of Gleanings, American Bee Journal, and Review.

Special Offers.

The Review is \$1.00 a year; but to each one sending \$1.00 for 1901 I am sending 12 back numbers (of my own choosing) free. For \$2.00 I will send the 12 back numbers, the Review for 1901, and a queen of the Superior, Long-tongue Stock. Queen alone, \$1.50.

W. Z. HUTCHINSON, Flint, Mich.

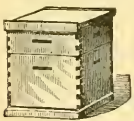

BEE-HIVES AND HONEY-BOXES,

in car lots—wholesale or retail. Now is the time to get prices. We are the people who manufacture strictly first-class goods and sell them at prices that defy competition. Write us today.



Interstate Box & Manufacturing Co., Hudson, Wis.

Marshfield Manufacturing Company.

Our specialty is making SECTIONS, and they are the best in the market. Wisconsin basswood is the right kind for them. We have a full line of BEE-SUPPLIES. Write for FREE illustrated catalog and price list.

Marshfield Manufacturing Company, Marshfield, Wisconsin.

1881

PAGE & LYON MFG. CO.

1901

We manufacture a full line of the latest
BEE-SUPPLIES.

Our motto is, "Perfect Goods and Prompt Shipment."

Send for our new free illustrated catalog.

PAGE & LYON MFG. CO., New London, Wisconsin.

NOW READY!

64-PAGE CATALOG OF EVERY THING BEE-KEEPERS NEED. Illustrated and fully described. Especially valuable to beginners for the information it contains. Send your address on postal and get it now. Established 1884.

J. M. JENKINS, Wetumpka, Ala.

LONG-TONGUED QUEENS!

YARD NO. 1.

By special arrangements with THE A. I. ROOT CO. to furnish them queens, I have secured their assistance in procuring the finest breeding queens that a thorough knowledge of the bees of the country and money can procure. Among them is a *select daughter of their \$200 queen that they refuse to quote me prices on.* This queen shows every superior quality of her mother. Her bees show an actual reach of 21-100 of an inch; are large, gentle, and beautiful to look upon.

MR. E. R. ROOT SAYS: "You have as fine bees as there are in the United States; and with a direct cross of their breeders you should be able to produce queens whose bees show a reach of 25-100 of an inch."

Send for descriptive price list. Watch this space, and don't forget my long-tongue stock is the best that money and knowledge can procure.

Pr ces: Untested queen, \$1.00; 6 \$5.00. Tested queen, \$1.50; 6 \$8.00. Fifty select breeders from long tongued strains, \$2.50 to \$5.00 each.

IMPORTED ITALIAN STOCK.

APIARY NO. 2.

Imported Queens, Daughters and Grand-daughters.

GOLDEN, OR 5-BANDED ITALIAN.

APIARY NO. 3.

Breeders, select tested, tested, and untested queens.

REMEMBER the bear picture goes as a premium on six queens. 1901 untested queens will be ready to mail March 25 to April 1st. Send in your order at once, and get in on the ground floor. Breeders, select tested, and tested queens go by return mail.

W. O. VICTOR, WHARTON, TEXAS.
QUEEN SPECIALIST.

QUEENS?

Improved Golden and Leather-colored Italians are what H. G. Quirin Rears.

We have one of Root's best long-tongued RED-CLOVER BREEDERS from their \$200 queen, and a Golden breeder from Doolittle, who says if there is a BREEDER of Golden bees in the United States worth \$100 this one is worth that sum. The above breeders have been added to our already improved strain of queens for the coming season.

J. L. Gandy, of Humboldt, Neb., wrote us on Aug. 5th, 1900, saying that the colony having one of our queen, had already stored over 400 pounds of honey (mostly comb). He states that he is certain that our bees work on RED CLOVER as they were the only kind in this locality and apiary.

A. I. Root's folks say that our queens are extra fine. While the editor of the *American Bee Journal* tells us that he has good reports from our queens from time to time. We have files upon files of unsolicited testimonials. After considering above evidence need you wonder why our orders have increased each year?

Give us a trial order and be pleased. We have years of experience in mailing and rearing queens. Safe delivery will be guaranteed. Instructions for introducing with each lot of queens.

Queens Now Ready to Mail.

Warranted Stock, \$1.00 each; 6, \$5.00.
Tested Queens, \$1.50 each; 6, \$8.00.
Select Tested, \$2.00 each; 6, \$10.00.

We Have 100M Folding Cartons

on hand, and so long as they last will sell at \$4.00 per 1000, with your address printed on in two colors; 500 for \$2.75. At above price you can not afford to place comb honey on the market without cartoning it. Address all orders to

H. G. Quirin, Parkertown, Ohio.

(Parkertown is a Money-order Office.)

WE WANT

to sell you bee-supplies. Our line is all new and complete. Send for our illustrated catalog. It will convince you that our Dovetailed hive is the best on the market. Our prices are right and our service is prompt.

Fred W. Muth & Co.,
Cincinnati, Ohio.

S-W. Cor. Front
and Walnut Sts.

Dittmer's Foundation !!!

Retail---Wholesale---Jobbing.

I use a PROCESS that produces EVERY ESSENTIAL necessary to make it the BEST and MOST desirable in all respects. My PROCESS and AUTOMATIC MACHINES are my own inventions, which enable me to SELL FOUNDATION and WORK WAX INTO FOUNDATION FOR CASH, at prices that are the lowest. Catalog giving

FULL LINE OF SUPPLIES

with prices and samples, free on application. BEESWAX WANTED.

GUS. DITTMER. AUGUSTA, WIS.

Get the Best Queens.

Evansville, Ind., Sept. 27th, 1900.

The Jennie Atchley Co., Beeville, Bee Co., Texas:
Dear Friends:—It gives me great pleasure to forward you this unsolicited testimonial regarding the merits of Atchley queens. The three (3) dozen queens purchased of you have made an excellent record for themselves. Not an Atchley queen among the twenty colonies lost during the severe drouth in July. I have bought queens from many breeders; and although the present crop is exceedingly short, the tiers of supers show where the Atchley queens are, and speak volumes for your method of queen-rearing. I find the progeny to be very gentle, strong winged, uniformly marked, long-lived, of large size, and last, but not least, the best honey-gatherers I ever had. I shall want 100 more next season.

Yours fraternally, J. C. WALLENMEYER.

Prices for Queens.

Tested, \$1.50 each; \$8.00 for 6, or \$15.00 per dozen. Untested, February, March, April, and May, \$1.00 each; \$5.00 per 6, or \$9.00 per dozen. Fine breeders, \$5.00 each. We have as good bees and queens as money and labor produce. We breed three-band Italians, Goldens, Carniolans, Cyprians, and Holy-Lands, in their purity, bred in separate yards 5 to 20 miles apart. If you want the best, call for Atchley's improved strains. Safe arrival guaranteed. Send for a sample copy of "The Southland Queen," the only southern bee-paper, \$1.00 per year. To new subscribers we offer as a premium a nice untested queen in order to get our paper introduced. Catalog, giving queen-rearing and management of apiaries for profit, FREE.

THE JENNIE ATCHLEY CO.,
Beeville, Bee Co., Texas.

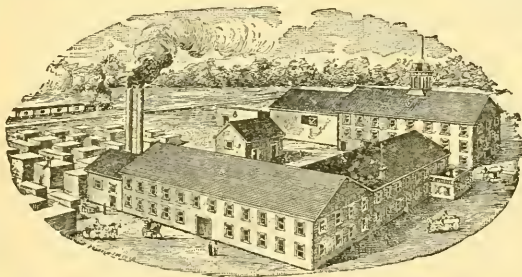

KRETCHMER M'FG CO., Red Oak, Iowa.

BEE-SUPPLIES.

Best-equipped factory in the West; carry a large stock and greatest variety of every thing needed in the apiary, assuring BEST goods at the LOWEST prices, and prompt shipment. We want every bee-keeper to have our FREE ILLUSTRATED CATALOG, and read description of Alternating Hives, Ferguson Supers, etc. Write at once for a catalog.

— AGENCIES: —

Trester Supply Co., 103 So. 11th St., Lincoln, Nebraska; C. C. Richards, 1223 17th St., Denver, Col.

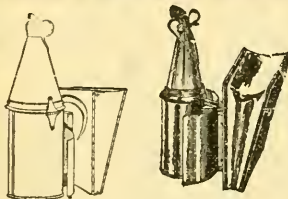

BINGHAM SMOKER.

Dear Sir:—Inclosed find \$1.75. Please send one brass smoke-engine. I have one already. It is the best smoker I ever used. Truly yours,
HENRY SCHMIDT, Hutto, Tex.

MADE TO ORDER

Bingham Brass Smokers.

Made of sheet brass, which does not rust or burn out; should last a lifetime. You need one, but they cost 25 cts. more than tin of the same size. The little open cut shows our brass hinge put on the three larger sizes. No wonder Bingham's four-inch smoke-engine goes without puffing, and does not drop inky drops. The perforated steel fire-grate has 381 holes to stir the fuel and support the fire. Heavy tin smoke-engine, 4-inch stove, per mail, \$1.50; 3 1/2-inch; \$1.10; 3-inch, \$1.00, 2 1/2-inch 90c.; 2-inch, 65c. Bingham smokers are the originals, and have all the improvements, and have been the standard of excellence for 22 years. Only three larger ones brass.

T. F. Bingham, Farwell, Michigan.

Contents of this Number.

Alfalfa, To Raise356
 Apiaries on Roof.....341
 Apiary, Somerford's.....337
 Beans, Soja356
 Bees from Old Combs.....332
 Bees in Fruit-orchard.....339
 Bees Puncturing Fruit.....346
 Bees, Hallucination of.....328
 Bees, Weight of.....327
 Bee-book, Morley's347
 Bee-keeping for Women.....339
 Brood-chambers, Shallow.....331, 334
 Clipping Wings, How to Do it.....345
 Combs, Position on Wagon.....326
 Distance Bees Fly.....328
 Florida, Travels352
 Foul-brood Law in Michigan.....346
 Frames, Hoffman, and Propolis.....329
 Havana, Street in.....337
 Hives, Large, Advantage of.....334
 Honey, Comb, as Freight.....327
 Honey, Granulated, in Old Sections337
 Miles, English v. German.....328
 Mold on Combs.....326
 Record for Honey Broken.....345
 Sections by the Piece.....326
 Sections, Size of, in England.....327
 Sections, Unfinished.....338
 Spraying in Bloom, Evidence Against.....346
 Swarms, Brushed, for Comb Honey.....333
 Tent for Controlling Mating347
 Transferring, by Doolittle.....343
 Queens, Good, To Rear.....311
 Queens, To Introduce.....343
 Worker, Load of.....325

Honey Column.

GRADING-RULES.

FANCY.—All sections to be well filled, combs straight, firm ly attached to all four sides, the combs unsoiled by travel stain, or otherwise; all the cells sealed except an occasional cell, the outside surface of the wood well scraped of propolis.
 A No. 1.—All sections well filled except the row of cells next to the wood; combs straight; one-eighth part of comb surface soiled, or the entire surface slightly soiled; the outside surface of the wood well scraped of propolis.
 No. 1.—All sections well filled except the row of cells next to the wood; combs comparatively even; one-eighth part of comb surface soiled, or the entire surface slightly soiled.
 No. 2.—Three-fourths of the total surface must be filled and sealed.
 No. 3.—Must weigh at least half as much as a full-weight section.
 In addition to this the honey is to be classified according to color, using the terms white, amber, and dark; that is, there will be "Fancy White," "No. 1 Dark," etc.

CITY MARKETS.

BUFFALO.—The demand continues slow for honey. Stock in market light, and no new arrivals. Fancy white comb, 15@16; A No. 1, 14@15; No. 1, 13@14; No. 2, 12@13; No. 3, 11@12; No. 1 dark, 10@11; No. 2 dark, 8@9. Ext'd white, 7@8; dark, 5½@6. Beeswax, 28@30. Mar. 29. W. C. TOWNSEND, Buffalo, N. Y.

PHILADELPHIA.—Odd lots of comb honey arriving in the market quite freely with very little demand. Prices are falling. We quote comb honey 13@14; amber, 11; extracted white, 7@8; amber, 6. Beeswax, 28. We are producers of honey—do not handle on commission. Wm. A. SELSER. Apr. 20. 10 Vine St., Philadelphia, Pa.

CINCINNATI.—The demand for comb honey is nearly over. The stock of it also well cleaned up. Fancy white yet brings 16; extracted in fair demand; dark sells for 5½; better grades bring 6@7½; fancy white clover, 8½@9. C. H. W. WEBER. Apr. 9. 2146-8 Central Ave., Cincinnati, Ohio.

TORONTO.—There is very little of any kind of honey in stock. What comb honey is in stock would about class A No. 1, which is worth \$1.75 a dozen; dark comb, \$1.00 a dozen. Extracted honey, 8@11, and very little to be had. M. MOYER & SON, Apr. 8. 408 Spadina Ave., Toronto, Canada.

CHICAGO.—The choice grades of white comb honey continue to sell at 16, and there is no surplus in sight. Other grades of comb sell fairly well at the following prices: No. 1 grades of white, 14@15; off grades, 13; light amber, 12; dark amber, 10@11; buckwheat and other dark combs, 9@10; candied and mixed colors, 7@9. Extracted is dull, and prices very weak, with the exception of some fancy linden and clover grades quotable at 7@8; ambers, 6½@7½; dark and buckwheat, 5@6. Beeswax, 30. R. A. BURNETT & Co., 163 South Water St., Chicago, Ill. Apr. 8.

ALBANY.—Honey market quiet and about over for this year, with very little stock receiving in this market. A No. 1 white scarce at any price; No. 1, 13@14; No. 2, 11@12; No. 3, 10@11. Great deal of honey is hard and candied more than usual this year. In all, it has been the poorest crop of comb honey in many years. We hope for better next season, which now looks favorable. MACDOUGAL & Co., Successors to CHAS. MCCULLOCH & Co., Albany, N. Y. Apr. 7.

NEW YORK.—The demand for both comb and extracted honey is very light just at present, with little or no stock on hand. We quote as follows: Fancy white, 15; No. 1, 14; No. 2, 13; buckwheat, 10. Buckwheat extracted, 5¼@5½. Beeswax, 27. FRANCIS H. LEGGETT & Co., Franklin, West Broadway, and Varick Sts., New York City. Apr. 8.

NEW YORK.—Comb honey in fair demand at unchanged quotations, with very little stock on the market. Market on extracted dull, and prices are gradually declining. Beeswax firm at 29. HILDRETH & SEGELKEN, 120, 122 West Broadway, New York. Apr. 9.

FOR SALE.—Extracted honey from alfalfa; 60-lb. cans at 7 cts., and smaller cans. D. S. JENKINS, Las Animas, Colo.

FOR SALE.—3000 pounds fancy comb honey. Write for prices. WILLIAM MORRIS, Las Animas, Col.

FOR SALE.—20,000 lbs. extracted honey from alfalfa and light amber from Rocky Mountain bee-plant. Two cans, 120 lbs. net, \$8.40; also 5 and 10 lb. pails. In ordering state if you want white or amber. M. P. RHOADS, Las Animas, Col.

WANTED.—Comb and extracted honey. State price, kind, and quantity. R. A. BURNETT & Co., 163 South Water St., Chicago, Ill.

FOR SALE.—Choice alfalfa honey. Two cans, 120 lbs. net, whitest, \$9.00; tinted, partly from other bloom, \$8.40. Also small cans. THE ARKANSAS VALLEY APIARIES, OLIVER FOSTER, Prop., Las Animas, Bent Co., Colo.

WANTED.—To sell or rent my entire apiaries of 250 colonies, and fixtures to work for extracted honey, located in one of the best basswood belts of southwest Wisconsin, town of 500 inhabitants. Good schools and churches. Located on W. W. R. R. Also good, new 8-room house, and 2-acre block. Must sell on account of health. A. J. McCARTY, Viola, Wis.

WANTED.—To sell ten-frame Simplicity hives, brood-frames, combs, Barnes' saw, extractor, etc., both new and second hand, at half price. Also surveyor's transit. For particulars, address A. N. CLARK, Agricultural College, Mich.

WANTED.—To correspond with any one who can use 2500 new No. 1 1-piece sections, 4¼x4¼x1¼, open all around, at a bargain. N. I. STEVENS, Venice, N. Y.

WANTED.—Parties interested in ginseng culture to send 5 cts. in stamps for my illustrated catalog and circulars, giving valuable information about this plant. 500,000,000 Chinese use it; easy to raise; 300 per cent annually in profit. Book on culture, \$1.00. Six years' experience. W. E. BOYCE, Houston, Mo.

Notice!



THE A. I. ROOT CO.

wish to announce that they have from their branch at 10 Vine St., Philadelphia, Pa., direct steamboat connections and very low rates of freight to the following States: Massachusetts, Rhode Island, Connecticut, New Jersey, Delaware, North Carolina, South Carolina, Georgia, Florida. As this is a branch of the factory, prices are the same. Full colonies of Italian Bees, \$6.00. Special discount in large quantities.

G. B. Lewis Company,

Watertown, Wis., U. S. A.

FIVE ✦ DIFFERENT ✦ STYLES ✦ OF ✦ BEE-HIVES.

We will furnish you
with the finest bee-
keepers' supplies in
the World.



Send us your Orders
and we will fill 'em
promptly. Send for
Catalog.

LEWIS' • WHITE • POLISHED • SECTIONS • ARE • PERFECT.

BRANCH: G. B. Lewis Company, 19 South Alabama Street, Indianapolis, Indiana.
AGENCIES: L. C. Woodman, Grand Rapids, Michigan; Fred W. Muth & Co., Southwest Cor. Walnut & Front Sts., Cincinnati, Ohio; Fred Foulger & Sons, Ogden, Utah; Colorado Honey-producers' Association, Denver, Col.; Grand Junction Fruit-growers' Association, Grand Junction, Colorado; Robert Halley, Montrose, Colorado; Pierce Seed and Produce Company, Pueblo, Colorado; E. T. Abbott, St. Joseph, Missouri, Special Southwestern Agent.

BEE-SUPPLIES!

ROOT'S GOODS
AT
ROOT'S PRICES

C. H. W. Weber, Cincinnati, Ohio.
2146-2148 Central Ave.

A NEW and complete stock for 1901 now on hand. I am The Root Company's representative for Cincinnati and surrounding territories. . . . You save TIME and FREIGHT CHARGES by having goods shipped from here. Convenience of railroad facilities here enables me to do so. Before buying elsewhere, write for my prices and catalog, which will be mailed you free of charge.

GLEANINGS IN BEE CULTURE

A JOURNAL DEVOTED TO BEES AND HONEY AND HOME INTERESTS.

ILLUSTRATED SEMI-MONTHLY

Published by THE A. F. ROOT CO.
\$1.00 PER YEAR MEDINA, OHIO.

VOL. XXIX.

APRIL 15, 1901.

No. 8.



IT'S TIME to suggest again that seed saved from the *first* crop of red clover will have a larger proportion of short-tubed seed. Or am I clear off? [I think you are correct.—ED.]

THOS. WM. COWAN says in *American Bee Journal*, that granulated sugar is adulterated with dry glucose. That makes me think more than ever that we ought to have some reliable source from which we could obtain pure cane sugar to feed our bees.

J. H. MARTIN and I are out again. He says, "A person devoting his entire attention to queen-rearing will strive to improve his stock." But how can he select his best stock, without having them store a crop to show which is the best stock?

A SMOKER could be made to give a *perfectly* continuous blast by having a bellows like a melodeon, and there would be no possible sucking of smoke into the bellows. But the continuous blast would be just so much the weaker, and the loss would probably be more than the gain.

DON'T BE DISCOURAGED, Bro. A. I., if you don't see many direct results from your fighting whisky, tobacco, and other evils. If it does no other good, it's making a better man of you, and for your encouragement I can tell you that, after reading last GLEANINGS, I hate tobacco worse than ever before.

"IF THERE IS any class of people who seem prone to only half observe, and to jump at conclusions, it is the bee-keepers," says Arthur C. Miller, in *Progressive*. There you are again, Arthur, doing that very thing yourself. If you would observe more carefully, I think you would find that bee-keepers are better observers than the average; but bee-keeping, more than other pursuits, contains so many things that elude observation.

"GEORGE W. YORK, Chairman Central Committee, Chicago," represents one relation of a bee editor. The rottenness of the Chicago city government is notorious, and the

names of leading candidates for city officers promise a continuance of the rottenness. Now a ticket of clean men has been put in the field, with the editor of "the Old Reliable" as chief manager. There isn't a ghost of a chance of success, but it's something for a good man to have a ticket that he can cast without despising himself.

A WORKER, according to Alex. Astor (*Rev. Intl.*), can carry about an eighth more than its own weight when honey is given to it. The maximum load of nectar brought in he found to be (about June 1) 65.5 milligrams (a little more than $\frac{3}{4}$ its own weight), and from then to Aug. 3 the weighings showed 50 mg., 45, 40, 28, 25, 18, 16, 10, 0. [This does not conflict with the footnote to the other Straw on this subject. It appears, then, that a bee can carry more of *honey* than it can of *nectar*—not larger in bulk, but greater in weight. These figures are very interesting.—ED.]

THAT DELIGHTFUL DREAMER in *Progressive*, Somnambulist, thinks that bee-keepers too often say "I" when they should say "we," thus giving due credit for the help of faithful wives. Amen, say I. Also that wives, like queens, should be chosen, not for beauty, but for real worth. Now, here's what puzzles me: One who places such high estimate upon the value of wives, and shows such discriminating judgment regarding them, would surely be expected to have a wife of the best type; and yet, if I am rightly informed, Somnambulist, who is no longer a spring chicken, has never had a wife.

HERE'S A HINT of value by Arthur C. Miller, in *Progressive*: "If you have no frames filled with drone comb, get some, and then paint the top-bar of those frames a brilliant red; thereby you can find them easily, no matter where they are distributed." Of course, these will be given to your choice colonies from which you will *not* raise queens. [This matter of red paint suggests the advisability of painting all tools red, which are used in the apiary. You gave this item about a year ago in one of your Straws, and it is worth repeating. A red screwdriver left in the grass would be more readily seen than one not painted.—ED.]

A NEW THOUGHT is brought out in *British Bee Journal*, that is sustained by what seems to be pretty good reasoning. It is, that, for successful wintering, the size of the cluster and the thickness of the combs (consequently the distance in spacing) must increase with the degrees of latitude. [Perhaps; but I do not believe there can be a mathematical proportion, as so much is dependent, not on the latitude, but on other conditions. The Gulf Stream, for instance, that flows around the British Isles, warms up that portion of the globe to a general average temperature above what it would be if there were no Gulf Stream.—ED.]

YOU ARE WISE, Mr. Editor, to sound a note of warning against losing our heads and depending *entirely* upon long tongues. A tall man can reach more apples on a tree than a short one; but two men of equal height may not be equally industrious at gathering apples. [Yes, and from present indications it may be necessary to continue the note of warning. While I believe in long tongues, and expect great results, yet it is evident that a good many are bound to be disappointed. The fact can not be too strongly emphasized, that daughters from the very best of mothers may prove to be very inferior; and I am afraid that 50 per cent of them may be only medium, or no better than other queens in the yard.—ED.]

THAT CART WHEEL extractor, p. 289, beats me. When "the end of the axle is planted firmly in the ground," I don't see how it is possible that "a light pressure in either direction moves the extractor and contents in direct range of the sun." If set to face the rising sun, how "under the sun" can any number of revolutions on a fixed axle make it face the setting sun? [This is a mistake of the engraver, and we did not notice the apparent mechanical impossibility until the journal was pretty well printed. The post on which the wheel stands should be perpendicular, so that the wheel will be horizontal. Then the back end of the extractor should be blocked up. As the wheel is revolved, it brings the extractor to the proper angle.—ED.]

DOOLITTLE speaks on p. 292 of a bluish-white appearance on the surface of combs, often mistaken for mold. I think I never saw it mentioned in print before, and I'd like very much to know what it is. It is seen chiefly on the cappings of sealed honey, and appears to do no harm; but after all I suspect it is something very much like mold. [I think I have seen this bluish-white coating on combs that had been stored in our honey-house, such combs not having been in contact with bees during the winter. It may be a very minute fungus or mold; but, as Doolittle says, it does no harm. But there is a mold, you know, that we sometimes see between the combs when the bees have nearly or all died. This mold is spongelike, often reaching from one comb to the other.—ED.]

OF THE HIVES that I have looked into since they came from the cellar, just two showed wet top-bars, and one of them, the worse one of the two, was a painted hive. Did the paint-

ing have any thing to do with the dampness, or did it just happen so? But Arthur C. Miller, in *Amer. Bee keeper*, makes a point by saying that bees thoroughly varnish the inner surface of a hive; and then how can the inside moisture pass through? [Your conclusion is correct. There is no advantage in an unpainted hive, except, possibly, the saving of paint; and is it not probably true that more would be actually saved in painting the hive during a period of ten or twenty years than without paint? I know you paint only the covers. Now, seriously, don't you believe you had better begin painting all your new hives-bodies?—ED.]

SECTIONS sold by the piece will give the customer more for his money than when sold by weight, says ye editor, p. 275. I confess I don't see why, although I'd be glad if all could be bought and sold by the piece. And if the customer is the gainer by the piece plan, who is the loser, the producer or the middleman? [If any one loses in the deal by selling by the piece it is the middleman, the grocer, and not the producer. I thoroughly believe that the way to sell comb honey is not by weight but by the piece. But such selling would be impracticable unless there is grading as to weights. If one produces non-separated honey, then, of course, it would be impracticable. I have seen a great deal of fence honey that would vary scarcely half an ounce to the section in the whole crate; and in a fair way the trick is not so difficult, if I may judge from what I have seen in York State, as it would appear.—ED.]

MARCH 25 the roads were muddy and rough. I drove down town, putting in the wagon two empty supers, setting them on one side. The front one ran across the wagon and the other lengthwise. The one running lengthwise fell down. Then I put the front one lengthwise and the other crosswise. As often as they fell I set them up again, constantly changing. Out of 13 times the lengthwise super fell first every time but one. That was going down a hill, but going down the steepest hill the lengthwise super fell and the other stood its ground. If I had been hauling combs on that trip, don't you believe they should have been loaded crosswise? Now some of you report how the same thing works on *your* road. [This is an interesting and valuable experiment. It is so easily tried that I wonder none of us had thought of it before. I would suggest that those of our readers who have "to drive to town" pretty often over bumpy roads try the same experiment and report. From the results above given it is very clear that the edges of the combs should point toward the wheels and not toward the horse.—ED.]

SEVEN PAGES of last GLEANINGS are devoted to giving a black eye to solar extractors. The question is between pressure in and pressure out of steam. Gerstung thinks his pressure in hot water is ahead of either. I wish I could try one of Gerstung's. [Yes, the solar wax-extractor has its uses; but in melting up old combs it should not be employed, as it is not adapted to that kind of work, unless, for-

sooth, we could rig up a press in such a way that the sun's rays could act on the slumgum that was to be squeezed. It is strange indeed that we Americans have been all this time discovering the advantages of a steam wax press, pressure being exerted on the refuse inside of the extractor, surrounded by hot steam. I hold in my hand a copy of the *Leipziger Bienenzeitung* for July, 1893. In this are two illustrated articles describing steam wax-presses embodying the principle of a steam wax-extractor and a screw press, the screw operating inside of the extractor. These extractors are the invention of Mr. Haeckel, of Schlath, Germany. While a wax press in a vat of hot water may be all right, yet it strikes me that such a device would be much more messy than a steam-press—that is, a press that squeezes the slumgum inside of a can filled with hot steam.—ED.]

ALEX. ASTOR reports in *Revue Int.* that he made 140 weighings of bees, weighing 2300 bees in all, and he gives in milligrams the weights of different kinds of bees. From this I deduce the following table, showing the number of bees in a pound avoirdupois:

- 4054 bees just out of the cell.
- 3898 bees falling before a swarming colony (probably 2 or 3 days old).
- 2457 wax-workers.
- 3974 swarming workers.
- 4885 black workers in May-June.
- 5066 Italian workers in May-June.
- 5151 black workers in July-August.
- 5271 Italian workers in July-August.

According to that, the load of honey of a swarming bee is about $\frac{1}{4}$ its own weight. [This table is exceedingly interesting—the more so, as I think it confirms very well the figures that have been given heretofore. It appears, then, that bees weigh more during the swarming season, and that wax-workers weigh the most of any. This fact is new as well as interesting. It appears, again, that in May, June, July, and August the black workers are heavier than the Italian. I had always supposed that the average Italian bee was, if any thing, a shade larger or heavier than the black. Is it not possible that the black bees referred to were Carniolans, or of that persuasion? If so, there would be all of that difference as indicated in the table in the relative weights, for we have come to assume that the Carniolan is the largest bee of the species *Apis mellifica*; and we have also assumed that the little black bees of this country—not the brown bees—were the smallest. With regard to the amount of nectar a bee can carry, it seems to me the figures that I have seen heretofore are somewhat in excess of one-fourth its own weight. There, I have just looked it up. Yes, Prof. Koons estimates there are 4500 bees in a pound, and that 10,000 bees can carry a pound of nectar, this being the fewest number to carry such an amount. According to this, then, a bee can carry half its own weight in nectar. But Prof. Koons estimates that on an average it will not carry more than one-fourth of its own weight; and this agrees with the above figures. But so far as wing power is concerned, we know that one bee can

carry one of its companions; it could, therefore, carry its own weight in nectar, providing its honey-sac would hold that amount, which is probably not true. I have dissected the honey-sac of worker-bees when they were filled with nectar, so that they almost dropped down as they flew in at the entrance. This sac was, at the time, about the size of a No. 4 shot, or perhaps a little larger.—ED.]

THE GRAND TRUNK RAILWAY has ruled out comb honey as freight, and, according to the *American Bee Journal*, something nearly as bad is contemplated on this side of the line, namely, to make double-first-class rates on comb honey in boxes with glass fronts, whether the glass is exposed or not. That makes 6 cents a pound from California points to Chicago, and the railroads might about as well say they would not receive the goods. [I regard this as a most serious matter. I can not think of any thing that would handicap bee-keeping any more, unless it be foul or black brood, than to have the railroads practically refuse to handle comb honey. We can not afford at the present rate to send any quantity by express; and if the new freight-classification should go through, we could not afford to send it by freight. Many large apiaries would be totally unable to dispose of their product, and the industry would not only be crippled but almost annihilated. I have already laid the matter before General Manager Secor, of the National Bee-keepers' Association. Action should be taken at once, it seems to me, because it is far easier, according to our experience, to prevent a bad classification getting on the tariff-books than to have such classification rescinded after it is once in force. Why, our Association could better expend every dollar in its treasury rather than have such a foolish, unreasonable, and uncalled-for discrimination against our industry. I am sure that our worthy General Manager will take suitable action at once. In the mean time the Ontario Bee-keepers' Association in Canada should see what could be done to have that unjust ruling of the Grand Trunk Railway rescinded. It is apparent that the proposed action on this side of the line was instigated by the fool ruling of the Grand Trunk on the other side; and as long as it stands thus, so long it will be a menace to us.—ED.]



The nations are in wild unrest,
Armies still are fighting;
The Bull, the Bear, the Eagle too,
Are all some grievance righting.

BRITISH BEE JOURNAL.

The discussion of the proper and best size of section for use in England seems to engross the attention of the best bee-keepers there to a great extent. As thoroughly as the ques-

tion was examined here, our English friends seem to have gone further in the pros and cons. Looks, price, cost of changing, weight, have all been debated with the fervor of a legal point in court. Space forbids many extracts, but I make the following from an article written by Wm. Boxwell, of Patricks-well, Ireland :

The sections have been ordered, and are to be packed in boxes holding 250 sections and 50 fences in each box. The fence separators are to have passageways cut through the two inner upright cleats to give the bees freer communication laterally from section to section, and the openings between slats give communication from one row of sections to those on the other side of fence, while the unbroken opening underneath, extending from one end of row of sections to the other, gives the bees almost as much passageway from brood-frames to sections as is to be found between brood and extracting frames.

As Mr. Sladen has observed, this size section requires no change in the section-rack further than to tack on top all round a $\frac{3}{4}$ -inch strip, so that every bee-keeper experimentally inclined can try it and report his findings.

The price of this section, Mr. Taylor thinks, will be higher than that of the ordinary 1-lb. section. This is only for a time, while special; when, or if, established, as it is narrower and requires less wood than the beeway, it will be cheaper.

It requires $\frac{3}{4}$ inch more comb foundation than the $\frac{1}{2}$ inch section. This is now made with so thin a base that practically there can be no fish-bone or observable mid-rib, and the extreme cost is more than compensated by the thick side walls of foundation given to the bees to draw out, and to save elaborating additional wax as in the thicker comb. The sections will be sold to dealers to distribute to bee-keepers, or to bee-keepers who take a full box of 250 sections at a time, with their fifty fence separators packed with them.

As to the weight of the new section, Mr. R. M. Lamb says, in replying to a critic :

Then he need not be afraid that the customers would not get a full 16 oz. of honey, as we could afford to give them 17 oz. or 18 oz. in a thinner section better than 16 oz. in the present. I do not think there is any danger of our adopting a light section. I, for one, would not agree to it. Such a one as I am advocating would be fair to the bees, the bee keeper, and the customers. To fussy customers I would give reasonable information; should any say they would take my remarks with a grain of salt, I would tell them that they are at liberty to take them with all the spices together, but I would recommend them to be taken with common sense. In order to get at the exact weight of wax in proportion to honey in both old and new sections I would suggest that Mr. Love-day take a good sample of each to an analyst to deal with, and let us have the results.

the winter months. There is some danger connected with an outpouring of bees when the ground is covered with snow. I have seen bee-keepers cover the snow with straw, so that any bees that drop may not come in contact with the snow, gain a safer foothold, and rise again and not chill. The majority of the bees that drop down to the ground are worthless old ones, ready to die anyhow, and one need not feel bad about the loss of them. But when the sunlight is so very bright, in combination with the whiteness of the snow, the bee seems to be dazzled. The effect upon man's eye is similar when he comes from a dark room suddenly into the sunlight. Under such a condition many strong and healthy bees fly right into the snow and die. This may be effectually prevented by sprinkling ashes and sawdust all about the hives and all through the apiary, thus changing the intense whiteness of the snow to a dark color, lessening also the reflection of the sunlight. The bees can then better take notice of the things around them, and will not fly down into the snow. It is well to pay thus a little attention to our bees at this time. Even a few bees are worth something in the spring.

In his Straws, Dec. 1, 1900, Dr. Miller says: "In the Lueneburg heath, apiaries of 120 colonies are located half a mile apart," and he thinks that not many localities here would stand such crowding. Why not? Doesn't Dr. M. overlook the fact that, when the *Centralblatt* speaks of a mile, it means a mile—not that insignificant little English mile of 320 rods, but the equivalent of $5\frac{3}{4}$ English miles? Thus it will be seen that the heath in Lueneburg is not any more productive as regards honey than the majority of localities in the United States. I believe any country that is suitable for bee-keeping may be crowded as closely as that without one apiary interfering seriously with the other. This, in turn, might lead us to the thought, "How far do bees fly in search of food?" I am aware that a great deal has been written on that subject, and still there might be a thought or two still new. Location may play an important part. In Borodino, bees have been known to travel 7 miles or more; in California, as much as 15 miles; but in most other sections of this country their flights are not nearly as extended. I am inclined to think few bees will go beyond the mile limit. I have many times moved bees during the summer season two or three miles, and I have never seen a bee come back to the old location. It would seem, had they been familiar with the surroundings of two miles around, some would surely have found their way back to their old home as they did when moved but a half-mile, as in the following instance: Once while moving bees in July a slight accident occurred on the journey. Several upper stories had not been fastened down, and slid off. The respective colonies had to be taken from the wagon right there and then, although it happened in the night. This was about half a mile from home. The bees (three colonies) had to be left there by the roadside till the next night, when they were taken on board with the next load. They



HALLUCINATION OF BEES.

Sprinkling Ashes on the Snow in the Bee-yard;
Overstocking the Heath with Bees (?); Plain
Sections and Fence Separators, etc.

BY F. GREINER.

Our bees have been shut in now for over two months. The usual January thaw has not come; but we are awaiting a chance for our bees to fly now, for, generally speaking, our bees will do better when having an opportunity to empty themselves once or twice during

lined up pretty strongly at the home yard the next morning. Evidently they thought they knew where they belonged.

Occasionally one finds quite a difference in the character of the honey gathered in different apiaries located within two miles of each other. If bees gathered their loads in fields up to within 15 miles, or even 7, the honey gathered in apiaries so near each other would be quite uniform, not only in quality but in quantity. We do not find this so.

I have an out-yard but $1\frac{1}{2}$ miles distant. I always get buckwheat honey there; my home yard does not produce it in such quantities. Combining all these minor facts and observations I can not believe that bees ordinarily make such long flights as from 7 to 15 miles.

I have received of late a circular from a dealer and queen-breeder in Maine. His comb-foundation samples are unsurpassed. He will work up wax on shares. It is interesting what he says about the no-beeway sections and fences. "The plain section has no beeways in the box; they are provided for in the fence separator. Some have cleats *nailed* on, where the boxes come against them, these cleats being exactly the amount lacking or taken off from the box. Now, I want to ask, *Is it any advantage to the bees whether the bee-space is on the box or the separator, after being crated and ready for use? How are the bees to know the difference? Now let us look at the separator. It is composed of slats, there are beeways through it. Is there any thing in this? Some one thinks it is, as the bees can see through it and see what the neighbors are doing. Now, brother bee-keepers, can a bee see in the dark?*"

It would lead too far to quote any more of this, and I wish to say: Now, brother bee-keepers, if you can bring out any sound arguments and facts either against or for the plain section or fence separator, let us have them; but do not waste breath with any talk of that kind. Time is worth too much to listen to it. Has it ever been claimed that the no-beeway section, *per se*, is of any material advantage to the bees? Has any one ever asserted, that, because bees can see through the beeways in the fence, they will, on this account, do better work? I answer no to these questions. Let us stop inventing ridiculous objections. I myself prefer to use a cleated whole separator; perhaps a wire-cloth separator, if I should get to using it, might suit me best—I do not know. I like the cleat on the divider because it gives us a box brimful of honey—an advantage to the consumer, not to the bees or apiarist. Shipping-crates will hold more no-beeway honey—an advantage to the apiarist. Perfectly free communication in the super insures better filling of the sections. I have used hundreds of supers without separators and free lateral communication. The sections in these were *always filled and sealed clear around to the wood*, an advantage in more ways than one. The more the free communication is hampered in the super, the less perfect the filling, other conditions being the same. While it is not denied that a good deal of perfect honey is made in supers between

whole separators, the chances are not as favorable as with wire-cloth separators or no separators at all; and the fence separator has its merit on account of the freer communication, not on account of the cleat. In these times it is entirely out of the question to produce comb honey without separators of some kind, and we might as well choose the best one in the lot while we are about it.

Naples, N. Y., Feb. 6.

[It is truly laughable, some of the objections that have been raised against the plain section and fence. The idea that it would make any difference to the bees whether the beeway was in the sections or separator or fence, is too absurd to require refutation. The fence system, while it favors indirectly the bees, favors the bee-keeper particularly. It does not make any difference to the bees whether they store honey in an old box hive or in the best hive ever invented; but it does make all the difference in the world to the bee-keeper what kind of hive he uses. The more marketable he can make his honey with the minimum of labor, the better. If modern appliances offer facilities that worthless appliances do not offer, then those are the appliances to adopt.

Bees seeing in the dark—well, I am not sure that they do *not* see. If we really thought the bees needed to see, we would make our hives with doors and windows and skylights.

But the fence, in spite of its opposers, is quietly making its way into the graces of bee-keepers everywhere. So far I do not know of any one who has given the fence system a careful trial on a reasonably large scale who has abandoned it.—Ed.]

HOFFMAN FRAMES AND THE MATTER OF PROPOLIS.

The Eight-frame Dovetailed and Ten-frame Jumbo.

BY W. W. SHEPARD.

Dr. C. C. Miller.—I commenced keeping bees in 1894, and have been feeling along in a small way, keeping not more than ten colonies, and studying their ways, also reading all I could find on the same. I now wish to build up to 100 colonies; and while I have practically little invested in hives and fixings, I am anxious to start with the best hive for the production of comb honey. As you and I live in about the same latitude, and, I should judge, about the same average temperature, I believed you could give me valuable information in regard to hives, as you have been testing the merits of different ones.

I will say here that my experience has been with only the Dovetailed hive and Hoffman frame. I lived, until the past year, 30 miles north of my present location, and the Hoffman frame worked all right there; but there is a large amount of propolis here, and the Hoffman frame is not *the* frame. Our surplus is from clover, basswood, and buckwheat (all we got this year was from buckwheat).

I am only a beginner, but I can not see for the life of me how one can counsel both the eight-frame Dovetailed and the ten-frame Jumbo for the production of comb honey. It seems to me that they are so wide apart that one or the other must be wrong.

My experience with queens satisfies me if I can get one to fill eight Langstroth frames with brood. I know that, if I succeed in doing it at the right time, I get the honey if there is any to be had. I winter on summer stands, but use a winter-case. Perhaps double-walled hives would be better.

In regard to covers, I am sorry to say that I have not seen any thing yet as good as the old telescope covers. I have never had one sent yet but would get out of shape and leave a crack.

Wayland, N. Y., Jan. 3.

[Dr. Miller, to whom the foregoing was sent, replies:]

You are very wise not to wait until you have a large number of hives on hand before settling down upon the one you wish to use exclusively; and it would have been still better if you had been trying something else, even while having only five or ten hives, if you think the kind you now have are not most suitable.

The same latitude does not necessarily make two places alike for bees, nor even the same temperature. The winds make a big difference, and I suspect your winters in York State are not so severe as out on these prairies.

It may be worth while, seeing the trouble you have with propolis, for you to do with your Hoffman frames as I have done with some of mine—cut away the parts that trouble, and space with nails or staples. To avoid trouble with propolis, one must have frames that have the smallest possible points of contact. The frames that are spaced with staples come well under this head. For my own use I prefer a frame a little heavier than that furnished with the Dovetailed hive, having top-bars, end-bars, and bottom-bar all the same width, $1\frac{1}{8}$ inches, spaced sidewise with nails and endwise with staples. The spacing endwise is important to avoid propolis. A very serious objection to this frame is that it is not at all standard, being made only to order, which is in and of itself an argument in the line of showing that it would not be liked by others as well as by myself. It is quite possible that you might like the regular frame with all staple spacers better. One good thing is that all three of the frames so far mentioned may be used in the same Dovetailed hive.

From your experience you are well satisfied if a queen fills eight L. frames with brood. I take it that you are using eight-frame Dovetailed hives, and my experience coincides with yours. Very few queens will have the whole eight frames filled. Some will have seven filled, and perhaps the greater number will have very little if any brood in either of the outside frames. But it would not be a very safe thing to conclude that, because only six frames are filled with brood, therefore a six-frame hive is large enough. The queen that

has only six frames filled in an eight-frame hive will not have as many as six in a five-frame hive. For some reason the bees do not seem to fill with brood the two outside frames. One reason is that pollen takes up a good deal of room, and the outside frames are the favorite places for a store of pollen.

So it will not do to argue that, because your best queens fill only eight frames, and others fill less, therefore an eight-frame hive is large enough. Take one of your colonies in an eight-frame having eight frames filled with brood. Now, how do you *know* that the same colony would not occupy more room if they had it? You may, however, say, "But the number that now fills eight frames is very small, and I don't care to have hives for the exceptional ones, but something about average." That does look plausible; but here's a better way: Have hives with room enough for the very best queen; encourage a large amount of brood by giving all the room that can possibly be used, and then by careful selection in breeding bring all colonies up to that standard. It is quite possible that, by confining your bees for a series of years to five-frame hives, you would finally have a strain of five-frame bees; and it is just as possible that, by giving abundant room, and making careful selection in breeding, you may increase the amount of room needed for your average colony.

Turning aside from theory, let us refer to actual facts. Here is what I have found:

When I have kept a colony in a hive with only eight frames, the eight frames have not always been filled; and in no case has such a colony filled more than the eight frames—never, in a single case. When I have given a colony two stories with sixteen frames, it has filled eight, ten, twelve, and in some cases fourteen and fifteen frames. It is possible that your bees would do as well; and in any case it is possible for you to have bees that will do as well.

When it comes to the direct question as to what is the best hive, I confess I don't know. After trying a good many others I had still not lost hopefulness, and expected a good deal from the Draper barn, or Jumbo, as you now call it, with its ten large frames. To me it is a stirring sight to see one of those frames filled with brood. The great thing that I expected from these hives with room equivalent to more than twelve L. frames was that there would be very little swarming. I am very sorry to say that in this I have been disappointed. The past season was not very bad for swarming, but the very first swarm came from a Jumbo, and one of the other two would have swarmed if I had not prevented. Even if I couldn't get as much surplus from them, if they were non-swarmer I would stick to them. But in respect to swarming they were a disappointment.

I expected, however, that after colonies became well established in them they would yield harvests above the average. I'm sorry to say they have been disappointing in this regard. I don't know why. Last spring the three hives contained rousing colonies; but

the yield was not above the average. If run for extracted honey the case might be somewhat different.

At present the best thing I know of is to use eight-frame Dovetailed hives. But I don't restrict myself to eight-frame colonies. When a colony has six frames filled with brood it gets a second story, if not before, and the bees have full permission to work down into this story which is added *below*, and they have all encouragement to build up as strong as possible before the harvest. It's the colonies strong at the beginning of harvest that do the business, and unlimited expansion is allowed up to that time. How much brood room then?

One year of failure in the harvest I had just one colony that gave me any surplus. That gave me one super and the others gave nothing. The one that gave the surplus had two stories (sixteen combs) for its brood-chamber throughout the whole season, and I think none of the others had more than one story. That looked as if it was the right thing to have two stories all the time. But I never could get the same experience repeated. I tried it quite thoroughly, but I couldn't get as good results with two stories as with one.

So my present practice is to reduce the brood-chamber at harvest to one story with the eight frames full of brood. It's not contraction. It's leaving the colony as much room as it had before, only it's swapping room in supers for the room it had in the brood-chamber. I don't know that it's doing violence to the instincts of the bees, for when a flow of honey comes the bees seem to get so interested in gathering that they shrink the space occupied by brood. At any rate, eight frames are all they have while the supers are on. When the supers are taken off they can have another brood-story if they want it. Before winter sets in, one of the stories is taken away. That makes it easier to handle the hives in hauling from the out-apiaries, and in getting into the cellar. If I were wintering outdoors (and I wish I could) I think the two stories would be allowed through the winter.

I think that's about as near as I can come to answering your question. If there's any thing more you want to ask about, and I know enough to answer, I'll tell.

Marengo, Ill.

C. C. MILLER.

[With regard to Hoffman frames, I think that in all my travels I never saw a locality where there was so much propolis as at Dr. Miller's. I then and there agreed with the doctor that in and about the region of Marengo, at least, Hoffman frames were impracticable. The matter in our catalog regarding Hoffman and staple-spaced frames suggests there are some localities where Hoffman frames will not give satisfaction; and it recommends that in such, staple-spaced frames be used instead. But in spite of that statement, very few of the last named are sold at all, while the Hoffmans have almost the exclusive run; and even in Cuba, where I have been advising against the use of Hoffmans, that form of frame is the one we sell most of. While propolis is plentiful, yet, owing to their

very warm climate, it never becomes stiff and hard; and our Mr. Boyden, who visited Cuba, said the Hoffman frames handled very nicely. I have been surprised myself, over and over again, even where I have urged the metal spacers, that bee-keepers prefer the Hoffman.

Regarding those Jumbo hives, I think your experience was very exceptional. The experience of Dadant and all his neighbors has been that such hives do not cast swarms; at least I think the statement was made that it was the exception to have more than one or two per cent of swarms.

Where the honey-flow is dependent almost entirely on clover and basswood, perhaps the eight-frame hive is large enough in capacity; but my own personal experience is in favor of 16 Langstroth frames in two stories, sometimes reducing those two stories to one, and substituting comb-honey supers for the upper story, and sometimes putting a super on top of the two stories. The main thing is to get a large force of bees. By a "large force" I mean a colony the bees of which will weigh 8 or 9 lbs., or what would aggregate in numbers 40,000 to 50,000. If one can succeed in getting a working force and a nurse force up to this strength he is bound to get honey if there is any to be had from the fields. But such a force must not be squeezed into an eight-frame capacity without giving plenty of sections above.—E.D.]

SHALLOW BROOD-CHAMBERS.

Their Economic Uses; Pollen in Sections, etc.

BY T. K. MASSIE.

Mr. Root:—In your footnote to Harry Lathrop's article, page 686, you invite correspondence from those who have been successful in the production of comb honey by using shallow brood-chambers and frames; therefore I will give you my experience, and mention *some* of the advantages of shallow frames.

For a number of years I have been using Dr. Tinker's Non-parcel hive with a closed-end frame of my own invention, containing combs $5\frac{1}{2}$ inches deep—a very shallow frame.

I have used these for comb honey almost exclusively, tiering up two and three brood-chambers to the hive, as occasion required, which gave me a deep comb for wintering, and brood-rearing purposes in the spring, and a shallow comb for the production of comb honey during the honey-flow. When a swarm issued I hived it on the old stand in a single brood-chamber under two, three, or more supers of sections, according to circumstances, strength of colony, season, etc. If the colony did not cast a swarm by the time the main honey-flow from basswoods was on I simply moved the colony to one side, set an empty brood-chamber in its place with the supers on it, as if I were going to hive a swarm in it. I then opened the old hive and shook most of the bees in front of the new one, leaving only enough bees to care for the brood, and strengthened the colony with hatching brood from the old stand in about 6 to 8 days, and

again in 12 or 15 days. Deep combs for wintering and shallow combs for the production of comb honey is one of the advantages of a shallow brood-chamber and *shallow frames*. They give us horizontal contraction in place of side contraction, and the brood-nest is always in its normal condition. The frames need no wiring, and yet the cells are never stretched out of shape, and the bees build all worker combs from narrow starters. If we want to extract from these frames the combs never break like the deep ones. The frames can be handled on the rough-and-tumble order, and not break the combs. I have tried several different kinds of hives and systems of management, but the shallow ones give me by far the best results.

Two years ago I purchased 40 Danzenbaker hives with combs about $6\frac{3}{4}$ inches deep, and have run them according to his system, and must say, with friend L., that "the Danzenbaker hive and system is all right." This season our best yield from any one colony was 123 finished sections, and the colony was in a Danzenbaker hive; but I must differ with friend L. in his conclusions that the Danzenbaker hive is an expensive one. Mr. L. says, "Among them all, no one knows better than Danzenbaker how to get comb honey; but we can't all adopt his hive, on account of the expense and work of changing." It is not fair to praise the Danz. hive and system, and in the same breath damage it by comparing the price of it with a single-walled shallow box in the rough with slats only.

Replying to a Straw, page 718, I can say that, in my locality, we have pollen coming in throughout the season. Bees gather considerable quantities of it almost daily, and with my shallow brood-chambers I have never had any trouble with pollen in the sections. Bees store pollen as close to the brood as possible; and when there is a break in the combs of more than an inch—the distance from top of brood-combs to the bottom of section combs—bees are not much inclined to pass over this space, away from the brood, to store pollen in the sections. Dr. Miller says two parties complained of pollen in the sections with the Danz. hive, and he had two of the same hives in use, and "more pollen in each D. super than 100 others." Here are four D. hives severely censured; and were it not for his concluding remarks one would think this a blow at the D. hive in particular; but he follows it with the conclusion that "shallow brood-chambers" favor pollen in the sections. Such is not my experience. I have a letter from a friend who tells me that, out of 16,000 sections produced over the D. brood-chamber this season, not one contained any pollen. Here, then, is a case, not "16 to 1," but *sixteen thousand to nothing*—16,000 sections, not one of which contained a trace of pollen. I should not fear to undertake, under a forfeit, to show 1600 sections with no pollen in them to one that has, and I would either "show up or hush up."

Avondale, W. Va.

T. K. MASSIE.

[I do not think that Mr. Lathrop intended to convey the impression that the Danzenba-

ker hive was more expensive than any other hive put out by the manufacturers, or enough more expensive to prohibit its use. He only intended to show how shallow brood-chambers *might* be used in an economical way for those who desired to experiment before they invested very much money in the general system of shallow brood-chambers.

Regarding the question of pollen in sections when shallow brood-chambers are used, this may be somewhat a matter of locality. But however that may be, I know of only three or four complaints of this character—so few, indeed, that I should hardly think them worthy of much consideration.—E.D.]

BEEES FROM VERY OLD COMBS.

BY B. ROBISON.

Mr. Editor:—On page 141 you seem inclined to ridicule Bro. W. T. Stephenson's assertion that bees hatched from very old combs are very perceptibly smaller than those hatched from new comb. I agree with you that "It is very easy for one to draw wrong conclusions and wrong inferences; and especially is this true, it seems to me, in the case before us" (italics mine).

Perhaps where a young man has been raised in an apiary (if I may be allowed the expression) that is and has always been conducted on "scientific" principles and theories, every thing in *nature* that comes to the notice of us old backwoodsmen, and which we have known for years to be facts, if, I say, these observations run up against some theory of *scientific* bee-men, the poor soul who is timorous enough to put his observation in writing must hazard the gauntlet of scientific criticism. And now to the text.

Bro. Stephenson is right about those bees being smaller in those very old combs; and, Mr. Editor, if you had transferred as many old and almost black combs from old weather-beaten box hives as I have, you wouldn't need to take your micrometer to measure either bees or cells to know it too. It's one of nature's facts.

When I began keeping bees, perhaps it was in 1875 or '76, I found that I knew so little about bees that it was absolutely necessary for me to "read up" and take a bee-journal. Well, I happened on the advertisement of one called GLEANINGS IN BEE CULTURE, published by A. I. Root, and I subscribed for it. Well, one of my neighbors came over to see my bees and "talk bee" with me. After I had convinced him there was no such thing as a king-bee, he said his bees were running out, or his old swarm that he had brought with him in the wagon from Sedalia was, any way. I asked him what he meant by running out.

"Why," said he, "they are so small they are not more than two-thirds as big as the others from the new swarms."

I laughed at him, but he stuck to his proposition, and told me I couldn't *theorize* him out of what was a plain visible fact. Well, I put my last GLEANINGS in my pocket, saddled a horse, and went home with him to see his lit-

tle bees; and, sure enough, they were little. Upon raising up the old hive we could see nothing but old comb, nearly black, with the smallest cells I have ever seen, I think. I asked him how old they were, and it is my recollection now that he said, after counting up, and of course consulting his wife, they were about sixteen years old.

"Well," said I, "Charlie, let us see what GLEANINGS says about it. I've got a new one that I've not read, and I just now remember there was a question asked, or something mentioned about those little bees last month." Sure enough, there it was, and the reason assigned for it was that each young bee that was hatched in a cell left a very thin film, or the covering of the pupa, while in the embryo state, sticking to the sides of the cell, and in time this would cause the cells to become so small that the bees were, perforce, very much smaller because there was not room to grow larger; but if we would cut out the old comb, and allow them to make new, the bees would be the usual size. My own observation since has confirmed that position. It is a fact just the same, that those old box-hive bee-farmers know about bees, and one among the very few facts they do know about them; that is, that the bees get smaller.

Schell City, Mo., Feb. 22.

[You refer to the "young man" who was raised in an apiary "conducted on scientific principles and theories." Perhaps you are not aware that that young man will be 39 on the 23d of next June. Besides the experience that he gleaned from our own apiaries conducted on "scientific principles" he has been under the tutelage of some of the successful bee-keepers in the land, visited some of the largest apiaries, and some of the small obscure ones.

Just 21 years ago this spring I (for I suppose I am the "young man" referred to) transferred, or helped to transfer at least, something like 100 colonies in box hives into the then modern Simplicity hives. At various times after that I did more or less transferring from box hives and from old-style Langstroth hives, the combs of which had been in almost constant use for about 15 years. About 10 years ago I transferred 80 colonies. In all my experience I do not remember that black bees in any of the old box hives, or of the old Langstroth hives, from the old combs, were any smaller than the bees of the same queens that were *subsequently* reared in combs just built off from foundation. You say I would not need to take a micrometer to measure either the bees or the cells. If the difference was so great as you point out, it seems to me I should have seen it.

Again, how are we going to get around this fact, brought out by Dr. Miller on page 217 in one of his Straws? If, as he says, the cocoons are as thick on the walls as in the bottoms, the cells would measure, so far as inside diameter is concerned, 13 to the inch instead of 5, and it would, according to his calculation, take $6\frac{3}{4}$ of the bees to weigh as much as a common bee. If you have ever attempted to render up combs in a solar wax-extractor you

could hardly fail to notice the cocoons in the *bottoms* of the cells were sometimes $\frac{1}{8}$ inch thick, while on the *sides* of the cells there might be three or four layers. Now, then, if the bees will remove the excess of cocoons on the sides at all, why should they not reduce them whenever the accumulation is sufficient at any time to hinder the growth of the bees? They leave the accumulations in the bottom of the cells because it is easier to do so, and then bring the length up to the required point.

As a maker of foundation I should like to believe all you write; but I do not believe the facts really support your position. I am still open to conviction; but if you are wrong and Dr. Miller and myself right, we should be saving bee-keepers hundreds of dollars—yes, thousands.

Still again, I think you will find that the actual micrometer measurement of the waists of the bees from old and new combs will not vary any considerable amount. It is true, the box-hive men sometimes *think* that bees are growing smaller; but old bees, after the fuzz is worn off their backs, *look* smaller and blacker, especially if they are black bees, than the younger ones. If some one near here will send me a comb that he *knows* to be 15 or more years old I will put this in a colony beside a new comb. After some bees hatch from each I'll measure them with a micrometer. This will settle the question beyond a peradventure.

I have been already making some measurements of the waists of bees; and after a little I will give some of the results to the public.—ED.]

ARTIFICIAL OR BRUSHED SWARMS FOR COMB-HONEY PRODUCTION.

Conditions Under which Brushed Swarms will do Better than Colonies that have Not Swarmed.

BY L. STACHELHAUSEN.

On page 87 C. Davenport raises some objections to my management for comb honey. First, he thinks that in his locality it is not profitable to swarm colonies before they have started queen-cells. I do not exactly form artificial swarms for comb-honey production, but I take away all the brood and give starters in its place. The brood is hatched in another hive, but given back when it is changed to field-bees, so the whole force of the colony is utilized in this single hive. The main purpose is to force the bees into the sections.

For discussion of this objection we will ask, "What causes the swarming-fever?" Without going into details, I will say that a surplus of young bees, compared with unsealed brood, will, at the proper season, incite the swarming impulse. In small hives this is caused as soon as the number of empty cells is not sufficient for the prolificness of the queen. In large hives the swarming-impulse is not incited before the queen reaches the limit of her prolificness. I have, in large hives, many times observed that the queen had laid, during the previous 21 days, 3400

eggs daily, on an average, nevertheless no queen-cells were started. In a ten-frame L. hive the colony had queen-cells, while the same calculation showed only 2500 eggs daily. The advantages of large hives in spring can be seen at once. It would be easy to start the swarming-fever in a strong colony if we could take away all unsealed brood. The same condition can be created if we contract the brood-nest. The swarming-impulse will be incited, sometimes, later, as soon as the queen can not lay the same number of eggs any more for lack of empty cells. By brushing all the bees from the combs we have about the same proportion of young and field bees as in a natural swarm, have the same condition which incites the swarming-impulse, and, if we are careful that the bees during the operation fill themselves with honey as they do before swarming, I can not see a reason why they should not build combs as well as a natural swarm. In fact, I never had any trouble in this respect with brushed swarms, made either on the old stand or on a new one.

Second, Mr. Davenport says, "With a large yard, or on a range well stocked, a good many strong colonies will not swarm naturally, and such colonies will store more surplus than they would if artificially swarmed."

An artificial or natural swarm will store less honey than a colony unswarmed if the honey-flow is of long duration, because the swarm is getting weaker every day, till 22 days or more afterward, when the first young bees will gnaw out of the cells. This long interval is avoided by my management.

If the colonies in a well-stocked range do not swarm as much, the reason is they do not gather as much honey in the spring (overstocking). This may either cause the development of the colonies to be slower or the brood-nest less crowded by the honey. In both cases swarming is delayed.

Third, with brushed swarms, made before queen-cells were started, "the queen sulked, or, for some reason, refused to lay until considerable comb below was built, and filled with white honey."

It is important to know which way the artificial swarms are made. If very few young nurse-bees are present, the queen is not nourished properly for egg-laying. If a queen-excluder is used over an empty brood-chamber, and too much super room given, the bees may prepare a brood-nest in the sections, and have not sense enough to understand why the queen will not come up and do her duty. By the way, this is one of the reasons why pollen is stored in the sections sometimes. Pollen is always stored around the brood-nest, or where the bees expect to have their brood-nest.

Fourth, "In numerous cases I had the bees themselves sulk, and refuse to do much work for a number of days when all the brood was taken away."

If we suddenly take away all the brood, the bees will always become very uneasy, and behave somewhat like queenless bees. For this reason I give them at first one frame of brood, in some years here, when the bees are not very much inclined to swarm, and in some lo-

calities, perhaps, this brood-comb can remain permanently in the hive. At other times the brushed bees get so much the swarming-fever, contrary to Mr. D.'s opinion, that they will swarm out if this comb of brood is not taken away the first day after brushing off the bees. In this way I always get the bees to work with the same vigor as a natural swarm.

ADVANTAGES OF LARGE HIVES.

I will state again what reason I have for my management. In the spring I use very large hives to get strong colonies without swarming, and without the work recommended by Doolittle, and necessary with small hives. If, over these large brood-chambers, section-supers were given, the outcome was never satisfactory to me. If the brood-chamber was contracted before the supers were given, the result in the honey crop was not much better, and many colonies swarmed. I always had trouble with old-established colonies in forcing them to start the work in the sections. Bait combs or not, they would sometimes rather hang outside of the hive than go into the supers. I got the most comb honey from swarms hived just before the commencement of the honey-flow. From all I have read I got the impression that the bulk of the comb honey is gathered by swarms. I will mention only Niver, page 608, 1899.

At first I united three or four swarms, which I got in large numbers from ten-frame Langstroth hives, and had good crops; but during a long honey-flow these swarms became weak too soon. Using larger hives I got no more swarms. I kept all the bees of one colony together, and added to it afterward all the bees which had hatched from the brood, which I had taken away as soon as they were able to do field work and were too old to cause the swarming-fever. In 1886 I managed an out-apiary on this plan; had a satisfactory honey crop, and no trouble from natural swarms.

SHALLOW BROOD-CHAMBERS.

Shallow brood-chambers are not absolutely necessary for this management. Mine have about half the capacity of a Dadant hive, and I have used them since 1881 — at first as extracting-supers, soon afterward two of them as brood-chamber, because I deem it a nuisance to have two different frames in the apiary. If a colony is prepared for comb-honey production I give at first only one story with starters, and this forces the bees into sections. As soon as this story is nearly built out, mostly with worker combs, I set the second story with full sheets of foundation or drawn-out combs under the first one, and then I have a full-sized brood-chamber again. The bees expand the brood nest down into this lower story as fast as they need more room for this purpose, and comparatively no honey is stored there. In the upper brood-story the bees can not store honey before the brood is hatched, so by and by enough honey is stored in the brood-chamber for the later season. I do not think it will pay here to force all the honey into the sections, and feed the colony afterward.

I use queen-excluders, if they are necessary;

but if I can dispense with them I surely do so. My experience is, that by their use more honey is stored in the brood-chamber, the brood is crowded too much, and the colony is too weak when the honey-flow ceases.
Couverse, Texas.

SEPARATORS v. NO SEPARATORS.

Advantages of Free Communication; Facing Comb Honey.

BY M. A. GILL.

While the majority of honey-producers use separators, the fact remains that a great many do not. Many of the former class think that it is at least impracticable, if not impossible, to produce a nice gilt-edge article without the use of separators, while many of the latter class believe that the bees enter the supers more readily without their use, and, furthermore, that the bees can cluster clear across the super, which enables them to economize better their heat; consequently the construction of comb is carried on faster without the use of separators than with. I myself believe this to be true during a moderate honey-flow and cool weather; but with strong colonies and a good honey-flow I confess I can see no difference. However, I have no trouble in raising a nice article by either method.

But I think everybody should admit (whether he will or not) that honey raised with separators is faced up a little truer and neater than without them. But other things have led me to use a system between the two.

The Colorado Bee-keepers' Association has adopted 22 lbs. as the net weight of a 24-lb. case of honey. Now, while this is, perhaps, about right, I have thought that there should be a difference between the weight of the separated and the non-separated honey—say 21 lbs. for the one and 23 lbs. for the other. There are many colonies that will not store quite 22 lbs. net where separators are used.

Now, before I give my plan I wish to advise every beginner to use separators (and many who do not) as the looks of their honey crop would be greatly improved; and to the man who puts up a nice honest article, always in marketable shape, I have nothing to say. Let him raise it as he will.

The non-separator man is ahead on weight; but look at 100 cases of each kind piled up side by side, and the separator man's honey looks the nicer. Why? Because it is the most even in finish.

Now I don't wish to start any thing, but I wish to say emphatically that the non-separator honey has the weight, has the value, is just as good, but does not look as well. As I said before, it does not have that *even* finish.

In order to obtain the required weight, and still have plenty of honey for facing, I have been using two separators in an eight-frame super. This divides the super into three equal apartments, and allows the bees to cluster in quite large clusters. A hive equipped in this way with full-sized starters, a strong colony of bees (have them strong if it takes all the bees

you have got), and one thousand acres of alfalfa within 1½ miles, will raise fine honey by almost any method if you will set your hive laterally by a spirit-level.

Before I go any further I must go back and attend to that facing business or some one might draw upon his imagination, and take me to task for facing honey. First, I will say I believe in and practice facing honey. I do it, not only for my own benefit, but for the benefit of the retailer. Every case of honey is the retailer's "show-case." The customer sees the honey, is attracted by its looks, and places his order. He, perhaps, never again sees it until it is cut from the section and on his table. I will warrant that he will get anywhere, from a case of my honey, the same grade and value that he would from one of the face sections. But it might not look so much like the rest of the face.

In conclusion I will say to the separator men in Colorado, try a few supers, with only two separators, and see if you don't still have nice honey and a little better weight. And let the non-separator men try a few and see if they don't still have good weight and a little nicer honey.

Longmont, Colo., Dec. 20.

[In the East, nearly every producer seems to be in favor now of using separators; but I was surprised to see there were some in Colorado who still thought they could dispense with them profitably, and yet be able to put out good marketable honey. But one significant fact was that some of those who once advocated the non-use of separators, or only one or two in a super, had gone completely back on such advocacy, and now recommended separators between all the rows of sections.

According to our own experience, we have sometimes wished there were a law by which every producer would be *compelled* to use separators. Some of the very ones who claim that their non-separated honey was as fine as any that could be produced—perfectly cratable, etc., have shipped some of their product to us, and such times as we have had with it! One face would be bulging out against the other, and a great deal of the honey would be leaking. If the veterans make bad work of it, what shall we say of the beginner? If one thinks free communication is a good thing, let him use the fence. Thus he has a very nice compromise.—ED.]

AIKIN'S PLAN OF PRODUCING COMB HONEY.

A Scheme to Control Swarming; Intelligent Expansion Followed by Contraction; the Use of Double Brood-chambers.

BY R. C. AIKIN.

Here is a matter for you to try in your apiaries. It is the system to be used with shallow divisible-brood-chamber hives. You have eight-frame hives. Take two of these for a brood-chamber through the spring. Manage so as to have the brood as much as you can in one of the chambers, say by having the brood-

nest in the upper one, and spread it and manipulate to get these combs solid full of brood. The success does not depend on this getting the one set of combs solid full of brood, though to obtain *best* results it will pay to do this. With this double brood-chamber there is so much room you keep down the swarming fever, and I think the room to spread, especially downward, gives a greater vigor of work than a crowded hive.

Ten days before the flow begins, put your queen in the lower chamber with a little brood—one comb with any amount of brood will be plenty; an excluder on this, and the rest of the brood on top. At the end of ten days, when the flow is just starting, take to a new stand the lower hive with the queen, and put the top chamber on the old stand with nothing but its *sealed* brood and no queen, but give a virgin queen or ripe protected cell, or wait two or three days and give a queen or cell. Give only a cell or a virgin queen, because the brood is *all sealed* that is left on the old stand; and while the virgin is mating, and getting ready to lay, the brood is hatching; so when she does begin laying, the last of the brood is about ready to emerge, and your colony is just in the condition of a colony that has swarmed naturally, and their young queen just ready to lay, except that you have kept the strength of the colony on the old stand, and have been getting section work. As the brood hatched, the brood-combs were filled with honey; but as that young queen begins to lay, that honey goes up to the sections out of her way, and you have no swarming either.

This system anticipates quite a contracted brood-chamber left on the old stand, which would be the result with one section of a divisible-chamber hive, hence there would not be any great amount of honey stored in it during the time the queen was not laying. To make the best test with the eight-frame hives I suggest that you use but six to the body, using a dummy at each side; thus you have a twelve-frame hive before the separation at the start of the flow, and six left when divided.

The whole plan contemplates a big hive up till the flow, then a very small one on the old stand, and yet all swarming effectually controlled, the force of fielders right where they will do the most good. The old queen never stops laying, and goes right on and builds up a good colony in her new location.

This is no idle dream, and I ask that you have it tried in your apiaries this season, to be written up later after trial. I have for years been studying the plan, and, to some extent, experimenting. I think I am the pioneer in it, though another man, and a good apiarist, in this State, has also used the principle, coming at it independently of me. If I have the success I anticipate for it, it will be *the* system with divisible-brood-chamber hives.

Loveland, Col., Mar. 13.

[Our readers will remember that about two years ago I advocated a plan very similar to this—that is, I practiced running two eight-

frame brood-chambers for the purpose of getting powerful colonies for the production of comb honey; then when then the honey-flow was fairly upon us I crowded this colony all into one brood-chamber and one or two supers containing sections and foundation. Sometimes I gave such colonies a shallow extracting-super, and after the bees had got them well started I took them off and substituted the comb-honey supers. There were a few of our readers who condemned the plan as impracticable and unorthodox; but I know that for some localities, and for some seasons at least, it is all right. Mr. Aikin's plan is, perhaps, an improvement on mine, and I wish a good many of our readers might try it and report at the end of the season.—ED.]

GIMPSES OF CUBA AND CUBAN BEE-KEEPING.

BY A. L. BOYDEN.

On the Monday following, I left Havana with Mr. F. O. Somerford, who had just returned from a brief visit to the States, to visit the apiary of Mr. E. M. Penfield, which is located at San Nicholas, and managed by C. E. Riggs. Mr. Riggs formerly devoted some time to bee culture in Missouri, and is very enthusiastic in regard to plain sections and fences for the production of fancy comb honey. While they have been at work a compar-



APIARY OF DR. TORIBIO DEL VILAR.

atively short time, they have a very nice apiary, and have already secured a considerable quantity of comb honey, which has later been sent to the United States markets, so I am told.

The following morning I bade adieu to Mr. Riggs at the station, and soon landed at Guines, where, in company with Mr. F. O. Somerford, who met me at this place, we called on Dr. Toribio del Villar, a physician who is also interested in bee culture. Very soon we were driving out to his apiary, situated near the stone road leading to Havana. This is, as will be seen from the picture below, com-

posed mainly of Heddon lives. Dr. Villar is also interested in the production of comb honey, and gave me some samples of honey he had just produced. After our visit at his place we proceeded out to Catalina, where I had a most enjoyable visit with Mr. Somerford. Our trip from Guines to Catalina took us past some of the most magnificent sugarcane I had ever seen. Mr. Somerford is considerably interested in the production of sugar, and believes there is much more encouragement for investment in this than in bee culture. The very low prices prevailing for honey, and the difficulties encountered by beekeepers, are not calculated to encourage investments in this line. Mr. Somerford is a genial companion, and I regretted that, to keep a previous engagement, I was obliged to leave him early in the afternoon. He is well and favorably known throughout Havana Province by all classes. Our friend Riggs, who lives a good many miles away, told me, if I did not find Mr. Somerford easily, to ask any one I met for Senor Frederico, and he would be able to tell me where Mr. S. lived, as he is so well known because of the service he rendered during the late war. Mr. Somerford's apiary is under a shed, as will be seen by the engraving below.

The following day, in company with Harry Howe, I made a visit out to Candelaria, and to the apiary of Glen Moe. Mr. Moe's success has been quite phenomenal. Starting with almost no experience in this line less than a year ago, he now has nearly 200 colonies, and has secured upward of 20,000 lbs. of honey already. Such a result in the United States would be the means of inducing many to embark in this business. Conditions are,



APIARY OF F. O. SOMERFORD.

cathedral, and many other interesting places, not least of which were O'Reilly and Obispo Streets. These streets, as will be seen from the picture below, are very narrow, while they are perhaps the most popular and fashionable shopping streets in the city.



A STREET IN HAVANA.

During my visit in Cuba there had been little or no rain so far; but on the morning I was to take my departure for the States there came a terrific rain. I have not been able to learn from my Cuban friends whether such a rain is usual there or not, but this is how I found O'Reilly Street at ten o'clock, Jan. 4.

You will notice the vehicles are wading through water up to their hubs. Our readers will bear in mind that this is a paved street. To the credit of Havana I ought to say that I presume this thing does not occur very often. The water simply rushed down so fast over the paved street from three directions that it was very deep before it could get out the other way. The sewerage is so badly planned that it is not able to take care of such a downfall.

GRANULATED HONEY IN SECTIONS OF PREVIOUS YEAR.

Doolittle's Statement Questioned.

BY MRS. A. J. BARBER.

When I see a statement like the one on page 137 I feel like saying something contrary, even if it is a Doolittle who makes the statement. I had to look twice to assure myself that it was Doolittle's name at the top of the article. Well, they must have a different kind of honey, or else the bees are more particular in New York than they are in Colorado. When we put on left-over sections here we always have trouble about granulating. You can take a section off the hive after they have finished it, and hold it to the light, and, instead of looking clear, it will be opaque or milky; and if you cut into it you will find the middle of it a soft grainy mess that will harden very

of course, very different in Cuba, for this honey has to be sold at 35 or 40 cts. per gallon in Havana, which leaves a very small profit to the producer.

The following Friday I spent in sight-seeing in Havana. In company with Harry Howe I visited Forts El Morro and Cabanas, the old

soon after it is taken from the hive. Why, we often have our extracting-frames break out in the extractor from having granulated spots in them. Sometimes we have some left over that we have stored for spring feed, and put them on early to get them cleaned out; and if the honey-flow comes on strong and fast the bees will just clean out a little bit of it, even if we uncap it, and store a little new honey on top of the old, and seal it up. I have lost many combs this way when I had careless help in the honey-house.

I don't even use sections of comb that have been licked clean, as I had an experience that made me think it didn't pay. Several years ago I took off fifty supers of fine sections; and as I was putting them into the honey-house at my lower apiary I let one fall on my foot; and as soon as I could get the honey all in I shut up the place and came home. I was not able to use my foot for several days, and when I did get back down there I found that the bees had got in and cleaned out those 1200 sections, leaving me a fine lot of combs. I took care of them, and in the spring I put them on, expecting to get them ready for market early. There came a good early honey-flow, and those sections of comb were filled in a few days. I lifted them and put new sections under. In a little while the new ones were filled and partly sealed, but not a cell sealed on the old sections. Some of those sections had to be lifted back and forth all summer, as the bees never sealed them as well as the newer ones; and when they did get them done they were what the boys called "a measly-looking mess," as they were spotted and old-looking; so I made a lot of second-grade honey, and did a lot of lifting of supers that could have been avoided, all to save a few sections. Now we never put a left-over section back on a hive. Near the close of the season we practice the go-back system, sending the go-backs to the best colonies. What unfinished sections we do have we sort out carefully. The sections that are not good enough to put into cases are cut out and sold as chunk honey to the neighbors at six cents a pound, and we use a lot of it on our table. The thin lean sections are cut out into a tank of warm water, and the honey strained out to make into vinegar, and the wax goes into the wax-extractor, and the section boxes into the kindling-wood box. In this way I think we more than get pay for new sections, and then we have no bother with the old things. I don't want any bait sections, but am sure that here, at least, we can get a first-class article of comb honey only by having every thing clean, new, and fresh about the sections.

Mancos, Colo.

[This is more in line with the reports that we have received in the past; but here are two reports on the "other side:"]

DOOLITTLE'S POSITION SUSTAINED.

I wish to enter my protest against your way of deciding against Mr. Doolittle's judgment in using last-year's sections with some honey in, over again, for the next season's crop, p.

138. Now, I do the same thing, and like them, provisionally; i. e., I want them to be clean and nice-looking sections, with light *comb*, no matter what the quality of the honey; then uncap them if any part are sealed, and put them on the strong colonies *early*, in apple-bloom if colonies are strong enough. There is nearly always a shortage just after apple-bloom, and the bees will carry down or use all the old honey, if uncapped, and generally all they have gathered in fruit-bloom too, unless there is a very abundant flow from cherry besides. The cherry honey is light, and so is peach honey, and worth saving in the surplus. The apple honey they are welcome to, though it sometimes comes in sufficient quantity to fill their brood-combs, and sets them up in supplies with quite a boost. But when the bees get a good big start in the partly filled sections, the second time, and when the first good flow fairly sets in, and the weather is warm, I raise up that set and put another set under it, with foundation in. That is where I get my nice honey, if anywhere, for that season. But you will say many of these sections are soiled, or some may have dark honey and old comb in them. Save all such for the fall flow, when dark honey is coming in, and they will do for the cheaper grade of honey. Use only the nice ones for the flow of light honey.

This is the way I got a colony to put up over 100 lbs. of sections before they swarmed, and not a very good season either.

Now as to using old brood-combs, I have many in use that were built from 1874 to '76, and they are good yet, and give me just as good bees as any other, though "black as a boot" and tough enough to lie on their side full of honey without bending or bulging.

J. O. SHEARMAN.

New Richmond, Mich., Feb. 25.

[But, look here; I have not "decided" against Doolittle's judgment. I stated the prevailing opinion regarding the practice, and then asked for reports.—ED.]

UNFINISHED SECTIONS; IS THE HONEY IN THEM MORE APT TO CANDY?

Mr. Root:—On page 138 you invite reports regarding the use of unfinished sections, other than baits. If I understand Mr. Doolittle he does not use them for any other purpose, but advocates using the partly filled ones again after extracting, without having the bees clean them up. This has been my practice for several years, and I find it works well. I am not troubled with candied honey; but then, honey in this locality seldom candies.

I would not advise any one to use partly filled sections except two or three in each super, for baits only—especially if there were capped cells. My experience is, when the bees are crowded for room they will invariably extend the open cells beyond those capped the previous season, which makes ugly and unsalable sections.

M. D. ANDES.

Bristol, Tenn., Feb. 23.

[Let's have more reports. In the multitude of counselors there is safety.—ED.]

BEEES IN A FRUIT-ORCHARD.

How to Improve the Flavor of an Off Grade of Extracted Honey.

BY R. G. HAWN.

The bee-yard shown in the picture is located in the apple-orchard. There is a good wind-break on the north. The part of a building shown is my bee-house, 16x20. It is well built; is mouse and bee proof. It has a large cook-stove and all necessary fixings.

I have tried many sizes of hives, but on the whole I prefer the eight-frame Langstroth. I aim to run from 40 to 50 colonies, and get a surplus of from 40 to 60 lbs. per colony, according to season. I am now running almost entirely for extracted honey, for the following reasons: 1. I can control swarming best that way. 2. It is not so much expense. 3. I get more pounds of honey of first quality. 4. It sells more readily, and at better prices; and, altogether, is more satisfactory to my customers.

Our sources of honey are early spring willow, then fruit-bloom, then dandelion, then white clover, and then a second crop of red clover, with a few wild flowers.

Mine is a home market, supplied by a peddling-wagon. It took hard work to get a start; but honest dealing and perseverance triumphed. I use quart Mason fruit-jars, sev-

en and fourteen pound lard-pails, and some fifty-pound tin cans.

This county is or rather has been flooded with adulterated honey. The discussion of the subject in the papers scared the people, and generally they quit buying extracted honey. I soon succeeded in convincing them that my honey was pure, and then they bought freely. Really the adulteration worked to my advantage.

The first extracted honey from fruit and dandelion is somewhat strong and bitter, and in that condition is unsalable. I let it candy hard, which it does in a short time. Then I melt it, and again let it candy. This last takes from four to six weeks; then I melt it again, set it away in fifty-pound open cans, cover with some loose stuff, so as to keep out the flies, and I soon have a first-class article, very thick, and of excellent flavor.

Thorpe, Wash., Feb. 28.

BEE KEEPING FOR WOMEN.

How 500 Colonies in the Rockies are Operated by Women Only, and Women who can Vote; a Big Record in Honey Production.

BY LYDIA CRAWFORD HARRIS.

I send you a picture of one of my apiaries, containing 167 colonies, located two miles south of Delta, Colorado, about two rods from the banks of the Uncompahgre River, in one



APIARY OF R. G. HAWN, THORPE, WASH. AN OBJECT-LESSON IN BEES AND FRUIT.

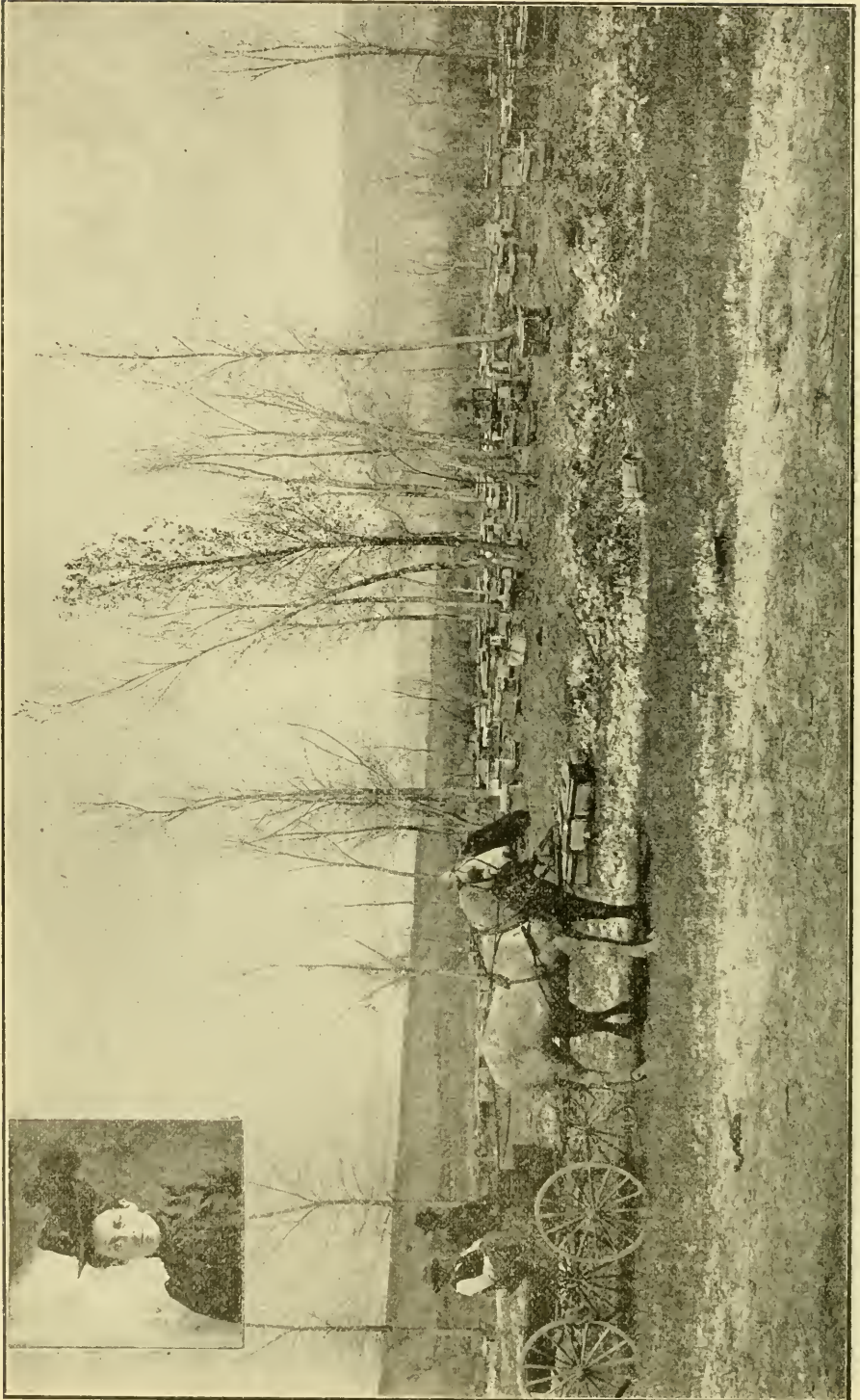

APIARY OF MRS. LYDIA HARRIS, DELTA, COLORADO. MRS. HARRIS IN UPPER LEFT-HAND CORNER.

of the largest alfalfa districts on the western slope of the Rocky Mountains. These colonies are in ten-frame (Langstroth size) hives, frames all wired and on full sheets of foundation. I prefer the ten-frame-size hive for this location on account of the long and mild winters. Frost generally comes about the middle of September, which destroys our last flow of honey. Then we have nothing until March. During all this time there are few days when the bees do not fly some time during the day. About the middle of March the squaw-bush blooms, which grows thick along the banks of the said river, and after that comes the fruit bloom—first the apricot, then the plum, then peach, pear, and apple; so by the first of June, when the first crop of alfalfa begins to bloom, the bees are generally in pretty good condition to store honey. This yard produced last year 160 60 pound cans of extracted honey, and 171 crates of comb honey. I have also two other apiaries, containing 334 colonies—in all, 500 colonies.

As we women in Colorado enjoy all the rights of voting, from the lowest county officers to the President of the United States, I propose to operate these yards with women help.

The farmers do not cut their alfalfa as soon here as in some other places, as they nearly all sell by measurement in the stack for feeding cattle; hence it grows stronger and larger, and, while doing so, naturally blooms longer.

We also have drawbacks in this part of Colorado, which I find mostly in freight rates; but these are not so high as I understand Mr. J. W. Hammersmark says they are, page 46, from the East to Reno, Nevada, or vice versa. At the same time, according to Mr. Martin's figures on page 81 it costs \$270 more to ship a car of 30,000 pounds from here to the East than it does from Los Angeles to the East. The freight rate is the same from here on comb honey as on extracted honey; and considering California and Cuba's prospective large crop of extracted honey I shall operate my bees principally for comb honey.

Delta, Colorado.

[We admire your spunk and independence. If the right of franchise has this effect on the gentler sex, let's give the women a chance. If the women of the land could vote there would be less of jobbery and wickedness in high places. I'll risk the women every time. —ED.]

ROOF APIARIES.

My Experience in Roof Bee Culture; Rearing Queens on a Tin Roof, and their Safe Introduction.

BY C H W. WEBER.

It is my intention to give my experience in the bee keeping line as few practice it (that is, on a roof), and also a few suggestions which may prove valuable to other bee-keepers who may be in the same kind of boat as I. I have kept bees on a roof in a small way for several years, but not until recently did I find it nec-

essary to increase my stock and move the same to the roof proper, where I had much more room, and more benefit from our sometimes too warm friend old Sol.

This mode of bee culture has its peculiarities, many of which I have already discovered, and some not altogether to my liking. I soon discovered, after the weather began to get hot, and combs began to get shaky and tumble down, that some method would have to be resorted to that would shield the hives from the direct rays of the sun, and also from the reflected heat. After some consideration, nothing seemed to possess so many good points as the long-shed arrangement shown in the photograph. This was all right to keep the sun off; but as the heat was also reflected up from the tin roof I found it necessary to pack all around and under the brood chambers with six inches of chaff, and since that day not a comb has melted down, nor am I troubled in the least from excessive heat.

Winter also has its drawbacks, and the cold is just as hard to contend with as the heat; but after having flaps, made of heavy canvas, put on the rear, and the brood-chambers still surrounded with chaff as in summer, little or no wind can strike the hives directly; and on the coldest day, if I work my hand down between the hives into the chaff, I always find it nice and warm, and the bees always ready to let me know by their contented hum that they are still very much alive. So much for the protection and shelter. Now let's look at the queen-rearing side of the subject.

TO RAISE GOOD QUEENS.]

I have found out as others have before, that the only way to get them is to use extra-strong colonies for this purpose, and I rear all queens in the second story of a double-brood-chambered hive, something on the order of Doolittle in his book. In the second story I place four frames of well-matured brood nearly ready to hatch. Between each two I insert a comb containing some very young larvæ, and eggs; then under the whole I place a queen-excluder, and take good care that the queen is on one of the combs below. This puts the bees in the same state as supersedure, and in three or four days one can find queen-cups on the center comb, which the bees have built for the queen to lay in.

After they are well started I insert on a frame artificial queen-cups previously supplied with a young larva from my choice breeding-queen, and destroy all cells which the bees may have started on the combs. On or about the tenth day I supply myself with a queen-nursery for each cell, and then proceed to single out the cells which I want to save, by surrounding them with one of these little cages which the cells and cell-frames are arranged to take without any trouble. In two or three days I have as nice a lot of virgin queens as any one would wish to look at. They are then introduced into the nuclei, and in another week or ten days they are ready for Uncle Sam's care or to be introduced into their future homes.

Before leaving this part of my subject it

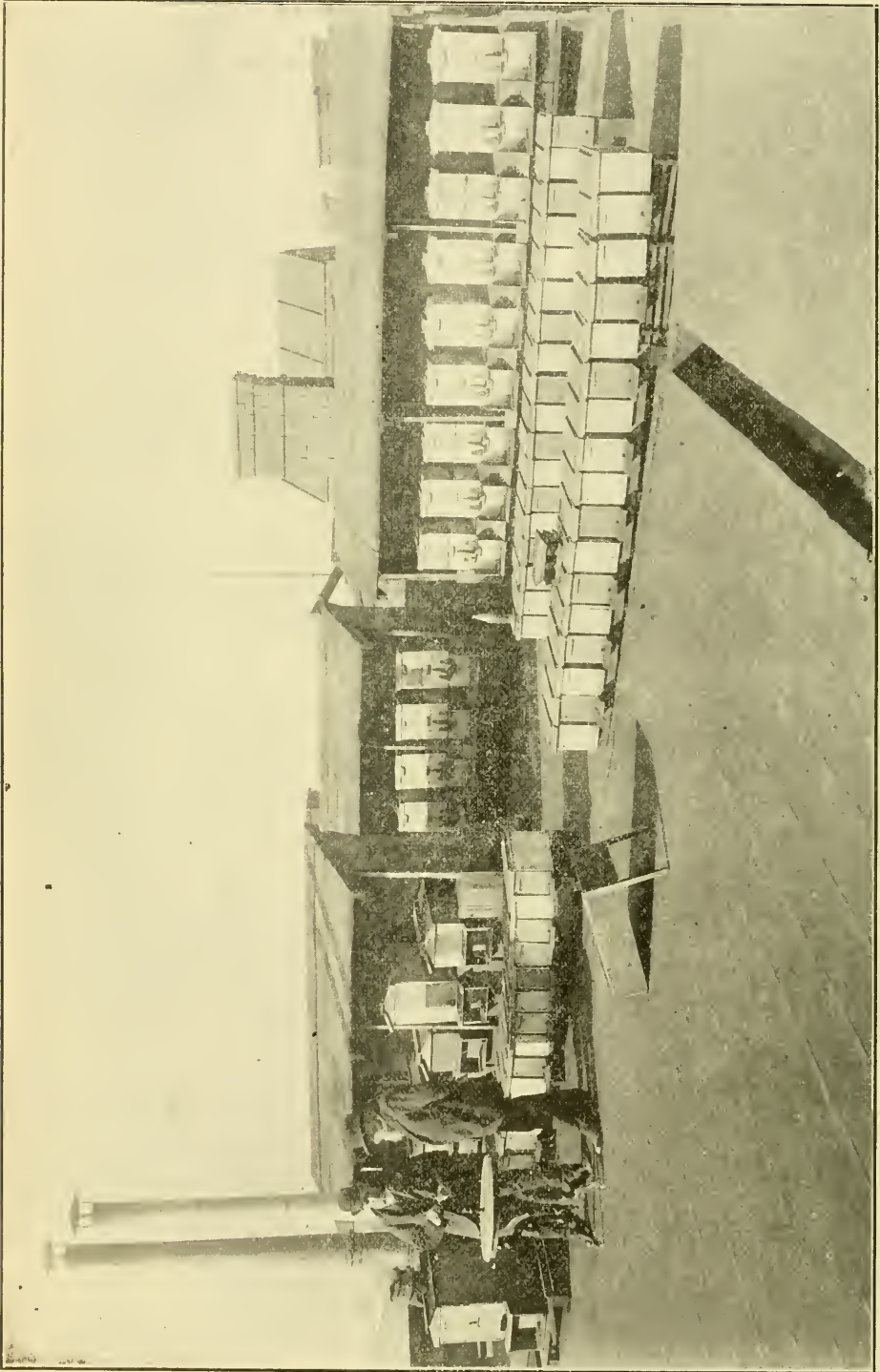

ROOF APIARY OF C. H. W. WEBER, CINCINNATI, OHIO.

might be well to mention that my nurseries consist of a long bar about an inch wide, cut to fit tightly between the two end bars of the regular-sized frame. This bar is partitioned off by tin walls into little chambers about one inch square, and covered on both sides with wire netting, all having the tops left open. When we have cells expected to hatch within a day or so we just take one of these nursery-bars and shove it up under the queen-cells on the frame, thus partitioning each queen-cell off by itself. At the bottom or under side, many corks can be seen which close a $\frac{1}{4}$ -inch hole, the exit to each of these little chambers.

INTRODUCING QUEENS.

To introduce queens I have found this to be the best method for me, excepting none. Take the queen away from the colony into which the introduction is to be made, and the bees will, as usual, start to construct queen-cells as usual. After they are all sealed, and to make sure that they are all sealed, I wait until the 7th or 8th day. By this time the bees begin to expect a new queen from the cells they constructed, and this is the time to introduce your new queen. Put her into a cage; or if she is in a mailing-cage, as she arrived through the mail, all right. Remove the piece of tin which you will find covering a hole at one end of the cage (we will suppose our queen has just arrived through the mail, and the colony was made queenless the day we sent for her—of course time will vary in filling orders, but it usually takes about a week to get the queen), and cover the opening with a piece of thin foundation. After doing this, open the hive and lay the cage on top of the frames, or somewhere between them. Before closing the hive, blow a few puffs of tobacco smoke into the hive, for good luck, and close quickly. The tobacco smoke, however, is not really necessary. In a day or so examine the hive and you will be almost certain to see your new queen on one of the combs, walking along as peaceably as if she had hatched from one of the cells which she only a few hours before destroyed. This method, although keeping the colony queenless for some time, is, nevertheless, one of the *surest*, and is well worth following when a valuable queen is at stake.

Cincinnati, O.

[Our experience in the matter of introducing queens has been almost the opposite of Mr. Weber's. We find that we get bad results in introducing to colonies with capped queen-cells. We succeed much better with colonies queenless but one or two days.

Roof apiaries are not very numerous, chiefly because of the difficulty of controlling the extremes of heat and cold; the only ones I know of who have made a success in such elevated spots are the late Chas. F. Muth, and Weber, as above, and Mr. G. E. Purple, of Chicago. Where land is expensive and can not be had, there is no reason why roofs of buildings may not be made available; but of course it will be necessary to provide against the extreme of heat as Mr. Weber has done. ED.]



TRANSFERRING.

It is the 14th day of March, and we have had the first day this year in which the weather approached anything nearly warm enough for the bees to fly, the mercury rising as high as 42° in the shade. The snow has been from two to ten feet deep ever since the middle of February, just in accord as the wind has piled it, and the bees that are out on their summer stands are suffering for a fly. Being in hopes that they may be able to fly to-morrow I am out looking at the entrances of the eleven colonies I have outdoors (near sunset), to see that none are obstructed. While doing this I see a man approaching, who proves to be Mr. Brown, who lives about a mile away, and who has the bee-fever, he having purchased a dozen or so colonies of an old box-hive farmer last fall. As he nears the bee-yard I accost him thus:

"Good evening, Mr. Brown. How are the bees getting on?"

"I was out listening at the entrances a little while ago, and I could hear a little hum from all the hives but one, and that I think is dead, as no response was given when I tapped on the hive."

"This long siege of cold and snow has been hard on the bees, but I hope they may fly to-morrow. I see one or two of mine flew a little to-day, but nearly all that flew died on the snow. But it takes only a few bees to make a great show on snow, and I expect the most of those which come out when it is not really warm enough for them to fly are old bees which would soon die anyway. Have you looked that your entrances are all free so the bees can fly to-morrow, should it be warm enough?"

"Yes. I carefully cleared the entrances of dead bees yesterday, hoping they might fly to-day, but only a few came out. Like you, I hope they may fly to-morrow. But I came over to have a talk with you about transferring. I have my new hives all made, and want to get the bees into them as soon as possible."

"Are you going to transfer them so as to try to save the combs? or are you going to use frames filled with foundation?"

"I wish to save the combs, of course, as I have only enough foundation to use for starters in the frames for the new swarms."

"Where we wish to transfer the combs as well as the bees, there are only two really favorable times for transferring, although it can be done at any time by using care."

"When are those favorable times?"

"The first is during fruit or apple bloom, and the second is 21 days after the first or prime swarm issues."

"Why those times in preference to others?"

"If done at the commencement of fruit-bloom, but little honey is in the way, so the

transferred combs are more easily held in place in the frames, while honey is coming in sufficiently to prevent robbing, as well as to enable the bees to repair rapidly the damage done the combs. If done 21 days after swarming, there will be no brood in the hives except a little drone brood, so there will be no loss from cutting through it, as all the bees from the eggs laid by the old queen will now have emerged from the cells, while the young queen will have only just begun laying."

"That seems reasonable. But is there no preparation to be made before I begin this work? If so, I wish to make these preparations now, while I have time."

"Yes, there are preparations to be made, and the first is to bore some eighth-inch holes through the center of each frame contained in the movable-frame hive, about four through the top bar, the same through the bottom-bar and side or end bars, if these latter are of equal length with the others. If shorter, then three will do for these."

"What are these holes for?"

"These are to slip pegs or thorns through, into the combs to hold them in place; and your next work will be to make the pegs or gather the thorns. The thorns are best, as they are smoother and sharper. You can find plenty of them on those thorn-bushes over toward the swamp."

"Yes, I know where they grow, and will get some; but there are other preparations, are there not?"

"Yes. Besides having the frames and pegs ready, a board about two feet square will be necessary, and a barrel or box of convenient height for the operator to place the board upon. On one side of the board should be tacked three or four thicknesses of cloth so the brood and combs will not be injured by being placed upon it. Besides these you will want a long thin-bladed knife."

"That completes the preparations, I take it."

"Yes; and, having these things in readiness, proceed to the hive and blow a few puffs of smoke in at the entrance to alarm the bees, when the box hive is to be turned bottom up and the frame hive placed on the stand the box hive occupied. Blow a little more smoke over the exposed bottoms of the combs, and place the cap of the hive, or any box, over the bottom of the hive for the bees to crawl up into. Select the side of the hive to which the combs run parallel, if possible, and proceed to pry off the side, using a cold chisel to cut the nails, if necessary. If there are cross-sticks through the center of the hive, these must be cut off with a saw, or otherwise."

"What becomes of the bees?"

"By this time the bees will all be off the combs next to you, when the first one is to be cut out and laid on the prepared board. Now lay one of your prepared frames on this comb, and mark the comb by the inside of the frame. Next, take off the frame and cut the comb a hair larger than the marks, so that it will fit snugly in the frame, when the frame is to be pressed over the comb until it fits nicely. The thorns are now pushed through the holes into

the comb so as to hold it in place in the frame when hung in the hive."

"Will these thorns hold it all right in picking up?"

"To take from the board requires a little skill, as the comb is generally stuck fast more or less with leaking honey. But if the board and all is raised until the frame stands in the position it hangs in the hive, there will be no danger of the comb falling out in causing it to part with the board. When free from the board, place the frame in the hive, and the bees which have returned from the fields will take possession of it, licking up the drip, etc. Proceed to cut out the rest of the combs and fit them in the frames as you did the first, until all are used, and set in the new hive, placing them in this hive in the same relative position, as nearly as may be, which they occupied before."

"What about the drone comb? Should there be much?"

"If drone comb to any amount is found, it is well to leave the most of it out."

"How about the smaller pieces?"

"If many pieces of nice worker comb are made by the combs cutting to a disadvantage, they can be fitted into frames, and fine wire wound around to hold them in place till the bees fasten all together. If this is done, the hive must be opened in a few days and the wire removed. The thorns can always remain, as they do no particular harm."

"How about the bees which have run up into the box?"

"As soon as all the combs are in, close the new hive and hive the bees which are in the cap or box into it, the same as any swarm would be hived, when the job is done. If a scarcity of honey exists at time of transferring, so that robbing is liable to occur, a bee-tent to set over the hive and operator is a good thing."

"You spoke at the start about using foundation in transferring. What did you mean?"

"We have at the present time what is termed the new way, or Heddon plan of transferring, and many of our best apiarists prefer that to the old way."

"How is that different from the one you have just told me about?"

"By the new way a new hive with the frames filled with comb foundation is set on the stand the box hive occupies, when the queen and three-fourths of the bees are drummed out and hived in the new hive, the old hive being left standing close by. In a week this old hive is carried to a new stand, this stopping all after-swarming by causing all of the flying bees to be left with the new hive. In 21 days, when all the brood has emerged from the cells, and the young queen commenced to lay, all of the bees are driven out, and from the combs and old box hive, and this drive hived in another new hive standing on the stand the box hive occupied just before this last drive. You have now two colonies from your old one that was in the box hive, both of which are in new hives with all-worker combs, while you have the contents of the box hive all free from bees, in a shape that

you can do what you please with it. Most of those using this new method prefer to put the old combs from this box hive into the solar wax-extractor, thus getting out the honey and wax from them, and separating the same so it is in fit shape for use."

"Well, this plan sounds nice, and had I the foundation I think I should prefer it to the other. But it is nearly dark, and I must go back. Good night."



BREAKING THE RECORD; 27 ½ TONS OF HONEY BROUGHT INTO ONE APIARY IN ONE SEASON.

I want to furnish an item for A. I. for GLEANINGS. In the Mar. 1st number, page 193, he says: "More than 22 tons of honey was brought into that one spot in one season, and all collected from flowers within range of the bees' flight. Can the world furnish a parallel?" (From 680 stands.) You send GLEANINGS to Bart Bartlett. He, one brother, and a brother-in-law, work under its firm name of Bartlett Bro & Merkle. A year ago this spring they came through with 760 laying queens, and from those queens and their increase, in one yard, in one season, they extracted 51,000 lbs. of A No. 1 white honey, or 27 ½ tons. Now, this is what I did last season, in one yard of 152 colonies. I extracted 42,000 lbs.; but on account of sickness I got behind and lost one extracting of 7000 or 8000 lbs. Now, can you beat that?

Vernal, Utah.

C. C. BARTLETT.

[Friend B., I am exceedingly obliged to you for the item you furnish, especially as a much smaller number of colonies did the work. You say 160 laying queens. These queens probably all had exceedingly strong colonies, and there might have been some queenless colonies to help out—probably not, however, the way you state it. This would be over 313 lbs. per colony, spring count. It would be interesting to know what the increase was. If the firm can give us further particulars in regard to the matter we should be very glad indeed to get them; and I suppose a good many of our readers would like to inquire whether there is unoccupied territory in your vicinity that will give any such yield as this. And you, my friend, did a wonderful thing also. If we take into consideration the 8000 lbs you lost, then your bees brought or might have brought into that one spot 50,000 lbs., or 25 tons. This amount, from 152, spring count, would not be quite equal to the former, but a stupendous achievement for all that. Now, instead of stampeding to Wewahitchka, hadn't we better turn about and investigate around about Vernal, Utah? I think your locality must be well named, friend B. Rest assured, if I ever make another trip to your State I shall try to hunt you up.

Mr. Calvert tells me that your honey was probably from alfalfa grown by irrigation. He also adds you are something like 125 miles from any railway station. How do you get this great crop of honey all this long distance in order to get a market for it?—A. I. R.]

CLIPPING QUEENS; HOW MANY AND HOW MUCH OF THE WINGS SHALL WE CLIP?

On page 838, Nov. 1, S. E. Miller says: "I am a little surprised by a late number of GLEANINGS to see that you and Dr. Miller do not know the correct way to clip a queen's wings, so I suppose I shall have to tell you both, as well as the other readers of GLEANINGS."

Now, Mr. Editor, as I am one of those readers you will surely give me a chance to protest against any such way. I have clipped a good many hundred queens—about 100 the past season, and I want to say that, if Bro. Miller's object in clipping queens is to keep them from flying, it is positively unnecessary to clip more than a third of *one* of the large or top wings, and that a small pair of sharp and pointed scissors is the proper thing to do the cutting with. The position of the knife across the wings in the illustration covers the four wings just above, so that the sight of Bro. Miller's queens with four stubs and a naked back can more easily be imagined than admired; but the single-wing method of clipping leaves that side of the wings apparently rounded off by the perfect or lower wing, which is a little shorter than the top ones.

Manistee, Mich., Feb. 4. W. HARMER.

[Referring to the article on page 838, last year, it is evident that you misunderstood the doctor and myself. We have not recommended that all four of the wings be cut off, leaving "mere stubs." The plan illustrated contemplated cutting only the two wings on *one side*. If the other two are left intact, the deformity is not so very noticeable.

You claim "it is positively unnecessary to clip more than a third of *one* of the large or top wings." Are you sure about that? Why, friend Harmer, I have seen queens fly when clipped as you describe. They will fly just far enough to get clear away from the hive, become exhausted, drop down, and get lost. Possibly they will crawl into some other hive where they will be destroyed. We have also had quite a number of reports where this scant clipping of one wing has resulted in a whole swarm of bees getting away with the queen. To make sure, it is better to cut quite close the one large wing, or cut both wings about half way up on one side.—Ed.]

A CORRECTION.

Mr. E. R. Root:—In commenting on Prof. Rankin's article on page 84, you are mistaken in saying that these are the same bees mentioned on page 924. The only bees of which both Prof. Rankin and yourselves had a sample were those mentioned on page 844 of the Nov. 1st issue.

J. H. GERBRACHT.

Spring Grove, Ill.



NATIONAL BEE-KEEPERS' ASSOCIATION.

OBJECT:—To promote and protect the interests of its members; to prevent the adulteration of honey.

OFFICERS:—E. R. Root, President, Medina, O.; R. C. Aikin Vice-president, Loveland, Col.; Dr. A. B. Mason, Secretary, 3512 Monroe St., Sta. B, Toledo, O.; Eugene Secor, General Manager, Forest City, Iowa.

BOARD OF DIRECTORS:—E. Whitcomb, Friend, Neb.; W. Z. Hutchinson, Flint, Mich.; A. L. Root, Medina, O.; F. T. Abbott, St. Joseph, Mo.; P. H. Elwood, Starkville, N. Y.; E. R. Root, Medina, O.; T. G. Newman, San Francisco, Cal.; G. M. Doolittle, Borodino, N. Y.; W. F. Marks, Chapinville, N. Y.; J. M. Hambaugh, Escondido, Cal.; C. P. Dabant, Hamilton, Ill.; C. C. Miller, Marenco, Ill.

FEES:—Annual membership fee, \$1.00. Remittances may be sent here or to General Manager as above.

GENERAL MANAGER SECOR has lately issued a pamphlet, giving the objects of the National Bee-keepers' Association and also the constitution. I presume a copy of this will be sent to any one who may apply. Those who are not members should know something of what this organization is and has been to bee-keeping during the last fifteen or twenty months, and what it proposes to do in the future.

So far the reports of wintering have been generally favorable, although there is one report from Wisconsin that seems to indicate that in that section, at least, there will be 50 per cent loss or more. The season generally will be late. It has been running all the way from cool to cold, with very little warm weather for brood-rearing. This, fortunately, has kept brood-rearing down, so that the bees have not wasted their strength before actual warm weather comes on.

"THE AMERICAN GARDENING" ON THE QUESTION OF BEES PUNCTURING FRUIT.

In the above-named publication for Feb. 9 there is an article headed "Do Bees Puncture Fruit?" It seems that one B. L. Ryder, in the issue of that paper for Jan. 12, intimated that bees were guilty of "puncturing and feeding on our finest peaches." This was vigorously denied by Mr. R. E. Huntington, who, among other things, said it was "painfully evident that the writer has not read up much on that subject within the last five years." He also referred to the findings in the case of Utter v. Utter, at Goshen, N. Y. The editor of the *American Gardening*, in commenting on this, while not assuming to deny or affirm that bees may puncture fruit, yet says, "The balance of evidence, as we see it, is proof in favor of the bees, and the little insects are honorably acquitted by the editorial court." He also refers to the experiments that were conducted at Aurora, Ill., where the bees were confined in a building where there was an abundance of sound fruit; and yet, although brought to a condition of hunger, thirst, and starvation, they could not be induced in any instance to attack the fruit unless it was first punctured.

Besides all the bee-journals, the little bees have on their side such staunch advocates as the *Country Gentleman*, the *Farm Journal*,

American Gardening, and a good many others. Truth is mighty, and bound to prevail.

THE NEW FOUL-BROOD LEGISLATION IN MICHIGAN.

I AM pleased to announce that the foul-brood bill which passed the Senate of the Michigan State Legislature has now gone through the House, and at last advices was awaiting the signature of the Governor. If he signs it, as I presume he will, the bill will become a law. Great credit is due to the Hon. George E. Hilton, a former member of the lower House, and who, by the request of bee-keepers, engineered the measure through both Houses. Several times the bill would have been "amended" or "shelved in committee" but for the energetic promptness of our old legislator who insisted on having just what the bee-keepers wanted, and he got it.

This piece of legislation was enacted none too soon, for foul brood has of late been making fearful progress through the State. The old law, now superseded, was defective in that it did not provide for a competent State inspector under the pay of the State. The bee-keepers of Michigan can now select the best man available; and such a man, if he be like the inspectors of Wisconsin and New York, will see that a sudden check is placed upon the further spread of the disease.

SPRAYING TREES IN BLOOM; MORE EVIDENCE AGAINST THE PRACTICE.

I HAVE already reported that the Experiment Station at Geneva, N. Y., counseled against spraying trees while in bloom; that it not only killed the bees, but also affected the delicate organs of the flowers; that in some cases those who had been most active in urging spraying during blooming-time had found to their sorrow that such spraying had seriously cut down their fruit crops. While these experiments were being conducted at Geneva and in that vicinity, the same kind of experiments were being carried on at Cornell University, N. Y.; and now we have a report from John Craig, of that station, confirming the findings of the Geneva station. This report is published in the *American Gardening* for April 6.

It has been urged by the advocates of spraying in bloom, that, during seasons like that of 1900, when the trees are heavily loaded with blossoms, spraying at such times has the effect of thinning away the superabundance of fruit. Regarding this, Mr. Craig very pertinently says: "It seems that, when this admission is made, the strength of the argument is very much weakened. If it is a thinning process, then it could be practiced with safety and advantage only in seasons of heavy bloom." Elsewhere he says, under the head of "Disadvantages of Spraying while in Bloom," that that the "researches at Cornell and elsewhere have indicated that the copper salts are very injurious to tender tissues; and that, the more delicate the structure, the more likely is injury to ensue. . . . The thinning which follows spraying trees in bloom is probably

due to the injury to the pistil or stigmatic surface by the fungicide." Mr. Craig then mentions another objection to spraying in bloom; viz., the "destruction of the bees;" and then, in giving a reason why such destruction should not take place, he says: "When cross-pollination is carried on by the bees, larger fruit will be secured than if self-pollination occurs. . . . Now, if we cover our apple-blossoms with mixtures which are likely to poison the bees, it seems to me that we shall be using against ourselves a double-edged weapon." When it is remembered that these experiments were begun at the Geneva and Cornell stations at the instigation of the fruit-men, who were anxious to prove that spraying during blooming-time was an advantage, the results, being just the reverse of what was expected, are all the more valuable.

MISS MORLEY'S HONEY-MAKERS.

IN looking over the many different bee-books on our list it would seem that the field is pretty well covered. The beginner, by studying Langstroth, may make himself acquainted with all the different phases of bee culture. The more advanced will profit by reading Heddon's "Success in Bee Culture," or by following Dr. Miller for a year. The student can satisfy his thirst after knowledge by perusing the pages of Prof. A. J. Cook's "Guide;" the queen-breeder or the experienced honey-producer wishing to breed his own queens will find Doolittle's book on queen-rearing just the thing. The ABC of Bee Culture is an encyclopedia for all, the beginner and experienced. So I might go on and name many other good bee-books.

Miss Morley, in her late book, "The Honey-makers," fills a vacancy which the honey-producers have not felt. But the laity will be pleased that this vacancy is now filled, for the book is especially adapted to the non-keeper, although this does not imply that the professional may not learn from it. The illustrations, particularly those of the external organs of the bee, can not help making it clear to even those who know nothing about this wonderful insect, what the organs are for, and how they are used. The whole book is written in such a pleasing, unique, and fascinating style as to lead the reader on and on so he will not rest until it is read clear through.

The first chapter gives a general outlining of the structure, habits, products, and mission of the honey-bee. The next 20 pages are devoted to the bee's tongue, which at present receives so much attention from the bee-keepers. The illustrations of this organ are so nearly perfect as to give the reader a very clear conception of the workings of this wonderful organ through which all the honey, stored for us, must pass. Chapter 3 describes eyes, antennæ, and brain; chapter 4, the wings; chapter 5, the legs. The reader will be informed that the six legs of the bee are not so many sticks to prop up the body of the bee, but that each one consists of many parts, forming a very complicated piece of mechanism, intended for various uses.

After the external organs are described, the writer makes the reader acquainted with the inner organs. Then the different members of the bee-family are described; further on, the whole as one family.

The different uses of honey in this and other countries are explained; many wonderful things are told regarding the customs of the ancients in the line of using honey. Many extracts from Hindu bee-literature, and that from Egypt and other eastern countries, are given. Much space is devoted to showing what knowledge the Greeks and Romans had of the physiology of the honey-bee.

The book will be an ornament in any library. May it find many readers, and thus disseminate bee knowledge among the general public. It may be the means of dispersing prejudice, and establishing a better feeling between the bee-keepers and those who can see in the bee only a disturbing element.

This book is published by A. C. McClurg & Co., Chicago. It contains 400 pages, well illustrated, and the price is \$1.50. It can be supplied from this office.

DAVITTE'S TENT FOR CONTROLLING THE MATING OF QUEENS.

IN our issue for March 15, page 247, I described the Davitte method of controlling the mating of queens, as given in the February issue of the *Bee-keepers' Review*; and through the courtesy of that paper I am able to reproduce that illustration showing the fertilizing tent that Mr. Davitte recommends, and described by him as follows:

I would secure 12 tall poles. I would have them at least 30 feet long—40 would be better. These I would plant firmly in the ground, 12 feet apart in a circle. From pole to pole, at the top, I would stretch No. 10 wire to keep the poles true and in place. I would also brace the poles from the inside; and the braces would be allowed to go up 20 feet on the inside, as the drones use only the upper part of the tent. At the top of the poles I would also stretch No. 10 wire from each pole to its opposite neighbor, thus strengthening the structure and furnishing support for the covering that goes over the top. I strengthen every seam of my netting by stitching on a strip of bride-rein stuff about an inch in width. This allows me to stretch the covering very even and tight without tearing it. Common boards can be used around the bottom to the height of five or six feet. At noon the tent should have the appearance of a sun-palace.

The secret of success, according to Mr. Davitte, lies in keeping the workers out of the cage, as they have a tendency to annoy drones. As I explained in GLEANINGS, this is accomplished by placing the hives around the tent as shown in the cut, each hive having two entrances, one communicating with the inside of the inclosure, and the other out-doors. The former is closed several days, or until the workers become thoroughly accustomed to the outside entrance, and then is opened to admit the drones from 11 o'clock till 1:30. After a little the drones begin flying inside of the inclosure, forming a "school" in the air, and, nine times out of ten, they will, according to Mr. Davitte, meet the queen on the wing before she reaches the top of the cage.

But the tent proposed by Mr. Davitte is

very large and expensive, and one must have reasonable assurance that such a structure will accomplish the result desired before he can afford to put one up. While I believe it will work, is it not possible that a smaller tent will do?

Mr. Thaddeus Smith, of Pelee Island, Canada, calls my attention to an article written by W. R. King, in the *American Bee Journal* for 1872, page 177. In this article I find that Mr. King employed practically the same principles recommended by Mr. Davitte, *except* that his fertilizing-house was only 6x8, and 8 feet high. This structure was boarded up two feet from the bottom, then covered the rest of the way up with cloth. The top was surmounted by a cone-shaped calico roof.

He says he succeeded in having "many queens fertilized last season by the foregoing method, carrying out every manœuvre just as I have presented them." But he scouts the idea, which at that time was being talked of a good deal, of the possibility of queens being fertilized in the hive. He says: "When any man tells you he has had queens fertilized in the hive, and four at a time, just tell him for me that he says—what's not true."

As soon as the weather opens up, and we can get drones, we will try the small house; then if that will not do we will try the larger structure.

There are several other old articles on this subject of fertilizing in confinement if one wishes to pursue the subject further. One

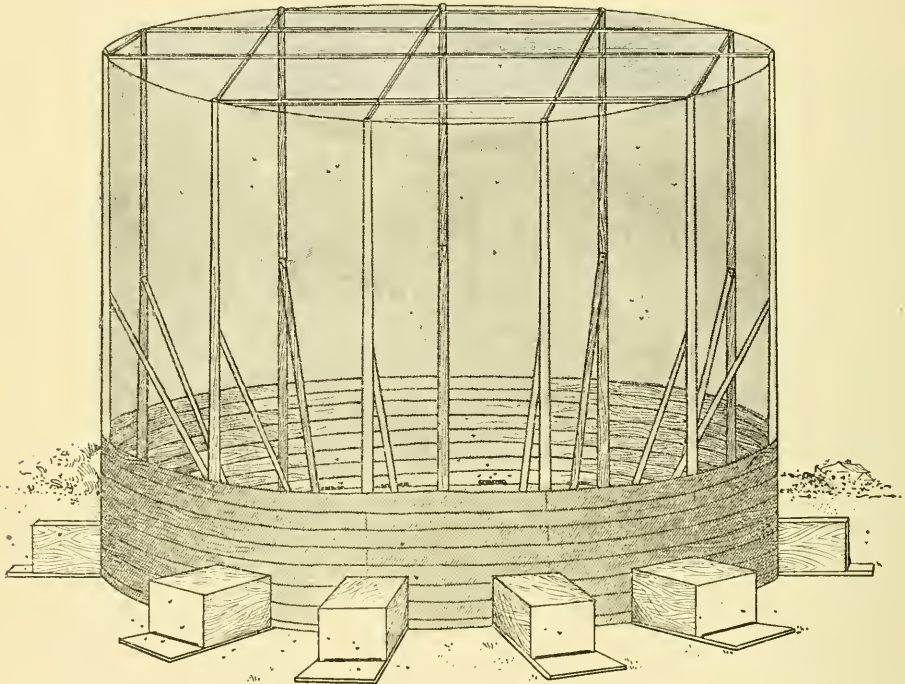

MR. J. S. DAVITTE'S TENT FOR CONTROLLING THE MATING OF QUEENS.

Mr. King, in several places in the article referred to, emphasizes the importance of keeping the workers *out of the fertilizing-room*. He considers this so important that he has put the statement in one form or another in several places in italics.

But his manner of keeping workers out of the tent was somewhat different. He put young drones, that had never flown, on some frames of hatching worker-brood. These frames were confined in a wire-cloth cage over a strong colony for four or five days. The drones were then released in the aforesaid room together with young queens of the right age. As the workers were too young to fly, Mr. King says none but drones and queens would be in the air. And now for results:

was written by G. M. Doolittle March 11, 1871—see the *Amer. Bee Journal* for that year, page 258. On the same page, and the one next following, are two more articles on the subject—one from Mr. R. M. Argo, and another from L. L. Langstroth. In the same issue there is an editorial on the subject by Samuel Wagner.

It is well to remember that, a few years after these articles were published, the idea of having queens fertilized in cages, or in confinement, was regarded as a universal failure; and the probabilities are that we to-day shall meet with no better results; but in a matter of such importance as this I believe that we should grasp even at straws; for peradventure we *may* in these latter days meet with success.



Thou shalt not covet thy neighbor's house, thou shalt not covet thy neighbor's wife, nor his manservant, nor his maid-servant, nor his ox, nor his ass, nor any thing that is thy neighbor's.—Ex. 20:17.

Our pastor, Rev. Jesse Hill, has been giving us a series of sermons on the ten commandments. I heard the first of them before I went to Florida, and I was fortunate enough to catch the last after my return home. In the outset he surprised and somewhat startled me by remarking that God gave us nine commandments in regard to our actions—thou shalt *not* do so and so. The tenth and the last is the only one that presumes to dictate to humanity what its thoughts shall be. This much, or this suggestion, is from my pastor. The rest of my talk may include something of his sermon, but will be mostly on a line of my own.

Most people would say one has a right to *think* about what he pleases, or, in other words, it is nobody's business what you think about or what your thoughts are. But this commandment teaches us that God, the great Father above, has really undertaken to tell us what we are permitted to think and what not. Of course, we may say we are going to think what we please, no matter what the Bible says or what the ten commandments say. We may do this; but if we do, then we must decide we are not in obedience to the great Father, and that we are not one of his people—certainly not his obedient child.

I confess it has troubled me almost all my life to understand the expression so often brought up from Holy Writ, that we are *all* sinners; but when I come to think we may sin in *thought*, without doing any thing else at all, then I begin to comprehend that humanity as we find it is really born in sin and born *to* sin. In fact, Job tells us that "man is born to trouble as the sparks to fly upward." If the word "trouble" may be understood to mean evil, I think I shall agree with Job.* If evil thoughts never went any further than just *thoughts* alone, no one would be particularly harmed, except, perhaps, the one who does the thinking; but we all learn the sad fact, sooner or later, that evil thoughts are only the commencement or *start* of evil actions. The thief, the robber, the murderer, must go through a series, and sometimes a long series, of evil thoughts before these thoughts ever ripen and blossom into crime. The sin of covetousness is an index of character. It soon begins to pervade the whole person. It is a low-lived, low-mannered, ungenerous, disgraceful sin. Oh how many times I have seen it lead even young people astray! I have seen jealousy get a lodging-place in the hearts of even chil-

dren. I have seen it get so dominant it seemed an almost utter impossibility to make the sufferer see the source of all his troubles. The young people in our employ sometimes come to me and complain that others are getting more pay than they, when they (the speakers) do nearly twice the amount of work. After having heard their version of the case I often say, "Why, my young friend, you are letting this thing that has got into your heart not only make you unhappy, but spoil your value." Then I explain to them as well as possible the mistakes they are making in looking with a jealous eye on some bright, happy, wideawake, go-ahead fellow-workman.

Jealousy and covetousness *blind* people. A man once said to me, "Mr Root, your own observation must have convinced you that I am doing more work for the pay I get than any other man in your establishment." Now, this poor foolish man had been looking with jealous eyes at A, B, and C, and comparing them with himself; and Satan had whispered to him that he was smarter and more useful to the business than any one else there, and that he was getting less pay than any one of them. The only way I could convince him of his error was to advise him to get a job somewhere else with somebody who had no prejudice against him in the way he insisted I was prejudiced; for, to tell the truth, he was, perhaps, the most unprofitable man I had at the time.

But this covetous spirit does not end here. Again and again it has urged people on to crime—yes, women as well as men; and many a time the guilty one has excused himself by saying, when he found out there was no chance of getting what he had justly earned, he took the liberty of appropriating what he thought would make it "about right."

But when Satan succeeds in getting into a man's heart along the line of this tenth commandment he does not stop with the pretense of making things *fair*. Yesterday's paper told us that in the neighboring town of Chardon five men broke into a bank in the night. They bound and gagged the night watchman, and then did the same thing to a physician who was out late at night. They threatened these two with instant death if they tried to get away or made the slightest noise. I do not suppose they pretended to justify themselves in what they were going to do. In blowing open the building and the safe they used a dozen or more charges of nitro glycerine. Of course, the citizens were awakened, and attempted resistance; but these five men, armed to the death, held them at bay. They retreated under a fusillade of bullets, got away on a hand-car, and escaped. They took their lives in their hands, and at a terrible risk; or, we might say, with terrible odds against them—in fact, with a probability that one or more of them would be killed, they wrecked the best buildings in the town, and actually blew open one of the best safes that is made in the world. They did not care how many lives they took; they did not care how many fine and expensive buildings they wrecked. They did not even care if the money they coveted was the

* Paul throws some light on this matter in an expression I never understood until just now, which we find in Romans 7:7: "Nay, I had not known sin but by the law; for I had not known lust except the law had said, *Thou shalt not covet.*"

earnings of poor, honest, industrious people. Had somebody told them this money belonged to poor women, say teachers and widows (perhaps *washer-women*), if they gave an honest answer they would have replied, "That does not make any difference to us. We do not care whose money it is nor how they came by it, nor how much suffering the loss of it would occasion. We have no regard nor care for anybody. We want money, and we are going to have it, no matter who is wronged and injured and made to go hungry."

As I write, three men have been arrested, whom there is good reason to believe are a part of the guilty five. Of course, they do not admit their guilt at this stage of the proceedings. Later on they may admit it. Sometimes such men confess their crime. If such a man does make an honest confession I'd like to ask him to tell me honestly and conscientiously what use he intended to make of the money—what caused him to long for something that belonged to somebody else to such an extent that he would risk life, reputation, and every thing else to get it. I never had a chance to ask a criminal such a question; but from what we can learn through the papers, of this class, I am led to believe it would be that he wanted it for tobacco, drink, and gambling. I believe these men usually lose the greater part by gambling in a short time. Drink and like excesses are *too slow*. Satan must furnish some way in which this money which cost so much can be sunk in an hour or a minute.

Sometimes we say, in considering the number of terrible crimes like the one I have mentioned, that there is only one man in thousands who would do such a thing, and that there is only one in a great many thousand who really *wants* money that belongs to somebody else. Oh dear me! I wish this were true. Even though the bank-robbers get caught, and a large part of them sent to the penitentiary, it does seem to me as if this thing were growing. A few get off scot free, with large booty; and this encourages others to undertake similar work.

Let us now think of a good man in contrast—a man who has been scrupulously honest and upright—yes, one who has been generous, and ready to divide his honest earnings, oftentimes, with people who are lazy and shiftless—that is, when he finds them in trouble. Let us contrast the good man—or shall we say the Christian man?—with the robber. What an enormous gulf lies between the two extremes! In a little tract sent out a few days ago, the story was told of some soldiers in olden time who were out on a march during a fierce blizzard. A larger part of the company died through starvation and cold. Their gallant and courageous captain, who was greatly beloved by the remnant of the little band, finally told his men they would have to give up; that for his part he would have to lie down and sleep, even if he knew that that sleep was death. He went to sleep, and, as he supposed, so did his few faithful followers. But after he lost consciousness these few men deliberately stripped themselves of their clothing, placed it over and under their captain so

that he awoke to life in the morning. But the first thing that met his gaze was the sight of his comrades frozen in death. They stripped themselves, and died, that he might live, even as Jesus deliberately chose death on the cross, the helpless victim, as they supposed, of his persecutors. He died that they might live. Now, we know that all through the ages there have been cases like this. Not only mothers but fathers have cheerfully accepted death that loved ones might be saved. Every little while we see illustrations of how some good generous soul suffered and died for the sake of some one else—sometimes, but rarely, even to save an enemy.

Yes, there *is* something Godlike in humanity. There is something grand, unselfish, and noble. Sometimes we find exhibitions of this unselfish and noble attitude of heart, even where we least expect it. Now contrast it, if you please, with an unfeeling, selfish criminal. These cases of terrible depravity are often found among the tramp classes. It was suggested that the affair at Chardon was the work of a gang of tramps. Skeptics have railed at the passages in the New Testament, describing a state or stage of humanity where Satan holds possession—demonic possession, it is sometimes called. How can any thing else explain the awful depravity of some human beings alive at the present day, except that Satan has entered into their hearts and obtained *complete possession* and control, driving out every thing else? These tramps or ruffians would strike down a refined and intelligent woman just to get her pocketbook. They would strike down an honest hard-working mechanic, or perhaps maim him or send him to the insane-asylum for the rest of his life, just to get possession of a few dollars of his hard earnings. Yes, and may God help us, there are *worse* people in this world of ours; yes, even now at the very commencement of this new century, than any thing I have described. Let us go back to our text:

It says, "Thou shalt not covet thy neighbor's house." This means that you must not become envious of somebody who has succeeded in getting a better home than yours, even if a chance should offer so that you could legally drive him out and get his fine home for yourself and family. You would not think of doing it. But the next sentence in the text tells us, "Thou shalt not covet thy neighbor's wife." I hardly need call attention to the fact that just now there seems to be a mania for striking down unprotected women—that is, where they can not be rendered helpless otherwise, simply that these wretches I have been describing might minister to a passion that *surely* had its origin in the bottomless pit. Of course, swift punishment has been meted out by an indignant public; and let me right here point to one result this swift punishment, without judge or jury, has brought. The criminal *now* recognizes that, if his victim lives to identify him, he will be strung up to the nearest tree, or burned at the stake; therefore of recent date this man, be he white or black, who is possessed of that particular spirit of evil, finishes up as a murderer.

A few years ago our courts at law dealt with a crime called rape. But that is gone by now, or is fast going by. In its place we have "assault and murder." A jury trial, even if it resulted in hanging or electrocution, would be less likely to urge the criminal to add murder to his other crime.

You may say, in extenuation, that those who commit this new form of crime are the offscourings of humanity—they do not deserve to live, and the best thing the world can do is to kill them off as soon as possible after they are once spotted. I presume the people who recommend this sort of treatment would have them shot as we shoot mad dogs, without any more scruple, and for the same reason—to protect innocent people engaged here and there in honest industry and employment. Let us see about this. I have alluded to the case of Jennie Boschiter, the factory-girl who was murdered in Paterson, N. J., last summer. In this case the murderers were not the offscourings of humanity like mad dogs or something of that sort, but they were four so-called respectable men. One of them was the husband of a young wife, and recently married. These four men claimed that they did not mean to *poison* the girl. But will somebody tell us which was to be preferred—death, or such a life as would have remained for her to live (supposing they had done as they planned) had it not ended in death? And then there is an intimation in that awful detail, as the papers gave it, that that was no *new* thing with those men or that class of men if you choose. They were in the habit of finding some unprotected factory girl—one who had no father or big brothers, for instance, say some widow's daughter, and drugging her, and, if she did not die, thinking it was only a small matter.*

By the way, some very good people, or people who call themselves good, criticise this old Bible of ours by saying there are many things in it that had better be left out. I do not know but I have heard people say

* Thank God that this terrible crime seems destined, not only to wake up the men of our land but the women also. See the following, which we take from the last number of the *American Issue*:

The Paterson, New Jersey, episode, whereby one young woman was lured to her death and four "society" dissolutes found guilty and sentenced to the penitentiary, three for 30 years each and one for 15 years, is bearing fruit in the city of Trenton, in the same State.

At a meeting of the Business Girls' Club, one young woman declared that "if the gay young men of this city want wives, they must give up beer," and following this announcement 97 girls signed the following pledge:

"I hereby promise not to keep company with or marry any man who is not a total abstainer from the use of all intoxicating liquors, including wine, beer, and cider; and I promise to abstain from the same myself. I will not marry a man to save him."

Says the Youngstown *Vindicator*:

"The young women who signed the foregoing pledge represent every class of educated bread-winners, and a large percentage of the really desirable girls of the city. The Paterson sensation and several similar, but not fatal, cases here, led to the meeting that resulted in the promulgation of the pledge.

"The young men about town take the matter seriously, and several engagements were put in the balance by the movement. It is expected that at least 300 young women will sign the pledge.

"Should the formation of such societies, and pledge-signing, become an epidemic, and spread over the country as did the old Washingtonian movement years ago in the cause of temperance, there would follow a falling-off of revenue to the government in the sale of brewers' stamps."

that this tenth commandment is all very well as it reads about the neighbor's house, servant, live stock, etc.; but that there is no particular need of shocking everybody and making it unfit for children, by putting in that clause about the neighbor's wife. To me it is something wonderful to think this old Bible fits and *hits* the state of affairs century after century as the years go by. The words, "neighbor's wife," are, of course, intended to cover his daughter (*especially* if that daughter be only a *child*), his sister, or mother, or any family relative. The crime of this century—perhaps I may say the *entire crimes* of the new century—is the outcome of violating this tenth commandment. The breaking commenced away back. When our dailies give us the details of crime we almost always say, if we look carefully, that the thing started away back. The man became greedy and overreaching. He got among bad companions. He became hostile to Christian people and to Bible teachings, especially the ten commandments—perhaps we might say the *tenth* one. For a time he tried to excuse himself, but finally he gave himself wholly over to Satan; and if he had a little success to encourage him, say in the way of legal robbery, he finally and deliberately plans running away with something belonging to the best friends he has in the world; and then it is but a step further, especially when nobody will trust him with any thing, to plan to blow up a safe so as to get the tax returns that hard-working farmers have brought in in little dribs—brought in to supply a fund for schoolhouses, good roads, public improvements, and every thing that is conducive to the best interests and happiness of humanity.

I have not touched on men in public office who turn traitor to their constituents, and accept bribes, or purloin the money that community at large has intrusted to their care. Peter once said to Simon the sorcerer, "Thy heart is not right in the sight of God;" and it has occurred to me again and again that these people who prove recreant to the trust imposed on them by the people were like poor Simon. Their *hearts* are not right in the sight of God, and perhaps *never have been*. I presume I have said enough about tobacco, drink, and gambling; but may I be excused for saying right here that, if we could or would put men into office who could not be induced either to *smoke, drink, or gamble*, we should have better times all around? But what a terrible uproar it would make if such a thing were undertaken—yes, even in Kansas! and may God bless the Kansas people, even if they *have* "gone too fast" or too far in the way of reform, as some of the wise (?) editors of the great dailies tell us. I want to confess that, so far in my life, I have, by some strange omission, neglected this tenth commandment. It seems just now, as I read it over and over, that obedience to this one commandment *alone* would Christianize the world, or at least give it a terrible cleansing, if it did *not* lead all mankind to the feet of Christ Jesus, the Lamb of God that taketh away the sin of the world.



Taking up my travels from where I left off in the last issue, after we got well out of sight of the old castle, my companion, Mr. Brown, commenced something like this:

"Mr. Root, did the mail-carrier say any thing to you about my house being haunted?"

"No, he did not mention it; but while I was looking it over on the evening of my arrival, waiting for you to come home, I made up my mind that something of this sort was at the bottom of finding such a place away out here in the wilderness, so thoroughly equipped and furnished with every thing."

"Well, Mr. Root, since you are not likely to go back there again, at least not right away, I think I shall have to tell you that a great part of the people around here could not possibly be induced to step foot into that house, especially to go in after nightfall. Some years ago the owner of the place was found dead in that same house, under very peculiar circumstances."

"What did he die of?"

"Well, he died in the very room you occupied last night, and, as nearly as we can make out, of the very same trouble you had, or something very much like it."

"Look here, Mr. Brown, this begins to sound a little supernatural. What sort of a man was he? What were his habits?"

"Well, to tell the truth he was an intemperate man, and the wine cellar and its contents might have had something to do with it."

When I was in such distress the night before, it *did* occur to me that Dr. Dowie says all sickness is of the Devil; and I confess it was an easy thing to imagine that Satan then had me in his clutches for sure. In any case, my earnest and honest prayers to Him who has been casting out Satan ever since the beginning of the world were not, in my case, out of place.

I said Mr. Brown was located away out in the wilderness. Well, so he is. But after driving through the woods a little more than a mile we came in view of one of these sudden contrasts that are often met in Florida. It was a beautiful oasis, not in the desert, but in the wilderness. Years ago a canal was projected, and quite a good deal of money spent in cutting it through the swampy lands, with the view of running boats clear up to Palatka. The project was carried out until the canal extended some little distance beyond Bulow. Well, on the side of this canal Mr. Knox has planted not only some fine orange-groves, but has built one of the most beautiful residences in Florida. I had to rub my eyes and look again to be sure I was not dreaming when I first caught a glimpse of the beautiful place. Where every thing else all around was woods, swamp, and the home of the wild fowl and the waterfowl, all at once we find a beautiful home with all modern appliances. The green lawn dotted with rare and beautiful exotic

plants—plants that brought forth exclamations of surprise at every turn—seemed too pretty to be reality.

As this locality is subject to frost, many of the plants were protected with cotton cloth, boxes made of light wood veneer, and some of them with neat structures covered with oiled paper. And here I commenced getting my first ideas in regard to protection from frost in Florida. Of course, since the severe freeze of six years ago many experiments have been made. I was astonished to hear Mr. Knox tell me, as others told me repeatedly afterward, that cotton cloth alone, even in the form of a square box or tent, is no protection from the frost whatever—in fact, that trees are often injured worse under the cloth than those with no protection at all. With the tent or box, or any such covering, there must be at least a little artificial heat inside, and the cheapest way of furnishing this for individual trees is coal-oil lamps or a cheap form of lamp made especially for protecting trees of different sizes. Another thing, there must be a ventilating-hole at the top. Where one has, say, an acre of trees to look after, he can not very well examine each lamp every hour to know the temperature; and sometimes more harm is done the trees by too much heat than by too little. Now, aside from quite a good-sized orchard where each tree had its own box or tent, Mr. Knox has one solid acre under protection. Around the outside is a tight board fence 18 feet high. Overhead are cloth curtains supported by a light framework of wood and galvanized wire. The cloth is in strips, say six or eight feet wide. Well, by suitable mechanism each strip of cloth is pulled up or shoved up together so that the top is virtually open to the sky. Now by a suitable mechanical contrivance these cloth strips can be spread out or gathered up in four or five minutes, simply by the power exerted by one man. This one man winds the wire on a sort of capstan by walking around as a horse goes around in an old-fashioned cider-mill. Now, inside of the one-acre shed there are piles of dry wood; and when the top is closed, or nearly so, by spreading out the cloth strips, a very little fire at different points inside of the shed will raise the temperature so as to hold in check effectually any freeze yet known in Florida. Mr. Knox said this structure was going to cost him, if I remember correctly, something over \$1000. W. S. Hart, at Hawks Park, who lives quite a way further south, has something similar that cost less than half as much.*

At this place, Bulow, I first saw an arrangement for making the artesian water pump water of a better quality. Most of the artesian water tastes strongly of sulphur and sometimes of other minerals; but the volume

*As we get further south, instead of a covering overhead that can be opened and closed they make simply a slatted roof, say a three-inch slat and then a three-inch space. Sometimes the space is made narrower than this. Well, these slatted roofs with a little fire inside answer every purpose, and the expense of constant manipulation of the overhead covering is saved. In a future issue I will give some pictures of a similar arrangement, although on a smaller scale, for covering pineapples.

is so great it is an easy matter to have it run a water-wheel, and this water-wheel works a pump that pumps from shallow wells or cisterns into a tank to be used anywhere on the premises. At Ormond we saw more or less orange-trees containing fruit right out in the open air; and, by the way, the past winter has been the mildest one known since the big freeze of six years ago. Many of the Florida people are beginning to have faith that they are going to have a series of winters no worse than they had for several years before the big frost.

On my former trip I spoke of the beautiful town of Daytona. Instead of stopping at Ormond to see the doctor, we went on to Daytona where we spent the night. This is one of the handsomest places in Florida. Residences, stores, streets, and every thing, are models. Although it has more than 3000 inhabitants, there is not a saloon in the place, never has been, and many of the people declare positively *there never shall be*. There is no drunkenness there; and as you go about the town at any time of day you see no roughs or toughs. You hear no cursing, and it seemed to me there was but comparatively little tobacco used. Driving out the saloons, you see, also drives away the tobacco habit, or at least a large part of it. Am I not right?

Daytona has her streets, walks, and every thing else beautifully adapted to the use of wheels; and somebody told me that, with a population of only 3000, they at one time counted up 1500 wheels owned in the place. As a consequence, you see not only boys and girls going everywhere on wheels, but old men and old women seem to ride with much ease and enjoyment.

Let me go a little further, and tell you there are four automobiles in the place, used almost constantly for carrying passengers. In order to save time I wanted to get over to Port Orange very early in the morning, only five miles away; and as the liverymen wanted \$1.50 to carry me there, I asked what it would cost me by automobile. The reply was that it would be 30 cts. if I waited till they had five passengers; but I wanted them to start by 7 o'clock so as to catch Mr. Case before he went off to any of his out-apiaries. Now, \$1.50 is a pretty big price to pay for being carried only five miles; but I had never ridden in an automobile, and it occurred to me it would be a rather fine thing to swing around to my friends' home early in the morning in an *automobile*. The landlord did not think they would get out their machine by 7 o'clock, even if they did promise to; but it was up before the hotel right on the minute, and then friend Brown and myself took our seats. I do not know but the driver guessed I was a Yankee before we made the five miles, which took us just 22 minutes. When about half way to Port Orange we met a man driving a white horse. He reined up by 'he fence in order to let us pass. Now, Mr. Brown says he told me that the man looked like Mr. J. B. Case, but I did not hear his remark. In fact, I was so intent on watching that automobile, and in asking questions, that I did not notice the coun-

try round about, nor any thing else. In due time we were at Port Orange. We went up to a store and inquired for the residence of Mr. Case. Pretty soon we were the center of an admiring group of juveniles, and some older people as well, who followed us to the Case residence. After Mrs. Case had extended to me a kindly welcome she looked troubled, and explained that her husband and daughter had just gone to Daytona. Friend Brown here interrupted by saying:

"Why, Mr. Root, that was Mr. Case we passed. Don't you remember a man with a white horse, with a nice-looking girl by his side in the buggy? As we passed them I told you I thought that was Mr. Case, but I guess you didn't hear me."

"Why, friend Brown, I saw a white horse and somebody driving, but my mind must have been *entirely* occupied by that automobile, for sure, for I did not see the driver nor (strangest of all) any *girl* at all."

Well, the automobile was awaiting my commands. I had hired it for an hour. I asked the man if he could catch the rig with the white horse before they got to Daytona. He replied that he could catch any horse that "ever made tracks" before it could go half that distance. So friend Brown and I got back into the carriage, and we started on a race with a man who had two miles the start of us. The driver undertook to turn too short, or else he imprudently ran into a bank of sand. The automobile balked. Friend Brown and I got out, but still it balked. By lifting on the wheels we finally got it out of the sand; but about that time something else happened; but before telling about it I wish to digress a little.

Some time last summer when the grandchildren and I were out in front of our home I thought I would show them some "tricks" I learned when a boy, of a sleight-of-hand performer. I tossed into the air a rather heavy enameled basin. This I caught on the point of a stick, and soon had it spinning like a top. Then I said to the boys, "Now, boys, I am going to show you a trick that is very difficult. In fact, I have seen but one other man in all my life who could do it."

I then threw up the basin, intending to catch it on the point of my stick as before. But something went wrong, and it struck me on the nose. It came pretty near knocking me down. I dropped the basin and stick, and started for the house. One of the boys went off giggling. The other one afterward informed his mother that he "shouldn't wonder if God let the basin strike grandpa on the nose as a punishment for bragging." Now, I did not *think* I was bragging when I told the boys I had never seen any person except one besides myself succeed in spinning a plate in the way I could do it, or at least used to do it when I was a boy, but I guess my young grandsons' reproach was a rather just one after all. Even *grandfathers* should be careful about bragging.

Well, when I rode into the town of Port Orange on an automobile I do not know but I felt a little proud—not, surely, of myself—

but of this great invention just coming out at the dawn of the present century; and had Howard been present when we were getting that automobile out of the sand I do not know but he would have said again, "May be God thought best to punish grandfather for wanting to 'show off.'"

Well, I was not trying to show off at the time I got my punishment, but perhaps I was a little in that line, just before. Two years ago, as some of you may remember, I got a "crick" in my back while lifting an iron pipe, and then stayed out in the mud and rain until I caught cold. Well, when I lifted on the wheels of that automobile, all at once I got another crick right in the well-remembered spot. But we got the machine started; and I thought that, if I kept real still, may be it would not last very long. We put after the white horse; but we had lost some time, as I have explained, and then we lost some more time in making inquiries. Although we made the five miles in 18 minutes we did not see Mr. Case and his white horse. We went all over the town and looked everywhere, and finally gave it up. So my \$1.50 was gone and here I was still in Daytona. I had been longing for a bicycle-ride over those beautiful streets, and so I got a wheel and was soon (in spite of the "crick") back again in Port Orange. The wheel cost 50 cents, and it cost 55 cents more to express it back; so you see my short cuts to get ahead of the railway were pretty expensive (\$2.55) after all.

Well, after I had had a good nap, the white horse, with my friend Case and his nice-looking daughter by his side, got around. Miss Case helps her father with the bees; and they two together rear not only more queens than anybody else in Florida, but I think their queens give about as good satisfaction as any reared in Florida or any other State. It was a bright warm day, and I enjoyed looking over the bees and watching them bring in their immense loads of variously colored pollen.

Before I dismiss the automobile, permit me to say the owners of the four machines are making arrangements to make regular trips to Daytona and surrounding towns. They issue coupons. Below is a copy of one of them.

THE DAYTONA TRACTION CO.

CASH FARE COUPON.

Good for One Mile or any portion thereof.

Not Good if detached.

No. 291.

These coupons are good for one mile, and cost 5 cents each. If one of the machines passes you anywhere in the country, and you have a coupon in your pocket, you can ride a mile or as many miles as you choose, at the uniform rate of 5 cents a mile.*

*Oh, yes! about my punishment. When I was riding a wheel or walking along the street the trouble in my back did not amount to much; but when I sat down, for even only a moment, I found it next to impossible to get up without limping and making a wry face; and I was obliged to explain to the friends for some days afterward the cause of my malady, and apologize to them for getting up and starting out with such great deliberation. Some of you may ask why I

In a garden in Port Orange we saw beautiful strawberries full of buds, blossoms, and ripe fruit. In the same place I saw some exceedingly ornamental foliage-plants. I believe they call it Chinese mustard. It is grown as a sort of salad.

My next stopping-place was New Smyrna. I started down the street to find a wheel to hunt up my bee-keeping friends, when somebody who was riding past on a wheel sang out, "Hello there!"

I stopped and replied, "Well, what is it?"

"Oh! nothing," said the stranger; "but I wanted to speak to you a minute."

Then I thought his voice sounded familiar. It was our irrepresible friend J. Y. Detwiler. If you do not know friend Detwiler, just get into his neighborhood and you *will* know him pretty soon. He peremptorily bade me come right along with him. He rides a wheel when on the land, and when on the water he rows a boat, taking his wheel along with him in the boat. His own little girl and two others were with us in the boat. Just before we embarked the obliging keeper of the refreshment stand near the landing gave the children a pineapple that was getting to be a little overripe. They thought it was not a very good one; but when a slice was passed to me just then and there, I should have pronounced the pineapple the greatest gift God ever gave to man in the way of fruit. I was just getting over my sickness enough to appreciate it, and had begun to regain my appetite. I suppose you know I am a great talker. Well, Mr. Detwiler is *something* of a talker himself (I can imagine a broad smile on the faces of his friends and acquaintances when they read this).

Mr. D. is not so much of a bee keeper just now, because he has another hobby. Most bee-keepers are given to hobbies more or less. Well, his present hobby is *fish*; and his special theme is to give the great wide world *more* fish and *better* fish than it has ever had before in any stage of human history. The State of Florida has already appointed him State Food Commissioner; and the United States itself has entrusted to his care millions of little fishes already (this is a true story, and I mean just what I say) to be entrusted to waters both salt and fresh that are outside and inside of Florida everywhere. While we were crossing the water he began explaining to me the valuable qualities of different varieties of clams; but I cut him short by telling him I tried to eat clams once when I was down east—(clear down to "Bosting," in fact); but, although I admired and enjoyed almost every thing around the Hub of the universe, I did not enjoy or admire *clams*. Friend D. did not say

did not have some pain-killer liniment ("arnica" or "witch-hazel") with me. Well, I have tried all of these things so highly recommended by almost everybody; but, to tell the honest truth, I can not see that they have any effect whatever one way or the other. The rubbing, of course, does good; and if the medicine is strong enough to raise a blister or even a slight counter-irritation, of course that helps for the time being. But my opinion is that hot water, as hot as you can bear it (or a little more so, perhaps), is just as good as any liniment ever invented. If I make a mistake, and these bottles of stuff in the drugstores possess *real* virtues, may God and my fellow-men help me to *see* my mistake.

any thing, but started off on another branch of the fish business. At supper the first course was some sort of soup. It looked a little like oyster broth. I was feeling a little faint, and longing for something nourishing and easy of digestion. Malted milk, it seemed to me then, would be just the thing; but this broth or soup at friend Detwiler's was more delicious, nutritious, and nourishing than any thing else in that line I ever tasted in all my life. Yes, I think that is so, come to think of it very deliberately. You see I am finding *every day* something better than I ever found before. That is one of the grand things about this world God has given us to live in. I looked across the table at my wideawake friend, and saw he was watching me.

"Well, Bro. A. I., what do you think of that sort of soup, any way?"

I told him just what I have told you.

"Oh! you do think it is *nice*, do you? And yet you are the chap who would not listen when I talked about clams for food."

"Why, friend Detwiler, you do not mean to say this is clam broth?"

"Yes, Mr. Root, that is exactly what I do say. This broth was made from a little bit of clam with shells about as large as a pea or bean. People around here call them periwinkles; but that is not the correct name. This is a salt-water clam, and there are beds of them where you can scoop them up with a scoop-shovel—bushels of them if you want them. Mash them up and they make the best chicken feed in the world—eggs and shell both at one feed. Wash off the salt water, mash them up, stew out the meat portion, strain the broth from the shells, and you have the delicious soup you are eating now, which certainly is the finest soup in the world, and the most nourishing and wholesome for people of weak digestion. If it could be put up and put on the market as a food for invalids I verily believe it would take the place of every thing else in the whole wide world."

A part of friend Detwiler's scheme is to introduce this periwinkle clam in thousands of places where it will thrive and flourish. And, by the way, before I forget it, let me tell you what friend Brown said about Mr. Detwiler. He said he was working with all his characteristic energy and zeal for the fish business throughout Florida, but that so far the State had never paid him a copper in the way of salary, and he had not *much* encouragement to think it ever will. The railroads are recognizing his value at large, and have given him free passes; and they also help unload his fishes, and place them where he wants them. As yet, friend Detwiler has the happy consciousness of having a job where he "works for nothing and boards himself."

After supper he said, "Mr. Root, would you like to see such a net as Peter had in his hand when the Savior bade him cast his net on the other side?"

"Why, yes, I *should* like to see such a net."

"Well, here is a cast net. Very likely it is pretty much the same thing as was used by the fishermen on the sea of Galilee, when the Savior was present. It is called a 'cast net'

because it is thrown with the hand by a peculiar motion."

Then he picked up the apparatus and started out in the dooryard to show me how it was used. Finally he said, "Why, look here, we might as well go out on the landing." So we walked along out in the darkness. The net was circular, like a big umbrella. Around the outer edge were fastened leaden weights with a cord attached to the center. As friend D. took one edge of the net in his teeth and asked us to stand back a little so he could get a swing I said, "Why, you can not get any fish right up close to the shore, can you?"

"Well, probably not, but I *might* strike one."

Suiting the action to the word he gave the machine a sling and a whirl. It spread out like a parachute in the air, and then dropped with a chug into the water, the leaden weights sinking it to the bottom. As he began to pull in slowly on the rope, a bystander suggested it had got caught on a root or something else. Friend D. said they did not have roots around in there. Then he began to haul up what was evidently a stump or an object of some kind about as large as the rim of your hat. When he landed it on the boards beside us, then, oh my! what a flopping there was! He said it was not the very best kind of fish, but he thought it would do very well for breakfast. It was what they call in Florida a "sheep-head." It looks like what we here in the North call a sunfish, only it has brilliant bars across its sides, painting it something like a zebra. Then my friend had to show me the scientific way of preparing a fish for the frying-pan. He scaled it in a very few moments, then made a few cuts at just the right spot with his knife, and removed one whole side of the fish, clear of the bones and every thing else—just clean meat.

"There," said he, "you see how quickly it is done. Now, that side of the meat is all ready for the frying-pan; or you can hang it up under proper conditions and it will dry out in the air without spoiling, and furnish excellent wholesome food for a long tramp across the desert or anywhere else."

The next morning we had some of that sheephead for breakfast; and, even if they have better fish in Florida salt waters, I think I should be well enough satisfied with the sheephead. But I would have a better name for it.

The next day we had a buggy-ride, and some of that same fish made us a most luscious dinner—at least it was luscious to me. We called during the day on many of the old friends whom I met six years ago. Harry Mitchell and his good wife are keeping a very pretty little country store, but they are still bee-keepers, and making good results too. I forgot to say that Mr. Case, Florida's great queen-breeder, has right along during these poor years secured something like 100 lbs. per colony, besides rearing hundreds if not thousands of dollars' worth of queen-bees annually.

It began to rain in the afternoon, and we had quite a trip to make, so our calls were very brief. We looked into friend Hart's or-

ange-shed at Hawks Park, and had a little chat with him at his home. He too has been doing fairly well with bees, even though many claim that frost has about killed the industry. Along toward night we called just long enough to shake hands with E. A. Marsh, his wife, and daughter. The Marsh people have one of the neatest and prettiest honey-houses I ever saw anywhere; and I think it must be all the time in apple-pie order, for I found it that way six years ago, and it was just the same then as on my last trip. Mr. Marsh has quite a pretty little grove of Japanese persimmons, and he had managed to save one of the beautiful fruits, and it was in nice order at the time of my trip. The Japanese persimmon is peculiar inasmuch as it has no seed. Just think of a plum the size of an apple, that is clean plum all the way through—no seed or core, nor any thing of the sort.

A little later we called briefly on T. M. Adams, who produced a crop of honey from 200 colonies that astonished everybody some years ago. These good friends are located near Oak Park, and we found lodging over night with another nice family of bee-keepers, Mr. H. S. Barker. One of our old-time boys, who used to work in the factory with us here in Medina, Mr. P. A. M. Feathers, is located just across the way from Mr. Barker. He has a very pretty little apiary for queen-rearing, and also a nice little garden.

The next morning I was obliged to bid my good friend Detwiler good by; and I confess I felt lonesome for quite a little spell, without him. By the way, I want to say that Mr. Detwiler has a very pleasant place where he entertains, not "summer boarders," but winter boarders; and instead of charging them "five dollars a day and upward," as some of the great stylish hotels put it, his terms are only \$5.00 a week. When I remonstrated at his exceedingly low prices considering the excellent table his good wife manages to get up at every meal, he replied something like this:

"Mr. Root, we tell all our boarders that, if they stay with us, they will have to wait on themselves to a great extent. We do not keep a lot of dorkies to chase around and wait on folks. We have plenty of every thing, and try to have it handy; and it is understood all around that, at our moderate prices, our boarders are to wait on themselves, at least to a great extent. Of course, we tell them where every thing is, and how to get at things."

Mr. and Mrs. Detwiler have a very pretty home; have water all around them, and plenty of fish; stores, postoffice, depot, just a little way across the water, and boats always ready; but you may have to take off your coat and "paddle your own canoe" where you pay only \$5 00 a week.

CONVENTION NOTICE.

The spring meeting of the Eastern division of the Northern Illinois Bee-keepers' Association will be held at the residence of B. Kennedy, 7 miles south-east of Rockford, Ill., on rural route No. 5, and 3 miles northeast of New Milford, Ill., on Tuesday, May 21, 1901. All interested in bees are cordially invited to attend.

B. KENNEDY, Sec'y.



PLANTING AND HARVESTING SOJA BEANS.

I have many letters asking me to give my method of planting, cultivating, harvesting and thrashing the soja bean. First, I prepare the land for soja beans as I do for corn. For seed, plant any time from the last of April to July 1, in rows $3\frac{1}{2}$ or 4 ft. wide. I put two or three beans in a hill, 12 or 15 in. apart, and work as I do a corn crop. I let all the leaves shed so the beans will get their full growth, and then dry. I take my bramble-hook or mower and cut in the morning while the dew is on them, because they will "pop out" during the middle of the day. I rake them up with a hay-rake, haul them up in the afternoon to the barn or pound lot, I make a rail pen, and thrash as fast as they are hauled. If I had plenty of barn room I would haul in and thrash after I got through cutting.

I plant soja beans, when wanted for hay, in 2 ft. rows, four or five beans in hill, 12 to 15 in. apart, and work twice with cultivator. I cut them any time after blooming. For cow feed I cut with mower two rows at a time, and let it cure as I would any other hay. I plant a large patch of soja beans by the side of my pasture, and find it a big help in August and September, when hot and dry. I cut them every morning and evening and throw them over to the cows, hogs, and stock of all kinds. They eat it as eagerly as green clover. They will do as well on it as on clover.

I sow soja beans broadcast in my corn at the last working, and gather my corn as soon as I can. Then I turn in my cows, hogs, and horses. I let the cows and horses stay in the beans only a short time the first one or two days, for fear they will eat too much. After that there is no danger of their overeating. I use no manure or fertilizer of any kind for soja beans. I often plant them on my thinnest land to improve it. I turn the beans under or cut them early and plant a second crop. It is a splendid crop to follow Irish potatoes. I like soja beans better than any kind of pea, because they do not rot easily when they get wet and are left out for a short time.

Norfolk Co., Va.

W. M. WILSON.

The above I clip from the *American Agriculturist*. My special reason for giving it here is because of what is said about cutting it night and morning for stock when pastures are poor. Soja beans will grow on almost any sort of soil, as above mentioned, and severe drouths seem to affect it but little. Of course, the later kinds do not ripen seed here in the North; but the early soja beans, the one we call coffee berry, will ripen seed perfectly any season as far north as Ohio.

ALFALFA.

Our Ohio Experiment Station has just sent out a press bulletin on alfalfa. We should be glad to give place to the whole of it had we space; but we *must* find room for the very sensible boiled-down hints as follows which they add at the close of their directions:

NOW FOR A FEW "DON'TS":

- Don't sow alfalfa on poor soil.
- Don't sow alfalfa on wet soil.
- Don't forget to clip it three times the first year.
- Don't turn any stock on it until the next May.
- Don't let alfalfa hay get dry before raking.
- Don't fail to cut your hay in time. That means to be ready to cut by June first.
- Don't ever let stock on your alfalfa meadows in cold weather.
- Don't sow alfalfa seed on unprepared soil, as you do clover.

If it fails with you, manure the ground, and try again.

Now is the time to sow alfalfa, or any time during May. Sow 15 to 20 lbs. per acre on good soil. When you once get a good stand it is good for many years.

HIGH-PRESSURE POULTRY.

I did not mean to say any thing more on poultry-keeping just now, but I really can not help it. We exchange with something like a dozen poultry-journals, and I tell the clerk to put every thing on my desk in the way of poultry. Well, they are all good—at least I suppose they are; but few of them contain any thing that particularly interests me. It seems to me they are too much the same old story over and over, while there are a thousand things I want to know about poultry that are rarely touched on. For instance, now many days may a hen lay an egg a day without skipping? I thought I had owned hens that would lay a hundred eggs and not miss a day. The trap nest tells me I am mistaken. Some writers say very few hens lay a dozen eggs without skipping a day. Now, this is an exceedingly important matter. If there are broods or individuals that will lay 100 eggs without a miss, *we want them*. Again, I am just beginning to discover by the trap nest that the quantity of food has much to do with it. My six pullets had been giving six eggs a day for four or five days. But one day they got out of their staple ration; and the little shortage in rations knocked off nearly half the eggs for two or three days in spite of the best food I knew how to give them, *after the shortage*.

I think I might fill a page with just such vital questions and suggestions; but this is not a poultry-journal. I wish to say a word, however, about that pugnacious rooster. He chases Mrs. Root out of the poultry-house, and he actually sent me off limping and with a wry face, this morning. I was fixing a nest for a hen that wanted to sit. I thought he could not do much harm anyway; but he flew at my knee, and struck it with both feet and with both wings so that I was glad to beat a retreat. Now, I never before heard through any of the poultry-journals of a rooster that would attack its keeper. After my knee got over hurting I tumbled him over and over in the grass, and gave him a pretty good cuffing, and after some time I succeeded in getting him to run. Then I chased him out and in among the bee-hives until I thought he was conquered; but in a little while he was crowing lustily, and wanted me to stop my work and engage in another "round." If there had been a crowd of the right sort (?) of people I do not know but there might have been bets as to which would whip—A. I. R. or the big lusty Plymouth Rock rooster that would "never say die."

Now, then, does this trait of that particular fowl necessarily indicate unusual vitality, vigor, or as well as courage? Will his chicks likely inherit this vigor? I think he would give a chicken hawk a pretty good tussle. He is not afraid of *any thing* nor of *anybody*. Every thing has to get off the walk and go around him—that is, when he is among his group of six pullets. If they are not around, he does not care particularly about fighting. He regards the poultry-house as his special domain; and he evidently thinks the eggs were not laid to be gathered. They are to hatch chick-

ens. Now, is he a sport among poultry, or "are there others"? He will take a little run, and spring high enough to knock a dish out of one's hands, and give your hands and elbows such a thumping you will be glad to back off. I have heard of people who would go for you in a fight, with "both feet." Well, he uses not only both feet but both *wings*.

Later.—I have finally got *three* sitting hens, and they are behaving nicely in the trap nests. When I set one of them I carried out a basin of eggs. I had just got them put under the hen all right, and straightened up, when "that rooster" made a spring, knocked the basin out of my hands, and not only the basin, but my nose-glasses too, went tumbling in the dust. Then he tipped his head to one side and gave me a look that evidently meant, "These sitting hens belong to me, and I propose to run this thing myself." Ernest is planning to get a snap shot of him some day when he is on the "war-path," and we will have him in GLEANINGS. Now if it is a *common thing* to find male fowls with such courage and strength as this one I will drop the subject. Can our poultry-men tell us about it?

By the way, the honey-bee has from time immemorial been considered the emblem of industry; but for patience and *perseverance* I would put a sitting hen at the head of all animated creation. I am just now studying sitting hens.

Special Notices by A. I. Root.

GILT-EDGED GRAND RAPIDS LETTUCE SEED.

We have still quite a number of packets left of this gilt-edged stock seed. If you want to grow some plants to *produce seed*, you had better get some of this, and you had better start in before it gets any later. It will pay you to have the best to start with; and then if you grow more than you want for your own use, there is a good market for a choice article of Grand Rapids lettuce seed every day in the year. Remember, a little packet of this gilt-edge stock seed, grown by the originator himself, costs you only 5 cts.

HUBBARD SQUASH SEED.

It will soon be time to plant it. We have a very nice stock of beautiful plump seed grown by a bee-keeper, and nice Hubbard squashes almost always sell. Large plump seeds are much more likely to make strong healthy plants. See what Gregory says about it in his squash-book. And, by the way, if you have never read "Gregory on the Squash," you had better have the book. The price is only 30 cts. The directions he gives for growing a big crop of squashes will apply very well to growing big crops of almost every thing. The price of the squash seed is 5 cts. per ounce; 1 lb., 50 cts. If wanted by mail, add 8 cts. per lb. extra.

POTATOES FOR PREMIUMS.

For every dollar you send for GLEANINGS, asking for no other premium, you may have a peck of our nice Red River stock of Early Ohio potatoes (35 cts.); and for every dollar you send, that pays for sending GLEANINGS to somebody who has never taken it before, thus introducing it in a new locality, we will send you half a bushel, worth 60 cts. For any of the other potatoes (see table, last issue) we will send you 25 cents' worth for renewal, or 50 cents' worth to any old subscriber who sends us a new name.

SEED POTATOES, SECONDS.

At present writing, April 15, we are practically sold out of all seconds except Carman No. 3 and Russets. These, you will see by the table, are \$1.25 per barrel. We have, however, 85 bushels of Early Ohio seconds, but we can not make these less than \$1.75 per barrel; 75 cts.; ½ bushel, 40¢; peck, 25¢.

BLUE VITRIOL (SULPHATE OF COPPER) FOR SPRAYING.

Some years ago I bought a barrel of the above chemical at 4 cts. per lb., and offered it in our seed catalog at a price away down below what we usually have to pay for it at the drug stores. But it did not seem to sell very well; and even after the price went away up at wholesale above our retail price, our friends did not seem even then to appreciate what I was trying to do for them. So I took it out of the price list. Just now, however quite a few begin to see what a chance they had, and remonstrate because I dropped it, and I have been induced to purchase another barrel, but I can can not sell it at old prices. In barrel lots I can barely make it at an even 6 cts.; in 50-lb. lots, 6½ cts.; less than 50 lbs., 7 cts.

THE NEW RUSSET SCAB PROOF POTATO.

I fear our friends are not giving the New Russet potato its just dues. We have never had what might be called a scabby potato on our ground, of this variety. There has never been one on Wilbur Fenn's place, in Summit Co., and he grows them by the hundreds of bushels. I was present last season in the Traverse region when they were digging the Russets, and I never saw a scabby one where there were thousands of bushels, although other varieties scabbed badly. Now, this is certainly a most valuable acquisition in this one respect: and just now in the month of April they are the best table potatoes we have got among our whole lot, not even excepting the Freeman. They are not sprouted a particle, and are sound and firm, and yet we are offering them for 35 cts. a peck; 60 cts. per half bushel; \$1 (0 per bushel, or \$2.50 per barrel—the same price as the Early Ohios. Had not you better plant a few? We can ship them from here or (by the barrel) from Traverse City, Michigan.

FINE-POINTED LACE SCISSORS FOR CLIPPING QUEENS' WINGS.

In the recent discussion in regard to clipping queens' wings I was a good deal surprised to see some of the—I was going to say veterans, but I think I shall say "big lights"—talking about clipping a queen's wing with a jack-knife. Why not get a spade or a crowbar, and be done with it? I have just discovered that, when we dropped the counter-store business, our fine-pointed steel scissors were dropped with it; yes, and the boys have dropped can files for filing circular saws (and the saws too, for that matter). But I am talking about scissors just now. No wonder that some of the women inquired if fine pointed scissors would not be a better implement than a jack-knife. Years ago I used to buy these scissors directly from the manufacturers, grosses at a time, and we have them in stock yet, and are having orders for them, even though our mailing clerk says they have not been advertised for four years. Price 25 cts., by mail, postpaid, 27. If you find them handy for any other purpose than clipping wings there is no patent right against using them that way. Ernest urges that a bee-keeper always has a jack-knife in his pocket, but not a pair of scissors; but I think he needs the scissors almost as much as he does a knife.

MONEY IN POPCORN.

We clip the following from *American Agriculturist*:

Last year I planted 14 acre of popcorn, and husked from it 36 bushels, a yield of 14 bushels per acre. The corn sold at \$1 per bushel. The land on which it was grown is worth \$80 per acre, less than half the value of the corn. The land had been in blackberries several years up to last year. The corn required no more labor than common field corn. The fodder was worth \$2.—W. L. Anderson, Indiana.

The above reminds me that, when I was a boy, I grew popcorn for my poultry. The grains were small enough for little chickens when they could not eat big corn. I remember I had a tremendous yield—more than farmers grew of the big corn. Well, we have secured some extra nice rice popcorn of Clark, the great seed-corn grower, and we can furnish it at the very low price of 10 cts. a quart; 60 cts. a peck, or \$2.00 a bushel. The above is beautiful, clean shelled corn. It is worth the money to pop; and, by the way, it furnishes an excellent food for human beings. If wanted by mail, add 12 cts. per quart for postage.

SUBSTITUTE FOR BEEFSTEAK AND LEAN MEAT IN GENERAL.

For some time I have been carefully testing the new products of the Sanitas Nut Food Co., Battle Creek, Mich.; and I am now pretty well satisfied that their protose, or vegetable meat, is as little liable to fermentation in the digestive apparatus as beefsteak and other lean meats. For many years I have had to

be very careful about eating fruits or sweets in general for my last meal of the day. Whenever I did so from choice or force of circumstances I have invariably had more or less distress during the night. When my last meal is pure lean meat and bread and butter, I keep in fairly good health. This matter has been so thoroughly discussed in GLEANINGS, and by tests of thousands of persons with poor digestion, that the matter may be considered pretty well settled. Well, so far as my own experience goes I believe protose will take the place of lean meat in a way that no other vegetable food does. This protose looks like meat and tastes like meat; and the food company claim it has the same constituents as lean meat. It looks and tastes a good deal like what we call beef loaf or a loaf made from chopped or ground meat. Well, now, this food company has lately brought out something that I think would be a formidable rival to honey and maple sugar. They call it meltose, or malted honey (it tastes a little like "malt'd" milk). At present I think I rather prefer it to either maple syrup or honey; and, strange to tell (at least it was strange to me), this sweet does not produce fermentation like other sweets, especially when eaten at the last meal of the day. I have eaten it repeatedly, and in larger quantities than I should were it not for experiment, and it digests perfectly.

The only objection to these two foods I have mentioned, at the present time, is their cost; but I do not believe the protose is going to cost any more than beefsteak for the same amount of nutriment. The meltose at present is rather higher than honey or maple syrup. I understand they are building a large establishment purposely to manufacture these health foods, and they hope to give us lower prices after a while. And, by the way, suppose they do cost a little more. With the protose there is a great saving in work for the good wife. I prefer it just as it comes out of the can, without any cooking at all; and with the meltose is it not worth something to be able to keep well without the expense of drugs or doctors? At present, meltose costs \$1.50 for a 1 gallon can; 80 cts. for half a gallon. A sample of either protose or meltose will be sent to any one on receipt of two 2-cent stamps.

A FEW LEFT---ORDER QUICK!

We have only a few of those slightly damaged bee-books left, so if you want one of them you will have to order very soon. It will be remembered that on January 1st there was a severe fire in our building, burning out entirely four floors above us. The water that was thrown on the fire came down through our floor damaging our stock of books, printing-office, etc. Some of the books were wet slightly, but enough so that they could hardly be sent out as perfect. These are the ones that we wish to offer. The reading pages of all are perfect, only the covers being a little soiled. Here they are, with prices postpaid:

- Prof Cook's "Bee-keeper's Guide," only 60c.
Doolittle's Scientific Queen-rearing, only 50c.
Newman's "Bees and Honey," only 40c.

They are all cloth bound, and latest editions. If you want a year's subscription to the old Weekly American Bee Journal, with any of the above books, add 75c to your order. This is a SPECIAL OFFER, and will last only so long as the slightly damaged books last. Better order AT ONCE if you want a bargain.

Remember we are

HEADQUARTERS FOR Bee-keepers' Supplies in Chicago.

Catalog and sample copy of the American Bee Journal free. Ask for them. Address

George W. York & Co., Chicago, Illinois. 144-146 ERIE STREET.



Tar Heel Apiaries!

THE BEST BEES KNOWN
IN : AMERICA : TO-DAY.

American Albino Italians.

They have no superiors and few equals, as hundreds of bee-keepers testify. Untested queens, \$1 00; 6 \$5 00. Tested queens, \$2 00 each. Choice breeders, \$5 00 to \$10 00. Nuclei, 75c per L. frame—add price of queen. 200 3-frame (L.) nuclei for sale in May and June. Safe delivery insured always.

Swinson & Boardman, Box 358, Macon, Ga.

Queens Now Ready!

If you are looking for queens we have them. We now have the largest establishment in the South, and run from 500 to 1000 nuclei. We can fill your orders promptly. We can give you satisfaction. Our queens have a reputation of which we are proud. Prices, either 3-band or Golden Italian or Holy Land, your choice, untested, 75c; six for \$4.25; tested, \$1.25; select tested, \$2.00; breeders, \$3.00 to \$5.00; select warranted, 25c extra. Discounts in quantities, and valuable premiums given away—among them one year's subscription paid to Progressive Bee-keeper on receipt of your first order. Our large circular free for the asking—gives prices, descriptions, methods, etc. Our motto.—Good queens and prompt service.

O. P. HYDE & SON, - HUTTO, TEXAS.

Honey Queens.

Have you noticed the change in my P. O. address? Did you know I am seeking to give my customers the best service possible?

Did you know that I have as good or better queens than can be bought elsewhere? Many have found this out, and continue my best customers. Golden and leather colored honey queens, bred in separate apiaries. Bees, nuclei, and full colonies for sale.

Price of queens—March and April—tested or untested, each \$1 00; 6 for \$5.00; \$10 00 per dozen. Breeders, \$2.50 to \$5.00 each.

— ADDRESS —

W. H. LAWS, BEEVILLE, TEXAS.

1901----Golden Italian Queens----1901

Untested—April, May, and June—\$1.00 each, or \$11.00 per dozen; after June, 50c each, or \$5.00 per dozen. Tested queens, half more. Breeding queens \$3.00 and \$4.00 each. W. P. Rock eggs, from 94-scoring birds at \$1.00 per 15. Cocks, \$1.00 each.

GEORGE W. COOK, - SPRING HILL, KANSAS.

EARLY QUEENS FROM THE SOUTH

We are rearing queens now in full colonies by the best methods known. Tested queen, \$2.00. Untested, \$1.00; 6, 5 00; 12 \$9.00. Full colonies, \$6.00; 3-frame \$2.00; 2-frame, \$1.50. Add price of queen to nucleus wanted. Write for discount on large orders, and circular. Satisfaction guaranteed.

Christian & Hall, Meldrim, Georgia.

QUEENS.—Golden Italians; unexcelled for business, beauty, and gentleness; bred from the best of stock obtainable. Untested, \$1 00 each; 6, \$5 00. Tested, \$1.50 each. H. C. TRIESCH, JR., Dyer, Ark.

U - NEED - A GLOSSOMETER.

It measures the actual reach of the tongue of a living bee to thousandths of an inch, also the capacity of the honey-sac; accurate, durable, practical. No rule or magnifying-glass needed. Satisfaction guaranteed. Price \$1.00 postpaid. Send for *Queen Circular*, and learn how to get a glossometer free. High-grade queens of the Sweet-heart and other strains at reasonable prices.

A. J. WRIGHT, Bradford, Steuben Co., New York.



LONE STAR APIARIES

G. F. Davidson
& Sons, Props.

Breeders of fine Italian Queens. Established in 1885. Write for circular.

G. F. Davidson & Sons,
Fairview, Texas.

QUEENS BY RETURN MAIL.

The Choicest of Tested
Italian Queens \$1 each.

Large yellow queens, healthy and prolific; workers the best of honey-gatherers. Safe arrival and satisfaction guaranteed in every case. Send for price list.

J. W. K. Shaw & Co., Loreauville, La.

Long-Tongued Yellow Queens.

"The cage of bees is received. The tongue-reach is 19-hundredths. This is very good." The A. I. Root Co., per E. R. Root.

The above is from my best breeding queen. Her mother is also long tongued. *It runs in the family.*

These are my 5-band or Golden strain that have been bred for business for years. Queens, untested, \$1.00; 6, \$5.00; dozen \$9.00. Fine tested, \$1.50; 6, \$5.00. Select tested, \$2.00. Breeding, \$3.00 to \$5.00. I am printing a limited number of circulars with Florida views—nice ones—free. An extra one with different views for 5c stamp. Better get one at once.

J. B. CASE, Port Orange, Fla.

Albino Queens.

If you want the most prolific queens; if you want the gentlest bees; if you want the best honey-gatherers you ever saw, try my Albinos. Untested queens, \$1.00; tested, \$1.50. J. D. GIVENS, Lisbon, Texas.

Red-clover Italian Queens.

The great honey-gatherers; are bred for business; satisfaction guaranteed. Untested queen, 65c; 2, \$1.25. Warranted, 80c; 2, \$1.50. Tested, \$1.25. Select tested, \$2. Estab'd 1872. C. M. HICKS, Hicksville, Md.

Bee-keepers' Supplies!!!

Root's Goods. Sold cheap. Bee-book given with order. Send for list explaining Barred Rock chickens and Belgian hares. Pedigreed stock.

W. D. Soper, R. D. 3, Jackson, Mich.

15 Swarms of Italian and Hybrid Bees For Sale.

In Dovetailed chaff hives, nearly new. The hives are 8-frame, L. size. Will be sold cheap, as I am unable to look after them.

CHAS. A. MONROE, S. Shaftsbury, Vt.

FOR SALE CHEAP.—65 colonies Italianized bees in two-story Langstroth hives complete, in quantities to suit purchaser. Also extra hives and fixtures. TALBOT'S RESTAURANT, Lucas, Lucas Co., Iowa.

CHAS. ISRAEL & BROS.,

486, 488, 490 Canal St.,
Corner Watt Street, N. Y.

HONEY & BEESWAX.

Liberal Advances made on Consignments.
Wholesale Dealers and Commission Merchants.
Established 1875.

Wants and Exchange.

Notices will be inserted under this head at 10c per line. You must say you want your ad. in this department, or we will not be responsible for any error. You can have the notice as many lines as you please; but all over ten lines will cost you according to our regular rates. We cannot be responsible for dissatisfaction arising from these "swaps."

WANTED.—To exchange choice W. and Buff Leg-horn, or W. Guinea eggs, for Italian queens.
C. T. COLE, Solville, N. Y.

WANTED.—By man of 20 years' experience, full charge, or otherwise, of apiary in any part of the U. S. W. E. BRAND, East Angus, Quebec, Can.

WANTED.—To exchange 100 colonies of bees on 8 L. (Hoffman) frames, valued at \$3.00 each, for beeswax.
H. VOGELER, New Castle, Cal.

WANTED.—To correspond with the party that has possession of the fire-arms formerly owned by the outlaws of Kansas, the Bender family.
Address 216 Court St., Reading, Pa.

WANTED.—To exchange bicycles and tandems, gasoline-engines (new and 2d-hand, 1 to 20 horse-power), for wood and metal working machinery of all kinds.
ROBERT B. GEYDE, LaSalle, Ill.

WANTED.—Large apiary in good basswood location in Wisconsin. Also a man to take permanent charge of same on shares with a guaranteed income.
H. W. FUNK, Normal, Ill.

WANTED.—To exchange 500 L. frames (comb) for bees.
J. H. STANFORD, Larrabee, Cher. Co., Ia.

WANTED.—Fifty colonies Italian bees in 10-frame Dov'd hives; Hoffman wired frames.
CHAS. D. HANDEL, Savanna, Ill.

WANTED.—An experienced apiarist to take charge of 100 hives of bees on salary or on shares, in Otero Co., Col. Do not apply unless best references as to character and ability can be furnished.
Address DR. W. W. BULETTE, Pueblo, Col.

WANTED.—Practical bee-keeper; steady work for one that can handle 300 to 400 colonies with assistant; run mostly for extracted honey; state wages; can commence work at once.
WALTER L. HAWLEY, Fort Collins, Col.

WANTED.—To care for apiary on shares or work for salary, by experienced bee-keeper. Can give references.
N. BLANCHARD,
414 Third St., Neenah, Wisconsin.

WANTED.—To exchange bee-supplies and fixtures, Italian queens, a 15-volume set of encyclopedia, dictionary, a fine list of other books, several volumes of Gleanings, strawberry, raspberry, and blackberry plants, and apple trees, for a type-writer, a combined wheel hoe and seeder, and beeswax. Write for lists.
F. H. MCFARLAND, Hyde Park, Vt.

WANTED.—Young man for work in greenhouse, vegetable and fruit growing, and some farm work. Experience not as necessary as ability for learning and rapid work. Work all the year.
C. WECKESSER, Marshallville, Ohio.

WANTED.—75 colonies of bees, to establish an out-apiary.
H. G. QUIRIN, Parkertown, Ohio.

WANTED.—Young man for apiary, greenhouse, and general work. Married man preferred. Experience not as necessary as industry, reliability, and willingness to learn.
J. A. GREEN, Ottawa, Ill.

WANTED.—A location for a custom saw and feed mill. Address
WM. S. AMMON, 216 Court St., Reading, Pa.

WANTED.—To pay cash for a number of strong colonies of Italian or hybrid bees with young queens on L. frames. Address
L. H. ROBEY, Worthington, W. Va.

WANTED.—Bees by the pound.
D. McLAREN, Alliston, Ontario, Canada.

To make cows pay, use Sharples Cream Separators. Book "Business Dairying" & cat. 288 free. W. Chester, Pa.

WANTED.—ALL, TO KNOW that I sell my hives and Root's goods at Root's prices, and will pay \$50 in three cash prizes for the best white honey exhibited at the Pan-American Exposition at Buffalo this year, produced in Danzenbaker hives in New York State; also the same for the three best lots outside of New York State. Specific information given on application.
F. DANZENBAKER,
Box 66, Washington, D. C.

FOR SALE. One 10 h-p engine and boiler (up-right boiler), one 18-inch planer, one Root saw-table, 30 ft. line-shafting, hanger pulleys, and belting. Will take \$250. J. W. Bittenbender, Knoxville, Ia.

Books for Bee-keepers and Others.

Any of these books on which postage is not given will be forwarded by mail postpaid, on receipt of price. In buying books, as every thing else, we are liable to disappointment if we make a purchase without seeing the article. Admitting that the book-seller could read all the books he offers, as he has them for sale, it were hardly to be expected he would be the one to mention all the faults, as well as good things about a book. We very much desire that those who favor us with their patronage shall not be disappointed, and therefore we are going to try to prevent it by mentioning all the faults, so far as we can, that the purchaser may know what he is getting. In the following list, books that we approve we have marked with a *; those we especially approve, **; those that are not up to times, †; books that contain but little matter for the price, large type, and much space between the lines, ‡; foreign, §. The bee-books are all good. As many of the bee-books are sent with other goods by freight or express, incurring no postage, we give prices separately. You will notice that you can judge of the size of the books very well by the amount required for postage on each.

BIBLES, HYMN-BOOKS, AND OTHER GOOD BOOKS.

Postage.]	[Price without postage.
8 Bible, good print, neatly bound	20
10 Bunyan's Pilgrim's Progress**	40
32 Christian's Secret of a Happy Life,** 50c; cloth 1 00	
8 John Ploughman's Talks and Pictures, by Rev. C. H. Spurgeon*	10
1 Gospel Hymns, consolidated, Nos. 1, 2, 3, and 4, words only; cloth, 10c; paper	5
2 Same, board covers	20
5 Same, words and music, small type, board cov. ..	45
10 Same, words and music, board covers	75
3 New Testament in pretty flexible covers	05
<i>One-third off on all Gospel Hymns mentioned above.</i>	
5 New Testament, new version, paper covers	10
4 Stepping Heavenward**	18
5 Tobacco Manual**	45

This is a nice book that will be sure to be read, if left around where the boys get hold of it, and any boy who reads it will be pretty safe from the tobacco habit.

BOOKS ESPECIALLY FOR BEE-KEEPERS.

20 A B C of Bee Culture, cloth	1 00
Advanced Bee Culture, by W. Z. Hutchinson	50
3 Amateur Bee-keeper, by J. W. Rouse	22
14 Bees and Bee-keeping, by Frank Cheshire, England, Vol. I, ‡	2 36
21 Same, Vol. II, ‡	2 79
Same, Vols. I, and II, postpaid	5 25
10 Bees and Honey, by T. G. Newman	65
10 Cook's Manual, cloth	1 15
5 Doolittle on Queen-rearing	95
2 Dzierzon Theory	10
8 Foul Brood; Its Natural History and Rational Treatment	22
1 Honey as Food and Medicine	05
10 Langstroth Revised, by Chas. Dadant & Son	1 10
15 Quinby's New Bee-keeping	90
British Bee-keeper's Guide-book, by Thomas William Cowan, England ‡	40
The Honey-bee, by Thos. William Cowan	95
3 Merrybanks and His Neighbor, by A. I. Root	15
Bienezucht und Honiggewinnung	50
Or "Bee Culture and the Securing of Honey," a German bee-book by J. F. Eggers, of Grand Island, Neb. Postage free.	

MISCELLANEOUS HAND-BOOKS.

5 A B C of Carp Culture, by Geo. Finley	25
5 A B C of Strawberry Culture,** by T. B. Terry. 35	
Probably the leading book of the world on strawberries.	

5 | A B C of Potato Culture, Terry**..... 35
 This is T. B. Terry's first and most masterly work.

7 | Barn Plans and Out-buildings*..... 50
 Canary birds, paper..... 50

2 | Celery for Profit, by T. Greiner**..... 25
 The first really full and complete book on celery culture, at a moderate price, that we have had. It is full of pictures, and the whole thing is made so plain that a schoolboy ought to be able to grow paying crops at once without any assistance except from the book.

15 | Draining for Profit and Health, Warring..... 1 35
 10 | Fuller's Grape Culturist**..... 1 15
 8 | Domestic Economy, by I. H. Mayer, M. D.**..... 30
 This book ought to save at least the money it costs, each year, in every household. It was written by a doctor, and one who has made the matter of domestic economy a life study. The regular price of the book is \$1.00, but by taking a large lot of them we are enabled to make the price only 30 cents.

10 | Farming for Boys*..... 1 15
 This is one of Joseph Harris' happiest productions, and it seems to me that it ought to make farm-life fascinating to any boy who has any sort of taste for gardening.

7 | Farming with Green Manures, postpaid**..... 90
 7 | Farm, Gardening, and Seed-growing**..... 90
 12 | Gardening for Pleasure, Henderson*..... 1 35
 12 | Gardening for Profit**..... 1 35
 8 | Gardening for Young and Old, Harris**..... 1 25
 This is Joseph Harris' best and happiest effort. Although it goes over the same ground occupied by Peter Henderson, it particularly emphasizes thorough cultivation of the soil in preparing your ground; and this matter of adapting it to young people as well as old is brought out in a most happy vein. If your children have any sort of fancy for gardening it will pay you to make them a present of this book. It has 187 pages and 46 engravings.

3 | Grasses and Clovers, with Notes on Forage Plants..... 20
 This is by Henry A. Dreer, author of the book, "Vegetables Under Glass" that has had such a large sale of late. This little book tells how six tons of grass has been grown to the acre, and gives much other valuable matter.

10 | Greenhouse construction, by Prof. Taft**..... 1 15
 This book is of recent publication, and is as full and complete in regard to the building of all glass structures as is the next book in regard to their management. Any one who builds even a small structure for plant-growing under glass will save the value of the book by reading it carefully.

12 | Greenhouse Management, by Prof. Taft**..... 1 15
 The book is a companion to Greenhouse Construction. It is clear up to the times, contains 400 pages and a great lot of beautiful half-tone engravings. A large part of it is devoted to growing vegetables under glass, especially Graud Rapids lettuce, as well as fruits and flowers. The publisher's price is \$1.50; but as we bought quite a lot of them we can make a special price as above.

5 | Garden and Farm Topics, Henderson**..... 60
 5 | Gregory on Cabbages, paper*..... 20
 5 | Gregory on Squashes, paper*..... 20
 5 | Gregory on Onions, paper*..... 20
 The above three books, by our friend Gregory, are all valuable. The book on squashes especially is good reading for almost anybody, whether they raise squashes or not. It strikes at the very foundation of success in almost any kind of business.

1 | Handbook for Lumbermen..... 05
 5 | Home Pork-making; 125 pages, illustrated..... 40
 I think it will pay well for everybody who keeps a pig to have this book. It tells all about the care of the pig, with lots of pictures describing cheap pens, appliances, all about butchering, the latest and most approved short cuts; all about making the pickle, barreling the meat, fixing a smoke-house (from the cheapest barrel up to the most approved arrangement); all about pig-troughs; how to keep them clean with little labor; recipes for cooking pork in every imaginable way, etc. Publisher's price is 50 cents, ours as above.

10 | Household Conveniences..... 1 40
 15 | How to Make the Garden Pay**..... 1 35
 2 | How to Propagate and Grow Fruit, Green*..... 15
 2 | Injurious Insects, Cook..... 10
 10 | Irrigation for the Farm, Garden, and Orchard* 1 10
 By Stewart. This book, so far as I am informed, is almost the only work on this matter that is attracting so much interest, especially recently. Using water

from springs, brooks, or windmills to take the place of rain, during our great drouths, is the great problem before us at the present day. The book has 274 pages and 142 cuts.

3 | Maple Sugar and the Sugar-bush**..... 32
 4 | Peabody's Webster's Dictionary..... 10
 Over 30,000 words and 250 illustrations.

5 | Manures; How to Make and How to Use Them; in paper covers..... 30
 6 | The same in cloth covers..... 65
 Nut Culturist, postpaid..... 1 50
 3 | Onions for Profit**..... 40
 Fully up to the times, and includes both the old onion culture and the new method. The book is fully illustrated, and written with all the enthusiasm and interest that characterizes its author, T. Greiner. Even if one is not particularly interested in the business, almost any person who picks up Greiner's books will like to read them through.

| Our Farming, by T. B. Terry**..... 1 50
 In which he tells "how we have made a run-down farm bring both profit and pleasure."
 If ordered by express or freight with other goods, 10c less.

1 | Poultry for Pleasure and Profit.**..... 10
 8 | Practical Floriculture, Henderson*..... 1 10
 10 | Profits in Poultry,*..... 75
 1 | Silk and the Silkworm..... 10
 10 | Small-Fruit Culturist, Fuller..... 1 10
 2 | Sorghum, Stock Beets, Strawberries, and Cement Floors. By Waldo F. Brown..... 08
 10 | Talks on Manures*..... 1 35
 10 | The New Agriculture; or, the Waters Led Captive (a \$1.50 book)..... 40
 11 | The New Egg-Farm, Stoddard**..... 70
 This is an enlarged edition of the 50-cent book published 25 or 30 years ago by H. H. Stoddard. If I could have only one poultry-book it would be the New Egg-farm. This book is of special value to me because it not only discusses most emphatically the value of exercise to poultry, but it touches on the value of exercise to all other animated nature including humanity. The book has over 300 pages and 150 illustrations. It is entirely different from any other poultry-book in the world, inasmuch as it discusses mechanical contrivances so that all the varied operations of a poultry-farm may be done as much as possible with the aid of machinery. The regular price is \$1.00, but by buying a quantity we are able to furnish it at price given.

2 | Treatise on the Horse and his Diseases..... 10
 5 | Tile Drainage, by W. I. Chamberlain..... 35
 Fully illustrated, containing every thing of importance clear up to the present date.
 The single chapter on digging ditches, with the illustrations given by Prof. Chamberlain, should alone make the book worth what it costs, to every one who has occasion to lay ten rods or more of tile. There is as much science in digging as in doing almost any thing else; and by following the plan directed in the book, one man will often do as much as two men without this knowledge.

5 | Tomato Culture..... 35
 In three parts. Part first.—By J. W. Day, of Crystal Springs, Miss., treats of tomato culture in the South, with some remarks by A. I. Root, adapting it to the North. Part second.—By D. Cummins, of Conneaut, O., treats of tomato culture especially for canning-factories. Part third.—By A. I. Root, treats of plant-growing for market, and high-pressure gardening in general.

3 | Vegetables under Glass, by H. A. Dreer**..... 20
 3 | Vegetables in the Open Air*..... 20
 This is a sort of companion book to the one above. Both books are most fully illustrated, and are exceedingly valuable, especially at the very low price at which they are sold. The author, H. A. Dreer, has a greenhouse of his own that covers one solid acre, and he is pretty well conversant with all the arrangements and plans for protecting stuff from the weather, and afterward handling to the best advantage when the weather will permit out of doors.

3 | Winter Care of Horses and Cattle..... 25
 This is friend Terry's second book in regard to farm matters; but it is so intimately connected with his potato-book that it reads almost like a sequel to it. If you have only a horse or a cow, I think it will pay you to invest in a book. It has 44 pages and 4 cuts.

3 | Wood's Common Objects of the Microscope**.. 47
 8 | What to Do and How to be Happy While doing It, by A. I. Root..... 65

The A. I. Root Co., Medina, O.

Fruit Packages of All Kinds.

— ALSO —

BEE-KEEPERS' SUPPLIES. . .

Order your supplies now before the busy season catches you. Price list free. Address

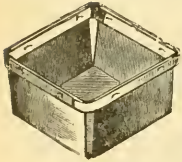

BERLIN FRUIT-BOX COMPANY,
Berlin Heights, - - Erie County, Ohio.

\$50.00 POP CORN.

100 seeds of this wonderful new Pop Corn for 25c and chance to compete for our cash prizes. Seed Due Bill good for 25c worth of other goods FREE with every order for Pop Corn. First-prize winner last year raised at the rate of 188 bushels per acre. We will pay \$50 for its equal in quality. Handsome seed catalog and free presents with every offer.

C. M. Goodspeed, Skaneateles, N. Y.

Wanted!

HONEY, WAX,
MAPLE SUGAR,
SYRUP, AND
POPCORN.

A. L. JENKS, 42 W. Market St., Buffalo, N. Y.

EGG FOOD! The kind that tones and keeps up the hen so that she simply must lay. LEY'S POULTRY CONDITION POWDER puts good red blood into poultry veins; kills all disease germs; tones and nourishes fowls — big and little get all there is in the food when fed in conjunction with it. Price 25c pkg.; 5 for \$1. Ley's Thoroughbred Minorca eggs, \$1 for 13. Thoroughbred Belgian Hares. Geo. J. Ley, Florence, California.

S. C. BROWN LEGHORNS.

I use well-striped breeding cocks. Eggs, \$1.00. Cockerels, \$1.00 and up. Also Italian bees. Circular free.
H. M. MOYER, SHANESVILLE, PA.

EGGS \$1.00 for 15 best Brown Leghorn or B. P. Rocks. Illustrated descriptive egg circular free. H. B. GEER, Nashville, Tenn.

1200 FERRETS. All sizes; some trained; first-class stock. New price list free. N. A. Knapp, Rochester, Lorain Co., Ohio.



Belgian Hares

I have some fine hares for sale at reasonable prices.

J. F. Moore, : Tiffin, Ohio.

The Modern Farmer and Busy Bee.

Emerson Taylor Abbott, Editor.

A live, up-to-date Farm Journal with a General Farm Department, Dairy, Horticulture, Live-stock, Poultry, Bees, Home and General News. The Editor has had practical experience in every department of farm work. To introduce the paper, it will be sent to New subscribers one year for 25c. Sample copies free. Best Advertising Medium in the Central West. Clubbed with *Gleanings* for \$1.00.

ADDRESS

Modern Farmer, St. Joseph, Mo.

SPRAYING FRUIT-TREES.

The question of spraying fruit-trees to prevent the depredations of insect pests and fungus diseases is now longer an experiment but a necessity.

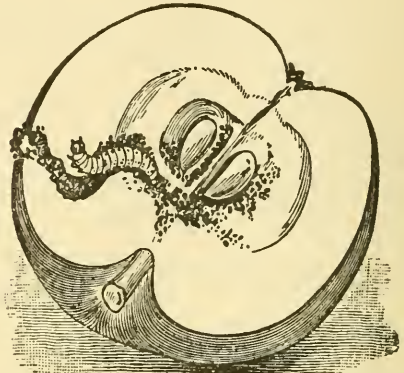

Our readers will do well to write Wm. Stahl, Quincy, Ill., and get his catalog describing twenty-one styles of Spraying Outfits and full treatise on spraying the different fruit and vegetable crops, which contains much valuable information, and may be had for the asking.

March's Mattituck Erfurt Cauliflower. Seeds and plants of this remarkable cauliflower described in *Gleanings*; true stock. Send for circular and prices. **Potatoes.** Carman No. 3 and Sir Walter Raleigh, bu., 80c; 3 bu., \$2.25; 2d size, bu., 60c; 3 bu., \$1.65. **Poultry.** Eggs from prize-winning, high-scoring White Wyandottes and White P. Rocks, \$1.00 per setting; three for \$2.00. Circulars of these and other specialties free. CHRISTIAN WECKESSE, Marshallville, Wayne Co., Ohio.

Mr. A. I. Root's Writings

of Grand Traverse territory and Leelanau County are descriptive of Michigan's most beautiful section reached most conveniently via the

Pere Marquette R. R.

For particulars address W. C. Tousey, D. P. A., Toledo, Ohio.

Home-seekers' Excursions.

On the first and third Tuesdays of each month the Chicago, Milwaukee & St. Paul R'y will sell round-trip excursion tickets from Chicago, Milwaukee, and other points on its line to a great many points in South Dakota, North Dakota, and other western and north-western States at about one fare. Take a trip West and see the wonderful crops, and what an amount of good land can be purchased for a little money. Further information as to rates, routes, prices of farm lands, etc., may be obtained by addressing F. A. Miller, General Passenger Agent, Chicago, Ill.

TWENTY MILLIONS IN GOLD FROM ALASKA DURING THE YEAR 1900.

Five millions of this came from the Nome district. Government officials estimate the output from the Nome district will be doubled the coming season. The Blue-stone, Kougarak, and Pilgrim Rivers have been found very rich. There is hardly a creek from Port Clarence to Norton Sound in which the precious metal is not found, and hundreds of creeks unprospected. A rich strike has been made on the Yellow River, a tributary of the Kuskokwim.

For full information regarding routes, steamship accommodations, and rates to all points in Alaska, address C. N. Souther, General Agent, Passenger Department, C. M. & St. P. R'y, 95 Adams St., Chicago.

You get the Profits



No. 3034, Price \$38.30
with leather quarter top.

Under our plan of selling carriages, buggies and harness, you get the profits. The jobber and retailer are cut out. By dealing direct with our factory, you pay only the cost of making with a moderate profit added: and you take your choice from the biggest stock and fullest assortment. Our plan of

Selling Carriages Direct

insures satisfaction — your money back if you are dissatisfied. Our complete illustrated catalogue, showing many styles of high grade vehicles, harness, robes, blankets and horse equipments, with detailed descriptions of each, mailed free.

THE COLUMBUS CARRIAGE and HARNESS CO., P. O. Box 772, Columbus, O.



No. 240
Single Strap
Buggy Harness
Price \$7.95



QUALITY

Carriages and buggies which are right all the way through. That describes the famous

Split Hickory Vehicles

In material and construction they are as good as American skill and enterprise can produce. They have a dozen little things about them which add to their durability, safety, comfort and appearance. Don't buy a vehicle before you have investigated the **SPLIT HICKORY** line.

Ohio Carriage Manfg. Co.,

PRICE

We sell direct from the factory and save you all of the dealers' and jobbers' profits, and **WE SHIP**

On Approval to Anybody.

If you are not perfectly satisfied return the vehicle at our expense. Send for our illustrated book of Vehicle and Harness Bargains. It contains many things concerning vehicle values, which you ought to know, whether you buy of us or not. It will save you dollars.

27 W. Broad St., Columbus, O.

LET'S BE FRIENDS.

There is certainly an advantage in doing business with a firm which will give you such rare value at such reasonable prices that you will always feel friendly toward it.



If you buy of us just once We will always be friends.

OUR 10 DAYS' FREE TRIAL PLAN

of selling vehicles of every description, at factory prices, is constantly making us friends of this kind. You don't have to buy "sight unseen" when you buy of us. We let you use the vehicle for 10 days before you decide to keep it. And we sell a better vehicle for less money than any other manufacturer or dealer in the country. Send for our big, free catalogue of vehicles and harness and think it over.

Kalamazoo Carriage & Harness Co., Dept. 22, Kalamazoo, Mich.

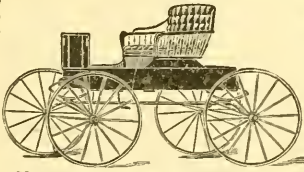
You Pay Double the Money

in many cases when you buy vehicles and harness from the agent or dealer. We do without these people and reduce the price of our goods to you to the extent of their commissions. We make 178 styles of vehicles and 65 styles of harness and sell them to the consumer direct from our factory at wholesale prices.

WE HAVE NO AGENTS

You pay a profit to nobody except our manufacturing profit, and you get the best goods which a given amount of money will buy. In a factory of the size of ours you get the best possible selection. Our large illustrated Catalogue contains cuts of everything we make. Remember that we ship our vehicles and harness anywhere for examination and guarantee safe delivery and warrant everything

No. 232—Driving Wagon. Has "Long Distance" axles, open head springs, Bailey loops, rubber covered steps and solid rubber tire. Price with shafts, \$65. Same as others sell for \$40 to \$50 more than our price.

No. 65—Single Buggy
Harness. Price with rubber trimmings \$16. Good as retail for \$22.

SEND FOR LARGE FREE ILLUSTRATED CATALOGUE.
Elkhart Carriage and Harness Mfg. Co., W. B. Pratt, Sec'y, Elkhart, Indiana.



SOJA BEANS FOR SEED—REDUCED PRICES.

We can now make the extra-early soja bean, the kind known as the American coffee-berry, at only \$2.00 per bushel. This ripens seed without any trouble all over the North. The later variety, the regular soja bean, will be \$1.75 per bushel; and if shipped from Richmond, Va., where the seed was grown, for immediate orders we can make the low price of \$1.50 per bushel. The latter kind will produce a large amount of feed; and if frost holds off it will usually ripen its seed here in the North.

GLASS ADVANCED AGAIN.

There has been another advance in the price of window glass, so that the best price we can now offer on 8x10 glass for greenhouse sash is \$1.00 per box. As we work off stock on hand we are modifying our shipping-cases by using a block at each end of the glass. This will enable us to use 16 inch strips in all four-row cases, or 12-inch strips in three-row cases. As we have quite a quantity of glass on hand, especially for two and three row cases, we will not incorporate this change into many of the cases sent out this year, but we expect to do so as soon as present stock is used up. We are already supplying some of the four-row cases in the new style.

SECOND-HAND MACHINERY.

Since our notice in this department two months ago we have sold several of the machines offered, but we still have a number of the machines offered, as well as others. We have sold the single cutter-head machines, but have the several double ones still on hand, one at \$40.00, practically new, and another, slightly damaged by fire, at \$30.00. We have one or two rip-saw tables to offer, one at \$10.00 and one or two more at \$15.00. One solid iron-frame V grooving machine, for 4 1/2 sections only, worth new \$200; will sell for a very low price. A solid-iron double-mandrel double-head machine for cutting beewax in sections or section-holders, worth new \$350; will sell cheap. A solid-iron hive-dovetailing machine, which is in excellent condition, and worth new \$500; will sell very low. Several 6-inch foundation-machines. Particulars and prices to those interested, on application.

MASON FRUIT-JARS.

We still have in stock a few gross of quart Mason fruit-jars with aluminum caps, which we offer, while they last at 55 cts. per doz.; 6 doz., \$3.15; 12 doz., \$6.25. We are expecting within a few days, from the factory, a carload of jars with porcelain-lined zinc caps in both green and flint glass. We placed our order for these before the higher prices now ruling went into effect, so that we are in a position to make closer prices than we should otherwise be able to do. The retail prices in our catalog are very close to the prices ruling at present on carload lots at factory. For the present we offer them at the following prices, which we can not guarantee for any length of time, as prices are likely to advance still further:

GREEN GLASS.

1 pint, 1 doz., 55; 6 doz., \$3.15; 12 doz., \$6.25.
1 qt., 1 doz., 58; 6 doz., \$3.30; 12 doz., \$6.50.
2 qt., 1 doz., 80; 6 doz., \$4.60; 12 doz., \$9.00.

FLINT GLASS.

1 pint, 1 doz., 60; 6 doz., \$3.45; 12 doz., \$6.75.
1 qt., 1 doz., 65; 6 doz., \$3.75; 12 doz., \$7.25.
2 qt., 1 doz., 90; 6 doz., \$5.20; 12 doz., \$10.00.

These jars are all put up one dozen in a partitioned case, and I think they are the best-made jars we have had in years.

ORDERS FILLED PROMPTLY.

While there has been a little delay in filling orders in a few cases during the past two or three months, we are glad to say that we are now close up on orders, and shipping promptly all orders as fast as received. Even odd-sized and irregular goods which have to be made to order are gotten out within a few days. Our various branches and agencies are also well supplied with goods, so that, if you are in need of bee-supplies, you can obtain them without delay. We

have in stock here over three million sections, and more than a third of these are No. 2. There is not a size listed in our catalog that we can not supply in No. 2, and these are fine sections compared with what we turned out as No. 1 a few years ago. Our No. 1 are perfection itself. If any one can suggest any further improvement upon them we should be pleased to get the suggestion.

FIFTEEN AND TWENTY-FIVE DOLLAR QUEENS HAVING A MEASURED TONGUE-REACH.

The call for queens of our celebrated \$200 imported mother has been so great that we have decided, in addition to the \$2.00, \$4.00, and \$6.00 grades of this stock, to offer some \$10.00, \$15.00, and even \$25.00 of this same blood. But these prices are for tested queens, the *tongues of whose bees have been measured.*

The \$10.00 queen is guaranteed to produce bees with a tongue-measurement of $\frac{13}{16}$; the \$15.00 queen, $\frac{23}{16}$; the \$25.00 queen, $\frac{25}{16}$.

These last are very rare, and with one exception this ($\frac{25}{16}$) is the longest tongue-reach yet secured. We reserve the right, when we do not have the stock with the tongue-reach called for, either to return the money or to send the next lower, remitting the balance. It would be well for our friends to put in their orders at once, and as soon as we get the grades we will send notice. When the money is sent, the queens will be forwarded. These will be put up in the very best manner possible; and while we guarantee safe arrival in good order to any point in the United States, on any railway line, we will not guarantee safe introduction. Such valuable queens should be released on hatching brood.

N. B.—It seems as if it ought not to be necessary to say that no one but a queen-breeder or a large honey-producer should order these high-priced queens; but it is a fact according to our experience that beginners with only a few colonies will order our highest-priced imported queens. Such bee-keepers have no more use for such queens than a pig has for a wheelbarrow.

SENDING BEESWAX BY EXPRESS.

Yes, I know I have talked about it several times before; but just now our express clerk opened a package of wax sent by express, with, I think, \$2.75 charges. But it could have been sent by freight, the proper way to send beeswax, for 75 cts., a clear saving of \$2.00; and the clerk informs me that this is almost a daily occurrence. When I asked him what he supposed ailed our bee-keeping friends to throw away their money at this rate he said he could not think of any reason unless it was that they were in a hurry for returns. I really hope, however, this is a mistake, for I am loath to believe that our bee-keepers, or many of them at least, are as hard up as this would seem to indicate. If it is true, however, that any of you are needing money badly, I will try for my part to see that our book-keeper gets the remittances straight back to you as soon as possible. Beeswax is a cash commodity. It ought to be spot cash every time. Of course, there are times and circumstances when express is about as cheap as freight, but it is rarely true. Before you ship your wax, ask your agent what the expense will be both ways. If you are in a hurry for the money, say so when you send the box, and we will try to get it back to you the very day the wax reaches us; and we shall not feel hurt, either, even if you do ask for very prompt payment.

Queens. I have 150 fine tested three-banded Italian queens for sale. They are last August queens, and their bees are fine honey-gatherers. Tested, \$1.25; select tested, \$1.50; breeders, \$2.00; untested, 75c each, or \$8.00 per doz. I guarantee safe arrival, and satisfaction on every queen. I have been a queen-breeder for 12 years, and know what good queens are.
J. W. Taylor, Ozan, Ark.

NOTICE.—I can not fill any more orders for early queens this season. Address changed to
W. C. Gathright, Las Cruces, N. M.

FOR SALE CHEAP.—California bee ranch and 500 colonies of bees. Write for particulars, price, and easy terms. I. A. KING, Almond, San Diego Co., Cal.

WANTED.—To exchange Japanese buckwheat at 80 cts per bushel; sacks, 15 cts, extra, for cash, or bees in shipping-boxes, if not too far away.

ALBERT L. MARTIN, Leonardsburg, Delaware Co., O.



TURN EGGS TO DOLLARS.

Get the most out of your fowls. Avoid the loss of time and eggs and chicks— Hatch right and brood properly. The ONE, ONLY way to do it is by the

RELIABLE

...INCUBATORS AND BROODERS...

They never fail. They hatch every fertile egg, and raise a larger per centage of chicks than any other machine made. They are constructed exactly right and are absolutely self-regulating. Their past record is their highest endorsement.

RELIABLE PLIANT LEG BANDS.
You can't lose them. Easily applied and don't wear out. Prices reduced. Sent post-paid for—12 bands for 20c.; 50 for 50c.; 100 for 80c.; 500 for \$3.75 and 1000 for \$7.00.

RELIABLE EXHIBITION COOPS.
Lightest, neatest, easiest to clean. Help set off the fowls on the exhibition benches.

20TH CENTURY POULTRY BOOK, The most practical treatise on poultry raising yet produced. Covers the ground. Is founded on practical experience. Incidentally it tells about the latest improvements in the Reliable Incubators and Brooders. The world's best. Book 10c.

Reliable Incubator & Brooder Co., Box B-49, Quincy, Ill, U. S. A.



The Only Trouble

with PAGE Poultry Fence is, it looks so much like a stock fence that *people will use it* for a stock fence. Weighs 10 pounds to the rod.

Page Fence Co., Box S, Adrian, Mich.

Minnesota Bee-keepers' Supply Mfg. Co.,
Manufacturers of
Bee-hives, Sections, Shipping-cases, and
Everything Used by Bee-keepers.

Orders filled promptly. We have the best shipping facilities in the world. You will save money by sending for our price list. Address

Minnesota Bee-keepers' Supply Mfg. Co.,
Nicollet Island Power Building, Minneapolis, Minn.

For Sale Cheap.

200 COMBS in Hoffman frames, wired and built from full sheets of foundation. Will take \$20.00 for the lot. Come quick if you want them.

GEO. E. HILTON, Fremont, Mich.

Union Combination Saw

For Ripping, Cross-cutting, Rabbeting, Mitering, Grooving, Gaining, Boring, Scroll-sawing, Edge-moulding, Beading. Full line FOOT and HAND POWER machinery. Send for catalog A.

SENECA FALLS MFG. CO.,
44 Water St., Seneca Fs., N.Y.

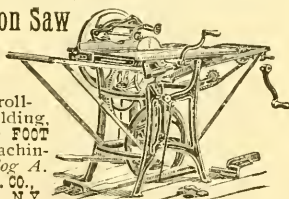

BULL-STRONG!

....PIG-TIGHT....

An Illinois farmer said that after harvest he had fully 200 bushels of loose oats on the ground that he could not secure any benefit from, because the fence around the field would not turn hogs. Figure the loss for yourself. He also said, all this would have been saved if he had used the Kitzelman Woven Wire Coiled Spring Fence, and the value would have gone a long way towards paying cost of the fence.

With the Duplex Machine any farmer can make it himself at the actual cost of the wire. Catalogue free for the asking.

KITZELMAN BROS.,
Box D31, Muncie, Ind.

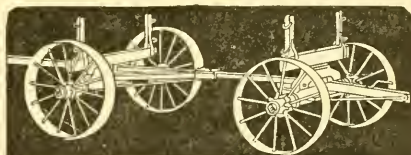

ELECTRIC HANDY WAGON.

When you buy a wagon, buy one that will last you a life time, without costing more for repairs than it is worth. Get one that is easy to load and easy to draw. That's the Electric—the best made wagon in the world. Steel wheels (24 to 56 inches high) wide tires, straight or stagger spokes. Send for handsome catalog of steel wheels, wagons and other implements at money-saving prices.

ELECTRIC WHEEL CO., Box 95 QUINCY, ILLINOIS.

Sweet-Potato Seed.
 Sound bright stock of the best varieties. Special rates by express. Descriptive price list free. Address
L. H. Mahan, Box 143, Terre Haute, Ind.

Maule's (35 new things for 1901)
Seed Catalogue
 You should, by all means, have this most modern catalogue of modern times. It is brimful and overflowing with good things in vegetable, farm and flower seeds, flowering plants, fruits, bulbs, etc. It contains 35 novelties in vegetables and flowers never offered before, has 136 large pages, seven handsome colored plates and hundreds of illustrations. It gives practical, up-to-date cultural directions and offers many cash prizes. The first edition alone costs over \$30,000, so while we send it free to all customers, we must ask others to send 10 cents for it, which amount they may deduct from their first order. You will make a mistake if you do not write to-day for this the Novelty Seed Book of the year. Address,
WM. HENRY MAULE, Philadelphia.

POTATOES **\$1.20 PER BRL.**
 Largest growers in the world of seed potatoes, grasses, clovers and farm seeds; potatoes \$1.20 and up per barrel. Big Farm and Vegetable Seed Catalogue for 5 cents postage.
JOHN A. SALZER SEED CO., LA CROSSE, WIS.

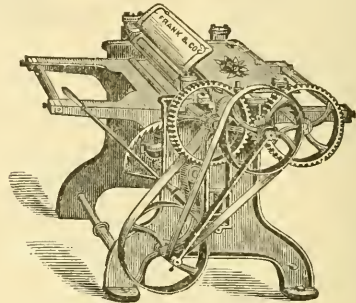

PLANERS

The above cut shows one of our small Planers, of which we make twelve different styles and sizes. Also large Planers, Band Saws, Buzz Planers, Moulders, Wood Lathes, and all kinds of

WOOD WORKING MACHINERY

Send for Catalogue.

The FRANK MACHINERY CO.

BUFFALO, N. Y.

AT ANY TIME—

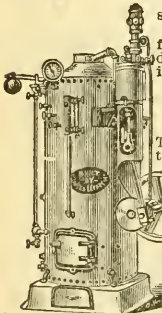

summer time or winter time, the **BEST POWER** for all purposes on the farm, in the dairy, creamery or cheese factory, is a

LEFFEL ENGINE.

They are very simple in construction, and easy to run and keep in order. Are very economic of fuel, are easy steamers and great power developers. They are made both horizontal and upright with engine mounted on boiler. Everything is made of best material throughout. They are ideal for cutting and grinding feed, sawing wood, pumping water, running cream separators, churns, butter workers, etc. Send stamp for Book on Power.
JAMES LEFFEL & CO., Box 89, Springfield, O.

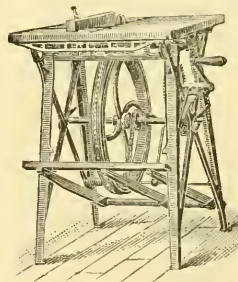

Barnes' Hand and Foot Power Machinery.

This cut represents our combined circular saw, which is made for beekeepers' use in the construction of their hives, sections, boxes, etc. **Machines on trial.** Send for illustrated catalogue and prices.
W. F. & John Barnes Co.,
 545 Ruby St.,
 Rockford, Ill.

New Smith Premiers Nos. 5 and 6.

The No. 6 takes paper 18½ inches wide and writes lines 16 inches long. The No. 5 takes paper 11 inches wide and writes lines 9½ inches long. These new machines in essential mechanical principles are the same as Models Nos. 2, 3 and 4—unequaled.

Write for Printed Matter Free.

The Smith Premier Typewriter Co.

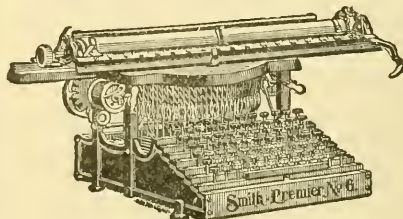

158 Prospect Street, Cleveland, Ohio.

In writing advertisers please mention Gleanings.

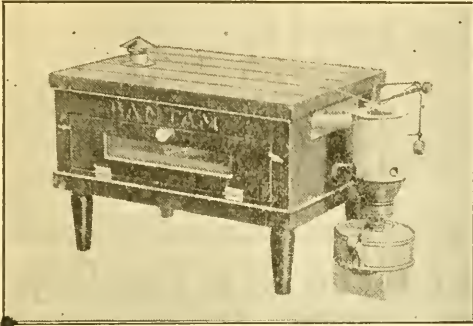

BIDDIES & BEES.
MAKE THEM BOTH PAY.

50-egg Bantam. Self-regulating.

Holds 50 ordinary-size eggs. No sitting up nights. 20 minutes' attention in twenty-four hours will operate it. Sold on

30 Days' Trial for \$5.00

Over 15 000 in use, and thousands hatching 50 chicks from 50 eggs. You can do as well. Either hot-water or hot-air heating. We have a brooder to go with it for \$3.00. Our catalog of valuable information, and describing incubators and brooders of all sizes and prices—all on trial—sent for the asking if you mention this paper.

Buckeye Incubator Co., Springfield, Ohio.

A START IN LIFE!

Everybody realizes its importance. Don't deny it to your chicks. Hatch 'em right, start 'em right, and they'll pay you back all right. The best way to hatch chicks is with the famous

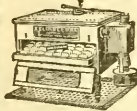

RELIABLE INCUBATORS AND BROODERS

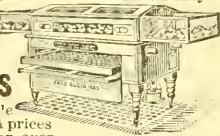

The machines which have satisfied more particular people than any other machine made. They hatch every fertile egg. All sizes and prices. Our \$5 BANTLING SPECIAL, 50-egg size, is the best small incubator ever sold at a low price. But send for our great 20TH CENTURY POULTRY BOOK—it tells all about all our incubators—all about our poultry supplies, and all about the poultry business in general—especially how successful men have made money at it. You won't find a better treatise on poultry anywhere. Only 10c for postage.

Reliable Exhibition Coops ARE LEADERS. RELIABLE INC. & BROODER CO.,
Reliable Pifant Leg Bands) You will see them at the Paris Exposition in 1900. Box 6-40 Quincy, Ill.



You Can't Afford to Guess

at results in the poultry business. If you fail to raise the chicks, you simply have no business. The way to be absolutely sure about getting the chicks is to employ a Cyphers Incubator in your hatching. We guarantee them to last 10 years and to outmatch any incubator made. The best way to know about it is to read our 224 page (8x11 in.) book, "Profitable Poultry Keeping." Has 250 illustrations and covers the entire subject. We send it for 10 cents in stamps. Ask for book 74. Circulars mailed free. Address nearest office.

CYPHERS INCUBATOR CO. Chicago, Ill., Wayland, N. Y., Boston, Mass.

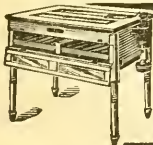

200-Egg Incubator for \$12.00

Perfect in construction and action. Hatches every fertile egg. Write for catalogue to-day. GEO. H. STAHL, Quincy, Ill.



GREIDER'S POULTRY

always do well. 50 standard varieties. Handsomest poultry book of the season for 8c stamps. Full of money-making hints. My birds are winners. B. H. GREIDER, Florin, Pa.

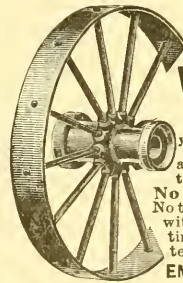

STEEL WHEELS

for your **FARM WAGONS**

any size wanted, any width of tire. Hubs to fit any axle. No blacksmith's bills to pay. No tires to reset. Fit your old wagon with low steel wheels with wide tires at low price. Our catalogue tells you how to do it. Address EMPIRE MFG. CO., Quincy, Ill.



EASY SPRAYING

No sprayer made gives better service than the Century Barrel Sprayer. Submerged brass cylinder, brass ball valves, everlasting plunger packing; automatic agitator. For ease of operation, durability, free water ways it is unequalled. Never scorches foliage. Send for catalogue of full line of pumps and sprayers. THE DEMING CO., Salem, O. Western Agents, Menon & Hubbell, Chicago

BETTER THAN WOOD.



Costs less; looks better; lasts longer. HARTMAN STEEL ROD LAWN FENCE will neither rot nor burn. HARTMAN MFG. CO., Box 50, Ellwood City, Pa. Or Room 40, 50 Broadway, New York City.

In all Probability

the long-tongue bees are the best honey-gatherers, but, whether this proves true or not, there is no risk in buying queens of the Superior stock, as, in addition to having as long tongues as any that have been measured, their *superiority has been proven*; and safe arrival, safe introduction, purity of mating, and satisfaction

are *guaranteed*. Price of queens, \$1.50 each. The Review for 1901, twelve back numbers, of my own choosing, and a queen of the Superior stock, for only \$2.00.

W. Z. HUTCHINSON, Flint, Mich.

I. J. Stringham, 105 Park Place, New York City.

Keeps in stock a full line of modern appliances for bee-keepers.

SILK-FACED VEILS.

As good as any made; 35 cents postpaid. Catalog free. Full colonies Italian bees, \$6.00. Apiaries, Glen Cove, Long Island.

I. J. Stringham, 105 Park Place, New York City.

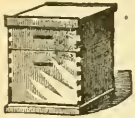

BEE-HIVES AND HONEY-BOXES,

in car lots—wholesale or retail. Now is the time to get prices. We are the people who manufacture strictly first-class goods and sell them at prices that defy competition. Write us today.



Interstate Box & Manufacturing Co., Hudson, Wis.

Marshfield Manufacturing Company.

Our specialty is making SECTIONS, and they are the best in the market. Wisconsin basswood is the right kind for them. We have a full line of BEE-SUPPLIES. Write for FREE illustrated catalog and price list.

Marshfield Manufacturing Company, Marshfield, Wisconsin.

SPECIAL LOW CLUBBING OFFERS ON GLEANINGS.

New readers who may see this issue for the first time, and old ones who have perhaps been subscribers, and have dropped out in the meantime, will be interested in the following special clubbing offers that we are prepared to make:

OFFER NO. 21.

For 25c we will send GLEANINGS 6 months' trial subscription to new subscribers.

OFFER NO. 22.

For \$1.00 we will send GLEANINGS for one year and an untested Italian queen valued at 75 cents; but at this low price we reserve the right to send queen some time in July when we have a choice supply.

OFFER NO. 23.

For 50c we will send GLEANINGS from the time your subscription is received till January 1, 1902, so that the SOONER you send in your order the more numbers you will get.

OFFER NO. 24.

If you order \$10.00 worth of goods from our catalog at regular prices, paying cash for them, for 50 cents more you can have GLEANINGS for one year.

OFFER NO. 25.

For \$1.00 we will send GLEANINGS one year and a Clark smoker, postage 20c extra. Or, for \$1.25 we will send the Corneil smoker, postage 25c extra.

OFFER NO. 26.

For \$1.75 we will send GLEANINGS one year and our cyclopedia on bees, the A B C of Bee Culture, 1901 edition, of 500 pages.

CLUBBING OFFERS.

We will send the *Review of Reviews* or *Youth's Companion*, new subscribers only, and a subscription to GLEANINGS, for \$2.25. Or for \$1.50 we will furnish GLEANINGS and any one of the following-named magazines or papers:

Success, Woman's Home Companion, Ohio Farmer, Michigan Farmer, Practical Farmer, Kansas Farmer, Indiana Farmer, Cosmopolitan, and Pierson's Magazine.

Subscriptions to *Review of Reviews* and *Youth's Companion* must be strictly new.

Old as well as new subscribers may take advantage of these several offers, but all arrears or back subscriptions must FIRST be paid at \$1.00 a year. Refer to these offers by number to avoid mistakes.

THE A. I. ROOT CO., Medina, Ohio.

1881

PAGE & LYON MFG. CO.

1901

We manufacture a full line of the latest
BEE-SUPPLIES.

Our motto is, "Perfect Goods and Prompt Shipment."

Send for our new free illustrated catalog.

PAGE & LYON MFG. CO., New London, Wisconsin.

NOW READY!

64-PAGE CATALOG OF EVERY THING BEE-KEEPERS NEED. Illustrated and fully described. Especially valuable to beginners for the information it contains. Send your address on postal and get it now. Established 1884.

J. M. JENKINS, Wetumpka, Ala.

NOW READY. LONG-TONGUED QUEENS!

YARD NO. 1.

By special arrangements with THE A. I. ROOT CO. to furnish them queens, I have secured their assistance in procuring the finest breeding queens that a thorough knowledge of the bees of the country and money can procure. Among them is a *select daughter of their \$200 queen that they refuse to quote me prices on.* This queen shows every superior quality of her mother. Her bees show an actual reach of 21-100 of an inch; are large, gentle, and beautiful to look upon.

MR. E. R. ROOT SAYS: "You have as fine bees as there are in the United States; and with a direct cross of their breeders you should be able to produce queens whose bees show a reach of 25-100 of an inch."

Send for descriptive price list.

From recent measurements I find I can warrant all tested and select untested queens to produce bees whose reach is 19-100 with an average reach of 18-100; Select tested queens to produce bees whose reach is 20-100, with an average of 19-100.

Prices: Untested, \$1.00; 6, \$5.00. Select untested, \$1.25; 6, \$6.00. Tested, \$1.50; 6, \$8.00. Select tested, \$2.00; 6, \$11.00.

Breeders, whose best bees show a reach of 21-100, with an average reach of 20-100, \$3.00. Breeders, whose best bees show 21-100, with an average of 20½-100, \$5.00. Breeders, whose best bees show 22-100, with an average of 21-100 \$7.00.

I have discovered 2 breeders whose best bees show 23-100; these are too good to sell; don't ask for prices.

Imported Italian stock. Apiary No. 2. Imported queens, daughters and grand-daughters. Golden, or 5-banded Italian. Apiary No. 3. Breeders, select tested, tested, untested queens.

**W. O. VICTOR, WHARTON, TEXAS.
QUEEN SPECIALIST.**

QUEENS?

Improved Golden and Leather-colored Italians are what H. G. Quirin Rears.

We have one of Root's best long-tongued RED-CLOVER BREEDERS from their \$200 queen, and a Golden breeder from Doolittle, who says if there is a BREEDER of Golden bees in the United States worth \$100, this one is worth that sum. The above breeders have been added to our already improved strain of queens for the coming season.

J. L. Gandy, of Humboldt, Neb., wrote us on Aug. 5th, 1900, saying that the colony having one of our queens had already stored over 400 pounds of honey (mostly comb). He states that he is certain that our bees work on RED CLOVER, as they were the only kind in this locality and apiary.

A. I. Root's folks say that our queens are extra fine. While the editor of the *American Bee Journal* tells us that he has good reports from our queens from time to time. We have files upon files of unsolicited testimonials. After considering above evidence need you wonder why our orders have increased each year?

Give us a trial order and be pleased. We have years of experience in mailing and rearing queens. Safe delivery will be guaranteed. Instructions for introducing with each lot of queens.

Queens Now Ready to Mail.

**Warranted Stock, \$1.00 each; 6, \$5.00.
Tested Queens, \$1.50 each; 6, \$8.00.
Select Tested, \$2.00 each; 6, \$10.00.**

We Have 100M Folding Cartons

on hand, and so long as they last will sell at \$1.00 per 1000, with your address printed on in two colors; 500 for \$2.75. At above price you can not afford to place comb honey on the market without cartoning it. Address all orders to

H. G. Quirin, Parkertown, Ohio.

(Parkertown is a Money-order Office.)

WE WANT

to sell you bee-supplies. Our line is all new and complete. Send for our illustrated catalog. It will convince you that our Dovetailed hive is the best on the market. Our prices are right and our service is prompt.

Fred W. Muth & Co.,
Cincinnati, Ohio.

S-W. Cor. Front
and Walnut Sts.

Dittmer's Foundation !!!

Retail---Wholesale---Jobbing.

I use a PROCESS that produces EVERY ESSENTIAL necessary to make it the BEST and MOST desirable in all respects. My PROCESS and AUTOMATIC MACHINES are my own inventions, which enable me to SELL FOUNDATION, and WORK WAX INTO FOUNDATION FOR CASH, at prices that are the lowest. Catalog giving

FULL LINE OF SUPPLIES

with prices and samples, free on application. BEESWAX WANTED.

GUS. DITTMER, AUGUSTA, WIS.

Get the Best Queens.

Evansville, Ind., Sept. 27th, 1900.

The Jennie Atchley Co., Beeville, Bee Co., Texas:

Dear Friends:—It gives me great pleasure to forward you this unsolicited testimonial regarding the merits of Atchley queens. The three (3) dozen queens purchased of you have made an excellent record for themselves. Not an Atchley queen among the twenty colonies lost during the severe drouth in July. I have bought queens from many breeders; and although the present crop is exceedingly short, the tiers of supers show where the Atchley queens are, and speak volumes for your method of queen-rearing. I find the progeny to be very gentle, strong-winged, uniformly marked, long-lived, of large size, and last, but not least, the best honey-gatherers I ever had. I shall want 100 more next season.

Yours fraternally, J. C. WALLENMEYER.

Prices for Queens.

Tested, \$1.50 each; \$8.00 for 6, or \$15.00 per dozen. Untested, February, March, April, and May, \$1.00 each; \$5.00 per 6, or \$9.00 per dozen. Fine breeders, \$5.00 each. We have as good bees and queens as money and labor produce. We breed three-band Italians, Goldens, Carniola, Cyprians, and Holy-Lands, in their purity, bred in separate yards 5 to 20 miles apart. If you want the *best*, call for Atchley's improved strains. Safe arrival guaranteed. Send for a sample copy of "The Southland Queen," the only southern bee-paper, \$1.00 per year. To new subscribers we offer as a premium a nice untested queen in order to get our paper introduced. Catalog, giving queen-rearing and management of apiaries for profit, FREE.

THE JENNIE ATCHLEY CO.,
Beeville, Bee Co., Texas.

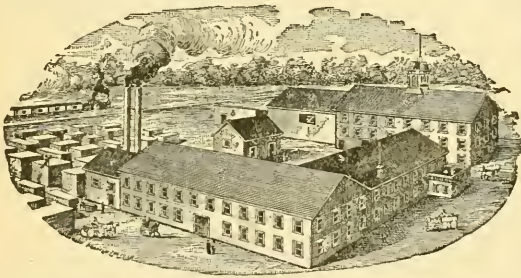

KRETCHMER M'F'G CO., Red Oak, Iowa.

BEE-SUPPLIES.

Best-equipped factory in the West; carry a large stock and greatest variety of every thing needed in the apiary, assuring BEST goods at the LOWEST prices, and prompt shipment. We want every bee-keeper to have our FREE ILLUSTRATED CATALOG, and read description of Alternating Hives, Ferguson Supers, etc. *Write at once for a catalog.*

— AGENCIES: —

Trester Supply Co., 103 So. 11th St., Lincoln, Nebraska; C. C. Richards, 1223 17th St., Denver, Col.

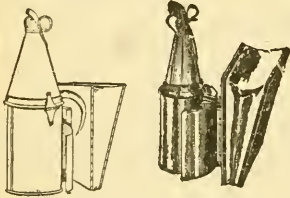

BINGHAM SMOKER.

Dear Sir:—Inclosed find \$1.75. Please send one brass smoke-engine. I have one already. It is the best smoker I ever used. Truly yours,
HENRY SCHMIDT, Hutto, Tex.

MADE TO ORDER

Bingham Brass Smokers.

Made of sheet brass, which does not rust or burn out; should last a lifetime. You need one, but they cost 25 cts. more than tin of the same size. The little open cut shows our brass hinge put on the three larger sizes. No wonder Bingham's four-inch smoke-engine goes without puffing, and does not drop inky drops. The perforated steel fire-grate has 381 holes to air the fuel and support the fire.

Heavy tin smoke-engine, 4-inch stove, per mail, \$1.50; 3½-inch; \$1.10; 3-inch, \$1.00; 2½-inch 90c; 2-inch, 65c. Bingham smokers are the originals, and have all the improvements, and have been the standard of excellence for 22 years. Only three larger ones brass.

T. F. Bingham, Farwell, Michigan.

Contents of this Number.

Adulteration in Germany381
 Adulteration, To Detect.....381
 Apiary, Marchant's.....406
 Apples, Rawley's.....410
 Bees, Number in Hive.....379
 Bleaching-house, Higgins'.....387
 California Prospects.....398
 Cellar, Blasted in Rock.....399
 Chickens Hatched over Bees.....399
 Comb Honey, Working for.....396
 Comb Honey, Removing from Dovetailed Supers.....398
 Cook's Review.....401
 Corns Cured with Beeswax.....381
 Dzierzon's Invention.....388
 Extracting from Sections Partly Filled.....398
 Foundation, Light for Brood-nest.....391
 Hive 133 Years Old.....381
 Hive, Dzierzon's Movable-comb.....380
 Hives on a Bench.....397
 Honey, Comb, Bleaching.....387
 Honey, Comb v. Extracted.....384
 Honey, Cuban, in Square Sections.....385
 Honey, Rose.....381
 Jackson, Mrs., as Bee-keeper.....392
 Langstroth v. Dzierzon.....388
 Organization for Bee-keepers Needed.....386
 Parthenogenesis, by Benton.....395
 Pineapple-shed.....408
 Poison of Bees, Composition of.....382
 Pollen, How Gathered.....390
 Queens Fertilized in Hive.....386
 Queens, Thoroughbred.....382
 Red clover, Honey from.....398
 Skin of Fruit v. Old Cells.....397
 Stands for Hives, Marchant's.....407
 Theory, Dickel.....393
 Tongues, How Measured.....399
 Tongues, Measuring.....383
 Tongue-reach v. Tongue-length.....401
 Top-bars, Thick v. Thin.....380
 Trap Nests.....410
 Winter Losses.....401
 Wintering in High Temperature.....390
 Wiring, Vertical v. Horizontal.....391

Honey Column.

GRADING-RULES.

FANCY.—All sections to be well filled, combs straight, firm ly attached to all four sides, the combs unsoiled by travel stain, or otherwise. All the cells sealed except an occasional cell on the outside surface of the wood well scraped of propolis.

No. 1.—All sections well filled except the row of cells next to the wood; combs straight; one-eighth part of comb surface soiled, or the entire surface slightly soiled; the outside surface of the wood well scraped of propolis.

No. 1.—All sections well filled except the row of cells next to the wood; combs comparatively even; one-eighth part of comb surface soiled, or the entire surface slightly soiled.

No. 2.—Three-fourths of the total surface must be filled and sealed.

No. 3.—Must weigh at least half as much as a full-weight section.

In addition to this the honey is to be classified according to color, using the terms white, amber, and dark; that is, there will be "Fancy White," "No. 1 Dark," etc.

CITY MARKETS.

MILWAUKEE.—At present writing the demand for honey is for something fancy in quality and condition, and but a limited supply of such. Have of late received some shipments of fancy white and sold readily at 18, while common and amber honey moves but little. We can now quote fancy 1-lb. sections, 16@18; No. 1, 15@16; common grades and amber, 13@14. Extracted white, in barrels, kegs, or cans, 7½@8½; amber, 7@7½. Beeswax, 26@28.

Apr. 19. A. V. BISHOP & Co.,
 Milwaukee, Wis.

NEW YORK.—Demand for comb honey about over, with stock well cleaned up. Prices nominal. We quote fancy white, 15@16; A No. 1, 14@15; No. 1, 12@13; No. 2, 10@11; buckwheat, 8@10. Extracted honey, demand dull; fancy white, 7@8; light amber, 6@7; amber and buckwheat, 5@5½. Beeswax is dull but steady; fancy, 28@29; average, 27@28.

Apr. 22. CHAS. ISRAEL & Bros.,
 486-8 Canal St., New York City.

CHICAGO.—The choice grades of white comb honey sell at 16, and there is no surplus in sight. Other grades of comb sell fairly well at the following prices: No. 1 grades of white, 14@15; off grades, 13; light amber, 12; dark amber, 10@11; buckwheat and other dark combs, 9@10; candied and mixed colors, 7@9. Extracted is dull, and prices very weak, with the exception of some fancy linden and clover grades quotable at 7@8; ambers, 6@7; dark and buckwheat, 5@6. Beeswax, 30. R. A. BURNETT & Co.,
 Apr. 20. 163 South Water St., Chicago, Ill.

NEW YORK.—We have to report a small stock of comb honey in this market. Prices rule about same as our last report, while there is but little demand, as follows: Fancy white, 15; No. 1, 14; No. 2, 13; buckwheat, 10. Buckwheat extracted, 5½@5½. Beeswax, 27. FRANCIS H. LEGGETT & Co.,
 Franklin, West Broadway, and Varick Sts.,
 Apr. 20. New York City.

PHILADELPHIA.—As the season advances there is less call for comb and extracted honey. The market is now nearly bare of comb honey except some refuse lots. Extracted honey quite abundant. We quote fancy white extracted honey, 7½; amber, 6½; dark, 6. We are producers of honey—do not handle on commission. WM. A. SELSER,
 Apr. 19. 10 Vine St., Philadelphia, Pa.

SCHENECTADY.—Notwithstanding the lateness of the season we have had a number of small consignments of comb honey recently; and while there is still some demand a few warm days will curtail it to an occasional case or two. We quote clover, 13@15; buckwheat, 10@12. No demand for extracted.
 Apr. 20. C. McCULLOCH, Schenectady, N. Y.

ALBANY.—Honey market dull; hardly stock enough on demand at present to change quotation any from last issue. A No. 1 white scarce at any price; No. 1, 13@14; No. 2, 11@12; No. 3, 10@11. MACDUGAL & Co.,
 Successors to CHAS. McCULLOCH & Co.,
 Apr. 24. Albany, N. Y.

CINCINNATI.—The demand for comb honey is nearly over. The stock of it also well cleaned up. Fancy white yet brings 16; extracted in fair demand; dark sells for 5½; better grades bring 6@7½; fancy white clover, 8½@9. C. H. W. WEBER,
 Apr. 19. 2146-8 Central Ave., Cincinnati, Ohio.

SAN FRANCISCO.—We beg to state that 1900 comb honey is practically exhausted, and it is difficult to state what the ruling prices are. GUGGENHIME & Co.,
 Apr. 23. San Francisco, Cal.

DETROIT.—Fancy white comb, 14@15; No. 1, 13@14; dark and amber, 10@12. Extracted white, 6½@7; dark and amber, 5@6. Beeswax, 27@28.
 Apr. 20. M. H. HUNT & SON, Bell Branch, Mich.

BUFFALO.—Honey is moving slowly, but prices hold steady. Fancy white comb, 15@16; A No. 1, 14@15; No. 1, 13@14; No. 2, 12@13; No. 3, 11@12; No. 1 dark, 10@11; No. 2, 8@9. Extracted, white, 7@8; dark, 5@6. Beeswax, 28@30. W. C. TOWNSEND, Buffalo, N. Y.
 April. 26.

FOR SALE.—Extracted honey from alfalfa; 60-lb. cans at 7 cts., and smaller cans. D. S. JENKINS, Las Animas, Colo.

FOR SALE.—20,000 lbs. extracted honey from alfalfa and light amber from Rocky Mountain bee-plant. Two cans, 120 lbs. net, \$8 40; also 5 and 10 lb. pails. In ordering state if you want white or amber. M. P. RHOADS, Las Animas, Col.

WANTED.—Comb and extracted honey. State price, kind, and quantity. R. A. BURNETT & Co.,
 163 South Water St., Chicago, Ill.

FOR SALE.—Choice alfalfa honey. Two cans, 120 lbs. net, whitest, \$9 00; tinted, partly from other bloom, \$8.40. Also small cans. THE ARKANSAS VALLEY APIARIES,
 OLIVER FOSTER, Prop., Las Animas, Bent Co., Colo.



Tar Heel Apiaries !

THE BEST BEES KNOWN
IN : AMERICA : TO-DAY.

American Albino Italians.

They have no superiors and few equals, as hundreds of bee-keepers testify. Untested queens, \$1.00; 6 \$5.00. Tested queens, \$2.00 each. Choice breeders, \$5.00 to \$10.00. Nuclei, 75c per L. frame—add price of queen. 200 3-frame (L.) nuclei for sale in May and June. Safe delivery insured always.

Swinson & Boardman, Box 358, Macon, Ga.

Queens Now Ready !

If you are looking for queens we have them. We now have the largest establishment in the South, and run from 500 to 1000 nuclei. We can fill your orders promptly. We can give you satisfaction. Our queens have a reputation of which we are proud. Prices, either 3-band or Golden Italian or Holy Land, your choice, untested, 75c; six for \$4.25; tested, \$1.25; select tested, \$2.00; breeders, \$3.00 to \$5.00; select warranted, 25c extra. Discounts in quantities, and valuable premiums given away—among them one year's subscription paid to Progressive Bee-keeper on receipt of your first order. Our large circular free for the asking—gives prices, descriptions, methods, etc. Our motto.—Good queens and prompt service.

O. P. HYDE & SON, - HUTTO, TEXAS.

Honey Queens.

Have you noticed the change in my P. O. address? Did you know I am seeking to give my customers the best service possible?

Did you know that I have as good or better queens than can be bought elsewhere? Many have found this out, and continue my best customers. Golden and leather colored honey queens, bred in separate apiaries. Bees, nuclei, and full colonies for sale.

Price of queens—March and April—tested or untested, each, \$1.00; 6 for \$5.00; \$10.00 per dozen. Breeders, \$2.50 to \$5.00 each.

— ADDRESS —

W. H. LAWS, BEEVILLE. TEXAS.

1901====Golden Italian Queens====1901

Untested—April, May, and June—\$1.00 each, or \$11.00 per dozen; after June, 50c each, or \$5.00 per dozen. Tested queens, half more. Breeding queens \$3.00 and \$4.00 each. W. P. Rock eggs from 94-scoring birds at \$1.00 per 15. Cocks, \$1.00 each.

GEORGE W. COOK, - SPRING HILL, KANSAS.

EARLY QUEENS FROM THE SOUTH

We are rearing queens now in full colonies by the best methods known. Tested queen, \$2.00. Untested, \$1.00; 6, 5.00; 12, \$9.00. Full colonies, \$6.00; 3-frame \$2.00; 2-frame, \$1.50. Add price of queen to nucleus wanted. Write for discount on large orders, and circular. Satisfaction guaranteed.

Christian & Hall, Meldrim, Georgia.

U - NEED - A GLOSSOMETER.

It measures the actual reach of the tongue of a living bee to thousandths of an inch, also the capacity of the honey-sac; accurate, durable, practical. No rule or magnifying-glass needed. Satisfaction guaranteed. Price \$1.00 postpaid. Send for *Queen Circular*, and learn how to get a glossometer free. High-grade queens of the Sweetheart and other strains at reasonable prices.

A. J. WRIGHT, Bradford. Steuben Co., New York.

FOR SALE CHEAP.—California bee ranch and 500 colonies of bees. Write for particulars, price, and easy terms. I. A. KING, Almond, San Diego Co., Cal.



LONE STAR APIARIES

Italian Queens.

Estab'd 1885. Prices of queens from imported mothers - Tested, \$1.50; 6, \$6.50; 12, \$12.00. Untested, 75c; 6, \$4.00; 12, \$7.00. Golden, same price. Select tested of either race, \$2.50 each.

G. F. Davidson & Sons,
Fairview, Texas.

A Rare Combination.

My bees are bred for business. They have long tongues, and are a golden strain. They are 'taking the cake.' My circular, free, gives full particulars—see April GLEANINGS.

Prices, untested, \$1.00; six for \$5.00; dozen, \$9.00; tested, \$1.50; select tested, \$2.00; breeders, \$3.00 up. A few very bright-yellow bees—very fine. Write for prices. Select and breeders are very nice.

J. B. CASE, Port Orange, Fla.

Northern Italian Queens

Reared from Imported Mothers.

Our stock is so carefully bred and selected as to secure carloads of honey. Locality free from foul brood and other bee-diseases. Prices: Untested queen, \$1.00; 6 for \$5.00; tested queen, \$1.50; 6 for \$7.50; best imported queen, \$6.00; fair imported queen, \$5.00.

Ada L. Pickard, : Richland Center, Wis.

QUEENS BY RETURN MAIL.

The Choicest of Tested
Italian Queens \$1 each.

Large yellow queens, healthy and prolific; workers the best of honey-gatherers. Safe arrival and satisfaction guaranteed in every case. Send for price list.

J. W. K. Shaw & Co., Loreauville, La.

Albino Queens.

If you want the most prolific queens; if you want the gentlest bees; if you want the best honey-gatherers you ever saw, try my Albinos. Untested queens, \$1.00; tested, \$1.50.

J. D. GIVENS, Lisbon, Texas.

Bees are : : Swarming.

To keep down increase I will ship, after May 1st, *Full Colonies* of Italian bees, with queen, in Dovetailed hives or light shipping-boxes, six L. frames of bees, brood, and honey, for \$3.50; five for \$16.00; 10 for \$30.00. Tested queens, \$1.00 each. My bees are honey-gatherers and white cappers. Having 15 years' experience I put them up so they go through o. k. Safe arrival and satisfaction guaranteed. Order now, as bees are ready.

J. N. COLWICK, Norse, Texas.

Minnesota Bee-keepers' Supply Mfg. Co., Manufacturers of Bee-hives. Sections. Shipping-cases, and Everything Used by Bee-keepers.

Orders filled promptly. We have the best shipping facilities in the world. You will save money by sending for our price list. Address

Minnesota Bee-keepers' Supply Mfg. Co.,
Nicollet Island Power Building, Minneapolis, Minn.

D. COOLEY,

DEALER IN BEE-KEEPERS' SUPPLIES,
KENDALL, MICHIGAN.

Root's Goods at Root's Prices. : : Catalog free.

Career and Character of Abraham Lincoln.

An address by Joseph Choate, Ambassador to Great Britain, on the career and character of Abraham Lincoln—his early life—his early struggles with the world—his character as developed in the later years of his life and his administration, which placed his name so high on the world's roll of honor and fame, has been published by the Chicago, Milwaukee, & St. Paul Railway, and may be had by sending six (6) cents in postage to F. A. Miller, General Passenger Agent, Chicago, Ill.

TWENTY MILLIONS IN GOLD FROM ALASKA DURING THE YEAR 1900.

Five millions of this came from the Nome district. Government officials estimate the output from the Nome district will be doubled the coming season. The Bluestone, Kougarak, and Pilgrim Rivers have been found very rich. There is hardly a creek from Port Clarence to Norton Sound in which the precious metal is not found, and hundreds of creeks unprospected. A rich strike has been made on the Yellow River, a tributary of the Kuskokwim.

For full information regarding routes, steamship accommodations, and rates to all points in Alaska, address C. N. Souther, General Agent, Passenger Department, C. M. & St. P. R'y, 95 Adams St., Chicago.

Fruit Packages of All Kinds.

— ALSO —

BEE-KEEPERS' SUPPLIES.

Order your supplies now before the busy season catches you. Price list free. Address

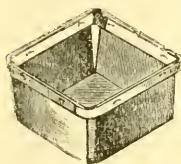

BERLIN FRUIT-BOX COMPANY,

Berlin Heights, - - Erie County, Ohio.

Take Notice.

We are headquarters for the Albino bees—the best in the world. If you are looking for the bee that will gather the most honey, and the gentlest in handling, buy the Albino. We can furnish others, but orders stand 50 to 1 in favor of the Albino. I manufacture and furnish supplies generally. Send for prices.

S. VALENINE, Hagerstown, Md.

March's Mattituck Erfurt Cauliflower. Seeds and this remarkable cauliflower described in *Gleanings*; true stock. Send for circular and prices. **Potatoes.** German No. 3 and Sir Walter Raleigh, bu., 80c; 3 bu., \$2.25; 2d size, bu., 60c; 3 bu., \$1.65. **Poultry.** Eggs from prize-winning, high-scoring White Wyandottes and White P. Rocks, \$1.00 per setting; three for \$2.00. Circulars of these and other specialties free. CHRISTIAN WECKESSE, Marshallville, Wayne Co., Ohio.

EGG FOOD! The kind that tones and keeps up the hen so that she simply must lay. LEY'S POULTRY CONDITION POWDER puts good red blood into poultry veins; kills all disease germs; tones and nourishes fowl—big and little get all there is in the food when fed in conjunction with it. Price 25c pkg.; 5 for \$1. Ley's Thoroughbred Minorca eggs, \$1 for 13. Thoroughbred Belgian Hares. **Geo. J. Ley, Florence, California.**

FOR SALE CHEAP.—100 nearly new second-hand Hilton chaff-hives. For particulars enquire of L. C. WOODMAN, Grand Rapids, Mich.

WANTED.—ALL TO KNOW that I sell my hives and Root's goods at Root's prices, and will pay \$50 in three cash prizes for the best white honey exhibited at the Pan-American Exposition at Buffalo this year, produced in Danzenbaker hives in New York State; also the same for the three best lots outside of New York State. Specific information given on application. F. DANZENBAKER, Box 66, Washington, D. C.

WANTED.—To exchange Japanese buckwheat at 80 cts per bushel; sacks, 15 cts. extra, for cash, or bees in shipping-boxes, if not too far away.

ALBERT L. MARTIN, Leonardsburg, Delaware Co., O.

Queens. I have 150 fine tested three-banded Italian queens for sale. They are last August queens, and their bees are fine honey-gatherers. Tested, \$1.25; select tested, \$1.50; breeders, \$2.00; untested, 75c each, or \$8 00 per doz. I guarantee safe arrival, and satisfaction on every queen. I have been a queen-breeder for 12 years, and know what good queens are. J. W. Taylor, Ozan, Ark.

FOR SALE. One 10 h.-p. engine and boiler (up-right boiler), one 18-inch plauer, one Root sawtable, 30 ft. line-shafting, hanger pulleys, and belting. Will take \$250. J. W. Bittenbender, Knoxville, Ia.

Wants and Exchange.

Notices will be inserted under this head at 10c per line. You must say you want your ad. in this department, or we will not be responsible for any error. You can have the notice as many lines as you please; but all over ten lines will cost you according to our regular rates. We cannot be responsible for dissatisfaction arising from these "swaps."

WANTED.—To exchange 100 colonies of bees on 8 L. (Hoffman) frames, valued at \$3.00 each, for beeswax. H. VOGELER, New Castle, Cal.

WANTED.—To correspond with the party that has possession of the fire-arms formerly owned by the outlaws of Kansas, the Bender family. Address 216 Court St., Reading, Pa.

WANTED.—Practical bee-keeper; steady work for one that can handle 300 to 400 colonies with assistant; run mostly for extracted honey; state wages; can commence work at once. WALTER L. HAWLEY, Fort Collins, Col.

WANTED.—75 colonies of bees, to establish an out-apiary. H. G. QUIRIN, Parkertown, Ohio.

WANTED.—To exchange samples of honey. Before sending, state what you can use and what you have to offer. I have alfalfa, basswood, clover, goldenrod, willow-herb, heartsease, horsemint, mangrove, marigold, mesquite, raspberry, sumac, and Cuban bellflower, from which I can furnish samples. I want to get samples of all other American and foreign honeys of choice quality, true to name. Want also to exchange American and foreign stamps. A. L. BOYDEN, Medina, Ohio.

WANTED.—A 2d-hand pony or 1-horse tread-power, with governor, yet in good serviceable condition, at a moderate price. A. MOTTAZ, Utica, Ill.

WANTED.—A few good colonies of Italian or hybrid bees in Simplicity frames, in light shipping-boxes. Will pay cash for same. ALBERT L. MARTIN, Leonardsburg, Ohio.

WANTED.—To exchange bee-hives, sections, supers, etc., for raspberry-plants or offers or cash. F. R. DAVENPORT, Box 383, Kalamazoo, Mich.

WANTED.—To sell or exchange set of histories, shotgun, and bicycle. O. A. BURNETT, Sunol, Pa.

WANTED.—Stamps; would be pleased to exchange with readers of *GLEANINGS*, or would send Australian shrub and vine seeds for higher values of U. S. stamps. HERBERT J. RUMSEY, Boronia, Barber's Creek, New South Wales.

WANTED.—To exchange hybrid queens (40c), mated (50c), untested, 5 or 3 band Italians (90c), tested (\$1.25), packet alsike, alfalfa, spider-plant, figwort, portulaca, bee-clover, sweet clover (10c each postpaid), for L. combs or offers. J. C. WALLENMEYER, Evansville, Ind.

Black and Hybrid Queens for Sale.

Have just come in possession of 40 swarms of common bees. The queens may be had for 35c each or three for \$1.00. H. G. QUIRIN, Parkertown, Ohio.

Notice!



THE A. I. ROOT CO.

wish to announce that they have from their branch at 10 Vine St., Philadelphia, Pa., direct steamboat connections and very low rates of freight to the following States : Massachusetts, Rhode Island, Connecticut, New Jersey, Delaware, North Carolina, South Carolina, Georgia, Florida. As this is a branch of the factory, prices are the same. Full colonies of Italian Bees, \$6.00. Special discount in large quantities.

G. B. Lewis Company, Watertown, Wis., U. S. A.

FIVE * DIFFERENT * STYLES * OF * BEE-HIVES.

We will furnish you with the finest bee-keepers' supplies in the World.



Send us your Orders and we will fill 'em promptly. Send for Catalog.

LEWIS' • WHITE • POLISHED • SECTIONS • ARE • PERFECT.

BRANCH : G. B. Lewis Company, 19 South Alabama Street, Indianapolis, Indiana.

AGENCIES : L. C. Woodman, Grand Rapids, Michigan ; Fred W. Muth & Co., Southwest Cor. Walnut & Front Sts., Cincinnati, Ohio ; Fred Foulger & Sons, Ogden, Utah ; Colorado Honey-producers' Association, Denver, Col. ; Grand Junction Fruit-growers' Association, Grand Junction, Colorado ; Robert Halley, Montrose, Colorado ; Pierce Seed and Produce Company, Pueblo, Colorado ; E. T. Abbott, St. Joseph, Missouri, Special Southwestern Agent.

BEE-SUPPLIES!

ROOT'S GOODS
AT
ROOT'S PRICES

C. H. W. Weber, Cincinnati, Ohio.
2146-2148 Central Ave.

A NEW and complete stock for 1901 now on hand. I am The Root Company's representative for Cincinnati and surrounding territories. . . . You save TIME and FREIGHT CHARGES by having goods shipped from here. Convenience of railroad facilities here enables me to do so. Before buying elsewhere, write for my prices and catalog, which will be mailed you free of charge.

GLEANINGS IN BEE CULTURE

A JOURNAL DEVOTED TO BEES AND HONEY AND HOME INTERESTS.

ILLUSTRATED SEMI-MONTHLY

Published by THE A. I. ROOT CO.
\$1.00 PER YEAR MEDINA, OHIO.

VOL. XXIX.

MAY 1, 1901.

No. 9.



IS THERE NO LAW against cock-fighting in Ohio to prevent A. I. Root from carrying on in the way described on p. 357?

I WONDER what makes the difference between Mrs. Barber's experience, p. 338, and mine. Her bait sections are left unsealed. Mine are sealed *first*, and in a season of failure a bait section will be filled and sealed, and not a drop of honey in another section.

L. STACHELHAUSEN'S brushed swarms have this in their favor, that they were championed by one of the ablest bee-keepers of the 19th century, the late C. H. J. Gravenhorst. [Yes, and then the advantage of such "swarming" is that it is all done at our convenience.—ED.]

THEODOR WEIPL, in *Deutsche Inker aus Boehmen*, speaking of the theory that bees inherit their qualities from the nurse-bees rather than the queen, says it appeared among others in GLEANINGS. Friend Weipl, I think it was not advocated in GLEANINGS, only mentioned as a foreign product that has not yet taken root in American soil.

I DON'T KNOW whether I made the blunder, p. 330, of saying that my top-bars, end-bars, and bottom-bars are $1\frac{1}{8}$ wide, or whether the printer was fooling with my copy; but at any rate it should be $1\frac{1}{8}$. Possibly $1\frac{1}{8}$ might be better, for there's more building between the bars than I like. [By referring to your copy, doctor, we find the mistake was yours.—ED.]

F. GREINER, p. 323, thinks that, when I said apiaries of at most 120 colonies were placed "at least $\frac{1}{2}$ mile" apart on the Lueneburg heath, the German $\frac{1}{2}$ mile was meant. I have not at hand the *Centralblatt* quoted from, so I can't be sure about it, but nowadays the metric measure is generally used in German journals; and if my memory is not at fault the distance was a kilometer, or about $\frac{5}{8}$ of a mile, and to put it in round numbers I said at least $\frac{1}{2}$ mile. Still, friend Greiner may be right, and the question is open.

HOW PRONE we are to have our eyes open wider to see what suits us than what doesn't! The editor, p. 326, calls Arthur C. Miller's theorizing my "conclusion," leaving entirely out of view the *fact* I gave on the other side. The theory looks pretty weighty, but I confess that the fact that, with four painted hives, in a lot of more than 200, the hive that stood conspicuous above all others for moisture was one of the painted ones, looks about as weighty as the theory referred to. [I should be inclined to believe that the one that was conspicuous for moisture was not conspicuous because of the paint, but because of some condition in or about the hive. But there is one point in regard to paint that has not yet been touched on, and that is this: The paint prevents the hive-body from warping and twisting; and aside from the one point of durability this is very important in moving bees to outyards. Unpainted hives are liable to gap at the corners, to say nothing of the fact that the covers do not rest down squarely.—ED.]

YOU MAY be right, Mr. Editor, that steam is better for a wax-press than water, but it must be remembered that Gerstung, who prefers water-presses, was familiar with different steam-presses by actual use, while you, perhaps, have tried neither. Of course, though, Gerstung might be expected to be partial to his own baby. Say—you try both, and then we'll trust your word as to which is best. [Mr. W. W. Cary, then of Colerain, Mass., advocated the use of a press in a vat of hot water, something like 23 years ago. This method was published in our A B C book in some eight or ten editions; but so far as I know no one who ever tried it liked it very well. When the press is put into hot water the wax must flow off on the surface of the water and with it. When the press is put into a box or can of hot steam, the wax, by gravity, runs down to the lowest portion of the enclosure, free from the hot water, and free from dirt. While just as much wax can be obtained by one method as by the other, yet steam gives us the advantage of convenience.—ED.]

ARE YOU NOT a little modest, Mr. Editor, in demanding only 40,000 to 50,000 bees, p. 331, for a "large force"? L. Stachelhausen says, p. 333, "I have, in large hives, many

times observed that the queen had laid, during the previous 21 days, 3400 eggs daily, on an average." Three weeks later about all the bees from that 21 days' laying ought to be on hand, making 71,400. If we count the life of a worker 6 weeks, then there ought also to be present bees from the eggs of the preceding 21 days. Say the queen during that time laid 2000 eggs daily, and allow that half that number had been lost by fatalities, we should have 21,000 to add to the 71,400, making 92,400 in all. Perhaps that is not often reached, but I suspect it's nearer the right mark than 40,000. [Some years ago, when we used to buy swarms, just as they clustered, from farmers, we bought them by weight. The swarm would be hived by the farmer into a box, and then brought up to Medina at night. The box of bees was put on the scales, and the weight recorded. The bees were then dumped on some frames of foundation, in a hive in the yard, and the box was then brought back to the scales and reweighed. Now for the results: We had some tremendous swarms brought to us that we sometimes had to hive in a double-story chamber. The heaviest of those swarms weighed from 8 to 8½ lbs. The average of them ran about 5 or 6. There are about 4500 bees to the pound, on an average; so you can see that my estimate of a "large force" of worker bees, of from 40,000 to 50,000, can not be far wrong. Now, those eight-pound swarms would fill two stories full of bees, and of course you know these would all be working bees, and that is what I was talking about. But, again, I think you are wrong, clear wrong, in assuming that a given number of eggs laid by the queen will give the same number of bees. There are hundreds and thousands of eggs that disappear, we know not where. Over and over again I have seen frames well filled with eggs in the working season, and yet when these same frames were put into a queenless colony there would be only about two-thirds of the number of cells occupied with sealed brood that were occupied with eggs in the frame in the first place. This spring we noticed that the queens in our home yard would keep on laying eggs, and yet there would be no sealed brood or larvæ to speak of. It was too cold for the bees to take care of much brood and so they reared only what they could cover. I should think we would be safe in saying that, out of 70,000 to 90,000 eggs laid by a queen, we could not expect over 40,000 or 50,000 bees. In rearing poultry we should consider that we were doing well if we got half of the eggs hatched into chickens.—ED.]

THICK VS. THIN TOP-BARS.—S. T. Pettit, p. 227, comes down pretty hard on deep top-bars, although he thinks he can't do with less than ¾. His strong point is that, by having ¼-inch more depth, the space of 1600 to 2000 cells is lost. The mistake is in counting that the same number of bees are occupied brooding those sticks as would be occupied in brooding ¼-inch depth of comb. The space between the top-bars is ¼-inch, and that between brood-combs about ½ inch, thus knocking out half his objection at a clip.

But even that half of the objection will not stand. When the weather is hot, as it generally is when supers are over the top-bars, there is no trouble about keeping up the heat; and at any time when it becomes cool the bees will shrink away from the space between the top-bars, and cluster on the combs above and below. Suppose you have a colony fully occupying two stories. Now put between those two stories another story filled with dummies an inch thick. Do you suppose it will take 50 per cent more bees to man the combs than it did before? I suspect 5 per cent would be plenty.

Even if the loss were all he supposes—1600 to 2000 cells, or ⅓ of the brood-chamber—I should still want the top-bar ¾ deep. At one time I used, entirely, wide frames holding 8 sections; and when I put on a super I put in the middle of it a brood-comb from below. The bees very promptly occupied that super, but it did not answer to leave the brood comb there very long. If I left it long enough for the bees to begin sealing the sections, they would carry across some of the old comb, and the sections would be about as dark as the combs opposite. With ⅓ top-bars, which I used exclusively for many years, the same thing would happen to a certain extent if no slat honey-board was used, especially if the sections were left on some time after being sealed.

So if the prevention of burr-combs by deep top-bars be all a delusion—which I do not believe—and if there is a loss of 1600 to 2000 cells to a colony—which I am very far from believing—I still want ¾ top-bars for the sake of having the sections so far from the brood-combs that the bees will not find it convenient to carry up a lot of black wax to spoil the snow-white sections. [It seems to me our friend Pettit assumes, or indirectly assumes, that those 1600 to 2000 cells are lost because of the brood that *might* have been reared in them; but it is very seldom that brood is reared any closer than within an inch of the top-bar, with ordinary L. frames. Well, then, if those 1600 to 2000 cells are lost for honey, where will the surplus of honey go? Why, it will have to go into the supers, if there is not room below, and in the supers is where we want it. There has been a very strong tendency toward shallower brood-nests. If the use of thick top-bars cuts down the inside depth of the L. frame, it is a move in the right direction. And, again, if these 1600 to 2000 cells to a colony are so valuable, why would not 5000 or 10,000 cells be more valuable? If we need more cells in the ordinary brood-nest, why not add to the depth of the brood-chamber? I believe that if we could by some process cut down the depth of all the L. frames in use throughout the country, we should be conferring a favor on the great class of beekeepers using such frames; and the use of thick top-bars, besides ridding of burr and brace combs, reduces the depth of the frame slightly. No one talks about making frames deeper unless he wishes to go clear over to the other extreme of making the frames so deep that eight or ten of such frames will accom-

modate the largest force of bees that can be held together in one brood-nest. My notion of brood-nests is this: One shallow enough so that two of them will accommodate a large colony, or one deep enough so that one will accommodate one such colony. Taking this view of the matter, I do not see that friend Pettit gains any thing by decrying the loss of 1600 or 2000 cells to a colony of L. depth, when we do not need, if the view be correct, that number of cells. But perhaps it may be asked, "Why not cut down the L. depth?" We are doing it in the Danzenbaker hive, to a certain extent, but we can not get bee-keepers who are already using L. depth (and we would not if we could), to go to the great expense of changing over their fixtures for the shallower depths.—ED.]



May-day! twine to the top, with flowers sweet,
The May-pole's stately shaft;
Let children laugh as did their sires
When they, around it, laughed.

Somebody says queens' wings need not be clipped—just slit them in the direction she walks, near the outer edge, and she will preserve her beauty, and yet not be able to fly a foot.

Now that the question is settled as to the damage bees do *not* do to fruit, let's determine what good they *do* as fertilizers of fruit-blossoms. The picture on page 339 would be a good starter for "Vol. I. No. 1."

Will bee-keeping die out as the country becomes settled? is now debated. It is settled, and yet the honey crop increases with civilization. Without doubt, Colorado alone produces more honey, from artificial sources, than was produced in the entire United States in 1850. Its use, too, is fast becoming more general.

Mr. F. Greiner sends us the following in regard to the adulteration of honey in Germany. It is a very welcome addition to this department, with more to follow.

The chemists in Germany have not yet been able to discover a reliable method to detect adulteration in honey. Mr. Kaempf, of the Pure-food Commission, says in the April issue of the *Leipziger Bienenzeitung*, that he collected samples of honey, taken from the stores in Königsberg, and submitted them to the Agricultural Experiment Station for analysis. The chemist of the station was to work on these samples for four weeks; and although it was evident that many were adulterated, only one of them could with any degree of certainty be pronounced as such, others receiving the attribute "suspicious."

Dr. Klien, it seems, took a great deal of pains in testing these different honeys by different methods. In testing a sample of suspicious American honey by the polariscope he showed the polarized rays turned to the left, as in pure honey. The alcohol test of pure basswood honey showed the same sort of sediment as in suspicious honeys.

The difficulty lies in the fact, so it is said, that different honeys differ in their composition, and for that reason the uncertainty. The chemist doesn't know where he is at.

The proposition is, first, to have as many samples of absolutely pure honey analyzed, each sample to be gathered from a different particular kind of blossom, as far as possible. Then when the chemist fully understands the behavior of the different kinds of honey, it is hoped he will be better able to detect adulteration. How anxious the German bee-keepers are about this matter appears from the fact that now a movement is on foot to raise a fund of \$250, this to be offered as a reward for an absolutely sure method of detecting adulteration of honey. Some liberal donations have already been made.

CENTRALBLATT.

A bee-keeper reports that he had a bad case of foul brood, in which half the brood was destroyed, and by the use of formic acid the plague was stayed and a perfect cure effected.

Corns can be removed by taking pure beeswax and spreading enough of it on a piece of paper to cover the corn, and binding it on for three or four days. At the end of that time the "hen's eye," as the Germans call it, can be easily removed. In some cases a second trial may be necessary. Another German bee-journal says propolis is still better for this purpose. Any thing that works will be welcome to most of us.

The Breslau *General Anzeiger* says that the adulteration of honey has brought a bee-keeper of Hennersdorf into a bad scrape. He procured of a foreign firm an enormous quantity of artificial honey, and sold it as pure honey. The police seized 1500 pounds of the stuff in the hands of the rogue. The event has created great excitement in apicultural circles, as such adulteration has been the means of a decline in the price of pure honey.

"Rose honey" sounds very attractive, and should not fail of its object, at least its high-sounding name should not, even if the artificial product itself should prove to be a disappointment. What is rose honey? asks the *Lux. Bienenzeitung*. It says: Take four parts of white potato syrup, one part of pure honey, mix thoroughly, and add two drops of warm honey-water to the mass, and—the rose honey is ready! Selling price, 36 cents a pound; cost price, 6 cents—a slick profit.

LE RUCHER BELGE.

Mr. Theodore Hercher, of Pfanzwirbach, Austria, has a hive made from the hollow trunk of a tree, and in this bees have been kept since 1767—a period of 133 years, and not a colony has ever died in it. As to old combs, Mr. G. de Layens says, "Apicultural writers continue to assert that it is necessary to renew old combs. Here is a fact which destroys this old prejudice." I will not give the "facts" here, but suffice it to say that some European bee-men think combs may be used indefinitely.

The editor asked Mr. Rauschenfels, the editor of *L'Apicoltore*, the chief bee-journal print-

ed in Italian, if he had ever seen in Italy bees having only one or two yellow bands. He says: "I have seen them with one yellow band, but very rarely. They more frequently have two more or less yellow." Mr. Chas. Dadant, writing on this subject in *Revue Internationale*, says, "I have already noticed that drones from imported Italian queens are more or less yellow, and at times entirely black, as the queens themselves happened to be. I have introduced into my apiary more than 2000 Italian queens since I began importing, and I have never yet found a single queen producing regularly drones that one could consider as Italians, judging by color."

BRITISH BEE-JOURNAL.

The following, relative to the poison of the bee, appeared originally in a German bee-journal. It was translated by Mr. R. Hamlyn-Harris. It seems to throw some additional light on this subject.

The inflammation and other unpleasant symptoms which usually appear after a bee sting are often attributed to that sharp acid so widely distributed in the animal kingdom, and known under the name of formic acid. This fluid, however, has nothing to do with the swellings; its utility to the bees is of quite another character. Professor Joseph Langer, of Prague, a little while ago, examined the contents of the poison-glands of 25,000 bees. This he found to be a clear fluid, soluble in water, tastes bitter, and has a pleasant aromatic smell, which, however, soon passes away; this scent can not, therefore, be the poison. The formic acid which gives its peculiar acid reaction to the contents of the gland is also very evanescent. The contents of the gland itself retain their poisonous properties, however, even when dried and subjected to heat. The poison is, we therefore suppose, a vegetable base, an alkaloid, as the most active poisons in the vegetable kingdom are known to be.

Professor Langer proved that the poison has no effect whatever on a healthy skin; if, however, injected under the skin, all the symptoms of bee-stings set in. Should it reach the larger veins or arteries it causes a general disorder of the system which reminds one of snake-poisoning. The weight of the poison injected into the wound made by a bee's sting is between $\frac{1}{1000}$ th and $\frac{1}{2000}$ th part of a gram. The largest part of this is formic acid, which is such an important factor for the well-being of the bees. This works as a means of preserving the honey, owing to its acid reaction. The bee allows a little formic acid to fall into each cell filled with honey before it is closed or sealed, and this small quantity is enough to prevent fermentation. Honey extracted from unsealed combs never keeps long unless 0.1 per cent formic acid be added, which is all that is required.



THOROUGHbred QUEENS.

What do we know about them?

By ARTHUR C. MILLER.

The excellent article by Mr. H. L. Jeffrey, on the "Value of Breeding-stock," Feb. 1, is most timely, and touches a subject which needs to be more generally written about and discussed. The editor's comments were a surprise to me, for I had presumed that, of course, he was familiar with the subject of biology.

Evidently he is not alone in his position, for an inspection of the text-books and journals reveals a grievous lack of familiarity with such authors as Huxley, Darwin, Spencer, Haeckel, and others in the same field. Prof. Cook, although referring to some of them, does so in only the briefest way, while the Revised Langstroth has but a footnote by Mr. Dadant on in-and-in-breeding, p. 87. Aside from the foregoing there is virtually nothing in our text-books which tends to call the student's attention to even the existence of laws of heredity, to say nothing of their application. If the authors of our text-books are silent on these subjects, and if the editors of our journals are ignorant of them, it is not to be wondered at that the thorough breeding of queen-bees is in a much mixed and unsatisfactory condition.

Apparently very few of the rearers of and dealers in queens know what "thoroughbred" means, yet their advertisements would lead one to believe that they did, and that they were, consequently, familiar with the laws of heredity and the steps necessary to turn them to their advantage. When a queen-rearer who is ignorant of these laws, or who, knowing them, ignores them, advertises choice-bred queens and breeding-stock, he is doing a direct injury to the bee-keeping industry. The use of the terms "choice bred," "straight golden breeders," "breeding-queens," etc., implies that the person claiming to have such stock has produced it according to the well-recognized laws of breeding; that for many generations the ancestry of this stock was pure and potent, and that these "breeders" will produce offspring which, when properly mated, will maintain the same traits as their parents, with virtually no variation. Just how many queen-rearers care to affirm that for their stock?

"Thoroughbred" is not "crossbred," as any high-class stock-raiser will testify. Thorough breeding is cautious, careful, scientific in-breeding (do not confound this with in-and-in breeding); and when alien blood is introduced the result can never be foretold with certainty, the chances being toward *atavism*, the reverting to a previous type.

Let those queen-rearers who would progress, read and re-read the very best authorities on biology which they can get, and then let them try to apply what they have learned. The works on the subject are many; and unless the student is enthusiastically interested by the time he has read two or three of the leading works he had better drop the business of stock-rearing, for he will never win fame or be truly successful at it. The true stock-breeder is an enthusiast of the first grade, of high ideals, exhaustless patience, and a determination which nothing can waver; and I believe the love of it must be born in one. I do not think it can be acquired.

Will the editors of our journals and the authors of our text-books please own up to what they know of this subject? and will those of them who are posted kindly give us articles which will arouse the whole fraternity?

It is high time we began to be scientific in

our work. The haphazard, guess-at-it rule-o'-thumb ways have prevailed altogether too long. We shall injure ourselves, and be held accountable by those who follow us, if, knowing, we do not set about to overcome the evils.

Providence, R. I., Feb. 26.

[Very recently my attention has been called to a series of articles in the *Jersey Bulletin* on the subject of in-breeding to get prize-winning stock. I was surprised to note how the breeders of high-class Jersey blood in-breed. In one or two instances I noticed that a mother had been bred to her son, and sisters to brothers, for the express purpose of accentuating certain desirable traits. I observed, further, that this practice has been carried on to great advantage for many years.

Bee-keepers have much to learn from the breeders of other fine stock. But we have one difficulty to contend with, and that is, that of getting a particular queen mated to a particular strain of drones. Hitherto no certain method has been known for accomplishing this result, except having, at great expense, the mating take place on an island or in some isolated place on the prairie. If we can bring about the union of queens and drones in confinement, as was described recently on pages 347 and 348, we should assuredly make an effort to in-breed on the lines already indicated.

Here is another article on the same subject.—Ed.]

MEASURING BEES' TONGUES.

Objections to the Steel-rule Method; Scientific Inbreeding; Long Tongues and Five Bands Combined.

BY J. H. GERBRACHT.

Mr. Root.—I inclose a slight correction to your comment on Prof. Rankin's article on page 84. The principal importance of this correction is that as Mr. Rankin has probably measured many other lots of bees, the correct ratio between the results obtained by the different methods is a matter of more or less interest; and as there was a difference in the tongue-reach of the two lots it is only fair that the comparison should be made with the right one. As a matter of fact, the different parts of a bee's tongue are not always in the same proportion, so that the results of such comparisons can not be relied on; and I will say that, in my measurements of the two colonies, using the same method as yourselves, the difference in average tongue-reach of the two colonies measured by Prof. Rankin was a trifle over .02 inch.

In the letter that accompanied the second lot of bees (the ones on page 924), I ran up against the difficulty of not making myself clearly understood. Those "924" bees were the progeny of a *daughter* of the queen which put up the 240 lbs. This daughter was discarded, after laying about two months, on account of lack of prolificness.

Incidentally, with just two exceptions, every queen that I had last spring met the same fate, though not for the same cause, for

the five-banders were prolific enough (their only good quality). The majority of their successors are from my own "best" one; the rest are about evenly divided between daughters of a selected "Superior" queen and one of your own red clover queens that I was lucky enough to secure before their discovery. This red-clover queen's bees average about .002 inch less than my best one, and the Superior bees are just the same. There are no other Italian bees in the neighborhood; and with this kind of queens and drones it will be tough luck indeed if I do not have a few extra good specimens to show for next season's work.

I think I will say a word right here about in-breeding. There is not in existence to-day a single strain of unusual superiority of either cattle, hogs, or chickens, in which this principle has not been employed to secure a fixed type; and after this has been done, the fixed type can be maintained only by the most careful and scientific line-breeding. Crosses between different strains produce just the same unreliability and tendency to degeneration as crosses of distinct breeds do, except in the few cases in which, either by accident or the exercise of most unusual good judgment, the two strains happen to "nick" well. In cattle and swine breeding, the infusion of one-eighth new blood is considered enough to offset whatever ill effects close in-breeding may produce, the idea being to use the least possible amount to maintain the vigor and stamina, with as little disturbance of characteristics and type as possible; and the success of the breeder depends to a great extent on his ability to do this accurately. In poultry-breeding, particularly in the varieties which have variegated plumage, in-breeding and line-breeding are the only ways by which any fixity of type can be secured; and some breeders boast of not having gone outside of their own yards for breeding-stock for twenty years. Of course, the results are sometimes the same as those attained by some breeders of five-banded bees—good to look at, but of no utilitarian value; but this is by no means necessarily the case; and the best laying and most vigorous-growing stock we have to-day is from this same line-breeding.

There is no earthly reason why we should not have straight five-banded bees, of the highest type of working qualities; and the fact that, as a class, they are what they are, is a most humiliating confession of the standard of efficiency of some of our queen-breeders.

To get back to the original proposition, I will say that many of the results obtained depend upon the way bees are chloroformed. Too much chloroform, or too long exposure to a moderate amount, has a drying effect, causing the bee's tongue to lose in a great measure its elasticity. I obtained much the best results by placing the bees in a bottle instead of a cage, and consequently the stage of asphyxiation could be watched and controlled to a comparative certainty; and I found that a piece of common wrapping-twine dipped $\frac{3}{4}$ of an inch in chloroform was about right for a half-pint bottle, the twine being long enough

to be suspended from the cork. After going over every colony I had, and measuring over 800 tongues, keeping a record of every measurement, I am certain that the heart-to-heart truth of the matter is that the length which a bee's tongue will reach can no more be ascertained and measured to a certainty than a similar piece of rubber. The crying need of the time is for a standard reliable glossometer in which the bee does the measuring; and until this is had, the results at present obtained can be regarded as only temporary makeshifts.

Spring Grove, Ill., Feb. 11.

[See footnote to article by A. C. Miller. With regard to the subject of measuring bees' tongues, I may state that I have taken the bees of our \$200 queen, for instance, and measured them two or three different times from as many different cages, and the results were the same— $\frac{2}{100}$. Afterward I did not know but some one else would get a different result, and therefore I instructed one of our men, Mr. R. G. Calvert, how to measure, and then told him to go and get the bees himself and measure their tongues. I did not tell him what measurement I had secured from this particular colony, as I wished to see if he would get as long a reach as I did. He measured one or two cages of these bees, and the result showed that he got $\frac{2}{100}$. I was satisfied. Occasionally we find a colony where there is a variation of $\frac{1}{100}$ or $\frac{3}{100}$, but not often.

As to a glossometer and its use, here is an objection that occurs to me: The bees will eat through the meshes of the screen, perhaps a dozen or so of them at a time. The distance from the wire cloth to the honey, after it is eaten down, will be the length of the tongue-reach, of course. Now, suppose there is a variation in the length of the bees' tongues of that particular colony. Obviously, the glossometer will show *only the longest tongue-reach*, and *not the average* of the whole colony. Some one else suggests letting the bees of a whole colony reach through the wire cloth screen until they have eaten the honey from under it down to a certain level, and then measure from the top of the wire cloth to the surface of the honey. Here again we are getting only the reach of the longest tongues, and perhaps there might be only a hundred bees in the whole colony that would have this reach.

I have experimented a good deal with chloroform, and I do not find any great variation in results if the chloroform is used properly. I put a very little of the liquid on a common handkerchief. The wet spot is placed right over the wire cloth of a cage of bees. In a few seconds I raise the handkerchief and look into the cage. If the bees are not wholly under its influence I let it remain a few seconds more. But in any case the handkerchief is left on only long enough to stupefy; and, while the little carcass is still quivering with life, it is dissected. The head is removed, and the tongue stretched on the micrometer scale, as I have explained on page 101, Feb. 1, and again in this issue, page 399.

Much inquiry has come as to where these

steel rules or scales could be had. Hitherto I have referred our friends to the large hardware stores; but finally we have been compelled to get a stock, and are now in position to furnish them, having hundredths of an inch marked on one side, for 40 cts. postpaid by mail. A magnifying glass and two large darning-needles, and a penknife with a sharp-pointed blade, are all that is absolutely necessary to complete the work of measuring.—E.D.]

COMB HONEY VERSUS EXTRACTED.

Comb Honey Scarce, but Extracted Becoming a Drug in the Market, at Low Prices; an Important Suggestion for the Consideration of Extracted-honey Producers; a Valuable Article.

BY HENRY SEGELKEN.

The season for 1900 being practically over, it occurred to us that it might be of interest to bee-keepers in general to learn our experience for the past two seasons regarding the sale of comb honey as compared with that of extracted. While the crop has been short for the past two seasons—in fact, almost a total failure in many sections of the country—we had no trouble whatever in securing all the extracted honey we could handle, and had an abundant supply; but our receipts of comb honey fell off to a very great extent, and we were unable to supply a large number of our customers, and outside trade in particular.

Large quantities of extracted honey of the 1899 crop were carried over, while, in the early spring of 1900, the markets were practically bare of all grades of comb honey, and prices were well kept up. Our market, at present, and we think all Eastern markets, are well cleaned up of comb honey, and prices are well maintained. This can not be said of extracted. More or less will be carried over this season, unless sold at reduced prices. Within the past two weeks extracted has declined about one cent per pound, and the indications point to a still further decline.

We believe it is generally claimed among bee-keepers, that, by producing extracted, they can produce twice the quantity they could if they were producing comb honey, and that, therefore, extracted could be sold at half the price of comb. Perhaps this is true, and for the past few years prices have ruled accordingly—extracted honey selling at from 5 to 8 cts., and comb at from 10 to 16, as to the various qualities. It must be borne in mind, however, that prices of extracted have not always remained firm, while on comb they have. Besides, as said above, we found no trouble in securing all the extracted we required, and could have handled thousands more crates of comb, but it was not to be found. Therefore it seems to us that it would be beneficial to the bee-keepers if they would cut off the production of extracted honey to some extent, and produce more comb. If not in general, we would certainly make this suggestion to the bee-keepers of the East, and especially to those living in the large buckwheat

sections of New York—the "Buckwheaters" as they have been termed.

The outlet for extracted buckwheat is very limited, and we have noticed a general falling-off in the demand of late years, which is very likely to continue. We do not believe that we shall ever have such a demand for buckwheat extracted again as in former years.

Now as to buckwheat comb. We could not fill our orders in the season of 1899, and have not been able to supply our customers from the beginning of the season, last fall. Extracted honey we can get from all over, while we had to depend largely on the East for comb honey, though we have been receiving some comb honey from the South—Florida, Georgia, North and South Carolina—for the past two years, where the production of comb honey seems to be increasing. However, as this is ready, and sent to market in the late spring and summer, it is generally disposed of before the Eastern honey comes to the market, and, therefore, will not conflict with the increased production of comb honey in the Eastern States.

city. We have heard them universally well spoken of by bee-keepers everywhere; and because this is so it is a pleasure to speak of them in this connection.

We believe Mr. Segelken is right in saying that too much extracted honey is being produced for the Eastern markets; and it would be well if some of the producers of the liquid article would turn their attention toward the production of comb honey—something that always does have a sale, and at a great deal better prices than extracted, as a rule. In Cuba, bee-keepers are beginning to learn this same lesson. But there are some honeys which, if put on the market in the comb, would have little or no sale. Such honey is used only by tobacconists, bakers, and the like, for manufacturers can not use honey in the comb. As a rule we may say that, when honey is rank in flavor, and is not used by consumers direct in the extracted form, it should not be marketed in the comb.

Our honey-man, Mr. Boyden, has been saying for some time that bee-keepers were making a mistake in putting so much of their

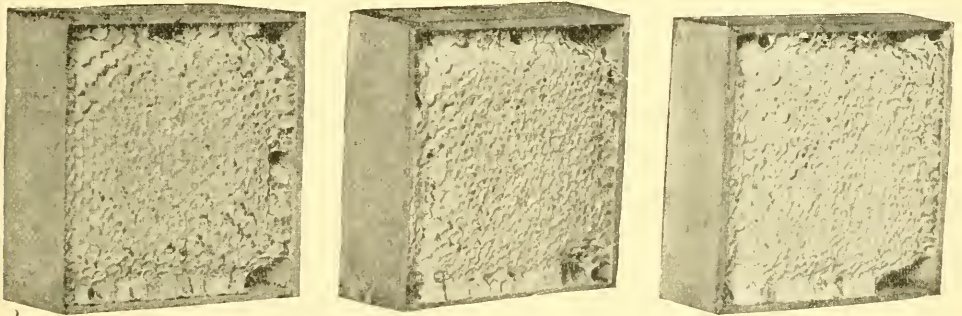

A SAMPLE OF CUBAN HONEY IN PLAIN SQUARE SECTIONS.

We have just received from Cuba a shipment of comb honey, in plain square sections, 28 to crate, with glass front, packed in shipping-cases with handles. The honey arrived in first class condition, and is nice and white. We think this is the first comb honey ever shipped from Cuba to the United States. We have noticed some correspondence in GLEANINGS by Cuban bee-keepers, wherein they say that all they receive for their honey is about 3 to 3½ cts. per lb. At this we should think that it would pay them to produce comb honey, for, instead of figuring on twice the price for extracted, they could safely figure on three times the price at least. There seems to be no doubt that comb honey could be produced in Cuba to advantage. Whether it will be done extensively is another question, unless American bee-keepers follow it up. In the course of time, however, Cuban comb honey may become quite a factor on our market, to be reckoned with; but we think that that time is, as yet, at a distance.

New York, Mar. 6.

[Mr. Henry Segelken is one of the firm of Hildreth & Segelken, a concern that handles such large amounts of honey in New York

product into extracted form—that there ought to be a larger per cent of it in comb. As Mr. Segelken's experience is quite in line with our own, bee-keepers may well consider how they shall put out their honey for the coming season.

I suspect that one reason why buckwheat extracted and other dark grades do not sell as they formerly did is because of the large importation of Cuban extracted honeys of better flavor and of better color. The buckwheaters of New York may well consider the matter of producing honey in the comb.

There is another reason why the darker grades do not sell as well as they formerly did, and that is, the general distrust against all honey in the liquid form. Consumers, as a rule, are getting to have confidence in honey put up in comb, as they believe it to be pure, in spite of the yarns that were circulated a few years ago over the country to the effect that comb honey could be successfully counterfeited by means of appropriate machinery.

Mr. Segelken sent us a photo of some of the Cuban honey to which he refers in his article, and this we have reproduced for the inspection of our American honey-producers. If the Cubans are finding it to their advantage

to produce honey in comb, how about us who are on American soil? While the great bulk of Cuban honey goes to other countries rather than to the United States, it behooves us here in America to be ready to meet competition that may come in time from Cuba.—ED.]

.....

A CO-OPERATIVE ORGANIZATION FOR BEE-KEEPERS NEEDED.

BY J. P. BERG.

Friend Aikin, on page 82, has hit the nail on the head. Sitting on his ridgepole as he does, he has taken a full view of the matter. Such an organization is absolutely necessary for bee-keepers to prosper in the future. See how all business is organizing in its various lines, except the bee-keepers and farmers in general.

Now for the farmers. I have given up all hopes, on account of the total ignorance of so large a share of them. You can never educate them, as a class, to be honest with each other, and have confidence in each other, like other business men. And what is the result? Farming is the poorest-paying business in America. And we bee-keepers (I am a farmer too) are served not much better. Seven years ago I moved to the State of Washington with 110 colonies of bees. I sold my honey that fall before I went there, in Traverse City, at 18 cents a pound, wholesale. I bought good pine lumber for 12 to 14 dollars per 1000. I bought my nails to make my bee-hives for 2½ cents per lb. Two years ago I came back from there, and found honey worth 12½ cents, and many sold it for 10; but the lumber I had bought 5 years before for 12 to 14 dollars was worth \$26.00 to \$28.00, and nails were worth 5 cents per lb. Did they run short of material for nails? Our bee-supply manufacturers were obliged to raise prices on nearly all supplies, on account of raw material rising in price. Has the price of honey raised correspondingly? All the lumber men of this part of the country have their monthly meetings here at Traverse City. In their December meeting they passed a resolution that none should be allowed to lumber this winter more than half as much as they did last winter. Do you see, brother bee-keepers, how they fix us? This seems to be the order of the day: "Limit production and raise the price." Let us organize thoroughly and systematically for co-operative business as well as intelligence. Let's not be afraid that some other bee-keeper might get a dollar out of it that we should not get. This is the snag that all farmers' organizations go to pieces on—miserable jealousy and distrust. Is it not more profitable and honorable to give a faithful officer \$1.00 than to give a dishonest dealer \$100? I have more hopes of the bee-keepers getting together than the farmers, for the bee-keepers as a class are better informed, and have more confidence in each other. But, as Bro. Aikin says, "We must have a national head," and should attend to it at once, before another crop comes on. Traverse City, Mich.

FERTILIZATION OF QUEENS IN THE HIVE.

Truth or Heresy—Which?

BY H. L. JEFFREY.

[In publishing the following I do not wish to be understood that I am in any sense giving it editorial indorsement. While I believe Mr. Jeffrey is honest, yet I can not help feeling some mistake has been made. On the other hand there is just a little danger that over-conservatism on this question may shut us out from receiving new knowledge of unorthodox truth. Some thirty odd years ago there was a great deal said on this question, and some even claimed that fertilization could and did take place inside of the hive; but at the time, I believe it was finally decided that no really authentic proof from careful and competent observers was offered. While I believe that fertilization might take place in a mammoth cage, as illustrated and described last issue, I feel very, very skeptical about the possibilities of the act taking place *within* the hive.—ED.]

Mr. Editor:—Dr. Miller writes, "That dead decayed thing that has been carried out and buried comes up smiling." Not dead but sleeping. That mating queens in confinement is and has been made practical is true, and has been made practically a success, is also true, and was proven fully possible away back in the '70's by a man named Cooke, of German-American ancestors, who lived in Beacon Falls, Ct. Cooke did not use any big cage or tent, but I do know that he made a reasonable and practical success of it. He worked at it for several years, and tried to get the results of his labors published, but none of the publications would give him a fair showing. In every attempt he made to publish his works, he met with sarcastic rebuff. Finally he became despondent, and died in the early '80's. The minute details of his *modus operandi* I never tried to ascertain until too late. For three or four years he mated queens for me with drones that I selected for him. He would succeed with from half to three-fourths of the queens that I sent him, and that was far more satisfactory than to run the chances of natural chance mating; and from some of the results of Mr. Cooke's labor was one of the main factors that made me believe—yes, and by which I know—that the damaging inbreeding clack is all a humbug.

So far as confinement matings of my own experience are concerned, I have been just successful enough so that I do know it can be done; but just how to succeed *every* time, I do not know how. Provoking success is the only fitting term for it.

Twenty years or more ago some writer in the *American Bee Journal* used these words, in meaning: "When both sexes and conditions are ready, mating will take place anywhere." I will give one instance out of many, to illustrate.

In 1884 I had a three-year-old queen I was using as breeder. Her own record, several of her sisters' and her mother's records were above the best average. From a batch of 30 or more I selected 8 that were very good resemblances of the old one. They were in two-frame nuclei, and were watched very closely. On the evening of their seventh day they were closely examined, as they had been every day, and they showed that uneasiness that is ap-

parent the day before they mate. Drones from the old queen that were of even coloring, maturity, and size, a good many of them, were caught and put into the hives the nuclei were put in. Each comb in every nucleus was closely looked over by three or four of us. The combs were wedged firmly to one side of a 9-frame hive, leaving a half-inch space between them; $\frac{3}{8}$ inch from the combs was keyed a division-board just one inch shallower than the combs. A board cover was put on with wire cloth, covered with thin muslin that covered the open space of the hive. Thus the 8 nuclei were left to quiet down over night. Between 7 and 8 o'clock the next morning these nuclei were all carefully examined to see that every thing was all right. Then the entrance closing blocks were screwed on, also the covers. The 8 hives were then loaded endwise into the body of a platform spring wagon. All were then pushed into the shade

sult, the same thing resulted. Hive after hive, the whole eight had mated and clipped queens. Each hive and queen was very carefully and cautiously examined in the morning before starting, and the drones were as carefully selected. That was a successful confinement mating.

Woodbury, Ct., March 21.

BLEACHING COMB HONEY.

How it is Done on a Large Scale in California.

BY D. A. HIGGINS.

I make a house expressly for bleaching the honey. I first build a floor upon legs, as you see by the drawing, each leg having a tin can at the bottom, and a tin plate at the top. These legs are placed between two plates of

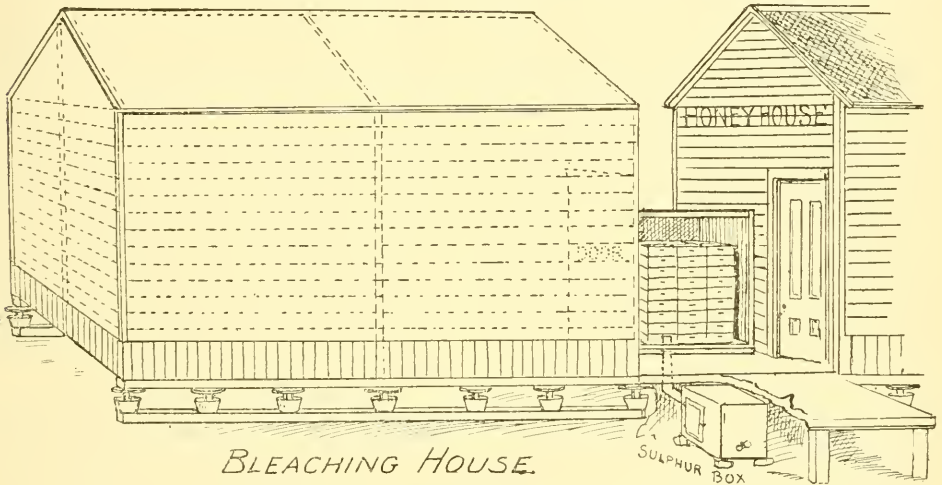

D. A. HIGGINS' COMB-HONEY BLEACHING-HOUSE.

to wait till other things were made ready. Every thing else ready, we (two besides myself) all drove to a selected place that, with diligent search, gave us sole possession of the locality, so far as bees were concerned. The load was left in the cool shade, then other preparations were made. Between 4 and 5 P. M., the bees having become quiet, the hive-stands all ready, and various other work all done, we proceeded to take the hives of bees from the wagon, place them on their stands, and carefully examine them one at a time.

Hive No. 1 being set on the stand, I took a screwdriver to take off the entrance-block, then the top board. The two assistants, one on each side, in a squatting position, in dead silence, watched. A dead and mutilated drone in the open space of the hive, also several others with protruding genitals, greeted our eyes; and on looking up the queen she was plainly ticketed as evidence. It took but an instant to take off her wings. Then hive No. 2 was brought forth; and with a little more caution, and more concern for a hoped-for re-

redwood, 2x4 inches, and 14 ft. long. At every 2 ft. I have a sleeper so as to make the floor strong. These sleepers are placed on these plates so that the legs are one. I have no underpinning under the center of the house. This is to keep out all mice or ants, which are very troublesome in this country, and they are especially troublesome in comb honey. The little tins at the bottom of the legs are filled with crude oil to keep out the ants, and the tin plate at the top keeps out the mice.

This house is covered with cloth, the top being heavy goods. Now we have the bleaching-house complete. On a platform in front of this house I build my surplus-box, 2 ft. wide and 6 ft. long. I next take one joint of stovepipe and cut a hole in one end of a square 60-lb. tin can, large enough for the pipe. One end of the pipe I insert in the can, and an elbow on the other end, and communicating with the sulphur-box. I now cover the pipe with earth about 6 inches deep. I next cut a hole in the side of the can, to put in sulphur.

I now take a large teacup of sulphur and place it in the can, and we then are ready to sulphur the honey.

THE METHOD OF BLEACHING.

I take my supers from the hive, place them on a wheelbarrow, and wheel them to the sulphur-box. Place them on the box until I have 30 supers, then I light the sulphur and let it stand for about three hours. I next wheel them to the bleaching-house, and place on the work-tables, which I have on both sides of my house, and reaching full length of the house. I now remove the honey from the supers and place it on shelves which run around the house, and are indicated by dotted lines. I leave them there about 24 hours, and then reverse the section and leave about 24 hours longer. I find that where the honey is badly stained it will now be very white.

It is necessary to have a good quality of sulphur, as it does not injure the honey, and the honey will bleach much nicer. It is the light which bleaches, so the cloth must be thin. The sulphur-box should be outside of the house, for it would be impossible to work in the house while sulphuring if the box were inside. This bleaching-house is very convenient if one does not sulphur his honey, for the reason one can store on shelves of a house 12 x 14 ft., about 100 cases of comb honey, giving plenty of time to clean and pack the honey.

Bonsall, Cal.

[There are some who are inclined to believe that there is not much in this bleaching business. Very recently we received a letter from one of the extensive and prominent bee-keepers in the East, stating that he was making bleaching a success. Comb-honey producers had better wake up to the fact that a great deal of their off-colored comb honey can be made A No. 1 by the proper use of sulphur and sunlight. It appears that bleaching in California has been extensively practiced for a number of years.—ED.]

MOVABLE COMBS V. MOVABLE FRAMES.

The Invention of Movable Combs in Germany; the Position that Dzierzon and Langstroth Occupy in Apicultural History.

BY DR. C. C. MILLER.

I have read with care your footnote on page 219, Mr. Editor, relating to the claims of Langstroth and Dzierzon; and, aside from inferences that may be drawn, there is nothing in either the Straw or the footnote that needs correction except one thing, and that is the statement that Dzierzon gave the movable frame to a large part of the bee-keeping world, instead of saying he gave the movable *comb*. So incorrect a statement as that can hardly be excused in one who parades himself before the world as knowing something of bee-keeping and its history. It may, of course, be said in extenuation that "movable-comb" and "movable-frame" are very commonly used as meaning the same thing, but that can not be accept-

ed as any excuse whatever. They *are* the same when you are talking about a Langstroth hive, because the movable frame, of necessity, makes the comb movable; but when speaking of Dzierzon's invention, how can there be a movable frame when there is no frame at all? It is a case of carelessness so glaring and culpable that there is no refuge except in the claim of stupidity. I don't know whether I'd rather be called careless or stupid, so on the whole it may be the best thing for me to say nothing, merely hoping to live down the disgrace, trusting that a forgiving public may forget all about it before I get to be an old man.

Having disposed of that one point, there still remains a certain amount of ignorance and misunderstanding that makes it desirable that the whole truth, so far as possible, should be brought out. Suppose you allow me to try to give what I understand to be the truth; and if I make as bad a break as I did before, you straighten me out.

If you ask a bee-keeper in this country who invented the movable comb he will promptly tell you it was Langstroth; and the chances are one out of five, if not one out of three, that he will have no idea of anything that stands to Dzierzon's credit, if, indeed, he knows that such a man lives. Unfortunately there are some, perhaps more than you would suppose, who would reply something after this fashion: "Oh! there's a lot of them. Mr. Langstroth invented one movable frame; Mr. King invented another, and I don't just know who else, but a whole lot of them," ignorant of the fact that in reality all movable frames are Langstroth's invention, and may properly be called Langstroth frames, no matter what their proportions.

Ask a bee-keeper in Germany who invented the movable comb, and he will very likely reply, "Dzierzon;" and when you say, "What about Langstroth?" he will stare at you. The fact is, there is too much ignorance and narrowness on both sides of the water; and before blaming too much the Germans for not crediting to Langstroth what fairly belongs to him, I should like to see my own countrymen do full justice to Dzierzon.

Allow me to disabuse your mind entirely, Mr. Editor, of any thought that I would pluck one leaf from the laurel that crowns the brow of our own Langstroth. Probably more than you and I appreciate the debt we owe him for movable frames, for *you did not begin bee-keeping with box hives*. Neither do you estimate as highly as I do the superiority of Langstroth's invention over that of Dzierzon. You say, "Dzierzon improved on this by using bars in a top-opening hive." Instead of being top-opening, his hives were side-opening, each comb being put in a little after the fashion of a drawer in a bureau. His frame (if you will allow me so to express myself) had neither bottom-bar nor end-bar, only a top-bar; and when a comb was to be taken out it had to be cut loose from the sides of the hive, and no comb could be taken out till all that preceded it were removed. When the tenth comb was to be taken out, instead of lifting out that comb

alone, as you and I do, he was obliged first to cut free and take out the first nine before he could reach the tenth. Langstroth gave us a system that, compared with this or any previous system, was revolutionary, making the work of bee keeping so easy that, if it were taken away from me to-day, and I were allowed the benefits of any one or all of the other systems, earlier or later, I should not be likely to continue a bee-keeper. I think you will now see that there is no quarrel between us as to the credit due Father Langstroth.

It detracts nothing from Langstroth's glory to give Dzierzon his full meed of praise. You refer me to *American Bee Journal*, Vol. I., p. 14. I do not find there the sentence you quote, but it is none the less true. I do find there this sentence that you have partially quoted: "The next invention, and that which alone received general approval and acceptance in Europe, was Dzierzon's movable bar hive, first publicly announced in 1845." Please note that, although this was a bar hive, it was an improvement on all previous *frame* hives. Note, too, that it was the only system that received general acceptance, and especially the fact that it *did* receive general acceptance. Putting that in different words, it means that Dzierzon gave to German bee-keepers a movable-comb hive that went into general use, and meant for them a grand step forward — was, indeed, a revolution.

You will say that Langstroth's hive was ever so much better than Dzierzon's. Certainly. As I have shown, I hold that with still stronger emphasis than you. But that does not change the fact that Dzierzon gave the Germans a movable-comb hive that they accepted and adopted, and they are in use to this day. Langstroth gave us a loose hanging frame, and we think him entitled to no less credit because we now have something better in the fixed-distance frame. Dzierzon gave Germany the movable comb, and he is entitled to no less credit because they now have something better in the Langstroth frame. If Langstroth's invention had never been made they would still be using Dzierzon's, as, in fact, some of them are; and we should also be using Dzierzon's in this country, and giving Dzierzon the credit honestly due him.

I suspect that the main trouble in the case is that, in this country, we look upon Dzierzon's invention as a thing not really practical, and bunch it along with those of Huber and others. Instead of that it stands on a different plane entirely. It was and is a practical thing, and some of those who adopted it and became accustomed to it can not see enough better in the Langstroth invention to warrant them in making a change. Please set this down as a fact: Not Langstroth, but Dzierzon, gave to Germany a movable comb, and later the improvement of Langstroth was introduced. Mr. Samuel Wagner is quoted in Dadant's Langstroth as saying that the best test of the value of Dzierzon's system was the results; and then he tells how, after suffering a loss of more than 500 colonies in one year, he made a threefold increase to nearly 400 colonies.

The latest number of *Revue Internationale*

quotes with apparent approbation from *Centralblatt* the statement that Dzierzon's movable comb worked a complete revolution in bee-keeping. The *Revue* is edited by the able Edouard Bertrand, who is the publisher of the French edition of Dadant's Langstroth, and entirely familiar with the whole matter.

In a nutshell the case stands thus: Langstroth gave to America the movable comb, and Dzierzon gave it to Germany.

Going back to the original proposition, I feel very sure that, if you were to make a tour among German bee-keepers, you would agree with me that no other living man has done as much for bee-keeping as Dzierzon. If you know of one, Mr. Editor, will you kindly name him?

Marengo, Ill.

[Now that you have been confessing error, and eating a little humble pie, it may be well for me to do a little of the same sort of thing. I was in error in stating that Dzierzon used movable combs in a top-opening hive. The real facts, as I get at them, are these:

Della Rocca, in Greece, first introduced movable combs. These were built to bars, but the attachments to the combs had to be cut from the sides before they could be taken out. Dzierzon took this same idea, as it was not practicable to cut the bottom attachments in a *top*-opening hive, and applied it to a *side*-opening hive, just as you state. But I do not see any real invention in this, but only a very slight improvement. Dzierzon did introduce, probably, the idea of movable combs to the German bee-keeping public, in the same way that A. I. Root introduced the honey-extractor in America, although it was invented by Hruschka. But there was no invention in this on our part, neither was there on Dzierzon's, as I see it. Della Rocca, as it seems to me, really invented the movable bar nearly 50 years before Dzierzon made use of it.

Huber, about the same time that Della Rocca gave his movable-comb hive to the world, brought out his leaf hive, or what embodies the essential principles of the "closed-end" frames of the present day.—ED.]

DZIERZON'S MOVABLE-COMB HIVE.

In your remarks about Dzierzon, p. 219, you are right in the main points. Dzierzon never invented a *frame* hive. Bars with combs attached to them were used by the old Greeks. This and Della Rocca's invention were entirely forgotten when Dzierzon, in 1845, invented his *bar* hive. As the combs had to be cut from the sides of the hive, he made a door to it and opened it like a wardrobe. This made it easier to cut the combs from the side of the hive, than by handling the combs from the top of the hive as he did at first. This hive and Dzierzon's management of the bees started a new era in bee-keeping in Germany, as did the Langstroth hive in America. So far it is proper to say, Dzierzon is the inventor of a practical bee hive with movable combs. In 1850 Baron von Berlepsch invented and used a frame with a bee-space all round in the same Dzierzon hive. At about the same

time, Langstroth invented his hive and frame. I do not think it matters any whether one invention is a few days earlier than the other, as both hives are different in many respects. If you say the Berlepsch hive is *no* practical hive, I can't agree. Of course, we prefer our American hives; but in Germany the Berlepsch hive, with some modifications, is still in general use, and I myself handled bees in such hives for about ten years. It is said, before the frames were invented the comb-bars were used in England and by Langstroth. It would be interesting to know whence Langstroth received the idea of using these bars. Did he know of any thing of Dzierzon's hive, or was his (Dzierzon's) *bar* a successor of Della Rocca's invention?

To go back to Dzierzon, he was opposed to *frames*, and always recommended his bars, till about ten years ago, when everybody in Germany used frames; and even his nephew, who manages Dzierzon's apiary, persisted in using *frames* instead of bars. Since this time, Dzierzon is silent about the demerits of the frames. If we know this, it sounds like a joke to call Dzierzon the inventor of a *movable-frame* hive. I. STACHELHAUSEN. Converse, Texas, March 25.

[I received your note after I had prepared the footnote above. From the general facts that I was able to glean I took it that Dzierzon got the idea of the use of the bar from Della Rocca, as the former, apparently, had not kept his light under a bushel; but Dzierzon doubtless made the use of the bar practical. But when we see the very wide gap between the Dzierzon movable combs, and the Langstroth movable frames, we are forced to the conclusion that Langstroth made a practical invention—one that revolutionized bee-keeping *all over the world*, while Dzierzon improved an old device that advanced bee-keeping but slightly and in only one country. I do not mean to detract from the glory that really belongs to Dzierzon, but I do believe that credit should be placed right where it does belong, irrespective of the living or the dead.—ED.]

POLLEN, AND HOW THE BEES GATHER IT.

Wintering Indoors with a High Temperature; the Secret of Success.

BY IRA BARBER.

Our sleighing has just left us—one continuous run from the middle of November until April 4, and still there is snow in places four feet deep on some of the roads.

The bees appear to be all right up to date in winter quarters, for we have not had a day when bees could fly with safety since last November.

I see in the *American Bee Journal* Prof. Cook's criticism on bees using their tongues to gather pollen, and claims they never do. Now, that is one of the many mistaken ideas that he tries to give us. Bees have to apply honey to all the pollen they gather, whether

it is from the flowers or from the corn or oat-meal that we give them, as every pellet of pollen is made into a little sweet cake when it is gathered; and how does Prof. Cook think it is done if the bee does not use its tongue to apply the sweetening?

I am much interested in the few colonies of bees in the little room you describe that is located within a room, where fresh air does not reach them.

Now, you have just the place to prove to your own satisfaction that bees can be wintered in a high temperature, and come out better and stronger in numbers than when they went into winter quarters. To do this it will take two or three winters to get the right number of colonies to heat the room to the right degree; and I can assist you to get a start in the right direction next fall. This winter you did not have bees enough in the room to raise the temperature; but next fall put in twice as many, so that every colony will have from one to two quarts of bees standing out on the hive at all times, no matter how cold it is outside; for when bees furnish their own heat, and are not affected by outside currents of air, I have always found them quiet and apparently happy, for they appear to be just as you find them on a warm muggy morning in August, when nearly every hive is half covered with bees, and they appear to be half asleep, so they are in winter quarters, as I found them in all the years that I wintered them in a high temperature, heated by themselves.

I always used a small ventilator—a three-inch pipe thirty or more feet long, and ventilated from the top of the room that the bees were in.

DeKalb Junction, N. Y., Apr. 9

T. F. C., Pa.—Referring to your inclosed clipping in your letter of the 9th, the idea that bees become intoxicated is rank nonsense. Bees will sometimes, when they are sick or diseased, behave as described in the clipping. It is doubtful if any honey-producer told any reporter that bees become drunk on the nectar of flowers.

H. W. C., Iowa.—My faith in self-hivers is very weak. There have been a dozen different devices invented, and some of them are in the United States Patent Office. The best one I ever saw or knew of is the one devised by E. L. Pratt, at that time of Beverly, Mass., now of Swarthmore, Pa. I think it would pay you well to look up the Patent Office records on this subject before you consider getting out a patent. If you desire to send a model to us, express prepaid, I will examine it and report what I think of it. But I am afraid my prejudices are rather against it than in favor of it, if any thing. If you consult most of our practical bee-keepers I think they will tell you you had better let the subject alone if you wish to save yourself expense. It is possible to hive swarms automatically, and the writer has hived a good many that way by the various devices; but if you will take my advice you will let the whole subject alone.

EXTRA LIGHT-WEIGHT FOUNDATION FOR THE BROOD-NEST.

Light and Heavy Weights on Wires; Vertical vs. Horizontal Wiring; Valuable Experiments.

BY J. M. RANKIN.

The manufacture and use of comb foundation dates back only a few years, and yet it is an exceptional thing to find a man who does not believe that this manufactured article is a money-maker. He has but to try it once for himself, and its advantages are so apparent that it needs no comparison to show him that it has been an advantage for him to use it. There has, however, been much discussion as to what weight to use. The wax from which the foundation is made is the expensive part of the article, and so the lighter the weight the more foundation can be made from the same amount of wax with little more expense. The lighter the weight, of course the thinner must be the foundation.

The object of this experiment was to determine how light this foundation could be made and still serve the original purpose, namely, to furnish a base strong enough to answer all purposes.

The foundations used were furnished by The A. I. Root Co., and were about as near perfection as it is possible to make a foundation. The weights used ranged from a grade a little heavier than that commonly known as medium brood down nearly to thin surplus or six Langstroth sheets, which would be 5.49 sq. ft. to 13 Langstroth sheets, or 11.89 sq. ft. to the pound.

The foundations were all used in full sheets, but with different methods of wiring, namely, vertical and horizontal. Five vertical wires in a Langstroth frame, bringing them 3.5 inches apart, were used. In the frames wired horizontally, four wires were used, and were just drawn tight but bearing very little strain.

The fittings of the hives used in this experiment are shown in the following table. The foundations are numbered 6, 7, 8, etc., according to the number of L. sheets in a pound.

	Sheets of fdn. No. 6 in hive.	Sheets of fdn. No. 7 in hive.	Sheets of fdn. No. 8 in hive.	Sheets of fdn. No. 9 in hive.	Sheets of fdn. No. 10 in hive.	Sheets of fdn. No. 11 in hive.	Sheets of fdn. No. 12 in hive.	Sheets of fdn. No. 13 in hive.
Hive A	4							4
Hive B	2				4	2		
Hive C		2			2		4	
Hive D		4						4
Hive E			4				4	
Hive F				4			4	
Hive G			2	2		2		2
Hive H			2	2		2		2
Hive I				4		4		
Hive J		2	3	1		1		1

It may be understood, unless otherwise stated, that in each hive one-half of the foundation of each kind was wired horizontally and one-half vertically.

Hives B, C, G, and J were used as extract-

ing-supers. Swarms were hived on all the rest.

Detailed records are as follows: Hive A, 24 hours after the swarm was hived the bees were working freely on the No. 13 foundation, and but sparingly on the number 6. In 48 hours all but the outside frame of No. 13 foundation was drawn, and contained nectar and a few eggs, while the two outside frames of No. 6 foundation were nearly untouched.

In four days after hiving, no difference could be seen in the appearance of those combs built on No. 6 and No. 13 foundations, excepting that the combs of No. 13 were wavy where the vertical wires were used. That is, the foundations had expanded, and the bottom of the comb projected over the bottom-bar to the right between two wires and over to the left between the next two. The No. 6 foundation remained straight and even on the vertical as well as on the horizontal wires.

Hive B was put over a strong colony at the beginning of the clover flow. The bees began working in it immediately. The No. 6 foundation was placed at the side of the hive. The No. 11 next, and the No. 10 on the other side. In 48 hours it was impossible to tell from the looks of the combs which was the heavy and which was the light foundation. In this hive was the only case where a foundation as light as No. 11 was not wavy on vertical wires.

Hive C was also an extracting-super. Bees began work on No. 12 foundation first. The colony did not fill all the combs with honey, and at the end of the season the two frames fitted with No. 7 and one fitted with No. 12 foundation contained no honey, and were only partly drawn.

Hive D, swarm was hived on these combs late in the season, July 20. No. 7 foundation was on one side of the hive and No. 13 on the other side. Bees began work on No. 13. At the close of the season the outsides of the outside frames of No. 7 were still empty and but slightly drawn. The vertical wired combs of No. 13 foundation were very wavy, but the other two could not be distinguished from the combs built from the No. 7 foundation.

Hive E. Swarm hived early in the season; foundation 8 on one side the hive and foundation 12 on the other. Bees began work in the middle of the hive, and showed no preference for either weight. The vertical wired sheets of No. 12 were wavy, but those wired horizontally could not be distinguished from the No. 8 foundation.

Hive F. Heavy swarm hived June 29 showed no preference. Vertical wired frames of No. 13 foundation were wavy, but those wired horizontally could not be distinguished from the No. 10.

Three days after hiving, hive G was put on as an extracting-super. The bees there showed no preference, and at the close of the season there was an empty frame on each side of the surplus case. One was a frame of No. 8 foundation, and one was No. 13 foundation. Both were partly drawn.

Colonies which had been infected with foul brood were shaken into hives H and I the

same evening. They were confined for 24 hours and released at evening. In neither hive was there any preference shown. The combs were all drawn out and nicely finished.

Hive J was used as a surplus case, and but very little work done in it, owing to the sudden breaking of all the flow.

In general we learn from the experiment that, for a light foundation, vertical wires are not as good as horizontal ones—four horizontal wires serving all purposes, even with a light foundation. The combs from light foundations, when built on vertical wires, were wavy in every case.

The bees seem to prefer, and certainly do not object to, the lighter foundations. Why they seem to prefer the lighter foundations I do not know unless it is because it is easier remodeled to suit their fancy.

It requires much more care to put these light foundations in the frames and properly imbed the wires than it does the heavy ones—the No. 13 especially.

This experiment was made in hives that were painted white, but standing directly in the sun, and in no case was a frame of the lighter foundations melted down.

Agricultural College, Mich.

The result secured in this set of experiments is somewhat of a surprise to me. I should have said, if my opinion had been asked, that the heavier grades of foundation would be accepted by the bees first; and that on the light weights, 10 to 13 sheets to the pound, a perpendicular wiring would necessarily have to be used to prevent a horizontal sagging. If it be true that we can use, for the brood-nest, a foundation running from 10 to 12 sheets to the pound, we will say, and if it is also true that we can use horizontal wiring, thousands of dollars will be saved to the bee-keepers of the land annually. The manufacturer can make a brood foundation running from 10 to 12 sheets to the pound*; but hitherto we, like all of them, have supposed that such a light weight would not be practicable for the brood-nest, for fear that the foundation would stretch in drawing out, making elongated cells in the resultant comb. The season is right now on us; and any one who desires to can easily conduct for himself some experiments along the line above indicated.

I have always advocated a horizontal wiring, but supposed that such wiring would be applicable only to a foundation not lighter than 7 to 8 sheets to the pound; but from some experiments I made a number of years ago with the perpendicular wiring, I am quite prepared to believe that Mr. Rankin is correct in stating that a horizontal wiring will be better for even the light weights of foundation; and, come to think of it, the experiments of Mr. Rankin agree very well with those of Mr. Wm. W.

* These light weights must have thin bases, and plenty of wax in the walls. It is not easy to make such foundation, but it can be made, and the Root Co. have made it, and can make it if there was a call for it in quantity. We are making tons and tons of 9 to 10 sheets to the pound. And even this weight we did not consider practicable at one time.

Whitney, as given in GLEANINGS for March 15, page 223.

Mr. Rankin and Mr. Whitney have drawn attention to some very important possibilities.

If I mistake not, the Michigan Agricultural College has not regarded experimental work in apiculture as particularly important; but the work that Mr. Rankin has already done in the matter of measuring bees' tongues, and in showing the possibilities in the use of light-weight foundation, is of the very best, and sufficient to warrant the continuance of the experiments, for he is a man who is eminently fitted to do work of this kind.—E.D.]

MRS. JACKSON'S BEE-KEEPING.

What a Woman can Do, and a Woman in Poor Health at That.

BY MRS. GEO. JACKSON.

In the fall of 1894 one of our neighbors, several miles away, called on us in the firm belief that he could sell us some bees. Mr. Jackson, being fond of honey, favored buying them; but I, not caring for honey, nor having any faith that they would amount to any thing, did not take kindly to the idea. Nevertheless, the neighbor, being a good talker, and telling us a nice little "busy bee" story, succeeded in selling us four colonies, and those bees were the best-paying investment we ever made.

When we set them out of the cellar, April 10, 1895, we had only two colonies, two having died during the winter. We knew nothing of the care of bees, and had only one swarm thrown off during the summer; but a nice supply of white honey came, that even I had to own I liked, and it made us quite enthusiastic on bee culture.

In the spring of 1896 we found the two old colonies in good condition, but the new one very weak, owing to a poor hive and lack of knowledge. The hives were home-made square ones.

We now thought it time that we knew something, and sent to A. I. Root for his A B C book—the next best investment we ever made; also five of his Dovetailed hives, and a smoker. But before receiving the goods I was taken sick, and was very sick for several weeks, not fully recovering until late in the season, and we think much credit is due the bees for my final recovery, I being much interested in them. I studied my book and studied the bees. The result was, in the fall I had seven strong colonies and an abundance of beautiful white comb honey. Mr. Jackson now gave up all claim to the bees, reserving only the privilege of eating the honey.

My seven colonies wintered well, and I had learned my book well during the winter. In the fall of 1897 I had 18 very strong colonies, and about 900 lbs. of comb honey. The bees again wintered well, and in the spring of 1898 I had still 18 strong colonies. Well, I felt, and do still feel, proud of those bees. They commenced work the first day they were out of the cellar, and worked every pleasant day

during the summer, and until heavy frost came in the fall. One colony, the "Queen" of my apiary, did itself "proud." During the season we took from it *ten supers* of well-filled and nicely capped white honey, each super containing 24 lbs. It did not swarm, and we had a heavy flow of basswood honey. The other colonies swarmed early, and the 10th of June I had 37 strong colonies. I did not get less than two supers of honey from any colony, and many of them four.

Summit City, Mich., Feb. 11.

[In my report of the convention at Traverse City, Mich., page 158, I spoke about the remarkable yield secured by a lady present, and she only a beginner. I have asked her to write it out, which she has done as above.—A. I. R.]

THE DICKEL THEORY.

What do we Know about Parthenogenesis and other Mysteries of the Hive?

BY F. GREINER.

A human being is naturally of an inquisitive mind; and when any thing is presented to him which has the appearance of being unreasonable he at once wants to know the hows and whys. In the case of parthenogenesis, it does not make any material difference whether it is acknowledged that *all* eggs laid by a normal queen are fertilized, and therefore contain sperm, or whether it is believed that only those eggs destined to become queens and workers enjoy that preference or privilege. Your bees will make you just as much or as little honey in the one case as in the other. Yet, we do not rest easy until we know what the exact truth is. If we bear in mind that all *good* people *seek* the truth, we ought to be willing to show not only charity to those who arrive at different conclusions, but we ought to even encourage them. If we have that feeling we will welcome Mr. Dickel, who has for years been trying to clear away mysteries surrounding the so-called Dzierzon theory, or parthenogenesis.

According to Webster, parthenogenesis means "the virgin production of living beings." Probably all of us have had unpleasant experiences with *laying* workers. I emphasize the word "*laying*," because many a time laying workers are called fertile workers. Even Prof. Cook names them so in his work on bees. That is a misnomer. We call a normal queen a *fertile* queen—she is impregnated, has met a drone. In this sense the laying workers are not fertile, for they are incapable of mating. Laying workers generally make their appearance in hopelessly queenless colonies, seldom at other times. The worker bee is so constituted that, in an emergency, she can lay eggs. She may have retained this faculty as an inheritance from most remote ancestry. These eggs, however, produce only male bees, apparently perfectly developed. A queen, when by chance she has not become impregnated, lays eggs exactly like those from

laying workers. A failing queen may also lay eggs which produce only drones, though they may have been deposited in worker-cells like the others. These facts were first discovered by Dr. Dzierzon, of Germany, in 1845, and are acknowledged the world over. Dzierzon further claimed that all drone eggs lacked the sperm, and that the queen could *at will* lay fertilized and unfertilized eggs.

It seems to be a law of nature among bees and fowls that the female offspring resembles the father and male offspring the mother. For example, I have crossed pure breeds of fowls. The pullets of a Langshan-Plymouth Rock cross were as black as the father, and, when matured, I was not able to tell them from the pure-blooded hens. The cockerels resembled the mother-hen, but were a little darker.

It may be Dr. Dzierzon was influenced by similar observations. If it was true that the drone originated from an unfertilized egg, then the drone would always be as pure-blooded as the mother-bee, regardless of how she had mated, and queen-breeding to a feather would be a heap easier than it would be otherwise.

What is our experience? I have had a good many mated black queens and some mated Italian queens. My observation leads me to the belief that the drones are slightly influenced in color, showing that of the father, in some instances at least. I do not say that all drones do, but only a part of them. Mr. Doolittle also holds the opinion that, by mating, a queen is contaminated as regards all her offspring, both male and female.

After Dzierzon proclaimed his theory that all drone-producing eggs were unfertilized, a severe fight ensued. It had been an undisputed scientific truth, a law of nature, "No life without fertilization." Even in the vegetable kingdom this law holds good. The pistillate strawberry-plant remains barren unless the pollen from a perfect-flowering plant reaches its ovaries. The Dzierzon theory upset this acknowledged truth completely. No wonder it met with opposition on every hand. After an undecided war, something happened that should end all further dispute for the time being. Prof. Siebold made a microscopic examination of bee-eggs taken from drone and worker cells at the apiary of Baron von Berlepsch, in Seebach, Germany. The eggs from drone comb contained no sperm, but those from worker-cells did. From this time on, parthenogenesis, in the Dzierzon sense, has been accepted by all people of all countries.

It excites the curiosity of the unprejudiced observer that, at no time, verifying examinations have been undertaken since, although the theory is of a rather uncommon—yes, unreasonable—character. This thought instigated Dickel to investigate the matter. Siebold had made his examinations in late season, when, according to Berlepsch, there were no drones being raised in healthy colonies of his apiary. The locality of Seebach furnishes no late honey. Early in July the season closes, and, in consequence, the breeding of drones is discontinued, and drones and drone brood

is killed. Berlepsch had one colony in his yard which, from early in the spring, had been determined to supersede its queen; but, by continuously removing, the queen had been kept from accomplishing the object. Berlepsch had at different times during the season removed or destroyed the drone brood in this hive. At the time when Prof. Siebold came into the apiary it had again plenty of drones in all stages, and all the drone eggs used for the examination were taken from this colony. There is no certainty that they came from a normally healthy queen. On the other hand, we have reason to suspect that they could not have contained sperm, by reason of the failing powers of the queen who laid them, and of which Prof. Siebold himself said, "She was near her end." Taking this view of the matter we can understand why the other eggs taken from worker-cells, and used for examination, were taken from other colonies in a normal condition.

After ascertaining these facts, Dickel could not consider Siebold's conclusions as of any value, and went to work and did some experimenting. He put a colony of bees into a hive full of drone comb, and watched the behavior of the bees. Eggs appeared and disappeared again. It seemed the bees hardly knew what to do; but finally they did the best they could under the circumstances, and raised workers in drone-cells. Late in the season, after all desire had subsided to produce drones, and the hive was entirely free from drone brood, Dickel dequeened the colony and observed that not only queens were raised, but also drones, drone brood being sprinkled in among the worker brood here and there. From this he judged that all the eggs of normal queens are exactly alike, and may produce queens, drones, and workers.

The following experiment has repeatedly been tried by Dickel and others, and turned out the same in numerous reported instances: A piece of drone comb was taken containing young drone larvæ. These were very carefully removed, and worker larvæ substituted. The so-prepared piece of brood was given to a queenless colony having no other brood. The bees went to work and again raised queens, drones, and workers, all from worker larvæ. By this experiment is shown that the sexual tendencies lie dormant in the worker larva till nearly the time it is being sealed, when, by some process not fully understood, the one or the other of those tendencies is induced to develop.

Dickel opposes the idea that a worker larva may be developed into a queen by the *difference* in the food the royal larva receives. He says there must be some other explanation of the mystery. A young Durham calf would sooner partake of the nature of a Jersey by bringing it up on Jersey milk. Indeed, there is something in this that might lead us to thinking. The two calves may be anatomically alike; but the queen and the worker show marked difference in their structure. A mere change of food does not generally produce such results, and I do not doubt that we do not fully understand this matter. Dickel has

his theory about *this*. He thinks the worker performs a sexual act by certain glands; a sort of developer, as the photographer says, is produced, which, when administered, affects the egg or the larva as indicated. Two glands are to perform the office; the secretion of one gland acts as a developer of the female tendency, while the secretion of the other gland acts as a developer of the male tendency; both together administered bring the worker into existence. In case of the true sex, individuals of the bee family, the drone and the queen, the development of the sexual organs begins when these secretions are first administered, and the queen and drone are still in the egg.

Bee-eggs, it is generally believed, can not be transferred, on account of the fragility of the egg. Dickel and some others claim that they have been successful in doing it. By transferring freshly laid eggs, untouched by the bees, Dickel says he has raised queens, drones, and workers, selecting eggs from the same class of cells.

No matter whether drones originate from eggs fertilized or lacking sperm, I can not think the queen knows what kind of egg she lays. I believe that an influence goes out from the cell, which causes the queen's ovaries, spermatheca, oviduct, and the whole apparatus to operate involuntarily.

Indeed, it would be hard to explain why a queen should consent to lay eggs in queen-cells, thus raising rivals, and possibly endangering her own life. Of the many queen-cups generally started in every part of the hive, many more than are ever actually used come in the way of the queen as she is traveling over the combs in search of empty cells, and she deposits an egg in them as readily as in a worker or drone cell, should she find any of them cleaned and primed, acting, as Dickel says, as an automatic egg-laying machine.

The true followers of Dzierzon are at present glorying over what they term "Dickel's capitulation."

Dickel is searching for truth; and when he discovers a fact, though it may testify against his theory, he is willing and anxious that that fact shall be known. In No. 11 of the *Hessische Biene* he has of late published the results of the latest microscopic examinations of bee eggs made at the University of Freiburg, Germany. Dickel himself furnished the eggs. In all, 272 eggs taken from drone-cells were examined, and 62 eggs taken from worker-cells. Among the first named, one egg was found to contain sperm; the 62 worker-cell eggs all contained sperm. One lot of eggs from drone-cells were purposely mislabeled by Dickel "worker-eggs," but the microscope could not be fooled.

So, then, so far, parthenogenesis has not been disproved by the microscope. I understand Dickel has not given up the fight. He proposes to continue in his work, and I have no doubt we shall hear from him again.

Naples, N. Y.

[I have been advised by some of my friends not to allow any discussion of the Dickel the-

ory to get into our column, for the simple reason that it occupied an immense amount of space in the European publications, with the result that nothing was proved in favor of the new hypothesis. But when I attended one of the conventions in New York recently, I listened to an excellent paper on the subject by Mr. Friedemann Greiner. As he had discussed the matter so thoroughly and impartially, I requested the privilege of the publication of his paper, which privilege he freely granted. I have held the paper till now so it would be more seasonable; but in the mean time I have received from Frank Benton a translation of an article on the same subject. Both have been held, and are now given.—ED.]

ON THE THEORY OF PARTHENOGENESIS AMONG BEES.

BY CAV. ANDREA DE' RAUSCHENFELS.

Translated from the Italian, by Frank Benton, U. S. Department of Agriculture, Washington, D. C.

[This article is translated from *L'Apicoltore*, Vol. XXXIV., No. 2, for February, 1901. Cavaliere Andrea de' Rauschenfels, the learned editor of this, the oldest Italian bee-journal, is the author of several valuable works on bee-keeping, and is one of the most eminent practical bee-masters of Europe. Being of Germanic descent he is thoroughly conversant with the language in which the main discussion of the Dickel theory was originally published. This short exposition by him of the latest phase of the matter is, therefore, a welcome contribution.—TRANSLATOR'S NOTE.]

Much water has rolled under the bridges since the lamented Don Lanfranchi, and, later, Mr. F. Dickel, undertook to revise the Dzierzonian theory of parthenogenesis among bees. The innumerable experiments carried out with admirable perseverance by the latter, and the deductions from these, treated with great acumen, and published in a very long series of articles in the *Noerdlinger Bienenzeitung*, then edited by him, and, above all, the eloquent exposition of the new theory (according to which the workers are the ones that determine the sex of the creatures developed from the eggs deposited by a fecundated queen, and therefore themselves, without exception like the latter, fecundated), made a great impression on the apiculturists present at the congresses of Cologne and Salzburg; the adherents were numerous, and the applause was entertaining.

Dr. Dzierzon and his followers combatted, naturally, to a man, the reformer; and the strife between the Guelphs and Ghibellines continued to rage more fiercely than ever in the journals, when there was brought forward by Dickel a formidable aid. His journal suddenly ceased publication, and with the journal this so *vexata questio* appeared to have been buried. It appeared to be so, but was not. Dickel continued his crusade in another journal, but the matter had lost its interest for apiculturists. This was not the case, however, among scientists. The zoological department of the University of Freiburg, in the Grand Duchy of Baden, had, for fully three years, been conducting investigations in regard to parthenogenesis among bees. The material

to be subjected to microscopic examination was furnished by the said Mr. Dickel. Out of 29 worker eggs in the first stage, 23 were found which contained traces of fecundation, while 94 drone eggs presented no such traces whatever; and among 62 eggs taken from worker-cells there was not found a single one which did not contain such traces, while of 272 male eggs one only showed a vestige.*

"How certain the method of examination practiced by the zoological department is," writes Prof. A. Weismann,† "may be inferred from the following: Mr. Dickel, who is not a microscopist, commenced during the time—certainly not short—occupied in the investigations, to doubt the full accuracy of the microscope in the solution of the questions concerning fecundation, something for which we did not reproach him, finding it, on the contrary, very natural. As he wished to put the matter to a test he changed the labels on the contents of two packages, the one with eggs taken from drone-cells and the other with eggs from worker-cells. This occurred when the results previously obtained had already fully convinced us that the eggs found in drone-cells are not fecundated. Hence we were not a little astonished upon finding in a new examination exactly the contrary; each egg which was supposed to have come from a drone-cell appeared fecundated, whilst none of those which, according to the label, must have been taken from worker-cells, contained a sign of fecundation. It was very natural to think at once that there must have occurred a chance error in labeling the contents of the two packages; and to ascertain this, an assistant, Mr. Petrunkevich, went to Darmstadt (Grand Duchy of Hesse-Darmstadt), to the residence of Mr. Dickel, and ascertained that the exchange of the labels had actually been made, and purposely. After all this," Professor Weismann concludes, "it may be taken as proved that the eggs deposited in drone-cells are normally not fecundated, while on the other hand, those deposited in worker-cells are always fecundated and that, therefore, the theory of Dr. Dzierzon remains unchanged."

But Mr. Dickel does not yet admit himself vanquished. Fecundation, he says, does not always depend upon the sperm, and he announces that, against the deductious of Professor Weismann, he will oppose other deductious.

Washington, D. C.

[I think we may safely say that the experiments conducted at the Zoological Department at Freiburg dispose of the matter, so far as the sex of the eggs is concerned, and it would seem as if the result of these microscopic findings, confirming as they do the findings of

* Although laid in a drone-cell this particular egg would probably have developed into a worker bee.—TRANSLATOR.

† Prof. August Weismann, the regular professor of zoology in the ancient University of Freiburg, is a celebrated evolutionist, embryologist, and comparative morphologist, whose researches and theories regarding the problem of reproduction, development, and evolution, place him among the foremost biologists of the age.—TRANSLATOR.

Siebold, knock the very props from under the Dickel theory. But there is one thing that still remains; and that is, Dickel maintains that the sex of the larvæ is changed after they are hatched from the egg, because he says that he can give drone eggs or worker eggs to a colony of bees, and, under the right conditions, secure from either set of eggs, workers, drones, and queens.*

While we do not care to go into a discussion of this matter, because we believe that that statement is not borne out in the experience of queen-breeders in this country, yet I believe it will prove interesting to our readers to glance over briefly a subject that has occupied the attention of the European bee keepers for so long a time.—ED.]



WORKING FOR COMB HONEY.

"Good morning, Mr. Doolittle. I came all the way from Iowa (by letter) to have a talk with you regarding how best to work for comb honey so as to be sure of securing a good crop should the season prove favorable."

"Not knowing your surroundings, etc., I will say that, to be successful, you must have a simple movable-frame hive of some kind. I formerly thought that there was nothing equal to the Gallup form of the Langstroth hive; but with years of working with the regular Langstroth hive at the out-apiary, together with cellar wintering, I am quite sure that the man who adopts the regular Langstroth hive and frame is making no mistake."

"How large a hive do you use?"

"In using the Langstroth hive I make the bodies to hold ten frames, and work all good colonies on the ten frames till the honey harvest opens, when the colonies are each confined to the number of frames the queen has brood in at that time."

"How do you manage to confine the bees on any certain number of frames, that number being governed by those having brood in them?"

"This is done by division-boards or dummies, as you have frequently read of in the bee-papers of late. The combs not having brood in them are taken out, and one of these boards put in the hive in place of each frame taken out. In this way the colony having brood in only six combs is as fully prepared for the honey harvest as is the one having brood in eight, nine, or ten frames, and will store fully as much in proportion to its numbers, according to my experience; while if the whole ten combs were left in the hive,

*If I mistake not, drone eggs have been repeatedly put into queen-cells, and each time a dead or cadaverous overfed drone, and only a drone, was the result.

There are other ways of explaining Dickel's observation on this point besides the one on the supposition of a new fact in science.

scarcely a pound of section honey would be obtained."

"But is this all there is to do to secure a good crop of comb honey?"

"By no means. But it is one of the very important factors in the matter."

"Well, what of the other factors?"

"All know that bees gather honey or nectar, instead of producing it, and that the eggs laid by the queen produce bees; consequently the more eggs the queen lays at the proper time, the more bees we have on the stage of action at the commencement of the honey harvest, and the more bees we have at that time the more honey they gather."

"That sounds very pretty."

"Yes. But it is a matter of fact as well, that the queen is really the producer of the honey; for without her no honey could come about, from lack of bees. Therefore, if we wish good returns from our bees we must see to it that we have good queens—queens that can be so worked that they will give us combs full of brood before the honey season commences, so that, when the honey harvest comes, these solid combs of brood, together with the boards taking the place of any combs not containing brood, will compel the bees to place the honey in the sections, as there will be nowhere else for them to store it."

"But how shall we secure combs full of brood and plenty of bees to do all the necessary labor, to secure the best results by the time our honey harvest begins?"

"As soon as spring opens, our bees should all be examined by lifting the frames in each hive; and any colonies which are weak in bees are to be shut to one side of the hive by means of one of the division-boards spoken of before, so as to economize the heat in the cluster of bees as far as possible, confining the bees to as few combs as have brood in them."

"But suppose there is not honey enough for food in the combs they are shut on?"

"In case there is not, I leave a comb of honey next to the side of the hive, and between that and the first comb of brood; and if a part of the cappings to the cells are broken a little on the side next to the brood it will help on the brood-rearing so much the more."

"How long do you keep them confined to these few combs?"

"Till the queen has filled them solid full of brood, and the bees begin to be crowded out beyond the division-board."

"What then do you do?"

"As soon as the queen has filled these combs, and the bees begin to be crowded on them, they are spread apart, and a comb of honey having the capping somewhat broken is set in the center of the brood-nest, or between those occupied with brood, and in a few days' time the queen will fill this also, and thus we are to keep on till all the combs the hive will hold are filled, or the honey harvest arrives, when, as spoken of before, the queen is now limited to as many combs as are filled with brood on the arrival of the honey harvest."

"Why do you put these combs of honey in

the center of the brood rather than on the outside?"

"Because the center of the brood-nest is the warmest part of the hive or colony; and this, with the removal of the honey, which the bees never allow (at this time of the year) in the center of the brood-nest, stimulates the queen to greater activity at egg-laying than otherwise would be, so that we are rushing on with mighty strides toward the army of workers which are to gather our nectar during the harvest time. To this one idea of securing workers in time for the harvest, every effort of both the keeper and the bees is to be directed at this time of the year if we would succeed."

"But do you not help some of the very weakest colonies any?"

"Yes. As soon as the strongest colonies have their hives full of bees and brood, or even when they have eight frames full, I take a frame of brood just gnawing out, and place it in the next weaker ones, giving the stronger an empty comb for the queen to fill again, and so keep on until all are full, if this is possible, before the harvest arrives."

"But does it not injure the strongest to thus take brood from them?"

"It would were we to do this early in the season; but as we do not do this till some of the colonies have their hives nearly or quite filled, it does not materially weaken them, but, on the contrary, stimulates the queen to still greater activity at egg-laying, and at the same time tends to check any desire to swarm."

"How about putting on sections? When is this done?"

"I generally put them on all good colonies a week to ten days before the honey harvest is to arrive, so that the bees may enter them on warm days and get used to going 'upstairs.' With the weaker colonies they are not put on till they are ready for them, or till they are confined to the brood they have at the time of the opening of the harvest."

"How are the sections prepared?"

"I now fill each section with the extra-thin foundation, while three or four sections to each hive should be those which are full of comb, or nearly so (called 'bait sections'), left over from the previous year, the same being those which were filled hardly well enough to be salable. These latter are very important, as they are the means of getting the bees at work in the sections at once."

"Are not these sections filled with comb finished quicker than those with foundation?"

"Yes. As a rule these are finished from three days to a week before the others; and where one has the time, I think it pays to take these out as soon as filled, putting those with foundation in their places, thereby causing the bees to work with renewed vigor to fill up the vacant space left where the full ones were taken out. But where time is scarce, or where sections are handled by the full super, this course can not generally be taken. This, in short, is the way I have worked my bees for the past 30 years, during which I have been enabled to take an average of very near-

ly 80 pounds of comb honey each year from each old colony in the spring."



HIVES ON A BENCH; ARTIFICIAL SUBSTITUTES FOR BROOD-REARING IN THE SPRING.

1. I have my bees on a 17-ft. bench; how close can I place them?

2. How long can a queen hatched from a cell be left in a cage?

3. Does a person gain any thing by feeding rye meal to his bees in early spring?

JOHN SCHNEIDER.

Manhasset, N. Y., Mar. 22.

[1. I would not place them much closer than about 6 inches. You will need room enough to get your hands down between the hives to handle properly. If you get the hives too close there is liable to be a little trouble from bees running from one entrance to the other, especially young bees. In the case of a valuable queen, I would not place the hive of such queen very close to that of another.

2. If supplied with candy she may live two or three weeks (possibly she might live that long without it, getting her sustenance from the bees), but ordinarily not more than four or five days. The older a queen is, the more difficult she is to introduce.

3. For the average beginner, I think not; but an expert may, perhaps, at times put out an artificial substitute that will prove beneficial. But as a rule we may say that natural pollen will come on as soon as the bees can afford to use pollen. The feeding of rye meal has a tendency to overload the combs and to stimulate brood-rearing at a time of year when it is too cold for bees to rear much brood profitably. More spring dwindling comes from a small cluster trying to hover over a large amount of brood in cool bad weather than from any other cause. In our locality we prefer to have brood-rearing kept down to as small a compass as possible, until the first of May; then the bees can usually take care of and keep warm all they will be likely to rear.—ED.]

THE SKIN OF FRUIT V. OLD BLACK CELLS.

I agree with you, that the bees never pinch a hole through the skin of a fruit, but I do not understand why they can not do it, as they are well able to cut down the cells of very old comb, and sometimes they will cut the septum also. Such old black cells, I think, must be nearly as tough as the skin of a fruit.

FERDINAND WAGNER.

Watertown, Wis., Mar. 21.

[Old black cells have considerable fiber in them; and, as I have before explained, the bees will pick to pieces a fibrous article just as we can pick to pieces with our fingers a ma-

nila rope. And, again, these old cells have cocoons imbedded in them. The cappings of brood-combs are almost entirely fibrous, with very little wax. But, you ask, why is it that bees can cut through the cappings of comb honey which are pure wax? In the first place, the mouth parts of the bee are especially formed for the working and handling of wax, a substance that is totally different from the skin of fruit. And, again, you will observe that the surface of comb honey is rough and uneven with slight excrescences, or what we might call minute mountains, hills, and valleys. These the bees can easily grab hold of and pull up. That is to say, they can tear, but they can not cut. Unless the wax has an irregular surface, the bees can not do any thing with it except under a temperature of from 90 to 100 degrees, and that is the inside temperature of the hive. It must be so soft that they can work it just as we work dough in the hands.

Reference has been made to the fact that bees will gnaw through enamel cloth. But I never yet saw any such cloth that had holes in it *unless* the enamel was cracked or rotten, leaving an edge which the bees could *get hold of* and pull, or the cloth itself were exposed so they could grab the fiber on the back. The surface of fruit is of a smooth semi-oily character. There is nothing for a bee to get hold of; but if the skin has minute rotten spots invisible to us but which the bees can see, or the skin is turned up anywhere so the bee can get hold of it with its mandibles it will tear it up; then it can go on and enlarge the opening to any size. Some have said that bees have the power, physiologically, to cut; but we are very sure of this: They have no conscientious scruples; for they will wade into the preserves of the housewife wherever they can in a dearth of honey. Whatever they *can do*, right or wrong, they will do it. The fact that no good proof has ever yet been advanced to show that bees *can* cut through sound fruit, goes a very long way to show that they can *not* do it.—Ed]

EXTRACTING FROM PARTLY FILLED SECTIONS.

Please tell me how to extract partly filled sections. I have a No. 5 Novice extractor, and should like to know if there is any way to extract nice pieces of comb honey from old-fashioned box hives and partly filled sections.

FLORENCE L. TOWNSEND.

Zana, Texas, Feb. 11.

[If the sections to which you refer are the common $4\frac{1}{4}$ square, put them into a wide frame, and then extract as you would common brood-frames. But this involves considerable work. Comb-honey producers, as a rule, do not fuss to put their partly filled sections in an ordinary honey-extractor. A far better way is to set them into supers, then pile the supers up on one or more empty hives a few rods from the apiary.

The entrance to the hive should be effected by means of a very small opening, large enough to admit only one or two bees at a time. On

the principle of slow robbing described in our A B C of Bee Culture the bees will clean these sections out far cheaper than you can fuss to do it with the extractor, and possibly enable them, if your apiary is small, to complete other sections already on the hives.

It has been recommended of late to put all such supers containing partly filled sections in the cellar, leaving the outside-cellar door open. Every one of the supers should be uncovered or left so that the bees can get at them freely. The bees will soon find their way to the cellar, and then there will be a big uproar of robbing. But as soon as the honey has all been taken away, the robbing subsides, and all is quiet. I have never tried it; but Dr. Miller, who has, assures me it works all right. While I think the plan can be followed by expert bee-keepers, the one of stacking supers up in a hive with a small entrance is the one recommended for beginners.—ED.]

HONEY PROSPECTS; ANOTHER VIEW OF THE SITUATION IN CALIFORNIA.

As the exact truth is better for all parties concerned, I wish to say that friend Mendelson *may* find that the few bees left in Southern California can more than supply local markets (page 194). Central California never had more bees nor better prospects, I think, for this time of the year. Where can we place, say, two train loads of extracted honey next fall? The annual report from Philadelphia is expected, showing that the market is ruined by commission men, but we must send honey somewhere. However, our continued rains are not going to make this a red-letter year from cause stated by Mr. M.

W. A. H. GILSTRAP.

Grayson, Cal., March 11.

REMOVING COMB HONEY FROM DOVETAILED SUPERS.

1. Will you kindly tell me how to remove the sections from the super (in a Dovetailed hive) when they are full of honey? We have had great difficulty in removing it because they were stuck together.

2. What is the best time of day to get the honey?

3. Is it necessary to cover the hive in winter?

B. A. JENNINGS.

Southport, Conn., Mar. 4.

[1. There ought to be no difficulty on this point if you are using the modern Dovetailed-hive supers, with super springs. With a screw-driver, loosen up the first fence or the first row of sections. Draw this out gently, and then all the rest will be free.

2. Along about the middle of the day, say after ten o'clock and before two, when bees are flying thickest.

3. The hives should either be protected by winter-cases or else be put in the cellar.—ED.]

QUALITY OF RED-CLOVER HONEY.

Long-tongued bees are all right. I believe we can breed bees to a great improvement in this line; but, really, did any of you ever eat

red-clover honey that was good? Some years my bees gather quite a lot from the second-crop bloom when the weather is dry and the bloom stunted. I have also eaten red clover honey in Missouri, and it all tastes alike to me—like bumble-bee honey. Am I right, or is it owing to locality? M. F. TATMAN.
Rossville, Kan.

[Yes, I have tasted what was said to be simon-pure red-clover honey. While the flavor is not quite up to that of white clover, yet I would call it good honey. If I could, by long-tongued bees, increase my honey-crop by 25 or 50 per cent of such honey, I should consider I was adding a big percentage to my income. Buckwheat honey has a large demand in the East, and I am sure red-clover honey would outrank buckwheat several times over.—ED.]

HATCHING CHICKENS OVER COLONIES OF BEES.

I take the liberty to send you something new in the bee and poultry line. Please tell me what you think of this. What style of hive do you think is used? I have no bees—have always been afraid of them, but think I should like them if I could use them for hatching chickens. JESSIE NEILL.

Benzonia, Mich., Mar. 8.

John McDonald, three miles south of Mahalassville, has on his premises 12 stands of bees. The tops of the bee-hives are so constructed that they receive the proper amount of heat for incubators. These tops are filled with eggs, and all that is to be done is to see that the eggs are turned in order to have a fine brood of chicks. He experimented last season with good success, and this year has his hives made about two feet square, so that more eggs can be accommodated, and is going into the business on a large scale. It is claimed, and has been satisfactorily demonstrated by Mr. McDonald, that bees furnish exactly the required amount of heat for the hatching of the eggs.

[I have heard of this being done, and see no reason why it could not be done successfully, as the temperature over a powerful colony of bees is about the same as that under an old hen. But Mr. McDonald and everybody else will find out the bees can not maintain heat enough to keep their own brood thriving, and hatch hen's eggs at the same time. What is gained in chickens will be lost in young bees or something near it.]

RESULT OF WINTERING BEES IN A CAVE BLASTED FROM SOLID ROCK.

You wished me to report how my bees wintered in the new cellar blasted out of the solid rock. I put in 32 colonies Nov. 20; took out 32 April 1, *all strong*. In the Portage apiary we put in 153; took out 149. In the Mauston apiary we put in 152; took out 146. C. H. PIERCE.

Kilbourn, Wis., April 8.

In paragraph beginning on page 225 I aimed to make it clear that the queen is left in the lower story and the extra brood is left to hatch in the third story and upward. The brood being left to stimulate the bees to greater activity is a help, in my judgment.

Grayson, Cal. W. A. H. GILSTRAP.



W. J. S., Okla.—I should be inclined to believe that a distillery in the immediate neighborhood of the bees might be somewhat prejudicial to the business of bee-keeping. We once lost a large number of our colonies because the bees helped themselves liberally to the juices of the apples at a cider-mill. If the liquor that they get is alcoholic, then the effect on the bees is certainly injurious; but whether they would come to like it or not, I could not say.

E. W. L., Mass.—This question of how much freezing bees can stand is a hard one for even veterans in the business to answer. We only know this: That, the less exposure and the nearer the temperature is kept down to 50 deg. during the winter, the less the consumption of stores. The lower the temperature and the greater variation in temperature, the greater the loss in stores and loss in bees. If the temperature is too great, and the cold weather is long-continued, and below zero, the bees will succumb.

HOW THE TONGUES OF BEES ARE MEASURED AT MEDINA.

H. E. H., Fla.—All that is required to measure bees' tongues is a steel rule with hundredths of an inch marked off on one side; a glass magnifying five or ten diameters; a pair of tweezers and a darning-needle, and a dime's worth of chloroform. Put up about a dozen bees of mature age in a common mailing-cage. Avoid taking young ones, as the tongues of such are not quite as long as those that are able to go to the fields. Pour a few drops of chloroform on a handkerchief and lay this over the bees. In about a minute the bees will be sufficiently stupefied so they can be handled, and the tongues will, from suffocation, be protruded almost their whole length. Pick up a bee and decapitate it. Lay the head and tongue on the steel rule just above the graduations of hundredths, face upward. With one hand exert a gentle pressure on the head of the bee, and, with the other, comb the tongue out straight, using needles or tweezers in either case. The pressure on the face is to cause the tongue to protrude its full length. Now, while the tongue is carefully combed out, take the glass, focus it on the tongue, and count off the hundredths, beginning from the ends of the mandibles or jaws, and ending with the end of the tongue. Proceed thus with all the bees in the cage, putting down on paper the exact results after each measurement. Strike a general average, and this average gives the measurement by which we go. As a rule I find there is but very little variation in the tongue-reach of the bees in any one colony. Sometimes they are all alike; but in the case of some individual bees it is more difficult to get the tongue combed out its full length.



NATIONAL BEE-KEEPERS' ASSOCIATION.

OBJECT:—To promote and protect the interests of its members; to prevent the adulteration of honey.

OFFICERS:—E. R. Root, President, Medina, O.; R. C. Aikin Vice-president, Loveland, Col.; Dr. A. B. Mason, Secretary, 3512 Monroe St., Sta. B, Toledo, O.; Eugene Secor, General Manager, Forest City, Iowa.

BOARD OF DIRECTORS:—E. Whitcomb, Friend, Neb.; W. Z. Hutchinson, Flint, Mich.; A. I. Root, Medina, O.; E. T. Abbott, St. Joseph, Mo.; P. H. Elwood, Starkville, N. Y.; E. R. Root, Medina, O.; T. G. Newman, San Francisco, Cal.; G. M. Doolittle, Borodino, N. Y.; W. F. Marks, Champaign, N. Y.; J. M. Hambaugh, Escudido, Cal.; C. P. Dabant, Hamilton, Ill.; C. G. Miller, Marengo, Ill.

FEES:—Annual membership fee, \$1.00. Remittances may be sent here or to General Manager as above.

DON'T fail to read J. M. Rankin's article on foundation, page 391.

To raise the freight rates on comb honey to *double first-class* as is proposed by the Western Classification Committee, "would strangle the honey business . . . on long hauls," says Mr. York. Bee-keepers should "line up" and fight for their rights. See Special Notices elsewhere, and then act in accordance with instructions.

THE *American Bee Keeper* is rapidly forging ahead. In spite of the fact that its editor is hundreds of miles away, the editorials are a strong feature of our cotemporary. They are fairly redolent of honey, wax, and of propolis; and I should not be surprised if some of Bro. Hill's were written on hive-covers, with a pencil daubed with bee-glue. Bee-lore written under such circumstances is bound to smack of practical experience.

AMONG other publications, the *Country Gentleman*, one of the very best farm papers issued, contains a warning against spraying fruit-trees while in bloom. It seems as if by this time that all progressive fruit-growers and farmers, to say nothing about bee-keepers, ought to know that spraying during fruit-bloom, so far from being an advantage, is a positive waste of time and chemicals as well as a serious menace to the lives of their best friends, the bees.

THE question has been asked in some circles whether it is positively known that the spraying of trees during bloom actually does kill bees. The chemicals that are ordinarily used do kill them by the thousands. There have been numerous reports showing how almost entire apiaries have been ruined just about blooming-time. Strong colonies will suddenly begin to dwindle, and keep on dwindling until nothing is left but young bees. But, thanks to a good many of the farm papers, fruit-growers on every side are being informed of the uselessness of spraying during bloom, and the terrible destruction visited on the bees.

MR. HUTCHINSON says in the *Review*, "The *Rocky Mountain Bee Journal* is the best bee-journal that has been started in many a long year." I have been looking over several numbers of this new bee-paper, and conclude that Mr. Hutchinson's judgment is about right. It is a very creditable publication, well edited, and nicely printed. Colorado is one of the greatest honey-producing States in the Union, and it may possibly be the greatest one, in the aggregate of honey produced, before another decade passes by. There is a splendid field for bee-journalism up among the Rockies, and we wish our cotemporary every success.

OUR re-reviews of Prof. Cook's reviews of the A B C book, in the *American Bee Journal*, are not for the purpose of showing that Prof. Cook is *wrong*, as he appears to be in some of his points, but for the purpose of drawing out and calling attention to some important facts or truths. Prof. Cook's criticisms have been and are models of courtesy, and we intend ours shall be as much so. He has done much to enrich and add to our bee-literature, and I wish to say that there is very much of value in his criticisms on the A B C, in the *American Bee Journal*. In the revision of the new work, where the new edition has not already been corrected we shall keep his corrections before us.

THOSE BEES UNDER THE MACHINE-SHOP.

AT this writing we still have the bees in the cellar under the machine-shop, and they are wintering perfectly. Next year we shall double the number of colonies; and if the results in the future prove to be as satisfactory we shall find it to our advantage, doubtless, to winter all our bees that way. The fact that potatoes are stored in another portion of that cellar, and the further fact that it is necessary to keep this cellar as cold as possible, makes it all the better for the bees. The temperature goes as low as 40, and up as high as 55. When it is very warm outside, the outside windows are closed, and when it is cold they are opened; but if it becomes very cold, they are closed to prevent too great a drop in temperature.

THE HEAVY SNOW-STORM OF APRIL 20.

ON the 20th we had one of the worst storms, or what some might call a blizzard, that we have ever had. The snow continued piling up for 48 hours. While the temperature did not get below freezing at any time, yet the wind was very chilly and raw. From reports that we gather from the paper, it is evident that this storm is general. It seems to have made its appearance in the West first, particularly in Colorado, then veered northward. As it did not reach us on schedule time we thought it had spent its force; but, lo and behold! on the morning of the 20th it had circled around and was hurling its force with unrelenting fury on the Central and Eastern States. So far as the bee-keeping industry is concerned, it will do no harm. The very heavy snowfall

will have a tendency to wet the ground up in good shape for clover. For about two weeks back it has been getting to be very dry—too much so for the interests of bee keepers and farmers alike.

WINTER LOSSES.

COOL weather, with but few days for the flight of bees, has held on so long throughout the Northern States that I am fearful there are going to be losses in some sections. So far reports have indicated that the bees have wintered well in Minnesota; rather poorly in Wisconsin, and not extra well in Michigan. In New York the bee-keepers entertain some fears as to what the results will show when settled warm weather comes on. J. E. Crane, of Vermont, says bees have wintered poorly in his section. From the great mass of reports, I gather that, while the loss numerically of colonies in the apiary will not be so great, yet the strength of those colonies will be reduced down to nuclei in very many instances. I am rather of the impression that stimulative feeding will have to be practiced this spring. The season will be late, so also the natural nectar supplies. If we should have, from now on, steady warm weather, the bees will probably be able to make up for the losses they have sustained during the past month or so. As to our own apiary, while our loss of colonies has been very light, yet our Mr. Wardell reports that there are a large number of weak colonies in the apiary.

A DISTINCTION BETWEEN TONGUE-REACH AND WHOLE TONGUE-LENGTH.

JUDGING from the variety of advertising that is now current, it is very apparent that some of the advertisers are talking about the whole length of the tongue, and others of only the tongue-reach. One advertiser in particular talks about tongue-reach when I know he means the whole length of the tongue. Customers, unless breeders are careful in this matter, are bound to be disappointed, and declare that the advertiser is a fraud. Let us all be careful to distinguish between *tongue-reach* and the *whole length* of the tongue. As I have before explained, tongue-reach includes only that portion of the proboscis that extends beyond the jaws of the bee; in other words, it is the available length that the bee can actually use in reaching down to the flower-tubes of clover. So far as I know, the longest tongue reach yet recorded is $\frac{23}{100}$. What the longest actual whole tongue-length is I do not know, and I don't believe it makes much difference. But it is important to know *how far* a bee can reach into a flower-tube with its *tongue*.

DOES LENGTH OF TONGUE-REACH HAVE A DIRECT RELATION TO AMOUNT OF HONEY SECURED? A PLAN TO PROVE OR DIS-PROVE IT.

WE have had considerable proof thus far to show that the honey-yields of certain colonies is in direct proportion to the average tongue-reach of the bees. While the evidence thus

far received points that way, yet there is one thing that has not yet been done, and that is, to measure the tongues of *poor* workers. If their reach is short, then we shall have further proof.

Now, I wish to suggest a plan that will entirely eliminate any prejudice or favor. I would request that a number of our subscribers send us one cage of bees from the very best workers in their yards, and another from the very poorest. But this test will have no value if there has been a recent change of queens in either hive. The bees of either colony must all be from one mother, of course. If brood has been exchanged so that the bees are from two different queens in the one hive, we can prove nothing. Then I should like to have some others send another pair of cages, one of which contains bees that distinguish themselves on red clover; and the other one, bees that do absolutely nothing at such times.

At the time of sending these bees in, *letter or number the cages*, and do not tell which are the good workers and which poor; but let me (blindfolded, as it were) send in a report of their tongue reach. After you get my report, send it, with the information of which are the good and poor workers, to Dr. C. C. Miller, Marengo, Ill. I'll give him instructions to tabulate the report and send it to GLEANINGS.

It is so easy for any us to be swayed in the direction we wish to believe, that I want to make sure in this case that both prejudice and favor shall be entirely eliminated. While I think I could be unbiased enough to give the plain facts, yet there may be a good many of our subscribers who, believing me to be intentionally fair, would nevertheless feel that I would be unconsciously prejudiced in favor of the long-tongue theory. But when the returns are all in, I suspect that we shall find that tongue-reach does not always bear a direct proportion to the amount of honey that a certain colony will gather; but we may prove that it is an important factor along with other factors.

PROF. COOK'S REVIEW OF THE A B C REVIEWED.

IN the *American Bee Journal* Prof. Cook has another installment of criticisms on the A B C. These criticisms are not upon the latest edition, and the editor says, with good reason, that this may be preferable because of the large number who have older editions. Instead of taking the criticisms in the order in which they occur, it may be well to take them in classes.

In the first class are three palpable errors that have been corrected in the latest edition. Under the first two figures that occur in the article on Honey-comb, the letters A and B are wrongly placed. A should be under the circles, and B under the hexagons. In the first paragraph of the article on Honey-dew, "scab insects" should be "scale insects." Prof. Cook is good-natured enough to say that this error may be due to his own poor writing. In the list of honey-plants, "motherwort" appears as "motherwork."

The second class contains three errors not yet corrected. Instead of 53 *varieties* of goldenrod, it should be *species*. In the article on honey-dew, the distinction is not as sharply made as it should be between aphid (or plant-louse) honey-dew, which is, perhaps, never very bad, and coccid (or scale-louse) honey-dew, which is never good. In the list of honey-plants, Prof. Cook says "Burr marigold" should be "Burr marigold"! It is quite possible the printer in Chicago is responsible for this, the intention being to show that only one *r* should be in the first syllable. Even then it needs further correction, for in the dictionary it is bur-marigold.

A third class contains nine items which not all would agree with Prof. Cook in calling errors.

In the chapter on Italian bees occurs a picture of the abdomen of a worker, which is said to be "detached from the shoulders." Prof. Cook says, "This use of the word *shoulders* is not warranted by any good usage that I know of; and as *thorax* is a perfectly good word, I see no need of coining a new one." The word *thorax* is undoubtedly the better word for those who understand what *thorax* means; but all are not so familiar with the word as an entomologist like Prof. Cook, and it is a question whether a larger number of readers might not catch the correct meaning better with the word *shoulders* than with *thorax*. However, in the latest edition the objectionable word does not appear, the reading being, "the body of the bee detached from the abdomen," which might be marked for further change, so as to read, "the abdomen of the bee detached from the thorax."

Prof. Cook has grave doubts as to honey from any plant being poisonous. It is possible that there is no such thing as poisonous honey, but there certainly has been some strong testimony in that direction. At any rate, as said in the latest edition, "In a matter involving severe sickness or possible loss of life it would seem to be policy to err on the safe side," so there can be no very great harm in telling about the reputation some plants have as to furnishing poisonous honey.

Prof. Cook says: "Is it wise to say that ten-day queens may be just as good as any?" Analysis by able scientists show that, for the first three days, a worker larva is fed the same as a queen, so it *may* be that a larva not more than three days old is as good as any from which to rear a queen. Mr. Cowan and others say a queen emerges 15 days after the laying of the egg. So a ten-day queen would be started from a larva two days old—surely as safe as one three days old. Without intending to make it so, Prof. Cook has used such wording that it might be understood that the book favors these ten-day queens. On the contrary the book says immediately; "but to be on the safe side, I should prefer giving them larvæ one or two days younger." In the latest edition the reading is, "These ten-day queens probably are not as good as those reared from younger larvæ."

In this same connection Prof. Cook says: "When things are normal they start the queen

from the egg. I think the wise breeder will always do the same." He would hardly have said that if he had taken the pains to inquire as to the practice of Doolittle and the majority of our best breeders who start queens from larvæ, and not from eggs.

Prof. Cook thinks that, when a young queen begins to lay after eggs and larvæ are given, the laying is more likely a coincidence than a result, and says a good many experiments should be tried before reaching a conclusion. Certainly many experiments have been tried, for many have made it a practice thus to give young brood; but it is a difficult thing to say in any given case whether the queen might not have begun laying just the same if no brood had been given. But the fact that so many have tried it, and that few or no cases of failure have occurred, makes the probability lie strongly on the side of the belief of result rather than coincidence.

"That the thread which evinces that mating has taken place is absorbed into the body of the queen, I think very improbable indeed," says our reviewer. The A B C says in substance that, when the queen returns from her wedding-flight, the bees sometimes pull at the protruding substance, but it is probably eventually absorbed into the body of the queen; and the day after, all trace of it will be a shriveled thread. That is not saying the thread is absorbed. It may be, however, that, aside from the filling of the spermatheca, there is no absorption in the case.

Prof. Cook says, "I am not at all sure that bees do not communicate. . . . That they are one-idea insects seem also to me not proven." That last sentence evidently refers to these words of the A B C: "I am quite sure they are unable to communicate to each other more than a single idea." Whether more than one idea at a time can be conveyed may be a subject for difference of opinion; but the very saying that bees are unable to communicate more than a single idea is practically saying that they do communicate—a belief which is also to be seen on other portions of the page, making it difficult to see how Prof. Cook should be so inconsistent as to arraign the A B C for teaching that bees do not communicate.

"Here, again, Mr. Root advises the use of the lantern," says Prof. Cook. "I have tried the night-working with bees several times when necessity compelled it, and I should be slow to recommend it, especially to a novice." Prof. Cook is a stickler for telling the truth, and on this page the author simply tells the plain truth as to his own experience, without directly advising any one to imitate his example. If Prof. Cook failed, that does not prove that the author failed, neither does it prove that any one else would fail who should exactly imitate the author.

Prof. Cook is right in saying that formic acid is not a vegetable acid, the A B C being faulty in calling a vegetable secretion that which is secreted from rather than by vegetable growth. But both reviewer and reviewed probably need overhauling for talking about formic acid as the poison, when latest investi-

gations (were they by Dr. Langer?) have shown that the poison is something separate from formic acid.

"I believe that it is equally untrue that the poison is more pungent when the bees are working," says Prof. Cook. "If the poison is more irritating at one time than another, it is because there is more of it. . . . Yet I have my doubts in this matter. I have never known bees to sting worse, or the wound to be more painful, than in the autumn, when the harvest was all over." There is here a field for investigation. It would be an exceedingly difficult thing to make practical bee-keepers believe that the results of all bee-stings are alike. In fact, it needs only the outside appearance to show positively that they are not alike. Neither would it be an easy thing to make bee-keepers believe that stings are not different at different times. What makes the difference? Is it in the person, or is it in the quality or quantity of the poison?

Prof. Cook says, "I am surprised that our author teaches that stinging does not kill the bee. Who has not known cases where thousands of bees have died from stinging?" In reply to this question it may be said that it is doubtful that five bee-keepers can be found to testify that they know of a case in which a thousand, to say nothing of thousands, of bees that have died from stinging. It is no doubt an injury for a bee to lose its sting; but many cases have occurred in which a bee was known to live so long after losing its sting that it is doubtful that it can be truly said that "losing the sting means to lose the life." A few years ago we published a report from a bee-keeper who told how one of his colonies became so enraged that the individual bees of it stung every thing in sight; that after this colony got quieted down from its rampage it appeared on examination as if there was scarcely a bee left that had not lost its sting. Yet this colony, he says, lived and prospered, and that for weeks and weeks afterward those "stingless" bees were seen to be going to and fro from the hive as though nothing had happened. This remarkable report was later confirmed by another subscriber who had had a similar experience. But this is true: That a bee that has lost its sting, and that is subsequently caged in a mailing-cage with about a dozen perfect bees, may die in a few hours, and we have had them live two weeks, or as long as the other bees with their stings.

In the fourth class are two items in which the book is so manifestly right and the reviewer wrong that Prof. Cook will no doubt change his mind when his attention is called to them.

Referring to the picture of the glass rhombic dodecahedron, Prof. Cook says: "This figure appears to me like a small cube inside a larger one. I should consider it a right-angled figure;" and so he thinks the figure a failure. If Prof. Cook, with one eye closed, will look directly at the glass dodecahedron at the point where three faces meet, he will find that he *can* see exactly the form of a cube within a larger cube. The picture looks just

like the object; and if there is a failure it is not in the picture but in the thing pictured.

The word "jessamine" is called a case of misspelling. He says: "I think it is always spelt jasmine or jasmin." Certainly jessamine can not be spelt jasmine; so if there is any thing wrong it is not a case of misspelling, but of using the wrong word. There is no wrong word used; for under the word jessamine, in the dictionary, will be found: "The jasmine: a popular name, common in literature."

CONVENTION NOTICE.

Mr. Editor:—Many inquiries have been received by the Executive Committee of the National Bee-keepers' Association regarding the time and place for holding the next convention of the Association. The reply has generally been that Buffalo, N. Y., would be the place of meeting; but until this morning the date of meeting had not been settled upon.

On March 2d the Secretary of the American Pomological Society wrote President Root in part as follows:

"As bee-keepers and fruit-growers have many interests in common which could be considered and discussed with mutual profit, our Executive Committee has instructed me to extend to your Association a cordial invitation to hold a joint meeting at some time during our session, the exact time to be decided later by correspondence.

At this meeting we would suggest that the subjects of discussion center round the general topic of the mutual relations of bee-keeping and fruit-growing, which can be briefly treated by speakers selected in advance from among our prominent bee-men and fruit-men, . . . in order that a better understanding of these mutual relations may be reached. . . . It has been suggested that a considerable portion of fruit-growers do not yet appreciate the preponderance of the benefit derived. It is felt that a full public discussion of the subject would, therefore, result in good to both industries."

Realizing, as the Executive Committee did, that this was a golden opportunity for presenting the bee-keepers' side of the subject to the representative men of the fruit-growing industry, the invitation of the Pomological Society was at once accepted by the committee in behalf of the Association.

We have had to delay the fixing of the date for our convention until the Pomological Society had fixed their time of meeting. Our convention will be held on the 10th, 11th, and 12th of September next, commencing on Tuesday evening the 10th.

We were at first undecided as to place of meeting, hoping that the G. A. R. would meet at Denver, Col.; but when it decided to meet at Cleveland, and we received the invitation of the Pomological Society, we felt that we ought not to miss such a splendid chance to enlighten some of them on the relation of bees to horticulture, and, by meeting at Buffalo, the York State and Canadian bee-keepers would be within easy reach of the place of meeting; so we at once fixed on Buffalo as the most desirable place.

It has been decided not to have any papers or essays, but to rely wholly on the question-box to bring out the best and most important matters for discussion, so that any one not being able to be at the convention, having any question or questions he may wish to have discussed, can send them to the Secretary at any time.

The Committee has taken the liberty to request the Secretary of the Ontario Bee-keepers' Association to ask the members of that Association who may attend the meeting at Buffalo to bring their badges with them and wear them at our sessions, whether they are members of our Association or not, so that we may feel more as one, and know who our progressive neighbors are.

Information regarding place of meeting, entertainment, and railroad rates will be given as soon as decided upon. Don't be in a hurry about securing a sleeping-place during the convention. There is plenty of time, and, later on, better rates can be secured; but if you are in a hurry, write to the Young Men's Christian Association, and don't be bled by "sharks."

A. B. MASON, Sec., Sta. B, Toledo, O.



He shall be like a tree planted by the rivers of water, that bringeth forth its fruit in its season; its leaf also shall not wither.—PSALM 1:3.

Wash ye, make you clean.—ISAIAH 1:16.

I do not know but some of the friends will object to the way in which I use or apply the first of my texts above. In fact, I do not know but they will object in the same way to the second one also — some of my ministerial friends especially. I can imagine the pleasant smile I see on their faces when they see this. God knows I have a most abundant reason for feeling that the clergy of all denominations who read these Home Papers are my firm staunch friends, even if they do not always agree with my "theology." It gladdens my heart when I get their kind letters, and it gladdens my heart still more when it is my privilege, as it sometimes is in traveling, to take them by the hand and see the cordial smile on their faces as they bid me Godspeed in defending our homes. Now for my use of the text, the first one.

People who till the soil and practice thorough underdrainage have been for years annoyed by the roots of certain plants and trees going down into the tile-drains; and many of you may have noticed that at times these tile-drains get filled up and clogged with fibrous roots, and at other times they never go into the tiles at all. Somebody finally suggested that whenever tiles carry running water that goes through all summer long, the roots of a great variety of plants will get into these tiles by some hook or crook. They are after the water that can not be found anywhere else. It is not only astonishing but it is laughable to see how the rootlets will crawl all over and around the tiles, and fairly hunt for cracks or crevices. Sometimes they will find a little hole left in burning the tile. A little root will get through this opening, and then spread out two or three feet each way, filling the tile with a broomy mass of fine rootlets until it is clogged entirely. This happens oftenest when the tiles are made use of to carry away the water from a natural spring or seeping-place, say in a side-hill. In this case the tiles would carry some water all summer, and the greedy, thirsty roots have found it out. One of the remedies suggested is to get vitrified sewer-pipe with collars, filling the joints with Portland cement. But if the job is not thoroughly done, the roots will actually squeeze through this cement and break it away. Willows especially are given to this kind of work.

During my childhood days there was a pretty little spring where I often used to drink, at the foot of a hill. Somebody stuck a willow twig in the damp mud close by this spring. Forty years later this twig was a tree three feet in diameter, and the spring had disappeared. The willow-tree had sent its roots all around the sources of that spring, and finally

utilized the moisture to such an extent that it made dry ground around where there used to be a running spring and a piece of wet bog.

We are often told that sunflowers ward off or prevent malaria. At first I thought that was on a piece with other silly superstitions; but a government bulletin has recently given notice that, if you plant a number of sunflowers wher the slop-drain from the kitchen empties, these sunflowers, when they get a going, will take up every particle of the dish-water and other slops, and in this way ward off malaria. The sunflower makes its rankest growth during hot weather, when bad smells are likely to emanate wher the slop-drain empties. By the way, I have all my life enjoyed utilizing things that bother us. You know how much trouble hens make in scratching just now when we are making garden. I believe it is the neighbors' hens that make the most trouble. Well, when somebody spoke of utilizing hen power in fining up manure I thought it was a big invention, or perhaps we might say suggestion. Some years ago one of the bee-friends in commenting on the many inventions there were to get rid of the moth-worm in hives, remarked that he on the contrary was engaged in *growing* moth-worms for profit. He said if anybody knew how to get a great stock of them on short notice he would like to find it out. After we all had racked our brains to know what earthly use moth-worms could be to anybody, he said he grew them to supply fishermen; that certain fish would bite quicker at a big fat moth-worm than at any other bait. Now, on the same plan we are going to work to coax by every means in our power the pesky roots and rootlets from all kinds of plants and trees to go down into the tile. The purpose of this is sanitary drainage.

That reminds me just now that I forgot to tell you in the outset this Home Paper is devoted, at least mainly, to *sanitary drainage*, or, perhaps we had better say, utilizing the sewage that must be disposed of in some way around every home. The Department at Washington has already published two bulletins in regard to this matter, and I believe they have recommended throwing the slops out on the garden or lawn, or pouring them around the trees, first in one place and then another. But this is a lot of work for the dear little wife, or, if you choose, the dear *big* wife. (If she is large and heavy it may be still *harder* for her to get around lively with the slops.) Yes, I know some of you will rather smile (may be with a little sarcasm) because I spoke about having a *wife* do these things, and suggest it is the hired *girl's* business. My good friend, do you know of any hired girl who would carry out slops and put them first in one place and then another, or pour them around the growing trees and plants that need it? If you know of such a one, she could get a hundred situations right here in Medina, this very day. But aside from this, if we love our neighbors as ourselves we should be almost anxious (?) to save the hired girl's steps and strength as to husband the energies of the mother of the

home. If we love the dear Savior we shall be working in the interests of *all* womankind.

Well, these government bulletins, while admitting the value of the slops, rather discourage underground slop-drains and cess-pools. They do speak about tiles laid so near the surface that vegetation can absorb the fermenting liquids; but they touch on the subject only lightly. The reason why we may feel pretty sure various plants and trees will find their way into the slop drain is because there is a certain amount of moisture going though said drains every day in the year. When the roots and rootlets discover it is a daily program, they are like a lot of chickens that have become accustomed to get feed and drink at a certain spot every day—they will very soon be on hand promptly, *without fail*, and ready for business. Some years ago a friend sent us a slip of willow that he said was an excellent honey-plant. We stuck it in the ground in a damp place in the lower part of the apiary. Well, it happened to be right near the roadway to the barn; and to keep this roadway dry a tile was run through under the road. Before the willow had been there many seasons this tile would not work. It was a mass of willow roots from one end to the other. We took them out and put in larger tile, and in two years this larger tile was utilized by the willow in the same way; and during the past winter I saw a pond of water in that old spot, and I suppose we shall have another job of getting those roots out of the way. It is like the text—a tree planted by running water; and, true enough, its leaf has not withered, even in a dry time. The willow-tree has made a most astonishing growth, and is going to crowd out evergreens, fruit-trees, and every thing else, if we do not take it away.*

In my earlier experiments in sanitary drainage I had a four-inch tile leading from an outdoor slop-basin down into the orchard. In a few years it would clog up with soapsuds and other stuff. By digging a pit at the lower end, however, the soapy jellylike mass would begin to move slowly, and finally run out like sausage from a machine (I beg pardon for the illustration), and after considerable coaxing we would get the tiles clear so they could be washed out. Now, a stoppage is likely to happen to almost any slop-drain or to any outlet to the water-closet; and to guard against such stoppages it occurred to me to have the tiles gradually increase in size as they recede from the house. So I bought a lot of tiles of all sizes. Through the wall of the basement of the house, and for perhaps 12 or 15 feet, we used four-inch glazed sewer-pipe, with the ends carefully cemented. This four-inch pipe was then introduced into some six-inch tiles. We ran these tiles 15 or 20 feet, then put in a size still larger, and so on till we got up to

twelve-inch tiles, keeping them just enough under ground so the plow would not strike where we go through the orchard. I wanted some hard-burned tiles that would not be easily crushed by the weight of the horses, and so I went to the tile-factory and bought a lot of culls. They were warped and twisted by being burned too hard. Now, these warped and twisted tiles could not be fitted together so as to make a tight joint; and, in fact, I did not want a tight joint. I wanted to give every chance possible for roots to get into this slop-drain. Just a little east from the house we have a Downy ever-bearing mulberry. This tree loves water almost as well as the willow.

A little further we have a choice early apple-tree. The apparatus was arranged with the view of having these trees send their roots into the drain as much as possible. In fact, I wanted to coax all the roots into this very drain. You may ask what is to be done when the tiles are choked up with roots. Well, I decided if it did not choke up too quickly I would either clear them out or buy some more tiles and put them alongside of the filled ones, whichever was the cheapest. The apparatus has been running now for about ten years without any stoppage or any supervision whatever. The fruit-trees are making wonderful growth, and bearing grand crops of fruit. A similar arrangement was constructed for Ernest's home, the tiles being carried down through our vegetable-garden. As there were no means for carrying it as far as at my home, after it had been running four or five years he was obliged to carry it a little further, and increase the size of the tiles to 18 inches. We both use water-closets. This necessitates a large quantity of water to keep every thing well flushed. The apparatus at my own home goes down through the orchard between two rows of apple-trees, and is perhaps 300 feet in length all together. After the size of the tiles had been increased to 12 inches we used twelve-inch tiles for about 25 feet. After that we laid only a four-inch drain to carry off the comparatively clear water. This four inch drain crosses at right angles some 2½-inch drain-tiles laid through the orchard in an opposite direction. Thus you see the liquid part of the slop is gradually spread over an orchard occupying something like an acre.

This method of disposing of sewage will, of course, work best on sandy soils. With an open porous sandy soil, fewer tiles may be used, and a much cheaper arrangement. You can tell, by experimenting, the length required to get rid of all the slops. Our own ground is stiff hard clay. Of course, these slops must be carried off so far from the well that no seepage or drainage can by any possibility reach the well. We use and prefer a cistern. A government bulletin directs that the sewage should be run off on the opposite side of the dwelling from the well; that the well should be on higher ground; that the sewage should go at least 100 feet, with a good fall before it is dropped where it could by any means accumulate and ferment. I feel sure the owner of any home could manage this matter so as to utilize the fertilizing qualities of the slops,

*In the government bulletin I have already referred to, it says that low wet ground, or places where water is liable to stand and make the vicinity of the home unwholesome, may often be made dry by planting suitable trees. A good-sized maple shade-tree, for instance, planted in a wet seepy spot, will make dry ground of a place that had been, before the tree was planted, even swampy.

and at the same time save a great amount of labor in spreading it around.

If you wish to use a water-closet you will have to have some sort of reservoir, either in your attic or up high enough to give a head—that is, if your town or city does not have waterworks. The people who sell water-closet fixtures will give instructions in regard to ventilation; but I think I had better say right here that every system of sewage, such as I have described, should have traps inside of the building so that sewer-gas can never come up through the tiles. Besides this, to make it doubly sure, right where the sewer-pipe comes through the cellar wall to get outdoors under ground, there should be a standpipe running up above the roof of the house. An iron pipe two or three inches in diameter is perhaps the safest thing for this purpose. Old boiler-flues screwed together make a cheap and substantial air-pipe or vent. This, of course, passes into the open air above the building; and should there ever be fermentation anywhere in the sewage-tiles, the product goes up this pipe, and is scattered to the winds above the roof of the house.*

Now, do not object to this thing on account of expense. It pays to save the strength of the women-folks. I hardly need tell many of you what hired girls cost—not only in money, but in health, comfort, and happiness. Then heavy doctor-bills might be avoided by a little money spent in sanitary arrangements. Typhoid fevers are now *almost every time* traced directly to heedlessness in the way of sanitary arrangements. Ask your family physician about it. Read the papers, and see what has been done in the cities where yellow fever formerly raged season after season. Even the bubonic plague is now yielding to energetic and heroic treatment by our most intelligent physicians. We are certainly making great headway in the line of *prevention*, even if we are not accomplishing all we should like, in the way of *cure*.

Perhaps this Home Paper has not touched very much on spiritual matters; and, in fact, many people may think both of my texts were intended for spiritual instruction only. Granting this to be true, I am sure the great Father above delights in teaching us to protect ourselves from disease, and in keeping not only ourselves but our homes *clean* in every sense of the word.

* Mrs. Root says, since the above was written, that this arrangement is worth more than you can tell as a convenient place to pour down slops, dishwater,



MARCHANT'S PLAN OF ARRANGING HIVES, APIARY, ETC.

On page 197 of GLEANINGS for March 1st I gave a brief description of the apiary I have pictured here. Friend Marchant has movable stands for his hives, constructed as shown in Nos. 1 and 2. Two rows of stands make a double row of hives with a space between the two rows so the operator can pass back and forth without getting in front of the hives or interfering with the flight of the bees. Now, instead of having these two rows in a long string, he has them arranged in the form of a hollow square, so that half an acre of ground will accommodate, say, 200 hives, and not have them crowded either.

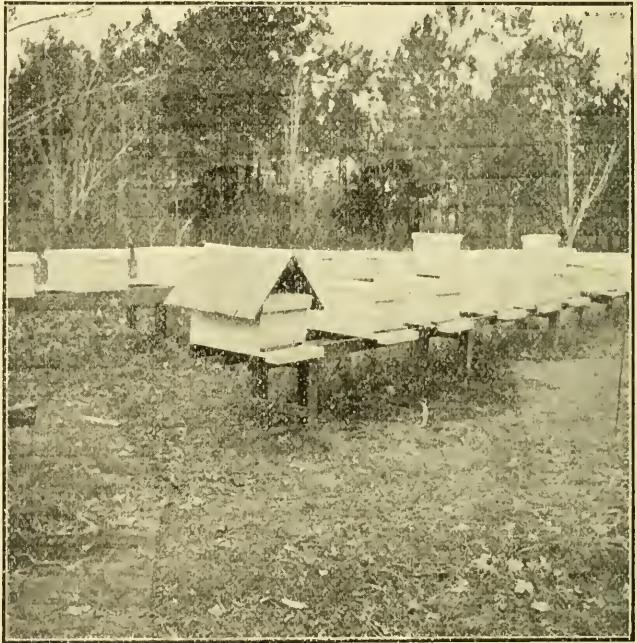

NO. 1.—A FEW HIVES OF MARCHANT'S APIARY AT MARCHANT'S LANDING, ON THE APALACHICOLA RIVER.

In No. 2 you will notice a number, 190, close by a hive in the center of the picture. These numbers are attached to the *stand* and not to the hive. If the hive is moved away, and another one put in its place, you do not have to remember to pull off the numbers and change them. Another thing, you will notice

etc., that you would not want to put into the kitchen sink. In all the years we have used it, no smell of any kind has ever been perceptible, even to the most critical nostril; and different people have been incredulous until they examined the whole apparatus most thoroughly, and yet it is within only a few yards of the kitchen and kitchen stove.

two boards or planks between the rows that form the stand. These planks are a little lower down. Now, the popular way of feeding in the South is to pour the syrup or honey on the bottom-board; but if the hive is level the feed will run out of the entrance and incite robbing. This manner of feeding is, of course, done at dusk, just after the bees have quit flying. In this manner every thing is licked up clean before morning, so there is no tendency to rob. Of course, the bottom-boards are permanent. Well, now, to keep the feed from running out at the front, the hive is pulled forward just enough to let the back end sink down and rest on the plank; and a hive may remain in this position as long as you are feeding unless you have considerable rain. If it commences raining very much you want to go around, lift up the back end of each hive, and slide it back.

Now, there is another advantage in these movable stands for hives such as I have de-

we have exceedingly high winds. If I remember correctly, friend Marchant says that, during the heat of the summer, he will put up posts and make a roof of boards to shade the hives and the operator. But this roof will be removable so it can be taken off and piled away during another fall, winter, and spring; for during winter, he says, he must have all the sunshine on the hives that can be had, and the same until the sun gets so hot that the shade-boards are an advantage.

Well, my two pictures are pretty good for a green hand with the kodak. Don't you think so? But lest you should not notice it, let me direct your attention to No. 1. It is a little like the puzzle pictures we see in some of the newspapers. If you look sharp, perhaps you will see two girls in the background. They do not belong to the bee-keeper, however. Mr. Marchant wanted to take me up to his out-apiary, a mile or more up the river. The obliging captain of a little steamer very kindly carried us up there. After

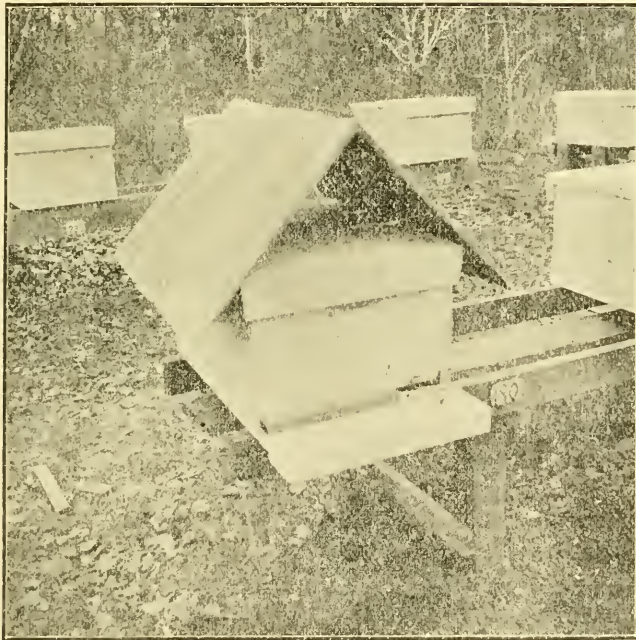

MARCHANT'S STANDS FOR HIVES, AND METHOD OF SHADING THE HIVES.

er we got back, his two little girls wanted to know if I could take their pictures. They stood up in front of Mr. Marchant's house. Well, I took their pictures, but forgot to turn the film. I insist that I did *not* forget — that I turned the film *every time*; but Ernest says that the *kodak*, like *figures*, never tells lies; and while the poor girls did not get a picture they are (after all) there just back of the hives. I wrote them the best apology I knew how to make; and next time I will try to turn off the film after I take a snap shot at the hives, especially when some good-looking little girls want their pictures taken.

At Stuart, Dade Co., Fla., I found our wide-awake veteran bee-keeper, O. O. Poppleton, as busy as usual, and actually getting honey from the Florida pennyroyal, although I rather think there is no other bee-keeper in Florida who secured any honey in the month of February. There was a very cool north wind, so the bees could not fly very much; but the hives were "chockful" of honey, and he said he would have been extracting had not the weather been so cold. This Florida pennyroyal grows more or less through the woods in many parts of Florida, but there is not such a quantity of it anywhere else that I know of as right around Mr. Poppleton's. The honey is not as light in color as some, but it is very fair, and it has a peculiar enticing flavor. We have a barrel of it on the way to Medina. When it comes I will tell you more

scribes. In many parts of Florida, ants are very troublesome. Some of the larger kind will drive out and destroy a colony of bees unless they have protection. Just put each leg of the hive-stand in a dish containing water, with a little coal oil on the surface, and the ants will be helpless so far as meddling with the bees is concerned. Last, but not least, these kodak views were taken to illustrate Marchant's method of shading. The shade-board is made of shingles, as you will notice, and their form is such that they hold their place on the hives unless

When it comes I will tell you more

about it. By the way, when I write of these honey-plants, a good many people will be sure to want seed; and this may all be very well for somebody who wants to make a collection of plants that yield honey. But it rarely if ever is the case that it will pay to plant any thing for just the honey alone. Friend Poppleton visits his out-apiaries with a gasoline-launch large enough to carry a dozen or more people; and, in fact, he uses it in bringing his bees from one locality to another, and it will carry successfully a considerable apiary.

I made a brief but pleasant call at Mr. J. E. Fultz', and another one where there was a very extensive pineapple plantation under a shed. Friend Poppleton and his neighbors claim that their locality is about the best point in Florida for growing pineapples, and also that the good ground is pretty well appropriated or held by somebody, with the expectation of getting big prices for it. I have told you something about Florida land that could be bought for £0 cts. an acre; but right near Mr. Poppleton's there is desirable property for growing pineapples, which can not be bought for \$100 an acre, even in its wild state. Owing to its proximity to the water, there is little danger here from killing frosts, even if pineapples are right out in the open air. But the sheds give better results, and are quite a protection during severe weather.

I succeeded in getting kodak views so perfect that they explain the construction of the sheds almost without any thing further. See cut adjoining.

The posts are made of some durable timber found in the woods, of such a length as to go three feet or more into the ground, and to keep the roof overhead about 8 feet from the surface. The slats are about 3 inches broad, usually of 1-inch lumber. The spaces between them are usually 3 inches, sometimes 4.

The shed pictured was constructed for a relative of Mr. Poppleton. I believe it was built under Mr. P.'s own supervision.

The second picture shows a view after the plants were pretty nearly full-sized. There are walks of different widths separating the plants into beds of perhaps 10 or 12 feet in width. Real healthy plants have sometimes spines or sharp-pointed needle-like leaves nearly as high as your head. In fact, it is somewhat dangerous business to get around among them. Friend Poppleton said there were a few ripe fruits that ought to be gathered. He said he would walk down one side of the bed and I down the other. He told

me to look out for apples that had commenced to turn. Now, I pride myself on being remarkable about keen vision, especially when it comes to picking up potatoes. Some of the boys claimed I could see a potato that was entirely under the dirt. Well, I felt sure I could find every pineapple fit to pick; but when my good friend pointed out a beautiful specimen I did not see, not over a yard from where I passed along the path, I began to think I was not so *much* smarter than common people after all.

A pineapple in bloom is a beautiful thing. Why, even if it did not bear fruit at all, I should not be surprised if the plant were grown in greenhouses just for the blossoms alone. Well, at the same time the plant is producing fruit, little plants something like suckers are growing up around the parent plant; and where the variety is valuable and high-priced, the little plants frequently bring as much money as the ripe fruit. It is no uncommon thing to have pineapples that bring

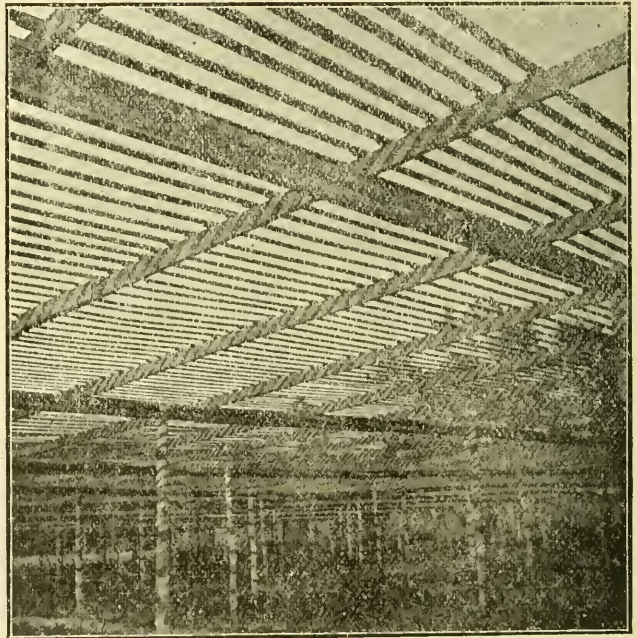

A NEW PINEAPPLE SHED, SHOWING CONSTRUCTION, AND LITTLE PLANTS JUST STARTING.

75 cents each at wholesale. Dyer Brothers, who are near neighbors to Mr. Poppleton, have sold during the past two years \$5500 worth of pineapples from about 12 acres. If I am correctly informed, a large part of the 12 acres is not yet in bearing. The pineapple grower gets some fruit in about 18 months after beginning operations, but not much before the plants are two years old. The fertilizer alone for an acre of pineapples costs about \$50 a year.

Right near his honey-house Mr. Poppleton has a little grape-fruit tree about as high as

my head, that had ten monstrous grape-fruits. Well, they were not really *hanging* on the tree, because they were so heavy that most of them rested on the ground. I took a kodak view of it; but Ernest pronounced it "no good." The locality round about Stuart will likely very soon be noted for its oranges and grape-fruits as well as for its pineapples.

Six years ago West Palm Beach was the terminus of the East Shore Railway; but the road now runs away down to Biscayne Bay, and on to Miami. I stopped one day at West Palm Beach to visit one of our Medina Co. boys, or one who used to be years ago, Mr. J. N. Parker, and also to look over the Royal Poinciana Hotel. Friend Parker is in the truck business. He grows pineapples to some extent, but does not give as much attention to it as they do in some other localities. He had some of the handsomest Irish potatoes I ever saw anywhere. At his place, for the first time, I ate guavas right from the bushes. He said it was a little early for nice ones. I spent

as large as peaches, but they look more like a potato. I found them for sale, however, on fruit-stands, and after a little practice I learned to like them tolerably well. They are rather sweet, and remind me of the mandrakes of my childhood. Once when I was a boy I got very sick by eating too many mandrakes, and therefore any thing that reminds me of this occurrence brings up recollections not exactly pleasant. If I am correct, the sapodilla is sometimes called the custard apple.

The morning I visited the great hotel I was told that 1600 people took breakfast, and that their breakfast costs the guests, on an average, \$1.00 each. It took about 400 waiters to take care of the 1600 guests. So this one hotel has a population, if that is the proper way to speak of a hotel, equal to a town of 2000. I did not get breakfast there myself, nor dinner. The dinner costs more than a dollar if I am correctly informed. But I very much doubt if anybody enjoyed his dinner more than I did mine. Shall I tell you what it was? I went to a fruit-stand and bought a nice ripe pineapple for 15 cents. Then I went to a restaurant and asked for some bread and butter. For a nickel I got a great plateful of bread and plenty of nice butter. The pineapple was both food and drink, and so I did not have any tea or coffee, and certainly did not *want* any. When the proprietor said five cents paid for the bread and butter I gave him another nickel for clearing up the remnants of my pineapple. Well, I had several meals of just pineapple and bread and butter; and I have a sort of notion in my head that such a diet would agree with me to a dot, three times a day, the year round; and I have been planning to take, some time, a vacation, and live on pineapples and bread and butter for several days, and prove to the world that such a diet is ample. Oh dear me! how many things there are I

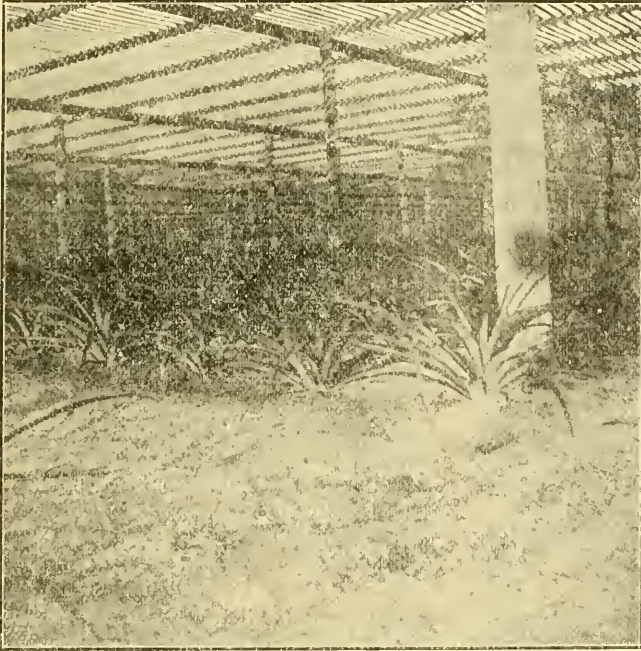

ANOTHER VIEW, SHOWING LARGER PLANTS.

half a day very pleasantly, and I think profitably, in looking over the wonderful tropical gardens belonging to the Royal Poinciana. Here we find almost every tropical plant known in any part of the world, and, better still, every plant, from the smallest flower to the largest tree towering away up toward the sky, and each plant, tree, or bush, is plainly labeled with the common name, and also the Latin name. In fact, it is quite a school to go over the grounds and learn by practice to call by name all these exotics by sight. Of course, you can not pick the fruit. I was greatly interested in the sapodilla-tree. The fruits are

should like to try if this busy world's cares did not stand in the way!

There is quite a pretty zoological garden connected with the Royal Poinciana; there is also an aquarial garden; but it is not taken care of as it might be, notwithstanding somebody is constantly on hand to take the 25 cts. one has to pay to look through it.

During the past few years, the Royal Poinciana has been enlarged by a sort of annex hotel that they call the Breakers. I believe the expense of stopping at the Breakers is a little less. It is not worth while, however, to find fault with high prices while everybody,

high or low, rich or poor, is permitted to ramble at will all over the beautiful premises, without a cent of expense.

Just now another magnificent structure, employing a small army of mechanics and laborers, is in process of construction. They were just laying the foundation for this building at the time of my visit. I was told it was to be the palatial residence for Mr. Flagler, the owner of the East Coast Railway. He is the owner, also, of half a dozen or more of these palatial hotels that accommodate people enough during the height of the season to make a fair-sized city.



DOES IT PAY TO HAVE SOME APPLE-TREES?
THE RAWLES GENET.

After planting an orchard of 100 trees we waited almost ten years before we had apples of any account; but now our orchard begins to do us some good. Last year we had two trees that gave us a heaping ten bushels each. That is not very much; but these apples now, toward the middle of April, are just as plump and crisp as if they had just come from the tree—yes, a good deal more so, because late in the fall, when picked, they were too hard to be fit for any thing. They are the variety called Rawles Genet. When the trees first began to bear I thought so little of them I wondered why anybody should want such a miserable, hard, worthless apple. The value of this apple, however, is something like that of the Kieffer pear. The trees are loaded down every season ("Never-fail" is another name for it), and the apple is a better keeper than any thing else I know of. But I made a big mistake last season that I did not pick off more than half the apples. Had I sorted out the gnarly ones, and small imperfect ones, where there were too many on the limbs, I think I should have more bushels, and all big nice smooth apples. We have got to come to hand-picking and thinning if we want to produce the finest high-priced fruit. Well, even as it is, these two trees gave us pretty nearly \$10.00 worth of apples each. In fact, the apples would bring more than a dollar just now, and there is not a bit of trouble in keeping them till May—at least, we have never had any trouble. Another thing, will it pay to plant fruit-trees when you are over 60 years old? I got to thinking of this because I have just ordered a lot of trees from a nursery, to be shipped to our Michigan ranch.

MY NEW TRAP NEST.

On page 160 one of the friends, you may remember, asked me to "walk around the stairway" and study up a cheap and efficient trap nest. I have, therefore, given the matter some thought, and have produced a very cheap one, and one that works so nicely I feel like shout-

ing "Eureka!" as did the philosopher of olden times. Perhaps, however, I had better hold back my enthusiasm a little until I see how it works in the hands of others, and how it stands the keen scrutiny of *bona-fide* poultry-men.

In the first place, you want to get a light box at the store or grocery. For small-sized hens an oblong box a foot wide, a foot deep, and 2 feet long, will do very well. But for medium fowls it had better be 13 inches wide and deep, inside measure, and 2 feet long. For some of the large breeds, 14 inches wide and 13 deep will be better.

The diagram below will make it plain, I think.

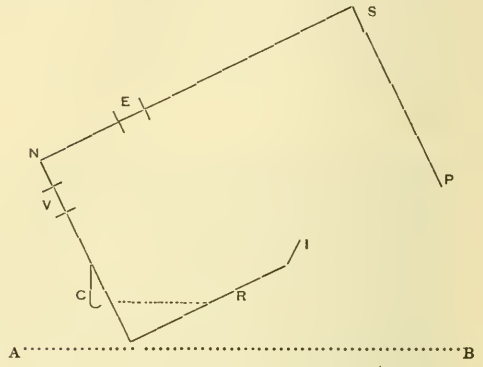

TRAP NEST UNDER A GROCERY BOX.

Let the dotted line AB represent the ground or floor of the poultry-house. Now let CPSN represent our drygoods box. Turn it upside down and cut off the lower corner down through on the line CR. Now fit a board in this opening so as to take the place of this dotted line CR. Now drop your box down on to this cut-away corner, and it will stay in position providing you put weight enough on CR to hold it down flat. For illustration, suppose we put a flatiron or a suitable-sized stone right in on the line CR. In this position it would be just the thing for a hen's nest or just such a nest as any hen likes. Suppose she is hunting for a nest, and walks along the line AB until she puts her head under at P. Of course, we have to make a bottom for the nest, with a board nailed in so as to have a bottom, IR, joining the dotted line CR. This bottom of the nest need not be tight. In fact, it is better to have cracks so the litter can sift out. Put in some leaves, cut straw, or excelsior; then a nest-egg, or two, if you choose, to get her started. She walks up under P, looks over the strip of board at I, and steps up on it to get into the nest. As soon as she steps on I, the box tilts and shuts her in. In the diagram, I is shown higher up from the ground than it really is; because, when that corner is sawn off, the dotted line CR rests on the dotted line AB.

Well, that stone or flatiron that I told you to put on the bottom CR is rather in the way, so we will have some iron rods for a weight, and we slide them into a sort of shelf shown at C. This shelf is made of a strip of tin

or galvanized iron rolled up like the cut at C, tacked on to the back end of our box. These rods are for weights so the box will just tip up enough to let the hen get into the nest. You can get the rods at any old iron heap. Have a blacksmith cut them off a foot or 14 inches in length. I would use these instead of one weight, because with a hen sitting you need more "ballast" than when there is only an egg or two, or three eggs, laid in the trap nest every day. You need not say it will not work, for it has been working to perfection for the past two weeks.

E and V are openings large enough for you to put your hand in to get the eggs every night; for I have found by experience that it is rather tiresome reaching over the front board I to get the eggs just above R. Whenever a hen is on the nest, the box tips down and is closed. No other hen can get in until this one gets off. When a sitting hen is off, some other hen might get in and lay an egg, it is true. But that is the case with any trap nest. The only remedy is to have the sitting hen let loose in a little yard or pen for her exclusive use. For my part, however, I like to see a sitting hen get off and have a good run, and have exercise as well as food and drink.

Some of you may say right here, "But, hold on, Bro. Root; this is not a trap nest at all;" to which I own up; but it is just such a nest as Fred Gundy describes, or perhaps, rather, it accomplishes the same result, and his nest costs a dollar to "know how." Besides, you can make a trap nest of this kind in almost no time.

You will notice the hook-shaped shelf near the letter C has an opening between the lower edge and the box. Select a single iron rod, just heavy enough to bring up the box nicely when the hen is off. Now bend the lower edge of the tin shelf so this rod will drop down on the ground as soon as the weight of the hen tilts the box down in the closed position. In this case the hen stays under the box until her owner picks the rod off from the ground and lays it on the shelf again. You might have a latch at P to snap on the box and catch it when it shuts down. But with this you would need to fit it on a permanent floor. With my arrangement you can pick the box up and move it wherever you like, and set it on some smooth ground or on the floor. In order to avoid having a heavy weight to raise the box up, the box should be of very light stuff— $\frac{1}{2}$ -inch sides, with all the rest $\frac{1}{4}$ or $\frac{3}{8}$, will do very well. In fact, a box made of veneer is as good as any thing. If you make a box on purpose you might round off or bevel the corners SN. Or instead of a box you could use a light basket. But a basket usually costs more than a box. I found an oblong bushel basket that makes a splendid trap nest.

Now, when you use a basket that is hardly deep enough, or if the grocery-box you get hold of is hardly deep enough, there is another way that will enable you to use your shallow box without cutting it at all, and this same arrangement is used for the basket. To do this, get two triangular pieces of wood like DBC in the diagram above.

Place them the right distance apart, then nail thin boards between the two, at C, B, and D, making the bottom of the nest. The boards at C, B, and D are lapped over the two side boards. The piece at I will need to be a little heavier, so you can nail through D, B, and C into the end of I. Now this arrangement is to be nailed secure to the open side of your box. Tip the box over, and you have your trap nest as first described. If you use a basket, this arrangement in Fig. 2 is to be fastened to the sides of the basket. Tip the basket over, and your trap nest is all complete like broken line over Fig. 2.

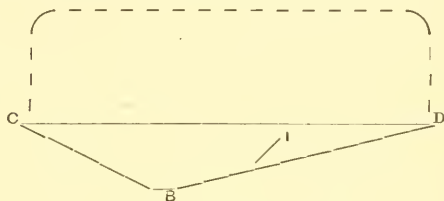

FIG. 2.—TRAP NEST WITH BASKET INSTEAD OF BOX FOR TOP.

In Fig. 2 the diagram represents the angle at B rather too sharp. It wants to be just right so that, when the nest rests on the base CB, D will be just high enough for the hen to stoop down and get under. You may say a hen will not go into such a place. That is because you do not know hens and do not know how to manage them. They are the easiest animals to teach any sort of trick, in the whole wide world, if you just take them right. When your nest is new, prop it up with bricks so that the hen can go under the edge of the box without ducking down at all. After she has got on the nest and laid one egg, she will do it next day sure. Then drop the box down a little, and she will be willing to stoop a little lower each time. Make the angle at B so that, when the nest is set ready for the hen, it will be just as low as she can get under D without too much squeezing. She will like it all the better if it is a little bit difficult to get into. The objection to having the box raised up too high is that changing from one base to the other makes too much "jostling" for the eggs. When you get this angle at B just right, it does not disturb the eggs at all when the hen steps on top of the threshold at I. Somebody will be sure to say a spring will be better than the weight I have arranged. Yes, it is a very easy matter to have a coiled spring of just the right tension from A to N, Fig. 1. But you can not move the nest around where you wish, and you have got to have a floor board under it at AB. If you do not want to bother with a coiled spring, just take a springy hickory stick and push it in the ground along the line CN; but I prefer the weight.

If you prefer a spring instead of a weight, in order to make it trap the hen, you must arrange so the spring will slip off or let go when she steps on the edge of the nest. Attach the basket to the nest proper with four pieces of annealed wire.



At the present writing there are a lot of new methods of treating disease, and people are sending their money and telling of the wonderful cures performed. Yes, you will meet somebody at every turn who will say something like this: "Well, I was just as skeptical as you are or anybody could be; but when I saw what was done right under my own eyes, I had to give up." And so it goes. A woman said a few days ago, in regard to so-called Christian Science, that, just as soon as she wrote to a certain great doctor, and described her troubles, just the minute he got her letter and understood the matter, she was well at once, and he was hundreds of miles away.*

Well, these wonderful cures do tell us something—in fact, they *ought* to tell us something—more especially the fact that all kinds of doctors and *doctrines* seem to cure just the same. It reminds me of a clerk in a drug-store who said he had noticed that, no matter what sort of patent medicine the ailing customer purchased, they all got better. Now, the wonderful lesson these facts ought to teach us (and I admit there *are* facts all around us), is that our troubles are either imaginary or else they are in some strange way so dependent on the will or the mind that a certain kind of shaking up, call it "faith" if you will, either in the doctor or in the medicine, produces wonderful results. There is something exceedingly fascinating in this matter. I do not understand it myself; and I fear I, too, have sometimes been carried away by these new treatments, or whatever else you may call it. May God help us in our efforts to sift truth out of so much fiction and superstition.

MORE ABOUT TOMALES.

Last week Bro. Root took a look over the Southern country, and entertained us with a very readable article, but he got terribly mixed up when he had Indians making his hot tomares. He must have meant Mexicans. An Indian knows as little about making tomares as a boy does about bee-keeping. The Mexican has the exclusive right to the tomale manufacture. No one is a success at the tomares and chillikin carne except them. R. C. MCPHAILL.

Graham, Tex., Mar. 21.

[Friend M., I stand corrected, and thank you for the correction; but, notwithstanding, the Indians certainly do pound up corn. In fact, we find these old stone basins scattered all over the deserts of Arizona, and this pounded corn is then made into a special cake. I can not remember the names, but you doubtless know all about it. Well, my impression was that the tomale was the same thing, only a little more elaborate, with chicken meat, etc.—A. I. R.]

* I should like to give the names of some of the new methods of treatment of disease, but I am afraid I should hurt the feelings of some of my near and dear friends. The new doctors are certainly getting *piles of money*, but I really fear the patients are *not* getting any just equivalent.

Much has been said, and is being said continually, of the advantage of feeding poultry green bone cut with the various bone-cutters on the market; but I had not thought of it before, that manure from bone-fed poultry has a special value over other poultry manure. In commenting on this matter the *Ohio Farmer* has the following:

Here is a pointer for poultrymen. The manure from such feeding is worth twice the cost of the bone at the meat-markets, and is worth all it costs as an egg-producer in addition, and the soft ration is balanced by the addition of potash.

Books for Bee-keepers and Others.

Any of these books on which postage is not given will be forwarded by mail postpaid, on receipt of price.

In buying books, as every thing else, we are liable to disappointment if we make a purchase without seeing the article. Admitting that the book-seller could read all the books he offers, as he has them for sale, it were hardly to be expected he would be the one to mention all the faults, as well as good things about a book. We very much desire that those who favor us with their patronage shall not be disappointed and therefore we are going to try to prevent it by mentioning all the faults, so far as we can, that the purchaser may know what he is getting. In the following list, books that we approve we have marked with a *; those we especially approve, **; those that are not up to times, †; books that contain but little matter for the price, large type, and much space between the lines, ‡; foreign, §. The bee-books are all good.

As many of the bee-books are sent with other goods by freight or express, incurring no postage, we give prices separately. You will notice that you can judge of the size of the books very well by the amount required for postage on each.

BIBLES, HYMN-BOOKS, AND OTHER GOOD BOOKS.	
Postage.]	[Price without postage.
8	Bible, good print, neatly bound..... 20
10	Bunyan's Pilgrim's Progress**..... 40
	Christian's Secret of a Happy Life,** 50c; cloth 1 00
3	John Ploughman's Talks and Pictures, by Rev. C. H. Spurgeon*..... 10
1	Gospel Hymns, consolidated, Nos. 1, 2, 3, and 4, words only; cloth, 10c; paper..... 5
2	Same, board covers..... 20
5	Same, words and music, small type, board cov. 45
10	Same, words and music, board covers..... 75
3	New Testament in pretty flexible covers..... 05
<i>One-third off on all Gospel Hymns mentioned above.</i>	
5	New Testament, new version, paper covers..... 10
4	Stepping Heavenward**..... 18
5	Tobacco Manual**..... 45

This is a nice book that will be sure to be read, if left around where the boys get hold of it, and any boy who reads it will be pretty safe from the tobacco habit.

BOOKS ESPECIALLY FOR BEE-KEEPERS.

20	A B C of Bee Culture, cloth..... 1 00
	Advanced Bee Culture, by W. Z. Hutchinson ... 50
3	Amateur Bee-keeper, by J. W. Rouse..... 22
14	Bees and Bee-keeping, by Frank Cheshire, England, Vol. I., §..... 2 36
21	Same, Vol. II., §..... 2 79
	Same, Vols. I. and II., postpaid..... 5 25
10	Bees and Honey, by T. G. Newman..... 65
10	Cook's Manual, cloth..... 1 15
5	Doolittle on Queen-rearing..... 95
2	Dzierzon Theory..... 10
3	Foul Brood; its Natural History and Rational Treatment..... 22
1	Honey as Food and Medicine..... 05
10	Langstroth Revised, by Chas. Dadant & Son..... 10
15	Quinby's New Bee-keeping..... 90
	British Bee-keeper's Guide-book, by Thomas William Cowan, England §..... 40
	The Honey-bee, by Thos. William Cowan..... 95
3	Merrybanks and His Neighbor, by A. I. Root... 15
	Bienenzucht und Honiggewinnung..... 50
	Or "Bee Culture and the Securing of Honey," a German bee-book by J. F. Eggers, of Grand Island, Neb. Postage free.

MISCELLANEOUS HAND-BOOKS.

5	A B C of Carp Culture, by Geo. Finley..... 25
5	A B C of Strawberry Culture,** by T. B. Terry.. 35

Probably the leading book of the world on strawberries.

5 | A B C of Potato Culture, Terry**.....35
This is T. B. Terry's first and most masterly work.

1 | Barn Plans and Out-buildings*.....1 50
2 | Canary birds, paper 25
2 | Celery for Profit, by T. Greiner**..... 50
The first really full and complete book on celery culture, at a moderate price, that we have had. It is full of pictures, and the whole thing is made so plain that a schoolboy ought to be able to grow paying crops at once without any assistance except from the book.

15 | Draining for Profit and Health, Warring.....1 35
10 | Fuller's Grape Culturist**.....1 15
8 | Domestic Economy, by I. H. Mayer, M. D.**... 30
This book ought to save at least the money it costs, each year, in every household. It was written by a doctor, and one who has made the matter of domestic economy a life study. The regular price of the book is \$1.00, but by taking a large lot of them we are enabled to make the price only 30 cents.

10 | Farming for Boys*.....1 15
This is one of Joseph Harris' happiest productions, and it seems to me that it ought to make farm-life fascinating to any boy who has any sort of taste for gardening.

7 | Farming with Green Manures, postpaid**..... 90
7 | Farm, Gardening, and Seed-growing**..... 90
12 | Gardening for Pleasure, Henderson*.....1 35
12 | Gardening for Profit**.....1 35
8 | Gardening for Young and Old, Harris**.....1 25
This is Joseph Harris' best and happiest effort. Although it goes over the same ground occupied by Peter Henderson, it particularly emphasizes thorough cultivation of the soil in preparing your ground; and this matter of adapting it to young people as well as old is brought out in a most happy vein. If your children have any sort of fancy for gardening it will pay you to make them a present of this book. It has 187 pages and 46 engravings.

3 | Grasses and Clovers, with Notes on Forage Plants..... 20
This is by Henry A. Dreer, author of the book, "Vegetables Under Glass" that has had such a large sale of late. This little book tells how six tons of grass has been grown to the acre, and gives much other valuable matter.

10 | Greenhouse construction, by Prof. Taft**.....1 15
This book is of recent publication, and is as full and complete in regard to the building of all glass structures as is the next book in regard to their management. Any one who builds even a small structure for plant-growing under glass will save the value of the book by reading it carefully.

12 | Greenhouse Management, by Prof. Taft**.....1 15
The book is a companion to Greenhouse Construction. It is clear up to the times, contains 400 pages and a great lot of beautiful half-tone engravings. A large part of it is devoted to growing vegetables under glass, especially Grand Rapids lettuce, as well as fruits and flowers. The publisher's price is \$1.50; but as we bought quite a lot of them we can make a special price as above.

5 | Garden and Farm Topics, Henderson**..... 60
5 | Gregory on Cabbages, paper* 20
5 | Gregory on Squashes, paper*..... 20
5 | Gregory on Onions, paper*..... 20
The above three books, by our friend Gregory, are all valuable. The book on squashes especially is good reading for almost anybody, whether they raise squashes or not. It strikes at the very foundation of success in almost any kind of business.

5 | Handbook for Lumbermen..... 05
5 | Home Pork-making; 125 pages, illustrated..... 40
I think it will pay well for everybody who keeps a pig to have this book. It tells all about the care of the pig, with lots of pictures describing cheap pens, appliances, all about butchering, the latest and most approved short cuts; all about making the pickle, barreling the meat, fixing a smoke-house (from the cheapest barrel up to the most approved arrangement); all about pig-troughs; how to keep them clean with little labor; recipes for cooking pork in every imaginable way, etc. Publisher's price is 50 cents, ours as above.

10 | Household Conveniences.....1 40
15 | How to Make the Garden Pay**.....1 35
2 | How to Propagate and Grow Fruit, Green*..... 15
2 | Injurious Insects, Cook.....1 10
10 | Irrigation for the Farm, Garden, and Orchard*1 10
By Stewart. This book, so far as I am informed, is almost the only work on this matter that is attracting so much interest, especially recently. Using water

from springs, brooks, or windmills to take the place of rain, during our great drouths, is the great problem before us at the present day. The book has 274 pages and 142 cuts.

3 | Maple Sugar and the Sugar-bush**..... 32
4 | Peabody's Webster's Dictionary..... 10
Over 30,000 words and 250 illustrations.

5 | Manures; How to Make and How to Use Them; in paper covers..... 30
6 | The same in cloth covers..... 65
1 | Nut Culturist, postpaid.....1 50
3 | Onions for Profit**..... 40
Fully up to the times, and includes both the old onion culture and the new method. The book is fully illustrated, and written with all the enthusiasm and interest that characterizes its author, T. Greiner. Even if one is not particularly interested in the business, almost any person who picks up Greiner's books will like to read them through.

1 | Our Farming, by T. B. Terry**..... 1 50
In which he tells "how we have made a run-down farm bring both profit and pleasure."
If ordered by express or freight with other goods, 10c less.

1 | Poultry for Pleasure and Profit,**..... 10
8 | Practical Floriculture, Henderson*.....1 10
10 | Profits in Poultry,* 75
1 | Silk and the Silkworm 10
10 | Small-Fruit Culturist, Fuller 1 10
2 | Sorghum, Stock Beets, Strawberries, and Cement Floors. By Waldo F. Brown..... 08
10 | Talks on Manures* 1 35
10 | The New Agriculture; or, the Waters Led Captive (a \$1.50 book) 40
11 | The New Egg-Farm, Stoddard**..... 70
This is an enlarged edition of the 50-cent book published 25 or 30 years ago by H. H. Stoddard. If I could have only one poultry-book it would be the New Egg-farm. This book is of special value to me because it not only discusses most emphatically the value of exercise to poultry, but it touches on the value of exercise to all other animated nature including humanity. The book has over 300 pages and 150 illustrations. It is entirely different from any other poultry-book in the world, inasmuch as it discusses mechanical contrivances so that all the varied operations of a poultry-farm may be done as much as possible with the aid of machinery. The regular price is \$1.00, but by buying a quantity we are able to furnish it at price given.

2 | Treatise on the Horse and his Diseases..... 10
5 | Tile Drainage, by W. I. Chamberlain 35
Fully illustrated, containing every thing of importance clear up to the present date.
The single chapter on digging ditches, with the illustrations given by Prof. Chamberlain, should alone make the book worth what it costs, to every one who has occasion to lay ten rods or more of tile. There is as much science in digging as in doing almost any thing else; and by following the plan directed in the book, one man will often do as much as two men without this knowledge.

5 | Tomato Culture 35
In three parts. Part first.—By J. W. Day, of Crystal Springs, Miss., treats of tomato culture in the South, with some remarks by A. I. Root, adapting it to the North. Part second.—By D. Cummins, of Conneaut, O., treats of tomato culture especially for canning-factories. Part third.—By A. I. Root, treats of plant-growing for market, and high-pressure gardening in general.

3 | Vegetables under Glass, by H. A. Dreer**..... 20
3 | Vegetables in the Open Air*..... 20
This is a sort of companion book to the one above. Both books are most fully illustrated, and are exceedingly valuable, especially at the very low price at which they are sold. The author, H. A. Dreer, has a greenhouse of his own that covers one solid acre, and he is pretty well conversant with all the arrangements and plans for protecting stuff from the weather, and afterward handling to the best advantage when the weather will permit out of doors.

3 | Winter Care of Horses and Cattle..... 25
This is friend Terry's second book in regard to farm matters; but it is so intimately connected with his potato-book that it reads almost like a sequel to it. If you have only a horse or a cow, I think it will pay you to invest in a book. It has 44 pages and 4 cuts.

3 | Wood's Common Objects of the Microscope**.. 47
8 | What to Do and How to be Happy While doing It, by A. I. Root 65

The A. I. Root Co., Medina, O.



DEAL DIRECT

**with the
Makers.**

When you buy a carriage, buggy or harness. Choose from the biggest stock and fullest assortment, and pay only the cost of making, with but one moderate profit added. Our plan of selling direct from the factory insures satisfaction—your money back if you're dissatisfied with your purchase—and enables you to **save the dealer's profit.**

No. 3034 Buggy. Price \$38.30 with leather quarter top.

Our complete illustrated catalogue, showing many styles of high grade vehicles, harness, robes, blankets and horse equipments, with detailed descriptions of each, mailed free. Write for it and learn how cheaply you can buy when the jobber's and dealer's profits are cut off.



THE COLUMBUS CARRIAGE AND HARNESS CO., Box 772, Columbus, O.

No. 240. Single Strap Buggy Harness. Price \$7.95.

WE CAN'T STRIKE A BALANCE

on this vehicle. The quality outweighs the price. The balance is always in your favor on our line. ~~Why? Because we make the highest grade of goods and sell them to you direct at factory prices, saving you the two profits of the jobber and dealer. Besides all this we send any vehicle on 10 days free trial. If not entirely satisfactory, return it at our expense. Can you ask more? Write for catalog.~~

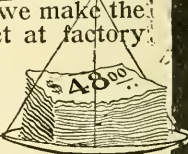
Kalamazoo Carriage and Harness Company,
Box 22, Kalamazoo, Mich.



28 Years' Experience

SELLING DIRECT.

We manufacture 178 styles of vehicles and 65 styles of harness and we sell direct to you at wholesale prices.

WE HAVE NO AGENTS

and are the largest manufacturers of vehicles and harness in the world selling to the consumer exclusively. We give you the advantage of the largest selection. You run no risk for we ship anywhere with privilege of examination, guaranteeing safe delivery. Our line consists of Rockaways or Depot Wagons, Surreys, Traps, Phaetons, Spiders, Stanhopes, Driving Wagons, Open and Top Road Wagons, Spring Wagons, Delivery Wagons, Milk Wagons, Wagonettes, and all styles of harness. Send for our large illustrated catalogue—FREE.

Elkhart Carriage and Harness Manfg. Co.
W. C. PRATT, Secy. **ELKHART, INDIANA.**

The Review for 1901.

The Bee-keepers' Review for 1901 has turned over a new leaf, taken up new lines, and entered a broader field. While it continues to give methods in detail, it is striving to arouse and encourage bee-keepers; to inspire them; to awaken them; to set them to thinking; to lead them to change the uncertainties of a few bees in one locality for the certainty of many bees in several localities; to organize and co-operate; to rise up in their might, and sweep contagious diseases of bees out of this country; to work for the improvement of their stock, and to comprehend that the conditions of bee-keeping are constantly changing; and that, in order to succeed, they must keep up with the times.

Even old bee-keepers, those who have kept bees and read journals for years, are aroused to enthusiasm by the reading of the last few issues of the Review. Several have written that it seemed to them that the last two or three issues contained more practical, solid, condensed, valuable information than they had ever before found in the same number of issues.

The Review for 1901, and 12 back numbers, for only \$1.00. For \$2.00 I will send the back numbers, the Review for 1901, and a queen of the Superior Long-tongue Stock.

W. Z. HUTCHINSON, Flint, Mich.



THE DZIERZON THEORY.

This little pamphlet has been out of print for a few months, and numerous orders for it have not been supplied. We have just printed another small edition, and are now prepared to furnish it again.

A B C OF POTATO CULTURE AND A B C OF STRAW-BERRY CULTURE.

We are now at work on a new edition of both of these works, as the old ones are practically exhausted. It will be several months before both books are completed. Orders will be filled with the old edition as long as they last, unless you specify, when you order, that you want the new edition, when ready.

WINDOW GLASS ADVANCED AGAIN.

We have received notice of another advance in the price of window glass, taking effect May first, which increases the price 5 per cent over the price in effect during the past month. We have also had notice of an advance of 25 cts. per gross on Mason fruit-jars; but we make no change in our prices quoted in last issue, for the present at least. We advise those in need of jars this season to place their orders before we are obliged to advance prices. There is no prospect of any lower prices.

A MATTER OF VITAL IMPORTANCE TO WESTERN BEE-KEEPERS.

In our last issue we stated that there would be an attempt made, probably, to raise the freight rate on comb honey from its present rate of 1½ times first class to double first class, whether the glass was exposed or not. This, according to Mr. York, of the *American Bee Journal*, "would well-nigh strangle the honey business * * * on long hauls," and he is right. This is a most serious matter for our Western bee-keepers, and while it would not affect the carload-commodity rate, yet a most vigorous protest should be sent in at once.

The next meeting of the Classification Committee will take place May 7, at the Hotel del Monte, Monterey, Cal. We suggest that comb honey producers and commission merchants of the West, at least (as it is too late to send letters) fire telegrams on or before May 7 to Chairman J. T. Ripley, of the Western Classification Committee, at Hotel del Monte, Monterey, Cal. Make the telegram read something like this:

"We protest against proposed raising of rate on comb honey."

Or word a telegram like this:

"Don't raise rate on comb honey; would ruin our business."

Or this:

"Raising rate on comb honey would handicap large industry."

These are only samples of wording that may be used, but don't adopt the exact wording; but every producer in the West should send a telegram as above directed. Do not assume that the "other fellow" will do it for you. This is bread and butter to you, and you must fight for your rights. If several hundred telegrams are fired into headquarters, prepaid (don't forget that, even if it does cost a dollar or more), it will cause the committee to know that bee-keepers represent a large industry, and that that industry must not, even in the interests of railroads, be handicapped in the manner proposed.

Special Notices by A. I. Root.

VEGETABLE-PLANTS—GOLDEN SELF-BLANCHING CELERY.

Owing to the press of other business we have been obliged to discontinue the vegetable-plant business, as our friends will notice; but we have now on hand a very nice lot of Golden Self-blanching celery-plants. Prices: 5 cts for 10; 40 cts. per 100; \$3.00 per 1000. If wanted by mail, add 5 cts. for 10, or 25 cts. per 100.

SEED POTATOES.

Our seconds are practically all sold out with the exception of the Early Ohio. For prices see page 357, last issue. Of the firsts, we have more or less of every thing except Maule's Commercial and Lee's Favorite. They are still in excellent condition, with scarcely a sprout started.

WHITE BLISS TRIUMPH POTATOES—REDUCED PRICES.

We have just purchased a lot of these from a bee-keeper in Wisconsin who said the people there would not buy them because they are white. Red Bliss Triumphs were all right, but they did not want white ones. It is funny what strange people there are in this world of ours. Well, these potatoes are so handsome we paid him a little more per bushel than we agreed to. They are good size, smooth, firm, not sprouted a particle, no scab, and yet we can make the same price as for the Early Ohio; viz., barrel, \$2.50; bushel, \$1.00; half bushel, 60 cts.; peck, 35 cts. I need not remind you this is at the present time, probably, the earliest potato in the world. It is the potato that is grown most successfully in the Bermudas, only they grow the red ones. The white ones have been, with great pains, grown as a sport from the red, and in most markets command a *higher* price than red potatoes.

PRACTICAL SUGGESTIONS FOR FARM BUILDINGS.

This is the title of Farmers' Bulletin No. 126, from the Department of Agriculture, Washington. You know I am specially interested in this matter just now, as I am getting ready to put up a cheap building off in the woods. This bulletin has 48 pages, and a lot of engravings and diagrams. It is so extremely practical that it commences by telling the farmer the importance of having a perfect title to his land before he begins to build. Then the place for locating the home is discussed most thoroughly; the advantages of hillside slope, proximity to timber; shade trees, the well, kitchen, garden, distance from the road, and all these things. Then they give a picture of a house that can be built for \$600, planned specially to put on an addition costing \$500 more when the farmer can better spare the means, and when his family begins to be a little larger. Every thing is figured up, not only for every piece of timber, but for nails, lath, and hinges, with a sensible discussion, not only in regard to the best and cheapest ways for building a house, but it considers precautions against fire, and how to warm the building in the best and safest way. The latter part of the book touches on barns and out-buildings, with plans and specifications. I for one feel very thankful to Uncle Samuel for this practical, sensible bulletin. You can all have it free of charge by applying to the Secretary of Agriculture, Washington, D. C.

HIGH-PRESSURE GARDENING; THE NEW RHUBARB CULTURE.

I do not know but some of the friends will complain that the department of High-pressure Gardening in this number is pretty well occupied by that trap nest. Well, I have just now in my hands a new book from the O. Judd Co. that I think is going to give high-pressure gardening a big lift. We have had the "New Onion Culture" and the "New Celery Culture," but the "New Rhubarb Culture" is going, in some respects, to beat them all, because it can be worked every day in the year, like the "hen business." See? I do not know when I have been so much taken up with a book, unless it was the *New Egg-farm*; but I feel sure, from what I have done with rhubarb, there is no myth about it. Whenever apples are worth a dollar a bushel or more, winter-grown rhubarb should pay big. It does not require an expensive house nor costly appliances. Any sort of cellar where it will not freeze is all right for it; and the small amount of heat necessary to force the rhubarb costs very little. The book is largely made up from reports of the work done by our experiment stations. One thing particularly comes out sharp and clear: Before forcing rhubarb the roots must be thoroughly frozen; and the best way to do it is to plow them out in the fall in great clumps and let them freeze through and through; then bring them into the cellar and you can in a very short time get great leaf-stalks two feet long or more, and larger than any thing you ever saw outdoors. Besides that, the quality for pies or sauce is away ahead of any outdoor-grown plants. There is already a big demand in the cities for winter-forced rhubarb.

You want the book right off, so as to sow your seed and start your plants. With ground rich enough you

can grow roots that will give a "crop of pies" next winter.

The book is nicely bound in cloth, full of illustrations, mostly photos from real work, 130 pages, and yet it is offered at the low price of 50 cts. We let the readers of GLEANINGS have it for 40 cts—5 cents more if wanted by mail. Or we will send GLEANINGS one year, and the book, postpaid, for \$1.25. Every market-gardener should have this book, for the lessons taught indirectly, in regard to forcing other crops besides rhubarb.

LEAFLETS AND PAMPHLETS FOR FREE DISTRIBUTION.

For some time back, both Ernest and myself have been having extra copies struck off, of articles appearing in GLEANINGS on subjects that there is very much inquiry about. As an illustration, so many have been asking about sweet clover, where it would grow, what it is good for, etc., that we made a collection of articles from different writers, and put them in the form of a little pamphlet. We have also similar leaflets or pamphlets on spraying fruit-trees while in bloom, on bees and fruit, bees and cider-mills, etc., besides the leaflets mentioned in our seed catalog. Below we give a list of every thing we have in stock. These have been used mainly heretofore to mail to people who made inquiries about things that had been thoroughly written up in GLEANINGS; but I have thought best to offer them free of charge to anybody who may want them. They are intended to be given free of charge only to those who subscribe for GLEANINGS; therefore our subscribers need not take the trouble to send stamps unless they choose to do so. Just tell us on a postal what leaflet or leaflets you want, and they will be mailed you. If you want to help us in this work of educating the rising generation, free of charge, you can do it by recommending and helping to extend the circulation of GLEANINGS. Below is our list:

LEAFLETS ON HONEY-PLANTS,—THE CLOVERS.

White Dutch Clover; Alfalfa, or Lucerne, or Scarclet; Sweet, or Bokhara (the latter is quite a pamphlet).

SEEDS OF OTHER HONEY-PLANTS.

Growing Baswoods from the Seed; Japanese Buckwheat (pamphlet); Dwarf Essex Rape; Cow Peas; Soja Beans and American Coffee-berry.

LEAFLETS ON TRUCK-FARMING, ETC.

Celery-growing by Sub-irrigation near Sanford, Fla.; Directions for Using the Grand Traverse Potato-planter; Mushroom Culture; Starting Onions in the Greenhouse; Sweet Potatoes.

LEAFLETS ON BEES AND FRUIT, ETC.

Bees on Fruit; How Bees are Sometimes wrongly Blamed; American Gardening on Bees Puncturing Fruit; Bees and Grapes—Bees not Guilty; How and When to Spray; Spraying Trees when in Full Bloom; Spraying Fruit while in Bloom—Experiments at the Geneva Station; Shall We Spray Trees when in Bloom? from Green's Fruit-grower; Agency of Bees in Fertilizing Fruit-blossoms; Bees as Fertilizers.

MISCELLANEOUS LEAFLETS AND PAMPHLETS.

Temperance and Government; Salisbury on Lean-meat Diet; California as a Honey Country; Water Cure Applied Internally as well as Externally; Child-training, by Miss Sarah W. Smith.

HONEY-LEAFLETS, ETC.

Food Value of Honey; Peddling Honey; Steam Wax Extractors and Presses; Foul Brood.

KIND WORDS FROM OUR CUSTOMERS.

We get better returns from GLEANINGS as an advertising medium than from any other journal.

Feb. 21. J. W. K. SHAW, Loreauville, La.

Through the medium of my want adv't in GLEANINGS I have secured a good position.

Feb. 17. H. J. BROMWICH, Stedman, N. Y.

I purchased five hives of your agents, John Nebel & Son, last spring. I am well pleased with your goods, and will use more in future. They were the cleanest, nicest lot of hives I ever saw.

S. MAXWELL, Regina, Mo.

THE A B C AS AN INVESTMENT.

I find more useful information in regard to apiculture in the A B C than in any other bee-work, and I would not be without it, as, cut off from the outer world as we are, with no one to consult with, it is a great help, and has saved me many a dollar.

H. H. SMYTH.

Kailua, N. Kona, Hawaii, Feb. 20.

I got my A B C in due time. I am wonderfully proud of it. It is just what I have been looking for. It is worth ten times what it is sold for, to a man who has just five stands of bees.

Peoria, Tex., Mar. 21.

J. L. REID.

AN OPINION OF GLEANINGS FROM AN OLD BEE-JOURNAL EDITOR.

GLEANINGS for April 1 came to hand this morning. You fairly outdid yourselves in this particular number. Bee-keepers who do not take GLEANINGS will find themselves far behind, by and by. You not only keep abreast of the times, but well ahead at all times.

Wenham, Mass.

H. ALLEY.

THE POST FOUNTAIN PEN.

I received the Post fountain pen all right, and I am inclined to believe it is the best fountain pen yet known. The filling of the pen, all done with one syringe, with so little trouble, there is no excuse for not having the pen always ready. It is a neat pen to use. I do not get ink on my fingers while using it. I have three other fountain pens besides this one; but the Post beats them all. Accept thanks for the small cost you have made this excellent pen to me with subscription to GLEANINGS.

Middleburgh, N. Y., Mar. 27.

N. D. WEST.

THE HOME PAPERS, ETC.

I read with interest Mr. A. I. Root's papers describing his combats with the Devil in various forms, also his description of travel and gardening. I take it that Mr. Root is a gentleman of the old school, with honesty and the golden rule his principal guides—a class, by the way, that has become almost extinct in commercial and political circles in the past forty years. I trust he will be long blessed with health and strength to make his fight against the great odds by which he is confronted.

Joplin, Mo., Apr. 6.

A. W. CARSON.

THE 4×5 VS. THE 4¼×4¼ FOR MARKET.

I did not have very good luck with the 4×5 sections, in the regular size Langstroth hive (sections cross-wise). Bees did not fill them as satisfactorily as the old-style. The poor season, and a little bungle in management, may have helped to give poor results; but one thing I do know, that is, they all sold in preference to the old-style—in fact, before one of the old-style sections was sold, all the 4×5 were gone. I shall use nothing else when I get rid of about 2000 old-style I now have on hand.

New Westminster, B. C., Mar. 20.

W. H. LEWIS.

THE TOBACCO HABIT.

I am with you heart and soul in the fight against tobacco. We have enough of its use here so that any one can see the results of its use. Men who can not get clothes to cover their children can and will consume ten cents' worth of tobacco every day of their lives. Not only this, but many men standing high in the church are constant users of the vile stuff. It is high time that every one should be aroused to the evil and power of this deadly habit, and that all professing Christians should stand shoulder to shoulder in the endeavor to rescue those who are its victims.

East Dixfield, Me., Apr. 8.

H. L. SMITH.

A TOBACCO TESTIMONY WITH THE RIGHT RING TO IT.

Mr. Root.—I enjoy your Home talks very much. They can not help doing good. I am with you on the tobacco and saloon question. Keep on in the good work. Almost every one here in Southern Illinois uses the filthy stuff excepting the women, and some of them use it, and I am sorry to say, some ministers. How can one who professes to be Christlike use the nasty stuff? When I became a Christian I quit using it, and I was keeping store too; but I cleaned it out and would not handle it.

Benton, Ill., April 14.

E. M. REED.

"STEPPING HEAVENWARD."

I have been trying for some time to quit the use of tobacco, but somehow I could not give it up till I read your article in GLEANINGS, April 1. It gave me strength, and I have not touched it since. I was in the habit of smoking. I am working in a store where people are smoking every day, but it bothers me but little, because I have made up my mind to quit. I hope you will continue to speak out on the subject.

Loachapoka, Ala.

T. W. COX.

THE NEW POTATO-PLANTER.

The potato-planter works to perfection. I used one last season with great satisfaction. There are no crooked rows by dropping the potatoes out of line—simply drop your potatoes in the planter, and put the machine where you want it, and it is dropped, covered, and planted in less time than it takes to tell it. They are indispensable to one planting only 1/4 acre. They beat a hoe for corn where it is rough. For dry seasons they are a fine thing, as they put the seed down where the ground is moist, and they also save a hoeing.

R. J. CARY.

Norwalk, Conn., April 14.

[I presume our friend means by the expression, "They also save a hoeing," that where each piece of potato is put right down into the moist ground it starts as quick as or quicker than the weeds, thus saving a growth of weeds before the potatoes come up. And I want to add that, if he will take one of the new weeders and go over the potatoes as soon as they are planted, and then do it again every three or four days, the potatoes will never need any hoeing at all.—A. I. R.]

MOSQUITOES AND THE FAULTLESS SPRAYER; A NEW USE FOR THE IMPLEMENT.

Last summer I purchased a brass Faultless sprayer for general purposes. I live in a mosquito-infested country, and in spite of screens they will accumulate in the corners of the room. My wife often urged me to "fan them out," so one day I loaded the sprayer with coal-oil and went after them. I soon rid every room of them. At first my wife objected to the scent of the oil; but it soon dissipates. The mosquito is more looked upon than formerly as a public enemy, and the sprayer is a "great gun" to exterminate him (or her).

REG. ARCHILLION.

Archillion, Ark., April 8.

[I suppose our friend, in his closing sentence, alludes to the fact that scientific men now quite generally agree that the mosquito is quite an agent in carrying contagious diseases; and with this in view it is quite an important matter to drive them away, or, better still, kill them with coal oil. A government bulletin has already given notice that mosquitoes may be banished from a neighborhood by covering stagnant water with a thin film of coal oil, only a small quantity being needed for the purpose.—A. I. R.]

I have a copy of the A B C book. It is more than its publishers claimed for it. E. J. SMITH. Bowling Green, Ky.

THE CIGARETTE BUSINESS.

We clip the following from the Practical Farmer, Philadelphia:

The most radical anti-cigarette measure yet proposed is now under consideration in the Minnesota Legislature, having been introduced by Senator Halverson, one of whose constituents recently died from smoking too many cigarettes. The proposed bill is modeled on the Tennessee law, which the United States Supreme Court has held to be constitutional, and makes it a misdemeanor to use tobacco in this form, bars merchants from bringing cigarettes into the State, makes giving away cigarettes an equally grave offense, and even prohibits the sale of the papers used in rolling cigarettes.

CONVENTION NOTICE.

The spring meeting of the Eastern division of the Northern Illinois Bee-keepers' Association will be held at the residence of B. Kennedy, 7 miles southeast of Rockford, Ill., on rural route No. 5, and 3 miles northeast of New Milford, Ill., on Tuesday, May 21, 1901. All interested in bees are cordially invited to attend. B. KENNEDY, Sec'y.

THE VERY BEST GRADES AND WARRANTED TO BE PURE HONEY ADDRESS THE A.I. ROOT CO. MEDINA OHIO 222222

Maple Syrup.

None finer in quality than Medina County product, which took 1st premium at World's Fair. We put up syrup in quarts, two quarts, and 1-gallon square cans.

Best Medina Maple Syrup in Sealed Tin Cans.

Table with 3 columns: Quantity, Price per unit, Total Price. One-quart cans, each, \$.30, 24 for \$6.00; Two-quart " " .55, 12 for 6.00; One-gallon " " 1.00, 10 for 9.00

Syrup guaranteed strictly pure.

THE A. I. ROOT CO., Medina, O.

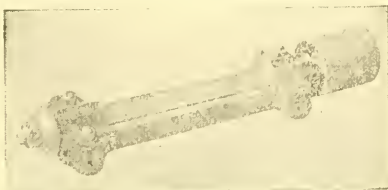

I WILL EXCHANGE SAW ARBOR

for Antique Furniture or old-time Flint Lock Firearms. Will also sell Saw Arbor for cash. WM. S. AMMON, 216 Court St., Reading, Pa.

E. R. Root says: "One cage . . . showed a measurement of .18 and 1/16; cage B showed a measurement of 1/16 and cage D 1/16. . . . If tongue-reach means any thing, they ought to be good workers." They are three strains and are good workers. Queen circular free. W. A. H. Gilstrap, Grayson, Cal.

A FEW LEFT---ORDER QUICK!

We have only a few of those slightly damaged bee-books left, so if you want one of them you will have to order very soon. It will be remembered that on January 1st there was a severe fire in our building, burning out entirely four floors above us. The water that was thrown on the fire came down through our floor damaging our stock of books, printing-office, etc. Some of the books were wet slightly, but enough so that they could hardly be sent out as perfect. These are the ones that we wish to offer. The reading pages of all are perfect, only the covers being a little soiled. Here they are, with prices postpaid:

- Prof. Cook's "Bee-keeper's Guide," only 60c. Doolittle's Scientific Queen-rearing, only 50c. Newman's "Bees and Honey," only 40c.

They are all cloth bound, and latest editions if you want a year's subscription to the old Weekly American Bee Journal, with any of the above books, add 75c to your order. This is a SPECIAL OFFER, and will last only so long as the slightly damaged books last. Better order AT ONCE if you want a bargain.

Remember we are

HEADQUARTERS FOR Bee-keepers' Supplies in Chicago.

Catalog and samp'le copy of the American Bee Journal free. Ask for them. Address

George W. York & Co., Chicago, Illinois. 14-146 ERIE STREET.

THE FASHION FLOWER OF THE DAY

Is the beautiful sweet pea. Recognizing the popularity of this garden favorite, we offer for 1901 five new and handsome sorts, for 5-cent stamps, together with a copy of our new seed book, the most modern catalogue of modern times. It is so costly a production we cannot afford to gratuitously distribute it. (Postage alone is 5 cents.) We send it postpaid for 10 cents together with one packet of each of these:

5 Grand New Sweet Peas.

Navy Blue. The best to date.	} separate packets.	Five
Gorgonian. Unique and distinct.		
American. White striped carmine.		
Royal Rose. A blushing beauty.		
Salopian. Intense scarlet.		

ONLY 10c.

With our new seed book free.

Features of our new catalogue for 1901 are 136 pages (9520 square inches of reading and illustrations) 7 handsome colored plates. A list of novelties in vegetable, farm and flower seeds to be had nowhere else this year, 33 new sorts now offered for the first time, and a complete list of standard seeds, bulbs, plants, fruits, etc., Other features, full cultural directions and many cash prizes. If you want an up-to-date garden and the best you ever had you must plant Maule's Seeds. Send 10 cents for catalogue and these new sweet peas to-day. Address,

WM. HENRY MAULE,
1711 Filbert Street, Philadelphia.

The Power Question

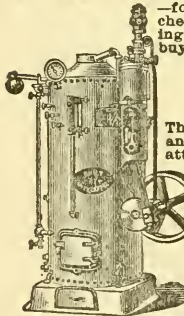

—for farm use, dairies, creameries, cheese factories—anything requiring light power, is best settled by buying one of these

LEFFEL ENGINES.

They are made in both horizontal and upright pattern, with engine attached to boilers. Being very simple and direct in construction they are economic of fuel and great developers of power. Best for cutting and grinding feed, sawing wood, pumping water, separating cream, churning, &c. Made of the best material throughout they are durable and long lived.

Send stamp for our Book on Engines and Power.

JAMES LEFFEL & CO., Box 89, Springfield, Ct.

250 Poultry Pictures

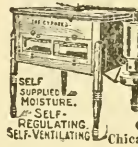

illustrating every phase of poultry raising and 224 pages of matter telling how, when and what. That and much more is in our "Profitable Poultry Keeping in all its Branches." Tells also about the warranted for 10 years Cyphers Incubator, which is guaranteed to outmatch any other incubator, or money refunded. Book for 10c in stamps. Circulars free. Address nearest office. Ask for book 74
CYPHERS INCUBATOR CO.
Chicago, Ill. Wayland, N. Y. Boston, Mass.

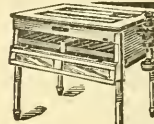

200-Egg Incubator for \$12.00

Perfect in construction and action. Hatches every fertile egg. Write for catalogue to-day.
GEO. H. STAHL, Quincy, Ill.



50 VARIETIES.

I breed fine poultry on one of the best equipped poultry farms in the world. Send 8c in stamps for new 1901 Book, telling all about 50 varieties, with special prices on fawns and eggs.
B. H. CREIDER, Florin, Pa.

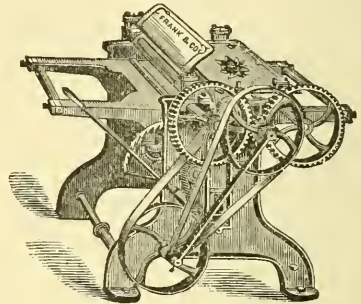

PLANERS

The above cut shows one of our small Planers, of which we make twelve different styles and sizes. Also large Planers, Band Saws, Buzz Planers, Moulders, Wood Lathes, and all kinds of

WOOD WORKING MACHINERY

Send for Catalogue.

The FRANK MACHINERY CO.

BUFFALO, N. Y.

New Smith Premiers Nos. 5 and 6.

The No. 6 takes paper 18½ inches wide and writes lines 16 inches long. The No. 5 takes paper 11 inches wide and writes lines 9½ inches long. These new machines in essential mechanical principles are the same as Models Nos. 2, 3 and 4—unequaled.

Write for Printed Matter Free.

The Smith Premier
Typewriter Co.

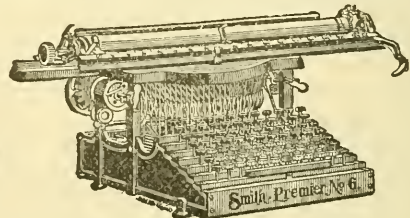

158 Prospect Street, Cleveland, Ohio.

SPLIT HICKORY



You know what Split Hickory is? It's the best possible material for vehicle building. It is what makes

The Famous Split Hickory Vehicles

the leaders in the trade. They are right in every detail. They have scores of "little things" which add to their durability, their comfort and their beauty. We sell them to you direct from the factory, saving you all jobber's and agent's commissions.

We Ship on Approval to anyone anywhere, and guarantee perfect satisfaction. Our free book tells lots of things you ought to know about vehicles. Send for a copy.



OHIO CARRIAGE MFG. COMPANY,
27 W. Broad St., Columbus, O.

S. C. BROWN LECHORNS.
I use well-striped breeding cocks. Eggs, \$1.00. Cockerles, \$1.00 and up. Also Italian bees. Circular free.
H. M. MOYER, SHANESVILLE, PA.

EGGS \$1.00 for 15 best Brown Leghorn or B. P. Rocks. Illustrated descriptive egg-circular free. H. B. GEER, Nashville, Tenn.

1200 FERRETS. All sizes; some trained; first-class stock. New price list free. N. A. Knapp, Rochester, Lorain Co., Ohio.



Belgian Hares

I have some fine hares for sale at reasonable prices.

J. F. Moore, : Tiffin, Ohio.

The Modern Farmer and Busy Bee.

Emerson Taylor Abbott, Editor.

A live, up-to-date Farm Journal with a General Farm Department, Dairy, Horticulture, Live-stock, Poultry, Bees, Home and General News. The Editor has had practical experience in every department of farm work. To introduce the paper, it will be sent to New subscribers one year for 25c. Sample copies free. Best Advertising Medium in the Central West. Clubbed with *Gleanings* for \$1.00.

ADDRESS

Modern Farmer, St. Joseph, Mo.

\$50.00 POP CORN.

100 seeds of this wonderful new Pop Corn for 25c and chance to compete for our cash prizes. Seed Due Bill good for 25c worth of other goods **FREE** with every order for Pop Corn. First-prize winner last year raised at the rate of 188 bushels per acre. We will pay \$50 for its equal in quality. Handsome seed catalog and free presents with every offer.

C. M. Goodspeed, Skaneateles, N. Y.



ALONG THE ROAD

PAGE 13 wire 58-inch Highway Fence is giving splendid satisfaction. It's so NEAT and STRONG. Page Woven Wire Fence Co., Adrian, Michigan.

THE WHEEL OF TIME

for all time is the

Metal Wheel.



We make them in all sizes and varieties. **TO FIT ANY AXLE.** Any height, any width of tire desired. Our wheels are either direct or stagger-spoke. Can **FIT YOUR WAGON** perfectly without change.

NO BREAKING DOWN.
No drying out. No resetting tires. Cheap because they endure. Send for catalogue and prices. Free upon request.

Electric Wheel Co.
Box 95 Quincy, Ills.

SPRAYING

with our new patent

KEROSENE SPRAYERS

is simple indeed. Kerosene Emulsion made while pumping. 12 varieties sprayers. Bordeaux and Vermorel Nozzles, the World's Best. **THE DEMING CO.** Salem, O. Western Agents, Henion & Hubbell, Chicago. Catalog, formulas free



Pig-Tight

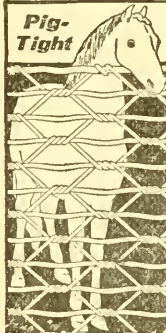

HORSE - HIGH!

... BULL-STRONG ...

With our Duplex Automatic Ball Bearing Woven Wire Fence Machine, any farmer can make 100 styles, and from **50 to 70 rods a day** of the best and most practical fence on earth at a cost for the wire to make it of from **20 to 30c. per rod** We sell Ornamental Fence and Gates, Farm Fence and Gates, Plain, Barbed and **Coiled Spring Wire** direct to the farmer at wholesale prices. Catalogue free.

KITSELMAN BROS.
Box D31. Muncie, Ind.

Union Combination Saw

For Rippling, Cross-cutting, Rabbiting, Mitering, Grooving, Gaining, Boring, scroll-sawing, Edge-moulding, Beading. Full line FOOT and HAND POWER machinery. Send for catalog A. **SENECA FALLS MFG. CO.** 44 Water St., Seneca Falls, N.Y.

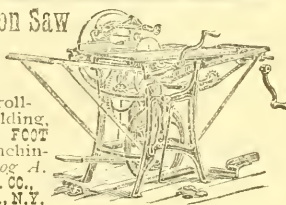

I. J. Stringham, 105 Park Place, New York City.

Keeps in stock a full line of modern appliances for bee-keepers.

SILK-FACED VEILS.

As good as any made; 35 cents postpaid. Catalog free. Full colonies Italian bees, \$6.00. Apiaries, Glen Cove, Long Island.

I. J. Stringham, 105 Park Place, New York City.

Marshfield Manufacturing Company.

Our specialty is making SECTIONS, and they are the best in the market. Wisconsin basswood is the right kind for them. We have a full line of BEE-SUPPLIES. Write for FREE illustrated catalog and price list.

Marshfield Manufacturing Company, Marshfield, Wisconsin.

SPECIAL LOW CLUBBING OFFERS ON CLEANINGS.

New readers who may see this issue for the first time, and old ones who have perhaps been subscribers, and have dropped out in the meantime, will be interested in the following special clubbing offers that we are prepared to make:

OFFER NO. 21.

For 25c we will send GLEANINGS 6 months' trial subscription to new subscribers.

OFFER NO. 22.

For \$1.00 we will send GLEANINGS for one year and an untested Italian queen valued at 75 cents; but at this low price we reserve the right to send queen some time in July when we have a choice supply.

OFFER NO. 23.

For 50c we will send GLEANINGS from the time your subscription is received till January 1, 1902, so that the SOONER you send in your order the more numbers you will get.

OFFER NO. 24.

If you order \$10.00 worth of goods from our catalog at regular prices, paying cash for them, for 50 cents more you can have GLEANINGS for one year.

OFFER NO. 25.

For \$1.00 we will send GLEANINGS one year and a Clark smoker, postage 20c extra. Or, for \$1.25 we will send the Corneil smoker, postage 25c extra.

OFFER NO. 26.

For \$1.75 we will send GLEANINGS one year and our cyclopedia on bees, the A B C of Bee Culture, 1901 edition, of 500 pages.

CLUBBING OFFERS.

We will send the *Review of Reviews* or *Youth's Companion*, new subscribers only, and a subscription to GLEANINGS, for \$2.25. Or for \$1.50 we will furnish GLEANINGS and any one of the following-named magazines or papers:

Success, Woman's Home Companion, Ohio Farmer, Michigan Farmer, Practical Farmer, Kansas Farmer, Indiana Farmer, Cosmopolitan, and Pierson's Magazine.

Subscriptions to *Review of Reviews* and *Youth's Companion* must be strictly new.

Old as well as new subscribers may take advantage of these several offers, but all arrears or back subscriptions must FIRST be paid at \$1.00 a year. Refer to these offers by number to avoid mistakes.

THE A. I. ROOT CO., Medina, Ohio.

Mr. A. I. Root's Writings

of Grand Traverse territory and Leelanau County are descriptive of Michigan's most beautiful section reached most conveniently via the

Pere Marquette R. R.

For particulars address W. C. Tousey, D. P. A., Toledo, Ohio.

For Sale Cheap.

200 COMBS in Hoffman frames, wired and built from full sheets of foundation. Will take \$20.00 for the lot. Come quick if you want them.

GEO. E. HILTON, Fremont, Mich.

Home-seekers' Excursions.

On the first and third Tuesdays of each month the Chicago, Milwaukee & St. Paul R'y will sell round-trip excursion tickets from Chicago, Milwaukee, and other points on its line to a great many points in South Dakota, North Dakota, and other western and north-western States at about one fare. Take a trip West and see the wonderful crops, and what an amount of good land can be purchased for a little money. Further information as to rates, routes, prices of farm lands, etc., may be obtained by addressing F. A. Miller, General Passenger Agent, Chicago, Ill.

To make cows pay, use Sharples Cream Separators. Book "Business Dairying" & cat. 288 free. W. Chester, Pa.

FOR SALE.—\$0,000 acres hardwood lands in north-western Wisconsin; fine locations for bee-keeping and stock and dairy farming; prices low, but advancing. Descriptive matter on application.

HARRY LATHROP, Agent, Monroe, Wis.

1881

PAGE & LYON MFG. CO.

1901

We manufacture a full line of the latest BEE-SUPPLIES.

Our motto is, "Perfect Goods and Prompt Shipment."

Send for our new free illustrated catalog.

PAGE & LYON MFG. CO., New London, Wisconsin.

NOW READY!

64-PAGE CATALOG OF EVERY THING BEE-KEEPERS NEED. Illustrated and fully described. Especially valuable to beginners for the information it contains. Send your address on postal and get it now. Established 1884.

J. M. JENKINS, Wetumpka, Ala.

NOW READY. LONG-TONGUED QUEENS!

YARD NO. 1.

By special arrangements with THE A. I. ROOT CO. to furnish them queens, I have secured their assistance in procuring the finest breeding queens that a thorough knowledge of the bees of the country and money can procure. Among them is a *select daughter of their \$200 queen that they refuse to quote me prices on.* This queen shows every superior quality of her mother. Her bees show an actual reach of 21-100 of an inch; are large, gentle, and beautiful to look upon.

MR. E. R. ROOT SAYS: "You have as fine bees as there are in the United States; and with a direct cross of their breeders you should be able to produce queens whose bees show a reach of 25-100 of an inch."

Send for descriptive price list.

From recent measurements I find I can warrant all tested and select untested queens to produce bees whose reach is 19-100 with an average reach of 18 100; Select tested queens to produce bees whose reach is 20-100, with an average of 19 100.

Prices: Untested, \$1.00; 6, \$5.00. Select untested, \$1.25; 6, \$6.00. Tested, \$1.50; 6, \$8.00. Select tested, \$2.00; 6, \$11.00.

Breeders, whose best bees show a reach of 21-100, with an average reach of 20 100, \$3.00. Breeders, whose best bees show 21-100, with an average of 20 1/2-100, \$5.00. Breeders, whose best bees show 22-100, with an average of 21-100 \$7.00.

I have discovered 2 breeders whose best bees show 23-100; these are too good to sell; don't ask for prices.

Imported Italian stock. Apiary No. 2. Imported queens, daughters and grand-daughters. Golden, or 5-banded Italian. Apiary No. 3. Breeders, select tested, tested, untested queens.

**W. O. VICTOR, WHARTON, TEXAS.
QUEEN SPECIALIST.**

QUEENS?

Improved Golden and Leather-colored Italians are what H. G. Quirin Rears.

We have one of Root's best long-tongued RED-CLOVER BREEDERS from their \$200 queen, and a Golden breeder from Doolittle, who says if there is a BREEDER of Golden bees in the United States worth \$100, this one is worth that sum. The above breeders have been added to our already improved strain of queens for the coming season.

J. L. Gandy, of Humboldt, Neb., wrote us on Aug. 5th, 1900, saying that the colony having one of our queens had already stored over 400 pounds of honey (mostly comb). He states that he is certain that our bees work on RED CLOVER, as they were the only kind in this locality and apiary.

A. I. Root's folks say that our queens are extra fine. While the editor of the *American Bee Journal* tells us that he has good reports from our queens from time to time. We have files upon files of unsolicited testimonials. After considering above evidence need you wonder why our orders have increased each year?

Give us a trial order and be pleased. We have years of experience in mailing and rearing queens. Safe delivery will be guaranteed. Instructions for introducing with each lot of queens.

PRICE BEFORE JULY 1st.

	1	6	12
Warranted stock.....	\$ 75	\$ 4 25	\$ 8 00
Selected warranted.....	1 00	5 00	9 50
Tested.....	1 50	8 00	15 00
Selected tested.....	2 00	10 50	
Extra selected tested—the best that money can buy.....	4 00		

Folding Cartons.

With address printed two colors, 100, \$4.00; 500, \$2 75.

H. G. Quirin, Parkertown, Ohio.
(Parkertown is a Money-order Office.)

WE WANT

to sell you bee-supplies. Our line is all new and complete. Send for our illustrated catalog. It will convince you that our Dovetailed hive is the best on the market. Our prices are right and our service is prompt.

Fred W. Muth & Co.,

S-W. Cor. Front and Walnut Sts.

Cincinnati, Ohio.

Dittmer's Foundation !!!

Retail---Wholesale---Jobbing.

I use a PROCESS that produces EVERY ESSENTIAL necessary to make it the BEST and MOST desirable in all respects. My PROCESS and AUTOMATIC MACHINES are my own inventions, which enable me to SELL FOUNDATION, and WORK WAX INTO FOUNDATION FOR CASH, at prices that are the lowest. Catalog giving

FULL LINE OF SUPPLIES

with prices and samples, free on application. BEESWAX WANTED.

GUS. DITTMER, AUGUSTA, WIS.

Get the Best Queens.

Evansville, Ind., Sept. 27th, 1900.
The Jennie Atchley Co., Beeville, Bee Co., Texas:
Dear Friends:—It gives me great pleasure to forward you this unsolicited testimonial regarding the merits of Atchley queens. The three (3) dozen queens purchased of you have made an excellent record for themselves. Not an Atchley queen among the twenty colonies lost during the severe drouth in July. I have bought queens from many breeders; and although the present crop is exceedingly short, the tiers of supers show where the Atchley queens are, and speak volumes for your method of queen-rearing. I find the progeny to be very gentle, strong-winged, uniformly marked, long-lived, of large size, and last, but not least, the best honey-gatherers I ever had. I shall want 100 more next season.
Yours fraternally, J. C. WALLENMEYER.

Prices for Queens.

Tested, \$1.50 each; \$8.00 for 6, or \$15.00 per dozen. Untested, February, March, April, and May, \$1.00 each; \$5.00 per 6, or \$9.00 per dozen. Fine breeders, \$5.00 each. We have as good bees and queens as money and labor produce. We breed three-band Italians, Goldens, Carniolans, Cyprians, and Holy-Lands, in their purity, bred in separate yards 5 to 20 miles apart. If you want the best, call for Atchley's improved strains. Safe arrival guaranteed. Send for a sample copy of "The Southland Queen," the only southern bee-paper, \$1.00 per year. To new subscribers we offer as a premium a nice untested queen in order to get our paper introduced. Catalog, giving queen-rearing and management of apiaries for profit, FREE.

THE JENNIE ATCHLEY CO.,
Beeville, Bee Co., Texas.

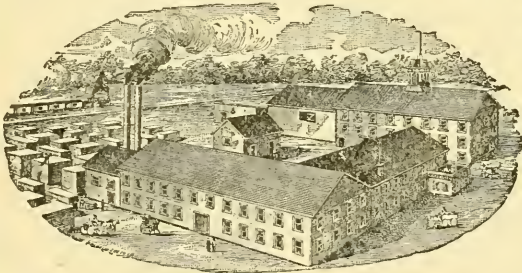

KRETCHMER M'F'G CO., Red Oak, Iowa.

BEE-SUPPLIES.

Best-equipped factory in the West; carry a large stock and greatest variety of every thing needed in the apary, assuring BEST goods at the LOWEST prices, and prompt shipment. We want every bee-keeper to have our FREE ILLUSTRATED CATALOG, and read description of Alternating Hives, Ferguson Supers, etc. Write at once for a catalog.

— AGENCIES: —

Trester Supply Co., 103 So. 11th St., Lincoln, Nebraska; C. C. Richards, 1223 17th St., Denver, Col.

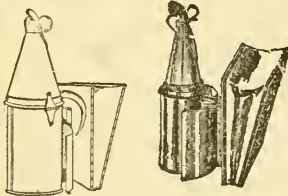

BINGHAM SMOKER.

Dear Sir:—Inclosed find \$1.75. Please send one brass smoke-engine. I have one already. It is the best smoker I ever used. Truly yours,
HENRY SCHMIDT, Hutto, Tex.

MADE TO ORDER

Bingham Brass Smokers.

Made of sheet brass, which does not rust or burn out; should last a lifetime. You need one, but they cost 25 cts. more than tin of the same size. The little open cut shows our brass hinge put on the three larger sizes. No wonder Bingham's four-inch smoke-engine goes without puffing, and does not drop inky drops. The perforated steel fire-grate has 381 holes to air the fuel and support the fire. Heavy tin smoke-engine, 4-inch stove, per mail, \$1.50; 3½-inch; \$1.10; 3-inch, \$1.00; 2½-inch 90c; 2-inch, 65c. Bingham smokers are the originals, and have all the improvements, and have been the standard of excellence for 22 years. Only three larger ones brass.

T. F. Bingham, Farwell, Michigan.

Contents of this Number.

Bee, Caucasian.....	431
Bees and Dark Clothing.....	430
Brown, Interview with.....	433
California, Central.....	437
Caramels, Honey.....	431
Clover, Yellow Sweet.....	434
Comb v. Extracted Honey.....	430
Cook's Review.....	443
Craig, W. J.....	442
Cuban Bee-keeping.....	432
Drink-bill of the Nation.....	429
Eggs, Loss of.....	430
E. R. Root's Western Trip.....	445
High priced Breeding-stock.....	444
Honey, To Get Light-colored.....	441
Honey, Pennyroyal.....	431
Nectar, Water in.....	429
Nuclei, Making.....	440
Old-comb Discussion.....	430
Poison of Bee-sting.....	429, 430
Queen-rearing, Swarthmore's.....	434
Rambler's Retreat.....	437
Roses, Late.....	429

Honey Column.

GRADING-RULES.

FANCY.—All sections to be well filled, combs straight, firmly attached to all four sides, the combs unsoiled by travel stain, or otherwise; all the cells sealed except an occasional cell, the outside surface of the wood well scraped of propolis.

A No. 1.—All sections well filled except the row of cells next to the wood; combs straight; one-eighth part of comb surface soiled, or the entire surface slightly soiled; the outside surface of the wood well scraped of propolis.

No. 1.—All sections well filled except the row of cells next to the wood; combs comparatively even; one-eighth part of comb surface soiled, or the entire surface slightly soiled.

No. 2.—Three-fourths of the total surface must be filled and sealed.

No. 3.—Must weigh at least half as much as a full-weight section.

In addition to this the honey is to be classified according to color, using the terms white, amber, and dark; that is, there will be "Fancy White," "No. 1 Dark," etc.

CITY MARKETS.

NEW YORK.—We report a quiet market on all lines. White comb honey is well exhausted—the old crop—still there is some arriving which has been carried by the producers, evidently for a higher price. Values are mostly nominal now, and it is only a first-class fancy article that will sell at quotation prices. We quote fancy white, 15; No. 1, 13; amber, 11@12; buckwheat, 9@10. Extracted is decidedly dull, and very little inquiry. Old crop California light amber and partly white is now being offered as low as 4½ f. o. b. coast, which, of course, hurts the sale of other grades to a large extent. Beeswax is firm, and sells on arrival at 28@29.

HILDRETH & SEGELKEN,

May 3. 120, 122 West Broadway, New York.

BOSTON.—Our market on comb honey is firm, with light stocks and a fairly good demand for this time of the year. Fancy white comb honey we quote at 17; A No. 1, 16; No. 1, 15@16. Absolutely no call for dark honey this year. Extracted, water white, 8@8½; light amber, 7½@8. Beeswax, 27.

BLAKE, SCOTT & LEE,

May 4. 31, 33 Commercial St., Boston, Mass.

ALBANY.—Honey market very dull; prices nominal. Honey pretty well cleaned, and very little call for it.

MACDOUGAL & Co.,

May 7. Albany, N. Y.

BUFFALO.—Our honey market is about the same as last quoted, with a pretty slow demand. Fancy white comb, 15@16; A No. 1, 14@15; No. 1, 13@14; No. 2, 12@13; No. 3, 11@12; No. 1 dark, 10@11; No. 2, 8@9. Extracted, white, 7@8; dark, 5@6. Beeswax, 28@32.

W. C. TOWNSEND, Buffalo, N. Y.

CINCINNATI.—No demand for comb honey any more. Stock of it well cleaned up. Extracted honey, dull; prices about the same. Dark sells for 5½; better grades bring 6@7½; fancy white clover, 8½@9.

C. H. W. WEBER,

May 7. 2146-8 Central Ave., Cincinnati, Ohio.

CHICAGO.—There is very little being done in honey at present, with practically no demand for the extracted grades; several consignments on sale here for some time, without any bids being made. A little choice white comb sells in a retail way at 16c, with all other grades scarce, and firmly held at about former prices. Extracted, 7@8 for fancy white; ambers, 6@7; dark, 5@5½. Beeswax scarce, and in demand at 30.

R. A. BURNETT & Co.,

May 7. 199 South Water St., Chicago, Ill.

PHILADELPHIA.—The trade is not very active in honey at present. Very little call, as fresh fruit is taking the place. We quote comb honey 13@15, and extracted honey 6@7. Very little variety in the market, and parties are accepting offers as to grade. We are producers of honey—do not handle on commission.

WM. A. SELSER,

May 7. 10 Vine St., Philadelphia, Pa.

DENVER.—The demand for comb honey is light; stock on hand very light. No. 1 brings \$3.00 per case of 24 sections; No. 2, \$2.65@2.75. Extracted white, 6½@7½. Beeswax, 24@26.

THE COLORADO HONEY PRODUCERS ASS'N,
April 24. 1440 Market St., Denver, Col.

DETROIT.—Fancy white comb, 14@15; No. 1, 13@14; dark and amber, 10@12. Extracted white, 6½@7; dark and amber, 5@6. Beeswax, 27@28. Demand very light, and but little in sight, for all grades of honey.

May 10. M. H. HUNT & SON, Bell Branch, Mich.

NEW YORK.—This market seems to be almost entirely bare of all grades of comb honey. There is little, if any, demand for comb or extracted at present. Beeswax is in fair demand at 27@28.

FRANCIS H. LEGGETT & Co.,

May 8. Franklin, West Broadway, and Varick Sts.,
New York City.

FOR SALE.—Extracted honey from alfalfa; 60-lb. cans at 7 cts., and smaller cans.

D. S. JENKINS, Las Animas, Colo.

WANTED.—Comb and extracted honey. State price, kind, and quantity.

R. A. BURNETT & Co.,

163 South Water St., Chicago, Ill.

WANTED.—Extracted honey—amber or dark. State price.

W. C. TOWNSEND, Buffalo, N. Y.

Fertilizing-frames explained in this issue of GLEANINGS sent postpaid all complete, with one sample box nailed, for \$1.75. Each frame has capacity for mating six queens. Any bee-keeper can rear queens by the Swarthmore plan. Send for queen circular. Address

The Swarthmore Apiaries, Swarthmore, Pa.

E. L. PRATT.

Bees are : : Swarming. To keep down increase I will ship, after May 1st, *Full Colonies* of Italian bees, with queen, in Dovetailed hives or light shipping-boxes, six L. frames of bees, brood, and honey, for \$3.50; five for \$16.00; 10 for \$30.00. Tested queens, \$1.00 each. My bees are honey-gatherers and white cappers. Having 15 years' experience I put them up so they go through o. k. Safe arrival and satisfaction guaranteed. Order now, as bees are ready.

J. N. COLWICK, Norse, Texas.

Northern Italian Queens

Reared from Imported Mothers.

Our stock is so carefully bred and selected as to secure loads of honey. Locality free from foul brood and other bee-diseases. Prices: Untested queen, \$1.00; 6 for \$5.00; tested queen, \$1.50; 6 for \$7.50; best imported queen, \$6.00; fair imported queen, \$5.00.

Ada L. Pickard, : Richland Center, Wis.

QUEENS IN STATE OF WASHINGTON.—I will raise Italian queens this season—the best that can be secured by swarming method. Have had many years' experience in queen-raising. The three-banders are the best—not so cross. Ready to mail about the last of May. Untested, \$1.00 each.

ROBT. MERRING, Dryad, Lewis Co., Washington.

Notice! THE A. I. ROOT CO.



wish to announce that they have from their branch at 10 Vine St., Philadelphia, Pa., direct steamboat connections and very low rates of freight to the following States: Massachusetts, Rhode Island, Connecticut, New Jersey, Delaware, North Carolina, South Carolina, Georgia, Florida. As this is a branch of the factory, prices are the same. Full colonies of Italian Bees, \$6.00. Special discount in large quantities.

C. B. Lewis Company, Watertown, Wis., U. S. A.

FIVE ❖ DIFFERENT ❖ STYLES ❖ OF ❖ BEE-HIVES.

We will furnish you
with the finest bee-
keepers' supplies in
the World.



Send us your Orders
and we will fill 'em
promptly. Send for
Catalog.

LEWIS' • WHITE • POLISHED • SECTIONS • ARE • PERFECT.

BRANCH: G. B. Lewis Company, 19 South Alabama Street, Indianapolis, Indiana.

AGENCIES: L. C. Woodman, Grand Rapids, Michigan; Fred W. Muth & Co., Southwest Cor. Walnut & Front Sts., Cincinnati, Ohio; Fred Foulger & Sons, Ogden, Utah; Colorado Honey-producers' Association, Denver, Col.; Grand Junction Fruit-growers' Association, Grand Junction, Colorado; Robert Halley, Montrose, Colorado; Pierce Seed and Produce Company, Pueblo, Colorado; E. T. Abbott, St. Joseph, Missouri, Special Southwestern Agent.

BEE-SUPPLIES!

ROOT'S GOODS
AT
ROOT'S PRICES

C. H. W. Weber, Cincinnati, Ohio.

2146-2148 Central Ave.

A NEW and complete stock for 1901 now on hand. I am The Root Company's representative for Cincinnati and surrounding territories. . . . You save TIME and FREIGHT CHARGES by having goods shipped from here. Convenience of railroad facilities here enables me to do so. Before buying elsewhere, write for my prices and catalog, which will be mailed you free of charge.

GLEANINGS IN BEE CULTURE

A JOURNAL DEVOTED TO BEES AND HONEY AND HOME INTERESTS.

ILLUSTRATED SEMI-MONTHLY

Published by THE A. H. ROOT CO.
\$1.00 PER YEAR MEDINA, OHIO.

VOL. XXIX.

MAY 15, 1901.

No. 10.



IN ADVISING against spraying fruit-trees when in bloom, don't forget that the poisonous spray seriously injures the delicate organs of the blossoms, thus injuring the fruit crop.

AT VIENNA is established a school for bee-keepers, with building and grounds for the same. The chief course occurs June 3-16, with side courses on 10 special days in June, July, and September. Tuition free, limited to 20 students for the chief course.

HONEY contains 20 to 25 per cent of water; nectar, 65 to 80. It is easier to remember that honey contains an average of 77 per cent of sugary matters, and nectar 33 per cent. For every pound of honey stored, the bees must bring in $2\frac{1}{2}$ pounds of nectar.

STENOG quotes some one as saying that slitting a queen's wings lengthwise will save her beauty and prevent her flying. Wouldn't the workers gnaw off such wings? In any case I shouldn't like it, for I want to be able at a glance to determine whether a queen is clipped.

"DR. DZIERZON, through the invention of the movable comb, became the founder of rational bee-keeping," says the editor of Gravenhorst's *Bienenzeitung*. No, he is not ignorant of Langstroth. Neither do we give Langstroth more credit than he deserves, but we are ignorant of Dzierzon.

DOOLITTLE thinks the argument in favor of painted hives, that bees glue the inside of the hive doesn't count, for the glue cracks apart in such fashion that moisture can escape through it. [I have great respect for Doolittle and his opinions; but I do not think much of his idea of moisture going through a $\frac{3}{8}$ -in. board, painted or unpainted, bee-glue or no bee-glue.—ED.]

THE POISON of a bee-sting, according to the investigations of Prof. Langer, quoted p. 382, not formic acid. These investigations were made more than three years ago (see Straws,

Jan. 15, 1898), and yet we still hear talk about bee-poison being formic acid. Prof. Cook, in his review of A B C, seems to take it for granted that it is.—See answer to another Straw on this subject.—ED.]

ALEX ASTOR, in *Revue Internationale*, says diurnal evaporation, which is always ignored, is really more than nocturnal evaporation. So when the scales show that the bees have gained 20 pounds since morning, the evaporation through the day must be taken into account, and they must be credited with carrying in 30.5 pounds of nectar. [Probably Mr. Astor is not far from right.—ED.]

THE DRINK BILL of this nation is, for the year, \$1,059,565,787, or \$13.94 for every man, woman, and child. [I believe the drink evil is the worst problem that civilized countries have to contend with, and sooner or later all right-thinking men must line up, either for or against the saloon. So far as I am individually concerned I propose to help fight the saloon through any organized effort that will mitigate this terrible evil.—ED.]

ONE ROSE in September is worth more to me than ten in June; so as soon as the blossom-buds show on the hybrid perpetuals I carefully pinch off every one except one or two of the most advanced on each bush. Then the bush is not exhausted with its June crop, so as to give no roses later. Of course, that will not do for June roses, but their stalks are cut back severely in spring, which makes the blossoms a little later and perhaps a little finer.

PROF. COOK, in *American Bee Journal*, doubts if the tongue has anything to do with gathering pollen. I don't know whether it has, but I know the A B C is right in saying that the tongue is extended while the bee is poised on the wing, and its feet seem to be doing something with it. I had supposed it was getting honey from its tongue to pack the pollen. Certainly the tongue appears to have something to do with gathering pollen. [The manner in which the bees pad the pollen on their hind legs is so deft and sleight-of-hand-like that it is almost impossible to witness the operation from end to end; but it is hard to escape the conclusion that bees use honey in

making these little pellets of pollen. They are always sweet—decidedly so; and without the honey I can hardly see how the pollen could be made to adhere together in so solid and compact a mass as the bee makes of it.—ED.]

THE ADVICE, not to put hives on a bench much closer than about 6 inches, p. 397, is correct. But the same number could be on the bench with less danger of bees entering wrong hives by having first space between hives 2 inches, the next space 10 inches, then 2 and 10 alternately. [When I visited Dr. Miller two years ago he demonstrated the truth of the statement he has just made. His hives were arranged as he describes in this *Straw*, and yet there was no confusion among the bees.—ED.]

YE EDITOR, it seems to me, is a little too ready to concede to Prof. Cook that the A B C is wrong in calling formic acid a vegetable acid, p. 402. The A B C doesn't call it so, although it squints that way. It wonders whether the poison is not similar to formic acid or the same, and says it (the bee poison) is probably a vegetable acid. According to Prof. Langer (p. 382) it is vegetable, but not an acid, "a vegetable base, an alkaloid." [Then you think Prof. Cook is wrong. Possibly he would modify his opinion if he were referred to your authority.—ED.]

THE OLD-COMB discussion has crossed the ocean. One writer calls ten-year-old combs a myth. *Per contra*, *Abeille Hongroise* reports a hive continuously occupied for 133 years! The able editor of *Le Rucher Belge* says a great number of distinguished practitioners carefully preserve their old combs, and that the objection to them is nothing but an old prejudice. [Is it not a fact, however, that when the old-comb discussion crossed the ocean it crossed from Europe to America, and not from America to Europe? That is, is it not true that we are reviving an old problem that has long been settled in Europe?—ED.]

THAT DARK CLOTHING is decidedly objectionable to bees, Editor Gravenhorst thinks proven by the following incident: With three visitors he was in the apiary, when a dog stirred up a colony. The excited bees pitched upon the lady and gentleman dressed in black, while himself and the lady in white were undisturbed. [I have seen cases where bees would attack persons with black hats when they would not molest those with light-colored head-gear. I have been slow to believe that they recognize color in this way; but in view of the evidence that has been cropping out here and there for a number of years, I am prepared to believe that black, at least, is at times offensive to bees that are not particularly good-natured.—ED.]

SOMETHING a little out of whack about the advice of Henry Segelken, p. 384. He says it's claimed twice as much extracted as comb can be produced. Expenses for sections, foundation, and shipping-cases far exceed cost of packages for extracted, so a pound of comb costs producer more than twice as much as a pound of extracted. So the New York mar-

ket for buckwheat comb ought to be more than twice as much as for extracted, but he wants the extracted men to change to comb while the market, p. 375, quotes comb at less than twice as much as extracted. [If it is true that twice as much extracted as comb can be produced, then there would be something wrong about the advice given by Mr. Segelken; but I do not think it is true, and under some circumstances as much comb as extracted will be produced. If there is a difference at all, it probably would not exceed a half more, and generally not more than a quarter. Mr. R. C. Aikin once said at a National convention that it was not true that more extracted could be produced than comb.]

But, look here, doctor; you are putting the difference of the cost of packages between extracted and comb a little too high. I should say that packages for comb would cost about a half more if we figure in barrels and square cans. You would have to figure in these large packages because the great bulk of honey sent to market is either in barrels or square cans. I think Mr. Segelken's general statement is true, that it would be more profitable for many bee-keepers to produce more comb rather than extracted honey. If there is any error in the statement it is the error in the relative cost of comb and extracted honey per pound.—ED.]

MR. EDITOR, you're another. I don't believe I'm a bit wrong "in assuming that a given number of eggs laid by the queen will give the same number of bees" in the circumstances under consideration, p. 380. You say when frames well filled with eggs are given to a queenless colony, only about two-thirds of the cells that had those eggs will be continued to sealed brood. Instead of two-thirds, I don't believe the average will be one fourth. I've known cases in which I think 19 out of 20 eggs disappeared. Queenless bees do that sort of thing. I don't know why, but they do. But we were not talking about queenless bees. You say, this spring when it was too cold for bees to take care of much brood the queens kept on laying, and the bees reared only what they could cover. Exactly. But we were not talking about a time when it is too cold. We were talking about a time when queens would lay 3400 eggs daily, and I don't believe any queen will do that unless the bees are fully able to care for all of them. She may lay eggs just for the fun of it when only a few hundred are required daily; but when it comes to thousands, that's business, and she'll lay no more than are needed. You know you can lift out frame after frame evenly filled and evenly sealed without a vacancy. If some were destroyed the vacancies ought to show. You say we'd be doing well to get half of a hen's eggs hatched into chickens. And you the son of a poultry-fancier! Better come and take lessons of Mrs. Miller. She thinks she doesn't do well unless she gets at least 10 chickens out of 13 eggs. But we were not talking about poultry, queenless bees, nor weak colonies in cold weather. We were talking about colonies with weather and queens that would allow 3400 eggs daily. Now you

figure how many bees ought to be in such a colony. And give proof, if you have any, that the bees destroy *any* eggs in such a colony. [Yes, while it is true that the destruction of eggs in the spring may not be particularly german to the question at issue, yet I introduced it to show that eggs do disappear at certain times, and why not at others? Then how do you know, doctor, that those combs that are filled solid with brood (by "filled" I mean two-thirds full) may not have had some cells filled with eggs more than once? You will remember that brood does not all hatch in the same day. As a rule it will continue hatching out young bees for a week. I can not escape the conclusion that, even during the height of the season, some eggs are laid which do not produce bees. At your next opportunity, weigh the heaviest swarm of bees just as it is taken from the tree. Confine them in a box for a day, and then weigh the swarm; or, better still, weigh all the bees in a two or three story colony occupying and covering 24 frames. If you can find a case where there will be more than 9 lbs. of bees (45,000 in number) I will buy you the best plug hat you can find in Marengo. This is not a bet, because I have nothing to gain, and I do not believe you have either. The real issue is whether a large colony of bees of three stories can have 40,000 to 50,000 or 90,000 to 100,000. I should doubt very much whether you could get 90,000 bees in a two-story hive, half the combs filled with brood and the other half with honey. If you can, go to the store and get your plug hat and send the bill to me.—E.D.]



Bees, buds, and blossoms
Are the order of the day;
Heaven's clime seems prophesied
In this month of May.

A writer in the *Australian Bee Bulletin* says, "I have a call for granulated honey, and would have more if I encouraged it, but liquid honey is less trouble to me. If you want honey to granulate, leave the cover off during wet weather for a day or two."

It is greatly to be regretted that Mr. Will Ward Mitchell, who assumed the editorship of the *Progressive Bee-Keeper* lately, was compelled to relinquish the work almost immediately, on account of failing eye-sight. If the good wishes of his friends avail, he will soon recover from what all consider the summit of misfortune—a failure of sight. May his "lines" fall in pleasant places.

That honey from pennyroyal, to which the senior editor refers on page 407, is here, but he is not; hence I take occasion to say a word

about it. It is light amber in color, and is practically invisible when spread on bread and butter. There is nothing about the flavor to suggest the pennyroyal of the North. To me the flavor is just like that of birch candy, which I consider a good recommendation. I shall use it while the present supply lasts.

Relative to the Caucasian bee in its native land, Mr. Fr. Greiner makes the following translation from the *Leipziger Bienenzeitung*:

The Mohammedan inhabitants of Caucasia not only love good horses but also honey, and the wealthier portion of them are often extensively engaged in bee-keeping, some of them owning from 100 to 400 skeps of bees. As might be expected, the hives used by these people differ greatly from ours. The bee-keepers make them themselves in the winter season from willow, basket fashion, daubed inside and out with clay.

As simple as are the hives, so is the management of the apiary, although migratory bee-keeping is the order. In the spring the colonies are moved on heavy wagons drawn by ox-teams toward the river, where the bees find the first pasture. A little later, and before swarming again, they are moved to the bountifully blooming heath (steppe). There are no trees or forests in these regions, and so the bee-keeper makes some kind of boxes out of bark, and places them about for the young swarms to light on. The bees are then easily dumped out and hived in the regular hive.

Practically the Caucasian bee does *not* sting except in sheer desperation or self-defense; consequently the bees are easily handled, and no protection is needed or used by the Tartar bee-keeper.

After swarming, the bees are moved for the third time, and this time into the mountains. Here most of these skeps become so crowded that more room must be given, which is done by digging a hole under each hive (all colonies are placed directly on the ground, without any floor-board under them). As soon as the fall flow ceases, all the heaviest colonies are brimstoned, and then the honey is sold in the city. Of course, this honey is cheap, yet quite an income is secured from its sale, and bee-keeping is considered a lucrative business.

GAZETTE APICOLE.

This journal, a French exchange, gives the following recipe for making caramels, which it pronounces "incomparable." Rose water, 15 grams; powdered sugar, 100 grams; fine honey, 200 grams. Mix and boil, stirring constantly, until a drop of the compound, when cooled, is hard and fragile. Pour out on a buttered or oiled marble slab, and shape the mixture into suitable pieces by means of a teaspoon.

To protect combs from the moth-miller, put them in a perfectly tight box in which are one or two bottles of sulphide of carbon. Stop the bottles loosely with cotton or paper, so as to allow a slight leakage of the drug. The eggs will hatch as usual, but the larvae will die immediately.

AMERICAN BEE JOURNAL.

In the issue for April 25, Mr. York has rendered us a great service in giving us a portrait of Mr. G. Kandratieff, editor of what is probably the only Russian bee-journal. Also quite a sketch of his remarkable life is given as a soldier, musician, and writer. More than any other man he has been the means of introducing modern apiculture into that very conservative country, Russia. He uses and recom-

mends what is here known as the Dadant hive and system. He translated Mr. Bertrand's "Guide to Apiculture" into Russian. These two men are very close friends. It is to be hoped he can make a visit to this country some time.

Prof. Cook's talk for the home circle, now running in the Old Reliable, constitutes a most excellent feature of it. They bear largely on the proper management of children, and home conduct in general. All who have Mr. York's paper will do well to read these lines of Prof. Cook the first thing, as they fit one for what follows. Best of all, we know that the writer speaks from experience, and in his daily life is an exponent of what he enjoins.



BEE-KEEPING IN CUBA.

Some Remarkable Figures; Unoccupied Fields
among the Mosquitoes.

BY H. G. OSBURN.

You will remember that, a few months ago, I took charge of this wreck of what was once the finest apiary in the world so far as we could find out. Well, the crop is off for this year. What I have done this winter is only a drop in the bucket compared with what can be done in good locations by one who understands how to work his bees in this stubborn climate.

In the five months past I have increased to 105 colonies; raised 95 young laying queens, and taken a crop of 40,500 lbs. of honey on a range that is supporting at present 1200 hives of bees; or, in other words, within a radius of three miles of this apiary there are over 1200 colonies, and we had a cold spring too. But this is 15,000 lbs. short of what it ought to have been; but I shall try to make up for it next winter, as I expect to take 100,000 lbs. of honey from 1000 colonies in three apiaries. I have already 5000 gallons of honey sold for next year's crop, so the reduced price doesn't worry me much. The cheaper it gets, the more we have got to raise in order to make our ends meet.

It may interest some of your readers to know what this apiary has produced in its 15 years of existence. I myself became anxious to know, the other day, so I began to go over my father's old records, and, after running them all up, and those of smaller bee-keepers who have had charge of this place for a short period from time to time, I find that this one ranch has produced almost a million pounds of honey. The exact figures are about 800,000 lbs. I should like to hear from anybody who can show a similar record for 15 successive years. Had I been able to run this ranch during the war, or the winter of 1898, I should

have beaten any record the world has ever seen in the honey line. As it was, there was over 50,000 lbs. taken from 200 hives.

I notice a 69 hive bee-keeper, p. 136, taking some of us old experienced chaps by the neck for not printing a truthful picture of the real state of the bee-industry in Cuba. I do not wish to offend him; but does the man really know what a bee location for 300 or 500 colonies means? Does he know that here the average force of a good working colony is about 10,000 bees, or three million workers, for a 300-hive apiary, or three million drops of honey every half hour, and six million every hour? or from 300 to 600 lbs. every 30 or 60 minutes? Now, from a close observation I have come to the conclusion that 15 blossoms of this bellflower will, as a rule, furnish a bee its load, and some mornings it will not take half this number. Now we see that, in order to furnish our three million workers a load every half-hour we must have 45 million blossoms at their disposal, or 90 million for one hour's work; and for 6 hours' work it would take the grand total of 540 million flowers, or blossoms, to furnish our 300-hive apiary six hours' work, representing 3600 lbs. for the six hours' work. These figures do not include the enormous amount of honey consumed by these 300 colonies every 24 hours. These figures are not very far from correct, as nearly as we can make calculations, for in years gone by we have had to extract from 2000 to 2500 lbs. every day, six days in the week, to keep up with our 500-hive apiary; then there was the honey they stored in the brood-chamber and fed to the brood, which, I think, is about a third of what they gather every day.

Now, if Mr. Luaces knows more about what is required for a large apiary to feed upon I shall feel that my 15 years of practical experience and close observation have not been altogether void of good. I am well aware of the fact that there are hundreds of good locations here yet unclaimed, where 500 and even 1000 colonies can't clean up the range; but, where are they? I can answer this question myself. They are in the middle and along the southern and southwest coast of the island, where nobody but colored people can live, on account of the insects. Then they are almost entirely shut off from communication with any of the large cities. I expect to penetrate some of them next year, and then I can tell the readers of this journal more about the honey resources of Cuba.

. Punta Brava, Cuba, Mar. 5.

[Your figures and estimates in regard to the honey resources of Cuba may be and probably are correct; but you have made a strange mistake, apparently, in your estimate as to "the average working force of a good colony" as being about 10,000 bees. From other things you say in this connection I judge you consider this a large force. If so, you are certainly wrong. If you will turn to page 380 you will see that we must place the number of a good colony at anywhere from 40,000 to 90,000; and you have allowed only a little over a tenth of the largest figure; or, in other words, your

estimates all through might be increased almost ten times; for the largest number of bees allowed by Dr. Miller was nine times what you figure on, and about one-fourth the number figured by myself. In this locality a colony of 10,000 bees would not be worth much for honey; and while I should assume that you could get more honey in Cuba, from a given number of bees, than we can here in the United States, yet a colony of four or five times that strength would do a great deal more in the amount of honey gathered than four or five nuclei, each of 10,000 bees.—[E.D.]

INTERVIEW WITH MR. BROWN.

BY CHALON FOWLS.

Calling next on Mr Brown I found him feeling pretty blue. When I urged him to join the Association he said, "I'll tell you what, Mr. Fowls, I feel as though I had put too much money in the bee business already.

your bees have not paid this year, they represent so much capital invested; and your membership fee of a dollar a year may be considered as a necessary investment to protect you from loss on what you have already invested."

"But the Association is not an insurance company, and will not protect me from loss by fire or flood."

"No; but you get protection from loss in other ways. You know ignorant or ill-disposed persons might do you much damage. Suppose some one should get an ordinance passed prohibiting the keeping of bees in the corporation."

"That would ruin my bee business, for, as I keep only 25 or 30 colonies, it would not pay me to establish an out-apiary with so few; but I would sell or give them away rather than go to law."

"Well, our Association prevents troubles of this kind by preventing such laws being passed. Then no one can threaten you with lawsuits."

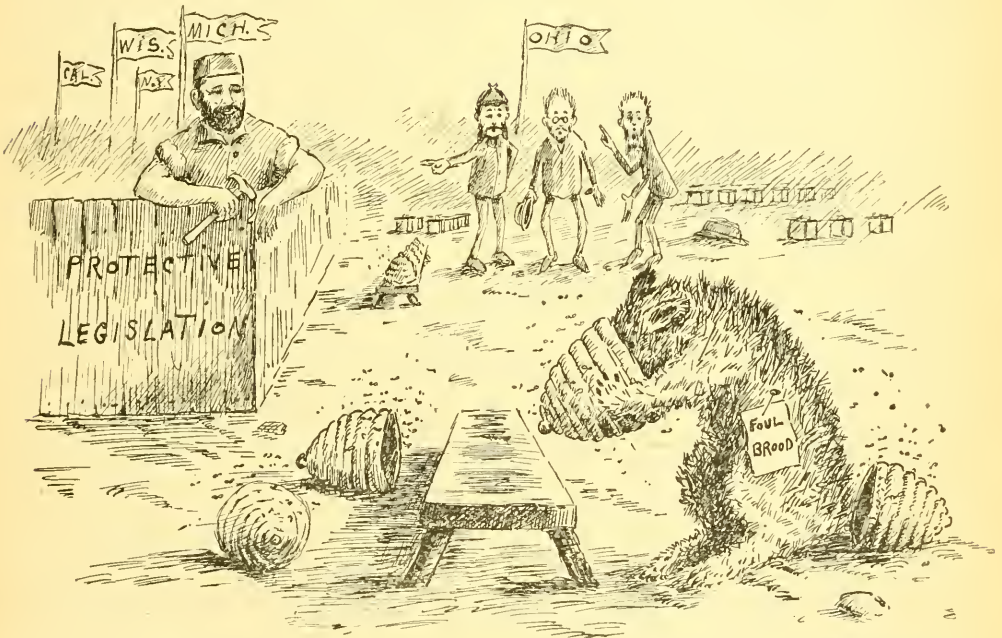

THE FOUL BROOD SITUATION IN OHIO.

I have had no returns from the bees the past season, and my other expenses have been heavy. You see my new building is just finished, and I have just had it insured, and you know these things all cost like sixty."

"Yes, that's so; but why don't you adopt the same business principles with regard to your investment in the bee business that you do with your other property?"

"Why, what do you mean by that, Mr. Fowls?"

"Just this: It is considered good management to get a new building insured, although it has given no returns as yet. Now, although

"But if I take membership, as a protection against unjust legislation by the town council, and I should need no help in the matter, would I get any benefit from the investment?"

"Yes, sir. The Association can help us as no individual can in prosecuting adulterators, helping to get pure-food laws passed, thus keeping up prices on a paying basis. Just think what a difference one or two cents a pound would make to the producers."

"Yes, and the rascals might damage the market that much if allowed to go unmolested."

"Besides all this, Mr. Brown, foul brood is liable to break out, and we have no foul-brood laws in our State."

"Well, Mr. Fowls, here is my dollar for membership. Glad you called my attention to the matter; and this point about foul brood is important. We need to be in position to do something in case it appears."

Oberlin, Ohio.

[Now that Michigan has recently passed a foul-brood law, Ohio, on the border, ought to follow suit. Our Ohio bee-keepers have talked over this matter a number of times, but so far it has all ended in "talk." In the picture accompanying, the artist intended to represent under the Ohio banner, beginning at the left, Mr. Fowls, your humble servant, and Dr. Mason. The man with a hammer in his hand, behind the legislative anti-foul-brood fence, is supposed to be N. E. France, the father of effective foul-brood legislation. No wonder he looks with complacency on such scenes in Ohio; and no wonder the poor little chaps in Ohio are beginning to be alarmed. But we must quit our "talking" and get down to business, and that means to see that our candidates *before* their nomination for the senate and legislature are favorable to a bill like the Wisconsin measure, for instance. I have already approached some of the candidates for my own district and county. Let's up and at 'em, *now*.—Ed.]

YELLOW SWEET CLOVER.

Some of Its Peculiarities.

BY M. M. BALDRIDGE.

I find from experience that sweet-clover seed, no matter how fresh it is, is no exception to the general rule about certain seeds germinating the first season. Only a part germinates, and there may be several distinct crops from one seeding.

Dec. 2, 1897, I planted a row of yellow-sweet-clover seed in my garden, in a shallow trench, and then covered the seed from one to two inches deep with soil. The seed was fresh, having been gathered by me in July the same year. In February or March following, we had a week or so of very warm spring weather, and a fine crop of plants came up. A few days after, there was a big change in the weather, and every sweet-clover plant was killed by frost. In April or May following, another crop of the plants made its appearance; and before the growing period ended they were perhaps 2 feet high. In February following (1898), the hard freeze destroyed these plants—roots included—with just one exception. At one end of the row one solitary stool of the plants survived, and they made a fine growth, and also a good crop of seed. This experiment thus far demonstrated that the yellow sweet clover will sometimes winterkill, and that the plant is a biennial, the same as the white variety, and not an annual, as some writer, whom I can not now recall, has claimed. This stool of plants was

at the extreme north end of the row of the seed I had planted in Dec., 1897.

Well, there came up in the spring of 1899 another crop of plants the whole length of that row, and from the same seed I planted in Dec., 1897, and they also made a satisfactory growth, being from 2 to 3 feet long before cold weather set in. These plants came through the winter in good condition, and in June, 1900, they were in full bloom quite early in the month—from 3 to 4 weeks before the white variety showed any blossoms. I think this row of plants was just passing out of bloom at the time Mr. A. I. Root visited this city and made me a brief call. See GLEANINGS for July 15, 1900, in Notes of Travel.

The foregoing shows three distinct crops of plants of the yellow sweet clover, and I know that only one planting of the seed had ever been made upon that plot of ground. As yet I have seen no sign of the fourth crop of plants, and do not expect to see it; but it would cause me no great surprise should it occur, for I am satisfied that the seed may remain in the soil for 20 years, more or less, and then germinate and grow. And this fact may explain why many who are not bee-keepers have tried to exterminate sweet clover from their premises, and have not succeeded.

St. Charles, Ill., Mar. 21.

THE SWARTHMORE SYSTEM OF QUEEN-REARING.

How to Prepare Small Nuclei; a Simple and Effective Plan for Getting Queens Fertilized.

BY SWARTHMORE.

A great deal has been written, said, and done to simplify and cheapen methods for cell-getting, until now queen-breeders have about all that can be desired in an almost perfect system of cellwork, from the egg to the mature queen, her care after hatching, and all that. But cell-getting is not the expensive part of queen-rearing; in fact, it does not represent an eighth part of the work connected with the securing of a laying queen, ready for posting to the customer far or near.

The *great* expense in queen-rearing is that necessary for the proper fertilization of the young queens after they are reared. The queen-breeder, heretofore, has been obliged to tear asunder large numbers of full colonies to form nuclei of a frame or two each to receive the young queens, each in a separate colony for mating purposes only.

Now, all this is expensive—not alone in bees but in time, labor, care, and a hundred other ways. Full colonies are ruined, and all revenue from bees thus treated is entirely cut off until a laying queen is secured, sold, caged, and mailed. All this woeful waste has set me to thinking about a plan of operation to lessen the expense and labor in queen-rearing at the mating period.

Some years ago I succeeded in mating a number of queens from $4\frac{1}{4} \times 4\frac{1}{4}$ section boxes, each supplied with a teacupful of bees; but not until the past season have I been able to say that I have discovered a practical meth-

od of mating young queens by the section-box plan, although I have used them now for about 13 years.

The plan I have at last adopted is as follows: Hive a good-sized swarm (natural or forced) into a body containing ten all-wood or Simplicity frames, each frame filled with $4\frac{1}{4} \times 5\frac{2}{3} \times 1$ inch one-piece plain sections, thus:

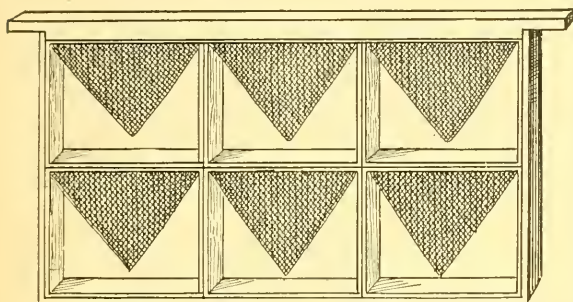

FRAME WITH FOUNDATION.

Each section should be supplied with a starter of brood foundation, as shown, and the frames are set rather close together until fully drawn out by the bees. Unless honey is coming in rapidly the bees should be fed constantly during comb construction, in the event of the swarm being a forced one.

In a few days a good prolific queen will have filled the most of these little combs with eggs, and in due time it will be found that each little comb has its supply of brood, honey, and bee-bread—the exact condition necessary for the successful formation of nuclei for queen-fertilization.

At this point take away all the section-holding frames, supplementing them with full sheets of capped brood, honey, etc., taken from other colonies; put on surplus arrangement, and close the hive. That colony will yet show you honey before the end of the season, even though you have borrowed every particle of their work from the time of hiving. Let them work on; you will not need to molest them more.

Remove the section-holding frames now clear of bees, just as taken from the hive, to the honey-house, and adjust to each side of each little comb, containing brood, a cover made of thin stuff, with $\frac{1}{4}$ -inch strips nailed all around the edges, as shown at A, Fig. 1. Four small staples, C C C C, driven part way into each corner of the lid, so as to project or telescope into the section box, will serve to hold the lids in place until they have become glued a bit by the bees.

When the lids are all in place, each little comb will be in a compartment by itself, and each com-

partment may be entered by the bees through the perforated zinc that covers the two $1\frac{1}{4}$ -inch auger-holes in the center of each lid, as shown in the drawing, E E, Fig. 4. The zincs are nailed fast to the inside of each lid. Pieces of section stuff do very well to close the zinc-covered holes when occasion demands (see dotted lines in Fig. 4).

A $\frac{1}{2}$ -inch flight-hole is cut just below the two large holes in one lid only. This is stopped with an ordinary drug-gist's cork, which is easily drawn when queens are to be introduced.

Now run a perfect-winged and sound-legged young virgin queen into each compartment; then recork the flight-holes and expose the zincs on all sides so that the bees can readily enter all the compartments from the sides, yet no queen can leave the compartment in which it is intended to restrict her. Then hang the frames in the hives of such bees as you may have just used in getting a batch of cells, or any

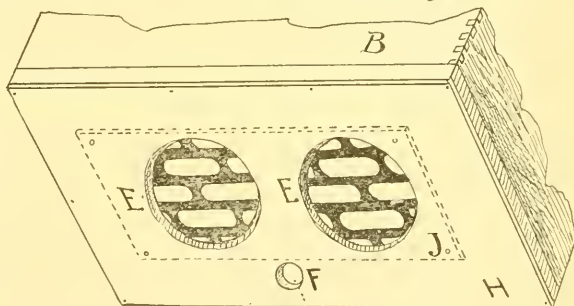
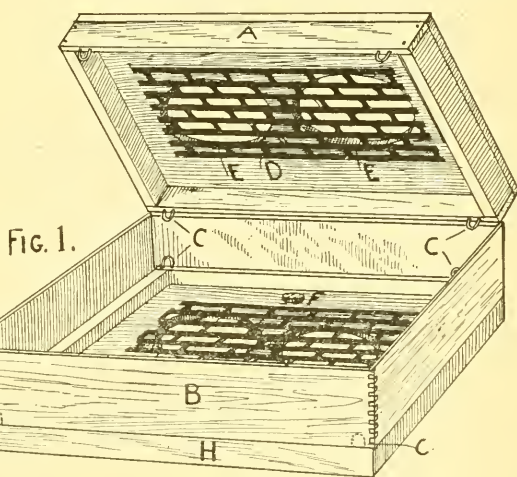

FERTILIZER NUCLEUS-BOX.

A, lid; B, section-box frame; C C C C, hive-staples, for guidance; D, perforated zinc; F, cork in flight-hole. Fig. 4 is a view of the under side of H, showing holes uncovered; B, part of section box; E, E, holes covered inside with perforated zinc; F, flight-hole uncorked; dotted lines show position of thin board when excluder-holes are covered.

queenless and broodless bees you may have at hand. Be careful, however, that there be no sort of queen with them, virgin or otherwise; and if they have been over three days queenless, a little tobacco smoke should be used.

A very simple way of supplying the compartments with young queens is to attach a ripe queen cell to each comb before adjusting the lids; then hang the frames among queenless and broodless bees with flight-holes corked, and zincs exposed. The bees will at once occupy the compartments, and in due time a young queen will hatch inside each compartment.

Any queenless bees will soon enter the compartments, and care for the brood and queens; and as soon as they become settled, feeding may begin. Feed a little sugar syrup (no honey) each day; and at the end of the fifth, if the weather is fine, remove the frames carefully, bees and all. Close all the entrances so none can escape from the compartments. If the weather is very warm, cover the holes on the flight side with wire net, as shown in the engraving, taking in as you do so, as many bees, that may be on the outside of the boxes, as possible.

the other, as shown above by the letters F F F. If the next day or two be fine, each and every queen will leave its little chamber to mate, and just as large a percentage will return safely as by any method of nuclei management now in vogue.

The life of these little colonies may be sustained several weeks by feeding lozenges of

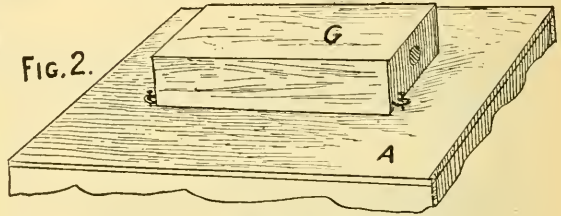

FIG. 2.

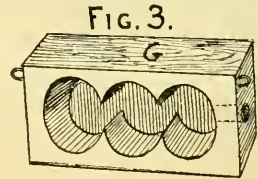

FIG. 3.

TOP VIEW OF COVER.—G, food feeder.

Good food every three to five days. Press the food into the holes at the back of each box. The blocks of Benton mailing-cages may be filled with Good food attached to the back of each compartment by two staples driven into the ends of same and hung on two corresponding wire nails driven into the back lid, as shown in engraving at G, Figs. 2, 3.

Examinations for eggs may be made quite well through the back-most holes, which are easily uncovered by unhooking the Benton cage feeders; and when it is found that the young queens are laying, they should be removed and other young virgins supplied; or the frames may be again collated and placed on a single stand where the laying queens will keep in good health for an indefinite period.

In my next letter, with the editor's kind permission I will tell more about these section-box nuclei; how I manage to run these miniature colonies through the entire season, taking from them several laying queens each during the months suitable for queen-rearing; also how I have succeeded informing 40 little colonies from one large stock, and successfully mating nearly every queen given to them.

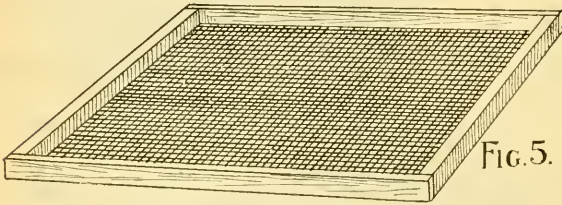
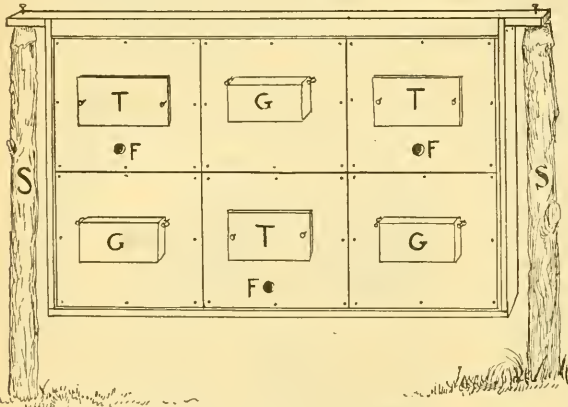

FIG. 5.

ALLEY CONFINING SCREEN.

Take these frames some distance from the old stand, and set them out separately on stakes driven into the ground, thus:



SWARTHMORE'S FERTILIZING-FRAMES, WITH NUCLEUS BOXES IN PLACE.

Toward evening open the flight-hole to each compartment—three on one side and three on

ered by unhooking the Benton cage feeders; and when it is found that the young queens are laying, they should be removed and other young virgins supplied; or the frames may be again collated and placed on a single stand where the laying queens will keep in good health for an indefinite period.

In my next letter, with the editor's kind permission I will tell more about these section-box nuclei; how I manage to run these miniature colonies through the entire season, taking from them several laying queens each during the months suitable for queen-rearing; also how I have succeeded informing 40 little colonies from one large stock, and successfully mating nearly every queen given to them.

[As I have explained elsewhere, this is the introductory article of a series giving a new system of queen-rearing. This method of having queens fertilized is something we have not yet tried, as it is too early in the season; but we give it in order that other breeders may put the plan to a test at

once. In our next issue Swarthmore will describe a new method of making queen-cups that I believe is original with him; also several other valuable kinks that will come in very good play just now.—ED.]

 RAMBLE 185.

Peculiarities of Central California; Extracting in the State; Strainers vs. Settling-tanks; Importance of Clear Honey.

BY RAMBLER.

"See here, Rambler, what have you stuck this thermometer up here under the shed for?"

"That's a funny question, Mr. McCubbin. I wonder if you do not know the use of a thermometer? Don-cher-know that is to enable me to keep a record of the heat? You

ly so hot, shade-boards are used quite freely. Many are successful without them, and I am coming to the conclusion that the providing of shade-boards anywhere in California is a useless expense. Then you have such little entrances to the hives, barely three inches in length. I should think there would be a congestion of both bees and heat."

"You see, Rambler, that's where my open-work covers and sack honey-board helps the bees to keep the hive cool—plenty of ventilation, and no melting."

"Now, then, Mr. McCubbin, as a precaution to myself, as well as comfort, and to save labor, I suppose you would have no objection to my erecting a sort of pavilion extracting-house under the peach-trees, and right alongside the bee-hives?"

"Not the least, Mr. Rambler."

And it was so accomplished. The pavilion was made as shown in the half-tone—a light



RAMBLER'S COOL RETREAT AMONG THE BEES AND PEACHES; EXTRACTING-HOUSE IN THE BACKGROUND.

said the other day that the temperature sometimes climbed up to 120. Now, I do not wish to be so foolish as to work under such a temperature; then if it *does* get up to 120, I want something reliable to brag about."

"Rambler, that is wrong; you should never mention the heated condition of this valley. Why, if you were in the real-estate business, as I am, you'd never catch the Eastern buyer. Ignore the heat, Rambler; ignore it, and throw that thermometer into the ditch."

"No, sir; I will tie to that thermometer, and I will report every hot day, and the effect upon the bees; but it seems strange to me that no shade-boards are in use in this country. Down south, where we have it not near-

framework, 8 feet square, 6½ in height. The lower half of the frame was covered with sacking, the upper half on three sides with wire cloth. This gave free access to any comfortable wind that might be stirring. The top was also covered with sacking; and, to aid the shade of the peach-tree, leafy boughs from other peach-trees were piled on, making a delightful, shady, and really comfortable place to manipulate the extractor.

I hope the half-tone will bring out those luscious peaches that were on the tree; but, mind you, they were not long there after they became luscious; and, by the way, there are many acres of peach-trees within 200 rods of this apiary, and not a complaint about the

bees injuring the fruit—no Utter here to utter against the bees.

The shady pavilion constructed, another matter caused anxiety. In the southern portion of the State our apiaries are located in canyons, and there is an abundance of uneven ground, so that the tank can be placed below the extractor; and still another drop below the tank, for the convenient filling and removal of the five-gallon cans. Honey runs naturally from one to the other, without waste or daub.

Here in Central California the land is a dead level, and we must put the extractor on a platform, and climb up to it or dig a hole in the ground and get into that to lift the cans out. Neither way is satisfactory, and many use a pail to draw off into from the extractor, then lift it and turn it into the tank; but that is a shiftless method, and not in harmony with neatness and cleanliness. Out of my anxiety

above it, it holds its level position. When the filled can gets to the proper place at the top, the catch drops into a slot automatically, and holds it secure. The empty can has, of course, followed the other end of the revolving framework, and is at the bottom ready to be filled. The spout is adjusted under the gate of the upper or full can, and the gate adjusted so as to draw it off fast or slow as desired. The honey runs into the Rambler's ahead-of-date strainer, and into the tank. While the upper can is losing its contents the extractor is extracting more honey, and the cans are filled, revolved, and emptied *ad infinitum*, or until the crop is harvested. After using it while extracting all by myself nearly ten tons of honey, I am sure I would not discard it for the old dauby way.

And now as to tanks, strainers, and the proper curing of honey. In Southern California, tanks are used holding all the way from one to six tons of honey. It is seldom that you find a bee-keeper, owning 100 or more colonies of bees, with a tank capacity of less than a ton—probably the average is between the two and three ton tanks.

My observation in respect to the tank question in Central California is limited; but in my immediate vicinity, 30 gallons or less is the rule, while not a few consider a galvanized-iron wash-tub a good-enough tank. One would suppose that where such small tanks are used the more care would

be taken in straining the honey; but the practice is quite the contrary. The honey is run through wire cloth such as we use for window-screens, and almost directly into the five-gallon cans.

A bee-keeper in my vicinity who owns upward of 500 colonies of bees had finished his day's work, had loaded his two frame extractor and twenty-gallon tank and his cans of honey into his wagon, and was ready to depart for his home when I rode up on my wheel. He showed me his day's work and his strainer.

"Well, now, see here, Mr. ———, is there not a quantity of particles of comb and other substances in the honey?"

"Probably there is," said he; and he unscrewed several caps from the cans, and, sure enough, any quantity of those specks were rising to the surface of the honey.

"Oh! well," said he, "I can sell it for as much as you can get for clean honey. It goes to San Francisco, and they mix it with glucose, and what is the difference?"

It does make a difference, though; for recently, in conversation with a gentleman who has purchased a good amount of honey, he

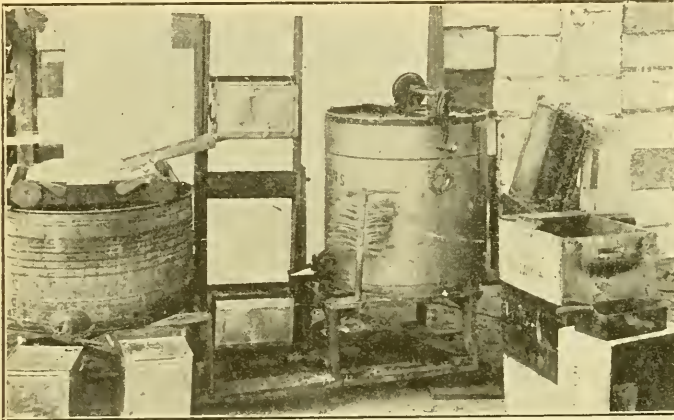

RAMBLER'S HONEY-ELEVATOR, STRAINER, AND SETTLING TANK.

to have things handy, up to date, and a little ahead of date, there was eliminated the honey-elevator shown in the smaller picture.

There is the four-frame Cowan extractor, and there is the tank—i. e., if a thirty-gallon tub can be called a tank. Under the small faucet are the five-gallon cans ready to be filled.

Between the extractor and tank is my non-patented honey-elevator especially adapted for use in a level country. Observe the two five-gallon tin honey-cans, one at the top and the other at the bottom of the uprights. The upper sides of these cans are cut out. They are also provided with screw-cap honey-gates, such as are advertised in A. I. Root's catalog. These honey-gates are set in a little below the level of the bottom of the cans. To operate, open the extractor-gate and fill the can under it. Now grasp the end of the upright that rises above and next to the extractor; loosen a little catch at the top of the upright next the tank, and revolve that portion of the frame which is pivoted in the large block in the center. The lower and filled can will rise, and, being suspended from the cross-piece

said that he would not purchase such honey. He had had experience in that line, and he said that all of those specks did not rise to the top of the honey in the can, but were mixed with the honey three or four inches down, and before it could be used it was necessary to warm and strain it.

With the large tanks used in Southern California the honey remains in the tank at least 24 hours, many times longer; and, even if the honey is strained, a thick scum will rise to the surface; and when the honey is drawn off, how beautifully clear it is!

The most complete clarifying process I ever saw was in the apiary of J. F. McIntyre. His method has been described in GLEANINGS, but will bear repeating. He strains his honey into a large shallow tank (it is clean from the start). After standing in this a proper length of time it is drawn off into another large tank, and when drawn from this it is honey fit for the most epicurian palate, and, as a general rule, Mr. McIntyre gets a better price for his honey than the majority of bee-keepers.

It would be better to use a large tank, and no straining whatever, than to allow a multitude of specks to run into the can with the honey; for, in the use of a large tank, there would be opportunity for clarifying the honey and skimming off the refuse. The dairyman is compelled to be particular respecting his milk and all receptacles for handling it. Our honey will not sour on our hands as the milk does in the hands of the careless milkman, but there is an aroma to retain; and to retain it in the highest quality requires as clean manipulation as is practiced in the dairy.

This hit-or-miss, careless, slovenish, whack-row-de dow, git - there - Eli honey - production will result only in a degradation of our product.

Referring to the small cut again, I wish to call attention to the bee-brush resting against the extractor. That brush has seen hard usage through the honey season, and it is a California invention, such brushes having been used here for the past dozen years or more. I use two of them. When one gets sticky with honey, wash it and throw it out in the hot sunshine. It will be dry enough to use by the time the other gets sticky.

[I envy Rambler the pleasure of that shady retreat, even though it be in a climate subject to extremes of 120 degrees. I envy the freedom of *any* Rambler, providing he is not of the tramp order. I am not sure that I shall see the Rambler this summer, but I am trying to get away; and if so I shall see him and other bee-keepers in California right in the midst of their extracting work.

Wherever practicable it is always advisable to have the extractor higher than the tank into which the honey flows; but in many cases it happens that both tank and extractor necessarily have to be on the same level. Mr. Cogshall, who extracts so many tons of buckwheat in New York, allows the honey to run into a pail, and then when the pail is full he empties it into kegs; but while I was there the pail ran over once, and I should imagine

that that would be just the trouble where one has to *remember* to empty. But say, Rambler, suppose you forget to revolve your honey elevator. Can't you somehow make the thing semi-automatic so that, when a can gets to be so full, it will ring a bell so that the operator will know when to reverse the machine?

We have examined your strainer, and believe it to be all right—the very best device that has yet been brought to our notice. We have been planning to catalog it, but somehow it is so hard to get a new thing started and under way; but if I see you I'll study its operation more fully.

What you say about clarifying honey is very timely and important. Too many of the California producers are very careless. Sometimes in car lots one man's fine honey in square cans will be mixed up with another man's very dirty honey. While the honey is doubtless just as good, yet it must necessarily sell at a lower price, or cause "a kick" from the purchaser. This mixing of good and poor lots of honey is apt to knock the price of all honey down to the poorest. They had better cut out your remarks and paste them in their hats.—ED.]



Pshaw! Dr. Miller, we are not at outs. It is because we do not see exactly alike.

A person devoting his entire attention to queen-rearing must necessarily improve his stock or he will lose his trade. His customers are the best judges; and the better the bees, the more orders. The secret, if any, in the matter, is, to get the very best stock to breed from, and continue to get the best stock. I have an idea that the plan outlined in the article referred to will be carried out in California at no distant day.

Well, well! that good-looking enthusiastic Arthur C. Miller seems to be knocking around quite a little in the bee-papers of late—getting the corners knocked off a little too. He will settle down into a steady gait after a while.

An old-time friend, Reynolds, from Merced Co., stopped a few hours with me, and then stayed a few hours more with Mr. McCubbin. We are both baching, Mc and I; and after 24 hours' experience with us, Reynolds exclaimed, "I'm going to get right back to Jane (my wife) as fast as I can go." He got. Mc and I are not dyspeptic—he is.

Those are very good "Hints on Keeping Well," by Prof. Cook, in the *American Bee Journal*. Along toward the end of his advice he says, "Cultivate the habit of conversation at the table." That's all right, Prof. C.; but what is a fellow going to do when he has no one to talk to? But, after all, in the absence of talk I am extremely well—no stomach trouble. I'll tell you what I have that's bet-

ter than talk. It is sunshine, professor—chunks of it all through my system.

This portion of Central California is receiving a thorough drenching to-day, Apr. 29, the first rain of any account for nearly three months. It will help out the newly sown alfalfa and many honey-producing plants.



MAKING NUCLEI.

“Mr. Doolittle! I wish to try my hand at rearing some queens this season, and I came over to see if you would tell me something about how I can make nuclei for this purpose.”

“Very well. Do you understand how to secure good queen-cells?”

“Yes, fairly well.”

“And about a queen-nursery to hatch them in?”

“Yes. I understand this part much better than how to get the nuclei to keep them afterward. Last season I tried to make nuclei, and made very nearly a failure of it on account of the bees going back home.”

“Well, bees taken from a colony having a laying queen are quite likely to go back to their old home unless some precaution is used. But if you will make a colony queenless, waiting till they have queen-cells sealed, you will have better success in regard to the bees staying.”

“I had not thought of that. How do you manage when you work that way?”

“Six to eight days after removing the queen I go to the colony and remove all the queen-cells but those which look the largest and best, and see that there are queen-cells on five frames, if the colony is a large one and in a ten-frame hive.”

“But suppose that the queen-cells are all on one or two combs—what then?”

“Then I cut out a queen-cell from the comb having more than one cell upon it, cutting out a piece of comb with it about an inch in diameter, so as to be sure not to injure the cell. Then I cut out a piece of comb from another frame of the same size as that having the cell on it, when the ‘cell-comb’ is slipped into the comb or frame where I wish it. In short, I graft a cell into each comb where I wish them.”

“But suppose the queenless colony is one you do not care to raise queens from—what then?”

“This is more apt to be the case than otherwise, and for this reason I start queen-cells from brood from which I desire to raise queens a day or two before I take the queen away from the colony I desire to break up into nuclei. Then at the proper time I destroy *all* queen-cells which the bees in the queenless colony have built, and put one, which has

been reared from the brood I desire, into each of five frames, when the colony is left for 24 hours to become accustomed to the new state of affairs.”

“What then do you do?”

“During the next day I place four hives, fitted up with a division-board, etc., ready for the nuclei, and place them where I wish the nuclei to remain during the season; and just at night, allowing me only time to complete the work before it gets too dark to see to work, I take two frames from the queenless hive, bees and all, one of which is to have one of the queen-cells on it, and set two in each of the four hives, thus making five nuclei out of the queenless colony. The one left on the old stand should have a division-board adjusted to its two combs the same as the others.”

“Why do you wait till so near night? Is that necessary?”

“Because, if done in the middle of the day the bees are more likely to go back. The change causes them to go to looking over their new quarters; and if it is midday they will often run out of the hive and take wing, only to return to their old home. But in the night they will not take wing, and by morning they become accustomed to their new surroundings, in a new hive having only two combs, and thus when they go out they are apt to mark their new location and stay by their young queen which will have emerged from its cell by this time, if you have timed the matter right.”

“Do you think this the best and easiest way of making nuclei?”

“No. I like the nucleus-box plan better.”

“What is that? I want the best.”

“The box is made as follows: Get out two pieces, 6 inches long by 6 wide by $\frac{3}{8}$ thick; also two pieces 12 long by 6 wide by $\frac{1}{4}$ thick. The latter are nailed to the former so as to make a box $10\frac{1}{2} \times 6$, inside measure, without sides. For sides I use two pieces of wire cloth, cut 12 inches long by $6\frac{1}{2}$ wide. One of them is nailed permanently to the box, while the other is left so as to be easily removable by nailing the wire cloth to a little frame like a slate-frame, which frame is lightly tacked to the box. In the top of the box is bored a large hole into which a funnel is to be inserted. This funnel is to be large enough to allow of one of your brood-frames to be shaken inside of it, and the hole in the small end should be 3 inches across, so that the bees will readily pass down through it and not clog. The hole in the box should have something to close it, like a large button or tin slide.”

“How is such a thing as that used in forming nuclei?”

“Having funnel and box ready, go to any hive that can spare from a pint to a quart of bees, according to the size of the nucleus desired; take out a frame or frames having bees on the combs (be sure you do not get the queen), and place it on the outside of the hive, or in a comb-carrier. Give the frame several sharp knocks with the thumb nail or a little stick, to cause the bees to fill themselves with honey, and, when so filled, shake as many down through the funnel into the box as you

wish in your nucleus. Take out the funnel and close the hole, when you will put the frame from which you shook the bees back into the hive and close it."

"Well, that is an easy way to secure bees, and a way I never thought of before. But what do you do next?"

"Next, take the box of bees into any room and throw a blanket over it, or darken in some way, when they are to be left three or four hours. At the expiration of this time they will realize their hopeless and queenless condition, telling you the same by their buzzing and running about the cage when you go to them, and be ready to take a queen of any kind."

"But where is the queen to come from, I should like to know?"

"As you said you knew how to raise queens and keep them in a nursery, I will only say that at this time I go to my queen-nursery and get a virgin queen, putting her in a cage having a 'candy cork,' and give them. Attach to the cage a short piece of wire, and you are ready. To put the cage in, set the box down suddenly, so that all of the bees will fall to the bottom, when the hole is opened, the cage put in and the hole closed again, all being done while the bees were trying to climb to the top again. The cage is pulled near the top of the box, and secured there by bending the wire over the button or tin closing the hole."

"Pray tell me what a 'candy cork' is."

"A candy cork is a cork, generally of wood, with a $\frac{3}{8}$ hole bored through it. This hole is filled with 'queen candy,' which the bees eat out and thus liberate the queen. The greater the length of the cork, the longer it will take the bees to eat out the candy. For this purpose I make the cork about half an inch long, so that the queen will be liberated in about twelve hours, or at some time during the night, as she is generally given about two to three o'clock in the afternoon."

"But you do not do any thing with this box of bees in the night?"

"No. They are left as they are after giving the queen, till near sunset of the next day, except to feed them if they need it, when they are put in a hive as follows: Prepare a hive by placing in it a frame containing a little brood and one of honey, together with a division-board, which are put on the opposite side of the hive from where you wish the bees. Now get the box, in which you will find the bees all compactly clustered like a swarm; carefully remove the movable wire-cloth side, and with a quick jerk dislodge the bees from the box on the bottom of the hive. Now draw the comb of honey, then the comb of brood and the division-board, across the rabbets of the hive, in the order named, to where the bees are, and they will be immediately on them. The hive is now closed, and, if all has been rightly conducted, and works as it should, you will have a fine nucleus in that hive for the whole of the season, with the queen laying nicely in a week. But I must go now, as I have an appointment to meet at our village in half an hour."



THE TRICK OF PRODUCING LIGHT COLORED EXTRACTED HONEY; THE EFFECT OF THE COMBS.

One year when the Illinois State Fair convened at my home, Peoria, Ill., I made an effort to put on exhibition a choice article of extracted white-clover honey. With this end in view I exercised the greatest care in selecting the honey, and to have the utensils clean, and free from other honey. I extracted from no comb, unless of the purest white; in holding a comb up to the light, if I discovered a few cells off in color they were not uncapped.

This honey was put on exhibition, along with a large collection from different producers living far and near. It was all white-clover honey, in pint glass jars, and arranged on a shelf in front of a window. In looking at the exhibit, no one would fail to see that mine was the lightest in color, and was given first premium. There was not the slightest difference in color, in all the other honeys on exhibition.

I inquired of the other exhibitors why this difference in color, and they replied, "We thought there was some trick about it." I told them what must have made the difference. It is not at all surprising that they inferred a "trick," as all of the other white clover honey did not vary one point in color. It may make no difference in color from dark combs, when one extracting follows another in quick succession.

MRS. L. HARRISON.

St. Andrew's Bay, Fla., April 3.

[I believe it has been before stated that, in order to get an extra-light-colored honey for exhibition purposes, it is very necessary that such honey be taken from new or white combs. If I mistake not, Mr. R. F. Holtermann, formerly editor of the *Canadian Bee Journal*, was among the first to urge the importance of this. But as a rule the average honey-producer uses combs of all colors and ages for the extracted honey he sends to market. It is possible that, when competition becomes stronger, as it probably will do, it will be best for him to discard the old black combs, melt them up in one of the presses shown in our columns recently, and use, instead, new combs made off from foundation. In spite of what you, Mr. Holtermann, and others have said on the subject of producing light-colored honey, I do not think that very many of the average producers are "on to the trick." As some extracted honey may be produced for the Buffalo Pan-American, it may be well for some of our friends to bear this little "trick" in mind.—ED.]

A CORRECTION; COLLIER'S EXPERIMENTS.

Mr. Editor:—Please correct the third paragraph from top first column, page 245. The detailed experiments of myself concerning

bees and fruit were not conducted at the Agricultural College at all, but they were made at, I think, eleven different locations in the western part of the State. The work was done for the Connecticut Board of Agriculture.

Page 248, G. Collier, Warsaw, N. Y.—Your supposition about the comb following the line of the foundation is, in the main, correct. I have used that plan of putting foundation in the sections on the catcornered, oblique, and in every conceivable improper way, for the sake of having misshapen, malformed sections of honey to exhibit at fairs, and made a grand success of the grotesque production.

Woodbury, Conn.

H. L. JEFFREY.



WE have had no very bad reports of wintering losses so far, that I know of. Colonies themselves, however, as I have already stated, appear to be considerably weakened; but the fine weather the past ten days, and the great number of fruit-blossoms, appear to be making amends for the bad weather and the late spring of a few weeks ago.

IF there ever is a time in the whole year when the absence of a laying queen in a strong colony means a heavy loss to a bee-keeper it is now. Be sure to go over every colony, and see whether eggs are being laid regularly and in sufficient number. Queenless colonies of good strength should be supplied with laying queens from nuclei or some weak stock that has just come through the winter that has only a queen and a few bees. Give these bees a cell, and their queen to the strong colony that needs her.

I HAVE in hand the introductory article of a series that is to be written on the subject of "Bees in Law." The writer will take up the subject of common and statutory law as it relates to bees, and then proceed to give specific mention of various classes of special legislation directly and indirectly affecting them. The important court decisions that have been handed down will also be given. It is possible we may have this put in pamphlet form for the use of the members of the National Bee-keepers' Association.

THE heavy snows in the Eastern and Northern Central States have given the clovers a wonderful start. The snow fell to the depth of one or two feet, and during the quite warm weather it took all of ten days for the last vestiges of it to disappear. This vast quantity of water trickling down every day upon the grasses, clovers, and other vegetation, had a most stimulating effect, and we shall, therefore, expect that, if good weather has any thing to do with nectar secretion early in the season, the clovers will do well this year.

I AM glad to introduce to our readers Editor W. J. Craig, of the *Canadian Bee Journal*. Mr. Craig succeeded Mr. R. F. Holtermann, both in the management of the supply business of the Goold, Shapley & Muir Co. and in the editorial conduct of the *Canadian Bee Journal*. A man of pleasing address, Mr.



W. J. CRAIG.

Craig seems to have predominantly in his makeup the faculty of making and keeping friends. The *Canadian Bee Journal* is well edited, and is in the front ranks of other publications of its class.

COMB HONEY VERSUS EXTRACTED.

IN the last issue of GLEANINGS it was advised to turn our attention more to the production of comb honey than of extracted. There remains one thing more to be said in favor of comb-honey production; viz, colonies run for comb are almost invariably in better condition for wintering than those run for extracted. It would seem that a colony regards the brood chamber and the extracting-super above as its sole domain which is not to be meddled with; and when the fall honey comes in, the same is distributed around with a view of having it on hand for winter use. When we now remove the extracting-super we throw things badly out of balance.

A comb-honey super is apparently not regarded by the bees as a favorable spot to locate during winter; and when preparing their nest it is left entirely out of calculation.

HOW THOSE BEES CAME OUT OF THAT MACHINE-SHOP CELLAR, ETC.

ON the 1st, 2d, and 3d of May we took all the bees out of the cellar under the machine-shop. They were in fine condition, and apparently just as strong as when they were put in last fall, about the first of December, but

had little or no brood. They had been confined just about five months. During all this time they were very quiet, and the number of dead bees on the cellar bottom was the smallest I ever saw. Well, now for the results :

Our Mr. Wardell says that those colonies are away ahead of the outdoor-wintered ones of the same strength last fall. The large force of bees has enabled them to take care of large quantities of brood, now that they are outdoors ; and the probabilities are that, when the honey-flow comes on, they will be worth nearly two of the colonies wintered outdoors. We estimate that our outdoor bees lost very heavily during the great storm of April 20 — a storm that was a record-breaker, and which will go down in history as one of the heaviest ever known. While the weather was not very cold, yet after the snow had fallen the bees flew out on the warm days following, dropped on the snow, and never got back. Thousands and thousands of bees were lost that way ; but the other bees were housed during this big storm, and were not put on their summer stands till about ten days later.

Ira Barber, in our last issue, recommends putting more bees in the cellar and raising the temperature. Our cellared bees were kept in a higher temperature than any bees we ever wintered indoors ; and they wintered the best, irrespective of the noise above in the machine-shop. But I am afraid that, if the temperature had been as high as Mr. Barber recommends, they would not have fared as well as they did. Nevertheless, we shall test his ideas on a small scale next winter.

PROF. COOK'S REVIEW OF THE A B C OF BEE CULTURE REVIEWED, AGAIN.

In the third and last instalment of Professor Cook's review of the A B C, published in the *American Bee Journal*, he has a word more to say about bees dying because they have lost their stings. He does not claim that they die in less than a day or two, the time varying. Bees that had lost their stings from use were put into a cage, and died within a day or two, while others uninjured were also caged, and lived for weeks. With such testimony it certainly seems that it might be well to give the subject further consideration. If bees thus injured were put in the same cage with uninjured bees, it ought not to be difficult to come to a decision.

"I am a little skeptical," says Prof. Cook, "as regards the queen leading out the bees. I would not be sure that Mr. Root was right in his conclusion." The reading of that, without referring to the A B C, might induce one to think that the book taught that it is a common thing for queens to lead out swarms. Of course, that would be incorrect, and it is not taught in the book. The thing that Prof. Cook has reference to is the statement that in one particular case a queen from several miles away was put in a nucleus, and after a day or two the queen led the nucleus back to the hive from which she was taken. Prof. Cook may be right in thinking that, even in this case, the queen was in no sense a leader.

Prof. Cook agrees with the book that swarming depends upon conditions or causes, rather than with Mr. Doolittle, who says the real cause of swarming is the fiat of the Creator, "Go forth, multiply, and replenish the earth."

"I was surprised," says Prof. Cook, "to note that Dr. Miller also gives his authority in favor of bees not clustering in case the queen does not go forth with the swarm. . . . In such cases they will always return to the hive; but in my long experience and observation it will be decidedly the exception and not the rule that they return to the hive without forming at least a partial cluster." Dr. Miller has probably had as long an experience as Prof. Cook, with probably a larger number of colonies, and he is by no means a careless observer. Both men agree that, with clipped queens, some swarms return to the hive without clustering, and that some cluster first. Is it not just possible that the majority of Prof. Cook's swarms clustered, and that the majority of Dr. Miller's did not? But Prof. Cook is certainly wrong in saying, "In such cases they will always return to the hive," for in a large apiary it is unfortunately true that in too many cases the swarm will enter another hive where swarming has lately occurred.

The reviewer notes the error of the A B C in saying "soiling" instead of "green-manuring" when speaking of plowing under a growing crop of turnips. He also thinks turnips are of little value for green-manuring as compared with leguminous crops.

When a colony is suffocated because the hive is too tightly closed, the A B C says the bees are wet by the honey involuntarily discharged. Prof. Cook thinks much of this moisture is caused by perspiration, and he may be right. He says : "In such cases bees try hard to cool off. The only possible way they can do it is by the evaporation of water." That sounds as though evaporation, which is entirely involuntary on the part of man, is voluntary on the part of the bee. Can that be possible?

"Here again," says Prof. Cook, "our author refers to bees separating water from honey while on the wing. I believe this is physically impossible. I have never as yet seen this 'mist' fall from the bees while flying in the air." No doubt there are many who have not seen it, but that does not invalidate the testimony of those who *have* seen it. "If such mist does fall from the bees," he continues, "it certainly must be the water of evaporation in the air-tubes, or else excreta from the intestines." One can hardly imagine that water evaporating from so small a creature could immediately condense into drops that would fall like water ; but that it falls as excreta from the intestines is exactly what one would understand from the book when it says, "I distinctly saw them discharge from their bodies what seemed to be only pure water."

The A B C says : "There are also known in commerce such as Japanese and Chinese wax, both of which may or may not be the product of insects or plants." Prof. Cook says the

Chinese wax is the product of a scale insect related to the cochineal insect.

"In speaking of the willow," says Prof. Cook, "it is stated that it does not furnish honey, and the late Mr. Quinby is quoted to the same effect. This is certainly not true of all our willows." One is at a loss to know how it is possible for any one so to misread. The author says he has had little or no experience with the willow; but as it does yield honey and pollen in some localities he yields the floor to Mr. G. M. Doolittle, who has had much experience with it, and is, withal, one of the most careful observers. Mr. Doolittle ranks some of the willows, the large growing kinds, as exceedingly valuable honey-plants, the pussy willows that grow in his locality being valuable for pollen alone, in which he concurs with Quinby.

Angustifolium epilobium, says the professor, should be *Epilobium angustifolium*, and it is so corrected in the latest edition.

The A B C gives white honey the preference to dark for wintering, but says that, although the dark is a little more apt to give dysentery, it usually does not have that effect. Prof. Cook makes what is no doubt a proper distinction, by saying that buckwheat and other dark floral honey is good, while that from scale lice is unfit for wintering.

In the glossary, *Apis* is given as the family to which the bee belongs, when it should be *genus*, as it is found in the latest edition.

But it should be understood that all these criticisms relate to an old edition of the A B C, and not to the new one out last January, and now offered for sale.

HIGH-PRICED BREEDING-STOCK — IS IT RIGHT TO ADVERTISE IT?

It is well always to be on guard against such excitement as shall attach fictitious valuations far beyond the real worth of an article. Many a town site in the West has had its boom when corner lots went skyward in price, and the man who paid his hundreds or thousands for a single lot has seen the price come down, down—never to rise again. On the other hand, there have been cases in which a man has been laughed at for paying what seemed to be a fictitious price for a piece of ground, but who, with very shrewd foresight, has held on to it and made a fortune. A good many things need to be taken into consideration in getting at the actual value of an article. Even in the matter of queen-bees it may be possible greatly to over-estimate values, and it may also be possible to undervalue. An editorial in the *American Bee-Keeper* reads as follows:

When a queen-breeder offers as his greatest inducement to buyers to send out queens from a mother valued at 50, 100, 200, 500, or 1000 dollars he should be regarded with suspicion. If he is not a fakir pure and simple, he is not what he appears to be in the eyes of the honest business world.

According to the dictionary, "fakir" is a slang word which means "one who originates a fake, humbug, or swindling contrivance." It can not be that a man would be considered a swindler who should urge, as the chief inducement for purchasers to order from him, that the stock from which he bred was of

great value. Evidently the thought is that no queen can have so high a value, and that a queen-breeder who claims to have a queen valued at \$50.00 or more is, in the eyes of the honest business world, a swindler. If our co-temporary had given the matter sufficient thought to make a proper estimate of the possible value of a queen, it never would have published that paragraph.

When hens' eggs can be had in abundance at 12 cts. or less per dozen, the man who advertises to sell a sitting of 13 for \$1.00 is not considered a swindler. When the average price of a horse is less than \$100 there are a few animals which change hands at prices away up in the thousands; and the men who receive such prices are not considered swindlers. The man who buys such an animal is not considered a swindler if he puts a still higher price upon his purchase, even though he should never sell at the price set. The only question is whether he would rather keep the animal than to sell it at any thing less than the price set.

Queens can be had by the thousand for one dollar each, and many are sold for the half of that; yet it is a common thing to see advertisements of certain queens at much higher prices; and the man is not considered a swindler who has received \$2.00, \$5.00, \$10.00, or more for such a queen. There is no question, then, that a man may be an honest man and sell a queen for more than the ordinary price. The only question is as to the limit beyond which a man may not go without appearing as a swindler in the eyes of the honest business world.

A great many queens are sold at a price of \$5.00 each or more. The man who buys such a queen does not expect to get his money back on it if he uses it as the average queen is used for securing a crop of honey. But by the improvement of his stock he may get back his money many times over. The results obtained from it give it its value. The question is whether such results can be obtained in any case as to warrant a valuation of \$50.00 or more. Suppose a queen-breeder who sells a thousand queens in a year has a queen of such qualifications that he can get an extra dollar for every queen of her stock that he sells. It matters not whether the extra value be in color, length of tongue, working qualities, or what not; if it is what his customers want, and if they are glad to pay the price, he gets an extra thousand dollars in the course of the season, not for extra work on his part, but simply and solely for the value there is in that queen. Suppose at the beginning of the season some one should say to him, "I'll give you \$50.00 for that queen." He might reply, "I get \$1.00 extra on each queen of that stock. I expect to sell 1000 queens this season at that advanced price. If I hold on to her I shall be worth \$1000 more at the end of the season than to let her go and breed from another queen. I should be foolish to take \$50.00 now for the prospect of \$1000 at the end of the season. True, she may die to-morrow; but the chances in favor of her living are such that I should hardly be willing to take less

than a fourth or a half of what she will bring me in extra if she lives. The least I would take for that queen is \$250." And the honest business world, instead of condemning him as a fakir pure and simple, would commend him for his business judgment.

The fact is, that the bee-keeping world is just beginning to wake up to realize something of the value there is in blood. Doolittle has been preaching that the queen is the center upon which all pivots; but year after year the average bee-keeper has been going on, making his increase from stock most given to swarming, hence least given to storing. It is a good sign that attention is awakened in the right direction. We are used to extra values in horses and cows, but not in bees. We hear of a horse being sold for five hundred times the average price, without a shock; but if fifty times the average price of a queen is mentioned, it is another thing. Perhaps queens can not be worth \$25, \$50, \$100, or \$200. I have no quarrel with any one who thinks otherwise. Indeed, I can see how such a person may think he is right; and yet on the other hand I can not see but I am justified in holding the opposite view.

The laurels of our breeder do not rest solely on the long tongues of her bees. But long tongues or no long tongues, she rolled in the honey last year, and is doing the same thing this spring in a way that eclipses every thing else in the yard. Sell her? Why, she is worth many times her weight in gold. She is now three years old, strong and vigorous, and very prolific. She was wintered in a four or five frame nucleus outdoors, and yet she and her bees came through in good order.

E. R. ROOT'S WESTERN TRIP.

I HAVE before given intimation that I expected to go to California in the near future. My plans are now all matured, and I start from Medina on the 20th of this month, or about the time this issue will reach the bee keepers. My route is as follows: Cleveland, Cincinnati, and them to Wetumpka, Ala., where J. M. Jenkins, the southern supply-dealer, holds forth. Then to New Orleans; San Antonio and Uvalde, Texas; Maricopa, Tempe, and Phoenix, Ariz.; Los Angeles, Fresno, and San Francisco, Cal.; Portland, Ore.; Pocatello, Ida.; Salt Lake City, Utah; Grand Junction and Denver, Col.; Omaha, Neb.; Des Moines, Iowa; Chicago, and back to Medina.

I shall be gone about six weeks or possibly two months. From many of the points named I shall make side-trips; and some of our friends must not be disappointed if I do not stay more than an hour or so at a time. In some cases I may not be able to say more than "how d'ye do?" and "good by." In other cases I may stay a day, depending on the train connections. I shall stay, perhaps, a day with J. M. Jenkins; and while in New Orleans I shall be glad to meet some of our friends preparatory to taking the train for the West. From San Antonio I expect to run down to Hunter to see Mr. Louis Scholl; down to Beeville to see the Atchleys, Mr. W. H. Laws, and D. M. Edwards, at Uvalde, Tex. At Tempe,

Arizona, I have an uncle, and also quite a number of bee-keeping friends. Phoenix is a veritable hotbed of bee-keeping, and I shall be in that vicinity perhaps a day or two. From Los Angeles I shall make a number of side-trips. I shall be in the vicinity of San Francisco a short time before starting northward. At Portland and Salt Lake City, and Grand Junction and Denver, I shall make stops for a day or two, taking in short side-stops. Leaving Denver I shall probably hurry homeward, making a visit, perhaps, to our friend Nysewander at Des Moines, Iowa.

Those who desire to reach me by letter can do so by addressing general delivery, San Antonio, Texas; care J. H. Root, Tempe, Ariz.; Union Hive and Box Co., Los Angeles, Cal.; Buell Lamberson & Son, Portland, Ore.; general delivery, Grand Junction, Col.; care L. A. Watkins Co., Denver, Col. I shall have with me three of the best kodaks that money can buy, and I shall endeavor to bring back many interesting views as well as notes of travel.

I can not tell the *exact* dates when I shall be at different points; but I think I shall reach San Antonio about May 24 or 25; Tempe, about the 28th or 29th; and Los Angeles about the 3d or 4th of June. Other dates will be given later.

N. B.—I forgot to explain that I shall attempt to prepare copy and write editorial matter on the fly. Communications for GLEANINGS may be sent to me at the addresses named; or if they come to our general office at Medina they will be forwarded to me. Letters intended for me personally had better be sent to Medina, whence they will be remailed to me.

TONGUE-REACH NOT IN DIRECT PROPORTION TO HONEY-YIELD.

ON page 401 I had an editorial on this subject; and in response to that I have received a letter from A. T. McKibben, of Ramey, Minn., that would seem to indicate that in the relative honey-yield there is no difference between the short-tongue and long-tongue bees. He has been measuring tongues, and was surprised to find that some of his "ornery" scrub colonies had a tongue-reach as great as that of his best honey-gatherers. This is the first and only report of this kind that has been received. All the others seem to point the other way; but let's have the reports, no matter what they show.

Another thing, Mr. K. gets a longer tongue-reach by following our directions than we do on the same bees; but in this letter he tells about "stretching" the tongues. This we do not do. We only comb them out straight on the scale. That our measurement is probably correct is shown by the fact that he took a glossometer, or extemporized one, and measured the reach of robbers scrambling for honey. This reach he found to be $\frac{20}{100}$. On the same bees he got $\frac{24}{100}$ and $\frac{25}{100}$ by stretching the tongues on the scale. By our method of measuring, and without stretching the tongues, we are supposed to get just what would be secured by the glossometer.



We have made a covenant with death, and with hell are we at agreement.—Isa. 28:15.

As I sit down to write this Home Paper, my conversation with Mrs. Root at the breakfast comes vividly to my mind. We were speaking of the bank robberies that are mentioned in almost every daily paper of late. First it is here, then it is there, then it is somewhere else. No portion of our country seems to be exempt. These hardened criminals are either scattered all through the community or else they are canvassing the country to find little towns or other places that promise a good field for their work. If some old farmer who does not read the papers, and is not up with the times, has been foolish enough to secrete a sum of money in or around his home, these emissaries of Satan, by some hook or crook, get hold of the matter. It does not matter how careful the old farmer has been to find a hiding-place for his money. It is of no avail. A gang of ruffians sufficient in number to overpower him and all the inmates of the home break down the doors, bind and gag the father, and make him tell where his money is hidden by torturing him by burning his hands or feet until he tells where his money is. Just lately, not far from here, a new scheme in this line (that must have been hatched out in the bottomless pit) is reported. When the farmer refused to tell where his hard earnings of thirty or forty years past were hidden they grabbed his daughter, 19 years old, and—I dare not put it on these pages; but one of them added, "Tell us where your money is and we will let the girl alone." The father still refused. He was probably a sort of miser; but the mother could endure it no longer. She took them down cellar, and told them where to dig in the ground. They got their money and went away.

Bank buildings are being wrecked with tremendous charges of nitro-glycerine. In fact, they do not hesitate to leave the most expensive building in a little town in ruins; and if the people come out and undertake to show fight, half a dozen or more desperate wretches hold the town at bay. Of course, we (sometimes) capture some of them; some of them are shot in the encounter, and our policemen and sheriffs are shot down. But they go to work and build up their town again, get a stronger safe, and put on additional night watches. I fear criminals sometimes get off by some technicality in law, and then go at the same thing again.

In the neighborhood of Medina there has been for forty years a gang of criminals; but I understand that now the *last* of the notorious Foster gang is in prison. These fellows have been arrested time and time again, and stood trial. But their numbers were sufficient so they brought witnesses in such a crowd they got off almost every time. If the officers

were getting the upper hand of this thing, even though slowly, we might cease worrying about it.

The loss of the people's hard earnings, especially the rural people, and honest, hard-working people who generally reside around these country banks, is a bad thing—yes, it is a terrible thing to think of that there are wretches in this land of ours who are so utterly devoid of conscience or principle that they would want the money that has been saved little by little by sweat and toil. How can these people—how can any one in human form be so heartless and selfish?

But, dear brother and sister, there is something more terrible still than the loss of property or the loss of money, that is going on in our land. For months past a book has been on my table, the title of which follows me like a nightmare. I looked the book over, and said that, although there is a great deal of truth in it, its statements are largely exaggerated. Then I began watching the papers—yes, I began watching our own State of Ohio, and finally our own neighborhood. The very title of this book startles one. It is, "*Traffic in Girls.*" Why, the thought is horrible. It is a disgrace to our country. It is a disgrace to the whole wide world to be obliged to admit there is *any* truth in the title at all—that there is really in the United States, as well as in other countries, a traffic in *girls*.

In my childhood I used to hear about the traffic in colored people. We used to read about the slave trade vessels; we read of human beings being sold at auction; and those of my readers whose hair is white like mine will remember the struggle and fight we had to cast off the reproach that for so many years rested on us as a Christian nation. May God be praised for Abraham Lincoln and the public sentiment that was back of him.

Well, now, let us go back to the title of the book. I fear, dear friends, that the title might have another word put in that would make it still more horrible, and yet the word might belong there. Suppose we put it "*Traffic in Little Girls.*" As I think of it my little prayer wells up from my heart, not exactly "Lord, help," but, rather, "May God help us." God help us as a Christian nation to rouse ourselves with such determination and Christian courage and heroism that this thing shall be stopped before it goes any further.

If a man should come into your town with a great club, striking down the little children going to school, killing them, or maiming them for life, would you, after he had done a lot of this work, have him arrested and tried, and then let unprincipled, greedy lawyers get him off by some technicality, or say he is insane? If it transpired, when you came to get right down to the bottom of the matter, that he was a millionaire, and had plenty of money, would the people be content to say his money shall save him? Or, if you choose, after he had served a short time in the penitentiary, would you permit some governor with a heart as foul and wicked as that of the criminal himself, to pardon him out and then let him set to work and do the same thing over again? Perhaps my

illustration is a little strong. But there is one point where I did not make it *strong enough*. Suppose this fiend in human form that I have been picturing should single out all the little girls instead of the little boys; suppose he selects the brightest, prettiest-looking one of the lot; let us suppose, still further, that he inquired around and found one beautiful little girl whose mother is a widow, and had no grown-up brothers to take her part. Suppose he should exult with fiendish glee in striking down this little girl and mutilating and crippling her for life, and then laugh about it, and, may be, brag about it, and try to get off scot free. Why, dear friends, this is an awful story I am telling—a horrible thing I am picturing; and yet God knows it is not *all* of the truth. What I am coming to comes about in a different way, and people say, "Oh! he did not intend to do her any harm. It was unfortunate and unlucky all around." My natural disposition would prompt *me* to say it was unfortunate and unlucky all around that the wretch was ever permitted to live one hour in this beautiful world of ours.

Once while off on my wheelrides I was told I could save some travel by taking a path through the fields. On my way I met the daughter of my friend the bee-keeper, a beautiful child of ten or eleven years. I shook hands with her, and told her who I was. Then she seemed to feel somewhat acquainted, because she had read GLEANINGS. She was very prettily dressed, and, of course, a little shy at meeting a stranger off alone; but the innocent, childlike look on her face followed me for hours. She was just coming out of childhood, and getting a glimpse of womanhood. She was looking out into this great world of ours full of people, with trust and confidence. Her little heart was good and pure, and with childish trustfulness she no doubt believed this great world to be good and pure. Since then I have met the daughters of other bee-keepers. If there is any thing in this whole wide world that should rebuke sin, and prompt a bad man to turn from his evil ways, and to be pure in heart and honest in deed, it seems to me it is these pleading childish faces—the faces of the *little girls*.

When up on my ranch in the woods last fall I took a walk of two miles one morning. It happened to be toward the schoolhouse, and just about schooltime. Three or four little girls came out of their homes, and I talked with them. They told me about their school, their teacher, their homes, and about their neighbors. Why, in that walk of two miles we became so well acquainted that I felt almost sorry when we reached the schoolhouse. Their childish voices were to me like the music of singing birds. In their innocence they told me some things about their homes and about their neighbors that perhaps an older person would not have told. They *trusted* me. They believed I loved little girls. I need not go any further. Is it indeed true that there are wretches in our land who would take pains to become acquainted with these little girls just in order that they might not only crush and disfigure their little bodies,

but that they might crush and disfigure them, *body and soul*? You may say this thing is done only in big cities. Well, I will grant that it is *mostly* done where there are saloons or frequenters of saloons. I need not tell you that, when a saloon gets to doing a fair business, they must have gambling-devices to help them along. After they get the gambling devices, then there is a dance-house in the back part of the saloon; and these dance-houses, to be attractive, must have girls—not women who are hardened criminals like the men who employ them. They must have innocent-looking country girls if they can get them. Yes, they offer *big prices* for them.

Some have told me that this is not so bad, because they bargain with the girls themselves, and the girls consent to this traffic. And this brings up a chapter of the book of which I have been speaking—the "age of consent." By the way, that word "consent," used in the connection I have just mentioned, always rolls me up. Through the work of the W. C. T. U. (thank God) the age of consent has been raised. In some of the States, if the girl is over twelve years of age her consent clears her betrayer. Alabama has got it the lowest of all—ten years. New York and quite a lot of others have got it up to eighteen. Ohio (and I say it to her shame) still holds to fourteen. A pamphlet comes with the book, in which is the following statement, together with an advertisement of the book:

There are 300,000 "felled" girls in our country, one-half of them from Christian homes or Sunday-schools, and three-fourths from country homes. They have been gotten into haunts of shame through the trickery and wiles of those engaged in the "traffic in girls," which is caused by the *traffic in drink*. Their average life is *five* years. Sixty thousand girls dragged down to this life every year; 5000 every month; 170 every day, or a young life blasted in our blessed land every eight minutes! Father! Mother! *Your* little girl is not safe. Read that startling book, "Traffic in Girls, and Work of Rescue Missions" and warn her in time. Price only 30 cents by mail; cloth, fully illustrated, 75 cents. All proceeds for mission work. Address CHARLTON EDHOLM, The Temple, Chicago.

I do hope and pray that this book may be widely read throughout our land. People are waking up, thank God. The case I have twice alluded to, that of Jennie Boschiter, of Paterson, N. J., illustrates it. If these fellows serve out their full term, two for 30 years and one for 15, well and good; but I begin to tremble already for fear some governor, who may happen to be a man like themselves, will pardon them out after they have served only a very small part of their sentence. In regard to the statement that these things exist only in the large cities, if we look about us we shall find the same thing, only perhaps in a different form, in almost every neighborhood.

Years ago a poor woman on her deathbed implored me to look after her fatherless children. She was then many years a widow. I tried to watch over them; but in spite of all I could do—perhaps I had better say, however, in spite of all I *did* do, and I made a big row several times about it—an unscrupulous and designing man, and a married man at that, succeeded in getting a beautiful little girl away from her friends and home. He spent months if not years in carrying out his scheme,

and declared again and again before God that he was honest and true, and would not harm the child for the world. I listened to others, and tried for a time to think that he was honest and sincere in what he said; but before the end came he admitted to me he was getting a divorce from his wife as fast as the law would move along, and then he was going to marry the child. Some people would object to my calling her a child at the time she went away from here; but the beginning of the whole disgraceful affair was when she was only a trusting and confiding child, such as I have described.

Now, dear friends, it would hardly be in keeping with my profession as a believer in the gospel of Christ Jesus if I let this matter drop right here. Jesus, when here on earth, taught us there was not only redemption and pardon for these poor lost girls, but redemption and pardon for the author of and leader in their sin and ruin. Sometimes when speaking of the sin and crime of this new century, my conscience has troubled me because, as memory carries me back, I can see a finger pointing to the time when the writer of these same Home Papers was little better, *in heart*, than some he denounces so vehemently. Some great and good man once said, as he pointed to a drunken sot in the gutter, "But for the grace of God, there lies myself." And, dear friends, as I look back, honesty and truth compel me to say that, but for the grace of God and the love of Christ Jesus, your old friend A. I. Root might have been—God only knows where. But still I shall have to confess my faith wavers when I think of reclaiming and reforming such wretches as I have described. May God help me, when I pray, to pray with more faith for those who seem to be lost through Satan's wiles.

Let me emphasize, in closing, the point made in that extract I have given. The traffic in strong drink is at the bottom of all this. The papers have told us how this traffic in our new possessions has led directly, in a very short time, to a traffic in human beings—yes, and I fear not only to a traffic in girls, but to a traffic in *little girls*. When African slavery reached a point in the United States where the people would stand it no longer, there was a great revolution, and we at once and for ever threw off Satan's yoke. We are fast approaching the same state of affairs in regard to the traffic in strong drink. Our local option bills here in Ohio have been again and again defeated when the voice of the people was in a large majority in favor of the bill; and I believe the time is near at hand when the people will rise and unite as they did in slavery times, to throw off this yoke imposed on us by drunken or drinking legislators and senators. May Good speed the day.

Objections have been frequently made that it is better for children to know nothing about these things. I do not agree with this. Thousands upon thousands of children might have been saved had they known in time something of what I have been telling you in this Home Paper. If their fathers and mothers will not tell them and warn them, let them read it in

the papers and journals. I for one shall be glad to have every child ten years of age or more, who cares to read what I have written, read it. Our own boys and girls were all taught by their father and mother, after they were old enough to be in danger of having their young minds poisoned by having the matter presented from a wrong standpoint instead of the right one, by some one who does not care for their future welfare as the father and mother do.

What I have written above refers to this traffic in the United States. The papers are just now informing us that the traffic is opening up, both in the Sandwich Islands and in the Philippines, and that, too, under a sort of sanction of this government of ours. Yes, the United States government that proposed to Christianize and civilize these heathen lands is, in one sense, in partnership with the men who barter, not in African slaves, but in *girls* of every nationality. Their excuse is, protecting the soldiers from contagious diseases—the same excuse these men offered for continuing the sale of beer to the soldiers (to keep them away from *worse* places). What a tremendous compliment we pay the manhood and Christianity of our soldier boys when we claim they *will* have beer in spite of us!

Well, our great generals have decided, we are told, that sanitary measures must be enforced to protect our soldiers; therefore these women and girls, after examination, have a permit from the government of the United States—I think I have got it right—to continue their traffic. They pay so much a month for this permit; and these great generals defend the traffic by telling how much *money* it brings into the treasury of the government. In the Sandwich Islands they have put a high fence around a certain part of Honolulu. I would not dare to print the rules and regulations, more than to say that one of them is that boys under age can not enter the inclosure. Another is, that no girl under 16 years of age will be permitted to occupy one of the—I was going to say *buildings* inside of the inclosure, but I guess I had better call it a "booth." A girl too young, generally speaking, the world over, to trade off her doll-baby, or any of her other childish treasures, is permitted by this government, under God's blue sky, to sell herself, soul and body! A great string of names in the form of a petition from the Young Women's Christian Association of the United States has been sent to President McKinley, pleading with him for humanity's sake, and for the sake of the women under the stars and stripes, and for *God's sake*, to use the authority that is vested in him to at once and for ever put a stop to this part or partnership that this government has in this awful traffic. Now, father and mother, brother and sister, every one whose eyes meet these pages, let your prayers follow this petition; and let us each and all, by every act in our power, put down this growing traffic as we put down the traffic in African slaves through the pen of Abraham Lincoln, who died a martyr because he was not *afraid* to take the lead.



FLORIDA TRAVELS, CONTINUED.

The town of Miami, at the terminus of the East Coast Railway, is a very new one. It has been almost all built up within two or three years. It is very prettily laid out, has fine streets, and, like all the rest of these Florida railroad towns, is especially adapted to wheeling—that is, if you do not get too far away in the country. When people were talking about the danger of frost six years ago we were told the only really safe place was Biscayne Bay, where even tomatoes could be grown the year round without any fear of injury, no matter what the state of affairs was in the northern part of Florida. I had quite a notion of making my way over to Lake Okeechobee, and making an effort to see if I could not get a passage through to Fort Myers, on the Caloosahatchie River. But I was told by the people that it was a difficult and hazardous undertaking for even a middle-aged man in good health, when used to roughing it. Besides, it would take more time than I could possibly spare, so I reluctantly gave it up.

A little way out of Miami is a celebrated golf ground. It is a beautiful meadow, as fine as a lawn, covering, I should judge, toward half a square mile. This is maintained and kept in trim exclusively for golf players. I do not know much about golf; but it has this in its favor—it takes open air and a lot of it. I saw the golf-players with their kit of tools—that is, if that is what they call them, with their colored boys to carry said tools and wait on the players. I suspect it is a rather aristocratic game. But just beyond the golf ground I caught a view of acres of garden-stuff, and this interested me more. I was about to obey the printed sign-board at the entrance of the golf ground, and wheel around it; but the obliging watchman told me to go straight through the ground. He said there was nobody there at the time, and it would not hurt the walks a particle; in fact, it would make them better to run the rubber tires over them. I demurred a little at taking my chances of being arrested, but he assured me he was "boss and all hands" when there were no players around.

I can hardly take space to tell you about all the beautiful crops I saw in that garden on the Miami flats. The ground is a level piece of prairie, I should call it. It probably had been swampy before ditches had been put through to carry off the water. There were acres and acres of tomatoes, all the way from little plants clear up to ripe fruit. The best plantations are trained on stakes; but as it was quite an additional expense, there was a difference of opinion as to whether it paid or not. Almost every vegetable known was grown here for the Northern markets, unless it is some that, like asparagus, rhubarb, and

others that absolutely require freezing weather.

When out in the fields away from any residence or workmen I saw beautiful strawberries reddening under the tropical sunshine. It was a variety I could not exactly make out, and I longed to taste them; but even though nobody was in sight I concluded I would not set a bad example—well, a bad example before *myself*, if you choose. But a little further on I stopped at the house and obtained permission to sample the berries, promising to take not more than half a dozen. The proprietor was away from home; but one of the boys smilingly took the responsibility of giving me permission to pick so many, and the quality I found fully equal to berries raised north.

Now, in these Miami gardens there are good, bad, and indifferent crops of almost every kind. Some will tell you the ground is not suited for this, that, and the other; but before I got around, somebody had proven that the very thing in question could be grown to perfection. It was the old story over again—the successful man had studied his crop and his locality, and finally, by dint of repeated trying, he had found out just *how* to manage to grow beautiful strawberries, or this, that, and the other, even on that low level ground.

I was pleased with the ranch of Jordeau Brothers. They had succeeded in growing bananas, oranges, and cumquats, right side by side with corn, beans, and potatoes. In fact, they had got good crops of almost *every thing*. Up in front of the pretty little home was a bulletin-board, and on this board were tacked market quotations from New York, and also orders received for certain stuff. Any one of the employees could see by glancing at this bulletin-board that so many crates of cucumbers, tomatoes, and strawberries were to be loaded up and sent to the station by just such a time in the afternoon.

Although there is no drawback in the way of frost in this Miami region, they have blight, fungus, and noxious insects to contend with. I reached town just in time to hunt up another nice pineapple for my noonday meal, and then I started out to see where I could find some bread and butter to go with it. Now, there is one queer feature about these Florida railway towns, especially in the vicinity of the great hotels. There are very few restaurants or low priced eating houses. I do not know whether the hotels have been instrumental in keeping them out or not. In two places in Miami I saw bright new signs hung out, saying "Restaurant" in large plain letters. But one of the men had quit business. The other man was running a tailor shop. I pointed to the signs, but they said they had not had time to take them down. Finally, down by the boat-landing, I found some beautiful white bread and nice butter to match, and I was happy and contented with a dinner that cost less than 25 cents. In the outskirts of Miami there is another palatial hotel. The grounds and the surroundings make one think of the oriental tales of the Arabian Nights. I found a similar display of tropical and exotic plants, one shaded house being devoted

exclusively to all kinds of ferns, and at another spot a garden devoted to every thing in the way of cacti. All these beautiful things are free to the tourist, whether he patronizes the hotel or not; and I for one feel grateful to the millionaires for this sort of entertainment for everybody, without money and without price.

ONLY 31 LEFT

of the Doolittle "Scientific Queen-rearing" books that were slightly damaged by water during the fire in our building January 1st. Do you want one? They are as good as new, except the covers, which are discolored somewhat. We also have some of Prof. Cook's books left—of the slightly damaged kind—at these low prices to close out:

Prof. Cook's "Bee-keeper's Guide," only 60c.
Doolittle's Scientific Queen-rearing, only 50c.

They are cloth bound, and latest editions. If you want a year's subscription to the old **Weekly American Bee Journal**, with either or both of the above books, add 75c to your order. This is a **SPECIAL OFFER**, and will last only so long as the slightly damaged books last. Better order **AT ONCE** if you want a bargain. Remember we are

Headquarters in Chicago for

Root's Bee-keepers' Supplies

at Root's Prices.

Catalog and sample copy of the
American Bee Journal free.
Ask for them. Address

George W. York & Co., Chicago, Illinois.
144-146 ERIE STREET.



Tar Heel Apiaries!

THE BEST BEES KNOWN
IN AMERICA: TO-DAY.

American Albino Italians.

They have no superiors and few equals, as hundreds of bee-keepers testify. Untested queens, \$1.00; 6 \$5.00. Tested queens, \$2.00 each. Choice breeders, \$5.00 to \$10.00. Nuclei, 75c per L. frame—add price of queen. 200 3-frame (L.) nuclei for sale in May and June. Safe delivery insured always.

Swinson & Boardman, Box 358, Macon, Ga.

U - NEED - A GLOSSOMETER.

It measures the actual reach of the tongue of a living bee to thousandths of an inch, also the capacity of the honey-sac; accurate, durable, practical. No rule or magnifying-glass needed. Satisfaction guaranteed. Price \$1.00 postpaid. Send for *Queen Circular*, and learn how to get a glossometer free. High-grade queens of the Sweet-heart and other strains at reasonable prices.

A. J. WRIGHT, Bradford, Steuben Co., New York.

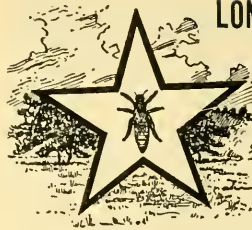

LONE STAR APIARIES

Italian Queens.

Estab'd 1885. Prices of queens from imported mothers: Tested, \$1.50; 6, \$6.50; 12, \$12.00. Untested, 75c; 6, \$4.00; 12, \$7.00. Golden, same price. Select tested of either race, \$2.50 each.

G. F. Davidson & Sons,
Fairview, Texas.

Long-tongued Golden.

According to E. R. Root's measurements our *breeders' bees* show a reach of 20 and 21-hundredths inches. We are booking orders for breeders, to be delivered in August and September. These queens will produce bees showing 95 per cent (or better) straight 5-banded, and have a guaranteed tongue-reach of 19-hundredths or better; all queens large and prolific. Price \$5.00; orders filled in rotation. Untested ones, this stock, ready June 1st, each 75c; 6 for \$4.25; 12 for \$8.00. Select warranted, \$1.00. Tested, \$1.25. Select tested, \$2.00. Also have a fine stock of three-banded Italians at the same price. Give our stock a trial. Our motto—good queens and prompt attention to business.

O. P. Hyde & Son, Hutto, Texas.

Your Order for Queens

—Tested and untested—will be promptly filled by return mail. Our strain of Italians is unsurpassed as honey-gatherers. Every queen guaranteed. Choice tested queens, \$1.00 each; \$12.00 per dozen; choice untested, 75c; \$8.00 per dozen. Send for price list. Address . . .

J. W. K. Shaw & Co., Loreauville, La.

Honey Queens.

Have you noticed the change in my P. O. address? Did you know I am seeking to give my customers the best service possible?

Did you know that I have as good or better queens than can be bought elsewhere? Many have found this out, and continue my best customers. Golden and leather colored honey queens, bred in separate apiaries. Bees, nuclei, and full colonies for sale.

Price of queens—March and April—tested or untested, each, \$1.00; 6 for \$5.00; \$10.00 per dozen. Breeders, \$2.50 to \$5.00 each.

— ADDRESS —

W. H. LAWS, BEEVILLE, TEXAS.

1901====Golden Italian Queens====1901

Untested—April, May, and June—\$1.00 each, or \$11.00 per dozen; after June, 50c each, or \$5.00 per dozen. Tested queens, half more. Breeding queens \$3.00 and \$4.00 each. W. P. Rock eggs from 94-scoring birds at \$1.00 per 15. Cocks, \$1.00 each.

GEORGE W. COOK, - SPRING HILL, KANSAS.

EARLY QUEENS FROM THE SOUTH

We are rearing queens now in full colonies by the best methods known. Tested queen, \$2.00. Untested, \$1.00; 6, 5.00; 12, \$9.00. Full colonies, \$6.00; 3-frame \$2.00; 2-frame, \$1.50. Add price of queen to nucleus wanted. Write for discount on large orders, and circular. Satisfaction guaranteed.

Christian & Hall, Meldrim, Georgia.

Albino Queens.

If you want the most prolific queens; if you want the gentlest bees; if you want the best honey-gatherers you ever saw, try my Albinos. Untested queens, \$1.00; tested, \$1.50.

J. D. GIVENS, Lisbon, Texas.

You get the Profits



No. 3034. Price \$38.30 with leather quarter top.

Under our plan of selling carriages, buggies and harness, you get the profits. The jobber and retailer are cut out. By dealing direct with our factory, you pay only the cost of making with a moderate profit added; and you take your choice from the biggest stock and fullest assortment. Our plan of

Selling Carriages Direct

insures satisfaction — your money back if you are dissatisfied. Our complete illustrated catalogue, showing many styles of high grade vehicles, harness, robes, blankets and horse equipments, with detailed descriptions of each, mailed free.

THE COLUMBUS CARRIAGE and HARNESS CO., P. O. Box 772, Columbus, O.



No. 240 Single Strap Buggy Harness Price \$7.95

BE YOUR OWN AGENT

and Save Money. Every time you buy an article from an agent or dealer you must pay him a liberal commission in addition to the actual value of the article. In many cases this places an article beyond your reach.

WE HAVE NO AGENTS

but sell you vehicles and harness direct from our factory at wholesale prices.

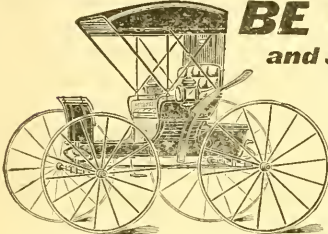

No. 191. Fancy Fody Top Buggy; is complete with side lamps, fenders, side curtains, storm apron and shafts. Price \$53.50. Retail dealers sell for \$80. Write for Illustrated Catalogue—FREE.

We are the largest manufacturers of vehicles and harness in the world selling to the consumer exclusively. We make 178 styles of vehicles, and 65 of harness. Remember that we ship our goods anywhere here for examination and guarantee safe delivery.

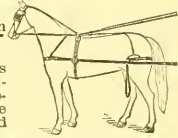

Elkhart Carriage & Harness Mfg. Co.,

W. B. Pratt, Secy.

Elkhart, Indiana.

THE WHOLE WORLD ADMIRES Split Hickory Vehicles,

and the best of it is, the closer you examine them, the better you like them. They are built right all the way through and they have a hundred special features—"little things" that add to their comfort, safety and durability found on no other. We sell

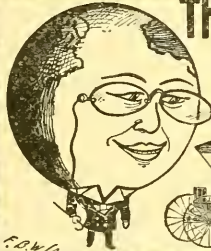

DIRECT FROM THE FACTORY

You save all agent's profits. We ship on approval. You don't keep it unless you think it a bargain. Send for our Vehicle and Harness catalogue. It will save you money.

OHIO CARRIAGE MANUFACTURING CO.,
27 W. Broad Street, Columbus, Ohio.

New Smith Premiers Nos. 5 and 6.

The No. 6 takes paper 18½ inches wide and writes lines 16 inches long. The No. 5 takes paper 11 inches wide and writes lines 9½ inches long. These new machines in essential mechanical principles are the same as Models Nos. 2, 3 and 4—unequaled.

Write for Printed Matter Free.

The Smith Premier
Typewriter Co.

158 Prospect Street, Cleveland, Ohio.

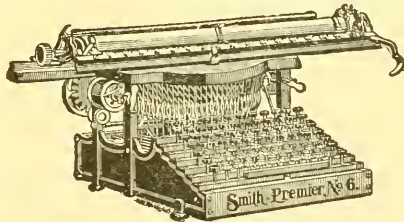

South Dakota Farms

is the title of an illustrated booklet issued by the Chicago, Milwaukee and St. Paul Railway, descriptive of the country between Aberdeen and the Missouri River, a section heretofore unprovided with railway facilities but which is now reached by a new line of the Chicago, Milwaukee & St. Paul R'y. Everyone contemplating a change of location will be interested in the information contained in it, and a copy may be had by sending a two-cent stamp to F. A. Miller, General Passenger Agent, Chicago, Ill.

Career and Character of Abraham Lincoln.

An address by Joseph Choate, Ambassador to Great Britain, on the career and character of Abraham Lincoln—his early life—his early struggles with the world—his character as developed in the later years of his life and his administration, which placed his name so high on the world's roll of honor and fame, has been published by the Chicago, Milwaukee, & St. Paul Railway, and may be had by sending six (6) cents in postage to F. A. Miller, General Passenger Agent, Chicago, Ill.



BUSINESS AT THIS DATE.

Orders continue to come in good volume, and keep us busy. It is gratifying to be able to fill them as fast as they come. If we should have an old time honey-flow and a consequent rush of orders we shall try hard to keep up our good record.

BEEWAX MARKET.

Beeswax is coming in quite freely, and the prospect is that, inside a month, we shall be reducing the price we pay by one or two cents a pound. If you have any to dispose of you had better take advantage of the present market price. We are paying at present 28 cents cash, 30 cents in trade, for average wax delivered here. If you want goods in exchange, and don't want to wait till wax reaches us, send us the shipping receipt from the railroad company, and give the number of pounds shipped, and we will send on your order promptly.

NO. 2 SECTIONS.

We have, during the past season, been more particular than sometimes in the past in the grading of our sections; and a larger proportion have gone into the No. 2 grade because not considered white enough for No. 1. This policy has served to increase our stock of No. 2 grade as well as to improve the quality of this grade. Candidly we consider our No. 2 grade of sections superior to any grade on the market ten years ago. They are, of course, not as white in color, but in every other particular they are superior. After all, the color is largely a matter of whim or prejudice. If many bee keepers who never used any but No. 1 grade could see the No. 2, or try them once, they would use them more largely. There are some sections of the country where only No. 1 grade is used. This is true of the Pacific-coast trade and export trade. It is mainly because of this fact that we have a surplus of No. 2 grade, especially of certain sizes.

Our stock of sections has been melting away very fast during the past few weeks, and we are now using new lumber and running our full capacity to keep orders up and make prompt shipment. Six weeks ago we had over two million No. 1 sections on hand, and over a million No. 2. We still have over a million No. 2, but of No. 1 we have less than a quarter of a million available for domestic orders, besides half a million for export. The No. 2 grade, of which we have a large surplus, consists of:

- 4 1/2 x 4 1/2 x 2-in., 2 and 4 becway.
- 4 1/2 x 4 1/2 x 1 1/2 2 and 4 becway.
- 4 1/2 x 4 1/2 x 1 1/2 1, 2, and 4 becway.
- 4 1/2 x 4 1/2 x 1 1/2 plain.
- 3 1/2 x 5 x 1 1/2 plain.
- 4 x 5 x 1 1/2 plain.

The price is \$3.00 per 1000; 3000 for \$8.25; 5000 for \$12.50; 10,000 for \$23.50. Two years ago we could not supply as many No. 2 grade as were ordered.

Send in your orders now, and see how promptly we can furnish them. Such a veteran bee-keeper as Doolittle uses No. 2 grade sections because he prefers the darker color of wood as it sets off better the white comb honey, and to save something in the price as well.

Special Notices by A. I. Root.

SEED POTATOES AS PREMIUMS; 500 BUSHELS TO BE GIVEN AWAY

As we still have a pretty fair stock of all kinds of seed potatoes in excellent condition, very little sprouting, many of them none at all, we make the following liberal offer to the readers of GLEANINGS:

Any one who sends us \$1.00 for GLEANINGS, past, present, or future, may have 50 cents' worth of potatoes; or anybody who sends \$1.00 for potatoes may have GLEANINGS six months free of charge, or six months for every dollar that is sent for potatoes. Second, every old subscriber who sends us a new name, and introduces GLEANINGS into a family or locality where it has not heretofore been going, may have \$1.00 worth of potatoes for every dollar he sends us for GLEANINGS as above; or for every dollar you send us for potatoes on and after this date

you may have GLEANINGS one year providing you introduce it into a new locality where it has not gone before. Now, please notice that the man who subscribed for GLEANINGS, even though he is new, does not have \$1.00 worth of potatoes. His subscription must be sent from somebody who is already a subscriber. Of course, we do not care who has the potatoes. Each of you can have half, or they can go wherever you choose. You will notice this exceedingly liberal offer is made in order to get GLEANINGS introduced into new homes and new neighborhoods. Last, but not least, please bear in mind you must pay your own transportation. If you want potatoes sent by mail you must send the money for postage. As a rule it does not pay to have potatoes sent by express. As small a quantity as a peck can be sent by freight. This offer lasts only so long as the potatoes hold out.

I presume our friends are aware that many of the most successful potato-growers prefer not to plant until June or even in July. In fact, up in the Traverse region I found the great potato growers wait till June before planting; and many of them plant clear up into July. In this way you get away from bugs and hot weather, and, as a sequence, you largely avoid the blight. Of course, there is danger of an early frost; but such a frost is not much worse than the bugs, blight, and hot weather—that is, if you do not put off your planting until too late.

We submit our table of varieties once more in order that you may have it all before you. More than half of the 500 bushels are the Red River stock, Northern grown, Early Ohio.

TABLE OF PRICES.

NAME.	1 lb. by mail.		3 lbs. by mail.		Half Peck.		Peck.		Half Bushel.		Bushel.		Barrel, 11 pks.	
	18	20	35	40	30	35	40	40	75	80	1.50	1.75	3.00	3.50
Red Bliss Triumph.....	18	20	35	40	30	35	40	40	75	80	1.50	1.75	3.00	3.50
White Bliss Triumph.....	18	20	35	40	30	35	40	40	75	80	1.50	1.75	3.00	3.50
Early Ohio.....	15	35	20	35	30	35	40	40	75	80	1.00	1.25	2.50	3.00
Early Trumbull.....	15	35	20	35	30	35	40	40	75	80	1.50	1.75	3.50	4.00
Bovee.....	15	35	20	35	30	35	40	40	75	80	1.00	1.25	2.50	3.00
Early Vermont.....	15	35	20	35	30	35	40	40	75	80	1.00	1.25	2.50	3.00
New Queen.....	15	35	20	35	30	35	40	40	75	80	1.00	1.25	2.50	3.00
Lee's Favorite.....	15	35	20	35	30	35	40	40	75	80	1.00	1.25	2.50	3.00
Freeman.....	18	40	30	40	30	40	40	40	75	80	1.25	1.50	3.00	3.50
Twentieth Century.....	25	50	35	50	35	50	50	50	85	1.50	1.50	3.50	4.00	
State of Maine.....	15	35	20	35	30	35	40	40	75	80	1.00	1.25	2.50	3.00
Maule's Commercial.....	18	40	30	40	30	40	40	40	75	80	1.25	1.50	3.00	3.50
Carman No. 3.....	15	35	20	35	30	35	40	40	75	80	1.00	1.25	2.50	3.00
Sir Walter Raleigh.....	15	35	20	35	30	35	40	40	75	80	1.00	1.25	2.50	3.00
New Russet.....	15	35	20	35	30	35	40	40	75	80	1.00	1.25	2.50	3.00
New Craig.....	15	35	20	35	30	35	40	40	75	80	1.00	1.25	2.50	3.00

* This is the same thing as Junior Pride.

At present writing, seconds are all sold out except a few Early Ohio. We are also sold out entirely on Early Trumbull, Lee's Favorite, and New Queen, except a few seconds of the latter.

CONVENTION NOTICE.

The spring meeting of the Eastern division of the Northern Illinois Bee-keepers' Association will be held at the residence of B. Kennedy, 7 miles southeast of Rockford, Ill., on rural route No. 5, and 3 miles northeast of New Milford, Ill., on Tuesday, May 21, 1901. All interested in bees are cordially invited to attend. B. KENNEDY, Sec'y.

Minnesota Bee-keepers' Supply Mfg. Co.,
Manufacturers of
Bee-hives. Sections. Shipping-cases. and
Everything Used by Bee-keepers.

Orders filled promptly. We have the best shipping facilities in the world. You will save money by sending for our price list. Address

Minnesota Bee-keepers' Supply Mfg. Co.,
Nicolllet Island Power Building, Minneapolis, Minn.

The A. I. Root Co.'s Goods

shipped from Jackson, Mich. Root's extra-polished sections, foundation, hives, shipping-cases, etc. cheap. Send for list.

W. D. Soper, R. D. 3, Jackson, Mich.

AT ANY TIME—

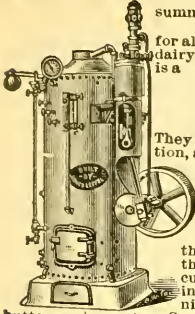

summer time or winter time, the **BEST POWER** for all purposes on the farm, in the dairy, creamery or cheese factory, is a

LEFFEL ENGINE.

They are very simple in construction, and easy to run and keep in order. Are very economic of fuel, are easy steamers and great power developers. They are made both horizontal and upright with engine mounted on boiler. Everything is made of best material throughout. They are ideal for cutting and grinding feed, sawing wood, pumping water, running cream separators, churns, butter workers, etc. Send stamp for Book on Power. **JAMES LEFFEL & CO., Box 89, Springfield, O.**

Fruit Packages of All Kinds.

— ALSO —

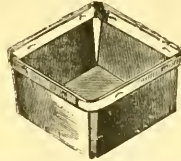

BEE-KEEPERS' SUPPLIES. . .

Order your supplies now before the busy season catches you. Price list free. Address

BERLIN FRUIT-BOX COMPANY,
Berlin Heights, - - Erie County, Ohio.

WANTED.—Parties interested in ginseng culture to send 5 cts. in stamps for my illustrated catalog and circulars, giving valuable information about this plant. 500,000,000 Chinese use it; easy to raise; 300 per cent annually in profit. Book on culture, \$1.00. Six years' experience. **W. E. BOYCE, Houston, Mo.**

Wants and Exchange.

Notices will be inserted under this head at 10c per line. You must say you want your ad. in this department, or we will not be responsible for any error. You can have the notice as many lines as you please; but all over ten lines will cost you according to our regular rates. We cannot be responsible for dissatisfaction arising from these "swaps."

WANTED.—To correspond with the party that has possession of the fire-arms formerly owned by the outlaws of Kansas, the Bender family.
Address 216 Court St., Reading, Pa.

WANTED.—75 colonies of bees, to establish an out-apiary.
H. G. QUIRIN, Parkertown, Ohio.

WANTED.—To exchange samples of honey. Before sending, state what you can use and what you have to offer. I have alfalfa, basswood, clover, goldenrod, willow-herb, heartsease, horsemint, man-grove, marigold, mesquite, raspberry, sumac, and Cuban bellflower, from which I can furnish samples. I want to get samples of all other American and foreign honeys of choice quality, true to name. Want also to exchange American and foreign stamps.
A. L. BOYDEN, Medina, Ohio.

WANTED.—To exchange bee-hives, sections, supers, etc., for raspberry-plants or offers or cash.
F. R. DAVENPORT, Box 383, Kalamazoo, Mich.

WANTED.—To exchange 500 L. frames (comb) for bees.
J. H. STANFORD, Larrabee, Cher. Co., Ia.

WANTED.—To exchange 50M polished sect ons (No 1, nice) for beeswax, at a bargain.
W. H. NORTON, Skowhegan, Me.

WANTED.—100 or 200 colonies of bees on shares or buy for one of my students, and 40 queens. Also chance for a man to learn trade; must have little experience.
W. L. COGGSHALL, W. Groton, N. Y.

WANTED.—To buy 100 or more strong colonies of bees on Hoffman wired frames (10 frame hives preferred) at some station on a Chicago R. R., not more than 150 miles from that city. Price must be low, and colonies healthy.
B. WALKER, Ewart, Mich.

WANTED.—Seed buckwheat and seed potatoes. I have a \$45.00 strawberry-box stapling-machine, at \$25.00. Shop worn. Bee hives and supplies of all kinds at a bargain.
W. H. PUTNAM, River Falls, Wis.

WANTED.—To exchange an 8 in. York water-motor, little used; for second-hand L. frame extractor.
E. J. BAIRD, Lock Haven, Pa.

Black and Hybrid Queens for Sale.

I have some good hybrid queens for sale at 30 cts. each
CHAS. D. DAY, Siegfried, Pa.

Wanted! HONEY, WAX, MAPLE SUGAR, SYRUP, AND POPCORN.

A. L. JENKS, 42 W. Market St., Buffalo, N. Y.

The Long Pole

knocks the persimmon. The man best prepared outstrips his fellows. The bee with the long tongue can reach the honey the short-tongued bee can't get. My bees are long-tongued, large vigorous, good workers, and gentle. Queens are \$1.00 each; tested, \$1.50; selected, \$2.00; breeding, \$3.00 and up; latter tested for tongue-reach, $\frac{1}{16}$ to $\frac{3}{16}$ inch. E. R. Root's method.

Last August Mr Morrow bought queens from 8 of the most prominent queen breeders. He writes: "I put the second queen you sent me in a two-story hive last Saturday, and she is now laying in 10 frames, has an immense colony of bees, and they are gathering more honey than any colony I ever had in the yard. I would not take \$25 for the colony."—Wm. H. Morrow, 719 Temple Court, Atlanta, Ga. May 1, 1901.

For particulars see free circulars.

J. B. CASE, Port Orange, Fla.

Red-clover Italian Queens.

The great honey-gatherers; are bred for business; satisfaction guaranteed. Untested queen, 65c; 2, \$1.25. Warranted 80c; 2, \$1.50. Tested \$1.25. Test tested, \$2. Estab'd 1872. **C. M. HICKS, Hicksville, Md.**

Queens. I have 150 fine tested three-banded Italian queens for sale. They are last August queens, and their bees are fine honey-gatherers. Tested, \$1.25; select tested, \$1.50; breeders, \$2.00; untested, 75c each, or \$8.00 per doz. I guarantee safe arrival, and satisfaction on every queen. I have been a queen-breeder for 12 years, and know what good queens are.
J. W. TAYLOR, Ozan, Ark.

E. R. Root says: "One cage . . . showed a measurement of .18 and $\frac{1}{16}$; cage B showed a measurement of $\frac{2}{16}$ and cage D $\frac{1}{16}$. . . If tongue-reach means anything, they ought to be good workers." They are three strains and are good workers. Queen circular free.
W. A. H. GILSTRAP, Grayson, Cal.

FOR SALE. One 10 h-p engine and boiler (up-right boiler), one 18-inch planer, one Root saw-table, 30 ft. line-shafting, hanger pulleys, and belting. Will take \$250. **J. W. BITTENBENDER, Knoxville, Ia.**

FOR SALE CHEAP.—100 nearly new second-hand Hilton chaff-hives. For particulars enquire of **L. C. WOODMAN, Grand Rapids, Mich.**

FOR SALE CHEAP.—California bee ranch and 500 colonies of bees. Write for particulars, price, and easy terms. **I. A. KING, Almond, San Diego Co., Cal.**

Our Advertisers.

Mr. L. W. Fullerton, Wadena, Ind., writes the Ohio Carriage Mfg. Co. 27 West Broad St., Columbus, Ohio: "Received my split hickory buggy to-day, and am very much pleased with it, and feel that I saved at least 25 per cent in price." We are sure every one of our readers will be pleased equally well. Send for catalog.

One of the best booklets which has come to our desk is *Seed Truth*, issued by Northup, King & Co., Seedsmen, of Minneapolis, Minn., and which is sent free to those who write for it.

Seed Truth not only offers valuable suggestions to those wishing to purchase seeds, but takes a strong stand against the exaggerations which characterize so many seed catalogs.

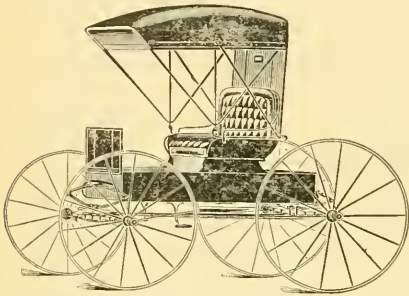

Ten Days on Trial.

In the past several years certain manufacturers and others, with that knowledge and unbounded faith born of experience have been sending out all sorts of things to the farmer to be first tried by him and paid for only after he is convinced of their merit, and satisfied with the bargain. So far as we know, however, the Kalamazoo Carriage & Harness Co., of Kalamazoo, Michigan, is the first firm in the United States offering to send out carriages, buggies, wagons, harness, etc., on this plan. Those of our readers who have followed their advertising as it appeared from time to time in our paper will have observed the proposition. The plan is to send any article which appears in this catalog to anybody, anywhere, on ten days' free trial. The purchaser orders the vehicle he may wish, and when it is shipped he goes to the railroad station, hitches up to it and drives home. He can use it in any legitimate way, and subject it to any test arising from reasonable use, for the space of ten days. If at the end of that time he is satisfied with the job, he simply pays the catalog price for it. If not, he ships it back to the factory.

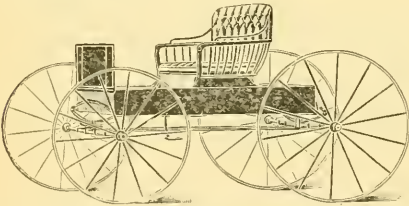

This appeals to us as being about as fair and open a method of doing business as it is possible to adopt. It is certainly a most gracious compliment to the honesty and fairness of the farmers of our country. It gives them the opportunity to see and try just what they are buying, and to test it in every way before being obliged to pay for it. Certainly the manufacturers who will offer their goods to people on such liberal terms have unbounded confidence in the value of their wares. We should expect under these conditions that the Kalamazoo Carriage & Harness Co. made only first-class vehicles, and trimmed and finished them in only first-class and enduring manner. Any of our readers who are in need of a vehicle or harness of any kind should write them at once for illustrated and descriptive catalog. They mail it free.

\$50.00 POP CORN.

100 seeds of this wonderful new Pop Corn for 25c and chance to compete for our cash prizes. Seed Due Bill good for 25c worth of other goods FREE with every order for Pop Corn. First-prize winner last year raised at the rate of 188 bushels per acre. We will pay \$50 for its equal in quality. Handsome seed catalog and free presents with every offer.

C. M. Coodspeed, Skanateles, N. Y.

EGG FOOD! The kind that tones and keeps up the hen so that she simply must lay. LEY'S POULTRY CONDITION POWDER puts good red blood into poultry veins; kills all disease germs; tones and nourishes fowls - big and little get all there is in the food when fed in conjunction with it. Price 25c pkg.; 5 for \$1. Ley's Thoroughbred Minorca eggs, \$1 for 13. Thoroughbred Belgian Hares. **Geo. J. Ley, Florence, California.**

WANTED.—ALL TO KNOW that I sell my hives and Root's goods at Root's prices, and will pay \$50 in three cash prizes for the best white honey exhibited at the Pan-American Exposition at Buffalo this year, produced in Danzenbaker hives in New York State; also the same for the three best lots outside of New York State. Specific information given on application. **F. DANZENBAKER, Box 66, Washington, D. C.**

Mr. A. I. Root's Writings

of Grand Traverse territory and Leelanau Co. are descriptive of Michigan's most beautiful section reached most conveniently via the **PERE MARQUETTE R. R.**

For pamphlets of Michigan farm lands and the fruit belt, address W. C. Tousey, D. P. A. Toledo, Ohio.

The Modern Farmer and Busy Bee.

Emerson Taylor Abbott, Editor.

A live, up-to-date Farm Journal with a General Farm Department, Dairy, Horticulture, Live-stock, Poultry, Bees, Home and General News. The Editor has had practical experience in every department of farm work. To introduce the paper, it will be sent to New subscribers one year for 25c. Sample copies free. Best Advertising Medium in the Central West. Clubbed with *Gleanings* for \$1.00.

ADDRESS

Modern Farmer, St. Joseph, Mo.



Belgian Hares

I have some fine hares for sale at reasonable prices.

J. F. Moore, Tiffin, Ohio.

S. C. BROWN LECHORNS.

I use well-striped breeding cocks. Eggs, \$1.00. Cockerels, \$1.00 and up. Also Italian bees. Circular free. **H. M. MOYER, SHANESVILLE, PA.**

EGGS

\$1 00 for 15 best Brown Leghorn or B. P. Rocks. Illustrated descriptive egg circular free. **H. B. GEER, Nashville, Tenn.**

1200 FERRETS.

All sizes; some trained; first-class stock. New price list free. **N. A. Knapp, Rochester, Lorain Co., Ohio.**

To make cows pay, use Sharples Cream Separators. Book "Business Dairying" & cat. 288 free. **W. Chester, Pa.**

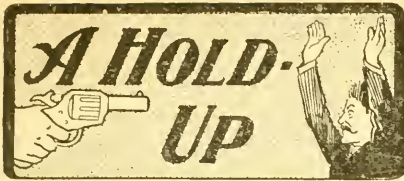

Is not always the work of a highwayman.

When a dealer charges you from 35 to 50 per cent more for a carriage or harness than we would charge you direct for the same, or better, you are certainly being held up. This however, is not the dealers fault. He must live, but why at your expense? We sell our vehicles at factory prices and save you both the jobber's and dealer's profit. We do still better; we send our vehicles on to Days Free Trial. Try it before you buy. If not wholly satisfactory return it at our expense. Write to-day for our free illustrated catalogue.

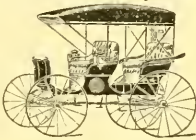

Kalamazoo Carriage & Harness Co.,
Box 22, Kalamazoo, Mich.

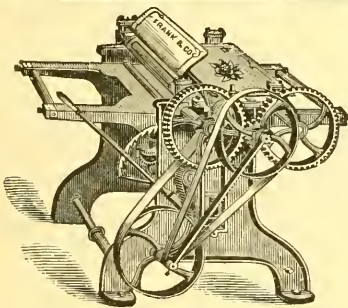

PLANERS

The above cut shows one of our small Planers, of which we make twelve different styles and sizes. Also large Planers, Band Saws, Buzz Planers, Moulders, Wood Lathes, and all kinds of

WOOD WORKING MACHINERY

Send for Catalogue.

The FRANK MACHINERY CO.
BUFFALO, N. Y.

THE VERY BEST GRADES AND WARRANTED TO BE PURE

HONEY

ADDRESS The ALROOT CO. MEDINA OHIO 22222222

EASY SPRAYING

No sprayer made gives better service than the Century Barrel Sprayer. Submerged brass cylinder, brass ball valves, everlasting plunger packing; automatic agitator. For ease of operation, durability, free water ways it is unequalled. New! scorches foliage. Send for catalogue of full line of pumps and sprayers.

THE DEMING CO., Salem, O.
Western Agts. Henion & Hubbell, Chicago



Supposing You Could

buy a cheap wire fence for a trifle less than you can buy a Standard PAGE, would it pay?
Page Fence Co., - Box S, - Adrian, Michigan.

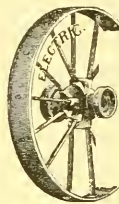

GOOD WHEELS

MAKE A GOOD WAGON.
Unless a wagon has good wheels it is useless. **STEEL THE ELECTRIC WHEELS** are good wheels and they make a wagon last indefinitely. They are made high or low, any width of tire, to fit any skien. They can't get loose, rot or break down. They last always. Catalogue free.

Electric Wheel Co., Box 95 Quincy, Ills.



BULL-STRONG!

....PIG-TIGHT....

An Illinois farmer said that after harvest he had fully 200 bushels of loose oats on the ground that he could not secure any benefit from, because the fence around the field would not turn hogs. Figure the loss for yourself. He also said, all this would have been saved if he had used the **Kitselman Woven Wire Coiled Spring Fence**, and the value would have gone a long ways towards paying cost of the fence. With the **Duplex Machine** any farmer can make it himself at the actual cost of the wire. Catalogue free for the asking.

KITSELMAN BROS.
Box D31. Muncie, Ind.

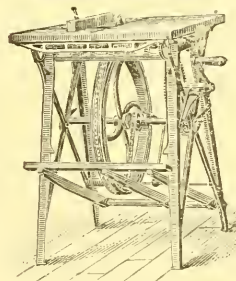

Barnes' Hand and Foot Power Machinery.

This cut represents our combined circular saw, which is made for beekeepers' use in the construction of their hives, sections, boxes, etc. **Machines on trial.** Send for illustrated catalogue and prices.

W. F. & John Barnes Co.,
545 Ruby St.,
Rockford - Ill.

Union Combination Saw

For Ripping, Cross-cutting, Rabbiting, Mitering, Grooving, Gaining, Boring, Scroll-sawing, Edge-moulding, Beading. Full line FOOT and HAND POWER machinery. Send for catalog A.

SENECA FALLS MFG. CO.
44 Water St., Seneca Falls, N. Y.

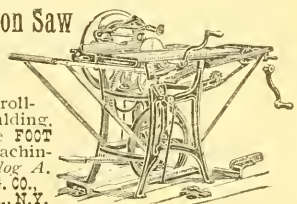

The Best Bees.

As I have several times mentioned in the editorial columns, my object in life is the good of bee-keepers. That I earn my living while thus engaged, makes me none the less sincere. In my younger days I taught several terms of district school. After securing a school I forgot, for the time being, that I was earning money. I went in to teach those children, and do them all of the good that I possibly could. For weeks at a time the thought never came to me that I was working for wages. I should be doubtful of the success of a teacher who taught simply for money. Now I am working for the good of bee-keepers. As in the case of school-teaching, I have become so interested that I often forget that I am earning my living by the work that I am doing. I should also be doubtful of the success of a bee-keeping editor who worked simply to make money. With that object in view, there are other occupations in which he could engage to better advantage.

I am trying to get bee-keepers to keep more bees, scatter them around the country, and learn to manage them with the least possible labor. I am trying to get bee-keepers to organize and secure the benefits of co-operation. I am trying to arouse them to the danger hanging over their heads from contagious diseases among bees, and to get them to bestir themselves and rid the country of these plagues. I am also striving to show them the importance of improving their stock—that there is just as much difference in bees as in other stock. Not only this, but circumstances have been such that I have been able to discover what, I am thoroughly convinced, is a strain of bees that are the equal, if not the superior, of any bees in this country; and I am trying to scatter this stock through the country. As I have said before, that I am earning my living while thus engaged does not make me any less sincere.

These bees are dark, leather-colored Italians. They are gentle, industrious, and hardy, and cap their honey as white as do the blacks. No bees, that have had their tongues measured, have shown a greater tongue-reach than have these bees. While there is little doubt that length of tongue and superior honey-gathering qualities go hand in hand, it has not yet

been PROVED, while it HAS been proved that THESE bees are very superior, whether it is from length of tongue or not. The price asked for these bees is higher than for common stock, and ought to be; superior stock always sells for more than common stock or scrubs. The Roots are now asking \$10.00 for a queen whose bees show a tongue reach of 19 100; \$15.00 for one whose bees show a reach of 20-100; and \$25.00 for one whose bees have tongues measuring 21-100; and it is all right to ask these prices. I hope that Mr. Root will sell a lot of these queens, as the more such queens are scattered around the country the better stock will there be. Only a queen-breeder, or some one with a large number of bees, could afford to pay such prices, but the ordinary bee-keeper can afford to pay the \$1.50 that I ask for a queen; and, while I do not guarantee the length of the tongues of the bees that such a queen will produce, it is true that the mother of these queens produces bees having a tongue-reach of 21 100. Not only this, but I guarantee safe arrival, safe introduction, if directions are followed, purity of mating, and complete satisfaction to the extent that, if, for any reason, the purchaser desires to return the queen inside of two years, he can have his money back and 50 cents in addition to pay for his trouble.

Besides this, there is a way in which one can get one of the queens for only one dollar, and that is in connection with a subscription to the Review. For \$2.00 I will send the Review one year, and one of these queens. This offer is open alike to old and new subscribers.

As my older readers know, I do not breed these queens myself. They are reared by a breeder who is neither in the North, nor in the extreme South, but whose name I do not give, simply because, if I did give it, the orders would go to him direct, and I would lose all of the advertising that I have done. A man has to be selfish to a certain extent, and it is all right that he should.

I make in the neighborhood of 50 cents on each queen that I sell, and it is right that I should, but the man who buys one will make dollars where I make cents.

W. Z. Hutchinson, Flint, Michigan.

I. J. Stringham, 105 Park Place, New York City.

Keeps in stock a full line of modern appliances for bee-keepers.

SILK-FACED VEILS.

As good as any made; 35 cents postpaid. Catalog free. Full colonies Italian bees, \$6.00. Apiaries, Glen Cove, Long Island.

I. J. Stringham, 105 Park Place, New York City.

Marshfield Manufacturing Company.

Our specialty is making SECTIONS, and they are the best in the market. Wisconsin basswood is the right kind for them. We have a full line of BEE-SUPPLIES. Write for FREE illustrated catalog and price list.

Marshfield Manufacturing Company, Marshfield, Wisconsin.

1881

PAGE & LYON MFG. CO.

1901

We manufacture a full line of the latest
BEE-SUPPLIES.

Our motto is, "Perfect Goods and Prompt Shipment."

Send for our new free illustrated catalog.

PAGE & LYON MFG. CO., New London, Wisconsin.

NOW READY!

64-PAGE CATALOG OF EVERY THING BEE-KEEPERS NEED. Illustrated and fully described. Especially valuable to beginners for the information it contains. Send your address on postal and get it now. Established 1884.

J. M. JENKINS, Wetumpka, Ala.

SUPPLIES FOR THE WEST!

The latest and best in the line of

BEE-KEEPERS' SUPPLIES

kept constantly on hand.

We carry a full line
and large stock of

The A. I. Root Co.'s Good

which we sell here at
their factory prices.

ESTIMATES CHEERFULLY GIVEN.

CATALOG FREE.

ADDRESS

Jos. Nysewander, Des Moines, Iowa.
710, 712 W. GRAND AVE.

NOW READY.

LONG-TONGUED QUEENS!

YARD NO. 1.

By special arrangements with THE A. I. ROOT CO. to furnish them queens, I have secured their assistance in procuring the finest breeding queens that a thorough knowledge of the bees of the country and money can procure. Among them is a select daughter of their \$200 queen that they refuse to quote me prices on. This queen shows every superior quality of her mother. Her bees show an actual reach of 21-100 of an inch; are large, gentle, and beautiful to look upon.

MR. E. R. ROOT SAYS: "You have as fine bees as there are in the United States; and with a direct cross of their breeders you should be able to produce queens whose bees show a reach of 25-100 of an inch."

Send for descriptive price list.

From recent measurements I find I can warrant all tested and select untested queens to produce bees whose reach is 19-100 with an average reach of 18 100; Select tested queens to produce bees whose reach is 20-100, with an average of 19 100.

Prices: Untested, \$1.00; 6, \$5.00. Select untested, \$1.25; 6, \$6.00. Tested, \$1.50; 6, \$8.00. Select tested, \$2.00; 6, \$11.00

Breeders, whose best bees show a reach of 21-100, with an average reach of 20 100, \$3.00. Breeders, whose best bees show 21 100, with an average of 20½-100, \$5.00. Breeders, whose best bees show 22-100, with an average of 21-100 \$7.00.

I have discovered 2 breeders whose best bees show 23 100; these are too good to sell; don't ask for prices.

Imported Italian stock. Apiary No. 2. Imported queens, daughters and grand-daughters. Golden, or 5-banded Italian. Apiary No. 3. Breeders, select tested, tested, untested queens.

W. O. VICTOR, WHARTON, TEXAS.
QUEEN SPECIALIST.

WE WANT

to sell you bee-supplies. Our line is all new and complete. Send for our illustrated catalog. It will convince you that our Dovetailed hive is the best on the market. Our prices are right and our service is prompt.

Fred W. Muth & Co.,
Cincinnati, Ohio.

S-W. Cor. Front
and Walnut Sts.

Dittmer's Foundation !!!

Retail---Wholesale---Jobbing.

I use a PROCESS that produces EVERY ESSENTIAL necessary to make it the BEST and MOST desirable in all respects. My PROCESS and AUTOMATIC MACHINES are my own inventions, which enable me to SELL FOUNDATION, and WORK WAX INTO FOUNDATION FOR CASH, at prices that are the lowest. Catalog giving

FULL LINE OF SUPPLIES

with prices and samples, free on application. BEESWAX WANTED.

GUS. DITTMER. AUGUSTA. WIS.

Get the Best Queens.

Evansville, Ind., Sept. 27th, 1900.

The Jennie Atchley Co., Beeville, Bee Co., Texas:
Dear Friends:—It gives me great pleasure to forward you this unsolicited testimonial regarding the merits of Atchley queens. The three (3) dozen queens purchased of you have made an excellent record for themselves. Not an Atchley queen among the twenty colonies lost during the severe drouth in July. I have bought queens from many breeders; and although the present crop is exceedingly short, the tiers of supers show where the Atchley queens are, and speak volumes for your method of queen-rearing. I find the progeny to be very gentle, strong-winged, uniformly marked, long-lived, of large size, and last, but not least, the best honey-gatherers I ever had. I shall want 100 more next season.
Yours fraternally, J. C. WALLENMEYER.

Prices for Queens.

Tested, \$1.50 each; \$8.00 for 6, or \$15.00 per dozen. Untested, February, March, April, and May, \$1.00 each; \$5.00 per 6, or \$9.00 per dozen. Fine breeders, \$5.00 each. We have as good bees and queens as money and labor produce. We breed three-band Italians, Goldens, Carniolans, Cyprians, and Holy-Lands, in their purity, bred in separate yards 5 to 20 miles apart. If you want the best, call for Atchley's improved strains. Safe arrival guaranteed. Send for a sample copy of "The Southland Queen," the only southern bee-paper, \$1.00 per year. To new subscribers we offer as a premium a nice untested queen in order to get our paper introduced. Catalog, giving queen-rearing and management of apiaries for profit, FREE.

THE JENNIE ATCHLEY CO.,
Beeville, Bee Co., Texas.

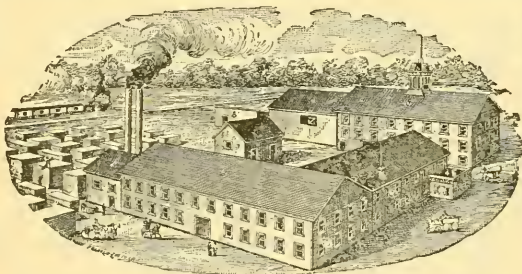

KRETCHMER M'F'G CO., Red Oak, Iowa.

BEE-SUPPLIES.

Best-equipped factory in the West; carry a large stock and greatest variety of every thing needed in the apiary, assuring BEST goods at the LOWEST prices, and prompt shipment. We want every bee-keeper to have our FREE ILLUSTRATED CATALOG, and read description of Alternating Hives, Ferguson Supers, etc. Write at once for a catalog.

— AGENCIES: —

Trester Supply Co., 103 So. 11th St., Lincoln, Nebraska; C. C. Richards, 1223 17th St., Denver, Col.

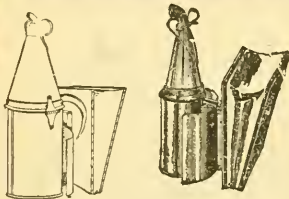

BINGHAM SMOKER.

Dear Sir:—Inclosed find \$1.75. Please send one brass smoke-engine. I have one already. It is the best smoker I ever used. Truly yours,
HENRY SCHMIDT, Hutto, Tex.

MADE TO ORDER

Bingham Brass Smokers.

Made of sheet brass, which does not rust or burn out; should last a lifetime. You need one, but they cost 25 cts. more than tin of the same size. The little open cut shows our brass hinge put on the three larger sizes. No wonder Bingham's four-inch smoke-engine goes without puffing, and does not drop inky drops. The perforated steel fire-grate has 381 holes to air the fuel and support the fire. Heavy tin smoke-engine, 4-inch stove, per mail, \$1.50; 3 1/2-inch; \$1.10; 3-inch, \$1.00; 2 1/2-inch 90c; 2-inch, 75c. Bingham smokers are the originals, and have all the improvements, and have been the standard of excellence for 22 years. Only three larger ones brass.

T. F. Bingham, Farwell, Michigan.

Contents of this Number.

Alfalfa, Rambler on.....	470
Azaleas	485
Bees Not a Nuisance.....	475
Bees, Starting in Sections.....	467
Bee-brush, Hammond's.....	475
Blue Curls of California	471
Blue-head among Bees.....	466
Colonies, Advantage of Strong.....	478
Covers for Hives in Colorado.....	467
Eaton, E. N., Report of.....	466
Editor Hiring Help in Michigan.....	479
Eggs, M. iling.....	466
Eucalyptus-tree.....	472
Florida, Editor in.....	483
Foundation, Improvement in.....	466
Foul-brood Law, Colorado.....	466
France, Report of.....	466
Goose Wing for Brushing.....	474
Greenhouse in March.....	486
Hans Pretzel's Interview.....	469
Honey, Amount Consumed in the South.....	466
Honey, To Load on Wagons.....	468
Increase, Doolittle on.....	473
Lawn-mower in Apiary.....	474
Rambler's Talk.....	470
Sections, Wetting, to Fold.....	467
Sorrel, Jamaica.....	484
Superseding Queens, Mania for.....	474
Syrup, Feeding, in Fall.....	468
Tongues, Measuring.....	477

Honey Column.

GRADING-RULES.

FANCY.—All sections to be well filled, combs straight, firmly attached to all four sides, the combs unsoiled by travel stain, or otherwise; all the cells sealed except an occasional cell, the outside surface of the wood well scraped of propolis.

No. 1.—All sections well filled except the row of cells next to the wood; combs straight; one-eighth part of comb surface soiled, or the entire surface slightly soiled; the outside surface of the wood well scraped of propolis.

No. 2.—Three-fourths of the total surface must be filled and sealed.

No. 3.—Must weigh at least half as much as a full-weight section.

In addition to this the honey is to be classified according to color, using the terms white, amber, and dark; that is, there will be "Fancy White," "No. 1 Dark," etc.

CITY MARKETS.

ALBANY.—No demand for comb honey, with no receipts. Prices same as last quoted.

May 21. **MACDOUGAL & Co.,**
Albany, N. Y.

DETROIT.—Very little desirable honey in sight. The new crop will find the market well cleaned up. The demand is always light in this market at this season of the year. Prices are held as last quoted. Fancy white comb, 14@15; No. 1, 13@14; dark and amber, 10@12. Extracted white, 6½@7; dark and amber, 5@6. Beeswax in fair demand at 27@28.

May 21. **M. H. HUNT & SON,** Bell Branch, Mich.

CHICAGO.—Market is nominal in almost all lines. A little comb sells at 15@16 for choice white, with dark and amber grades ranging from 2c to 5c less. No movement of any consequence in extracted. All dealers seem to be expecting a lower range of prices. A little fancy white clover and basswood sells at 7@8, depending on flavor, quality, and quantity taken; ambers, 6@7; dark and buckwheat, 5@5½. Beeswax steady at 30.

May 20. **R. A. BURNETT & Co.,**
199 South Water St., Chicago, Ill.

MILWAUKEE.—The demand for honey is only local, and the limited supply of salable quality prevents the regular consumptive demand; and whenever a shipment of fancy grade comes to hand it sells very readily at 17@18, in 1-lb. sections, while the dark and lower grades do not move. We can now quote fancy 1-lb. sections, 17@18; No. 1, 16@17; off grades nominal at 12@15. Extracted white, in cans and pails, 9@9½; amber, in kegs, 7@7½. Beeswax, 28@30.

May 22. **A. V. BISHOP & Co.,**
119 Buffalo St. Milwaukee, Wis.

BOSTON.—Our market continues dull on honey, with very light stocks on hand. Our nominal prices are as follows: Fancy, 1-lb. cartons, 17; A No. 1, 16; No. 1, 15; No. 2, 12@14. Extracted, 6½@7½.

BLAKE, SCOTT & LEE,
May 21. 31, 33 Commercial St., Boston, Mass.

NEW YORK.—There is little if any stock of comb honey on this market at the present moment, and the demand is very slight indeed. Market prices rule as follows: Fancy white, 15; No. 1 white, 13@14; No. 2 white, 11@12; mixed and buckwheat, 10. Beeswax, 28. Extracted honey of all kinds is ruling at low prices, with little if any demand.

FRANCIS H. LEGGETT & Co.,
Franklin, West Broadway, and Varick Sts.,
May 22. New York City.

PHILADELPHIA.—Comb honey entirely cleaned out of this market, except some odds and ends that are sold at buyer's offers. Extracted honey, fancy white, 7; amber, 6. Beeswax, 27. We are producers of honey—do not handle on commission. **WM. A. SELSER,**
May 23. 10 Vine St., Philadelphia, Pa.

CINCINNATI.—No demand for comb honey, also stock of it well exhausted. Extracted very dull. Sales are more or less forced. Lower prices from ½ to 1c per pound. **C. H. W. WEBER,**
May 20. 2146-8 Central Ave., Cincinnati, Ohio.

WANTED.—Comb and extracted honey. State price, kind, and quantity. **R. A. BURNETT & Co.,**
163 South Water St., Chicago, Ill.

FOR SALE.—Extracted honey from alfalfa; 60-lb. cans at 7 cts., and smaller cans.
D. S. JENKINS, Las Animas, Colo.

Northern Italian Queens

Reared from Imported Mothers.

Our stock is so carefully bred and selected as to secure carloads of honey. Locality free from foul brood and other bee-diseases. Prices: Untested queen, \$1.00; 6 for \$5.00; tested queen, \$1.50; 6 for \$7.50; best imported queen, \$6.00; fair imported queen, \$5.00.

Ada L. Pickard, : Richland Center, Wis.

The Long Pole

knocks the persimmon. The man best prepared outstrips his fellows. The bee with the long tongue can reach the honey the short-tongued bee can't get. My bees are long-tongued, large, vigorous, good workers, and gentle. Queens are \$1.00 each; tested, \$1.50; selected, \$2.00; breeding, \$3.00 and up; latter tested for tongue-reach, 1½ to 2½ inch. E. R. Root's method.

Last August Mr Morrow bought queens from 8 of the most prominent queen-breeders. He writes: "I put the second queen you sent me in a two-story hive last Saturday, and she is now laying in 10 frames, has an immense colony of bees, and they are gathering more honey than any colony I ever had in the yard. I would not take \$25 for the colony."—Wm. H. Morrow, 719 Temple Court, Atlanta, Ga. May 1, 1901.

For particulars see free circulars.

J. B. CASE, Port Orange, Fla.

Honey Queens.

Have you noticed the change in my P. O. address? Did you know I am seeking to give my customers the best service possible?

Did you know that I have as good or better queens than can be bought elsewhere? Many have found this out, and continue my best customers. Golden and leather colored honey queens, bred in separate apiaries. Bees, nuclei, and full colonies for sale.

Price of queens—March and April—tested or untested, each, \$1.00; 6 for \$5.00; \$10.00 per dozen. Breeders, \$2.50 to \$5.00 each.

— ADDRESS —

W. H. LAWS, BEEVILLE, TEXAS.

Notice!



THE A. I. ROOT CO.

wish to announce that they have from their branch at 10 Vine St., Philadelphia, Pa., direct steamboat connections and very low rates of freight to the following States: Massachusetts, Rhode Island, Connecticut, New Jersey, Delaware, North Carolina, South Carolina, Georgia, Florida. As this is a branch of the factory, prices are the same. Full colonies of Italian Bees, \$6.00. Special discount in large quantities.

C. B. Lewis Company, Watertown, Wis., U. S. A.

FIVE ✪ DIFFERENT ✪ STYLES ✪ OF ✪ BEE-HIVES.

We will furnish you
with the finest bee-
keepers' supplies in
the World.



Send us your Orders
and we will fill 'em
promptly. Send for
Catalog.

LEWIS' • WHITE • POLISHED • SECTIONS • ARE • PERFECT.

BRANCH: G. B. Lewis Company, 19 South Alabama Street, Indianapolis, Indiana.
AGENCIES: L. C. Woodman, Grand Rapids, Michigan; Fred W. Muth & Co., Southwest Cor. Walnut & Front Sts., Cincinnati, Ohio; Fred Foulger & Sons, Ogden, Utah; Colorado Honey-producers' Association, Denver, Col.; Grand Junction Fruit-growers' Association, Grand Junction, Colorado; Robert Halley, Montrose, Colorado; Pierce Seed and Produce Company, Pueblo, Colorado; E. T. Abbott, St. Joseph, Missouri, Special Southwestern Agent.

BEE-SUPPLIES!

ROOT'S GOODS
AT
ROOT'S PRICES

C. H. W. Weber, Cincinnati, Ohio.
2146-2148 Central Ave.

A NEW and complete stock for 1901 now on hand. I am The Root Company's representative for Cincinnati and surrounding territories. . . . You save TIME and FREIGHT CHARGES by having goods shipped from here. Convenience of railroad facilities here enables me to do so. Before buying elsewhere, write for my prices and catalog, which will be mailed you free of charge.

GLEANINGS IN BEE CULTURE

A JOURNAL DEVOTED TO BEES AND HONEY AND HOME INTERESTS.

ILLUSTRATED SEMI-MONTHLY

Published by THE A. I. ROOT CO.
\$1.00 PER YEAR MEDINA, OHIO.

VOL. XXIX.

JUNE 1, 1901.

No. 11.



COLORADO State Bee-keepers' Association has 207 members. What other State can match it?

I NEVER WORE a plug hat, and couldn't be hired to wear one. And now just see what a deep-laid scheme the editor has concocted (p. 431) to inveigle me into wearing one of the abominations!

H. G. OSBURN reports taking 40,500 lbs. of honey with an increase to 105 colonies. That's a big thing in any case; but it makes a good deal of difference whether he started with 104 colonies or with 4, and he doesn't mention the number at start.

H. G. OSBURN and you are not so far apart as you think, Mr. Editor, p. 432, as to the working force of a colony. You are talking about the total population, and he's talking about the field force. You can tell that by his sending all afield.

VERY LEVEL-HEADED is this advice to beginners given by Editor York: "First get and read a good bee-book thoroughly, then get the bees. Then read your book again. Then you will be ready for a good bee-paper, and, very likely—more bees."

IF YOU CLIP the large wing of a queen on one side, it will change her looks so little that a hasty glance will not show that she is clipped at all. But just on that account I clip both wings on one side, for I want to see at a glance, as the queen runs over a comb, whether she is clipped or not.

L. STACHELHAUSEN, in *Southland Queen*, thinks it an error to teach that, because the winter in the South is warm enough for bees to fly more, bees consume more. They don't fly unless they can gather. From the last flower in fall to the first in spring, Southern bees consume less than Northern.

"HOW CAN QUEENS be forced to lay in queen-cell cups?" is given in *Southland Queen* as one of the topics for discussion at a

convention. Can they? [Forcing queens to lay in queen-cups—why, it seems to me we should do well if we could get them to lay, to order, in natural cups made by the bees themselves. In fact, I do not know that we are sure that they ever do so of their own sweet will under any circumstances.—ED.]

THE COLORADO foul-brood law is somewhat circumstantial. If you know of foul brood *anywhere*, and fail to report to the inspector or secretary of State association, you're subject to a fine of \$5 00. If you conceal the fact that your own bees have foul brood, you may be fined \$20 to \$50, or imprisoned one to two months. About right too. [I never noticed this provision in the law; but it is a very good one, and ought to be in every law designed to suppress foul brood or similar contagious diseases.—ED.]

I DON'T KNOW for sure all about it, but I *think* the old-comb discussion has been something like this: Some years ago it was the common thing across the ocean to teach that combs should be renewed when they became a few years old, and I do not remember that any on that side opposed such view. It was copied and commented upon here, and that started the discussion here. I don't know, but I suspect the discussion on that side arose from reading the discussions in American journals. But the advocacy of old-comb renewal is of trans-Atlantic origin.

THE BLUE-HEAD is a disease of the brood, named in *Deutsche Imker aus Boehmen*. Scattered among the sealed brood are pupæ, either unsealed or with holes in the sealing. The pupæ are dead, and have blue or white heads, or heads spotted white and blue. Turn the comb on its side, and many of these pupæ fall toward the opening. While the disease is not very malignant, and perhaps not contagious, the diseased colony makes poor headway. [Why, doctor, aren't you and those other people making a blunder? See what is said about "bareheaded" brood on page 57 of the A B C book. I should say there was nothing the matter with the pupæ at all, even if they do fall toward the opening when you tip the comb over. I have seen exactly what you describe, and have kept careful watch, and the

bees hatched out all right just as well as those that were capped over.—A. I. R.]

ARTHUR C. MILLER has the joke on me. On p. 325 I quote him saying, "If there is any class of people who seem prone to only half observe and to jump at conclusions, it is the bee-keepers," and then I reproach him by saying that, if he would "observe" more carefully himself he would find the observers all right, but the things observed, elusive. Now he comes back at me by saying that, if I had "observed more carefully" myself I would have seen that he made that identical remark right after the words I had quoted. And I don't know of any satisfactory reply to make.

SWARTHMORE, in *Rocky Mountain Bee-Journal*, reports success in obtaining early drones last year, by having drone eggs mailed to him from the South, and giving these eggs to queenless colonies. If eggs can be successfully mailed, there might be a traffic in eggs from choice queens for queen-rearing. [Something like twenty years ago we used to send worker-eggs from a choice queen by mail, and succeeded in doing it very nicely up to a distance of 100 miles; but beyond that we never had any success. I should have said that it would be impossible for Swarthmore to get drone eggs that would hatch, from a distance of three hundred miles.—ED.]

THE QUESTION whether extracting-combs should be cleaned out by the bees in the fall has had a thorough discussion in *Revue Internationale*. Reviewing the testimony, J. Crepieux-Jamin says it is remarkable that the advocates for fall cleansing offer the sole argument that the honey not cleaned out will ferment. The chief argument on this side, I think, is the granulation of particles left to hasten granulation in the next year's crop—an argument of double weight when applied to unfinished sections. [I think the only reason why we in this country prefer to have our extracting-combs cleaned out by the bees is, as you suggest, to prevent the accumulation of particles of granulated honey. But in Europe there may be localities where these wet combs will ferment.—ED.]

SOMETIMES it is said that a beginner gets a yield of honey that he never after equals, because his first enthusiasm is gone. I believe that's a libel on many of the veterans. A bee-keeper may ride his hobby so hard as to kill it, but they don't all do it. Just forty years ago I took the bee-fever, and the temperature is just as high now as it was then. I'm looking forward to some things I want to do with bees next summer with just as keen a relish as I had forty years ago. The extra results achieved by a beginner are largely to be credited to the fact that he has a small number of colonies, and so the bees have a better harvest. [Your last sentence explains it. In the A B C book the statement is made to the effect that the average yield per colony will be much larger in a small apiary, remote from any other yard of bees, than in larger apiaries.—ED.]



Four weeks ago we shoveled snow
That drifted deep all over;
And now to-day where frost held sway
We move great heaps of clover.

"Diseases of Bees and Legislation" is the succinct title of the report of N. E. France, Foul-brood Inspector of Wisconsin. It consists of an exceedingly detailed description of foul brood in all stages, together with the best known methods to arrest its ravages. It also treats on pickled brood and black brood, and dysentery and other diseases of the bees, and gives an account of the present state of legislation relative to these diseases in the United States. The subject of adulterated honey is well treated. No price for the book is given. All wishing a copy should apply to Mr. N. E. France, Platteville, Grant Co., Wis.

Mr. F. Greiner writes:

The Bee-keepers' Society of Erfurt, Germany, will hold its 50th anniversary this summer. An interesting exhibition is planned in connection with this convention or celebration. Bee-keeping of a hundred years ago is to be shown. One hundred and fifty stands of bees will be on the ground, which will be prepared and started for the health in Thuringia at the close of the festivities. A portable apiary of 30 colonies (wanderwagen) will also be on exhibition.

Mr. Greiner also adds the following relative to an improvement in comb foundation:

Lorence Horvat, of Austria, speaks of a new style of comb foundation in a recent number of the *Centralblatt*. He describes it as having *notched* cell-walls instead of the smooth, and says, when this new foundation was first brought out the claim was made that the bees would more readily draw it out into combs, but he did not take much stock in it. Since then a test has been made at a bee-keepers' institute, held at Vienna last summer, as follows: Three brood-frames were filled with new-style, three others with old-style foundation. The six were inserted in the brood-nest of a good colony, bees between brood-combs, alternating them with the frames of foundation. When an examination was made 24 hours later, it was found that the three frames of new-style foundation had been drawn out into combs, and eggs had already been deposited in a few cells. The three forms of ordinary foundation had hardly been touched by the bees, although they had been given an equally favorable position in the hive. A number of trials of this kind were made, but turned out practically the same in each instance.

Our thanks are due to E. N. Eaton, State Analyst of Illinois, for a copy of the report of the State Food Commissioner, Mr. Alfred H. Jones. As a copy of it can be had (free, I think) by addressing the Illinois State Food Commission, Room 1623, Manhattan Build'g, Chicago, it will not be necessary to say much about it, except that it shows the result of the analyses of nearly every thing used as food in that State (or perhaps all States), such as milk, cheese, extracts, butter, ice, honey, vinegar, etc. Even a hasty glance at its pages shows a very strange feature of our life. It seems as if adulteration of the most unblushing kind were the fate of nearly every thing the people of Illinois get to eat. Of course

this is not really the case, but it is true to a fearful extent, as the laws against adulteration fully attest. Fortunately sugar and flour seem to get to us in a pure state, as their adulteration is difficult, and the things themselves are about as cheap as any adulterant could be. Liquor-sellers have long been styled the "poisoners-general" of the people; but they must certainly share that honor with the adulterators of food-stuffs which all *must* buy, while they *can* get along without the liquor. Mr. Eaton will be remembered with gratitude by bee-keepers as the one who made such a vigorous attack on the adulterators of extracted honey in Chicago two years ago. Concerning this matter I quote the following:

Pure honey may be defined as the nectar of flowers, transformed, and stored in a comb by the honey-bee. Extracted or strained honey is the same article removed from the comb by man, usually by centrifugal force. Comb honey can be adulterated only by the bee, which seems to have a patent on capping the cells. Extracted honey, next to vinegar, is more universally adulterated than any other staple food products.

In Minnesota, before the honey clause was added to the Food Statute, about 33% per cent of extracted honey proved to be adulterated. In Illinois, about the same ratio of adulteration was proven to exist. Last year a committee acting for the National Beekeepers' Association secured a large number of samples in Chicago. Being at that time employed in commercial work I examined the samples for the Association and found that more than 50 per cent were adulterated. This month (Dec. 1900) finds extracted honey again seeking the winter trade. Inspector Mrs. Frank Hubbard has visited many stores in Chicago, and reports finding very much less extracted honey offered than the year before. This is owing to the enforcement of State law requiring the labeling of adulterated honey, thus driving a dishonest competitor from the market. While none of the samples taken this winter have as yet been analyzed, many of them are of those brands which proved genuine in former analyses.

The most common adulterant of honey is glucose, although adulteration with cane sugar and invert sugar is possible, and sometimes practiced. The adulteration thus far discovered on the Illinois market has been of the cheapest and most gross kind—glucose flavored with a small slice of honey in comb.

See also page 652, 1899.



STARTING BEES INTO SECTIONS.

Hiving Swarms on Full Combs and Starters; Hive-Covers; some Peculiarities of the Colorado Climate; Wetting Sections for Folding.

BY M. A. GILL.

In advising the use of an extracting-super to start to work in sections, are you not aware that thousands of us bee keepers do not have an extracting-super on the place? I would advise any bee keeper working for comb honey to exchange supers with colonies that are tardy about working in sections with one that has made a *good start*, and be sure to carry along some of the comb-builders (young bees) which are the last to leave the super. The colony given the super with full sheets of

foundation will at once resume work, from the force of the same habit you say they have acquired by the use of your extracting-super.

Dr. Miller asks you how many days after the extracting-super is given before they will start work in the sections. I would say that depends upon two conditions—namely—the condition in the brood-chamber, and the other condition in the field.

If the brood-chamber is full of brood, and running over with bees, and the conditions in the field are such that honey is coming in, they will start at once; otherwise they will wait until these conditions do exist, even if it takes all summer. I prefer to work for those conditions that force the bees into the sections, rather than to bait them, although I have just finished filling 500 supers with drawn comb for the first round.

On page 239 Dr. Miller advises using full combs and dummies to hive swarms upon. Some one has said starters for the expert, and full sheets of foundation for the novice, in hiving swarms, but never full frames of comb when working for comb honey. Somehow my experience just fits the above advice, and I feel like saying amen to it. If I have full combs for young swarms I cut them out and make them into wax, leaving from one to two inches of comb along the top-bar; this strip will be stored full of honey within a very few hours after hiving, and then you have just the proper condition for getting honey in the sections, for the bees will commence building comb upon each side of these narrow combs of stored honey, and the queen will occupy the new comb being built in the brood-combs; and the honey coming in is thus forced into the sections. I frequently get two supers of comb honey by the time the brood-chamber is filled.

Some will say I will get too much drone comb built. If the queens are old, and will perhaps be superseded that season, such will be the case. But there will be a time the next season, between hay and grass, which, in fact, is just the time for spreading brood, when these combs will be empty or nearly so, if kept at the outside of the hive; then take them out and exchange with full sheets of foundation. This is the only time I use full sheets in the brood-chamber when working for comb honey. The combs taken out are made into wax. There are certain times when the construction of comb is not as expensive as some have been led to believe. As a rule, I think bee-keepers could make much more wax than is made.

On page 233 you speak of a new cover you have adopted for hot climates. Along this line I wish to say that the best flat cover ever put out for this climate was the old $\frac{7}{8}$ inch thick, with grip on each end, and painted on both sides so as to be reversible. The Higginsville and Danz. covers are not the thing for this climate, and neither will be the cover you have adopted, as I understand it is simply your old flat cover covered with paper. Here we winter out of doors, and sealed covers are not the thing. With two or three thicknesses of burlap, and an air-chamber, our bees win-

ter nicely. Again, we need the air-chamber badly, on account of the summer heat, as shade is not practicable here in many of our out-aparies, and for my part I don't want it.

Last season I bought 100 of your Colorado covers. They gave the best of satisfaction during the summer, and every one of the 100 colonies under them has wintered nicely. Last season, during the heat of midday, when the bees would be driven out of the supers under flat covers, the supers under Colorado covers would be full of bees, and comb-building going on undisturbed. But there is too much wood surface and too many nail-heads for the sun to get at for them to last. Remember, there is no nail-puller invented like the Colorado sun. No wonder the microbes kink up their backs and quit when it strikes them. Why, I heard a "lunger" from the East say last summer that he dried out so that his shin bones and short ribs rattled when he walked.

What we want is some kind of cover with an air-chamber like the Colorado cover, and that covered with something to keep it from the sun. I have adopted a cover with a rim nearly like the Colorado cover, so as to give two inches of air-space, and covered with roofing-paper (Neponset), and painted two coats of lead and oxide of zinc. They are neat and attractive, water-proof, and I think they will stand, say, ten years, and perhaps longer. I have a notion to send you one.

I saw covers yesterday covered with old second-hand duck, and painted well, that have stood 12 years, and they are absolutely water-proof yet. They are made with $\frac{3}{8}$ -inch rim and $\frac{1}{2}$ -inch thick top, and poor lumber can be used.

In wetting sections I use a fountain syringe. Don't hang it too high; take the "shut off" in left hand to control the stream. In this way I can wet a crate of 500 sections, ready for immediate use in a moment, and can cut 500 (full sheet) starters with a miter-box and a sharp scalloped bread-knife in the same length of time.

Longmont, Col.

[I am well aware that many do not have extracting-supers. Perhaps the full-depth brood-nest might answer the purpose of drawing the bees above; but if I did not have extracting-supers I would get a few and use them exclusively for getting stubborn colonies to working upward. As fast as the combs are sealed I would extract them and put them back into use.

The new cover that we have in mind for hot or dry countries, and which we shall probably put out for another season, will be a good deal like the ordinary flat cover in appearance. It will consist of two thicknesses of boards about $\frac{3}{8}$ inch thick, separated by three narrow strips of wood, one in each end and one in the middle. The top will then be covered with Neponset red-rope roofing-paper. On each end will be nailed the ordinary grooved cleats such as are used on flat covers that were sold so extensively a few years ago. The side edges of the paper will be held in place with side

cleats, and the top surface of the paper will be kept from wrinkling by means of large-headed tacks. When completed it will look very much like a single-board flat cover, except that it will be covered with paper. Such a cover will have the advantage of being light and strong, with dead-air spaces.

All that you say about the ability of the Colorado climate to pull nails out of hives and covers is too true. When I came back from your State I made up my mind that the covers and hives would have to be of special construction to stand such exacting conditions; and, as a consequence, we made a special cover for our Colorado trade. But if the bee-keepers of your State would be willing to pay the price, it strikes me that drive-screws should be used instead of nails — I mean screws that are driven by means of a hammer. These, I think, would hold their place, providing, of course, the stuff had been properly seasoned in Colorado before nailing together. Stuff that is seasoned in the East, and then sent to Colorado, will season still more.

I am quite prepared to believe that a cover of duck well painted would last for years on hive-covers; but I see no reason why good roofing-paper like Neponset would not give equally good results, and save money in the investment. The perfect hive-cover for Colorado is yet to be made, I believe—yes, and for Cuba and all other countries that have special conditions that are very different from those of the northern part of the United States.—Ed.]

COMB HONEY—HOW TO LOAD ON WAGONS.

Feeding Thin v. Thick Syrup in the Fall.

BY H. D. BURRELL.

I agree with Dr. Miller about the placing of hives of bees on wagons for moving, referred to on page 908, Dec. 1st; that is, the combs should extend *across* the wagon. On ordinarily good roads there is considerable side shaking to wagons; and if roads are rough or much cut up by ruts the side-to-side strain on combs is serious, as first one wheel and then another drops into a hole. With careful driving there are few sudden jars forward or backward, even when there are hills. In an experience of over 20 years I have moved a great many bees on wagons, distances varying from a few miles to over 25, and with very little injury to bees or combs. Formerly I thought it necessary to fasten loose hanging frames in hives, but soon found even that unnecessary, unless the combs had been handled and brace-combs broken a short time before the moving. In moving bees on cars the worst strain is endwise of the car, in starting and stopping, and the combs should be lengthwise of the car.

On page 869 the old subject of preparing syrup is referred to. Is it not possible that the inexperienced may be misled by such directions? In most localities there is more or less honey gathered from fall flowers, and in most cases it is not possible to tell how much

feeding will be necessary until this fall bloom is gone, often not till October. Then it would be hardly safe to feed thin syrup, and depend on the bees to ripen it into good winter stores. The nights then are usually cool, and bees work slowly; and it is not best to stimulate brood-rearing so late in the season. Very young bees are apt to winter poorly. One winter I had about 50 colonies starve after they had been fed with sugar syrup, which hardened in the combs. The thin syrup is all right fed slowly in August; but after Sept. 15th I would by all means feed a syrup of nearly the consistency of good ripe honey. About 10 lbs. of the best granulated sugar, boiled with 4 lbs. of water, is about right in my experience. To prevent granulation, mix thoroughly in at least a fourth as much good extracted honey, or, if that is not convenient, for each 10 lbs. of sugar dissolve in a little warm water one even teaspoonful of tartaric acid. Feed the syrup quite warm, and enough at one feed if possible.

South Haven, Mich.

[As to the matter of feeding where the food is to be given late in the fall, I have and do advocate making it thicker. But better—far better—feed early, and make the syrup *thin*.

Here is something further on the loading question, from Mr. Greiner.—ED.]

LENGTHWISE OR CROSSWISE.

BY F. GREINER.

In an article on moving bees, written for the *American Bee-keeper*, I made no special mention of how the hives should be placed on a wagon. I thought it was well understood that the combs should run crosswise of the wagon. I am somewhat surprised that the editor should think differently. The roads in and around Medina may be so excellent, and come so near the steel roads, that it is practical to carry the hives lengthwise, and he may, therefore, have come to the conclusion that *that* is the proper manner. Here with us, even when the roads are the finest, the side shake is more severe than the jerking endwise, and I would not think of loading comb otherwise than across the wagon. Our land here is not as level as that around Medina and Marengo. Mr. W. F. Marks says the most of it lies "up and down," and still I find it safer to carry hives with their combs crosswise. Half-story hives with loose hanging frames I often carry without fastening the frames, which I am sure I could not do with frames running lengthwise. The moving on a sleigh is a different thing. There is no side motion worth noticing, but the jerk endwise is severe; so I always load the hives with frames running lengthwise as we would load on railroad cars. I believe it would be safe to lay down a rule thus:

For moving on sleigh or car, load with the frames running lengthwise. For moving on a wagon, load with frames running crosswise. On a very smooth road it will do no harm to

have combs run lengthwise with the wagon, and I would load as most convenient.

Naples, N. Y.

[And here is something further.—ED.]

In regard to the instructions on your caution-cards, we might say that we have always considered that the part which refers to loading honey on to wagons was wrong. The side bumps on our road to market are, we believe, a thousand to one end bump, and consequently we have always loaded our honey with the edge of the comb pointing toward the wheels. This brings the crates crosswise of the wagon, and also economizes room. How many crates could you get in an ordinary wagon-box if loaded as directed on the cards? Mr. Byron Walker's caution-cards have the instructions right, as we consider it, and he evidently thinks so too.

Dr. Miller says, p. 908, that on *good* roads the side shake is more; and we want to add that it is the same on *bad* roads. We have to travel several miles to market, over the worst broken corduroy road in the country.

Sanilac Center, Mich. W. J. MANLEY.

[This is quite in line with other evidence that we have been having from time to time, especially with the Stray Straw on this subject, page 326. I think we may set it down now as a fact that comb honey should be loaded crosswise in a wagon, and lengthwise on a car. Our printers have had instructions to change our printed labels accordingly.—ED.]

INTERVIEW WITH HANS PRETZEL.

BY CHALON FOWLS.

There is that scattereth and increaseth yet more; and there is that withholdeth more than is meet, but it tendeth only to want.—PROV. 11:24.

My next call was on an old German back in the country, whom I will call Hans Pretzel, because that isn't his name. On approaching the house I found my way barred by a big bulldog; but the owner soon appeared, saying,

"Vell, vell, vell; vy don'd you come in, Mr. Fowls? Looks like you vas pushful."

"Well, you see, Hans, your dog looks so big that I feel small. Say—he looks as though he could see clear through me. May be he knows that I came after money."

"Vy, mine goot gracious, Mr. Fowls; I nefer taut as you would pe after my monish. What have you now in your hedt?"

"Oh! I want you to subscribe for GLEANINGS, and join the Bee-keepers' Association."

"Nit; my bees do notting dis year. I haf notting to fool away on dem vellers."

"Yes; but you have got the bees, and ought to keep posted, so you can get a good price when you do get a crop, and we may get a good crop next season."

"Nix; I vill no more fool away good monish in handt for dat good-for-notting bird mit de bush; he vill prob'ly pe un old crow when I get him."

"Why, how do you make that out, Hans?"

"Vell, ven I got someding, den first ting I know I don'd ain'd got it. Ven I taut I got a big brice for my honey, I youst gif it away. Dem shneaks in de city stheal de whole shooting-match. Say—I like now pretty bad, ven I could set my dog Bose on dem vellers."

"You seem to have a good deal of confidence in your big watchdog."

"Yaas, I eats him vell and he keeps me vatch."

"Well, that just illustrates what our association would do for you if you would support it. It would be like your big watchdog, ready to protect you from these commission sharks and other enemies."

"Vell, vell; may pe so; but I don'd like to pay monish for someding I don'd got alretty."

RAMBLE NO. 186.

Some New Facts Relative to Alfalfa.

BY RAMBLER.

Perhaps with only two seasons' experience with alfalfa as a honey-factor I should hold my peace. I am, however, inclined to give my experience so far as it goes, and will.

My first crop of honey from alfalfa was secured in Scott Valley, in the extreme northern portion of the State. The first cutting for hay was early in July; the next, late in August. Upon both growths there was a profusion of flowers, and the farmers allowed it to stand several days in bloom, and the bees secured a fair honey crop of excellent quality.

It was stated by the bee-keepers of the val-



A DOLLAR CLOSE BEFORE THE EYES WILL SHUT OUT GOD'S RESPLENDENT SKIES.

"But, Hans, even your big dog would not keep watch for you if you were too stingy to feed him first. The trouble with you is that you have been too much in the dark. A dollar may blind you if held close to your eye. It is penny wise and pound foolish for a bee-keeper to withhold the dollar that should go to support the best organization for mutual protection that the bee-keepers of this country ever had, and just as foolish to hang on to the dollar that should go to pay for a journal like GLEANINGS."

"Vell, vell; here is my tollar; you send in my name right quick, for I want to get in mit dem vellers vat vatch out for dem rascals like my big dog."

ley that the yield from this source fluctuated to quite an extent; and there was proof of this the next year when I learned that the yield was very light.

In respect to honey in other localities, we have been led to believe that it never fails to yield from a fair to a good crop of honey. For instance, in Arizona we never hear of total failures, and I think the same conditions exist in Colorado and Utah, and I presume Central California has reported no failures. From my own observations in the latter location I must conclude that alfalfa yields honey sparingly occasionally, in some districts.

The experience of others has been the same, for I know of five bee-keepers who moved

their bees from Southern California, into widely different portions of the central portion, and their success was indifferent. Still, in some portions of Central California a fair yield of honey was secured, and I presume it was attributed to alfalfa.

Let us observe the conditions in the locality under my own observation. The first blossoms the bees work upon with vigor are the almond, in February; after this comes a profusion of fruit-bloom in March, with a few honey-producing wild flowers—alfileria the principal one. After the fruit-bloom there is a dearth of honey-producing flora; and if the bees are not well supplied with honey to last them through May, and often through June, a little feeding will be necessary.

"But," you say, "where was the alfalfa bloom in that alfalfa country?"

There is certainly a splendid growth of alfalfa, and the first mowing is in April; but there is no bloom upon it worth mentioning. A good share of the heads are blasted, and there is a fuzzy whiteness where the bloom ought to be. If there should happen to be a few or many blossoms, the bees are not inclined to work upon them. In May the conditions are about the same. While in June alfalfa may and may not secrete nectar, some seasons an extracting can be obtained; the next, perhaps not a pound.

The bees have made a useless spurt of brood-rearing from fruit-bloom away back in March. If they swarm during this bloom, the new swarms will hardly make honey enough to live upon, and the old colonies will use their stores upon useless brood-rearing, finally diminishing the brood-nest. As the honey-season approaches in an uncertain way in June or July, the first few weeks of it are spent in bracing the colonies up for business.

My experience with our out-apiary in the weed-patch during this dearth of nectar was new and very interesting. The colonies were not in very good condition in the spring—weak, and short of honey. On the 25th of May I put down this record: "Average of one ounce of honey to the colony."

Many of these colonies were examined in the morning; and, though there was, on an average, 200 square inches of brood in each hive, I failed, after close scrutiny, to find one cell of honey. Examine the same combs near evening, and a few cells of honey would be found near the brood. They were actually living from hand to mouth, and decreasing instead of increasing the brood-nest. Yellow sweet clover was the source of the honey-supply. The weakest colonies were fed sparingly, and they came up to the July honey-flow in fair condition.

If the bees do not get up to the swarming-point during the fruit-bloom, the starving-period in April and May takes the desire all out of them, and, no matter how freely honey comes in afterward, or how full the hives become, there is no desire to swarm; and, as a bee-keeper remarked, who owns 500 colonies in several apiaries, and cares for all of them himself, "this starvation-period is our salvation from the swarming-fever."

If there is no alfalfa-bloom previous that the bees work upon, there is a profuse bloom in July, August, and September; but even during these months the secretion of alfalfa nectar is sometimes meager.

The failure of the bees to secure alfalfa honey is wholly due to an atmospheric condition, and not because the alfalfa is cut too early. It would be much to the advantage of the bee-keeper if it were allowed to stand a little longer; but in a district where there is a large acreage there is more or less of it in bloom all the time. Each farmer cuts his alfalfa four times during the hay-curing season. Mr. A cuts his this week, Mr. B next week; they are not all ready to cut at the same time, and the whir of the mower is heard almost continuously through the summer. Then there are the alfalfa-pastures where hundreds of cattle are grazing. There is quite an amount of bloom in these fields.

But if alfalfa is almost a failure, sometimes there are other flowers in many localities that come to the rescue.

If there were a small hill handy I would take you to the top of it and direct your attention eastward. Well, let's climb to the roof of the veranda. Off toward Dinuba, five miles away, are hundreds of acres of wheat land. After the wheat is cut, the California compass-plant, or

The sunflower that, with warrior mein,
Still eyes the orb of glory where he glows,

puts in an appearance, and grows and blooms with utmost luxuriance. The bees work upon it with considerable vigor for both pollen and honey for six weeks in August and September.

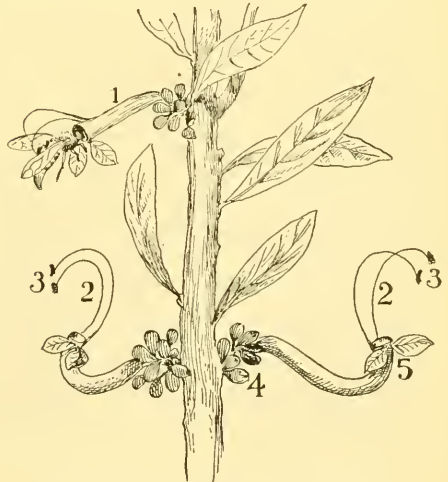

BEE WORKING ON BLUE CURLS.

- 1.—Tube straightened by bee, and pollen striking back.
- 2.—Hair-like stamens bearing pollen-grains.
- 3.—Pollen-grains.
- 4.—Buds.
- 5.—Two leaves at end of tube for bee to alight upon.

Another plant with as many names as the locations in which it is found comes into bloom early in August, and continues until frosts

subdue it in October. It is here called camphor-weed, from its rank odor; but its true name is "blue curls." "Wild Flowers of California" says of it, "This species blossoms late in the summer, and grows upon very dry ground, where it seems almost a miracle for any plant to thrive."

It seems to grow upon portions of wheat lands where the sunflower will not, and is in bloom at about the same time. I have met this plant in all portions of the State. In the northern portion of the State the honey from it is dark and of rank flavor, but here in Central California it is of good flavor, with a dis-

exhibit one of the wonderful plans of nature for the proper distribution of pollen grains and the perpetuation of its species.

I noticed one day that the bees were coming in with their backs painted a dirty greenish hue, and the next time I was out upon a tour of observation I found the bees working blue-curl blossoms, and here was one of nature's paint-brushes. The blossom is in shape something like that of white-sage. The bee alights upon the curled-up corolla of the latter, and its weight opens, as it were, a trap-door, giving access to the nectar-tube (see illustration in A B C, page 262, 1900 edition).

But the nectar-tube of blue curls has a sharp bend in it, and above are two long curved stamens, or filaments, with pollen-grains upon the extreme tips. The bee alights upon the edge of the corolla; its weight straightens the nectar-tube, giving it access to the tube. At the same time the two curved filaments drop down and strike the bee on the back of the thorax, and leave their mark. The illustration will give some idea of this language of the flowers:

To him who, in the love of
nature, holds
Communion with her visible
forms,
She speaks a various language.

The bee and the grape have been under controversy for many years, and apiaries in this State have been burned by grape-growers for the fancied injury to their product; but that happened in the southern end of the State. Here is a vineyard that corners right up to our apiary of 160 colonies. An eighth of a mile away is another vineyard of 35 acres; a little further along, another of 40 acres—vineyards and bees in all this region. The bee-men and the grape-men ought to be at perpetual warfare; but it is quite the contrary. They dwell in harmony.

Through the early portion of the grape season, not a bee disturbs the ripening grapes; and when the large clusters are spread upon the trays for drying, not a bee disturbs the raisins. The only time during the past season when the bees worked upon the grapes was late in the fall, and upon what is called the second crop. It is too late in the season to cure this crop. Birds, squirrels, and various insects, including bees, work upon it. Not much profit is expected from the late crop. A good share of the vineyardists get a little profit out of this crop by selling the grapes to the wineries. Mr. McCubbin, being a consistent Prohibitionist, will not sell to the winery.



EUCALYPTUS-TREE PLANTED 11 YEARS AGO, NOW 85 FEET HIGH AND 3 FEET IN DIAMETER.

tinctly acid quality, and almost water-white. It is in an extreme hurry to granulate, and will commence this process within three days after extracting. When secured in the comb it soon granulates there.

Although people apply vile names to the plant, and keep as far from the odor as possible, still it is a most interesting plant to visit; and the mechanics of the blue curl's blossom

He thinks the juice of the late crop more useful to birds and insects than as an intoxicant, and upon that point Mr. McCubbin and the Rambler are in accord.

When bees store this juice in the hives, no evil effects follow. It seems to answer all the purposes of honey.

Peachtree Utter should come here and see the harmony between the peach-growers and the bee-men—no disagreements. Apricots, while drying, are badly infested by the bees; but the owner of a large apricot-orchard has a few colonies of bees himself. He is so much civilized that he thinks a few colonies placed in his fruit-orchard of prunes, peaches, and apricots, are more benefit than a damage.

The umbrella-tree, though not numerous, is a honey-producer, and the eucalyptus is in evidence in this portion of California, and it gives a good record as a honey-producer.

To give the reader some idea of the value of this tree as a wood-producer, I present the accompanying photo. This tree was planted eleven years ago by Mr. McCubbin, who, with his two children, Grace and Bruce, are sitting under it. It was about twelve inches in height, and as large as a wheat straw. By actual measurement when the photo was taken, it was 85 feet in height and three feet in diameter. The eucalyptus is planted here mostly for shade around the house, or in avenues along the highway.

There are but few plantations of it for wood. If the acreage of it were increased for this purpose it would have a happy effect upon the bee-keepers.



INCREASE AND ITS PREVENTION.

"Good morning, Mr. Doolittle. I came over to have a little talk with you on the swarming question, as some of my bees are becoming crowded so they hang out on the outside of the hives."

"Well, Mr. Brown, swarming is a large subject, and one very many bee-keepers have studied over; but up to the present time no one has fully stopped all swarming when working for comb honey. But I do not wish to stop all swarming, for I believe that swarms which issue previous to ten days before the honey harvest are a good investment; and to try to prevent such swarms as are disposed to issue at that time, or earlier, has proven nothing but vexatious with me, the result being a loss in honey—or, at least, I think so, and so I let all first swarms which come ten days or more before the main honey harvest commences be hived in a new hive."

"Very well. And how do you manage these swarms?"

"As soon as the hive is half to two-thirds full of comb I put on the sections; or where I furnish the new hive with empty combs, or

fill the frames with comb foundation, I put on the sections at once."

"I see you are pretty well posted in managing prime swarms; but what about after-swarms?"

"I have very little trouble with these, as I generally set the new hive with the swarm on the stand the parent colony occupied, placing the old hive on a new stand where I wish a colony to be. This draws the most of the field-bees in with the swarm so that the parent colony has little desire to swarm when the first young queen hatches, therefore allow her to destroy the other queen-cells."

"But can you depend on this always?"

"No, not always; and for this reason I look over the combs in the moved hives nine days after moving; and if the bees have destroyed the cells, and no piping is heard, I am sure that colony will not swarm. If I hear piping, or find the cells not torn down, then I destroy all but one myself, saving the best-looking one, unless I find a cell from which the queen has emerged, which I always do where piping is heard, in which case I destroy all. But what I wish to know is, what I shall do with such colonies as have not swarmed within five or ten days of the honey harvest. To allow them to swarm at the very commencement of the harvest spoils the old colony from doing any thing in sections."

"Well, so far you have been instructing me, and now I will try to see if I can help you. My plan to prevent swarming at the commencement of the honey-flow has been to stop them by way of a moderate increase, by the following plan: Shake all the bees and queen from a populous colony into an empty hive—that is, a hive having frames filled with foundation, and a super on containing sections filled with thin foundation, for this shaken colony will contain a half more bees than would a swarm from the same hive. The combs taken, freed from bees, but full of brood, are arranged back in the old hive, when I move another colony to a new stand and place this hive having the combs of brood in its place, giving them a laying queen. This last colony moved may be the weaker of those which have not swarmed, as any colony strong enough to think of swarming at all will furnish field-bees enough to care for the brood, providing the change is made at a time when the bees are flying freely. You will see that I make one new colony from two old ones, having all in the best possible condition to store comb honey by the time the harvest arrives."

"Yes, I think I understand the plan, and I will try it. But suppose that I have all the increase I desire from the swarms which issue previous to ten days before the honey harvest. Is there no way of stopping the rest from swarming, and still have them work to advantage in sections?"

"Do you clip the wings of your queens?"

"Yes, always."

"All right. Now, if we have decided that prevention of increase will be more profitable than further increase, when a swarm issues catch the queen as she is found running around in front of the hive, and place her in a wire-

cloth cage, kept on hand for this purpose; spread the combs a little in the center of the hive, and then by means of a wire attached to the cage suspend it in the center of the hive, and the bees will soon return. The first queen-cell will be due to hatch in seven days; but if we wait the seven days and cut off the queen-cells at that time the bees will have brood still young enough so they will start cells over the larvæ, and often cherish these cells, raising a queen from them and killing the old queen when liberated, thus destroying the usefulness of the colony, as a queen reared from such brood is practically worthless. So to overcome this difficulty I open the hive in four days and cut off all the queen-cells which are sealed, allowing the rest to remain, which satisfies the bees so they do not build any over brood. I now wait six more days, or ten days from the time the swarm issued, when all queen-cells are cut off and the queen liberated. The bees will now go to work in the sections, with a will that is almost surprising; and the honey that has been stored in the combs while the queen has been caged, together with that coming from the fields, makes an aggregate which booms work in the sections to the greatest degree."

"But suppose that I do not wish swarms to issue; what then? Can not the queen be caged without waiting for the swarm to issue?"

"Yes, I often hunt them up and cage them, putting the cage near the entrance in one of the frames, allowing it to rest on the bottom-bar to one of the frames not having the comb built fully down near one end. Where you cage in this way it is necessary to cut the queen-cells but once, unless you find some nearly ready to seal, for none will hatch from those built over brood before the eleventh to thirteenth day. Therefore, if we cut the cells on the tenth day and liberate the queen we are all right. But where a swarm has not issued, the bees will not always be satisfied without trying to swarm, if the queen is released in ten days' time, so on cutting the cells at this time I put a plug filled with queen candy in the cage, which is long enough to take the bees three or four days to eat out the candy to get to her, thus liberating her."

"This candy is put in a hole bored through the center of the plug?"

"Yes."

"How long a plug does it take for three days?"

"If the hole is only $\frac{3}{8}$ inch, 3 inches long is about right, as they eat out about an inch a day. But I hear a horn blowing up at your house. What does it mean?"

"It means my bees are swarming, and I'm off."



A MANIA FOR SUPERSADING QUEENS FOR THE WHOLE APIARY.

Honey is coming in at a good rate, and the bees are casting a few swarms. We are met with a condition that is causing us considerable trouble, for the reason we are not able to strike on any plan to prevent it. The condition is, the bees are possessed with a mania for superseding their queens. Queens of last season's rearing have been superseded while keeping from four to six frames filled with eggs and brood in all stages. Often they will build queen-cells, and just a few days before hatching will tear the whole lot down, thus rendering themselves hopelessly queenless. At other times they will permit a queen to come out, become fertilized, and kill her before she begins laying; and, again, they will permit the queen to lay a few days, then start cells while the queen is yet laying; and about the time the cells are ready to seal, the queen is missing from the hive. The trouble is not with a colony or two in a large apiary, but we are finding about thirty such in one apiary of 250 colonies, and a neighboring bee-keeper reports over 60 in an apiary of 200 colonies. I noticed a little trouble of the same nature last season, but attached little or no importance to it; but this year we hear of several apiaries with the same trouble. We should like the opinion of bee-keepers as to what causes the trouble, for trouble it certainly is.

M. W. SHEPHERD.

Marchant, Fla., Mar. 26.

[The condition you describe is somewhat remarkable. I have known of colonies that persisted in superseding queens, but I never knew the mania to extend to any considerable number. It would almost seem as if there were some disease or trouble that the bees had knowledge of, which you as their owner could not discover. We lay it down as a rule that supersedure does not take place unless the queen is defective or is getting old. I should, therefore, be inclined to believe that there is some disease that attacks the queens, but which for the time being does not apparently cut down the egg-laying to the observer. If some one else is in position to give information on this question we shall be glad to hear from him.—ED.]

GOOSE WING FOR BRUSHING BEES.

If you have never tried a quill out of a goose's wing to brush bees off the comb, try one. I use them and think they are nice. When it gets sticky, throw it away and catch a goose and pull some more. One at a time is enough for a brush.

IRVING PIERCE.

Union City, Mich.

[I have used turkey feathers and chicken feathers, but I do not remember distinctly that I ever tried the big feather of a goose;

THE lawn-mower is now needed in the apiary to keep down grass. If the apiary is fenced in, try a few lambs or even sheep. It is not safe to turn larger stock into the backyard. But it will not do to use sheep if there are grapevines for shade, for the sheep will eat the vines as well as all other vegetation.

but I know that such devices for brushing bees off the combs are very generally used by bee-keepers, especially if they are located on a farm where feathers are plentiful.—ED.]



BEE-KEEPERS who expect to attend the convention of the National Bee-keepers' Association at Buffalo next September are requested to prepare questions and hand them in. The committee, however, would be glad to have these questions sent by mail in advance, so that all duplicates may be stricken out. Send questions to Sec. A. B. Mason, Station B, Toledo, Ohio.

ROBBING is dreaded by the beginner more than by the veteran, generally. If the colony being robbed is weak, and has little honey, it might as well be left to its fate: If it has much honey it will be best to remove the bulk of it to safer quarters. If the attacked colony is worth saving it might be best to take it to the cellar for a few days till things have become quiet and the robbers have taken to a more legitimate business.

THE W. T. Falconer Co. and The A. I. Root Co. will have exhibits at the Pan-American exposition, in the Agricultural Building. These exhibits will be conspicuously placed in the gallery, this gallery being reached by means of a traveling sidewalk. The two exhibits are placed together in the same booth, as it were, facing each other. Huber Root, youngest son of A. I. Root, will be in attendance on our exhibit a good portion of the time, to explain the goods and answer questions. He is at present attending school at Oberlin, O.; and when he returns, after a little "coaching" in Medina he will probably be able to receive bee-keepers at the Root Co.'s exhibit at the Pan-American.

AN IMPORTANT DECISION FOR OHIO; HONEY-BEES NOT A NUISANCE.

THE following letter contains a piece of news that will be read with much pleasure, not only by the bee-keepers in Ohio, but by those in every State where this question comes up, or is liable to come up, as to whether bees are a nuisance or not. Here it is:

Mr. Root:—C. W. Carr, of this county, was indicted for maintaining a public nuisance, in that he kept and maintained a place for the raising of honey-bees. We defended Mr. Carr, and know that you will be interested in the outcome, as we have talked with beemen considerably, and read your article on the Utter trial.

We have just argued a demurrer to the court, and the court held that it was not a public nuisance to keep and maintain honey-bees in this State.

It was the same old story of jealousy and malice. Mr. Carr is a young man, and the head of a family consisting of his widowed mother and young brothers and sisters. His health is such that he is unable to work at hard labor, and he has managed to keep

the family together by raising chickens, keeping bees, and a small garden-patch. His neighbors, unfortunately, were men whose business was in the use of a jack-knife upon dry-goods boxes, and grumbling. Wauseon, O., May 10. HAM, HAM & HAM.

This is a case that had not, if I am correct, been referred to the N. B. K. A. If so, I had no knowledge of it. At all events, a victory has been won. Mr. Carr has been vindicated, and the bees declared to be not a nuisance. This decision, coming as it does, will have important and far-reaching results; and I have no doubt that General Manager Secor will secure a copy of the decision so that it can be used in other cases that may come up in this or other States. The attorneys who defended the case so successfully deserve the thanks of all bee-keepers.

SNAP SHOTS ON THE FLY.

Pullman car, en route to New Orleans.

I have just come from a delightful visit with J. M. Jenkins, at Wetumpka, Ala. Yesterday, May 21, he met me at Montgomery, and then behind his little pony we drove 14 miles across the country through the pines and over the cotton-plantations to Wetumpka.

For the first time in my life I saw the cotton-fields being plowed and cultivated by the black man and his family in the good old-fashioned way. Regarding the colored race, I plied friend Jenkins with a thousand and one questions; but of these and the replies I shall perhaps have more to say later.

We stopped at one of Jenkins' out-yards, took some pictures, and drove on. Later in the day we "changed horses," this time taking one of Jenkins' mules, and started for the out yard among the pines. On the way the aforesaid mule entertained us (or me, rather) with several characteristic solos. Say—he could beat all the mules I ever heard in running up and down the scale. Such beautiful zigzag trills I never heard before. You just ought to have seen the black faces pop out of the cabin doors. You see they (the owners of the faces) knew it was Jenkins' mule, for they know Jenkins and his mule all over that country. Well, on arriving at the yard I took some more views and some more notes, and then we started back.

Strawberries, blackberries, and dewberries were in full bearing, although the season was a month late. In Mr. Jenkins' orchard were several peach-trees that would have some ripe peaches within a week, and—

Say—this train joggles my elbow so that I shall have to give up writing for now; but as soon as I get my pictures developed and engraved I'll have more to say about the visit to Mr. Jenkins.

Later.—I'm taking some snap shots with my little pocket camera. We are crossing bridge after bridge, and such beautiful scenery! I wish you could see what I see as the kaleidoscope changes.

A NEW BEE-BRUSH.

MR. JOHN HAMMOND, of Buena Vista, O., a manufacturer of brushes of all kinds, and also a bee-keeper, has sent us a sample of his

double brush for brushing bees off the combs. It is very unique in principle; and in practice, from the limited number of tests we have been able to give it this spring, it is all it seems to be in theory. Both sides of the

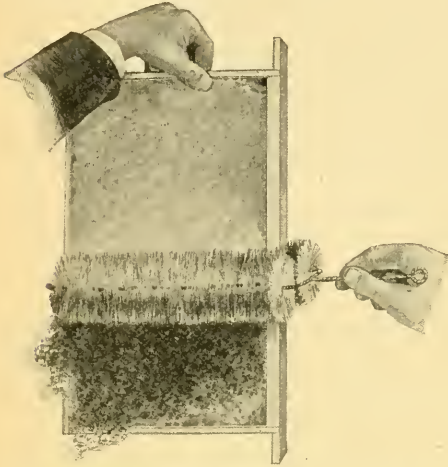

comb are cleaned with one or two sweeps. In the average extracting apiary a large number of bees can be driven off the combs by the right use of smoke. Some little time ago I described how, by the use of a quilt or cloth laid over the top of the frames, one could

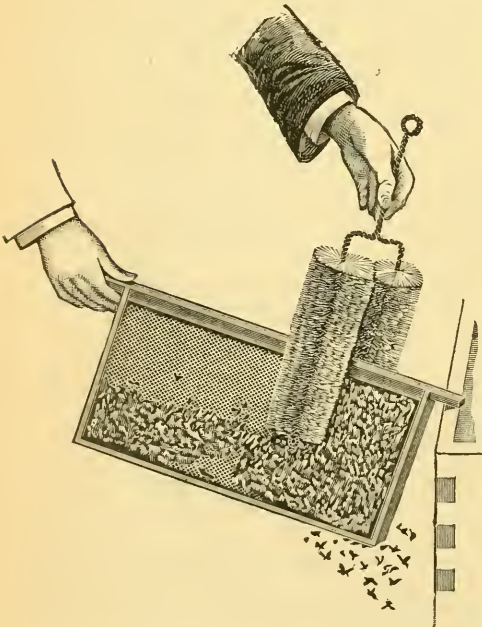

cause the smoke to be sucked down into the brood-nest by an alternate succession of flops of the quilt, producing a suction, such suction causing the smoke to go down into the extracting-combs, driving the bees before it into the brood-nest. In the Cogshall apiaries I

have seen combs so treated taken out of populous colonies, almost free of bees. Well, suppose there were quite a number on each side. Just imagine how quickly one could disengage every bee with a double brush like the one shown in the illustration.

We have been so well pleased with these brushes we have decided to catalog them next year, and in the mean time we will furnish them to those who desire them, at the prices mentioned elsewhere under the head of Special Notices.

IS THE TRADE IN LONG TONGUED BEES ALL RIGHT?

In *The American Bee Journal* for May 9 appears an article written by G. M. Doolittle, with the heading, "Long-tongued Bees—Fad or Fallacy, Which?" which is somewhat of a surprise. Mr. Doolittle says he feels it his duty to call a halt, "that too much money need not be sunk on this latest fad, even if we do not call it a fallacy." There is some danger that too much may be expected, and that disappointment may result, hence the propriety of some words of warning, or, as Mr. Doolittle expresses it, of calling a halt; but Mr. Doolittle is in error when he says "no one has seen fit to do this," for such words of warning in very distinct terms have more than once been given in these columns.

Mr. Doolittle speaks of the search for long tongues as a fad upon which money has been wasted, and he wants to ask about it "before more money is wasted on the fad." The attempt to secure in some way the crop of red-clover honey is no new thing. For many years there has been a longing to secure it, either through a change in the bees or in the clover. E. E. Hasty and others have made commendable efforts to obtain a strain of red clover with short tubes. At different times red-clover strains of hive bees have had much said in their favor, and earnest effort has been made, especially by bee-keepers of Mr. Doolittle's own State, to induce government to introduce *Apis dorsata* for the sake of its longer tongue. Petitions to this effect were printed and circulated. Why did not Mr. Doolittle call a halt while this expenditure of time and money was going on, instead of waiting till the object of search was believed by many to be just within reach?

Mr. Doolittle objects to the claim for superiority of long-tongued bees in New Mexico and elsewhere where there is no red clover. If such superiority has been observed, why not report it? Whether it be that other good qualities are found closely connected with long tongues, or whether it be that there may be other plants from which the nectar can be obtained only by tongues of unusual length, if the fact remains that, in more than one instance in regions without red clover, when a colony was found to have distinguished itself in the matter of honey-gathering, measurement has shown tongues of unusual length, is there any impropriety in making such fact known?

The chief charge seems to be that, when any thing has been said in favor of long

tongues, it has not been accompanied by the statement that long tongues were of value only in red-clover regions. Was there any necessity for such accompanying statement? Has it not been so generally understood that it did not need mention? If, however, it turns out that the value of long tongues is not restricted to red-clover regions (and testimony to that fact is not wanting), then still less is it necessary.

Numerous quotations in favor of long tongues are given, and then Mr. Doolittle says:

"And so I might go on, giving quotation after quotation of statements made along this line, without any special qualification, or, if any qualifications have been made, they have been so hidden under a lot of rubbish, or so twisted that the reader is led to believe that long-tongued bees are just the thing he should have if he would succeed, no matter about red clover, or in what portion of the country he resides.

"Now, as I hinted in the start, long-tongued bees *do* have an advantage outside of the red-clover districts, or they *do not*; and to give misleading statements, or those actually false, is something that our bee-papers of the present day should not stoop to doing, not even when the motive of gain prompts its advertisers."

As all the quotations immediately preceding these two paragraphs are from GLEANINGS, there is no blinking the fact that GLEANINGS is the paper meant. It is true the words "bee-papers" are used; but it seems evident that Mr. Doolittle had only one paper in mind, for, immediately following, in the same sentence, he speaks of "its advertisers."

The direct charge of hiding under a lot of rubbish and twisting the truth, and the scarcely veiled charge of giving misleading statements, or those actually false, is a somewhat serious one, and GLEANINGS promptly enters a plea of not guilty, and asks Mr. Doolittle to be specific and give an instance of either of the things charged, in which case prompt retraction and apology will be forthcoming. The quotations given do not substantiate the charges. The rubbish under which the truth is hidden is not shown; nor the twist given to it; and the statements quoted are not such as to mislead.

There seems a degree of inconsistency in making the charge that the attempt has been made to cover up the fact that red-clover regions only could benefit by long tongues, when immediately preceding the charge Mr. Doolittle makes a quotation from GLEANINGS which, if correctly attributed to the editor, would distinctly disprove the charge, capitalizing and italicizing it as follows: "The movement for longer tongues is simply to get the red-clover crop of the North, which now is practically all wasted. The bees, NO ONE CLAIMS, would be any better except on that account."

Mr. Doolittle is hardly justified in making that quotation in such a way as to give the impression that the editor holds the opinion expressed in the quotation. Many times a view of a correspondent is not held by the editor. Neither does the editor necessarily hold the views given by one who conducts a special department in GLEANINGS. This is frequently seen in Dr. Miller's department of Straws, and might happen in Mr. Doolittle's department, or in that of Stenog, from whom the quotation was made.

It is not very strange that Stenog should so express himself, for it is probably true that the majority of bee-keepers, especially until lately, have had in mind red clover when speaking of long tongues. But the editor by no means holds it as proven that red clover is the only honey-plant with flower-tubes so deep that bees with ordinary tongues can not reach to the bottom. All the same, the inconsistency is, none the less, to be charged with hiding a thing while at the same time holding it up to view.

It is mentioned as not just the right thing that advertisers from Florida and Texas commend their bees with long tongues. Suppose their *is* no red clover in Florida and Texas; does not Mr. Doolittle know that such advertisers expect to find customers in the North, where there is red clover? In any case, if an article is offered for what it honestly is, is there any thing wrong in that? Is a man to be considered a cheat unless every long-tongued bee he offers has a tag attached, reading, "Good in red-clover regions only"?

GLEANINGS has tried, and will continue to try, to give the whole truth about bees with long tongues. If measurements show that a large number of the best bees have long tongues in regions where red clover is not grown, then there will be ground for believing that there may be some advantage outside of red-clover regions, in having bees of that sort, whatever the explanation for their superiority may be. Bee-keepers are an intelligent lot, each one capable of judging for himself whether bees with a certain characteristic will be an advantage in any given case. Nor will they relish as a compliment being told that they do not know enough to judge for themselves whether they want long tongues or not.

It might be in order to ask why, if it is Mr. Doolittle's duty to call a halt on the long-tongued fad, it was not an equal duty to say something about the fad for five bands. In that there could be no gain in the honey-crop—the only money gain being to those who had queens to sell; while it is a certainty that a sufficient length of tongue will bring an increase of honey wherever there are flower-tubes of honey-plants just beyond the reach of tongues of ordinary length. Did Mr. Doolittle ever call a halt with regard to the chase after color? Did he not, indeed, promote it? and does he not claim to be one of the chief agencies, if not the chief agency, in establishing the five-banded bees? If it was right to have a prominent part in a fad that could bring money into the pockets of only a small number engaged in queen-rearing, it hardly seems necessary to be so intensely severe upon a fad which seeks to put money into the pockets of many times that number through extra gains in crops of honey.

OUR METHOD OF MEASURING ILLUSTRATED; SOME INTERESTING OBSERVATIONS.

IN spite of all I have said on this subject, there are still a good many who do not seem to understand our method of measuring. At several of our bee-conventions last winter I

threw on the screen a picture of our Mr. Wardell, who has charge of our apiary, in the act of measuring a bee's tongue, and I now show the same thing in half-tone. A queen-cage is shown near the left hand. Between the two hands is a steel rule having hundredths of an inch graduated off on one side. In the left is a pair of tweezers, and in the right a knife-blade. In front of the right hand is a bottle of chloroform and a handkerchief. Mounted on a standard, standing directly over the rule, is a magnifying-glass.

The cage of bees is chloroformed by putting the spot in the handkerchief, dampened with a few drops of the anesthetic, over the wire cloth. In a minute, more or less, the bees will be "laid out," but still quivering with evidences of life. In this condition the wire cloth is pried back. With the tweezers the

as fruit-bloom is beginning, they show $\frac{20}{100}$. It would appear that the tongues of the bees, in order to show their greatest length, must be developed by *straining* to reach the depth of certain flower-tubes. Use has a tendency to develop any organ among the *vertebrata*, and why should it not in the case of the *insecta*?

And, again, it seems possible and probable that bees that have been sent through the mails will not show as long a tongue-reach as before they started.

We shall shortly conduct some experiments that will either prove or disprove some of these propositions.

In the mean time let us not jump to the conclusion that long tongues inevitably mean large crops of honey. We must not forget that long tongues constitute only one factor.



MR. WARDELL MEASURING A BEE'S TONGUE.

operator takes out one bee, and holds it while the head is removed with the knife-blade. The head is then laid on the steel rule, directly over the hundredths marks, *face upward*. A needle combs out the tongue, which the chloroform has caused to be extended, and lays it carefully in a straight line. The operator then counts off the hundredths with the glass, beginning from the end of the tongue and ending at that point at the end of the mandibles.

A good deal of evidence has come in of late, going to show that the length of tongues of any particular colony of bees varies according to the season, and also according to the age of the bees themselves. Early in the spring, mature bees will show from $\frac{2}{100}$ to $\frac{3}{100}$ shorter tongue-reach than they will later in the season. Bees that last year showed a reach of $\frac{21}{100}$ during the height of the honey-flow, early this spring showed only $\frac{18}{100}$ and $\frac{19}{100}$. Now, just

A tall man has the advantage of seeing over his fellows, and of being able, perhaps, to take longer steps, but he may not be able to "get there" as soon as his shorter brother.

STRONG COLONIES ONLY ARE PROFITABLE AS HONEY-GATHERERS.

THE buckwheaters do not need to have their colonies in working order till the month of August, and there is no use in having them overflowing with bees in June. Colonies just arriving at their maximum strength at the beginning of the honey-flow will accomplish much more than other colonies having reached that state a month or two sooner. The buckwheaters would do better to divide the strong colonies in the early part of the season. With doubled stock, and all just coming into their prime, the honey crop can be doubled.



Thou shalt love thy neighbor as thyself.—MARK 12:31.

These are the things that ye shall do: Speak ye every man the truth to his neighbor; execute the judgment of truth and peace in your gates; and let none of you imagine evil in your hearts against his neighbor; and love no false oath; for these are things that I hate, saith the Lord.—ZECH. 8:16, 17.

You will notice from my texts that I am to talk about "neighbors" this time, rather than "our homes;" and the matter has come up especially as I am starting a new home—that is, a new summer home—among new people. You have probably all heard the story of the hotel-keeper. I think he must have been a Yankee as well as a philosopher, for he was much in the habit of getting acquainted with all his guests. Well, a man came along with his teams and family to stop with him over night. He was moving to a new locality. He gave, as a reason, that he had always been unfortunately located among the meanest set of neighbors to be found on the face of the earth, and therefore he was going to try to find a better place. Our philosophical host informed the man, however, that he would find exactly the same kind of neighbors around his new home that he had left behind. There was no difference. Next day another mover came along, who explained in his talk that certain circumstances made it advisable for him to leave his old home, but he greatly regretted being obliged to leave, because his neighbors had always been so exceedingly *kind, fair, and friendly*. He said it almost broke his heart to think about breaking the ties that bound him to each and all. Well, our wise friend replied to this man much as he did to the other, saying something like this: "My good friend, I am happy to tell you that you will find just as good neighbors where you are going as you have left behind. You need not feel troubled nor worried."

What a wonderful truth this story illustrates—that is, if it indeed be true, and I rather suspect it is! Can it be true that it is not so much what the people are as what we make them? or, in other words, the state of your own heart has more to do with the neighborhood than any thing else. I suspect this hotel-keeper must have been a Christian, although the story did not say so. He had discovered the real *philosopher's stone*, the source of joy and peace and happiness in this world of ours.

I thought of this little story when I managed to secure a dozen days of absence from business during the busy fore part of May. In fact, I set foot in Leelanaw Co., Mich., on the first day of May, and I remained there eight days, Sunday included. I thought of the neighbors, especially as I wanted to go around among them and employ men with their teams to help me during my brief stay, and start a very humble home out in the woods. Yes, I knelt and prayed for these

neighbors, even before I had seen them. I do not think they will feel hurt if I call them by name; for, although I am going to give you a picture of a special locality, I have prayed that God shall give me grace and wisdom not to find too much fault, even if I touch upon the weaknesses and frailties of average humanity.

The first day we had only two men and a team, not counting myself. We made quite a clearing by hauling away the logs that cumbered the ground three or four deep in some places. The timber had been previously cut down, and was mostly in lengths so that a team could move it. The next day we were to grub, get out stumps, and plow. I had made arrangements to have several good men, some boys, and a team. A man living very near me had promised a team, or at least I supposed he had. He said if he could not arrange to go himself with his team and plow he would get his brother-in-law, and that I could depend on having one or the other—at least so I understood it. But when I was on the ground in the morning, I waited and waited for the men, boys, and team to show up. For a good while (so it seemed to me) nobody was visible. Finally the man who lived furthest away came with his ax. After waiting till the forenoon was pretty well spent I put off on foot to hunt up my helpers. I found the man with the team, who had promised so fairly, plowing his own field. I asked him why he was not on hand as he agreed. But he did not remember that he had made any positive promise. He said he was working for Mr. Oberlin, and must get in the oats. When I asked about his brother-in-law he said the boat had come in at the dock, and they all had to load it up. I remonstrated, and explained the circumstances. I offered to pay him extra if he would drop his work there and come and help me. But he said he could not do that at any price. He was at work for Mr. Oberlin, and Mr. O. was a very particular man.

"But, friend Burdo, I saw Mr. Oberlin last evening, and arranged to have the lumber delivered at my place, and he said they would furnish me any thing I wanted. He said that was their business, and he was glad to help me locate in the neighborhood. Now, Mr. B. I will stand *between* you and Mr. Oberlin. I know by the talk I had with him he will not charge you very heavy damages for stopping and helping me for half a day."

But I could not move him. He reasoned like this:

"Mr. Root, suppose I should hire out to work for you, and somebody else should come along, and I should go off and work for him. No, I can not work for you this afternoon, not if you were to give me \$25, unless you first see Mr. Oberlin and get permission for me to stop putting in oats."

Now, this is good square common sense; but why did not my "neighbor" apply the same common sense to our talk the evening before? I expostulated, on the ground that Mr. Oberlin was three miles away, and no telephone wire. I told him I could get permis-

sion in a minute, but I should have to take a three-mile wheelride and back again before we could get to work. As there was no help for it I started to make the trip. Then he told me to go down to the dock and see his brother-in-law, Mr. Weisler. Mr. W. said he could not possibly come before afternoon, but he would come then, sure, and bring a stoneboat, plow, and harrow. Mr. W. further told me that Mr. Henshaw, the foreman of the dock, was invested with full authority to manage Mr. Oberlin's men and teams. Said he:

"You go to Mr. Henshaw and tell him how you are fixed, and Mr. H. will take the responsibility of directing Mr. Burdo to stop on the oats from now till noon."

You see I was to have Mr. Weisler's team after dinner. Mr. Henshaw very courteously declared it would be all right for Mr. Burdo to stop the rest of the forenoon, and he did so. On my way back to the ranch I thought of my boys. Pretty soon I heard some boys in the thicket; and there I found Orville, who had promised to help me the afternoon before, but he did not show up. The mother also promised he should come. But she said, when I asked her why he did not come, that they had to have him help load the boat.

Orville and his companions were making whistles out of basswood sprouts. The basswood was just leaving out. Now, I am always glad to see boys make whistles, providing they can make them with a clear conscience; but Orville had hired out to me, as I understood it, and his mother said he was down helping them load the boat. Perhaps I had better explain here that, when a vessel comes into the dock, it must be loaded, whether or no; and for this work the men and boys get much higher prices than they get for ordinary farm-work, so every thing else has to stand aside.

"Why, Orville, your mother said you were down helping load the boat, even though you had promised fair and faithfully to work for me; and here you are, sitting in the shade, making whistles."

He hung his head down, but ventured as an excuse that they found out they did not need him at the dock.

"But why in the world did you not hustle up at once to meet your appointment to work for me? You know you promised to be there yesterday afternoon."

"But, Mr. Root, I did not know that I promised to work for you to-day."

To tell the truth, he had not exactly promised to work for me any longer than that afternoon. But I told him I wanted him badly right along, and I expected, of course, he would help me right along. This was only a sort of boy's philosophy. I have learned by experience with boys that they have sometimes queer ideas of things; and it is not best to expect too much of them, either physically or in the way of keeping promises. Let me say right here that Orville helped me right along after that, and proved to be an excellent boy in almost every respect. He and I are the best of friends, and I hope we shall be as long as we live. Mr. Burdo came with his big team, and did a tremendous lot of stump-pull-

ing, plowing, and removing big stones for the rest of the forenoon, about 3½ hours.

After dinner my men were on hand, but no team showed up. Mr. Weisler's boy was soon there. He said his father was surely coming, for he saw him start off with his team; but when the afternoon was a good part gone I sent Charley to see what the matter was. He said the wind changed, and the vessel could not get under sail without assistance from all the men and teams in the neighborhood. I did not learn how they use teams to move a vessel out in the water; but that is the way I understood it. We had to get along the best we could, and I managed to keep my men busy, though not in a profitable way, without any teams.

Mr. W. promised to be on hand early next morning. Sure enough, he did come; but instead of having a plow and stoneboat he had nothing but a harrow. He explained that the stoneboat was a mile away from home, and he had not had time to go for it. The plow was all broken to pieces, and therefore he could not bring one.

Now, I had made up my mind to make friends with the people all round about my home, no matter what it cost. I was going to have their good will and co-operation; and I knew by past experience that finding fault and blowing a man up would not help—well, let us say it does not help one to sleep well nights, and get along nicely with those who live around him. Some of you will understand me if I tell you that I not only prayed for all these people, but I prayed that God would give me grace and wisdom and understanding to help me build something of a thousand times more importance than the garden and the little home out there in the wilderness. When I saw my friend and neighbor come up with nothing but a "drag" in place of the plow and stoneboat, I prayed the great Father above to help me get along profitably with just the drag.

I think I will not tell you of any more of my disappointments and troubles in consequence of broken promises. When I found I could not have the plow I set the big team to moving rocks without a stoneboat, getting out stumps, snags, etc. I had the big rocks located for the foundation of my building, and then I remembered three hewn timbers, forty feet long, that somebody had cut out and left in my woods. You see, while I was far away, and paid no attention to my property, my neighbors sort of helped themselves to my timber. My conscience did not trouble me for appropriating these forty-foot sticks. I cut each in two in the middle, and then placed them on top of the big rocks we had placed for the foundation, nailed some boards across them, and there was the foundation of our new home—a good solid one too.

We used the team and drag all that afternoon to very good advantage; and after overcoming all my perplexities one by one I began to get very happy. I worked very hard—perhaps as hard as I ever worked in my life; but I rarely if ever have passed a happier eight days, and I was happy when Sunday came.

The boy who was helping Orville make bass-wood whistles came along with us. We called him Earl. Pretty soon another friend of the two boys, named Thomas, came and proffered his services. Well, when I could not secure any men or teams to help me work I had just these three boys—sometimes four of them; and I tell you we did a lot of work. I know there is an old saying that "one boy is a boy; two boys are half a boy, and three boys are none at all." I had some experience with this trouble. So many boys together would have fun and play more or less in spite of anything I could do. If a chicken-hawk soared overhead, they had to stop and look at it. If Earl's puppy got a woodchuck in a hole it was boylike to want to see the fun. Sometimes I became discouraged; but when I did so I prayed, and then the boys all of a sudden did a man's work for quite a little spell. Toward noon they would get pretty tired; and when I stopped to take my nap on my big blanket on a pile of leaves I suppose they took things pretty easy, and I don't care if they did. May God bless and guide those four boys.

One afternoon when they were pretty tired, and did not seem to feel like working at any thing much longer, I told them I had got to go to Bingham on my wheel to order lumber for the building. I suggested to them that there was not a very good wheel-path through the thicket in the corner belonging to Orville's mother. I asked them if they would not cut away the briars, and fix it so we could get through easier, back and forth. Then I went to Bingham. When I got back it was about dusk, and I was surprised to find something like half a day's work done in fixing up a very nice little roadway through that troublesome thicket.

"Why, Orville, you boys did a tremendous lot of work after I left. You must have worked after quitting time, didn't you?"

Then his mother suggested that they did not get around till after 7 o'clock. Now, you see boys sometimes give us pleasant surprises, especially when they take a *notion* to a job; yes, and after they are apparently tired out with a hard day's work they will jump and run as if they had not done any work at all. Oh how I do love nice clean pure-minded boys! Even if they do vex and try us at times, God knows we can well afford to overlook a great deal.

Right in this line let me give you one more experience. I had been delayed and disappointed so much in getting the ground ready for those peach-trees that I had about given up thinking they would amount to any thing. Finally, one day after we had got the ground all slicked up in pretty good shape, and I was just about ready to think of sending for trees, friend Hilbert drove up with his ponies and spring wagon, with all my stuff. Sure enough, some of the peach-trees were budded, and almost in bloom. I told the boys how anxious I was to get the trees out, even if it did rain, and we kept right at it except when it rained the hardest, and got them out in good order. Of course, we stayed in the building when it rained the most.

About five o'clock one of the boys said he had to go home early that night. As it was his last day with us, I paid him off. When he objected to receiving full pay for the rainy day, I told them they had shown their good will by working out in the wet, and so I did not take out any thing for the time it rained. At this all the rest of them set up a "hooray." Then one of them volunteered, "Mr. Root, is there any thing else you would like to have us do before we quit? If you are going to pay us wages for the time we sat still when it rained, we will try to make you out a better day's work."

Well, I had almost given up clearing up my ravine. I wanted it done badly, for I thought it was about the best ground I had on the place. The raspberry-bushes down in that dark place last fall were toward ten feet high, and there were luscious berries on them almost up into November. I knew the ground was very rich, and I wanted to use it for some of my choice varieties of fruits and vegetables. I told the boys I should be very glad to have that ravine cleared out of rubbish, and every thing that would be in the way of working on it, the next day. They went at it with another hooray, and an hour later I could hardly believe it possible that those boys alone could have done so much work. Most of the stuff had to be pulled down hill; and they would all together get hold of some tree or log, and down it would go on the fly. I had brought with me a Daisy wheelbarrow, and the most approved spades, shovels, hoes, mattocks, etc., that could be found in the market; and the boys seemed to take to those nice new tools almost as ducks take to water. In just a few days they became very expert with them.

I had almost forgotten to tell you about building the house. The boys and I fixed the foundation and laid the floors, as I have told you. I engaged two carpenters, but they could come only one day. I could not possibly manage to get them any longer. I had, however, four boys to wait on them, and a very good man who is handy with tools, even if he is not a carpenter. By noon we had the walls up, and a little after noon we were ready to begin shingling. I asked the carpenters if they could not each take a boy, one on each side, and keep watch so that they would lay the shingles and make a tight roof. The four boys were all ambitious to help in shingling; and you ought to have seen that roof go on. Of course, the boys were expected to wait on the carpenters; but once when he thought I was not looking I saw the boss carpenter carrying shingles from the ground up to the roof, and he put up quite a lot of them too. He said he would rather do it himself than to urge the boys to get more. The roof was on, the door was made and hung, even to the lock and key; and all the windows would have been in, but the teamster who was to bring them over from the store at Bingham forgot to put them on top of his load of lumber. I wonder if this fashion of forgetting things, that throws expensive men out of a job, and costs people sums of money untold, is preva-

lent *all over* the world. My dear friend, in the neighborhood around your home is it customary to have a builder, or, say, a crowd of men stopped in their job because some carrier "forgot" to load on all his stuff? There, there! if I do not look out I fear I shall be finding fault again.

In our hurry to get the logs out of the way, we piled them up just back of the house. I did not set fire to them—first, because they were too damp to burn well; and, secondly, if the wind were to change I knew it would greatly annoy us in our work. As soon as we got the shingles on, several of the older men began shaking their heads, and looking at that log-pile almost as high as the house. They said if a fire got into the woods, and the wind were in the right direction, the house that was built in just one day would burn down in a good deal *less* time. The log-heap would have to be burned up before I went home. I started it going one night just after the men left, and I spread my blanket in the new house, and proceeded to watch. Even though the wind was away from the house, the heat was so great that it almost scorched the boards. There was no water nearer than twenty or thirty rods, and I was alone in the wilderness. If the wind were to change, my house could not stand a minute. A little after midnight it did change, and the sparks fell on that roof for a little while in a way that was fearful. I had a ladder and one bucket of water. Of course, it was not a very serious matter; but it was dear to my heart, even if the whole thing was not worth more than forty or fifty dollars. Just as I began to fear trouble the raindrops began to patter on that roof. What a joyous thing it was just then to thank God for having answered my prayer in this strange and unexpected way! The contrary wind that came up all of a sudden was probably brought on by the rain that was just behind it.

Just one more little circumstance. After the boys and I had cleared off the ground where we were to plant our peach-trees, somebody suggested we ought to have a floater to make the ground smooth. I suppose I need not tell you what a floater is. There was nothing on the premises that we could draw over that ground, to scrape off the high places and fill up the hollows. Oh! yes, there was. When the carpenters needed a ladder badly I took two light sticks of timber and nailed boards across, making a rough but strong ladder. I told Orville to get his team, and another boy to get the log-chain; and then I hitched the chain so the ladder would go forward with a slant, enabling it to slip by the stumps and obstructions; then I loaded the boys on the ladder, and told Orville to start up. It did beautiful work; but the ground was so uneven and rough, and there were so many roots, it went by jerks, especially when going down hill. Of course, we might have piled logs on the ladder, but we wanted it weighted down in such a way we could take off the weight in going up hill, and put it on in going down. We wanted it weighted down with something that had sense and intelligence. I explained the matter to the boys,

and distributed them along the ladder, and then—what do you suppose? We not only made that orchard look like an onion-bed, but those four boys had—well, something I should call *better* than a circus. Sometimes the whole four went over backward in spite of all they could do to hold on; and about as soon as they got back, the next tumble was over in front under the horses' heels. I kept telling them they must hold on tighter. The boys laughed and hurrahed till they made the woods ring; and I finally laughed till the tears ran down my cheeks, making furrows, I suppose, through the dust and grime. Oh, yes! when I went up to Michigan I had to wear an overcoat and a muffler and my winter flannels. I had the grip across my chest, rheumatism in my leg, and a cold besides. When I got to work with the boys, after three or four days I was bareheaded (barefooted a part of the time), wore neither coat nor vest, and some of the time I had to remove some of my underclothing. When my feet got sore I bathed them at night in cool running water from that spring, and did not catch cold. I boarded at a farmhouse, and had farmers' fare; was happy and well, without any beefsteak or other things that we get with so little trouble when we live in a town or city.

On Sunday I found a churchful of people, young and old, in Sunday-school. There was no preaching in the middle of the day at Bingham, and not every Sunday in the evening; therefore they generally have an excellent turnout at the Sunday-school, and it rejoiced my heart to see them come from miles around. Yes, and it rejoiced my heart again when the superintendent asked me if I would talk to the children at the close of the lesson. I told them I wanted to talk about two things—fishing and swearing. I asked how many had ever been fishing. In response the boys pretty much all raised their hands. Then I asked how many knew *how* to fish, and the hand of pretty nearly every one in the room went up. Then I told them something about fishing in olden times, and the cast net that Peter was requested to throw on the other side, and which I described on page 355. Then I spoke something as follows:

"Children, I might now take up the other part of my subject and ask how many of you have ever heard swearing. But I do not want to do this. I do not want to know how much swearing there is in this community, for I am almost a stranger. I might ask all those who have ever been tempted to swear to raise their hands; but, God forbid. The subject is too serious and sacred a matter to even ask questions about in this way. Peter was an expert fisherman. It was the business of his life before Jesus found him. The Bible tells us that Peter knew how to swear as well as how to fish. Can anybody tell me how Peter probably learned these awful bad words?"

Somebody replied that Peter had most likely heard *others* swear. And, dear friends, this is the way swearing comes about. The little boys hear the bigger ones swear, or the old men, or the "neighbors." If everybody would stop it, the little boys pretty soon would

not know there was any such thing as swear words. I have been here only four days, and yet I have heard some terrible swearing. A young man was drawing off stones on a stoneboat. He was on a side hill, away up in plain sight, and where everybody could hear him. He drove his team over where the bank was so steep the stoneboat tipped over, and the stones all went rolling to the bottom of the hill. At this he swore just awfully. He seemed to want to let everybody *know* what a bad and wicked heart he had. Now, pretty nearly at the same time, and not far away, another boy (or young man) was also drawing stones and logs and stumps. When he was going after a log, the log-chain caught in a stick, and he called to his horse to stop, and then stooped down to get the end of the stick out of the chain. But the horse started suddenly, without orders. The stick flew up and struck him under his chin, and knocked him down flat in the dirt. I think it must have hurt him considerably. Now, it would have been quite natural for this boy, angered by the pain, to scold at the horse—may be to swear—that is, if he was in the habit of swearing, because the horse started without orders. But this last boy is not a swearing boy. He just looked pleasant and good-natured, and laughed about it. I saw him sprawling in the dirt, and asked him what the matter was, and he told me how it happened. He did not "yell" at his horse, and he did not even talk loud. He took it all as an accident. "Now, children, let us consider a little about that other boy. Whose fault was it that his stoneboat tipped over? Was it the fault of the horse?"

"No, sir."

"Was the *stoneboat* to blame?"

Some of the children smiled at the idea of a stoneboat being to blame for an accident.

"Well, children, a good many people swear at stoneboats and other inanimate objects. They seem to think it is sensible, and may be smart, to curse things that have no sense or responsibility. You have told me the horses were not to blame for this accident, and the stoneboat was not to blame. Then who was to blame?"

"The boy himself."

Another answer came from another part of the house:

"Mr. Root, the accident was the result of his own carelessness or stupidity."

Then I added:

"Children, people sometimes say swearing does not hurt anybody. It *does* hurt people. It pains everybody who loves righteousness and hates iniquity. It sets a bad example for the younger ones. It is catching, like smallpox and cholera; and I am inclined to believe it is worse than either. It worries the horses. You watch the horses, and see how they look when somebody swears at them. *They* know what swear words mean. More than all, it harms the man who allows himself to yield to the temptation to use such words. First he swears at his team, then he whips and pounds them. Then they get contrary and stubborn, and work is interrupted and hindered. I have sometimes thought that the man who swears

at his team was worth only about half as much as the man who does not swear; and there are some owners of horses who will not have a man on the premises who swears and gets mad at his team, at his stoneboat, or at his work."*

You may urge it is not so bad to swear at a stoneboat, for that has no feelings; but there is less sense and reason in it than swearing at horses. It is a very bad plan to swear at horses, but not nearly as bad as to swear at your neighbors. The last of our text's says, "Let none of you imagine evil in his heart against his neighbor;" and then it adds, "Love no false oath, for all these are things that I hate, saith the Lord." The man who swears at a stoneboat and at horses will soon swear at his neighbors, especially if he has difficulty with them. Then come blows, lawsuits, penitentiary, and sometimes death. A man not far from where I live quarreled with his neighbor about a division fence. One of them was killed, and the other is now in the penitentiary. Very likely it commenced by the foolish habit of swearing; but before swearing comes, there must be "evil imaginations" in the heart. The swearing only tells to the world, and publishes abroad, the badness of the man's heart. Where the spirit of Christ Jesus rules, there can never be any thing of this kind.

Poor Peter! It may be that he would have never used those very bad and awful words had he not been around where he heard somebody else use them. May God help you, dear children, to keep from this terrible habit. Keep away from it; let it alone just as you would smallpox, cholera, or that terrible malady known as the "black death."



FLORIDA TRAVELS, CONTINUED.

My trip *down* the coast was in the night, so I could not get a glimpse of the towns in the vicinity of Miami. Going back, however, I had a better opportunity for doing so. All along the railway from Miami to Palm Beach there are acres and acres of pineapples. These require no sheds—that is, so far as frost is concerned; but they did not show the luxuriance and thrift that we find in smaller plantations, especially those under sheds.

* It so happened, strangely enough, that, during the week following my Sunday talk, the young man who swore at the stoneboat came to help me. I did not send for him, but a neighbor for whom he was working sent him. He began to swear before my four boys. I remonstrated; but a little later I saw him offering one of the boys some tobacco, telling him he would "never be a man" until he could use tobacco. Do you see, boys, how these things go together? It seems as if each one of you must sooner or later make a choice—a choice either for righteousness or iniquity. Which shall it be? Almost every thing depends on the way you start out. May God help you to choose rightly.

My first stop on my return was at Fort Pierce, the home of Harry Hill, editor of the *American Bee-Keeper*. Friend Hill has been so far away from the editors of the other bee-journals that we have not become acquainted with him, for, as a matter of course, he can not well attend our annual conventions. I found him at work at his hives, and greatly enjoyed talking over the bee-journals, our special industry, and other things. When I got off at Fort Pierce I inquired at the hotel for a bee-keeper named Perry Saunders. The lady at the desk said she did not know any *man* by that name, but there was a little boy there by that name who went to school. A juvenile near by replied, "Oh! that's him, ma. He's got bees and rears queens, and makes lots of money."

When I found friend Hill in his bee-hive workshop, Perry Saunders was also present. When I was introduced, friend Hill remarked that he wouldn't wonder if that boy was the youngest subscriber to GLEANINGS, out of the whole 12,000. Sure enough, he was a little fellow in short pants, but full of enthusiasm. He subscribed for GLEANINGS with his own money, has bought the A B C book, and read it over and over. Just when I met him he was directing his father and a neighbor how to cut the boards for some hives. It was amusing indeed to see this little fellow giving directions to a couple of gray-haired men. Perry had, last season, half a dozen colonies of bees. He has raised queens successfully, and produced quite a crop of honey, and is full of enthusiasm in planning for a larger apiary and more extensive operations during the coming year.

Mr. Hill (like a good many other bee-keepers) is quite an expert in photography, and he has sent us some views of branches of orange-trees, with the foliage and the fruit in natural colors. I believe it was his own coloring. The world has not yet got up to the point of giving us a picture in natural colors that can be printed in bee-journals. When it does, friend Hill will have something rare and fine to show us.

Gifford Station was my next point, and I was pained to find my old friend Harry Gifford suffering from the effects of a gunshot wound. A brief notice of this sad affair is given on page 294. Fortunately, however, friend Gifford was recovering rapidly, expecting to be around again in a few days. He has done quite a little in the way of Florida fruits during the past six years, and is also getting to be quite an extensive bee-keeper, having about half a dozen out-apiaries. Like most bee-keepers he has some peculiar notions of his own. For instance, he says queens should always be sent by mail just as soon as possible after mating, and *before* they begin to lay. He firmly believes that a queen is more or less injured by taking her out of the hive when she is doing her best at egg-laying during the middle of the season. To prove his position he purchased, during the season of 1900, 200 queens of H. G. Quirin, of Parkertown, Ohio. The understanding was that these queens were all to be shipped as nearly as possible before

they began to lay; and he says they gave him better results—that is, considering such a long trip from Ohio to Florida, and that he was satisfied that that is the right way to send queens. This makes a pretty heavy testimonial in favor of my suggestion of several years ago, that all queens should be shipped to purchasers at a low price before they are tested, letting each individual do his own testing.

Friend Gifford furnishes us a fact in bee culture that, so far as I know, has never been recorded before. When saw-palmetto was in full bloom, his whole apiary started off *toward midnight* by moonlight, and actually did a large business for several hours in gathering honey. I forgot to ask him at the time if they labored during the day as usual. There has been quite a little speculation as to whether bees sleep or not. In this case they actually worked both night and day. Perhaps the moon did not come out in full splendor until toward midnight. At any rate, he says they stopped work at dusk as usual; but along toward midnight on two separate occasions, when the honey-yield was very large, the weather sufficiently warm, and the moonlight at its very highest splendor, they actually stored honey by night as well as by day.

The little postmistress that I mentioned on my trip six years ago is still postmistress; but now she is a blooming maiden of 18. I did not find her quite as sociable and communicative at 18 as she was at 12; but she not only knows how to manage Uncle Samuel's business, but she makes such beautiful nice biscuits that they have a reputation in the neighborhood under the name of "Ruby" biscuit. With fresh fish, such as only the Florida homes can furnish, we had a little "spread" that was fit for a king. Her brother, his wife, and Ruby, made up the company. If I am correct, it was here I met another of my happy surprises. Some beautiful-looking sauce was dished out and passed around. It looked a little like cranberries. When I tasted it I uttered an exclamation of surprise and delight.

"Why, what is this new and delicious fruit?"

"Well, Mr. Root, since you seem to like it, suppose you *guess* what sort of fruit it is."

"Why, it looks a little like cranberries; but there are no seeds, and it is certainly more delicate and enticing than cranberries or *any other berry* I ever tasted in my life."

"Mr. Root, it is not a fruit at all, and it is not a berry at all."

You may be sure my curiosity was aroused when they told me it was what is called Jamaica sorrel. It is a plant that is known in catalogs as "Roselle." It is quite common in Florida. The part that is used as a sauce has a sort of fleshy husk inclosing the immature seeds. We gathered some seeds, and I sent them home and had them planted in the greenhouse; but at the present writing only two of them have come up. I feel sure it can be grown all through the North by starting the seeds in a greenhouse (exactly as we do tomatoes, peppers, etc.), and possibly by planting the seeds now in the open ground.



SOMETHING ABOUT THE FLOWERS IN THAT
LITTLE GREENHOUSE.

Quite a few have been wondering if I was not going to have something more to say about "posies." Well, dear friends, I have had a lot in mind to say; but this world is so exceedingly full of wonderful things our journal

with mixed colors (unnamed) for only 20 cts. each, or 3 for 50 cts. I sent for three of them, and along in March they began to bloom. I had no idea these little bits of plants would blossom the first year; but I was greatly surprised—yes, agreeably astonished—to see what even one little azalea could do. I carried one of them all around the factory, and it made about as much excitement (just because it was so little) as the big one did. I asked Ernest to take a photo of it as it stood in the greenhouse in one of the beds. Below is the picture.



A 20-CENT AZALEA, FROM JOHN LEWIS CHILDS, FLORAL PARK, N. Y.

is not half large enough to even hint at them all. A year or more ago I told you about some azaleas growing in pots that I carried around the factory, and made such a breeze among our people, and especially among the girls and women. The azaleas I then mentioned cost about 50 cts. each. They generally sell, in full bloom, for 75 cts. up to \$1.00. Well, last fall, when I got John Lewis Childs' catalog, I was pleased to note that he had azaleas as low as 25 cts. each; yes, and some

Ernest threw his handkerchief over some of the other plants so as to make a background for the azalea. The pot is a three-inch one. The plant has very little foliage, as you will see; and what there is, is almost hidden by the immense flowers. I think there were four on the one little plant. They are larger than a good-sized rose. The delicate coloring and penciling, it seems to me, outrivals the most beautiful rose, and they remain in bloom from ten days to two weeks. I do not know of a

more beautiful plant in the whole floral kingdom than a penciled azalea. It looks as if one had taken a delicate brush, and, with more gorgeous colors than any painter ever mixed, wrought forms of tantalizing beauty. Yes, I could honestly say to the children that this kind of painting and coloring was God's own handiwork. I asked Ernest to take a picture of the azalea alone, but he took in also a magnificent brughmançæ; and after I had gone he turned his apparatus on the greenhouse in general, and here it is.

The picture shows you how cheaply the beds and paths are constructed. At the left, overhead, you get a glimpse of the annex we put on last winter. Right below the annex there is a golden-leaved salvia that has been

are six or seven kinds, and all different. Over in another bed, off to the right, not shown, we have a lemon-tree with half a dozen nice lemons on it. A guava from Florida is just full of bloom. It bore one nice fruit that Mrs. Root sampled when I was in Florida. She said it was splendid. In this bed are a great lot of pelargoniums. Our friend Pike, of St. Charles, Ill., sent us an assorted lot of rooted cuttings about a year ago. We planted them outdoors, and got a lot of strong vigorous plants a foot high or more. They were put in the greenhouse last fall, and just grew and grew, without showing any signs of bloom until along in April. Then they just outdid themselves in the multitude of blossoms. They are not only of all colors of the



A GLIMPSE INSIDE OF THE LITTLE GREENHOUSE IN MARCH.

bearing scarlet blossoms, and loads of them, for one whole year continuously, and each blossom contains quite a little drop of honey. Beyond the salvia there are tomatoes. Away over in the corner, at the end of the path, are roses. Right near the roses you can get a glimpse of one of the tiles where we let in water for sub-irrigation. The beds are all watered in the same way. Just beyond the brughmançæ there is a clematis that has been bearing beautiful clusters of white flowers all winter. At the right of the big plant, just under one of the great blossoms (nearly if not quite a foot long), there is a bed of fuchsias. These fuchsias have been blooming and blooming all through the latter part of the winter. There

are rainbow, but many of them are spotted, speckled, splotched, and penciled, with such a wilderness of beauty as to almost be "wilder" one.

In the cut showing the azalea, at the right, you can get a faint glimpse of some of the large pelargonium-blossoms. The penciling is so faint, however, that it does not show in the half-tone, although it can be seen very plainly in the photo. They grew in very rich soil with sub-irrigation, and the plant made such a rank growth I presume the blossoms are unusually large. Some single blossoms are an inch and a half across.

The front of the greenhouse is now raised up. When the women-folks go along the

stone walk in front, it is just fun to hear their exclamations at such a variety of new and startling "Lady Washington geraniums" as a good many persist in calling them.

Do you wish to know what is in the annex? Well, we have been so busy that we could not attend to it, and a lot of things came up themselves. Last year we had Burpee's dwarf nasturtiums, and they had their own way, and went to seed. This year the "stertians" came up like weeds all over these beds. The boys pulled up a great lot of them, but some of them escaped long enough to get into bloom, and then they were so pretty the boys hadn't the heart to pull them. Well, they just clambered all over the annex, and now it is just a bank of nasturtium-blossoms.

Now, isn't this enough about the posies for one issue? But it isn't all. I will, however, tell the rest of it in another column, that is, unless the boss printer says he can not possibly find room for any more of my talk about chickens, posies, and gardening.

TRAP-LANTERNS, ETC.—A WARNING.

Just now there are several vendors of patent moth-traps (for orchards) trying to make out that their trap will take the place of spraying. They even go so far as to tell how inefficient spraying is, how it kills domestic animals, etc., in order that they may better show up the advantages of their trap. I came pretty near saying worthless trap, but it does destroy some insects; but it is just as likely to destroy insects that are a benefit to the farmer as the other kind. Unfortunately these fellows have got one experiment station to give a sort of recommend. See the following, which we clip from the *Country Gentleman*:

Information has just come to me from a fellow-entomologist to the effect that a certain manufacturer of trap-lanterns secured his partial indorsement of his apparatus in a letter which was properly quoted at first; but now, I am informed, the restrictive phrases have been omitted, and the professor is made to appear as though recommending the device for all insects. I wish to state that money invested in trap-lanterns of various forms, including those which have attractive sweet or other fluids, phosphorescent paints and the like, to make them more effective, is a good investment only in a very few special cases; and before buying them, the advice of an entomologist should always be sought. Some of these trap-lanterns catch many insects, most of which, unfortunately, are of comparatively little economic importance, and the trouble is to get a device which will capture large numbers of the destructive species. Extensive experiments at Cornell University have shown that the trap-lantern can not be recommended as a practical means of controlling many insect pests. Beneficial as well as well as injurious insects are captured, and some pests, like the codling moth, are taken in very small numbers. Farmers are, therefore, advised to go very slow in buying trap-lanterns.

E. P. FELT,
N. Y. State Entomologist.

Prof. Felt is good authority, and he is, without question, right about the matter.

Humbugs and Swindles.

On page 410, May 15, 1900, we showed up Prof. Weltmer, of Nevada, Mo., and mentioned that the postal authorities had decided him to be a fraud, and refused to deliver mail to him any longer. I have also since mentioned that he simply started business again under

the name of Joseph H. Kelly, and kept right on. I forwarded several bundles of his advertising matter* to the Postoffice Department, at Washington, and now we notice by the Henry Co. (Mo.) *Democrat*, of May 3, that both parties are now arrested as frauds. See the following, which we take from the above periodical:

MAGNETIC HEALERS FINED.

Kansas City, Mo., April 27.—Stephen A. Weltmer and Joseph H. Kelly, who operated the "American School of Magnetic Healing," at Nevada, Mo., were fined \$1500 each in the federal court. The charge was using the mails for the purpose of fraud, by promising for a consideration to cure persons of poverty and all known bodily ills through absent treatment and mental suggestion.

ARE FINED \$1500 EACH; JUDGE PHILIPS MAKES IT LIGHT ON WELTMER AND KELLY.

Prof. S. A. Weltmer and Joseph H. Kelly, the Nevada "magnetic healers," who pleaded guilty in the United States Court at Kansas City to nine counts of using the mails for fraudulent purposes, were, on the 26th inst., fined \$1500 each by Judge Philips. The maximum punishment was \$5000 fine and a year's imprisonment. The Judge, it will be noticed, made the punishment very light, but the lesson will no doubt cause the "healers" to quit fishing for gullible people in this part of the country.

THEY PLEADED GUILTY; WELTMER AND KELLY THE MAGNETIC HEALERS OF NEVADA ADMIT THE GOVERNMENT'S CHARGES.

The trial of Weltmer and Kelly, the Nevada Magnetic Healers, took place in the United States court in Kansas City this week under the charge of obtaining money through the mail by fraudulent pretenses, to heal by absent treatment, etc.

They plead guilty Tuesday on nine counts, charging violation of the postal laws, and threw themselves on the mercy of the court. Sentence was deferred. It will probably be a heavy fine.

Weltmer and Kelly were doing a business of \$250,000 a year, when the postoffice department issued a fraud order against them, because they advertised to cure by "absent treatment." Their business was so enormous that it raised the Nevada postoffice to first class and made it the best paying office for a town of the size in the United States. Their mail, held up for three weeks, was found to contain \$30,000.

United States Senator Burton, of Kansas, who appeared for the healers, admitted that they had violated the law, but declared their motives were good. "They are on a par with Christian Scientists and divine healers, who cure by suggesting health instead of disease," he said. Senator Burton pleaded for leniency for his clients, on the further ground that the advertisements on which they were convicted were written by a St. Louis agency, without suggestion by Weltmer or Kelly, which, to say the least, smacks of downright prevarication, and is too contemptible to deceive any one. Such talk shows a disposition to crawl through a very small hole.

It seems to me this is a very light sentence. What is \$1500 to a fraudulent institution that is swindling people to the extent of \$250,000 a year? It reminds me of the way the saloon-keepers are fined. They simply laugh at the matter, hand over the cash, and go right on doing business. I hope, however, the United States courts will give these fellows to understand that they are no longer to be trifled with.

* Perhaps I might explain that I corresponded with the "American Institute of Science" at Nevada, Mo., in regard to terms for being taught "magnetic healing." At first they wanted quite a sum of money for teaching this wonderful art. After a little time, as I did not reply (I sent them no money), they offered to come down a half, owing to some peculiar circumstances. Later still there came another proposition to the effect that, if I would send them the money before a certain date, they would make a still further and most wonderful concession, telling me I could easily make from \$5 to \$25 a day, etc. Many of you probably know the lingo.



NO CHANGE IN CLASSIFICATION OF COMB HONEY.

We learn just as we go to press that the Western Classification Committee, at their recent meeting in Monterey, Cal., after full consideration, made no change in the classification of comb honey.

BEESWAX MORE PLENTIFUL.

As we have a good supply of beeswax, and it is being offered more freely, we mark down the price we pay one cent a pound, and will likely reduce further by the middle of June. Price we pay now will be 27 cents cash, or 29 in trade for average wax delivered here.

NEW ROOT ZINC.

We have been making new dies and punches for our Root zinc-perforating machine during the past few months, and are just starting them in operation. The perforations have round end holes like the Tinker zinc, and the holes are a little longer than the Tinker and almost as close together, so that our new Root zinc will be just as accurate and perfect as Tinker zinc. Send for sample if interested.

GERMAN WAX-PRESS.

We are bringing out a new wax-extractor which we shall call the German wax-press. We hope to have an illustration to present in next issue. It is very strongly made of No. 20 galvanized iron, 16 inches diameter, 24 inches high, with heavy wire-cloth basket, holding about a bushel of combs, and with galvanized cast-iron cover, plunger, and basket-support. Price for introduction, \$7.50.

HAMMOND BEE-BRUSHES.

On another page we illustrate a new bee-brush manufactured by a bee-keeper in Southern Ohio, who is also a brush maker. We have for the present three grades of material in these brushes—tampico at 50c.; horsetail hair at 65c.; Russian bristle at 80c. By mail, 10c each extra for packing and postage. After testing them this season we shall no doubt decide upon one grade only. The hair or bristle brushes will probably be much more desirable than the tampico.

Special Notices by A. I. Root.

JAMAICA SORREL—THE NEW FRUIT.

We have just received ½ lb of good seed from a seedhouse in Florida, and are going to give it a good test; if you want to help us make the test, send for a five-cent package. See p. 484.

BOOKS ON GINSENG CULTURE, ETC.

If any of our readers sent \$1.00 for the book on ginseng culture, advertised in our last issue, we will make good what they are out of pocket if the advertiser refuses to take the book and refund. The advertisement would never have been received had we seen the "book" before inserting it.

NICE SEED POTATOES TO BE GIVEN AWAY TO THE READERS OF GLEANINGS.

We still have about 300 bushels more than we shall need to plant, to be given away to our patrons, as described on page 452 of our last issue. The greater part of them are Early Ohio, celebrated Red River stock. Our own potatoes, most of them, will be planted during this month of June; and we rather prefer the latter part of June to the fore part. We still have every thing in the table except Early Trumbull, New Queen, Lee's Favorite, Twentieth Century, and New Craig.

EGG FOOD! The kind that tones and keeps up the hen so that she simply must lay. LEY'S POULTRY CONDITION POWDER puts good red blood into poultry veins; kills all disease germs; tones and nourishes fowls—big and little get all there is in the food when fed in conjunction with it. Price 25c pkg.; 5 for \$1. Ley's Thoroughbred Minorca eggs, \$1 for 10. Thoroughbred Belgian Hares, Geo. J. Ley, Florence, California.



Tar Heel Apiaries!

THE BEST BEES KNOWN
IN : AMERICA : TO-DAY.

American Albino Italians.

They have no superiors and few equals, as hundreds of bee-keepers testify. Untested queens, \$1.00; 6-85 00. Tested queens, \$2.00 each. Choice breeders, \$5.00 to \$10.00. Nuclei, 75c per L. frame—add price of queen 200 3-frame (L.) nuclei for sale in May and June. Safe delivery insured always.

Swinson & Boardman, Box 358, Macon, Ga.

FRUIT-CANNING made easy and sure by using Coddington's Self-melting Self-sealing Wax Strings. Very convenient and economical. Inquire of your dealer or send me his name and 45c in stamps for 100 strings, by mail. Mention this paper. C. C. FOUTS, Middletown, Ohio.

For Sale. Choice prolific Italian queens—granddaughters of a queen of which Doolittle wrote me, "100 will not buy her"—mated with drones of Hutchinson's Superior Long-tongue Strain. Warranted queens, 75c; tested, \$1.00 and up. Good references, and satisfaction guaranteed.
EARL Y. SAFFORD, Salem, N. Y.

FOR SALE.—20 strong colonies of long-tongued strictly pure Italians with tested queens, and in new light chaff eight-frame hives, combs in Hoffman wired frames. Price \$6.50 including hive; \$5 per colony without hive, or five colonies at \$20.
W. C. KISTLER, Rutherford, N. J.

FOR SALE CHEAP.—California bee ranch and 500 colonies of bees. Write for particulars, price, and easy terms. I. A. KING, Almond, San Diego Co., Cal.

WANTED.—A purchaser for a second-hand ten-inch Root comb-foundation mill in good condition. Price \$10. Also for sale about 50 second-hand hives, 10 L. frame. Also many other fixtures for an apiary.
W. H. BIRNEY, Nelson, N. Y.

Wants and Exchange.

WANTED.—To exchange 50M polished sections (No. 1, nice) for beeswax, at a bargain.
W. H. NORTON, Skowhegan, Me.

WANTED.—To exchange two ladies' bicycles—but little used and high grade—for offers.
J. W. PROVAN, Traer, Iowa.

WANTED.—To exchange first-class bee-keeping supplies for 2000 lbs. beeswax. Will allow 32c for nice wax.
W. H. NORTON, Skowhegan, Me.

WANTED.—To exchange a 100-chick hot-air brooder—in good condition, used only once—for three colonies of Italian bees in 8-frame dovetailed hive, on wire Hoffman frames. Also 350-egg incubator for Cowan extractor.
M. M. WYGANT,
18 Bergen St., Hackensack, New Jersey.

WANTED.—To exchange Japanese buckwheat at 80c per bu.—sacks, 15c extra—for bees in shipping-boxes, if not too far away.
ALBERT L. MARTIN, Leonardsburg, Del. Co., O.

WANTED.—To exchange a \$50 Columbia bicycle that has not been ridden 100 miles; never been rained on; out of the factory only about one year. I will sell it or exchange for clover honey, or two-frame Cowan extractor and new Dovetailed hives, to the value of \$35.
A. H. KANAGY, Milroy, Pa.

WANTED.—A young man or married man, to work with 50 to 100 colonies of bees, and work on fruit-farm the rest of his time. Good position to right man. Want one that likes to work with bees; don't care if he doesn't know so much about them, as I have my own method. Good house and plenty of fruit free to married man.
J. A. TAYLOR, Wynnewood, Ind. Ter.

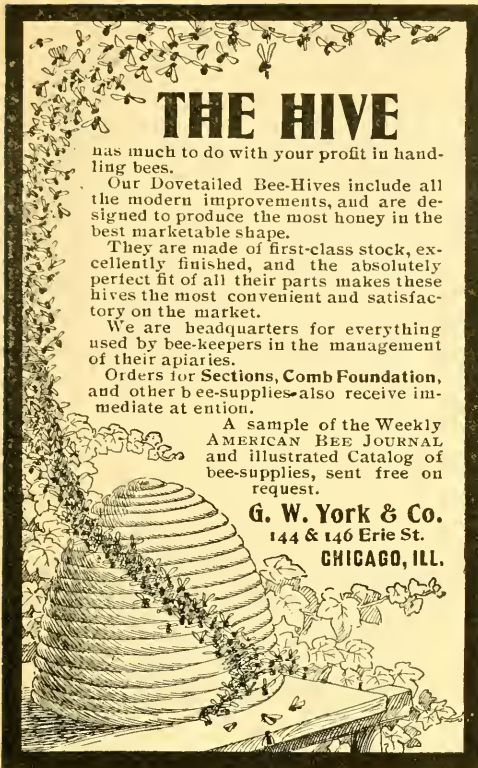

THE HIVE

has much to do with your profit in handling bees.

Our Dovetailed Bee-Hives include all the modern improvements, and are designed to produce the most honey in the best marketable shape.

They are made of first-class stock, excellently finished, and the absolutely perfect fit of all their parts makes these hives the most convenient and satisfactory on the market.

We are headquarters for everything used by bee-keepers in the management of their apiaries.

Orders for Sections, Comb Foundation, and other bee-supplies also receive immediate attention.

A sample of the Weekly AMERICAN BEE JOURNAL and illustrated Catalog of bee-supplies, sent free on request.

G. W. York & Co.
144 & 146 Erie St.
CHICAGO, ILL.

Long-tongued Golden.

According to E. R. Root's measurements our breeders' bees show a reach of 20 and 21-hundredths inches. We are booking orders for breeders, to be delivered in August and September. These queens will produce bees showing 95 per cent (or better) straight 5-banders, and have a guaranteed tongue-reach of 19-hundredths or better; all queens large and prolific. Price \$5.00; orders filled in rotation. Untested ones, this stock, ready June 1st, each 75c; 6 for \$4.25; 12 for \$8.00. Select warranted, \$1.00. Tested, \$1.25. Select tested, \$2.00. Also have a fine stock of three-banded Italians at the same price. Give our stock a trial. Our motto—good queens and prompt attention to business.

O. P. Hyde & Son, Hutto, Texas.

Your Order for Queens

—Tested and untested—will be promptly filled by return mail. Our strain of Italians is unsurpassed as honey-gatherers. Every queen guaranteed. Choice tested queens, \$1.00 each; \$12.00 per dozen; choice untested, 75c; \$8.00 per dozen. Send for price list. Address

J. W. K. Shaw & Co., Loreauville, La.

1901====Golden Italian Queens====1901

Untested—April, May, and June—\$1.00 each, or \$11.00 per dozen; after June, 50c each, or \$5.00 per dozen. Tested queens, half more. Breeding queens \$3.00 and \$4.00 each. W. P. Rock eggs from 94-scoring birds at \$1.00 per 15. Cocks, \$1.00 each.

GEORGE W. COOK, - SPRING HILL, KANSAS.

FOR SALE. One 10 h.-p. engine and boiler (up-right boiler), one 18-inch planer, one Root saw-table, 30 ft. line-shafting, hanger pulleys, and belting. Will take \$250. **J. W. Bittenbender, Knoxville, Ia.**



STEEL WHEELS

for your **FARM WAGONS**

any size wanted, any width of tire. Hubs to fit any axle. No blacksmith's bills to pay. No tires to reset. Fit your old wagon with low steel wheels with wide tires at low price. Our catalogue tells you how to do it. Address

EMPIRE MFG. CO., Quincy, Ill.

\$5 BATH CABINET FOR \$2.50.



Every one can afford one now. For Turkish, Hot Air and Vapor Baths, **Opens the millions of pores**, draws out the poisons which cause disease and keeps the body in a clean and healthy state, during the hot summer weather. The Cabinet is 36 in. sq., by 42 in. in height. Folding frame covered with specially prepared white canvas, giving same results as those selling for from \$5 to \$10. Send \$2.50 for sample, and be convinced. Agents wanted. Easy to sell. Big income for hustlers.

DENNIS & LAWSON, NORWALK, O.

[D. & L. are reliable.—A. I. R. CO.] Dept. Z.

U - NEED - A GLOSSOMETER.

It measures the actual reach of the tongue of a living bee to thousandths of an inch, also the capacity of the honey-sac; accurate, durable, practical. No rule or magnifying-glass needed. Satisfaction guaranteed. Price \$1.00 postpaid. Send for *Queen Circular*, and learn how to get a glossometer free. High-grade queens of the Sweetheart and other strains at reasonable prices.

A. J. WRIGHT, Bradford, Steuben Co., New York.

Minnesota Bee-keepers' Supply Mfg. Co.,
Manufacturers of
Bee-hives, Sections, Shipping-cases, and
Everything Used by Bee-keepers.

Orders filled promptly. We have the best shipping facilities in the world. You will save money by sending for our price list. Address

Minnesota Bee-keepers' Supply Mfg. Co.,
Nicollet Island Power Building, Minneapolis, Minn.

Albino Queens.

If you want the most prolific queens; if you want the gentlest bees; if you want the best honey-gatherers you ever saw, try my Albinos. Untested queens, \$1.00; tested, \$1.50.

J. D. GIVENS, Lisbon, Texas.

Take Notice.

We are headquarters for the Albino bees—the best in the world. If you are looking for the bee that will gather the most honey, and the gentlest in handling, buy the Albino. We can furnish others, but orders stand 50 to 1 in favor of the Albino. I manufacture and furnish supplies generally. Send for prices.

S. VALENTINE, Hagerstown, Md.

Queens.

I have 150 fine tested three-banded Italian queens for sale. They are last August queens, and their bees are fine honey-gatherers. Tested, \$1.25; select tested, \$1.50; breeders, \$2.00; untested, 75c each, or \$8.00 per doz. I guarantee safe arrival, and satisfaction on every queen. I have been a queen-breeder for 12 years, and know what good queens are.

J. W. Taylor, Ozan, Ark.

FOR SALE CHEAP.—100 nearly new second-hand Hilton chaff-hives. For particulars inquire of **L. C. WOODMAN, Grand Rapids, Mich.**



SPLIT HICKORY VEHICLES

are made by the best workmen of the highest grade material obtainable. They have scores of little things about them which add to their beauty, safety, comfort and durability. We sell direct to you from the factory and

SHIP ON APPROVAL.

If it's not equal to any vehicle you ever saw costing $\frac{1}{2}$ more, don't keep it. You run no risk in buying of us. We finish and trim to suit your taste. This is our leather quarter top light buggy, with leather trimmings, full silver mountings, screw rimwheels, long distance axles, braced and leather shafts. Material first-class throughout. Price, \$48.50.

Send for full catalog of Split Hickory Vehicles and Oak Tanned Harness at factory prices.

OHIO CARRIAGE MFG. CO.,
27 W. Broad St., Columbus, Ohio.



New Smith Premiers Nos. 5 and 6.

The No. 6 takes paper $18\frac{1}{2}$ inches wide and writes lines 16 inches long. The No. 5 takes paper 11 inches wide and writes lines $9\frac{1}{2}$ inches long. These new machines in essential mechanical principles are the same as Models Nos. 2, 3 and 4—unequaled.

Write for Printed Matter Free.

The Smith Premier
Typewriter Co.

158 Prospect Street, Cleveland, Ohio.

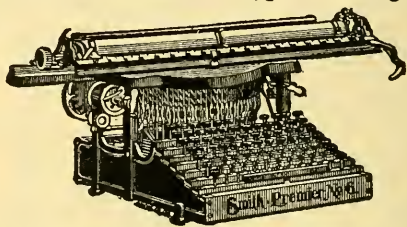

The Power Question

—for farm use, dairies, creameries, cheese factories—anything requiring light power, is best settled by buying one of these

LEFFEL ENGINES.

They are made in both horizontal and upright pattern, with engine attached to boilers. Being very simple and direct in construction they are economic of fuel and great developers of power. Best for cutting and grinding feed, sawing wood, pumping water, separating cream, churning, &c. Made of the best material throughout they are durable and long lived.

Send stamp for our Book on Engines and Power.

JAMES LEFFEL & CO., Box 89, Springfield, O.

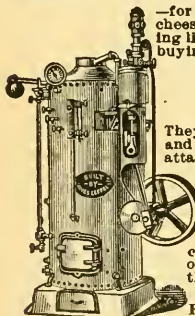

Fruit Packages of All Kinds.

— ALSO —

BEE-KEEPERS' SUPPLIES. . .

Order your supplies now before the busy season catches you. Price list free. Address

BERLIN FRUIT-BOX COMPANY,
Berlin Heights, - - Erie County, Ohio.

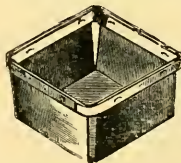

Mr. A. I. Root's Writings

of Grand Traverse territory and Leelanau Co. are descriptive of Michigan's most beautiful section reached most conveniently via the

PERE MARQUETTE R. R.

For pamphlets of Michigan farm lands and the fruit belt, address W. C. Tousey, D. P. A. Toledo, Ohio.

South Dakota Farms

is the title of an illustrated booklet issued by the Chicago, Milwaukee and St. Paul Railway, descriptive of the country between Aberdeen and the Missouri River, a section heretofore unprovided with railway facilities but which is now reached by a new line of the Chicago, Milwaukee & St. Paul R'y. Everyone contemplating a change of location will be interested in the information contained in it, and a copy may be had by sending a two-cent stamp to F. A. Miller, General Passenger Agent, Chicago, Ill.



Belgian Hares

I have some fine hares for sale at reasonable prices.

J F. Moore, : Tiffin, Ohio.

BELGIAN HARES!

Either domestic or imported, of any grade from a pedigreed prize-winner to a common rabbit, at prices that are right. Write

GEO. M. TEETER, PENNVILLE, IND.

To make cows pay, use Sharples Cream Separators. Book "Business Dairying" & cat. 288 free. W. Chester, Pa.

SPRAYING

with our new patent
Kerosene Sprayers
 is simple indeed. Kerosene emulsion
 made while pumping. 12 varieties
 sprayers, Bordeaux and Vermorel
 Nozzles, the "World's Best."
THE DEMING CO., SALEM, O.
 Western Agents, Henion & Hubbell,
 Chicago. Catalogue and formulas free.



PAGE

IF YOU NEED

a Portable Fence, try the PAGE. It can be taken down and restretched any number of times.

Box S. Page W. W. Fence Co., Adrian, Mich.

THE WHEEL OF TIME

for all time is the
Metal Wheel.

We make them in all sizes and varieties, **TO FIT ANY AXLE.** Any height, any width of tire desired. Our wheels are either direct or stagger-spoke. Can **FIT YOUR WAGON** perfectly without change.

NO BREAKING DOWN.
 No drying out. No resetting tires. Cheap because they endure. Send for catalogue and prices. Free upon request.

Electric Wheel Co.
 Box 95 Quincy, Ills.



HORSE-HIGH!

... BULL-STRONG ...

With our **Duplex Automatic Ball Bearing Woven Wire Fence Machine**, any farmer can make 100 styles, and from **50 to 70 rods a day** of the best and most practical fence on earth at a cost for the wire to make it of from **20 to 30c. per rod**. We sell Ornamental Fence and Gates, Farm Fence and Gates, Plain, Barbed and **Coiled Spring Wire** direct to the farmer at wholesale prices. Catalogue free.

KITSELMAN BROS.
 Box D31. Muncie, Ind.

Plg-Tight

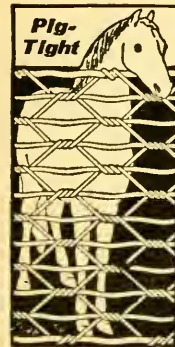

Belgian Hares

Fully pedigreed of the highest breeding, at prices that will suit. With every hare sold goes a full pedigree, register number, and score-card, scored by an official judge; and, when desired, does will be bred to one of our famous high-scoring bucks before shipment. Address **J. B. MASON,** Mangr. of The A. I. Root Co., Mechanic Falls, Me.



Union Combination Saw

For Ripping, Cross-cutting, Rabbering, Mitering, Grooving, Gaining, Boring, Scroll-sawing, Edge-moulding, Beading. Full line **FOOT** and **HAND POWER** machinery. Send for catalog A.

SENECA FALLS MFG. CO.
 44 Water St., Seneca F., N. Y.

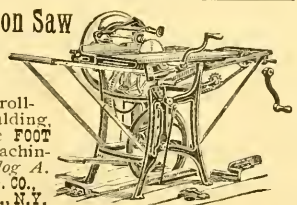

HOW TO BUY A \$100.00 SURREY

Follow Instructions Carefully

Take \$100. give your wife \$35.20 for pin money. Purchase a draft or money order for \$64.80 and mail it to us and we will ship you at once, our **No. 292 Extension Top Surrey**—the best Surrey ever sold anywhere for \$100. spot cash. The \$35.20 you give your wife represents the two extra profits you would have to pay in getting the job from a dealer. We **Sell Direct from our Factory** to you and give you **10 DAYS' TRIAL** before you pay for it.

Get our large illustrated catalogue of our full line of Vehicles and Harness. It is full of bargains. Send for it to-day. **IT IS FREE.**

Kalamazoo Carriage & Harness Co.
 Box 22, Kalamazoo, Mich.

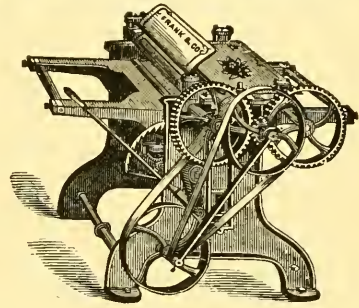
PLANERS

The above cut shows one of our small Planers, of which we make twelve different styles and sizes. Also large Planers, Band Saws, Buzz Planers, Moulders, Wood Lathes, and all kinds of

WOOD WORKING MACHINERY

Send for Catalogue.

The FRANK MACHINERY CO. BUFFALO, N. Y.

1200 FERRETS. All sizes; some trained; first-class stock. New price list free. **N. A. Knapp, Rochester, Lorain Co., Ohio.**

S. C. BROWN LECHORNS.
 I use well-striped breeding cocks. Eggs, \$1.00. Cockerels, \$1.00 and up. Also Italian bees. Circular free.
H. M. MOYER, SHANESVILLE, PA.

Career and Character of Abraham Lincoln.

An address by Joseph Choate, Ambassador to Great Britain, on the career and character of Abraham Lincoln—his early life—his early struggles with the world—his character as developed in the later years of his life and his administration, which placed his name so high on the world's roll of honor and fame, has been published by the Chicago, Milwaukee, & St. Paul Railway, and may be had by sending six (6) cents in postage to F. A. Miller, General Passenger Agent, Chicago, Ill.

The Breeding of Bees.

Also Something about the Review's Latest Correspondent.

Little has been done in the scientific breeding of bees, compared to what has been done in the breeding of other domestic stock. Some of us have bred our queens from those queens whose colonies have given the best results. So far, so good; but regarding the effects of inbreeding or outcrossing, most of us are woefully ignorant. This whole question of heredity, the laws of breeding, etc., is a broad one, but the Bee-keepers' Review is going to tackle it; and, by the way, it has been fortunate enough, at the very outset, to secure the services of a very competent man—Mr. Frederick B. Simpson, of Cuba, N. Y.

I must beg Mr. Simpson's pardon for what I am about to say, for praising him to his face, so to speak, but, as a new-comer in the field of apicultural literature, I feel that it is no more than fair to mention his qualifications for writing upon that subject.

Even though I am not particularly interested in stock, I have for years heard of the Simpson herd of Jerseys. For years it was headed by the famous bull, Mercury. Not only has Mr. Simpson been interested in the breeding of Jerseys, but trotting stock has occupied his attention; there being from 150 to 250 horses always on hand. There is a 1200-acre farm at New Hudson, 100 acres at Hunt's Point, New York City, and a mile track at the home farm at Cuba. It was amid such surroundings that the younger Simpson (the Review's correspondent) was brought up. He has the advantage of a college education, having taken a degree in civil engineering, which taught him

to do everything with great accuracy. He was always passionately fond of natural history, and studied it and biology quite extensively, being familiar with the writings of such men as Darwin and Spencer. He has an extensive collection of insects, many of which he had the pleasure of rearing from the egg to the perfect insect. During the past seven years he has devoted his entire time to the management of his father's trotting-horse interests—especially to the studying of breeding problems. By the way, although so much of a horseman, Mr. Simpson never bets, gambles, swears, nor indulges in liquor or tobacco, or other dissipations. Of late he has taken an interest in bees, and is going at it with enthusiasm, aided by his vast and varied knowledge on the subject of breeding, to try to solve some of the problems regarding the scientific breeding of bees. Space forbids my telling the start he has made, and the plans that he has for the future, but I feel sure that I have told enough to show that the four pages that he contributes to the June Review will be read with interest by every bee-keeper.

Neither must I forget our old friend Arthur C. Miller, who first stirred up this subject in the bee journals, and who has an article in the June Review on "Variations, how they are Started, Intensified, and Established."

The Review is \$1.00 a year; or I will send it for 1901, and a queen of the Superior Stock, for only \$2.00. Queen alone is \$1.50.

W. Z. Hutchinson, Flint, Michigan.

I. J. Stringham, 105 Park Place, New York City.

Keeps in stock a full line of modern appliances for bee-keepers.

SILK-FACED VEILS.

As good as any made; 35 cents postpaid. Catalog free. Full colonies Italian bees, \$6.00. Apiaries, Glen Cove, Long Island.

I. J. Stringham, 105 Park Place, New York City.

NOW READY!

64-PAGE CATALOG OF EVERY THING BEE-KEEPERS NEED. Illustrated and fully described. Especially valuable to beginners for the information it contains. Send your address on postal and get it now. Established 1884.

J. M. JENKINS, Wetumpka, Ala.

1881

PAGE & LYON MFG. CO.

1901

We manufacture a full line of the latest
BEE-SUPPLIES.

Our motto is, "Perfect Goods and Prompt Shipment."

Send for our new free illustrated catalog.

PAGE & LYON MFG. CO., New London, Wisconsin.

Marshfield Manufacturing Company.

Our specialty is making SECTIONS, and they are the best in the market. Wisconsin basswood is the right kind for them. We have a full line of BEE-SUPPLIES. Write for FREE illustrated catalog and price list.

Marshfield Manufacturing Company, Marshfield, Wisconsin.

NOW READY. LONG-TONGUED QUEENS!

YARD NO. 1.

By special arrangements with THE A. I. ROOT CO. to furnish them queens, I have secured their assistance in procuring the finest breeding queens that a thorough knowledge of the bees of the country and money can procure. Among them is a *select daughter of their \$200 queen that they refuse to quote me prices on.* This queen shows every superior quality of her mother. Her bees show an actual reach of 21-100 of an inch; are large, gentle, and beautiful to look upon.

MR. E. R. ROOT SAYS: "You have as fine bees as there are in the United States; and with a direct cross of their breeders you should be able to produce queens whose bees show a reach of 25-100 of an inch."

Send for descriptive price list.

Prices: Untested, 75c; 6, \$4.25; 12, \$8.00. Select untested, \$1.00; 6, \$5.00; 12, \$9.00. Tested, \$1.00; 6, \$6.00. Select tested, \$1.50.

Breeders, whose best bees show a reach of 21-100, with an average reach of 20-100, \$3.00. Breeders, whose best bees show 21-100, with an average of 20½-100, \$5.00. Breeders, whose best bees show 22-100, with an average of 21-100, \$7.00.

I have discovered 2 breeders whose best bees show 23-100; these are too good to sell; don't ask for prices.

Imported Italian stock. Apiary No. 2. Imported queens, daughters and grand-daughters. Have just received an importation direct from Italy which has been introduced into this apiary.

Golden, or 5-banded Italian. Apiary No. 3. Breeders, select tested, tested, untested queens.

W. O. VICTOR, WHARTON, TEXAS.
QUEEN SPECIALIST.

SUPPLIES FOR THE WEST!

The latest and best in the line of

BEE-KEEPERS' SUPPLIES

kept constantly on hand.

We carry a full line
and large stock of

The A. I. Root Co.'s Goods

which we sell here at
their factory prices.

ESTIMATES CHEERFULLY GIVEN.

CATALOG FREE.

ADDRESS

Jos. Nysewander, Des Moines, Iowa.
710, 712 W. GRAND AVE.

E. R. Root says: "One cage . . . showed a measurement of .18 and 1/100; cage B showed a measurement of 1/100 and cage D 1/100. . . . If tongue-reach means anything, they ought to be good workers." They are three strains and are good workers. Queen circular free.

W. A. H. Gilstrap, Grayson, Cal.

FOR SALE.—Italian bees and queens. Untested queens, \$1.00; tested, \$1.25; full colonies, \$4.00; nuclei, one frame with queen, \$1.50; two frames, \$2.00; 1 lb., \$1.00. MRS. A. A. SIMPSON, Swarts, Pa.

Standard - Bred Queens!

Acme of Perfection ; Not a Hybrid among Them.

Improved Strain Golden Italians.

World-wide reputation; 75c each; six for \$4.00.

Long-tongued 3-banded Italians.

Bred from stock whose tongues measured 25-hundredths inch. These are the red clover hustlers of America. \$1.00 each; six for \$5.00. Safe arrival guaranteed. Catalog on application. Headquarters for bee-keepers' supplies.

Fred W. Muth & Co., Cincinnati, Ohio.
South-west Corner Front and Walnut Streets.

Dittmer's Foundation !!!

Retail---Wholesale---Jobbing.

I use a PROCESS that produces EVERY ESSENTIAL necessary to make it the BEST and MOST desirable in all respects. My PROCESS and AUTOMATIC MACHINES are my own inventions, which enable me to SELL FOUNDATION, and WORK WAX INTO FOUNDATION FOR CASH, at prices that are the lowest. Catalog giving

FULL LINE OF SUPPLIES

with prices and samples, free on application. **BEEWAX WANTED.**

GUS. DITTMER, AUGUSTA, WIS.

Get the Best Queens.

Evansville, Ind., Sept. 27th, 1900.

The Jennie Atchley Co., Beeville, Bee Co., Texas:
Dear Friends:—It gives me great pleasure to forward you this unsolicited testimonial regarding the merits of Atchley queens. The three (3) dozen queens purchased of you have made an excellent record for themselves. Not an Atchley queen among the twenty colonies lost during the severe drouth in July. I have bought queens from many breeders; and although the present crop is exceedingly short, the tiers of supers show where the Atchley queens are, and speak volumes for your method of queen-rearing. I find the progeny to be very gentle, strong winged, uniformly marked, long-lived, of large size, and last, but not least, the best honey-gatherers I ever had. I shall want 100 more next season.

Yours fraternally, J. C. WALLENMEYER.

Prices for Queens.

Tested, \$1.50 each; \$8.00 for 6, or \$15.00 per dozen Untested, February, March, April, and May, \$1.00 each; \$5.00 per 6, or \$9.00 per dozen. Fine breeders, \$5.00 each. We have as good bees and queens as money and labor produce. We breed three-band Italians, Goldens, Carniolans, Cyprians, and Holy-Lands, in their purity, bred in separate yards 5 to 20 miles apart. If you want the best, call for Atchley's improved strains. Safe arrival guaranteed. Send for a sample copy of "The Southland Queen," the only southern bee-paper. \$1.00 per year. To new subscribers we offer as a premium a nice untested queen in order to get our paper introduced. Catalog, giving queen-rearing and management of apiaries for profit, FREE.

THE JENNIE ATCHLEY CO.,
Beeville, Bee Co., Texas.

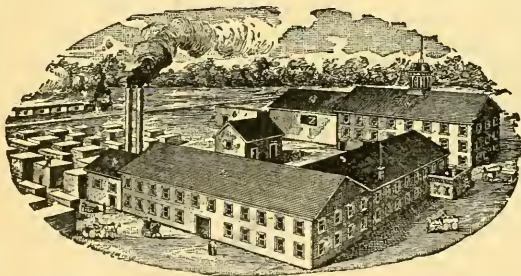

KRETCHMER M'F'G CO., Red Oak, Iowa.

BEE-SUPPLIES.

Best-equipped factory in the West; carry a large stock and greatest variety of every thing needed in the apiary, assuring BEST goods at the LOWEST prices, and prompt shipment. We want every bee-keeper to have our FREE ILLUSTRATED CATALOG, and read description of Alternating Hives, Ferguson Supers, etc. *Write at once for a catalog.*

— AGENCIES: —

Trester Supply Co., 108 So. 11th St., Lincoln, Nebraska; C. C. Richards, 1223 17th St., Denver, Col.

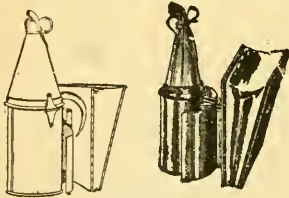

BINGHAM SMOKER.

Dear Sir:—Inclosed find \$1.75. Please send one brass smoke-engine. I have one already. It is the best smoker I ever used. Truly yours,
HENRY SCHMIDT, Hutto, Tex.

MADE TO ORDER

Bingham Brass Smokers.

Made of sheet brass, which does not rust or burn out; should last a lifetime. You need one, but they cost 25 cts. more than tin of the same size. The little open cut shows our brass hinge put on the three larger sizes. No wonder Bingham's four-inch smoke-engine goes without puffing, and does not drop inky drops. The perforated steel fire-grate has 381 holes to air the fuel and support the fire.

Heavy tin smoke-engine, 4-inch stove, per mail, \$1.50; 3½-inch; \$1.10; 3-inch, \$1.00; 2½-inch 90c; 2-inch, 65c. Bingham smokers are the originals, and have all the improvements, and have been the standard of excellence for 22 years. Only three larger ones brass.

T. F. Bingham, Farwell, Michigan.

Contents of this Number.

Adulator, German, Fined502
 Anti-saloon League at Buffalo.....530
 Ants, To Kill.....519
 Bees and Grapes.....518
 Bees and Grapes, Illustrated.....514
 Bees, Long-tongued, for the South.....520
 Bees, Uniting with Peppermint.....518
 Blue-head.....502
 Capping.....507
 Cell-compressor, Grace.....505
 Co onies, Value of Strong.....502
 Combs, Old, for Brood-rearing.....516
 Comb, Old, Thickness of.....508
 Compost-heap Fertilizer.....528
 Covers for Warm Climates.....507
 Drone Comb, Cost of.....521
 Editor in Florida.....526
 Flower-tubes, Deep.....521
 Foul Brood in Michigan.....520
 Foundation, Non-sagging, Without Wires.....509
 Foundation, To Fasten in Brood-frames.....509
 Ginseng Culture.....528
 Glucose for Bees a Poor Food.....518
 Heat and Honey-flow.....502
 Hives of Plaster of Paris.....502
 Hive-covers, Paper-covered.....501, 522
 Honey-plants in Texas.....520
 Honey, Comb or Extracted, which?.....510
 Honey, Straining Extracted.....502
 Load that Bees can Carry.....502
 Martin, Dr. G. M.....522
 Out-apiaries for Comb Honey.....523
 Pollen, Value of.....530
 Profanity in Packing-houses.....501
 Queens, Fertilizing in Confinement.....507
 Queens, Our Premium.....518
 Queen-nursery Cage, Swarthmore.....506
 Queen-rearing, Modern Methods.....507
 Queen-rearing, Swarthmore's System.....504
 Railroads and Liquor.....530
 Rambler and Ferris Extractor.....511
 Recipes, Secret, for Canning.....529
 Rhododendron.....528
 Sales of Honey, To Make.....517
 Separators, History of.....503
 Spraying, Time of.....502
 Swarming Problem Solved.....523
 Swarming with Deep Frames.....517
 Swarming, How Conducted.....515
 Tongues of Bees Measured in 1882.....502
 Tongues, Long, Value of.....508
 Trap Nest, Improved.....528
 Wax from Old Combs.....518
 Wax press, Economy of.....518
 Wings, Clipping.....522
 Workers, Fertile, Remedy for.....517

Honey Column.

GRADING-RULES.

FANCY.—All sections to be well filled, combs straight, firm ly attached to all four sides, the combs unsoiled by travel stain, or otherwise; all the cells sealed except an occasional cell, the outside surface of the wood well scraped of propolis.
 A No. 1.—All sections well filled except the row of cells next to the wood; combs straight; one-eighth part of comb surface soiled, or the entire surface slightly soiled; the outside surface of the wood well scraped of propolis.
 No. 1.—All sections well filled except the row of cells next to the wood; combs comparatively even; one-eighth part of comb surface soiled, or the entire surface slightly soiled.
 No. 2.—Three-fourths of the total surface must be filled and sealed.
 No. 3.—Must weigh at least half as much as a full-weight section.
 In addition to this the honey is to be classified according to color, using the terms white, amber, and dark; that is, there will be "Fancy White," "No. 1 Dark," etc.

CITY MARKETS.

CHICAGO.—Not any new comb honey has come to this market up to date hereof, but promises are being made for some before the month closes. A little good white comb still on sale which easily brings 16. Not any other kind here. Extracted very dull; practically no sales made. Beeswax firm at 30.

June 7. R. A. BURNETT & Co.,
 199 South Water St., Chicago, Ill.

ALBANY.—Honey market very quiet now, with no stock on hand and no call. It is between seasons now. Beeswax wanted at 30 cts. MACDOUGAL & Co.,
 June 9. Albany, N. Y.

DETROIT.—Strawberries are taking the attention, and very few sales of honey are made, but prices seem to keep up on good lots. Beeswax in fair demand at 27@28. M. H. HUNT & SON,
 June 8. Bell Branch, Mich.

NEW YORK.—There is some demand for white comb honey; and while the old stock is well cleaned up, new crop is beginning to arrive from the South, and receipts are sufficient to supply the demand. We quote fancy white, 15; No. 1, 13@14; No. 2 white, 12; amber, 11. Extracted honey is dull, and while there is more or less moving there seems to be no settled market for the time being. We quote white 7@7½; light amber, 6; dark, 5@5½; Southern, in barrels, 55@65 per gallon, according to quality. Beeswax firm at 28@29. HILDRETH & SEGELKEN,
 June 3. 265 Greenwich St., New York City.

BUFFALO.—Honey is selling very slow now. Fancy white comb, 14@15; A No. 1, 13@14; No. 1, 12@13; No. 2, 11@12; No. 3, 9@10; dark, 8@10. Extracted, white, 6@7; dark, 5@5½. Beeswax, 28@30.
 June 8. W. C. TOWNSEND, Buffalo, N. Y.

NEW YORK.—There is no comb honey to speak of on this market at present. Our prices for comb given you in last issue, represent nominal market prices at present. Extracted honey will be very much lower than last year. California and Florida are offering at very much lower prices. Beeswax is in good demand, and sells readily at 28.

FRANCIS H. LEGGETT & Co.,
 Franklin, West Broadway, and Varick Sts.,
 June 7. New York City.

DENVER.—Stock of comb honey all cleaned up now. Extracted, white, 6½@7½; beeswax, 22@25.
 THE COLORADO HONEY PRODUCERS' ASS'N,
 June 10. 1440 Market St., Denver, Col.

We will be in the market for honey the coming season in carloads and less than carloads, and would be glad to hear from producers everywhere which they will have to offer. SEAVEY & FLARSHHEIM,
 1318-1324 Union Avenue, Kansas City, Mo.

WANTED.—Comb and extracted honey. State price, kind, and quantity. R. A. BURNETT & Co.,
 163 South Water St., Chicago, Ill.

FOR SALE.—Extracted honey from alfalfa; 60-lb. cans at 7 cts., and smaller cans.
 D. S. JENKINS, Las Animas, Colo.

THE PRIZE WINNER.

My breeding queen has been awarded the \$25.00 prize offered by The A. I. Root Co. for the longest-tongue bees bred from their extracted queen, producing bees with a TONGUE REACH OF 2½ 100. This is not the whole length of tongue either. Do not fail to notice this. The demand is so heavy for daughters of my 2½-100 breeder that I have been obliged to make another large addition to my queen-rearing apiary in order to accommodate my increasing trade. Untested queens, \$1.00; six, \$5.00; dozen, \$9.00. Select untested, \$1.25; six, \$6.00; dozen, \$11.00. Safe arrival and satisfaction guaranteed. Descriptive circular sent free. Address

J. P. Moore, Lock box 1, Morgan, Pend. Co., Ky.

(Mr. J. P. Moore is entirely reliable.—A. I. R. Co.)

Albino Queens. If you want the most prolific queens; if you want the gentlest bees; if you want the best honey-gatherers you ever saw, try my Albinos. Untested queens, \$1.00; tested, \$1.50.
 J. D. GIVENS, Lisbon, Texas.

QUEENS! Fine, large, gentle, and prolific; long-tongue reach; either 3 or 5 banded; 75 cents each; six for \$4.25. Try them and be pleased.
 CHAS. H. THIES, Steeleville, Ill.

Notice!



THE A. I. ROOT CO.

wish to announce that they have from their branch at 10 Vine St., Philadelphia, Pa., direct steamboat connections and very low rates of freight to the following States: Massachusetts, Rhode Island, Connecticut, New Jersey, Delaware, North Carolina, South Carolina, Georgia, Florida. As this is a branch of the factory, prices are the same. Full colonies of Italian Bees, \$6.00. Special discount in large quantities.

C. B. Lewis Company,

Watertown, Wis., U. S. A.

FIVE * DIFFERENT * STYLES * OF * BEE-HIVES.

We will furnish you
with the finest bee-
keepers' supplies in
the World.



Send us your Orders
and we will fill 'em
promptly. Send for
Catalog.

LEWIS' • WHITE • POLISHED • SECTIONS • ARE • PERFECT.

BRANCH: G. B. Lewis Company, 19 South Alabama Street, Indianapolis, Indiana.
AGENCIES: L. C. Woodman, Grand Rapids, Michigan; Fred W. Muth & Co., Southwest Cor. Walnut & Front Sts., Cincinnati, Ohio; Fred Foulger & Sons, Ogden, Utah; Colorado Honey-producers' Association, Denver, Col.; Grand Junction Fruit-growers' Association, Grand Junction, Colorado; Robert Halley, Montrose, Colorado; Pierce Seed and Produce Company, Pueblo, Colorado; E. T. Abbott, St. Joseph, Missouri, Special Southwestern Agent.

Queens now Ready to Supply by Return Mail

STOCK which can not be **EXCELLED!!** Bred under the **SUPERSEDING CONDITION** of the colony. **Golden Italians**, the great honey-gatherers. They have no Superior and few Equals. Each 75 cts.; 6 for \$4.00. **Red-clover Bees**, the Long-tongue Italians, which left all **Records** behind in **Gathering Honey**, \$1.00 each; six for \$5.00. **Safe Arrival Guaranteed.** Headquarters for Bee-supplies. Root's Goods at Root's Prices.

C. H. W. Weber, 2146-2148 Central Av., Cincinnati, Ohio.

Successor to Chas. F. Muth.

Catalog Free: Send for Same.

A JOURNAL DEVOTED TO BEES AND HONEY AND HOME INTERESTS.

ILLUSTRATED SEMI-MONTHLY

Published by THE APOSTOLICAL CO. MEDINA, OHIO.

\$1.00 PER YEAR

VOL. XXIX.

JUNE 15, 1901.

No. 12.



In *Centralblatt* it is reported that, when honey is used as a lubricant in making foundation, bees take more readily to such foundation than to others.

HONOR to whom honor. *Le Progres Apicole* gives a picture of a cell-protector it says I invented. Sorry to say I wasn't smart enough to do so — it was our good friend N. D. West.

THE USE OF HONEY is recommended in *L'Abeille de l'Aisne*, for insomnia, when it proceeds from indigestion, and in some cases when it results from a wearied brain or muscular system.

TO REAR A DRONE costs .0141 oz. honey; and after it is reared it will consume .00635 oz. of honey daily.—*Bulletin Alsace-Lorraine*. [This is splitting hairs; but I believe it is not far from the truth.—ED.]

A BLUER SEASON up to June 3d I think I never knew — so cold that fire is needed yet, and many colonies have not held their own. A severe drouth is now on, which has obliged some to plow up their fields of oats. I made a mistake in taking bees out of the cellar too early. There is a big show for white clover, but a small show of bees to work it.

M. A. GILL may be right, page 467, in preferring starters to full combs for swarms, and certainly he is not alone in that view. But in my own practice, if I had the full combs I do not think I'd melt them up and use foundation. With only four combs in the brood-chamber and a lively queen, I should expect her to hold her own against the honey-storers. To give a whole hiveful of full combs would be another story.

"THE PERFECT HIVE-COVER for Colorado is yet to be made," quoth ye editor, page 468. I wonder how mine would work. It is much like the one described, with dead-air space, but covered with tin. Possibly paper would do as well. Out of the fifty in use for two years, not one has twisted, the only flat cover

I've ever tried of which that could be said. It is essential that the grain of the two thicknesses of boards shall run in opposite directions. That prevents twisting.

MANY A POUND of pollen is allowed to go to waste by those who would not think of wasting that amount of honey. Yet in some regions a pound of pollen may be worth as much as a pound of honey. Dr. Planta's analysis showed the pollen of the hazel to contain 5 per cent nitrogenous material, 8 per cent cane sugar, and 5 per cent starch.

BEEES IN WINTER, when short of stores, have the same appearance as bees that die of starvation in summer. But death is not real, only apparent. Bring them into a warm room; and if the apparent death has not been too long continued they revive. So starvation in winter, properly speaking, is not starvation, but death by freezing.—*German Journal*.

THE *Rocky Mountain Bee Journal* seems to have sprung out of the ground. Who knew they had a man out there by the name of Morehouse who could get up so beautiful a publication, and edit it like a veteran? Lovey, Rauchfuss, Thompson, and the other sages on the western frontier, know a lot about bee-keeping; and if that journal doesn't live it will be a wonder.

THE COLDER the weather in winter, the warmer the center of the cluster. That being the case, theory would lead us to expect brood-rearing earlier in cold than in warm winters. I've often wondered whether that theory was indorsed by practice. Now comes L. Stachelhausen, in *Southland Queen*, and says: "When I kept bees in a cold climate, more than 30 years ago, I observed in outdoor wintering that, the colder the winter, the earlier brood-rearing commenced."

"LEST WE FORGET," Editor Wathelet, of *Le Rucher Belge*, expresses the hope that the eminent editor of GLEANINGS will do his best to learn and make known Swarthmore's plan of wintering 75 queens in one colony. [Those Frenchmen are great fellows in the use of adjectives. "Eminent" doesn't fit me, and never will. However, I appreciate the motive back of it, and hereby ask Swarthmore to tell how he does it before he forgets it.—ED.]

I MOVE a reconsideration of a Straw and its footnote on page 80. Sylviac scouted the idea of a bee carrying a load weighing more than its own body. I suppose I should have said a load of *nectar*, and ask Sylviac's pardon for the omission. But the rest of the Straw shows that he meant only what was carried *in its sac*, and Sylviac is right to rail at the idea of a bee carrying in its sac enough nectar to weigh more than its own body. [I stand corrected with you.—ED.]

SCHACHINGER'S investigations showed that, when 20,000 bees stored daily $\frac{1}{2}$ lb. honey,
 30,000 " " " $1\frac{1}{2}$ " "
 40,000 " " " $\frac{1}{4}$ " "

It's well to repeat this occasionally, to show the importance of having strong colonies. In the stronger colony a larger *proportion* of the bees go afield, and a smaller proportion of the product is used for daily consumption. [This is according to observation and experience. I have seen many colonies on this, my western trip, but many—too many—are too weak to get the best results in honey.—ED.]

IS THE LARGE INTESTINE of a bee large enough to contain all the feces that will be stored in it during four months' confinement? There ought to be less undigested remains of a bee's food than of a man's food proportionally; but if it is counted the same, there will be $\frac{1}{15}$ residue or $7\frac{1}{2}$ mg. in four months. Prof. Fisher's many weighings of bees before and after a cleansing flight showed that the excrement discharged by each bee was 15.86 milligrams, showing that, under good conditions, a bee can stand not only four months but eight months without emptying itself. So says *Illustrierte Monats Blätter fuer Bienenzucht*.

ACCORDING to a writer in *L'Apiculteur*, bees in summer do not stay in the hive on certain days because it is too cold, but because there is no nectar to be had. He finds that the secretion of nectar has direct relation to the amount of light and heat. Some plants secrete nectar in partial shade; but the rule is, that nectar secretion ceases, even with partial shade—the brighter the sun and the stronger the heat, the more nectar. That agrees with my observation that the days when one is afraid of the sunstroke are the ones when the honey rolls in. [This agrees very well with what the bee-keepers in the Salt River Valley, Arizona, have been telling me. But they want the heat to be from 95 to 110 in the shade, to get the best results. When the temperature is below 90 there is quite a perceptible decrease in the inflow of honey. Apparently the Arizonians want more heat than we of the North.—ED.]

THE BLUE-HEAD, mentioned on p. 465, Mr. Editor, you think the same as "bareheaded" bees which hatch out all right. If you will read again you will hardly think the bees in question will hatch out all right, for "the pupæ are dead." Possibly the observer may be mistaken as to their death. [Years ago, just before this matter was considered in the ABC book, bee-keepers kept writing in to know what disease was in their brood. Some of

them thought it was foul brood; but I had been studying the same thing, and told them they were mistaken—the brood was not dead; and that, even if the pupæ were so loose as to shake up and down in their cells when the comb was tipped, they would hatch out all right. I watched them daily, and sometimes almost hourly, for a good part of a season. Now, I do not wish to be contrary; but I do not believe those bareheaded pupæ were dead. At any rate, *ours* did not appear to be "sensible of the fact," for they hatched out into perfect live bees.—A. I. R.]



Propolis dissolved in alcohol, with linseed oil added, is said to give a durable red paint for hives, says the *Leip. Bienenzeitung*.

F. Mehring, of Germany, the inventor of comb foundation, is also the first one who ever transferred larvæ. He described the method and his experience minutely in the *Dorf-Zeitung* for 1866.

Hives were made of plaster of Paris in Germany years ago. The latest is a hive made of cement mixed with cut straw. It receives a glazing on the outside which would be the equivalent to paint on wooden hives.

W. Wankler, of Germany, makes the claim in *L. Bienenzeitung*, 1893, page 112, to have invented and used an implement of his own for measuring bees' tongues, in 1882. He says he exhibited the same at a bee-keepers' meeting and exhibition in Frankfort in 1883, where he sold the instrument to Frank Benton.

"Received his just dues," as reported in *Centralblatt* and *L. Bienenzeitung*. A grocer in Cologne, Germany, has been convicted of having adulterated honey. For several years he had been carrying on a business of manufacturing and selling a 20-per-cent honey mixture. Sixty witnesses and nine experts were present at the trial. The enterprising grocer received one month's imprisonment, and was fined \$150.

The following, from the *Rural New-Yorker*, is good advice:

Although the time of applying Bordeaux depends upon circumstances—the locality, the condition of the weather, and the kind of plant treated—a general practice may be followed of first spraying just before the fruit-buds appear; next, just after the blossoms fall, and again about two weeks later. If the season is unusually wet a number of other sprayings should be practiced. Under no conditions should the spray be applied while the plants or trees are blooming, as pollination may be seriously affected.

Charton Froissard, of France, made use of an implement which he invented for measuring bees' tongues. He is reported in *Leipziger Bienenzeitung*, 1893, as having conceived the same idea the American bee-keepers are bent on at present; viz., breeding long-tongued bees able to secure the honey from red clover. It is not stated what success Mr. F. has had in improving his stock in the line of long tongues. Perhaps our friend Dandant, who is at home in France, might tell us or trace the matter up.

E. Reidenbach, editor of the *Pfalzer Bienen Zucht*, writes in regard to the use of old brood combs; "Long-continued breeding increases the thickness of the midrib very materially—sometimes up to 5 millimeters. The cell walls of old combs, however, are scarcely perceptibly thicker than those of new comb, because the bees have ways of gnawing away the silken cocoons. The cell walls of brood-combs are probably lengthened according as the midrib thickens from the accumulating deposits."

N. Ludwig says to this, in the *Leipziger Bienenzeitung* that his own observation coincides with Reidenbach's, and claims that, after making exact measurements, there exists no difference in general roominess between the brood-cells of old and new comb.



SEPARATORS.

Early History of; why it is Not Wise to Dispense with them.

BY F. GREINER.

The subject of separators versus no separators has been gone over a number of times during the past 25 years, and the evidence has always been greatly in favor of separators. The reason why a small minority of our beekeepers still cling to the open or undivided super lies in the fact that there exists a great difference in people. Some are satisfied if they produce an article that will just pass, while others do not rest easy until they have reached actual perfection. This difference may be noticed everywhere in life. For instance, in planting a field to corn, some farmers have the rows as crooked as an old-fashioned rail fence, and in planting out an orchard the trees are put in haphazard fashion. Other farmers will have the rows as straight as a string. The crooked rows would be an eyesore to me, and trouble me nights. The imperfections in the out-of-date section honey would produce a like effect upon me. As to how we came to use separators, there is a little history connected with that. It might interest some.

When we first commenced keeping bees on a more scientific basis, i. e., using frame hives, our super made no use of separators in any form. For several years—and as beginners, mind you—we produced comb honey for the city market without separators, and without the use of comb foundation, not even for starters. Comb foundation was not commonly used, as now, and we always tried to collect enough newly built comb during the season to start our boxes.

Some well-known honey-producer once expressed his sentiments thus: "The success to produce comb honey without separators depends upon the skill of the apiarist," although it appeared later that it would be desirable, if not necessary, to crate such non-separator-raised honey in the order it had been built by the bees, and that a certain per cent of the section honey could not be crated at all. I consider it of great importance to be able to crate our honey just as it happens, or as we think best—a grave disadvantage if we must crate in the same order as the sections came out of the super; the matter of uncratable sections perhaps amounts to but little.

As that beginner in keeping bees, I certainly did not pretend to be skillful; still, I found very little trouble to make a success in raising comb honey in open supers. At present, with the comb foundation to use for starters or in full sheets, it would indeed be easy enough to raise a fair or at least a salable article.

There was, of course, a reason why we did not continue the use of undivided supers. We were using a shipping-case with two glass fronts at that time, and it required six nice straight combs for facers to each 15 sections. While we could crate very nearly all the combs built in the open supers, it was, nevertheless, a fact that they were lacking that uniformity equally desirable to the grocer and to the apiarist; in particular the facers were not perfectly on a level, but were wavy in nearly all cases. The most desirable face combs we often found in the outside rows, the face next to the hive-wall being perfect. The thought occurred to us, "Why not have more hive-walls?" So, sure enough, we did just as friend Gill did (see page 335, Apr. 15th GLEANINGS), and put in some dividers. First we used but two; and as that particular honey season advanced we fitted other supers with more. We were so well pleased with the looks of that honey that we adopted the separator to be used between all combs, and we have never had reason to be sorry for making the change.

Tin and zinc were the materials of our first separators. The supers we used at that time were such that a stiffer divider seemed much more desirable; and since the wooden side of the hive answered quite well to produce a perfectly smooth face on the outside comb, we saw no reason why the same material should not answer the same purpose in the middle of the hive. We brought the matter up for discussion. Mr. A. I. Root and Mr. James Heddon somewhat discouraged us as to the adaptability of wood for separators. I think you will find some of these things recorded

in GLEANINGS and *American Bee Journal* of 1878 and '79. Notwithstanding, after testing paper and other materials we changed all our supers at that time, adapting them to wooden separators.

The comb surfaces of our honey since have been so perfect, the weight of the sections so uniform, that I should be very unwilling to go back to the open super. It would certainly be a step backward. I can see no material advantage in dispensing with the separator. As to getting along without them when trying to produce honey in no-beeway sections, that simply is out of the question. What looks better than a no-beeway section brimful of honey?

Naples, N. Y.

[I once heard an extensive bee-keeper get up in convention and say he had no use for separators—that he could and did dispense with them; and, what was more, he got just as good prices for his non-separated honey as he did for that produced with them. It so happened that, months afterward, I ran across some of this man's non-separated honey; and, of all the "kicks" I heard from the buyer! The long and short of it was, he would never buy any more of that honey again. It was too crooked, too bulged, too every thing; so when I hear a non-separator man talk I wonder whether he holds his trade.—Ed.]

lay the back lid on the grass, inside up, then carefully remove the front lid with the box in hand. When you see the queen, place the front lid crosswise on the back lid, always inside up, and then lift your queen up quickly but gently. Then, lastly, stand the little frame directly across the lids, and cage the queen. Now put the box together once more, and proceed to examine the lower box in the middle row. After the middle row has been removed, the side boxes will easily draw from the frame.

If any of these little colonies are found queenless, and too weak to care for themselves longer, they should be doubled with

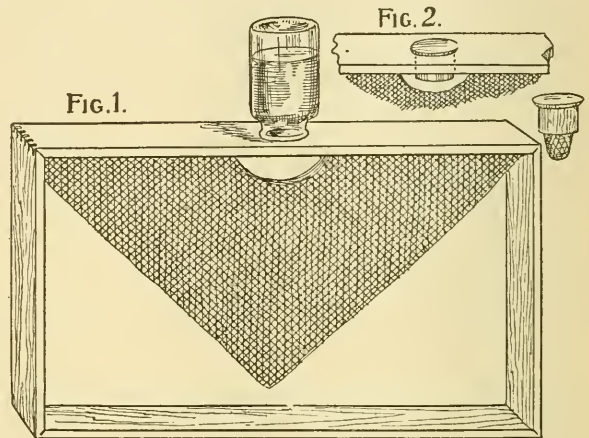

SWARTHMORE'S SYSTEM OF QUEEN-REARING.

How to Maintain and Handle the Miniature Nuclei in Brood-frames, Described on Page 434.

BY SWARTHMORE.

When the little combs are heavy with brood and honey it has been my practice to bind the boxes (described on page 434 of our issue for May 15) snugly together with three strands of cord or twine after the lids have all been adjusted. Pass the cords around each row of boxes longitudinally, and tie a slip knot at one corner of the top-bar. Any rough handling can not then loosen the lids.

A piece of water-proof (not tar) paper folded neatly and tied securely over the top of each frame (as illustrated at the bottom of page 436), when set out on the stakes will prevent rain from entering the compartments. It will also protect the frame and boxes from the sun's rays, and will give more comfort to the bees occupying such close quarters. If possible, place the frames where they will be shaded the greater part of the day, and let them stand high enough to get what air there is stirring.

When the time comes for caging the queens, just untie the middle cord first, and then remove the top box by tilting the tier toward you. Remove the back lid and keep a sharp eye for the queen. If not found on that side,

the one in the same row by placing them back to back. The feeder (Fig. 2, p. 436) is then placed on one of the two front lids. Tie all snugly together with the cord that was used about the frame, and in three days another virgin can be run in, as Alley does it, with tobacco smoke, or a hatching cell may be given as shown in the illustration above.

Fig. 1 is one of the section-box frames, shown on p. 435, May 15th issue, with a $\frac{3}{4}$ -inch hole cut through its top bar for the insertion of a liquid feeder (salt-shaker), or a shell containing a ripe queen-cell. Fig. 2 shows the manner of inserting the shells; and just below this may be seen a fully developed queen-cell built from a shell cup which will hereinafter be described.

Some time previous to the introduction of the second young queen, the back lids coming together may be removed, and in their stead may be placed a rim of half-inch stuff between the boxes, to give the necessary beespace. This will give the new queen the range of both combs, much to the advantage of the little colony.

It should be understood that the doubled nuclei are not again put back into the frame, as illustrated at the bottom of page 436, May 15, but are placed directly on the grass, with a piece of board under them to keep them out of the wet; or they may be hung on a single stake a few inches from the ground.

If these little colonies are kept well fed with

sugar and water they will last the season through, and will also turn out just as many queens as any nucleus hive.

As the season nears its close, gradually double all nuclei down until none are left. Carefully preserve the little combs for another and yet another season's use.

We have formed as many as 40 of these miniature colonies from a single full stock, and once we took a young laying queen from all but two on the first round. One must leave

plained in the first part, and adjust the lids. Expose the zincs on all sides, and cork the flight-holes. Run a young laying queen into each compartment, and hang the frames forthwith in a hive containing bees that have been queenless three days. No unsealed brood should be allowed outside the compartments; and, to make assurance doubly sure, use a little tobacco smoke as you hang in the frames containing the queens. To keep up the full strength of such colonies, a frame of hatching

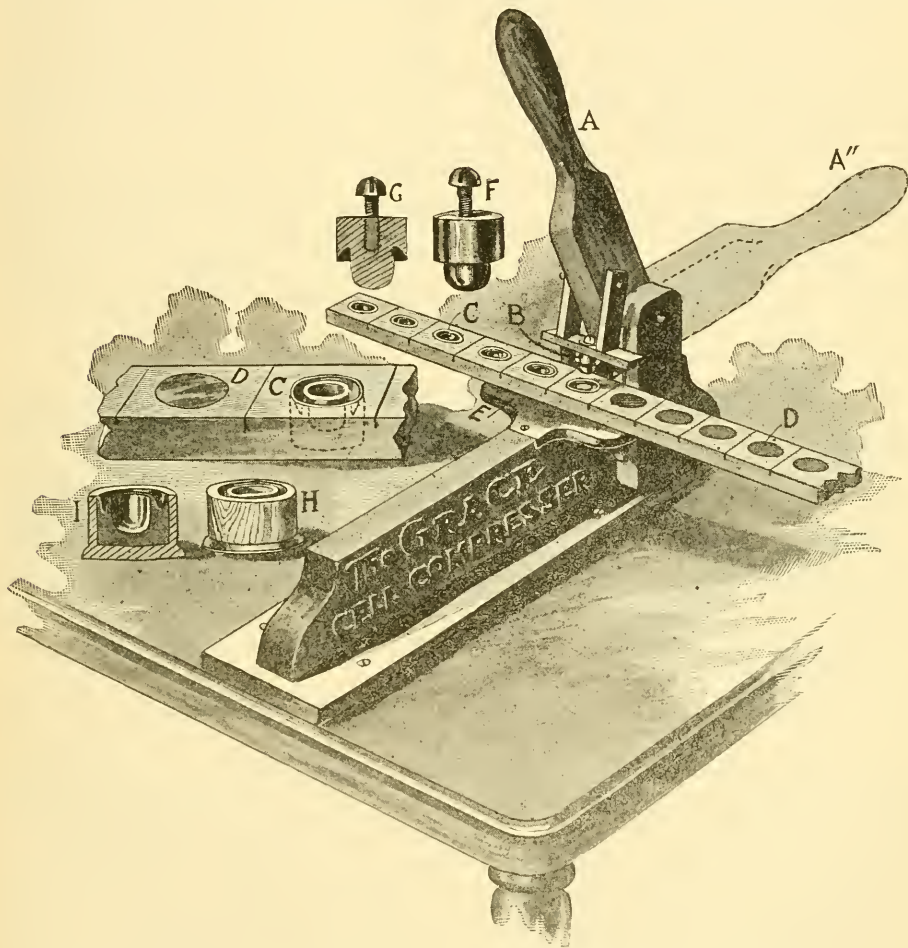

A.—Lever for operating.
 A''—Lever thrown back to get at cell cup.
 B.—Brass cell-moulding cap.
 C.—Molded cells in bar.
 D.—Holes filled with wax.

E.—Bed-plate.
 F.—Enlarged view of molding-cap.
 G.—Sectional view of molding-cap.
 H.—Wood cell cup with molded cell.
 I.—Wood cell cup, sectional view.

the young laying queens in these section-box fertilizing-hives long enough for them to restock the combs with brood, or they will soon dwindle down to almost nothing.

METHODS OF COLLATING.

Young laying queens may be preserved an entire season, each in a compartment by herself, by proceeding as follows:

Secure frames of brood and honey, as ex-

brood should be given occasionally. Feed thin sugar syrup flavored with a little honey, or frames of capped stores may be put into the hive.

The secret of success in the introduction of a plurality of queens lies in the giving of them all at one time to bees that have been queenless but three days. An indefinite number of queens may be confined in boxes or cages arranged in such a way that none can

come in contact, yet allowing the bees freedom to go and come, to do as they will.

If one has to draw often from his "magazine of laying queens" it is much handier to tie each box separately with tough cord, and place them in the hive, without frames, arranged in tiers. Magazine hives should be kept in a cool shady place.

THE GRACE CELL-COMPRESSOR; A SIMPLE HAND TOOL FOR RAPIDLY FORMING QUEEN-CELL CUPS IN SOLID PLUGS OF COOL WAX BY PRESSURE; SHELL CUPS AND IMPROVED HATCHERY.

The cut on the preceding page is an excellent and most comprehensive illustration of a very handy little machine for making compressed queen-cell cups or goblets into wax plugs for queen-rearing.

A brass die, F, is screwed fast to a plunger, as shown at B. This plunger is jointed to the handle, A, and the handle is pivoted to the two uprights, bolted fast to a rigid frame, thus forming a lever; and when the handle is brought down from the point indicated by the

it is moistened, each time the handle is lifted up, either by the tongue of the operator or with a sponge saturated with castile soap and water, or olive oil.

Down at one side of the machine will be noticed little wooden shells into which some cups have been compressed. These "shell cups" are to render queen-cells more easily removable or separable, which will be hereinafter fully explained.

The machine does most excellent work in these shell cups, at the rate of from 10 to 15 a minute—all perfectly formed and partially drawn, so that the bees will accept them quite readily.

The cut below is a perfect drawing of an improved queen-nursery cage for the incubation of cells and the confining of virgin or laying queens.

The top-bar has a series of eight $\frac{3}{4}$ -inch auger-holes, one inch apart, along its entire length, into which wooden shells fit snugly. A, A, are shells removed entirely from the holes. B (1) is a shell in place, and B (2) is a sectional view of the same. G shows how the cells appear when fully drawn out by the

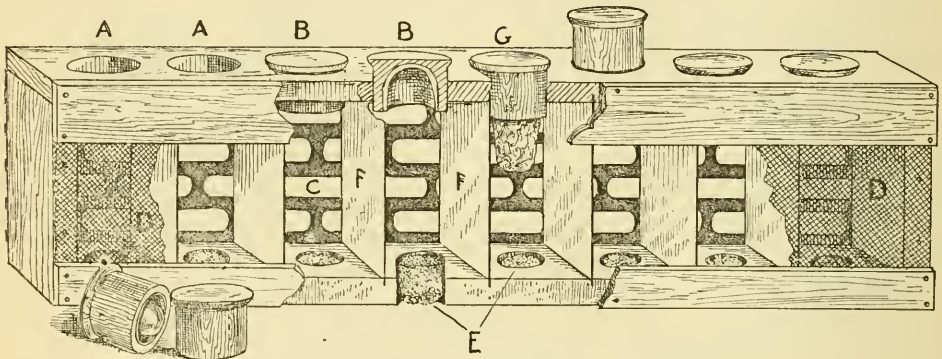

THE SWARTHMORE QUEEN-NURSERY CAGE IMPROVED, SHOWING THE APPLICATION OF SHELL CUPS.

dotted lines, the die is forced into the center of the wax plug, forming a perfectly smooth indentation, like the base of a natural queen-cell, into which indentation larvæ may be afterward transferred or grafted, and from which bees will construct queen-cells.

The pressure not only makes a cavity in the wax, but it forces out the edge of the cell to a certain extent, which is very acceptable to the bees because of its natural form and appearance.

A Swarthmore nursery-cage top-bar is shown under the die, ready for compressing. To the left are the finished cups, and to the right are plugs of wax yet to be pressed. These bars are placed to accurate gauge upon the table. Each time the handle is brought down the bar is slid one notch further. In this way very rapid and perfect cell-work can be done with little or no exertion. Dies for the transfer of "cradle and all," by the Pridgen method, are made pointed at the end, and work well in the compressor.

To prevent the die from sticking in the wax

bees. Along the bottom-bar is a corresponding row of half-inch holes to receive bits of sponge for the purpose of feeding the young queens when confined entirely with wire. A sponge in place, and a sectional view of the same, is shown at E.

Between the holes in each bar is a saw-cut for receiving the division-tins, F, F, which are easily slid in or out at will.

Perforated zinc covers the front side, and wire netting is placed over the back side of this cage. The zinc is removable. The netting is nailed fast to the cage by means of thin strips at top and bottom. These strips, also the netting, D, D, are shown torn away in the drawing.

The top-bar is removable, and may be used in a frame as recommended by some of the leading breeders of the country.

These cages fit six to the Hoffman frame—two across and three to the tier, thus forming compartments for 48 queens to the frame—a great saving of space in the incubation of cells or the storing of virgin or fertile queens when

rearing on a large scale. In a booklet soon to be published I shall endeavor to explain fully the details of the storage of numerous queens in a single colony, with much other matter as yet unpublished.

MODERN METHODS OF QUEEN-REARING.

The Progress Made During Late Years.

BY W. H. PRIDGEN.

Since the dawn of modern apiculture there has not been a time when there was the same interest manifested in queens and queen-rearing as now. The tendency on the part of the honey-producers is, to a greater extent than ever before, to rear their own—not only because a larger per cent of those reared at home give better results than those transmitted through the mails, all else being equal, but because the essential conditions necessary for the production of those of the highest type are more generally understood.

The cardinal points were given to the public years ago by men who spent much time and talent in experimenting; and by their persistent efforts the foundation was laid, not only for the most fascinating branch of our pursuit, but the most promising field in which to spend our thoughts and energies.

Bees are no longer looked upon as bees without considering their qualities; but each progressive bee-keeper is continually on the lookout for superior honey-gatherers and other desirable traits shown by individual colonies.

The ability to rear our own queens from the best mothers, and control their mating to some extent by weeding out and preventing the production of objectionable drones, and thus, step by step, make permanent improvements in the working qualities of our bees, not only increases our profits, but lends enchantment to pleasure.

We are indebted to Messrs. Doolittle and Alley for the fundamental principles of what is termed artificial or scientific queen-rearing, who differ in some of the minor details.

For instance, Mr. Doolittle uses artificial queen-cups to which he transfers the larvæ with a toothpick, while Mr. Alley prefers strips of worker comb containing eggs ready to hatch, over which the bees fashion the cells to their own liking.

As these veterans differ on some of the less essential points, so also do others differ with them, and consequently the subject is kept alive—short cuts devised, and modifications made by the lovers of the art.

In some of the manipulations, as much is accomplished in a few hours now as was formerly done in as many days; but what works perfectly in the hands of those who conceive new ideas and adopt measures to carry them into effect are often considered to be failures by others who have become proficient in more faulty methods with which they are acquainted; and hence the diversity of opinion as to the best or easiest way to accomplish certain ends.

Without these differences of opinion and

failures that lead to investigation, new ideas or the different ways of accomplishing the same thing, would not come to light; and in going over the ground that has been covered by those who have contributed toward the success of modern queen-rearing, the object is to lend a helping hand toward a further advancement of the industry.

As a rule, the reader cares but little how, when, or from whom the writer gained his information, but generally prefers the part relating to the object in view; and inasmuch as it is generally known who advanced the different ideas that make up our queen-rearing system, in complying with the request for a more elaborate treatise on the subject these explanations will be omitted to some extent, without any intention of doing any one an injustice.

Creek, N. C.

CAPPINGS.

Bees that are Rustlers; Covers adapted for Warmer Climates; Comb Honey in Two-pound Sections; Straining Preferable to Settling Extracted Honey; Fertilizing Queens in Confinement.

BY E. H. SCHAEFFLE.

At present the efforts of the queen-breeders seem to be confined to stretching the tongues of their stock to the utmost limit. While this elongating of the bee's tongue may be of benefit to those bee-keepers living in red-clover sections, to the average apiarist the working qualities of the bee are of far more importance. It is a well-known fact that some stands of bees will put up several hundred pounds of honey in a season, while others in the same apiary will not give a pound of surplus. I hold that the bee wanted is one that will give the most honey under average conditions. When I sit down by one of my best colonies and compare their movements with that of the average hive I find that the rustlers come out of the hive on the run, stop an instant to gather themselves for the spring, and then are away like a bullet. Turning to the average hive I see that the bees come out leisurely, slowly crawl half way up the front of the hive, stop for the spring, and then, springing out slowly, circle and leisurely wing their way to the fields. Returning, the rustlers come down on the alighting-board with a bounce, and rush into the hive as though the queen's business could not wait, while the bees of the average hive drop on to the alighting-board exhausted, rest there for several seconds, and then slowly crawl into the hive.

Now, I can not go with the bees to the "fields and far away," but it is safe to assume that they work in the field as they do at the hive. If this is the case, the rustlers will make two trips to the sluggards' one. I believe we can, by careful selection, produce a strain of rustlers just as the fast trotter has been developed.

A non-warping top is a desirable feature in this hot climate. Last season I set out in the blazing sun three ten-frame hives. One of

these had a cover of $\frac{1}{2}$ -inch stuff; another the usual flat cover, and the third a ventilated cover. The thin-top hive got so hot along the top that the combs all melted loose. The single flat cover warped, while the ventilated cover retained its shape. This ventilated cover is made of a thin board, flat, over the hive. This is let into a strip, at each end, and has in addition a $\frac{1}{2}$ -inch strip nailed across the center to prevent warping. The cover is a half-inch above, and is the usual three-piece cover, extending $\frac{1}{2}$ inch beyond the sides, to shed rain. It will be noticed that this test was on the wide ten-frame hive. The usual eight-frame hive is not so apt to warp its covers.

For twenty years past I have been producing comb honey in two-pound sections. My experience has been that I could secure 50 per cent more in this size than in the usual one-pound size. At the same time I have had a number of one-pound hives in operation; but, with the exception of two boom years, I have been compelled each year to take the sections off and put on extracting-supers in order to get some honey from these hives. The usual one-pound section with its separators compels the bees to cluster in small bunches of a half-teacupful each; prevents sociability and the massing of large numbers of bees to make comb. This season I have gone back to an old style, and made frames to take (two deep) Danzenbaker sections. These frames each hold 8 sections, or 64 to the case, using a ten-frame hive. Now, in this super there are no separators, the bees hanging in one sheet from the top of the upper section to the bottom of the lower, and filling all of the space between two sections. By this arrangement I get about four times as many bees to work in the same space. The bees take to these sections kindly, and I expect good results if the season continues favorable.

It is not always convenient to have to wait for the particles of wax and pollen to rise to the surface before canning. I can all of my honey as fast as extracted. First the honey is allowed to ripen on the hive. If in shaking off the bees the honey flies out of the comb, that comb is returned to be ripened up, and only those taken that hold their honey when shaken. When the honey is extracted it is run into a wire-cloth strainer that catches all the small particles of wax, bees, and grubs. From this strainer it flows into another, made of cheese-cloth. When the honey leaves this it is free from all particles of pollen, bright and clear, and ready to go direct to the hive. Where honey is not remelted the presence of small particles of pollen may not injure the honey; but if it is remelted it will color the honey. Some object to the cheese-cloth on account of its being a slow way of straining; but this depends entirely on the size of the strainer. Mine is 8 inches across and a foot deep, reinforced by strips of cloth sewn over the sack. This will allow the warm honey to flow as fast as the gate on the extractor will deliver it.

I find that dark combs color honey. Californians allow the queen access to the supers in the early spring. In consequence, many of

the combs are dark, and the honey from them a shade darker, so that, to get a shade lighter honey, it will pay to soak these combs in water before using, and have the water dissolve and take out the color that would otherwise go into the honey.

Some fifteen years ago I tried fertilizing queens in confinement. I found the queen more than willing, but I could do nothing with the drones. Mr. Davitte has succeeded by first accustoming the drones to confinement before liberating the queens, and, second, by using drones that are from queenless hives. It is essential that the drones be content, and that they be from hives which, being queenless, have their drones "fertilized."

Murphys, Cal., Mar. 20.

ARE LONG TONGUES OF VALUE ONLY IN RED-CLOVER REGIONS?

BY DR. C. C. MILLER.

In the *American Bee Journal*, page 293, G. M. Doolittle enters a protest against the fad for long tongues because they are not of special value where there are no flowers with tubes too long for the reach of ordinary bees, and quotes a remark from GLEANINGS which he puts in capitals and italics as follows: "The movement for longer tongues is simply to get the red-clover crop of the North, which now is practically all wasted. The bees, NO ONE CLAIMS, would be any better except on that account."

Now I want to know who authorized either Stenog or Bro. Doolittle to say that red-clover blossoms are the only ones with tubes too deep for ordinary bees, and yet not so deep that they can not be utilized by some of the bees now in existence that have tongues of unusual length. Are you sure that there are never white clover blossoms so deep that some bees can not reach clear to the bottom?

In one place Mr. Doolittle is not quite so bad as Stenog, for the former does not leave red clover as the solitary example of a honey-plant that keeps its nectar tantalizingly near the reach of ordinary bees, and yet just beyond that reach, for he says, "Long-tongued bees would be an advantage only to those residing where red clover and other long-tubed flowers abound." That's as much as to say that, if there would be a gain from red clover through long tongues, there might also be a gain from other plants with long tubes, while Stenog bars out all but red clover. To be sure, Mr. Doolittle does seem to do the same barring-out in another place, where he says: "I am satisfied that long tongues are of advantage only to those in red-clover districts," and then he immediately hastens to throw some doubt upon the red-clover gain by adding, "if they are of any special advantage anywhere," which seems to throw doubt upon their special value in any case.

Mr. Doolittle calls attention to the fact that in New Mexico and elsewhere, where no red clover grows, there come reports that the bees that do the best are those with long tongues.

I do not deny that it is possible that long tongues may be generally accompanied by other good qualities, thus accounting for the superiority of long tongues where no red clover is found; but it seems to me more reasonable to suppose that the extra gain is made on flowers with tubes longer than ordinary. Why should it be considered a strange thing that other flowers should have tubes of the same depth as red clover? It is possible that many of the flowers commonly visited for nectar have tubes of different lengths, some of them accessible only to tongues of unusual length, thus giving long tongues the advantage aside from red clover. Again, a flower-tube may be of such a depth that only part of its contents can be reached by a tongue of ordinary length, while one a little longer may drain it to the bottom.

Please don't understand that I believe that length of tongue is the only thing to be considered. I should prefer to make selection by noting the amount of stores gathered rather than by measuring tongues. It is possible that, among several colonies, the one with longest tongues may be the poorest. One colony may excel it because of greater diligence. Another may work earlier in the day. Another may excel because of greater longevity. So I think it would be unwise to depend upon tongue-length alone. But I do insist that the advantage of long tongues has not been proven to be exclusively associated with red clover; and it is possible—not probable, I think—that the gain from other flowers with long tubes may be even greater than from red clover.

Marengo, Ill.

[It is true that a colony, A, with long tongues, *may* do less execution than another colony, B, with shorter tongues. But that is no argument against the value of long tongues. If B, because of its superior industry, does better than its longer-tongued neighbor, A, might it not do *still better* if it had the same length of tongue as A? The truth in a nutshell is about this: In any case where there is nectar to be found in flower-tubes beyond the reach of ordinary tongues, if two colonies are alike in all other respects, the one with the longer tongue-reach will have the advantage.—Ed.]

FASTENING FOUNDATION IN BROOD-FRAMES AND SECTIONS.

A Unique and Simple Plan; How to Make the Tool; How to Prevent Foundation in Brood-frames from Sagging, without Wires or Wooden Stays.

BY C. DAVENPORT.

I have noticed that, in most improvements (or shall I say changes?) made in our fixtures, the firm GLEANINGS represents leads, and the others all follow in time. I am willing to concede, and know, that most of these changes have been real, and some of them great improvements over what they supersede. This, for instance, will apply to the present styles

of self-spacing brood-frames over the old loose hanging or unspacing kind; but I consider a molded top-bar, or one that has a crease or groove cut in the center of it to receive the foundation, inferior in many ways to one that is simply flat on the bottom side. It is, for one thing, much more work to clean them of wax and propolis if, as is always the case to a greater or less extent, this has to be done after they have been used; and the foundation, either full sheets or starters, can be fastened to a flat top far quicker and easier than it can to either a molded or grooved one in the usual way.

I will here describe my method of doing this, for the principle will work with either molded or grooved bars; and starters or full sheets can be fastened in sections by this plan nearly as fast as with a hot-plate machine; in fact, I often use it when putting full sheets in sections, although I have two machines for this work. The whole apparatus costs but a few cents aside from a small amount of work. One of the implements required is a small instrument made on the same principle as a medicine-dropper. Mine is made of a tin tube about 4 inches long, and not quite $\frac{1}{2}$ inch in diameter. The lower end of this tube is gradually tapered down to a point, so the hole at the extreme end is a little less in size than what it would be on an ordinary lead-pencil if the lead were removed to the upper part of the tube. A rubber nipple or bulb is attached, and it is important to have this rubber fit over the tube tight enough to exclude air. When the lower end is placed in melted wax, or any other liquid, with the rubber bulb compressed between the thumb and finger, as soon as it is allowed to expand, by air suction it draws some of the liquid up into the tube. By allowing the rubber to remain expanded the tube will not leak when withdrawn, no matter what position it is held in. Pressure on the rubber forces the liquid out slowly or fast, just as desired.

For fastening the foundation in brood-frames I have a board a trifle wider than a frame is deep, and a little longer than the length of four frames. Along one side of this board are fastened four pieces that are $\frac{1}{4}$ inch smaller than the inside measurement of the frame, and these pieces are just half as thick as the top-bars of the frames. It is on the same principle as the piece on the Daisy foundation-machine, over which the section is placed, so that, when a frame is placed over one of these pieces on the board, the foundation, when placed inside the frame, will be held perfectly true and straight, exactly in the center of the frame. When used, this long board is set up edgewise on a bench or table, and propped up so it will lean over from the operator. A frame is placed over one of these pieces, with the top-bar down on the lower side next the bench. On the lower side of the long board, under each piece over which the frames fit, is nailed a narrow strip on which the top-bar rests. With the board in position a frame is placed on at one end, the foundation placed in, and, if I have made my description plain, it will be seen that the foundation rests exact-

ly in the center of the top-bar, and is held there by the piece over which the frame fits, and the angle, or leaning way, at which the long board is placed. A dish of melted wax stands over a small lamp at one end of the table. Some is taken up in the machine I have described, the point held close to the edge of the foundation where it rests on the top-bar. As the dropper, or whatever one likes to call it, is moved slowly along the top-bar, a very small but continuous stream of melted wax is dropped between the edge of the foundation and top-bar. Then another frame is laid over the next piece on the board, and so on until the foundation has been fastened in the four frames.

By this time the melted wax on the first one has set enough to allow the frame to be hung in an empty hive near by; then by the time another frame is filled, the second frame on the board can be removed, and so on as long as there are frames to fill. After things are in place, and the wax melted, either full sheets or starters can be fastened in frames very rapidly by this method. But speed is not so much the advantage of this plan as the fact that the foundation is fastened so it hangs perfectly true and straight in the frame, and can be pulled in pieces without being loosened from the top-bar. Of course, this method will work just as well if the frames were wired. For fastening full sheets in sections I have a board similar, except in size.

The great superiority of the wax-dropper I have described over any I have seen mentioned, is the absolute control it gives the operator of the melted wax, which can either be dropped slowly or rapidly, or a small continuous stream can be forced out; even the size of the stream can be regulated by the pressure on the rubber. It is very easy to operate it, and the only difficulty one can have with it is in drawing too much wax up into the tube so some gets in the rubber. The rubber on mine has too much suction; and unless care is used when the wax is drawn in, some may run up into the rubber. When this is done the hot wax does not, as one might think would be the case, injure the rubber, for, after the wax is removed, it works as well as ever. But if care is used, or with a bulb the right size, no wax will be drawn into it.

In this connection I will describe a plan I have practiced somewhat to prevent full sheets in unwired frames from sagging. This sagging or stretching of the foundation, as those who have had trouble in this respect know, is next to the top-bar, a strip two or three inches wide. After foundation has been fastened in a frame, and while it still remains in position on the board, the point of this wax-dropper is held close up to the foundation, two or three inches above the top-bar; then a small stream of wax is forced out. As the point is lowered to the top-bar, this adheres to the foundation; and if the operation is repeated at intervals the whole length of the top-bar, it will prevent the foundation stretching when the bees first get on it; and by the time they do, these strips of wax off the foundation are usually drawn out enough to hold it from sagging.

This wax-dropper is also very handy in fastening pieces of comb in sections, and in patching up combs by cutting out patches of drone comb, and replacing with pieces of worker comb or foundation. But a board such as I have described is essential when fastening full sheets in brood or full-depth frames.

In reading this over I see that I forgot to say that, if the wax is heated to only about the melting point, when commencing to use the dropper it may, unless one works fast, harden and adhere to the sides of the tube, or even clog it up. In this case, or if for any reason work is suspended, and the wax is left in the tube until it hardens, all that is necessary is to hold the tube in the melted wax an instant, then what is in the tube melts and can be allowed to run out; but with the wax hot enough there will not, unless wax is left in the tube, be any trouble in this respect. I explain this matter in detail because, if one tried a dropper of this kind with the wax at only the melting-point, some might consider it a failure. After the wax is heated quite hot it remains liquid in the tube much longer than is necessary.

Southern Minnesota.

[Your device is nothing more nor less, if I understand you, than a large-sized medicine-dropper, or what druggists call a pipette. A device quite similar has been illustrated in our columns, without the rubber bulb. It was simply a tin tube $\frac{1}{2}$ or $\frac{3}{4}$ of an inch in diameter, tapered at the point to a small hole. This was partially submerged in hot wax, and allowed to fill. It was next removed, and the point was then drawn along the edge of the foundation, gravity forcing the wax out in a fine stream, said stream forming a bond of union, when cold, between the foundation and the top-bar. But one difficulty with this device was that it fed the wax too fast, and at other times not fast enough. This rubber bulb would overcome this difficulty, giving a perfectly regular feed and stopping it at the moment desired. These bulbs can be purchased, probably, at the drugstores; at any event, they can be obtained of any of the large rubber concerns; for example, the Hartford Rubber Works, Hartford, Ct.; the Goodrich Rubber Co., Akron, O.; the Diamond Rubber Co., Akron, O. After getting the bulb, make the tin tube, or get your tinner to do it for you. To overcome the difficulty of the wax being drawn up into the bulb spoken of by Mr. Davenport, make the tube a half longer, and then always hold the bulb "this side up with care," or bulb upward.—ED.]

.....
SHALL WE WORK FOR COMB HONEY OR EXTRACTED, OR BOTH?

BY WM. A. SELSER.

The paper written a few weeks ago by our good old friends in New York city has no doubt been read very carefully by a large number of honey-producers. The writer having had a large experience in the Eastern markets,

feels that there are some exceptions that should be taken to this article. It reminds me very much of one ascending Pike's Peak, in Colorado. After ascending two-thirds of the way up to the peak, one looks across a beautiful stretch of country, and certain impressions are formed; but on reaching the top, and getting that grand extended view for many, many miles, quite a different impression is formed. In looking over the city of New York in reference to the honey-producing capacity, our friend's conclusions are correct, and especially so with regard to the buckwheat honey, of which Northeastern Pennsylvania and New York produce over half of the United States supply. The reason why extracted buckwheat honey is not profitable to produce any more in the Eastern markets is because, first, the biscuit trust can buy a better grade of honey, for the same price, than buckwheat has always been sold for in the past. Second, two years ago a patent discovery was made by which large producers in New York city can turn out an adulterated article by the carload, and make it sugar in four days after it is manufactured, which looks and tastes exactly like the genuine buckwheat honey, and can be told only by chemical analysis. Therefore, it follows that buckwheat comb honey is the only way that buckwheat honey will sell at all, unless at very low figures.

Now, then, ascending the mountain a little bit higher, on looking over the vast area of the United States in reference to its honey production in relation to comb and extracted honey, we advise the bee-men to go on just as they have. About four years ago this summer, Wisconsin had hard trouble to dispose of its crop of comb honey at 8 cts. a pound, and it was very pretty at that. Since Colorado, Utah, Arizona, and other new places have come to the front in producing alfalfa comb honey, there has always been sufficient comb honey to go around. With all the human cry last fall of a short crop, the writer knows of two cars, one sent to Philadelphia and the other sent to New York, that could not find buyers, and had to be stored for future offerings.

One reason that comb honey has been scarce with the dealers is because they were not willing to pay the price. This year, with the prospect of an immense crop from California, and these new places heretofore mentioned, that seldom fail with an average crop, the prospect is that comb honey will be a drug on the market; and the bee-man should remember that comb honey, if not sold before the following season, is not worth very much. The average price for which California comb honey has sold on the Philadelphia market with a good yield, has been 7 and 8 cts., a comb running a little short of a pound. Now, then, how should bee-keepers fare who have always been able to get on the average 7 cts. per lb. for fancy white-clover extracted honey, and some years even more, if they turned around and changed their hives to produce comb honey, and we should have a big season, and they could not sell it at an average price of 10 cts., and would have to carry it over,

and probably realize about 4 cts. per lb. for it? I would say in conclusion to our fellow honey-producers, do as I propose to do—raise comb or extracted honey in proportion as they have in the past years, and not be carried away with the high price comb honey would bring one year in ten.

Jenkintown, Pa.

RAMBLE NO. 187.

An Experience with the Ferris Wax-extractor.

BY RAMBLER.

"Good morning, Mr. McCubbin; glad you came around. I've just been over all of our colonies of bees, and cleaned house, as I call it. There was an everlasting amount of brace-combs and bits of comb at the ends of the frames. Why, it seems to me there was a pound of wax daubed around in useless places inside those hives."

"And, Rambler, you have got all these boxes full—had no idea there was so much. I suppose you will now render it out."

"Well, no; not just yet. I think I will wait until I can use the sun extractor. I notice an April sun is not a good wax-worker."

"But, Rambler, why not use my Ferris wax-extractor? You know there is one in the back room."

"Yes, yes. I have noticed your old Ferris concern; but, I'll tell you right now I wouldn't give a row of pins for it."

"You wouldn't, hey? Say, Rambler, did you ever use one?"

"No, and I don't want to. Why, I have used no end of these steam wax-extractors. If a man has just one swarm of bees and a milk-pan full of combs it might be of use, for the women-folks could put it on the stove and then it would take all day to render it."

"Well, Rambler, you have a great amount of prejudice. I don't see that this Ferris extractor is any slower than any other way of boiling in water. Then you must know that mine is the first one sent to California."

"Is that so, Mr. McCubbin? Ha, ha! Well, it ought to be the last one. No, sir; you can't fool me on these steam wax-extractors; besides, I have a brand-new way for rendering wax, that will just paralyze Ferris and his extractor. I don't mind if I reveal the plan to you. You know when we boil all this stuff in an open boiler, the refuse, instead of staying at the bottom, where it ought to, comes to the top, and wax and refuse have a remarkable affinity for each other; and, even in your much-vaunted steam-extractor, much wax goes into the slumgum. Now, my plan is to put all of that refuse into the bottom of the boiler, leaving nothing but wax on top. The boiling water will eliminate every particle of wax from the refuse, and there is absolutely no waste."

"Well, Rambler, that is a very pretty theory; but did you ever make it work?"

"No, but I am just ready to. The plan is very simple. I place a roller, or, rather, a large tin spool, in the bottom of the boiler. I

attach to this a long strip of cheese-cloth with pockets across it. Now actuate the roller; and the breadth of cheese-cloth rolls down, the pockets have the openings downward, and gather in all the slungum, and the latter is all wound up on the roller under the water. You see it strains and compresses it all at once. Remove the clear wax, and then the roller with its load of refuse can be removed. You see it can be put into a common wash-boiler, and need cost not over one dollar. Oh! I'll show you and Ferris which shank of a razor-back hog has the most fat on't."

"Well, Rambler, your plan looks reasonable. Go ahead with it, and success to you; but I must be going. I have a thousand acres of land to sell this week. I'll be around again in a few days. So long."

A week later.—"Hello, Rambler! Well, I'm around again; how is that razor?"—

"So I observe, Mr. McCubbin. Did you sell that thousand acres of real estate?"

"I did not; but, see here. I am interested in wax-extractors just now. How did your new-fangled roller-me-jig work?"

"Sit down here, Mr. McCubbin, and I will unfold to you a story of bright hopes, of disappointment, and of conversion. Well, sir, I tried that roller-up plan, and somehow the pressure was not strong enough to eliminate all of the wax, and it appeared in little granules all through the mass. It is possible that the thing might work after a few improvements to increase the pressure; but I have not the tools for making the thing as I want it. I therefore fell to considering your charge of prejudice; and if I had any I cast it aside and resolved to try the Ferris extractor. I set it going properly on the stove, got a *McClure's Magazine* and the *Examiner* to help while away the time, for I expected a whole day's job at rendering a sack of old combs and scrapings. Just as I had gotten the fire to going nicely Mr. Wescott came along and we talked a while about his mowing the alfalfa near the apiary. I started back to the stove, and was a little surprised to see something trickling from the spout of the extractor. 'Nothing but water,' said I; but a closer view revealed quite a little wax with it, and it was running on to the floor. Well, I hustled around to get a dish, and by that time quite a respectable stream was running. Then I had a curiosity to see the inside of the extractor. The removal of the cover let into my face a great rush of steam, and I was really surprised to find the baskets nearly empty. I filled them again, and crowded down some hard lumps; and, though I had to poke my nose into the extractor several times just to see how it was working, those lumps melted away in a perfectly satisfactory manner. I looked at the big letters 'FERRIS' stamped on the front of the machine, and gracefully took off my hat to Mr. Ferris, inventor of the first satisfactory steam wax-extractor. I soon had occasion to melt and recake quite an amount of wax, and I put in some quite large chunks just to clog it if possible; but it was no use; it seemed as if something was 'chawing' it down at the bottom. Yes, sir; I will indorse

the Ferris; and his later machines, with the pressure principle, must be near perfection."

"Well, Rambler, I am pleased to know that you are liberal enough to throw aside your prejudice and indorse a good thing when you try it. But, see here—what are those wooden boxes for?"

"Those are for molding wax. The usual plan, you know, is to mold in an old five-gallon can; but such vessels are as small at the top as at the bottom, and often the can has to suffer before the cake of wax can be removed. Now, my idea of the matter is that every well-regulated apiarist should have three or four square tin dishes made with the tops about an inch larger than the bottoms, and large enough to hold 20 or 25 lbs. of wax. Not having such vessels, and not having even old rusty tin cans, I made these wooden boxes. They hold 20 lbs. of wax; and I want to know, Mr. McCubbin, if you can make a wooden box, that will hold water or melted wax, with a saw and hammer."

"Well, no, Rambler. I am not much of a mechanic. I think you must have some kink about the way you do it. Or, say—I might possibly make such a box if you will allow me to nail it up with a harrow-tooth."

"Well, I can tell you how to do the same trick, harrow-tooth or not. Get your boards the proper size for the box you want. These three boxes are made of $\frac{3}{4}$ -inch boards, 12 inches square at the top, 9 inches deep, and $\frac{1}{2}$ inch smaller at the bottom. When you get the pieces of boards ready to nail up, put some beeswax into a shallow tin dish—an old bake-tin will do. Next get some strips of heavy woolen cloth; cut them from an old pair of pants, before nailing up the sides of the box. Cut the woolen strips one inch wide, and a little longer than the depth of the box. Let your wax get boiling hot; thoroughly saturate a strip of cloth, and quickly lay it on the joint to be nailed, and quickly nail the other piece right down upon it. So continue for all four corners; then put the bottom on in the same way. Those strips of cloth saturated with boiling wax, nailed firmly into every joint, fill up all of the pores and inequalities; and if the boards have been gotten out with reasonable care your box will not leak. But, to be doubly sure, after the box is nailed up and the edges all trimmed down smooth, another set of waxed cloths can be nailed down with cleats over the cracks."

"That seems to be a nice way to do it, Rambler; and your cakes of wax all look so nice and yellow; free from those discolorations that are sure to come from old tin dishes. But does not the wax stick to the wood?"

"It did not in the case of these 12 cakes; but I had to exercise some care toward the last caking. No, wood is not so good as tin; but this way to make boxes is worth knowing. You can make a nice tray for developing photographs, by this method; or by lining the tray with a piece of flannel saturated in beeswax; or you can make a very good and serviceable bachelor's wash tub. Here is a photo of our waxworks for the season. The Ferris has the post of honor in the center. In front

of it is an old five-gallon can that has seen rough usage in the removal of a cake of wax. The 12 cakes of wax run about 20 lbs. each. The molding-boxes are, one on top of the extractor, the others at the ends; the one at the left shows the doubly sure box with the extra cleats. Then this wax was all strained through that endless strainer hanging in the center."

"You are all right on the wax question, Rambler; but here is one small cake that is darker than the rest, and it has a peculiar odor."

"I can account for that only from the fact that, in caking a quantity of wax, I shave off the bottom of the cake clear down to the yellow wax; and, by the way, a drawshave is the best tool for that purpose. Next to a drawshave give me a hatchet. When we take all of these shaved portions, and cake them, it is darker than the rest. I believe there is a goodly amount of bee-glue in it. I 'dunno'—do you?"

"Dunno me too, Rambler. Well, I must be off. Real estate is on the boom. I've just

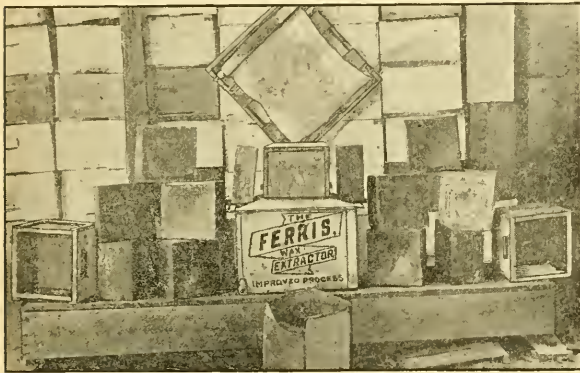

RAMBLER'S WAXWORKS.

bought a choice eighty myself. I will put it all out to alfalfa—several thousand acres more just as good for sale."

"Why, Bro McCubbin, you will be as bad as the old woman, and sail yourself one of these days. You see, this woman put up a notice on her house, 'This place for sail.' A wag saw the notice, and immediately sought the woman, and, said he, 'Ma'am, when does this place sail?' 'It will sail, sir,' said she, 'just as soon as the person comes along who can raise the wind.'"

"Well, Rambler, that's where we must know the difference between sail and sale. But I am like the old woman—ready to sale either way. All that is necessary is the raising of the wind. But I must be off. Get up, pony. So long."

"So long."

Since writing the foregoing, GLEANINGS for April 1st has arrived, wherein the steam and press methods are quite thoroughly presented. From my experience I think better results are attained by pressure under boiling water. Parties in this State have, during the

past three dry seasons, made a business of purchasing old combs, and even old slumgum, and have made a good thing from the wax rendered. They used some sort of press under water, and the refuse is put under such pressure that it comes out as hard as a brick, and every particle of wax out of it.

It would be impossible to apply such pressure in the Ferris extractor; but I believe that the pressure, such as it is, should be applied under water. The Ferris should have some sort of faucet on the outlet to enable the can to be partly filled with water. But I am judging much from the old two-basket extractor here, and have no doubt the present improved extractor is the best all-round machine on the market.

COMB 40 YEARS OLD.

BY GEORGE W. ADAMS.

I was much interested in the article on p. 332, 333, on the size of bees from old combs.

One of the best colonies for work I ever saw was put into a hive made by a neighbor, between 1850 and 1853, the swarm being hived the same year. This is not "tradition;" but I think that, with a little trouble, the month and year can be definitely fixed. For over 40 years this colony did good work; but two years ago, the old hive having become badly decayed, they were transferred. I did not hear of it in time to be present, but made careful inquiries, and learned that the comb "was very black," and had very few drone-cells, the owner describing the drone comb as "a patch about as big as my hand only." The old comb was carefully preserved, and I will send you some if you like.

The owner is one of our leading citizens, a man of intelligence, and a close observer and keen reasoner. He is very decided in his opinion that the bees grew no smaller, and now has most of the comb in the new hive. He certainly would not have used it if he had any idea the bees were growing smaller.

I don't believe you will find much older comb where the age can be definitely proved, and this can certainly be done.

South Byfield, Mass., April 25.

[If those are correct who claim that the cells fill up with cocoons, and become so small that the comb ought to be renewed in five, four, or three years, and that it is easy to recognize the smaller size of bees reared in comb ten years old, then bees raised in this forty-year-old comb ought to be pigmies indeed. But they were not perceptibly smaller, and the colony was one of the best. Incidentally it might be observed that the good reputation of the colony was to some extent due to the fact that very little drone comb was present.—ED.]

AN OBJECT-LESSON IN BEES AND GRAPES.

BY J. B. HAINS.

I send a photograph of grapes, part of them punctured and part of them sound, which I placed in the upper story of hives, together with other fruits—peaches, pears, etc.—last summer, by request and co-operation of C. A. Ennis, justice of the peace, and ex-mayor of Bedford. We examined them from time to time as long as they would keep without rotting, and found all that we punctured entirely consumed except stems and skins; while every specimen not punctured was untouched. We placed them in a portico outside the hive, and in a few minutes we discovered yellow-jackets on them. Then we removed them to the inside of the hive to protect them from wild bees, and possibly from birds, which we believed to be the really guilty parties. Bedford, O.

es they *guess* they make the holes, when we have shown over and over again that bees do not make the holes unless the skin is affected by rotten spots at first invisible to the naked eye.

I wish to call particular attention to the fact that there seems to be *one* large puncture in each grape of the shriveled specimen, and only one. In one or two specimens it will be seen the large hole is made larger by the constant twisting, squirming, and struggling of the bees. In the name of common sense, if bees can do their own puncturing why does not each bee make a hole for itself? But, no; you will see them all struggling at one hole—a hole that has been made previously by some other insect, or, as in this case, by man.

We shall have some of these struck off so that our friends who are met by the statement that bees puncture fruit will be in a position to give ocular proof that they do not; for, as



GRAPES HAND-PUNCTURED, AND AFTERWARD SUCKED DRY BY BEES.

[This is the old, old story. But here is a very good photo, and photos do not lie, showing that sound fruit, when placed right in among the bees, will not be molested, while that which has been punctured by outside agencies they will suck dry; and yet there are some, even among bee-keepers, who insist that bees do puncture peaches. They admit that they have never seen them do it; but from the fact they see them working on the peach-

I understand it, the sound specimens shown in the picture were put right among the bees and left there, with the result that they were untouched. Those that were punctured in the first place, and that had been subsequently sucked dry by the bees, would have been of no value, and therefore no financial loss would have been sustained. It is sound fruit in every case that is of value, and this the bees do not pretend to molest.—Ed.]



HOW SWARMING IS CONDUCTED.

"Here I am, down again to bother you with some more questions."

"Well, what is it this morning, Mr. Brown?"

"You will remember that, when I left you the other day, I went in a hurry because the blowing of the horn told me my bees were swarming."

"Yes, I know you got off about as lively as any fellow I ever saw, except one who has some bees in his hair. You left me without even saying why you were going."

"Well, after I had hived that swarm an old farmer bee-keeper came along and told me that, as only old bees went with the swarm, it was always best to give each swarm a frame of hatching brood on hiving them, so they could have young bees coming on as the old ones died off. Then he told me other strange things, among which was that the young queen emerged from her cell within 24 hours after the swarm left, so the young bees, left behind, would have some one to rule over them before they got wild."

"Did you believe him?"

"Well, hardly; but as I could not answer him to my satisfaction I thought I would run down a little while this morning and see what you thought in the matter."

"Up to within a few years I allowed natural swarms to issue as a means of increase, and have experimented largely during thirty years to know under what conditions swarms issue, as a rule, and have found, as regard to age of bees, that bees of all ages, in about equal proportion, leave the parent hive, from the old forager to the bee that has been out of its cell but a few hours."

"How do you know a bee which is an 'old forager' as you call the old bees?"

"They are very easily told by their lack of hair, darkness of color, and their jagged wings. Did you never look close enough to discover such in your hives?"

"Yes, I have often seen such bees with torn and tattered wings, and have often seen them with the swarm, but I had supposed that something had happened to them."

"There undoubtedly had, but nothing only what is the rule with old field bees during June and July. Very much of our white clover grows with other grasses; and in searching for the honey the bees hit their wings more or less against this other grass, so that, soon after beginning gathering clover honey, the wings of the older bees begin to be torn; for, the older the bee the more easily torn are the wings—very much on the principle that it takes a much less blow to bruise or break the skin on an old person's hands than it did while that person was in youth."

"I see; but how tell the young bees?"

"They are more easily told than the old

ones. Young bees, when they first emerge from their cells, are light-colored, from their being all covered with fine hairs, or down, which wears off and changes color as they grow older. Many and many times have I seen the ground in front of the hive nearly covered with bees so young as to be unable to fly, after the last of the swarm had got in the air, looking so white and feeble that a feeling of sympathy would come over me, and I would try to gather them up and put them back in the hive; but a little watching soon told me that they would all get back themselves, if a proper alighting-board were used so that they could travel back on foot."

"Since you speak of it, it reminds me that I have seen the ground covered with bees in the same way; but I thought that such bees had loaded with honey so heavily that they were unable to carry their load."

"If you had looked more closely you would have noted that they were not loaded nearly so heavily as multitudes with the clustered swarm. I am very sure that bees of all ages go with the swarm, so that each swarm is composed of field bees, wax-workers, and nurse bees, in about equal proportions, this showing that the allwise Creator knew how things should be when he pronounced good all which he had made."

"Then you think that a prime swarm needs no frame of brood to give them young bees?"

"Of course, the young bees from a frame of brood would materially strengthen the swarm; but such strengthening is not necessary; for, had it been, the swarms of our fathers would have perished—yea, and those since the foundation of the world, for no one ever thought of giving brood to prime swarms before the latter half of the last century."

"I guess you are right."

"Well, if you are satisfied on this part, let us suppose we are looking inside of a hive when preparations for swarming are being made, and see if we can not arrive at the truth in the matter as regards the conditions under which swarms issue, when the first queen hatches, etc."

"Can you tell any thing about such things?"

"Certainly; and so can you, if you study these matters. The first indication of swarming is the laying of eggs in the drone-cells. While eggs in drone-cells are not a sure sign that swarms will issue, yet, so far as I have observed, swarms never do issue without eggs laid therein. If the weather is propitious, the next step is the building of queen-cells, soon after which the queen deposits eggs in them. In about three days these eggs hatch into larvæ, and said larvæ are fed an abundance of food by the nurse-bees for about six days, when the cells containing the embryo queens are sealed over. If no bad weather has intervened, the swarm issues the next day, the old queen going with the swarm."

"Is this always the case?"

"Not always. But this is the rule with the black (or German) bee, and generally with the Italians; still, the Italians often swarm when the eggs are first laid in the queen-cells,

and sometimes without the least preparation at all except for drones, although this last is something very rare indeed."

"You spoke of the swarm issuing on the sealing of the first queen-cell. Surely she could not emerge from the cell 24 hours later, as the bee-keeper told me, could she?"

"All good authorities say that the queen larva remains seven days in the cell, as my experience also proves, and I can not conceive how any could make a mistake of six days, unless the swarm was held back by bad weather for six days from the time the cell was sealed. Should it be possible that any swarm was thus held back, then there might be such a thing as a young queen emerging from her cell 24 hours after the first or prime swarm issued."

"That seems plain."

"Yes. And that you may understand a little further I will say that I have found, as a rule, that the first queen emerges from her cell from six to seven days after the first swarm. If more swarms issue they usually come out two days after, or from the eighth to the tenth day after the first, and never later than the sixteenth day. As soon as the bees decide that no more swarms shall issue, all queens in their cells are destroyed, when in from five to nine days the reigning young queen goes out to meet the drones—two days after which, she commences to lay."

"I think I understand natural swarming much better than ever before, and I'll be going, as I see you are very busy."



STRAINING EXTRACTED HONEY; FOX'S METHOD.

Friend Root:—In reply to your request, p. 240, relative to clarifying honey, I beg to say I am not one of the *large* producers, but will compare my honey with the *largest* or the *best*, and, if agreeable, will give my method of straining and clarifying.

I have six large barrels holding about 600 lbs. each, arranged around my extracting-room on a strong bench, with heads out, and molasses-gates near the bottom. Each barrel is supplied with a *fine* cheese-cloth strainer tied securely over the head. I draw the honey from the extractor into an ordinary water-pail and transmit to these barrels through the strainers. This takes out the minutest specks. It is left in these barrels from one to six weeks according to the time in the season of extracting), when it is drawn off into 60-lb. cans, caps screwed down *tight*, and placed in cases, and securely nailed, ready for shipment. I have practiced this method for the past 18 years, and have never had a *word* of fault found.

A while ago I noticed quite a little in GLEANINGS relative to drones produced by virgin queens and fertile workers. Of course,

all bee-keepers know this to be a fact; but does any one know that such drones are fertile? I have never seen a word in print in regard to it. I am of the opinion that they are no nearer perfect than their mothers.

Hillsboro, Wis., Mar. 25. ELIAS FOX.

[I had the pleasure of meeting Mr. Fox at the last Wisconsin convention. For one who has been so extensively engaged in the business, and who knows so much about bees, he is very modest concerning himself. His method of straining his honey, and allowing it to settle, is not only simple but very effective, if I may judge from the reputation of the Fox honey. Your question in regard to drones is considered on the last page of our little book, the Dzierzon Theory. Since that book was written, others as well as Dzierzon have decided that such drones are virile males.—A. I. R.]

OLD COMBS FOR BROOD-REARING.

I think that, while W. T. Stephenson is sincere in his remarks, careful investigation will show him wherein he errs.

The idea that the cells get too small to raise full-sized bees is as absurd as it is erroneous. I can trace some of the combs in my yard, and in my best colonies, that are over 20 years old, and I do not know how much older. Are those bees any smaller than the other stock? No.

Now, I think there is one fact about bees that neither you nor Mr. Stephenson has observed. Bees, like all other creatures, change their physical condition and get "fat" and "poor" (thin) according to food conditions, and this fattening process does not necessarily enlarge the thorax. In going through my apiary when honey has not been gathered for a month I have often been struck with the thought, "Are my bees degenerating?" they seeming smaller in appearance than usual; but after a week's run of honey I am struck with the thought, "What fine, large, sleek-looking bees they are!"

I think friend Stephenson's bees, when they appeared larger, were working better than when he thought them undersized.

Baptisttown, N. J. W. W. CASE.

[I had not thought of the fact that there are times when bees appear very much smaller than at others; but repeatedly have I noticed that when bees were put into a mailing-cage they look large and beautiful; yet when those same bees have been confined for four or five days, or a week, they would look small and insignificant.

No, I can not believe that Nature has made such an egregious blunder (indeed, she does not make such blunders) that, in the process of time, the bee-cradles will become so small as to dwarf the size of the infants during their period of growth under the coverlet—the capping. I shall be much obliged if you will send me one or two samples of comb which you know to be at least 20 years old. These I shall be pleased to examine closely; and in the mean time I hope you will conduct this experiment: Put one of those 20-year-old combs in a brood-nest, and alongside of it

another comb one year old. Allow each to remain in the brood-nest until they have capped brood almost ready to hatch. At this time put each in a wire-cloth cage in the upper story of a strong colony, shutting out all the bees at the time of caging the combs. Now wait for the bees to hatch out. Keep the bees confined in those combs, and then ask an unprejudiced bee-keeper, who does not know any thing about the controversy, to give his opinion as to which bees are larger, if any. Let us put this matter clear beyond the possibility of guesswork or prejudice. After you have called the attention of various persons to the matter, send samples of each lot of bees in a mailing-cage to me, and at the time of sending these bees mail a card referring me to this issue and this page. We have micrometers with which we can measure to the ten-thousandth part of an inch. I will ask one of our men, who does not know any thing about this controversy, to measure the bees and see if he can detect any difference in the size of the thorax, or waist. I should be pleased to have any others who have any combs that they *know* to be 15 or 20 years old make similar experiments, and then send the bees on to me for measurement. At the time of sending the cages number them, but do not tell which bees are which. If I have any prejudice at all (and I think I have not) I wish to be in position to give the facts just as they are.—ED.]

TAKING ADVANTAGE OF THE SITUATION TO MAKE SALES.

A certain portion of J. C. Wallenmeyer's article on page 189 is open to criticism. If Mr. W. means his advice for just this season only, it does very well for those who actually have a short crop; but one would naturally suppose he meant it for all seasons and all places. You will notice Mr. W. says, "Tell the would-be buyer that the crop is very short, and that you would not have much to sell." I wish to say to Mr. W. that you can't catch birds with chaff. I have been a commercial traveler some six or eight years, and let me tell the bee-keepers the best way is never to misrepresent in order to make a sale. If Mr. W. would tell his customers his crop was short when, in fact, it was not the truth, he is not worthy the name of bee-keeper, saying nothing about being a salesman. AARON SNYDER.

Kingston, N. Y., Mar. 7.

[Mr. Wallenmeyer says:]

The above criticism certainly displays Mr. Snyder's wonderful ability as a sophist in thus construing (or misconstruing rather) such a plain statement as the one referred to. The readers of GLEANINGS can rest assured that the editor would never allow any article containing even the slightest fabrication to enter its columns. In proof whereof I will state I was asked, in 1895, by the editor to submit an article on making and selling honey lemonade at fairs. The same was rejected because I advocated the use of "large, heavy, 10-oz. thick-bottom glasses." Mr. Snyder has simply set up a "man of straw" and administered

"knock-out drops." Is there not a short crop in every State in the Union (except two) *this year*? Is not the article written for the present time? and does any one suppose it would stiffen prices, or increase the tendency to buy, if you inform the "would-be buyer" you have 5 *lons* of honey? If I have a large crop I keep mum; if a small crop, I use that information to advantage. J. C. WALLENMEYER.

Evansville, Ind., Mar. 20.

[I think Mr. Snyder, in view of Mr. Wallenmeyer's statement, will be very ready to acquit Mr. W. of any misrepresentation. Certainly we have a right, when the crop is short, to make as much of a handle of the fact as possible, and a bee-keeper would be a fool if he didn't. When there has been a short crop the price *ought* to be higher, and the only way to get it higher is to impress on the consuming public that what little there is must be sold at an advanced price.—ED.]

SWARMING WITH DEEP FRAMES.

My experience with the Jumbo hive last season was exactly the same as Dr. C. C. Miller's. My first swarm came from one of those hives. I have two of these hives I made myself. The only difference is, I made them eight frame instead of ten. Neither of them gave me any surplus. I experimented with two Dovetailed hives, one on top of the other, last season, with good results, one of them giving me 66 lbs. of comb honey. Mineral Springs, O. J. L. ELDRIDGE.

[Evidently it is not an easy matter to draw definite conclusions where results seem so contradictory. Possibly, advocates of large hives might say something like this: "Your eight frames with increased depth still left your hive quite too small to prevent swarming; for your hive was only about the same size as a ten-frame hive with the regular Langstroth frame. If you have a hive small enough, it will be difficult to get the colony strong enough to swarm; and this hive, being a little larger than the other eight-frame hives, allowed a stronger colony to winter in it, thus being sooner ready to swarm. If you want a hive large enough to prevent swarming it must be still larger."

If two stories did better than one, it is hard to see any reason why a hive having a capacity between the two would not be better than the one-story hive.—ED.]

A REMEDY FOR FERTILE WORKERS.

Last spring I found one colony queenless, and with one or more laying workers. I read all I could find on the subject, hunted for the pests, gave the colony frames of brood, young larvæ, and eggs, from other colonies, and also those containing queen-cells, but got only drones, drones, drones.

On June 19th I found an after-swarm bunched on a tree, and, not knowing where they came from, I removed the cover from the queenless colony's hive, turned up one corner of the quilt, exposing space between frames about equal to a hive-entrance, placed an

empty hive - body (without frames) on top thereof, and shook the after-swarm therein. Result—in two days the bees were all in the queenless hive—no fighting—removed empty body, and put on super. Later I took off 20 lbs. of surplus, and put a good colony away for wintering.

W. H. REED.

Canton, Minn., March 28.

[Shaking large bunches of bees from a strong colony into a hive of fertile workers would have practically the same effect. This can be done at any time here.—ED.]

BEEES AND GRAPES.

In your footnote on the above caption in *Beginners' Questions*, page 244, March 15, you offer the clearest and strongest evidence in exoneration of bees that I have ever seen. Let me quote: "Now, to convince yourself that bees do not make fresh incisions, I would call attention to the fact that three or four, yes, five or six, will be circling around one hole, sometimes standing on top of each other, all running their tongues down into the same hole. If they could make fresh incisions they would not crowd and jostle each other as they do; but each bee would make for itself a hole where it could work without being hampered in its efforts to extract the juices."

If any "candid man" will take pains to observe the operation to which you call attention he will surely be convinced that the bees are not guilty of puncturing grapes. The trouble is, people are so apt to jump at conclusions without sufficient (or any) investigation.

Birds, nearly all kinds, but especially English sparrows (and are they not found everywhere?) are the guilty parties. With us, catbirds and robins do a good deal of mischief, but they give us in return some very sweet music, while the English sparrow has no redeeming qualities at all. Better devote them to destruction, and protect the innocent bees.

JOHN T. SILER.

Berkeley Springs, W. Va.

OUR PREMIUM QUEENS, HUSTLERS.

Mr. Root:—You will remember my telling you last summer that one of my premium queens was superseded. The young queen proves to be an exact duplicate of her mother. I was looking the hive over to-day, and found brood in every one of the eight frames, every available cell being occupied, and without any spreading of brood, and plenty of bees to begin business in an upper story, which I added. I would not take five dollars for her to-day. She and her bees are "hustlers." They are all three-banded, yet slightly on the leather-color order.

ELIAS FOX.

Hillsboro, Wis., May 4.

THE ECONOMY IN THE USE OF A WAX-PRESS.

Your articles and illustration on the Hatch-Gemmill press, I think, are the best that have ever appeared in your journal. Six

years ago I rendered 100 lbs. of clean wax from 300 old and promiscuous combs. I pressed the wax out on a cider-press. Shortly afterward the question was asked in *GLEANINGS*, "How many Langstroth combs does it take to make 1 lb. of wax?" As nearly as I can remember, your correspondents made 1 lb. of wax from five to eight combs. I then was satisfied that they did not press their refuse, or made a very bungling job of it. I think the Hatch-Gemmill press is altogether the best and cheapest apparatus made for securing the largest quantity of clear beeswax.

West Bend, Wis.

H. P. AHLERS.

PROPORTION OF WAX OUT OF OLD COMBS.

From 15 lbs. of comb out of box hives I made 8 lbs. of wax; and from 8½ lbs. of refuse (out of which a neighbor had taken all the wax he could get) I secured 1¾ lbs. of beeswax. If the editor would like to see samples of wax and refuse I will send them to him free by mail. I do not know how old the combs in box hives were. The man who brought the combs to me got them when his father died in 1897, and his father kept bees for many years. I have been in the bee business nearly ten years, and I haven't any combs as heavy and black with cocoons as those were.

St. Anns, Ont.

HERBERT TREAS.

[You do not say how you rendered this wax; but I would assume that you used a press of some kind.—ED.]

UNITING BEES WITH PEPPERMINT.

Old bee-keepers will smile, I dare say, when they read how I unite two colonies. I just remove the cover from each hive, pour in a few drops of peppermint essence, cover up for 15 minutes, then remove the cover from the one I want vacated, and set the other on top; then I find them all in the upper hive in two or three days, and no dead bees.

Davenport, N. Y.

E. E. STEBBINS.

[But if I am correct old bee-keepers seldom have trouble in uniting, even without the peppermint. If there is any trouble, or liable to be, smoke will answer as well.—ED.]



C. W. C., Iowa.—Glucose is a very poor food for bees, and it is very seldom they will take it. It would be better and cheaper for you to give them sugar syrup, as described on page 28 of our catalog. There is more nutrient in syrup made from granulated sugar, for the money, than any glucose made, no matter what the price may be.

C. C., N. Y.—You ask how you can tell whether your box-hive colony is queenless; and, unless you are a pretty expert bee-keep-

er, you can not tell ; but you could do this : Turn the hive upside down, and then smoke down between the combs. If you can not see any capped brood, then the colony is possibly queenless. The better way would be to transfer this colony into a modern hive with movable frames. For particulars see our A B C of Bee Culture.

R. C., Mich.—In reply to yours of April 29 I would state that, in my opinion, you did not have foul brood, especially if the dead larvæ were white. This would likely be a case of chilled or overheated brood, or possibly poisoning. I should hardly suppose that the onion pollen would be detrimental ; if so, it would be the first case of which we have ever heard. Bees have been kept within the vicinity of onion-farms for many years, without any bad effect.

A. J. B., Texas.—I do not quite understand your question ; but if you mean that the bees cluster out too much in front of your hives, and you desire to get them to work, we would advise you to see that such hives are properly shaded, and that they be also given a good wide entrance—one inch deep at least, by the full width of the hive. It is sometimes a good practice to lift the hive clear off from the bottom-board, and put between the four corners of the hive and bottom-board a block $\frac{7}{8}$ inch thick, thus raising the hive $\frac{7}{8}$ inch higher on the bottom-board than it was before. This would make the hive cooler, so the bees will go in.

G. W., Fla.—Bee-paralysis is a disease that is very hard to cure. I would advise you to take all colonies that are thus affected and move them at least a mile and a half from the healthy bees. Remove the queen from each of the affected colonies, and give them a virgin from some healthy stock. If you have the bees to spare, and have only two or three diseased colonies, unite a healthy stock with every diseased one. The healthy bees will carry off the dead and dying, and in time may possibly effect a cure. But bee-paralysis is a very stubborn disease, and you should by all means get the affected bees away. For further particulars, see Diseases of Bees, in the A B C of Bee Culture.

W. T. G., Ohio.—To kill ants we do not mix any thing in molasses, as whatever is poisonous to the ant would be poisonous, also, to the bees. The method of destroying ants, recommended in GLEANINGS, is this: Find the nest, and, with a crowbar, make a hole right through the center of the hill, about a foot deep. Pour into this a teaspoonful of bisulphide of carbon, and then stop the hole with a plug of earth or sod. It is the gas permeating the galleries of the nest, that does the destructive work. This chemical you can get at the drugstore. A ten-cent bottleful will destroy a dozen ant-holes. If you can not get the bisulphide of carbon, use gasoline or coal oil ; but in that case use a larger quantity, perhaps a gill ; but the bisulphide of carbon is the best, for it destroys the ants, eggs, and every inmate of the nest. Be careful in handling this drug, and do not get it near the

fire, as it is very explosive. It should not be stored in a building where there is likely to be a lighted lamp.

ON THE USE OF VEILS IN THE APIARY.

R. C. M., Fla.—It is evident that you do not understand the position of ourselves and Dr. Miller. The writer very seldom puts on a veil when he goes out among the bees. There are only a very few of our colonies that will offer an attack ; but in the production of comb and extracted honey, a great many bee-keepers believe that a cross between the blacks and Italians is superior. Such bees are much crosser than the pure yellow stocks direct from Italy. It is always better, in such cases, to wear a veil, as one can work more rapidly, and with more comfort. But any one of these bee-keepers may work among the bees without smoke and without veil, and for hours and for days, sometimes, at a time ; and when bees are working strong in the fields it is sometimes a common practice to lift the veil up, and pull it down only when an obstreperous colony is encountered.

P. T., Iowa.—1. I can not explain why bees sometimes die in the hives, leaving plenty of good stores. As a general thing we may say the cause is too much cold or lack of protection. Sometimes a colony will eat all the food around it, or around the cluster, rather ; and, if the weather continues cold, they are not able to move the cluster over to the food, and, as a consequence, starve to death.

2. Moth-worms do not trouble strong colonies in modern apiaries. If you use modern hives with a dash of Italian blood in the bees, you will not be troubled with moth-worms.

3. Bees do not die for want of bee-bread in winter.

4. A good judge can not tell by the looks of a queen whether it is a good or poor one, although an experienced man can often tell an old queen from a young one. We can, however, very often judge of a queen by a glance at the comb that she has been laying in.

5. Queens often die without leaving a young queen. In that case the bees usually rear cells from eggs or larvæ left by the old queen.

6. Artificial swarming pays under some circumstances, but not when one desires to produce comb or extracted honey, and does not care for increase.

7. Yes, one can feed common sugar syrup—that made from granulated sugar is best.

8. There are some localities in the United States where bees do not have to be fed, as a rule ; but any locality is liable some years to have a scarcity of honey. In such a case the bees require to be fed.

9. As to the different kinds of honey-bees I would name a few of the most prominent : Blacks, Carniolans, Syrians, Cyprians, Holy Land, Tunisians, Egyptians, Italians.

10. The sugar honey, so called, tastes a little different from real honey from the fields ; but sugar honey must not be put on the market as honey, nor is it profitable to produce it. The nectar from the fields costs nothing, while the sugar itself does cost something.



NATIONAL BEE-KEEPERS' ASSOCIATION.

OBJECT:—To promote and protect the interests of its members; to prevent the adulteration of honey.

OFFICERS:—E. R. Root, President, Medina, O.; R. C. Aikin, Vice-president, Loveland, Col.; Dr. A. B. Mason, Secretary, 3512 Monroe St., Sta. B, Toledo, O.; Eugene Secor, General Manager, Forest City, Iowa.

BOARD OF DIRECTORS:—E. Whitcomb, Friend, Neb.; W. Z. Hutchinson, Flint, Mich.; A. I. Root, Medina, O.; E. T. Abbott, St. Joseph, Mo.; P. H. Elwood, Starkville, N. Y.; E. R. Root, Medina, O.; T. G. Newman, San Francisco, Cal.; G. M. Doolittle, Borodino, N. Y.; W. F. Marks, Chapinville, N. Y.; J. M. Hambaugh, Esccondido, Cal.; C. P. Dadant, Hamilton, Ill.; C. C. Miller, Marengo, Ill.

FEES:—Annual membership fee, \$1.00. Remittances may be sent here or to General Manager as above.

LET us not forget that the Italian bees seem to resist the attacks of black brood very much better than the native stock. Better make an effort to supplant the blacks by the yellows.

ON THE FLY.

As you will see, I am "outing" it among bee-keepers of the great South and West; and while on the fly I am trying this editing business "at long range," *a la* Hill. And speaking of *hills* reminds me that it is rather up-hill business writing copy with a pencil on my grip, and grip on my slippery lap. Then when the train at a 40-mile speed jerks and lunges this way and that, my copy is more horrible than can be explained.

HONEY-PLANTS BY THE MILE.

I HAVE been riding all day in Texas at the rate of 40 miles per hour, and yet I can't get out of sight of some of the great honey-plants of the State. First and foremost for quality and quantity is the guajilla, pronounced *wawhea*. The honey from this, so they tell me, is literally water-white. Next is the cat-claw, a low tree that looks like the northern thornapple. The honey from this is very fine and white. The mesquite is another honey-tree that looks like our willows at a distance. It furnishes a sort of amber honey, and would rank favorably with any Northern amber. But I'll tell more about these plants later.

A BEE-KEEPER'S PARADISE.

En route to El Paso.—I have just come from a county about 40 miles square that has more bee-keepers to the square mile than any other locality of its size I ever visited. The inhabitants talk bees at the hotels, on the streets, and everywhere, just as farmers talk crops and business in the North. This county produces more honey than any equal area, I believe, in the United States. Some say that its yearly output is a *whole trainload of honey*; but many aver that this is too low, and that two whole trainloads would come nearer the truth. Of course this great amount doesn't go all in one lot, but in large and small shipments.

The average per colony is high, and there

is a honey crop every season. It is estimated that in this one county, outside of the towns, nearly one-half the population are bee-keepers.

The great bulk of the honey is of the very finest, and some of it is literally water-white. There are thousands and thousands of acres of honey-plants on cheap land; and bees—there are not enough to gather it all.

The bees commence swarming early in the spring; and, *when the main honey-flows commence, actually stop swarming*, destroy cells, kill off the drones, and commence business. Did you ever hear the like of it before? You say, "No, and no one else." Well, I think I can prove every statement; but for the present I am not at liberty to give the place or other details; but very shortly I'll tell the whole story, with some fine pictures.

LONG-TONGUED BEES FOR THE SOUTH.

DURING my short visit through Texas I have run across two prominent honey-plants that have deep flower-tubes; viz., horsemint and the buffalo clover. Either one has longer tubes than those of the red clover of the North. If long tongues are an advantage on red clover, they certainly would be on the plants above named. Nearly all of the small bell-shaped flowers of the Southland (and there are myriads of them) have long tubes. Mr. Doolittle's implied assumption, or one he apparently tries to bolster up, viz., that long tongues would amount to nothing in the South and a large part of the North, simply because they have no red clover, seems to one who is making a tour of five or six thousand miles through the greatest bee sections in the United States as a little queer. If long tongues are an advantage to the bees in getting the nectar in deep flower-tubes (and I have not yet positively affirmed that they were) then the great Southland (and it is truly great), and the whole of the north country, so far as bee-keeping is concerned, will have made one step forward.

FOUL BROOD IN MICHIGAN.

The following from Geo. E. Hilton, the man who, more than any one else, got the Michigan foul-brood bill passed, will explain itself:

To the bee-keepers of Michigan:—So many letters are coming to me regarding the foul-brood law in Michigan that I will try through the journals to answer in a general way, and save myself valuable time at this hurrying time of year.

First, the law is in operation to-day, the inspector is appointed, and I feel very much relieved. I have made four trips to Lansing in behalf of the measure, and it required all the influence myself and others could bring to bear to secure its passage, its importance was so little understood. I have paid out about \$50.00 in expenses, to say nothing of the time I have donated, which would amount to as much more. And now I want the bee-keepers of the State to take advantage of and receive the benefits that may come from our efforts and the bill. I went to Lansing last week, spending a portion of three days, and succeeded in having John M. Rankin, our State Apiarist, appointed as our inspector, and I know of no one who can better attend to the work, or who is more worthy of the position. The work is under the management of the State Dairy and Food Commissioner, Hon. W. B. Snow, Lansing, Mich., to whom all communica-

tious should be sent. He is in direct communication with the Agricultural College, and will inform Mr. Rankin what is expected of him. We have but \$500 to use this season; but as the necessity of the work becomes apparent we shall be able to get more. The disease has an alarming foothold in our State, and it behooves every bee-keeper here to do his whole duty in assisting to exterminate this dread malady.

Trusting the above will make every thing plain, and save me many personal letters, I am

Very respectfully yours,

May 20,

GEO. E. HILTON,

Pres. Mich. State Bee-keepers' Ass'n.

Just after the above was put in type we received the following:

To the bee-keepers of Michigan.—I take this method of informing the bee-keepers concerning a few points in regard to the Michigan foul-brood law. A locality must be reported to the Dairy and Food Commissioner, Lansing, before it can be inspected; and as our funds are limited it would be a great saving if the bee-keepers would work with the Inspector by reporting all localities where foul brood exists, or where it is thought to exist, as soon as possible. If this is done it will enable the Inspector to plan a trip through the State, and cover the whole territory to be inspected at a much smaller traveling expense. Localities first reported will receive first attention; and those who neglect to report their localities until late will, in all probability, be obliged to wait until next year for assistance. J. M. RANKIN.

COST OF DRONE COMB.

PROBABLY the majority of bee-keepers discourage the presence of much drone comb. Just as probably the majority have a good deal more drone comb than is profitable. The bee-keeper who has supplied his bees with full sheets of worker foundation is not safe for all future time. Here and there a mouse will nibble a hole in a comb in winter, and by one means and another there will be holes that the bees must fill in, which holes will almost invariably be filled with drone comb. If no attention is paid to the matter this will increase from year to year, but the bee-keeper perhaps gives it little thought. If his attention is called to it, he will say, "Yes, there is some drone comb in most of my hives that have comb of any age, but it doesn't amount to much. There isn't an average in each hive of more than enough to fill a pound section."

Let us figure up the cost of a piece of drone comb of that size—4 inches square, or 16 square inches. Counting 18 cells to the square inch, or 36 for the two sides, 16 square inches will contain 576 drone-cells. Suppose only one brood of drones is reared, and that each drone lives 60 days: what will be the cost of those 576 drones? Taking the estimate that it costs .0141 oz. of honey to rear a drone, and that it consumes .00635 ounce of honey daily, it will consume in 60 days .381 oz. of honey, which, added to the cost of rearing, makes .3951 oz. of honey that each drone costs. Multiply this by 576, and you have 227.5776 oz., or 14.2236 lbs. of honey that it has cost to rear and support the drones from that piece of comb the size of a pound section.

"But," you say, "I don't stand all that expense, for I slice off the heads of the sealed brood every time I go over them, so I stand only the trifle that it costs to rear them."

Suppose we figure on that. Multiply .0141 by 576, and you have 8.1216 oz. of honey that each slicing has cost you. Remember that this cost has occurred before the cells are

sealed; and as fast as you slice off the heads of the brood a fresh lot will be started so long as there is a moderate degree of storing. Suppose you begin slicing June 1, and slice every two weeks, making the last slicing July 13. That will make four times, costing you a trifle more than 2 lbs. Don't you believe you could go over 25 colonies in a day, cutting out the drone comb and putting patches of worker comb in place thereof? That would give you a payment of 50 lbs. of honey for the day's work, to say nothing of the saving in future years. *Cut out the drone comb.*

DEEP FLOWER-TUBES — ARE THEY CONFINED TO RED CLOVER?

THE matter of the depth of the flower-tubes of honey-plants is an unexplored region. We know that red clover secretes a large amount of nectar, and we know that the tubes are too deep for the tongues of hive bees in general. That is about as far as our knowledge about deep flower-tubes goes. Without having made any investigation, there has come to be a general belief among bee-keepers that might be formulated in a few words: "All honey-plants have flower-tubes of such depth that bees can get all the nectar from them with the single exception of red clover." Red clover is set off in a class all by itself. Why is that belief so general? What ground is there for it?

Suppose one lived on a barren rock, who knew nothing of the vegetable world except by reading, and were told that some specimens of the vegetable kingdom grow to a height of 100 feet, and some are but an inch in height. Would he at once conclude that every plant less than 100 feet is only an inch high? Would he not be more likely to think that there might be specimens at different heights all the way from an inch to 100 feet? Why should he not judge the same way about flower-tubes?

We know there are flower-tubes within easy reach of bees, and we know of at least one kind beyond their reach. Why should we not expect to find every shade of length between the two?

These thoughts were suggested by the following, from Dr. C. S. Phillips, Waco, Texas, in *Southland Queen*:

At this writing they are bringing in some honey from primrose. The country is a beautiful carpet of it. We have examined it, and find that it secretes a great deal of nectar; but the shank is long, and the bees' tongues are too short to get much. So you see we need long-tongued bees.

In this case it seems that a large quantity of nectar is secreted, but the bees can reach only a portion of it. Is there any reason to believe that such honey-plants are confined to Waco, Texas? Is it not possible that there may be in most places, if not everywhere, some honey-plants with flower-tubes entirely beyond the reach of ordinary tongues, some with such tubes that only a small part of the nectar can be obtained, some in which occasional tubes are too deep, and some from which all the nectar can be easily gathered?

It would be unwise to make dogmatic assertions; but there may be nothing criminal in

asking the question, "Are you sure that the value of long tongues for red clover may not be less than their value for other plants?"

CLIPPING QUEENS' WINGS; WHY AND HOW.

ARE the queens all clipped? If not, why not? It's an advantage, particularly where bees are kept in thickly settled localities. Sometimes neighbors object to having the bee-keeper enter their premises when in pursuit of his bees. While he may lawfully pursue them, it will preserve better feelings if he has not go to do it.

HOW TO CLIP.

There are various good methods. A friend in New York says his hands are calloused, and it would not be safe for him to depend on the sensitiveness of his finger-tips to hold a queen by the thorax; so he picks her up by the wings with the left hand (thumb and fore finger); her majesty's wings are then in just such position as to be easily severed by a sharp knife, drawing it over the tip of thumb or fore finger, whichever way is handiest, letting her drop back on the comb or on the exposed frames.

By this method both or all wings are apt to be cut, and this friend cuts them quite closely, which has the advantage that such clipped queens can afterward much easier be found, having a snake-like appearance.

Another New York friend practices a different method. He picks up a queen by her wings as in the other case, but with his right hand, letting her grasp the thumb of his left hand with her feet. He then brings the tips of thumb and fore finger together vise-like, thus fastening or holding the queen by her feet. He then releases the wings and proceeds to cut any one wing or all of them, as he prefers, with a pair of scissors.

The writer has clipped a queen "on a run," sometimes; i. e., without holding her at all, simply by carefully lifting up one of her wings with one blade of a pair of scissors, and dropping it right there and then, while she was on the comb among her attendants.

When one practices clipping for a series of years he will be surprised how many colonies he will come across that have changed queens unbeknown to him. Half of the queens reared in 1899 were found superseded this spring in a large apiary in New York. We have had a similar experience in our yards. Unless a queen has been clipped, one can not be sure of her identity.

DR. MARTIN AND PAPER-COVERED HIVE-COVERS.

I AM pleased to introduce to our readers Dr. Martin, of Mercersburg, Pa. He is a bee-keeper who has been using paper-covered hive-covers for a good many years. One of these he sends that he has had in continuous use for 12 years. Although the paper is sound and good, some of the boards under it had rotted out. The paper he used in this case is what is known on the market as Neponset red-rope roofing-paper.

The secret of making this or any paper answer for covers, according to Dr. Martin, is cleating the cover all around where the paper is folded in such a way that the edges can not be torn up. On top are driven some large-headed tacks with washers. If such a cover



DR. G. M. MARTIN.

is thoroughly painted, at the start, and no sharp instrument is allowed to come in contact with the paper, it will probably last almost indefinitely.

A feature of the paper that is important is that it will take up a large quantity of linseed oil, and therefore paint applied to it will hang to it much more tenaciously than it would to the same surface of metal, or even of wood.

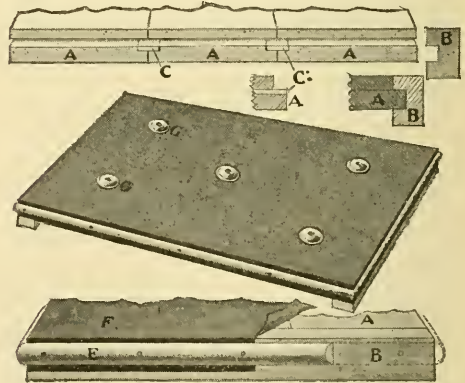

In the annexed engraving I present a sample of a cover made on Dr. Martin's plan. It is nothing more nor less than a flat cover made of one, two, or three pieces cleated all around at the ends and sides, as shown. Such a cover may also be made double (we have made them) that is, of two thicknesses, separated by quarter-inch strips of wood, dead-air spaces between, and then the whole covered with paper. I should imagine such a cover would be just the thing to suit another doctor, the M. D. at Marengo, Ill.

SWARMING PROBLEM SOLVED; THE INFLUENCE OF LOCALITY.

THIS trip, in many ways, has so far been a revelation and a surprise. More than ever I am impressed with the influence of locality. Some of the teachings in the ordinary standard text-books, viewed from the standpoint of some portions of this great, *great* country, seem more like idle tales than a sober statement of truth. Bees do many strange things in the "wild and woolly West" that they were never known to do down east. For example, what bee-keeper in the northern and eastern parts of our country ever knew his bees to commence swarming *before* the actual honey-flow, and then, when it did come on in real earnest, kill off their drones, destroy their cells—in short, stop swarming altogether, and get down to real business? Yet that is just what the bees in Uvalde Co., Texas, and Maricopa Co., Arizona, *do* do.

When Mr. D. M. Edwards, of Uvalde, Texas, told me of this as if it were a common trait among bees generally, I thought I misunderstood him. Said I, "Tell me that over again," and then he went on more elaborately to explain the same proposition. "Why," I exclaimed, with eyes all amazement, as if it were some sleight-of-hand trick, "tell me *how* you do it. I'd like to get hold of that trick," and I whipped out my note-book.

"No trick at all," he replied. "That's the way bees do down here."

"Wh-a-t?" I said. "How accommodating! Why, we poor fellows up north have been bothering our heads over this vexed and unsolved problem for years; and it is no nearer solution with us now than when we began. So it is literally true that you are not bothered with swarming when honey is coming in quite strong?"

He assured me for the third time that it was the fact. It appears that the early bloom yields just enough honey to stir up thoughts of increase among the bees, and then they swarm. When the heavy yields from mesquite, catclaw, and guajilla (pronounced *waw-hea*) come out, the bees conclude that they must quit their foolishness, and get down to business, which they do in two or three days, for they do not stop the swarming immediately. At this time it is not necessary to keep a man in the outyards longer.

When I got into Arizona I explained this queer phenomenon to the bee-keepers there, and was met with the calm statement that their bees were just as accommodating for them, "and," said they, "there's a lot more things in your text-books that won't work here at all;" and before I left the Territory I was convinced that they were right.

A good bee-keeper from the North, until he can unlearn some things and learn new ones, when he comes into these regions he is almost sure to meet with failure for the first year; and before he "gets on to" the Western notions, newly acquired, of *the very bees he brought south*, he is apt to be a sadder man, even if he is not a wiser one; and he is generally both before very long.

There is many another strange thing that I

have picked up that I will tell about in future issues; but for the present I must stop pushing my pencil, as the beautiful climate of Los Angeles that I have dreamed about these many moons is inviting me out—and, hark! I hear the footsteps of a bee-keeper just outside of my door. I gladly go to take in new sights, new beauties, and, perhaps, new and strange things.

RUNNING OUT-APIARIES FOR COMB HONEY.

THE principal difficulty in running out-apiaries for comb honey lies in the tendency of the colonies to swarm. This tendency is much stronger than when running for extracted honey. The greater amount of room, and the empty comb given the latter, seems to satisfy. Colonies run for comb honey must necessarily be crowded to produce best results, and swarms are likely to follow.

If we produce comb honey instead of extracted, as has been recommended, the apiarist must be prepared to meet the difficulty, and it will pay him to re-read the articles that have lately appeared on this subject in these columns.

It seems quite a number of bee-keepers in different parts of the land have hit on nearly the same method, unbeknown to each other, although, as Stachelhausen says, Gravenhorst, of Germany, was probably the first one who brought the method to a system and had it published. Gravenhorst's original management was, in brief, to draw on the weaker colonies for brood to make the already good colonies stronger; finally brush them from their combs, and give them empty hives. The gained brood-combs were used to make the next strongest colonies as populous as possible when they were brushed off also, etc. With a long continuous honey-flow this system may be all right, but *not so* with a honey-flow of short duration. As many colonies as possible should be brought into that prosperous condition, when they may be brushed off at one and the same time, and that time is at the beginning of the main honey-flow.

By the way, this method of brushing the bees from their combs, and putting them into empty hives (small brood-chamber) is a most excellent plan to treat such colonies as sulk or refuse to work in the sections. It seems to bring them to their senses.

Young swarms are nearly always fed for a few days after hiving, by the bee-keepers in Germany. We believe it is a good practice, particularly should it be rainy for a few days. Brushed swarms would come under the same head.

REPORTS that come from across the sea, from time to time, of bee-keepers' associations numbered not only by the hundred but by the thousands, make one wonder why in this regard the bee-keepers of this country should be so far behind. However, it is well to look on the bright side; and it is encouraging to know that there never was a time when the prospect was so encouraging for a large membership in the National Bee-keepers' Association. If not already a member, by all means send in your dollar.



What doest thou here, Elijah?—I. KINGS 19:13.
I pray not that thou shouldst take them out of the world, but that thou shouldst keep them from the evil.—JOHN 17:15.

I become discouraged sometimes. Several times of late I have had a longing to go away off to some other country. Yes, I have been so disheartened and discouraged that I have felt like saying to some of the people (I was going to say *good* people, but I guess I do not mean that), "If you are absolutely determined to have whisky, tobacco, gambling, and drinks all about you on every corner, I think we who love righteousness and hate iniquity had better go away by ourselves, and let you have things as you like them, without hindrance or restraint." And then I reflect that such things *have* been tried. People have gone off by themselves. They have put fences up, so to speak, to keep out the evil. But Satan gets through or over any fence that was ever constructed. The Christian people at Lakeside had quite a community where they could go and rest on the shore of the lake in their summer cottages; and that whole ground was under such strict police regulations that there was no profanity, no tobacco. They used to say with pride that no one could buy a cigar on the grounds. But pretty soon a fellow opened a cigar-stand on the other side of the fence, and did quite a trade by passing the cigars through the pickets and taking back the dimes and nickels. There *was* somebody who *wanted* cigars, even in that Christian institution. I do not know how it is going to be this summer, whether they will keep out the tobacco and such things or not. I hope they will not be weary in battling for purity and temperance, and I for one shall be glad to help them. Our own place of business is in many respects a model establishment. People come here and look us over, and sometimes they thank God for the privilege of even *looking* over a place managed with so much system and thoughtfulness for the wants and comforts of the employees. And yet sometimes I become impatient because things do not go on everywhere exactly after *my* fashion. May be I had better say after the *old* fashion. I hope the younger members of the firm will forgive me for just hinting at some of the things that are not just as *I* would have them—mind you, I do not *say* just as they *ought* to be, but because they are, perhaps, not just according to *my* notions.

It is customary of late for most periodicals to club with others; and publishers of magazines have been striving to outdo each other in their liberal efforts. Well, once when I came home from my travels I found the boys had remodeled the list of periodicals I recommended—yes, they had made startling offers to include some other periodical for the price of our own, or a little more than that. I remonstrated something like this:

"But, look here, boys; you have given great prominence to some periodicals that I do not consider at all standard, and some that I would hardly dare to recommend as home papers. Again, you have left out from your list entirely some of the agricultural papers that I read and endorse from beginning to end, week after week."

The reply was that they had made big offers on A, B, and C because they furnish them to us for premiums at an *exceedingly* low price, and that my favorite periodical was left out because it cost so much money.

There, friends, you see one of the prevailing errors of the present age. Even in the agricultural papers the cheapest is not the best by any means. No doubt merchants advertise certain goods extensively because they buy them cheap and can offer them at a low price and still *make money*, and so the regular standard goods (the *best* goods) are left in the background.

"But," said one of the boys, "what is your objection to *this* periodical?"

Then he unfolded its pages, showing me the pictures, clear print, etc.

"Is not that a nice paper? and is it not worthy of all the praise we give it?"

"Yes, boys, it is a nice-*looking* paper; but it contains articles on the cultivation of tobacco—tells young farmers all how to do it, *so as to make money*, without a single word in its pages in regard to the *terrible evils* that tobacco is bringing on us."

If I remember correctly, some of the boys laughed; but I think one of them said something like this:

"Why, father, you must not be so critical. It is a part of the business of an agricultural paper to tell how to grow all kinds of crops; and there is a great difference of opinion, you know, in regard to the use of tobacco."*

I presume he might have added, truthfully, that the majority of people—at least the majority of *men*, believe in tobacco, both in practice and theory.

"But, boys, *you* don't, any of you, believe in tobacco, either in practice or theory; and the paper I should have put at the head of the list, especially so far as recommending it as a *home paper*, you have not mentioned at all, just because it costs a little more money than the other." Now, I am going to speak right out in meeting just here, and say that the *Rural New-Yorker* will have nothing to do with the cultivation of tobacco; and, not only that, puts in wholesome cautions against things of this kind in almost every issue. I may be wrong in saying that the *Rural* is the *only* agricultural periodical that takes this stand. The Philadelphia *Farm Journal* comes pretty near it, and it is one of the cheap papers too. May God reward the publishers of these home papers, even if the farming people of our broad land do forget sometimes to give them

*At one time when this matter was up, one of the firm said, "Here is another thing: This paper you object to gives us more inquiries in response to our advertisement than any other one on the list." Then he picked up a record-book on a desk near by, that showed just how many inquiries each one of our advertising periodicals had brought in.

the encouragement they deserve in doing right.

Now, lest you think I am finding fault with the boys, let me say right here they always say, "Why, father, you go ahead and recommend any paper you think deserves encouraging words, and offer it to your readers at any price you choose." Our business is now getting to be so large that certain lines sometimes are neglected; and any one who notices the neglect sometimes takes the matter up, may be without inquiring about it of the one who formerly had it in hand.

This matter of periodicals is only one of several things that are not managed exactly as I would manage them if I had the strength of mind and body to take a bird's-eye view of *every thing* as I used to do years ago, but, as I have said or hinted, their way *may* be as near right, all things considered, as mine. Sometimes when I am very tired I begin to feel that, inasmuch as things will eventually fall into other hands, I had better not worry. And, again, it occurs to me that may be things might, in some respects, get on better if I were to go away, say to my Michigan ranch, and let the younger ones manage until they learn by experience, just as I have done.

Mrs. Root has sometimes asked, "Why can't the good people of a country have a nation of their own where they can put good men into office, and have the laws enforced, and keep entirely out those who love *only* iniquity?"

In the first place, dear friends, the very iniquity you seek in this way to avoid will very soon crop out in your own heart, especially when you get the idea in your head that, if you were alone on an island, like Robinson Crusoe, it would be an easy matter to have every thing pure and lovely. Jesus tells us in his own words, in the last text I have quoted, that it is not his will that we should retire from the world. I think he wants us planted here and there amid sin and crime, even though at times it does almost overpower us. A dear brother away off in California sends me a bright and encouraging letter which I wish to bring in right here:

Friend Root—Long have I appreciated your efforts to make your journal a Christianizing influence in the homes of the bee-keepers of this country; but your article, "Traffic in Girls," which wife read to us last night, has stirred me up to do at once what I have long desired to do—that is, write and tell you about it. I feel like giving you all the help and encouragement I can; but all I know to do now is by way of offering a few suggestions.

In those cases of stealing, I fear you did not lay the ax at the root of covetousness as you might have done. It seems to me that no man will be in much danger of being robbed in the way you speak of if he lays up his treasures in heaven, and not upon the earth, as the Lord taught us to do. Was it not covetousness in one man that led him to hide his treasure? and covetousness in other men that led them to steal it? Had the good man spent his surplus time and money in a loving and faithful effort to convert those around him, might not the very ones that stole his money have been converted, and have become a blessing to society, instead of a curse? Or, perchance, it was the covetousness of this or some other man who stood high in the church, it may be, that was one of the causes that drove those men into a life of crime.

But, be this as it may, is it not true that a pure and united church is the only remedy for all these horrible evils of which you so justly complain? Our blessed Lord prayed for the unity of Christians that the world

might believe. To be united to each other, we must be united to God through Christ our Lord, the source of all power, to convert the world around us. Now, it seems to me that covetousness and other sins tolerated in the church prevent the unity, damage the salt, dim the light, and hinder the conquest of the world; and so much so that many seem disposed to abandon the church as the means to this end, and a multitude of societies have sprung up that propose to do the work that the church was designed of God to do; while many, like yourself, feel that the strong arm of the law should be invoked to arrest the tide of evil which the church seems powerless to contend with.

But, my dear brother, should not the child of God appeal to the Father rather than to the arm of flesh for help against the enemy of all righteousness? God is the author of all good, our refuge from the storm, the source of our strength, and should we not honor him before the people by looking to him in every time of need? Is not the church God's great life-boat? and is not the law for putting it in repair in all our homes? Should we not then repair it, launch it, and come to the rescue of a lost, ruined, and suffering world? Christian homes will save the girls. But while Christian evangelists have degenerated into professional revivalists, parents turn over the religious training of the children to the Sunday-school, and Christians are not united to one another in Christ their head, can we hope for much improvement in this poor sin-cursed world of ours?

Yours for a united church and a faithful membership,
H. H. HAWLEY.

Madera, Cal., May 24.

Amen, Bro. H. Most fervently do I unite with you in praying that God may give us a united church—a body of Christian people united as one through Christ Jesus, our Lord and Savior. You suggest that, if the good man had used plenty of money in trying to convert those about him (laid up treasures in heaven, instead of here on earth), there would have been no temptation to rob him.

Most heartily do I indorse your closing sentences, dear brother; right here comes that glorious promise, "Blessed are they which do hunger and thirst after righteousness, for they shall be filled." Surely we who do hunger and thirst after righteousness ought to be united; and we can be united through Christ Jesus. May God help us in working together for that united church you speak of.

When I read this, I had a longing to go back to pioneer times and live *without* money. God knows I do not want much of it any way—certainly not enough to tempt anybody to murder me for it. But, dear friends, people can not be kept from suffering if we go without money. The manufacturers of our land, where they pay people wages every Saturday night, are a great blessing. But *somebody* must handle quite a sum of money on pay-days, and the banks must take care of this money.† By the way bank safes are now being blown up, and the bankers and policemen killed and crippled for life, it would not be strange if every one should want pretty good pay for accepting these responsible positions.

† May be this is not just the place, but I wish to insist right here that everybody be urged to stop keeping money around the house. Think of the robberies and cruelties that have been inflicted just because it became noised abroad that somebody had money hidden on his premises. Do not keep your money in your house or on your person over night. Put it in the bank. If you sell property and take money, let everybody understand that it is taken to the bank at once. Many people are foolish in this respect. Even if banks do fail once in a great while, it is a thousand times better to lose money in this way than to have some of the family murdered because of the folly of keeping money in the house.

Then another thing, my good friends: We must face the fact that *money* is not at the bottom of *all* these evils. It is painful to me, at least, to be obliged to revert to the subject I spoke of in my article—the traffic in girls. You may say, "Let these fiends in human form have the money." Shakespeare said, "He who steals my purse steals trash." You may let it go that way if you choose. You may say the loss of a little money does not disturb your tranquillity or peace of mind, and perhaps you have a right so to do. A few days ago \$20 worth of postage-stamps was lost, and I made quite a little stir about it. Finally it occurred to me I was making too much fuss about the loss of a little money; and so after having done all I could to locate the loss I dropped the subject and trusted God for the outcome. I did not care so much about the money. I cared more because I feared by heedless methods of doing business we might have tempted some poor soul somewhere to be dishonest. In a week's time the stamps came back of their own accord. Nobody had been dishonest in the least—only a little careless. Well, we may philosophically decide not to worry about money; but we are just beginning to discover (and may God help us) there are other things than money that men covet when Satan has entered their hearts. You can let the *money* go, and say you are only so much poorer. But suppose your little *girl* (or your *neighbor's girl*) has been spirited away by the ruffians—what then? No, no, dear friend; we can not, like Elijah, go and sit down under a juniper-tree and ask God to take us out of the world. Jesus said, "I pray not that thou shouldst take them out of the world, but that thou shouldst keep them from the evil." Bad men are getting into office, and they will just chuckle among themselves, if we do as Elijah did. God forbid. I know, dear brother, that sin seems entering everywhere. Even ministers of the gospel are forgetting their sacred calling, and are stepping down into a whirlwind of worldly things. The great college town of Oberlin has for years past been celebrated for its strict and almost puritanical ideas. I am told that just recently one of its professors joined in a game of cards on one of the electric cars, and kept it up during a trip of several miles from one city to another. No doubt some of you will say I am behind the times in thinking there is any thing wrong in this. Dear friends, it is something very different indeed from what Oberlin has been in times past; and I feel sure, too, that this professor will not particularly commend Oberlin to anybody as a place to send our boys and girls by such conduct as I have mentioned. May God help us in the conflict—a conflict we can not evade or dodge, especially if we profess to be *consistent* followers of Christ Jesus. And especially may he help us to work unitedly for that united church our brother has so well emphasized the need of, thus fulfilling the prayer of the Savior in the well-known text:

That they may all be one, as thou, Father, art in me and I in thee, that they also may be one in us.—JOHN 17:21.



FLORIDA TRAVELS, CONTINUED.

My next stop was at Mr. Bedell's, at Lake Helen. There are beautiful little lakes all around Lake Helen, as, in fact, there are almost everywhere else all through Florida. I can hardly believe there is another spot on the face of the whole earth where there are as many lakes of clean pure soft water as in Florida. The shores and the bottoms are mostly pure clean white sand—so clean that if you wade along the pebbly brink you do not even make the water muddy—at least a great part of them are like this. Mr. Bedell has all sorts of fruits and flowers, and a very pretty little place withal. Mrs. B. said that, as I seemed to be hunting up fish-stories, her husband had one to tell. One day a fish-hawk dove down into the lake close by their home, and brought up a fine large fish; but before he had got very far away an eagle, that had been *watching* to see what "luck" the hawk would have, pounced down on him, and, after a squabble in the air, the fish was dropped. Instead of falling back into the lake it dropped into Mr. Bedell's garden, and they had a very nice fish for dinner.

As one of the principal points of interest in that locality, Mr. Bedell took me over to the Stetson plantation at Deland, some five miles away. We rode in a brand-new buggy that Mr. Bedell said he ordered from one of the carriage-makers who advertised in GLEANINGS. That vehicle certainly *did* do us excellent service, especially when a cold rain caught us. Stetson is one of the Florida millionaires—at least they call him so. He is the founder of the Stetson institute or seminary, at Deland. I was invited to visit this great educational institute, but I could not spare the time. I wanted to see the great orange-sheds and pineapple-sheds of that locality. We found orange-trees inside of these inclosures, perfectly protected from frost, and bearing loads of great luscious fruit. These sheds have to be kept under lock and key; and, even as it is, they are troubled more or less from vandalism. The sides are simply a tolerably tight high board fence—sometimes 18 or 20 feet high. The roof is covered with movable panels. Various devices are used by different orange-growers for opening and closing the roof. They do not even try to have the whole thing so it will shut up air-tight. Many experiments have shown that this is not advisable. In the neighborhood of Deland, however, it is found necessary to have the roof so it can be opened during warm days, to give sunlight and air; and when a frosty time comes, these openings are pretty well closed. Then piles of firewood are located all through the shed. Sometimes a sort of rude stove keeps the wood from getting scattered about where the heat might endanger the trees near by. Unless a certain amount of ventilation

is allowed through the roof, the smoke and heat might do more harm than the frost. I can not just now be real sure, but I think I was told the most efficient apparatus (overhead), considering expense and every thing else, was panels made of boards to be moved back and forth by two men, one standing at each end of the panel. In this case the roof, of course, must be substantial enough so that men can walk over it when handling the panels or shutters. While cotton cloth is used by a good many, there is quite a disposition among other successful men to declare they do not want any more cloth flapping in the wind, getting torn, and subject to decay, etc.

I have already described the pineapple-houses, and pictured them. They are a good deal after the same plan, although in these further north, at Deland, for instance, the openings between the slats must be closed, or partially closed, during very severe weather. We obtained permission at the office to look over the grounds. I can not tell you of all the beautiful scenes we saw during that one afternoon. At one place there is an alligator-pond with a big stout iron fence around it to keep the great reptiles from wandering away. Friend Bedell said he was going to get over the iron fence in order to get a closer view of the "animile." After cautiously keeping one hand on the fence we leaned over the stone abutment, and, sure enough, down in the clear water close by our feet was a motionless creature larger than any horse. It began to rouse up and move along the bottom of the pool, and just then I began making tracks for the fence. Friend Bedell assured me there was no danger. While the foreman of the ground was taking us from one interesting point to another I asked quite a good many questions as usual. Finally he turned to friend Bedell suddenly, and said:

"What name was it you called that man by just now?"

"I called him Root."

"Why, dear me! is this really Mr. A. I. Root whom I have been showing around, and who has been asking me all these questions? I looked at him several times, and was actually wondering what Yankee it was that wanted to know so many things, and also seemed to know quite a little himself."

Then he asked us if we had visited the little greenhouse. We told him we did. He asked us if we saw his particular pet right overhead in the peak of the roof. Neither of us remembered seeing it. You see we went into the greenhouse before we found the foreman; so we started back to the little greenhouse, or conservatory, perhaps I should say. Then for the first time I raised my eyes, and looked overhead. As I did so we both uttered exclamations of surprise and delight. It was a *Bougainvillea Sanderiana*. The vine started in one corner, and sent up a bare trunk like an old grapevine. This ran along without flowers or foliage till it was clear up in the peak of the roof. Then it spread out and made such a display of beauty and brightness as only the bougainvillea can make. A plant I saw in Bermuda covered a house with such a

mass of startling brilliancy as to call forth exclamations of pleasure and surprise from the passerby who was a *whole half mile* away. Now, that is not any "fish story." The first one I saw in Florida was in a garden near the Royal Poinciana. I saw a very pretty one last fall at the Ohio Experiment Station. A year ago last winter we purchased two plants at 15 cents each, to put in our little greenhouse. In the spring we set them in the open ground, and they made a great mass of green foliage, perhaps six feet across, but no bloom.

We moved them into the greenhouse, and succeeded in getting them to live without shortening any of the branches at all; but we carried along a great lot of dirt with them. During the latter part of the winter they were growing luxuriantly—great masses of green, but no sign of flowers. Those who knew, however, told me not to worry—in due time I would get my reward. Some time in March, little white blossoms began to show here and there, and a little later some leaves or bracts began to appear around the insignificant bloom, these new leaves or bracts gradually taking on a rose-colored hue; and they kept getting brighter and larger day after day and week after week. During the middle of April these two plants were the center of attraction, and they have been getting brighter and more fascinating all the time. The word *animated* seems to hit it better; and, no matter how dull I may feel (yes, I feel dull and tired sometimes), this bougainvillea always gives me a start. I feel like saying out loud, "O you precious bright little darling!" So many people have wanted just one little sprig of the brilliant plant that it has now been pretty well robbed of its luxuriant beauty. But still as I write this, June 15, it is just as brilliant, what there is of it, as it ever was. I can not understand why this wonderful and magnificent vine is not oftener seen in the greenhouses of private residences. So much for the bougainvillea.

Then the foreman said we would have to go into the house and see his wife. Her father is a bee-keeper away up in the North, and he takes (or did take) GLEANINGS. While looking about the various objects in the beautiful home I picked up a fine piece of porcelain painting. The lady of the house remarked, "O Mr. Root! I especially wanted to show you that picture. I suppose you know what it is."

"Why, it is the most beautiful painting I ever saw, of John Alden and Priscilla—at least that is what I should call it."

"Well, do you remember my husband's name is Alden?"

Sure enough, that was the name friend Bedell mentioned when he introduced us. The lady resumed:

"Well, *we* are descendants of John Alden;" and then there was a pleasant surprise all around. Dear friends, it may not be of any great moment who our ancestors were away back; but it is of great importance that we hand on down to the coming generations a character and a heritage that can be spoken of with pride *long after* we are dead and gone.



GINSENG AND ITS CULTURE; NOT SO DIFFICULT AFTER ALL.

Oh dear me! when shall I ever be old enough to cease making blunders? I felt so sure my ginseng plants were all dead I did not even mulch them last fall. After they died in the latter part of the summer or early fall, I left the slatted frame over them (to give them the right amount of shade), and paid no more attention to them all winter. Well, on May 14, imagine my surprise to see a good thrifty plant right over the spot where every plant died last fall. In fact, I think they will all live, with the exception of one plant, which was thrown out, root and all, by the frost. The fact is, my *treatment* was all right, and my *plants* were all right; but I was not sufficiently acquainted with the "critter" to know that its habit was to cease growing and die down so early. I think now I shall have to apologize to the ginseng advertisers so far as the plant being very difficult to grow is concerned. I was almost as bad as the Irishman who insisted that the mud-turtle was dead after its head was cut off. When they told him it was certainly alive because it was crawling around, he replied, "The craythur is dead, without any question, but he does not, as yet, seem to be *sinsible* of the fact."

COMPOST-HEAP FERTILIZER.

Year after year the most effective fertilizer we ever got hold of (not even excepting stable manure) is that from our compost-heap. We have tried it on strawberries, squashes, potatoes—in fact, all sorts of crops; and wherever this compost-heap is put out and plowed under we get the biggest crops. It is a heap of trash not far from the kitchen. All weeds and useless trash from the garden are piled on this heap; all slops from the kitchen are poured on with the other stuff; every thing that we wish to get rid of that will decay is dumped here. I sometimes almost have to quarrel to get the boys to stop putting on broken glass, crockery, brush, and the like. Well, this pile is allowed to grow until it begins to give off traces of unpleasant odor. Then we load it on a wagon, spread it out on some piece that is to be plowed, and turn it under. Several times I have thought I had got hold of a new variety of strawberries, potatoes, Hubbard squash, or something of the sort; but afterward I remembered that this plant with such wonderful vigor grew where we turned under the compost-heap. A great many times squashes, potatoes, and other vegetables come up self-sown where this heap is spread; and they have such remarkable vigor the boys hate to kill them, and hence let them grow. Then we have a great crop of something—a dozen big squashes on a single vine, a great lot of large potatoes as the product of a single sprout, and such like things. By all means have a compost-heap, and you will find it like money in

the bank, besides helping to keep things tidy around the premises.

THE RHODODENDRON.

Something more than twenty years ago a rhododendron was planted in our old cemetery, and I confess that for years I had forgotten it. But this morning, before breakfast, one of our men who lives near the cemetery came to the door with a most beautiful cluster of great purple blossoms, much like the azalea I have just been talking about, and asked me if I could tell the name. I replied at once:

"Why, Mr. K., you have got a most beautiful cluster of blossoms of rhododendron. Where in the world did you find it?"

"It is growing over in the old cemetery. It stands almost as high as your head, and I think there must be toward a hundred clusters of bloom, each one fully equal to this one I have in my hand."

You may be sure I got on my wheel, and in a little time went down to see it. There were 52 clusters, by actual count. The plant is worth going miles to see. We have one in our front yard, on the north side of our house, so as to be in the shade during the hottest part of the day; but it is not yet quite in bloom.

There has been considerable discussion as to whether a rhododendron is hardy enough to be left outdoors unprotected. Storrs & Harrison informed me that, if placed in partial shade, when once established they will live for years. This one at the cemetery is shaded during the hottest part of the day by some large forest-trees on the south. It is true, these beautiful growing plants cost quite a little to start with. I think they are quoted in the catalogs now at from 50 cents to \$1.00. When you get one established, so it will stand, blooming every year for twenty years or more, the cost per annum is almost insignificant. They remain in bloom quite a long time. The clusters and flowers are considerably larger than those of the azalea; and the foliage makes it a very handsome plant, even when not in bloom, for it is really a magnificent flowering evergreen.

AN IMPROVEMENT ON MY TRAP NEST.

Mr. Root.—I inclose a plan or model for a trap nest founded on the automatic nest you showed us on page 410. I think this catch would be an improvement over the one you suggested. Yours is the best trap nest I have seen, though I have plans for one that cost me a dollar. One thing to be remembered about your nest is, it must either be set under a platform or a cover provided, or the hens will get on top of it and close it. No cover is needed when used as an automatic nest, as it will open as soon as they get off. This catch, as you see, can be turned over on top of the nest, and instantly changed from a self-operating to a trap nest.

Bellton, W. Va.

R. C. HINKLE.

I will explain the model as follows: In order to make the nest so it will not rise up and let the hen out when she steps out of the nest, get a strip of wood say 2 feet long. Hinge one end at the corner N (see page 410). When used as an ordinary nest this strip lies flat down on the top of the nest, say along the line E. When you wish to trap the hen, throw it over so the loose end will rest on the ground.

This end catching on the ground will prevent the box from rising up when she steps off the nest. This device is probably cheaper and simpler than the arrangement I proposed, of having a piece of iron on the shelf C, that will drop off when the nest is shut down. By the way, I have learned that a box or basket does not need to be arranged so as to rise up very far. If it tilts easily the hen will soon learn to put her head under the edge and raise it up. In fact, they will exert quite a little force in order to get into the nest when you wish them to stay out. A sitting hen, for instance, will get in by some hook or crook almost in spite of you. My experience thus far convinces me it is exceedingly important to weed out the unprofitable hens. We have two White Plymouth Rocks that look so much alike it is almost impossible to tell one from the other, and yet one lays three times as many eggs as the other, and keeps it up right along. Without a trap nest we are blundering in darkness, not only in getting eggs for table use but in getting eggs to hatch from our most fertile layers.

OUR THREE SITTING HENS.

They hatched out 26 chickens, and not one of the 26 was lost. They are now six weeks old, and fully feathered out. It is no more than fair, however, to say that *Mrs. Root* took care of them. She was raised on a farm, and knows how to manage not only chickens but their *mothers* also. I did not know before what a wonderful amount of vitality a chicken has. When ours were three weeks old they ran through the wet grass from daylight till dark, during all that long cold rainy spell, and they just flopped their wings and had fun, rain or no rain. Of course, *Mrs. Root* kept them well fed (all they would take) with a good variety of nourishing food.

VALUABLE SECRETS, PROCESSES, ETC., OBTAINED BY SENDING A CERTAIN AMOUNT OF MONEY.

You see, friends, I have not become discouraged yet in thinking I may some time get hold of something really valuable in answering advertisements relative to wonderful secrets. The last one, I found in the *Agricultural Epitomist*. It reads as follows:

SECRETS OF CANNING WITHOUT CHEMICALS.

By sending A. D. Hursh, Supt. of the Springfield, Illinois, Canning Co., one dollar, families will receive instructions for canning all vegetables and fruits by proper application of heat on the kitchen stove. All goods will keep fresh, whole, and delicious for years. Mr. Hursh uses this formula in his factory work.

Off went the dollar. The advertisement does not say so, but I rather expected to get some sort of book for a whole dollar; but after considerable delay I received the following letter:

CANNING WITHOUT CHEMICALS.

The formulas that I give below are taken from the recipes that I use in my factory work in canning all vegetables and fruits. Persons who follow the directions given herein will be delighted with results, for the goods will keep delicious, whole, and fresh, indefinitely. In canning fruits and vegetables I recommend the use of tin cans whenever possible, for three reasons: First, the soldering makes them more secure from leaks; second, they save time; third, they protect the goods from the light at all times, thereby preventing

them from losing their color and flavor; and by using your solder-iron to melt the solder around the lid, and following it with an awl or stiff knife under the lid, the can can be taken off, the can emptied, dried inside, and saved for another year. When tin cans are used, it will be necessary to use solder for soldering the lids on, in place of sealingwax used in ordinary canning, for the reason that all goods when hermetically sealed will swell or bulge at both ends after they are in boiling water long enough to cause the steam and gas to rise from the goods in the can. The solder is put on with a hot copper tipping-iron; and in order to make the solder spread and follow the iron, it is necessary to use a little flux or acid in the groove after the lid is on the can. The flux is made thus: Get a pint or more of muriatic acid, put it in an earthen vessel, and set it out of doors. Put into the acid all the zinc it will cut. When it quits sizzling and gets cold it can be diluted with water one-half. Then it is ready for use. Apply with a small brush in the groove of the can after the lid is on. Get a 3-lb. copper tipping-iron at the hardware store. The iron must be kept tinned so the solder will follow it around the lid.

TO TIN THE COPPER-IRON.

Heat the iron very hot in the stove, so it will sizzle when stuck into the flux. Take the iron out of the flux and rub the point and lower part with solder. Repeat this process until the solder sticks to the iron and looks as bright as silver; then it is ready for use. When the tin becomes burned off the iron by constant use, the tip of the iron may have to be filed down to a point, and till the copper shows bright, then tin again as before.

HOW TO SOLDER.

Punch a small vent-hole in the center of the can-lid, with an awl. Put the lid on the can, apply a little flux or fine rosin around the groove of the can. Take the iron in the left hand; apply the solder to the iron with the right; move iron around slowly in the groove of the can; keep the point of the iron well in the groove. If the iron is hot enough the solder will flow freely, and follow the iron around till it flows together on both sides. After the groove is filled with solder, and no pin-holes remain, tip the center (or vent) hole in the lid, and the can is ready for the process, or hot water.

RECIPES FOR CANNING.

We are now far enough advanced in the business to do some canning, and so we will proceed to can a gallon of sweet corn in quart tin cans. The amount of ingredients used in this gallon may be increased or diminished in the same proportion, according to the amount of corn used at one cooking. The corn should be taken fresh from the stalk, when it is in the milk. Cut the corn from the cob; scrape the cob with the back of the knife, to get all the juice; put the corn into a porcelain or tin kettle. To each gallon of cut corn add 8 ounces (one cup) of granulated sugar, and 4 ounces (half a cup) of salt, and one quart of water. Heat and stir all together until the sugar and salt are well dissolved, and the milk curdles in the corn, or just before it strikes the boil. Now dip this hot corn out of the kettle, into your tin cans. Fill the cans within half an inch of the top. Solder the can air-tight at once. Have your wash-boiler two-thirds full of hot water; put the cans into the water at once, and process 30 minutes from the time the water begins to boil; then take out and keep in a cool dark place till used. The cans must be kept at least four inches under water while boiling. They will have to be weighted with a board and brick. Note—it will be well to remember that corn, pumpkin, and peas must be kept hot from start to finish. They must be put in cans hot—sealed hot—and put into hot water at once, and processed the required time.

TO CAN PEAS.

Pick the peas before they get too hard. Hull them, put into a pan, pour boiling water over them, and keep them in it three minutes to blanch them. Dip them out of this water with a strainer-dipper into the cans. Fill the cans within an inch of the top. Have boiling salt water ready, made from one cup of salt to one gallon of water. Pour this, boiling, over the peas in the can till they are well covered, or nearly to the top of the can. Now solder the cans air-tight, and put into the boiler of hot water the same as corn. Process three hours.

TO CAN PUMPKIN.

Cut in small pieces. Boil in a pot with a tight lid until mushy. Add water to keep from burning. After they become soft, add boiling water, and mash in potatoes, which will thin enough to dip into cans. Fill the cans nearly full; seal air-tight; put into a boiler with hot water, and boil two hours from the time the water begins to boil.

TO CAN TOMATOES.

Scald the tomatoes just enough to take the skin off. Take out the cores with the point of a knife. Put the tomatoes in the can whole. Press them down gently till the can is well filled. Seal air-tight; put in a boiler of hot water, and boil 30 minutes from the time the water begins to boil. Take out and keep in a cool dark place.

TO CAN STRING BEANS.

Take the strings from the beans. Place them in cans with the fingers till the can is well filled; then fill the cans with boiling salt water (same as peas), seal air-tight, place in a boiler of hot water, and process one hour from the time the water begins to boil. To have nice tender beans they must be picked before the beans swell the pod.

TO CAN ALL FRUITS.

To can fruit, care must be taken to cleanse it of all rotten, green, and sour specimens, before canning. Fruit can be put up in plain boiling water, or in a syrup made of 2 lbs. of granulated sugar to one gallon of water. In either case the berries are put into cans, and the boiling syrup poured over them till the can is nearly full. Seal air-tight, place in a boiler of hot water, and use time according to the following table: For all berries, cherries, and grapes, 10 minutes from the time the water begins to boil. Apples and pears, pared

and quartered, 40 minutes from the time the water begins to boil; peaches, 20 minutes.

FOR CANNING IN GLASS JARS.

In using glass jars for canning, the same time is to be used as for tin cans; but the first half of the time the rubber must be left off, the lid screwed down only part way, to allow the gas to escape. The water in the boiler is to be within 3 inches of the top of the cans. After the first half of the time is exhausted, put the rubbers on, screw air-tight, add hot water till the cans are covered 4 inches, and proceed with the last half of the time. After the cans are taken out of the boiler, set them with the top end down, on white paper. If any show leaks, screw the lid tighter or press putty where the leaks are.

Very likely our friend thought if he got dollars enough he might have his directions *printed*. Perhaps I was the only fish that bit at his bait. I hope so, at least. Well, if he could not afford to print it I have done so for him. Let me see: If it goes to ten thousand different readers, and it is worth a cent to each one of them, I shall get back (or, rather, you will get back) \$100. So far as I know, the directions are all very good—that is, if any one wants to fuss to put up fruit and vegetables in this way when he can buy cans of tomato, corn, etc., at 10 cts. each, or three for a quarter. The whole thing illustrates the folly of undertaking to do work at home so as to compete with a canning-factory. It gives one the impression that "the Springfield Canning Co." must be a very small, one-horse concern.

Temperance.

We are glad to give place to the following:

ANTI-SALOON LEAGUE PAN-AMERICAN BUREAU OF INFORMATION AND LOCATION.

Comfortable rooms with reliable Christian homes can be secured through the League Bureau within easy reach of the exposition grounds at reasonable rates.

A corps of uniformed cadets, wearing the Anti-saloon League badge, will meet at depots and League headquarters all of our church and temperance friends, who by correspondence have secured rooms in advance through our Bureau.

The Anti-saloon League Encampment, or village of neat and attractive tents, floating the Anti-saloon League banner, will be a unique feature for accommodating those who prefer a cool tent to a hot room.

One large tent will furnish a delightful meeting place for social and public occasions.

Persons desiring to make definite arrangements for rooms or tents in advance, will please write promptly, enclosing postage for reply.

JOHN F. BRANT,
Supt. Buffalo District.

309 D. S. Morgan Building, Buffalo, N. Y.

We are pleased to note that the Anti saloon League of the United States is going to be on hand at the great exposition, and look after temperance matters and the enforcement of temperance laws. We have just received the following:

Evo. Root.—Will you kindly make note in your excellent magazine that the New York Anti-saloon League and the Pan-American Exposition, Rev. John F. Brant, Supt. for Buffalo District, writes that arrangements are completed for holding a Pan-American Anti-saloon Congress in Buffalo, July 19–21. Speakers and workers of national reputation will address the various sessions of the congress. Buffalo has been getting ready by outlawing 55 concert saloons. The Buffalo Anti-saloon League leads in this crusade.

JOHN F. BRANT.

If you do not know, dear friends, how pleasant it is to meet with somebody who loves righteousness and hates iniquity (as you do), amid a great crowd at a national exposition, I can assure you that I do. Many times when

I have felt myself alone, and have begun to get homesick in a great crowd of unsympathizing people, it has rejoiced my heart, and made me breathe praises to God, to find somebody who could introduce me to those who love temperance, purity, and every thing that is good. May God be with the temperance people of our land as they work together to keep back the foe.

Here is something still later:

The Buffalo Anti-saloon League is making a vigorous effort to combat all forms of vice growing out of the saloon traffic during the Pan-American Exposition. It has met the concert-saloon issue, and won out before the city council, forbidding the issuing of any more concert-saloon licenses; it has even compelled the midway exhibitions to modify their performances by conforming to State laws and city ordinances. The League will be on guard day and night, with 100 churches and the best business men and professional men of Buffalo back of them.

The League Bureau of Information and Location is undertaking to direct Exposition visitors to safe and reliable Christian homes. Their office is 309 D. S. Morgan Building, Buffalo, N. Y.

JOHN F. BRANT, Supt.

While I am about it, let me mention another encouraging thing which I copy from the last *American Issue*:

MORE RAILROAD PROHIBITION.

A press dispatch from Frankfort, Ind., May 10, states that the Clover Leaf Railroad Company has issued a general order prohibiting its employees entering saloons at any time, either on or off duty.

The order also prohibits employees of the road from boarding or rooming at any place with which there is a bar connected directly or indirectly, and states that any violation will bring instant dismissal.

The order with reference to boarding-houses will affect fully 1000 men.

There is little danger of accidents from drunken employees on a road that has taken an advanced stand like this.

GOOD FOR CHICAGO.

"Grapho," in the *Advance*, says:

We have often heard that Chicago is a "pig-sticking" city. It is in order now to remark that one of our great packing-houses, Swift & Co., has put up a placard which says: "No profanity permitted in this house." Some of the big publishing houses, which are not sticking pigs, and which pride themselves on their literary taste, would do well to hang up a similar placard. They should not be less refined than a packing-house.

While reading the above I was wondering if it would hit anybody in our printing-office, and I drew a breath of relief when I decided, at least in my own mind, it would not hit any of our people—at least not while they are on our premises; and I hope and pray that it does not hit them anywhere.

Special Notices by A. I. Root.

THE DARLING STRAWBERRY.

This variety is ahead of all the rest in the matter of ripening, as usual, and this year it has given me one of my happy surprises in having almost every plant loaded with fruit. In fact, there are no plants on our grounds that have more berries. And, strange to tell, they are old plants that were moved from another bed some time last July.

A TEN-CENT BOOK ON GINSENG CULTURE.

It is quite refreshing to get a nice little book at the above price—a book containing modest and moderate statements—after the exaggerated figures we have had from other growers, and exaggerated prices, not

only on seeds and plants, but books also. This little book is fairly well illustrated, was issued in February, of this year, by J. W. Sears, of Somerset, Ky., and it has a *date* on it. A good many of these high-priced ginseng "books" have not even a date to tell whether they were printed during the current year or ten years ago.

THE DZIERZON THEORY.

I do not know but it is a pretty good thing that I am obliged to read all the proof before GLEANINGS goes to press since Ernest is away. Well, for some time back I have been feeling that most of our journals have been giving place to the discussion of questions that were pretty well settled years and years ago by long and laborious experiment. When GLEANINGS was started, every bee-keeper in the land was more or less familiar with the Dzierzon Theory; and they were forced to admit, too, that, although this little book is quite old, very little that is found in its pages has been found to be incorrect. Now, I do think every bee-keeper of the present day ought to read through, at least once in his life, the Dzierzon Theory. It is the cornerstone and solid rock upon which nearly all we know about bees is based. The little book is only 10 cents, postpaid. If any one thinks the price is too high I will take the responsibility of putting it 5 cents. We do not care whether we make money out of it or not; but we want the people to read it.

OUR ANEROID BAROMETERS.

Two troubles have met us in selling the small-sized instruments we have for years had for sale. We have been sending them by mail; but where the mail-bags are thrown or banged about, the instruments are very likely to be out of order when received; therefore we have decided hereafter to recommend in all cases having them sent by express. The charges will be seldom more than 25 cts. Another thing, we have heretofore used the smaller-sized instrument in order to lessen the expense of postage. After having carefully tested the different sizes we find rather more satisfactory work from the larger size, costing \$3.50 instead of \$2.50 as heretofore. These larger instruments, placed side by side with our mercurial barometer, do most excellent service, many times indicating the approach of a storm, even before the mercurial, because they are more sensitive. Instructions accompany each instrument—one set from the manufacturer, and one set that I have had printed for myself, after having watched the barometer almost daily for several years past. It is a pleasure to me to sell one of these new instruments, because I think they will give both pleasure and profit to the purchaser.

Since testing half a dozen of these instruments right beside our mercurial barometer, under all sorts of circumstances, I find the aneroid is affected more by change of temperature than the mercurial barometer. All barometers should be in the open air. The north porch, where the instrument will be sheltered from rain, and, as far as may be, from drifting snow, is a good place; and the aneroids especially should be where the sun does not strike them; for the heat of the sun, especially in hot weather, is very likely to cause a temporary fluctuation in the needle that might lead one astray if he did not make allowance for it.

MALTED NUTS; A NEW FOOD FOR INVALIDS.

I suppose most of our readers are more or less familiar with malted milk, which has been such a Godsend to thousands of people with weak digestion. But our enterprising friends of the Sanitas Food Co., Battle Creek, Mich., have, in my opinion, gotten out something that is even ahead of malted milk. They call it malted nuts, and say it is a pure product of nuts and nothing else. It is a grayish powder much resembling malted milk; but only two teaspoonfuls, dissolved in a cup of hot water, makes the most delicious and nourishing drink I ever got hold of. When faint with hunger and fatigue, either mental or physical, there is nothing in this world that braces me up so quickly as this drink. Tea and coffee are nowhere, in my opinion. I have been using it now considerably for over a month, and it does not seem to me as if I should ever want tea or coffee again, when I can get hold of this new substitute.

Another new thing in the way of good foods I wish to mention is granose biscuit. With some of this, and malted nuts and a little hot water, I have a delicious meal with very little trouble to the good wife or anybody else. One of the problems just now is help

in the kitchen. Well, Mrs. Root and I are planning now so that we shall not need any hired help in our new summer cottage; and we desire to manage also so that she can have much leisure outdoors. We are planning to live so as to save her not only a lot of labor in preparing food, but the same in taking care of a lot of dishes. Just one cup and a spoon, something to hold the pure hot water, some malted nuts, good bread and butter, fruits and vegetables from our own garden, and we are all right. If we feel the need of fresh meat out there in the woods we can get fish very easily; or, failing in that, canned corn beef or roast beef at the country store near by. I am not sure, but I think the Sanitas Food Co., Battle Creek, Mich., would be glad to send any one a sample of malted nuts. We have given it around to our neighbors, especially those in feeble health, and the universal verdict is that it agrees exactly, even with those who have greatest trouble with indigestion.

One thing I almost forgot to add. There is more nourishment and strength in this new food, pound for pound, than any thing else I have ever come across in the way of food products. If bought in quantity, the dry powder costs only about 40 or 50 cts. per lb. But it is so light that a pound goes a great way. I think one could come nearer to carrying his dinner in his vest pocket with this new food than any thing else I know of.

WHAT CAN BE PLANTED IN THE MIDDLE OR LAST OF JUNE?

Almost every thing, for that matter; and it is particularly the time to plant beans—better now than earlier, because they are more likely to escape the bean-weevil. It may be a little late for the large lima bean, but is just right for Henderson's bush limas. We have a large lot of these that we are offering for only 10 cts. per quart, or 65 cts. a peck. Where there is difficulty in getting large lima beans to ripen, these smaller bush limas are almost sure to make a crop. We have also three or four bushels of the Prizewinner shell bean that that is so early we grew two crops of them last year in the same ground. Quart, 20 cts.; peck, \$1.25. We have a nice stock of Banner field beans at the low price of 10 cts. a quart; 70 cts. per peck; bushel, \$2.75.

Sweet corn will be all right for roasting ears, and it is a good plan to plant three or four kinds the same day, from the earliest to the latest. Popcorn is all right if put in now. We have some extra nice rice popcorn at only 10 cts. a quart; peck, 65 cts.

Cucumbers I would put in just now as you do corn. Plant several kinds, from the earliest to the latest, all the same day.

Do not forget lettuce—that is, in localities where people have learned to use it the year round; and I believe it finds a ready sale in all the large cities every day in the year.

All kinds of melons will give a crop now unless we happen to have an extra-early frost.

In our locality we have no trouble in growing peas right through the hot weather. In fact, we have just been planting five different kinds, from the earliest to the latest, on the same day. Without any more attention this gives us green peas right along without any further care or trouble.

Pumpkins are all right; and if you have not put at least a few among your growing corn, better do so now. They are not only pretty but useful, and often make the most of their growth after the corn is cut, especially early corn. We have Early Sugar pumpkin seed for 30 cts. per lb.; field pumpkin, only 15 cts.

Beets, carrots, and salsify may all be put in now—yes, parsnips too, if you do not care to have them very large; and the medium-sized ones are better for table use than large ones.

Better get in some Hubbard squashes if you have not done so before.

Of course, you know it is just the time for putting out plants—cabbage, cauliflower, celery, tomatoes, etc.

It is a little early for turnips, except the Breadstone and large sweet rutabagas. They should be put in in June, because they need a long season.

If you order any of the above seeds by mail, please remember to add 9 cts. per lb. for packing and postage; beans and peas, 15 cts. a quart, and corn 12 cts. a quart, for postage.

Last, but not least, our favorite season for planting potatoes is the last of June. We still have plenty of potatoes for seed of the Early Ohio, and small lots of other kinds, at 75 cents per bushel right through. A leaflet giving reduced prices on seeds late in the season will be mailed on application.

REARING QUEENS IN SECTION BOXES.

Several pages are occupied in this issue in describing some very ingenious arrangements for rearing queens, not only in little hives, but even in a section box. Now, while I succeeded, years ago, in getting queens fertilized with only the brood contained in a single section box, I decided the matter was too difficult, and required too much constant supervision to make it practical. Very likely our friend "Swarthmore," with trained assistants under his supervision, could have queens fertilized by the hundreds, by his arrangement; but in reading it over I was strongly impressed with its being something familiar; and all at once the new book, "Egg Farm," came to my mind. Now, this latter book is wonderfully ingenious, and the story is exceedingly interesting; but careful investigation shows that no one has ever made it a practical success—not even the inventor himself. "Too much machinery" is the trouble. Quite a few of us have had more or less experience with inventions requiring too much complication. The cell-cups are, without question, all right. Our friend W. H. Pridgen has, along a similar line, been making quite a practical success, and I sincerely hope "Swarthmore" may do as well. I am sure he will accept this as a kindly caution (in regard to rearing queens in section boxes) from his old friend who has been "through the mill" pretty well.



SECOND-HAND CANS.

We have a few over 100 boxes of second-hand cans, 2 in a case, in fair condition, which we will sell, while they last, at half price, \$3.75 for 10 boxes, or 50 boxes at 35 cts. a box. Some of these cans are oxidized inside, and all need cleaning before using. They are whole and sound, and we believe will hold honey.

BEESWAX LOWER.

Beeswax is being offered much more freely, and market price is declining. We reduce the price we pay, till further notice, to 26 cents cash, 28 cents trade, for average wax delivered here. We have more than enough on hand to supply our trade for this season, but will take it in at above figure for the present to store for next season.

60-LB. HONEY-CANS.

The American Can Co., commonly known as the Can Trust, having absorbed, practically, all the factories making cans, have raised the price so that, if we had to buy of them at their present prices, we could not sell at the price listed in our catalog, at a profit. We are fortunate in having a carload on hand, bought before the rise in price. We have another carload contracted, to arrive this month or next, so we are in shape to fill orders from Medina for 60-lb. cans at the prices listed in our catalog till further notice.

MASON JARS.

Our carload of Mason jars, ordered last February, and promised for delivery in April, is just shipped as we go to press, and, we trust, will be here in good time to fill all orders booked before July 1. The price of jars in the market is advancing, and the outlook for an abundant fruit crop will tend to boost prices of jars still higher. We can not guarantee prices last announced, for any length of time, and will doubtless mark them up a little July first. If in need of jars, send up your orders. We have two or three gross left of quart jars, green glass, with aluminum caps, at 55 cts. per doz.; 6 doz., \$3.15; 12 doz., \$6.25. The jars in the car coming have porcelain-lined zinc caps, and the prices are:

GREEN GLASS.

1 qt., 1 doz., 58c; 6 doz., \$3.30; 12 doz., \$6.50.
2 qt., 1 doz., 80c; 6 doz., \$4.60; 12 doz., \$9.00.

FLINT GLASS.

1 pint, 1 doz., 60c; 6 doz., \$3.45; 12 doz., \$6.75.
1 qt., 1 doz., 65c; 6 doz., \$3.75; 12 doz., \$7.25.
2 qt., 1 doz., 90c; 6 doz., \$5.20; 12 doz., \$10.00.

All put up, one dozen in partitioned cases, and well made.



Every Year's Use

adds to the popularity of Page Fences. This season's sales surpass all previous records.

Box 5. Page W. W. Fence Co., Adrian, Mich.

EGG FOOD! The kind that tones and keeps up the hen so that she simply must lay. LEY'S POULTRY CONDITION POWDER puts good red blood into poultry veins; kills all disease germs; tones and nourishes fowls—big and little get all there is in the food when fed in conjunction with it. Price 25c pkg.; 5 for \$1. Ley's Thoroughbred Minorca eggs, \$1 for 13. Thoroughbred Belgian Hares, Geo. J. Ley, Florence, California.

W. H. Pridgen,

of Creek, Warren Co., N. C., whose money-order office is Warrenton, N. C., is now prepared to fill orders promptly with the Hutchinson "Superior stock," or golden untested queens at 75 cts. each, or queen-cups at \$2.00 per pound, postpaid.

FOR SALE.—Nuclei, in chaff-hive frames; three frames with queen, \$1.75. Good Italians.
H. L. FISHER, New Paris, Ind. R. D. No. 2.

FOR SALE.—100 brood-combs in Hoffman frames, L. size, 12c each. E. R. GIBBS, Norwalk, O.

Wants and Exchange.

WANTED.—To exchange 100 extracting combs—L. size, for rifle or offers.
F. W. HUMPHREY, Oronoque, Ct.

WANTED.—To exchange 50M polished sections (No. 1, nice) for beeswax, at a bargain.
W. H. NORTON, Skowhegan, Me.

WANTED.—Seed buckwheat—silverhull or Japanese. I have bee hives and supplies of all kinds at a bargain. Some are slightly shopworn, but all in serviceable condition. CASCADE BEE-HIVE CO., W. H. Putnam, Agent. River Falls, Wisconsin.

WANTED.—To exchange a pair of field and marine glasses (cost \$40) or Dobson banjo (cost \$35) for Italian bees on Hoffman wired frames. State condition and number of colonies offered.
DIAMOND, 109 West 42d St., New York City.

WANTED.—To exchange first-class bee-keeping supplies for 2000 lbs. beeswax. Will allow 32c for nice wax.
W. H. NORTON, Skowhegan, Me.

WANTED.—To exchange Japanese buckwheat at 80c per bu.—sacks, 15c extra—for bees in shipping-boxes, if not too far away.
ALBERT L. MARTIN, Leonardsburg, Del. Co., O.

WANTED.—To exchange a \$50 Columbia bicycle that has not been ridden 100 miles; never been rained on; out of the factory only about one year. I will sell it or exchange for clover honey, or two-frame Cowan extractor and new Dovetailed hives, to the value of \$35.
A. H. KANAGY, Milroy, Pa.

WANTED.—A young man or married man, to work with 50 to 100 colonies of bees, and work on fruit-farm the rest of his time. Good position to right man. Want one that likes to work with bees; don't care if he doesn't know so much about them, as I have my own method. Good house and plenty of fruit free to married man.
J. A. TAYLOR, Wynnewood, Ind. Ter.

Black and Hybrid Queens for Sale.

Hybrid and Italian queens, from requeening an apiary, 25c each. O. H. HYATT, Shenandoah, Ia.

THE TRUE TEST!

of a strain of bees is the amount of honey they gather under like conditions, compared with others. Mr. D. R. Keys, Dixie, Ga., an old bee-keeper, writes: "That queen from you is simply *splendid*, has shown no disposition to swarm. Her bees have filled three supers of 35 sections each, capped *snow-white*, while the average is not one super so far.—June 6, 1901." See back ads. and write for circular, free. I have carefully selected the best queens for breeders for years, and culled out the poor ones. My stock is a five-band strain, and has *long tongues*. No small or poor-laying queens sent out. Untested, 75c each; six, \$4.00; dozen, \$7.50. For select warranted add 25c. Tested, \$1.25. Select tested, \$2.00. Breeders, \$3.00 and up. Queens sent promptly. **J. B. CASE, Port Orange, Fla.**



Sections

The appearance of the honey helps to sell it.

If brought to market in our beautiful sections, it has an appetizing look which recommends it.

These Sections are made of the very best grade of basswood, perfect in finish, and free from defects.

Comb Foundation

and everything that bee-keepers require to make their business profitable, always on hand.

Illustrated catalog for the asking. If requested, we will also include a sample copy of the Weekly AMERICAN BEE JOURNAL.

Geo. W. York & Co.

144 & 146 Erie Street,
Chicago, - Illinois.

WANTED!

Offers on our ENTIRE QUEEN BUSINESS, including our reputation, our Superior long-tongued stock, three entire apiaries, 500 nuclei, and entire outfits for queen-rearing. We have a favorable climate and excellent locations. Cause for selling made known on application. Full particulars free. If interested let us hear from you.

There is no foul brood or other disease in Texas. Single nuclei (with their queens) winter perfectly here.

O. P. HYDE & SON, HUTTO, TEX.

Wanted! HONEY, WAX, MAPLE SUGAR, SYRUP, AND POPCORN.

A. L. JENKS, 42 W. Market St., Buffalo, N. Y.

Red-clover Italian Queens.

The great honey-gatherers; are bred for business; satisfaction guaranteed. Untested queen, 65c; 2, \$1.25. Warranted, 80c; 2, \$1.50. Tested, \$1.25. Select tested, \$2. Estab'd 1872. C. M. HICKS, Hicksville, Md.

The A. I. Root Co.'s Goods

shipped from Jackson, Mich. Root's extra-polished sections, foundation, hives, shipping-cases, etc., cheap. Send for list.

W. D. Soper, R. D. 3, Jackson, Mich.

D. COOLEY,
DEALER IN BEE-KEEPERS' SUPPLIES,
KENDALL, MICHIGAN.

Root's Goods at Root's Prices. : : Catalog free.

For Sale. Choice prolific Italian queens—grand-daughters of a queen of which Doolittle wrote me, " \$100 will not buy her"—mated with drones of Hutchinson's Superior Long-tongue Strain. Warranted queens, 75c; tested, \$1.00 and up. Good references, and satisfaction guaranteed.

EARL Y. SAFFORD, Salem, N. Y.

FOR SALE.—Seventy-five worker combs on Lang. frames (not self-spacing) 8 cts. each.

E. D. BARTON, East Hampton, Conn.

Swarthmore!

We now have facilities for making the Improved Swarthmore Queen-nursery Cages rapidly, and can fill all orders by return mail at 75 cts. each, or 70 cts. by express with other goods. Mr. E. R. Root said: "I believe that the Swarthmore will eventually supersede all other methods of cup-making, it is so simple." Mr. R. V. Murray, artist for The Root Co., says: "I believe your cell-cups and methods of forming by far the simplest and most *up-to-date* thing out—no fuss, no feathers—as handy as a pocket in a shirt." A large queen-breeder in the South says: "Your plan is O. K., and I shall adopt it. Send full outfit at once. We have succeeded in getting 40 cells out of a possible 40 accepted, several times—and such fine ones, too!" We will send a single sample Fertilizing Box, postpaid by mail, for 25 cts. Queens now ready. We have the Golden-all-over and the much-talked-of Long-tongued stock. Tested, either strain, \$1.00 each, *by return mail*. Send for circular.

The Swarthmore Apiaries,
E. L. PRATT. Swarthmore, Pennsylvania.

Northern Italian Queens
Reared from Imported Mothers.

Our stock is so carefully bred and selected as to secure carloads of honey. Locality free from foul brood and other bee-diseases. Prices: Untested queen, \$1.00; 6 for \$5.00; tested queen, \$1.50; 6 for \$7.50; best imported queen, \$6.00; fair imported queen, \$5.00.

Ada L. Pickard, : Richland Center, Wis.

FOR SALE.—200 crates of two 60-lb. cans each; been used once; in good condition: in lots of 10 crates, 35 cts. each. **FRED W. MUTH & Co.**
Southwest Corner Front & Walnut, Cincinnati, O.

The \$25 Prize

offered by The A. I. Co. for the longest-tongue bees goes to J. P. Moore, Morgan, Ky. He has a queen, some of whose bees show a TONGUE-REACH of 23-100 of an inch. Now, please bear in mind that this is not the *whole length of the tongue* by a good deal. It is the length of *that part only* which extends beyond the mandibles of the bee, and is, therefore, available in securing nectar from the flowers. There are other ways of measuring that would make these tongues show a measurement of 33-100 of an inch, perhaps. This queen is a daughter of The A. I. Root Co.'s \$200 red-clover breeder, and is of the typical leather color. See adv't on page 499.

U - NEED - A GLOSSOMETER.

It measures the actual reach of the tongue of a living bee to thousandths of an inch, also the capacity of the honey-sac; accurate, durable, practical. No rule or magnifying-glass needed. Satisfaction guaranteed. Price \$1.00 postpaid. Send for *Queen Circular*, and learn how to get a glossometer free. High-grade queens of the Sweetheart and other strains at reasonable prices.

A. J. WRIGHT, Bradford, Steuben Co., New York.

Minnesota Bee-keepers' Supply Mfg. Co., Manufacturers of Bee-hives, Sections, Shipping-cases, and Everything Used by Bee-keepers.

Orders filled promptly. We have the best shipping facilities in the world. You will save money by sending for our price list. Address

Minnesota Bee-keepers' Supply Mfg. Co.,
Nicollet Island Power Building, Minneapolis, Minn.

Cell-compressor. We have ordered parts for the Grace Cell-compressor, illustrated in this issue of *Gleanings*, and shall be prepared to furnish complete improved machines at \$2.00 each, postpaid by mail. Users of cage may have the compressor for \$1.50.

The Swarthmore Apiaries, Swarthmore, Pa.



Belgian Hares

Fully pedigreed of the highest breeding, at prices that will suit. With every hare sold goes a full pedigree, register number, and score-card, scored by an official judge; and, when desired, does will be bred to one of our famous high-scoring bucks before shipment. Address

J. B. MASON,
Mngr. of The A. I. Root Co., Mechanic Falls, Me.



Belgian Hares

I have some fine hares for sale at reasonable prices.

J. F. Moore, : Tiffin, Ohio.

BELGIAN HARES!

Either domestic or imported, of any grade from a pedigreed prize-winner to a common rabbit, at prices that are right. Write

GEO. M. TEETER, PENNVILLE, IND.

1200 FERRETS. All sizes; some trained; first-class stock. New price list free. N. A. Knapp, Rochester, Lorain Co., Ohio.

S. C. BROWN LEGHORNS.

I use well-striped breeding cocks. Eggs, \$1.00. Cockerels, \$1.00 and up. Also Italian bees. Circular free.
H. M. MOYER, SHANESVILLE, PA.

To make cows pay, use Sharples Cream Separators. Book "Business Dairying" & cat. 288 free. W. Chester, Pa.

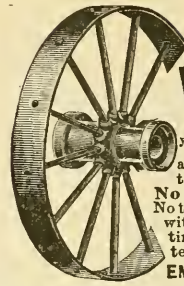

STEEL WHEELS

for your FARM WAGONS

any size wanted, any width of tire. Hubs to fit any axle. No blacksmith's bills to pay. No tires to reset. Fit your old wagon with low steel wheels with wide tires at low price. Our catalogue tells you how to do it. Address
EMPIRE MFG. CO., Quincy, Ill.

1901---Golden Italian Queens---1901

Untested—April, May, and June—\$1.00 each, or \$11.00 per dozen; after June, 50c each, or \$5.00 per dozen. Tested queens, half more. Breeding queens \$3.00 and \$4.00 each. W. P. Rock eggs from 94-scoring birds at \$1.00 per 15. Cocks, \$1.00 each.

GEORGE W. COOK, - SPRING HILL, KANSAS.

Your Order for Queens

—Tested and untested—will be promptly filled by return mail. Our strain of Italians is unsurpassed as honey-gatherers. Every queen guaranteed. Choice tested queens, \$1.00 each; \$12.00 per dozen; choice untested, 75c; \$8.00 per dozen. Send for price list. Address . . .

J. W. K. Shaw & Co., Loreauville, La.

3 Good Points

Good Stock ;
Low Prices ;
Prompt Service.

My stock is from J. P. Moore's long-tongue strain, A. I. Root's famous \$200 queen, and from the stock of J. F. McIntyre that filled supers when other colonies were starving. I sell warranted queens in any quantity, at 50 cts. each. If a queen proves impurely mated, another is sent free of charge. All queens go by return mail unless otherwise ordered. I guarantee safe arrival and entire satisfaction. Otherwise, the money is refunded.

L. H. Robey, Worthington, W. Va.

FOR SALE. One 10 h.-p. engine and boiler (up-right boiler), one 18-inch planer, one Root saw-table, 30 ft. line-shafting, hanger pulleys, and belting. Will take \$250. J. W. Bittenbender, Knoxville, Ia.

Mr. A. I. Root's Writings

of Grand Traverse territory and Leelanau Co. are descriptive of Michigan's most beautiful section reached most conveniently via the

PERE MARQUETTE R. R.

For pamphlets of Michigan farm lands and the fruit belt, address W. C. Tousey, D. P. A. Toledo, Ohio.

South Dakota Farms

is the title of an illustrated booklet issued by the Chicago, Milwaukee and St. Paul Railway, descriptive of the country between Aberdeen and the Missouri River, a section heretofore unprovided with railway facilities but which is now reached by a new line of the Chicago, Milwaukee & St. Paul R'y. Everyone contemplating a change of location will be interested in the information contained in it, and a copy may be had by sending a two-cent stamp to F. A. Miller, General Passenger Agent, Chicago, Ill.

New Smith Premiers Nos. 5 and 6.

The No. 6 takes paper 18½ inches wide and writes lines 16 inches long.
 The No. 5 takes paper 11 inches wide and writes lines 9½ inches long.
 These new machines in essential mechanical principles are the same as Models Nos. 2, 3 and 4—un-
 equaled.

Write for Printed Matter Free.

**The Smith Premier
 Typewriter Co.**

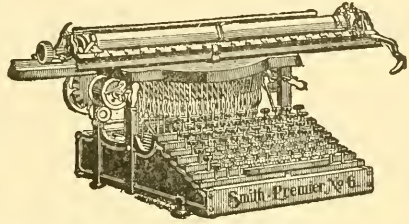

158 Prospect Street, Cleveland, Ohio.

AT ANY TIME—

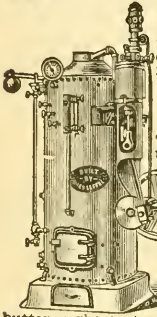

summer time or winter time, the
BEST POWER
 for all purposes on the farm, in the
 dairy, creamery or cheese factory,
 is a

LEFFEL ENGINE.

They are very simple in construction, and easy to run and keep in order. Are very economic of fuel, are easy steamers and great power developers. They are made both horizontal and upright with engine mounted on boiler. Everything is made of best material throughout. They are ideal for cutting and grinding feed, sawing wood, pumping water, running cream separators, churns, butter workers, etc. Send stamp for Book on Power.

JAMES LEFFEL & CO., Box 89, Springfield, O.

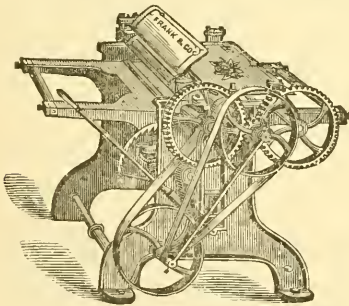

PLANERS

The above cut shows one of our small Planers, of which we make twelve different styles and sizes.

Also large Planers, Band Saws, Buzz Planers, Moulders, Wood Lathes, and all kinds of

WOOD WORKING MACHINERY

Send for Catalogue.

The FRANK MACHINERY CO.

BUFFALO, N. Y.

FRUIT-CANNING made easy and sure by using Coddington's Self-melting, Self-sealing Wax Strings. Very convenient and economical. Inquire of your dealer or send me his name and 4c in stamps for 100 strings, by mail. Mention this paper. C. C. FOUTS, Middletown, Ohio.

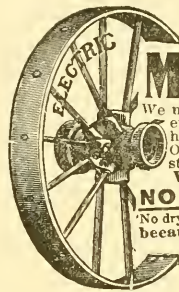

THE WHEEL OF TIME

for all time is the

Metal Wheel.

We make them in all sizes and varieties, TO FIT ANY AXLE. Any height, any width of tire desired. Our wheels are either direct or stagger spoke. Can FIT YOUR WAGON perfectly without change.

NO BREAKING DOWN.

No drying out. No resetting tires. Cheap because they endure. Send for catalogue and prices. Free upon request.

**Electric Wheel Co.
 Box 95 Quincy, Ills.**

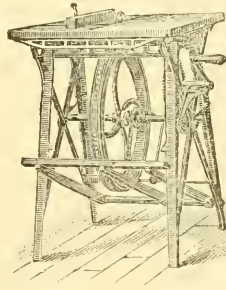

Barnes'

Hand and Foot Power Machinery.

This cut represents our combined circular saw, which is made for bee-keepers' use in the construction of their hives, sections, boxes, etc. **Machines on trial.** Send for illustrated catalogue and prices.

**W. F. & John Barnes Co.,
 545 Ruby St.,
 Rockford - - Ill.**

Union Combination Saw

For Ripping, Cross-cutting, Rabbeting, Mitering, Grooving, Gaining, Boring, Scroll-sawing, Edge-moulding, Beading. Full line FOOT and HAND POWER machinery. Send for catalog A.

**SENECA FALLS MFG. CO.,
 44 Water St., Seneca Falls, N. Y.**

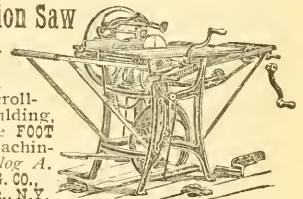

Fruit Packages of All Kinds.

— ALSO —

BEE-KEEPERS' SUPPLIES. . .

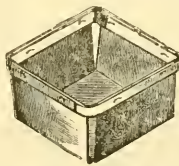

Order your supplies now before the busy season catches you. Price list free. Address

**BERLIN FRUIT-BOX COMPANY,
 Berlin Heights, - - Erie County, Ohio.**

The Best Bees.

Much has been said of late regarding the relation of long tongues in bees to their honey-gathering abilities on other sources than that of red clover. In the article contributed to the June Review, by Mr. F. B. Simpson, mentioned in my adv. in the last issue of Gleanings, there appears the following:

"In conclusion, my opinion, based on the above points, is as follows: Whenever a colony of long-tongued bees is superior to a colony of bees with shorter tongues, as shown by the gathering of nectar from red clover, such superiority is due to increased vigor, which (other things being equal) shows that the greater length of tongue is due to increased use of and energy in the use of that member, usually through several generations, it being apparent that it takes more energy to use a long tongue than a shorter one. It naturally follows that in a locality, or at a time when red clover fails to yield nectar, this increased energy of the long-tongued colony will not go to waste, but will be used to advantage in the more rapid storing of more easily reached nectar, regardless of its source. And it is quite pertinent to the subject, that the colony which has given me the most nectar to date, this season, from fruit bloom, contains by far the longest-tongued bees that I have. And this

also is a point in favor of my idea that the best bee is the best, regardless of locality."

The strain of bees that I have been advertising for three years, as "Superior Stock," have not only proved themselves superior by their works, but no bees have yet been reported with longer tongues. Whether they are superior because they have long tongues, or have long tongues because they are superior, makes no difference so long as they are really superior. This is the report that comes from North, South, East, and West. I sell one queen for \$1.50, but I guarantee safe arrival, purity of mating, safe introduction, if instructions are followed, and complete satisfaction to the extent that the queen may be returned any time within two years and the money will be refunded, and 50 cts. additional to pay for the trouble. There is only one way in which you can get a queen for less money, and that is by subscribing for the Review. For \$2.00 I will send one of these queens and the Review for 1901.

W. Z. Hutchinson, Flint, Michigan.

Long-tongue Adel Bees.

From one 3-frame nucleus of Adel bees you sent me I took 213½ lbs. extracted honey.—*Wm. S. Barclay, Beaver, Pa., Apr. 4, 1901.* Queens, \$1 each. Any queen guaranteed to be perfect, and just as good in all respects as any queens at any price. Address

Henry Alley, Wenham, Mass.

I. J. Stringham, 105 Park Place, New York City.

Keeps in stock a full line of modern appliances for bee-keepers.

SILK-FACED VEILS.

As good as any made; 35 cents postpaid. Catalog free. Full colonies Italian bees, \$6.00. Apiaries, Glen Cove, Long Island.

I. J. Stringham, 105 Park Place, New York City.

NOW READY!

64-PAGE CATALOG OF EVERY THING BEE-KEEPERS NEED. Illustrated and fully described. Especially valuable to beginners for the information it contains. Send your address on postal and get it now. Established 1884.

J. M. JENKINS, Wetumpka, Ala.

1881

PAGE & LYON MFG. CO.

1901

We manufacture a full line of the latest
BEE-SUPPLIES.

Our motto is, "Perfect Goods and Prompt Shipment."

Send for our new free illustrated catalog.

PAGE & LYON MFG. CO., New London, Wisconsin.

Marshfield Manufacturing Company.

Our specialty is making SECTIONS, and they are the best in the market. Wisconsin basswood is the right kind for them. We have a full line of BEE-SUPPLIES. Write for FREE illustrated catalog and price list.

Marshfield Manufacturing Company, Marshfield, Wisconsin.

RED-CLOVER QUEENS!

ESTABLISHED 1881.

200 lbs. per colony is our record last season; principally from red clover. Will say that if any one doubts our word, and if you come here and find that our strain of bees don't work in red clover as well as in white I will give you \$100 down. No disease known here. Ten years ago we bought an imported queen from A. I. Root, and we queen our stock with her. The next year we found our bees worked red clover, and so we call them red-clover queens. We use the best queens that money and labor can procure. Our trade has been doubling every year the past ten years. Prices: Untested queens, \$1.00; dozen, \$10.00. Tested, \$1.50. Breeding queens, \$3.00 and up. We guarantee safe delivery. All queens sent by return mail. Our bees are beauties to look at; gentle and prolific; try them. My money-order office is Guernsey. Address

G. R. Routzahn, Menallen, Adams Co., Penn.

HONEY QUEENS!

Leather-colored Long-tongues.—I have a breeder for which \$25 has been offered and refused. You make no mistake in buying her daughters. They are dandies.

Goldens.—The Laws strain is as good as years of patient selection and breeding can establish.

Holy Lands.—These are a deserving race of bees. With two years' acquaintance I find them great workers, with no vindictive traits, easily handled, are becoming popular, especially in South.

The above races of bees are each bred in separate apiaries, and you can get them in their purity. Am filling all orders by return mail, and I sell at the following low prices, with the usual guarantees. Single queen, untested, 75c; six for \$4.00. Tested, \$1.00; six for \$5.00. Breeders, either race, \$2.50 each. Address

W. H. Laws, Beeville, Texas.

If You Want to Secure

a large crop of honey in 1902, stock your apiary with daughters of Moore's 23-100 breeder. See ad. page 499.

NOW READY. LONG-TONGUED QUEENS!

YARD NO. 1.

By special arrangements with THE A. I. ROOT CO. to furnish them queens, I have secured their assistance in procuring the finest breeding queens that a thorough knowledge of the bees of the country and money can procure. Among them is a select daughter of their \$200 queen that they refuse to quote me prices on. This queen shows every superior quality of her mother. Her bees show an actual reach of 21-100 of an inch; are large, gentle, and beautiful to look upon.

MR. E. R. ROOT SAYS: "You have as fine bees as there are in the United States; and with a direct cross of their breeders you should be able to produce queens whose bees show a reach of 25-100 of an inch."

Send for descriptive price list.

Prices: Untested, 75c; 6, \$4.25; 12, \$8.00. Select untested, \$1.00; 6, \$5.00; 12, \$9.00. Tested, \$1.00; 6, \$6.00. Select tested, \$1.50.

Breeders, whose best bees show a reach of 21-100, with an average reach of 20-100, \$3.00. Breeders, whose best bees show 21-100, with an average of 20½-100, \$5.00. Breeders, whose best bees show 22-100, with an average of 21-100, \$7.00.

I have discovered 2 breeders whose best bees show 23-100; these are too good to sell; don't ask for prices.

Imported Italian stock. Apiary No. 2. Imported queens, daughters and grand-daughters. Have just received an importation direct from Italy which has been introduced into this apiary.

Golden, or 5-banded Italian. Apiary No. 3. Breeders, select tested, tested, untested queens.

**W. O. VICTOR, WHARTON, TEXAS.
QUEEN SPECIALIST.**

FOR SALE.—Italian bees and queens. Untested queens, \$1.00; tested, \$1.25; full colonies, \$4.00; nuclei, one frame with queen, \$1.50; two frames, \$2.00; 1 lb., \$1.00. MRS. A. A. SIMPSON, Swarts, Pa.

Standard - Bred Queens!

Acme of Perfection; Not a Hybrid among Them.

Improved Strain Golden Italians.

World-wide reputation; 75c each; six for \$4.00.

Long-tongued 3-banded Italians.

Bred from stock whose tongues measured 25-hundredths inch. These are the red clover hustlers of America. \$1.00 each; six for \$5.00. Safe arrival guaranteed. Catalog on application. Headquarters for bee-keepers' supplies.

Fred W. Muth & Co., Cincinnati, Ohio.
South-west Corner Front and Walnut Streets.

Dittmer's Foundation !!!

Retail---Wholesale---Jobbing.

I use a PROCESS that produces EVERY ESSENTIAL necessary to make it the BEST and MOST desirable in all respects. My PROCESS and AUTOMATIC MACHINES are my own inventions, which enable me to SELL FOUNDATION, and WORK WAX INTO FOUNDATION FOR CASH, at prices that are the lowest. Catalog giving

FULL LINE OF SUPPLIES

with prices and samples, free on application. BEESWAX WANTED.

GUS. DITTMER. AUGUSTA, WIS.

Get the Best Queens.

Evansville, Ind., Sept. 27th, 1900.

The Jennie Atchley Co., Beeville, Bee Co., Texas:

Dear Friends:—It gives me great pleasure to forward you this unsolicited testimonial regarding the merits of Atchley queens. The three (3) dozen queens purchased of you have made an excellent record for themselves. Not an Atchley queen among the twenty colonies lost during the severe drouth in July. I have bought queens from many breeders; and although the present crop is exceedingly short, the tiers of supers show where the Atchley queens are, and speak volumes for your method of queen-rearing. I find the progeny to be very gentle, strong-winged, uniformly marked, long-lived, of large size, and last, but not least, the best honey-gatherers I ever had. I shall want 100 more next season.

Yours fraternally, J. C. WALLENMEYER.

Prices for Queens.

Tested, \$1.50 each; \$8.00 for 6, or \$15.00 per dozen. Untested, February, March, April, and May, \$1.00 each; \$5.00 per 6, or \$9.00 per dozen. Fine breeders, \$5.00 each. We have as good bees and queens as money and labor produce. We breed three-band Italians, Goldens, Carniolans, Cyprians, and Holy-Lands, in their purity, bred in separate yards 5 to 20 miles apart. If you want the best, call for Atchley's improved strains. Safe arrival guaranteed. Send for a sample copy of "The Southland Queen," the only southern bee-paper. \$1.00 per year. To new subscribers we offer as a premium a nice untested queen in order to get our paper introduced. Catalog, giving queen-rearing and management of apiaries for profit, FREE.

THE JENNIE ATCHLEY CO.,
Beeville, Bee Co., Texas.

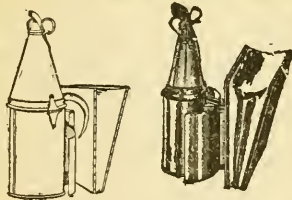

BINGHAM SMOKER.

Dear Sir:—Inclosed find \$1.75. Please send one brass smoke-engine. I have one already. It is the best smoker I ever used. Truly yours,
HENRY SCHMIDT, Hutto, Tex.

MADE TO ORDER

Bingham Brass Smokers.

Made of sheet brass, which does not rust or burn out; should last a lifetime. You need one, but they cost 25 cts. more than tin of the same size. The little open cut shows our brass hinge put on the three larger sizes. No wonder Bingham's four-inch smoke-engine goes without puffing, and does not drop ink drops. The perforated steel fire-grate has 381 holes to air the fuel and support the fire.

Heavy tin smoke-engine, 4-inch stove, per mail, \$1.50; 3½-inch; \$1.10; 3-inch, \$1.00; 2½-inch 90c; 2-inch, 65c. Bingham smokers are the originals, and have all the improvements, and have been the standard of excellence for 22 years. Only three larger ones brass.

T. F. Bingham, Farwell, Michigan.

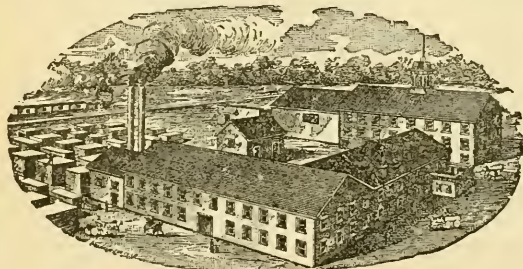

KRETCHMER M'F'G CO., Red Oak, Iowa.

BEE-SUPPLIES.

Best-equipped factory in the West; carry a large stock and greatest variety of every thing needed in the apifary, assuring BEST goods at the LOWEST prices, and prompt shipment. We want every bee-keeper to have our FREE ILLUSTRATED CATALOG, and read description of Alternating Hives, Ferguson Suppers, etc. Write at once for a catalog.

— AGENCIES: —

Trester Supply Co., 103 So. 11th St., Lincoln, Nebraska; C. C. Richards, 1223 17th St., Denver, Col.

Contents of this Number.

Apple-tree Borer.....566
 Bee-keeping as a Business.....559
 Bees and Pearls in California.....558
 Blacks v. Italians.....558
 California, Distances in.....558
 Clover, Red, Value of.....59
 Clover, Sweet, for Hay.....557
 Drones Hatched from Queen-cells.....557
 Drone-trap Frick's.....556
 Drone-trap, New.....557
 Editors of Journals.....560
 Editor's Travel.....551
 Florida, Editor in.....564
 Hives, etc., in Cuba.....553
 Honey, Bottling.....547
 Lantern, Trap.....566
 Potato, Craig.....567
 Queens, \$200.....567
 Queens, High-priced.....58
 Sparrows and Bees.....547
 Swarms, Absconding.....555
 Swarms, To Make.....554
 Swarm, Peculiar.....557
 Wellspring, The.....567
 Wilkin, R.....561

Honey Column.

GRADING-RULES.

FANCY.—All sections to be well filled, combs straight, firm ly attached to all four sides, the combs anointed by travel stain, or otherwise; all the cells sealed except an occasional cell, the outside surface of the wood well scraped of propolis.
 No. 1.—All sections well filled except the row of cells next to the wood; combs straight; one-eighth part of comb surface soiled, or the entire surface slightly soiled; the outside surface of the wood well scraped of propolis.
 No. 1.—All sections well filled except the row of cells next to the wood; combs comparatively even; one-eighth part of comb surface soiled, or the entire surface slightly soiled.
 No. 2.—Three-fourths of the total surface must be filled and sealed.
 No. 3.—Must weigh at least half as much as a full-weight section.
 In addition to this the honey is to be classified according to color, using the terms white, amber, and dark; that is, there will be "Fancy White," "No. 1 Dark," etc.

CITY MARKETS.

SAN FRANCISCO.—To the Trade.—Comb honey, 10@12. Extracted water-white, 6½@7; light amber, 5@5½; dark amber, 4½@5. Beeswax, 25@27. To the Producer.—1c a pound less, and 5 per cent commission. Commission houses charge 1c a pound more than they al on the producer. E. H. SCHEFFLE, June 11. Murphys, Cal.

NEW YORK.—The market for comb and extracted honey remains dull. There is no stock on hand, and but little demand for comb; while extracted seems plentiful, but no buyers in the market at present. Prices remain as per our previous quotations. FRANCIS H. LEGGETT & Co., Franklin, West Broadway, and Varick Sts., June 19. New York City.

CHICAGO.—The new comb honey has not yet reached this market. It would sell at 15@16 if choice white, and the ambers at 12@13. The market is entirely bare with exception of a few cases of a lot that we had held for us, expecting it would be needed. Advices are that shipments will be started by July 1st. Very little trading is being done in extracted, as large dealers will not contract this season unless at low figures. Some sales of amber have been made at 4½ and 5 for early autumn delivery. White is held at 5½. Beeswax sells at 30. R. A. BURNETT & Co., June 19. 199 South Water St., Chicago, Ill.

MILWAUKEE.—There is a continued demand for fancy quality comb honey, and if this should fall under the eye of any shipper we advise him to ship to us, as we can make sale readily at this time, and we invite correspondence. Extracted very quiet, and not much wanted. We quote fancy 1-lb. sections, 17@18; A No. 1, 16@17; No. 1, 15@16; amber, 13@14. Extracted white, in cans and barrels, 8@9; amber, in same, 7@7½. Beeswax, 25@28. A. V. BISHOP & Co., June 19. 119 Buffalo St. Milwaukee, Wis.

BOSTON.—There is practically no comb honey in our market, and owing to warm weather very little call for it. Are expecting some new comb early next month. Market for extracted dull, and prices nominally the same as last. BLAKE, SCOTT & LEE, June 14. 31, 33 Commercial St., Boston, Mass.

PHILADELPHIA.—It being now between seasons, it is very hard to give an intelligent quotation on honey. Some few sales of extracted honey (new Southern crop) have been made in barrels at 5¾@6. No comb honey in this market, except some old lots which are selling at buyers' offers. Beeswax a little weaker, selling at 26@27. We are producers of honey—do not handle on commission. WM. A. SELSER, June 20. 10 Vine St., Philadelphia, Pa.

TORONTO.—There is very little honey in sight. The old is nearly all sold, and there is no new honey yet. Being a little out of season, and to clear out what is left, fancy comb would sell for \$1.80 a dozen; A No. 1, \$1.50; dark, \$1.00. M. MOYER & SON, June 19. 408 Stalina Ave., Toronto, Canada.

DETROIT.—Very few sales of honey, but prices are sustained on good lots. The new crop will start out at good prices, and with little old honey. Beeswax in fair demand at 27@28. M. H. HUNT & SON, June 24. Bell Branch, Mich.

We will be in the market for honey the coming season in carloads and less than carloads, and would be glad to hear from producers everywhere what they will have to offer. SEAVEY & FLARSHHEIM, 1318-1324 Union Avenue, Kansas City, Mo.

WANTED.—Comb and extracted honey. State price, kind, and quantity. R. A. BURNETT & Co., 163 South Water St., Chicago, Ill.

FOR SALE.—Extracted honey from alfalfa; 60-lb. cans at 7 cts., and smaller cans. D. S. JENKINS, Las Animas, Colo.

GRAY CARNIOLANS

We are the largest breeders and importers of this race of bees in America. They are the most gentle bees and the best of workers. Untested queen, 65c; tested, \$1.25; select tested, \$2.25; best imported, \$4.00. Golden Italian queens, same prices. For prices on large orders, nuclei, and full colonies, send for descriptive price list. Address as below.

F. A. LOCKHART & CO., Caldwell, N. Y.

See How Simple.

When a colony swarms cut out some of the best cells, and place them in Swarthmore Fertilizing Boxes; attach the boxes to the outside of the hive, and the queens will mate all in one colony and all from one stand. No fuss—any child can do it. Sample box, by post, with directions, 25c. Queens now ready, only \$1.00. Swarthmore Nursery Cage, 75c. Cell compressor, \$2. Compressed Cells, 2c each—will last a lifetime used over and over. Address Swarthmore Apiaries, Swarthmore, Pennsylvania. E. L. PRATT.

Albino Queens.

If you want the most prolific queens; if you want the gentlest bees; if you want the best honey-gatherer you ever saw, try my Albinos. Untested queens, \$1.00; tested, \$1.50. J. D. GIVENS, Lisbon, Texas.

QUEENS! Fine, large, gentle, and prolific; long-tongue reach; either 3 or 5 banded; 75 cents each; six for \$4.25. Try them and be pleased. CHAS. H. THIES, Steeleville, Ill.

Queens! I have now some very fine queens for sale, either 3 banded or 5 banded goldens, at the following prices: Untested, 1c; 6, \$4.25; 12, \$8.00. Tested, \$1.25; 6, \$6.50; 12, \$12.00. Select tested, \$2.00. Golden breeders, \$5.00. We have Root's bee-supplies at Root's prices. We have a special low price on honey-cans. Give us your orders, and I will guarantee you satisfaction. Robert W. Rogers, Hutto, Tex.

Wm. A. Selser, Honey Expert,

When you buy honey, send a 3-oz. bottle, have it tested, to be sure it is pure. Price \$2.50 per sample. By doing this you may avoid over ten times this amount in litigation with pure-food laws. Chemist's certificate given.

The A. I. Root's Co.'s Office, 10 Vine Street, Philadelphia, Pa.

C. B. Lewis Company, Watertown, Wis., U. S. A.

FIVE ✻ DIFFERENT ✻ STYLES ✻ OF ✻ BEE-HIVES.

We will furnish you
with the finest bee-
keepers' supplies in
the World.



Send us your Orders
and we will fill 'em
promptly. Send for
Catalog.

LEWIS' • WHITE • POLISHED • SECTIONS • ARE • PERFECT.

BRANCH: C. B. Lewis Company, 19 South Alabama Street, Indianapolis, Indiana.
AGENCIES: L. C. Woodman, Grand Rapids, Michigan; Fred W. Muth & Co., Southwest Cor. Walnut & Front Sts., Cincinnati, Ohio; Fred Foulger & Sons, Ogden, Utah; Colorado Honey-producers' Association, Denver, Col.; Grand Junction Fruit-growers' Association, Grand Junction, Colorado; Robert Halley, Montrose, Colorado; Pierce Seed and Produce Company, Pueblo, Colorado; E. T. Abbott, St. Joseph, Missouri, Special Southwestern Agent.

Queens now Ready to Supply by Return Mail

STOCK which can not be **EXCELLED!!** Bred under the **SUPERSEDING CONDITION** of the colony. **Golden Italians**, the great honey-gatherers. They have no **Superior** and few **Equals**. Each 75 cts.; 6 for \$4.00. **Red-clover Bees**, the **Long-tongue Italians**, which left all **Records** behind in **Gathering Honey**, \$1.00 each; six for \$5.00. **Safe Arrival Guaranteed.** Headquarters for Bee-supplies. **Root's Goods at Root's Prices.**

C. H. W. Weber, 2146-2148 Central Av., Cincinnati, Ohio.

Successor to Chas. F. Muth.

Catalog Free; Send for Same.

A JOURNAL DEVOTED TO BEES AND HONEY AND HOME INTERESTS.

ILLUSTRATED SEMI-MONTHLY

Published by THE A. I. ROOT CO. \$1.00 PER YEAR MEDINA, OHIO.

VOL. XXIX.

JULY 1, 1901.

No. 13.



FOR CHAPPED HANDS or rough face, one part borax, two parts honey, eight parts glycerine, and a few drops of orange-flower water. —*Union Apicole.*

UNDER no consideration use basswood in brood-frames. Use pine, as that will not warp and twist and crawl out of the hive. [You are right, I think.—ED.]

THE STATEMENT is going the rounds in foreign journals that a monument costing \$3000 has been put up in memory of Langstroth. That gives American bee-keepers undue credit. It should be \$300.

DEACON HARDCRABBLE, in the *American Bee-keeper*, quotes Mrs. Rorer as saying, "Honey is an admirable sweet if taken once in a while with moderation." Instead of taking his with moderation, the deacon prefers to take it with bread and milk.

THE ASSERTION that, when the bees of a colony with laying workers are shaken off the combs at some distance from the hive, the laying workers will not find their way back, Editor Kellen, of the *Luxemb. Bienenzeitung*, says is simple humbug. I guess he's about right.

IN HUNGARY, says the *Leipziger Bienenzeitung*, where tobacco is largely cultivated, at Nagy-Iesca, bees work busily on the blossoms, but thousands of dead bees are found on the leaves, and colonies are greatly weakened. Why don't they offer the bees a smoker to let the nasty stuff alone?

IT IS SAID there is a vast amount of ignorance about "scientific queen-rearing." That hits me. I don't know much about it, and I should like to. If the good brethren who know all about it would take up less space scolding and more in giving information I should have a better chance to learn. ["Scientific queen-rearing"—is that not somewhat of a misnomer? All queen-rearing has to do with science. The word "scientific" in this

connection I suspect more often means "modern" or "up to date."—ED.]

THE RULE that a bee works on only one kind of flower on the same trip is not without exception. I have seen a bee vibrate from one kind of flower to another half a dozen times in half as many minutes, and I've seen a bee busily working on white clover with orange pollen on its legs. [I have seen bees in California work from one species to an entirely different species of flower. If bees work on one flower I suspect that it is because almost nothing else is in bloom.—ED.]

COMPARING the bee with ourselves, we are likely to think of the thorax as containing a considerable portion of the digestive system. Nothing of the kind. All of the digestive system found in the thorax is the œsophagus, or gullet, a narrow tube that runs straight through the thorax to find the honey-sac in the abdomen. Then comes the chyle-stomach, or true stomach, and the small and the large intestine. But the length of intestine is very small compared with that of the human system.

YES, that cover described on page 522 may be just what is wanted. The dead-air space is all right, and it is absolutely essential that the grain of the two thicknesses run in opposite directions. That secured, and the cleats so made that they will not project below the surface, and I see no reason why you have not a cover for all climates. [I find that there is a tendency to use a double cover here on the Pacific coast. Rambler has just shown me one of his, and it is like our cover. It must be a good one.—ED.]

THAT SUGGESTION of E. H. Schaeffle is worth thinking about. It seems pretty well agreed that honey extracted from black brood-combs is not quite as light as that from new comb, and any one may have noticed that when water stands for some time in old brood combs, and is then shaken out, it will be quite black. But I think Mr. Schaeffle is the first to put the two facts together and suggest washing out the combs. Lay the combs flat, fill the cells with water from the rose of a watering-can, then after soaking throw the water out with an extractor.

HERR KRAMER, in *Deutsche Bienenzucht*, speaks of certain American breeders who maintain that it is a matter of indifference whether eggs or young or old larvæ are used for queen-rearing. There must be some mistake about that. I think no American breeder uses larvæ more than three days old, and it is doubtful that a three-day-old larva is as good as one younger, seeing that queenless bees, when given their choice, prefer the younger. [Herr Kramer has misread or mistranslated your article on the subject. It is to be regretted that we do not all have one universal language.—ED.]

COMPLAINT is made by some that, when no queen-excluder is used, the queen goes up and lays in the sections. The curious part is that A says he has no trouble at all, while B has brood in a fourth of his sections. Possibly this explains it: There is no drone comb in the brood-chamber in either case. B's bees have only starters in the sections, and they will build drone comb there, and the queen will come up to lay where the drone comb is. A's sections are filled with worker foundation, and there will be no drone comb there to bait the queen up. [In California, so far as I have gone, perforated zinc seems to be generally used, even for comb honey.—ED.]

RASPBERRY-BLOSSOMS have interested me much. Acres of raspberries are on my place, and Langstroth's mention of the "drooping blossoms that protect the honey from moisture" may be all right for the wild plants with canes 6 to 10 feet long, but here the blossoms are upright. Work begins on these blossoms in the early morning, and I've seen bees on them at 7:40 on a rather cloudy evening. At first I thought no pollen was gathered from raspberry; but patient looking showed one bee among a great many with a small load, and by looking closely in the morning, with glasses, I found nearly every bee had a very small load. This makes me think it must be a mistake that a bee does not gather nectar and pollen on the same trip.

ELIAS FOX raises the question whether drones from laying workers and drone-laying queens are virile. I think it would be hard to prove that drones from laying workers are not all right, but I should not want them. But I should have no fear about drones from a well-developed queen, whether fecundated or not. What change can fecundation possibly make upon eggs that are in no case fertilized? Are not the drones of a played-out queen just the same after the contents of her spermatheca have become exhausted as before? And why should they not be the same before the fecundation of the queen? Of course, that is not positive proof. There was a case in Australia—possibly others in this country—in which positive proof was claimed: a queen properly fecundated at a time when it was known there could be no other drones except those from a drone-laying queen. [If we can make the matter of fertilizing queens in confinement a success we might prove or disprove the virility of drones from laying workers.—ED.]



Jupiter Pluvius reigns this spring,
And gives the rain loose rein;
It comes in cloudburst, shower, and storm,
On city, field, and plain.

BEE-KEEPERS' REVIEW.

H. D. Burrill has a good article on the prevention of swarming. He says, "A good deal may be done to discourage swarming by giving plenty of surplus room, and ample ventilation and shade. Have no queens over two years old in honey colonies."

In my opinion, this (June) is the best issue Mr. Hutchinson ever got out. He either sits up nights to do such fine work or else he studies on his plans after retiring. The frontispiece shows the main street in Flint. It is spanned by several iron arches, each supporting 50 incandescent lights, and these alone add greatly to the beauty of the street, which stretches away into illimitable perspective in the distance; and, what a place for wheeling! the astonishing statement is made that more vehicles are made in Flint than in any other place in the world except Cincinnati, and it is likely that it will soon stand at the head. About 800 houses will be built there this year. They have a thousand-dollar marble drinking-fountain for people, supplied from an artesian well 600 feet deep, all built by private subscription. It seems that what they want they get and pay for it.

The star article is written by F. B. Simpson, on in-breeding. As stated in Mr. Hutchinson's advertisement in this journal, p. 492, Mr. Simpson may well be regarded as an authority on this subject. "If practiced it should be sparingly and with good judgment" is the tenor of the whole article, occupying four and a half pages, every line of which is readable. After speaking of the advantages that have resulted by in-breeding in case of some plants and cattle he says:

Until we can get some absolute proof that these arguments are untrue in the specific case of bee-breeding, it would seem unsafe for any queen-bee breeder to do any in-breeding with the intention of selling the resulting stock; but only as a matter of research until some absolute proof could be obtained by experimental work through several generations of bees. Few queen-bee breeders will consider that they can afford to do even this amount of experimenting in view of the fact that out-crossing has none of the objectionable features in the public mind that in-breeding possesses. One of the bottom facts of in-breeding is, that *nature* never does it unless compelled to.

Concerning bees with long tongues, Mr. Simpson says:

Other things being equal, I want long tongues; but if I were raising my ideal of a bee for sale, the "long-tongue" part of my advertisement would be in smaller type, while with great "scare heads" I would proclaim "Superior Suckers." Above all, I want a bee that can suck and carry as large a load as possible, or else make it up in increased number of loads. To my mind, the long-tongue agitation is too much like treating a *symptom*, instead of the *disease itself*. . . .

Whenever a colony of long-tongued bees is superior to a colony of bees with shorter tongues, as shown by the gathering of nectar from red clover, such superiority is due to increased vigor, which (other things being equal) shows that the greater length of tongue is due to increased use of and energy in the use of that member, usually through several generations, it being apparent that it takes more energy to use a long tongue than a shorter one. It naturally follows that in a locality, or at a time when red clover fails to yield nectar, this increased energy of the long-tongued colony will not go to waste, but will be used to advantage in the more rapid storing of more easily reached nectar, regardless of its source.

The last sentence will stand another reading.

Concerning the value of bee-papers to bee-keepers, Rambler makes the following forcible suggestion:

I am acquainted with a bee keeper who owns 600 colonies of bees. I broached the subject of bee-papers, and he said he had not taken a bee-paper for several years; he didn't see that a paper did him a bit of benefit. "Here, I have my bees," said he. "The bees suit me, the hives are right, I know how to extract, and what more can I know about the business that would be of benefit?"

All very well so far. A few months after, I was in one of his apiaries with him and he made a great complaint about getting queen-cells accepted. "Why," said he, "they tear down almost every one I insert; do you have such trouble?"

"Certainly," said I. "Unless I cage the cell." I then showed him how to make a very simple cell-cage by taking a piece of wire cloth about three inches square and working a lead-pencil through the center, leaving it cone-shaped. Now, he might have learned that simple thing a dozen years ago from a bee-paper just as I did; but he had to wait to get it second-hand, and away past date. All the same, it came through reading the bee-papers. And there you are, Mr. Editor. If you arouse that class of bee-men you have a big job on your hands.

A "big job" truly; for all experience shows that men have been as averse to the things that help them as to those that injure. All great inventions have had to plow their way through icebergs of prejudice, especially the steam-engine and telegraph.

BRITISH BEE JOURNAL.

A writer has the following to say in regard to sparrows:

My apiary is situated in the garden, and I noticed after the young sparrows had flown from the nest that they, along with the old ones, spent a good deal of time near the bee-hives. After watching them for some time I noticed the old sparrows perched on top of the hives, and now and again making a dart caught any bee that came near; indeed, they sometimes alighted on the ground in front of the entrance and picked up any poor bee that had fallen down too heavy-laden to reach the alighting-board, and carried them off to where the young sparrows were waiting, and in the midst of great rejoicing devoured them. I will leave you to guess what were the feelings I had to see my workmen so ruthlessly destroyed, and sparrows are now, and ever will be, classed by me among the worst enemies of bees. I regard them as far worse than tom-tits.

These birds should doubtless be destroyed wherever found, just as rats and mice are.

AMERICAN BEE JOURNAL.

In speaking of our national affairs, Prof. Cook says, in his Home Circle:

The entire world looks enviously at our commercial progress. They watch our rapid and increased thrift. They watch our continued and rapidly increasing prosperity with almost consternation. That should make us no less energetic or frugal. It should make them hasten to study our methods, and to adopt our practice.



BOTTLING HONEY.

How it is Kept in the Liquid Form; a Few of the Secrets of the Trade Explained; How to Construct Special Apparatus for a Large Bottling Business.

BY J. R. SCHMIDT.

The bottling of extracted honey for the wholesale and retail trade to supply a market which calls for and wants only extracted honey must necessarily be undertaken on a large scale, and one somewhat larger than most bee-keepers have been accustomed to battle with. Cincinnati, as many know, is a market for extracted honey from the small ten-cent bottle to the 500-lb. barrel shipped in by the carload, and bought by the manufacturer who uses a large quantity of the darker and inferior grades. Then comes the grocery trade, each store with its large or small display of various-sized bottles containing extracted honey of the best looks and the best flavor—the very cream of the bee-keeper's labor. This trade, although not as large as the manufacturer's, is nevertheless a very important and delicate one; for, if the honey is granulated, it is looked upon with suspicion. A shelf containing bottles filled with liquid honey, and one just below it with granulated honey of the same quality, the latter will stand untouched while the former is often sold twice over.

This state of affairs has set Mr. C. H. W. Weber, our Cincinnati honey-merchant, to thinking; for, to be continually replacing honey which granulates so quickly during cold weather, was a task almost impossible, and not at all profitable. Mr. W. follows a plan of putting up honey which he calls the new way of liquefying and bottling honey; and this plan is not only a success so far, after the most severe tests, but also allows the work to be done rapidly and to the very degree of perfection. Through the kindness of Mr. W., who explained every thing in detail, and allowed me to take several photographs, I will try to impart some of this interesting knowledge to the bee-keepers.

This new (?) method is to some extent based on the same principle which our mothers and grandmothers have been practicing for years, and is now still in use, and probably will be through the present century and may be the next one. We all know how much care is taken at home, during preserving time, to have all the jars and cans containing the fruit to be preserved for future use very hot just before they are sealed air-tight. Fruit put up this way in their rich syrup will keep for years, and the syrup will never show the slightest trace of granulation. Now, why can't this method preserve honey in the liquid form? Well, it can do it in this case just as well as in the first. This is Mr. W.'s foundation upon which he bottles honey; and as most of the

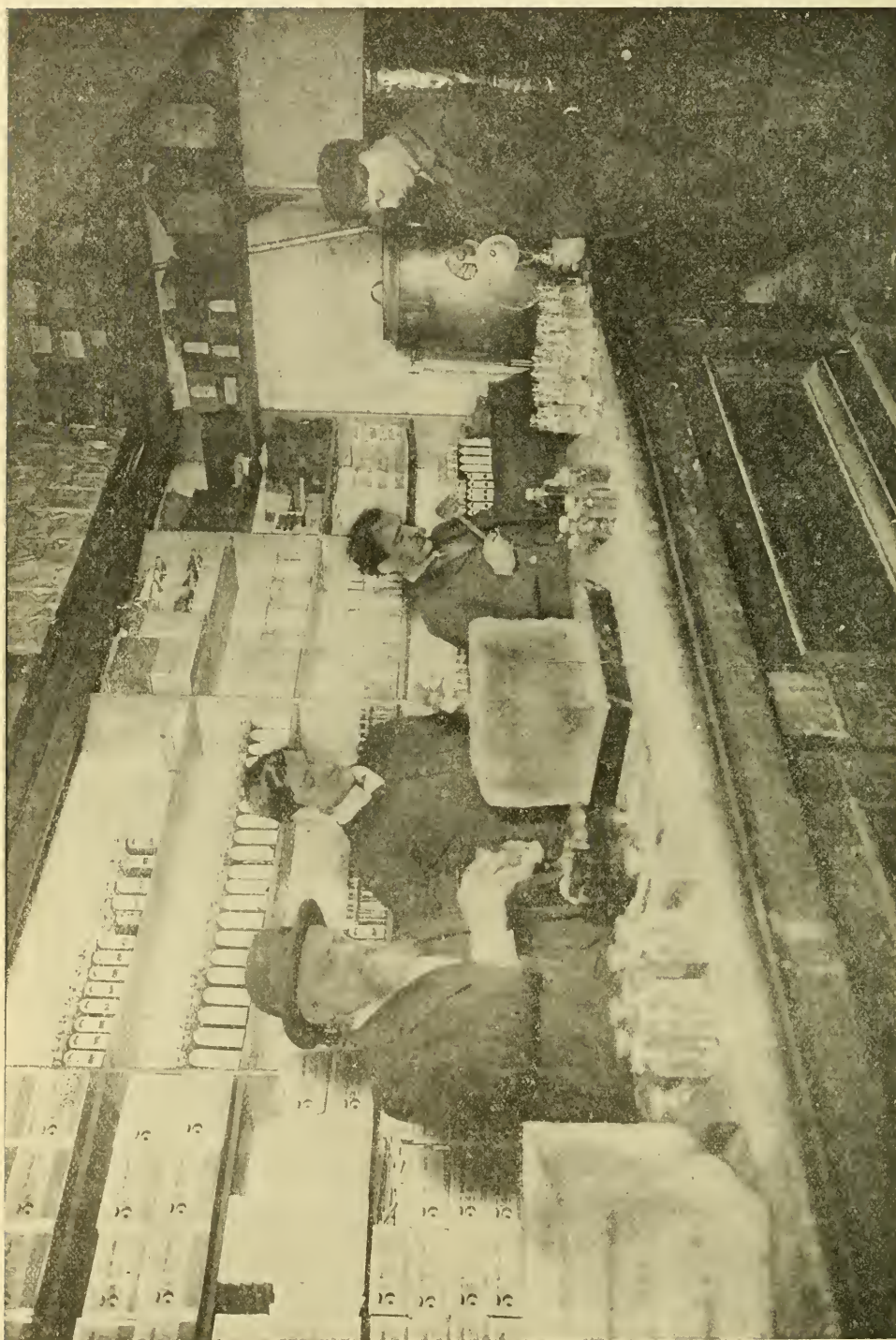

BOTTLING HONEY ; FILLING, CORKING, AND COOLING THE BOTTLES AFTER BEING FILLED.

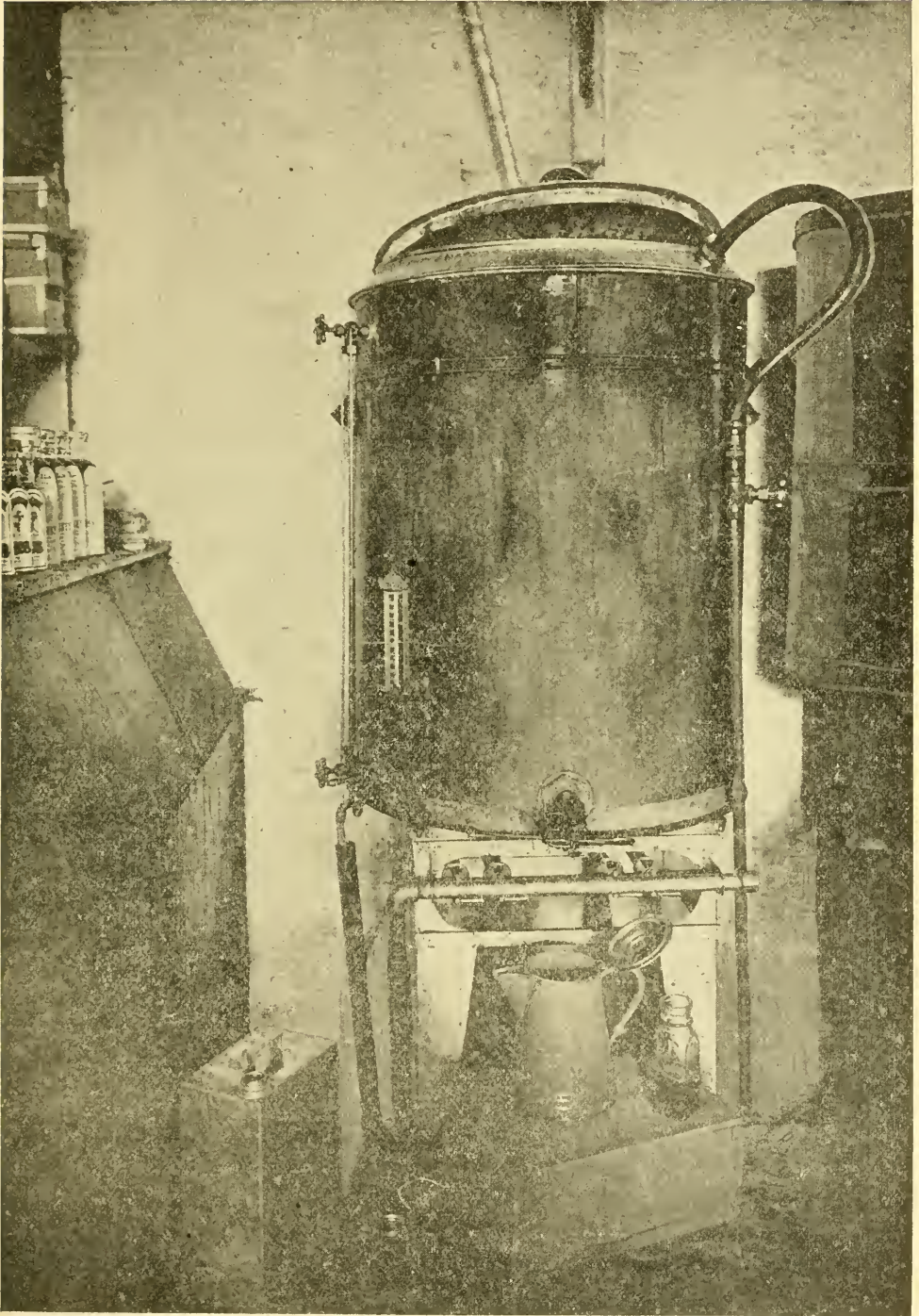

WEBER'S HONEY-MELTING TANK FOR BOTTLING PURPOSES.

honey which comes to him is in the granulated form, this method must be worked on the wholesale plan; for, instead of working with quarts or gallons, we must now consider barrels at a time.

For this purpose a large tank was constructed (see photo) which will easily hold one barrel of granulated honey at a time. This tank is an ingenious affair, and is really two tanks in one. The inside, or honey-chamber, is surrounded by an outer tank made of copper, with a three-inch space between the two for the water. This surrounding water is heated by a gas-stove of special design which also acts as a support for the tank. The height of the water within the tank is registered on the outside (at the left) at all times, and this amount can be increased by turning on the water connection which is shown on the right-hand side. Should the water supply become too great, a turn or two on the small wheel at the bottom of the tank on the left-hand side allows the water to escape into a drain, and it is carried away without further attention.

This brief description, together with a study of the photograph, will give some idea as to how the honey is liquefied.

When the honey has been reconverted into the liquid state, and the register on the tank shows that the proper temperature has been reached (180°), or has been so for at least five or ten minutes, one of the assistants at work allows a quantity of the hot honey to run into the large coffee-pot, which is found to be an excellent article in this work on account of the large lip which makes pouring without spilling an easy thing. Then he immediately proceeds to fill the empty bottles waiting for him at the end of the counter (see photo). The next man, supplied with corks and a mallet, takes the bottles as fast as they are filled, and hammers a cork into each. This method of inserting corks seems rather strange; for, to see him rain heavy blows upon the mouth of each bottle, makes one believe he possesses a wonderful amount of skill to hit the cork every time and keep the bottle from flying to pieces; but upon investigation the whole secret is found to be in the mallet, which is made of solid *rubber*; and any amount of hammering on the bottle would not break it. This mallet does its work well, for it puts the cork in squarely and rapidly, and has never been known to break a bottle. From his hands the corked bottle passes on to Mr. W., who dips the same into a melted preparation of rosin and beeswax, which gives the bottle a perfectly air-tight seal, and also a nice yellow cap, which is in perfect harmony with the light-yellow honey within the bottle; and last, but not least, this cap is cheap.

The bottle next passes to the cooler, who takes the same and arranges the bottles near the large block of ice in order that the caps will harden quickly, thereby preventing air-bubbles from working through the cap, which would leave a weak place in the same, and finally allow air to enter; and the ice also prevents the bottles from accumulating in an unfinished condition on the operating-table.

This part of the operation is not yet perfect-

ed, as Mr. W. intends to have a track built, upon which a small carriage travels, constructed so as to hold about one dozen bottles in an inverted condition, and this carriage is to carry and hold the bottles over a tray of crushed ice. After the caps on the bottles are hardened they are placed on shelves, and afterward properly labeled, and then are ready for the trade, with the guarantee that the contents is strictly pure, and with the assurance that no granulation will take place in the future.

The rapidity with which this work is done is really astonishing. The three experienced helpers can easily bottle one barrel of honey in three hours, or 1200 bottles. The success of this method of bottling honey may be readily seen from the fact that some honey put up and sealed last summer had been kept on ice since bottling, and, after passing through the present winter, is just as clear as it was the day it was put up, and not a case of granulated honey had to be replaced this winter. The whole operation of reliequifying and bottling honey is done right in Mr. W.'s large roomy store, where customers and visitors are always welcome to witness the operation from beginning to end. This, many take advantage of; and when they see a barrel of granulated honey transferred to the large tank (part of which may be seen at the further end of operating-table), and then extracted from the same in the form of thick golden liquid, and, after following it through the various operations until the sealed bottle stands at the end of the table ready to receive the label, little doubt remains in their mind as to the purity of the article, and many leave with the old proverb, that "all pure honey granulates," badly exploded, for they have just learned that "all pure honey will not granulate," which may now be called the twentieth-century revision of what has heretofore been pumped into the ears of the public, and supposed to be a true test for pure honey.

Now, instead of trying to teach people to accept something they don't want, why not spend less time, do less talking, and make more money, by giving them what they *do* want? for, "a man convinced against his will is of the same opinion still;" and if he asks for extracted honey, and you talk him into buying a bottle or a barrel of granulated honey, nine times out of ten he will hesitate the next time, and generally go where he knows he can get what he asks for.

A tank like the one described costs about \$100; but this price depends a great deal on the pocket-book; for \$100 includes a tank made of the very best material, the "made-to-order" gas-stove, and the cost of having the separate hydraulic connection made. In fact, this price could be reduced nearly half, and still would do the same work, but, of course, not so rapidly or conveniently. Probably in a few years, when the good points are known, a tank will be placed on the market for less than half the price, for it may become almost as great a necessity, if not as great, as the wax or honey extractor is to many beekeepers to-day.

Cincinnati, Ohio.

[This is the last of a series of articles on the subject of bottling honey. We believe we have now covered every detail of the *modus operandi* of some of the largest bottlers of extracted honey. Mr. Weber is in the very field so successfully filled by Mr. C. F. Muth. In consequence of the educational work done by him years ago, there seems to be in the Cincinnati market a strong demand for bottled honey, and Mr. Weber is now taking advantage of the situation.

This we consider one of the best articles of the series, and those who contemplate embarking in the business will do well to lay this journal aside.—Ed.]

NOTES OF TRAVEL.

A Visit with J. M. Jenkins; among the Black People of the Cotton Belt; the Bloody Shirt, etc.

BY E. R. ROOT.

J. M. Jenkins, of Wetumpka, Ala., quite to my surprise, met me at Montgomery, from which point I expected to take another train to his home. After we had exchanged greetings he asked whether I would prefer to wait and go by train or drive across the country through the cotton-plantations with his pony. I chose the latter; but before leaving we took a stroll through the city. We visited the State capitol, in which was held the constitutional convention to consider the question of granting to or withholding the right of franchise from the illiterates of the State. We stood on the very spot, on the stone steps marked by a star, where Jefferson Davis stood when he took the oath of office of the Confederacy; saw the house which he occupied with his cabinet; took several snap shots, and then started on our drive overland through the cotton-plantations occupied and worked by the black people. This ride was to me one of rare interest. As we passed field after field and cabin after cabin with its inmates out in front, I fairly rained the questions upon friend Jenkins. I presume—yes, I know—that I asked many a silly question in regular Yankee style, for I was anxious to know and understand the problem of the colored race from a truly Southern standpoint; for I was sure that we of the North, with our prejudices, did not have all of right on our side. While I can not go into the matter fully here I'll give a few incidents:

After we had gone about a mile out of the city Mr. Jenkins stopped his horse in front of an old colored woman hobbling on crutches. As he did so he said, "Howdy, Aunt Carrie? Stop a minute; we want to talk to you."

She seemed neither surprised nor pleased.

"How old are you?" said Mr. Jenkins.

"Dunno, boss."

"What do you do for a living?"

"Nufun. Gits what I can find."

"How long have you been here?"

"Since 'mancipation."

"When was that?"

"Dunno."

With this Mr. Jenkins handed her a dime,

which she received with the same blank look, without a show of surprise, pleasure, or thanks.

As we drove on Mr. Jenkins explained that a large majority of the "old timers" among the colored people knew no more of their history than this old black woman. The younger generation, having the advantage of schools, are much better off; but in the matter of thanks for favors received, he said they are on about a level with their parents.

Mr. Jenkins, in this connection, told how, one winter, when it was quite cold, he sent around a load of wood to each of his colored tenants free. When the wood was all gone, with one exception they would come back and talk after this fashion:

"Say, boss, that wood you sent is all gone. When you gwine to send some mo?" And this came from able-bodied men who had the privilege of going to his woods and cutting for themselves as much as they liked.

We passed by many and many a cabin where the "man of the house" was loafing, lazing away in a listless sort of fashion in the shade during the best part of the day, when he should have been at work. The cotton-plants, full of weeds, were just at that time needing attention. I fairly ached to spank some sort of ambition into them. Not all the colored men that I watched were thus indolent, but it seemed to me over half that I saw in that stretch of 14 miles were, and those that did work did so in a lazy way.

I saw on many of the plantations trees that were girdled, dead, and standing up like great black shafts.

"Why don't they cut the trees down in the first place, and then dig up the stumps?"

"Because," said Mr. Jenkins, with a smile, "the other way is easier."

About this time we got into the vicinity of one of Mr. Jenkins' out-apiaries; and, as we neared the yard, we could hear the roar of the black bees overhead, busily at work, and in delightful contrast to the way the other blacks worked, and which I have just been describing. Presently we came up to the apiary located in the midst of a thick woods, and bearing the name of Hallonquist yard. It contains 100 colonies run for extracted honey. The hives are well made, neatly painted, and well laid out. The annexed engraving gives a partial view of the yard. The building shown in the foreground is the extracting-house; and the novel part of it is that it is made up of panels so that the house can be taken down at any time, and its panels loaded on to a wagon whenever it becomes necessary to move the yard to some other location. The panels are so neatly joined together that a careful scrutiny of the engraving will scarcely show where the one begins and the other ends.

The bees seemed to be working well, but apparently did not like to have me point my camera in a threatening manner. While I was engaged in picture-taking Mr. Jenkins had found a big snake. I suggested that he put it in front of a hive and see what the bees would do with it. I was not sure but that the act would be one of cruelty to animals; but I eased my conscience by thinking that it was

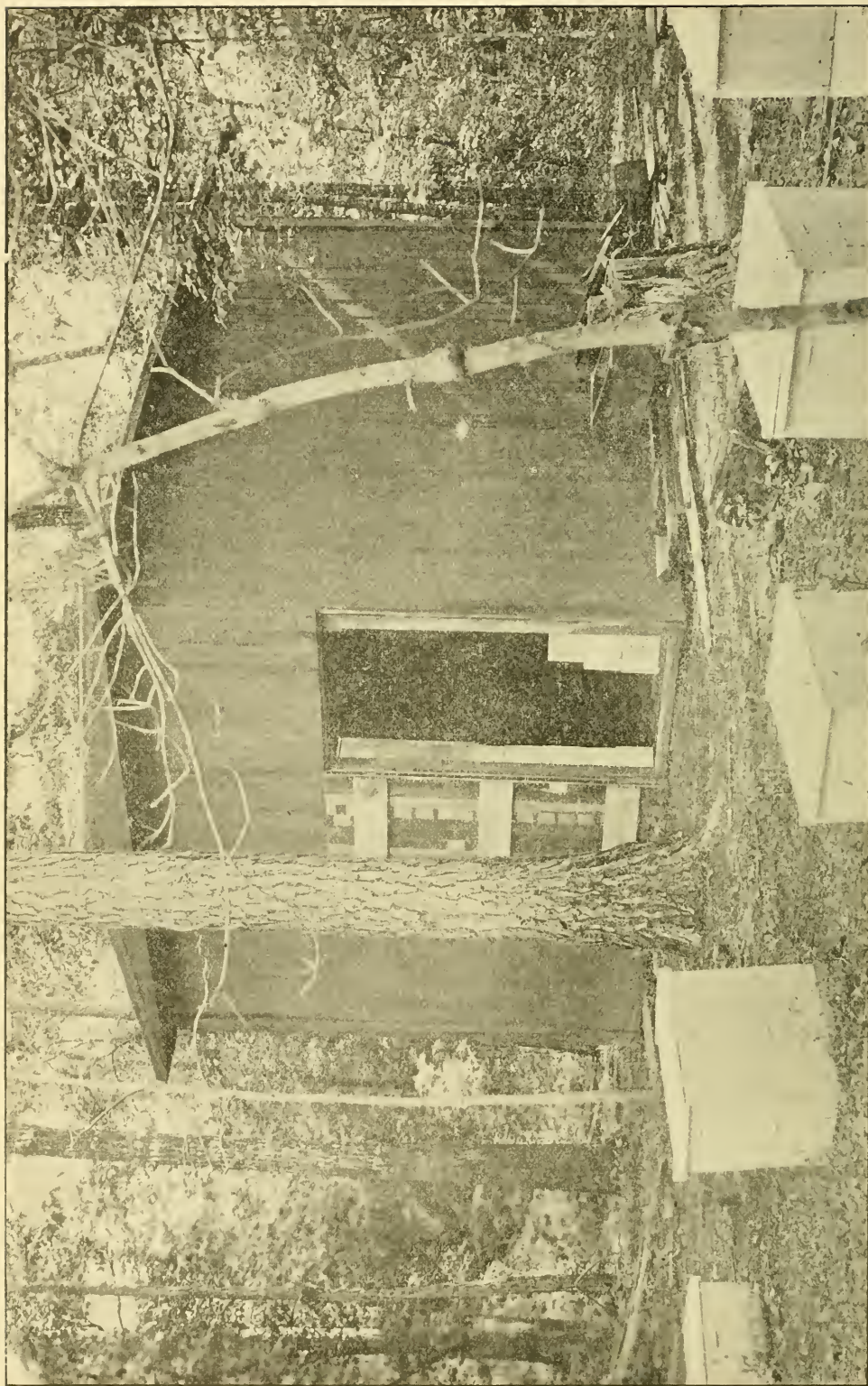

JENKINS' TAKE-DOWN HONEY AND EXTRACTING HOUSE.

"in the interest of science." Whatever friend Jenkins thought of it, he immediately put my suggestion into effect, and, presto! how infuriated those bees became! Instead of attacking his snakeship they literally poured out (punched) their vials of wrath on our faces. For my cruel suggestion I received no less than five stings around one eye, and broke my glasses in the bargain. By the way Mr. Jenkins was performing, slapping his face and neck, I concluded he was being served in like manner; but, nothing daunted, he kept on "steering" the aforesaid snake with a stick, toward the entrances. Those bees would rush out and make for us. A closer scrutiny (when the bees would give us a chance to see) showed that the skin of the snake was so tough that stings had no effect on it. However, the reptile had no desire to crawl into an entrance. When we found we couldn't get the bees to kill it, Mr. Jenkins dispatched it in the good old-fashioned way, with a stick.

CONSTRUCTION OF HIVE-COVERS AND BOTTOM-BOARDS.

Peculiar Conditions in Cuba.

BY W. W. SOMERFORD.

As time glides along, progress is constantly bubbling up and out to the readers of GLEANINGS, especially through Trade Notes. As "simplicity," cheapness, and durability are essentials to success, I will offer a few observations for Trade Notes.

Covers have often been under discussion. I saw in one of Dr. Miller's Straws that, so long as his "covers came from Medina," even when new, they would continue to be "stuffed with rags." I was surprised to see such a slam from the doctor on the Root hive-covers, as I have read GLEANINGS for more than fifteen years, and distinctly remember that Dr. M. figured very prominently in "the Medina delegation" when it met to discuss and devise a *perfect hive*—a hive without a blemish from top to bottom. The Root Dovetailed hive, with flat cover, was the decision of the Medina commission. I have used said hive since its birth, and am *sure it is perfect*, and especially the flat-cover feature. I have had those same flat reversible covers in use since their birth, and have yet to see the first robber bee go under them. But deliver me from such trash as the Excelsior cover. I had a shipment of them last October. They are now spreading their wings as though to fly, and summer hasn't come yet either. Still it would take a bagful of rags to make them all bee-tight, even to-day. "Unless otherwise specified, this cover will be furnished with *all* our hive combinations." Deliver us!

As the good old Medina flat reversible cover has come for ever to stay, I will discuss it just a bit.

It is easier than the easiest to put together, and will last longer than the longest, because necessarily made of the best material. It will ventilate better than the best by lifting and pulling back just one inch, so as to catch the end cleat on the front of the hive. It will

keep warmer than the warmest by using a top cloth under it. In fact, it is simple perfection. In making you have only three pieces to nail together. In making the Excelsior cover you have six pieces to nail together.

Now comes the question for the poor "bug-man." I say "poor," for I've never known one any other way. The price? That is the question that caused me to write this letter. It is, of course, high, as such lumber runs "in the fifties," and lumber at \$50.00 per 1000 makes dear covers, although good ones.

Now, to cut the price I began experimenting ten years ago with thickness. I tried $\frac{1}{2}$ inch in thickness; found it to be too thin; then I tried $\frac{3}{8}$, and have used them for years. I have just completed 500 of them, and can assure any one that a cover $\frac{3}{8}$ thick is nicer, lighter, and cheaper, by a lot, than the old inch-thick cover adopted years ago. The thinner ones warp with less force. It will last a lifetime, if painted, and never need rags if occasionally reversed. In fact, they are for me a happy solution of the vexed cover question. Now for bottom-boards.

The bottom-board question has troubled me more than the cover question; but I have solved it too, at last. The fact is, I belong to the 90 per cent or more who set bees on the ground, or very close to it, for many good reasons. I find that, the closer to the ground, the better. Why? They are warmer in winter and cooler in summer when standing flat on the dirt. These are facts; and no queens ever get under the bottom-boards and get lost—a big thing here in Cuba, where hives are so often opened to empty them.

A friend of mine, with a 300-hive apiary, said he had the real hive-staud, two railroad irons on the ground, side by side, and 15 inches apart (cost him a lot, though, and had to throw them away very soon, as, in going over with the first extracting after getting over, he found 37 queens out of 300 *black ones* between the rails under the hives, with bees and combs started). The best bottom-boards must have the $\frac{7}{8}$ bee-space, in order to handle big colonies in a hurry, as, with the $\frac{3}{8}$ space, bees don't pile up and clog under the frames when rammed in in a hurry—a very important item. The way I solved the bottom-board question, I began using the $\frac{7}{8}$ side of the Danzenbaker bottom-board—set them flat on the ground, and soon learned that Don Carlos, one of our big tough Cuban grasses, would find the joints in the bottoms, and crawl right up through them, ramming the tight joints out to bee-entrances—a bad thing, too—many of them in the same bottom-board. So I scratched my head, knowing there was not a hive factory in the world that could make of wood a bottom-board to rest on the ground and keep Don Carlos out, to say nothing of decay and wood-eating bugs that are so numerous down here. As I said, I scratched my head, got on my wheel, and started off with a Spanish-talking American bee-keeper, to a tile-brick factory. We soon found the jolly owner, and told him just what we wanted—smooth and straight flat-pressed brick, 16 inches wide by 21 long. He smiled, and said

he had just the "American machine" to make them with, and made them. And, gentlemen, I can tell you now, as I place them on nice flat ridges of earth, it is with a feeling that I shall be grown old and gray before the meanest one begins to even show decay. The man who made them said they would last for ever. Just think of a nice bottom-board lasting for ever, and costing only ten cents! If you have no tile-factory to apply to, concrete or cement will make them—are cooler than the coolest in summer, and warmer than the warmest in winter.

As many wonder why the Hoffman frame has been pushed so to the front, I will explain the matter to my readers. GLEANINGS has an editor of rare ability as an observer, and a hard thinker, coupled with long years of experience and observation in many parts of the country. In contact with the bright lights of apiculture, he knows a good thing for the average bee-keeper at a glance; and the Hoffman frame, for the average bee-keeper, is the only thing for the average bee-keeper. Why? Because, without the Hoffman or a self-spacing frame it is almost impossible to induce beginners to space properly. I have taught bee culture to many, and find they all hang on spacing—can't space brood-combs close enough. The Hoffman frame does it, of itself, and is, of course, the only thing for the beginner, and rightly belongs in the front ranks; and as the old story holds true about the lady who carried a cow on her back, the Hoffman frame to begin with is always the frame. The way the lady came to carrying a cow on her back is this: She lived in a city, and had a little calf given her; and as it was not possible to leave it in the street nights she began carrying it upstairs, and got used to it, so it didn't bother her to carry a cow on her back. The Hoffman frames are the same way—only need to get used to them. I heard a leading light once say that they were beautiful, from the fact that they were absolutely "fool-proof."

Those staples for end spacing, that the catalog shows so plainly, should be driven in at the *bottom* corners of all frames, not at the top corner, as in cuts in catalog. When at the bottom corners you can snatch frames out or in, in a hurry, and not a bee be killed. W. L. Coggsball is the leader, and user of such staples, and has been for years. Just try them, and you will wonder why any one ever put them at the top corners of frames.

Caimito, Cuba, May 12.

[We are very glad to get any thing of this nature, even if it is in the way of criticism of the goods put out by us or by any other manufacturer. But the Excelsior covers, the Higginsville, the Danzenbaker, and other three and four piece covers, are designed for the average of localities in the United States. But such covers, I am free to confess, probably are not as good as the plain flat board covers for hot and dry climates such as we find in Colorado, California, and even in Cuba; and it is possible that locality may have a similar bearing on bottom-boards. But it is al-

most impossible to get up a cover or bottom board that will suit all classes and all climates; and my impression is that the sooner supply-manufacturers make such covers for special climates, the better it will be for them and for their customers.

If there are any of our subscribers who desire to raise a good-natured "kick," or any other kind of "kick," I hope such a one will be free to let drive his pedal extremity clear into the editorial sanctum of GLEANINGS, which, for the time being, and for the convenience of "kickers," will be found anywhere from Medina to California and return. —Ed.]



MAKING SWARMS.

"Busy at the bees this morning, are you, Mr. Doolittle? Well, I'll hinder you but a few minutes."

"The man who is interested in his calling will always be busy with it, friend Jones; and when his body is not busy with them, as in the case of the bees, his mind will usually be actively engaged in planning for them, or for their future welfare. But what do you wish to hinder me about?"

"Only about two-thirds of my bees have swarmed, and I wish to make the rest swarm, and done with it; and what I want to know is, how best to do this."

"Many plans have been given in the past to make swarms of bees, other than by natural swarming, those advocating these plans believing that the apiarist could make his swarms to better advantage to himself, if not to the bees, than to have them swarm as their instinct directs; and from this cause many modes of artificial increase have arisen without much, if any, reference to the laws which govern natural swarming and the general economy of the hive, thereby causing a failure to a certain extent."

"Are there any special laws that govern bees in swarming? I thought they came out hap-hazard, just as each one feels at the time."

"I do not think there is any hap-hazard work in this matter. Evidently, the same laws that governed bees in their primitive state govern them now; and in all of the various operations conducted in the apiary, the bee-keeper should conform to these laws as nearly as possible, if he wishes to be a successful apiarist in the fullest sense of the word. A plan for making swarms, to be successful, must carry with it the taking of bees of all ages, and making them stay contentedly where put, the same as does a natural swarm."

"Do you think that necessary? My old neighbor, Smith, claimed that it was mostly old bees which went with the swarm."

"Many think that way; but after careful

observation, covering a period of 30 years, I am sure that bees of all ages, in about equal proportions, go with a prime swarm; and when any plan for making a swarm arises which compels the old bees, or field-workers, to become nurse-bees and perform the labors which, when the bees are in a normal condition, devolve on the young bees, we should not adopt it."

"Have you a plan which you consider meets all of the requirements of the laws governing the hive?"

"I think so, or, at least, as nearly as may be."

"Well, what is it?"

"Have you any queen-cells on hand?"

"I suppose there are plenty in any of those hives which have swarmed during the last week."

"You will see why I asked about the queen-cells before we get through. Now to the plan: Take a box holding from three pecks to a bushel, and place it on a wide board a few feet from the hive you wish to make the swarm from, raising the front edge on a little block, enough so the bees can run under. Now open the hive you wish to make the swarm from, and find the queen, caging her on one of the combs, when all the frames are put back in the hive again. If you do not see plenty of unsealed honey, uncap some along the top-bars of the frames and close the hive. Now blow in quite a little smoke at the entrance of the hive, and rap on the sides of it as you would in driving bees, rapping at intervals, and leaving the entrance open so that the bees returning from the fields may enter the hive. In from five to eight minutes open the hive and take out the frames and shake the bees in front of the box, and thus continue till you get at least three-fourths of the bees in the box. When you come to the frame which has the queen on it, place her at the entrance of the box and let her run in with the bees. When you get the desired amount of bees in the box, put the frames back in the hive and close it."

"Why do you run the bees into such a box instead of into a hive all prepared for them?"

"If you will not be impatient I will tell you so you will see the reason. Now, we will suppose that you have three-fourths of the bees, and the queen in your box. You are next to take the box of bees to the shade of some tree and lean the box against the tree in an inclined position, with the open side of the box outward, leaving it there three-quarters of an hour, at which time you will find them clustered in the upper part of the box as they would be on the limb of a tree, if they had swarmed naturally. During the three-quarters of an hour, if you have more to make, keep on making from other hives in the same way. At the end of the time, hive the bees that are in the box the same as you would hive any natural swarm. Put the hive on the stand you wish them to occupy, and see that all of them go into the hive, and they will stay and work the same as a natural swarm would."

"Then this leaving them the three-fourths

of an hour with the open side of the box out is to make them think they have left home, so they will mark their location as does a swarm?"

"Exactly."

"I see now why mine would not stay when I shook them into a hive. But what about what is left in the old hive?"

"The next day after making such a swarm, give the old colony a queen-cell from one of the hives you say have such, giving cells from the colonies which have those the nearest ripe, and the work is done. If you have stopped to think as we went along you will see that you have bees of all ages in your made swarm, just as there would be in a natural swarm, and that each bee has its sac full of honey the same as they do when they come out themselves, the drumming causing them to fill themselves full more completely than they do when swarming. By being left three-quarters of an hour to cluster in the box they mark their location anew, the same as a natural swarm, as you expressed a few moments ago."

"But is the old colony in as good condition as if it had swarmed naturally?"

"I think so, fully, and more so; for in natural swarming the first young queen does not emerge from her cell in less than seven days, unless the swarm has been kept back by bad weather; while with our made swarm, and a ripe cell being given, they will have a queen in two days from the time of making. If preferred, and you have them, a laying queen can be given to the old colony."

"Why would not this be a good plan to work an out-apiary, where there was no one to take care of swarms when they issue?"

"It would. And it is equally adapted for those who can not be at home between the hours of 8 A. M. and 4 P. M. to care for their bees when swarming naturally."

"Well, I have bothered you long enough, and think I understand how to work. Good day."



CROWFOOT AS A HONEY-PLANT.

In our locality it grows extensively, and I think it produces a nice lot of honey when it is the most needed, as it comes right after fruit-bloom and dandelion, and lasts from about May 10 till white clover comes.

Rohr, W. Va.

W. D. KEPHART.

ABSCONDING SWARMS.

I am a beginner in bee-raising. I had a swarm of bees Monday. It clustered on a limb of a tree. I cut the limb and laid it on the ground in front of the hive. After they entered the hive I set it with the rest of my hives, and they worked like little men on Tuesday, making 3 combs about 5 inches around, and on Wednesday morning not a bee

was remaining in the hive. Another colony sent out a swarm Tuesday, clustering on a limb. I hived them half an hour afterward, but they left the hive and entered the old hive. On Wednesday they swarmed again. I stopped them five or six rods from the hive, and they clustered on a limb. I cut the limb, and laid it on the ground in front of the hive. They all entered at 10 o'clock in the morning; by 7 o'clock in the evening not a bee remained in the hive. How would you account for such an occurrence? they were all large swarms. CHRIS. KINSEL.

Dysart, Iowa, June 13.

[Such a case as you mention happens occasionally, although not very often. If you have the A B C of Bee Culture you will notice we recommend giving every new swarm a frame of comb containing a little unsealed brood. This unsealed brood will almost invariably hold the colony in any new hive. Sometimes the bees desert the hive because it is put right out in the hot sun. It is possible that the queen was missed in one of the cases you mention; therefore the bees left the hive as soon as they discovered she was not with them; but in such a case unsealed brood would hold them just about as well as the queen. In practice I should give every swarm put into any hive at least one comb containing brood. Then they will stay, no matter whether they have a queen or not; and if they have a queen, she will go to laying at once; and I think they always work better if they have the comb. Another thing, if this brood is present you will know at once when the queen is missing by finding queen-cells started inside of a few hours. Thus you see, unsealed brood, be it only a little patch in the comb, renders it unnecessary for you to get sight of the queen at all to be sure she is with the bees.—A. I. R.]

CANDIED COMB HONEY; USING SECTIONS CONTAINING CANDIED COMB HONEY.

I meant to drop you a line before, bearing on the position taken by Doolittle with reference to the use of sections containing candied honey, but have, as usual, been too much rushed to spare time for the purpose. I wish to say here that I am greatly astonished at such teaching from such a source, and wish to enter an emphatic dissent to the views expressed in the article referred to. I will say that I have had occasion to handle a great many lots of honey in past years, containing sections having more or less old and candied honey in the combs, and there is no question that either this honey does not become liquid to any extent while on the hives, or else it recandies (as one would naturally expect), after removal; and as the sale of such honey on a city market does as much as any one thing to prejudice purchasers against the use of comb honey (as they are quite sure to regard the presence of the candied part as a sure proof

of the impurity of the goods), the practice in question certainly can't be too strongly condemned. B. WALKER.

Battle Creek, Mich., May 10.

AN IMPROVED DRONE-TRAP.

The inclosed drawing is a queen and drone trap that I have made. I work my hives for extracted honey, so of course I do not have any swarms—at least not for the four seasons I have owned bees. It catches the drones all right, from the fact that, in their first flight, they do not discover the side entrance, but go toward the light in the front of the hive. I have concluded the queen would do the same. The field bees (the majority) use the side entrance as an exit too. They are not bothered with the perforations, and the pollen is not brushed off their legs. In comb honey it

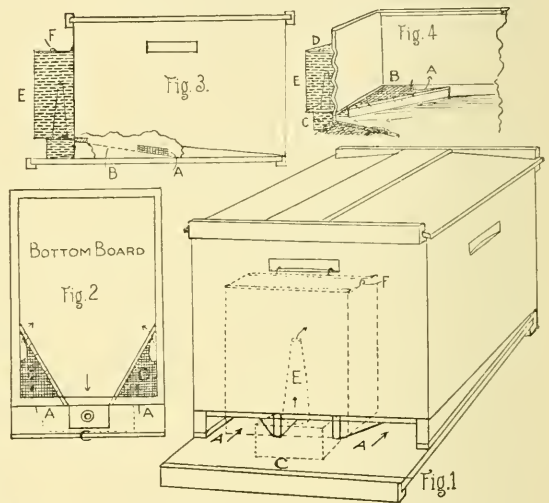

FRICK'S QUEEN AND DRONE TRAP.

- AA, entrance.
- BB, wire cloth.
- C, guard.
- ED, trap for drones.

would send them up the sides into the super, which, I understand from your journal, is an important factor. HENRY N. FRICK.

North Wales, Pa.

[The object of this improvement, as I understand it, is to make it unnecessary for the field bees to go to and fro through perforated metal. To accomplish this the incoming bees go through that part of the entrance (the two sides) that are not obstructed at AA, pass under the wire cloth BB, finally reaching the orifices at the corners, or as indicated by the arrows in Fig. 2, and by A in Figs. 3 and 4. The drones and queens would, of course, rush for the first time (as do the workers also) toward the light, and there would be barred by the perforated metal, when they would be trapped by the cone opposite E in Figs. 3 and 4. The workers soon learn the trick of going through the unobstructed way, and, of course, would not pass the metal.]

The objection to this trap is that of expense and the difficulty of fitting it to various styles of hives. After all, the regular Alley trap will be just as good and much cheaper. If the perforated metal is of the Tinker style the bees can pass it with little or no hindrance.—ED.]

A NEW DRONE-TRAP.

If you want a perfect drone-trap, cut a saw-kerf in the side-bars on the deep side of the Danzenbaker bottom-board, an equal distance from the edge and bottom-board proper; tack some $\frac{3}{8}$ -inch strips to the bottom-board, and slip a sheet of perforated zinc in the saw-kerf, and allow it to rest on the strips. Turn the end of the zinc up and tack it to some blocks on the front of the hive, and set an ordinary drone-trap, minus the bottom part, over it. The drones will escape through the upper entrance thus formed, while the one next to the bottom-board will be left free for the exit and entrance of the workers. There will be no danger of clogging or suffocation.

An ordinary excluder placed on a bottom-board with an entrance above and below the excluder, with a drone-trap adjusted to the upper entrance, removes the objectionable features of a drone-trap so far as the trapping of the drones is concerned, and does not interfere with the progress of the workers at all, further than forcing them to pass through the excluders.

W. H. PRIDGEN.

Creek, N. C.

BEE-KEEPING IN OKLAHOMA.

Mr. Root:—Did you know there were beemen in this new country, and that the business is growing? Two years ago I had the only bees in this neighborhood; now there are some ten or twelve men keeping bees. Our honey is from sumac and cotton. You no doubt know what it is—white and light amber—and it sells as well here as the alfalfa honey that is shipped in. My average, last season, was 66 lbs. per colony, spring count. The season is somewhat backward. Bees are just beginning to swarm, which is about ten days later than last year; but I hope they will make up the lost time.

F. W. VAN DE MARK.

Ripley, Okla., June 6.

SWEET CLOVER FOR HAY, ETC.

Is melilot, or sweet clover, of any value for hay? and, if so, when should it be cut? Can it be cured sufficiently to mow away? I have several acres in my pastures, and this wet weather of the past few weeks has pushed it till no grass will grow beneath it. Stock will not eat it green; but mules and hardy Canadian horses are said to relish the hay made from it.

S. S. FETHEROFF.

Era, Ohio, June 10.

[Friend F., you evidently have not been reading GLEANINGS very long, for this matter has been most fully discussed for several years past. Horses and cattle, after they have once acquired a taste for sweet clover, either green or cured, as a rule prefer it to any other

kind of hay. If cut before it gets tall, so as to be hard and woody, it makes the best kind of hay that I know of for all kinds of stock; and I can not remember that I have ever seen any stock that would not eat it when thus cured. See pamphlet we are mailing you, free of charge, that tells all about sweet clover.—A. I. R.]

WHY DID THE SWARM GO OFF TO THE WOODS?

I had a swarm issue June 17, with a clipped queen. I caught the queen, and moved the old hive away—set a new one in its place with starters. The bees settled close by. I had every thing ready. I gave the cluster a little smoke, and they started back. I put the clipped queen at the entrance, and she went in. The next day they came out again, and I picked up the same queen and caged her; but the bees did not stop—they went to the woods. Do you think they had two queens in the hive?

WM. FOX.

Longwood, Wis., June 19.

[This case is evidently one where there were two queens in the hive—mother and daughter. At this season of the year this thing is not so very unusual. The clipped queen was getting old, and the bees had reared another, and both were very likely laying eggs right along together. Of course, the bees did not care particularly for the old queen, so they went straight for the woods, where they had probably selected a home some days before the swarm came out.—A. I. R.]

HATCHING DRONES FROM QUEEN-CELLS.

Before it slips our mind, we desire to report the hatching of a perfect drone from a queen-cell. Cell was cut from a comb of a choice colony of Italians, and placed in a queen-cell cage, the same being put into a nursery. I do not remember seeing or having any thing of the kind happen before, and so thought it worth while reporting. There was no chance of a slip twixt cup and—in this case.

H. G. QUIRIN.

Parkertown, Ohio, May 21.

A GOOD REPORT.

There is one of the finest honey-flows here now that we have had since 1897. In fact, the white clover lacks but little of being as plentiful as it was then. But I find a great many more bees on red clover than on white. The honey is just rolling in. I have a good many colonies with the second super on. I commenced to raise the first super up the 15th of June. Basswood is going to be simply grand.

CHAUNCEY REYNOLDS.

Fremont, O., June 21.

Half of the bees or more have died here, and in near-by towns, where they have been wintered out of doors. The season was wet and cold up to June 1. We have now had a few fair days, raspberry just beginning to bloom. Bees have commenced swarming where they have wintered well.

N. D. WEST.

Middleburgh, N. Y., June 7.



NATIONAL BEE-KEEPERS' ASSOCIATION.

OBJECT:—To promote and protect the interests of its members; to prevent the adulteration of honey.

OFFICERS:—E. R. Root, President, Medina, O.; R. C. Aikin Vice-president, Loveland, Col.; Dr. A. B. Mason, Secretary, 3512 Monroe St., Sta. B, Toledo, O.; Eugene Secor, General Manager, Forest City, Iowa.

BOARD OF DIRECTORS:—E. Whitcomb, Friend, Neb.; W. Z. Hutchinson, Flint, Mich.; A. I. Root, Medina, O.; E. T. Abbott, St. Joseph, Mo.; P. H. Elwood, Starkville, N. Y.; E. R. Root, Medina, O.; T. G. Newman, San Francisco, Cal.; G. M. Doolittle, Borodino, N. Y.; W. F. Marks, Chapinville, N. Y.; J. M. Hambaugh, Escondido, Cal.; C. P. Dadant, Hamilton, Ill.; C. C. Miller, Marengo, Ill.

FEES:—Annual membership fee, \$1.00. Remittances may be sent here or to General Manager as above.

In the *American Bee-Keeper* which has reached me on the fly I see that Editor Hill has replied to the editorial on page 476 of GLEANINGS regarding the matter of high values on queens. While I differ on many of his points, there is one on which I feel constrained to acquiesce; viz., that, if one owner of some really valuable queen places a high value on her, other breeders, perhaps less scrupulous, may put equal or higher values on breeders comparatively mediocre or even poor. As the matter is liable to abuse we have decided to place no values on breeders which we propose to keep and will not sell. But queens from such choice stock, best we have, we may hold all the way from \$10.00 to \$25.00.

THE BEES AND PEAR-BLIGHT IN CENTRAL CALIFORNIA.

On the train to San Francisco, June 21.

It has been charged by the fruit-men at Hanford, Cal., that bees are responsible for pear-blight through the medium of the blossoms in the spring. There were threats of the law and of the poisoning of the bees. As an officer of the National Bee-keepers' Association I was asked to come and investigate, which I did. Result, a truce was declared, and a compromise agreed to pending an investigation. For the time being good feeling on both sides prevails. Full particulars later.

E. R. ROOT, *Pres. N. B. K. A.*

"GO WEST, YOUNG MAN."

THIS is sometimes good advice and sometimes it is not; but there are many locations for bees in the South and West not yet occupied. These are *not* in fields already occupied by bee-keepers, and generally overstocked, but in new locations about to be irrigated. As fast as enterprise and capital can move onward, places now desert that will hardly support jack rabbits and coyotes will be converted into veritable gardens of Eden, raising the richest vegetation of the tropics. I have seen many such places during the last few days on my travels, that, fifteen years ago, were barren wastes with very scanty vegetation, but are now growing alfalfa, great trees, oranges, lemons, peaches, pears, and a long list of luscious fruits too numerous to mention. The fields already occupied by bee-keepers are, as

a rule, overstocked, and no one should go into these territories without buying some one out.

Now, don't think that I am interested in some new tract of land for myself or any one else, for I am not. One who goes west should be very cautious, for many a poor man has been fleeced by the land-sharks that are all too numerous. I'll have more to say on this subject later, and until then the prospective home-seeker had better go slow if he is following in the wake of my travels.

THE MAGNIFICENT DISTANCES IN CALIFORNIA.

THERE are "magnificent distances" in California. On the ordinary map it *looks* as if the town of one bee-keeper in the State might be close to that of another; but when one gets here and finds that they may be two or three hundred miles apart, he concludes that he won't visit both in the same day—at least that has been my experience. While I was traveling through this State of the setting sun at home, "on paper," I saw, for example, that one bee-keeper whom I desired to visit from a central point where I expected to make my headquarters was "only over in the next county," and that I could easily, in imagination, wheel out to him in a few hours. Well, when I got here, and found that he was 200 miles away, and that some eastern States could be spread out inside of one of these California counties—yes, two of 'em—well, I stood aghast. My time was very, very short, and my pocketbook ever so small. I say this in apology for not calling on some of my friends along the route. The same thing was true of Texas, and, for a like reason, I missed seeing several whom I had planned to meet in the Lone Star State. I shall make between five and six thousand miles, all told, among the bee-keepers of this great, great West; and, although I have made many stops, and kodaked as many apiaries, I still find that there are very many that I ought not to have missed.

This is written while I am stopping with Rambler at the home of J. C. McCubbin, Reedley, Cal.

CHARACTERISTICS OF BLACKS AND ITALIANS.

ONE of the few who prefer black bees is C. Davenport, although he calls them "brown" bees, and says there is as much difference in brown bees as there is in Italians. In the *American Bee Journal* he gives his reason for preferring the dark bees, a preference based on years of experience on a large scale with both kinds side by side. That experience teaches him that he can secure more surplus white comb honey in his locality with the brown than with Italians. He says:

"The main trouble I find with Italians is their determination to stuff the brood-chamber at the commencement of the flow, and I have never been able to overcome this trait. And then, after they have put anywhere from 15 to 30 pounds of white honey in the brood-chamber which should have been in sections, instead of then being willing to work in sec-

tions they are usually determined to swarm." In this respect he thinks the brown bees better. It would be very interesting to know whether other localities or other management would lead to the same conclusion. Certainly there are fine crops of comb honey secured by Italians. What makes the difference?

As Mr. Davenport avowedly prefers and keeps black bees, his testimony in favor of Italians should have weight. He says:

"For extracted honey I prefer Italians. They will gather more honey, go a greater distance, and protect their hive and combs from the ravages of the moth-worms much better than will brown bees, and this is no small matter in my locality.

"Some claim that moth-worms never injure strong colonies of any kind of bees; but this is a mistake, for the combs will be injured, and hundreds of eggs, larvæ, and hatching brood, will sometimes be destroyed here by moth-worms in strong thrifty colonies of brown bees."

RED CLOVER — HOW IMPORTANT IS IT?

THE desire to obtain the nectar secreted by red clover is one of long standing; and the common impression is that a very large quantity of nectar per acre would be secured from it if the flower-tubes were not too deep for the reach of the honey-bee. Latterly some discredit has been cast upon red clover as a honey-plant, even supposing that all its nectar could be secured, by the fact that it is not a plant of universal cultivation.

There are a few plants that yield an enormous amount of nectar; but as they are kept only in greenhouses, averaging less than one plant to the acre, they are valueless from a bee-keeper's standpoint. If, however, any good honey-yielder were widely distributed in dense quantity over a single State, then it would assume some degree of importance. The buckwheat crop of the State of New York would be no trifling matter, even if not another acre of buckwheat were found elsewhere in the United States. If it were possible to obtain certain bees that would double the buckwheat-honey crop of New York, the amount of money gained by that would warrant no small outlay. Is it not possible that there are single States in which the nectar secreted by red clover would amount to several thousand dollars?

But is red clover confined to a rather limited area? It would be interesting to know just what is the average acreage. Lacking that, some estimate may be made from the amount of clover seed raised. The government statistics give us the figures, and it is probably safe to infer that by "*clover seed*" is meant that from red clover. According to the last census available, that of 1900, an amount of clover seed, large or small, is given as being raised in every State and Territory of the United States except Montana and Wyoming. Certainly that shows that it is not confined to so small an area as some suppose.

The North Central division leads with a product of 2,544,864 bushels. The South Central comes next with 77,783 bushels; the North

Atlantic, 71,128 bushels; So. Atlantic, 35,155 bushels; Western, 24,250. Total, 3,753,180 bushels.

That shows a very unequal distribution; but the distribution of the growing plants is by no means what the figures would indicate. From the States that are the greatest producers, as New York and Pennsylvania, large quantities are exported, and, of course, other States import, thus making the acreage grown in the different States much more uniform than the amount of seed produced.

If all the seed raised is sown again — and it is not likely that it is ever used for any other purpose — and if a peck of seed is sown to the acre, it would cover a little more than eleven millions of acres. To speculate as to the amount of honey that could be obtained from this acreage would be outside of the present inquiry, and it is doubtful as to there being sufficient data to justify any thing like a reasonable estimate. It is only desired to show that the aggregate of red-clover territory is no trifling affair, and that it is widely distributed.

BEE-KEEPING AS A SOLE BUSINESS.

ONE of the questions likely to occur to every young bee keeper who has made a substantial success with a few colonies of bees may be worded in some such terms as the following: "Can I make a good living at bee-keeping alone?" On this account comes very frequently the question as to what may be depended upon as the average yield or profit from a single colony of bees, or the question, "How many colonies of bees shall I need so that I may depend upon them alone for a living?" — questions which no man living can answer definitely.

C. Davenport gives the matter some discussion in the *American Bee Journal*, and settles the question as to whether one can make a living at bee-keeping alone by saying he *has* done it. But he says his is a good locality, and that he has no wife or family to support, and adds, "While I would not advise a young man to take up bee-keeping as a lifework, in my opinion there is no question but that a living can be made at it in a good locality if one understands the business."

While he may be entirely right in this, there are those who would not be in accord with his ideas when he says, "If I had my life to live over I would not be a bee-keeper; for I believe the work I have done to make what might be called a success in our pursuit would, in some others, have resulted in better success financially, and also in other ways." It is just possible that, if Mr. Davenport could live his present life through, and then live another life without bees, in some business at which he could make more money, he might give his judgment as follows: "I must say that, after having lived the two lives so that I am now able to judge between them, I prefer the bee-keeper's life, which, although giving less opportunity for amassing wealth, gives one the opportunity for a greater amount of happiness."

Taking the expressions of some of the veterans who have been in the business many years, we might suppose one of them near the close of life to express himself as follows :

"Judged from the standpoint of those who measure success in life only by the amount of wealth accumulated, my life has not been a great success. Folks compare me with my brother John, and have a feeling for me akin to pity. John and I started life with equal chances; and, if I may be allowed to judge, John had no more business ability than I. He went into merchandizing, and devoted all his energies to making money. He said he did not care for money, only as it would allow him to have something he could enjoy; and when he got enough he would give up the drudgery and enjoy life. But somehow he kept on piling up more and more, turning his business talents in this direction and that; and although to-day he could buy and sell me many times over, I don't believe he enjoys life any better than I. I have all I can eat, and that's all he has in the way of food. He may buy dainties that I can not afford, but his dyspeptic stomach will punish him for eating them; and, having spent so much of my time outdoors all these years, I have a hearty appetite that makes me relish plain and wholesome food more than he relishes dainties. The great difference, however, between John's life and mine is that, in the past years, his has been one of continual drudgery, and mine has been one mainly of enjoyment. I've had my good times as I went along. Working at the bees has been just as good sport as going hunting or fishing, and it's a sport of which one never wearies. So you see my playtime has not been something to look forward to in the future, but something I've had all along. No, with all his wealth I wouldn't swap places with John."

Some one may say, "That's very pretty talk; but my experience has been that there's hard work in bee-keeping, and lots of it." Sure. But isn't there hard work in nearly all kinds of play? Do you work any harder at bee-keeping than you do when you hunt or fish all day? Do you begin to work as hard as the man who plays ball till he is as red as a beet in the face, and is so sore and lame at night that he can not lie still?

AS TO EDITORS OF BEE-JOURNALS.

It seems to some a matter of reproach that editors of bee-journals are not completely informed on all topics nearly or remotely connected with the subject of bee-keeping. On page 332 Arthur C. Miller complains of the silence of the text-books and the ignorance of editors as to the laws of heredity and the principles of breeding; and now F. L. Thompson, in *Progressive Bee-Keeper*, takes up the refrain at still greater length. This reproach against the ignorance of bee-editors does not seem to be bitterly resented by at least one editor, for the editor of *Progressive* makes no word of reply, and it is not likely that any other will attempt to deny the charge. No one is more likely than the editor of a bee-journal himself to be conscious of his need of

information; and the reproach that he has not yet learned all that is to be known about bee-keeping is likely to strike him much as would the reproach that he has not strength to live on without eating.

The mistake that Mr. Thompson seems to make is in supposing that editors of bee-journals pose as the repositories of all knowledge on the subject of bee-keeping. If bee-keepers had any such view, then their journals would be made up entirely of editorials. But at the present day no bee-journal is conducted on any such line. Instead of being filled up entirely with what the editor has to say, the bee-journal of the present day seeks contributions from all quarters. If any bee-keeper has had special opportunity for becoming particularly well informed on some one subject connected with bee-keeping, contributions from him upon that subject will be eagerly sought. Instead of a bee-journal being a mouth-piece through which one man seated on a pinnacle may deal out wisdom to the common herd below, it is, rather, a clearing-house through which may pass in exchange the gathered wisdom of all.

Still greater is the mistake that a bee-journal should seek to repress knowledge upon a subject with which the editor is not entirely familiar. Having learned that an article having some reference to the matter of scientific queen-rearing had been sent to appear in the columns of this journal, Mr. Thompson says, "I fear that either it will never get there, or, if it does, it will be accompanied by a crushing footnote, written more in sorrow than in anger." If he will turn to page 382 he will find the article in question, with a footnote not at all "crushing," containing neither sorrow nor anger. So far from that, he will be rejoiced to find the footnote only commendatory, saying, "Bee-keepers have much to learn from the breeders of other fine stock," and his joy will be increased to find that sufficient progress has been made to commend heartily in-breeding on the lines indicated. No, the bee journal that seeks to repress knowledge that may benefit bee-keepers in general would be committing suicide. The watchword with all should be, and probably is, "Let there be light."

R. WILKIN—CAREER OF A REMARKABLE MAN.

R. WILKIN, whose death occurred just before the writer reached there, was one of the pioneer bee-keepers on the Pacific coast, going to California in 1875 with a carload of bees, and subsequently settling in the Sespe Valley.

His first experience with them was in helping to prepare a shipment of bees for Mr. Harbison, who was then about to leave Pennsylvania (where he was then residing) for California. This was some time in the early '50's; and the result of this venture, and how Harbison subsequently came to be the great bee-king of California, owning and operating at one time some 6000 colonies, are matters of history.

Mr. Wilkin began keeping bees while he

was at Westminster College, Pa. The next we know of him in connection with bees was at the county fairs of Northern Ohio. On these occasions he astonished the natives by having a swarm of bees hanging from his hat and beard. This series of remarkable feats was accomplished by having a queen caged under his chin; and as long as she remained the bees continued to hang from his head, to the wonder of the aforesaid natives. It is not told that he was ever stung, except on one occasion, when he says he very foolishly attempted to put some of those gentle, fly-like bees in his mouth. The incident resulted in his being stung in the throat, and from that time on he never attempted the feat again.

At this time Mr. Wilkin's home was at Cadiz, Ohio. From this point he attained considerable celebrity as a bee-master; and so many were the questions that were plied him that he finally, to answer all, wrote a book of 100 pages, entitled "Hand-book on Bee Culture," which at the time, 1871, had a considerable sale.

Just what induced him to go to California is not stated. Possibly the success of Harbison, who had preceded him, had much to do with it; but after he had gone to the coast in 1875, with his family and a carload of bees, and had produced those enormous yields of sage honey in the now celebrated Sespe Apiary, his celebrity, which had hitherto been only local, was made world-wide. Here he produced honey by the carload, and sold in the London markets for a number of years.

His largest yield was in 1884, when he produced from his Sespe Apiary 60,000 lbs. of honey. The largest number of colonies he had in this yard at one time was 700. Such a number managed profitably, in one apiary, seems, to an Eastern bee-keeper, almost incredible. But to one who has just come from the location, as I have, with its great mountains on every side, and the orange groves in the valley, the number does not seem so impossible of belief after all. Indeed, to see is to believe.

In later years the Sespe Apiary has been occupied by his son-in-law, J. F. McIntyre; and during all the years this location has supported on an average 500 colonies.

Mr. Wilkin, even up to the time of his death, retained a deep interest in bees; and, though his success in life had been such that it was no longer necessary for him to work, yet at the time of his death he was managing an apiary at Newhall, Cal., some 450 colonies, I believe.

A few days before his death he had sent me a pressing invitation to visit him, saying that, although he had got to be an old man, there was much that he wanted to talk to me about on bees, and it was with no little surprise and sorrow that, on arriving at Los Angeles, I learned of his short illness and death.

Although well advanced in years, when most old men lose interest in the business of a lifetime, Mr. Wilkin retained all the enthusiasm of youth. His love of bees seemed to be as strong as ever; and even up to the last days his mind seemed to possess all the vigor

of his earlier years. A college graduate, it is said of him that he was "a close and profound thinker."

His daughter, Mrs. McIntyre, who had been called to his bedside at his last illness, told me recently that he seemed to count much on my visit, and at the time had no thought but that he would get well. Among other things he told her that, when I came, he would show me some old brood-combs that he got of Adam Grim that were 30 years old, and which at the time were still in use, rearing bees that were full size. Evidently he had no faith in the late dogma that old combs raise small bees, and should, therefore, be melted up.

Mr. Wilkin was twice elected President of the California State Bee-keepers' Association, and in all the doings of that organization was a prominent and conspicuous figure. There

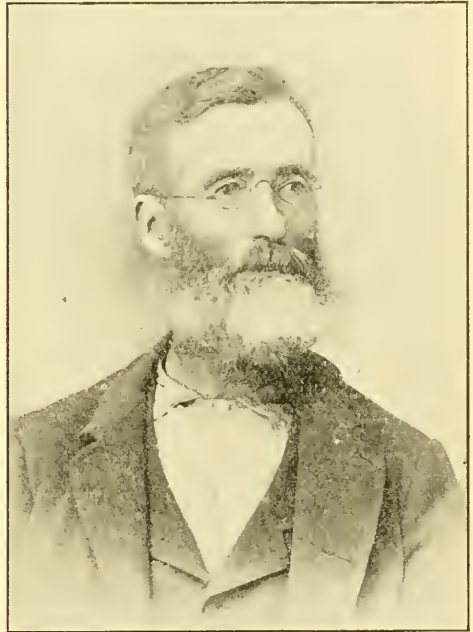

R. WILKIN.

is many a present-day bee-keeper in the State who will remember the kindly services performed for them by our departed friend; and although he is gone he will not be forgotten.

N. B.—For the main facts of this write-up I am indebted to his daughter, Mrs. McIntyre, who, I judge, must, in years gone by, have been an efficient helper to her father. At a later time I shall have occasion to refer to my visit to the McIntyre's, all of whom, including the baby, are bee-keepers, from the ground up.

This is written on the train, *en route* to Fresno, Cal., and if Mrs. McIntyre finds any inaccuracies it will be because this jiggly-joggy train has jiggly-joggled my memory.



And the nations of them which are saved shall walk in the light of it; and the kings of the earth do bring their glory and honor into it. And the gates of it shall not be shut at all by day; for there shall be no night there. And they shall bring the glory and honor of the nations into it. And there shall in no wise enter into it any thing that defileth, neither whatsoever worketh abomination, or maketh a lie; but they which are written in the Lamb's book of life.—REV. 21: 24-27.

Years ago I said in these Home Papers that Revelation was a very hard book for me to understand; but I have said at different times, also, that, as I grow older, the book seems to unfold—at least certain parts of it. A few days ago we had a certain portion of this book for a Sunday-school lesson. In our morning reading I frankly acknowledged to Mrs. Root that I could not understand or explain it. I said further that the explanations given in commentaries and by doctors of divinity did not seem to me the correct ones. I felt somewhat encouraged later on to find that one of the very best lessons—helps I know of said substantially the same thing—that there are so many differences of opinion, even among learned scholars, as to the real meaning of certain passages, that it was very likely no one had as yet struck upon the true meaning. Skeptics might throw it up to us that a great part of our precious Bible no one could understand, and perhaps no one ever would understand.

Well, even if this is true, there are passages all along through the whole Bible, and even in the book of Revelation, that are so much in advance—so far superior to any words of any other book ever written, that we have at least very good reason for believing the Bible to be divinely inspired, or, if you choose, for believing it to be the work of God and not of man. The words that I have put at the head of this talk, from the next to the last chapter of Revelation, form one of these wonderful and beautiful passages. The description seems to be of the holy city. The first words, about there being no darkness and no night, would indicate it would afford no harbor for those who love darkness rather than light. The next verse tells us that this city is so great in area that *nations* shall walk therein; and we are told the gates of it shall not be shut at all by day, and that there shall be no night there. It is a pleasant thought about the gates being always open; and, in fact, we may suppose there is nobody there, outside or inside, to be kept out. I suppose there are no policemen there, for everybody *wants* to do right. The glory and honor of all the nations of this earth shall be brought into this holy city. The last verse is the crowning one of all, the cappingstone of the citadel—"There shall in no wise enter into it any thing that defileth; neither whatsoever worketh abomination or maketh a lie." I can imagine how the average man of the world who never gives much thought or attention to the Bible or Christian-

ity would receive any such statement. He would probably laugh and jeer at the idea; and if he would tell you the whole truth that lies right down at the bottom of his heart I do not know but he would say he did not wish to live in any such place. Such a state could be congenial only to those who love righteousness and hate iniquity.

Some might ask, "When is all this coming to pass? when shall we have that new Jerusalem?" I for one do not know. I know it is coming, for the Bible tells us so. Its promises are scattered all through, from the first page to the last. We are told in substance, over and over again, "Blessed are they which hunger and thirst after righteousness, for they shall be filled."

I know there has been a great amount of dispute about this whole matter of the new heaven and a new earth. Some claim that at death we are ushered into the new Jerusalem. Others say it does not come to pass until the judgment day. As for myself, I do not see why we should waste time or thought in regard to this matter where there are so many differences of opinion. We have God's promise, and that is enough for me. "Shall not the Judge of all the earth do right?" I am willing to trust *him* to manage the whole matter. I do not even believe I can afford to read the books and pamphlets that are sent me, arguing on different sides of the matter. Jesus said to the thief on the cross, "This day shalt thou be with me in paradise." Of course, I know some maintain that "paradise" is a wrong translation. But that would make no difference to me. If I am to be where Jesus is, I am content. I ask nothing more.

But, friends, God has not seen fit as yet to usher us into this holy city. He has placed us here in this world of ours to work. I am sure of that. He did not put us here to idle away our time; and we are to work either for righteousness or iniquity. Which shall it be?

Perhaps I have said a great deal of late in regard to the wickedness that seems to be abroad throughout our land and throughout the whole world at the present time. Dear friends, I am not oblivious to the good that is also abroad. I assure you I am looking on with joy and thanksgiving and praise to note the progress that is being made in praiseworthy directions. I love to read our daily papers. Perhaps I had better say I love to read our *good* dailies; for when I am away from home I pick up daily papers here and there that I do not love at all. I often read them, however, even if with pain; and sometimes I read them, too, with shame. I feel ashamed that our people, with all our present enlightenment, should encourage and sustain papers that seem to say on the face of them that they love iniquity rather than righteousness. But even in the worst of our dailies we find a record, more or less, of good things. The world at large is climbing out of many of the abuses in which we have for long ages existed. I think the general trend is upward; yes, and in some directions we are making marvelous progress. The experiment stations of the world are achieving wonders in the

way of separating truth from falsehood and superstition, by real scientific research—a research that is managed with sense and reason. Our government bulletins from Washington are also doing grand things in teaching the world at large honest and substantial truth. By the way, I have been greatly pleased with the bulletins discussing the real value to the human family of certain articles of food. There has been one published in regard to beans, another in regard to sugar. In considering the food value of these articles of regular diet, we have had another one recently all about eggs for food, and all of these bulletins are scholarly efforts. I think the writers come very near the exact truth. Now, why can not the United States, in the same way, give us a calm, honest, and unprejudiced discussion in regard to tobacco—this crop for which we spend about 600 millions of dollars annually. I wish I had influence enough with the Agricultural Department at Washington to induce it to publish a bulletin with a heading something like this:

“Tobacco, and its General Effect on the Human Family. Should its Cultivation and Dissemination be Encouraged or Discouraged?”

Then I should like to have a closing chapter something like this:

“The Effect of Tobacco on Children and Young People. Should its Use be Prohibited to those under a certain Age? if so, what Age? Also a Consideration of the Cigarette Habit.”

Now, if the above suggestion is not a proper one for a bulletin, will the authorities at the heads of the proper departments explain why the matter can not be discussed just as honestly and frankly as these bulletins I have mentioned discuss the food (and *health*) value of beans, sugar, eggs, etc.? Surely Uncle Samuel can give even one of the humblest of his subjects a fair and frank answer. If tobacco comes under some other head, *why* does it? Our country is doing great things in the way of sanitary measures for the protection and preservation of the health of our people. We are making great strides in many directions. We are even able to go into cities of foreign lands and drive out contagious fevers that have existed there for ages. In the matter of sanitation we are able to teach every nation on the face of the earth. If there is any thing that blocks the way and hinders our being able to grapple with something like tobacco, that ruins more bodies and souls than any thing else in the world, unless it is strong drink, what reasonable excuse can there be for evading or avoiding the subject? May God help us.

I told you some time ago there was something I feared more than intemperance—yes, I may say more than intemperance and tobacco; but I suppose the reason is because intemperance exists largely *because* of this thing I fear. It is the disregard of law. I think I may say the great disregard and ignoring of law—not only the laws of our land but the laws of God—the laws of truth, honesty, and fairness. Excuse me if I go over ground that I have touched a great many times already.

The people voted to have intemperance excluded from the army as it had been from the navy. The brewers and saloon men were furious. They declared the law should not stand, even if they had been fairly and squarely beaten by the temperance people. But they were in a corner, and there was no honest way out of that corner. There was no *legal* way out of it. In this crisis Griggs, backed by the brewers, perpetrated the notorious “nullification act.” I presume he and those back of him laughed because we in our turn—at least some of us—felt “furious.” There was a universal feeling of indignation growing and spreading all over our land. The powers that be evidently decided it would not be wise to try the patience of the Christian temperance people any further in that direction. They finally gave us the law we should have had a long time ago. But now the brewers and whisky men are furious once more. They have been forced to admit that in honest, fair fight, we are too much for them; and just now they are leaving no stone unturned to accomplish by foul falsehood, and with money, a thing they can never bring to pass by fair means; and the contest is now going on right before the eyes of the people of America. Which will win—falsehood with millions of dollars back of it, or truth and honesty with nothing back of them except the conscience of our people?

Some of you may say, as has often been said to me, “Mr. Root, this is a comparatively small matter—an exceedingly small one compared with other things that need prompt and immediate attention.” But I do not agree. If falsehood wins in this case it is going to win in every other one, and we as a nation will soon be bound hand and foot with Satan’s shackles. The strings of falsehoods would not trouble me so much if they were only confined to the liquor dealers’ periodicals. Neither would I feel greatly troubled if our great dailies once in a great while gave place to them by mistake, and would promptly acknowledge, when furnished adequate proof, that they had been wrongly informed. Of course, I mean they should make acknowledgment as public as they made the falsehood public. I allude to the stories that are now current almost everywhere about the disastrous results upon our soldiers since the closing of the army canteen. Evidently quite a few of the readers of GLEANINGS seem to think I am reading only one side of the matter, and am not posted. I judge from clippings from different periodicals sent to me. The great dailies that we have considered reliable, and honest and fair, have, by some process unknown to me, been induced to lend their aid to circulate falsehoods. Worse than all, as I have told you, proof after proof, furnished by mayors and other officials, with sworn statements, have been forwarded to these editors, asking them to recall the whole-cloth falsehood they had been induced to print in their columns; but the only reply has been to reprint the same falsehoods in a more aggravating form, and to continue that policy. While I write, clippings are before me from the fol-

lowing papers: New York *Herald*; Washington *Times*; New York *Journal*; Chicago *American*; New York *Evening Post*; Tacoma *News*; Chicago *Chronicle*; Atlanta *Journal*.

I have given the names of papers from different cities to show how universally this thing is carried on, and how systematically it is managed. Not one of these periodicals, at least so I am told by some of our most reliable papers, has consented to publish a retraction of their false statements. If this thing keeps on would it be anything strange if a large number of well-meaning — well, say Christian voters, should decide they were mistaken, and that this army canteen was really a temperance (?) institution as all these dailies, and perhaps a thousand other papers, would lead us to think? I do not know why so many periodicals have gone into this thing. I do not know whether it is because the managers love drink themselves, or whether the brewers have bought the space, and have bought it on condition that these editors should not print the truth, even when it is proven to them beyond all question.

I have been told from childhood that lies do not carry the day *very long*. My father used to say, perhaps in language not very elegant, that even the Devil would hang himself if you give him rope enough; but I confess I have begun to fear of late that the brewers, with their millions, have got out some patent-right way of managing the Devil so that he does not show his hoofs and horns as he used to do after he had been given about so long a time.

In olden time, we are told, there was a certain people who said by their acts, if not in words, "We have made lies our refuge, and under falsehood have we hid ourselves." Isaiah does not tell us very clearly just how far these people got along under that sort of cloak and refuge; but I am really afraid the brewers are going to make a great deal of trouble just now unless the *church of God* bestirs herself. A few religious periodicals are helping to expose these falsehoods. The strictly temperance papers are all fighting valiantly; but unless the church, and a united church, takes hold and helps us, I really fear the canteen will be re-established, and that, too, by the votes of well-meaning but foolish people.

Do you ask me for proof that *I* am right? Well, if you want straight clear proof, go yourself to any one of the forts where it is claimed these new saloons have been started, and witness the strings of lies that have no foundation whatever. If you will be satisfied with the affidavits of the mayors and officers of the town, and with the statements of some of the army officers and chaplains besides, in those places where are located the soldiers' barracks, you can find them in any of our temperance papers, some of them reproduced *in fac simile* by the photograph.

The closing words of our text tell us that no one shall enter the holy city who "worketh abomination or maketh a lie;" and I have sometimes wondered what place would be accorded to good people who stand about with their hands in their pockets, figuratively,

while these frauds are perpetrated, and pass through the medium of the press into almost every home in our land. May God help us; and may God help me to be sure that I am making no mistake and holding up a warning again and again about something that is, as some tell me, only a comparatively small matter after all.

Just one thing more: If a paper comes into your home, making these statements in regard to the disastrous results of shutting up the canteen, remonstrate with the editor. If he pays no attention to your protest, subscribe for some paper that is willing to tell the *truth* in regard to the drink-traffic.

Permit me to say that I have never seen in the Cleveland *Leader* one of these preposterous statements. On the other hand, they continue to give us brief editorials in the cause of truth and temperance every little while. If our people would promptly protest to the editors themselves whenever these false statements appear, they would soon conclude that their championing the brewers may prove to be, after all, an expensive piece of business.



GETTING LOST IN THE FLORIDA WOODS.

When I came into Oak Hill, Fla., on the automobile, as I have told you about, I was putting on considerable style — that is, considerable for *me*. But a great many times in my travels I make my appearance before beekeepers without very much style — in fact, sometimes without any style at all. Once or twice I have received a gentle rebuke. When I was passing on that long trip over the Ozark Mountains, in Missouri, I called on a subscriber to GLEANINGS who had a very pretty greenhouse. He looked me over and finally said right out:

"Why, Mr. Root, I can hardly understand how a man occupying the position you do would wish to be seen riding about the country in this eccentric style, far from home, on a *wheel*."

I tried to explain to him that I was doing it just for the fun of the thing, because I loved adventure; but a good many times his kindly reproof occurs to me. Several times I have promised Mrs. Root — yes, I have promised myself, after getting into a disagreeable fix — that I would try in the future to be a little bit more dignified, and not rush things so much.

I reached the station at Sanford, Fla., before sundown. I remembered there was an old friend of mine a little way out in the country, Mr. J. A. McMillan, where I had a most pleasant visit six years before. I inquired at a livery stable what they would charge to take me out there. They wanted a pretty big price, I thought; and as I had been riding in a buggy nearly all day I felt a good deal like walking. In fact, I walked out there six years be-

fore, and, as nearly as I could remember, it was only a mile or a little more. I knew it was not far from Fort Reed, where there is a little settlement and a store. If it took me till after dark I figured I could easily get directions at the store. When I came to the store, however, I found it was something like two miles; and, to tell the truth, there was not any store. It had been burned down, and there was no house in the immediate neighborhood. Yes, and it gets dark in Florida *all of a sudden*. They do not have the long twilight we have here in Ohio.

I followed the directions as nearly as I could remember, planning to inquire at the first house. Said house was quite a piece away, especially when the roadway was all through soft yielding sand. Before the darkness came I looked at my list of subscribers, and discovered, for the first time, that the address was printed *Mrs.* instead of *Mr.* J. A. McMillan. Then it occurred to me that my old friend must have died without my having known it.

I was told on inquiry that it was quite a difficult matter to reach the widow's home in the night time; but my informant went quite a piece with me through the sandy woods, got me on the right road, and gave me plain directions to a little place where Charlie McMillan lived, not far from his mother's house. He said Charlie would gladly take charge of me. The directions were that I should pass three unoccupied houses, and then go down to the left through a little lane or by-path, and the first house was the one I wanted. I found the place all right; but as it was quite a distance I had "waded" through the soft sand, I became pretty tired. Then I discovered that no one was at home. I then went on to the next place, quite a fine-looking residence; but after going around to all the doors, and trying them all, I decided that *that* place too was unoccupied. A little further on, another fine residence proved likewise; but away off in the distance, I could not tell just how far, a light twinkled from a fine-looking mansion. The gentleman who went part way with me said Charlie's mother lived not more than twenty rods from his little home. I remembered, too, it was on the shore of a little lake. I said to myself, "If Mrs. McMillan's house is not more than twenty rods from this spot, and on the shore of a lake, I can certainly find it in the course of half an hour." But I explored north, south, east, and west. There was no such establishment in that vicinity. I was getting to be very tired, and finally decided to go for that twinkling light and get information. Before I got near the place, however, struggling through the weeds and bushes, I came to the shores of a little (but not *the*) lake. With weary steps I pushed my way around the borders of the lake, and came to a fine mansion and beautiful grounds, and every thing in city style. I could not find the bell, so I rapped on the door. A woman's voice inside asked what was wanted. I explained the circumstances and asked for directions. She did not think proper to open the door. She said Mrs. McMillan's house was a long way off, and asked what I wanted

of her at such a time of night. I tried to explain matters, told her that I had plenty of money to pay for all time and trouble, and asked if I could not sleep somewhere there till daylight. She said her husband was too unwell to come and give me the information I wanted, but said if I would follow around the lake some of their hired help had a cottage there, and he would give me what information and assistance I desired.

Now, this seemed for the time a little bit hard on a stranger, but the circumstances were much against me. I was disturbing people after the usual hours of repose. I was not coming exactly like a thief in the night, but I was coming very much like a *tramp* in the night. Had I come in the day time, with a carriage, or even a humble equipage, very likely I should have received a most cordial welcome from these good people, who, under the circumstances, seemed quite willing I should sleep outdoors in the sand; and, in fact, I meditated doing so. My bed would have been soft enough, no doubt; but I think I might have had chills before morning. The cottage I was referred to was kept by some colored people. They told me where I could find the residence of Mrs. McMillan. But I got lost again; and out in that deserted wilderness I found another beautiful mansion. Why, it was almost princely in its appointments—fruits, flowers, beautiful walks, curved driveways with curb made of artificial stone, and here and there summer-houses. Tired as I was, it seemed as if I had fallen into a place of enchantment. The moon had come out by this time, and I wondered if the "Arabian Nights" had not broken out away up here in the sandy Florida wastes. I rapped at the door, and a woman's musical voice responded from above. I wondered if she was not some fairy lady who was kept there by "enchantment." She listened to my "tale of woe," and seemed exceedingly kind and sympathetic. She tried to direct me to the place I was seeking; but it was so near midnight, and I had become so "rattled," I really did not know any thing. When she told me that Mrs. McMillan's house was in plain sight of their place in the day time I almost felt like shouting for joy. I did not know north, east, south, or west; but by centering my mind on the matter I *could* decide which was my right and which was my left hand. She told me to go right through the gate where I came in, turn to the right, and just follow the road, and I would reach Mrs. McMillan's in a few minutes. I did so, and received such a cordial welcome that I forgot all my troubles and fatigue. But I made some big resolutions that night, to the effect that you would not catch me again, lost in the Florida woods and sand after dark. A refreshing sleep made me myself again when daylight came. Charlie and his wife, it seems, had left their own home, and were staying with his mother at the time. While we were laughing over the adventures of the night before, I asked Charlie to explain what the storekeeper meant by saying his place was not over twenty rods from his mother's house.

"Well," said he, "because that is about the distance."

"Why, look here, Charlie. Your place—at least the place I went to in the night—is away off in *that* direction, and it is certainly a good big mile from here."

Charlie was contrary, however. He declared he ought to know about the matter, for he had lived several years right near his mother.

After breakfast I said, "Now, Charlie, I want you to go out in the direction you say your place lies, and find it for me within twenty rods of where we are."

Well, Charlie was quite right. Sure enough, right close by, was the little home where I had rapped on the door so persistently, but without effect, the night before. It made me think again of a land of enchantment. Some of our older readers will remember that that is the place where I found a pony that had been tamed and civilized by feeding him bread and honey. Some sad changes had taken place during the years that had passed. My genial friend was gone to the great unknown beyond. The bees did not prosper as they did years before; and, in fact, the frost had ruined things generally in that neighborhood. The deserted homes where I could not find anybody to wake up the night before were one of the results of that memorable freeze.

That day Charlie very kindly took his horse and buggy and carried me around among the celery-growers. On page 252, March 15, you will find an account of our visit. Now, here is the wonderfully strange and inconsistent thing that astonished me all over Florida. This great discovery in the way of growing celery is right in the very neighborhood of these deserted plantations; and notwithstanding the enormous profits experts are making with the favorable soil and artesian water, land may be bought for almost a song all around in that locality.

There is another strange thing about Florida. There are vacant houses and deserted farms here in Ohio; but usually, before they are vacated, the place has run down and looks forbidding. In Florida the places will have every evidence of being occupied and cared for; but investigation shows the owner has all at once dropped every thing and gone. There is going to be a change in Florida, no doubt—in fact, great changes have been made already in many of these deserted places. When people learn how to avoid the disastrous results of the sudden changes in temperature, then things will be started on a firmer basis.



THE APPLE-TREE BORER; HOW TO CIRCUMVENT IT; ALSO SOMETHING ABOUT THE TRAP LANTERN.

The inventor, or one of the inventors, of the trap lantern, sends us the following:

THE APPLE-TREE BORER.

There are two species of apple-tree borers—one known as the flat head, that bores into the body of the tree; the other the round-headed borer that enters the tree near the surface of the ground.

In over 2000 acres of apple orchards we have had no trouble with body borers for many years. I learned how to eliminate the body-borer in the summer of 1874. My father, the late Hon. Ira S. Haseltine, planted a pioneer orchard of 90 acres, consisting of more than 100 varieties of apples, and a large number of varieties of pears and peaches. While working in this orchard I discovered that the body-borers were in the trees that had been sun-scalded or injured on the south and southwest side. I therefore bent limbs and twisted suckers so as to shade the trunk or body of the tree. These trees had all been headed high in the nursery. We notified the nurserymen who expected to supply us with future nursery stock to head their trees low, and raised nursery stock ourselves for additional orchards, and headed or limbed the trees near the ground, for three reasons: 1. To prevent the body-borer from entering the tree; 2. To prevent the winds from tipping the trees so easily; 3. To make apples one-half cheaper to gather. In planting these trees we leaned some of them a little to the southwest to protect the body until the head or top was sufficiently large to shade it thoroughly, and also from the fact that our prevailing winds are from the southwest, and would otherwise lean the tree in the opposite direction. In this way we have entirely eliminated the body-borer and made strong, vigorous, healthy trees.

The root or round-headed borer was not so easily dealt with. It is the most destructive orchard-pest, as it girdles the tree and kills the orchard if not removed. Until I invented my moth-catcher we used a jack-knife and wire to extract them as the only sure means to protect the trees. Many washes have been recommended, some tried. But until we discovered that we could catch the beetles, as the Department of Agriculture at Washington, D. C., in their bulletin No. 32, July 1, 1898, page 7, says: "They are attracted to a light at night to some extent, and so meet their end in this way," we had still to use the jack-knife and wire to get out the old stock of worms, as the larva of the beetle stays in the tree about three years, and we did not discover how to catch the striped parent beetle or bug until last year. This borer-beetle lays eggs in the month of June, and later. Therefore, now is the time to catch it.

S. A. HASELTINE.

The suggestions in regard to leaning fruit-trees to the southwest as a remedy for borers are all right. I have followed almost exactly the plan outlined for years. Trees that are allowed to be tipped over toward the northeast by the prevailing winds are almost sure to have sun-scald, and, later on, borers. I find young basswood-trees very susceptible to sun-scald, if they are allowed to tip over so the sun strikes directly on their bodies, almost at right angles, in the middle of the afternoon. Pull them over by some efficient means so that the foliage of the tree will shade the trunk till the sun is nearly down, and they will recover all right. The suggestion about the moth-catcher referred to in the last part of the article, I am not so sure of. Just now, however, Mr. Haseltine sends me the following from Prof. Stedman:

I can recommend the Haseltine moth-catcher to gardeners, farmers, and horticulturists for catching the following injurious insects: The moths of the striped worm in corn, cotton, and tomatoes (corn or boll worm); June or May beetle, adults of the white grubs; tent caterpillar moths; pickle-worm moth in cucurbit; army-worm moth; cut-worm moth; fruit-leaf roller-moth, adult of the worm that eats apple, pear, peach, plum, cherry, quince.

J. M. STEDMAN, Entomologist.
Experimental Sta., Columbia, Mo., June 18, 1901.

Now, I must confess I am not enough of an entomologist to decide whether the above list includes the beetle that produces the borers

or not. No doubt the trap-lantern will catch some of these enemies of the fruit-grower; but the testimony from several experiment stations seems very strong to the effect that it is not going to accomplish by any means all that the vendors claim for it in their circulars. It is always in order to get the borer out of your trees just as soon as you discover they are at work. But the question of keeping them away by means of trap-lanterns placed at intervals through the orchard is one yet to be settled. I would ask our readers to take notice that Prof. Steadman does not anywhere, in the above, mention the codling-moth; yet the circular that Mr. Haseltine sends out claims in the very first sentence that it destroys the codling-moth; and in some of their advertisements they have declared it would render spraying unnecessary*. I should say this latter claim is pretty nearly preposterous. We shall be glad, however, if the device will do only a part of what they claim for it.

Special Notices by A. I. Root.

AN ILLUSTRATED WEEKLY PAPER FOR YOUNG PEOPLE, WHICH WE CAN HEARTILY RECOMMEND.

In our June 15th issue I said our people had been making exceedingly liberal offers to club GLEANINGS with other periodicals, and that some of these periodicals that had been "pushed" quite vehemently I did not particularly indorse. Well, a few weeks ago I picked up a Sunday-school paper belonging to some of the grandchildren. The articles were of such merit, so full of instruction in business and other matters in life, I was agreeably surprised. When I mentioned the name of the paper to the other members of our firm I found each one of them had been reading the *Wellspring* (for that is its name), and all were equally delighted with its high moral tone as well as its beautiful pictures and exceedingly interesting articles; and when I said, "Boys, here is something really worthy of encouragement. Now, even if it is not offered at so low a price as some other periodicals, let us give it such a recommend as it deserves, and try to introduce it into homes where GLEANINGS goes," they all assented. I wrote the publishers, and they made me a better offer than I had any right to expect. This paper, so interesting that even I take time to read it, comes weekly, is beautifully illustrated and yet we are going to club it with GLEANINGS for only \$1.25. The regular price of the little paper is 75 cts. a year. You can have a sample copy free on application. The publishers do not say so, but I do, just write me on a postal, "Send a sample copy of the *Wellspring*," and I will see that you get it. Then if you want it a whole year, it will be only 25 cts. more than you pay for GLEANINGS—that is, if you ask for no other premium.

THE NEW CRAIG POTATO.

We say now just as we said a year ago, that the New Craig is the best cooking potato we have in our whole assortment at this season of the year. A dish of them that we had on the table this morning looked so handsome and floury, rolling open almost like a dish of popcorn, I felt like having it photographed. Now, I confess this is one of my happy surprises. We have

* Here are some more statements I find in the Haseltine circular in regard to the moth-catcher:

By spraying, many head of stock were killed, several of them thoroughbreds. . . . Trees that had been sprayed the most, show signs of decay, and may die. Spraying apples may cause an early decay.

In regard to stock being killed by spraying fruit-trees, I have never been able to find such a case; and some of our best agricultural journals say the same. In regard to injuring trees by spraying this is the first time I ever saw such a suggestion, and I know of orchards that had been sprayed thoroughly almost ever since spraying was introduced.

had the New Craig for seven years. It is the best yielder we have ever gotten hold of—almost as handsome in shape as Carman No. 3—a rank strong grower that is seldom troubled with either bugs or blight on our ground. Besides this it is one of the best keepers, if not the very best one, we know of. It is very slow to sprout in the spring. The potatoes keep hard and firm, with very little care, clear on into June; and during the whole spring months it is our very best table potato, not even excepting the Freeman and Snowflake. On our own grounds, and in our own cellar, it has no drawback whatever. It stands at the head of late potatoes. With us, it has no fault; but, to tell the truth, it does not seem to succeed in some localities as well as it does here in Medina. Not only on our own grounds, but our neighbors all around us succeed with the Craig just as I have told you above; but when we send it away, a good many complain of it. Why, our own Ohio Experiment Station reported one year that they thought it was especially subject to blight, when *with us* it is the nearest to being blight-proof of any thing on our grounds.

Oh yes! there is one other thing. Prof. Chamberlain, of Hudson, O., objected to it on the ground of its being a *red* potato. Well, we have some good news right here. Last season we planted New Craigs entirely on a piece of ground along the railroad. We did not manure and underdrain it, as the land is not ours; but we got a splendid crop of New Craigs, nevertheless. Why, it was one of the biggest of my happy surprises. And then there was another happy surprise on top of it all. The boys found about a bushel and a half of *white* Craigs in one spot of ground where it was rather more sandy and gravelly than the rest of the lot. I do not know what in the world should have made them white, but white, almost entirely, they were, and rounder and smoother than any Craigs I ever saw before. Every one of our readers who grows potatoes ought to try the New Craig. If it succeeds on your ground as it does with us, it ought to be worth a pile of money to you.

Just one thing *more* in their favor, and it is a big point too. Unless you plant them quite close, many of the potatoes will be too large to suit the women-folks. With close planting the vines will very quickly cover the entire ground, choking out weeds of every kind. We have them every year so I can stretch single vines higher than my head. Well, when the ground is covered with such a heavy mat of potato-vines there is no more cultivating to do, and no trouble with weeds, and very seldom any trouble with bugs.

I know this is saying a great deal about just one potato; but year after year keeps telling the same story in our locality, and I think the world at large ought to give this splendid potato more attention.

Now, this story is not told as a preface to get you to buy some Craigs, for every one of them is planted. I would advise you, however, to lay in at least a few in the fall, when we come to dig them. For a big crop you will need to plant them early, for they will keep green and growing clear on till frost, no matter when you put them in the ground.

New York State Apiarian Exhibit at the Pan-American.

Nearly all the honey in the New York apiarian exhibit is to be replaced by honey of this year's production as soon as the latter can be obtained from the bee-keepers of this State. A goodly number of New York bee-keepers are now represented, but it is desirable that many more participate. Let all bee keepers of this State who are so fortunate as to be favored with fine honey, both comb and extracted, correspond with the superintendent of the New York apiarian exhibit with a view of sending in an exhibit. There will be absolutely no expense to the exhibitor, further than the extra pains he takes to produce fine exhibition honey, and in the extra care taken to ship the same in a manner to minimize danger of breakage.

OREL L. HERSHISER, Superintendent.

GLEANINGS AS AN ADVERTISING MEDIUM.

I desire to express my gratification over the result of the small "ad" the Pere Marquette R. R. is running in GLEANINGS. It has attracted attention and brought forth requests for further information from Oklahoma to Ontario, Can.

W. C. TOUSEY,
Toledo, O., May 1.

To Our Shippers.

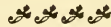

About May 1st last, we removed our business from the buildings, 120-122 W. Broadway, to larger and more commodious quarters at Nos. 265-267 Greenwich Street, and 82-84-86 Murray Street, and we duly sent to our friends in the trade a notice of our removal. Shortly after we vacated the premises, 120-122 W. Broadway, one Joseph M. McCaul, rented a portion of our old quarters, and hung out a sign, "Hildreth, McCaul Co., Jos. M. McCaul, Prop.," with other large signs to the effect that his business is "Headquarters for honey, beeswax, maple sugar, and maple syrup."

The mercantile agencies report that Joseph M. McCaul is the sole proprietor of the new business, and that he claims to have paid to one Henry P. Hildreth, who has no connection with our business, a consideration for the use of his name.

We will not comment upon the act of leasing our old quarters and exposing thereon the sign, "Hildreth, McCaul Co.," further than to state that we have instructed our attorneys to apply for an injunction restraining the said McCaul from using the name "Hildreth" in connection with his business in any manner whatsoever.

We value highly the good name and business we have established by many years of satisfactory dealing with our friends in the trade, and we therefore send this notice so that you may not possibly confound us in any manner with the so-called "Hildreth, McCaul Co."

Our firm name remains as heretofore, and all our business is carried on at our new quarters, Nos. 265-267 Greenwich St., and Nos. 82-84-86 Murray Street, New York.

Respectfully yours,

HILDRETH & SEGELKEN.

TRIAL TRIP.
3 Months, 20c. 6 Months, 30c.

TO NEW SUBSCRIBERS. — We want every subscriber of *Gleanings* to read the WEEKLY AMERICAN BEE JOURNAL for 3 or 6 months at least, and so we make the above very low offers to those who are not already getting our journal. Just think of it—13 Nos. for 20c, or 26 for only 30c! Better send in your subscription at once, and begin with July 1st.



ALSO DON'T FORGET that we're headquarters in Chicago for

Root's Bee-keepers' Supplies.

A catalog and also a sample copy of the American Bee Journal free upon request.

George W. York & Co.,
144-146 Erie Street, Chicago, Ill.

Prices for July and August.

Your choice, either golden or leather-colored queens. Prices are, 1 untested, 65 cts.; 2 for \$1.00. Tested, \$1.00. Breeding queens, \$3.00 to \$5.00 each. If you want tons of honey try them. See my ad. in June 15th number.

G. ROUTZAHN, Menallen, Pa.

D. COOLEY,

DEALER IN BEE-KEEPERS' SUPPLIES, KENDALL, MICHIGAN.

Root's Goods at Root's Prices. : : Catalog free.

EGG FOOD! The kind that tones and keeps up the hen so that she simply must lay. LEY'S Poultry CONDITION POWDER puts good red blood into poultry veins; kills all disease germs; tones and nourishes fowls—big and little get all there is in the food when fed in conjunction with it. Price 25c pkg.; 5 for \$1. Ley's Thoroughbred Minorca eggs, \$1 for 13. Thoroughbred Belgian Hares. **Geo. J. Ley, Florence, California.**

For Sale. Choice prolific Italian queens—grand-daughters of a queen of which Doolittle wrote me, "\$100 will not buy her"—mated with drones of Hutchinson's Superior Long-tongue Strain. Warranted queens, 75c; tested, \$1.00 and up. Good references, and satisfaction guaranteed.

EARL Y. SAMPFORD, Salem, N. Y.

GLEANINGS AS AN ADVERTISING MEDIUM.

From the number of letters I found awaiting me when I arrived where I got my mail, referring to GLEANINGS with reference to bee-hives, I concluded you gave me a free ad't. I thought I had fixed all my matters so I would have no mail to follow for the two months I was on the wing; but I was surprised to find more letters than I have found time to read, much less answer; so please say to the many friends, "hives sold;" my apology for not answering. I fully realize GLEANINGS is the place to advertise.

Hemet, Cal., June 6.

H. I. MORSE.



A SMALL SNAKE

may go through PAGE 25-wire 58-inch Fence, but no rabbit, chicken, pig, hog, horse, nor bull can.

Box S. Page W. W. Fence Co., Adrian, Mich.

Don't Dig Potatoes by Hand

It is a slow and expensive way. The cheapest, quickest, and easiest way is to USE THE IMPROVED

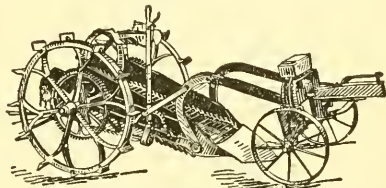

DOWDEN POTATO-DIGGER.

It gets them all, no matter how deep or shallow. Our book explains how. Book is free. Write for it now. **DOWDEN MFG CO., - Box 23, Prairie City, Ia.**

YOU CAN NOT afford to let the season pass without introducing some of Moore's 23-100 stock into your apiary. See advertisement on page 571.

FOR SALE.—Nuclei, in chaff-hive frames; three frames with queen, \$1.75. Good Italians. **H. L. FISHER, New Paris, Ind. R. D. No. 2.**

Wants and Exchange.

WANTED.—To exchange 40 hives—13x15 in. inside, 9 in. in depth, made to tier up—and a good gear-4-frame extractor, for anything that I can use. **J. M. JONES, Palmyra, N. Y.**

WANTED.—To exchange two ladies' bicycles—but little used and high grade—for offers. **J. W. PROVAN, Traer, Iowa.**

WANTED.—To exchange Barnes saw for camera, not less than 4x5. **M. W. SHEPHERD, Mannville, Putnam Co., Florida.**

WANTED.—To exchange first-class bee-keeping supplies for 2000 lbs. beeswax. Will allow 32c for nice wax. **W. H. NORTON, Skowhegan, Me.**

WANTED.—To exchange Japanese buckwheat at 80c per bu.—sacks, 15c extra—for bees in shipping-boxes, if not too far away. **ALBERT L. MARTIN, Leonardsburg, Del. Co., O.**

WANTED.—To exchange a \$50 Columbia bicycle that has not been ridden 100 miles; never been rained on; out of the factory only about one year. I will sell it or exchange for clover honey, or two-frame Cowan extractor and new Dovetailed hives, to the value of \$35. **A. H. KANAGY, Milroy, Pa.**

Black and Hybrid Queens for Sale.

Hybrid and black queens, good ones, 25 cts. each. **F. H. MCFARLAND, Hyde Park, Vermont.**

Forty mismated queens, reared last fall and this spring, 25 cts. each; 3 black queens, 15 cts. each. **B. F. AVERILL, Howardsville, Va.**

New Smith Premiers Nos. 5 and 6.

The No. 6 takes paper 18½ inches wide and writes lines 16 inches long. The No. 5 takes paper 11 inches wide and writes lines 9½ inches long. These new machines in essential mechanical principles are the same as Models Nos. 2, 3 and 4—unequaled.

Write for Printed Matter Free.

**The Smith Premier
Typewriter Co.**

158 Prospect Street, Cleveland, Ohio.

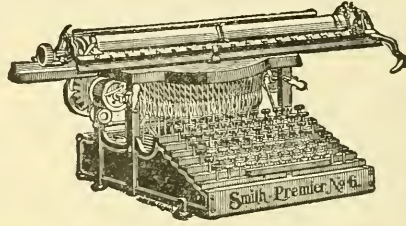

The Power Question

—for farm use, dairies, creameries, cheese factories—anything requiring light power, is best settled by buying one of these

LEFFEL ENGINES.

They are made in both horizontal and upright pattern, with engine attached to boilers. Being very simple and direct in construction they are economic of fuel and great developers of power. Best for cutting and grinding feed, sawing wood, pumping water, separating cream, churning, &c. Made of the best material throughout they are durable and long lived.

Send stamp for our Book on Engines and Power.

JAMES LEFFEL & CO., Box 89, Springfield, O.

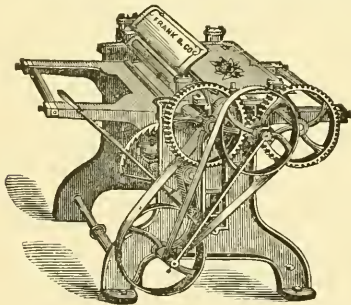
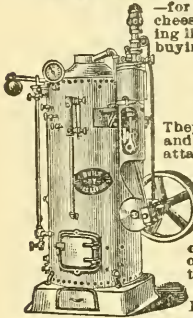

PLANERS

The above cut shows one of our small Planers, of which we make twelve different styles and sizes. Also large Planers, Band Saws, Buzz Planers, Moulders, Wood Lathes, and all kinds of

WOOD WORKING MACHINERY

Send for Catalogue.

The FRANK MACHINERY CO.
BUFFALO, N. Y.

FRUIT-CANNING made easy and sure by using Coddington's Self-melting, Self-sealing Wax Strings. Very convenient and economical. Inquire of your dealer or send me his name and 45c in stamps for 100 strings, by mail. Mention this paper. C. C. FOUTS, Middletown, Ohio.

FREE Drug Book

They cost us \$2. each. 1500 illustrations. Contains over 15000 drugs, medicines, home remedies, flavoring extracts, tinctures, electric belts, paints, oils, etc. We save you 15 to 75% on any of them. Send 10c to pay cost of mailing book which amount is refunded on your first order. Send for book to-day, you may need medicine to-morrow. One can never tell. Better get it and keep it handy. We are "The Only Mail Order Drug House in the World." Heller Chemical Co. Dept 40, Chicago, Ill.

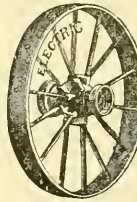

A Good Wagon

begins with good wheels. Unless the wheels are good the wagon is a failure. IF YOU BUY THE **ELECTRIC STEEL WHEEL** made to fit any wagon—your wagon will always have good wheels. Can't dry out or rot. No loose tires. Any height, any width tire. Catalog free. **ELECTRIC WHEEL CO.** Box 95 QUINCY, ILL.

Minnesota Bee-keepers' Supply Mfg. Co.,
Manufacturers of
Bee-hives. Sections. Shipping-cases, and
Everything Used by Bee-keepers.

Orders filled promptly. We have the best shipping facilities in the world. You will save money by sending for our price list. Address

Minnesota Bee-keepers' Supply Mfg. Co.
Nicollet Island Power Building, Minneapolis, Minn.

Union Combination Saw

For Ripping, Cross-cutting, Rabbeting, Mitering, Grooving, Gaining, Boring, Scroll-sawing, Edge-moulding, Beading. Full line FOOT and HAND POWER machinery. Send for catalog A. **SENECA FALLS MFG. CO.** 44 Water St., Seneca Falls, N.Y.

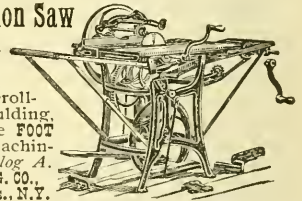

Fruit Packages of All Kinds.

— ALSO —

BEE-KEEPERS' SUPPLIES. . .

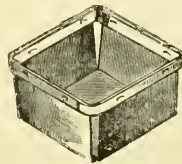

Order your supplies now before the busy season catches you. Price list free. Address

BERLIN FRUIT-BOX COMPANY,
Berlin Heights, - - Erie County, Ohio.

Long Tongues Valuable South as well as North.

How Moore's strain of Italians roll in the honey down in Texas:

Hutto, Texas, Nov. 19th, 1900.

J. P. Moore.—Dear Sir:—I wish to write you in regard to queens purchased of you. I could have written sooner, but I wanted to test them thoroughly and see if they had those remarkable qualities of a three-banded Italian bee. I must confess to you I am more surprised every day as I watch them. They simply "roll the honey in." It seems that they get honey where others are idle or trying to rob; and for gentleness of handling, I have never seen the like. Friend E. R. Root was right when he said your bees have the longest tongues; for they get honey where others fail. I will express my thanks for such queens. I am more than pleased. I will stock my out-apiaries next spring with your queens.

Yours truly, HENRY SCHMIDT.

The above is pretty strong evidence that red clover is not the only plant which requires long-tongue bees to secure the greatest quantity of nectar.

Daughters of my 23-100 breeder, the prize-winner: Untested, 75c; six, \$4.00; doz., \$7.50. Select untested, \$1.00; six, \$5.00; dozen, \$9.00. Safe arrival and satisfaction guaranteed. Descriptive circular sent free. I am filling all orders by return mail, and shall probably be able to do so till the close of the season.

J. P. Moore, Lock box 1, Morgan, Pend. Co., Ky.

(Mr. J. P. Moore is entirely reliable.—A. I. R. Co.)

FOR SALE. Orchards, farms, and city property in S. W. Mo.; climate, water, and fruit unexcelled. Sample bargain for \$1750; 15 acres in city limits, with two good dwellings (one has 7 rooms); large barn; out-buildings (all new); water, etc.; 3 blocks from square of county seat of 2000 inhabitants, on direct railroad to Kansas City. Write quick to F. E. Scotten, Bolivar, Mo., or come and see.



Belgian Hares

Fully pedigreed of the highest breeding, at prices that will suit. With every hare sold goes a full pedigree, register number, and score-card, scored by an official judge; and, when desired, does will be bred to one of our famous high-scoring bucks before shipment. Address J. B. MASON, Mauger of The A. I. Root Co., Mechanic Falls, Me.



Belgian Hares

I have some fine hares for sale at reasonable prices.

J. F. Moore, : Tiffin, Ohio.

BELGIAN HARES!

Either domestic or imported, of any grade from a pedigreed prize-winner to a common rabbit, at prices that are right. Write GEO. M. TEETER, PENNVILLE, IND.

1200 FERRETS. All sizes; some trained; first-class stock. New price list free. N. A. Knapp, Rochester, Lorain Co., Ohio.

S. C. BROWN LECHORNS.

I use well-striped breeding cocks, Eggs, \$1.00. Cockerels, \$1.00 and up. Also Italian bees. Circular free. H. M. MOYER, SHANESVILLE, PA.

To make cows pay, use Sharples Cream Separators. Book "Business Dairying" & cat. 288 free. W. Chester, Pa.

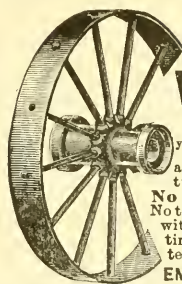

STEEL WHEELS

for your FARM WAGONS

any size wanted, any width of tire. Hubs to fit any axle. No blacksmith's bills to pay. No tires to reset. Fit your old wagon with low steel wheels with wide tires at low price. Our catalogue tells you how to do it. Address EMPIRE MFG. CO., Quincy, Ill.

1901====Golden Italian Queens====1901

Untested—April, May, and June—\$1.00 each, or \$11.00 per dozen; after June, 50c each, or \$5.00 per dozen. Tested queens, half more. Breeding queens \$3.00 and \$4.00 each. W. P. Rock eggs from 94-scoring birds at \$1.00 per 15. Cocks, \$1.00 each.

GEORGE W. COOK, - SPRING HILL, KANSAS.

Your Order for Queens

—Tested and untested—will be promptly filled by return mail. Our strain of Italians is unsurpassed as honey-gatherers. Every queen guaranteed. Choice tested queens, \$1.00 each; \$12.00 per dozen; choice untested, 75c; \$8.00 per dozen. Send for price list. Address . . .

J. W. K. Shaw & Co., Loreauville, La.

3 Good Points

Good Stock ;
Low Prices ;
Prompt Service.

My stock is from J. P. Moore's long-tongue strain, A. I. Root's famous £200 queen, and from the stock of J. F. McIntyre that filled supers when other colonies were starving. I sell warranted queens in any quantity, at 50 cts. each. If a queen proves impurely mated, another is sent free of charge. All queens go by return mail unless otherwise ordered. I guarantee safe arrival and entire satisfaction. Otherwise, the money is refunded.

L. H. Robey, Worthington, W. Va.

FOR SALE. One 10 h-p engine and boiler (up-right boiler), one 18-inch planer, one Root saw-table, 30 ft. line-shafting, hanger pulleys, and belting. Will take \$250. J. W. Bittenbender, Knoxville, Ia.

Mr. A. J. Root's Writings

of Grand Traverse territory and Leelanau Co. are descriptive of Michigan's most beautiful section reached most conveniently via the

PERE MARQUETTE R. R.

For pamphlets of Michigan farm lands and the fruit belt, address W. C. Tousey, D. P. A. Toledo, Ohio.

Yellowstone Park.

Extended tour, leisurely itinerary with long stops in the Park. Private coaches for exclusive use on the drive. Pullman sleeping and dining cars. Established limit to number going. Escort of the American Tourist Association. Rean Campbell, General Manager, 1423 Marquette Building, Chicago. Colorado and Alaska tours also.

Tickets include all Expenses Everywhere.

Train leaves Chicago, via Chicago, Milwaukee & St. Paul R'y, Tuesday, July 9, 10:00 P. M.

What I Guarantee.

I am selling queens of a strain of dark Italians that are the equals of any bees and the superior of many. No other breeder guarantees his queens in as many respects as I guarantee these queens. First, I guarantee safe arrival. If the queen arrives dead, another is sent. Second, I guarantee safe introduction if instructions are followed. This is not done by any other breeder, so far as I know. Third, I guarantee purity of mating. If a queen proves impurely mated, another will be sent free of charge. Fourth, I guar-

antee satisfaction to the extent that any time within two years a queen may be returned and the money will be refunded, and 50 cts. extra sent to help pay for trouble. Don't you see that you run no risk whatever in buying one of these queens. I run all of the risks, and you can have your money back any time inside of two years if you are not satisfied.

Price of a queen is \$1.50, or I will send the Review one year and a queen for only \$2.00.

W. Z. HUTCHINSON, Flint, Mich.

1881

PAGE & LYON MFG. CO.

1901

We manufacture a full line of the latest

BEE-SUPPLIES.

Our motto is, "Perfect Goods and Prompt Shipment."

Send for our new free illustrated catalog.

PAGE & LYON MFG. CO., New London, Wisconsin.

NOW READY!

64-PAGE CATALOG OF EVERY THING BEE-KEEPERS NEED. Illustrated and fully described. Especially valuable to beginners for the information it contains. Send your address on postal and get it now. Established 1884.

J. M. JENKINS, Wetumpka, Ala.

I. J. Stringham, 105 Park Place, New York City.

Keeps in stock a full line of modern appliances for bee-keepers.

SILK-FACED VEILS.

As good as any made; 35 cents postpaid. Catalog free. Full colonies Italian bees, \$6.00. Apiaries, Glen Cove, Long Island.

I. J. Stringham, 105 Park Place, New York City.

Marshfield Manufacturing Company.

Our specialty is making SECTIONS, and they are the best in the market. Wisconsin basswood is the right kind for them. We have a full line of BEE-SUPPLIES. Write for FREE illustrated catalog and price list.

Marshfield Manufacturing Company, Marshfield, Wisconsin.

THE TRUE TEST!

of a strain of bees is the amount of honey they gather under like conditions, compared with others. Mr. D. R. Keys, Dixie, Ga., an old bee-keeper, writes: "That queen from you is simply *splendid*; has shown no disposition to swarm. Her bees have filled three supers of 35 sections each, capped *snow-white*, while the average is not one super so far.—June 6, 1901." See back ads. and write for circular, free. I have carefully selected the best queens for breeders for years, and culled out the poor ones. My stock is a five-band strain, and has *long tongues*. No small or poor-laying queens sent out. Untested, 75c each; six, \$1.00; dozen, \$7.50. For select warranted add 25c. Tested, \$1.25. Select tested, \$2.00. Breeders, \$3.00 and up. Queens sent promptly. **J. B. CASE, Port Orange, Fla.**

WANTED!

Offers on our ENTIRE QUEEN BUSINESS, including our reputation, our Superior long-tongued stock, three entire apiaries, 500 nuclei, and entire outfits for queen-rearing. We have a favorable climate and excellent locations. Cause for selling made known on application. Full particulars free. If interested let us hear from you.

There is no foul brood or other disease in Texas. Single nuclei (with their queens) winter perfectly here.

O. P. HYDE & SON, HUTTO, TEX.

Northern Italian Queens Reared from Imported Mothers.

Our stock is so carefully bred and selected as to secure carloads of honey. Locality free from foul brood and other bee-diseases. Prices: Untested queen, \$1.00; 6 for \$5.00; tested queen, \$1.50; 6 for \$7.50; best imported queen, \$6.00; fair imported queen, \$5.00.

Ada L. Pickard, ; Richland Center, Wis.

U - NEED - A GLOSSOMETER.

It measures the actual reach of the tongue of a living bee to thousandths of an inch, also the capacity of the honey-sac; accurate, durable, practical. No rule or magnifying-glass needed. Satisfaction guaranteed. Price \$1.00 postpaid. Send for *Queen Circular*, and learn how to get a glossometer free. High-grade queens of the Sweet-heart and other strains at reasonable prices.

A. J. WRIGHT, Bradford, Steuben Co., New York.

NOW READY. LONG-TONGUED QUEENS!

YARD NO. 1.

By special arrangements with THE A. I. ROOT CO. to furnish them queens, I have secured their assistance in procuring the finest breeding queens that a thorough knowledge of the bees of the country and money can procure. Among them is a *select daughter of their \$200 queen that they refuse to quote me prices on*. This queen shows every superior quality of her mother. Her bees show an actual reach of 21-100 of an inch; are large, gentle, and beautiful to look upon.

MR. E. R. ROOT SAYS: "You have as fine bees as there are in the United States; and with a direct cross of their breeders you should be able to produce queens whose bees show a reach of 25-100 of an inch."

Send for descriptive price list.

Prices: Untested, 75c; 6, \$4.25; 12, \$8.00. Select untested, \$1.00; 6, \$5.00; 12, \$9.00. Tested, \$1.00; 6, \$6.00. Select tested, \$1.50.

Breeders, whose best bees show a reach of 21-100, with an average reach of 20-100, \$3.00. Breeders, whose best bees show 21-100, with an average of 20-100, \$5.00. Breeders, whose best bees show 22-100, with an average of 21-100, \$7.00.

I have discovered 2 breeders whose best bees show 23-100; these are too good to sell; don't ask for prices.

Imported Italian stock. Apiary No. 2. Imported queens, daughters and grand-daughters. Have just received an importation direct from Italy which has been introduced into this apiary.

Golden, or 5-banded Italian. Apiary No. 3. Breeders, select tested, tested, untested queens.

**W. O. VICTOR, WHARTON, TEXAS.
QUEEN SPECIALIST.**

HONEY QUEENS!

Leather-colored Long-tongues.—I have a breeder for which \$25 has been *offered* and *refused*. You make no mistake in buying her daughters. They are dandies.

Goldens.—The Lays strain is as good as years of patient selection and breeding can establish.

Holy Lands.—These are a deserving race of bees. With two years' acquaintance I find them great workers, with no vindictive traits, easily handled, are becoming popular, especially in South.

The above races of bees are each bred in separate apiaries, and you can get them in their purity. Am filling all orders by return mail, and I sell at the following low prices, with the usual guarantees. Single queen, untested, 75c; six for \$4.00. Tested, \$1.00; six for \$5.00. Breeders, either race, \$2.50 each. Address

W. H. Laws, Beeville, Texas.

FOR SALE.—Italian bees and queens. Untested queens, \$1.00; tested, \$1.25; full colonies, \$4.00; nuclei, one frame with queen, \$1.50; two frames, \$2.00; 1 lb., \$1.00. MRS. A. A. SIMPSON, Swartz, Pa.

Standard-Bred Queens!

Acme of Perfection; Not
a Hybrid among Them.

Improved Strain Golden Italians.

World-wide reputation; 75c each; six for \$4.00.

Long-tongued 3-banded Italians.

Bred from stock whose tongues measured 25-hundredths inch. These are the red clover hustlers of America. \$1.00 each; six for \$5.00. Safe arrival guaranteed. Catalog on application. Headquarters for bee-keepers' supplies.

Fred W. Muth & Co., Cincinnati, Ohio.
South-west Corner Front and Walnut Streets.

Dittmer's Foundation !!!

Retail---Wholesale---Jobbing.

I use a PROCESS that produces EVERY ESSENTIAL necessary to make it the BEST and MOST desirable in all respects. MY PROCESS and AUTOMATIC MACHINES are my own inventions, which enable me to SELL FOUNDATION, and WORK WAX INTO FOUNDATION FOR CASH, at prices that are the lowest. Catalog giving

FULL LINE OF SUPPLIES

with prices and samples, free on application. BEESWAX WANTED.

GUS. DITTMER. AUGUSTA, WIS.

Get the Best Queens.

Evansville, Ind., Sept. 27th, 1900.
The Jennie Atchley Co., Beville, Bee Co., Texas.

Dear Friends:—It gives me great pleasure to forward you this unsolicited testimonial regarding the merits of Atchley queens. The three (3) dozen queens purchased of you have made an excellent record for themselves. Not an Atchley queen among the twenty colonies lost during the severe drouth in July. I have bought queens from many breeders; and although the present crop is exceedingly short, the tiers of supers show where the Atchley queens are, and speak volumes for your method of queen-rearing. I find the progeny to be very gentle, strong-winged, uniformly marked, long-lived, of large size, and last, but not least, the best honey-gatherers I ever had. I shall want 100 more next season.

Yours fraternally, J. C. WALKENMEYER.

Prices for Queens.

Tested, \$1.50 each; \$8.00 for 6, or \$15.00 per dozen. Untested, February, March, April, and May, \$1.00 each; \$5.00 per 6, or \$9.00 per dozen. Fine breeders, \$5.00 each. We have as good bees and queens as money and labor produce. We breed three-band Italians, Golden, Carniolans, Cyprians, and Holy-Lands, in their purity, bred in separate yards 5 to 20 miles apart. If you want the best, call for Atchley's improved strains. Safe arrival guaranteed. Send for a sample copy of "The Southland Queen," the only southern bee-paper. \$1.00 per year. To new subscribers we offer as a premium a nice untested queen in order to get our paper introduced. Catalog, giving queen-rearing and management of apiaries for profit, FREE.

THE JENNIE ATCHLEY CO.,
Beville, Bee Co., Texas.

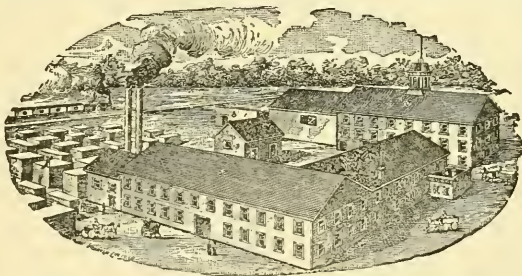

KRETCHMER M'FG CO., Red Oak, Iowa.

BEE-SUPPLIES.

Best-equipped factory in the West; carry a large stock and greatest variety of every thing needed in the apiary, assuring BEST goods at the LOWEST prices, and prompt shipment. We want every bee-keeper to have our FREE ILLUSTRATED CATALOG, and read description of Alternating Hives, Ferguson Supers, etc. Write at once for a catalog.

— AGENCIES: —

Trester Supply Co., 103 So. 11th St., Lincoln, Nebraska; C. C. Richards, 1223 17th St., Denver, Col.

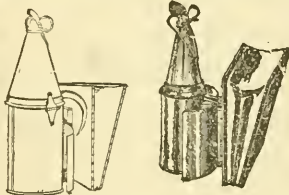

BINGHAM SMOKER.

Dear Sir:—Inclosed find \$1.75. Please send one brass smoke-engine. I have one already. It is the best smoker I ever used. Truly yours,
HENRY SCHMIDT, Hutto, Tex.

MADE TO ORDER

Bingham Brass Smokers.

Made of sheet brass, which does not rust or burn out; should last a lifetime. You need one, but they cost 25 cts. more than tin of the same size. The little open cut shows our brass hinge put on the three larger sizes. No wonder Bingham's four-inch smoke-engine goes without puffing, and does not drop inky drops. The perforated steel fire-grate has 381 holes to air the fuel and support the fire. Heavy tin smoke-engine, 4-inch stove, per mail, \$1.50; 3½-inch; \$1.10; 3-inch, \$1.00; 2½-inch 90c; 2-inch, 65c. Bingham smokers are the originals, and have all the improvements, and have been the standard of excellence for 22 years. Only three larger ones brass.

T. F. Bingham, Farwell, Michigan.

Contents of this Number.

Alley, Visit to.....	586
Bears in Apiary.....	589
Bee and Fruit Case at Hanford.....	602
Bees as Fertilizers.....	600
Bee in Law.....	583
Bees, Busy and Lazy.....	601
Bees Improvement of.....	583
Beta Naphthol.....	599
Birds Killing Bees in Florida.....	599
Brood-chambers, Shallow.....	592
Cell getting Contrivance.....	589, 590
Cuban Bee-keeping.....	587
Exhibits at Pan-American.....	595
Foundation, Staying with Splints.....	597
Glossometer, Whiting's.....	586
Glossometer, Wright's.....	585
Hives for New Zealand.....	599
Hives, Scholl's.....	591
Home Circle.....	609
Honey, Price of California.....	600
Honey, Section.....	596
Idaho for Honey.....	600
Introducing, Bonney Method.....	599
Jenkins' Apiaries.....	592, 593
Notes of Travel, by E. R. Root.....	592
Queen Worth \$3750.....	582
Queen-breeders not Writing.....	601
Queen, Age of.....	598
Queens, Ordering High-priced.....	598
Sections, Bait.....	598
Swarming.....	596
Swarthmore System of Queen-rearing.....	588
Tobacco, Value of.....	609
Tongues, How Bees Use.....	597
Tongues, Longer, v. Shorter Stings.....	598
Tongues, Measuring.....	584

Honey Column.

GRADING-RULES.

FANCY.—All sections to be well filled, combs straight, firm fly attached to all four sides, the combs unsoiled by travel stain, or otherwise; all the cells sealed except an occasional cell, the outside surface of the wood well scraped of propolis.

A No. 1.—All sections well filled except the row of cells next to the wood; combs straight; one-eighth part of comb surface soiled, or the entire surface slightly soiled; the outside surface of the wood well scraped of propolis.

No. 1.—All sections well filled except the row of cells next to the wood; combs comparatively even; one-eighth part of comb surface soiled, or the entire surface slightly soiled.

No. 2.—Three-fourths of the total surface must be filled and sealed.

No. 3.—Must weigh at least half as much as a full-weight section.

In addition to this the honey is to be classified according to color, using the terms white, amber, and dark; that is, there will be "Fancy White," "No. 1 Dark," etc.

CITY MARKETS.

BUFFALO.—Fancy white comb, 14@15; A No. 1, 13@14; No. 1, 12@13; No. 2, 11@12; No. 3, 9@10; fancy dark, 10@11. Extracted, white, 6@7; dark, 4½@5. Beeswax, 28@30. Very little demand for old honey. New will sell very well. W. C. TOWNSEND, Buffalo, N. Y. June 28.

NEW YORK.—Our market is practically bare of comb honey, and we are having a good demand for white comb. Fancy stock sells readily at 15; No. 1 white, 13@14; amber, 11@12. Extracted not in much demand, with plenty of supply. We quote white 6@6½; light amber, 5½; dark, 4½@5. Beeswax remains firm at 29. HILDRETH & SEGELKEN, 265 Greenwich St., New York City. July 8.

CHICAGO.—The new honey is arriving, and some nice lots of white-clover comb have sold at 16. The urgent demand has been supplied (which is very light at this season of the year), and we find shipments beginning to accumulate, so that 15c would be accepted if offered. Amber grades are nominal at 12@13. Extracted white is selling slowly at 5½@6; amber, 5@5½, according to body, flavor, and style of package. Beeswax, 30, for choice yellow. R. A. BURNETT & Co., 199 South Water St., Chicago, Ill. July 8.

WANTED.—Comb and extracted honey; will buy your honey no matter what quantity. Mail sample of extracted; state quality of comb honey, and price expected delivered Cincinnati. I pay promptly on receipt of goods. Refer you to Brighton German Bank, this city. C. H. W. WEBER, 2146-2148 Central Ave., Cincinnati, Ohio.

WANTED.—Western honey in car lots, also northern fancy white comb in no-drip cases; state price delivered. We pay spot cash. Reference, German National Bank, Cincinnati. FRED W. MUTH & Co., Front and Walnut Streets, Cincinnati, Ohio.

We will be in the market for honey the coming season in carloads and less than carloads, and would be glad to hear from producers everywhere what they will have to offer. SEAVEY & FLARSHHEIM, 1318-1321 Union Avenue, Kansas City, Mo.

WANTED.—Comb and extracted honey. State price, kind, and quantity. R. A. BURNETT & Co., 163 South Water St., Chicago, Ill.

FOR SALE.—Extracted honey from alfalfa; 60-lb. cans at 7 cts., and smaller cans. D. S. JENKINS, Las Animas, Colo.

Wanted! HONEY, WAX, MAPLE SUGAR, SYRUP, AND POPCORN.

A. L. JENKS, 42 W. Market St., Buffalo, N. Y.

LONE STAR APIARIES
Italian Queens.



Estab'd 1885 Prices of queens from imported mothers: Tested, \$1.50; 6, \$6.50; 12, \$12.00. Untested, 75c; 6, \$4.00; 12, \$7.00. Golden, same price. Select tested of either race, \$2.50 each. For a short time I will mail tested leather-colored queens at \$1.00.

Your money back if you are not satisfied. Address G. F. DAVIDSON & SONS, FAIRVIEW, TEX.

Your Order for Queens

—Tested and untested—will be promptly filled by return mail. Our strain of Italians is unsurpassed as honey-gatherers. Every queen guaranteed. Choice tested queens, \$1.00 each; \$12.00 per dozen; choice untested, 75c; \$8.00 per dozen. Send for price list. Address J. W. K. Shaw & Co., Loreauville, La.

QUEENS! Fine, large, gentle, and prolific; long-tongue reach; either 3 or 5 banded; 75 cents each; six for \$4.25. Try them and be pleased. CHAS. H. THIES, Steeleville, Ill.

Notice! After July 15 I will sell fine young Italian queens of the same strains as I advertised in June GLEANINGS, at 50 cts. each; tested, 85 cts. These queens are carefully reared by the Doolittle method; are large, yellow, and prolific. Safe arrival and satisfaction guaranteed. EARL Y. SAFFORD, Salem, N. Y.

30 COLONIES Italian bees for sale cheap; in good condition; no disease. Also S. C. B. Leghorns; no better; circular free. H. M. Moyer, Shanesville, Pa.

FOR SALE.—Nuclei, in chaff-hive frames; three frames with queen, \$1.75. Good Italians. H. L. FISHER, New Paris, Ind. R. D. No. 2.

Wm. A. Selser, Honey Expert,

When you buy honey, send a 3-oz. bottle, have it tested, to be sure it is pure. Price \$2.50 per sample. By doing this you may avoid over ten times this amount in litigation with pure-food laws. Chemist's certificate given.

The A. I. Root's Co.'s Office, 10 Vine Street, Philadelphia, Pa.

G. B. LEWIS CO., WATERTOWN, WIS.



Bee-hives,
Lewis' White
Polished Sections,
Shipping-cases.



Perfect Goods,
Prompt Shipment.

BRANCH: G. B. Lewis Company, 19 South Alabama Street, Indianapolis, Indiana.
AGENCIES: L. C. Woodman, Grand Rapids, Michigan; Fred W. Muth & Co., Southwest Corner Walnut & Front Sts., Cincinnati, Ohio; Fred Foulger & Sons, Ogden, Utah; Colorado Honey-producers' Association, Denver, Col.; Grand Junction Fruit-growers' Association, Grand Junction, Colorado; Robert Halley, Montrose, Colorado; Pierce Seed and Produce Company, Pueblo, Colo.; E. T. Abbott, St. Joseph, Missouri, Special Southwestern Agent.

Queens now Ready to Supply by Return Mail

STOCK which can not be **EXCELLED!!** Bred under the **SUPERSEDING CONDITION** of the colony. **Golden Italians**, the great honey-gatherers. They have no **Superior** and few **Equals**. Each 75 cts.; 6 for \$4.00. **Red-clover Bees**, the **Long-tongue Italians**, which left all **Records** behind in **Gathering Honey**, \$1.00 each; six for \$5.00. **Safe Arrival Guaranteed**. **Headquarters for Bee-supplies. Root's Goods at Root's Prices.**

C. H. W. Weber, 2146-2148 Central Av., Cincinnati, Ohio.

Successor to Chas. F. Muth.

Catalog Free; Send for Same.

GLEANINGS IN BEE CULTURE

A JOURNAL DEVOTED TO BEES AND HONEY AND HOME INTERESTS.

ILLUSTRATED SEMI-MONTHLY

Published by THE A. I. ROOT CO.
\$1.00 PER YEAR MEDINA, OHIO.

Vol. XXIX.

JULY 15, 1901.

No. 14.



I'M DELIGHTED to see by the footnotes that A. I. Root is getting interested again in bee-keeping.

THE *American Bee Keeper* now wears footnotes, and Editor Hill seems to be a good footnoter.

E. F. ROBINSON says in *Canadian Bee Journal* that he weighed a lot of natural-wax scales on jeweler's diamond scales, and found 192 to the grain. That makes 1,344,000 to the pound.

EDITOR YORK is determined the young Methodists shall not grow up in ignorance as to bees. The *Epworth Herald* contains two instructive articles from his pen. [Good for York!—ED.]

IT SEEMS STRANGE that C. H. W. Weber, the man who is in the front rank in bottling honey that never granulates, should be a successor to C. F. Muth, the man who did more than any one else to popularize granulated honey.

THE DZIERZON THEORY "is the cornerstone and solid rock upon which nearly all we know about bees is based." I am glad A. I. Root had to read proof, so as to make him say that on page 531. Every bee-keeper who is not yet familiar with the Dzierzon theory should make it his first business to get it.

EASTERN BEES may not do exactly as Texas and Arizona bees are said to do on page 523; but still it is well known that they are much less inclined to swarm when a full yield is on than when there is a moderate flow. [But did you ever know them, when the honey-flow begins, to kill off the drones and destroy cells?—ED.]

A NOTION lingers with me that, before the year is out, the editor will discover that hot water is ahead of steam for wax-presses. Germans who are familiar with both put hot water in the lead, and Rambler seems to be of the same way of thinking, page 513. Now, Rambler, tell us all you know about it. [I

may change my mind, perhaps. But I don't see how the hot-water device is going to be as simple and clean.—ED.]

FRIEND A. I. ROOT, when you solve the puzzle why government can't give us bulletins about beer as well as beans, here's another for you to tackle: Why is it that, if more liquor is drunk since the abolishment of the canteen, the men who manufacture the liquor are the ones most anxious for the re-establishment of the canteen?

AFTER a queen has distinguished herself for three successive seasons as the best in your apiary, you are anxious to have her live longer so as to breed from her. Don't shorten her life by profuse laying in a strong colony, but keep her in a nucleus. [That is just what we are doing with our best breeder, and did do last season. The advice is sound.—ED.]

DAVITTE says the important thing in his big tent is to tame the drones. The problem now is to find the smallest tent in which drones can be trained to fly at ease. Possibly it may be yet brought within the reach of every bee-keeper. [When I get home I expect to try a small tent, then a larger one later. I can't get away from the belief that a small tent would fill the bill.—ED.]

IS IT TRUE that, when bees are deprived of a queen, they of choice select for the rearing of queens larvae that are three days old or older? Any one ought to be able to settle the question for himself. All you need to do is to look at the cells first started and see the size of the grub. I have yet to see a case where the first larva selected was three days old if younger were present.

AFTER REFLECTION I am not prepared to admit that "scientific queen-rearing" is a misnomer, and I think there's very little science in most of the queen-rearing that's done, page 545. The man who rears queens with no attention to the stock from which his queens are reared, and no regard to the drones used, is not doing a scientific job, even if he uses up-to-date methods, Doolittle cups and all.

W. W. SOMERFORD thinks the flat cover perfect, p. 553. That may be due to the "peculiar conditions in Cuba." In Illinois it will

warp, and, worse yet, it will twist. No doubt he is right that the $\frac{5}{8}$ cover will warp less than the $\frac{3}{4}$. His top ventilation (pulling back the cover to rest on cleat) would be too much in Illinois. The flat cover is warm with a cloth under it; but wouldn't it be still warmer with a dead-air space and a cloth?

AND NOW the geographical center of the honey-yield shifts to Arkansas, where L. E. Kerr lives. He tells in the *Amer. Bee-Keeper* that, in his locality, all a wide-awake bee-keeper has to do in the seven months of slow, steady flow, is to care for swarms in April and May, keep good queens, and let the bees alone, and he will average 100 to 300 lbs. of first-class comb honey. [I could and will tell of some other geographical centers a little later.—ED.]

"IF YOU WOULD see the influence of a queen on her bees, take the mildest colony that you have, and also the most irritable, and exchange their queens, and note the effect 36 hours after the queens are liberated," says D. B. Norton in *American Bee Keeper*. I never watched so closely as that; but when I've killed a queen because her bees were savage, I have been puzzled to find a marked change before there could be much change in the bees. [Similar statements have been made before, and I believe there is something in it; and yet—and yet—it seems hardly possible that a queen could exert so great an influence in so short a time.—ED.]

SCIENTIFIC queen-rearing requires careful selection of sire and dam, adapting one to the other. Little can be done at that till fecundation can be controlled. In the mean time, if every bee-keeper persistently breeds from queens whose colonies store biggest crops, I'm sure he will bring up his average. [Yes, that is true.] J. F. McIntyre, of California, has a row of hives in his apiary, each of which has a queen from his best breeder. He says it was easy to see that this row of hives gives a larger yield than any other row of an equal number and strength. By the by, in my travels I have run across a number of bee-keepers who have daughters from this McIntyre queen, and they all say they are something extra. Their colonies surpass in honey the other colonies in the yard. If McIntyre gets a free advertisement out of this he is welcome to it.—ED.]

LONGEVITY in bees is coming to the front. Assuming that in harvest time a worker lives six weeks, and goes afield when 16 days old, if its life were prolonged a week it could store 27 per cent more. If one queen lives twice as long as another, will not her workers live at least a little longer? Is it not possible that, by proper selection continuously exercised, we might add that week to the life of the worker? If we could add a sixth to its summer life, that ought to add a sixth to its winter life. In that case a bee born Oct. 1, which now lives till Apr. 1, would live till May 1—quite a help in the wintering problem. Another thing: We can tell better what a queen is by two or three seasons' work than we can by a single season's work. The one that shows herself

best for three seasons is a safe one to breed from. I have queens born in 1897 that are among the best—one of them, I think, the very best I have. [While this is true, the average queen, I think, had better be displaced in two years by a young one.—ED.]

G. M. DOOLITTLE does some figuring in the *American Bee Journal*, that seems to have no flaws in it, by which he shows that a queen in the hands of a queen-breeder may be worth \$3750. That seems an astounding value, but it's hard to get away from it if we admit his data: A queen whose bees store 10 lbs. more than the common, one-fourth of whose queen progeny will equal the mother, which will live three years, or long enough for the breeder to rear from her 4000 queens. The important thing, connected to a certain extent with this, that I'd like to ding into the ears of every bee keeper, is that, if he will take the pains to keep a record of the performance of his bees, and then breed only from the queen whose bees have done the best storing, he would be materially adding to his income. [Doolittle is not far wrong. See my answer concerning the McIntyre queen, in the preceding column.—ED.]



Summer's blossoms everywhere,
Sweetest perfumes fill the air;
Bees are busy all the day
Buzzing their melodious lay.



Dr. Miller says in a private letter: "Unless rain comes soon every thing will be dried up." Quite the opposite in this region of country. The amount of rain fallen between May 25 and July 5 has almost if not entirely broken the record, while the heat has touched the 100 point.



A Cleveland daily of July 4 speaks of what it calls a very odd consignment of goods from Italy—"a queen-bee, a large bee designed as the nucleus of an apiary." Is it possible that such a thing should create surprise in a city whose smoke can be seen from the Home of the Honey-bees? A constant stream of such bees has been flowing from Italy to America for years, and they have been sent even to Australia and other remote countries.



The indications are that bee culture is taking great strides now in Italy, in common with many other lines of industry. The papers tell us that Italy has just passed France in point of population, and will soon regain much of its lost prestige among the great nations. Conservatism among bee-keepers is fast giving way to the search-light of actual test. As Italy has done so much in the way of giving to the world its best bees, we can

not help feeling a deep interest in the welfare of that land of song. Its chief and almost only bee-journal is *L'Apicoltore*, published at Milan. It is, to a great extent, an able summing-up of bee culture in Europe and other countries.

AMERICAN BEE JOURNAL.

In his issue for June 27 Mr. York seems to have gotten up a little surprise party for the benefit of Dr. C. C. Miller. The doctor's picture appears on the first page, accompanied by some lines supposed to represent the retrospective views of a man who has just passed 70 years of life, as the doctor did on the 10th of June. Mr. York speaks of Dr. Miller as "the most prolific writer on bee culture today." This is probably true, although G. M. Doolittle certainly gives him a close second. It is very gratifying to have the doctor tell us of his good health and of the amount of work he is still able to do personally. He calls himself "seventy years young," and that is certainly a good way to put it.

AUSTRALIAN BEE-KEEPERS' REVIEW.

The first issue of this journal has just arrived, and is simply an index of the rapid advance in bee culture now being made in Australia. It has 16 pages, very plain print. What strikes me as the star article was written by Mr. J. E. Crane, of Middlebury, Vt. It is in regard to what might almost be called a good hobby with Mr. Crane—the improvement of bees themselves rather than spending so much time with hives and appliances. He says:

"It is not certain that the great mass of bees to-day are any better for honey-gathering than in the days of Virgil and Aristotle. So busy, indeed, have bee-keepers been during this nineteenth century inventing hives, boxes, sections, supers, foundation, smokers, extractors, with systems of management, manipulation, and a thousand and one other things connected with bee-keeping, that they seem to have almost forgotten the possibilities of improving the bees themselves."

It seems, however, as if the matter of improved bees had not been entirely neglected in these columns.

The printer, not being familiar with the word "Carniolans," has disguised it under the new spelling of "Carrinolaus."

L'APICULTURE PRATIQUE.

This journal, published at the old home of Charles Dadant, in France, makes the following parallel between the honey display in Paris last year and that at Buffalo this year:

The exposition of 1900 was the admiration of the whole world. That is an understood thing; but was it really practical? We are in a position to doubt it from our point of view. Apiculture was represented there, it is true, but with what parsimony was space allotted to it! Under such circumstances, what was the impression visitors received of our industry? Thorough contempt, probably.

The Americans, on the other hand, understanding the importance of a well-arranged exhibit, have not hesitated to make the greatest sacrifices for the Pan-American.

A special building has been decided on, where will be exhibited all the implements used in apiculture, as well as their products. But the most interesting point is that all systems of hives will be exhibited

filled with bees, which, by an ingenious arrangement, will be able to communicate with the outside while doing their work, while visitors will be able to examine the interior of the hives through observation glasses. It will be tried in every way to demonstrate the part bees play in the fertilization of blossoms. An exhibition of this kind will certainly make a great impression on the public, who frequently are ignorant of the elementary principles of apiculture.

The above is designed as an addition to Dr. Mason's announcement in this issue. It certainly should stir our people up to do their best in the way of an exhibit.

Combs built by bees, when one and two years old, are more fragile, and require more care if used in the extractor, than those built on sheets of foundation. With the former it is necessary to turn the extractor very gently, and avoid sudden stoppages. The third year, the natural combs become more firm.



THE BEE IN LAW.

Property Right in Bees.

BY R. D. FISHER.

There is natural cause for wonder why the legal status of the bee has not been more definitely exploited, since bee culture has long since passed from that of a fad, by a large number of persons who had no definite reason why they kept bees other than that they can be kept on a farm without expense and with very little trouble, to that of a scientific and profitable business. Just as the law of real property differs from that of personal property as dealing with what is immovable and indestructible, so the law of animate differs from that of inanimate property—a distinction far more significant in the science and philosophy of the law than one would suppose who had given the subject but little thought. As a matter of fact, these powers and liabilities in animal life form the basis of an elaborate system of rights and responsibilities, and by no means has the bee been overlooked or wholly disregarded. However, so far as the present writer has been able to ascertain, no effort has been made, as yet, to work these scattered elements into any sort of publication. It is hoped, therefore, that this and subsequent articles may serve to the accomplishment of such an end.

It must be primarily understood that, animals being personal property, the whole law governing such property is applicable, of course, to bees; but it is only such particular portions of that law as relate distinctly to their peculiar qualities that can be called, with any technical accuracy, the "Law of Bees."

Matters connected with their natures, dispositions, and habits, their inclination and liability to injure and be injured are proper subjects for consideration, and are more and more

becoming active factors in the results of litigation to establish the property rights in the bee and the liability of the owner thereof.

In the treatment of this subject it will be our object to let the cases speak as much as possible for themselves—in other words, to give, as far as is consistent with reasonable brevity, the facts and grounds of the decisions of our courts in the more important cases. Further along, if deemed advisable, we may compile a digest of the statutory laws of the respective States on the subject of bees; but at present we shall only aim to awaken in our readers a deeper interest in the rights and responsibilities of the bee-keeper as relating to property rights.

GENERAL NATURE OF THIS PROPERTY.

The distinction between wild and domestic bees as subjects of property is one that exists both in the common and the civil law. Without discussing the question whether all bees were originally wild by nature until tamed by man, and the distinction of the law between such animals as we generally see tame and are, therefore, seldom, if ever, found wandering at large, and such creatures as are usually found at liberty, though sometimes tamed and confined by the art and industry of man, it is safe to assume that a qualified property right may exist at common law in bees where a man reclaims and tames them, or confines them so that they can not enjoy their natural liberty. So in the civil law, the title termed "occupation," or the acquisition of ownership by taking possession of bees formerly without an owner, exists; but it must be kept in mind that, "if we have caught a wild beast or bird or fish or bee, the moment this animal has been caught it becomes ours, and it is regarded as ours so long as it is under the restraint of our safe keeping; but when it has escaped from our keeping, and regained its natural liberty, it becomes the property of the first taker, because it ceases to be ours; and such an animal is considered to regain its natural liberty when either it has escaped out of our sight, or, though still in our sight, the pursuit is difficult."

Having laid down the general rules that govern property in wild animals, we shall consider their application to bees. With regard to bees, Blackstone, the great law-giver, says: "Bees also are *feræ naturæ* (wild by nature); but when hived and reclaimed, a man may have a qualified property in them by the law of nature as well as by the civil law." And to the same purpose, not to say in the same words with the civil law, speaks Bracton: "Occupation, that is, hiving or including them, gives the property in bees; for, though a swarm alights upon my tree, I have no more property in them till I have hived them than I have in the birds which make their nest thereon; and, therefore, if another hives them, he shall be their proprietor; but a swarm which flies from out of my hive is mine so long as I can keep it in sight and have power to pursue them; and in these circumstances no one else is entitled to take them." But in respect to such animals as are in the habit of

going and returning, as pigeons and bees, which are accustomed to go into the woods and fields, and come again, we have this traditional rule that, if they cease to have the intention of returning, they also cease to be ours, and become the property of the first taker, because they cease to be what are termed *animus revertendi* when they have discontinued their habits of returning.

Ownership in bees is *ratione soli*—that is, bearing reference to the soil, and is said to be the ground of ownership in bees. So in the civil law, if a swarm of bees had flown from A's hive they were reputed his so long as they remained in sight and might easily be pursued; but they do not become private property until they are actually hived. Bees, along with other wild animals, furnish the only distinct class of chattels which have been made the subject of primary occupancy. Even here, notwithstanding the universal principle of law, that all mankind may pursue and take animals, whether of the air, earth, or water, in a wild state, the first occupant becoming the owner, there is found a restraint which ownership of the soil imposes, and which fastens the closer as population grows and civilization advances.

[This is one of a series of articles that will follow in the coming issues. We hope to have them in book form for convenient reference, as there are many "nice points," as a lawyer would say, affecting bees.—ED.]

MEASURING BEES' TONGUES.

BY A. J. WRIGHT.

I have been reading with much interest the various articles on the above subject appearing in your journal from time to time. There can be no question, I think, that a long-tongued bee has a decided advantage over a short-tongued one in the ability to reach the nectar; and I think, too, that the agitation of the question will result in an improvement of stock; but it strikes me that the experiments have not been carried far enough. In looking to the length of the tongue, have we not overlooked the capacity of the honey-sac and the individual energy of the bee—two very important factors? Suppose we take two bees having the same length of tongue, we would conclude, if we stopped here with the experiment, that these bees would store an equal amount of honey; but it is a fact that there is as much difference in the capacity of the honey-sacs and the energy of bees as in the length of their tongues. It is also a fact that a long-tongued bee has a larger honey-sac than a short-tongued one, and also greater energy.

Now, while this places long-tongued bees in a class by themselves, and gives them a great advantage over short tongues, the fact still remains that there is a difference between individual members of the long-tongued class—a difference in the capacity of the honey-sac and the energy of the bee.

With the foregoing in mind I began a year ago to experiment and construct a glossometer

that would give practical results along the right line.

A glossometer, to be practical, must be simple in construction, and free from delicate springs and wires. It must be direct in action. It must be accurate. It must measure the length of the tongue of the *living* bee, not the length of tongue of the carcass. It must give measurements of the capacity of the honey-sac, and must show the energy of the bee. It should have a scale or dial that can be plainly read to thousandths of an inch, without the aid of rule or lens. To meet the requirements I constructed the instrument shown.

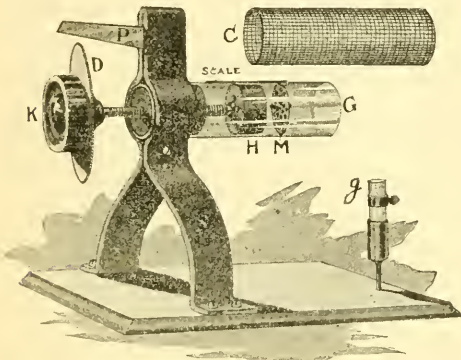

WRIGHT'S GLOSSOMETER.

- S, metal standard.
- P, pointer, or indicator.
- G, glass tube, length 2 in., diam., $\frac{1}{2}$ in.
- M, mica disk.
- D, dial plate, reading to thousandths.
- H, candy-cup filled with Good candy.
- g, small glass tube to hold thin honey or sugar syrup.
- C, wire-cloth cage.
- s, screw.
- K, knob.

The bees to be tested are placed in wire cage C, which is slipped over glass tube G, allowing bees to enter the tube as far as the disk, M, which has perforations corresponding in shape and size to the large end of the largest red-clover corolla-tubes. The honey-cup H is brought in contact with this disk by means of the screw. The bees will quickly begin to take up the candy through the perforations. The instrument is placed before the operator, with knob K at left hand, and, preferably, in front of a window or before a lamp or other good light. When the bees are working at the candy, the knob K is turned slowly away from the operator. This causes the candy cup to recede from the disk, and this is continued until the bee has done its best, when the pointer is brought down upon the dial, and the reading to hundredths or thousandths is easily taken.

To get a clearer idea, we will suppose that the threads of the screw are one-tenth of an inch apart. Then it is evident that one complete turn of the dial-plate will cause the candy-cup to recede one-tenth, or ten-hundredths from the disk. It is also evident that, if the circumference of the dial-plate is five inches, and this is divided into ten equal spaces, each

space will be $\frac{1}{2}$ inch; and if the pointer is caused, by turning the dial, to move over this $\frac{1}{2}$ inch, it will move the candy-cup only one-hundredth of an inch away from the mica disk; and if this half-inch space is again divided into tenths, each space will be $\frac{1}{20}$, which would represent only a thousandth between the disk and candy-cup; and the divisions on the dial can, of course, be easily read without the aid of rule or lens.

The energy of the bees is clearly shown in their efforts to reach the candy. While some are easily discouraged, and give up without much effort, others will persevere, and work and stretch their tongues to the utmost limit; and when the candy is clearly beyond their reach they seem loath to yield.

The small tube, g, is filled with thin honey or sugar syrup, and brought up under the wire-cloth cage. The bee to be tested may then be left to fill its honey-sac. The little band of brass may then be moved until its rim just comes in line with the surface of the liquid left in the tube, which is then removed and placed on top of the large tube horizontally, and measurements to thousandths of an inch are made in the same manner as in measuring the tongues. One or several bees may be placed in the cage for tongue measure, but, of course, the honey-sac of one bee only can be measured at one time. It occurs to me that any arrangement which requires the bee to put its tongue through wire cloth must be a partial failure, as the meshes vary considerably in size, and the *shape* also gives chance for considerable variation. It seems to me that any attempt to measure a colony collectively would not amount to much, as at the best only the longest tongue of a single bee in the colony would be the result, and then it would not be at all certain that the bee in question belonged in the colony at all, as bees mix to quite an extent.

Glossometer tests bring out some curious facts. One is, that the living bee, when reaching for nectar, can protrude its tongue further than the tongue of the dead bee can be stretched without rupture. Another striking fact is, that the bees of a queen, *if pure*, differ but little from each other in tongue measure, capacity of the honey-sac, and working energy.

I am of the opinion that the only practical method is to measure the actual reach of tongue of the *living* bee through perforations of a standard size. I have adopted .065 as a standard diameter. Wire cloth in common use measures the square way of the mesh about .075 to .08; cornerwise it measures from .10 to .11, showing its unreliability. I believe the glossometer will recommend itself to every humane bee-keeper, as it renders unnecessary the killing of our pets to determine the length of their tongues.

If we are to accept .25 ($\frac{1}{4}$ inch) as the maximum depth of red-clover corolla-tubes, then I think we need not worry much about the best of our long-tongued strains being able to secure the crop. I have found bees in my best colony of Sweetheart's that would reach .259, and I have found none showing less than .238. This is not a free advertisement for this strain,

as every queen-breeder has his favorites; but it shows that, in the near future, the red-clover crop is *ours*.

Bradford, N. Y.

[Mr. Wright is entirely correct in regard to wire cloth. The meshes of ordinary queen-cage cloth are too large, and, what is worse, they are usually somewhat irregular. Sometimes the bees will stick their noses down through a large hole, and at others through a small one. Perforated metal having openings as large as the corolla-tubes of red-clover, for instance, should be used. Then care should be taken to see that there are no burr edges around the perforations. It is possible and even probable that a glossometer—something that requires the bees to stretch their tongues (while in life) to their utmost limits may be better than the measurements effected by methods described in GLEANINGS recently, by which the bees are chloroformed, decapitated, and the tongues combed out on the steel rule. But such treatment can hardly be regarded as inhuman, as suggested by Mr. Wright, for the simple reason that any animal or insect under the influence of chloroform experiences no pain, much less when the head has been severed from the trunk; but for other reasons the glossometer may give us more uniform and accurate results; and if so I should be very glad to acknowledge the fact.—ED]

do not lay claim to owning the longest-tongued bees.

Now it strikes me that, if the proper-sized wire mesh could be decided on, then every bee-keeper with some such arrangement as I send you could find the length of his bees'

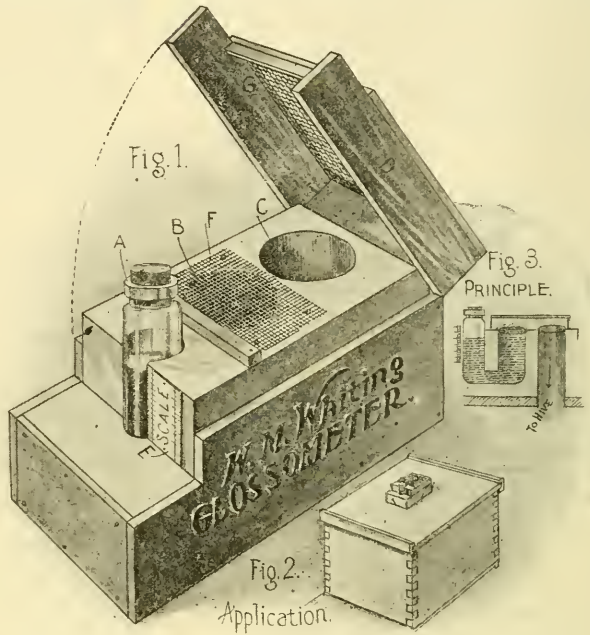

FIG. 1.—A is a bottomless bottle connecting with wire-covered hole B, which passage also is well waxed to prevent absorption. C, hole or bee-passage connecting through the cover of the hive. E, measuring-scale. F, wire mesh covering hole B. D, confining-frame. G, wire cloth covering D.
 FIG. 2.—This shows the application of the glossometer to hive D.
 FIG. 3 shows the principle involved.

WHITING'S GLOSSOMETER.

A Simple and Practical Device.

BY W. M. WHITING.

I take the liberty of sending you a feeder that I have been experimenting with to find the length of my bees' tongues. The parts of the feeder that hold the diluted honey have been waxed so as to stop all absorption. I first level the hive so that the top is perfectly level. Then I bore an inch hole through the top board, and place the feeder over the hole. In a short time the bees will lower the liquid as far as they can reach it through the wire netting. I have one colony of bees (and the best honey-gatherers I ever owned) that lower the liquid $\frac{2.6}{100}$; and as the longest-tongued bees that I ever read about have tongues only $\frac{3.0}{100}$, I think my feeder must be a little off, as I

tongues with very little trouble. I have tried measuring the tongues with a rule, and I consider it too uncertain.

East Orange, N. J.

[This glossometer is all right, I think, and so simple any one can make one. We have tried it to some extent, as we go to press, with fairly good results. The wire cloth through which the bees run their tongues is 11 meshes to the inch. It is so coarse the bees can run their mandibles clear down through the meshes. For this reason the tongue-reach is longer than what we get by our steel-rule plan.—ED.]

A VISIT TO HENRY ALLEY.

BY A. C. MILLER.

Mr. Henry Alley, easily the foremost queen-rearer in the country, is as hale and hearty at 67 as many a man at 40. In a recent visit to his apiary I found him hard at work, moving with a quick, springy step, all his operations betokening a sound body and an alert mind.

His home in the pretty country town of Wenham, Mass., is almost hidden among the trees, and his apiary was so distributed among the raspberry and currant bushes that a satisfactory photo was impossible. Mr. A. said he had been too busy to trim away the bushes and to slick things up, but the essentials he certainly does not neglect. His kitchen garden was as free from weeds, and as thrifty, as any one could desire; and while his workshop, spare hives, etc., were in some confusion, it was only such as is brought about by a rush of work. It was a pleasure to watch him as he made up nuclei, fixed frames of cages containing cells or queens, and prepared strips of comb for cell-building. To those who are not familiar with Mr. Alley's system a brief description may be interesting.

First, his breeding queens are kept in little hives containing five frames about five inches square, and from these little frames he cuts a comb whenever he wants eggs for cell-building. For doing this work he prefers black bees, buying many colonies of them every spring. He has to send far afield for them now, as those anywhere near Wenham were gone long ago. When received, the entrance is covered with a drone-trap, and all black drones kept from flying until he is all ready to use the colony for cell-building. To prepare them for this they are taken into his workshop where the queen is found and removed, and the bees are brushed into an empty hive and shut in with a wire-cloth cover, so to remain for several hours. When they have been shut up long enough, the prepared eggs are given to them and they are left until night when they are placed on a stand out of doors, and the entrance opened. The operation of preparing the cells I will describe as I saw him do it.

In his shop he lighted a kerosene-stove and set on it a pan containing a mixture of bees-wax and rosin. Then he took two L. frames from which the lower half of the combs had been cut, and, by a quick stroke of his knife, removed the remains of a previous lot of cells. He then went to the colony of one of his breeding-queens, picked out one of the little combs, stepped back into the shop, and, with a hot knife, cut the comb from the frame, slit it into strips containing one row of cells each, took a match and destroyed the egg in each alternate cell on one side of the strips, dipped the other side into the melted rosin and wax, and stuck them to the bottom edge of the L. combs above referred to. His next step was to hang these in an empty hive, fill the rest of the hive with combs of honey and pollen, jar the confined bees to the bottom of the hive they were in, put on the top of it a zinc excluder ("drone-strainer" he calls it), place on this the hive containing the prepared strips of eggs (enough for 60 cells), and over this a wire screen. In a few minutes a large part of the bees were in the upper hive. The operation from the time he went for the eggs until they were given to the bees was just eight minutes. When the cells are sealed they are cut apart and each one put into a little cage by itself, and a lot of these cages are fastened

into an L. frame and hung in any queenless colony until they hatch. The next step is the making of a lot of little nuclei from the small 5x5 frames, stocking them with bees, giving them a virgin queen and carrying them to an out-apiary where he has his drone-rearing colonies.

I am fairly familiar with both this and the cell-cup system; and for celerity of operation and excellence of results I consider Mr. Alley's plan far ahead of the others. His system is certainly best for those bee-keepers who rear queens solely for their own use; but each commercial queen-raiser will use the system he is most accustomed to. He had in cages a lot of virgin queens of various ages; and finer and larger queens I never saw. From their size I took it for granted they were laying queens just caged, until informed to the contrary.

The Adels are large, active bees, clinging well to the combs, easily handled and reasonably gentle. Mr. Alley speaks highly of their honey gathering and comb-building qualities; but with them in that respect I am not familiar. The using of black bees for building cells has its advantages (one of which is cheapness) and its disadvantages, the chief being their stings. Ah, but how they stung! They used my head and neck for a pin-cushion, but not a sting did I get from the Adels. Mr. Alley never wears a veil, but does have a handkerchief hanging from the back of his hat to protect his neck and the back of his head. To see him working among the bees one would never think a sting troubled him. He has a pleasant, genial way of treating his visitors that causes a visit to be agreeably remembered.

Providence, R. I., June 25.

BEE-KEEPING IN CUBA.

Large Honey Yields; Peculiar Conditions in the Island.

BY FRANK N. SOMERFORD.

After a long disastrous drouth which lasted all spring, greatly shrinking the amount of late spring surplus honey, and retarding natural as well as artificial increase, besides causing great loss to the agricultural industries, we were visited in this section some days ago by one of the heaviest rains known for many years, which inundated large tracts of flat lands, doing great damage. One man alone, a Cuban, lost 300 chickens; another, several colonies of bees, besides several who lost cattle that were staked in low places. Much damage was also done to roads, bridges, etc. This was followed by the hottest weather known for 15 years, as stated by Spanish papers; and now the rainy season seems to have burst upon us, and vegetation is growing at a rate almost astonishing. We are enjoying mud, mud, mud; and wheel-riding, except on the macadamized roads, is done with now for a while.

Mr. Harry Osburn's honey crop for the past season was taken from about 400 hives. I

visited his ranch last summer, and there were over 300 hives; in early autumn he increased 100, which gave a total of about 400. Of this number there are possibly 50 from which no honey, scarcely, was taken.

In Mr. Osburn's calculations I think he should have stated that there were 1200 colonies on his range, including the apiary that he has; and I might add that 500 or 600 of these will barely come within the three miles; or, in other words, are just about three miles away. This, however, doesn't place the entire force of all those bees on that same territory, because, five miles from Mr. Osburn, or one, two, and three miles from the other two large apiaries along the coast, the range is almost as good as if not better than the range near him.

The two other apiaries are separated by three or four miles, thus scattering those bees over a much larger territory than Mr. Osburn seems to indicate. He also signifies that, could he have remained at the apiary and personally superintended or done the work himself, during the winter of 1898, he would have made a great record; yet whoever had the ranch that year secured more than double the amount per colony that Mr. Osburn received the past season.

Taking the unusual amount of 50,000 lbs. from 200 hives, this gives 250 lbs. per colony. Taking the 400 colonies that Mr. Osburn had the past season, that produced 40,500 lbs., this gives a fraction over 104 lbs. per colony. This is not saying much for him as a record-smasher, for a single year, but his figures for a term of years are very large. It should be taken into consideration, also, that the year 1898 was when farming was paralyzed, and there were but few stocks on the range to eat and trample under foot the flowers that at that time must have grown in profusion everywhere, thus making it possible at that time to secure such large yields.

There is something strange regarding the quantity of honey a bee or a hive will gather here as compared with what a colony of the same strength would gather in the States. In the best of the honey-flow it requires here on an average a third more time or a third longer for a hive to fill up and become ready to extract than in the States. I think several others have noticed this too, and I have heard Mr. Harry Howe say that he has never seen bees work here with the eagerness and rapidity with which they work in the North. I might add, though, that people are affected in the same way; and what is done is by force more than by the natural desire that a person has for activity in the States.

I can look at the cut of "Rambler's Retreat" among the peach-trees, with the fruit in plain view, with a longing eye and watering mouth. It reminds me a little of our mangoes here in Cuba, excepting that the mango grows very large, and tall, almost, as an oak-tree, and are sometimes laden with fruit from the first branches clear to the top, and will have small fruit and ripening fruit at the same time. This is a large fruit, rather coarse, though, that to some extent fills the

vacancy of the peach here. But I am afraid, were Rambler here with that pretty ranch in so much shade, without sheds, he would soon find things unpleasantly damp, especially through June, July, and August. That little 22-caliber honey-elevator looks more like the inventive genius of a novice than the man of Rambler's experience; and should he, while extracting, allow his thoughts to ramble as his pen does sometimes he would soon find that honey to be of a rambling disposition also. However, some of our Cuban bee-keepers prefer a little can arrangement, to place honey in the cask with. An American in Cuba, though, can be partially excused for such arrangements, for they tend to concentrate a person's thoughts and keep him from thinking of the good country, good people, good society and surroundings, where the good English language is spoken. That little elevator would, of course, place all such thoughts in oblivion, as it were, to the operator, whose thoughts would be occupied thus: "Can I uncup this comb before that can runs over? can I throw out these two combs before that can runs over? can I put some more fuel in the smoker by the time that can is full?" or else in steps a friend whom you were not expecting, and you can't give him a welcome handshake, and an unrestrained greeting, on account of that miserable little can.

Yes, you all know this, and even more is true. I've traveled this path, and have decided, just for one season, a platform just high enough to allow the honey to run right into the tank. This must have a long gradually sloping plank approach to allow the cart to run right up on the platform beside the uncapping-box and extractor; then you can work unmolested; and should you hear some noise in the apiary, or something call your attention, your honey is going right on into the tank. And this question of honey at a little less than 3 cents per lb. that we have to contend with here is not conducive to a desire to handle it any more than is actually necessary.

However, I am glad to learn that Mr. Osburn has so satisfactorily settled this question for himself that it gives him no uneasiness. I think I shall go over and see friend O., and see if I can't get a key to the situation. All Cuban bee-keepers should be annexationists. Bejucal, Cuba, June 11.

THE SWARTHMORE SYSTEM OF QUEEN-REARING.

Starting Queen-cells by the Shell cup Plan.

BY SWARTHMORE.

To start queen-cells by the shell-cup plan, proceed as follows:

To an empty hive-body attach, at top and bottom, frames covered with wire netting so as to confine a swarm of bees as Henry Alley does in his well-known "swarm-box." In the top screen is left an opening to admit of placing several Swarthmore top-bars side by side, as shown in the drawing. Bind the bars close together with four pins, A, A, A, A. Then

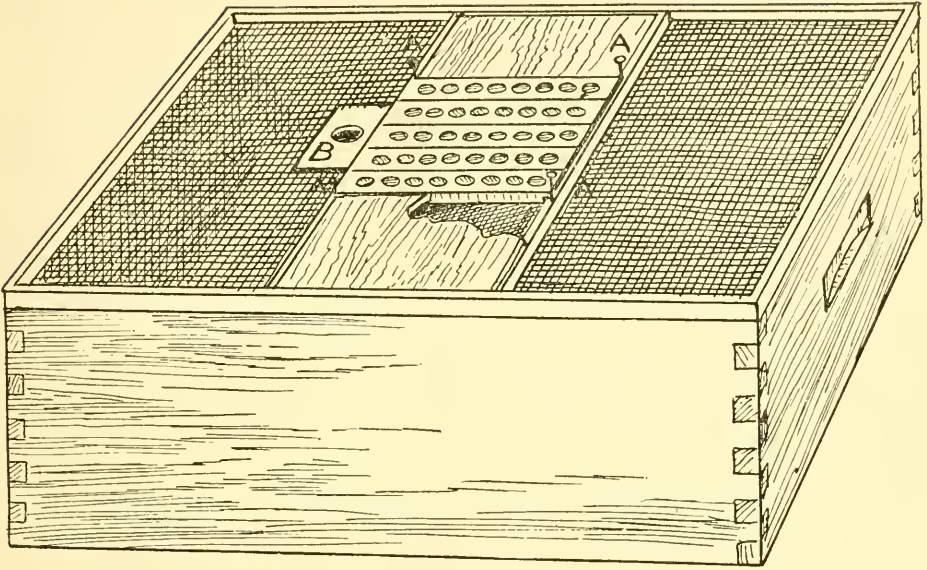

A NEW CELL-GETTING CONTRIVANCE.

Above is shown a cell-starting screen attached to a Dovetailed hive-body, showing manner of adjusting the shells for queen-cell starting.

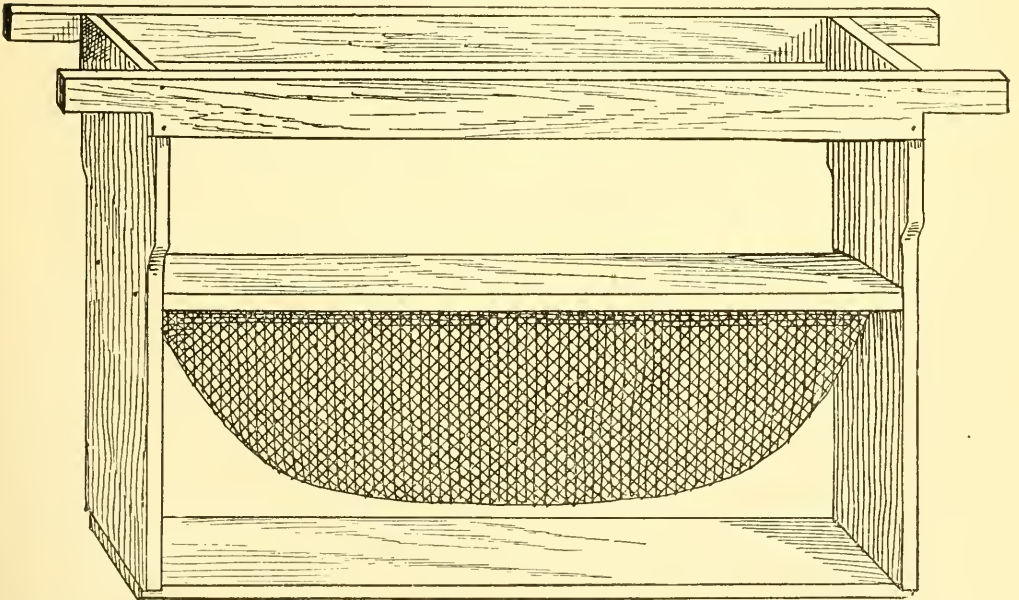

OPEN-TOP OR BARLESS BROOD-FRAME, FOR CONVENIENCE IN DRAWING CELLS FOR USE.

This drawing is from a half-size model. The real frame is L., or any other standard size,

supply the holes in the series of top bars with compressed shell cups. Now shake into the hive-body a goodly number of bees that have just had their queen taken from them, and, after placing in this hive combs containing honey, pollen, and water, *no brood*, put on the cell-starting screen. Then remove the chamber to the honey-house, and leave the bees thus confined until they are fully aware of their absolutely queenless condition—perhaps over one night. In the morning set the hive close up to the bench, and proceed to graft the shell cups. Begin at one corner; and as you draw the shell have ready a blank to plug the hole, and so on, one at a time, systematically, until each cup has been sup-

At the end of 36 hours, place the hive on its original stand; collate the perfect cells and fit the top-bars into the cage parts, slip in the dividing-tins, adjust the zincs, and divide the cages among powerful colonies, allowing no more than 16 cells to a single colony.

If cells are to be finished by queenless bees they need not be caged until capped.

For convenience in distributing cages, or in getting at to remove a single queen, cell, or a cageful of either, at any time, without disturbance to the bees, or the use of smoke, even, have several brood-frames constructed with open tops—that is, the regular top-bar of a plain frame is dropped down about 2 inches, and is there nailed fast to the end-bars. Two

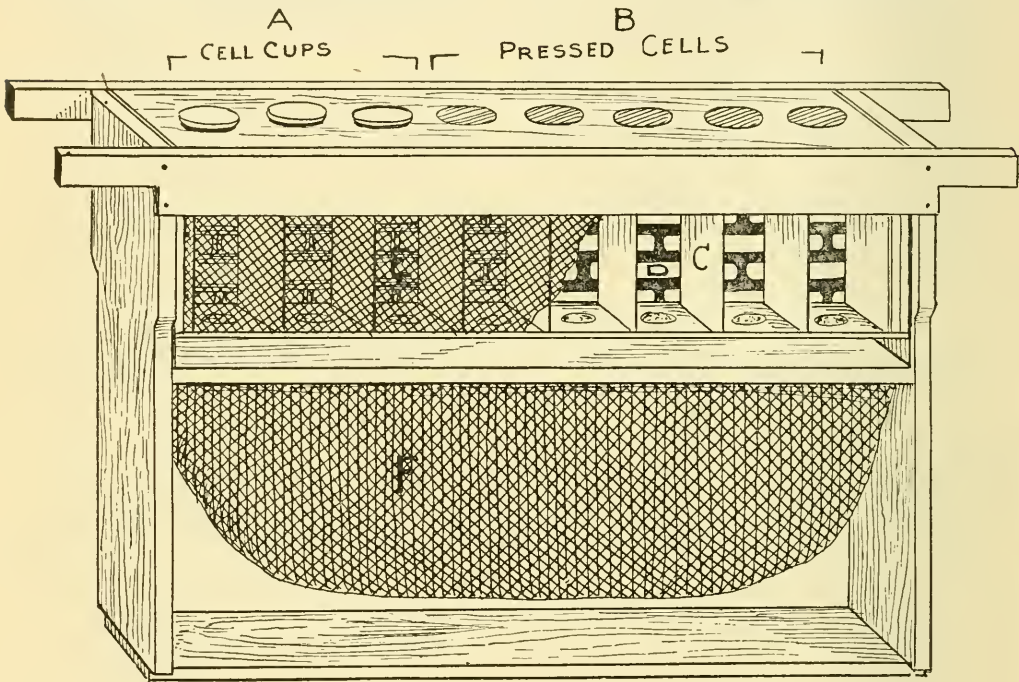

OPEN TOP FRAME WITH CAGE IN PLACE.

In the cut above, A shows shells in place; B, shells removed; D, zinc side; E, wire side; C, division-tins, F, comb or foundation to fill the lower part of the frame.

plied with a larva. Take all the time in the work you wish. There is no need of hurrying, for, even as you proceed, the bees are at work constructing cells from the first cell-cups grafted.

Directly after grafting, fill a salt-shaker feeder with thin honey, and adjust it into the hole shown at B, in the screen. Let no time be lost between the removing of the blank plug and the inserting of the shells or the feeder, lest too many bees escape. There is no need of allowing even one bee to escape if the apiarist is skillful. Leave the colony undisturbed until the cells are well under way. Make examination toward evening by drawing one shell at a time, marking any that have failed, and the next morning new larvæ can be grafted into each shell marked.

strips are then nailed edgewise across the top, as distinctly shown in the drawing, thus forming a frame with an open top, into which two cages will fit nicely. Fill the lower section of this frame with brood comb (or full sheets of brood foundation can be used), and hang in the midst of any powerful colony all ready to receive nursery-cages at any time. When not occupied by cages, fill the space with a block of wood cut a little short so it may be easily removed, even if covered with burr-comb.

Cover the frames with an ordinary sheet split in the middle so as to expose the shell cups; then when you want cells, simply draw them—no smoke, no disturbance to the bees.

[I do not hesitate to say that, in my opinion, Swarthmore has devised a very simple

and perfect system of queen-rearing. The feature of having removable shells that can be handled for grafting or when the cells have been completed, is excellent. There are several other unique ideas that Swarthmore has that will be described later.—ED]

THE HIVE I USE.

Producing Comb and Extracted Honey; Eight and Ten Frame Langstroth Hives; the Hyde-Scholl Divisible-brood-chamber Hives.

BY LOUIS SCHOLL.

After considering all of the many good points possessed by some of all the hives before the bee-keepers now, with frames of different depths and lengths—eight, ten, and more frames in a brood-chamber, using one deep body for the brood-chamber with shallow supers for the surplus, and others with two shallow chambers, and also with the supers of the same depth, has led me to try a number of hives which will be described further on.

Starting with the eight-frame Dovetailed hive, which was then considered the standard size, I thought myself up to the times. But these soon proved to be too small for this southern climate, with its long flows, so the ten-framers were considered. These proved to be some better; but the depth of the Langstroth frame proved to be objectionable. This was true when producing comb honey in section-supers above the brood-frames. There was trouble from the bees filling the deep frames with the honey that ought to go into the sections—this to a greater extent during a slow flow, and especially along the top edge of the comb above the brood; and after this honey was once sealed, the bees were quite loth to store surplus above such sealed stores, causing them to loaf and to hang out in great festoons all over the front of the hive.

Besides, the queen was also crowded out, as the bees filled every cell with honey as fast as the young bees hatched out, although there was plenty of room in the super above.

Now, the question was, how to avoid this trouble and how to get that honey out of the way and into the sections, and this also with as little labor as possible.

Of course, this could be done by inverting the whole hive and letting it remain for a few days for the bees to remove the honey; but this causes a great deal of trouble and labor. Here, now, is a good point in favor of reversible frames, but I am not an advocate of such.

Then I found that it can be accomplished to a great extent by using a divisible-brood-chamber hive by exchanging the upper case (which has the honey along the top) with the lower one, which puts the honey in the center of the brood-nest where it will be removed by the bees.

As there now is brood in the frames which are now above, the bees are compelled to store the honey in the sections above; and by removing the honey in the brood-chamber the bees also provide more breeding room for the

queen. By exchanging the cases of the brood-chamber in this way at certain times during the main honey-flow it is possible to get nearly all the honey of that flow into the sections.

Then shallow frames possess a great many other advantages over deep frames, which I learned when using shallow frames in supers above my standard Langstroth hives, which led me to adopt a hive with shallow frames throughout. Especially when running for extracted honey, the hive consisting of two, three, or more cases with all shallow frames, one is not bothered with frames of different depths, and all cases are interchangeable.

These cases are more convenient to handle, as they are not as heavy as full-depth supers, and are also easier to remove when full, as, by smoking the bees thoroughly when raising the cover, they can be readily driven down out of such shallow supers, when they are taken off practically free from bees, and without any brushing of bees.

Then the shallow frames are easier to uncap, as one draw of the knife uncaps a whole side of the comb, while it takes longer with deep frames, besides being awkward to handle, and the danger of broken combs.

Shallow frames I prefer, too, for a great many other purposes in the apiary; and as there is not very much need of handling the frames individually except in a few instances, the hive is mostly handled by cases with the whole set of frames; and all that is necessary when examining colonies for any purpose at any time is to tilt the upper case of the brood-chamber back, and then one can get a full view of the brood-nest.

In this way it is quite easy to ascertain the conditions and strength of a colony at any time, and also during the swarming season, when looking for queen-cells. If there are any present in any hive they will generally be found on the bottom edge of the upper frames.

When providing more room for the queen in early spring, or for honey later on, one of these shallow cases is added, without the bad result of giving too much room at once, as is mostly the case when giving full-depth supers.

Many other points in favor of shallow frames used in connection with such a hive could be recited; but as time and space do not permit, I will now give a description of the hive which, after being used in the apiary, has given good satisfaction.

The brood-chamber consists of two shallow dovetailed cases, standard ten-frame L. size, but only $5\frac{3}{4}$ inches deep each, both giving a brood-chamber $11\frac{1}{2}$ inches in depth.

Each case holds a set of 10 shallow Hoffman self-spacing frames, the same in size as the standard L. frame, but only $5\frac{3}{8}$ inches deep; this makes 20 frames, with a comb surface of nearly 12 Langstroth frames, thus providing a large brood-nest.

The Danzy bottom-board and cover are used on this hive.

The same shallow-frame cases are used when producing extracted honey, and the supershell of the section supers is one and the same kind.

The comb-honey super is the same in every

particular as the "Ideal," with tall plain sections, $3\frac{3}{8} \times 5 \times 1\frac{1}{2}$; 35 in each super, in 7 rows, 5 in a row, resting on plain slats the same width as the sections, and these taking up the full inside length of the super, except the separators, as the Hyde-Scholl No. 2 separators are used in this super, one between each row of sections, and also one on each outside row next to the wall, when all is tightened up with a follower-board and super-springs.

This super is, in my mind, superior to any other for section honey; and if time permits I will say something more about it in some future article.

Hunter, Texas.

[There is a great deal of sound truth given in the article above. There are times and places when there is an advantage, undoubtedly, in using shallow or divisible brood-chambers. While they have their objections, yet it is probably true, if I may judge from correspondence, that these double brood-nests are increasing in popularity.—ED.]

SHALLOW BROOD-CHAMBERS, AGAIN.

The time is drawing nearer when the bee-keepers will be putting to the test some of the theories that have been advanced through the journals during the winter and previous season. I suppose that quite a few of the readers of this journal will try the shallow, temporary brood-chambers for swarms or colonies worked for comb honey. I for one shall use that plan for all colonies that swarm or that make unmistakable preparations for swarming. As some who have written on the subject do not seem to have gotten hold of the plan in all its phases I should like to call attention to some points that I consider of the greatest importance.

I will quote from the article by Mr. Atwater, on page 8. He says: "To illustrate, the past summer I hived a strong natural swarm in a single section of the Heddon hive. The frames contained foundation starters $\frac{1}{2}$ inch wide. The hive was put on the old stand. The three ideal supers were taken from the parent colony and placed on the swarm. Work in the supers went on for about two weeks. By that time the colony was weakened so by the loss of old bees that super work was almost entirely discontinued. A little over half as much comb honey was taken from this colony as from colonies of like strength that did not swarm."

Now, it would seem that Mr. Atwater left out one of the most essential points in the whole plan. I like the plan especially, because the working colony in the shallow brood-chamber *does not* become weak from the loss of old bees, for the reason that I constantly strengthen them by shaking off bees from the hatching combs of brood contained in the parent hive. I use that hive as a feeder, and do not expect to make a working colony out of it for the white-honey harvest.

I make it a point to watch the working colonies closely, and give them bees enough to keep up the maximum force for storing. If I can't get the bees from their own parent hive

I can get them from some other part of the yard. Fifty such strong colonies will store more surplus honey than one hundred with forces divided, and therefore concentration of forces is my motto. As soon as the main honey-flow is over, these working colonies can be united to the parent hive; and if there should be a late crop of amber honey you will have good strong colonies to secure it.

HARRY LATHROP.

Browntown, Wis., Mar. 26.

NOTES OF TRAVEL.

A Visit with J. M. Jenkins; the Bloody Shirt, etc.;
Continued from Last Issue.

BY E. R. ROOT.

After leaving the yard we met on the road one of the veterans of the Confederacy. Mr. Jenkins introduced me as "a real live Yankee from the North." He received me most cordially, after the manner of a true Southern gentleman, which he was. I remarked that I was glad to see that there was less of a disposition on the part of the Northern and Southern press to "wave the bloody shirt" than formerly.

"Yes," said he sadly, "but the bloody shirt is *there* all the same," and I am afraid the remark is too true; and "it will be there" so long as the veterans of both sides remain alive. The boys in blue don't like to forget Libby and Andersonville; and the boys in gray are no more inclined to forget how their homes and plantations were overrun and destroyed, and how, for years after the war closed, the North kept standing armies in the South. But in the minds of the younger generation I am sure these bitter memories will fade, and the great North and the great South will be united as they never were before. While "the bloody shirt is there" it is buried, I believe, where it never more can wave.

We next arrived in Wetumpka, visited the bank in which Mr. Jenkins is a director and stockholder, and then crossed the big bridge for the other side of the town, where our friend's bee-hive factory is located. He has quite an extensive plant—one which will be enlarged to twice its present capacity the coming season. There will be a new and larger engine and boiler, a new double-surfacer planer, besides other new machinery and a brand-new shop.

Of the two remaining pictures, one shows a view of the home yard with its long shed, and the other, another out-yard, the Evelyn, located in a beautiful grove of pines. This yard, as well as the other ones, is under the direct management of Mr. H. Fitz Hart, formerly of Florida. Mr. Hart is a bee-keeper who is exceptionally well posted on all bee-lore, both of this country and of England, for he is a native of that country. While in the motherland he made the acquaintance of such men as Frank Cheshire, who has acknowledged that he received important suggestions and assistance from Mr. Hart in his scientific work. Mr. Hart has written for these columns at va-

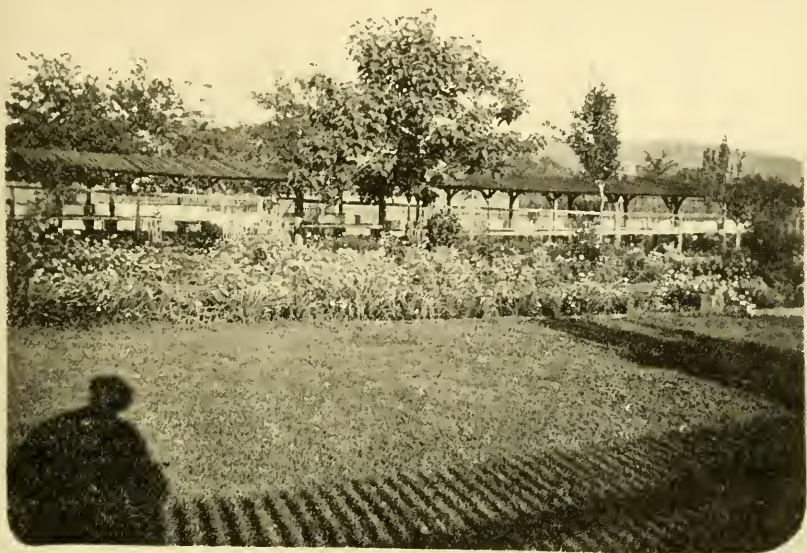

J. M. JENKINS' HOME APIARY UNDER SHFD; ALSO ONE OF HIS OUT-APIARIES (EVELYN) AMONG THE PINES.

rious times, and will be remembered by our older readers.

On returning from the bee-yards Mr. Jenkins proposed that we drive around to some of the cabins of the colored people on his plantation, and talk with them. We drove up to the home of one old colored woman, and Mr. Jenkins, after calling her out to the buggy, began the conversation in this wise:

"Well, auntie, I brought around a real gospel train you talk so much about. Is it running yet?"

"You'h jes' right it's a runnin', Mista Jenkins, all de time. Yis, sah; it runs all de time. An' so dis ge'men's from de No'th, is he? Glad to see you, Mista Root. Hab you got on dat gospel train?"

This was a pointed question, and I did not know whether I had got on *her* train or not, and I answered her accordingly.

"Bettah git a ticket putty soon, for it may be too late, Mista Root."

"But your ticket has all run out," said Mr. Jenkins banteringly.

"No, 'tain't, Mista Jenkins. De Lor' Jesus he punched my ticket."

"But your ticket ought to be renewed."

"Yis, yis, Mista Jenkins. I have de Lor' Jesus renew it eb'ry day, Mista Jenkins. Say, Mista Jenkins, does you renew you's eb'ry day? an' you, Mista Root?" said she, looking me straight in the face. I said I hoped so.

"Well, you bettah. De debble is aftah ye, sartin' shu', Mista Root."

"But," said Mr. Jenkins, "how are we white folks going to get on *your* train?"

"We'll all be white when we git on dat train. The' won't be no compahments for brack folks. You, me, an' all on us will be white—yis, sah, Mista Jenkins."

"But where will the black folks go?" inquired Mr. Jenkins.

"If dey doan git on dat gospel train dey'll all go down to hell—yis, sah, down to hell, an', say; dar'll be some white folks dat'll go down to hell. Dey'll be white up heah, but be brack down dar. Yis, sah; dey'll all be brack down dar; but in hebbem we'll all be white, no mattah whethah we got a brack skin heah o' not—yis, sah; yes, sah."

"How do you renew your ticket?"

"I makes my peace with my God eb'ry night an' eb'ry mo'nin'—yis, sa. Say, Mista Jenkins and Mista Root, do you do it eb'ry night an' mo'nin'?"

We told her we tried to, and then drove on to see others.

Mr. Jenkins explained that the religion of the black people is largely sentimental; that some of the loudest shouters would lie and steal, and yet *not seem to know* that their lives were inconsistent. They need a gospel so taught that it will take hold of their lives, he explained. "They need to be taught," he said, "to be provident; to have a sense of ownership, and, more than all, that lying and stealing are an offense unto the Lord."

Mr. and Mrs. Jenkins are earnest Christians, and are doing much for the blacks all around them. The colored folks always had a pleas-

ant smile for "Mista Jenkins," and are always glad to see him.

"But," said Mr. Jenkins, "some of the theories held by some of the Northern white people concerning this race problem will not work out in practice. What the colored people need is not higher education but a practical knowledge of some trade. They should be taught to read and write, to earn and buy a home, not to rent one. Booker H. Washington's methods are all right."

I must confess that many of my preconceived notions have been materially changed since visiting the Southland, and I only wish that there might be more charity on the part of the Christian press of the North in dealing with the race problem.

CONVENTION NOTICE.

All arrangements for the next convention of the National Bee-keepers' Association have been completed so far as possible, and the convention will be held in the audience room of the Buffalo Society of Natural Sciences, Sept. 10th, 11th, and 12th; commencing on the evening of the 10th. The place of meeting is in the Buffalo Library building, corner of Washington and Clinton Streets, near the business center of the city. The president of the Natural Sciences Society, Mr. Smith, has also kindly offered our Association the use of his library and other committee rooms during the time of our convention, and to do all in the power of the society to help make our meeting a success.

Railroad rates will vary in the different passenger association territory, from one cent per mile each way to one and one-third fare for the round trip. Each person can readily learn the rate on inquiry at his railroad station.

The Buffalo bee-keepers will try to provide entertainment at reasonable rates for all attending the convention, who will notify Mr. Sydney S. Sleeper, of Holland, N. Y., by Sept. 2d, of their wish for entertainment.

In a letter just received from Mr. Sleeper he says, "We want all to come who can, for we wish to make the Buffalo meeting the most pleasant and instructive one that was ever held in America. We will have the co-operation of all the sciences as well as the school board," and names some professional men who are interested in our specialty and will be at the convention to help.

In a long letter from Mr. Hershiser, just received, he closes by saying, "Call upon me for whatever further assistance I am able to render," and Mr. Penton, an ex-president of the Erie County Bee-keepers' Society, and others, have offered to do all they can to provide for the comfort of the delegates.

As stated in my previous convention notice in GLEANINGS, there will be no fixed program and no papers, and the time will be occupied in answering and discussing questions, except that on Thursday evening there will be a joint session of our association with the American Pomological Society, to discuss "the mutual relations of bee-keeping and fruit-growing;" and Prof. Beach, of the N. Y. Agricultural Experiment Station, and Prof. Fletcher, of the Central Experimental Farm of the Dominion of Canada, will help talk for the bees at that session, and it is hoped that much good will result to fruit-growers and bee-keepers from this joint session.

If any bee-keeper who can not be at the convention has any questions, knotty or otherwise, he would like to have answered at the convention, will send them to me I will see that they are presented.

A. B. MASON, Sec., Sta. B, Toledo, O.

ROBBING the bees is a term used by many of the Western bee-keepers for taking off the finished supers. Our forefathers used to talk about robbing their bees when they sulphured them in the good old fashioned way, and the term has crept into use, even among up-to-date bee-keepers in the great West.

APIARIAN EXHIBITS AT THE PAN-AMERICAN.

BY OREL L. HERSHISER.

Now that we have settled warm weather the daily attendance at and interest in the Pan-American is rapidly increasing, and this has been especially noted in the Apian Department. Besides the many visitors who take only a passing interest in the fine appearance of honey, and marvel at the instinct of the bees, we are now having daily visits from scientific gentlemen eager for the more substantial and practical knowledge of apiculture. One professor of agriculture, of an agricultural college in one of our Southern States, contemplates the teaching of apiculture as a part of the course, just as it has been taught for many years at the Michigan Agricultural College, and was therefore greatly interested. One Pan-American commissioner of a South-American Republic is seeking knowledge as to whether bees would be likely to do well on the tablelands in equatorial South America, and when, in the course of our conversation, I learned that bees were practically unknown in his country, and that alfalfa was very extensively and generally grown there, it created that longing for "pastures new" that so many apianists have experienced in these recent years of failure of the honey crops. Another scientific gentleman and extensive fruit-grower, after a short discussion of the great value of bees as pollenizers of fruit-bloom, expressed a wish that he had a thousand hives of bees within reach of his 200 acres of fruit-trees.

At present New York is the only State represented in the apian exhibits of honey and bees. The show-cases in this exhibit are similar in appearance to those used for apian exhibits at the Columbian Exposition. All the cases are 10 feet high from the floor, and about 2½ feet wide by 7 feet high, inside measure. The space allotted to New York is approximately 16½ feet deep by 39 feet front. On the west end of this space is a case approximately 2½ ft. by 11½ ft., and set at right angles with the front line of space, and the south end of case on the front line, leaving a spacious passageway between its north end and the wall. A large case about 2½ by 23 feet rests with its outer edge on the long dimension of the space next to the main passageway, with its west end about 5½ ft. from the first mentioned case. A third case of the same dimensions as the first mentioned is placed at right angles with the front line and on the east end of space, leaving a space of about 5½ feet between the east end of the second mentioned case and the west side of the third case. A fourth case, about 4½ by 11½ feet, is built against the wall, covering a large window, the glass of which have been removed. This case is built at right angles with the third-mentioned case, and its east end about 2½ feet from the west and north corner thereof. In this space, and between the north end of the third-mentioned case, is constructed a small locker for the storage of supplies for the exhibit. Thus the entire

space is enclosed, making a spacious booth with a passageway at either end opening into the main passage, and another spacious passageway between the wall and the first-mentioned case opening into the exhibit of The A. I. Root Co. and that of The W. T. Falconer Mfg. Co.

The fourth-mentioned case is for the exhibit of a small apiary of bees at work in hives of various patterns, one of which is an observatory hive. This case has glass front and glass on the west end, and the hives rest on a platform about 9 inches high. The third-mentioned case has glass on the side facing the booth and the end facing the main passageway. The second-mentioned case has glass on both sides and both ends; and the first-mentioned case has glass on both ends and the side facing the booth. The back of this case also forms the background of the exhibit of The W. T. Falconer Mfg. Co., between which and the exhibit of The A. I. Root Co. is a spacious passageway opening into the main passage at the south, and into the New York booth at the north. An ornamental railing and cornice bearing the legend, "The A. I. Root Co." and "The W. T. Falconer Mfg. Co.," surmounted by three beautiful bronzed or golden imitation straw bee-hives, one at either end and one in the center, the latter marking the dividing line between the two exhibits, completes the front of this double booth. The background of the exhibit of The A. I. Root Co. is also 10 feet high, and extends from the main passageway to the wall, a distance of about 16½ feet. The combined width of these two spaces is 11½ feet.

Owing to the very general failure of the honey crop of 1900, the exhibits in this line are not what might have been expected under more favorable conditions, and there is no doubt that this failure has deterred several States from making exhibits early in the exposition. I am informed, however, that Canada and several of the States will make exhibits of the present season's honey as early as possible, and we may therefore expect a large showing of the apian interests. It is well known that there are many Canadian bee-keepers who understand well the art of exhibiting apian products. In fact, I believe the Ontario Bee-keepers' Association annually appoints a representative to each of their principal expositions. Buffalo being quite convenient to Canada, we may therefore expect some very handsome exhibits from that quarter.

All the apian exhibits are to be placed in the west end of the gallery of the Agricultural Building, which, when the moving stairway is in operation, will be very easy of access. This gallery makes a beautiful promenade and balcony, from which to view the collective agricultural exhibits on the main floor. Many other interesting exhibits are in this gallery.

Our white-clover harvest came to a close yesterday—owing to extreme heat and dry weather—22,500 lbs. clover. Basswood is opening, but bees so far fail to find honey in the bloom. N. E. FRANCE.
Platteville, Wis., July 1.



SWARMING, AND SECTION HONEY.

"Hello, Doolittle! Awful hot to-day. My hives are covered with bees hanging out, and I fear they are going to have a swarming-time just when basswood is at its best, as it will be in ten days now. What method do you use in order to keep the bees from swarming just when it is important to keep the hives crowded with bees in order to secure a good yield of section honey?"

"You are not the first one to ask such a question, Bro. Brown, for this is something bee-keepers have been asking during the past quarter of a century. If the apiarist has done what he could to get his hives full of brood at the proper time, he will have lots of bees in time for the honey harvest—hives overflowing with bees, as you say yours are now; and in order to be successful with them, all swarming should be done before the height of the season arrives."

"But I supposed you did not allow your bees to swarm, for, I am told, no large amount of section honey can be obtained if we let our bees swarm."

"In this you err, for the swarm and parent colony, if rightly managed, will do fully as much with the average bee-keeper, when just one swarm is allowed to issue, as could be gotten were they not allowed to swarm; and, besides, if we tried to keep them together by cutting out queen-cells, giving extra section room, etc., we would, as a rule, only delay swarming, so it would come during the last half of the honey harvest, when it would be the most detrimental to our interests."

"But is there no such thing as non-swarming hives, used when working for section honey?"

"Whenever I hear men talking about non-swarming hives in connection with raising section honey I feel quite a little like doubting their practical experience as apiarists."

"Well, what is *your* method, if you do not use non-swarming hives, and let your bees swarm at will?"

"All my early swarms are hived singly in a hive having but five frames in them, containing a starter of comb foundation about half an inch deep, and the sections are put on at time of hiving, as five frames give hardly room enough for a large prime swarm."

"What do you mean by those coming early?"

"Such as come out from ten to fifteen days before the main honey harvest, which, in this locality, is generally from basswood."

"And do all of your colonies obey and swarm during those five or six days?"

"No; I do not have all swarms come out just as I might wish, but I have a different plan of management for those that come later, say from five to eight days before the harvest. These later ones are united, so that two are

put in a hive filled with combs, the section boxes being set from one of the old colonies on the hive containing the united swarms. Then this old colony is set on a new stand, and the hive containing the two swarms put in its place, thus giving all the field bees from this colony, in addition to the two swarms, which makes a colony which will do wonderful work during the honey harvest, a colony from which I take 100, 150, and even 200 one pound sections of the choicest of honey, according as the season proves."

"But what about the queens? Do you let both go in with the doubled swarms?"

"No. The queens having their wings clipped gives me the power of disposing of them as I think best, and so I let the queen go back with the colony which was moved to a new stand, and allow the one from the colony not moved to go with the united swarms. The moved colony losing not only the swarm, but also all of its field bees, feels so poor that the queen-cells are torn down, and all idea of swarming is given up; but this colony soon picks up from the multitudinous emerging brood, so that often it will do quite good work in the sections."

"But will not there be after-swarms from the other parent colony?"

"The hive furnishing the queen for the doubled swarms is not disturbed in eight days, at which time the first young queen will have emerged from her cell, when the hive should be opened and all queen-cells destroyed, which will entirely prevent any attempt at second or after-swarming."

"But if all have not swarmed up to within a day or two of the opening of the harvest, what do you do with them—keep on uniting two swarms together?"

"No. All that have not swarmed at the commencement of the honey harvest are made to swarm in this manner: A hive is filled with frames of empty combs, or those partially or wholly full of honey, and placed upon the stand of one of the colonies which has not swarmed, and all the sections are taken off and placed thereon; then all the bees are shaken and brushed off their combs of brood and honey in front of this prepared hive. Thus we have the queen, bees, partly filled sections, etc., which make a colony ready for business at once. Previous to this a few nuclei should have been started, so that we may have the needed laying queens to use. Now take all the combs from which the bees were brushed except one, and arrange them in the hive, carrying it to the stand of another colony which has not swarmed. Next take the comb of brood which was left out, and go to a nucleus, taking out the frame having the laying queen on it, and put the comb of brood in its place. Take the frame (bees, queen, and all) and set it in the place left vacant for it when arranging the combs of brood. Put on the sections, and when all is complete move the colony, not having swarmed, to a new stand and set the prepared hive in its place. Thus we have a laying queen and enough of her own bees to protect her, combs full of brood, and all of the field or old bees

from the removed colony, which makes a colony that is ready to go into the sections in a very few days. The removed colony has simply lost the old or field bees, so as to stop the swarming impulse, and in a week will be ready for work in the sections again."

"That sounds good, and I believe I will try some of my colonies that way. But don't you think non-swarming would be desirable under any circumstances?"

"Yes, I certainly do, especially for out-apiaries. We have many of our best bee-keepers at work in the matter, and I fully expect that, before the year 1925 shall be ushered in, something of universal value will have been brought out for the benefit of the fraternity. But the above is as good as any thing in sight at present for the home apiary, such as yours. But I hear Mrs. D. calling me, and I was to help her a little while."



STAYING FOUNDATION WITH WOOD SPLINTS;
THE PLAN A SUCCESS; HOW TO USE THE
SPLINTS.

Noting your editorial footnote in regard to wood splints, as advanced in *Stray Straws* by Dr. Miller, I beg to say that I have used splints with best results to a considerable extent. These splints need not be waxed, as the queens lay in the same regular manner on the splints in the bottom of cells as on either side of the splints in adjacent cells. I used splints sawn from cottonwood lumber; but some material of harder texture may be more suitable. These splints were $\frac{3}{8}$ by $\frac{1}{16}$, and $\frac{1}{4}$ inch longer than the inside depth of the frames. A saw-kerf is required in both top and bottom bars for the insertion of the ends of the splints. These should be $\frac{1}{8}$ deep. No fastening is required if the sheets of foundation touch the top-bars the entire length. Otherwise the foundation bulges from the weight of a new swarm, and irregular, wavy combs are the result. Seven splints will answer to the frame with medium brood foundation; for light brood, 8 splints would probably be required. With foundation wired from the mill, the foundation would still have to be attached to the frames; with the splints, the foundation is put in the frames, and securely stayed at the one operation. I could put in frames from 100 to 125 sheets per hour, with the splints, and I never have seen more perfect combs, all things considered. They stand extracting remarkably well. No cracks appear in the combs from this strain, as with horizontal wiring. I wrote you a few years ago about this matter, and again am prepared to say that you can advocate the general adoption of wood splints for foundation brood-combs, without hesitation as to their giving any dissatisfaction.

In putting in the splints, a board of suitable

thickness is placed inside the frame. Put 4 splints in place, then lay on the sheets of foundation; then put the other splints in place and roll them down with moderate pressure. Turn the frame and roll down the first splints; and this completes the job. Why not get out a few of these splints, and give them a trial? I am convinced that they will meet with your approval. B. F. AVERILL.

Howardsville, Va., Apr. 9.

[I believe the use of wooden splints is all right; and for some bee keepers it may be the very best method of staying up foundation. Personally, we here at the Home of the Honey-bees prefer horizontal wires—wires fastened to the end-bars of the frames.—ED.]

HOW BEES USE THEIR TONGUES IN SIPPING
UP HONEY; THE ALLEGED BIAS OF
THE EDITOR.

After reading the discussion of long tongues, beginning on page 476, I began trying to think of some reason why bees with long tongues would be better on other flowers than red clover. Wishing to observe closely just how bees use their tongues, I took some honey in a bottle, and a small piece of board, and went out into the apiary. In the first place I put some large drops of honey on the board, and presented it to the bees. It took only a minute to see that they always inserted the tongue into the drop about one-third its length. The honey was then spread out on the board as thin as I could spread it with my finger. In sipping this, the bees doubled the tongue back about the same distance that they inserted it in the drops in the first instance. When the honey was nearly all taken up, so that the board was only wet with it, they doubled their tongues back still further. From those observations it seems to me that the bees can take honey faster, at least, with the tongue bent backward at some distance from the tip, and I believe they would have much difficulty in getting honey if it could be reached only with the extreme tip of the tongue. The tongue is brush-like at the tip, and honey could rise on it only by capillary attraction, not at all by suction. Of course, we can not see how the tongue is used in a flower-tube, but it is quite probable that it is used the same as on a flat surface. If this be the case, a long-tongued bee could gather a load in much less time, even on white clover, than a short-tongued one; for the tenth part of a second saved on each floweret would enable it to get its load in 30 per cent less time, which would mean 30 per cent more honey.

In regard to the bias of the editor, alleged by Mr. Doolittle, in looking over *GLEANINGS* for the last year I have been unable to find an instance where the case was not stated with perfect fairness. The editor undoubtedly knows (what every one should know) that the best way to convince an opponent is to show a friendly consideration for the evidence on the other side.

C. F. BENDER.

Newman, Ill.

[The microscope shows that the bee's tongue is made up of a series of compound tubes.

There is one very small one that reaches clear to the end of the tongue; but this tube is so minute that the process of taking honey through it is very slow. But your point, that bees bend the tongues when taking honey rapidly, is true, and therefore long tongues would be an advantage, even with white clover.—ED.]

SHORTER STINGS V. LONGER TONGUES.

So much has been said recently about long-tongued queens that I feel that there is another "burning" question that should be brought, more or less, before the public; viz., produce bees with short stings. Every time I get this "pointer" I come to the hasty conclusion that the barbed-wire injector is about two feet long. That's an objectionable "point," eh? It is indeed an "intricate point" to overcome; but she (the workers) should have more tongue and less sting. I'm not pugnaciously inclined, as I would not walk across the street to witness a so-called prize-fight; but I might believe in the plan to catch the drones and attach eight-ounce gloves to their fore hoofs so that, during the virgin's flight, she would be so frightened by the "sporty" costume of her male attendant that her offspring would be birth-marked, and known thereafter as "boxer" bees. If some inventive genius can not find a means to "curtail" this "intricate point," why, I will think seriously of running opposition to our hot-air and steam-heater establishments. What is the use of going to the expense of purchasing coal to heat our dwellings when you can run an apiary to supply the heat? If it's extremely cold weather, apply three bees to your anatomy; milder weather, one would be quite sufficient. I'm with the queen-breeder who can give more attention to the rear end. These rear-end collisions are becoming entirely too numerous.

Cranford, N. J., May 9.

RESNAW.

HOW LONG WILL A QUEEN LIVE AND DO GOOD WORK?

In going over a yard recently bought, the other day, clipping the queens, I found one already clipped. The man who is working the yard said he knew there had never been a queen clipped in that yard, and could account for it in only one way. This particular hive, with others of the same kind, had been bought and brought from a distance, six years ago, and this queen must have come from that yard. If F. McNay sees this article I wish he would answer it, as this queen was found in his old Mauston yard, in a hive with oak top-bars. The queen had a fine lot of brood.

Bees in this locality are building up finely.

C. H. PIERCE.

Kilbourn, Wis., May 18, 1901.

[I saw Mr. McNay at Los Angeles, and it is his practice to have young queens. Mr. McNay is a very successful bee-man, and one of his secrets of success is in having young queens. I hope if he sees this he will give us the further history of that old queen if he can.—ED.]

"BAIT SECTIONS;" DIFFERENCE IN EXPERIENCE.

Dr. Miller wonders what makes the difference between my experience and his in using bait sections (p. 379, May 1st). I believe he hints at the reason himself in the last three lines of his Straw. I think likely that, in a slow or short honey-flow, the baits would be sealed as he says. Our honey-flow always comes with a rush, as thousands of acres of alfalfa come into bloom at about the same time. The bees pile the ready-made combs full of thin honey; and the sections being thick the honey does not ripen as fast as that stored as the comb is built, so they just take their time about sealing it, and we often find sections left until the end of the season. I think this is probably another case of "locality."

MRS. A. J. BARBER.

Mancos, Col., May 10, 1901.

[When Mrs. Barber speaks of locality she hits the nail on the head. As I travel over the country I am more and more impressed with the differences in locality.—ED.]

PIGS, WHEELBARROWS, AND QUEENS.

In GLEANINGS and elsewhere, after an offer of queens at exceptionally high prices, are to be found the following words:

It seems as if it ought not to be necessary to say that no one but a queen-breeder or a large honey-producer should order these high-priced queens; but it is a fact according to our experience that beginners with only a few colonies will order our highest-priced imported queens. Such bee-keepers have no more use for such queens than a pig has for a wheelbarrow.

I never was a pig, so I may not be a competent judge as to the yearnings that animal may have for a wheelbarrow; but I have been a beginner in bee-keeping, and I am not so far from being one now that I can be satisfied to read those words without entering a protest. I am not going to uphold the idea of gouging the queen-breeder or the large honey-producer by making him pay \$25 for a thing as little as a queen-bee, but I do protest that we beginners are not away off in trying to get the best that is to be had. "Beginners with only a few colonies will order our highest-priced imported queens," forsooth. Why shouldn't they? Any scrub stock will do for the beginner with five or six colonies, and then when he gets up to 50 or 100 he should get a best imported queen and have a time working out all his poor stock. Please tell us why it would not be the wise thing to begin with the best and have the best all the time. Wouldn't it be a good deal easier to change the stock with five colonies than with fifty?

Perhaps you will say, "But not every beginner with five colonies increases to fifty. Wait till you know that he will have enough to make it worth while. It may be that he will be satisfied not to go beyond the five colonies." Well, suppose he should never go beyond five. Let us figure a little to determine what he might afford for those five. If he is in an average locality, with only five colonies, and those no better stock than beginners usually have, it would be nothing strange that a change to best imported Italians would in-

crease the harvest of each colony a sufficient number of pounds to amount to one dollar a year. That would be \$5.00 a year; and if he should continue only two years in the business it would be \$10.00. That would pay for a best imported Italian queen, and leave a remainder of \$3.00 to \$5.50. Look at it another way. Suppose a beginner with five colonies pays \$7.00 for a best imported queen. He might be allowed at least three years in which his increased harvest should pay for the queen. That would be \$2.33 a year, or 47 cents a year for each colony. Do you think it would be difficult to reach that increase? Please stop throwing pigs and wheelbarrows as stumbling-blocks in the way of beginners.

Marengo, Ill. C. C. MILLER.

[I still think my advice is good; but you make one good point when you say it is cheaper to start out with good stock than to get it after the apiary assumes some size. Agreed; but I would still advise the beginner not to get an imported or a high-priced breeder until he has acquired some experience. Let him get good stock by all means; but get untested from some fine breeding-queen. These untested are cheap, and may develop to be as good as the breeder.

Say—you are no spring chicken in the business.—ED.]

BEARS IN THE APIARY.

For the past three weeks I have been bothered a great deal by bears in one of my out-apiaries. They have caused me considerable loss in honey, bees, and hives. I lost five colonies entirely, and a good deal of honey from other colonies; but the trouble and expense of watching and protecting the apiary, and at the same time getting rid of the bear, has been the greatest loss. On the night of the 11th I succeeded in wounding one measuring 6 feet 7 inches from tip to tip; so that, on the 12th, I was able to capture him; and on the night of the 19th I was fortunate in killing one measuring 7 feet 11 inches from tip to tip, which I trust will close the chapter for the present.

W. O. VICTOR.

Wharton, Texas, June 21, 1901.

THE BONNEY METHOD OF INTRODUCING QUEENS.

J. H. Martin says, on page 80, that he would like to ask Mr. Bonney or any one using his method of introducing queens if he ever had any trouble from the queen killing the bees. In answer I would say that I never have had any such trouble, nor have I ever seen a queen kill workers but in a single instance. Then a virgin queen stung four workers to death in quick succession when the comb which she was on was lifted from the hive. I consider this a freak, as I have never seen any thing like it in all my experience.

I judge from Mr. Martin's statement, that he placed the queen in the cage and then put in the bees one at a time. A queen might possibly attack a single strange bee, but I am inclined to think it would be more of a freak than a regular occurrence. Mr. Pridgen tells

us he sometimes puts in the bees one at a time, and I have done so myself, and there was no quarreling; but I prefer to cage quite a number of bees until they have a sense of loneliness and queenlessness, then place the queen among them, and in no case has the queen or worker shown any disposition to harm the other. I have never lost a queen by this method, and I regard it as the safest of any plan I know unless it is Mr. Alley's method of tobacco smoke, which is, perhaps, equally sure; but I like my plan best, as the bees do not have to remain queenless so long, and there is less danger from robbing; besides, some do not like the smell of tobacco smoke, and I do not like to handle it myself. I hope Martin the Rambler will give this method a thorough test, and let us hear his echo on the subject, through GLEANINGS.

C. T. BONNEY.

BIRDS KILLING BEES IN FLORIDA.

In this part of Florida bee-keepers are just recovering from a severe loss of bees. The late storm in April brought thousands of birds which were never known in this portion of Florida before. They were the most destructive bee-enemy ever known here. They would alight on the hives and catch every bee that came out. If a bee chanced to escape to the fields they would capture it. We killed the birds by hundreds. They now have emigrated to parts unknown. The birds were something like our Northern cherry-birds—male, red collar, but no tuft on top of head; female, yellow breast, brown wings.

W. T. MUNDT.

Pt. Washington, Fla., May 10.

BETA NAPHTHOL VS. SALICYLIC ACID.

Last spring I fed salicylic acid, but foul brood appeared again in the fall. This spring I sprayed the empty brood-combs with a solution of beta naphthol, using a Faultless sprayer, and also used the same drug to medicate syrup fed. I also kept a piece of naphthaline in each hive, on the back of the bottom-board. My hives under this treatment are practically free from foul brood. See Cowan's "British Bee-keeper's Guide."

HIVES FOR NEW ZEALAND.

Although an eight-frame Langstroth hive in the hands of a practical bee-keeper is good, yet in a climate like that of New Zealand, where bees fly all the year round, and we frequently have rough weather in the spring, I am inclined to think that the ten-frame Jumbo would be more suitable here, as it holds more stores, and consequently requires less attention. My experience with bees hived in kerosene-boxes, which are about 14 inches deep and 9×18, is that they make 9 or 10 inches of brood and 3 or 4 of sealed honey above; hence I believe the Jumbo frame more nearly meets the natural requirements of the bees than the Langstroth depth, and the queens would rarely lay in the Dadant shallow extracting-supers above the Jumbo brood-nest.

CHARLES F. ENGLAND.

Foxton, N. Z., Feb. 4.



NATIONAL BEE-KEEPERS' ASSOCIATION.

OBJECT:—To promote and protect the interests of its members; to prevent the adulteration of honey.

OFFICERS:—E. R. Root, President, Medina, O.; R. C. Aikin Vice-president, Loveland, Col.; Dr. A. B. Mason, Secretary, 3512 Monroe St., Sta. E, Toledo, O.; Eugene Secor, General Manager, Forest City, Iowa.

BOARD OF DIRECTORS:—E. Whitcomb, Friend, Neb.; W. Z. Hutchinson, Flint, Mich.; A. I. Root, Medina, O.; E. T. Abbott, St. Joseph, Mo.; P. H. Elwood, Starkville, N. Y.; E. R. Root, Medina, O.; T. G. Newman, San Francisco, Cal.; G. M. Doolittle, Borodino, N. Y.; W. F. Marks, Chapinville, N. Y.; J. M. Hambaugh, Escondido, Cal.; C. P. Dadtan, Hamilton, Ill.; C. C. Miller, Marengo, Ill.

FEES:—Annual membership fee, \$1.00. Remittances may be sent here or to General Manager as above.

It is not true that alfalfa honey is always light. In some localities it is a light amber, and in others it is next thing to water-white. But the flavor, so far as I can find, is always good.

HUTCHINSON is right in preaching "more bees." I find in my travels that the most successful bee-keepers—those who make money—are those who run from 500 to 1000 colonies, and some of them make more clean cash than the ranch and fruit men with ten times the investment.

MY LONG TRIP.

By the time this journal reaches our Western readers my trip of some five or six thousand miles on the cars, and some three or four hundred more in a buggy, will be near the end. My note-book and cameras have been kept busy; and as the months go by I'll try to tell you what I have seen and learned.

I find it hard work writing copy on the cars, and trying to edit a bee-journal at long range, even with so good a veteran as A. I. R. at home to read proof and splice out the gaps. Editor Hill has my sincere sympathy.

PRICES ON CALIFORNIA SAGE HONEY.

SOUTHERN CALIFORNIA will not have the big crop that was expected earlier in the season. The rain fell short at just the critical time. But some of the buyers and commission merchants are trying to cram the idea into bee-keepers that the yield has "been tremendous," and, in consequence, are making low offerings. A few who need ready money may have to take advantage of the low market; but I am satisfied that prices will advance a little later, as soon as some small lots are sold. But I know of some large lots that will be held till better prices are obtained.

THE FUTURE OF IDAHO AS A BEE COUNTRY.

ONE of the paradises of bee-keeping to be in the State of Idaho. I have just passed through thousands and thousands of acres of white clover, red clover, and alfalfa, and yet no bees in sight. Thousands of acres of alfalfa are to be opened up as soon as irrigation is extended. I don't mean to say that there are

no bees in Idaho, for there are a good many, but not nearly what the State will support if what I can see and learn is correct. But no one should locate in Idaho, or anywhere else, until he has investigated for himself, and made a preliminary advance trip; and no one should even then think of going on to the bee-range of some other person already located.

THE FOURTH OF JULY AT THE HOME OF THE HONEY-BEES.

THE machinery is still, and everybody has gone except two or three of the faithful ones. Mr. Wardell is in the apiary, and has been almost ever since daylight. He rather wanted some help, but nobody wanted to help on the Fourth. Basswood is in full bloom, and honey is coming in with a rush. Every empty comb on the premises has been gathered up, and, later, every frame containing sheets of foundation, and yet some of the bees are building combs back of the division-board. "Robert" promises to have plenty of sheets of foundation in the frames bright and early to-morrow morning, but he did not want to tackle the work on Independence day.

Well, we are glad that honey has finally come. There is not any more need of feeding at present. Each one of the 540 colonies and nuclei is filling its combs, and the bees all seem to be happy.—A. I. R.

BEEES AS FERTILIZERS.

IN our intercourse with the farming class we not infrequently meet people who are almost if not quite hostile to the bee-keeper. They seem to think the bee-keepers' bees have no business trespassing on some one else's land, etc. Many of these people can not be reached through the agricultural press, for they do not read agricultural papers. Some of them, of course, could, and the more professional apicultural writers should, write from time to time suitable articles for these papers. It should be the bee-keepers' business to furnish their local newspapers with such articles, and thus all classes could be reached.

While it can not always be positively proven that honey-bees are important factors in bringing about fertilization of blossoms, yet we do know that in some instances they help materially. If they are a help in some cases, they at least should stand above suspicion of doing harm in other instances.

We know of many fruit-trees—cherry, apple, and pear—standing in the midst of large apiaries, bearing fruit abundantly from year to year. If these trees can fruit under such conditions it certainly can not be said that bees are doing them injury; and if they do not injure the fruit-bloom it is not likely they will other bloom—for instance, the buckwheat.

A neighbor of one of our friends in New York expressed his fear that the bees might injure his buckwheat if he should sow it next to the apiary. It took a great deal of arguing to convince him that there was no such danger.

Honey-bees are by no means the only in-

sects visiting blossoms for the purpose of obtaining honey and pollen. Let us observe once how many different bees and insects visit the sunflower. It would seem that all the pollen and nectar this flower produces would be carried away. Yet every single floweret becomes fertilized, and seeds form with the greatest regularity.

The honey or nectar the blossoms secrete is of no direct use to them—they do not need it for their development. If it were necessary, many plants would have become extinct long ago. For what other reason would a plant continue to produce this nectar year after year if it were not for the very purpose of drawing insects? These and other points may be brought out by the bee-keeper in his local paper to good advantage.

Our friend W. F. Marks, one of the Directors of the National B. K. A., has the following advice to offer in the line above mentioned: "Owing to the hostility or prejudice against bees in many localities, bee-keepers as a class should be urged to step forward and take an active part in the various agricultural, fruit-growing, and kindred organizations when possible to do so. In so doing they can quietly but surely bring about a change for the general good of their pursuit—a matter that should not be neglected or ignored. This need in no way interfere with their duties in and for the bee-keepers' organizations. To this we can only say amen.—F. G.

"BUSY" BEES AND LAZY BEES.

An old veteran bee-keeper from an adjoining county is just here. He is very much put out because of 15 queens he bought of a noted queen-breeder. He says they are "no good," and thinks he has been swindled. When I asked him if they did not keep their hives full of bees he said, "Yes, too full." He says they just keep raising brood all the while. Now, the question is, "What *more* does anybody want of a queen?" But his complaint is this: These hives full of bees do not gather any honey of any account; while another colony, whose queen is a daughter of our celebrated clover queen, rolls the honey right in. Now, may be you think we ought to be satisfied with such a testimonial for our stock; but I am not satisfied. I may be after a while, but I am not yet. I can hardly think that one colony overflowing with bees will not get honey, while another, equally or less populous, does get honey. This is a thing we are trying to settle; but I believe we are all more or less in the dark in regard to it. We can tell how many eggs one hen lays compared with another, and I hope our experiment stations or somebody else can soon tell us whether 40,000 bees in one hive gather more honey than 40,000 bees in another hive. The 15 queens mentioned came from one of our most reliable breeders, and one who has also a queen producing bees with tongues of extra length, the daughter of our clover queen. I think our friend may change his mind if he waits till a little later in the season. Mr. Wardell says he does not expect our high-

priced queen to show much difference in honey-gathering till later in the season, about the time of red-clover bloom. Of course, we are drawing on her brood heavily, and shall be doing so all through the season, so she probably will not have as many bees as some of our other colonies.—A. I. R.

QUEEN-BREEDERS WHO CAN NOT AFFORD TIME AND MONEY TO WRITE A POSTAL CARD.

THE following appears in the middle of a pleasant letter from a subscriber down in Texas. It was not intended for print, but I think it ought to be printed. I have thought best to withhold the name of the writer, at least for the present:

I ordered some queens from a certain breeder who, by the way, is an advertiser in GLEANINGS, and now nearly two months have passed and no queens have shown up, though I have written him twice. I wrote him the other day to return the money, and can't hear a word. If he doesn't do something I will give you his name soon. He may be sick, or something else bad; but he certainly could let me hear from him some way—drop me a card with the one word "Rheumatism," as one other one did, and I should be better satisfied. But I will await further results and developments.

Ladonia, Texas, July 2, 1901.

Some may urge that perhaps this queen-breeder did not get the money. Of course, the writer does not say he acknowledges having received the money; but he does refuse to answer inquiries. Now, the man who wrote the single word "rheumatism" on a postal card did a little better; but even that is not good business. Whoever advertises any thing in any periodical, should, before he sends the advertisement, provide himself with postal cards and other stationery (perhaps something partly printed to save time), and then he should get some sort of acknowledgment back by the very first mail whenever he receives money. If he can send a queen by next mail I suppose there is not any particular need of writing even a postal card; but if there is going to be a delay, let the customer know at once just about how much delay so he can make his plans accordingly. If, later on, he finds there must be still more delay, write another postal. When you have received money for queens, you are in a measure responsible for every day that passes without sending the queen, and should be, so to speak, "on your good behavior." You are indebted to the customer who sent you the money, and you are under special obligations to be courteous and pleasant, not only because it is manly and Christianlike to do so, but because *your bread and butter* depends on it.

Now, if there is anybody who advertises in this journal, who can not afford a postal card to acknowledge the receipt of money, and another one to explain why delays occur, we do not want his advertisement. The single word "rheumatism," it is true, may be better than nothing, but it is hardly enough—that is, if you have got somebody's money, and are keeping him waiting.

Our friend in the above speaks about asking to have the money returned. Any man who makes any pretensions to being honorable and

square in deal will, of course, return the money the very day he receives orders to do so. Of course, everybody who is complained of should have a hearing; but it will do us all good to have these loose ways of doing business held up before the people. If nothing else will answer, we are ready to do some advertising that we do not get any pay for. If there are any more "Luptoms" among our number we wish to weed them out before they get a going very much.—A. I. R.

THE BEE AND FRUIT CASE AT HANFORD, CAL.; DO BEES SPREAD PEAR-BLIGHT?

AS announced in our last issue, trouble has been brewing for some months between the fruit-men on the one side and the bee-men on the other at Hanford, in the San Joaquin Valley, Cal. On the part of the first-named, the contention was that the bees, the property of the other parties, were the principal means of spreading the pear-blight, which had been working such awful havoc among the pear orchards in the vicinity mentioned. The bee-men, on the other hand, took the ground that their stock were not carrying the pear-blight; and, even assuming that they might do so, averred that other insects, and birds, as well as the wind, might and could do all the mischief laid to the door of the bees, and that, therefore, the removal of the insects under the direct control of man would not afford the relief sought. The contention waxed warm. Each side called special meetings to discuss the matter. Bitter words as well as threats were used. Some of the more rabid of the fruit-men proposed to use poison to exterminate the bees in case they were not speedily removed by their owners. This only tended to aggravate matters. The bee-men retorted that, if any one were foolish enough to resort to such a procedure, not only killing the bees but endangering the lives of human beings, they would meet them on the issue half way; that they had, as backing, the National Bee-keepers' Association, which had hundreds of dollars to its credit, had fought many cases in court, and had always been successful; that, moreover, it had decisions already on the question of poisoning bees, and that the fruit-men "could drive ahead" if they wished to. The latter maintained that they "had looked up the law," and that they knew what they were about.

It appears that those who indulged the most freely in this war of words were not those who had the largest interests at stake, either in the bees or in the pears; that the large pear-growers as well as the largest bee-keepers were men who indulged in no threats, but who believed that a compromise might be effected between neighbors who were men of fairness as well as men who are willing to listen to reason, and so the sequel proved.

The president of the National Bee-keepers' Association was asked by resident members to make a visit to the scene of the impending trouble; investigate, and take such action as might, after a conference, seem most advisable. Accordingly, on the 18th of June that

officer appeared at Hanford, Cal., being dropped, as it were, into that "nest of hornets" by the redoubtable John H. Martin (Rambler), and J. C. McCubbin, of Reedley, who came with him officially and unofficially to see that no harm was done him; but, be it said, they deemed it advisable to go home that same day, although they did participate in one or two little "skirmishes" on the street. Unfortunately the Rambler didn't have along his invincible umbrella and stovepipe hat; for with such offensive and defensive weapons he would surely have come off victorious. As it was, it was a "draw," and he departed with John C. under his arm.

It appears that the local members of the Association had made a great handle of the coming of the President of the National; of the strength of our organization, how it had never lost a case in court, and that it had secured valuable decisions from the high courts. But as he did not come at the time expected, and days went by, and still he did not come, the fruit-men began to think that this talk was all "bluff;" and when he did appear, there seemed to be a feeling on their part that he had come, not to bring peace, but war, and that an organization that would send a "walking delegate" clear from Ohio surely meant business. After a little sparring on both sides, a truce and a compromise began to be talked of. On our side was a special committee appointed by the Central California Bee-keepers' Association, at its last meeting, to meet the representative of the National Bee-keepers' Association; and on the other was N. W. Motheral, Horticultural Commissioner, of Hanford, Cal., who seemed to represent the fruit-men, but whom some jokingly said was the mother of the whole trouble.

When both sides got together it was suggested by one of the fruit-men that, as a compromise, the bees be moved from the vicinity of the pear-trees during the time they were in bloom, and that, after they were out of bloom, and when the alfalfa began to yield nectar, they be returned to take the heavy or main crop. This, it was thought, would give the bee-men time to investigate for themselves, and if, after investigation, it was shown that the claims of the fruit-men were well grounded, afford in the mean time the necessary relief. This was finally agreed to, although it would entail a big expense on the bee-men.

It may be wondered why the latter were willing to listen to a compromise at all. In the first place, they desired to be fair; and in the second place, the fruit-men had the testimony of Prof. M. B. Waite, Assistant Chief of the Division of Vegetable Physiology and Pathology at Washington, D. C. This official takes the position that bees do carry the microbes of pear-blight from flower to flower while the trees are in bloom. In this opinion he appears to be supported by Prof. N. B. Pierce, Pathologist of the Pacific Coast Laboratory, Santa Ana, Cal.

The following letter, directed to N. W. Motheral, Commissioner of Horticulture at Hanford, Cal., from Prof. Pierce, explains the position of the scientists, in a nutshell:

Mr. N. W. Motheral, Horticultural Commissioner, Hanford, California.

Dear Sir:—In fulfillment of my former letter, and in reply to your request, I herewith give the main facts upon which are based the claim that bees take an active part in spreading the disease of trees variously known as pear-blight, twig-blight, fire-blight, etc.

1. Pear-blight is a bacterial disease which affects pear, apple, crabapple, quince, and related trees. It is induced through the action of a specific microorganism belonging to the bacteria, and known as *Bacillus amylovorus* (Burrill), de Toni.

These facts have been demonstrated by many scientific workers by careful inoculation, experiments conducted with pure cultures of the bacillus. The cause of the disease has therefore been well known for many years.

2. The identity of the blight of pear-trees in the Clow and Taylor orchards near Hanford (these particular orchards are cited only for the sake of accuracy, as there are many others affected) with true eastern pear-blight has been demonstrated at this laboratory. *Bacillus amylovorus* was isolated in pure culture by the plate process from blighted branches from Mr. Clow's trees, and a young and thrifty pear-tree was inoculated, and died to within a few inches of the ground of true pear-blight. A control tree treated the same way as the inoculated tree, except that the bacillus was not introduced, remained perfectly healthy.

Mr. M. B. Waite, Assistant Chief of this Division of the Department, has kindly supplied the following additional facts bearing on this matter:

3. "The occurrence of the blight on the blossoms in great quantities, and the great rapidity with which the disease spreads from flower to flower, indicates a normal and very effective method of distribution."

4. "The germs were found growing freely in the nectar of the blossoms."

5. "Bees were seen repeatedly visiting the infected flowers, and some were caught taking infected nectar, and, by means of plate cultures, the pear-blight germs were isolated from their mouth parts."

6. "By covering parts of the trees with sacks of various kinds of material, and then artificially infecting certain flowers on the tree, the blight was observed to spread very freely over the uninfected and uncovered blossoms, but was entirely absent in the blossoms covered by mosquito netting."

7. "Blossoms were infected, and at once covered with sacks, and the blight, in such cases, was retained in the infected blossoms."

8. "Pear-blight germs died very soon after being dried up, and lived for only a brief period on exposure to weather conditions out of doors, hence they can not live in dust, and be blown around to any great extent by the wind."

9. "Pear-blight virus, particularly that which occurs on blossoms, is a very sticky substance, and is readily carried by insects, birds, or other animals, but can not be blown by the wind."

This brief presentation will, I believe, furnish your board with the main facts needed to show the connection existing between the visits of bees to pear-flowers and the spread of pear-blight.

Sincerely yours,
APRIL 23, 1901.

NEWTON B. PIERCE,
Pathologist in Charge.

Prof. Pierce happened to be in the city at the time, and in an interview which we had with him he gave utterance to substantially the statements as are given above. If any thing, his verbal statement incriminating the bees was even stronger. So far as I could judge, he seemed to be a competent scientist, and a fair-minded gentleman; but, unconsciously, he is prejudiced, I think, in favor of the pear-men, with whom he has come much in contact of late. I asked him if it were not true that wild bees, insects, and birds, over which man has no control, could do all the mischief ascribed to the bees. He admitted that this was possible but not probable. Did he not think that bees were valuable as fertilizers of the blossoms, especially of those of the Bartlett pear? He thought they were. Well, did not this service of the bee, year in

and year out, more than counterbalance the alleged mischief done by them in the occasional year when pear-blight was so prevalent? He could not say, although he was of the opinion that, by a certain alteration of varieties, the services of the bee might be dispensed with entirely; but of this he was not sure.

From Prof. Waite's statement it would appear (to express it in common parlance) that the bees have been caught "red-handed," bearing the marks of the alleged criminal act. If I understood Prof. Pierce he had not found the bacteria of pear-blight on the tongues of the bees, nor had he himself seen the microbes in the nectar. If this be true, we have, as the only real incriminating chain of evidence, the statement of Prof. Waite. Without detracting in the least from the skill of the professor, it is proper to remark that even the best of scientific men make mistakes, and we as bee keepers can not accept the unsupported statement of Prof. Waite without further investigation by some of our men equally competent and fair.

This is a nice question, as a lawyer would say, and we need to go at it carefully and candidly to get at the truth, cut where it may.

There is some evidence that goes to show that Prof. Waite is mistaken. For instance, there are young pear-trees, acres and acres of them, that have never been in bloom, and yet these young trees are blighted to death. How in the name of reason did the bees carry blight to these trees when it is apparent that they never went near them? And then there are little shoots that have pushed up from the ground since the big trees were in flower, and yet these shoots are blighted like the rest. Assuming, for argument's sake, that bees may carry the blight on old trees, we must admit that there is some agency, possibly the wind, Prof. Waite to the contrary, that carries the destructive microbe to the young shoots and the young trees. There are some things that are not explained yet.

Again, I believe we have the right to insist, for the present, until we have more corroborative evidence that wild bees, other insects, and birds, over which man has no control, may be able to spread the blight just as much as the bees under the control of man. For example, this illustration was used: If a barrel full of water has two plugs in it near the bottom, the larger plug, represented by the tame bees, and the other plug (the small one) by insects, birds, and wild bees, will not the small plug exhaust the barrel just as surely as the large one? If this be true the removal of the bees controlled by man would not bring the relief expected, by a long way.

In conclusion, let me say that I visited the worst-affected large pear-orchards in the vicinity of Hanford, Cal. The large pear-growers were fair, intelligent men. While they thought the bees were to blame, they also thought the pear-men had some responsibility in the matter.

I visited one orchard of 120 acres, and every tree was badly blighted, and no mistake; but in this orchard we found the badly blighted little shoots I have referred to.



Behold the Lamb of God that taketh away the sin of the world.—JOHN 1:21.

We have not a high priest that can not be touched with the feeling of our infirmities, but was in all points tempted like as we are, yet without sin.—HEB. 4:15.

More than twenty-five years ago, before I began to write or talk for Christ Jesus—yes, at a time when I knew not the Lamb of God that taketh away the sin of the world, I stood with a companion looking out into the street. Nobody was near to hear our conversation. A remark was made to me to the effect that even the poor dumb brutes and domestic animals in the street were more worthy of confidence than my own poor sinful self. They were not responsible before God and before man for their actions; but *I*, who professed to be a man, and a man of integrity, really belonged on a scale lower than that of the brutes. This was spoken in a sort of sarcasm. And, by the way, it is rather strange, but none the less true, that partners in crime sometimes speak the truth plainly. I have seen several men together in a drunken orgie, when one of them would speak out and tell the other what a beast he was making of himself by his continued intemperance; yes, and after winding up what might be considered a pretty good plain temperance lecture to the poor sot, the one who told this plain truth would finish by saying, "Now, boys, is it not true, every word I said?" When they would assent with grave-looking faces, the speaker would add, "Come, let's take another drink."

I do not mean to tell you, friends, that I was a *drinking* man at this time—at least, that was not my particular sin. When my companion uttered this plain scathing truth I bowed my head in shame, for I knew it was true. A spark of manhood, however, did prompt me to make a feeble resolution to do better, and I think I added something like this; and I said it, too, with honest, sober sadness: "If what you say is true, I think I had better turn over a new leaf right here on the spot, and be a little more of a man than I have been."

I remember I had considerable of a dogged determination in my heart just then to show my tormentor, for the time being, that I could and *would* be different in the future. At this point I received a still more cutting piece of sarcasm, and that from one who had not labored very hard in times past to make me better. The words were something like this:

"Turn over a new leaf, and do differently from what you have been doing? No, you won't. You will keep right on just as it has been for months and years past."

When I came to think it over in my sober moments, and remembered the resolutions I had made but never kept, I was forced to acknowledge there was very little probability, as things were going, that I would ever be any different or any better. May God help the

poor sinner who has lost hope because he has struggled in vain so many times to break asunder Satan's shackles. Why do I bring this thing up from so long ago? Well, I think it was a dream that reminded me of the occurrence. I was away back in the old times; but in the dream I did not bow my head in shame, in submission, and in despair. Do you know why I didn't? Because, since that time I have had more than twenty-five years' experience in breathing that little prayer I have told you of so often, "Lord, help." When my companion taunted me with the fact that I was not only away down in conscience and rectitude, but that I was helpless and *lost*, in my dream, I forgot that reference to my helpless and lost condition, and turned from my tormentor—yes, I turned from all the world with all its trials and temptations. I turned toward that "Lamb of God," as we have it in our text, and implored help. I said, "Lord, I am weak and sinful. My *record* is bad. I have made resolutions again and again; but Satan has brushed them away as if they were cobwebs. I have nothing to plead in the way of my own merit. I am a lost, helpless sinner without the help of thy strong arm. Lord, help and save."

In an instant I felt my feet planted on the solid rock. Poor and unworthy as I was, I was *not* alone. In my *dream* the wondrous truth burst upon me, of the great and inestimable privilege it is to have Christ Jesus for a friend and a helper! It seemed to me then as if nothing this world could furnish—no, not even death itself—had any terrors, for Jesus promises to be not only with us through life, but he promises to be our pilot and guide through the dark valley of death.

Those who have read GLEANINGS very long know something about this turning-point in my life. In mechanical work men often go to great expense to get something solid and substantial to tie to. When planting heavy machinery they go away down into the ground and build piles of heavy and expensive masonry, to get something solid. When erecting buildings, or any sort of structure, men look about for something solid on which to fasten their ropes. Sometimes a large tree holds a guy rope. If this tree, or whatever it is, should give way, loss of property and loss of life might ensue. Old experienced hands in building bridges and other great structures will never be satisfied unless they have something *solid* and *substantial*. During that old life I had no substantial anchor. Worst of all, I had lost confidence in undertaking to break away, because I had failed, miserably failed, every time. I did not know in that old life, that this whole wide universe offered any thing solid and secure when the poor weak human will was found to be inefficient. Yes, let me say again in my *waking* moments, as I said in my *dream*, it is a great and wonderful privilege to any human being to feel that he is permitted to reach out and grasp hold of the strong arm of Him who created the world. Nay, more than that: when there is not time, and you have not the strength to reach out, just breathe that little prayer, and He whom

even the winds and waves obeyed has promised to look after and care for you. I remember hearing of a certain old colored man who used to say, when greatly tempted, "Lord, your property is in danger." When asked how he dared pray with such assurance, he said that for many years he had belonged to the Lord, and therefore he had a *right* to consider himself the Lord's property.

Now, that dream I have alluded to might have been forgotten and passed by, but a strange thing brought it to mind. We are now having exceedingly hot and sultry weather, for to-day is July 1. Well, along with the hot weather we are getting out our easy-chairs, hammocks, cushions, etc., so that we can take rest and enjoyment in the shade. Among other things, Mrs. Root showed me a beautiful soft pillow. It is covered with silk, and on the silk is an inscription. Some good lady away off in California worked it out in fancy needlework and embroidery, and sent it to me for a present. Here are the words :

Lord, help! this is my favorite prayer
In time of trouble and of care,
I may not all the wants disclose,
But these my loving Father knows;
But help I need, and up to heaven
I lift my prayer and help is given.

You will notice I have two texts at the head of my talk. You might infer from the above that, during the twenty-five years that are past, I had triumphed very easily over every temptation. Please do not understand me so. It is true I have been ultimately delivered, and have come safely through all trials; but I have had my sore conflicts like the rest of humanity. Again and again have I exhorted others to let go of the follies and trials of this world, and turn to the Lamb of God, and yet in just a few hours afterward I have been myself, as it were, struggling in the Slough of Despond, as we have it in Pilgrim's Progress; and many times I have thought, "Well, it is a long time since Satan has had hold of me along that line. Very likely he has met with so little success that he has given up the job and concluded he can accomplish more by prowling around somewhere else;" but again and again (sometimes in just a few hours) I have found that I am a good deal the same chap that I have been all through these years. I hope I am climbing slowly away from earth, and up toward heaven. But earthly things hang to me with a strong grip, even yet. Sometimes I wonder at these conflicts and skirmishes. Yes, sometimes I am really appalled by the sin that still lurks in my own heart. Let me digress a little.

During these twenty-five years or more, I have exhorted many to turn to the Lamb of God that taketh away the sin of the world. Sometimes I have been asked to settle difficulties, and have been chosen arbitrator. I have had one recent experience. The parties are both friends of mine, and they have been for years friends to each other. They have been mutually helpful to each other, doing business in the way of buying and selling honey to the amount of hundreds if not thousands of dollars. They are both, I think, professing Christians. Of course, each was to present the

matter from his own standpoint. In the first place, they had trusted each other *too* much. Things that ought to have been down in black and white had been allowed for years to go without a settlement. We have no right to do this, any of us. After the disagreement, each questioned the other's sincerity and Christianity. I plead with both of them to consider the other as still his brother, and that they should fix the matter up and go on doing business together like two brothers. But Satan had got into their hearts (I hope both will forgive me for speaking thus plainly), and I fear I succeeded very poorly. I have seen many cases of this kind. A man goes on at great length to tell me of the inconsistency and mistakes of his neighbor. When I remind him of how many years they got along pleasantly together, my informant says, "Yes, that is true; but something has got into him lately. He did not use to be so mean and ugly."

I reply, "Yes, my friend, something *has* got into his heart. Satan has got hold of him. Are you not sorry for this neighbor of yours? Do you not pity him?"

The reply, however, is something very often like this: "No, I do not pity him a bit. I do not care how much trouble he has. I should like to punch his head this minute."

Sometimes I have tried to make peace between husband and wife. I have told you about it on these pages. I have begged and implored each of the two parties to remember the good qualities of the dear partner. I have urged each one to pray that God might loosen the hold the evil one had got on the heart of the other. Sometimes I have said, "Why, Mr. A, can you not look at this thing as you would if your wife had suffered some misfortune? or as if it were sickness that ailed her? Let us just suppose for a minute that she is unfortunate and to be pitied. Perhaps through no particular fault of her own, Satan has got into her heart. Can you not help restore her to her old self by being kind and gentle? Will you not try very hard not to fan into a flame this thing that is only just started, by any imprudent or foolish act of your own? Never mind who is right or who is wrong. Never mind if she *is* unreasonable, yes, and even exasperating. 'A soft answer turneth away wrath.' Disarm her by kindness and gentleness, and show a spirit just the very opposite from the one *she* exhibits."

Sometimes my exhortations bear good fruit; but too often the husband declares he is going to pay her back in the same coin she gives him. And then comes a separation, even after the two have brought up a family of children.

Sometimes a row is started because one man calls another one a liar. Again and again I have tried to persuade both parties that this was not an excuse for a "fight."

I have sometimes said, "Why, if he told the truth, and you *are* a liar, you ought to thank him for telling you of your faults. And then you ought to go to work right earnestly to break away from such sinful habits. If you are not a liar, denying the charge in his

present frame of mind would not convince him at all. Just quietly keep telling the truth so persistently that nobody will believe what he says."

I have sometimes *almost* wished somebody would call *me* a liar so that I could demonstrate to those around how easy a thing it is to look pleasant and smiling under such trials, rather than to strike back, or even reply by like unkind words.

I fear I was getting to be unconsciously proud of the example I was setting in respect to such things. Howard suggested to his mother that may be God punished "grandpa" for boasting. I do not know but the dear Savior has just been punishing me for being self-confident. One evening I had been reading until I felt tired and sleepy. I said I would have to go right to bed, for I could hardly hold my eyes open a minute longer; but in less time than you can think I was so wide-awake that hours passed before I could quiet the tumult that rankled within, enough to even *think* of sleep. Some little incident occurred. A discussion as to "who was to blame," sprang up before I knew it. It was a little misunderstanding over a matter of no importance to anybody. It is true, something happened with some of my utensils that I can not understand even yet; but there was no reason in the world why this trifling displacement of some of my property should even start a discussion. It lasted hardly a minute by the clock. During that minute the blood was coursing to my very fingers' ends. The warning note of danger, my little prayer, kept sounding louder and louder, but I was *sorely tempted* to have out *first* my say, and listen to the warning *afterward*. But I had grace enough to stop. But, even though I uttered no word, that did not end it. A fierce conflict was going on in my soul, and that warped my better judgment and drowned out my sense and reason. I prayed for peace and tranquillity; but for some reason or other the dear Savior did not see fit to send it. I dare not put on paper the vicious and evil thoughts that trooped through my mind as I sat at my accustomed desk trying to read the paper before my face. Some of my friends will say that it will hurt me, and perhaps spoil my influence, to make even such a confession as I have made. But, dear friends, I do not believe I shall suffer in the estimation of good people who know what it is to be sorely tempted, even as I am and have been tempted. I knew I was not myself, and for a long time it seemed as if there was little I could do to help matters except to keep still and pray. We have a picture in the Bible of the way in which Satan was allowed to persecute and try Job. I have wondered since if it can be true that the Lord permitted Satan to gain just enough access to my heart to give me a glimpse (or a sample) of the machinery he employs in breaking up homes and making the nearest and dearest friends the bitterest enemies. I am sure one of Satan's favorite plans to get a foothold is to start foolish discussions and disputes. I once visited a family where every thing was lovely outside and indoors except

the habit of contradicting each other. Somebody would make a statement in answer to a question that I innocently asked. Almost before my question was answered, some other member of the family would say, "It's no such thing." Then a third one would put in, "You are neither of you right. I was there myself yesterday." And thus it kept going until it seemed as if they must come to blows when there were no visitors around. There is an old adage that comes in very pat on such occasions—"Least said, soonest mended."

We are all of us startled almost every day by the newspaper accounts of how some man shot his wife and then committed suicide. Humanitarians are becoming appalled at the frequency of such tragedies. I have watched all such statements in order to see what started the trouble. A great many times we are told a man and his wife had disagreed a good deal, and had had frequent jangles, but nobody thought it would amount to any thing more than just talk. I have suspected, however, that Satan has learned a new trick. He is always trying to start a fuss between the best friends, even between parties who are united by the nearest and dearest ties of relationship God ever formed between two persons—man and wife. He gets into the heart of one of them, and suggests a harsh and unfeeling speech. Then quicker than an electric flash he goes into the heart of the other, and suggests an appropriate (?) keen, cutting reply. Thus he goes back and forth until good breeding and good sense prompt either one or both parties to stop. A Christian spirit and a love for Christ Jesus in the heart of each one of the two ought to extinguish such sudden flames at the very outset. May God help me, as I utter these words, to practice *better* what I preach.

Some kind sympathetic friend will suggest to me right here that I was overworked and worn out. Perhaps my nerves were overwrought by the hot weather or something of the kind. I am glad to say that such excuses for me have no weight. I never felt stronger or healthier in my life than I do now. I have been for weeks living on a diet mostly of strawberries and bread and butter. My drink has been distilled water, and I am *just as well as can be*. I had a good half-hour nap on the afternoon in question, and I was in full possession of all of my powers of mind and body. I think, too, I was reasonably filled with love toward Christ Jesus and love toward humanity. Satan got into my heart, notwithstanding, in just a few brief seconds, and touched hidden springs of my life and my being (that I never knew of before) in that brief time, so that I felt it the next day. Some time last winter the sewage-pipe to our kitchen sink got out of order. I looked at it, and thought I could fix it in about a minute. But when that was done, something else needed fixing, and I kept on pulling it to pieces until I had worked hard for over an hour. Had I known how many repairs were needed, I would have sent for a plumber; but after I got started I did not like to give up beat on the job. I came out ahead and made it all right; but I

had to work in such a cramped position it made my muscles and joints ache for several hours afterward. Next day I wondered what made me feel so sore all over. I did not know but I was going to be sick, until I remembered about cramping and twisting myself while working at that pipe.

Now, this encounter that I have been telling you about, with the powers of evil, affected my nerves and my spirituality more or less all the next day. Every little while I would be wondering what was the matter with me, and then I would reflect. Bunyan gives us a very good picture of such a conflict, in *Pilgrim's Progress*, where Christian had a hand-to-hand conflict with Apollyon. The latter was much the larger, and poor Christian was no match at all for him in point of strength. Reason and common sense would have said that Apollyon might crush him as one might crush a fly. Well, the loving Father looked on, and he always looks on, and will never let a faithful "soldier of the cross" be overcome nor entirely overpowered. We are tempted to have but little charity for the actors in these suicides and murders. We might say, "Let them get out of the world so good people can have peace." But, dear friends, this remark does not seem to work. Even though a good many are gotten out of the way by this process, the thing seems to grow. In fact, there seems to be a good deal of reason for taking the stand that these unfortunate people are not *altogether* to blame. Satan had got hold of them; and sometimes a man or woman in an unguarded hour lets Satan get a start. We frequently see the remark in the papers something like this: "This man had been such an exemplary person all his life that no reason can be given for the strange act but temporary insanity." Let us be warned and prepared beforehand for these very cases of temporary insanity that are getting to be so frequent. Is not a great deal of it only a new scheme started by the evil one?

In the latter of the two texts, we are told that even the dear Savior himself was in all points tempted like as we are; and would it be any thing very strange if he in his great love should think best to give even his followers like glimpses of great temptation, that they might be better able to preach the gospel, and warn mankind of the evils that Satan brings to pass? We read in the first chapter of James, verses 2, 3:

My brethren, count it all joy when ye fall into divers temptations; knowing this, that the trying of your faith worketh patience.

In thinking the matter over I am forced to believe that a foolish pride is at the bottom of many of these troubles. We are not humble enough—not meek enough, if you choose. "Blessed are the meek, for they shall inherit the earth." Sometimes people think *I* have not pride enough. When I was prowling around in the Florida woods in the middle of the night I needed more of a certain kind of pride; but in some other ways I am often tempted to be proud and overbearing. A few days ago I dictated something to one of our typewriter clerks. When I read the letter af-

terward I told him he must have omitted a very important part of it. The conversation was something like this:

"You may have meant to put in something, Mr. Root, but you must have forgotten it, for I wrote down every word you said."

Now, I knew certain reasons why I could not have dictated just what he wrote, that he did not know as well as I did. I said quietly, "Hunt up your notes and see if you did not omit two or three lines in copying your notes on the typewriter." He replied:

"It isn't any use to hunt up the notes, for I wrote down every thing you said."

Now, the young man was foolish in being so positive. I suppose most of us are often foolish in being over-positive. I felt sure I was right, but I thought I would not say any thing for fear I might betray my—was it not pride? He should have remembered the years of experience I have had in such matters. He did not know that it has long been my practice to watch the pencil of the clerk as he makes his crooked marks, to see just when he has finished the sentence as I dictate. If a line is dropped I am pretty sure to notice it by the motion of the pencil. I did not say any thing more, but stood by him while he hunted up his notes and commenced to read his record. There was quite a change in his countenance when he said:

"Oh! I beg pardon. I *did* leave out something after all."

I mention this as an illustration, not because I wish to reflect severely on the young man. We meet the same thing, most of us, thousands of times. The hired girl tells you very pertly you did not say a word about a part of the work you explained quite at length. What shall be done about it? Why, keep cool, and do not get proud and overbearing, even if you are boss or mistress, and even if you have grown gray in watching to see how these little mistakes come about. Take a humble place in the affairs of life. Sit at the feet of the dear Savior, and learn of him. O God, help me to practice *all the time* the precepts I am now trying to give to others. I know how natural it is to go to great pains, and to great lengths, to prove we are right. In the case I have mentioned, I knew the pencil-marks of my young friend would prove to him that I knew what I was talking about. But in ordinary talk or in ordinary disputes we do not often have such proof in black and white of exactly what we did say.

Of late it has been a difficult question to decide whether certain ones are insane or simply ugly. Judges are appointed to decide the matter. Now, if I were a judge, and if I were to settle the question as to whether some one in a quarrel was getting out of his head or not, I would test him by a scripture text. When he got to going on about his neighbor, and began telling his side of the story, of how he had been used, I would quietly ask him to hold on just a minute. Then I would say:

"My friend, you know the Bible says, 'Love ye your enemies; do good to them that hate you; bless them that curse you, and pray for them that despitefully use you.' Now,

what do you think of the above words? Do they not sound more like the words of the heavenly Father to his contrary children than like words that ever came from any human being?"

If the person assents that these *are* probably the words of *God*, and that they are grand and glorious words to sinful humanity, I should say right away that the man is not crazy at all. He is perfectly sound in mind. If, however, these beautiful texts should make him angry, and even uglier and more vindictive than he was before, then I should say, "That man has a touch of insanity. He will be crazy if he pushes ahead in this quarrel or other like quarrels."

My prediction in this way has several times come true. There is a kind of insanity that prompts these crimes we read about, and this insanity is Satan's work. *He* is at the bottom of every bit of it. Now, dear brothers and sisters, if we believe this, if we recognize that Satan is *really* going about as a roaring lion, just as the Bible says, then let us be careful. Whenever the time comes that you can not kneel down at night and pray honestly for every one who has provoked you or even done you harm during the day, Satan is getting into your heart; and may God help you to say, "Get thee behind me, Satan."



FLORIDA TRAVELS, CONTINUED.

My next point from Sanford was Sorrento. There is a railway off in this direction; but since the big freeze the trains run only twice a week. As my destination was only about twenty miles, we made the trip with a horse and buggy. On the way we had to cross a river. As there is not travel enough to pay for an expensive bridge, two counties unite and keep a man at the crossing, with a ferry-boat. He is paid a salary, so the traveler has nothing to pay. At a moment's warning, day or night, he is carried safely over the stream. It seemed to me as if it must be a pretty big job to push the boat over when loaded with horses and vehicles. But the ferryman's daughter, scarcely a dozen years old, said she had ferried people over frequently during her father's absence. Of course, there is not very much current to this river. In fact, it is like a good many of the Florida rivers—only a narrow stream connecting one lake with another one.

At Sorrento I stopped at R. M. McColley's. Mr. M. is, like many other bee-keepers, a sort of odd genius. He has a home in Ohio, not very far from Medina, and it is a very nice comfortable home too; but on account of his health he has for several years spent his winters in Florida. At the present time he has also a very nice place in Florida. In fact, he has a steam-engine to pump water and saw wood, and quite a lot of agricultural imple-

ments; and when GLEANINGS described the home-made windmills a little while ago he had to make such a mill. It was my privilege there to pick luscious tangerines right from the trees; in fact, he has succeeded in growing some very fine fruit almost without protection.

This matter of having a home in Florida and another in the North, and migrating back and forth as the birds do, is one that has been considered a good deal. But there is a serious drawback to it. When you get every thing fixed up nice, and wish to go away, you must either close up every thing, and hope nobody will break into the house and steal while you are gone, or you must leave hired help to look after things and take care of it; and the latter is sometimes more unsatisfactory than the former. Mr. and Mrs. McColley were telling me how they found things in Ohio after they had trusted to hired help or renters for several years. I believe the tenants did not get quite to the point of keeping "pigs in the parlor," but they came very near it, and our two friends are now back in Ohio fixing up their home again, growing crops, and getting things in shape as well as they can, as they were before they went to Florida.

In the afternoon I was driven over to Mount Dora, where I met our good friend Longstreet, who was one of our veteran bee-keepers. He lived for many years in York State, not far from Doolittle. He went to Florida on account of poor health, and at the time of my visit he was feeling very poorly on account of the grip and some other troubles that had set in. I was almost frightened to see him several times make such an effort to get his breath. He said he would feel better to get out in the sunshine in his beautiful yard among the orange-trees; and after a while he recovered so as to talk about the bees, tropical gardening, etc., quite like his old self. I feared when I bade him good-by he was not going to live long; but still I was somewhat surprised to learn that he died shortly after my visit.

As my visit was on the day of the semi-weekly train, I decided to wait for it in order to ride six miles to Tavares. Well, this train that runs only twice a week was delayed *six hours*. Of course, I could have made the trip on foot much easier than to wait away along into the night; but the operator kept telling us all the while the train would be along in a short time. Well, when we got to Tavares (after waiting six hours to get six miles) the station had been burned down, and I did not recognize the place, so I was carried on past my stopping-place. The conductor *declared* that he called out "Travares;" but so many passengers said with me they did not hear any thing of the kind, he finally relented. I was carried on to a beautiful little town called Eustis. The conductor, of course, gave me free transportation there and back. At Eustis I found a bee-keeper, and for the first time in my life saw redbud-trees in full bloom; and let me tell you redbud is one of the handsomest ornamental trees to be found anywhere in the world. The sight of a tree in full bloom, in a dooryard, called forth exclaima-

tions of surprise; and I wonder now that the tree is not grown more as an ornamental shrub. We tried it years ago here in Medina, but did not succeed in getting it to bloom. From Tavares I went to Oakland, on the shores of Lake Apopka.

We hear people boast, many times, that this, that, or the other locality is entirely free from grip, and that people never have grip in that region. These statements often come from people who have real estate to sell. I think they have some grip in Florida. When I was waiting for the train at Mount Dora, within about fifteen minutes I began to feel my breathing-apparatus clogging up. I put on my overcoat, and bundled up unpleasantly warm; but I had such a cold by the time I reached Oakland I was pretty nearly down sick. In studying the matter over I got an idea that plenty of heat applied in the right way to the seat of the mischief would help very much to get rid of the grip, or, if you choose, any sudden severe attack of cold. My cousin's folks had a fireplace, and a good lot of pitch-pine wood to make a nice hot fire. Well, I got the heat from that open fireplace to strike right square on my bald head, and I kept on with the treatment until it really seemed as if my brains would get to boiling—that is, if there were any brains down through my thick skull—and I just roasted that cold clear out of my head and throat. I presume it was something on the same principle as the cabinets or vapor baths that are advertised so extensively. It did the business; and after resting two days I started on to Orlando, comparatively well. At this place I was nicely entertained by Mr. A. E. Woodward, a veteran bee-keeper from York State, who spends his winters in Florida.

Daytona has often been called the handsomest town in Florida; but Orlando is certainly equal to Daytona, and I do not know but it is a little ahead. It is situated in the midst of a group of beautiful pure soft-water lakes. If I am correct, there are four or five around in the suburbs of the town. The finest pineapple-shed I saw in the whole State was at Orlando. It was managed by Mr. T. J. Arnold, of the Little Gem Pinery. He has taken from half an acre in two years fruit and slips to the amount of \$2600. The slips bring him 12 cents each, and are mostly engaged in advance. He had then an acre and a half under shed. In the vicinity of Orlando there are perhaps 200 acres of pineapple-sheds. It costs about \$2500 to shed, set, fertilize, gather, and market the first crop, per acre.

Orlando has five nice churches, a fine bank, very pleasant hotels, and boarding-houses. The latter, where I stopped with Mr. Woodward, has rates of only \$7.00 a week, and every thing was in excellent trim. There are beautiful stores, orange-groves covered with bloom all around the town. Orlando is said to be on the highest ridge in the State. The land is what is called "pine land" for many miles about the town. Strawberries and all kinds of vegetables are in abundance the year round. Friend Woodward, during the summer time, lives at Grooms, N. Y.

Tobacco.

TOBACCO—IS IT A GOOD THING OR A BAD THING?

The Philadelphia *Farm Journal*, that bright little sheet that you can get (in clubs) five years for \$1.00, hits the spot once in a while. It says:

There is a clashing of interests in Connecticut quite remarkable. A law of the State provides that the children in the public schools shall be taught that tobacco is a poison which no human being should ever take into his system. While Connecticut is spending money on tobacco culture, she is teaching her children that the growth and use of tobacco is a wicked sort of business. The moral inconsistency of the situation is easily grasped by outsiders at least. The situation is an odd one, but it is not likely that Connecticut will be extricated from it. The State will continue to grow tobacco, and the depravity will probably continue to be taught to the rising generation.

I would suggest that the teachers and professors of Connecticut hold a joint convention with the agricultural papers and moneyed men, and discuss the question, and try to have it settled as to who is right and who is wrong. Or they might put it this way: Which is of more importance, the health and moral growth of our boys, or the tobacco business, together with the money invested in the traffic? You know we had some years ago a joint convention of the bee-keepers and fruit-growers of Michigan, and good came of it. Now, Connecticut might have a convention in regard to a matter of a thousand times more importance than either fruit or bees, and all the other States and *all the rest of the world* might look on with profit.

THE HOME CIRCLE.

The above is the title of a department in the *American Bee Journal*, conducted by our good friend Prof. Cook. It rejoices my heart to read friend Cook's exhortations for righteousness, temperance, and purity; and it rejoices my heart again to see the bee-journals of our land standing out so boldly and bravely against tobacco and intoxicants.

In the issue for June 13 we find the following from Prof. Cook in regard to tobacco:

Over 100 of our college folks—almost half of us—went to Los Angeles last Saturday to attend the Inter-collegiate Oratorical Contest, and the second contest of three arranged with one of the colleges to decide who were champions in base-ball. I was proud, as our fellows won the trophies in the ball game, as they had won in the first, with a great score of 15 to 2. I was still more proud as we achieved victory in the oratorical contest. But I was most proud of the gentlemanly character of our students. One way this was shown, was in the entire absence of smoking among our fellows. The others smoked. We did not. I rejoice that we have no smoking at our college. I wish tobacco were eschewed in all our homes. Our friend A. I. Root, in "Our Homes" has done splendid service in urging against this habit. I wish I could be like happy in these "Home Circle" columns. To the hundreds of students that I have taught physiology, I have always spoken, as best I might, against all use of tobacco.

The worst cost that perhaps can be brought against this arch enemy of the well-being of our people, and especially of our youth, is the tendency of the habit to make its patrons thoughtless—regardless of the comfort of others, and thus to destroy the gentlemanly instinct among us. How often in public places our ladies must endure the poisonous fumes from cigar or pipe! Only a few days ago I was pre-

siding at a large picnic gathering, where speaking was going on, when some ladies appealed to me to relieve them from just such an annoyance. I have had to do this unpleasant duty over and over again. Can people acquire the tobacco habit, and preserve their gentlemanly instinct, all unimpaired?

There is one special point in the above that is worth noting. In any contest requiring the fullest development, both of nerves and muscles, and especially alertness as well as strength, the young man who does not use tobacco will, as a rule, come out ahead; expert cyclists learned this a long time ago; and in every department of business where a clear head and a cool ripe judgment are required, the boy or man who lets stimulants alone has the advantage. Long live the Home Circle in the *American Bee Journal*; and may Prof. Cook be spared for many years to conduct it.

TRAP LANTERNS, ETC.—SEE PAGE 566, JULY 1.

A communication from Prof. J. M. Stedman, Entomologist at the Experiment Station, Columbia, Mo., is just at hand, severely criticizing Mr. Haseltine, the inventor of the trap lantern, for his unfair way of using Mr. Stedman's name to push his invention. We have not room here for giving the whole paper, but we make the following extracts from special newspaper bulletin No. 16, June 26:

It should be distinctly understood that the moth-catchers can not in any sense of the word take the place of sprays, in a general way. While the moth-catcher is a good thing for certain very restricted insects at a certain very restricted time in the proper season of the year, and while it is true that sprays are to a certain extent unsatisfactory for certain insects, yet, on the whole, the spray may be relied upon, even though used by inexperienced persons; while the moth-catcher can not be relied upon without a thorough knowledge of the exact time it should be used for each special case.

We can say that the moth-catcher is the best thing that can be used in large fields for the corn-worm moth, for the fruit-leaf roller, for the pickle-worm moth, and for the June or May beetle. Let it be definitely understood, then, that we recommend the moth catcher for no other insects than those named; and that for the tent caterpillar, the army-worm, and the cut-worm, there are other methods of fighting these insects that are much better.

Taken as a whole, then, the use of moth-catchers by the general public will do more harm than good.

J. M. STEDMAN,
Entomologist of the Experiment Station,
Columbia, Mo.

June 26.

Permit me to add further that we have purchased one of the largest-sized Haseltine moth-traps. The price is excessive, and there is no reason in the world why *any one* (if he wants to) should not use a lamp over a tub of water, with pieces of tin or cheap looking-glasses arranged so the insects will bump against the mirrors and fall into the water.

GETTING MONEY IN SOME EASIER AND QUICKER WAY THAN BY DAILY TOIL.

I have long been thinking of saying something about this matter; but the *Philadelphia Farm Journal* has said so much better exactly what I would say, I take the liberty of copying the following. The italics are mine:

Now, what shall we say about the great Wall Street stock gamble, which culminated in May in one of the greatest shearing of the innocent lambs that has ever

taken place: Tens of thousands of people all over the country were drawn into the maelstrom of speculation, and most of them lost money. A few won more than they lost. These we hear of; but of the many that lost, little is said. They keep quiet about it, though sooner or later the bankrupt court will know what has happened. If people who are tempted to speculate only knew that, whether they win or lose in the gamble, they receive injury beyond repair, they would not engage in it. If they lose, that is the loss only of money, which is not so bad; but if they win, their character is likely to suffer. *It is bad to lose, but it is worse to win; for to win means that, ever after, they will be tempted to get gain by games of chance.* Money won by any kind of gamble is not going to be of any benefit. It will not last. Sooner or later another venture will sweep all away. We pity the poor lamb that is shorn, but the shearer is worse off or will be finally. Money should be honestly earned to do anybody any good. And it is best to come slowly, little by little, day by day, and should fairly represent the patience, honesty, and toil of the individual and not the lucky chance of an hour.

A minister wisely says: "The evils of drink are familiar to you. There are other evils. But the greatest peril is the insane spirit of gambling which seems to have taken hold of the people irrespective of social standing or religious belief. The insane desire to get rich quickly is at the bottom of it all. There is no difference between the newsboy who flips coins and the man in Wall Street who buys stocks on margins on a chance that they will rise or fall. Both wish to get something for nothing; both are gamblers. "From the tiny lad selling newspapers on the street to the men dwelling in a palace, the gambling spirit seems to have invaded all. Where is this thing going to end?"



HONEY-CANS.

We are supplying a good many 60-lb. cans, two in a case. Since our last report we have received another carload of these cans, so that we are prepared with nearly two carloads, which we are selling at prices listed in our catalog—\$7.50 for 10 boxes. Most of those handling our goods by the carload are supplied with these cans also. At the rate we have been shipping them for the past two weeks our stock will not last more than two months, and we can not guarantee these prices beyond our present supply of stock. We can not replace it from the Can Trust, and come out even, at present prices. If in need of cans, send in your orders while the supply lasts.

BUSHEL BOXES AND CRATES.

Because of changes in some of our manufacturing processes the slats used in our slatted and all-slatted bushel boxes are a little wider and thicker than formerly, so that we are not able to pack 13 K. D. boxes inside of two nailed up, as we have done heretofore; but we can pack 12 inside, making 14 complete boxes, with nails, in a crate of the all-slatted kind, and 12 each of the slatted or galvanized bound. We have also revised our prices on boxes to the following:

All slatted, per crate of 14, \$1.90.

Slatted, tight ends, per crate of 12, \$1.65.

Galvanized bound, per crate of 12, \$2.25.

This is a slight reduction on prices ruling the past two years. These prices are subject to a discount of 5 per cent in lots of 10 crates or more.

NO. 2 SECTIONS FOR FALL HONEY.

Those who produce amber or dark grades of comb honey should use No. 2 grade of sections in order to have the wood of the section more in harmony with its contents. In fact, the whitest grades of honey will make just as good appearance in the most of our No. 2 grade sections as they will in No. 1. Don't be afraid to try the No. 2 grade. You can save money by using them. They cost 50 cts. per 1000 less than No. 1, and, as containers of honey, are just as good. Some people have a prejudice against No. 2 sections because they think the color of the wood, being a little darker, must be nearer the heart of the tree, and therefore is more brittle or brash. This is an entirely mistaken

notion. The wood in our No. 2 sections is every bit as strong as the No. 1. We put absolutely no heart timber into sections at all. I have so much faith in our No. 2, as they are now put up, that I feel satisfied that fully half of those now using No. 1 would be well pleased with the No. 2, and prefer them at the reduced price.

BEE SWAX.

Until further notice we will pay 26 cents cash, or 28 in trade, for average wax delivered here. Be sure to mark your package so we may know whom it comes from. We are continually being annoyed by careless people shipping us wax without the slightest sign or mark of identification. They seem to think they are the only people sending us wax, and, of course, we ought to know that it comes from them without any identification marks. If you will please bear in mind that some days we have as high as ten or a dozen shipments coming in from as many different people, and that there are six days in every week, and 52 weeks in a year, and will try to put yourself in our place, I am sure you will not think we are unreasonable in asking you to place your name and address in or on each package, and write us when you can make shipment, giving the gross weight of each package, also its weight before the wax is put into it, and the net weight of wax. Get a receipt from the railroad agent, with the rate of freight inserted, if possible, and send that with your letter. Be careful also to send us nothing but pure beeswax, as we have no use for any other kind.

MASON FRUIT JARS AND NO. 25 JARS.

Our carload of jars reached us just before going to press for July 1st, but space was so crowded I was unable to get in a notice. We were disappointed in not getting any flint jars except in the pint size. All the quart and two-quart jars are green glass. They are not as green as the jars we have handled in the past, and few will find them objectionable as regards color. They are smoother, better-made jars than any we have had for years. The tops are zinc, porcelain-lined. We have pints in both green and flint glass. In the same car we received a good supply of No. 25 jars which hold just one pound of honey. The prices, till further notice, will be as follows:

1-pint flint-glass, 60c doz.;	6 doz.,	\$3.45;	12 doz.,	\$6.75
1 " green " 58c "	6 "	3.35;	12 "	6.50
1-quart " 60c "	6 "	3.45;	12 "	6.75
2 " " 85c "	6 "	4.85;	12 "	9.50
2-gross lots deduct 25c per gross.				
5 " " " 50c "				

Jars are all put up one dozen in a case, with partitions. These prices are below the market, and are not guaranteed. When our stock is exhausted we can not replace them nor offer them at these prices. If you need jars, send on your orders. These prices are only for shipment from Medina.

NEW ROOT PERFORATED ZINC.

The illustration below shows the size and style of perforations in our new queen excluding zinc made on our Root perforating-machine. We have expended a large sum in refitting this machine with new dies and punches, and the product is as near perfection as

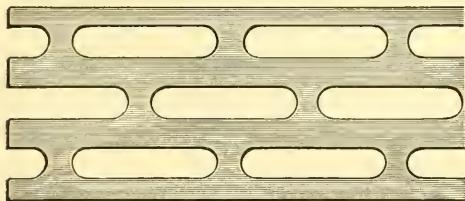

it is possible to reach. The perforations are uniform in size, and $\frac{1}{16}$ of an inch, which seems to be the correct size for surely excluding all queens and drones, and allowing the workers to pass freely. The rows of holes, although not quite as close together as in the Tinker zinc, are much closer than in the old Root zinc. In a sheet of zinc 28 in. wide there are 87 rows of holes, while in the old there were 70 rows—an increase of 25 per cent. Then the holes are longer and with rounding ends, making the increase in total space of perforations over the old zinc fully 30 per cent. We shall list only one kind hereafter, as we regard this fully equal to the Tinker zinc. We shall be pleased to mail samples to those interested.

Special Notices by A. I. Root.

BUCKWHEAT—TIME TO SOW IT.

From now on to the middle of August is the time to sow buckwheat, in my opinion. I know a good many think it ought to be sown in June, and some say the fore part of July. But buckwheat is a cold-weather plant, and it does not set its grain well unless the weather is cool. The largest crops I have ever seen matured just before the first killing frost. Of course, it is a little risky to get too close to the frost line, but I do not believe a frost is very much worse than having it almost or quite ruined by hot weather when it comes into bloom. Perhaps it may be well to make two or three sowings, and then some of them may hit it just right. We have a nice stock of Japanese seed at \$1.10 per bushel, or a two-bushel sack for \$2.00; half-bushel, 60 cts.; peck, 35 cts.

CRIMSON OR SCARLET CLOVER.

Now is the time to get it in whenever the ground is vacated by any thing else. You certainly can not afford to let any piece of ground grow up to weeds, and I believe there have been very few failures with crimson clover where it was put in in July; and, so far as I can learn, medium red and mammoth clovers have also succeeded when sown by themselves in July. Up in the Traverse region, Michigan, they succeed by sowing any of these clovers in August; but, of course, they have more snow for protection, as a rule, than we do here. In our locality, on our rich ground, we succeed with crimson clover year after year when put in at any time in August; and we usually get a good stand if sown during the fore part of September. A year ago we put in a piece where mammoth clover failed because our wheat grew so rank. After the wheat was cut we sowed crimson clover on the stubble, and went over it at once with the cutaway harrow. The clover made a dense mat before winter, and the ground was so thickly covered with this same mat in the spring that the frost had no effect on it whatever. From 8 to 15 lbs. of seed is sown to the acre. On poor land, put more seed; for in rich land it branches out so one seed makes a great mass of clover-stalks. We consider it worth almost as much as red clover to turn under, and it blossoms so much earlier we can get it out in full bloom (getting the advantage of a honey crop) and then have time to turn it under for potatoes and get them in early. We rather prefer mammoth clover for enriching the ground; but it does not get in full bloom till the last of June, and a good many people object to waiting till so late for planting potatoes.

The present price of crimson clover, new seed, is, two-bushel sack, \$10.00; bushel, \$5.50; half-bushel, \$3.00; peck, \$1.60; half-peck, 85 cts.; 1 lb., 15 cts.; by mail, 1 lb., 25 cts.

I know crimson-clover seed is offered at a lower price than the above; but after having had some sad experience with crimson clover that germinated only from 10 to 50 per cent, and one lot, in fact, that would not grow at all, although it looked all right, I do not dare, hereafter, to handle any thing except the best new seed. The seed we offer for sale is absolutely new, and what is called "fancy." As the seed is mostly grown in the latitude of Philadelphia, quotations on it will always be a little lower in the south-east. Of course, we have to add something for freight from the place where grown.

EXCURSIONS TO NORTHERN MICHIGAN.

When this reaches our friends I shall probably be in the Grand Traverse region, but for only a brief stay, however. The friends who have been thinking about an excursion to Northern Michigan may be pleased to know that a very low price for the round trip from Toledo is to be made July 25. The Pere Marquette Railway Co. write us as follows:

We are to run an excursion to Ludington, Manistee, and Traverse City, July 25th, at \$4.00 for the round trip. Tickets may be used out of here on all trains on the 25th, good returning in 15 days. For the accommodation of excursionists we will arrange to run through coaches.

W. C. TOUSEX, Toledo, Ohio.

The Pere Marquette Railway Co. will, on application, send you descriptive pamphlets, free of charge, describing the attractions of Northern Michigan, telling all about crops grown there, price of land, etc. Address S. S. Thorpe, Majestic Building, Detroit, Mich.

To Our Shippers.

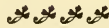

About May 1st last, we removed our business from the buildings, 120-122 W. Broadway, to larger and more commodious quarters at Nos. 265-267 Greenwich Street, and 82-84-86 Murray Street, and we duly sent to our friends in the trade a notice of our removal. Shortly after we vacated the premises, 120-122 W. Broadway, one Joseph M. McCaul, rented a portion of our old quarters, and hung out a sign, "Hildreth, McCaul Co., Jos. M. McCaul, Prop.," with other large signs to the effect that his business is "Headquarters for honey, beeswax, maple sugar, and maple syrup."

The mercantile agencies report that Joseph M. McCaul is the sole proprietor of the new business, and that he claims to have paid to one Henry P. Hildreth, who has no connection with our business, a consideration for the use of his name.

We will not comment upon the act of leasing our old quarters and exposing thereon the sign, "Hildreth, McCaul Co.," further than to state that we have instructed our attorneys to apply for an injunction restraining the said McCaul from using the name "Hildreth" in connection with his business in any manner whatsoever.

We value highly the good name and business we have established by many years of satisfactory dealing with our friends in the trade, and we therefore send this notice so that you may not possibly confound us in any manner with the so-called "Hildreth, McCaul Co."

Our firm name remains as heretofore, and all our business is carried on at our new quarters, Nos. 265-267 Greenwich St., and Nos. 82-84-86 Murray Street, New York.

Respectfully yours,

HILDRETH & SEGELKEN.

TRIAL TRIP.

3 Months, 20c. 6 Months, 30c.

TO NEW SUBSCRIBERS. — We want every subscriber of *Gleanings* to read the WEEKLY AMERICAN BEE JOURNAL for 3 or 6 months at least, and so we make the above very low offers to those who are not already getting our journal. Just think of it—13 Nos. for 20c, or 26 for only 30c! Better send in your subscription at once, and begin with July 1st.



ALSO DON'T FORGET
that we're headquarters in Chicago for

Root's Bee-keepers' Supplies.

A catalog and also a sample copy of the American Bee Journal free upon request.

George W. York & Co.,
144-146 Erie Street, Chicago, Ill.

3 Good Points

Good Stock ;
Low Prices ;
Prompt Service.

My stock is from J. P. Moore's long-tongue strain, A. I. Root's famous \$200 queen, and from the stock of J. F. McIntyre that filled supers when other colonies were starving. I sell warranted queens in any quantity, at 50 cts. each. If a queen proves impurely mated, another is sent free of charge. All queens go by return mail unless otherwise ordered. I guarantee safe arrival and entire satisfaction. Otherwise, the money is refunded.

L. H. Robey, Worthington, W. Va.

W. H. Pridgen,

of Creek, Warren Co., N. C., whose money-order office is Warrenton, N. C., is now prepared to fill orders promptly with the Hutchinson "Superior stock," or golden untested queens, at 75 cts. each, or queen-cups at \$2.00 per pound, postpaid.

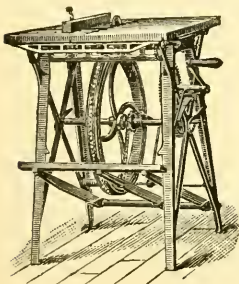

Barnes' Hand and Foot Power Machinery.

This cut represents our combined circular saw, which is made for beekeepers' use in the construction of their hives, sections, boxes, etc. **Machines on trial.** Send for illustrated catalogue and prices.

W. F. & John Barnes Co.,
545 Ruby St.,
Rockford - - Ill.

ALBINO QUEENS. If you want the most prolific queens, the best honey-gatherers, the best comb-builders, the hardest and gentlest bees known, try my albinos. My untested queens, 75c. **J. D. GIVENS, Lisbon, Texas.**

YOU CAN NOT afford to let the season pass without introducing some of Moore's 23-100 stock into your apiary. See advertisement on page 614.

FOR SALE. One 10 h.-p. engine and boiler (upright boiler), one 18-inch planer, one Root saw-table, 30 ft. line-shafting, hanger pulleys, and belting. Will take \$250. **J. W. BITTENBENDER, Knoxville, Ia.**

WANTED.—To exchange Barnes saw for camera, not less than 4×5. **M. W. SHEPHERD, Mannville, Putnam Co., Florida.**

WANTED.—To exchange worker combs, in either Hoffman or Simplicity frames, for Italian queens. **L. D. GALE, Stedman, N. Y.**

Abbott L. Swinson,

practical apiarist, and breeder of bees and queens for over 12 years in the "Tar Heel" aparies, at Goldsboro, N. C., is now one of the firm of Swinson & Boardman, Macon, Ga., and the apiarist in charge, where he will be pleased to hear from his old friends, and supply them as of old with bees and queens.

Respectfully, **ABBOTT L. SWINSON,**
Box 358, Macon, Ga.

Hybrid and black queens, good ones, 25 cts. each.
F. H. McFARLAND, Hyde Park, Vermont.

KIND WORDS FROM OUR CUSTOMERS.

Don't stop GLEANINGS, please. I don't want to miss its bright face even once; neither do I want to miss Uncle Amos' talks. **K. C. LUCKEY,**
Poy Sippi, Wis., May 31.

I bought a queen from you five years ago, and I believe my stock from her is the *best in the world*. I wish to test your strain again. I will give it a fair, critical test, and report to you. **EVAN E. EDWARDS,**
Alexandria, Ind., May 11.

The premium queen you sent me last July is a beauty. I bought myself a rule with 100ths of an inch on it, a small microscope, and some chloroform. I measured some of her bees' tongues the other day, and they were nearly $\frac{3}{16}$ of an inch long. I have several virgin queens ready to mate, and some in cells almost ready to come out, from the premium queen you sent me. **L. A. HAMMOND,**
Keedysville, Md.

Having spent 17 years in a salaried pastorate in Illinois and Colorado, and now 6 years as a faith missionary in the desert, I know the advantages of both God's and man's promises; and as a working capital in any circumstance I prefer God's word *every time*. Tell your people to *have faith in God*. We eat at the same table with our Indian children; and if you come out here to visit us I would invite you to do the same, and make no apology. **HOWARD R. ANTES,**
Anath, Utah.

THE "AGE OF CONSENT."

Mr. Root:—On page 47 you say that the age of consent in Ohio is 14 years. The W. C. T. U. of Ohio succeeded in getting the age raised to 16 years in 1898. I enjoy reading your Home Papers.

ANNIE W. CLARK, Pres. Ohio W. C. T. U.
Columbus, O., May 20.

May the Lord be praised for this information, dear sister. Now, it is of great importance that the misstatement which I copied from the book, "Traffic in Girls," be corrected at once. Let it not be said of such a book that it contains one misrepresentation or exaggeration. Thank God for the raising of the age of consent from 14 to 16 years. But why not have Ohio stand beside New York and make it 18? But doubtless the age given, 14, was correct when printed.

Long Tongues Valuable South as well as North.

How Moore's strain of Italians roll in the honey down in Texas:

Hutto, Texas, Nov. 19th, 1900.
*J. P. Moore.—Dear Sir:—*I wish to write you in regard to queens purchased of you. I could have written sooner, but I wanted to test them thoroughly and see if they had those remarkable qualities of a three-banded Italian bee. I must confess to you I am more surprised every day as I watch them. They simply "roll the honey in." It seems that they get honey where others are idle or trying to rob; and for gentleness of handling, I have never seen the like. Friend E. R. Root was right when he said your bees have the longest tongues; for they get honey where others fail. I will express my thanks for such queens. I am more than pleased. I will stock my out-apiaries next spring with your queens.

Yours truly, HENRY SCHMIDT.

The above is pretty strong evidence that red clover is not the only plant which requires long-tongue bees to secure the greatest quantity of nectar.

Daughters of my 23-100 breeder, the prize-winner: Untested, 75c; six, \$1.00; doz., \$7.50. Select untested, \$1.00; six, \$5.00, dozen, \$9.00. Safe arrival and satisfaction guaranteed. Descriptive circular sent free. I am filling all orders by return mail, and shall probably be able to do so till the close of the season.

J. P. Moore, Lock box 1, Morgan, Pend. Co., Ky.

(Mr. J. P. Moore is entirely reliable.—A. I. R. Co.)



Belgian Hares

Fully pedigreed of the highest breeding, at prices that will suit. With every hare sold goes a full pedigree, register number, and score-card, scored by an official judge; and, when desired, does will be bred to one of our famous high-scoring bucks before shipment. Address J. B. MASON, Mangr. of The A. I. Root Co., Mechanic Falls, Me.



Belgian Hares

I have some fine hares for sale at reasonable prices.

J. F. Moore, : Tiffin, Ohio.

BELGIAN HARES!

Either domestic or imported, of any grade from a pedigreed prize-winner to a common rabbit, at prices that are right. Write

GEO. M. TEETER, PENNVILLE, IND.

1200 FERRETS. All sizes; some trained; first-class stock. New price list free. N. A. Knapp, Rochester, Lorain Co., Ohio.

GINSENG!

September, October, November, and December are the months in which to set this plant. We have a large stock of cultivated roots. Will quote prices on seed or roots, and guarantee safe shipment.

C. M. Goodspeed, Skaneateles, N. Y.

To make cows pay, use Sharples Cream Separators. Book "Business Dairying" & cat. 288 free. W. Chester, Pa.

STEEL WHEELS

for your FARM WAGONS

any size wanted, any width of tire. Hubs to fit any axle. No blacksmith's bills to pay. No tires to reset. Fit your old wagon with low steel wheels with wide tires at low price. Our catalogue tells you how to do it. Address

EMPIRE MFG. CO., Quincy, Ill.

Don't Dig Potatoes by Hand

It is a slow and expensive way. The cheapest, quickest, and easiest way is to USE THE IMPROVED

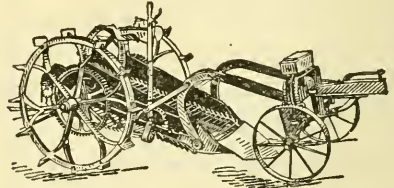

DOWDEN POTATO-DIGGER.

It gets them all, no matter how deep or shallow. Our book explains how. Book is free. Write for it now. DOWDEN MFG CO., - Box 23, Prairie City, Ia.



FENCE A LAWN

with 13 or 16 inch wire PAGE Fence, and it is well fenced for a lifetime. Write for descriptions. Box S. Page W. W. Fence Co., Adrian, Mich.

PHOTO BUTTONS. Send any tintype, photograph, or lodge emblem and 10 cents, and have a button made, as a sample of our work. Buttons for advertising purposes. Or in quantities write for prices, as we can furnish any button made. All photos returned unharmed. Address C. G. RICHEY, 1495 E. Main St., Columbus, Ohio.

Mr. A. I. Root's Writings

of Grand Traverse territory and Leelanau Co. are descriptive of Michigan's most beautiful section reached most conveniently via the

PERE MARQUETTE R. R.

For pamphlets of Michigan farm lands and the fruit belt, address W. C. Touzey, D. P. A. Toledo, Ohio.

Yellowstone Park.

Extended tour, leisurely itinerary with long stops in the Park. Private coaches for exclusive use on the drive. Pullman sleeping and dining cars. Established limit to number going. Escort of the American Tourist Association, Reau Campbell, General Manager, 1423 Marquette Building, Chicago. Colorado and Alaska tours also.

Tickets include all Expenses Everywhere.

Train leaves Chicago, via Chicago, Milwaukee & St. Paul R'y, Tuesday, July 9, 10:00 P.M.

New Smith Premiers Nos. 5 and 6.

The No. 6 takes paper 18½ inches wide and writes lines 16 inches long. The No. 5 takes paper 11 inches wide and writes lines 9½ inches long. These new machines in essential mechanical principles are the same as Models Nos. 2, 3 and 4—unequaled.

Write for Printed Matter Free.

The Smith Premier Typewriter Co.

158 Prospect Street, Cleveland, Ohio.

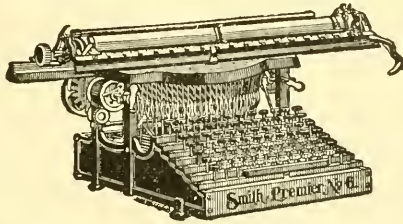

AT ANY TIME—

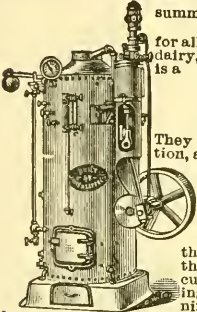

summer time or winter time, the **BEST POWER** for all purposes on the farm, in the dairy, creamery or cheese factory, is a

LEFFEL ENGINE.

They are very simple in construction, and easy to run and keep in order. Are very economic of fuel, are easy steamers and great power developers. They are made both horizontal and upright with engine mounted on boiler. Everything is made of best material throughout. They are ideal for cutting and grinding feed, sawing wood, pumping water, running cream separators, churns, butter workers, etc. Send stamp for Book on Power, **JAMES LEFFEL & CO., Box 89, Springfield, O.**

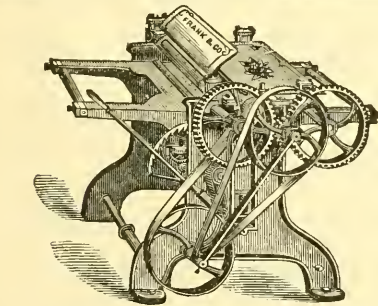

PLANERS

The above cut shows one of our small Planers, of which we make twelve different styles and sizes. Also large Planers, Band Saws, Buzz Planers, Moulders, Wood Lathes, and all kinds of

WOOD WORKING MACHINERY

Send for Catalogue.

The **FRANK MACHINERY CO.**
BUFFALO, N. Y.

FRUIT-CANNING made easy and sure by using Coddington's Self-sealing Wax Strings. Very convenient and economical. Inquire of your dealer or send me his name and 4c in stamps for 100 strings, by mail. Mention this paper. **C. C. FOUTS, Middletown, Ohio.**

BUY MEDICINE BY MAIL

Be aware "The Only Mail Order Drug House in the World." Our large and handsome **Illustrated Drug Book** contains a list of 15,000 drugs, medicines, family remedies, sick room necessities, trusses, flavoring extracts, oils, paints, etc., 1500 illustrations. We send it for 10c to pay cost of mailing, and refund the amount out of the first order you send us. Send for a copy. You cannot tell how soon you may need something. **HILLER CHEMICAL CO., Dept. 10, Chicago, Ill.**

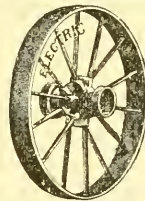

A Good Wagon

begins with good wheels. Unless the wheels are good the wagon is a failure. **IF YOU BUY THE ELECTRIC STEEL WHEEL** made to fit any wagon—your wagon will always have good wheels. Can't dry out or rot. No loose tires. Any height, any width tire. Catalogue free. **ELECTRIC WHEEL CO., Box 95, QUINCY, ILL.**

Minnesota Bee-keepers' Supply Mfg. Co.,
Manufacturers of
Bee-hives. Sections. Shipping-cases, and
Everything Used by Bee-keepers.

Orders filled promptly. We have the best shipping facilities in the world. You will save money by sending for our price list. Address
Minnesota Bee-keepers' Supply Mfg. Co.,
Nicollet Island Power Building, Minneapolis, Minn.

Union Combination Saw

For Ripping, Cross-cutting, Rabbering, Mitering, Grooving, Gaining, Boring, Scroll-sawing, Edge-moulding, Beading. Full line **FOOT and HAND POWER** machinery. Send for catalog. **A. SENECA FALLS MFG. CO., 44 Water St., Seneca Falls, N.Y.**

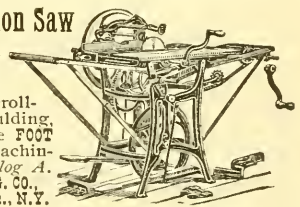

Fruit Packages of All Kinds.

—ALSO—

BEE-KEEPERS' SUPPLIES. . .

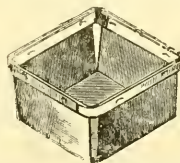

Order your supplies now before the busy season catches you. Price list free. Address

BERLIN FRUIT-BOX COMPANY,
Berlin Heights, - - Erie County, Ohio.

Twice as Much Honey!

Dr. Mason's Experience with Superior Stock.

Dr. Mason, Secretary of the National Bee-keepers' Association, writes me, on date of June 28, as follows:

"I think that I am safe in saying that the colony of bees that has the \$1.50 queen that I got of you about a year ago, although not as populous as most of our colonies, is gathering nearly, if not quite, as much honey as any *two* of our most populous colonies. I never use any smoke in handling them and never get stung.

It's just fun to handle them. When I remove a comb, unless it rubs against another, they don't run and make a fuss about it, but keep quiet and attend to their business."

Price of a queen, \$1.50, or the Review one year and a queen for \$2.00.

W. Z. HUTCHINSON, Flint, Mich.

1881

PAGE & LYON MFG. CO.

1901

We manufacture a full line of the latest
BEE-SUPPLIES.

Our motto is, "Perfect Goods and Prompt Shipment."

Send for our new free illustrated catalog.

PAGE & LYON MFG. CO., New London, Wisconsin.

NOW READY!

64-PAGE CATALOG OF EVERY THING BEE-KEEPERS NEED. Illustrated and fully described. Especially valuable to beginners for the information it contains. Send your address on postal and get it now. Established 1884.

J. M. JENKINS, Wetumpka, Ala.

I. J. Stringham, 105 Park Place, New York City.

Keeps in stock a full line of modern appliances for bee-keepers.

SILK-FACED VEILS.

As good as any made; 35 cents postpaid. Catalog free. Full colonies Italian bees, \$6.00. Apiaries, Glen Cove, Long Island.

I. J. Stringham, 105 Park Place, New York City.

Marshfield Manufacturing Company.

Our specialty is making SECTIONS, and they are the best in the market. Wisconsin basswood is the right kind for them. We have a full line of BEE-SUPPLIES. Write for FREE illustrated catalog and price list.

Marshfield Manufacturing Company, Marshfield, Wisconsin.

THE TRUE TEST!

of a strain of bees is the amount of honey they gather under like conditions, compared with others. Mr. D. R. Keys, Dixie, Ga., an old bee keeper, writes: "That queen from you is simply *splendid*, has shown no disposition to swarm. Her bees have filled three supers of 35 sections each, capped *snow-white*, while the average is not one super so far.—June 6, 1901." See back ads, and write for circular, free. I have carefully selected the best queens for breeders for years, and culled out the poor ones. My stock is a five-band strain, and has *long tongues*. No small or poor-laying queens sent out. Untested, 75c each; six, \$1.00; dozen, \$7.50. For select warranted add 25c. Tested, \$1.25. Select tested, \$2.00. Breeders, \$3.00 and up. Queens sent promptly. J. B. CASE, Port Orange, Fla.

Crimson-Clover Seed.

I have fifty bushels grown on hard land, a No. 1 article, at \$4.00 per bushel for one or more bushels; 1/2 bushel, \$2.25; 1/4 bushel, \$1.25; bags free. Reference, any business firm or bank in Kent Co., Del.

J. Colby Smith, Willow Grove, Del.

EGG FOOD! The kind that tones and keeps up the hen so that she simply must lay. LEY'S POULTRY CONDITION POWDER puts good red blood into poultry veins; kills all disease germs; tones and nourishes fowls—big and little get all there is in the food when fed in conjunction with it. Price 25c pkg.; 5 for \$1. Ley's Thoroughbred Minorca eggs, \$1 for 13. Thoroughbred Belgian Hares. Geo. J. Ely, Florence, California.

The A. I. Root Co.'s Goods

shipped from Jackson, Mich. Root's extra-pollished sections, foundation, hives, shipping-cases, etc., cheap. Send for list.

W. D. Soper, R. D. 3, Jackson, Mich.

Queens! I have now some very fine queens for sale, either 3 banded or 5 banded goldens, at the following prices: Untested, 75c; 6, \$4.25; 12, \$8.00. Tested, \$1.25; 6, \$6.50; 12, \$12.00. Select tested, \$2.00. Golden breeders, \$5.00. We have Root's bee-supplies at Root's prices. We have a special low price on honey-cans. Give us your orders, and I will guarantee you satisfaction. Robert W. Rogers, Hutto, Tex.

Northern Italian Queens

Reared from Imported Mothers.

Our stock is so carefully bred and selected as to secure carloads of honey. Locality free from foul brood and other bee-diseases. Prices: Untested queen, \$1.00; 6 for \$5.00; tested queen, \$1.50; 6 for \$7.50; best imported queen, \$6.00; fair imported queen, \$5.00.

Ada L. Pickard, : Richland Center, Wis.

GRAY CARNIOLANS

We are the largest breeders and importers of this race of bees in America. They are the most gentle bees and the best of workers. Untested queen, 65c; tested, \$1.25; select tested, \$2.25; best imported, \$4.00. Golden Italian queens, same prices. For prices on large orders, nuclei, and full colonies, send for descriptive price list. Address as below.

F. A. LOCKHART & CO., Caldwell, N. Y.

NOW READY. LONG-TONGUED QUEENS!

YARD NO. 1.

By special arrangements with THE A. I. ROOT CO. to furnish them queens, I have secured their assistance in procuring the finest breeding queens that a thorough knowledge of the bees of the country and money can procure. Among them is a select daughter of their \$200 queen that they refuse to quote me prices on. This queen shows every superior quality of her mother. Her bees show an actual reach of 21-100 of an inch; are large, gentle, and beautiful to look upon.

MR. E. R. ROOT SAYS: "You have as fine bees as there are in the United States; and with a direct cross of their breeders you should be able to produce queens whose bees show a reach of 25-100 of an inch."

Send for descriptive price list.

Prices: Untested, 75c; 6, \$4.25; 12, \$8.00. Select untested, \$1.00; 6, \$5.00; 12, \$9.00. Tested, \$1.00; 6, \$6.00. Select tested, \$1.50.

Breeders, whose best bees show a reach of 21-100, with an average reach of 20-100, \$3.00. Breeders, whose best bees show 21-100, with an average of 20 1/2-100, \$5.00. Breeders, whose best bees show 22-100, with an average of 21-100 \$7.00.

I have discovered 2 breeders whose best bees show 23-100; these are too good to sell; don't ask for prices.

Imported Italian stock. Apiary No. 2 Imported queens, daughters and grand-daughters. Have just received an importation direct from Italy which has been introduced into this apiary.

Golden, or 5-banded Italian. Apiary No. 3. Breeders, select tested, tested, untested queens.

W. O. VICTOR, WHARTON, TEXAS.
QUEEN SPECIALIST.

HONEY QUEENS!

Leather-colored Long-tongues.—I have a breeder for which \$25 has been offered and refused. You make no mistake in buying her daughters. They are dandies.

Goldens.—The Laws strain is as good as years of patient selection and breeding can establish.

Holy Lands.—These are a deserving race of bees. With two years' acquaintance I find them great workers, with no vindictive traits, easily handled, are becoming popular, especially in South.

The above races of bees are each bred in separate apiaries, and you can get them in their purity. Am filling all orders by return mail, and I sell at the following low prices, with the usual guarantees. Single queen, untested, 75c; six for \$4.00. Tested, \$1.00; six for \$5.00. Breeders, either race, \$2.50 each. Address

W. H. Laws, Beeville, Texas.

FOR SALE.—Italian bees and queens. Untested queens, \$1.00; tested, \$1.25; full colonies, \$4.00; nuclei, one frame with queen, \$1.50; two frames, \$2.00; 1 lb., \$1.00. MRS. A. A. SIMPSON, Swarts, Pa.

Standard - Bred Queens!

Acme of Perfection; Not a Hybrid among Them.

Improved Strain Golden Italians.

World-wide reputation; 75c each; six for \$4.00.

Long-tongued 3-banded Italians.

Bred from stock whose tongues measured 25-hundredths inch. These are the red clover hustlers of America. 75 cts. each; six for \$4.00. Safe arrival guaranteed. Catalog on application. Headquarters for bee-keepers' supplies.

Fred W. Muth & Co., Cincinnati, Ohio.
South-west Corner Front and Walnut Streets.

Dittmer's Foundation !!!

Retail---Wholesale---Jobbing.

I use a PROCESS that produces EVERY ESSENTIAL necessary to make it the BEST and MOST desirable in all respects. My PROCESS and AUTOMATIC MACHINES are my own inventions, which enable me to SELL FOUNDATION, and WORK WAX INTO FOUNDATION FOR CASH, at prices that are the lowest. Catalog giving

FULL LINE OF SUPPLIES

with prices and samples, free on application. BEESWAX WANTED.

GUS. DITTMER. AUGUSTA. WIS.

Get the Best Queens.

Evansville, Ind., Sept. 27th, 1900.
The Jennie Atchley Co., Beeville, Bee Co., Texas:

Dear Friends:—It gives me great pleasure to forward you this unsolicited testimonial regarding the merits of Atchley queens. The three (3) dozen queens purchased of you have made an excellent record for themselves. Not an Atchley queen among the twenty colonies lost during the severe drouth in July. I have bought queens from many breeders; and although the present crop is exceedingly short, the tiers of supers show where the Atchley queens are, and speak volumes for your method of queen-rearing. I find the progeny to be very gentle, strong-winged, uniformly marked, long-lived, of large size, and last, but not least, the best honey-gatherers I ever had. I shall want 100 more next season.

Yours fraternally, J. C. WALLENMEYER.

Prices for Queens.

Tested, \$1.50 each; \$8.00 for 6, or \$15.00 per dozen. Untested, February, March, April, and May, \$1.00 each; \$5.00 per 6, or \$9.00 per dozen. Fine breeders, \$5.00 each. We have as good bees and queens as money and labor produce. We breed three-banded Italians, Golden, Carniolans, Cyprians, and Holy-Lands, in their purity, bred in separate yards 5 to 20 miles apart. If you want the best, call for Atchley's improved strains. Safe arrival guaranteed. Send for a sample copy of "The Southland Queen," the only southern bee-paper, \$1.00 per year. To new subscribers we offer as a premium a nice untested queen in order to get our paper introduced. Catalog, giving queen-rearing and management of apiaries for profit, FREE.

THE JENNIE ATCHLEY CO.,
Beeville, Bee Co., Texas.

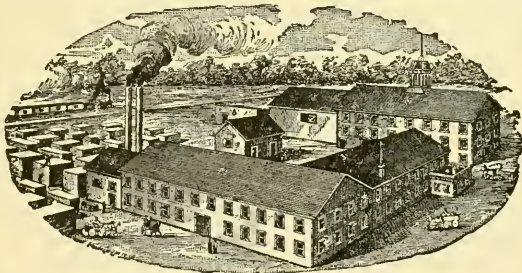

KRETCHMER M'FG CO., Red Oak, Iowa.

BEE-SUPPLIES.

Best-equipped factory in the West; carry a large stock and greatest variety of every thing needed in the apiary, assuring BEST goods at the LOWEST prices, and prompt shipment. We want every bee-keeper to have our FREE ILLUSTRATED CATALOG, and read description of Alternating Hives, Ferguson Supers, etc. Write at once for a catalog.

— AGENCIES: —

Trester Supply Co., 103 So. 11th St., Lincoln, Nebraska; C. C. Richards, 1223 17th St., Denver, Col.

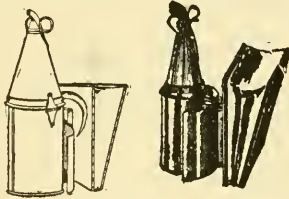

BINGHAM SMOKER.

Dear Sir:—Inclosed find \$1.75. Please send one brass smoke-engine. I have one already. It is the best smoker I ever used.
Truly yours,
HENRY SCHMIDT, Hutto, Tex.

MADE TO ORDER

Bingham Brass Smokers.

Made of sheet brass, which does not rust or burn out; should last a lifetime. You need one, but they cost 25 cts. more than tin of the same size. The little open cut shows our brass hinge put on the three larger sizes. No wonder Bingham's four-inch smoke-engine goes without puffing, and does not drop inky drops. The perforated steel fire-grate has 381 holes to air the fuel and support the fire. Heavy tin smoke-engine, 4-inch stove, per mail, \$1.50; 3½-inch; \$1.10; 3-inch, \$1.00; 2½-inch 90c; 2-inch, 65c. Bingham smokers are the originals, and have all the improvements, and have been the standard of excellence for 22 years. Only three larger ones brass.

T. F. Bingham, Farwell, Michigan.

Contents of this Number.

Bee Legislation in France.....	626
Cells, Pre-constructed.....	26
Drouth in Illinois.....	626
Editor in Texas.....	627
Feeding Back.....	643
Formic Acid in Honey.....	625
Foundation, Pressed and Rolled.....	626
Frame, Hoffman Barless.....	634
Hive-tool, Handy.....	644
Honey, Comb and Extracted in One Hive.....	635
Honey for Nursing Children.....	625
Honey to Color Agate.....	625
Honey-knife, Miller's.....	626
Honey-plants of Texas.....	628
Horsemit of Texas.....	630
Howe, Harry, Health of.....	644
Nassonoff's Organ.....	639
Organ in Bee, New.....	639
Queens, Keeping Over Extra.....	644
Rambler's Talk.....	640
Rauchfuss, Herman.....	633
Scholl, Louis.....	628
Season for 1901.....	649
Separators, Harrison's.....	645
Silver Linden and Bees.....	625
Stachelhausen, L.....	628
Sugar, Beet, for Bees.....	644
Super, Queen-mating.....	633
Swarms Hived in Roomy Hives.....	646
Swarthmore Criticised.....	630
Swarthmore System of Queen-rearing.....	634
Wiring, Horizontal.....	625

Honey Column.

GRADING-RULES.

FANCY.—All sections to be well filled, combs straight, firmly attached to all four sides, the combs unsoiled by travel stain, or otherwise; all the cells sealed except an occasional cell, the outside surface of the wood well scraped of propolis.

A No. 1.—All sections well filled except the row of cells next to the wood; combs straight; one-eighth part of comb surface soiled, or the entire surface slightly soiled; the outside surface of the wood well scraped of propolis.

No. 1.—All sections well filled except the row of cells next to the wood; combs comparatively even; one-eighth part of comb surface soiled, or the entire surface slightly soiled.

No. 2.—Three-fourths of the total surface must be filled and sealed.

No. 3.—Must weigh at least half as much as a full-weight section.

In addition to this the honey is to be classified according to color, using the terms white, amber, and dark; that is, there will be "Fancy White," "No. 1 Dark," etc.

CITY MARKETS.

CHICAGO.—Choice white comb honey is arriving rather more freely, and brings 15 cents. There is no accumulation at this writing, as receipts sell within a week after arriving, some of them on the same day. Amber grades bring about 12 cents. Extracted, dull and slow of sale at anything over 5@5½. Beeswax steady at 30 cents, with good demand.

July 18. R. A. BURNETT & Co,
199 South Water St., Chicago, Ill.

ALBANY.—Honey market quiet, but some inquiries from both buyer and bee-keeper. We look for good demand earlier this season than usual, as no old honey is remaining over.

July 21. McDUGGAL & Co.,
Albany, N. Y.

NEW YORK.—Comb and extracted honey market dull and featureless. Some small lots of Southern comb honey arriving, but demand is very limited, quoting 11@15c per lb. as to quality. The outlook at the present is for a good crop, and prices are not likely to rule as high as last season particularly extracted. Beeswax is not as firm as has been, and prices not ruling as high; fancy, 30@31, average, 28@29.

July 19. CHAS. ISRAEL & BROS.,
486, 488, & 490 Canal St., Cor. Watt St.

DETROIT.—Fancy comb, white, 15c; No. 1, 13@14; no dark to quote. Extracted, white, 6@7c; dark and amber, 5@6c.

July 18. M. H. HUNT & SON,
Bell Branch, Mich.

SAN FRANCISCO.—The following are the quotations of the San Francisco Chronicle, of July 11th:

Comb honey, per lb., 10@12; extracted, water white, 5½@6½; light amber, 4½@5½; dark amber, 4@5c. Beeswax, per lb., 25@27.

Mr. H. J. Wilder, of Riverside, writes me as follows: "Riverside, Cal., July 9, 1901. It is true that a report went east early in the season, to the effect that we were going to have an immense crop, but it came from sensational newspaper correspondents, and not from bee-men; they knew that with three-fourths of our bees dead the output of honey couldn't be heavy."

As Mr. Wilder is the president of the Bee-keepers' Exchange of Los Angeles, he can be said to speak with authority.

Murphys, Cal., July 13.

E. H. SCHEFFLE.

NEW YORK.—Just at present the market is almost entirely cleaned up of all kinds of comb honey. Some few lots of fancy white have been received from the South and sell readily at from 14@15c per lb. Extracted honey is without demand at present, and is selling at from 4½@6, according to grade. Beeswax is in good demand and sells promptly at from 28@29c.

FRANCIS H. LEGGETT & Co.,
West Broadway, Franklin & Varick Sts.

July 22.

MILWAUKEE.—The receipts of new comb honey thus far have been very fine, showing an improvement on receipts of last year, and the demand is very fair considering the season, and sales at good rich values for the producer. We can encourage shipments of best quality, and assure good sales. We quote fancy 1 lb., 17@18c; A No. 1, 16@17; amber, nominal, 13@15. Extracted, in bb's, kegs, pails, or cans, white, 6@8c; amber, 5@6. Beeswax, 20@25@30.

July 20. A. W. BISHOP & Co.,
119 Buffalo St., Milwaukee, Wis.

DENVER.—New comb honey, No. 1 white, \$3.00 per case; No. 2, \$2.75 per case. Extracted, white, 7c. Beeswax, 22@24.

July 20. THE COLORADO HONEY PRODUCERS' ASS'N,
1440 Market St., Denver, Col.

WANTED.—Western honey in car lots, also northern fancy white comb in no-drip cases; state price delivered. We pay spot cash. Reference, German National Bank, Cincinnati. FRED W. MUTH & Co.,
Front and Walnut Streets, Cincinnati, Ohio.

WANTED.—Comb and extracted honey. State price, kind, and quantity. R. A. BURNETT & Co.,
163 South Water St., Chicago, Ill.

WANTED.—Extracted clover honey in cans; cans furnished if desired. Quote price. I. J. STRINGHAM, 105 Park Place, New York.

WANTED.—To buy your honey. State your lowest cash price, kind, and quantity. EDW. WILKINSON, Wilton, Wis.

WANTED.—Honey; car lots or otherwise. Will send man to receive when sufficient amount to justify, and pay highest market price, spot cash. Address, stating quantity, quality, and price desired at your station. THOS. C. STANLEY & SON, Fairfield, Ill.

FOR SALE.—Extracted honey in 60-lb. cans, No. 1 alfalfa, 7½c per lb.; partly from other bloom, 6½c. D. S. JENKINS, Las Animas, Colo.

We will be in the market for honey the coming season in carloads and less than carloads, and would be glad to hear from producers everywhere what they will have to offer. SEAVEY & FLARSHIM,
1318-1324 Union Avenue, Kansas City, Mo.

NO MORE SPOILT FRUIT.

Canning made easy and sure by using my Standard Patent self-melting, self-sealing wax strings. Very economical, and easy to apply. Valuable fruit information and 100 strings, by mail, for (forty-five) 45 cents in stamps.

C. C. Fouts, Middletown, Ohio.

Write Me for price if you want 100 or 200 colonies of bees in 8 frame hives, delivered in New York City or Havana, Cuba. I want 25 Carniolan queens October 1st.

W. L. COGGSHALL, W. Groton, N. Y.

Wm. A. Selser, Honey Expert,

When you buy honey, send a 3-oz. bottle, have it tested, to be sure it is pure. Price \$2.50 per sample. By doing this you may avoid over ten times this amount in litigation with pure-food laws. Chemist's certificate given.

The A. I. Root's Co.'s Office, 10 Vine Street, Philadelphia, Pa.

G. B. LEWIS CO., WATERTOWN, WIS.

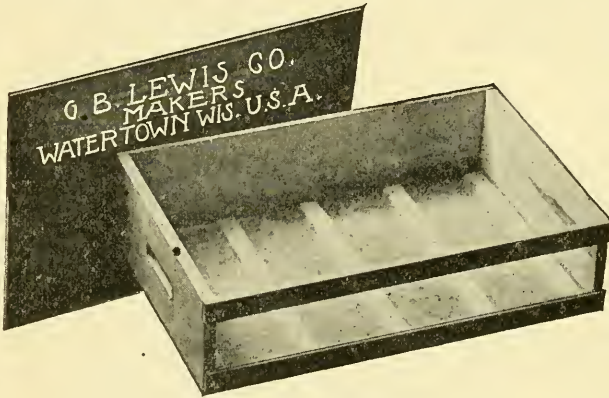

Bee-hives,
Lewis' White
Polished Sections,
Shipping-cases.



Perfect Goods,
Prompt Shipment.

BRANCH: G. B. Lewis Company, 19 South Alabama Street, Indianapolis, Indiana.

AGENCIES: L. C. Woodman, Grand Rapids, Michigan; Fred W. Muth & Co., Southwest Corner Walnut & Front Sts., Cincinnati, Ohio; Fred Foulger & Sons, Ogden, Utah; Colorado Honey-producers' Association, Denver, Col.; Grand Junction Fruit-growers' Association, Grand Junction, Colorado; Robert Halley, Montrose, Colorado; Pierce Seed and Produce Company, Pueblo, Colo.; E. T. Abbott, St. Joseph, Missouri, Special Southwestern Agent.

Queens now Ready to Supply by Return Mail

STOCK which can not be **EXCELLED!!** Bred under the **SUPERSEDING CONDITION** of the colony. **Golden Italians**, the great honey-gatherers. They have no **Superior** and few **Equals**. Each 75 cts.; 6 for \$4.00. **Red-clover Bees**, the Long-tongue Italians, which left all **Records** behind in **Gathering Honey**, \$1.00 each; six for \$5.00. **Safe Arrival Guaranteed**. Headquarters for **Bee-supplies**. **Root's Goods at Root's Prices**.

C. H. W. Weber, 2146-2148 Central Av., Cincinnati, Ohio.

Successor to Chas. F. Muth.

Catalog Free; Send for Same.

GLEANINGS

BEE CULTURE

A JOURNAL DEVOTED TO BEES AND HONEY AND HOME INTERESTS.

ILLUSTRATED SEMI-MONTHLY

Published by THE A. ROOT CO.
\$1.00 PER YEAR MEDINA, OHIO.

VOL. XXIX.

AUG. 1, 1901.

No. 15



A FOUL-BROOD LAW is strongly opposed by bee-keepers in Australia. T'other way here.

THE Chicago *Record-Herald* has this:

The bee stings once, and then
May never sting again;
The slanderer, day after day,
In wanton malice stings away.

AUSTRALIA now has a third bee-journal. Like its predecessors, the new comer rejoices in a long name, *Australian Bee keepers' Review*.

THE WORST DROUTH I ever knew in July. Grass entirely dead, to all appearance. Bees in danger of starving. [See answer to Straw elsewhere.—ED.]

FOR TARTAR on the teeth, dentists use, says *Le Miroir des Modes du Jour*, the following: One part muriatic acid, one part water, and two parts honey.

FOR CRACKED LIPS.—Apply, on going to bed, a lotion consisting of two parts honey, two parts lemon juice, and one part cologne water.—*Le Progres Apicole*.

DOOLITTLE says in *Progressive* that stimulative feeding in time of dearth will keep up laying if weather is fairly comfortable, but it will do little or no good after three or more days of continued bad weather.

SILVER LINDEN was accused of destroying bees, many dead bees being found under it. Numerous defenders have appeared in the foreign journals, and it now seems doubtful that it was ever guilty in any case.

MRS. BARBER's explanation seems reasonable for her bees, p. 598; but it still leaves the puzzling question, why do my bees act so differently? for when honey comes in a flood the baits are the first sections sealed in the super.

E. RUFFY reports in *Revue Internationale* that he put in his hives beside the feeders balls of unwashed cappings, and the bees used the wax of the cappings in building out comb with great rapidity. The balls may be the

size of an apple to the size of one's head, and it is essential that the cappings be unwashed.

B. F. AVERILL beats me in using foundation-splints without waxing. The bees tore down such splints for me. I like better the length of his splints, but putting them in out of hot wax I must use them shorter. I think I must try again and see if I can succeed with dry splints.

JULY 15 some of my colonies have stopped brood-rearing on account of the drouth. Sealed brood and eggs in the hive, but no unsealed brood, showing that the queen still lays, but the workers will not rear brood. I think that occurs more frequently than is generally supposed.

"AFTER A BEE has filled a cell with nectar she turns round and puts a drop of formic acid in it to preserve it."—Dear *British B. J.*, how could you allow such a statement in your columns without saying it was rank nonsense? [That does sound queer in so reliable and scientific a bee-paper as our esteemed cotemporary the *British Bee Journal*.—ED.]

In *Wegweiser* is reported the case of a child brought up on the bottle. Equal parts of milk and water were used, sweetened with honey. In 7 months the child had consumed 25 lbs. of honey (nearly 2 oz. a day). Later the proportion was 4 parts milk to 1 of water, the honey still continued. The child was very hearty, sleeping the whole night, and being remarkably free from the usual ills of childhood.

THAT HONEY is used for a coloring material, *Illustrierte Monatsblätter* rightly says, is not generally known. The coloring of agate depends upon the porosity of the individual layers of the stone, which are capable of absorbing liquids. The stone lies several weeks in dissolved honey, and is then boiled in sulphuric acid. The charred honey colors the stone black where of greater porosity, gray or brown where of less.

AT MEDINA you like horizontal wiring. So do I, if I could get combs built clear down to the bottom-bar. Can you do that at Medina with horizontal wiring? [Yes, and no. It depends on the season when such frames of wired foundation are given to the bees in the

first place. I have taken a set of Hoffman frames, and laid on them two strips of wood, turned the hive upside down on the bottom-board, and let the hive remain upside down for two or three days during the height of the honey-flow. It does not take long for the bees to force the comb clear up to the bottom-bars in this case.—ED.]

Die Biene reports that H. Heimberger had 4000 combs built from cylinder foundation, and 1000 built from foundation made in a foundation-press. The latter were the only ones that did not stretch out of shape. [By "cylinder foundation" I suppose is meant that which comes off from ordinary foundation rolls. The ordinary article I have seen, that comes from the press, has a thicker base and much heavier walls than that which comes from the rolls. If this is the case, of course the former would not be as much inclined to stretch as the latter. Foundation from rolls, as a general thing has lighter walls; and I should incline to the opinion that it is not a question of rolls or plates, but a question of cell-walls in the first place.—ED.]

A PUTTY-KNIFE of overgrown size is greatly liked by S. E. Miller (*Progressive Bee-keeper*). Handle and all, it is nearly a foot long; will pry apart bodies with ease and without a snap, and will scrape burr-combs from two top-bars at once. It is made of $\frac{1}{8}$ -inch steel, $2\frac{1}{2}$ broad at the end, tapering to $1\frac{1}{4}$ inches $\frac{6}{8}$ inches from end, or where handle begins. The handle is made of two half-round pieces of wood riveted on like handles of butcher-knives.—[Our people at the Home of the Honey-bees use, as a general thing, a putty-knife for a hive-tool, seeming to prefer it to any thing else. Although I have handled a variety of hive-tools, yet they all seem to be laid aside, and the good old-fashioned putty-knife is used.—ED.]

AN ERROR that seems to have more or less credence among those who might easily know better, if they would use their eyes, is that a post-constructed queen-cell consists of three cells made into one. It is never any other than a single worker-cell enlarged. The usually reliable *British Bee Journal* admits an article with the error aggravated by speaking of the queen laying in cells "consisting of three cells turned into one." [You seemed to be surprised once because I did not know what "post-constructed" and "pre-constructed" cells were. Well, now, I am not going to say whether I have forgotten or not; but methinks you had better make a definition of both, so we can have it incorporated in GLEANINGS and in the A B C book.—ED.]

MY HEART is singing with gratitude this 18th of July. Last night we had a glorious rain to break the terrible drouth. For weeks no rain, and for many days up to 98° to 100°, one day reaching 105° with an incubator thermometer. The honey crop is a failure, some other crops as well, but there's lots to live for yet. It's worth while to be roasted a while to find out how good a thing a drenching rain is. I'm now writing on the piazza at 9:30 A. M., with the thermometer at 83°, and it seems

so nice and cool. [On my trip from Colorado eastward I took occasion to ride through Kansas and Nebraska in the day time, because I had heard about the awful drouths in those two States, and I wanted to see for myself. Sure enough, the corn was beginning to show the effects of the drouth, and no mistake. But, fortunately, I soon had the pleasure of seeing the gathering clouds, and in a day or two afterward I heard that those two States had had a good shower; but it would take a number of them, I should judge, before the thirsty ground would have enough to put things on a boom again. When I got into Iowa I found every thing parched just the same; and at Des Moines the lawns were all brown. It had been found to be practically useless to sprinkle them, as the heat was so intense. As I moved eastward I could see more and more evidences of rain; and when I got into Ohio, my dear old State, the ground was nice and moist, and every thing on a boom. While in the mountain States the ranchers in the valleys were discussing the drouth in the States east of them, and were congratulating themselves because they could have water, and plenty of it, any time they opened their irrigating-ditches.—ED.]



"Whew!" says Denver; "It's getting cool;
It's down to 96;"
"I fear we'll melt," says Illinois;
"It's up to 96."

In the previous issue I spoke of an article appearing in the *Australian Bee-keepers' Review*, credited to J. E. Crane. W. Z. Hutchinson informs me that said article first appeared in the *American Bee-keeper*, of Jamestown, N. Y., our Australian friends failing to give proper credit. I am glad Mr. Hutchinson noticed the error.

REVUE UNIVERSELLE D'APICULTURE.

As Mr. Fisher's regular article, Bees in Law, does not appear in this issue I thought that it might not be uninteresting to the readers to know that this matter has been before the French courts, and constitutes a very considerable part of their jurisprudence. The questions arising in regard to swarms have been matters of judicial action since the days of the Romans at least; and out of a great many precedents we have to-day the law as it stands in France. I make a translation of only the essence of some decisions thus far arrived at, omitting the dates of the laws.

As to the right of pursuit, the owner has the right to capture and rehive a swarm so long as he has not ceased to follow it. This confers on the owner of the hive the right to follow, in preference to that of any other person. The legitimacy of this right is recognized in

all legislation, and can not be contested. It is evident that the swarm belongs to the owner of the hive whence it issued, so long as he has not abandoned pursuit, for he thus shows his intention to keep what has never ceased to be his property.

Can the owner of a swarm chase it by proxy? We do not believe a man can be compelled to chase his swarm in person. No law prescribes that; and no one can in right refuse the right of pursuit to one who, unable to do so himself, authorizes a second person to take his place.

As to following a swarm on uninclosed land, if a swarm alights on such ground the bee-keeper may follow it, but is responsible for all incidental damage. If the land is fenced, the pursuer has the right to claim and retake when entrance to the farm has been accorded. But how shall one act when permission is refused? In that case he goes before a justice of the peace and gets out a "letter of delay," in view of the urgency of the case, summoning the owner of the land before the court, ordering him to give up the swarm or pay for it. It has been decided that one who refuses to the owner of a swarm the right to have access to his land, even when surrounded by walls, and whereon the bees have lodged, becomes responsible for the damage caused by this refusal.

In regard to following a swarm lodged in an empty hive, such swarm belongs to the pursuer, at least so long as he has not abandoned pursuit. In such a case, no right can take priority over his own; hence he may take the swarm, without hesitation. But suppose the hive is already occupied, what then? It often happens that a swarm, in quest of a home, attacks a feeble colony, or one ill defended, overpowering it by main force, and, after a regular siege, occupies the hive. The pursuer, in this case, finds it impossible to identify or retake his own bees; for how can he tell his own bees from the others? It has then been generally decided that the swarm should belong to the owner of the hive where it is lodged, and without indemnity to the pursuer, who has gained nothing, but lost the greater part of his bees. The Roman law did not confer the right of pursuit except when the chase was easy. The French law seems to confirm this, as it presupposes the possibility of retaking the swarm.

On whom is it incumbent to prove the ownership of the swarm? In cases of dispute with the owner of the land on which the bees have settled, it is for the owner of the bees to prove that they came from his hive. The owner of the land finds himself the owner of the bees unless he has by fraud enticed them, or unless the owner of the hive has given up pursuit. This decision conforms to the old laws, and especially to the Ordinance of Louis IX., in 1270. Ordinary proof by witnesses is admissible. But it often happens that witnesses were not on hand at the time the swarm issued; but for all that, reasonable presumption must be allowed.

The pursuit of bees may be interrupted by a temporary obstacle, such as the coming of

night or the passage of a stream of water. But the right to follow is maintained in this case, but on condition that the owner of the bees shall resume pursuit as soon as possible—for example, in the morning or when the stream is crossed.

The right to follow ceases with the abandoning of the pursuit.

Has everybody, like the owner of a colony, the right to follow an abandoned swarm? It would seem, at first sight, that such a swarm belonged to nobody; that the first one coming might follow it as well as the original owner. But this opinion can not be sustained; for, as Mr. Varembeys says, the right to follow, accorded by the law of 1839 to the owner of a hive casting a swarm, is an exceptional right which can not be extended to other cases. The pursuit should not be confounded with occupation, the latter consisting only of the real taking of the bees. Everybody may follow, without doubt, an abandoned swarm, without having a real *right* to follow, including all the results arising therefrom. He who, then, is the first to take possession of an abandoned swarm becomes thereby the rightful owner to the exclusion of all others.

In reference to an abandoned swarm in simple repose, such swarm, before choosing a habitation, frequently does not stop except momentarily for a rest. In this case who is the owner? The law is silent in this case; but there is no doubt that the swarm, having regained its natural liberty, should be considered wild, and the property of the finder.



NOTES OF TRAVEL.

A Visit with L. Stachelhausen and Louis Scholl; the Honey-plants and Honey-resources of South-central Texas.

BY E. R. ROOT.

After leaving Mr. Jenkins at Wetumpka, Ala., I took the train for San Antonio, Texas, going through Mississippi, Louisiana, and part of Texas without a stop. At the station I was met by a thick-set, full-bearded gentleman, no less a personage than L. Stachelhausen, of Selma, Texas. As a writer on bees in the journals of both America and Germany, no man is better known. Always practical, his writings show a marked familiarity with the bee literature of both continents. When, therefore, the person I have described modestly stepped forward and introduced himself as Stachelhausen it was with a real thrill of pleasure that I grasped his hand—a hand that knows well how to lift heavy supers of honey as well as swing the pen. He explained that he was serving on the jury, and hence was temporarily in San Antonio. As court had been dismissed for the day, and knowing the

hour of my arrival, he came down to the train. How we did talk over men and methods! He was still using his method of brushed swarms with success—something that he described in GLEANINGS some months ago. As Mr. Stachelhausen was to go on duty the next day I took the train for Hunter, Texas, where resides a young bee-keeper not yet of age, but who, nevertheless, has become quite well



L. STACHELHAUSEN.

known through the bee-journals. I refer to Louis Scholl, an intimate friend of another young bee-keeper, and equally well known—H. H. Hyde, of Hutto, Texas. These two enthusiasts have gotten up what is known as the Hyde-Scholl separator, a device which, if I may judge from results, is not without some merit. Some one let leak the fact in my ears that a pretty sister of one of the boys made the attachment all the stronger. What could be more natural than that one of the boys would contrive to see the other (boy) just as often as he could? But be that as it may, the two (mayhap the three) evidently have studied and planned many a little convenience for the apiary. Certainly the workshop of Mr. Scholl, which I saw, gave many evidences of it. There was a machine for putting starters in sections, and one for putting them in brood-frames. The last named is quite ingenious, and perhaps Mr. Scholl will describe it later.

Among other interesting things in the aforesaid shop Mr. S. showed me a very complete herbarium of all the honey-plants of Texas, with their names, and a brief note of their importance to the bee-keeper. It is the best collection of honey-plants for one State I have ever seen, and it serves to show the thoroughness with which our young friend has gone into the study of every thing connected with his pets, the bees.

Of three of the most important for his part of the State, and on which he relies for his main crop, I took photographs from life, and nearly life size. These I present to our readers. Concerning each I asked Mr. Scholl to prepare a short note, and this he has done.

HORSEMINT—MONARDA PUNCTATA.

“Begins to bloom in May, sometimes a little later, June, depending on the season, such as a very dry and a backward spring. The honey is compared with that of the basswood of the North on account of its peculiar strong flavor which it resembles; is of light color; one of the best honey-plants of the South, and tremendous yields have been obtained. I have just gone out to procure some of the flowerets, and send same to you herewith. Perhaps you remember what you said about a chance for long tongues while taking the shot at the horsemint on our porch. I have been interested in this question, and can not see how short-tongued bees could ever get every thing that is nectar out of those long tubes. What do you think about it? Red clover not alone for long tongues.”

MARIGOLD—(?).

“Marigold is one of our main honey-producers, yielding in May and June a rich golden

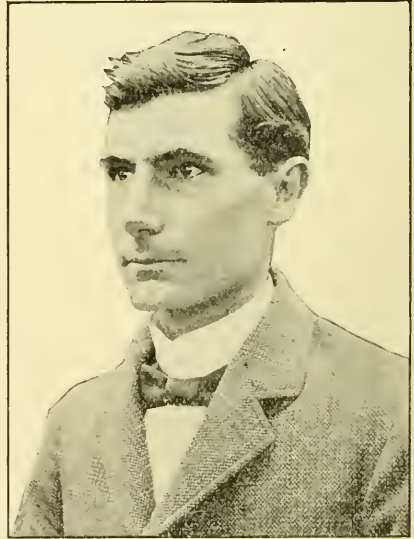

LOUIS SCHOLL.

honey, having a flavor that is liked by many and preferred to others. The honey is of a very heavy body, as sections of the plain ($3\frac{3}{8} \times 5 \times 1\frac{1}{2}$) kind, filled the same as those with mesquite or cotton honey, outweigh these by over 2 oz., the heaviest weighing a little over $16\frac{1}{4}$ oz. The comb also is of a golden yellow color.”

HOARHOUND—MARRUBIUM VULGARE (?).

“Some time in February the hoarhound begins to bloom, lasting and yielding a steady

flow of nectar until very late in summer or until very hot and dry weather puts an end to it. The honey is of a golden color, heavy and limpid in body. It will be remembered that the honey from this source is generally proclaimed as being so bitter that it is worthless; but such does not seem to be the case with it here, as in some years quite a lot was produced, and sold too, without any complaints. The honey is really sweeter, or has such a sweet taste that it is nauseating to some. It has good medicinal qualities, and has been recommended as such by some persons having had good results after using."

As Mr. Scholl had no recent photograph of himself I made one of him. This picture, as originally taken by me, is half life size, and yet it was taken with a 7×5 folding kodak, without a ground glass, and weighing only 4 lbs. and 4 oz. It was pronounced so perfect by an expert in Los Angeles, who saw the negative, that he wanted to send it in for me to compete for the \$500 prize offered for such work, and this he has done. If this picture receives even honorable mention, friend Scholl can send a copy of it to that pretty girl, with my best compliments; but the prize money—I'll pocket that. I am not worrying what I'll do with the money, for I'll never get it, for the chance is as one in a thousand.

The other picture shows Mr. Scholl in his work clothes—rough and ready for work

among the bees. He is standing before one of his favorite colonies, prepared to open it. On the right will be seen a handsome bunch of cactus, just as it came up naturally. To Mr. Scholl and his people there was nothing rare or beautiful about it, as it is too abundant with its pricklers to be at all pleasant. But I thought, what would a florist or a landscape-gardener of the North give for such a beautiful thing? How true it is that a prophet is not without honor save in his own country, and that familiarity breeds contempt, even for cacti!

Another thing that interested me was the Texas horned toads that were running over this apiary, and even over the buildings. These ugly things, more suggestive of his satanic majesty than any thing else, did not win my admiration as did the cacti. But the way they would dart about was enough to arrest the attention of any tenderfoot.

Mr. Scholl uses and prefers, I believe, shallow brood-chambers. He has been testing various styles of hives side by side for several years, and the more he experiments the more he inclines to the divisible brood-chamber, for the production of comb honey at least.

I did not go further north, as I had planned, to see the Hydes, as I saw that it would throw me out of my schedule, which had been too hastily laid out; so I bade Mr. Scholl good by and took the train back to San Antonio.



LOUIS SCHOLL AT WORK AMONG HIS BEES; EVERGREEN SHADE ON THE LEFT AND CACTUS ON THE RIGHT.

THE SWARTHMORE SYSTEM OF FERTILIZING NUCLEI CRITICISED.

Is the Scheme of Small Nuclei for the Purpose a Permanent Success?

BY GEO. J. VANDE VORD.

My attention was arrested by the fascinating and alluring description of Swarthmore's effective (?) plan of getting queens fertilized from those little one-frame (section size) nuclei, described in *GLEANINGS*, page 434; and I almost found an old-time enthusiasm arising in me on the subject of mating queens from small nuclei; but a mental picture of past experience that was pretty full of shadows effectually cooled me off, and I began to wonder how many more of *GLEANINGS* readers had struck shoal water on small nuclei since A. I. Root first enthused on them, only to abandon them after using them for some time. It may interest those who see in his article a way to produce queens at a greatly reduced price, to read of some difficulties that

lie ahead of them in following his plan, and that he has entirely failed to mention.

For several years I was using, or trying to use, nuclei composed of from two to four sections, placing several together in one section-super, and having entrances nearly 14 inches apart—about twice as far as Swarthmore's—and differing from one another by having blocks of varying shape at every other entrance.

I found such nuclei to be all right for keeping virgin queens in up to the time of their flight; but an extra large percentage would at that time take to running around outside the entrances; and if the bees at the neighboring entrance should be fanning, she would run over there, presumably to see what the fun was, and quite frequently she would slip inside the entrance unopposed, to "visit with Cousin Kate," but, unlike Timmy Doolan's cat in the comic song, she would never come back.

Then there is always, by any system, a percentage that get lost when taking their flight; and by Swarthmore's plan the nuclei from



TEXAS HORSEMINT; ONE OF THE PLANTS THAT HAS LONGER FLOWER-TUBES THAN RED CLOVER.

which these queens come are a source of danger to the neighboring queens, as they are very much given to running across to the nearest entrance having a queen within, leaving barely any bees to care for the few cells of brood in their old home; and while, if honey is coming in freely, they will rarely do any harm, yet if it is not, they are very apt to ball the queen they came to pay homage to, within two days, if she should not have begun laying. If she has begun laying, then the addition to the number of bees in the little nuclei only hastens a danger that is always present with very small nuclei, of the queen and bees swarming out and completely deserting their home, brood or no brood, honey or no honey, on account of its small size and entire unfitness to retain a normal colony, of which the bees often seem more aware than their owner.

In those cases where the queen gets safely

through the previous dangers, and begins laying, she will scarcely have been laying 24 hours, when, becoming discontented with her small accommodations, she must be quickly removed or fastened in by entrance-guards if she is to stay where the bee-keeper can put his fingers on her.

If black or hybrid bees are used for forming the nuclei, the danger from the bees running from one entrance to another is greatly augmented.

I have sometimes seen the bees from one of these little nuclei, after losing their queen on her flight, come out in a string and run to their nearest neighbor, fanning their "queenless" note, and entering without opposition, staying only a short time, evidently searching for their lost queen, when out they came, and on to the next entrance; and whenever they will go in, and yet not stay, you may confidently open the nuclei to take out a balled



MARIGOLD, ONE OF THE PRINCIPAL HONEY-PLANTS OF TEXAS; BUT FOUND ALL OVER THE UNITED STATES.



TEXAS HOARHOUND STALKS (LIFE SIZE) WITH SMALL, WHITE, STAR-LIKE FLOWERS.

queen; and sometimes, even when they stay, the queen disappears in a few days.

One swallow does not make a summer, nor does success with an occasional bunch of these small nuclei, when every thing is favorable, and the queen and bees happen to refrain from "visiting," warrant the conclusion that such nuclei are both practical and profitable.

I'll warrant the opinion that there is not one in four of the queen-breeders of to-day who has not tried and discarded some such plan of running little nuclei; but there are few who will rush into print to tell of the things they have tried and found unworkable. We all know that a queen is very reluctant to lay in a single comb; and many young queens will swarm out after becoming fertilized, and arriving at the point of laying, rather than begin in a frame that is not protected by combs on each side of it; and this is especially true of single combs that are smaller than half the size of a Langstroth frame.

His directions for collating a large number of queens in one hive (magazine hives, page 506), will work for only a few weeks, and then the bees will favor one of the queens, and neglect or even destroy all the rest. That is my experience, at all events.

Daytona, Fla.

[It is possible and even probable that most people will fail in getting queens fertilized in nuclei as small as Swarthmore describes, and especially so many of them so closely put together; but there are several who have made a success in having queens fertilized in small three-comb nuclei of no larger size than three $4\frac{1}{4}$ sections.

Herman Rauchfuss, of Colorado, told me, when I called on him recently, that he had succeeded in having 6 out of 8 queens fertilized in these little three-comb boxes. He divided off an ordinary super into 8 compartments, each having three little combs of the size of a section honey-box. There are two entrances on each side, and two on each end. In these little nuclei he not only had queens fertilized, but confined them and

kept them there by the use of perforated metal after they had begun laying eggs. Two years ago, when I visited Mr. Rauchfuss I took a photo of him, his little girl, and the queen-mating super, one of which he is holding in his hand. Its general mode of construction will be apparent from the engraving.

Mr. E. F. Atwater, of Meridian, Idaho, was using something quite like this when I called on him recently, and he was making a success of it; and in a letter received from one of the best queen-breeders in the country, Mr. W. H. Pridgen, I found he has also used something similar and made it work; and you yourself, I believe, have accomplished it, but you do not consider it a reliable plan. But Swarthmore has gone one step further; and instead of having three little nucleus frames he has only one, and that a little larger size. If it is possible to make the others a success, *perhaps*, with the right management and the requisite amount of skill, one could make the other. This is a matter of considerable importance; and if bees sufficient to cover one or two Langstroth frames, and equivalent brood, can be made to have six or

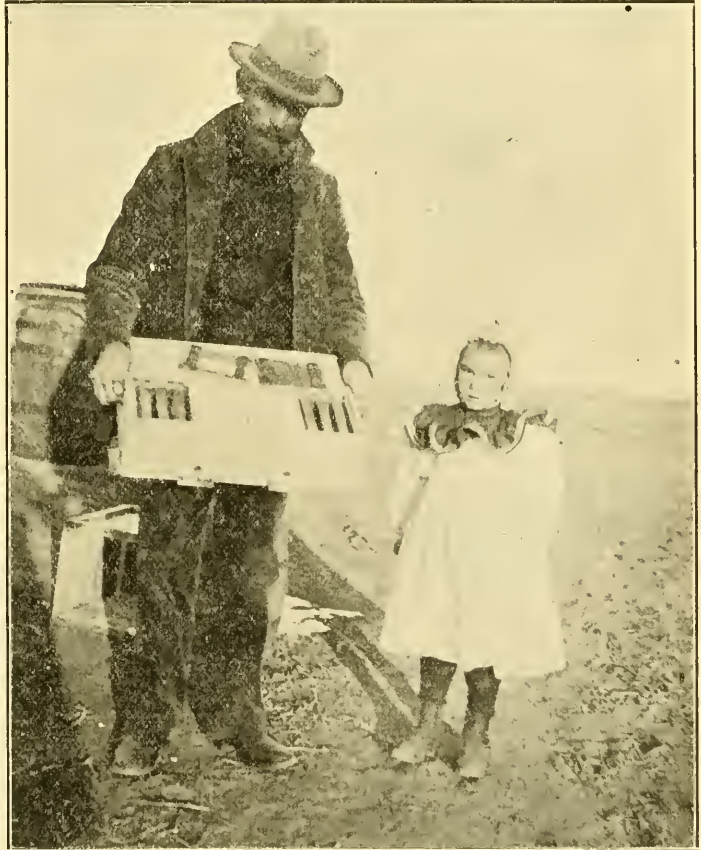

MR. HERMAN RAUCHFUSS SHOWING HIS QUEEN-MATING SUPER.

eight queens fertilized where only one would be ordinarily, then we have made a step in advance. Swarthmore's method may be open to criticism; and if so, let those who have had experience enlighten us, for it is only by discussion that we can get at the full truth.—

Later.—We have just received word from Carl F. Buck, of Augusta, Kan., who has been trying the Swarthmore methods, that he had "just taken from ten Swarthmore nuclei boxes nine queens. I attached the boxes to brood-chamber above an excluder. Will you please let me know what you actually think of the fertilizing of queens in Swarthmore nuclei boxes, attached to upper chamber above excluder?" Answering your question, A. I. R. feels sure that the one-comb section-box will not generally prove to be a success.—
[Ed.]

THE SWARTHMORE SYSTEM OF QUEEN-REARING.

Continued from last Issue.

BY SWARTHMORE.

With open-top frames and shell cups, all one needs to do, when he wants queens or cells, is to roll the sheet back a bit and draw one or a cageful—no smoke, no stings, no undue disturbance to the bees, no laborious work in the hot sun, no fear from robbers—just the simple act of "drawing one;" then replace the hive-cover and come away. One has all he needs, without lifting a frame.

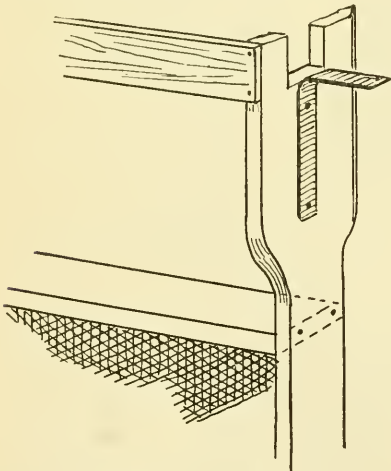

HOFFMAN BARLESS FRAME.

The above shows the manner of converting a Hoffman frame into an open-top or barless frame for receiving nursery-cages.

It might be well to say, that the sheet should be split directly over the "open frame," then it is not necessary to skin the entire surface of the frames every time one needs a cell or a queen, or a cageful of queens.

To convert a Hoffman frame into an "open frame," remove the regular top-bar and fit a

$\frac{3}{8}$ strip between the end-bars, two inches below. Screw brackets of strap iron firmly on to each end-bar, as shown in the sketch, to form ears for the support of the frame in proper position. One thin strip nailed edgewise on to the flat edges of the end-bars will suffice to steady the cages.

MAKING PLUG-CUPS.

The molding of the plugs ready for compression can be done on cool days—when a little fire is welcome, you know. I prepare 500 to 600 plugs at a time, and do them all at one melting, thus:

The top-bars are laid flat upon strips of tin in lots of 50 or more, and the shells are stood upon end in shallow trays, in lots of 100 or more. The melted wax is then poured into each hole very quickly, with a long-nosed ladle or small coffee-pot. If one is skillful and neat, very little shaving will have to be done afterward.



BURNISHING OR FORMING STICK.

A hand tool for mending and smoothing plug-cups.

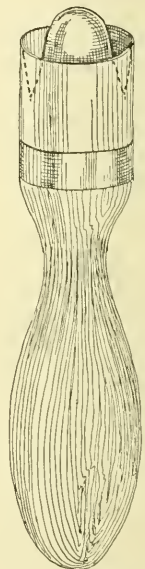

HAND CELL-COMPRESSING TOOL.

The above is for reshaping cell-cups, or for queen-rearing on a small scale by the plug-cup plan.

As soon as the wax has cooled hard, strike the top-bars on the bench, and the tin strips will drop off, leaving a perfectly smooth surface upon the face of each plug; then they are ready for the compressor any time.

The advantages of compressed cell-cups over dipped or molded cell-cups are many. First, they are not so fussy to prepare, and they do not require so much skill in the making; second, they are not delicate waxwork—the bugaboo of such a clumsy fellow as myself. The average bee-keeper can readily operate a cell-compressor where the dipping of cells would be an utter failure with him. Third, compressed cell-cups will stand pretty rough usage without being injured, where the

least little mishap will ruin a whole row of dipped cell-cups. Fourth, compressed cell-cups may be worked over and over again—they are practically indestructible, either by the bees or the bee-keeper himself. Fifth, compressed cell-cups are marketable and mailable; they are also practicable to both maker and user. Being encased or surrounded with wood they are protected at all times. Sixth, compressed cell-cups are readily mended by simply smoothing them a bit with a forming-stick and a little spittle; both of which are always at hand. Seventh, the making of compressed cell-cups is comfortable work, while the dipping of cell-cups is exasperating—especially during a hot summer's day. Eighth, in the wholesale dipping or molding of cell-cups an endless list of paraphernalia (hot wax, fire, water, steady nerves, etc.) more or less intricate and ingenious, is necessary; but with compressed cell-cups only the one simple hand tool is required, which any child can work.

The "shells" are designed to fit the holes in the top-bars of the Swarthmore cages to render the cells easily removable; but with a drop of wax they may be stuck on to any thing anywhere.

Suppose one is starting a batch of cells. If one or two cells should fail they may be replaced with others that are on the way toward development, thus saving much cage space.

And, again, suppose the apiarist desires a hatching cell, he can at any time draw one from any cage, without taking the cage apart or even lifting out a frame—simply roll back the sheet of the hive containing the cageful, and—there you are. Draw one, close the hive, and all is well—no trouble—not even smoke being necessary.

[These tools will form cells very quickly; and it is surprising how perfect and smooth they can be made.—Ed.]

PRODUCING COMB AND EXTRACTED HONEY IN THE SAME HIVE AT THE SAME TIME.

The Use of Divisible Brood-chambers.

BY LOUIS SCHOLL.

Having described the hive I use, page 591, it will, perhaps, be of interest to some to know how colonies in such hives were managed for the surplus honey. As I have a demand for it, my object is to produce both comb and extracted honey, and, instead of manipulating a certain number of colonies to produce the required amount of comb honey, and using other colonies solely for extracted honey, as is generally done, I have found that I could produce both at the same time with all the colonies, and with greater satisfaction.

Now, before giving my mode of operation for the season I wish to state, as there is a difference between our seasons here in the South, that these rules will not apply to the North, and will, therefore, have to be changed accordingly. Then, too, as we have such changeable weather here in Texas our honey resources are not alike each season, so each

must know his locality, study his honey resources, and must also know when to expect his honey-flows. He must also have every thing in readiness beforehand, by having his supers and every thing else in shape when a flow happens.

The fall before, all colonies are put in order for winter in three-hive sections, with plenty of honey. Each colony must have a good queen to keep up a strong colony of bees during the season; and, indeed, much depends on what kind of queens we have. We can not afford to keep any but good ones.

No further attention is given till about February, or when we expect continuously warm weather. Then we overhaul the bees to see that all are supplied with sufficient stores to last till the main honey-flow; for as pollen and honey have been coming in, brood-rearing is going on rapidly now, and during this time more honey will be consumed than at any other time of the year. To examine the colonies, simply pry apart the two lower cases. By tilting the upper one back we can easily ascertain the strength and condition of the colony, which we note. If some are found short of stores, these are provided either with combs of honey, or fed diluted honey or sugar syrup. All queenless colonies are supplied with good queens as soon as possible, and, if none are on hand, they are purchased of some reliable queen-breeder.

After all are in proper order they are let alone for a few weeks; and when the weather is warm and favorable, and honey coming in (we generally have enough honey coming in all along to keep up brood rearing, and sometimes we get some surplus), we again go through all; and, taking off the top (or third) story, we go through the brood-chambers, putting all combs with honey in the top, or the third super, and all the empty combs in the two chambers of the brood-nest, arranging the combs so as to spread the brood, and to push brood-rearing, as we want a great force of bees just at the beginning of the main flow, which with us is about the first of May. The other super, containing the combs of honey, is now set on top. This operation will generally be done at about swarming-time in the month of March, sometimes sooner or later, depending on the earliness or lateness of the season; and at this examination, if some colonies are overpopulous, combs of hatching brood are taken from them and used either to strengthen weaker colonies or for making nuclei. If some of the colonies have already started queen-cells they are destroyed or otherwise as the case may be. I have already said something about swarming; but with such a large brood-chamber, and providing plenty of room for the queen, there will be very little if any swarming; but I gave the foregoing for the "exceptions." Now comes the time of our main flow, which is just beginning; and if every thing has been favorable we shall have strong colonies with a large force of bees; and, besides having had plenty of honey for breeding purposes, they will have some surplus stored in the shallow extracting-super above.

We must now hurry and get on our comb-honey supers; so, taking our section-supers, which we had all nice and ready, with foundation in the sections, and an extra Danzenbaker reversible bottom-board, we proceed as follows:

First set one of the section-supers down, and on this set the upper (or third) case of the hive, without removing the cover. Then move the two lower chambers, bottom-board and all, to one side of the stand, and in its place put the extra Danzenbaker bottom—the deep entrance side up—putting on this the upper one of the two brood-chamber cases, and on this the lower one, thus cutting the brood-nest in two, thereby putting the honey in the upper frames in the center of the brood-nest for the bees to remove, while the upper frames now contain brood.

The two other supers, the section super with the extracted-honey super above it, are now set on top of the brood-chamber. Here are two features with which I am greatly pleased; namely, in having bees first used to storing in shallow extracting-supers; and when the section-super is put in between this and the brood-nest, they go right on to work in the sections without losing any time; and I have also found that nicer and fuller boxes of honey can be produced between such a super than where the cover is directly over the sections. Then by using shallow extracting-supers during the time before the main flow, as we have honey coming in nearly all the time, and sometimes a little more than is necessary for brood-rearing, it is stored in these supers, leaving plenty of room for the queen, while otherwise it would have to go to waste or the bees would store it in the brood chamber, thereby crowding out the queen. With a set of these frames above, too, if a colony has more honey in the brood-chamber than is needed, the bees, when providing room, will carry the honey up into these frames, also bringing the brood up closer to the top of the frames.

Of course, something has already been said about this plan, now known as the "Barber" plan, which was also my own idea. Another feature in forcing the bees and the honey into the sections is by reversing the two brood-cases, cutting the brood-nest in the middle, and putting the honey of the upper frames below, and a large space of brood right under the sections. If the honey-flow continues long enough, this reversing can be done at certain times during the main flow, and all of the honey forced into the sections. This I do not practice to any great extent, as there is sometimes danger of not having sufficient honey below for the winter, as we are not always sure of a later or fall flow.

Now our main flow is over, and we will now proceed to take off the surplus. The shallow-frame super I leave on over the sections during the time, as the bees finish the sections up nicer. Some advise removing the frame-super when putting on sections; but I prefer to let them remain, for the reason given above, and then the extracted honey is much nicer, being well ripened. All of the supers are then re-

moved, the section supers piled up until we have time to tend to them, while the honey of the shallow frames is extracted and the supers put back on the hive.

I have *sometimes* put these in between the two brood-cases, and, when the bees clean up these combs, they provide lots of breeding-room for the queen.

Right here, if I am not mistaken, is something that bee-keepers in northern localities would not think of practicing, hence their talk about useless consumers. But as our season is of such a nature that we have another flow later, after the first main flow, with several weeks of no honey, or very little, between, bees must breed up so as to have sufficient numbers for that last flow.

Having said this much, and hoping that my management is clear, I think each could modify it so as to be used in any locality.

Hunter, Texas.

[The honey season is holding out in and near Medina in a most remarkable manner. The honey comes from red and sweet clover.

—ED.]

CONVENTION NOTICE.

All arrangements for the next convention of the National Bee-keepers' Association have been completed so far as possible, and the convention will be held in the audience room of the Buffalo Society of Natural Sciences, Sept. 10th, 11th, and 12th; commencing on the evening of the 10th. The place of meeting is in the Buffalo Library building, corner of Washington and Clinton Streets, near the business center of the city. The president of the Natural Sciences Society, Mr. Smith, has also kindly offered our Association the use of their library and other committee rooms during the time of our convention, and to do all in the power of the society to help make our meeting a success.

Railroad rates will vary in the different passenger association territory, from one cent per mile each way to one and one-third fare for the round trip. Each person can readily learn the rate on inquiry at his railroad station.

The Buffalo bee-keepers will try to provide entertainment at reasonable rates for all attending the convention, who will notify Mr. Sydney S. Sleeper, of Holland, N. Y., by Sept. 2d, of their wish for entertainment.

In a letter just received from Mr. Sleeper he says, "We want all to come who can, for we wish to make the Buffalo meeting the most pleasant and instructive one that was ever held in America. We will have the co-operation of all the sciences as well as the school board," and names some professional men who are interested in our specialty and will be at the convention to help.

In a long letter from Mr. Hershiser, just received, he closes by saying, "Call upon me for whatever further assistance I am able to render;" and Mr. Penton, an ex-president of the Erie County Bee-keepers' Society, and others, have offered to do all they can to provide for the comfort of the delegates.

As stated in my previous convention notice in GLEANINGS, there will be no fixed program and no papers, and the time will be occupied in answering and discussing questions, except that on Thursday evening there will be a joint session of our association with the American Pomological Society, to discuss "the mutual relations of bee-keeping and fruit-growing;" and Prof. Beach, of the N. Y. Agricultural Experiment Station, and Prof. Fletcher, of the Central Experimental Farm of the Dominion of Canada, will help talk for the bees at that session, and it is hoped that much good will result to fruit-growers and bee-keepers from this joint session.

If any bee-keeper who can not be at the convention has any questions, knotty or otherwise, he would like to have answered at the convention, will send them to me I will see that they are presented.

A. B. MASON, Sec., Sta. B, Toledo, O.

THE ROOT GERMAN STEAM WAX-PRESS.

BY E. R. ROOT.

We have been making and selling for two months back a steam wax-press that embodies all the best features of the most improved German machines that have given such excellent results for the last ten or twelve years. The illustration herewith shows the complete machine as we now make it. It is all metal, galvanized, and is strongly built. The cover is of cast iron, ribbed and braced, and is held

particle of wax is pressed out. The basket is dumped, and the operation is repeated as before.

It is advisable to use a sheet of burlap or cheese-cloth to line the inside of the basket during the process of rendering, otherwise the cocoons will be forced between the meshes of the coarse wire cloth. A finer mesh of cloth would not stand the enormous pressure,

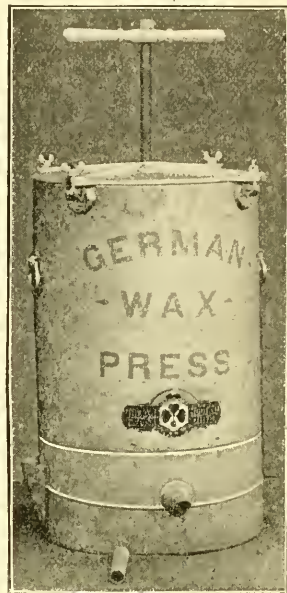

securely in position by four thumb-screw lugs. Through this head passes a powerful screw; and on the end of this screw a plunger plate is pivoted. The basket is made of strong heavy galvanized wire cloth, and is securely hooped and riveted. To stand the enormous pressure of this screw a cast-iron spider is riveted inside of the can, about 8 inches from the bottom.

To use, the can is placed on a common stove, and is filled with about 3 inches of water. The wire-cloth basket is filled with old comb, slungum, or any wax refuse. The water is brought to a boil, when the basket with its contents is set down into the can. The handle is unscrewed until the pressure-plate rests against the cover plate. This is then set down on top of the can, and the water is allowed to boil. The steam generated passes all through the mass, and when the wax in the basket settles down, more refuse is put in. After all the free wax is steamed out, the screw and plunger-plate are turned down. One person grasps the two handles of the can, and another one turns the screw down until a tight squeeze is exerted. It is then left for a little while when another squeeze is applied, and so alternately for a period of 15 or 20 minutes. The screw is then raised up, and the slungum is poked over with a stick, and again pressure is applied. By this time every

and hence burlap or cheese-cloth in connection with a coarse wire cloth should be used.

This machine is large enough to hold about a bushel and a quarter of comb at a time; and in connection with a solar wax-extractor it will handle the product of from 500 to 1000 colonies.

MARKETING HONEY.

Fumigating with Bisulphide of Carbon.

BY EARL C. WALKER.

The marketing of honey is one of the most important questions which confront the honey-producer. Many bee-keepers are successful, so far as producing honey is concerned, but comparatively few are eminently successful in marketing it. One may toil throughout the season and obtain a big crop, and a really fancy article of honey, but, through slipshod methods in putting it up, will receive pay for a second or a third class article. Too many think that, as soon as their crop is taken off from the hives, their season is over and their work ended. They are utterly indifferent as to how it is put up or how it should be marketed so as to bring the highest price.

When the producing season is over, the bee-keeper's labor has really just begun. The

bees have produced the honey, and *he* should see that it brings all that it is worth, by properly marketing it. It requires experience and skill to produce a gilt-edged article of honey, and it requires business tact to market it, and, of course, experience too. I wonder why some easy-going, slipshod bee-keeper doesn't breed a bee that will market his honey for him.

The most important item in marketing any thing is to have a good article, and have it put up in as attractive a shape as possible. My experience has been that a fancy grade of honey—yes, and an ordinary grade too—will sell itself. When a customer, either retail or wholesale, learns that he can depend on your honey as always being first-class, you can rest assured that he will continue his patronage, and he will pay you the right price too. If he tries to cut the price, let him know that you are independent, and that your honey will sell anywhere, and that others will be glad to get it. When he learns that you give him his money's worth, and that he gets just what he pays for, he will gladly buy of you.

Let us suppose we have secured a crop of comb honey. I will tell how I prepare it for market.

As soon as the honey is taken from the hive I fumigate it. I use carbon bisulphide, as sulphur is apt to discolor the comb, and, if too strong, leaves a disagreeable odor. For a fumigating-box I use a large ice-box or refrigerator, which is lined with zinc and is practically air-tight, except that it has ventilating-holes at top and bottom. When supers are well filled I place them bodily, as they come from the hive, into the bottom part of the fumigating-box, in such a manner as to allow the free circulation of the fumes about and through them. If the supers are not entirely filled, I of course place only the finished sections in the fumigating-box. I then place an open vessel, filled with bisulphide of carbon, in the top part of the refrigerator, and close the door. The fumes settle and circulate around the honey. It takes about an hour for the fumes to fill entirely the large fumigating-box. As soon as they have, I close the ventilating-holes, thus stopping all drafts, and let the whole thing alone till morning, or for a period of from eight to ten hours. After this time every vestige of a moth worm or egg will have been destroyed. I then remove the vessel of carbon bisulphide and open the ventilators, and, as soon as all fumes have passed off, the honey is ready to be removed.

The honey is then stored in a warm room on shelves, and allowed to sweat. The room should have screen doors and windows, which should be opened to allow a free circulation of air.

Next the sections are scraped, all propolis and stains being removed. As the sections are cleaned the honey is graded. I use three grades. Then it is put into 24-lb. single-tier non-drip shipping-cases with glass on one side. It doesn't pay to "face" the crates. Put sections next to the glass that are a fair sample of the rest of the honey in the whole crate. I have bought honey, as well as produced it.

Nothing is more aggravating than to buy honey at a fancy price, and find "gilt-edge" sections next to the glass, while the remainder of the case is second or third grade. It pays to be honest. The man who practices fraud and deception, in the long run cheats himself. When a small boy I raised a crop of pickle cucumbers. When they were ready for market I put them in bushel baskets, and I *faced* them too. I put all the little ones in the bottom, and the great big "stunners" on top. I drove to market, and was already counting the money I should receive for them. But the first grocer I showed my cucumbers to laughed, and said he could not use such large cucumbers. "No one wants large cucumbers for pickling—they want the *little ones*." I saw my mistake, and confessed that the baskets were "faced." We emptied them, and he bought all the small ones, and I took the big ones back home. There were not very many big ones.

This experience made a lasting impression. When I buy honey I don't want it faced. When I sell, I don't face it.

After the honey is crated I put a label on each case, stating grade, net weight, gross weight, and number of sections in case.

Being near my market I take a sample section of each grade and call on my customers or any dealers to whom I wish to sell. I show my goods and ask them if they wish to purchase. If they are not handling honey, and are in doubt as to whether they want to do so, I propose that they let me bring them a case on trial, and, in nine times out of ten, when I see them again they want more. I then sell for cash. I always sell my own crop, and then buy to supply the trade.

Last season I called on one of my old customers. He is a close man, and always wants to drive a close bargain. I asked him 13 cts. for my honey. He said the honey was all right, but the price was too high. I told him that the honey crop all over the country was short, and that my price was really cheap. He said, "Why, I can get all the honey I want at 10 cts., and it is fancy too."

I told him I should like to buy it at that, and that, if he could do so, he ought to get all he could at that price. I did not make any further effort to sell to him. In about six weeks he sent word that he would like to see me. I called at his store.

"Mr. Walker," he said, "what is honey worth?"

"A fancy article is worth 15 cts." was my answer.

"I will take 2000 lbs. at that price."

"I don't know where you will get it. I have sold all of mine, and should like to buy some myself," was my response.

Oh! but it did me good to tell him this. I asked him why he did not buy the 10-cent honey he had spoken of. He said, "Well, I didn't know the man who offered it to me; and as the price was so low I feared it would not be good."

Now he pays me my price, and is glad to buy of me.

New Albany, Ind.

A SCENT-PRODUCING ORGAN IN THE ABDOMEN OF THE BEE.

The Scent Produced Forms a Means of Communication between the Members of a Swarm or Colony.

BY F. W. L. SLADEN.

The following is a summary of an article on the above subject, contributed to the *British Bee Journal*:

Last July, through the apparent absence of definite evidence that bees are able to hear ordinary sounds, I was led to investigate the phenomenon known as the "joyful hum" among bees. In "The Bee-keeper's Guide-book," 16th edition, page 26, we read, "The joyful hum of the bees as they enter the hive will entice others to follow." I asked myself the question, "Is it entirely the *hum* that attracts the bees, or is there anything else that exerts the influence?" It was in endeavoring to answer this question that I was led to make certain observations, and to form a theory which I have been unable to find stated in any work on bees, and of which the following is a short account:

If a comb be lifted out of a hive, and the bees on it be shaken off on to the alighting-board, many of the bees will not at once rush into the entrance, but they will pause at the portal, and commence humming, evidently for the purpose of attracting their mates. When humming in this way the bee adopts a certain peculiar attitude. She stands with her head turned toward the entrance. She elevates her abdomen, and uncovers a narrow white membrane situated at the base of the 6th dorsal segment, which, when at rest, is entirely hidden, and covered by the 5th segment. As this membrane is near the extremity of the abdomen it seems but reasonable to suppose that the abdomen is especially elevated to give prominence to it. The "joyful hum," whether it is made, first, under the above circumstances; or, second, when a swarm is being hived; or, third, when a queen is accompanied by a few workers in a cage; or, fourth, when a young or tired bee discovers, after more or less difficulty, the entrance of her hive, is always accompanied with the protrusion of the above-mentioned membrane; and it then has the effect of attracting other bees; and when a number of bees hum in this way, as when a swarm is being hived, their attractive effect on other bees is very marked. On the other hand, when fanning is done merely for the purpose of ventilation, as at the mouth of the hive in very hot weather, the above-mentioned membrane is not, or, at most, is scarcely exposed, and no attractive effect seems to be intended or is observable.

After making the above observation it seemed to me clear that the membrane in question had a great deal to do with the attractive effect produced during the "joyful hum;" and, calling to mind the extremely meager evidence we have that supports the theory that the sense of hearing, as we understand it, is developed in either ants or bees, and, on the other hand, the strong evidence we have in

favor of the high development of the sense of smell in these insects (both points being confirmed, in the case of bumble-bees, by recent experiments of mine), I was led to form the theory that the membrane above mentioned (A, below) contains scent-glands, and that these produce a certain scent which, when the membrane is exposed, forms an important means of communication, by attraction, between the individuals of a colony or swarm. The fanning of the wings during humming would help to distribute this scent.

To endeavor to prove my theory, when hiving a swarm last July I put my nose close down over the mass of humming bees that were spread out on the hiving-board, to try to detect the suspected scent. I certainly smelled a curious, somewhat pungent odor, resem-

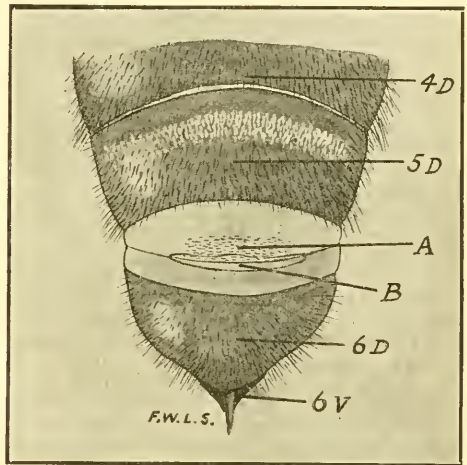

Tip of distended abdomen of worker honey-bee seen from above, slightly enlarged.

4D, 5D, 6D, 4th, 5th, and 6th dorsal segments.

6V, 6th ventral segment.

A, Nassonoff's organ.

B, long hollow depression on the outer margin of the same.

bling slightly the scent of formic acid that is produced when a nest of *Formica rufa* (the common European wood ant) is disturbed; and, though I was not able at the time to prove it, I strongly suspected that it was the scent produced by the above organ. A sweet "seaweed" scent, which I recognized to be of the same nature, was produced by a few bees accompanying a caged queen a few days later.

I then endeavored to cut off communication in a line of humming bees by dividing it into two parts by the interposition of a thin canvas screen charged with various kinds of scent, which I hoped would nullify the effect of the bees' scent, while allowing a free passage through it for the sounds they produced. If I could do this I thought it would, to a great extent, prove that "humming" bees communicate by the scent they produce, and not by their sound. This experiment had no definite result.

On March 13th of the present year, while dissecting the abdomen of a freshly killed bee in order to examine further the above membrane, I suddenly perceived an odor which I at once recognized as the pungent seaweedy odor that I smelled last summer in hiving the swarm; and in the queen experiment mentioned above I immediately separated the membrane with as little of the connecting tissue as possible, and placed it on a piece of card. I then placed the whole of the rest of the abdomen (except the sting and its appendages, which had been previously removed) on another card. The card with the membrane on it gave out the odor strongly for some minutes; but the card bearing the rest of the abdomen had no perceptible smell. I repeated the experiment with another abdomen, and it produced the same result. I consider that this striking experiment seems to prove the truth of my theory.

The membrane in question appears to have been first noticed as long ago as the year 1883, when Nasonoff, a naturalist of Moscow, described the organ, and an account of his description was sent by Zoubareff to the Swiss *Bulletin d'Apiculture* (translated by Mr. F. Benton, in the *British Bee Journal* for Dec. 15, 1883).

The organ is described as a canal. "At the bottom of this canal a large number of small glands open, each one of which has an oval cell with a well-defined globule. From each cell a duct starts out and extends to the bottom of the canal." Nasonoff further says that the walls of the ducts are of a chitinous texture. He assigns a secretory function to the glands, suggesting that they produce the perspiration. Zoubareff, while not absolutely rejecting Nasonoff's theory, connects the existence of the glands with the little drops of liquid that bees are said to let fall when they are on the wing, which, he says, represent the excess of moisture which nectar freshly gathered from flowers contains over ripened honey, and which, he thinks, is collected and then thrown off by these glands.

These ideas seem to be very crude, and would hardly be believed at the present time, but they are copied into the present edition of Cowan's "Honey-bee," which seems to indicate that the organ in question has not been further investigated since 1883.

In the accompanying illustration, the view represents the extremity of a distended abdomen of a worker honey-bee. *A* is Nasonoff's organ; *B*, a long hollowed-out depression at the outer margin of it.

I hope to send you a description of the structure of the membrane, with some further notes, in a later paper.

The following is a list of the chief works I have consulted:

V. Buttel-Reepen.—"Sind die Bienen Reflexmaschinen?" Leipzig, 1900.

Cowan.—"The Honey-bee." London, 1890.

Cowan.—"The British Bee-keeper's Guide-book," 16th edition. London, 1900.

Cheshire.—"Bees and Bee-keeping." London, 1886.

Lubbock.—"Ants, Bees, and Wasps," 5th edition. London, 1881.

Packard.—"Text-book of Entomology." New York, 1900.

Zoubareff.—"Concerning an Organ of the Bee not yet Described." *British Bee Journal*, 1883.

Ripple Court, Dover, England.

[I have repeatedly noticed that bees, when crawling toward the entrance *en masse*, would elevate the abdomen, as explained, but always supposed this was an act signifying extreme joy. I shall be anxious to watch the bees more closely this summer to discover whether there is something more than mere "noise" that attracts the bees and directs them to a common direction.—ED.]

RAMBLE 188.

Struck it Rich Again.

BY RAMBLER.

I should be getting out of my element if I did not have to fold my cot and move; so, here I am on the wing again. "Where now?" do you ask? Oh! I am only going back to Los Angeles, that beautiful city at the southern end of the State.

"But, Mr. Rambler, you have not told us how much of a honey crop you secured."

Well, that is an inquisitive question; but if you must know, I would say that I secured a



fair crop and a sack of coin. You'd 'a' smiled to see me enter the "City of the Angels." Land sakes! how "we apples" swimmid! new plug hat, new umbrella, new kid gloves, a monacule pants creased "fore and aft." Why! when I struck the town of Reedley a few months ago I told artist Murray how I felt, and you all know how forlornish he pictured me; but I forgive him. Then Arthur C. Miller had to chip in and tell me I "looked like 30 cents;" said if I'd come to Rhode Isl- and he would put me through a clam-

bake with very good results. I can't tell what he was driving at, but I utterly ignored him. Why! I'd like to dump all the Millers I know into one of our hot sulphur springs and boil some of the gall out of them; but that is enough time wasted on the Millers, so just look at me now. Did the bee-men all

around Los Angeles recognize me? Well, I guess so—especially the sack. Poor fellows! how hungry they looked! worse than 30 cents—no honey season, no sack, no coin. I was sorry for them.

Then what changes in a few months! There was friend Jim Crow. When I went north he was all Belgian hares—couldn't talk any thing but does and pedigrees; had 100, great and



“Then there was Brodbeck, just a trifle in the oil business.”

small, and going right along to a thousand; but now it was oil stocks—couldn't say here; referred me to his wife—only 30 hares, and gradually declining.

Then there was Bro. Brodbeck, just a trifle in the oil business when I went away—worse now; all oil; reminded me of an oil-derrick—head turned; sacks of coin galore. Behold the effects of the oil craze. But, after all, Bro. Brodbeck is wise to hold to his bees also—good grit there.

After these pleasant greetings I made haste to visit my apiary in the secluded defiles of Durfee Canyon, and 69 colonies answered the roll-call. There had been some rain before my arrival, but I gave them another liberal sprinkling with the contents of my sack of coin; and, how they brightened up! I don't know why it is, but a little coin here and there in an apiary is a wonderful help. Quite a few bee-keepers utterly ignore this feature

of bee-keeping, but it pays. And, O ye frozen-toed bee-men of the East, all of this brightening-up work was done in December and January, when you were clinging to the stove. You can scarcely imagine how lovely it is to hear the hum of the honey-bee all day long in mid-winter.

Just as I had got my work well done, and was setting out to “ramble” among my old friends in the San Bernardino country, a far cry came from the Simi Valley. Our friend Richardson, afflicted with poor health, needed some one to help regulate things in his apiaries. I heeded the call, and promptly made the 60 miles on my wheel. I found that the three dry seasons had diminished his 1200 colonies about a half, and there were over 12,000 combs to look after in several apiaries. Some of these had been piled up in blocks of bee-hives for two years, and several thousand in a sealed honey-house. Here was surely a study in the preservation of empty combs. We should think that those 250 hives full of empty combs piled five high in a solid block under a live-oak tree, and so long in a semi-tropical climate, would not have much more than webs and powdered refuse in them. In the first place, they were put in the hives just as an experienced bee-man would put them—spaced so that surfaces would not touch. As



Song and dance by Mendleson and others. “Lovely rain; glorious rain.”

a consequence, fully half of the combs were fit to use in the hives again. Now and then a column of hives would have every comb destroyed; others, webbed only in the center. Often a new bright comb would be found untouched, while those on each side of it were destroyed. I found the same conditions in the house. The photo gives a glimpse into the interior, and of the ragged combs. These combs had been sulphured many times, but they were

in worse condition than those piled under the trees. I had a helper a portion of the time; but for all that it was a great scrape — over 5000 combs to be cut out, and the frames cleaned. Well, we completed the job in fine shape, and there was a great pile of sacks of old comb, etc., to be rendered into wax.

You will notice that my helper is cutting out comb with a long knife; another is leaning against a hive. These are uncapping-knives, very long, thick in the center, straight shank, and heavy. A down stroke is intended with these tools.

An excellent machine for rendering this wax would have been the Ferris steam wax-extractor; but other plans and other parties were called into the work later. In Ventura Co. are some very expert men with the wax proposition. Three dry seasons, much loss of bees, much wax to render, has developed a

wide open), said my friend, "I believe I'd like to take a nip; how is it with you, Rambler?"

"No nip for me, my friend. I never nip."

And I walked right along.

"Well—w-e-l-l," said he, hesitating a little; "I guess I won't nip, after all."

After a little silence, said he, "Well, Rambler, that is what we may call the power of example. If you had entered the saloon with me we might have had several nips, hey? but I guess my appetite for breakfast is about as good without it;" and I noticed at table that he ate quite heartily.

When on the street again, whom should we meet but Mr. Mendleson? He came spattering along on a cart. Mud—just happy in mud; rubber boots, just the thing for rainy weather; lovely rain; going to have some more too.

Our accumulated force started out to hunt up some more happy beemen. We found Mr. Wilkin under his own vine and pepper-tree. He greeted us with his accustomed broad and genial smile.

"Why, Rambler, you must have rained down. What a glorious rain!"

We hitched another man to our crowd here and climbed the hill to Mr. Mercer's, and there, in spite of the great rain, we found him humped up in a rocking chair near a blazing hearth, all broken up with the grip.

I always feel it my duty to cheer up the afflicted, and I told Mr. Mercer that I had a plan in mind that I thought would cure his grip. That brightened him up quite a little.

He had two carloads of bees and fixtures away up in Central California. It was high time they were moved south, but this grip had him fast.

"Well," Mr. Mercer, "my remedy is for you to go to Ana Capa Island. I am getting up a party to—"

"You get right out of this, Rambler; don't you mention Ana Capa to me;" and he tore around the room, shaking his fist at me. His wife, dear good woman, pacified him. "Yes, Rambler, you got me over there once, but you can't do it again. The grip—jinct—that's nothing like being seasick. Why, I can feel the way that old crazy schooner bobbed all over the ocean now. Don't you mention Ana Capa to me again."

I think the recalling of the trip to the island in 1894 had a very beneficial effect upon our friend. It roused him up, and I

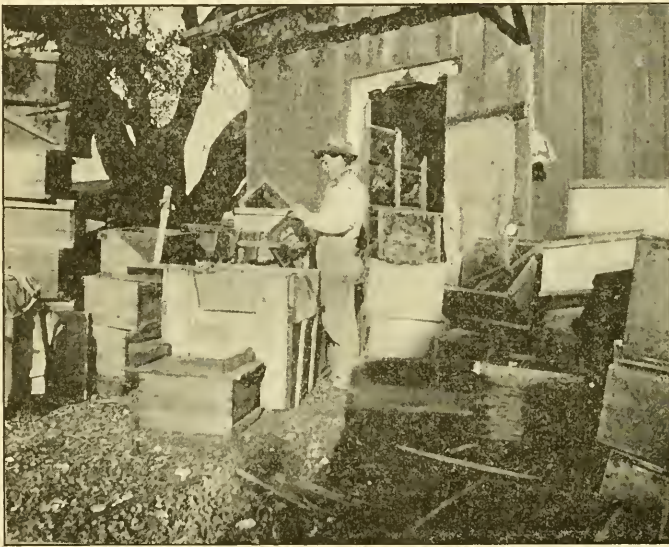

RAVAGES OF THE BEE-MOTH.

new industry in the wax business. These experts pick up old black slumgum, and, in fact, any old thing that has ever been in a bee-hive, and they wring wax out of it. They claim to get 95 per cent.

I was denied the privilege of getting away from Bro. Richardson's on my wheel. Our great scrape wound up with a great rain; and the harder and longer it rained, the better we bee-men felt. Streams were swollen, roads washed out, trains delayed; but what of that? Plenty of rain means plenty of honey.

After several delays, and nearly a day for it, I reached Ventura, 40 miles. At one of the delay points I met a bee-man from San Bernardino Co., and he was happy too—rain, I suppose. We both stopped at the Ana Capa Hotel. We were out at about the same time in the morning, and took a stroll before breakfast. As we passed a saloon (of course it was

understand he started out in a few days and safely moved his bees south.

Our force marched back down town, and further calls upon bee-men were prevented by the arrival of the train; and I left, feeling as though I had some very good friends in Ventura, and no nips taken either.

Along with the pleasure of meeting friends in Los Angeles and Ventura there were also sad features. One of these was in finding a vacancy in the ranks of the bee-keepers by the death of Mr. C. C. Aldrich. He was always in attendance at our conventions, and was a thoroughly posted bee-keeper, and his name has appeared many times in the bee-papers. He was much of a genius in the matter of hives and management. His prime days of bee-keeping were spent in Minnesota, where he manufactured bee-keepers' supplies, and published a little book upon bee management. He came to California about ten years ago to spend his declining years. His apiary was at Elsinore, Cal.; and when not attending his bees he was selling his honey in a little honey-store in Los Angeles. His sign read, "Honey from first hands." Mr. Aldrich was a little over 72 years of age.



FEEDING BACK.

"Good morning, Bro. Doolittle. Can you tell me what is meant by 'feeding back'? I see something about this matter in one of my bee-papers, but I do not think I fully understand it."

"In order that Bro. Brown may know just what was meant, I will say that feeding back is the feeding of extracted honey, taken during the honey-harvest, back to the same colony from which it was taken, after the harvest is past, for the purpose of getting said honey stored in sections, the colony at this time having been fixed for section honey."

"What is that for?"

"The object of such a procedure is to get an article of a less price converted into one which brings a greater price. By using the extractor during the honey-flow, nearly twice the honey is obtained that would have been secured had the colony been worked for comb honey; but this extracted honey does not bring more than about half the price it would if stored in sections. Thus you will see that, if a way could be devised whereby the double quantity of extracted honey could be gotten into the same amount of comb honey, a great gain could be made."

"Yes, I see; and that is something after the idea I got in reading what I did. Say—that would be just the thing for me, as I have a lot of extracted honey on hand; and if I could turn it into section honey it would be a big gain to me. Tell me more about it."

"You get excited over the matter, just as the rest of us have during the past, and I know of no better way to tell you what I wish than to give some of my experiments conducted during the past."

"That is right. That is just what I wish to know about."

"When comb foundation was proven to be a success I thought here was a chance to make a profitable business by extracting my honey during the flow from white clover and basswood, and feed it back during the time of scarcity between basswood and buckwheat. Accordingly, after the harvest of white honey was over I prepared three colonies that were strong in numbers, to one of which was given 44 sections with baits in the center, the same as would have been put on at the commencement of the season had I been working for section honey. The second was given the same number of sections partly filled from colonies which had not fully completed what they had in their hives, while a third was given the same number of sections with only starters of foundation in them. I now fed these colonies 15 lbs. each, which they carried off during the first day, and kept on feeding as fast as they would take it afterward until I thought the sections ought to be filled."

"How did the matter come out?"

"Those having the partly filled sections took 42 lbs. of honey before the sections were ready for market, and the 44 sections weighed about 47 lbs. when completed; but as they weighed some 32 to 34 lbs. when placed on the hive for feeding, you will see that I had fed 42 lbs. of extracted honey to make a gain of only 15 lbs. in the sections."

"Whew! Not much profit there."

"No; and when it came to the one prepared as we do those worked for section honey at the commencement of the season, I had to feed 134 lbs. before they were completed, or 134 lbs. to secure about 46 lbs. in the sections."

"Worse and worse! But what became of the one having only starters?"

"This part was never completed; for after I had fed them some 50 lbs. they only just got to building comb nicely, and soon after this comb-building seemed to get to be an old story, so that, after awhile, they simply lived out of the feed-dish, and did nothing else."

"But do not others have better success?"

"Some claim that they do; but it was said that, if we thinned the honey, it would be more like the nectar which comes in from the fields, and thus we would secure good results. I tried this, and have made many experiments along this feeding-back line, many times and in many ways, but generally with no real success, unless it may be called a success to have such sections as are nearly completed, those lacking just a little of being full enough for market, finished up for market. In this case I think it pays, even if we have to feed three or four times the amount we get back of what we feed; for, did we not do this, these nearly filled sections would have to be carried over to the next season, and this makes considerable work."

"How do you account for having so much

more taken out of the feeder than what was finally stored in the completed sections?"

"In all of my feeding operations I have ascertained this fact: Bees, fed in excess of what they consume in feeding the brood, become idle, simply living out of the feeder, not getting an ounce from the fields, while those not fed will nearly or quite secure a living from the fields. If fed when honey is plentiful in the fields, they will store no faster out of the feeder than others not fed will from the fields; while those storing from the fields will work in the sections with double the energy which those do that are being fed."

"Then you think that what I read was more from theory than from practice?"

"From all my past experience I must so conclude. But at the same time I am hoping that some way may yet be devised so that it may be a profitable thing to feed the bees extracted honey in such a way that it may be profitably turned into nice section honey."



SOME USEFUL HINTS.

The Daisy foundation-fastener may be kept from slipping on the floor, when working with it, by driving two wire nails into the part that rests on the floor. Let the nails protrude about $\frac{3}{4}$ inch, and file sharp. Have one at or near each corner.

Sections fresh from the factory generally make up without breaking. Old and well-dried sections may be made to absorb enough moisture to make up without breakage by keeping them in a cellar for a number of days. Do not forget and leave them in the cellar long, or they will become moldy.

The weather has been very unfavorable for bees. It is reported to us that, during the first (rainy) week in June, queens ceased to lay, and that at the end of that week almost no unsealed brood could be found in many hives, although well supplied with old honey.

Try to have all old honey used up or worked over. It is not safe to depend on it for next winter's supply. I use a spiked roller to make holes through the cappings of old honey, then place combs so treated into empty hives located somewhat by themselves in the apiary. The honey is then removed by the bees in a short time, and the combs are ready to be used some way or other.

The honey-dearth in June and July caused many bees to suffer last season—so much so that much brood actually died of starvation. In some parts of New York the rumor was spread that the bees were affected with black brood. When the foul-brood inspector came he pronounced it a case of starvation. The disease (?) disappeared as soon as buckwheat yielded honey. The inspector visited the same yard this spring and found the bees all right.

Prof. A. J. Cook speaks at length in June 6th *Amer. Bee Journal* of the Dzierzon and the Dickel theories. Perhaps not many are better fitted to handle this subject and always apply the correct terms. I urge all who are interested to read the article carefully.

Naples, N. Y.

F. GREINER.

THE EX-LIGHTNING OPERATOR.

I see by GLEANINGS that you mention my sickness, so I will report. There were two months when I did not work to speak of, but am now able to nail frames and do other light work part of each day. The doctor says I will never be able to do any more hard work, but that, with care, I may be able to do light work. So please put an "ex" before the "lightning operator" in the future.

HARRY S. HOWE.

Artemisa, Cuba, May 25.

[The moral seems to be that it doesn't pay to work so hard; i. e., it is better *never* to be a "lightning operator" than to be afterwards an ex-lightning operator.—Ed.]

KEEPING OVER EXTRA QUEENS.

Is there any plan by which I can keep over extra queens from one season until the next spring—that is, keep two or more queens in the same hive by caging or otherwise?

DR. M. FIELDS.

King Creek, Ky., June 7.

[There is no plan that I know of which I would consider reliable. The only way is to keep queens over in nuclei, and winter the nuclei in a good cellar. That is what we did last season.—Ed.]

HIVE-COVERS, BOTTOMS, ETC.

After reading the July 15th issue I indorse Somerford's idea as to the flat top being best hive-cover, and believe the tile bottom a good thing for permanent apiaries. Here I shall hereafter make bottoms of red cedar, as it is cheap, \$1 00 a hundred for No. 3, and never rots out like pine.

A good honey-flow has come to an end by dry weather.

CHIP HENDERSON.

Murfreesboro, Tenn., July 5.

FEEDING BEET SUGAR.

Out of twelve good swarms I now have only four left. I think one thing that killed them was feeding them beet sugar last fall. The queen you sent me last year as a premium with GLEANINGS was one of your red-clover stock. Her bees were more than a third longer than the rest that I had, and she built up a good colony; but I gave them some beet sugar, and that used them up.

A. J. TRUAX.

Leonidas, Mich., May 20.

[I don't think beet sugar killed them. See article by W. K. Morrison, next issue.—Ed.]

A HANDY HIVE-TOOL.

I inclose an exact pattern of one of the most handy tools a man or woman ever handled when opening hives and manipulating brood-frames. With the beveled side toward

you, press the lifter down between the brood-frames and press the chisel end down. This pushes the hook point under the lower edge of the frame, and at the same time lifts the frame up, when you take hold of the frame with the left hand; then move the lifter to the opposite end to your right, and raise the frame, which will not slip off. You can carry the frame any place you desire, or you can turn the frame in any position, look for queen, eggs, or brood, without any fear of dropping the frame; and, besides, I will guarantee that no one will ever get rheumatism in his thumbs or fingers when using the lifter, no difference how many frames are lifted, as one often does when having to lift frames with thumb and fingers. Again, no difference how tight a frame is stuck down with propolis, the lifter will just raise it without molesting a bee, besides lifting the frames. If there are any clumps of

separate Hoffman frames, by pushing in 2 inches, and giving a twist. You will see the steel is left $\frac{3}{16}$ thick as far as the hook, and is

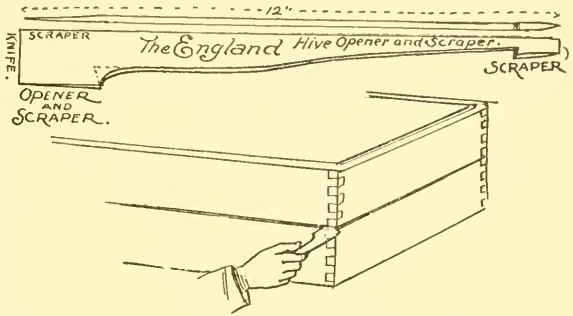

ENGLAND'S HIVE-TOOL.

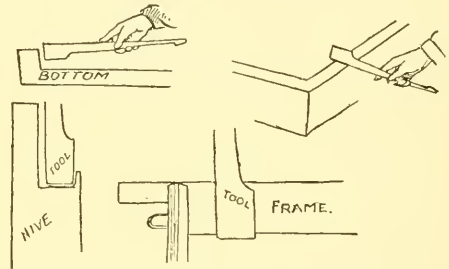

MANNER OF USE.



propolis on the frame, just turn the lifter end for end, bevel side up; press the end of the frame against something solid, holding the frame with the left hand, and with the right you can shave all propolis off. Catch the frame with the lifter, and replace it in the hive.

J. A. GOLDEN.

Reinersville, Ohio.

[In the design and style of a hive-tool, much depends on the kind of hive and kind of frame one is using, as well as his special method of working. If he has a great deal of propolis in his locality, rendering it necessary to scrape the top-bars as well as the rabbets and other inaccessible places in the hive, a tool like the one described by C. F. England would be better. See description just following.—Ed.]

AN AUSTRALIAN HIVE TOOL.

Here is a sketch of a really good hive-tool I have made. Subscribers to GLEANINGS are welcome to copy it. It is made of file steel, 1 inch wide, $\frac{3}{16}$ thick, drawn out as in sketch. The broad end will open hives, clean bits of comb off the frames, clean bottom-boards, cut bits of comb off the inside of hive-bodies, and perhaps be handy to kill a cross bee now and then. The wide edge is made nearly sharp enough to cut. The sides of the tool for one inch from each end are left square, as they clean the side pieces of the bottom-boards and tin rabbets better. The small end is just right to clean the inside of the tin rabbets, or to use for a screwdriver, etc., and the hook above is just perfect to lift the end of a division-board or frame. It is cut just a little under to form a slight hook, as it is then less liable to slip. The small end is also used to

then gradually tapered. Perhaps $\frac{1}{8}$ -in. steel would be heavy enough.

CHARLES F. ENGLAND.

Foxton, Australia.

[This tool, in its general design, is one of the very best I have yet seen. Any hive-tool, to be really serviceable, should be of such construction as to be a pry, screwdriver, hook, and scraper, all combined. Mr. England has come very near giving us that kind of tool—perhaps nearer than any one else. If we could be satisfied that this implement would equal the best yet devised we would have them made by the quantity, and all of them drop-forgings. One of malleable iron might do for a cheap article; but something really serviceable should be tool steel.—Ed.]

HARRISON'S SEPARATORS FOR PLAIN AND SLOTTED SECTIONS.

I send you by this mail a sample of the separators I have been using for the past three years in the production of comb honey—separators which I find to be quite an advantage in several ways. I think I get more honey per colony; whiter; sections better and more uniformly filled; while any thing that can be said of the fence will apply to No. 1, which I use with plain sections. No. 2 I use with common beeway sections, open on three sides. As I do not tier up, I have closed tops. No. 3 simply gives a beeway in connection with No. 1, at end or side of super to suit the user, as per style and size of super, one at the

side, or end, using a plain follower at the spring side. I use the same follower with No. 1, which I use with plain sections. You will see that the openings in the separators are at a point where the sections meet, giving free passage each and every way through the super, also giving the cappers a chance to close up their bees in fine and uniform style, and giving them a chance to recede and get out of the

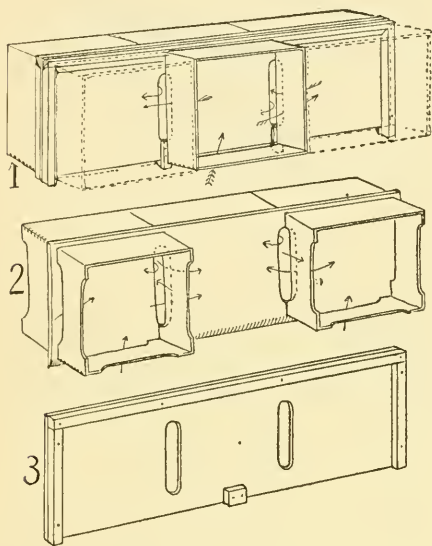

No. 1.—Plain sections.
No. 2.—Grooved sections, top closed, 3 sides open.
No. 3.—Follower.
Arrows show beeways.

way while changing sections. I do the work of taking out full and replacing empty sections at same time, taking out none but well-filled ones. I work only for comb honey.

Last season was an off one, yet I averaged over 65 well-filled sections per colony, most of which would class as "fancy white." I call my separator the "Harrison" for want of a better name.

GEO. W. HARRISON.

Susanville, Cal., Mar. 3.

[The peculiarity of your mode of using sections is that they can not be tiered up—that is, I judge your honey-flow must be of such a nature that you require only one tier of sections at a time; but in most places in California the practice is to use two tiers of sections—sometimes three and four, and it is certainly a great advantage to do so, or at least I so considered it in the localities I visited. However, you can get very nice honey, beautifully well filled, on the plan you describe. With the exception that the openings through the top are closed, your method is the same as that which has been used in England, for a good many years in connection with slotted separators. It is also practically the same, with the exception of the open top, as that used by L. A. Aspinwall, and by Louis Scholl and H. H. Hyde, mentioned in this issue. All things considered, I think you will find it an advantage to practice tiering up.—Ed.]

WHY THE QUEEN WOULD NOT STAY IN THE HIVE.

June 27th I introduced a clipped queen in a hive of bees. On the 28th, about 4 o'clock, she came out of the hive with quite a number of bees gathered around her on the grass. I put her back into the hive. The next day, at about the same hour, she came out again with bees around her as before. I put her back again. The next day, 30th, she did the same as before, and so on for four or five days. July 4th she came out twice. I caged her and introduced another queen. The bees seemed to be very uneasy until I introduced the second queen, but are all right now. Before I introduced the second queen I opened the hive, taking out the frames, some of which were two-thirds filled with comb with considerable honey, but could not find an egg. What do you think was the trouble?

L. C. UPP.

Mt. Pulaski, Ill., July 6.

[Friend U., you do not tell us where you got the queen that behaved so queerly. Unless you know she had been laying in some other hive I should say she had never been fertilized. Then the question arises, "Who was so foolish as to clip a queen without knowing that she was a laying queen?" Unless you tell us what you know about her before this queer behavior, we should hardly want to conjecture a reason. I *have*, however, known laying queens, when introduced into a new hive, go out in the manner you mention, as if they were displeased about something; but I never knew one to hold out so long in the way you describe. I should say she was not worth bothering with any way, and you did the proper thing in giving the bees another queen.—A. I. R.]

HIVING SWARMS IN ROOMY HIVES.

Say to Chris. Kinsel, p. 556, if he will use two hives instead of one in hiving his large swarms he won't be troubled by their leaving the hive. The upper hive should contain the frames, and the lower hive should be empty. Shade the hive well, and the third day take away the bottom hive and lower the top hive on to the bottom-board.

WM. CRAIG.

Luce, Mich., July 8.

[Very likely, friend C., more room inside of the hive, especially during exceedingly warm weather, would have a tendency to prevent the bees from leaving. Of course the hive should be in the shade if the sun is shining very warmly.—A. I. R.]

B. M. H., N. C.—If your bees have plenty of honey in the hive, don't bother about feeding them now. In fact, feeding should not be resorted to at all unless there is a liability of the bees becoming short during the coming winter. In your locality the bees should have, along about November, at least 25 lbs. of sealed stores, or what would be the equivalent of six frames, Langstroth size, or honey partly capped over.



NATIONAL BEE-KEEPERS' ASSOCIATION.

OBJECT:—To promote and protect the interests of its members; to prevent the adulteration of honey.

OFFICERS:—E. R. Root, President, Medina, O.; R. C. Aikin, Vice-president, Loveland, Col.; Dr. A. B. Mason, Secretary, 3512 Monroe St., Sta. B, Toledo, O.; Eugene Secor, General Manager, Forest City, Iowa.

BOARD OF DIRECTORS:—E. Whitcomb, Friend, Neb.; W. Z. Hutchinson, Flint, Mich.; A. I. Root, Medina, O.; E. T. Abbott, St. Joseph, Mo.; P. H. Elwood, Starkville, N. Y.; E. R. Root, Medina, O.; T. G. Newman, San Francisco, Cal.; G. M. Doolittle, Borodino, N. Y.; W. F. Marks, Chappinville, N. Y.; J. M. Hambaugh, Esccondido, Cal.; C. P. Dadant, Hamilton, Ill.; C. C. Miller, Marengo, Ill.

FEES:—Annual membership fee, \$1.00. Remittances may be sent here or to General Manager as above.

OUR subscription-list is increasing more rapidly than we have ever known it to before. For this we are grateful.

WE are compelled to give eight extra pages again, as we have so much good matter on hand that has been awaiting insertion.

I SUCCEEDED in catching Rambler on a genuine ramble. He was on the bicycle; and, although he has passed his threescore years, he has acquired the regular bicycle hump. I will show you the picture later.

I HAVE been told that the very excellent anti-adulteration law that was recently enacted in California is now being made a dead letter. The same informant says that a large corporation owns the glucose interests in that State, and is seeing that its interests are not hampered by this recent piece of legislation. I hope this is a mistake.

UNTIL one makes an extended tour of the South and West he can form no adequate comprehension of the immensity of the bee-keeping industry in those sections, nor of the big scale with which the Westerner, including bee-keepers, does things. I kept my kodaks snapping right and left; and if the negatives are good I'll give you more peeps at some of the things I saw.

THE black locusts, in California, in some localities, seem to kill the bees when these trees are in bloom; at least in the vicinity of Hanford I was told there would be hundreds and thousands of dead bees found under them. But in other localities, as, for example, in Colorado, the same trees were considered one of the important sources of honey; and, what was peculiar, they had no bad effect on the bees that gathered the nectar.

SOME little time ago I promised to tell about the bee-keepers' paradises in Texas. I have this on the docket, and it will appear as I take up the line of my travels. But since running across that paradise I have run into two or three others. There is one west of the Rockies, in Colorado, that is not yet over-

stocked with bees or bee-keepers; another one in Central Idaho—in fact, I do not know but the whole State. These will be described in turn. The fact is, millions of capital are being invested in irrigation; irrigation means alfalfa; alfalfa means a paradise for bees; but I found all along my trip that alfalfa-growing preceded bee-keeping by two or three years, for it seems to take about that length of time before bee-keepers find these gold-mines that have been hitherto unoccupied.

MR. H. W. COLLINGTON, editor of the *Rural New-Yorker*, will be one of the speakers to represent bee-keepers at the joint session of the bee and fruit men, at Buffalo. This session will be made up of the members of the American Pomological Society and of the members of the National Bee-keepers' Association. The *Rural New-Yorker*, according to A. I. Root, is one of the best agricultural papers published. It is practical and up-to-date, and Mr. Collington, its editor, a pleasing speaker, has been an open friend of the bee-keeper. He manifested much interest, as it will be remembered, in the Utter v. Utter case, urging that it be carried up to the higher court for appeal, which was done.

A LIST OF THE GREAT HONEY-PLANTS WITH LONG COROLLA-TUBES.

IN addition to the great honey-plants, red clover, buffalo clover, and horsemint, of Texas, that have long corolla-tubes, I can now add to the list the mountain sages of California, especially the white sage. This last has quite deep corolla-tubes; and I was told, while on the coast, that unless these corolla-tubes are very full the bees do not get much honey from this source. This is exactly the case with red clover. So it appears that long-tongued bees, if good in the North, will be in great demand all through the South, throughout Central and Southern California, as well as throughout all those States that grow red clover; and I have been surprised to find so much of it in the West. It appears, then, that, if long-tongued bees are an advantage on red clover, they will be equally advantageous in the case of all the other honey-plants I have named.

GENERAL IMPRESSION OF THE IRRIGATED REGIONS OF THE GREAT WEST.

I ARRIVED home from my trip, of some 6000 miles in the cars and 500 miles in a buggy, on Tuesday, the 16th, just after our last issue went to press. The whole trip seems like a dream to me now—a beautiful dream of paradises for the bee-men and ranchers whom I visited. I did not take in all the best bee country of the great West, but I went through some of the very best of it.

Some things that I could not have believed, had they been told me, I now credit because I saw them. When they told me, for example, that fence-posts planted in the ground would grow into trees in those irrigated sections, I did not believe it; but when I saw some posts that were sprouting—that is, leafing out, and

when I saw trees 20 inches in diameter, once fence-posts, that were said to be only 10 years old, with a barbed wire running right through the center of them, around the big fields, then I began to think there must be something in the fence-post canard. Again, when I was in Arizona and saw hens and chickens that had been hatched on pantry shelves under the influence of the climate alone, I was pretty nearly prepared to believe any thing they told me.

But speaking about hot climates, I have been where it was up to 120, and ranged from that down to 110 on the irrigated lands; but I did not feel the heat nearly as much in those places as I do here at 90. The reason is the excessive amount of humidity in the East compared with the West. A high temperature with high humidity is killing, especially when there are hot nights. A high temperature with low humidity is quite endurable—indeed, it is quite pleasant. A high humidity with low temperature is chilling and killing, as those of us in the East know.

But the great West does not have all that is nice and pleasant. I missed the ever present shade-tree in the open fields, of which we have so many here. I missed the large areas of woods, or hard-wood forests, some might call them. In much of the West, trees grow only along irrigation-ditches. One can leave some Western towns, beautifully shaded, and in an hour's drive get out into the desert where, if he should lose himself, he would die from want of water or food of any kind unless he could knock down a jack-rabbit. And then the great West, at least many portions of it, has hot winds and sandstorms; and the tenderfoot who has been through one of these, almost concludes he will put up with a foot of Eastern mud in the road; damp and chilly weather; rains, floods, hail, snow, sleet, zero weather, and every thing else, rather than go through another sandstorm; and the worst of it is, these sandstorms have a way of filling the houses full of dirt and grit. One can not screen it out, nor shut it out with the windows. He has to live and endure it. If there is a person who has ever eaten a "peck of dirt" in this world it is the one who lives out west in localities subject to sandstorms. I ardently hoped for a genuine sandstorm, and my wish was gratified the very next day. My face smarted from the sharp blasts of cutting sand. It poured down my back; it filled my ears, went all through my clothing, into my shoes; and see? One might just as well shut his eyes, plug up his nose, ears, and mouth, occasionally catching a breath of air through the dust and grit.

There is another thing I did not like in the great West in some places; and that is, a sort of weed known as foxtail. These peculiar spears will rub off on one's clothing, come clear through, and then turn around and come out backward. I have been for weeks picking the ugly things out of my clothes. They are about $\frac{3}{4}$ inch long, and bearded in such a way that they slide easily one way but not the other.

While the nights in most portions of the West are cool and delightful in spite of the

noonday heat, I was most disagreeably reminded of the presence of fleas and mosquitoes; and occasionally some other nocturnals that neither fly nor hop.

But with all the disagreeable features that I have described, if I were a young man, and desired to seek an occupation outdoors, I would take Horace Greeley's advice and "go west," for there is plenty of room in the irrigated regions, and the most of the time a delightfully pure air; little or no rain; and, where when the ground gets too dry, one can irrigate. Many and many a place that I saw, once a barren desert, is now, thanks to the mountain snows and irrigation, a veritable garden of Eden. The luxuriant vegetation and fruits of the tropics make one feel that these beautiful ranches could never have been any thing but beautiful and fruitful.

THE HONEY SEASON FOR 1901; HOW WILL PRICES RULE?

BEFORE going into detail I would say that the reports show that there were fewer bees that produced honey this year than the year before. In fact, the number has been dropping down from year to year, owing to the poor seasons that have prevailed in so many of the good honey localities. This is particularly so in Southern California, where probably three-fourths of the bees have died through neglect or starvation, just because the owners could not afford to keep on feeding them from year to year—at least they thought so.

In a general way we may say that white clover yielded better this year in the States where it grows than it has done for several seasons past; but the trouble was, there were not the bees to gather the nectar that there have been in years when clover was in abundance; so that, notwithstanding there has been a fairly good clover yield in the northern and central States, the actual amount of clover honey is not as great as it ordinarily is. It also appears from the reports that there is less basswood honey than a year ago. There will be less alfalfa honey from the western States, and so, as a natural result, the tendency of the market in the East, so far as the fine grades of honey go, should be as high as last year rather than lower; and I should not be surprised to see it advance.*

While Southern California has had a good year for honey, there have been so few bees to gather it that the amount of California sage that will be offered in the eastern centers will be comparatively light. Buyers in California have been trying to scatter broadcast the impression that there was a tremendous crop of sage honey, and that, therefore, prices would rule low. But that is a great mistake. Prices should be the same as last year, and will be, if I am not very much mistaken. The large producers, rather than sell at a low figure, will

*There has been, up until now, a general impression that this would be a big honey year, and, as a natural result, the market on extracted has been temporarily weak; but we are expecting it to stiffen up very soon now. Comb honey has not been put on the market yet to any extent, and it ought to start off at good prices.

hold their crop till next season; and I know of at least five or six carloads that will be held absolutely rather than sell at a low price.

In Colorado the crop of alfalfa honey, east of the Rockies, will be from one-half to two-thirds as heavy as it was a year ago, while west of the Rockies the season will probably be as good. Last year there was considerable alfalfa honey offered in the eastern markets, and there will be this year, but not so much, probably.

Two or three weeks ago our people were prepared to believe that prices would be lower for honey this year than last; but a careful analysis of all the reports seems to indicate that prices, instead of being from a cent to two cents lower than last season, should and probably will seek the level of 1900, for the simple reason that the entire honey crop of the country, probably, is no larger than it was a year ago.

But, aside from the report, we find that no more honey has been offered us than last season at this time—a fact that seems to prove the statements given by the reports. It may not be generally known, but the Root Co., perhaps, buys more *small lots* of honey than any other concern in the United States, and, as a general rule, we can get some idea of the amount of honey produced by the number of offerings, and the price asked for the honey. Every thing considered, then, it appears to us, from a careful survey of the whole field, that prices should rule the same as last year. If they should take a decided slump it will be because the big buyers succeed in conveying the notion that there has been a large crop, in order to get the honey at low prices, and then when prices stiffen *they* and not the producers will get the advance. Bee-keepers should, therefore, take it on themselves to inform each other.

Let me give one interesting fact in this connection. The Root Co. finds it can buy honey, from those who do not read bee-journals, at a lower figure than from those who take one or more and keep track of the market. It is not our rule to set prices. We ask for a sample and the prices asked; and it is a fact that *the fellow who thinks he can not afford to take a bee-journal will sell his honey enough lower in one season to pay for all the bee-journals for ten years.*

A careful analysis of the season in the principal honey States below, will, perhaps, give one a better idea of the actual situation.

From Michigan it appears from something like 30 reports, covering the entire State, that the season is not as good as that of last year. It will be remembered that, in 1900, our sister State produced a pretty fair yield of honey; and all the clover honey the Root Co. could buy came from Michigan. With very few exceptions the reporters for that State assert that the season is poorer than last year; and yet it has produced some honey this season.

New York, on the other hand, that has been having a series of poor seasons, comes up with a smiling face. The clover crop in that State has been universally good; and the York Staters, if their bees have not largely

died on account of black and foul brood during the several poor years, will, if they are not in too much haste, find a good market.

Pennsylvania does not make a good showing. While it is true that some honey has been produced, it appears that the season has been even poorer than last year, and that was about as poor as it could be.

Some bee-keepers in Illinois have had an absolute failure, while others have apparently obtained some honey, and the same may be said of Iowa.

Kansas, Nebraska, and Missouri, as well as Arkansas, have, as every one knows, suffered from a terrible drouth; and the reports in those States indicate little or no honey.

Wisconsin, a State that usually shows up well with basswood, if it does not with clover, does not seem to have been blessed with a good season; while its sister, Minnesota, seems to have had generally a good yield.

Some parts of Texas, usually one of the best bee States in the Union, have had a poorer year than last. But Texas never seems to have a complete failure; for, so far as I could learn while in that State, the bee-keepers always make a living, and generally a good one.

Utah, going to the extreme west again, has had a rather flat failure. The bees died off very badly in the spring. At the time I was there, the prospects were not encouraging.

Virginia and West Virginia, have not had a very favorable season.

Only two or three reports have come from Vermont, but they pronounce the season better than last year.

I have tried to give the situation fairly and impartially, and I believe I have stated the facts not far from the real truth.



GERMAN WAX-PRESS.

In another column we show the new wax-press we are putting on the market. The introduction price is \$10.00. We are likely to catalog it at a higher price than this, and are offering it for only a short time at this rate. So far as tried, it seems to fill the bill.

HONEY, COMB AND EXTRACTED.

We are again in the market for both comb and extracted honey. We are having a brisk demand already for a choice article, and shall be pleased to hear from those having any for sale, with a sample of extracted. Write us how much you have, how it is put up for shipment. We prefer extracted in 60-lb. cans. In offering comb honey, tell us how it is packed, how much you have of each grade, and what you ask for it. We have a lot of unfilled orders waiting for stock to arrive.

NO. 25 JARS AND MASON JARS.

Of the carload of jars received about a month ago we have already sold all of the pint size, both flint and green, and almost all of the 60 gross of No. 25 jars. We have ordered another car, consisting of 100 gross No. 25 jars, and more pint Masons. We hope to have these here by Sept. 1. In the meantime we still have a good supply of quart and two-quart Mason jars, which we will sell, while they last, at prices last quoted. The supply of quart jars is not so large as of the two-quart, and may not last very long. Send us your orders while the supply lasts. They can not be replaced at these prices.



If thou turn away thy foot from the sabbath, from doing thy pleasure on my holy day; and call the sabbath a delight, the holy of the Lord, honorable; and shalt honor him, not doing thine own ways, nor finding thine own pleasure, nor speaking thine own words, then shalt thou delight thyself in the Lord; and I will cause thee to ride upon the high places of the earth, and feed thee with the heritage of Jacob thy father; for the mouth of the Lord hath spoken it.—ISA. 58:13, 14.

Create in me a clean heart, O God, and renew a right spirit within me. Cast me not away from thy presence, and take not thy Holy Spirit from me. Restore unto me the joy of thy salvation, and uphold me with thy free Spirit. Then will I teach transgressors thy ways, and sinners shall be converted unto thee.—PSALM 51:10—13.

I was up in the Traverse region, on the very summit of one of the high hills. My boarding place was about a mile and a half from my little ranch in the woods, and each morning my wheel and I climbed this hill. It was just a little after sunrise. Cool breezes were coming from across the water; in fact, water was visible more or less in every direction. But before one gets to the water there are fertile fields, and homes of the tillers of the soil, scattered here and there in the valleys and on other hills. I was all alone. No human being was anywhere near, and there was nothing to hinder my speaking out loud as I thanked God (as I often do) for having given me a human life to live. Then I thanked him for my privileges, and almost unconsciously I began praying aloud for the different ones of my friends and acquaintances.

Some of the friends who read these pages may think it a singular thing that I enjoy talking out loud to the Maker of this universe. But the fact is, for many years I have greatly enjoyed this sort of communion, whenever I am sure no human being is near; and really is there any seclusion—that is, if we take it in the sense of freedom from interruption—like being on a hilltop when the hill is far away from all human beings? If I am correct, the Bible tells us of several cases where Jesus went up into a mountain to pray. There were several reasons that morning why I needed an opportunity for communion with God. You know what I said about that neighborhood, and being neighborly. Well, I had already got into an entanglement with a neighbor. I did not mind the few dollars involved, for I would have freely given the money to him; but I did not feel it would be right to let him think he succeeded by means that were not (as it seemed to me) fair and honorable. I prayed that God would give me grace to do just right in the matter.* Then I prayed for the inmates (whom I knew) of the differ-

ent homes that were right in sight in different directions.

I went down the hill through the cool shade of the old lumber road, through the ravine, very happy. In a few hours more I was working pleasantly side by side with the man with whom I had trouble, and I did not let him have his own way either. The Holy Spirit seemed to be with me.

After several days of hard work on the ranch I decided to take a rest by visiting some of the summer resorts further north. Bay View, just one mile north of Petoskey, is a sort of Michigan Chautauqua. Here religious people and some of our great divines address the people in the auditorium, not only every day but *several times* a day. I reached there Friday evening. I rather wanted to spend Sunday at Bay View because of the religious instruction; but what should I do with Saturday? My eye soon caught on a little bulletin that read, "An excursion of 170 miles for only 50 cents, to Mackinac Island and return, July 22." This would hit me exactly right, but I wanted to start home Monday. During the evening we had a splendid address, illustrated by a magnificent stereopticon, in regard to a trip over the route, as nearly as can be made out, where the children of Israel wandered for forty years. After the talk was over I noticed some new bulletins swinging in the breeze under the electric lights. I stopped to read them. It was something like this:

"The steamer Fanny Hart will touch at Petoskey at 9 o'clock Saturday morning. She will give passengers two hours at Mackinac Island, six hours in the middle of the day at the Soo, returning Monday. Price only \$5.00, including board and lodging."

Now, this gave me Mackinac Island with the "Soo" thrown in. It was to start Saturday morning, and that would let me make my trip back home Monday morning. The only trouble was, it was, at least in some sense, a Sunday excursion, and you know how pronounced I have been all my life against such things. But there was to be a stop of six hours at the Soo. This would take in church time, and why couldn't I attend church there as well as anywhere else? I debated the matter more or less all night, and finally decided to take the trip, although I did not feel quite easy about it. We had a very pleasant trip on Saturday, and reached Mackinac Island just a little before sundown; but we could not look over the celebrated objects on the island as we had planned, on account of a thunderstorm. We reached the Soo rather late Sunday morning, on account of the great number of vessels passing to and fro through that wonderful canal, cut through Saint Mary's River; but for some reason, unknown to the passengers, the captain announced that the boat would leave the Soo at 10 o'clock A. M. sharp. This shut off all chance of attending religious services. I inquired if there were any Sunday-schools before church, but did not find any. I also inquired if there was a Y. M. C. A. building there. A policeman told me the city had been talking about it, but hadn't got around to it yet. So I wandered

* I also prayed for that little Sunday-school where I talked to the young people the day before, nestled down in the valley, scarcely half a mile away. It seemed then an easy matter to pray for every thing and for everybody, for my enemies as well as for my friends; and there was a sort of feeling of confidence or faith given me that at least some of these prayers would be answered.

about with a conscience heavier and heavier every hour. Of course, I was interested in the wonderful sights of the great locks where boats toward 500 feet long are all the while awaiting their turn to be passed through. The passengers on board the boat were all very nice people. There was not any thing objectionable going on; but, at the same time, it was evident that none of the passengers were particularly spiritually minded. I found a very nice plain-print Bible on the piano, and I read in it a good part of the day. One young man admitted that he, like myself, was a church member, and that, although he was going to stay over till the next day, he did not propose to go to church while there were so many wonderful things to see and inquire about.

As we left the Soo, the mate informed us that, in consideration of the fact that we did not have a chance to go over Mackinac Island the day before, they would drop passengers—at least as many as wished—for four hours on the island while they went to unload some freight at Cheboygan. Here was a chance to attend the evening services; but the passengers were discussing the wonderful sights on the island—Arched Rock, Devil's Kitchen, Lover's Leap, beautiful cold-water springs, etc.

It was not church time when we landed, so I thought I would go with the rest and see some of these wonderful things, and get back in time for church service. Yes, it is true your old friend A. I. Root was not only off on a Sunday excursion, but he was out sight-seeing when he ought to have been getting ready to be promptly on hand with God's people, at the place of worship. As I passed along the beautiful macadamized roads between the water and the cliff I was somewhat nervous and excited. I imagined I heard Dr. Miller's voice saying, "Mr. Root, when you tell us of these wonderful sights you saw up here, you will, of course, remember to mention that it was on Sunday you 'took them in.'" Then I thought I heard the children discussing the matter, and it seemed to me I could hear Ernest laughing in his sly way (for he has always been more or less up to mischief), to think *father* was off sight-seeing on a *Sunday* excursion. These things troubled me so much that I passed by the Devil's Kitchen, and did not see it. A man I made inquiry of said he thought I certainly would have heard the running water from the springs right where you turn off and climb up among the cliffs. I turned and went back hastily. The evening was quite warm, and I was getting sweaty. I found the spring, and the water of it was certainly most refreshing. I saw the wooden steps that led up to the kitchen; but at first I said, "No, I am going straight back to church, even if I have come hundreds of miles to visit Mackinac Island, and stand just on the threshold of the 'kitchen.'" Then somebody or something suggested that I take just "one look" inside. I think it must have been the same person who suggested to mother Eve that she simply take "one bite" of that beautiful apple.

I climbed up the wooden stairs, but the kitchen was evidently further up. I followed a steep footpath; but the foliage was so dense, and it was so near night, I could not see very well. The pathway became more intricate and dark. Finally I emerged into an open grassy plot. I thought the kitchen must be down at my right, and I hurriedly pushed on that way, and then decided it must be at the left. Then I gave it up and tried to go back the way I came. But I could not find the opening where I came through the thicket. I tried quite a spell, and then meditated pushing down over the cliffs, without any path. But I only tore my clothes, got into a tangle, and got more sweaty, and I hadn't found any kitchen at all; but I mentally decided I was in the Devil's "*trap*" in good earnest, even if not in his "kitchen." A guilty conscience was making me more and more nervous and excited. Finally I slid down along a water-pipe I had noticed in climbing up. I had come further from the town than I supposed. I thought if I only succeeded in getting to church just before the services closed, or could get near the church doors among Christian people, I should feel better; but after visiting two different places of worship I only succeeded in going home with the crowd from one of them.

Just a week before, at that little Sunday-school over among the hills I gave the young people a talk about holding fast to their spirituality, or, if you choose, to the influences of the Holy Spirit. I told them a clear conscience and a sense of God's presence is worth more in life than any thing money can buy. With it they would be happy anywhere under almost all circumstances; and without it they could not be happy, even with all that wealth could furnish. Then I spoke to them about grieving away the Holy Spirit by doing things that their conscience told them were wrong; and yet after all this talk, within one week I *myself* had driven away all happiness just by chasing after the things of this world.

The steamer left us a little after five. The four hours would take us till something after nine; so we went out on the dock and waited for the steamer to show up. It was ten o'clock, and she had not come; eleven, and she had not come; midnight, no steamer. A little after one o'clock the electric lights from the upper bow could be seen away off across the waves. About half-past one we were on board. Besides the half-dozen passengers who decided to stop on the island, there were the dining-room girls who waited on the table. There in the night we had quite a chance to become acquainted; and had the circumstances been any different I might have exhorted those girls to lead Christian lives; but with what consistency could I then hold up Christ Jesus to them? Under other circumstances I might have done so; but I felt, for the present, myself ruled out. I passed them several times on the island, and they recognized me. *They* knew that I was of the world and among the worldly crowd and not with the church-goers.

Years ago I told you about riding twenty miles after dark over sandy roads rather than

even take a wheel-ride early Sunday morning. I said then that I tried not to do any thing that would make me feel ashamed to tell people my name and where I lived. Saturday night after dark, I was not ashamed nor feared recognition; but on Sunday morning, even if only a little after daylight, I would a little rather not be seen by any one who knew me. I said then, "Since I have become a Christian I can always and everywhere say to everybody I meet, 'I am A. I. Root, of Medina, Ohio. Who are you?'" But on this Sunday I do not think I told anybody my name. Several asked me, "Where do you come from?" I replied, "Ohio." In response to a further question I said, "Medina, Ohio, near Cleveland;" but I did not tell anybody I was A. I. Root. It was the first time in many, many years when I felt at all backward in giving my name and full address.

Many of you, perhaps, will remember that Sunday evening, July 21, was during one of our hot periods—at least so I have been told by the papers. Perhaps I might add my testimony in regard to the cooling winds of that northern region. The wind blew right across the water that night.* I had forethought enough to take my overcoat when I left the boat; but even with that overcoat, after midnight I became chilled to the very bone. When I got into my neat pretty little stateroom I thought I should get warm with the abundance of woolen blankets provided; but I did not get really warm before daylight, and I was used up physically as well as spiritually for the new week that opened before me. Years ago we had here in these Home Papers a little verse which read:

A sabbath well spent brings a week of content,
And strength for the work of the morrow;
But a sabbath profaned, whatever is gained,
Is a sure forerunner of sorrow.

Now, why should I tell all this? For one thing, it illustrates how easily one is led out of the straight and narrow path. Christian, in the Pilgrim's Progress, tells of getting over into another road that he felt sure was not the right one; but his companion declared it was all right. Pretty soon they met a man, and asked him about it, and he declared very positively they need not worry a bit, for it was *the* road. But by and by all three got deeper and deeper into trouble. I know there are many among our readers who will think I make a big fuss about a very little thing. They will say, "Why, the best church-member in the world does not expect to go to church *every* Sunday; and, besides, when peo-

ple are out on a vacation, or an outing, very few attend church *at all*. Even the ministers do not have any Sunday at such times. They are taking a *rest*." Well, you can have it that way if you like; but I do not want any such "rest."

Well, suppose you *have* followed after worldly things and worldly people, and made a mistake. What shall you do? Wait till the guilty feeling wears off? or perhaps, as the children might say, shall we wait till God forgets about it? God forbid. Such an experience fits us to appreciate the wonderful thought in the second of my texts. Again and again have I wondered that human language can so well express what a sinner feels. "Create in me a clean heart, O God." *Any* penitent sinner, under *all* circumstances in life (or even in death), could use this prayer; and the latter part of it, "renew a right spirit within me," is fully equal to the first. David recognized that his heart was not right. He was not what he ought to have been. But God himself is equal to the task of taking the wrong feelings and putting back the right ones. And then, again, we have the expression, "Cast me not away from thy presence." Those who have been in the habit of living near the Holy Spirit can realize what a punishment it is to be cast away because of sin. There is only one remedy; and David seems to comprehend it when he says, "Restore unto me the joy of thy salvation." And after God has thus given a new heart and a new spirit, and restored the lost joys, *then* may we point out to sinners the straight and narrow path. How grandly that point comes in, "Then will I teach transgressors thy ways, and sinners shall be converted unto thee." In my talk with the girls in the little crowd that was there waiting for that steamer I urged (as well as I could under the circumstances) pure and upright lives; but how could I exhort any thing in the line of either of my texts after the way they had *seen* me spend the Sabbath; and since that experience I value, as I never did before, having a life and *character* back of me so that I can consistently plead with people in the way suggested in the text, "*then* will I teach transgressors thy ways; and sinners shall be converted unto thee."



THE SUMMER RESORTS OF NORTHERN MICHIGAN.

Nearly a year ago I told you considerable about the beautiful resorts in the region of Grand Traverse Bay; but now I wish to speak of some of the celebrated places a little north of Traverse City, especially of the region round about Charlevoix and Petoskey. Charlevoix is situated just between Lake Michigan and Pine Lake. It is often called Charlevoix-

* In regard to the cooling winds, at one point on our trip on the steamer a lady at my elbow remarked, "Why, what a funny country this is! One time the wind blows hot, and sometimes cold." Sure enough. A hot breeze would come from off the land, that would make one feel almost faint; and, immediately after, a breeze from a slightly different direction from off across the water would brace one up with a delicious coolness that was really enjoyable. Sometimes when there does not seem to be any breeze at all from off the water an excursion is planned to some point where they can easily, at a slight expense, get the cool breeze, either on the boat or on some point of land that extends out into the water. The Traverse peninsula, where my ranch is situated, is one of these latter points.

the-Beautiful, and was named after F. X. Charlevoix, an early missionary there, from France. The Indians seemed to have recognized it as a beautiful spot before the white men ever had a glimpse of it. The station on the Pere Marquette Railway is itself a spot of wonderful beauty. Between the station and Pine Lake there is a fine lawn interspersed with flowers; and just back of the station is the Charlevoix Inn. You go up a broad flight of stone steps that look as if they might be made of marble; and just before you is a fountain that drops its waters into a large stone basin of this same white marble-like stone, with beautiful speckled trout so tame one can almost touch them, making it seem like a fairy land. All about the place are beautiful residences of the summer resorters as well as magnificent hotels. Electric lights are seen everywhere along the shores of Little Traverse Bay. The current is mostly furnished, I believe, by streams of great coolness and crystal purity that come from springs at the base of the hills. In fact, all along the northern part of the shores of Lake Michigan there is almost unlimited water power, and the water is so clear and pure that the waters along the pebbly beach of Little Traverse Bay look like clear spring water rather than lake water. The water is so clear in Little Traverse Bay that in many places you can see objects plainly at a depth of thirty or forty feet.

Charlevoix is only 16 miles from Petoskey, which is situated just within Little Traverse Bay. Here we have quite a large city on the side of the hill fronting the bay. Beautiful hotels with spacious grounds in front, and princely summer residences, are all along the bay. No matter how hot the weather, cool breezes are almost constantly coming from over the water from the north or northwest. During one of the hottest July days I took a trip off over the hills about seven miles, in the vicinity of Bear Lake, to hunt up a beekeeper. Well, over among these hills the July weather seemed very much like that in Ohio and Southern Michigan away from the great bodies of water. It was really unpleasantly sultry. When I got back to the shores of the bay and the great lake, it seemed like a different climate.

One mile north of Petoskey is Bay View, a place that has been celebrated for years past as the special resort of literary people. The university has a faculty of 42 instructors from the leading colleges; and then it has what is called the "Bay View Reading Circle," enrolling thousands of members.

Although electric lights are everywhere in Bay View, Petoskey, and Charlevoix, they have not yet caught on, if I may use the expression, to electric railways. There is, however, a very pretty arrangement of steam-cars, made much like our best trolley cars, that make trips to the surrounding resorts at a very low rate. For instance, they run every half-hour at the very low rate of 25 cts. for an eight-mile trip and return. Beautiful little steam ferries make a similar price; and the tickets will carry you either by steam or rail, as you choose. Besides this, there is a beautiful bi-

cycle track constructed at considerable expense from Bay View to Roaring Brook, and of course I had to try my wheel on the beautiful track. I forgot to time myself, but it seemed to me I never rode so many miles before in so short a time. Roaring Brook is six miles from Bay View. A stream of wonderful clearness and purity comes tumbling down the hillside through thickets of cedar and other evergreens. Walks have been cut all along through the tangled thicket; and one can scarcely imagine finer places for a picnic dinner than there are all along here. The ground under our feet is carpeted with the most beautiful moss. The air is perfumed with evergreen cedars—I think the same kind that furnishes the wood for our lead-pencils. Drinking-places are everywhere; and I can add my testimony to the statement that the water bubbling from these springs is nearer ice water than any other spring waters in the world. I regret I did not carry along a thermometer. The statement is made that the gushing springs along the shore are only 12 or 15 degrees above the freezing-point all the year round.

After riding my wheel it seemed as if I could never drink enough of that water, and I really feared several times that so much cold water might interfere with my digestion, but it did not a bit. The crowds around me seemed to feel as I did. They drank and drank, and evidently decided in their own mind that there was no more delicious drink to be found on the face of the earth than this pure cold spring water. By the way, I do not remember seeing a saloon anywhere along those resorts. In fact, if one were to start a saloon I am inclined to think the surroundings would persuade people that the spring water is better, and more to be desired than any thing to be found in those dens of iniquity.

Now, I wish to give Harbor Springs a good write-up; but I am afraid I can not do it justice. I should call it a little island about a mile long and half a mile wide. It *would* be an island if there were not a little neck of land connecting it with the shore. But clear around this island are summer cottages. They are as close together as they can be placed—that is, and not be too much crowded against their neighbors. They are all around fronting the water, and close to it, like cottages along a suburban street. These cottages are all different. Each one has some peculiar piece of architecture and fancy painting. In front of each cottage, right out in the crystal water with its pebbly beach and bottom, there is a boat-house covered with canvas or light painted woodwork. Every resident owns a boat of some sort. As the sand is rather soft to walk in, wooden walks curve along with the irregularities of the shore, and narrow walks lead up to the doorway of each residence. Not only does Nature seem to have put on her holiday attire, but all the people—men, women, and children—are dressed in light summer garb. As I gazed in astonishment I fell to wondering if all the pretty women congregated at Harbor Springs, or was it their attractive and novel attire and the sur-

roundings that would have made any woman look lovely under similar circumstances? Perhaps they looked lovely because they were good people. "Handsome is that handsome does," you know.

Every little while the motor cars and the ferry-boats were loading and unloading their cargoes of people who were in summer attire enjoying their vacation. Of course, electric launches, costing all the way from a few hundred to a few thousand dollars, were flitting in and out everywhere. For 15 cents you can take short trips and back again; and those dainty launches, upholstered like a Pullman car, easily gathered a crowd of passengers almost everywhere they stopped.

I have told you before that I am in love with "babbling brooks." Well, Roaring Brook is a "babbling brook" indeed, and on a considerable scale, for there are waterfalls every few rods. Now, there are other resorts all along the northern part of the east shore of Lake Michigan. Perhaps, however, the center of all this work is more in and about Little Traverse Bay than anywhere else.

Some of you may say, "Oh, yes! that is all well enough for *rich* people." But, wait a little, my friend. I had this matter especially in view when I made the trip. The railroads are making exceedingly low rates all the while up to this vacation region, and return. While there are hotels that charge several dollars a day for board and lodging, there are great numbers of private residences advertising furnished rooms. You will see there little shingles hanging out from almost every cottage in some streets. At Traverse City I had a letter of introduction to Mr. Frank A. Risley (a college student), who is employed during his vacation by the American Sunday-school Union to look after the Sunday-schools of Northern Michigan. Well, he has his headquarters in Traverse City in one of the very pretty little cottages on West Seventh Street. While talking with him about his work, his salary, and his expenses, he gave me the following information: The little sleeping-room where he and I were talking cost him 75 cts. a week. He was at liberty to occupy the room every day and every night if he chose; but in his mission work he was, of course, absent a great deal of the time. Well, now, mind you, this nice pretty little room with dainty bed, washstand, towels, etc., cost him only 75 cents a week. Then at the same house he purchased 21 meal tickets for \$2.50—only about 12 cts. a meal, you will notice. Now, he could use these meal-tickets just when he chose. He was going and coming every day. The room was, of course, to be paid for any way; but no meals, only when he was present. When I suggested that it must be rather plain fare for so small a price he invited me in to supper, and it was just as good a meal as I would ask for. In fact, I think I would enjoy better health with such fare, and, as a consequence, more happiness, than if I could be at a hotel where meals cost 50 cts. each, and a bed the same. I am told that similar prices can be obtained in almost all of these towns and cities. Of course, you will have to choose

a cottage somewhat away from the center of the town, where rents for that kind of property are low, to get these low rates.

At every stopping-place I easily found nice clean restaurants where a good meal could be had for from 15 to 25 cts. In this respect Northern Michigan is certainly away ahead of some other parts of our country. The people are also pleasant, civil, and accommodating. Their bread and butter largely depends on securing boarders and lodgers, and in treating them so well that they will want to come to the same place again next year; and hundreds and thousands of people are making trips regularly every summer to these northern resorts.

I have told you elsewhere something about my trip further north. Mackinac Island is much like Harbor Springs, but not quite as retired among the cedar-trees and thickets; but just about sundown you can perhaps see more women, girls, and children, in fantastic holiday attire, on the side hill on Mackinac Island than in any other spot on the face of the earth. It made me think of collections of gaudily painted butterflies we often see in entomological collections. You gaze at one, and think she is about the most attractive woman you ever saw. Then you look at another, and finally conclude she is rather ahead of her sister, although in a different way. Then a third eclipses both, and so on until you are utterly bewildered. Now, such scenes do not give me unalloyed pleasure. I often fall to wondering if these lovely women have the love of Christ Jesus in their hearts; and then I begin wondering, again, if such is the case how can they consistently spend so much money in dress and so much of their time in display? Now, I try not to be too critical in this direction, for I believe God intended that women—yes, and men too—should use quite a little time and money in making themselves look neat and well, in the eyes of their fellow-men. I have sometimes wondered just where the line should be drawn, especially when I pay ten cents to have my shoes nicely shined, and then have some adventure a few minutes later that takes the shine all off again.

The Soo canal is the most wonderful spot in Northern Michigan, in my opinion. While it has some of the attractive features I have been speaking about, the Soo and its surroundings remind us more of the great progress that has been made and is being made in transporting the merchandise of the world. All the way up through that canal cut in the solid rock of the St. Mary's River, we pass great boats laden to their utmost with iron and copper ore, wood pulp from the Canadian forests, and other articles of merchandise. I never knew before that there were hundreds of great steamers, made almost entirely of steel, pretty well toward a quarter of a mile long, engaged in this great traffic. These steamers, when laden, are mostly under water except the little turret that the pilot and the officers of the boat occupy. They call them whalebacks; and, in fact, the waves are expected to pass right over them without hindrance. These boats are going and coming at such a rate that the great double Soo canal

has all it can do, and sometimes more than it can do, to let them through without expensive delays. These canals are cut in the solid rock, right beside the celebrated Soo Rapids. This rapids is in the Saint Mary's River, that permits the waters of Lake Superior to pass down to Lake Huron. The rapids is, I should say, a river half a mile wide and perhaps a mile long where it splashes and foams over the rocks. The fall is about 20 feet. Each side of this mile in length, not only the walls of the canal but the pavement over the ponderous machinery are solid hewn stone, the peculiar white building stone I have mentioned, that looks so much like marble. The buildings containing the machinery for operating the locks are little houses made entirely of glass and stone. The power to move the ponderous gates all comes from water-motors driven by the enormous water power of the Soo canal. Just back of the city a new canal is being constructed 200 feet wide at the bottom, and 30 feet deep. This canal is sawed out of solid stone. The walls are cut down by appropriate machinery as true as the walls of a building. Railroad tracks run along the bottom, and cars carry out the broken rock. The work has been in progress for two years and a half, and it is estimated it will take two years more. This canal is to furnish water power, and the power-house is now partly finished, almost a quarter of a mile long, and is said to be the longest single building in the world. An electric-power plant is to be installed that will rival the great electric plant at Niagara Falls.

When I expressed surprise that there was enough shipping to keep two great canals constantly busy, one of the officers informed me that the old canal, built many years ago, was soon to be enlarged, because the capacity of the two was not sufficiently great for commerce.* The material on which all daily papers are printed—yes, the very paper on which you read these words—probably comes from the Canadian forests through that great Soo canal. The officer mentioned told me the traffic in paper pulp was getting to be so great that a project was on foot to bring the pulp from Canada to the United States through an immense viaduct, something like the great tunnels that bring water for our large cities. This pulp was to be pumped through to paper-mills run by the great power-plant I have mentioned, and they expected to furnish paper enough, not only for all the newspapers, but for all the books to be made in the United States. When I asked how long the Canadian forests would hold out, my informant said that there were miles and miles of the spruce timber, and that there was raw material enough in Canada to supply the United States for at least a hundred years.

At the close of my visit to the great Northwest, I wish to mention once more my in-

* Besides the two great canals with their ponderous locks, on the American side, I must not fail to mention that there is also a similar canal on the Canadian side; and these three together are not able to pass the great boats so as to prevent navigation at times from being blocked, and suffer delays that are enormously expensive.

debtedness to the officers and employees of the Pere Marquette Railroad. I suppose most of the friends know already that I am always making blunders, in traveling. I have fits of doing things absent-mindedly. On one occasion a baggage-master gave me a check for my bicycle. I suppose I must have taken it and put it in my pocket; but I was so sure I *didn't*, I looked another baggage-master squarely in the face and declared I never received any sort of check. They thought it very strange, and gave me another. Afterward, in *another* fit of absent-mindedness, I put both checks in my overcoat pocket, and when I wanted the wheel (at the Traverse City station) my overcoat was out at my ranch in the woods, ten miles away. I explained matters, and got my wheel without a check at all. Now, these Pere Marquette people *all* seem to be good-natured. I think they must take it for granted that, in carrying people off on an excursion, they must put up with a good deal, so the excursionists can have a good time and want to come again.

Just one thing more: During this hot dusty period I have always found plenty of clean water in even the common railway coaches; and not only that, two great big roller towels to every coach, that were *certainly* nice and clean every morning when they started out.

In the next issue I will tell you something about strawberries, peaches, and potatoes in the Traverse region—especially about ripe strawberries for the markets of Chicago after the middle of July.

Special Notices by A. I. Root.

WHAT CAN WE SOW OR PLANT ON VACATED GROUND DURING AUGUST?

Well, August is the great month for turnips. The Purple top White Globe seems to be the special favorite. A good many sow the seed the last of July; but if grown during hot weather they are apt to be too strong for table use. If you want real nice turnips for the table, sow them several times during August—yes, even up into September. They will not be real nice until they are out in a frost or two; and those sown so late that they do not get very large are best for table use. The White Egg is a good deal like the White Globe, but a good many think them more tender and sweet.

Of late there has been considerable said in the agricultural papers about sowing turnips on spare ground, to plow under as a fertilizer. Now, turnips are not worth as much as clover, by any means; but they are better than nothing at all, and for this purpose the long White Cowhorn is recommended. Its roots go away down and bring up fertility that the round turnips growing on top of the ground will probably miss. They will also stand a drouth better when they once get started.

We can furnish seed of the turnips mentioned above, at 5 cts. an ounce; 1 lb., 30; 5 lbs., \$1.25. If wanted by mail, add 9 cts. per lb. for postage and packing.

DWARF ESSEX RAPE.

This is something after the turnip family, or perhaps, rather, the cabbage family. It will stand more frost than either cabbage or turnip. It can be put in among corn at the last cultivating. I have seen it sown in this way so as to stand 3 feet high after the corn was cut and out of the way. It may be sown at any time from May to August. In my trip through Michigan I saw field after field of it, some of them ten acres or more in extent, and sheep and lambs were feeding off the crop during the last of July. Where the drouth was very severe this plant seemed to stand up bright and green.

Prices: 1 lb., postpaid, 20 cts.; 50 lbs., by freight or express, 7 cts.; 100 lbs., \$6.00.

SEVEN-TOP TURNIP FOR HONEY OR TO PLOW UNDER.

I omitted mentioning in the proper place that the seven-top turnip is perhaps the best one to plow under for fertilizing the soil. It will also give a good crop of honey before it is turned under in the spring. If sown any time in August or the fore part of September it will get rooted so as to stand any winter. In fact, I never knew it to be thrown out by the frost here in Ohio when it gets a good start. It comes into bloom between apple-blossom and white clover. It may be plowed under for potatoes or any other crop. Price, ounce, 5 cts.; 1 lb., 20 cts.; 10 lbs. or more at 15 cts. If wanted by mail, add 10 cts. per lb. extra.

CRIMSON OR SCARLET CLOVER, ETC.

With a fair amount of rain this will do all right on almost any good ground, sown during the fore part of August; but the earlier the better. For prices, etc., see our last issue.

In the Traverse region in Michigan, medium and mammoth clovers catch all right and stand the winter when put in during August. Some experiments have been made here in Ohio, but I can not find any thing very definite about it. But I have tried it on small patches where strawberries were turned under. I think that, with good ground and favorable circumstances, all the clovers will make a stand when sown in August.

WINTER OR EGYPTIAN ONION-SETS.

We are just now gathering a fine crop of these. Quart, 10 cts.; peck, 50; bushel, \$1.50. If wanted by mail, add 10 cts. per quart for postage and packing. As we are getting a good many orders, if you want them at the above price you had better get in your order at once. Now is the time to plant them, and the sooner the better. They never fail to grow, and they will stay in the ground for years unless you dig them out. It takes a very smart weed to crowd the winter Egyptian at any season of the year; but, of course, they do very much better where the weeds are kept out, and clean cultivation given. Perhaps I might add, in conclusion, that, if the weather is not too hot and dry, almost all kinds of peas will give a nice crop for table use if put in during the fore part of August.

SEED POTATOES FOR 1902.

The prospects are just now that potatoes for any purpose will be scarce and high. The Cleveland market quotes potatoes for table use at \$4.50 per barrel; seconds, from \$1.00 to \$1.25 per bushel. In our own market new potatoes are retailing at 40 cts. a peck, and they are small and poor at that. The only kind we have that are harvested and ready to ship is the White Bliss Triumph. Prices at present will be, $\frac{1}{2}$ peck, 35 cts.; peck, 50; $\frac{1}{2}$ bushel, 85; bushel, \$1.50; barrel, \$4.00. Small seconds, half above prices. This is probably the earliest potato in the world. If it were not for its susceptibility to blight, it would easily take the place of every thing else. The above prices are just about what they are worth for table use. They may be cheaper later on. No one can tell just now. Red Triumph, same price as above.

CHAS. ISRAEL & BROS.,
486, 488, 490 Canal St.,
Corner Watt Street, N. Y.

Honey and Beeswax.

Liberal Advances made on Consignments.
Wholesale Dealers and Commission Merchants.
Established 1875.

D. COOLEY,

DEALER IN BEE-KEEPERS' SUPPLIES,
KENDALL, MICHIGAN.

Root's Goods at Root's Prices. : : Catalog free.

COMPRESSED CELLS can be used over and over; the oftener they are used the better they work. We compress cells in removable wooden shells at 2c each; or you can own a Grace cell-compressor for \$2.00, post-paid; blank shells, 1c each; started queen-cells, 5c each. Get a queen-rearing outfit and rear your own queens. All by mail. New circular ready.

The Swarthmore Apiaries, Swarthmore, Pa.



A Superior Red-clover Queen for 25 cts.

An Offer for New Subscribers:

We want to add a lot of new readers to our WEEKLY AMERICAN BEE JOURNAL list during August and September. For that reason we are making those who are not now reading our journal regularly, this liberal offer: Send us \$1.25, and we will mail you the Bee Journal for a whole year, and also one of our SUPERIOR LONG-TONGUED RED-CLOVER QUEENS—untested Italian.

We arranged with one of the oldest and best queen-breeders (having many years' experience) to rear queens for us this season. His bees average quite a good deal the longest tongues of any yet measured. The breeder he will use is direct from Italy, having imported her himself. Her worker-bees are large, somewhat leather-colored, very gentle, and scarcely requiring veil or smoke. They stored red-clover honey last season. All queens guaranteed to arrive in good condition, and all will be clipped unless otherwise ordered. All queens mailed promptly.

Headquarters in Chicago for Root's bee-supplies at Root's prices. A free catalog and sample of the American Bee Journal on request.



George W. York & Co., Chicago, Ill.
144, 146 Erie Street.

Standard - Bred Queens!

Acme of Perfection; Not
a Hybrid among Them.

Improved Strain Golden Italians.

World-wide reputation; 75c each; six for \$4.00.

Long-tongued 3-banded Italians.

Bred from stock whose tongues measured 25-hundredths inch. These are the red clover hustlers of America. 75 cts. each; six for \$4.00. Safe arrival guaranteed. Catalog on application. Headquarters for bee-keepers' supplies.

Fred W. Muth & Co., Cincinnati, Ohio.
South-west Corner Front and Walnut Streets.

QUEENS! Fine, large, gentle, and prolific; long-tongue reach; either 3 or 5 banded; 75 cents each; six for \$4.25. Try them and be pleased.
CHAS. H. THIES, Steepleville, Ill.

**DON'T EXPECT**

PAGE Fence results unless you use The PAGE.
Page Woven Wire Fence Co., Adrian, Mich.

SAVE A DOCTOR BILL

by having a supply of medicine on hand. Our Big Drug Book contains 15000 drugs, medicines, family remedies, extracts, paints, oils, etc. We save you 15 to 75% Book mailed for 10c.—refunded on your first order. "The Only Mail Order Drug House in the World." HELLER CHEMICAL CO., Dept. 40 Chicago, Ill.

To Our Shippers.

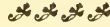

We were obliged to notify you a few weeks ago that one Joseph M. McCaul had leased our old quarters at Nos. 120-122 West Broadway, New York City, and had there started up business under the name "Hildreth, McCaul Co.," and had distributed a multitude of circulars so worded as to create the impression that his business was a successor to or a branch of the business of Hildreth & Segelken.

For the protection of our shippers and ourselves, we at once instructed our attorney to commence action to enjoin the said McCaul from using the name HILDRETH in any manner whatsoever in connection with his business. On the 10th day of July, 1901, Hon. David McAdam, Justice of the Supreme Court of the State of New York, after a full argument upon the merits, issued a peremptory injunction, of which the following is an extract:

"And it appearing that the plaintiffs have for a long time been and now are carrying on business under the style of "Hildreth & Segelken," and that the defendant has recently opened a business at 120-122 West Broadway, in the Borough of Manhattan, City of New York, and is carrying on the same under the style of "Hildreth, McCaul Co.," and that such act is in violation of the plaintiffs' rights, and that the commission or continuance thereof, during the pendency of this action, will produce irreparable injury to the plaintiffs; . . . it is

ORDERED that the defendant (Joseph M. McCaul) and each of his agents, servants, and employees, and all other persons acting under his authority and direction be, and he and they are hereby restrained and enjoined from showing, displaying, or otherwise using during the pendency of this action in or upon any papers, devices, sign or signs, or otherwise, in the business conducted by the defendant at No. 120-122 West Broadway, in the Borough of Manhattan, City of New York, or elsewhere the name of "Hildreth" separately or conjunctively with any other name, designation, or description."

Outside of our desire in our own interests to protect the name which we have built by years of satisfactory dealings with our customers, we hastened to procure this injunction as soon as possible, to prevent our shippers from being misled into sending their goods to one who would make an attempt to gain their trade by such a trick and device.

With thanks for the many expressions of good will we have received from our shippers concerning this attempt to trade under our name, we are

Sincerely yours,

HILDRETH & SEGELKEN.

265-267 GREENWICH STREET, NEW YORK CITY.

THE SMITH PREMIER TYPEWRITER

Occupies an Imperishable Position in the BUSINESS WORLD.

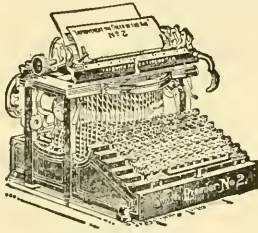

Unquestionable Superior Merit

Annually adds thousands of names to the long list of Smith Premier users, representing every line of trade and every profession.

ILLUSTRATED CATALOGUE FREE.

The Smith Premier Typewriter Co.,

158 Prospect Street, Cleveland, Ohio.

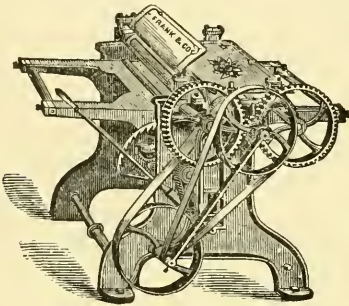

PLANERS

The above cut shows one of our small Planers, of which we make twelve different styles and sizes. Also large Planers, Band Saws, Buzz Planers, Moulders, Wood Lathes, and all kinds of

WOOD WORKING MACHINERY

Send for Catalogue.

The FRANK MACHINERY CO.

BUFFALO, N. Y.

Union Combination Saw

For Ripping, Cross-cutting, Rabbeting, Mitering, Grooving, Gaining, Boring, Scroll-sawing, Edge-moulding, Beading. Full line FOOT and HAND POWER machinery. Send for catalog A. SENECA FALLS MFG. CO., 44 Water St., Seneca Fa., N.Y.

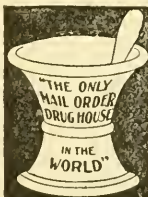
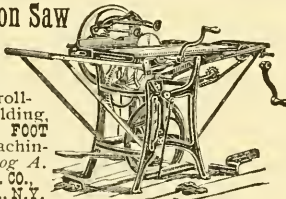

\$2 for 10c.

Our large Illustrated Drug Book contains 15000 listed drugs, medicines, family remedies, trusses, instruments, veterinary preparations, paints, oils, flavoring extracts, etc. We save you 15 to 75% on any of them. The book costs us \$2. We mail it to you for ten cents and refund the amount on your first order. Heller Chemical Co., Dept. 40, Chicago.

To make cows pay, use Sharples Cream Separators. Book "Business Dairying" & cat. 288 free. W. Chester, Pa.

In writing advertisers please mention Gleanings.

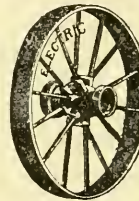

A Good Wagon

begins with good wheels. Unless the wheels are good the wagon is a failure. IF YOU BUY THE ELECTRIC STEEL WHEEL made to fit any wagon—your wagon will always have good wheels. Can't dry out or rot. No loose tires. Any height, any width tire. Catalog free. ELECTRIC WHEEL CO., Box 95 QUINCY, ILL.

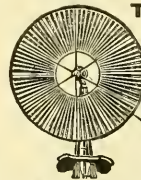

The Storm Proof KING WIND MILL

produces 25 to 50% more net power from any kind of wind than any other mill made. Wheel being only 1 in. thick, cuts the wind like a knife and is 400% more storm proof than any other. Exceedingly light, but wonderfully strong. Very sensitive—runs in lightest winds. Numerous sizes—6 ft up, both pumping and power, back geared or direct stroke. Send for circulars and prices before you buy. Medina Mfg. Co., Box 11, Medina, O.

Don't Dig Potatoes by Hand

It is a slow and expensive way. The cheapest, quickest, and easiest way is to USE THE IMPROVED

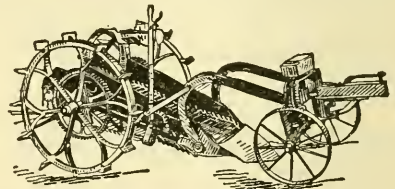

DOWDEN POTATO-DIGGER.

It gets them all, no matter how deep or shallow. Our book explains how. Book is free. Write for it now. DOWDEN MFG CO., - Box 23, Prairie City, Ia.

Mr. A. I. Root's Writings

of Grand Traverse territory and Leelanau Co. are descriptive of Michigan's most beautiful section reached most conveniently via the

PERE MARQUETTE R. R.

For pamphlets of Michigan farm lands and the fruit belt, address W. C. Tousey, D. P. A. Toledo, Ohio.

LONE STAR APIARIES

Italian Queens.

Estab'd 1885 Prices of queens from imported mothers: Tested, \$1.50; 6, \$6.50; 12, \$12.00. Untested, 75c; 6, \$4.00; 12, \$7.00. Golden, same price. Select tested of either race, \$2.50 each. For a short time I will mail tested leather-colored queens at \$1.00.

Your money back if you are not satisfied. Address
G. F. DAVIDSON & SONS, FAIRVIEW, TEX.

Your Order for Queens

—Tested and untested—will be promptly filled by return mail. Our strain of Italians is unsurpassed as honey-gatherers. Every queen guaranteed. Choice tested queens, \$1.00 each; \$12.00 per dozen; choice untested, 75c; \$8.00 per dozen. Send for price list. Address . . .

J. W. K. Shaw & Co., Loreauville, La.

HONEY QUEENS!

Leather-colored Long-tongues.—I have a breeder for which \$25 has been offered and refused. You make no mistake in buying her daughters. They are dandies.

Goldens.—The Laws strain is as good as years of patient selection and breeding can establish.

Holy Lands.—These are a deserving race of bees. With two years' acquaintance I find them great workers, with no vindictive traits, easily handled, are becoming popular, especially in South.

The above races of bees are each bred in separate apiaries, and you can get them in their purity. Am filling all orders by return mail, and I sell at the following low prices, with the usual guarantees. Single queen, untested, 75c; six for \$4.00. Tested, \$1.00; six for \$5.00. Breeders, either race, \$2.50 each. Address

W. H. Laws, Beeville, Texas.

ALBINO QUEENS. If you want the most prolific queens, the best honey-gatherers, the best comb-builders, the hardiest and gentlest bees known, try my albinos. My untested queens, 75c. J. D. GIVENS, Lisbon, Texas.

W. H. Pridgen,

of Creek, Warren Co., N. C., whose money-order office is Warrenton, N. C., is now prepared to fill orders promptly with the Hutchinson "Superior stock," or golden untested queens, at 75 cts. each, or queen-cups at \$2.00 per pound, postpaid.

Crimson-Clover Seed.

I have fifty bushels grown on hard land, a No. 1 article, at \$4.00 per bushel for one or more bushels; ½ bushel, \$2.25; ¼ bushel, \$1.25; bags free. Reference, any business firm or bank in Kent Co., Del.

J. Colby Smith, Willow Grove, Del.

Minnesota Bee-keepers' Supply Mfg. Co.,
Manufacturers of
Bee-hives, Sections, Shipping-cases, and
Everything Used by Bee-keepers.

Orders filled promptly. We have the best shipping facilities in the world. You will save money by sending for our price list. Address

Minnesota Bee-keepers' Supply Mfg. Co.,
Nicollet Island Power Building, Minneapolis, Minn.

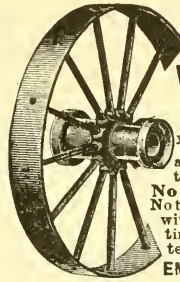

STEEL WHEELS

for your FARM WAGONS

any size wanted, any width of tire. Hubs to fit any axle. No blacksmith's bills to pay. No tires to reset. Fit your old wagon with low steel wheels with wide tires at low price. Our catalogue tells you how to do it. Address
EMPIRE MFG. CO., Quincy, Ill.

Long Tongues Valuable South as well as North.

How Moore's strain of Italians roll in the honey down in Texas:

Hutto, Texas, Nov. 19th, 1900.

J. P. Moore.—Dear Sir:—I wish to write you in regard to queens purchased of you. I could have written sooner, but I wanted to test them thoroughly and see if they had those remarkable qualities of a three-banded Italian bee. I must confess to you I am more surprised every day as I watch them. They simply "roll the honey in." It seems that they get honey where others are idle or trying to rob; and for gentleness of handling, I have never seen the like. Friend E. R. Root was right when he said your bees have the longest tongues; for they get honey where others fail. I will express my thanks for such queens. I am more than pleased. I will stock my out-apiaries next spring with your queens.

Yours truly, HENRY SCHMIDT.

The above is pretty strong evidence that red clover is not the only plant which requires long-tongue bees to secure the greatest quantity of nectar.

Daughters of my 23-100 breeder, the prize-winner: Untested, 75c; six, \$4.00; doz., \$7.50. Select untested, \$1.00; six, \$5.00; dozen, \$9.00. Safe arrival and satisfaction guaranteed. Descriptive circular sent free. I am filling all orders by return mail, and shall probably be able to do so till the close of the season.

J. P. Moore, Lock box 1, Morgan, Pend. Co., Ky.

(Mr. J. P. Moore is entirely reliable.—A. I. R. Co.)

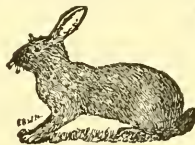

Belgian Hares

Fully pedigreed of the highest breeding, at prices that will suit. With every hare sold goes a full pedigree, register number, and score-card, scored by an official judge; and, when desired, does will be bred to one of our famous high-scoring bucks before shipment. Address
J. B. MASON,
Mangr. of The A. I. Root Co., Mechanic Falls, Me.

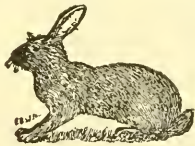

Belgian Hares

I have some fine hares for sale at reasonable prices.

J. F. Moore, : Tiffin, Ohio.

BELGIAN HARES!

Either domestic or imported, of any grade from a pedigreed prize-winner to a common rabbit, at prices that are right. Write
GEO. M. TEETER, PENNVILLE, IND.

1200 FERRETS. All sizes; some trained; first-class stock. New price list free. N. A. Knapp, Rochester, Lorain Co., Ohio.

Twice as Much Honey!

Dr. Mason's Experience with Superior Stock.

Dr. Mason, Secretary of the National Bee-keepers' Association, writes me, on date of June 28, as follows:

"I think that I am safe in saying that the colony of bees that has the \$1.50 queen that I got of you about a year ago, although not as populous as most of our colonies, is gathering nearly, if not quite, as much honey as any *two* of our most populous colonies. I never use any smoke in handling them and never get stung.

It's just fun to handle them. When I remove a comb, unless it rubs against another, they don't run and make a fuss about it, but keep quiet and attend to their business."

Price of a queen, \$1.50, or the Review one year and a queen for \$2.00.

W. Z. HUTCHINSON, Flint, Mich.

1881

PAGE & LYON MFG. CO.

1901

We manufacture a full line of the latest
BEE-SUPPLIES.

Our motto is, "Perfect Goods and Prompt Shipment."

Send for our new free illustrated catalog.

PAGE & LYON MFG. CO., New London, Wisconsin.

NOW READY!

64-PAGE CATALOG OF EVERY THING BEE-KEEPERS NEED. Illustrated and fully described. Especially valuable to beginners for the information it contains. Send your address on postal and get it now. Established 1884.

J. M. JENKINS, Wetumpka, Ala.

I. J. Stringham, 105 Park Place, New York City.

Keeps in stock a full line of modern appliances for bee-keepers.

SQUARE CANS & SHIPPING-CASES.

One-pound square flint jars with corks, \$5.00 a gross. Cartons of a superior quality at a low price. Tested Italian queens, \$1; untested, 75c. Apiaries, Glen Cove, L. I.

Catalog free.

I. J. Stringham, 105 Park Place, New York City.

Marshfield Manufacturing Company.

Our specialty is making SECTIONS, and they are the best in the market. Wisconsin basswood is the right kind for them. We have a full line of BEE-SUPPLIES. Write for FREE illustrated catalog and price list.

Marshfield Manufacturing Company, Marshfield, Wisconsin.

\$1-TESTED QUEENS=\$1.

A nice lot of young golden tested queens at \$1.00 each while they last; selected, \$1.50; warranted queens, 60c;—6 for \$3.50; select warranted, 80c—6 for \$4.50. My bees are a five-band strain, selected for size, energy, working qualities, long tongue-reach—and, lastly, beauty. I have never tested a strain that excels them. A pile of letters assert the above claims are true, and also that they winter well north. Queens are sent promptly.

J. B. CASE, Port Orange, Fla.

30 COLONIES Italian bees for sale cheap; in good condition; no disease. Also S. C. B. Leghorns; no better; circular free. H. M. Moyer, Shanesville, Pa.

FOR SALE.—7500 lbs. clover and basswood honey, in 60-lb. cans, at 7 to 8 cts. Also fine tested Italian queens, \$1.00 each.

ELIAS FOX, Hillsboro, Wis.

FOR SALE.—Nuclei, in chaff-hive frames; three frames with queen, \$1.75. Good Italians.

H. L. FISHER, New Paris, Ind. R. D. No. 2.

FOR SALE.—One 2 frame Cowan extractor in good order at half price.

H. W. THOMPSON, LaPorte, Texas.

Forty more mismatched queens reared last fall and this spring, 25c each. **B. F. AVERILL, Howardsville, Va.**

Wants and Exchange.

Notices will be inserted under this head at 10c per line. You must say you want your ad. in this department, or we will not be responsible for any error. You can have the notice as many lines as you please; but all over ten lines will cost you according to our regular rates. We cannot be responsible for dissatisfaction arising from these "swaps."

WANTED.—To exchange worker combs, in either Hoffman or Simplicity frames, for Italian queens. **L. D. GALE, Stedman, N. Y.**

WANTED.—To exchange 25 Belgian hares—Fashodas and Yankans—for bees or supplies. **GEO. R. CRANDALL, 5707 N. 20th St., Omaha, Neb.**

WANTED.—Lot of L. brood-frames (Hoffman if possible) before winter. Must be free of any bee-disease. **E. HOCHSTADTER, Poughkeepsie, N. Y.**

WANTED.—300 to 500 colonies bees on shares in Cuba; or would work for salary; references given and required. **FRED E. MUNSON, W. Grotton, N. Y.**

WANTED.—A strong, healthy young man of good habits to work in bees by September. Must have had some experience. Write at once, stating particulars and salary wanted. Permanent job for right party. **GLEN E. MOE, Candelaria, Cuba, W. I.**

WANTED.—Location for a custom saw and feed mill. **W. S. AMMON, Reading, Pa.**

WANTED.—A few bushels of Egyptian onion-sets or roots. Who can furnish them cheapest? Send sample and price by mail. **E. B. BEEBEE, Oneida, N. Y.**

WANTED.—Apples. I wish to correspond with some bee-keeper in the middle West, or elsewhere, in section where there is a good crop of apples. **F. W. DEAN, New Milford, Pa.**

NOW READY. LONG-TONGUED QUEENS!

YARD NO. 1.

By special arrangements with THE A. I. ROOT CO. to furnish them queens, I have secured their assistance in procuring the finest breeding queens that a thorough knowledge of the bees of the country and money can procure. Among them is a select daughter of their \$200 queen that they refuse to quote me prices on. This queen shows every superior quality of her mother. Her bees show an actual reach of 21-100 of an inch; are large, gentle, and beautiful to look upon.

MR. E. R. ROOT SAYS: "You have as fine bees as there are in the United States; and with a direct cross of their breeders you should be able to produce queens whose bees show a reach of 25-100 of an inch."

Send for descriptive price list.

Prices: Untested, 75c; 6, \$1.25; 12, \$8.00. Selected untested, \$1.00; 6, \$5.00; 12, \$9.00. Tested, \$1.00; 6, \$6.00. Selected tested, \$1.50.

Breeders, whose best bees show a reach of 21-100, with an average reach of 20-100, \$3.00. Breeders, whose best bees show 21-100, with an average of 20 $\frac{1}{2}$ -100, \$5.00. Breeders, whose best bees show 22-100, with an average of 21-100, \$7.00. I have discovered 2 breeders whose best bees show 23-100; these are too good to sell; don't ask for prices.

Imported Italian stock. Apiary No. 2. Imported queens, daughters and grand-daughters. Have just received an importation direct from Italy which has been introduced into this apiary.

Golden, or 5-banded Italian. Apiary No. 3. Breeders, select tested, tested, untested queens.

W. O. VICTOR, WHARTON, TEXAS.
QUEEN SPECIALIST.

EGG FOOD! The kind that tones and keeps up the hen so that she simply must lay. **LEY'S POULTRY CONDITION POWDER** puts good red blood into poultry veins; kills all disease germs; tones and nourishes fowls—big and little get all there is in the food when fed in conjunction with it. Price 25c pkg.; 5 for \$1. **Ley's Thoroughbred Minorca eggs, \$1 for 13. Thoroughbred Belgian Hares. Geo. J. Ley, Florence, California.**

Queens! I have now some very fine queens for sale, either 3-banded or 5-banded goldens, at the following prices: Untested, 75c; 6, \$1.25; 12, \$8.00. Tested, \$1.25; 6, \$6.50; 12, \$12.00. Selected tested, \$2.00. Golden breeders, \$5.00. We have Root's bee-supplies at Root's prices. We have a special low price on honey-cans. Give us your orders, and I will guarantee you satisfaction. **Robert W. Rogers, Hutto, Tex.**

QUEENS IN THE STATE OF WASHINGTON.

Experience teaches me that only those queens raised by the natural-warming method are larger and superior. Such are mine, and you will be satisfied with them. Untested Italian queens from now on 75 cts. each. Tested, \$1.00 each. **Robert Mirring, Dryad, Wash.**

WANTED.—Customer for farm of 65 acres; good land; good buildings, and water; one mile from railroad station, and four villages and college; 125 colonies bees; \$1600. Ten head of cattle, team, farming tools, 5000 lbs. extracted and comb honey. Write for description and particulars. **N. A. BLAKE, Beebe Plain, Quebec, Canada.**

3 Good Points

Good Stock ;
Low Prices ;
Prompt Service.

My stock is from J. P. Moore's long-tongue strain, A. I. Root's famous \$200 queen, and from the stock of J. F. McIntyre that filled supers when other colonies were starving. I sell warranted queens in any quantity, at 50 cts. each. If a queen proves impurely mated, another is sent free of charge. All queens go by return mail unless otherwise ordered. I guarantee safe arrival and entire satisfaction. Otherwise, the money is refunded.

L. H. Robey, Worthington, W. Va.

YOU CAN NOT afford to let the season pass without introducing some of Moore's 23-100 stock into your apiary. See advertisement on page 659.

Dittmer's Foundation !!!

Retail---Wholesale---Jobbing.

I use a PROCESS that produces EVERY ESSENTIAL necessary to make it the BEST and MOST desirable in all respects. My PROCESS and AUTOMATIC MACHINES are my own inventions, which enable me to SELL FOUNDATION, and WORK WAX INTO FOUNDATION FOR CASH, at prices that are the lowest. Catalog giving

FULL LINE OF SUPPLIES

with prices and samples, free on application. BEESWAX WANTED.

GUS. DITTMER. AUGUSTA, WIS.

Get the Best Queens.

Evansville, Ind., Sept. 27th, 1900.

The Jennie Atchley Co., Beeville, Bee Co., Texas;

Dear Friends:—It gives me great pleasure to forward you this unsolicited testimonial regarding the merits of Atchley queens. The three (3) dozen queens purchased of you have made an excellent record for themselves. Not an Atchley queen among the twenty colonies lost during the severe drouth in July. I have bought queens from many breeders; and although the present crop is exceedingly short, the tiers of supers show where the Atchley queens are, and speak volumes for your method of queen-rearing. I find the progeny to be very gentle, strong-winged, uniformly marked, long-lived, of large size, and last, but not least, the best honey-gatherers I ever had. I shall want 100 more next season.

Yours fraternally, J. C. WALLENMEYER.

Prices for Queens.

Tested, \$1.50 each; \$8.00 for 6, or \$15.00 per dozen. Untested, February, March, April, and May, \$1.00 each; \$5.00 per 6, or \$9.00 per dozen. Fine breeders, \$5.00 each. We have as good bees and queens as money and labor produce. We breed three-band Italians, Goldens, Carniolans, Cyprians, and Holy-Lands, in their purity, bred in separate yards 5 to 20 miles apart. If you want *the best*, call for Atchley's improved strains. Safe arrival guaranteed. Send for a sample copy of "The Southland Queen," the only southern bee-paper. \$1.00 per year. To new subscribers we offer as a premium a nice untested queen in order to get our paper introduced. Catalog, giving queen-rearing and management of apiaries for profit, FREE.

THE JENNIE ATCHLEY CO.,
Beeville, Bee Co., Texas.

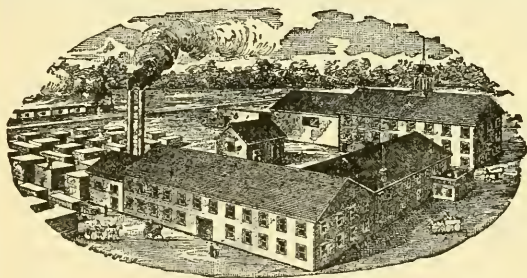

KRETCHMER M'F'G CO., Red Oak, Iowa.

BEE-SUPPLIES.

Best-equipped factory in the West; carry a large stock and greatest variety of every thing needed in the apiary, assuring BEST goods at the LOWEST prices, and prompt shipment. We want every bee-keeper to have our FREE ILLUSTRATED CATALOG, and read description of Alternating Hives, Ferguson Supers, etc. *Write at once for a catalog.*

— AGENCIES: —

Trester Supply Co., 103 So. 11th St., Lincoln, Nebraska; C. C. Richards, 1223 17th St., Denver, Col.

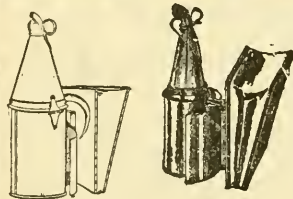

BINGHAM SMOKER.

Dear Sir—Inclosed find \$1.75. Please send one brass smoke-engine. I have one already. It is the best smoker I ever used.

Truly yours,
HENRY SCHMIDT, Hutto, Tex.

MADE TO ORDER

Bingham Brass Smokers.

Made of sheet brass, which does not rust or burn out; should last a lifetime. You need one, but they cost 25 cts. more than tin of the same size. The little open cut shows our brass hinge put on the three larger sizes. No wonder Bingham's four-inch smoke-engine goes without puffing, and does not drop inky drops. The perforated steel fire-grate has 381 holes to air the fuel and support the fire.

Heavy tin smoke-engine, 4-inch stove, per mail, \$1.50; 3½-inch; \$1.10; 3-inch, \$1.00; 2½-inch 90c; 2-inch, 85c. Bingham smokers are the originals, and have all the improvements, and have been the standard of excellence for 22 years. Only three larger ones brass.

T. F. Bingham, Farwell, Michigan.

Contents of this Number.

Apiary, Richardson's.....	477
Bee in Law.....	474
Cells, Preconstructed.....	470
Covers Boiled in Oil.....	479
Davidson, G. F.....	480
D one Brood with Foul Brood.....	485
Editor in Michigan.....	487
Editor at Toepfer's.....	477
Foul Brood, Spread of.....	470
Hives, Home made.....	481
Honey, To Market.....	480
Locust, Black, Effects of.....	469
Putty-knives.....	475
Rambler in Buuk.....	475
Rambler Described.....	485
Queens, Confining Laying.....	471
Sugar, Beet and Cane.....	472
Swarming, Doolittle on.....	482
Taunton Bee Suit.....	485
Uncapping-bob, New.....	479
Water, Temperature of.....	469
Wintering in Large Cellar.....	483

Honey Column.

GRADING-RULES.

FANCY.—All sections to be well filled, combs straight, firm ly attached to all four sides, the combs unsoiled by travel stain, or otherwise; all the cells sealed except an occasional cell, the outside surface of the wood well scraped of propolis.

No. 1.—All sections well filled except the row of cells next to the wood; combs straight; one-eighth part of comb surface soiled, or the entire surface slightly soiled; the outside surface of the wood well scraped of propolis.

No. 2.—All sections well filled except the row of cells next to the wood; combs comparatively even; one-eighth part of comb surface soiled, or the entire surface slightly soiled.

No. 3.—Three-fourths of the total surface must be filled and sealed.

No. 4.—Must weigh at least half as much as a full-weight section.

In addition to this the honey is to be classified according to color, using the terms white, amber, and dark; that is, there will be "Fancy White," "No. 1 Dark," etc.

CITY MARKETS.

BOSTON.—The honey market is practically nominal, demands being nothing, owing to the warm weather. We have had one lot of new honey in that sold at 17. Extracted light amber, 8; amber, 6@7.

BLAKE, SCOTT & LEE,

Aug. 3. 31, 33 Commercial St., Boston, Mass.

CHICAGO.—For choice white comb demand is equal to the receipts at 15c, but off grades are slow at 1 to 3c less. Extracted is selling more freely at 5½@6; white amber, 5@5½. Beeswax steady at 30.

R. A. BURNETT & Co.,

Aug. 7. 199 South Water St., Chicago, Ill.

DENVER.—New comb honey, No. 1 white, \$5.00 per case; No. 5, \$2.75 per case. Extracted, white, 7; beeswax, 22@24.

THE COLORADO HONEY PRODUCERS' ASS'N.,

Aug. 10. 1440 Market St., Denver, Col.

SAN FRANCISCO.—The following are the quotations of the San Francisco Chronicle, of July 23d:—To the trade: Comb honey, per lb., 10@12. Extracted, water white, 5½@6½; light amber, 4½@5½; dark amber, 4@5. Beeswax, per lb., 25@27.

Aug. 7. E. H. SCHAEFFLE, Murphys, Cal.

NEW YORK.—There is some demand for new-crop comb honey, and receipts are quite numerous for this time of the year. They have been principally from the South, but we are now beginning to receive shipments from New York State and near by. We quote fancy white, 15; No. 1 white, 13@14; amber, 11@12. No new buckwheat honey is on the market as yet, and do not expect any before next month. Extracted is decidedly dull. Plenty offerings with only a limited demand, and quotations are rather nominal. We are selling at from 5@6½, according to quality; Southern in barrels at 55@65 per gallon. Beeswax dull and declining. For the present we quote 27@28.

HILDRETH & SEGELKEN,

Aug. 7. 265 Greenwich St., New York City.

MILWAUKEE.—The receipts of new honey are not large at this writing, and the demand very moderate indeed. The quality thus far has been very fair, yet the demand is not what we expect will soon come as the bad spell is past, and fruit not so abundant. New comb sells mostly at 17@18. We quote fancy white 1-lb. sections, 16@18; A. No. 1, 15@16; amber and old, nominal, 10@14. Extracted white, in bbls. or kegs, 7@8; amber, 6@7. Beeswax, 26, 28, 30.

A. V. BISHOP & Co.,

Aug. 9. 119 Buffalo St., Milwaukee, Wis.

NEW YORK.—Market dull, very little demand. Quotations only nominal. Fancy white, 15c; No. 1 white, 13@14; No. 2, 12; extracted, white, 6@6½; light amber, 6; beeswax, dull and lower, 27@28; fancy, 29.

CHAS. ISRAEL & BROS.,

Aug. 10. 486, 488, & 490 Canal St., Cor. Watt St.

CINCINNATI.—Market is rather dull, on account of the warm weather. Extracted sells only to manufacturers from 5@6c. Better grades, alfalfa water white, from 6@7. White clover, 8@9; fancy white comb honey sells from 13½@15½. C. H. W. WEBER,

Cincinnati, O.

BUFFALO.—Fancy new white-clover comb, 17@18; choice, 16@17; No. 1, 15@16; No. 2, 14@15. Extracted, white, 7@8. Hardly any old left, and no demand for it. Pretty good call for new honey.

W. C. TOWNSEND,

Aug. 6. 84, 86 W. Market St., Buffalo, N. Y.

WANTED.—Comb and extracted honey. State price, kind, and quantity. R. A. BURNETT & Co.,

199 South Water St., Chicago, Ill.

WANTED.—Western honey in car lots, also northern fancy white comb in no-drip cases; state price delivered. We pay spot cash. Reference, German National Bank, Cincinnati. FRED W. MUTH & Co.,

Front and Walnut Streets, Cincinnati, Ohio.

WANTED.—Extracted clover honey in cans; cans furnished if desired. Quote price.

I. J. STRINGHAM, 105 Park Place, New York.

WANTED.—To buy your honey. State your lowest cash price, kind, and quantity.

EDW. WILKINSON, Wilton, Wis.

WANTED.—To buy quantity lots of fancy and No. 1 white-clover comb honey in no-drip cases.

BYRON WALKER, Clyde, Cook Co., Ill.

WANTED.—Honey; car lots or otherwise. Will send man to receive when sufficient amount to justify, and pay highest market price, spot cash. Address, stating quantity, quality, and price desired at your station.

THOS. C. STANLEY & SON, Fairfield, Ill.

WANTED.—Comb and extracted honey; will buy your honey, no matter what quantity. Mail sample of extracted: state quality of comb honey, and price expected delivered at Cincinnati. I pay promptly on receipt of goods. Refer you to Brighton German Bank, this city. C. H. W. WEBER,

2146-2148 Central Ave., Cincinnati, O.

FOR SALE.—Extracted honey in 60-lb. cans, No. 1 alfalfa, 7½c per lb.; partly from other bloom, 6½c.

D. S. JENKINS, Las Animas, Colo.

We will be in the market for honey the coming season in carloads and less than carloads, and would be glad to hear from producers everywhere that they will have to offer. SEAVEY & FLARSHEIM,

1318-1324 Union Avenue, Kansas City, Mo.

NO MORE SPOILT FRUIT.

Canning made easy and sure by using my Standard Patent self-melting, self-sealing wax strings. Very economical, and easy to apply. Valuable fruit information and 100 strings, by mail, for (forty-five) 45 cents in stamps. C. C. Fouts, Middletown, Ohio.

Write Me for price if you want 100 or 200 colonies of bees in 8 frame hives, delivered in New York City or Havana, Cuba. I want 25 Carniolan queens October 1st.

W. L. COGGSHALL, W. Groton, N. Y.

Wm. A. Selser, Honey Expert,

When you buy honey, send a 3-oz. bottle, have it tested, to be sure it is pure. Price \$2.50 per sample. By doing this you may avoid over ten times this amount in litigation with pure-food laws. Chemist's certificate given.

The A. I. Root's Co.'s Office, 10 Vine Street, Philadelphia, Pa.

G. B. LEWIS CO., WATERTOWN, WIS.

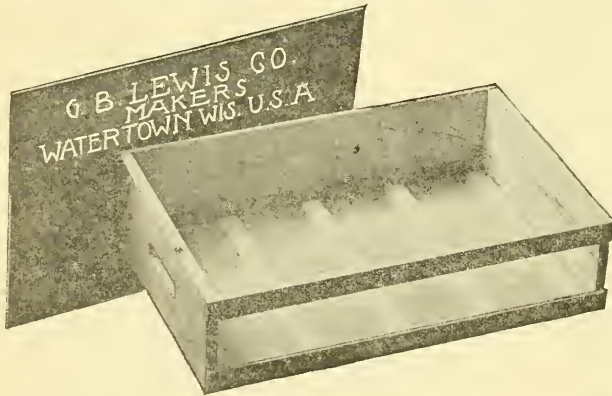

Bee-hives,
Lewis' White
Polished Sections,
Shipping-cases.



Perfect Goods,
Prompt Shipment.

BRANCH: G. B. Lewis Company, 19 South Alabama Street, Indianapolis, Indiana
AGENCIES: L. C. Woodman, Grand Rapids, Michigan; Fred W. Muth & Co., Southwest Corner Walnut & Front Sts., Cincinnati, Ohio; Fred Foulger & Sons, Ogden, Utah; Colorado Honey-producers' Association, Denver, Col.; Grand Junction Fruit-growers' Association, Grand Junction, Colorado; Robert Halley, Montrose, Colorado; Pierce Seed and Produce Company, Pueblo, Colo.; E. T. Abbott, St. Joseph, Missouri, Special Southwestern Agent.

Queens now Ready to Supply by Return Mail

STOCK which can not be **EXCELLED!!** Bred under the **SUPERSEDING CONDITION** of the colony. **Golden Italians**, the great honey-gatherers. They have no Superior and few **Equals**. Each 75 cts.; 6 for \$4.00. **Red-clover Bees**, the **Long-tongue Italians**, which left all **Records** behind in **Gathering Honey**, \$1.00 each; six for \$5.00. **Safe Arrival Guaranteed.** Headquarters for Bee-supplies. **Root's Goods at Root's Prices.**

C. H. W. Weber, 2146-2148 Central Av., Cincinnati, Ohio.

Successor to Chas. F. Muth.

Catalog Free; Send for Same.

GLEANINGS

A JOURNAL DEVOTED TO BEES AND HONEY AND HOME INTERESTS.

BEE CULTURE

ILLUSTRATED
SEMI-MONTHLY
Published by THE A. I. ROOT CO.
\$1.00 PER YEAR MEDINA, OHIO.

VOL. XXIX.

AUG. 15, 1901.

No. 16



25 lbs. each night. [I believe your plan is all right; but should not the beginner use some method of feeding in the hive rather than in a wholesale way as you describe, where all the bees can help themselves?—ED.]

WHEN A COLONY is ripe for swarming, says *Oesterreichische Bienenzeitung*, smoke is a reliable means to make the swarm issue. Sometimes a few puffs will start the swarm at once, sometimes it takes several minutes. This helps against several swarms issuing at once.

A BIG VEIL, I thought, would be a fine thing, so I had one made wide and long. Didn't like it at all. It flopped around loose and got in folds so I couldn't see well through it. I now prefer one as narrow as it can be for the hat-brim, and as short as it can be to pin down tight in front with a safety-pin.

DRONE DESTRUCTION is thus advised in *Revue Eclectique*: After dinner put a strip of excluder zinc at the hive-entrance; very early next morning, while the drones are chilled at the entrance, scrape them with a trowel into a dish of cold water. [This plan is all right if one happens to have chilly weather toward morning; but during the last two or three weeks, in most localities, drones would have been any thing but chilled.—ED.]

"IF YOUR BEES have plenty of honey in the hive, don't bother about feeding them now," p. 646. That's what I should have said two months ago; but I find there may be exceptions. The last half of July brood-rearing largely ceased in my colonies. In some of them were eggs and sealed brood, but no unsealed brood. In some were eggs, but no brood of any kind. Heavy with honey. I fed, not to start the queen to laying, but to start the workers to rearing brood, because I want bees for a possible moderate fall flow.

HERE'S THE WAY I fed my bees to start brood-rearing about July 22 (ought to have done it sooner); I laid 53 empty brood-combs on the bottom of the shop-cellar; filled them with water with a water-sprinkler; sifted handfuls of sugar over them; then several times a day sprinkled them again with water. Sprinkling water on the bees didn't hurt them a bit. The sugar was put on at night—about

I WONDER if that charge against black locust, p. 647, is not like the hue and cry raised against silver lindens in Europe. Thousands of dead bees were found under the silver lindens, but it seems to be now agreed that the lindens had nothing to do with killing them. [I hardly think this can be true in this case. Several at Hanford, Cal., called my attention to the fact that the bees were found dead under the black locusts. I thought there must have been something wrong somewhere; but when F. E. Brown, a careful bee-keeper, corroborated the statement, I believed it; and yet the bee-keepers in Colorado told me the black locust was one of their good honey-plants, and that the bees had never been found dead under it.—ED.]

READING, p. 653, about that spring water at 44° to 47°, I fell to wondering at what temperature it would be best to have our drinking-water. Ice water, we are told, is certainly not the best to quench thirst. I went to the pump, and found the water fresh from the well was just 50°. I wonder if any thing colder than that is really desirable. [Perhaps you will remember that, about 15 years ago, I tested a good many wells for their temperature. The average, in and about Medina, was 50° Fahrenheit. Some went down as low as 45, and the temperature of the well seemed to be the same winter and summer, providing the water from the surface of the ground was 20 feet down. In California and Arizona, well water would be as high as 70°, and sometimes it would be almost as cold as it is here.—ED.]

COMPLAINT is occasionally made that bees do not gnaw the pasteboard off shipping-cages. Possibly that is because the cage is put in the wrong place. Bees can hardly be expected to gnaw the pasteboard if it is where they must go out of their way to get at it. The pasteboard end of the cage should be right on the brood, where bees are sure to be all the time. [You are probably right; but

to provide against the dying of the queen we now add to our directions specific instructions, when the pasteboard has not been gnawed within 24 hours to tear it off. By that time the queen and bees have had 24 hours' acquaintance; and even if they do release her within five or six hours she will probably be accepted all right. The object of the pasteboard is to prevent the bees from gnawing in to the queen before they have had an opportunity to become acquainted with her. As a general rule, when the cage has been properly placed the fibrous material will be eaten away, the candy consumed, and the queen released. The pasteboard, under the right condition, is a great improvement.—ED.]

A PUTTY-KNIFE seems the favorite hive-tool at Medina. Have you given the Muench hive-tool a fair trial? After using one for two years I wouldn't give it for fifty putty-knives. [Yes, I have used the tool, and so have our men; but in the course of two weeks they will lapse back to the putty-knife. This very morning I went out to the apiary to ask Mr. Wardell why he preferred the last-named tool. "Mainly because it is flexible," he said. By putting the square end of the knife on top of the top-bar, at a very acute angle, he can scrape off propolis and burr-combs, with less effort and jar to the frames, than if he used a blunter tool that will not bend. A thin blade will bend, forming an arc of a circle on the surface scraped. In this shape it will shave the surface clean and easily. If the steel is good, the thin blade can be inserted between the super and brood-chamber, and a very light twist of the handle causes a separation. Then a thin blade—one that is flexible—he thinks would enter a crack better than a sharp blunter blade that will not bend. The Muench hive-tool has a scraper on it at right angles, like the blade to a hoe; and when in the act of scraping, the scraper-blade necessarily has to stand at quite an obtuse angle, with the result that it jars the frame.—ED.]

WHEN BEES rear a young queen for swarming or superseding, a cell is built whose bottom is quite different from the bottom of a worker or drone cell, being smoothly concave like the inside bottom of a teacup. The cell is much larger than a worker or drone cell, its diameter being about $\frac{5}{8}$ of an inch. Because it is built of this large size *before* it is occupied, it is called a *preconstructed* queen-cell. After a *preconstructed* cell is built out to a certain extent it is called a cell-cup, and many cell-cups are started that are never occupied. If a colony becomes queenless when no occupied queen-cells are present, the bees proceed to rear one or several queens from larvæ in worker-cells. The first change noticed in one of these worker-cells is that the outer part of the cell is enlarged, the walls having the appearance of being pushed apart so as to increase the diameter. Then a hood is built over the cell, and this is built downward to make the full size desired. In the meantime the larva has been lavishly fed so that it is floated out of the narrower part of the cell. Because such a queen-cell is built

from a cell *after* it has been started as a worker-cell and is occupied by a larva, it is called a *postconstructed* cell. You may not always be able to tell from outside appearance whether a cell is preconstructed or postconstructed, but you can always tell by tearing it down and seeing whether it has a smoothly concave base, or an angular and smaller base like a worker-cell. A preconstructed cell has an egg deposited in it, never a larva at the start. A postconstructed cell is built over a worker-cell containing a larva, although in very rare cases it may contain an egg. [There, now we understand what is meant by preconstructed and postconstructed cells. But there is not one reader in ten who has any knowledge of Latin; and if he does not, he may become confused as to the meaning of the terms; and, what is more, I do not remember to have seen the terms used outside of your own writings in any American bee literature. It strikes me that far better terms would be "emergency cells" and "swarming cells." The last named would take in the supersedure cells as well as those built during the height of the honey-flow, when the bees are not compelled to do something on the spur of the moment. The first-named, emergency cells, would apply to those cups that are built when the bees find themselves suddenly deprived of a queen; for, under the stress of the condition, they hurry things. Why not adopt the simpler and more descriptive terms—or, rather, terms that will be more easily grasped and retained by the average farmer bee-keeper? You say that a preconstructed cell, or what I should prefer to call a swarming-cell, never has a larva deposited in it. Would that not seem to argue that, if the bees were given their own way, they would prefer an egg?—ED.]



August, month of drouth and heat,
Now o'er all holds sway;
Fields are brown as touched by fire—
All for showers pray.

L'APICOLTORE.

In the April issue, Mr. Dubini takes the following figures from GLEANINGS:

In the United States, out of 30,372 colonies visited by the inspectors 7253 were found to be infected with foul brood. They ordered 5972 to be disinfected, and 1281 destroyed.

Mr. Rauschenfels, the editor, says:

We should like to know what Mr. Charles Dadant would say to that, who, in 1895, wrote in the *Revue de Nyon*:

"I do not know on what document Mr. Rauschenfels based his assertion that the pest follows the American hive like its shadow, breaking out more rapidly there where the hive with movable bottom is in use; for, although I have used such hives for 33 years, and although I have opened them often to look for queens, etc., the very thing which, according to

Mr. Rauschenfels, will give foul brood, I have never yet seen a case of foul brood in my life, although this malady exists to a slight extent *here*, but is confined to a few districts; and, instead of tending to spread, it is disappearing, thanks to watchfulness and the ease with which frame hives with movable bottoms can be inspected."

Mr. Rauschenfels adds :

So frightful a proportion of infected hives among healthy ones is found in no other country.

Mr. Dadant replies as follows, which I translate from the French :

To reply to Mr. Rauschenfels, I should add that the under-scored word *here* does not refer to my home, but to the State of Illinois, as is shown by the words "few districts." I will add that the four inspectors appointed by the government went to New York, as, after having assisted at several apicultural congresses, it was decided that New York was the most badly affected. And even there they found the disease confined to a narrow district in the eastern part of the State, the middle and west having no traces of the trouble.

As to the proportion of foul-broody hives in the United States as compared with that of foreign countries, I may cite the case of Mr. Dzierzon, who lost, in one single year, 500 colonies, being able to save but 10, or only two per cent. One may read this in a letter written by Mr. Samuel Wagner, a German, who, some time after, founded the *American Bee Journal*. This letter was published by Mr. Langstroth in the third edition of his book.

In New York according to the citations above, the colonies attacked did not reach 25 per cent, and even the greater part of these were saved.

The thing that incites Mr. Rauschenfels to write those few lines is his belief that foul brood is of spontaneous generation; for we read in his "Bee and its Cultivation," 1901, page 100, that experience actually shows that the bad management of bees, etc., may lead to this disease without there having been actual contact. He cites, as proof, a certain bee-keeper who made an apiary, and carried to it, in June, 30 colonies. These were all attacked by foul brood, and died, as well as ten which he bought to replace them in the fall, and which he fed with honey from the colonies that died.

These things prove absolutely nothing. It is enough that one single colony should be diseased in order to impart to the others the disease. After hauling them, especially in summer, it is a common thing to find the bees of one colony mingled with those of another.

We have had hives the frames of which were broken in hauling, and others in an apiary which, not being sufficiently sheltered from the direct rays of the sun, had their combs melted; but none of these hives produced foul brood.

This disease is so rare in the United States that Langstroth never saw it; and although my son and I have visited numerous apiaries, neither one of us has ever yet seen a case of foul brood.

The hive with movable bottom, according to Mr. Rauschenfels, will not winter bees well outdoors. After having tried the cellar and the silo, we keep our bees outdoors, and our losses never exceed 5 per cent, yet the winters here are long and severe. A winter in this part of Illinois is considered mild when the mercury does not go below 4 degrees below zero, Fahrenheit; and 30 to 35 is not rare.

Aside from the points involved in the above, it is interesting as showing the tenacity with which old ideas cling to nations as well as to persons.

R. J. H., Ill.—It is hardly probable that the swarm you refer to in your letter of July 30 came out without a queen. The fact that you could not find her would hardly be evidence that the virgin or something that the bees regarded as a queen was not in the swarm. Some virgin queens are very small, and look so much like the worker bees that one might very easily overlook them.



CONFINING LAYING QUEENS A BAD PRACTICE.

Why Brood-combs should be Kept Out of the Extractor; the Difference in Colonies; Some Fair Criticisms from a Fair Man.

BY F. GREINER.

Mr. Editor.—I have just read your issue for June 15th, and I feel prompted to do a little criticising, or call a halt, as Mr. Doolittle puts it. Swarthmore says, on page 506: "The cut below is a drawing of an improved nursery-cage for the incubation of cells and the confining of virgin or laying queens." The words I wish to draw the attention of bee-keepers and queen-breeders to are at the end of the sentence quoted. They give rise to the questions, "Is it safe to confine laying queens?" and, "Do queen-breeders practice any such thing?" I have nothing at all to say against Swarthmore's cage. I believe it is good if rightly used; but against caging laying queens in them I must raise my voice. I have repeatedly proven to my satisfaction that a laying queen is more or less injured by confinement during a season when she would be most active. It does not make any difference, either, whether she is absolutely confined, or simply restrained by means of queen-excluding zinc. The injury is in proportion to the length of time a queen is kept confined. I believe queens suffer less by the rough handling in the mails than they do from the length of time the confinement lasts. The confinement in the mailing-cages during transit can not well be avoided, as bad as it is; but if to this we add days or possibly weeks of unnecessary confinement in nursery-cages, then good-by queen business. I for one would quickly drop any queen-breeder who stores queens in this wholesale fashion. The only proper place to keep laying queens is in small colonies; or, if they can be thus safely kept, in separate compartments inside of a hive where they may follow their natural inclination by depositing eggs.

I do not know that Swarthmore meant to have it understood that he advised or sanctioned the confinement of laying queens; but some queen-breeders who have not had the experience may conclude that it is a good way, and practice it. To sell such queens after some confinement would seriously injure his trade and his customers. I wish to denounce the method *before* it becomes a practice.

As to using these or any blocks for queen-cell starters, I am not so sure that they are the best thing for the purpose. I confess I don't like my cells *set into* a block or any thing else; and it seems to me more natural, and for the best development of the queens, if the bees have access to the cells on all sides, bottom included. Little blocks of wood with

cells attached to them are convenient in handling, and regular Doolittle cell cups may be attached to them instead of imbedding them. I greatly prefer it, any way, and I thus save the price of the press for making the depressions.

On page 507 E. H. Schaeffle says in regard to the difference in the working qualities of different colonies, "It is a well-known fact that some stands will put up several hundred pounds of honey in a season, while others in the same apiary will not give a pound of surplus." Really, has such a thing ever happened anywhere? If it did, would it not be jumping at a conclusion to say the reason for this difference is in the greater business integrity of stand No. 1? In another season stand No. 2 might outstrip stand No. 1. There are often some other conditions we do not understand that bring about different results. But now to the fact: According to my experience, *no such difference in stock exists*. If there is ever a very wide difference in the yields of two colonies, the principal cause lies somewhere else, and may have been overlooked. If we search carefully we may be able to find the real cause. I do not mean to say there is no difference in stock, but we need not look for such a wide difference. Progress is always slow. One of the best ways to test different strains of bees as to their honey-gathering quality is to hive new natural swarms of equal strength at the same time into empty hives, and watch results.

In speaking of straining extracted honey, Mr. Schaeffle says, a little further on, "When the honey is extracted it is run into a wire-cloth strainer that catches all small particles of wax, bees, and *grubs*." For the purpose the wire-cloth strainer is a good thing; but I am sure the great majority of consumers of honey would object to Mr. S.'s product provided they knew that a lot of *grubs* had been fished out of it. I myself don't think a bee-larva any thing horrible, yet I don't want it in my food any more than I do flies or fly-blows. Aside from this, if we extract from combs containing open brood, some larval food will find its way into the honey. Even in small quantities it will not serve to make our product any more appetizing. This extracting from combs with open brood in them should be denounced on all sides, no matter how widely it is practiced.

[It may be that the confinement of queens is injurious to them. If so, sending them by mail has its bad effects. It was Mr. W. Z. Hutchinson who once showed me his little three-section nuclei, 8 of them in one super, and above the screen of wire cloth, the same thing as is shown in the hands of Herman Raufuss in last issue, on page 633. When I called on Mr. Hutchinson he showed me how he was keeping a surplus of queens in these little nuclei over strong colonies—that is to say, he utilized the heat from powerful stocks to take care of eight queens. Each of these queens would lay a very few eggs, and, having a few bees, were confined by means of zinc until such a time as he might have an

order. While we have never confined queens in this way I should not have supposed that such a practice would have been at all injurious, because a queen can lay a few eggs; and to give her a little rest for a week or ten days I should suppose would be beneficial rather than otherwise.

With regard to Mr. Schaeffle's statement concerning one stock that would produce three or four hundred pounds of honey while another one would not produce a single pound of surplus, I suppose he had in mind the difference there is between colonies in the same yard, for there is a difference; but Mr. Schaeffle has, perhaps, made it much too strong. Some colonies, as we know in our own yard, will gather honey and fill supers while others will be disinclined to go into supers, or would store comparatively small amounts of surplus. Mr. Doolittle calls attention to the fact that one colony will store 30 lbs. more than another; and if this is so, it is important for us to breed from the strain that has more energy. For instance, the bees of our red-clover breeder keep on storing honey, even after the honey season; and this thing is true of the bees of the daughters of this queen. But it would hardly be fair to say that this one queen would produce 300 lbs. of honey while the mediocre stock would not produce one pound. But I think we do need to pay attention more to strains of bees than we have been doing of late; and the fact that beedom is now getting awakened is a rather healthy indication.

About straining extracted honey, I notice that, even when an effort is made to extract only from combs in the extracting-super, there will be occasionally a grub on the wire cloth of the strainer. This I saw in some of the best apiaries in California. The fact is, there will be occasionally little patches of brood unless perforated zinc is used under the super combs. But I believe your point is well taken, that it is a bad practice to extract from brood-combs, especially when those combs constitute all the brood-nest. There may be conditions that warrant it, but as a rule the practice should be condemned.—ED.]

SUGAR.

The Difference between Beet and Cane Sugar;
which is Better to Feed Bees?

BY W. K. MORRISON.

There seems to be a doubt in the minds of some that cane sugar is better than beet for feeding purposes, though European bee-masters have long since arrived at the conclusion that cane saccharine matter is always superior to beet. Though the bulk of the bee-keepers who use cane sugar could not give a sound scientific reason for the faith that is in them, I do not think that their experience lacks scientific proof.

In the first place, cane sugar is sweeter, just as Jersey milk is richer than Holstein milk; and for this reason alone it commands

a higher price. In the London market, Demerara yellow crystals always command a higher price than any other sugar; and, knowing this, the German refiners color their sugar with aniline dyes so as to imitate very closely cane sugar; but, like all imitations, it is not so good as the original.

Only a few days ago a grocer in England was tried for selling dyed beet sugar as "Demerara yellow crystals," and he was heavily fined. It was a test case, and the best legal talent was retained on either side; but the judge very properly decided that dyed German sugar was not Demerara yellow crystals as the customer had ordered, therefore the grocer was guilty of a fraudulent transaction.

According to the "theory" of expert chemists like Prof. Wiley, cane sugar is beet sugar, and beet sugar is cane sugar; but in practice this idea is worthless. The fact is, that plain common sense is a better guide. By the same process of reasoning, "saccharin," which is 500 times sweeter than ordinary sugar, ought to be "cane sugar" also, but it is not; and some countries have gone so far as to prohibit its use altogether as dangerous to the public health.

Some chemists, among whom stands Prof. Wiley, maintain that honey is glucose and glucose is honey; but he is a very poor judge indeed who can not tell the difference between the two. The chemists have been altogether too hasty in this matter, and I believe the very latest theories give the bee-keepers much more standing-room. What the chemists seem to forget is that honey contains small amounts of powerful substances that are not present in manufactured sugar, and, hence, to compare them is odious. Because the chemists can do nothing with these ethereal substances they have neglected them altogether, or set them down as "extraneous substances."

I do not believe any living chemist is smart enough to tell us what gives basswood or any other honey its distinctive flavor; therefore I hold that, until they can, all chemists should be careful in making round assertions with regard to honey. It is the same with sugar. The chemistry of sugar has been largely created by French and German chemists, and therefore favors beet sugar; yet we can read between the lines and see for ourselves "whether these things are so."

The best *white* sugar sold is very highly refined, be it cane sugar or beet. The bee-men of Europe carefully avoid it because, in the process of refining, it has been robbed of some of its finest constituents.

Here is an analysis of a good quality of highly refined cane sugar.

	Per cent.
Cane sugar, - - - - -	98.00
Glucose, - - - - -	.50
Water, - - - - -	1.00
Ash, - - - - -	.30
Organic matter, - - - - -	.20

Now notice the difference in a sample of muscovado sugar which has not been refined to the same extent.

Cane sugar, - - - - -	84.00
Glucose, - - - - -	6.00
Water, - - - - -	5.50
Ash, - - - - -	1.50
Organic matter, - - - - -	3.00

Notice the difference. The large amount of glucose makes it more agreeable to the bees, and the 3 per cent of organic matter contains flavoring extracts or ethers that give to muscovado sugar its honey-like flavor, so much appreciated by the bees. The first sugar is the best from a chemist's point of view, but from the point of view of a good Italian bee the muscovado is healthier, and nicer to the taste.

I believe that, in this matter, we have been too hasty in following the crowd. American and English housewives buy sugar from its look; but the careful bee-man ought to consider that bees do not judge by looks; and in buying a sugar with a high percentage of natural glucose he is pleasing the bees and conforming to their wants. For my part I believe the larger the percentage of glucose in sugar the better it is for the bees; and, seeing that it is cheaper than white sugar, why should we not use it?

Barbados makes large quantities of this kind of sugar, which is exported to New York to be refined into white sugar. It is the old-fashioned sugar, but nevertheless a good one for some uses. Jaggery, or palm sugar, would be better still; but it is not easy to get, being mostly produced in India. But any sugar having a high percentage of glucose ought to have the preference, as it is more readily assimilated by bees, being nearer their natural food, and therefore less likely to cause derangement to their intestines, ending in bee-diarrhea and perhaps other troubles. There is no trouble in getting all the muscovado sugar that is required, hence the way is plain.

Bridgetown, Barbados.

[This is one of the best if not the very best articles on the subject of cane and beet sugar we have ever published; and, moreover, it is stated so simply that any one, be he scientist or layman, can understand every point that is made.]

I have till recently believed that beet sugar answered all the purposes of general cane sugar; but while on my trip through California I was told that the large canning-factories on the coast positively will use nothing but *cane* sugar, because beet sugar does not give them the desired results.

Mr. Thos. Wm. Cowan, editor of the *British Bee Journal*, and, in fact, a great many of the bee-keepers in England, recommend cane sugar for feeding bees, in preference to beet, as they consider it a higher grade of sweet. But it seems to me reasonable that a beet sugar such as we have used here at the Home of the Honey-bees with excellent results for fifteen or twenty years will be equally good if not better. I have always supposed that nine-tenths of the granulated sugars on the market were beet, and that the average bee-keeper, in the United States at least, when he buys sugar for feeding, receives that sugar.

The table showing the analysis of the two sugars is very interesting. Now, I should also like to see an analysis showing the chemical constituents of refined beet sugar made in the United States. It probably would be very much like the muscovado sugar. Perhaps some of our readers are in position to give us a table that will show the exact analysis, for the purpose of comparison.

I have had several conversations with Prof. Wiley; and while I believe he has said that cane sugar and beet sugar were the same chemically, yet I feel satisfied that he recognizes that there is a difference. I also feel confident that he would not consider honey and glucose as one and the same. Indeed, he has published a pamphlet on how to detect glucose in honey.—ED.]

THE BEE IN LAW.

Qualified Property Right—How Acquired; Pursuing, Reclaiming, Replevin.—Article 2.

BY R. D. FISHER.

Having in a previous article laid down the general rules that govern property in wild animals, we shall endeavor to show how the general nature of this class of property is applicable to bees.

Bees are classed with and regarded as wild animals; therefore, as previously stated, a qualified property right may be obtained in them by reclaiming them and making them tame by art, industry, and education, or by so confining them within one's own immediate power that they can not, as a body or swarm, escape and use their natural liberty. Therefore, since bees are wild animals, and until reclaimed and hived no property right can be acquired in them, hived bees are the *bona-fide* property of the one who has reclaimed them, notwithstanding a temporary escape. So long as the owner can identify them they belong to him, and not to the owner of the soil to which they escape, although he can not enter the land to retake them without consent or committing a trespass. But even in such case it will be seen, during the existence of this qualified right, bees are under the protection of the law the same as any other property. Every invasion of this property is redressed in the same manner, and reclaimed after the same forms of law, as any other property of the same class.

Bees are regarded in law as a common species of property, an article of trade or barter, and the wildness of their nature by practice and art has become essentially subjected to the will and power of man.

FLIGHT AND PURSUIT.

In case a swarm fly from the owner's hive, his qualified right continues only so long as he can keep them in sight, and possesses the power to pursue them where he has a right to pursue, or otherwise positively and distinctly identify them. The difficulties in reclaiming bees after taking flight are many. The decisions of our courts furnish numerous peculiar

circumstances, and unfold the difficulties in reclaiming bees that have escaped from the hives or soil of the original owner. In the case of *Goff vs. Kiltz* (15 Wend. N. Y., 550), the New York Supreme Court held that, where a swarm of bees left the hive of the plaintiff, and went into a tree on the land of another, he having followed the bees and marked the tree in which they entered, while he had no right to enter upon the property to recover them without the consent of the owner, yet he could maintain an action of trespass and damages against a third party who entered the land, cut the tree down, killed the bees, and took the honey away.

Puffendorf, in his *Law of Nature*, chapter 6, says: "While bees are no doubt wild by nature, since their custom of returning to their hives doth not proceed from their familiarity with mankind, but from their secret instinct, they being in all other respects utterly unteachable, it is, nevertheless, one of Plato's laws, whoever shall pursue the swarms which belong to others, and, by striking on the brass, shall draw them with the delightful sound to settle near himself, let him make restitution to the owner." But it is held in a Scotch case (*Harris vs. Elder*, 57, J. P., 553), that reclaimed bees remain the property of the owner only so long as he is pursuing them where he is entitled to go, and that, if they come upon another's land, that person is entitled to prevent pursuit on his land, and becomes the owner of the bees if he hives them. This is not good law. As a general proposition, and by the weight of authority in this country, it seems that bees belong to the first party reducing them to his possession, and, while followed from the hive of their owner, and located by him, are held to be his property unless he abandons them.

The New York court, in the case of *Goff vs. Kiltz*, above, said: "They remain his property notwithstanding a temporary escape: the owner keeping them in sight, and marking the tree into which they entered, they belong to him and not to the owner of the soil." It was argued that the owner of the soil was entitled to the tree and all within it. The court said: "This may be true so far as respects an unreclaimed swarm. But if animals *feræ naturæ*, that have been reclaimed, and a qualified property right obtained in them, escape into the private grounds of another in a way that does not restore them to their natural condition, a different rule obviously applies. They are then not exposed to become the property of the first occupant or possessor after their escape. The right of the owner continues; and, though he can not pursue them without due process of law, without being liable for trespass, still this difficulty should not operate as an abandonment of the bees to their former liberty."

HOW RECOVERED—REPLEVIN.

Replevin is the universal remedy in the United States when chattels have been wrongfully taken or are wrongfully detained from a claimant, and he seeks to recover them *in specie* instead of satisfaction in damages. It is a

statutory action, and the statutes are considerably variant. (See Cooley's note to Blackstone Com., p. 144.)

Trover is the remedy by which, under the same circumstances, to recover satisfaction in *damages*, the defendant being allowed to retain the chattels as of his own property. Of this subject, however, we will speak later on.

Replevin, in modern practice, being a remedy for any unlawful detention of personalty, the same being delivered to the claimant upon security given, either to make out the injustice of the detention or to return the property, may be employed to recover bees which have swarmed and left his hive. Replevin lies for a swarm of bees. Fitz, N. B., 68.

RAMBLE 189.

Old Combs vs. Foundation; the Russian Drone Story.

BY RAMBLER.

"How d'ye do, Mr. Smith? Better get up here and ride if you are going my way."

"Why, bless me! how d'ye do, Rambler? certainly I am glad to ride with you. I am getting tired of this walking; and if you are going through Hollywood I will sit by you for a few miles."

"Yes, Mr. Smith, I am going through Hollywood, on over the Caluenga Pass, across the San Fernando Valley, over the San Susanna Pass, down the Simi Valley to Mr. Richardson's, a little short of 50 miles."

"I must say, Rambler, you have quite a drive ahead of you with a late start, slow road, and (I should judge) not a speedy horse. Don't believe you will make it to-day."

"Well, if I don't, Mr. Smith, I will make two passes at it."

"On some bee business, I suppose?"

"You may be sure of that, Mr. Smith. Bees and honey seem to be second nature to me. Whenever I try to get out of the business I get put back into it with such a sudden jolt that I am now inclined to stay there; and there is more and more developing in bee-keeping now than at any time before, and the business is decidedly interesting as well as profitable; and this journey of mine I suppose some of the progressives would call an old-fogy piece of business. You know I told you about the great scrape I had at Richardson's. Well, he had so many good combs that I thought might get moth-eaten before he could use them that I had a great hankering for them, and finally made a bargain with him for 500, and that is what I am after this very minute. The 500 will fill 50 supers, and you know that will give the bees a big boost right now."

"But, Rambler, you use the Heddon frame, and I suppose R. uses the L., and you will have to cut and trim and waste."

"No, Mr. Smith; R. uses a frame about 12 inches square; and by cutting through the center the combs will fit with but little waste."

"Ha, ha! Why, you are indeed an old fogy.

Don't you know it is a waste of energy to be transferring old combs when you can get plenty of foundation nearer home?"

"I am happy to say, Mr. Smith, that I don't know any thing of the sort. You see, bees will not draw out foundation for some weeks yet, and these combs can be put to use immediately; and then as far as combs are concerned I have used them when they were 20 years old. A comb is never too old for my use."

"My, my, Rambler! I have been led to believe if the combs are not renewed often the cells will get smaller and smaller, and the bees ditto, until they are no larger than gnats."

"Who led you to that belief, Mr. Smith? How long have you kept bees, and how many colonies have you?"

"Le'me see. I have 25 colonies; bought ten three years ago of Mr. Podovosky. He is an expert, and I have been led by him, as it were. He says we don't know much about bee-keeping in this country; but in Southern Russia, where he came from, they are very expert."

"Well, now, Mr. Smith, don't you be led by any such foolish notion as that. I will loan you a late issue of GLEANINGS, where there is an account of combs 40 years old, and still fit for use. And by the way, Mr. Smith, you need to take that bee-paper. It will be dollars for your pocket and sense for your head; you will then have no use for Russian experts."

"I'll think the matter over, Rambler, and talk with my wife about it; and if we agree on the subject we'll take the paper. And, by the way, that Russian told me that the drones commit suicide. What do you think about it?"

"What an idea, Mr. Smith! Why, anybody can see that the bees drive them out of the hives—actually tumble the poor things out."

"That's how it always appeared to me; but this Russian says the struggle between bees and drones is when the bees try to prevent the suicide, and that the cause of suicide is owing to their having a female to rule over them."

"That is a sad condition, Mr. Smith; but of all the queer ideas about bees, that takes the cake. I guess that Russian is an anarchist, sure. I know you do not indorse such things, Mr. Smith."

"Oh, no! I do not believe in these anarchistic ideas; but I didn't know but Mr. Podovosky was correct about the bees, seeing he claims to be an expert. I think my wife and I will have to take that paper; but, whoa! halt your horse, Rambler. Here I am, a whole block past where I ought to get off—got so interested in bee-talk I forgot where I was at. Good by, Rambler; hope you a pleasant journey and a profitable venture."

"Thank you, Mr. Smith; I am sure those combs will be of immense value to my bees. Sorry to lose your companionship."

As Mr. Smith surmised, I was late getting into the Simi Valley, and the shades of night settled down heavily when there were several

miles of the most difficult part of my journey to perform.

To ford a river several times, follow various windings in a canyon, and do several other things not comfortable to do in the dark, led me to consider the matter seriously, with the result that I drew up to the many buildings upon a big California ranch.

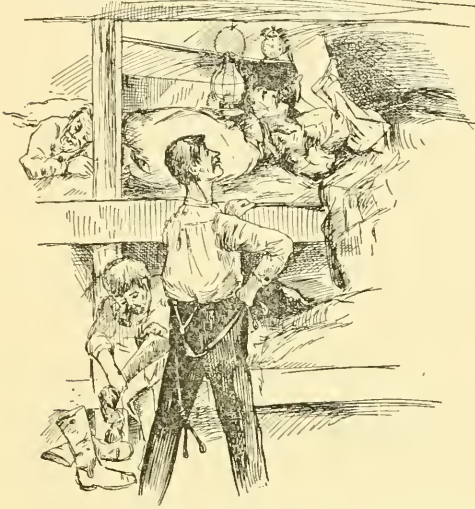

"I was assigned a portion of a bunk with a light-hearted Frenchman."

It was nearly 9 o'clock; but the men came rousing out with their lanterns, and the dogs set up a chorus of welcoming howls. I am not sure but the roosters began to crow. It is what they are likely to do in this land.

In answer to my inquiry about the road, the men said it would be utterly impractical to get through in such a black night as this. "Why," said one of the young men (the rancher's son, as I afterward learned), "I tried to ford the river a day or two ago at the old crossing, and came near drowning a horse. You are welcome to stay here, stranger; we have room in the bunk-house for you."

So these men did a "good Samaritan" act—took care of the stranger and his tired beast.

This was my first experience in a bunk-house with a crowd of ranchmen and cow-punchers, for this was a cattle-ranch with not less than a thousand head.

The buildings on a 5000 or 10,000 acre ranch approximate quite a village in appearance—the residence, several barns, tool-houses, shops, big corrals, and (the most interesting to me just now) the bunk-house. This is not a very elaborate or ornamental affair. This one was about 12×8 feet. The floor was somewhat littered with dogs, a saddle, now and then a strap or a lariat; but the distinctive feature was a series of bunks along one side, arranged one above the other like berths in a ship; but these, instead of holding one man, were designed for two in a berth or bunk. There were no spring mattresses in these bunks. In place of springs there was the soft side of a board made a little softer with a few blankets.

When bedtime arrived I was assigned a portion of a bunk with a light-hearted Frenchman. He turned in on the back portion of the bunk, hung a lighted lantern over his head and an alarm-clock over mine; lighted his pipe, and, as a preliminary to going to sleep, proceeded to smoke, and read the *Examiner*.

Well, between the novelty of the situation—dogs, fleas, and the alarm-clock, my sleep was in the nature of cat-naps, and I was, perforce, up early in the morning.

The men who gathered around the breakfast-table were a motley crowd—American, Spanish, Irish, and French. Each gnawed his bone in comparative silence; a large somber room, a large somber table, no table linen, no flowers, no ladies. The only redeeming feature was a young girl to bring in the hash.

The men were soon off on their horses for the distant cattle range, and that is the way things run on a big ranch, day after day. When I offered to pay for my entertainment, the young man refused acceptance—every thing was free.

I was soon crossing and recrossing the Simi, and it was almost as much as I could do to keep the trail in the daytime; but what would I have done in the night? Simply camped; and when we have the tools with us it is infinitely better than bunk-houses.

I surprised Bro. Richardson at an early hour in his 40-acre olive-orchard, and was forthwith given *carte-blanc* rights to take empty combs from the home apiary.

The 500 combs just fitted my wagon, the power of my horse, and the climb over the San Susanna Pass.



CROSSING SAN SUSANNA PASS.

In almost a week after my return those combs were all in use, and, from their acceptance by the bees, they were away ahead of foundation.

Whatever, whoever says to the contrary, when I can fit two pieces of good worker comb into a frame it will be done at any season of the year.

I will give your readers a glimpse of a portion of the Simi (*see me*) Valley and Mr. Richardson's home apiary. Note the largeness of the apiary. When the photo was taken there were 400 colonies. It is intended, I believe, to accommodate over 500. Note the vegeta-

tion—a variety—buck-brush, artemisia, purple and white sage, cactus, live oak, and away beyond. Yes, that valley used to be covered with the same vegetation that is near the apiary—lots of sage; but see what a usurpation the plow has made upon the rights of the bee, and the bee has no right to protest. The usurped land is now devoted to grain culture, and it is only a question of a little time when the rest of the level land will be usurped, and then the bees will hie away to the distant hills which are covered with a variety of vegetation; but even here on the accessible portions hundreds of cattle range to the detriment of honey-pasturage.

Away across the grain-fields, nearly three miles, Mr. Richardson has another large apiary, right in the hills, where the plow can not usurp, illustrated in GLEANINGS some time ago, and also in the A B C. A corner of the

NOTES OF TRAVEL.

A Visit with Udo Toepperwein and G. F. Davidson.

BY E. R. ROOT.

Everywhere I went it seemed as though I brought rain. When I got into Alabama I learned there had not been any showers for two months. The morning I left home it had poured hard, and for that matter all the way; and on arriving at the home of friend Jenkins I found I had brought the rain with me. Surely I would leave it behind I thought when I got over into Texas; but I had not been in the region of San Antonio for more than two or three days when it began to rain there. Prior to that, there had been a continuous drouth for two or three months. It got so that I told my friends along the way, that,

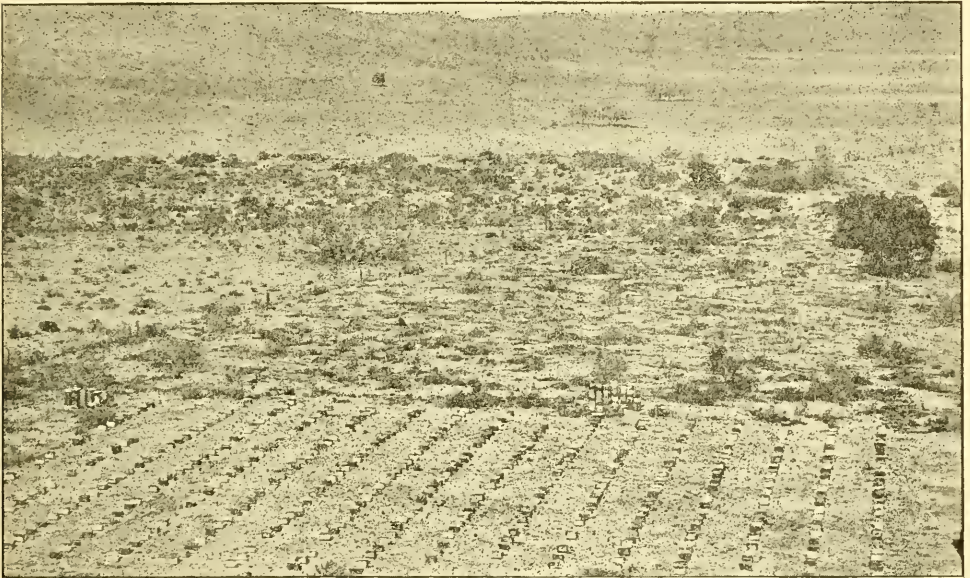

RICHARDSON'S HOME APIARY, SIMI VALLEY, CAL.

40-acre olive-orchard is shown at the right. The olive-tree has a little insignificant blossom, but the bees work upon it to advantage. Across another corner of the olive-orchard there is a new year-old railroad, the S. P. Coast Line; and instead of hauling his many tons of honey 20 miles or more he ships right from his door, so to speak, and so progress advances with steady tread.

The small photo shows the Rambler's load of empty combs crossing the San Susanna Pass. There is a clump of sage by the roadside, and many more among the rocks. Plow nor cow will ever usurp the bees' rights here. And, by the way, allow me to remark that this same San Susanna Mountain is being punctured with one of the largest tunnels in the country—over four miles in length, and on the before-mentioned Coast Line R. R.

if they needed showers any more, just send for me and I would bring them. Well, when I arrived at San Antonio, after calling on Mr. Scholl, as described in our last issue, there was every indication that there would be a hard shower; and, sure enough, there was one—a good hard downpour. But in the meantime my friend G. F. Davidson, of Fairview, who, knowing that I was to be in San Antonio at a certain time, had come up to make me a visit. He had been hunting for two days, not knowing I had gone up to see Mr. Scholl. When I reached San Antonio the second time he was awaiting me.

Mr. Davidson, it will be remembered, is a queen-breeder as well as a honey-producer. I believe he owns, or did own, something like 800 colonies. He almost needs no introduction to the readers of GLEANINGS, yet I am



UDO TOEPPERWEIN.

glad to present him, not in his everyday work clothes, but in his go-visiting dress. Perhaps there is no bee-keeper better known within 100 miles of San Antonio than Mr. Davidson, for he has traveled over a great deal of the territory, buying and selling honey as well as selling bee keepers' supplies. He had never visited Mr. Toepperwein, and so we together made arrangements to call on him at Leon Springs.



G. F. DAVIDSON.

But, who is Mr. Toepperwein? He is a young man fully six feet high, a giant in strength, full of enthusiasm, ambitious and honest. He has been in the bee-business a number of years, but during the last year or two he has been devoting his whole attention to bees.

At the time of my visit he had only a small number of colonies; but since leaving there I understand he has, with his partner, Mr. A. Y. Walton, come into possession of over 400 colonies, and in the very near future will have

nearly 1000. The two have formed a partnership to take the business of the A. I. Root Co., and have opened a store at San Antonio for buying and selling honey, as well as for handling the Root goods. With them will be associated Mr. G. F. Davidson, and the trio expect to do a good business. So much for Mr. Toepperwein and his business connections.

It had been raining at Leon Springs, and it was not possible, therefore, to use the camera to any extent; but as soon as the drops had ceased to fall, and the clouds had cleared away a little, I asked Mr. Toepperwein and Mr. Davidson to step out into the bee-yard, as I desired to take pictures of them. Mr. Toepperwein came first on the docket. I asked him to stand near one of his favorite colonies in his apiary, stretch himself up to his full height, put on his blandest smile, and to assume for the time being that his best girl was looking at him, as I expected to turn on him all the eyes of the great GLEANINGS family.* He did so, and the camera records the result. The picture is a fairly good one, and shows him to be just what he is, one of nature's noblemen, a perfect specimen of rustic health, capable of any amount of hard honest work, and good enough to win the heart of any "best girl." His partner, Mr. Walton, I saw for only a few moments; but from what I can learn the two are well matched.

Just as I had finished taking the picture we heard the rumbling of distant thunder. Some more black Medina clouds were hanging ominously low. Over in the distance we had heard the patter of big drops. I told Mr. Davidson to fix himself up quickly—I wished to get a shot at him. There was no time to think—no time to do any thing; but I poised the camera as best I could, pressed the bulb, and then we three started on a run for Toepperwein's bee-hive shop, in between the big drops that were beginning to come thick and fast. On arriving home I was sorry to find that the picture was "no good"—at least so poor I did not like to disgrace my friend Davidson, and I accordingly asked him to sit for a picture and send me one, which he did, which and we reproduce.

A NEW UNCAPPING-BOX.

How to Extemporize one Out of Old Hive Bodies;
Something about the Most Extensive Bee-keeper in the World.

BY HARRY HOWE.

Take a good tight hive and nail a cover to the bottom; then wax the track, and you have a fair capping-tank. For the box to cut the cappings into, take another and tack a piece of wire cloth over the bottom. Bring the edges of the cloth up inside of the hive-body some two inches or so, and tack a strip over it all the way around. This will leave it

* To be honest I don't know that he has any "best girl," but I thought if he hadn't any, that possibly, perhaps, I might find one for him, or, better still, one who, attracted by his good looks, would find him.

so that the bulge from the weight of cappings will come down into the lower body, which is used as a tank. By tacking the screen inside, the two bodies will fit close together and make a good joint. Then, too, none of the dripping honey will fall outside.

Put a piece of board across the top to rest the frames on while they are being uncapped. Then when you wish to leave it, a cover closes it bee-tight. This will hold enough for half a day's work if the cappings are cut up once in a while with the uncapping-knife, and this cutting helps very much in the draining.

In this way one gets the lower hive-body just about full from the cappings that the upper one will hold.

Have a pail of water and a good whetstone handy by, and keep the knife in perfect cutting order. Then when you cut, *cut*. Many people take off the cappings as though the combs were something precious, and not to be handled roughly. By cutting just into the honey one can cut much faster, and will have more wax. If a comb bulges, cut it down level. By putting eight in a ten-frame super they mostly do bulge some; but it is easier to take the honey from eight big thick combs than from ten thin ones.

W. L. Coggshall has been listening to the fellow who advises out-apiaries. He now has them in Wisconsin, New Mexico, and Cuba, besides seventeen or twenty in New York. It is said that he also has his eye on the Philippines, and is planning a system to keep the boys extracting the year round. But he can not get *all* the honey. There are others. Doo-little seems to feel bad because we are selling more than we buy. His idea seems to be that true prosperity consists in producing \$500.00 worth of honey a year and buying \$600.00 worth of groceries and clothes. Then perhaps he has been hearing Niver talk about single tax. A man who can talk people into buying buckwheat honey in preference to Cuban bellflower, and who can sell "blue sky" by the township, should not talk politics.

Osburn's figures on increase and bee-loads is a trifle startling, but he meant all right. In this locality one bee often gets a load from one bellflower in the morning, and in the afternoon it may take very many.

When the long tongues are a fixed fact, then breed from the best hustlers among them, and there you have it. One of nature's laws seems to be that the offspring from parents that vary from their parents are more apt to vary. Or, to put it another way, variation is a characteristic itself. For instance, "five-banders" would be more apt to vary than black; and five-banders with long tongues more yet. For this reason, in-breeding is necessary to fix the desirable change when once it is achieved.

Artemisa, Cuba.

[Your uncapping-box is so simple that any one can make a good one out of the material at hand.

That man Coggshall if he keeps on will have more bees than any one else in the world, if he has not already; but one should

look out and not get too many at "long reach." It is one thing to manage a business when one can give his personal supervision, and another when he has to depend on hired help a thousand or more miles away. This is not intended as "gratuitous advice" to Coggshall, but to some others who might attempt to follow his example. Coggshall is a good business man, and where he would succeed others might fail.—ED.]

HOME-MADE HIVES.

Suggestions for a Simple Method of Transferring; Hive-covers Boiled in Linseed Oil; that Cheap Land in Florida; Comb Honey vs. Extracted.

BY E. H. SCHAEFFLE.

In home-made hives the strip cut out at the ends warps badly. To remedy this defect I have made some hives in which the ends come up to the bottom of the rabbet, and a strip is then nailed on that extends across and secures both the end of the rabbet and the side of the hive. This saves material, labor, and effectually prevents warping.

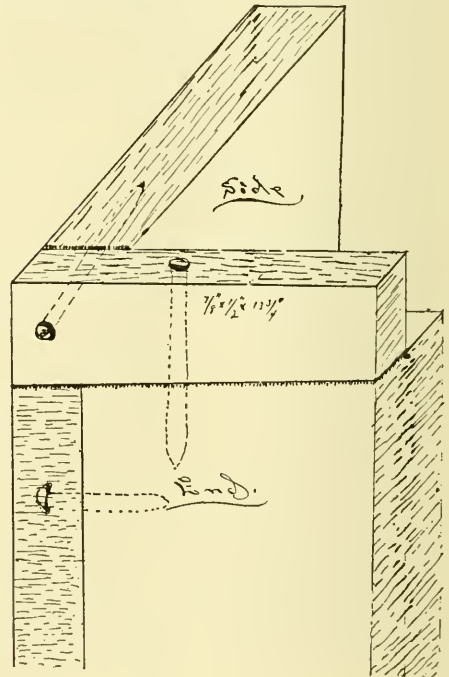

I have this season transferred bees by smoking them down on to other frames, then slipping a queen-excluding zinc under, and, when the brood has all hatched out, placing a bee-escape board on, running the bees all down, and leaving the old combs free from bees to be taken to the bee-house and cut out at leisure. No dead bees, no smear, no stings.

Bottlers of honey tell me, "We can take one can of your honey and add three of glucose to it, as it has a strong honey flavor,

while the honey from other sections will not take more than can to can." I think this difference is largely due to the fact that the tasteless honey was thrown out by the extractor as fast as it was brought in, and then evaporated by sun heat. The heat of the sun dissipated the flavor. With me the honey is allowed to remain on the hive until it is heavy in body. Honey with an objectionable flavor I have corrected by heating, thus evaporating the rank taste and odor.

If it is desired to have the bees build comb while storing honey, I find placing a frame with a starter only, in the center of the brood-nest, where the cells will all be worker, a better plan than to "cut deep" in extracting. The cappings are worth but 26 cts. when melted into wax, while the drawn combs are worth \$1.00 a pound. I do not mean that old combs are worth this per pound, as they are heavy, but light new combs the same weight as the cappings.

Lumber boiled in linseed oil is almost waterproof. Why not make hive-covers of the ventilated type, and boil all the parts in oil? It would cost a little more at the start, but the wood would absorb but little paint, while the covers would be almost indestructible. If you would test the matter, take two pieces of a section; boil one in oil, and soak the other in water; now expose the two to the sun's heat, then soak both in water, and observe the difference when exposed to the sun.

Mr. Root's description of the 50-cents-an-acre lands of Florida, with water on tap, caused me to ask, "Why don't they raise alfalfa, and feed it to stock?" Land of that description is worth a hundred dollars an acre for alfalfa, anywhere in the United States. Alfalfa would in that climate produce four to six crops, and make four to eight tons of hay to the acre. Fed to stock it would bring, in cattle or pigs, \$5 to \$10 a ton, at the least. Hogs thrive as well as cattle on green alfalfa, and do well on it when dry, if cut and steamed.

There may be sections where comb honey can be produced to as great a profit as extracted. Where this is the case, comb honey should be given the preference, as it commands a better sale, and can not be injured by the substitution of glucose. With me, while all stands produce a certain amount of extracted honey, only the very strongest will build comb honey; and the proportion of comb, when compared with what they would produce of extracted, is so small that extracted at 5 cts. a pound pays better than comb at 25. For this reason starvation would stare the bee-keeper in the face who ran all for comb honey, in this section. What is wanted is not less extracted honey, but less glucose *sold for extracted honey*.

Murphys, Cal., May 15.

[Very possibly your method of making a rabbit would be an improvement; but I should expect checking or splitting at the nails in time, in your climate—the nails that secure the rabbit in position.

The next time bottlers of honey tell you that they can take one can of honey and

three of glucose, etc., quietly give me their names, if you can get them to make the statement in the presence of several witnesses. They are just the chaps we should like to get hold of. I am aware that your California pure-food law has recently been made a dead letter; but if we get strong enough evidence we may be able to do something, even under the law, emasculated as it is.

I have no doubt that hive-covers boiled in linseed oil will prove to be very durable. This suggestion may be worth a great deal to the bee-keepers of California and Colorado, as well as other States where the climate is very dry and warm.

If extracted honey brought 5 cts., and comb honey 25, I do not see why it would not be more profitable to produce the latter, twice over.—ED.]



MARKETING HONEY; MARKET QUOTATIONS IN GLEANINGS ENDORSED; SELLING OUT-RIGHT AND SELLING ON COMMISSION; ORTHODOX ADVICE.

"You know, Doolittle, that you told me to grade, crate, and get my comb honey ready for market a few weeks ago."

"Yes, I remember."

"Well, I have it all done, and now I come over to have you tell me how I'd best market it."

"In telling you regarding this matter I would say that much depends upon the amount of honey you have and your surroundings. If not more than from 100 to 500 pounds, probably you can dispose of it in our nearby towns and to the farmers."

"Perhaps I might dispose of part of it that way."

"Yes, I think you can; but before disposing of any of it you wish to know what to ask for it, not selling it too low, nor ask so much for it that you can not dispose of it at all."

"But how am I to know about what price to place on it?"

"To know in this matter you should take some paper which gives a reliable report as to what honey is selling at in our large cities; and I know of nothing more accurate as to reports, or that takes more pains to ascertain the truth in these matters, than GLEANINGS IN BEE CULTURE."

"I am glad to hear you say this, for I take GLEANINGS."

"Very well. Find the quoted price for each grade of honey which you have, in the city to which you would send your honey, did you ship any away, and then figure the expenses for freight, cartage, and commission out, and you will have what it is worth at your nearest railroad station. For example, the rates on comb honey from Skaneateles to New York city is fifty cents per 100 pounds.

As this is gross weight, we find by a little figuring that about 55 cents per 100 lbs. is what the freight will cost, and the cartage will bring it up to 60 cents. Quotations during the months of July and August are generally little more than nominal; but from them we will guess that fancy honey will bring from 13 to 15 cents this year. But unless your honey is exceptionally fine I should not put it above 14. Then as most commission men charge 10 per cent for selling, we have \$1.40 as the cost of selling 100 lbs. This, added to the 60 cents freight and cartage, makes a cost of about 2 cents per pound to get our product to market, and the cash for it in our possession, so that, on the basis of these figures, if you can not sell the honey you have in Skanateles and surrounding towns at 12 cents per pound, you had better send it to New York."

"Well, I had never thought of reasoning it out in that way. I thought I ought to have 13 cts. for it, or only one cent less than New York quotations."

"It is an old saying, that 'a nimble sixpence is better than a slow shilling;' and I fear you will find that your honey will go very slow at 13 cts., while it would sell rapidly at 12 cts. Then there is a possibility that, when the market comes to be established this fall, honey may go still lower than the nominal prices we have used, in which case it would be better to move it off rapidly by putting the price at 11½, where a party would take a whole crate. But there are some other things I wish to talk about a little."

"What are they?"

"You said, the last time I saw you, that you had thought you would have three or four thousand pounds of white comb honey."

"Yes, and upon getting it crated I find I have nearly 4700 pounds."

"You do not think you can dispose of all of that in the towns about you, or in the 'home market' as it is called?"

"No, probably not more than 1000 pounds."

"Well, what are you going to do with the rest?"

"I thought I might sell it to some dealer, if I could get the price I asked for it."

"And what were you going to ask for it?"

"I had calculated to ask 13, the same as in my home market. Would not this be right?"

"After getting at the real value of my crop, as nearly as I can by the line of figuring we have been using, I have always placed the selling price, at my nearest railroad station, at one cent per pound less than I thought it would bring when sold on commission."

"What is that for?"

"My reasons for so doing have been that there is some risk always in shipping on commission, which risk you do not have to run when you sell for cash. Then in selling outright I have the money at my disposal and can often invest it so as to make more than the penny a pound would amount to before a return was made from the commission men, because this selling on commission sometimes proves to be a slow process of disposing of our product."

"But can you always get cash at the railroad?"

"No, not always, and I might say not often; and this is the reason why I have not oftener sold my product, instead of shipping on commission being the rule. I always demand cash at the railroad, when sending to a person I do not know; and if I spoke my mind freely I should say that this is best always, as right wrongs no man. I much prefer to wait a few weeks or months on the commission men to waiting a few years, or never getting any pay of a dishonest buyer."

"Did you ever have any experience with dishonest buyers?"

"Years ago I not only sold my own crop to a buyer in Philadelphia, but bought several thousand pounds from neighboring bee-keepers for the same party, and was foolish enough to let it go with the promise to pay on its arrival at Philadelphia, but 'arrival' proved to mean five years, and I got it then only through strenuous efforts. Thus I learned a lesson which I have tried to profit by."

"I am very glad to have had this talk with you, and I will try to profit by your experience also."

"Before you go, allow me to sum up a little: I would say always, put up your honey in the most attractive shape possible, grading each kind of honey into at least three grades, and sell as much in the home market as possible at from 2 to 2½ cents less than reliable market quotations from the large cities. If you have more than can be disposed of in this way, sell the rest for cash if you can obtain as much for it into a cent a pound as you think it will bring you when shipped on commission. If you can not thus sell what you have above what your home market will take, ship on commission to reliable parties."



QUESTIONS ON SWARMING.

Mr. Root.—Will you please publish the full law on bees in the State of New York?

1. What is the reason bees cluster out on the front of an old hive, as mine have been doing for the last week?

2. Is there any way of telling from which hive a swarm issues if you do not see it come out of the hive?

3. What is the cause of swarms leaving the hive after they have been hived? They have been hived three times within three days, and each time left.

4. What is the cause of water on top of super of sections in summer, as the roof doesn't leak? It is one of those ventilated gable roofs, with an air-space; and in the winter, when the snow is blowing, it will collect in the air-space, and stay there until there comes a warm day; then it will melt, and run down through the bottom of the roof and on to the

bees; and the frames too are wet with it. Is there not a way to remedy it?

CHAS. MAC DONOUGH, JR.

Shokau, N. Y., July 22.

[The New York State law to which you refer is doubtless the one relating to foul brood and other brood diseases. We gave the whole text of it on page 365, May 1, 1899.

1. There are several reasons why the bees may be induced to cluster out: Too small an entrance; a hive that is not protected from the glaring rays of the sun; a hive that is too small; a poor season. Any one of these, especially if there are two or three in combination, will force the bees out of the entrance and cause them to loaf during the day. The remedies are obvious.

2. No, not unless you can discover the hive, around the entrance of which the bees are acting queerly. A few bees will become demoralized, run about, and there may be a string of bees from the swarm in the air to the entrance of this hive. A practical bee-keeper will often locate the hive from which a swarm has issued by the way the bees behave around that particular hive.

3. Very often a newly hived swarm will come out again, not once, but two or three times after they have been hived. It is usually advisable to give swarms a frame of unsealed brood, with a little honey; but even then they will sometimes come forth. It is then advisable to hive them in an entirely different location—one that is well shaded, and in a hive that is roomy, with a large entrance, not forgetting the brood. But when any swarm behaves in this way it is advisable to clip the wing of the queen at the time of hiving, if she can be found.

4. The water could hardly have come from melted snow as late as summer. If I understand your locality, the snow would have all melted months before. The moisture is probably due to the warmth of the bees coming against the super cover, and in contact with the cool air of the previous night. Many and many a time I have noticed the exact size of a cluster of bees by the moisture on top of the cover. In such cases the night had been cool, and in the morning there would be a sort of sweat, as around an ice-pitcher, right over the exact spot under which was the cluster of bees—ED]

WINTERING BEES IN A LARGE CELLAR; THE
EXPERIMENT AT THE HOME OF
THE HONEY-BEES.

I was very much interested in your indoor wintering as described in GLEANINGS, in your cellar partitioned off from the main apartment. Now, do I understand that the only provision for ventilation was what would percolate through the sacking? How did they compare with the outdoor colonies, as to building for the harvest?

I am thinking of partitioning off a space like that in one end of my cellar under the store. Vegetables, etc., are kept in the main part of the cellar. Would you recommend it with your present light? I have always win-

tered outdoors with hives packed, but do not like it. The winters are too severe.

GEO. SHIBER.

Franklinville, N. Y., Aug. 6.

[We were very much pleased with your experiment in wintering bees under the machine-shop, as described in GLEANINGS, pages 195, 246, and 400. They came out in fine condition, were much stronger, and were in better condition for the honey-flow when it came—much better.

There is no reason why you could not secure the same results we did, providing you see to it the temperature does not go below 40 nor above 55, for that is the range that prevailed in our cellar; but on account of the large number of potatoes we had in other parts of the cellar we opened and closed the windows quite frequently. During very warm spells, when the temperature was above freezing we kept the cellar closed to keep in the cold air; then when it became quite cold, and the temperature went up a little too much, the windows were opened.

But it should be understood that the bees were in a compartment *wholly within the cellar*, and the potatoes were stored in the space around the compartment or room in which the bees were. We closed up the space or ends of this room by means of sacking or burlap, two or three thicknesses, one over the other. The bees were scarcely examined all winter except to note the variation in temperature occasionally; and the number of dead bees was the smallest I have ever seen. In fact, one could almost walk on his tip toes without stepping on dead bees. The colonies were kept in the cellar until it was so warm outside that one could almost rear queens, and we kept them there late just to see how long they would remain and keep quiet, even after other bees were gathering pollen from natural sources outside. We shall, the coming fall, put in twice the number of colonies; and as the cellar is 36×96 we do not consider that the increase in numbers will make any practical difference so far as the atmosphere of the general cellar is concerned.

I think one secret of the successful wintering is due to the fact that the cold air came into the outer compartment of the cellar, and then gradually percolated through the burlap (after it got warmed up) into the place where the bees were. The result was, there was no sudden change of temperature, and plenty of fresh air.

I am satisfied now that one trouble from indoor wintering is that cellars are often too small for the number of colonies accommodated. One may put 150 colonies into a cellar 10×10; but the cubic capacity of air for so many bees is altogether too small to get good results. In our machine-shop cellar there were only 30 or 40 colonies in a cellar 36×96, although the bees themselves were confined in a room the two ends of which were shut off with burlap, not larger than 8×8. But, understand that, although this room itself was small, the air could circulate through it and into it from the big cellar on the outside.

I imagine one would get about the same result with only 10 colonies in a 10×10 cellar; or in the cellar you speak of, under the store, you could probably put as many as you required, as the cubic feet of air would be sufficient to keep the bees in the inner compartment in good condition, provided the windows were opened and closed occasionally to keep the cellar as cold as possible, and above the freezing-point for the protection of vegetables. I do not think that the presence of vegetables, provided there are no bad smells, would do any harm.—Ed.]



NATIONAL BEE-KEEPERS' ASSOCIATION.

OBJECT:—To promote and protect the interests of its members; to prevent the adulteration of honey.

OFFICERS:—E. R. Root, President, Medina, O.; R. C. Aikin Vice-president, Loveland, Col.; Dr. A. B. Mason, Secretary, 3512 Monroe St., Sta. B, Toledo, O.; Eugene Secor, General Manager, Forest City, Iowa.

BOARD OF DIRECTORS:—E. Whitcomb, Friend, Neb.; W. Z. Hutchinson, Flint, Mich.; A. I. Root, Medina, O.; E. T. Abbott, St. Joseph, Mo.; P. H. Elwood, Starkville, N. Y.; E. R. Root, Medina, O.; T. G. Newman, San Francisco, Cal.; G. M. Doolittle, Borodino, N. Y.; W. F. Marks, Chapinville, N. Y.; J. M. Hambaugh, Esccondido, Cal.; C. P. Dadant, Hamilton, Ill.; C. C. Miller, Marengo, Ill.

FEES:—Annual membership fee, \$1.00. Remittances may be sent here or to General Manager as above.

QUEEN-REARING this year at the Home of the Honey-bees has been progressing very smoothly. The honey-flow was good; then after the main crop was secured, red and sweet clover came in, giving the bees something to do every day, and they are still working so that robbing is not annoying to the extent that it interferes with our queen-rearing operations.

We are beginning to get good reports of the German wax-press. Already it would appear that in most cases the machine will pay for itself in one or two days' time because it makes use of and turns into cash the material that hitherto has been thrown out in the garden, and considered as so much waste. A machine that can coin gold dollars out of nothing is worth its price and keep.

THE Root Co. especially invite visitors on the way to or from the Pan-American to stop at Medina and see their apiaries as well as inspect their methods. We have one yard of over 500 colonies, and another one of about 50. Both are in exceptionally fine condition, and are almost as orderly and neat as a city park. Our Mr. Wardell has charge of the bees, and is beating all our previous records.

ON my spare evenings I am developing the pictures that I took on my western trip. I have gotten about half way over the series, and I am glad to say they are fine. Most of the pictures were taken with the time-shutter and smallest stop, with the result that there will be a sharp focus and good strong con-

trasts. Many of them will be reproduced in GLEANINGS.

We have not yet put up our queen-mating cage, for three reasons. First, the great expense involved; second, the doubt as to whether it will work after the money is paid out; third, lack of time. To make a thing of that kind work, one must have infinite faith in it. I still believe that it will work; and if I can get time to give it my personal attention I will try it on a small scale and then on a larger one.

THE Home of the Honey-bees is being enlarged again this year. We expect to have masons at work in a few days putting up a wax-working building, one that will be fire-proof, and devoted exclusively to the manufacture of fine grades of foundation. There will be other additions to some other departments. Another new printing-press has been ordered. A new automatic machine is just being completed, and some special machines will be purchased in the near future.

Do not forget the big convention at the Pan-American, Sept. 10, 11, 12, Tuesday, Wednesday, Thursday, commencing on the first day in the evening. The place of meeting is the Buffalo Library Building, corner Washington and Clinton Streets, near the business center of the city. This promises to be one of the best-attended conventions we have ever had. The meeting at Chicago was nearly 500 strong. Let's break the record at Buffalo.

IN our last issue I referred to the fact that the editor of the *Rural New-Yorker* would speak at the joint session of bee-keepers and fruit-growers, on Thursday evening, Sept. 12. In doing so I referred to his name as Collington instead of Collingwood. Our readers will please take note of the correction, and remember that Mr. Collingwood's address will be something exceptionally interesting. At this session there will be other speakers who will be well worth hearing.

MR. W. A. SELSER, the honey-man of Philadelphia, writes that, so far as his locality is concerned, there is more honey than last year; and he fears that, if bee-keepers in the East go on the assumption that the crop is as scarce as last year, they will be waiting in vain for high prices. He says he has had many more offerings up to date than a year ago.

But this would apply only to the extreme East. The central and western markets, as nearly as we can judge, will be about on a level with last year.

A PARAGRAPH of the honey reports as given in our last issue was inadvertently omitted. In substance it stated that the information was based on a 6000-mile trip in the West, and on something like 400 or 500 reports that had been received from all sections of the country. Our honey-man, Mr. Boyden, sent out blanks to many of the largest honey-producers and buyers of the country, represent-

ing all the best honey territory of the United States. The statement that we gave in our last issue I think, therefore, was as nearly correct as it is possible to make it after making *every effort* to get all the information possible.

A CORRESPONDENT asks if we have ever seen drone brood affected by the disease known as foul brood. Personally I have always been under the impression that this malady is no respecter of persons; but just at this moment I can not be positive that I have ever seen a case of rotten drone brood. If there are any of our subscribers who have found combs of worker brood that were badly diseased, and in the same frames patches of drone brood perfectly healthy, will they please let us hear about it? I can not believe that the microbes would destroy the larvæ of one sex and leave those of the other untouched. If they do, then it must be because the drone brood has slightly different food, rendering it immune.

In our last issue and this, the Rambler seems to have struck some of his happiest veins of writing. As I went through California some of my friends would say, "Why, that man Rambler is an ordinary-looking sort of a duffer, isn't he? One would not think, to see and talk with him, that he could get off so much fun in his writings." At other places I heard a remark something like this: "Why, when I saw Rambler I expected to hear him talk funny all the time; but he didn't. He talks kind o' quiet, and is just as sober as an old deacon." But J. H. Martin hardly ever goes through any territory without being recognized at once. "Why, this is Rambler, isn't it?" and Mr. Martin, who introduces himself as Martin, very modestly pleads guilty.

THE TAUNTON BEE-CASE; BEES VINDICATED AND DEFENDANT DISCHARGED.

The following note, just received from W. F. Marks, a Director of the National Beekeepers' Association, will explain itself:

Mr. E. R. Root.—The Rochester bee-keepers win! See inclosed clipping from a Rochester paper.

I notice that you are publishing a series of articles on "The Bee in Law." I hand you herewith a copy of a New York case. As the court wrote an extended opinion, citing many authorities, I consider it one of the most satisfactory court opinions in a bee way on record.

W. F. MARKS.

Chapinville, N. Y., July 22.

This is the clipping to which Mr. Marks refers:

The celebrated case of Mrs. Eliza Taunton, charged with keeping bees within the city limits in violation of a city ordinance, was called in police court yesterday morning. The arrest was made May 28th, and since that time the case has been called and adjournments granted until both sides finally announced themselves ready for trial. Attorney Callahan prosecuted the case, and Attorneys Dutcher and Barhite acted for the defense.

The case was argued at some length a week ago. Attorney Barhite declared that the ordinance was unconstitutional, as it tended to give administrative powers to private individuals in a case where the law did not work with equality to all. It was held that the council had no right to so delegate such powers, therefore the ordinance was invalid.

On the other hand, Attorney Callahan cited the barbed-wire ordinance as a sample of what could be done in the line of administration by consent. The court requested the attorneys to file briefs, which was done.

Yesterday Attorney Barhite made a motion for the discharge of Mrs. Taunton, and the motion was granted. The court agreed with the attorney that the council had exceeded its rights in granting administrative powers to private citizens, and for this reason the ordinance was said to be invalid.

The ordinance says that no person shall keep bees within the city limits, and at the same time provided that if the consent of all the people within 100 feet of the place where the bees are kept is obtained, it is within the law to keep bees. This delegation of power on the part of the council was the part which Judge Ernst thought made the ordinance void.

Next follows the decision, which is very full, and so valuable that I place it before our readers in its entirety. I will have copies of this struck off, and furnished to the General Manager of the Association, who can use them in other cases that may arise.

SUPREME COURT, STATE OF NEW YORK—EARL VS. VAN ALSTINE.

One who owns or keeps an animal of any kind becomes liable for any injury the animal may do, only on the ground of some actual or presumed negligence on his part.

It is essential to the proof of negligence, and sufficient evidence thereof, that the owner be shown to have had notice of the propensity of the animal to do mischief.

Proof that the animal is of a savage and ferocious nature is equivalent to proof of express notice. In such cases notice is presumed.

The owner of bees is not liable, at all events, for any accidental injury they may do.

Where, in an action against the owner of bees for an injury done by them to the plaintiff's horses while traveling along the highway past the place where the bees were kept, it appeared that the bees had been kept in the same situation for eight or nine years, and there was no proof of any injury ever having been done by them, but, on the contrary, witnesses residing in the neighborhood testified that they had been in the habit of passing and repassing the place frequently, without having been molested. It was held that this rebutted the idea of any notice to the defendant, either from the nature of bees or otherwise, that it would be dangerous to keep them in that situation, and that he could not be made liable.

This action was commenced in a justice's court. The complainant alleged that the defendant was the owner of 15 hives of bees, which he wrongfully kept in his yard adjoining the public highway, and that the plaintiff's horses, while traveling along the highway, and passing the place where the bees were kept, were attacked and stung so severely that one of them died and the other was greatly injured, etc. The answer denied the charge contained in the complaint.

Upon the trial, the keeping of the bees as alleged, and the injury to the horses, were proved, and the plaintiff recovered judgment for \$70.25 and costs. Upon appeal to the county court of Wayne County this judgment was reversed, and the cause was brought to this court by appeal from the judgment of the county court.

By the court, Selden, J. This case presents two questions: 1. Is any one who keeps bees liable, at all events, for the injuries they may do; and, 2. Did the defendant keep these bees in an improper manner or place, so as to render him liable on that account?

It is insisted by the plaintiff that, while the proprietor of animals of a tame or domestic nature, *domilia nature*, is liable for injuries done by them (aside from trespasses upon the soil) only after notice of some vicious habit or propensity of such animal; that one who keeps animals *feræ nature* is responsible at all events for any injuries they may do; and that, as bees belong to the latter class, it follows, of course, that the defendant is liable.

In order to determine this question, upon which no direct or controlling authority exists, that I have been able to find, it becomes necessary to look into the principles upon which one who owns or keeps animals is held liable for their vicious acts. It will be found, on examination of the authorities upon the subject, that this classification of animals by the common law into animals *feræ nature* and *domilia nature* has ref-

erence mainly, if not exclusively, to the rights of property which may be acquired in them, those of the latter class being the subjects of absolute and permanent ownership; while in regard to the former, only a qualified property can exist, and the distinction is based upon the extent to which they can be domesticated or brought under the control and dominion of man, and not at all upon the ferocity of their disposition, or their proneness to mischief. For instance, the dog, some species of which are extremely savage and ferocious, is uniformly classed among animals *domitæ nature*, while the hare, the rabbit, and the dove are termed *feræ nature*, although comparatively harmless. It would not be rational to suppose that a classification adopted with exclusive reference to one quality of animals could be safely used to define and regulate responsibilities growing out of other and different qualities; nor would it accord with that just analysis and logical acumen which distinguish the common law, that it should be resorted to for that purpose. And although some dicta may be found in the book which might seem to countenance the idea, the decided cases do not lead to any such conclusion.

It is unnecessary to enter into any examination of the cases which establish one branch of the proposition contended for, to wit: that, in order to make the owner of a domestic animal liable for any violent injury done by them unless connected with a trespass upon land, it must be averred and proved that the defendant had notice or knowledge of the mischievous nature of the animal. This, as a general rule, is settled by a series of decisions which have been entirely uniform from the earliest days to the present time. But although, in many of these cases, most of which are cases of injuries done by dogs, the words *domitæ nature*, or equivalent words, are used to describe the animals for the mischief done, by which their owners would not be liable without notice; yet it is not alone because they belong to that class that the exemption arises, but because animals of that class are usually of a harmless disposition. I apprehend that, if a person chooses to keep a domestic animal, as a dog, which is naturally savage and dangerous, he does so at his peril, and that he would be liable for any injury done by such dog without evidence that he had ever done mischief before. This position is not without authority to support it, although it does not rest upon any adjudged case. In *Judge v. Cox* (1 Stark, 285), Abbot, J., suggests the question, but expressly reserves his opinion upon it as unnecessary to the decision of that case. But in *Hartley v. Harriman* (1 Barn & Ald., 6.0), which was an action for an injury done to sheep by dogs, the declaration contained a special averment that the dogs were accustomed to worry and bite sheep; and the court held that this averment was not supported by proof that the dogs were of a ferocious and mischievous disposition. But Lord Ellenborough and Mr. Justice Bayley both said that it would have been sufficient to allege generally that the dogs were of a ferocious nature, and unsafe to be left at large, and that evidence of that fact would support the action. These dicta are so obviously in accord with common sense and reason that they will undoubtedly be sustained whenever the question shall arise. It is true that, in a case of injuries done to sheep, our statute makes the owner liable without notice, provided the sheep are killed, but principle would apply to any other injury.

But while, as I have said, the cases which define the responsibilities of the owners of domestic animals are very numerous, those which apply to the liability of the proprietor of wild animals are rare. It has been assumed, rather than decided, that the latter class are kept at the peril of their owners. In *Rex v. Huggins* (2 Ld. Raym 1583) it is said, "There is a difference between things *feræ nature*, as lions, bears, etc., which a man must keep up at his peril, and beasts that are *mansuetæ nature*, and break through the tameness of their nature, such as oxen and horses. In the latter case the owner must have notice; in the former, an action lies against the owner without notice." The case in which this was said was an indictment for murder; but the language here given is copied and adopted by Buller, in his *Nisi Prius*, (Bull. N. P., 77.) It will be observed that, while these authorities speak of a whole class, "things *feræ nature*," yet the example given is that of lions, bears, etc.

So in a late case in our own courts, *Van Leuven v. Lyke* (1 Comst., 516), Judge Jewett, after stating the rule in respect to domestic animals, says: "But as to animal's *feræ nature*, such as lions, tigers, and the like, the person who keeps them is liable for any damage they may do, without notice, on the ground

that by nature such animals are *feræ* and *dangerous*." Here the learned judge, although adopting the same classification, yet states the true ground of the owner's responsibility. The substance of the rules as given by him is, that one who keeps lions, tigers, or other fierce and dangerous animals, is liable at all events for any injury they may do. The words *feræ nature* add nothing of any value to the rule, but rather tend to mislead, as they are descriptive of many animals that are not ferocious or dangerous.

Peake, in his work on evidence, under the head of "Actions Founded in Negligence," has the following: "If one man keeps a lion, bear, or any other wild and ferocious animal, and such animal escape from his confinement and do mischief to another, the owner is liable to make satisfaction for the mischief so done, without further evidence of negligence in him; for every person who keeps such noxious and *useless* animals must keep them at his peril. On the contrary, if a man has a dog, a bull, or any other domestic animal such as are usually kept, and are, indeed, *necessary to the existence of man*, no action is maintainable without proof of knowledge, etc.; for without such knowledge no negligence or fault is imputable to the defendant." (Norris Peake, 486.) Three things are worthy of notice in this extract. In the first place, the author mentions animals that are not only wild but ferocious, and speaks of them as not only noxious but *useless*. In speaking of domestic animals he dwells upon their utility and value; and, lastly, he makes negligence the foundation of the liability of the owner.

Again, Chitty, under the head of actions on the case for negligence, gives the rule as follows: "The owner of domestic or other animals, *not naturally inclined to do mischief*, as dogs, horses, and oxen, is not liable for any injury committed by them to the person or personal property unless it can be shown that he previously had notice of the animal's mischievous propensity." (Chit. Plead. 82.) This accurate elementary writer did not fall into the error of applying the rule to the whole class of animals *domitæ nature*, but adds the qualification, "not naturally inclined to do mischief." By his arrangement of the subject, too, he confirms the view of Peake, that the liability is based upon negligence.

These authorities seem to me to point to the following conclusions. 1. That one who owns or keeps an animal of any kind becomes liable for any injury the animal may do, only on the ground of some actual or presumed negligence on his part. 2. That it is essential to the proof of negligence, and sufficient evidence thereof, that the owner be shown to have had notice of the propensity of the animal to do mischief. 3. That proof that the animal is of a savage and ferocious nature is equivalent to proof of express notice. In such cases notice is presumed.

These views derive some support from the case of *May and wife v. Burdett* (9 Adol. & El. N. S., 101). That was an action on the case for an injury done to the wife by the bite of a monkey. The declaration alleged that the defendant kept the monkey wrongfully, well knowing that it was of a mischievous and ferocious nature, and accustomed to bite, etc., but did not aver that the defendant had been guilty of any negligence. A verdict was found for the plaintiff, and the defendant moved in arrest of judgment, on the ground that, as the action was founded in negligence, the declaration was defective in not containing any averment that the defendant had been guilty of negligence. The motion was overruled, it being after verdict. Ch. J. Denman says, "But the conclusion to be drawn from an examination of all the authorities appears to us to be this, that a person keeping a *mischievous animal with knowledge* of its propensities, is bound to keep it secure at his peril; and that, if it does mischief, *negligence is presumed*. The negligence is in keeping such an animal after notice." The injury for which this action was brought was done by an animal clearly *feræ nature*, and yet it was deemed necessary to aver the mischievous nature of the animal, together with knowledge on the part of the owner; and the question which arose and was very elaborately discussed was, whether the plaintiff should not have gone still further and inserted an averment of negligence.

Having shown, then, as I think, clearly, that the liability does not depend upon the classification of the animal doing the injury, but upon its propensity to do mischief, it remains to be considered whether bees are animals of so ferocious a disposition that every one who keeps them, under any circumstances, does so at his peril. If it is necessary for the plaintiff to aver and prove the mischievous nature of the ani-

mal, nothing of the kind was done in this case; but if courts are to take judicial notice of the nature of things so familiar to man as bees, which I suppose they would be justified in doing, then I would observe that, however it may have been anciently, in modern days the bee has become almost as completely domesticated as the ox or the cow. Its habits and its instincts have been studied, and, through the knowledge thus acquired, it can be controlled and managed with nearly as much certainty as any of the domestic animals; and although it may be proper still to class it among those *fera natura*, it must nevertheless be regarded as coming very near the dividing line; and in regard to its propensity to mischief I apprehend that such a thing as a *serious* injury to persons or property from its attacks is very rare, not occurring in a ratio more frequent, certainly, than injuries arising from the kick of a horse or the bite of a dog.

There is one rule to be extracted from the authorities to which I have referred, not yet noticed; and that is, that the law looks with more favor upon the keeping of animals that are useful to man than such as are purely noxious and useless. And the keeping of the one, although in some rare instances they may do injury, will be tolerated and encouraged, while there is nothing to excuse the keeping of the other. In the case of *Vrooman v. Lawyer* (13 *John. Rep.* 339), the court says, "If damage be done by any domestic animal kept for *use or convenience*, the owner is not liable to an action, without notice." The utility of the bees no one will question, and hence there is nothing to call for the application of a very stringent rule to the case. Upon the whole, therefore, I am clearly of the opinion that the owner of bees is not liable *at all events* for any accidental injury they may do. The question is still left, whether the keeping of these bees so near the highway subjects the defendant to a responsibility which would not otherwise rest upon him. I consider this question as substantially disposed of by the evidence in the case. It appears that bees had been kept in the same situation for some eight or nine years, and no proof was offered of the slightest injury ever having been done by them. On the contrary, some of the witnesses testify that they had lived in the neighborhood, and had been in the habit of passing and repassing frequently with teams and otherwise, without ever having been molested. This rebuts the idea of any notice to the defendant, either from the nature of the bees or otherwise, that it would be dangerous to keep them in that situation; and, of course, upon the principles already settled, he could not be held liable.

The judgment of the county court must be affirmed.



And it came to pass the same day, that Isaac's servant's came, and told him concerning the well which they had digged, and said unto him, We have found water.—*GEN.* 26:32.

He maketh me to lie down in green pastures; he leadeth me beside the still waters.—*PSALM* 23:2.

Mrs. Root did not go with me to my ranch in the woods during July. There were several reasons why she begged to be excused. First, the bargain was she was to go and take care of me because my health is poor; but during the past July there was not a thing the matter with me. In fact, one day when I alighted from my wheel up town an old friend of mine said, "Why, look here, Mr. Root, you get off from that wheel as if you were a boy. Are you not forgetting that you are an old man, and gray-headed?"

Well, I do not know but it is true that I do act like a boy, and, in fact, I do not believe I ever felt much spryer when I was a boy in my teens than I do just now. May the Lord be praised for health and strength.

In the second place, we were going to take Mrs. Root up to the Traverse region to escape the hot July weather of Ohio; but our daily papers—yes, our daily papers do sometimes tell the truth—said they had had a higher temperature in Traverse City than in Cleveland.

Third, Mrs. Root worried about the water supply near our new home. She has all her life been in the habit of having pure soft water in unlimited quantities, especially in hot weather. I was obliged to tell her there was no real nice cold spring water within less than a quarter of a mile of our ranch. Of course, the spring that runs 300 barrels a day was on higher ground than the ranch, but it would have to be carried in pipes a quarter of a mile. These pipes would cost a good many dollars, and she said the water would be warm by the time it reached the house. It is true there was a little spring within 500 feet of the house. The cows had been in the habit, however, for years, of wading into this spring to get a drink. They had stamped it full of leaves and filth, and it was any thing but an inviting place. She did not believe such a spring could ever be made wholesome.

Fourth, when she began to inquire about green grass around the new house I had to admit there was not a blade of grass anywhere much nearer than the spring. Who would expect to find grass right out in the dense woods?

Well, Mrs. Root did not go in July, but I have faith to believe she will go a little later on when it is cooler and more pleasant to travel. I captured her more than forty years ago when she was a girl in her teens. I came pretty near using the word "captivated," but I guess that is not what I mean. I *captured* her over forty years ago, as I have just said, and induced her to take up with me and my home for better or worse; and I rather think I can capture her again; and during my July trip I had this purpose in view.

The garden in the cleared-off spot in the wilderness was doing finely. After I had fixed it up according to my notion a little more, it was really a thing of beauty—to me at least. Our very first work was to tackle the spring. I secured the services of a stout German near by, named Burdo, who said he had dug wells and fixed up springs, and he knew he could fix mine all right. In the first place, he dug up carefully and scraped out every bit of filth and mud—yes, and even the dark-colored sandy soil around the spring was cleaned away till we came to the clean white sand or clean yellow clay in the bottom; and we found the water oozed out all around where the sandy and gravelly top soil rested on a stratum of impervious clay. We made a dish-shaped excavation down into the clay, but I told the man not to go down through it, for I feared we should strike sand again, and that would let all of the nice clear water escape; so we just made a bowl-shaped cavity, perhaps 20 or 24 inches deep, below where the water came in. Then I timed it by my watch, and found that, even in this dry July, with its tremendous heat, the water ran in half a barrel an hour,

or at the rate of 12 barrels a day. I first drank the water boiled. Of course, it was all right then. Then I commenced drinking it just as it runs out of the sandy ground, and I had one of my pleasant surprises. That cold spring water did not interfere with my digestion a particle—at least not while I was at work on the ranch.

Now, when I describe to you with great minuteness the way in which Mr. Burdo fixed my spring, I hope it may be helpful to thousands of others who have like springs or like springy places. He got some pieces of 4×4 hemlock, long enough to reach about two feet above the level of the ground, and down to the bottom of the spring. Then he made a square crib or curb by nailing on hemlock boards 3 feet long. He said hemlock would not give the water a taste, and that it is the only kind of wood in that region that can be safely used for curbing a spring. Of course, a stoneware sewer-pipe two feet or more in diameter would be better; but I did not choose to go to that expense then and there. The hemlock boards, you see, let water through all along the sides—that is, if they are nailed on a little piece apart where they come under water. After the curb was in place we filled all around it with cobblestones up to within, say, 18 inches of the surface of the ground, putting large stones in the bottom, and smaller ones gradually on the surface. Then on top of this surface of small stones or gravel he put the impervious clay that he dug out of the bottom of the spring. This was stamped down hard, and made to slope in every direction away from the well. Then a ditch was run around the spring on all sides, with an outlet at the lowest point. This was so that all rain water would run away from the spring and down *around* it instead of running *into* it. We did not want any sort of seepage from the rotten logs and dead leaves above the spring in the woods. Then the clay was covered with sods of a heavy turf of June grass cut from a cleared place some little distance away.

"Now," said Mr. B., "whoever comes here for a drink of water should dip out a good lot and give this turf a good wetting. After it once gets started and rooted into this clay it will keep *green* and *clean*." So Mrs. Root will have *some* green grass around the spring, any way.

During the week or more that I remained at the ranch this grass took on a lively green, and I really enjoyed myself in lying down on that green turf and looking into "*my* spring" while I lay in the shade of the trees that overshadow it, and looked down into its crystal depths. By the way, there is a dense growth of basswoods all around that spring. The roots, no doubt, go down into the damp sand and gravel that overlies the hard clay. And, by the way, will not such a location be tiptop for many kinds of fruit? I have before spoken of the Downing everbearing mulberry grown under such circumstances. Well, the trees and every thing else grow with wonderful luxuriance all around this spring. During my visit at all other times of the year a little

stream has been running away from the spring. This time, owing to the severe drouth, no water ran away while I remained there. No doubt the vigorous basswood and other trees all around the spring took up a large quantity of this water during the height of their growing season. After their leaves drop, and the trees take on their rest, I shall expect to see the stream of water running away from the spring again as it was last fall.

Now, I made some (at least to me) very interesting and valuable discoveries in studying that spring and playing with it. When I became very warm and tired in working at my lawn around the house, for instance (oh, yes! we are going to have a lawn—I will tell you more about it further on), I used to go down there and not only get a cool drink but wash my face and hands and arms in the cooling fluid. For ten cents I bought a very pretty little wash-basin. By the way, is it not a wonder that we at the present day have so many luxuries in the way of neat and pretty utensils for such a small amount of money? This enameled iron wash-basin has such a smooth and glossy surface you can keep it clean enough to eat or drink out of, almost without any trouble at all. That basin seemed to be a special accompaniment to my spring. I used to keep it hanging on the limb of a basswood-tree. A tin cup and a tin pail are likewise hanging near by.

Oh! I forgot to say that Mr. Burdo made a board cover over the spring. This is to keep out leaves and dirt when the wind blows hard, and to keep out the sun. He says the sun should never shine on the surface of the water of any spring or wherever drinking water is kept. The sunlight induces the development of a plant-like substance called *algæ*, commonly known as green scum, which is seen on soft-water ponds and brooks. He said, however, that, even though the sun, leaves, and dirt, are kept out, the spring must have a certain amount of ventilation, so the board on the front side was made about six inches lower than the other boards. This made it a little easier to kneel down in the grass, to reach down and dip up a pail of water.

Now for my discovery. Whenever I got hot and thirsty at work in the garden during those very warm days in July (yes, it was very warm up along Traverse Bay as well as other places) I used to go down to the spring, take a big drink, and wash my hands and face in the cool soft water. For years I have not been in the habit of drinking cold water, as I have told you; but I found I could drink that water just as it came from the spring all right, providing I drank it slowly; but as the temptation was quite strong to drink a great deal in order to get cooled off quicker, I began pouring it on my hands and arms, the arms being pretty well bared up to the elbow. Mr. Burdo said, you know, that I must pour some water on the grass around the spring every day; so I took my enameled wash-basin and poured water on my hands and arms before it ran off on the grass; and my discovery was that, by pouring it on my wrists, and cooling them, the cooled-off blood would very soon

go all over my body. I thought I was original in this idea; but somebody at the dinner-table spoke of doing the very same thing; and in the last number of the *Philadelphia Farm Journal* I saw that Judge Biggle also recommended pouring cold spring or well water on the wrists to get cool, without drinking too much cold water. Well, after I received so much help and refreshment in this way I began to pour the cold spring water over my head, keeping my head low over the grass that needed irrigation. Finally one evening, after a very warm day, I wanted to ride over to Mr. Hilbert's, across the hills; but I had worked so hard I felt too tired to even ride my wheel. But there was a particular reason why I wanted to go just that night. As I passed by the spring I picked up my wash-basin and bar of Ivory soap, thinking I would try the big spring on the other side of the ranch, and see how its waters compared with those of the new one. Of course, I had to wash my hands and face. Well, this spring is over in the dense woods. In fact, it is quite dark in that close thicket, even at noontime. I bathed my arms and head and neck as before; and this sort of shower bath did me so much good I was struck with the idea of a similar shower bath of cold spring water over my entire body. I remembered what Father Kneippe, of Germany, had said about it in his book, and others in other parts of the world since then. In a twinkling I was stripped of my light summer clothing. The spot is so retired that there was no need of a bathing-suit or bathing-house. After taking a good wash with the soap I began to practice on the cold shower bath by pouring water from my basin on my head. At first it made me gasp for breath, the water was so cold; but every succeeding basinful gave me less and less unpleasantness on account of the cold water, and in a little time I was delighted to find that my system had become so inured by the repeated dashes of cold water that all unpleasant feeling was gone. I drenched myself again and again with basinful after basinful, and I thanked God meanwhile that, as there was 300 barrels a day going to waste, I need not worry about extravagance in the way of using water. Finally, after I had fully satisfied myself that it is not only a safe thing to bathe in cold water—yes, even take a shower bath—I decided it was one of the most enjoyable things I had ever discovered. I put on my light clothing, and started off on my wheel. Then came one of my happy surprises. All the tired feeling was entirely gone. I felt like a boy in his teens when school is out. I went over to Bro. Hilbert's, exulting in my new-found strength, slept soundly, and did not feel a particle of reaction. I tried the same thing several times afterward; but to get this exhilaration I have been speaking of, the bath should be taken when you are warm and sweaty—say after a hard day's work. I first washed myself thoroughly by taking water from the wash-basin with my hand and applying it to every part of the body. Of course, this left me more or less soapy. Now, I feel sure from

many years' experience that soap should never be left to dry on the body. Soap should all be rinsed off with plenty of pure soft water, either hot or cold. Now, my discovery is not, of course, any thing particularly new. A cold-water shower bath was quite a craze fifty years ago, as I can well remember. Notwithstanding, I never before realized what a *wonderful* change it makes one feel in exceedingly warm and dusty weather.*

Pure soft-water springs are appreciated to a great extent; in fact, many homes have their especial locations just because of such springs; but I do not believe we have realized the comfort and the bearing on the health of the inmates of the family that these springs, especially when brought right into the home, may be. Many of the springs are high enough above the homes so the only expense is suitable pipes to carry the water where wanted. Where they are not high enough in location a hydraulic ram will lift the water sufficiently to bring plenty of it right up beside the cooking-stove if you choose to have it so near; but if your well is like the new one I have described, and there is not really enough water to run up over and overflow, then the wind-mills that are offered at from \$15.00 to \$20.00 will do the work very well indeed. The only trouble is, the wind does not always blow; but by having a pretty good-sized reservoir you may always have water to use and waste or get away.

At Petoskey I visited a bee-keeper's home where a large family of children have been brought up. A spring of beautiful water, of a considerable volume, is only a few hundred feet from the house, and perhaps 20 feet below it. But their water, during all these years, has either been brought by hand or drawn up by the barreland by horses. Why, I fairly ached to go to work myself and put a hydraulic ram in that spring, just to show those people what it would do.

One very warm July evening I went over to a schoolhouse a few miles southeast of Traverse City, where they have comparatively level land; but a supply of nice drinking-water is all around just the same. Within a mile of the schoolhouse there is a watering-trough beside the road, where pure soft water pours

*Dr. J. H. Kellogg, of the Battle Creek Sanitarium, is just now engaged in writing a new book on medicine. His brother, Will Kellogg, has been kind enough to send me some of the advance sheets, and from these I make the following extract:

"A person who has never experienced the glow of exhilaration, the invigoration and buoyancy of body and mind, which accompany the state of reaction from a short, general cold application, can not well appreciate the value or significance of the cold bath as a physiological stimulant. It is not too much to say that it is, of all measures known to man, the most valuable as a means of arousing to activity the flagging energies of the body, and lifting the enervated invalid out of the morasses and quagmires of chronic disease.

"The reaction produced by tonic applications fills the skin with blood; and if it is daily repeated, the blood is finally fixed in the skin, thus permanently increasing its vascular activity, and relieving internal congestion.

"Of the several forms of *douche*, the *rain douche*, or shower bath, is the most strongly refrigerant, since it impresses at each instant the largest portion of the surface."

over the sides of the trough all around its whole length. Not only this, but the V-shaped trough of boards that carries water from the spring to the trough seems insufficient to take care of all this wealth of cold spring water; and it pours over the sides of this trough almost its whole length. This water all comes from one spring. Mr. E. Black told us there had been talk of carrying the water in pipes to Traverse City.

A little way north of this schoolhouse, where the superintendent of the Sunday-school lives, we saw irrigating-pipes all through his garden, just as if he had water under pressure. I wondered why his place was thus equipped when his home was on a level plain, comparatively, with nothing that would indicate a spring or city water-works in sight. We were out so early the family had not finished breakfast; but he smilingly marched us into the pantry, right close to the kitchen stove, and there a stream of water was pouring forth under pressure from a pipe that I should call $1\frac{1}{4}$ or $1\frac{1}{2}$ inch. It was from an artesian well, and he said he put the pipe down *only 28 feet*. When I suggested that it might not hold out if left running with such volume, he said the stream had been going just like that for *nine years*.

Well, our good friend W. F. Silsby, one of our subscribers in Traverse City, has just purchased 20 acres of land in that neighborhood, for less than \$20 00 per acre. Shall I tell you why he bought it? There is more alsike clover grown in that vicinity than for many miles around; and he is establishing an out-apiary on his newly acquired land.

I had a curiosity to see the speckled trout in the cold spring brooks in that region, and so our good friend got some hooks and lines, and we went over into a field a little beyond the house, where we found a babbling brook hurrying and scurrying through the clover-field, and in a little time we had caught several of the speckled beauties. I expressed surprise that fish of that size should be found in so small a rivulet; but I was told that little runs like that, of cold spring water, were just the place for them. On our way back a man was cutting alsike and timothy for hay; and he said he was having a great deal of trouble because there was such a growth of alsike in with the timothy. It was so heavy he feared he could never cut it at all.

The last of my texts refers to green pastures and still waters. A part of my July work was to make some June grass grow around our rude summer cottage. Perhaps many of our readers know as well as I how to make a nice lawn. If so, they all know that it requires a great deal of hard work. Notwithstanding, I have decided again and again it is worth while. Many of our cities are now spending large sums of money in making parks and boulevards; and often the first thing they do is to set a lot of men at work smoothing off the rough inequalities of nature, fining up the ground, and then grading and leveling it preparatory to making lawns. We did the same thing at our ranch. We dug the ground over thoroughly, then raked out

the roots and stones, raking it over again and again, filling in here and cutting down there. Of course, we can not always have a lawn exactly *level*; but to be handsome it needs to be smooth. There must be no ups nor downs, nor inequalities. How wonderfully it rests the eye, and rests the person, to get just a glimpse of a beautiful lawn in front of or adjoining a home! In the outskirts of Traverse City there are some of the finest lawns I ever saw in the world. Mr. Hilbert said his impression was they were made of June grass and nothing else. After our lawn was finally graded and raked to my satisfaction, I gave Mr. Burdo some lawn grass and white clover to seed it down with. He said it wanted to be raked in just before a good heavy rain. While I was up in the Soo, as you may remember, a good rain came, and the seed is all in; so I suppose on my next trip, or, if you choose, *our* next trip, Mrs. Root and I will have the pleasure of seeing at least a little green grass around the door among the trees and garden stuff. By the way, you can not have a real nice flower-garden without having at least some green grass for a background; and to have this lawn nice, especially during real warm weather, without rain, like the past season, for instance, you need water for irrigation. A running spring, a hydraulic ram, or a windmill, will, any one of them, furnish abundant water to water the lawn. Of course, you want a reservoir, and one of the revolving sprinklers we see so often in front of the cottages in the suburbs of nearly all of our cities, large or small.

Since dictating the above I find that T. B. Terry, in the *Practical Farmer*; W. I. Chamberlain, in the *Ohio Farmer*, and Judge Biggle, in the *Philadelphia Farm Journal*, have been writing about what to do in warm weather—what to eat, what to drink, how to keep cool, and how to keep well. It was an agreeable surprise to me to find that this Home Paper is so much in line with what some of our great rural teachers have been talking about.

CONVENTION NOTICE.

All arrangements for the next convention of the National Bee-keepers' Association have been completed so far as possible, and the convention will be held in the audience room of the Buffalo Society of Natural Sciences, Sept. 10th, 11th, and 12th; commencing on the evening of the 10th. The place of meeting is in the Buffalo Library building, corner of Washington and Clinton Streets, near the business center of the city. The president of the Natural Sciences Society, Mr. Smith, has also kindly offered our Association the use of their library and other committee rooms during the time of our convention, and to do all in the power of the society to help make our meeting a success.

Railroad rates will vary in the different passenger association territory, from one cent per mile each way to one and one-third fare for the round trip. Each person can readily learn the rate on inquiry at his railroad station.

The Buffalo bee-keepers will try to provide entertainment at reasonable rates for all attending the convention, who will notify Mr. Sydney S. Sleeper, of Holland, N. Y., by Sept. 2d, of their wish for entertainment.

In a letter just received from Mr. Sleeper he says, "We want all to come who can, for we wish to make the Buffalo meeting the most pleasant and instructive one that was ever held in America. We will have the

co-operation of all the sciences as well as the school board," and names some professional men who are interested in our specialty and will be at the convention to help.

In a long letter from Mr. Hershiser, just received, he closes by saying, "Call upon me for whatever further assistance I am able to render;" and Mr. Penton, an ex-president of the Erie County Bee-keepers' Society, and others, have offered to do all they can to provide for the comfort of the delegates.

As stated in my previous convention notice in GLEANINGS, there will be no fixed program and no papers, and the time will be occupied in answering and discussing questions, except that on Thursday evening there will be a joint session of our association with the American Pomological Society, to discuss "the mutual relations of bee-keeping and fruit-growing;" and Prof. Beach, of the N. Y. Agricultural Experiment Station, and Prof. Fletcher, of the Central Experimental Farm of the Dominion of Canada, will help talk for the bees at that session, and it is hoped that much good will result to fruit-growers and beekeepers from this joint session.

If any bee-keeper who can not be at the convention has any questions, knotty or otherwise, he would like to have answered at the convention, will send them to me I will see that they are presented.

A. B. MASON, Sec., Sta. B, Toledo, O.



HONEY-PACKAGES OF TIN.

Owing to the strike of the members of the Amalgamated Association and those who sympathize with them, and the consequent stoppage of the larger number of mills making tinplate and sheet metals, there is a sheet-metal famine, and prices are abnormally advanced for the time being, not only on the sheets but on articles made from them as well. The last price quoted us by the tin-can trust on one-gallon cans is \$1.50 to \$3.50 higher than the price we are selling them for. We do not propose to increase our price so long as our stock lasts; but we can not fill orders after stock on hand is used up until we can obtain more. Of tin honey-packages listed in our catalog we have the following in stock.

RAISED-COVER PAILS.

300 pint, 150 quarts, 200 2-quarts, boxed separately.
400 nests $\frac{1}{2}$, 1, and 2 quarts.
350 nests $\frac{1}{2}$, 1, 2, 3 and 4 quarts.

RECORD'S TIGHT SEAL-COVER PAILS.

150 No. 1; 400 No. 2; 575 No. 3; 1000 No. 5, and none of No. 10.

CANS WITH SCREW CAPS.

2000 5-gal. cans with $1\frac{3}{4}$ -inch screws, and a few with 2-inch lever seals, which will be boxed one or two in a box as required.

500 1-gal. square cans with $2\frac{1}{4}$ -inch screws.
1400 1-gal. square cans with $1\frac{3}{4}$ -inch screws.
300 1-gal. oblong cans with $1\frac{3}{4}$ -inch screws.
700 $\frac{1}{2}$ -gal. square cans with $2\frac{1}{4}$ -inch screws.
300 $\frac{1}{2}$ gal. square cans with $1\frac{3}{4}$ -inch screws.
1000 $\frac{3}{4}$ -gal. square cans with $1\frac{3}{4}$ -inch screws.

We have also some 600 $\frac{3}{4}$ -gal. oblong square cans with 2-inch lever seal, which we do not list, which we offer at \$6.00 per 100 or \$5.50 if the whole lot is taken. We have also 400 1-quart round cans with 2-inch lever seal, which we offer at \$4.50 per 100, or \$4.00 if the lot is taken.

HONEY PACKAGES, GLASS.

We still have a good supply of half-gallon Mason jars; only a few of quarts are left, and none of the pints. Prices remain the same for such stock as we have.

Of No. 25 jars holding a full pound of honey we have on hand and engaged, 100 gross, part packed one gross in a barrel and part 2 dozen in a partitioned case. We have also 25 or 30 gross of the same style of jar holding about 14 oz. of honey, No. 100, which we sell at 50 cents per gross less than No. 25.

We have 11 bbls. of 1-lb tumblers, No. 789; 2 bbls. 788 and 789, nested, and 2 bbls of 788; 1 bbl. of 775 glass pails, and 2 each of 776, 777, and 778.

Prices on all the above will be found in our catalog, pages 26 and 27. If in need, order while we have the stock to furnish.

SECOND-HAND 60-LB. HONEY-CANS.

We still have on hand about 100 boxes of second-hand honey-cans in fair condition, which we offer, to close out, at 40 cts. per box in 10-box lots; 25 boxes or more at 35 cts. per box. These cans need scalding out before they are used. They would be a very cheap package for amber or low grade of honey, and most of them, when properly scalded out, will do nicely for good honey.

GLASS FOR SHIPPING-CASES.

The price of window glass is so high that at present market price we should have to ask \$5.00 a box for all strips up to 16 inches in length, and \$5.50 for those over 16 inches. It is only by getting strips cut from waste, as we are able to find them, that we maintain present catalog prices on cases including glass strips. We can not agree to furnish glass alone at catalog prices, only as we have a surplus. Any thing cut to order will have to be \$5.00 per box at least.

Special Notices by A. I. Root.

Travels, both in Florida and Northern Michigan, are crowded out of this issue for want of room.

WHAT TO PLANT THE LAST OF AUGUST; SEE P. 655, LAST ISSUE.

We are just in receipt of a letter from a friend in Kansas who says he has excellent success in sowing alfalfa during the last of August and first of September. The ground is to be made very fine by repeated workings, and very firm by repeated rollings, just as you fix it for wheat. Then sow 20 lbs. to the acre. Full particulars will be given in our next issue.

ANOTHER LOW-PRICED EXCURSION TO NORTHERN MICHIGAN.

We have just received another notice from the Pere Marquette Railroad Co., Toledo, as follows:

"On September 3d, we will have a \$5.00 ten-day excursion to Ludington, Manistee, and all points north of Baldwin as far as Harbor Springs; \$6.00 to Mackinaw City and return for the same dates."

W. C. TOUSEY, D. P. A., Toledo, Ohio.

You will see the above takes in all of the places I have been recently writing about. This low rate to Harbor Springs, only \$5.00, is less than one-fourth the regular fare. The excursion starts from Toledo.

Readers of GLEANINGS who expect to buy a queen or two to test the merits of different stock, will do well to read H. G. Quirin's advt. on last cover page. Good stock at prices which are right, is his motto.

WANTED.—To sell my entire and complete apiary consisting of 75 colonies of bees, on Lang, and American frames, hives, winter-cases, extracting-supers with comb, extractor, and all other necessary equipments. Big bargain. Write for particulars. Also good 40 acre farm to rent or sell.

W. H. ALLSWED, Sanford, Mich.

WANTED.—A helper in the bee and honey business; one who has had success in this direction; an active young man; one with a conscience, good habits, and who can give references to cover the case; a steady job to the right person.

BYRON WALKER, Clyde, Cook Co., Ill.

GLEANINGS AS AN ADVERTISING MEDIUM.

We wish to say that our ad't in your journal paid us back many times the cash expended for it. The inquiries and orders received were treble what we had from the others. We did a better business than we expected. The reason we stopped our ad't was that we had sold all we cared to sell, as we did not wish to lose trade by returning money; and, what was more satisfactory, we have not had a single complaint so far. All reports from patrons are satisfactory.

Meldrim, Ga., June 18. CHRISTIAN & HALL.

Minnesota Bee-keepers' Supply Mfg. Co.,
Manufacturers of
Bee-hives, Sections, Shipping-cases, and
Everything Used by Bee-keepers.

Orders filled promptly. We have the best shipping facilities in the world. You will save money by sending for our price list. Address

Minnesota Bee-keepers' Supply Mfg. Co.,
Nicollet Island Power Building, Minneapolis, Minn.

Crimson-Clover Seed.

I have fifty bushels grown on hard land, a No. 1 article, at \$4 00 per bushel for one or more bushels; ½ bushel, \$2 25; ¼ bushel, \$1.25; bags free. Reference, any business firm or bank in Kent Co., Del.

J. Colby Smith, Willow Grove, Del.

GINSENG!

September, October, November, and December are the months in which to set this plant. We have a large stock of cultivated roots. Will quote prices on seed or roots, and guarantee safe shipment.

C. M. Goodspeed, Skaneateles, N. Y.



Belgian Hares

Fully pedigreed of the highest breeding, at prices that will suit. With every hare sold goes a full pedigree, register number, and score-card, scored by an official judge; and, when desired, does will be bred to one of our famous high-scoring bucks before shipment. Address J. B. MASON, Managr. of The A. I. Root Co., Mechanic Falls, Me.



Belgian Hares

I have some fine hares for sale at reasonable prices.

J. F. Moore, : Tiffin, Ohio.

BELGIAN HARES!

Either domestic or imported, of any grade from a pedigreed prize-winner to a common rabbit, at prices that are right. Write

GEORGE M. TEETER, PENNVILLE, IND.

1200 FERRETS. All sizes; some trained; first-class stock. New price list free. N. A. Knapp, Rochester, Lorain Co., Ohio.

To make cows pay, use Sharples Cream Separators. Book "Business Dairying" & cat. 288 free. W. Chester, Pa.

Mr. A. I. Root's Writings

of Grand Traverse territory and Leelanau Co. are descriptive of Michigan's most beautiful section reached most conveniently via the

PERE MARQUETTE R. R.

For pamphlets of Michigan farm lands and the fruit belt, address W. C. Touzey, D. P. A. Toledo, Ohio.

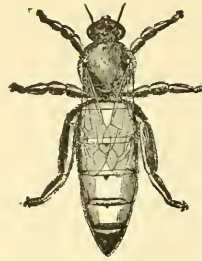

A Superior
Red-clover
Queen
for 25 cts.

An Offer for New Subscribers:

We want to add a lot of new readers to our WEEKLY AMERICAN BEE JOURNAL, list during August and September. For that reason we are making those who are not now reading our journal regularly, this liberal offer: Send us \$1.25, and we will mail you the BEE JOURNAL FOR A WHOLE YEAR, and also one of our SUPERIOR LONG-TONGUED RED-CLOVER QUEENS—untested Italian.

We arranged with one of the oldest and best queen-breeders (having many years' experience) to rear queens for us this season. His bees average quite a good deal the longest tongues of any yet measured. The breeder he will use is direct from Italy, having imported her himself. Her worker-bees are large, somewhat leather-colored, very gentle, and scarcely requiring veil or smoke. They stored red-clover honey last season. All queens guaranteed to arrive in good condition, and all will be clipped unless otherwise ordered. All queens mailed promptly.

Headquarters in Chicago for Root's bee-supplies at Root's prices. A free catalog and sample of the American Bee Journal on request.



George W. York & Co., Chicago, Ill.
144, 146 Erie Street.

Standard-Bred Queens!

Acme of Perfection; Not a Hybrid among Them.

Improved Strain Golden Italians.

World-wide reputation; 75c each; six for \$1.00.

Long-tongued 3-banded Italians.

Bred from stock whose tongues measured 25-hundredths inch. These are the red clover hustlers of America. 75 cts. each; six for \$1.00. Safe arrival guaranteed. Catalog on application. Headquarters for bee-keepers' supplies.

Fred W. Muth & Co., Cincinnati, Ohio.
South-west Corner Front and Walnut Streets.

CHAS. ISRAEL & BROS.,
486, 488, 490 Canal St.,
Corner Watt Street, N.Y.

Honey and Beeswax.

Liberal Advances made on Consignments.
Wholesale Dealers and Commission Merchants.
Established 1875.

The A. I. Root Co.'s Goods.

shipped from Jackson, Mich. Root's extra-polished sections, foundation, hives, shipping-cases, etc., cheap. Send for list.

W. D. Soper, R. D. 3, Jackson, Mich.

FOR SALE.—One 2 frame Cowan extractor in good order at half price.

H. W. THOMPSON, LaPorte, Texas.

To Our Shippers.

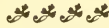

We were obliged to notify you a few weeks ago that one Joseph M. McCaul had leased our old quarters at Nos. 120-122 West Broadway, New York City, and had there started up business under the name "Hildreth, McCaul Co.," and had distributed a multitude of circulars so worded as to create the impression that his business was a successor to or a branch of the business of Hildreth & Segelken.

For the protection of our shippers and ourselves, we at once instructed our attorney to commence action to enjoin the said McCaul from using the name HILDRETH in any manner whatsoever in connection with his business. On the 10th day of July, 1901, Hon. David McAdam, Justice of the Supreme Court of the State of New York, after a full argument upon the merits, issued a peremptory injunction, of which the following is an extract:

"And it appearing that the plaintiffs have for a long time been and now are carrying on business under the style of "Hildreth & Segelken," and that the defendant has recently opened a business at 120-122 West Broadway, in the Borough of Manhattan, City of New York, and is carrying on the same under the style of "Hildreth, McCaul Co.," and that such act is in violation of the plaintiffs' rights, and that the commission or continuance thereof, during the pendency of this action, will produce irreparable injury to the plaintiffs; . . . it is

ORDERED that the defendant (Joseph M. McCaul) and each of his agents, servants, and employees, and all other persons acting under his authority and direction be, and he and they are hereby restrained and enjoined from showing, displaying, or otherwise using during the pendency of this action in or upon any papers, devices, sign or signs, or otherwise, in the business conducted by the defendant at No. 120-122 West Broadway, in the Borough of Manhattan, City of New York, or elsewhere the name of "Hildreth" separately or conjunctively with any other name, designation, or description."

Outside of our desire in our own interests to protect the name which we have built by years of satisfactory dealings with our customers, we hastened to procure this injunction as soon as possible, to prevent our shippers from being misled into sending their goods to one who would make an attempt to gain their trade by such a trick and device.

With thanks for the many expressions of good will we have received from our shippers concerning this attempt to trade under our name, we are

Sincerely yours,

HILDRETH & SEGELKEN.

265-267 GREENWICH STREET, NEW YORK CITY.

THE SMITH PREMIER TYPEWRITER

Occupies an Imperishable Position in the BUSINESS WORLD.

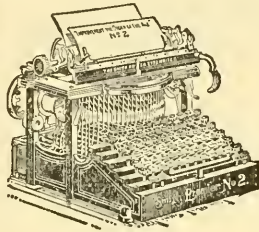

Unquestionable Superior Merit

Annually adds thousands of names to the long list of Smith Premier users, representing every line of trade and every profession.

ILLUSTRATED CATALOGUE FREE.

The Smith Premier Typewriter Co.,

158 Prospect Street, Cleveland, Ohio.

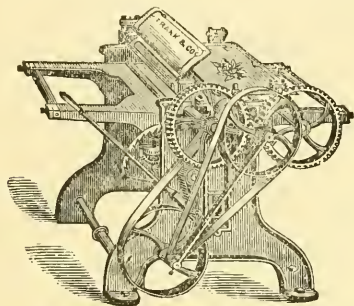

PLANERS

The above cut shows one of our small Planers, of which we make twelve different styles and sizes. Also large Planers, Band Saws, Buzz Planers, Moulders, Wood Lathes, and all kinds of

WOOD WORKING MACHINERY

Send for Catalogue.

The FRANK MACHINERY CO.

BUFFALO, N. Y.

Union Combination Saw

For Ripping, Cross-cutting, Rabbeting, Mitering, Grooving, Gaining, Boring, Scroll-sawing, Edge-moulding, Beading. Full line FOOT and HAND POWER machinery. Send for catalog A. SENECA FALLS MFG. CO., 44 Water St., Seneca Fs., N.Y.

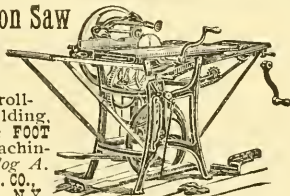

Barnes' Hand and Foot Power Machinery.

This cut represents our combined circular saw, which is made for bee-keepers' use in the construction of their hives, sections, boxes, etc. **Machines on trial.** Send for illustrated catalogue and prices.

W F. & John Barnes Co., 545 Ruby St., Rockford Ill.

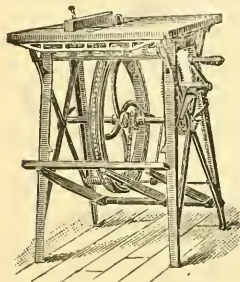

ONCE IN A LIFE TIME

is often enough to do some things. It's often enough to buy a wagon if you buy the right kind. The

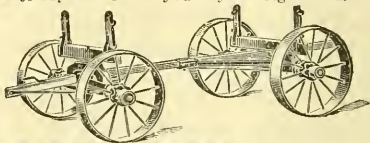

ELECTRIC HANDY WAGON

lasts that long under ordinary conditions. First the life of a wagon depends upon the wheels. This one is equipped with our Electric-steel Wheel, with straight or stagger spokes and wide tires. Wheels any height from 24 to 60 in. It lasts because tires can't get loose, no re-setting, hubs can't crack or spokes become loose, felloes can't rot, swell or dry out. Angle steel hounds.

THOUSANDS NOW IN DAILY USE. Don't buy a wagon until you get our free book, "Farm Savines,"

ELECTRIC WHEEL CO., Box 35, Quincy, Ills.



The Storm Proof KING WIND MILL

produces 25 to 50% more net power from any kind of wind than any other mill made. Wheel being only 1 in. thick, cuts the wind like a knife and is 400% more storm proof than any other. Exceedingly light, but wonderfully strong. Very sensitive—runs in lightest winds. Numerous sizes—5 ft up, both pumping and power, back geared or direct stroke. Send for circulars and prices before you buy. Medina Mfg. Co., Box 11, Medina, O.

Don't Dig Potatoes by Hand.

It is a slow and expensive way. The cheapest, quickest, and easiest way is to USE THE IMPROVED

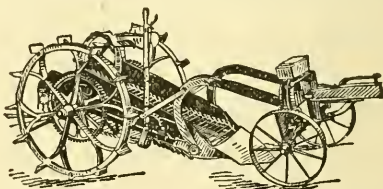

DOWDEN POTATO-DIGGER.

It gets them all, no matter how deep or shallow. Our book explains how. Book is free. Write for it now. DOWDEN MFG CO., - Box 23, Prairie City, Ia.

SAVE 15 to 75 PER CENT on all drugs, medicines, home remedies, extracts, paints, oils, veterinary remedies, etc., by selecting them from our Large Drug Book. Contains 15,000 listed articles. Book only 10c—refunded from first order. "The Only Mail Order Drug House in the World." HELLER CHEMICAL CO., Dept. 4, Chicago, Ill.

Wanted! HONEY, WAX, MAPLE SUGAR, SYRUP, AND POPCORN.

A. L. JENKS, 42 W. Market St., Buffalo, N. Y.

CARNIOLANS.

To make room for queen-cells during the buckwheat flow we will sell, for 30 days, fine young laying Carniolan queens at 50 cents each. The Carniolans are hustlers to work, and the gentlest bees in the world. Descriptive price list free.

F. A. LOCKHART & CO., Caldwell, N. Y.

HONEY QUEENS!

Leather-colored Long-tongues.—I have a breeder for which \$25 has been offered and refused. You make no mistake in buying her daughters. They are dandies.

Goldens.—The Laws strain is as good as years of patient selection and breeding can establish.

Holy Lands.—These are a deserving race of bees. With two years' acquaintance I find them great workers, with no vindictive traits, easily handled, are becoming popular, especially in South.

The above races of bees are each bred in separate apiaries, and you can get them in their purity. Am filling all orders by return mail, and I sell at the following low prices, with the usual guarantees. Single queen, untested, 75c; six for \$4.00. Tested, \$1.00; six for \$5.00. Breeders, either race, \$2.50 each. Address

W. H. Laws, Beeville, Texas.

ALBINO QUEENS. If you want the most prolific queens, the best honey-gatherers, the best comb-builders, the hardiest and gentlest bees known, try my albinos. My untested queens, 75c. J. D. GIVENS, Lisbon, Texas.

W. H. Pridgen,

of Creek, Warren Co., N. C., whose money-order office is Warrenton, N. C., is now prepared to fill orders promptly with the Hutchinson "Superior stock," or golden untested queens, at 75 cts. each, or queen-cups at \$2.00 per pound, postpaid.

COMPRESSED CELLS can be used over and over; the oftener they are used the better they work. We compress cells in removable wooden shells at 2c each; or you can own a Grace cell-compressor for \$2.00, postpaid; blank shells, 1c each; started queen-cells, 5c each. Get a queen-rearing outfit and rear your own queens. All by mail. New circular ready.

The Swarthmore Apiaries, Swarthmore, Pa.

Bees that have a Record

Have longest tongues—handsome, gentle, and great hustlers for honey; all breeding queens, and sold at rate of \$8 per dozen. Now ready.

H. ALLEY, - WENHAM, - MASS.

CHEAP BEES!

I will sell 40 colonies of Italian bees, mostly in Root Company hives with Hoffman frames. Price here, \$50.

WM. GARRY, - SYLVAN, PENN.

FOR SALE.—A few hives of Italian bees in Root's eight-frame hives. Good strong colonies. No disease. L. I. SHRADER, New Albany, Ind.

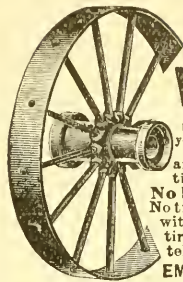

STEEL WHEELS

for your **FARM WAGONS**
any size wanted, any width of tire. Hubs to fit any axle. No blacksmith's bills to pay. No tires to reset. Fit your old wagon with low steel wheels with wide tires at low price. Our catalogue tells you how to do it. Address **EMPIRE MFG. CO., Quincy, Ill.**



PAGE

READ THE LABEL!

If it's "PAGE," it's safe to shake and take. Try it. Page Woven Wire Fence Co., Adrian, Mich.

PINEAPPLES!

Choice fruit and plants now ready for shipment. Suitable land for sale, sheds constructed, pineries set and cared for. Correspondence solicited.

Lewisiana Pinery Company, Orlando, Florida.
C. H. Lewis, Manager.

Long Tongues Valuable South as well as North.

How Moore's strain of Italians roll in the honey down in Texas:

Hutto, Texas, Nov. 19th, 1900.

J. P. Moore.—Dear Sir:—I wish to write you in regard to queens purchased of you. I could have written sooner, but I wanted to test them thoroughly and see if they had those remarkable qualities of a three-banded Italian bee. I must confess to you I am more surprised every day as I watch them. They simply "roll the honey in." It seems that they get honey where others are idle or trying to rob; and for gentleness of handling, I have never seen the like. Friend E. R. Root was right when he said your bees have the longest tongues; for they get honey where others fail. I will express my thanks for such queens. I am more than pleased. I will stock my out-apiaries next spring with your queens.

Yours truly, HENRY SCHMIDT.

The above is pretty strong evidence that red clover is not the only plant which requires long-tongue bees to secure the greatest quantity of nectar.

Daughters of my 25-100 breeder, the prize-winner: Untested, 75c; six, \$4.00; doz., \$7.50. Select untested, \$1.00; six, \$5.00, dozen, \$9.00. Safe arrival and satisfaction guaranteed. Descriptive circular sent free. I am filling all orders by return mail, and shall probably be able to do so till the close of the season.

J. P. Moore, Lock box 1, Morgan, Pend. Co., Ky.

(Mr. J. P. Moore is entirely reliable.—A. I. R. Co.)

Your Order for Queens

—Tested and untested—will be promptly filled by return mail. Our strain of Italians is unsurpassed as honey-gatherers. Every queen guaranteed. Choice tested queens, \$1.00 each; \$12.00 per dozen; choice untested, 75c; \$8.00 per dozen. Send for price list. Address . . .

J. W. K. Shaw & Co., Loreauville, La.

Twice as Much Honey!

Dr. Mason's Experience with Superior Stock.

Dr. Mason, Secretary of the National Bee-keepers' Association, writes me, on date of June 28, as follows:

"I think that I am safe in saying that the colony of bees that has the \$1.50 queen that I got of you about a year ago, although not as populous as most of our colonies, is gathering nearly, if not quite, as much honey as any *two* of our most populous colonies. I never use any smoke in handling them and never get stung.

It's just fun to handle them. When I remove a comb, unless it rubs against another, they don't run and make a fuss about it, but keep quiet and attend to their business."

Price of a queen, \$1.50, or the Review one year and a queen for \$2 00.

W. Z. HUTCHINSON, Flint, Mich.

1881

PAGE & LYON MFG. CO.

1901

We manufacture a full line of the latest
BEE-SUPPLIES.

Our motto is, "Perfect Goods and Prompt Shipment."

Send for our new free illustrated catalog.

PAGE & LYON MFG. CO., New London, Wisconsin.

NOW READY!

64-PAGE CATALOG OF EVERY THING BEE-KEEPERS NEED. Illustrated and fully described. Especially valuable to beginners for the information it contains. Send your address on postal and get it now. Established 1884.

J. M. JENKINS, Wetumpka, Ala.

I. J. Stringham, 105 Park Place, New York City.

Keeps in stock a full line of modern appliances for bee-keepers.

SQUARE CANS & SHIPPING-CASES.

One-pound square flint jars with corks, \$5.00 a gross. Cartons of a superior quality at a low price. Tested Italian queens, \$1; untested, 75c. Apiaries, Glen Cove, L. I. Catalog free.

I. J. Stringham, 105 Park Place, New York City.

Marshfield Manufacturing Company.

Our specialty is making SECTIONS, and they are the best in the market. Wisconsin basswood is the right kind for them. We have a full line of BEE-SUPPLIES. Write for FREE illustrated catalog and price list.

Marshfield Manufacturing Company, Marshfield, Wisconsin.

\$1-TESTED QUEENS=\$1.

A nice lot of young golden tested queens at \$1.00 each while they last; selected, \$1.50; warranted queens, 60c;—6 for \$3.50; select warranted, 80c—6 for \$4.50. My bees are a five-band strain, selected for size, energy, working qualities, long tongue-reach—and, lastly, beauty. I have never tested a strain that excels them. A pile of letters assert the above claims are true, and also that they winter well north. Queens are sent promptly. **J. B. CASE, Port Orange, Fla.**

WANTED.—Customer for farm of 65 acres; good land; good buildings, and water; one mile from railroad station, and four villages and college; 125 colonies bees; \$1600. Ten head of cattle, team, farming tools, 5000 lbs. extracted and comb honey. Write for description and particulars. **N. A. BLAKE, Beebe Plain, Quebec, Canada.**

Wants and Exchange.

Notices will be inserted under this head at 10c per line. You must say you want your ad. in this department, or we will not be responsible for any error. You can have the notice as many lines as you please; but all over ten lines will cost you according to our regular rates. We cannot be notified for dissatisfaction arising from these "swaps."

WANTED.—To exchange long-distance-record homing pigeons for bees, supplies, books, bee-papers, or offers. **GEO. A. FRANCIS, Bridgeport, Conn., 1433 Sea View Ave.**

WANTED.—To exchange worker combs, in either Hoffman or Simplicity frames, for Italian queens. **L. D. GALE, Stedman, N. Y.**

WANTED.—To exchange 25 Belgian hares—Fashodas and Yankans—for bees or supplies. **GEO. R. CRANDALL, 5707 N 20th St., Omaha, Neb.**

WANTED.—300 to 500 colonies bees on shares in Cuba; or would work for salary; references given and required. **FRED E. MUNSON, W. Groton, N. Y.**

WANTED.—A strong, healthy young man of good habits to work in bees by September. Must have had some experience. Write at once, stating particulars and salary wanted. Permanent job for right party. **GLEN E. MOE, Candelaria, Cuba, W. I.**

WANTED.—Location for a custom saw and feed mill. **W. S. AMMON, Reading, Pa.**

WANTED.—Apples. I wish to correspond with some bee-keeper in the middle West, or elsewhere, in section where there is a good crop of apples. **F. W. DEAN, New Milford, Pa.**

WANTED.—One second-hand Barnes saw. Address **J. G. THAYER, Ivy Depot, Albemarle Co., Va.**

WANTED.—To exchange second-hand 60-lb. cans, practically as good as new, at 20c per can in lots of 20 or more, f. o. b. Chicago, for white-clover honey at market price. **B. WALKER, Clyde, Cook Co., Ill.**

WANTED.—To exchange for bees, brood-combs, or offers, black Belgian hares—a breeding doe and buck and eight young ones about four months of age, fine pedigrees; also my prize-winning rose-comb white leghorns at the Cortland show, in 1900, and my this season's breeders, and a few early-hatched cockerels; score-cards by Judge Zimmer. **LEON A. STAFFORD, Blodgett Mills, N. Y.**

NOW READY. LONG-TONGUED QUEENS!

YARD NO. 1.

By special arrangements with THE A. I. ROOT CO. to furnish them queens, I have secured their assistance in procuring the finest breeding queens that a thorough knowledge of the bees of the country and money can procure. Among them is a select daughter of their \$200 queen that they refuse to quote me prices on. This queen shows every superior quality of her mother. Her bees show an actual reach of 21-100 of an inch; are large, gentle, and beautiful to look upon.

MR. E. R. ROOT SAYS: "You have as fine bees as there are in the United States; and with a direct cross of their breeders you should be able to produce queens whose bees show a reach of 25-100 of an inch."

Send for descriptive price list.

Prices: Untested, 75c; 6, \$4.25; 12, \$8.00. Select untested, \$1.00; 6, \$5.00; 12, \$9.00. Tested, \$1.00; 6, \$6.00. Select tested, \$1.50.

Breeders, whose best bees show a reach of 21-100, with an average reach of 20-100, \$3.00. Breeders, whose best bees show 21-100, with an average of 20½-100, \$5.00. Breeders, whose best bees show 22-100, with an average of 21-100, \$7.00.

I have discovered 2 breeders whose best bees show 23-100; these are too good to sell; don't ask for prices.

Imported Italian stock. Apiary No. 2. Imported queens, daughters and grand-daughters. Have just received an importation direct from Italy which has been introduced into this apiary.

Golden, or 5-banded Italian. Apiary No. 3. Breeders, select tested, tested, untested queens.

**W. O. VICTOR, WHARTON, TEXAS.
QUEEN SPECIALIST.**

EGG FOOD! The kind that tones and keeps up the hen so that she simply must lay. **LEY'S POULTRY CONDITION POWDER** puts good red blood into poultry veins; kills all disease germs; tones and nourishes fowls—big and little get all their life in the food when fed in conjunction with it. Price 25c pkg.; 5 for \$1. **Ley's Thoroughbred Minorca Eggs, \$1 for 13. Thoroughbred Belgian Hares. Geo. J. Ley, Florence, California.**

Queens! I have now some very fine queens for sale, either 3-banded or 5-banded goldens, at the following prices: Untested, 75c; 6, \$4.25; 12, \$8.00. Tested, \$1.25; 6, \$6.50; 12, \$12.00. Select tested, \$2.00. Golden breeders, \$5.00. We have Root's bee-supplies at Root's prices. We have a special low price on honey-cans. Give us your orders, and I will guarantee you satisfaction. **Robert W. Rogers, Hutto, Tex.**

QUEENS! Fine, large, gentle, and prolific; long-tongue reach; either 3 or 5 banded; 75 cents each; six for \$4.25. Try them and be pleased. **CHAS. H. THIES, Steelevator, Ill.**

30 COLONIES Italian bees for sale cheap; in good condition; no disease. Also S. C. B. Leghorns; no better; circular free. **H. M. Moyer, Shanesville, Pa.**

FOR SALE.—7500 lbs. clover and basswood honey, in 60-lb. cans, at 7 to 8 cts. Also fine tested Italian queens, \$1.00 each.

ELIAS FOX, Hillsboro, Wis.

LONE STAR APIARIES

Italian Queens.

Estab'd 1885 Prices of queens from imported mothers: Tested, \$1.50; 6, \$6.50; 12, \$12.00. Untested, 75c; 6, \$4.00; 12, \$7.00. Golden, same price. Select tested of either race, \$2.50 each. For a short time I will mail tested leather-colored queens at \$1.00, not satisfied. Address

Your money back if you are not satisfied. Address **G. F. DAVIDSON & SONS, FAIRVIEW, TEX.**

YOU CAN NOT afford to let the season pass without introducing some of Moore's 23-100 stock into your apiary. See advertisement on page 695.

Dittmer's Foundation !!!

Retail---Wholesale---Jobbing.

I use a PROCESS that produces EVERY ESSENTIAL necessary to make it the BEST and MOST desirable in all respects. My PROCESS and AUTOMATIC MACHINES are my own inventions, which enable me to SELL FOUNDATION, and WORK WAX INTO FOUNDATION FOR CASH, at prices that are the lowest. Catalog giving

FULL LINE OF SUPPLIES

with prices and samples, free on application. BEESWAX WANTED.

GUS. DITTMER, AUGUSTA, WIS.

Get the Best Queens.

Evansville, Ind., Sept. 27th, 1900.

The Jennie Atchley Co., Beville, Bee Co., Texas:
 Dear Friends:—It gives me great pleasure to forward you this unsolicited testimonial regarding the merits of Atchley queens. The three (3) dozen queens purchased of you have made an excellent record for themselves. Not an Atchley queen among the twenty colonies lost during the severe drouth in July. I have bought queens from many breeders; and although the present crop is exceedingly short, the tiers of supers show where the Atchley queens are, and speak volumes for your method of queen-rearing. I find the progeny to be very gentle, strong-winged, uniformly marked, long-lived, of large size, and last, but not least, the best honey-gatherers I ever had. I shall want 100 more next season.

Yours fraternally, **J. C. WALLENMEYER.**

Prices for Queens.

Tested, \$1.50 each; \$8.00 for 6, or \$15.00 per dozen. Untested, February, March, April, and May, \$1.00 each; \$5.00 per 6, or \$9.00 per dozen. Fine breeders, \$5.00 each. We have as good bees and queens as money and labor produce. We breed three-band Italians, Goldens, Carniolans, Cyprians, and Holy-Lands, in their purity, bred in separate yards 5 to 20 miles apart. If you want the best, call for Atchley's improved strains. Safe arrival guaranteed. Send for a sample copy of "The Southland Queen," the only southern bee-paper. \$1.00 per year. To new subscribers we offer as a premium a nice untested queen in order to get our paper introduced. Catalog, giving queen-rearing and management of apiaries for profit, FREE.

THE JENNIE ATCHLEY CO.,
Beville, Bee Co., Texas.

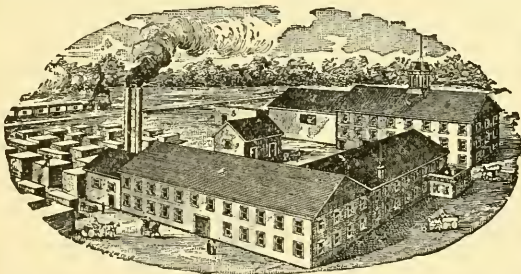

KRETCHMER M'F'G CO., Red Oak, Iowa.

BEE-SUPPLIES.

Best-equipped factory in the West; carry a large stock and greatest variety of every thing needed in the apiary, assuring BEST goods at the LOWEST prices, and prompt shipment. We want every bee-keeper to have our FREE ILLUSTRATED CATALOG, and read description of Alternating Hives, Ferguson Supers, etc. Write at once for a catalog.

— AGENCIES: —

Trester Supply Co., 103 So. 11th St., Lincoln, Nebraska; C. C. Richards, 1223 17th St., Denver, Col.

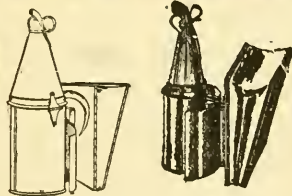

BINGHAM SMOKER.

Dear Sir—Inclosed find \$1.75. Please send one brass smoke-engine. I have one already. It is the best smoker I ever used. Truly yours,
HENRY SCHMIDT, Hutto, Tex.

MADE TO ORDER

Bingham Brass Smokers.

Made of sheet brass, which does not rust or burn out; should last a lifetime. You need one, but they cost 25 cts. more than tin of the same size. The little open cut shows our brass hinge put on the three larger sizes. No wonder Bingham's four-inch smoke-engine goes without puffing, and does not drop ink drops. The perforated steel fire-grate has 381 holes to air the fuel and support the fire. Heavy tin smoke-engine, 4-inch stove, per mail, \$1.50; 3 1/4-inch; \$1.10; 3-inch, \$1.00; 2 1/2-inch 90c; 2-inch, 65c. Bingham smokers are the originals, and have all the improvements, and have been the standard of excellence for 22 years. Only three larger ones brass.

T. F. Bingham, Farwell, Michigan.

Contents of this Number.

Cakes, Honey.....715
 Cell-building on Dry Combs.....714
 Corn, Bees on.....706, 707
 Cuba for Bees and Honey.....711
 Disinfecting Tools.....717
 Fly-escape.....707
 Forestry, Government.....708
 Foul Brood, Mild, in Germany.....706
 Gasoline v. Bisulphide.....715
 Hive-covers with Saw-kerfs.....714
 Honey Without Bees.....707
 Honey, Extracted, Declining.....717
 Honey, Grading, Schaeffle on.....713
 Honey, Prices on.....713
 Idaho for Bees.....715
 Lucerne, Tree.....708
 Muench Tool.....716
 Pacific Bee Journal.....718
 Pear-blight Matter.....718
 Pre-constructed, etc., Defined.....705
 Queen, Peculiar Disappearance.....715
 Queen, Virgin, Rough Handling of.....714
 Rambler.....708
 Season, Doolittle on.....712
 Sugar, Cane v. Beet.....706
 Sulphur v. Bisulphide.....705
 Syrup, Feeding Medicated.....717
 Tree Lucerne.....708
 Veronica.....708
 Wax, Production of.....710

Honey Column.

GRADING-RULES.

FANCY.—All sections to be well filled, combs straight, firm ly attached to all four sides, the combs unsoiled by travel stain, or otherwise; all the cells sealed except an occasional cell, the outside surface of the wood well scraped of propolis.

A No. 1.—All sections well filled except the row of cells next to the wood; combs straight; one-eighth part of comb surface soiled, or the entire surface slightly soiled; the outside surface of the wood well scraped of propolis.

No. 1.—All sections well filled except the row of cells next to the wood; combs comparatively even; one-eighth part of comb surface soiled, or the entire surface slightly soiled.

No. 2.—Three-fourths of the total surface must be filled and sealed.

No. 3.—Must weigh at least half as much as a full-weight section.

In addition to this the honey is to be classified according to color, using the terms white, amber, and dark; that is, there will be "Fancy White," "No. 1 Dark," etc.

CITY MARKETS.

ALBANY.—Honey market not fairly opened yet, although have received some and sold at good price. White-clover comb, fancy, 16 A No 1, 15; No. 2, 13@14. No buckwheat or dark comb appeared, yet we could get 12c for some buckwheat comb. We look for white extracted to sell at 7@7½; mixed, 6½@7. Received none as yet, but have some inquiries.
 Aug. 18. McDUGAL & Co., Albany, N. Y.

BOSTON.—Several lots of new Vermont honey in cartons have thus far been received, meeting a ready sale at 17, although, of course, in a small way. The trade generally seems disposed to hold off, looking for larger receipts and lower prices. This is somewhat due, of course, to the fact that the demand is still light owing to the warm weather. Cooler weather will make a better demand and naturally make a better feeling. Our market to-day is about 16@17 for fancy; 15@16 for A No. 1; 14@15 for No. 1. Extracted, full supply and light demand.
 Aug. 19. BLAKE, SCOTT & LEE, 31, 33 Commercial St., Boston, Mass.

BUFFALO.—Since last quotations new honey is coming more freely, and selling a little lower. Too early yet to move large quantities. Fancy white comb, 15@16; A No. 1, 14@15; No. 1, 13@14; No. 2, 12@13; No. 3, 11@12; dark, 10@12. Extracted white, 6@7 dark, 5@5½. Beeswax, 27@30.
 Aug. 26. W. C. TOWNSEND, 81, 86 W. Market St., Buffalo, N. Y.

TORONTO.—Honey turns out to be a very light crop, and in consequence prices are, for good white honey, about 8@9. Comb, 12½@16. M. MOYER & SON, Aug. 14. 408 Spadina Ave., Toronto, Canada.

CINCINNATI.—Extracted honey is coming in plentifully. Prices are still 5@6. Better grades, alfalfa water white, from 6@7. White clover, 8@9; fancy white comb honey sells from 13½@15½.
 Aug. 22. C. H. W. WEBER, Cincinnati, O.

DETROIT.—Fancy white comb honey, 14@15; No. 1, 13@14; dark and amber, 11@12. Extracted white, 6½@7½; dark and amber, 5@6. Beeswax, 26@27. Honey is demanding a little more attention, as fruit is scarce.
 Aug. 22. M. H. HUNT & SON, Bell Branch, Mich.

MILWAUKEE.—The receipts of honey on this market are not large, offerings are quite numerous, and the demand only fair. Later we expect a larger want will exist, when the cooler season approaches, and consider this market favorable for shippers of good honey. We quote fancy white 1-lb. sections, 16@17; A. No. 1, 15@16; amber, nominal, 12@14. Extracted in barrels, kegs, or pails, white, 7@8; amber, 5½. Beeswax, 25@30.
 Aug. 24. A. V. BISHOP & Co., 119 Buffalo St., Milwaukee, Wis.

NEW YORK.—There seems to be some little demand for comb honey. The receipts so far are very light. We quote as follows: Fancy white, 14; No. 1 white, 13; No. 2 white, 12. There is hardly any demand for extracted, and sales are reported at 4½@6. Beeswax is in light demand at 27@28.

FRANCIS H. LEGGETT & Co., Franklin, West Broadway, and Varick Sts., Aug. 24. New York City.

SAN FRANCISCO.—I have succeeded in advancing quotations on honey ½ to 1½c per lb. in two leading papers. The following are San Francisco prices on Aug. 10: Comb, 10@12. Extracted, water white, 5½@6½; light amber, 4@5½; dark amber, 4@5. Estimates of the season's crop for the State run all the way from 150 to 300 cars.
 Aug. 12. E. H. SCHAEFFLE, Murphys, Cal.

CHICAGO.—White comb brings 15 for the choice grades, with other lines not grading, No. 1 selling at 13@14; light amber, 12@13; dark, 10@11. Extracted, fair demand for white at 5½@6; amber, 5½@5½; dark grades, 5. Beeswax steady at 30 for choice yellow.
 Aug. 22. R. A. BURNETT & Co., 199 South Water St., Chicago, Ill.

SCHENECTADY.—Receipts of new comb honey are small as yet, and prices not well established. We quote clover, 13@15; buckwheat, 10@12. No sale for extracted except in fancy glass packages.
 Aug. 22. C. McCULLOCH, Schenectady, N. Y.

WANTED.—Comb and extracted honey. State price, kind, and quantity.
 R. A. BURNETT & Co., 199 South Water St., Chicago, Ill.

WANTED.—Western honey in car lots, also northern fancy white comb in no-drip cases; state price delivered. We pay spot cash. Reference, German National Bank, Cincinnati. FRED W. MUTH & Co., Front and Walnut Streets, Cincinnati, Ohio.

WANTED.—Extracted clover honey in cans; cans furnished if desired. Quote price.
 I. J. STRINGHAM, 103 Park Place, New York.

WANTED.—To buy your honey. State your lowest cash price, kind, and quantity.
 EDW. WILKINSON, Wilton, Wis.

WANTED.—To buy quantity lots of fancy and No. 1 white-clover comb honey in no-drip cases.
 BYRON WALKER, Clyde, Cook Co., Ill.

WANTED.—Honey; car lots or otherwise. Will send man to receive when sufficient amount to justify, and pay highest market price, spot cash. Address, stating quantity, quality, and price desired at your station.
 THOS. C. STANLEY & SON, Fairfield, Ill.

WANTED.—Comb and extracted honey; will buy your honey, no matter what quantity. Mail sample of extracted; state quality of comb honey, and price expected delivered at Cincinnati. I pay promptly on receipt of goods. Refer you to Brighton German Bank, this city.
 C. H. W. WEBER, 2146-2148 Central Ave., Cincinnati, O.

Wm. A. Selser, Honey Expert,

When you buy honey, send a 3-oz. bottle, have it tested, to be sure it is pure. Price \$2.50 per sample. By doing this you may avoid over ten times this amount in litigation with pure-food laws. Chemist's certificate given.

The A. I. Root's Co.'s Office, 10 Vine Street, Philadelphia, Pa.

G. B. LEWIS CO., WATERTOWN, WIS.



Bee-hives,
Lewis' White
Polished Sections,
Shipping-cases.



Perfect Goods,
Prompt Shipment.

BRANCH: G. B. Lewis Company, 19 South Alabama Street, Indianapolis, Indiana.

AGENCIES: L. C. Woodman, Grand Rapids, Michigan; Fred W. Muth & Co., Southwest Corner Walnut & Front Sts., Cincinnati, Ohio; Fred Foulger & Sons, Ogden, Utah; Colorado Honey-producers' Association, Denver, Col.; Grand Junction Fruit growers' Association, Grand Junction, Colorado; Robert Halley, Montrose, Colorado; Pierce Seed and Produce Company, Pueblo, Colo.; E. T. Abbott, St. Joseph, Missouri, Special Southwestern Agent.

Queens now Ready to Supply by Return Mail

STOCK which can not be **EXCELLED!!** Bred under the **SUPERSEDING CONDITION** of the colony. **Golden Italians**, the great honey-gatherers. They have no **Superior** and few **Equals**. Each 75 cts.; 6 for \$1.00. **Red-clover Bees**, the **Long-tongue Italians**, which left all **Records** behind in **Cathering Honey**, \$1.00 each; six for \$5.00. **Safe Arrival Guaranteed**. Headquarters for Bee-supplies. **Root's Goods at Root's Prices.**

C. H. W. Weber, 2146-2148 Central Av., Cincinnati, Ohio.

Successor to Chas. F. Muth.

Catalog Free; Send for Same.

GLEANINGS IN
BEE CULTURE

A JOURNAL DEVOTED
 TO BEES
 AND HONEY
 AND HOME
 INTERESTS.

ILLUSTRATED
 SEMI-MONTHLY

Published by THE A. F. ROOT CO.
 MEDINA, OHIO.
 \$1.00 PER YEAR

VOL. XXIX.

SEPT. 1, 1901.

No. 17



I UNDERSTAND bee-keepers are to have a pow-wow at Buffalo, Sept 10. Who goes from Medina? [A. I. R. and E. R. R. expect to go.]

I DON'T USE the scraper of the Muench hive-tool, but take it off. I prefer a garden hoe as a scraper, for a wholesale job on top of frames, and for the smaller jobs the circular end of the Muench tool is ahead of a putty-knife. But scraping is not the chief use of a hive-tool. For starting frames, supers, and covers, the Muench is 'way, 'way ahead.

"WE WILL HAZARD the prediction that the highest standard of excellence is to be secured through careful selection, rather than through intensification by in-and-in breeding," says the editor of *American Bee-Keeper*. I'm too much of a coward to say I agree entirely with that, but I'll risk saying that in-and-in breeding is a pretty safe thing for us common bee-keepers to let entirely alone.

ROBBER-BEES that take stores by force, bee-keepers are familiar with. W. W. McNeal, in *American Bee-Keeper*, calls attention to another criminal class, thieves. They take stores by stealth, and there is no apparent remedy against them. The best-storing colonies are the most likely to be their victims, and Mr. McNeal thinks we should be on the lookout lest these thieves make us err in judgment when deciding upon the best stors to breed from. [There may be something in this; but how is any one to prove that a certain colony produces large averages by dishonesty rather than by hard honest toil?—ED.]

A. C. MILLER, in *American Bee-Keeper*, prefers the Alley plan for rearing queens, and says that by the cell-cup plan "in the hands of any person but those of an expert, there are many chances of producing inferior queens." I don't understand why. With the Alley plan a careless person may have queens reared from too old larvæ, a danger not met in the cell-cup plan. But the Alley plan is less troublesome, and takes less time.

With proper care the best of queens can be reared by either plan. [Our Mr. Wardell, after having tried all plans, prefers a modified Alley plan; that is to say, he uses the Alley method; but instead of worker he uses drone cells, and, all things considered, he says he prefers them.—ED.]

IF IT IS TRUE that bisulphide of carbon will kill moth eggs as well as larvæ, why is it not a long way ahead of sulphur for those who fumigate their sections? Bisulphide can be used once for all when sections are taken off, or within two weeks, and save the repetition of the fumigation that sulphur requires, also saving the danger of making the sections green with sulphur. [If the reports are true, the man who persists in using sulphur in place of bisulphide of carbon is far behind the times. The bisulphide is more thorough, and much less trouble to use. While it is subject to more or less danger from explosion, the burning of sulphur, even in an iron kettle, also has its danger.—ED.]

YOU DO NOT remember, Mr. Editor, to have seen the terms *preconstructed* and *postconstructed* used by others. Turn to p. 54, *American Bee Journal*, 1861, and you will find them used by as good authority as Samuel Wagner, who says that's what the Germans call them. *Emergency* is a better term than *postconstructed*. But it seems very inappropriate to call a cell a *swarming* cell which is not intended for swarming. [Page 54 of the *American Bee Journal* for 1861 is away back of my time, for I was born in 1862. Say, look here, doctor, can't you trot out a reference that is not quite so ancient? Well, now, emergency cell is all right. We are agreed on that. If a swarming cell and a supercedure cell are alike, why not use one term to designate both?—ED.]

WHEN CELL-CUPS are used for queen-rearing, no matter how much royal food is given at the time, says W. W. McNeal in *American Bee-Keeper*, the bees always remove it, and in a few hours the larva is left dry. He thinks this is against rearing the best queens, so in about 24 hours he removes the larva and substitutes another, which will never be limited in its food. Would it not be cheaper to use

the Pridgen plan, taking the cocoon-cup with the larva? In that case I think there is never any stinting. [Some one else, some little time ago, I do not remember who, stated that all the royal jelly will be removed. Possibly there is something in this; but our Mr. Wardell says that, whether it is removed or not, it has a tendency, and a decided one too, to induce the bees to accept cells so supplied. The Pridgen method would probably be an improvement on this.—ED.]

IN GERMANY, besides the malignant foul brood, they say they have a mild kind. Graevenhorst's *Bienenzeitung* says the mild kind extends only to the death of the unsealed larvæ. These become a clear-gray purulent mass, finally drying into a crust. From the hive, proceeds a foul, sour smell, and brownish crumbs that the bees have dug out of the cells lie on the bottom-board, which, when rubbed in the fingers, give out the same smell. In this stage the disease is not yet contagious, and generally disappears by the efforts of the bees. It may be considered of the mild sort so long as the dead bees lie curled up on the bottom-board; but when they take a stretched-out, reversed position, then we have the malignant form. [From the description you give, I should be almost inclined to believe that what the Germans call a mild form of foul brood we call "pickled brood;" for, under some conditions, such brood has a sour smell, and hence the name.—ED.]

THE GREATEST PART of the cost of rearing a queen has been considered the time occupied in the nucleus to get her to laying; and, like others, I have made some effort toward seeing how few bees might be successfully used in a nucleus. But is not the cost of nuclei magnified? If I am not mistaken, a colony with a virgin queen will work just as vigorously as one with a laying queen, and a field bee will carry just as much nectar to a nucleus as to a full colony. If that is correct, and if a ripe cell is given at the time of removing a laying queen from a nucleus, then there will not be more than two days when the nucleus will not be in good storing condition, and when too much honey is in a nucleus a full frame can be exchanged for an empty one. Of course there will be some loss from the larger proportion of bees required to keep up the heat in a small nucleus. But I suspect that the gain from fewer bees in a nucleus is overrated.

YOU ASK, Mr. Editor, whether the fact that a preconstructed cell is never first occupied by a larva does not seem to argue that, if the bees were given their own way, they would prefer an egg? Hardly. The cell being prepared in advance, the egg is a sort of necessity. When given their choice on the removal of a queen, they prefer the larva to the egg. In rare cases I've seen them start with the egg, but I *think* there were no larvæ present. [There you go, using the word "preconstructed." Although I spent seven years of my school life on Latin, I had to go and look up our last issue to see whether it was swarming or supersedure cells. I now see that a preconstructed cell is a swarming cell. Of course,

I understand that *pre* means *before*, and *post* means *after*; but before and after what? That is what I could not remember. Well, it would seem, then, from your experience, that a swarming cell usually has an egg, while an emergency cell has a larva. Is this correct? Now, look here; if you come at me again with "preconstructed" and "postconstructed" I will throw my old shoes at you.—ED.]

BEEN WATCHING bees working on corn. Pollen lemon-colored. They stand in the air poised on wing, making their legs work lively packing the pollen. Now and then the tongue is thrust out, appearing to be wiped by the front feet. What's that for, unless to provide honey to pack the pollen? All the packing, however, is not done on the wing. A good bit of it is done while hanging to the flower, some of the time by one foot. [You are right. I also have watched this act on the part of bees while they were gathering pollen. It is very interesting and at times ludicrous. The tongue certainly has an important part to play; but, as nearly as I can make out, the moist edges of the tongue rub among the pollen grains in the flower, and then the bee draws the tongue between its two front claws. This will leave a wad of pollen grains, mixed, probably, with a little honey. It is then transferred from the fore feet to the middle legs, and from these, by a wonderful piece of dexterity bordering on sleight of hand, to the hind legs on which are located the wax-pockets.—ED.]

I'M GLAD that sugar question is getting a stirring up. I've an uneasy feeling that Mr. Cowan may be right, that beet sugar is not so good as cane sugar. [Personally I do not have any uneasy feeling about the sugar question. It is not proper for us to boast; but for the last ten or twelve years we have used beet sugar for feeding our bees; and if any one can show a higher wintering average than we—one who has used cane sugar—we should like to have him hold up his hand. Our wintering losses very often do not exceed 2 per cent, and the very highest is 15 per cent, I believe. This covers a period of about 20 years. I suppose a fair average would be between 3 and 4 per cent. If Mr. Morrison, in our last issue, is correct, the beet sugar is better than cane. But my honest impression is that, with either sugar, we shall get good results. The trouble from sugar-fed colonies is more because the syrup is fed too late or too thick, and the bees do not have opportunity to ripen it. If it is fed during warm weather, when they can fly, half and half, *other things being what they ought to be*, I would not give two cents to have the colonies insured.—ED.]

EDITOR HILL raises uneasy feelings by suggesting that, when a colony is storing while others have to be fed, the storing colony may be quietly stealing from those that are fed—a fact which might be ascertained by comparing a sample of the surplus with the goods being fed. [While this may be true, yet when red clover was in bloom the only colony that stored any honey during this time was the colony of our old red-clover queen-breeder,

and one other one in the same apiary. These red-clover bees showed their largest gains when red clover was in bloom; and as long as any of it was out they would more than hold their own. If there was absolutely nothing else that they could gather from the fields, then they showed no unusual activity at the entrance. But in support of what Mr. Hill says, I would state that the bees of our *old original red-clover queen* of 20 years ago—the one that distinguished herself so greatly—were the worst robbers we ever had. They could not only beat any thing else in the yard during a genuine honey flow, but if any sweets were to be obtained by pilfering they were the chief leaders. I have seen a regular bee-line from a robbed colony to the hive of this red-clover queen. This is a point well worth raising; and in estimating the value of a queen we need to consider whether the bees are honest at all times or not.—E.D.]



Welcome, first month with frost,
That breaks this torrid heat;
That brings again the needed rain
The harvest to complete.

Mr. Albert Gale, of Sydney, Australia, sends us the proof of an article written by him for the *Australian Agricultural Gazette*, wherein he contends that common corn does not yield honey, and that bees have nothing to do with it on account of its sweetness. As the concluding paragraph is a brief *resume* of the whole subject I give it. This is to be read in connection with what Dr. Miller says in *Straws* in this issue.

I have visited all parts of this State on matters connected with bee life. I have seen very many samples of so-called maize or corn honey, and these samples never agree the one with the other, either in aroma, flavor, or color. If those were *bona fide* samples of corn honey, there should have been uniformity in the points referred to, but such was not the case. Corn honey seems to be a thing of modern invention. I lived for years on the Lower Clarence, prior to the advent of sugar culture there, when it was perhaps second only to the Hawkesbury as a corn-producing district. I, with others, kept a number of bees, and in no case did the faintest suspicion enter my mind that I was harvesting corn honey, because I knew the grasses yield nothing of the kind. Neither did the bee-keepers around me hint at corn honey. There, in those days, I never heard the words used. We may as well expect to get honey from ferns or mosses as from the grasses, or expect a hen that is without ovaries to lay eggs as to expect honey from a plant that has no nectaries. Bees can not gather honey from maize, because the flowers have no glands wherewith to secrete it.

BEE-KEEPERS' REVIEW.

In the August issue Mr. Hutchinson gives three views which to me, at least, are very interesting, and I know they will be to all. The first is a view of his new residence where the *Review* is made, and two showing inside views of his office and type-room. It is prob-

ably the neatest and daintiest composing-room in the country. The pictures are accompanied by a brief sketch of Mr. Hutchinson's career as a bee-keeper from first to last. He has just been making a trip through Canada, and at the residence of Jacob Alpaugh he found a device for keeping out flies which I am sure will interest the women folks as well as the rest of us. He says:

At each upper corner of each window-screen the wire cloth was pried up $\frac{1}{4}$ of an inch by pushing in two little blocks of wood. Flies get into a house when the doors are opened. Sooner or later a fly goes to the window, runs up to the top, scurries along first to one corner or the other, and, if he finds an opening, out he pops, never to find his way in again by the same route. What would we think of a honey-house with crowds of bees hanging around the door that was opened dozens of times a day, and no opportunity for the bees to escape over the tops of the windows? We know that it would be full of bees all of the time. A dwelling with screens on the doors and windows is an exact parallel. Put escapes at the tops of the windows, and there is no necessity for sticky fly-paper.

ROCKY MOUNTAIN BEE-JOURNAL.

Under the title of "Honey without Bees," Mr. Morehouse has the following. He treats the matter without gloves, and in a manner that is refreshing. He says:

"HONEY WITHOUT BEES."

Such is the bombastic title of an advertisement of the Sanitas Nut Food Co., of Battle Creek, Michigan, that appeared in a recent number of the *American Mother*. Here is a sample of the wisdom of this bumptious ad. writer:

"Marvelous have been the discoveries in electricity and the uses of steam and the utilization of the various forces of nature; but a discovery which is really more far-reaching in its results, and perhaps capable of immediately benefiting a large number of persons, is a process worked out by an eminent physician by years of laboratory research whereby it is possible to make honey directly from wheat and other cereals, without the aid of chemicals of any sort, and by a process essentially identical with that by which honey is manufactured by plants ready to be collected and stored by the cunning little feet of the honey-bee."

Of course, such a pyrotechnic display of idiocy will only cause the bee-keeper to smile; but at the same time the assumption that genuine honey can be produced by artificial processes is capable of doing great harm by the suspicion it will create against the pure product. Won't some of our Michigan friends please hunt that fellow up and tell him that bees do not "collect and store honey with their feet"? We quote further:

"Malt honey, or mellose, is genuine honey—not an imitation or a substitute, but the real thing derived from the original source—the plant, but without the assistance of bees."

Bee-keepers will have no contention with these people if they will only be content to call their spurious concoction "mellose," and let it go at that. But to advertise it as "genuine honey—not an imitation or a substitute," is making for it a dishonest claim, and perpetrating a base fraud upon the public, that ought to render them liable to prosecution.

Be it remembered that no chemist's or physician's laboratory ever has, or ever will, produce a drop of "genuine honey."

It is to be hoped the Sanitas Food Co. will call that "bumptious ad. writer" to order.

J. W., Mo.—Your three acres of buckwheat will help to supply your six colonies with the necessary stores for fall and winter; but unless the flow is extra good it probably would not give enough honey, and sometimes buckwheat fails entirely.

GENERAL CORRESPONDENCE

RAMBLE 190.

Shall a Government Forestry Commission be Organized?

BY RAMBLER.

People in Los Angeles go to Santa Monica, mostly for a plunge in the ocean. It is only a trifle over 20 miles. The crowds go on the steam and electric lines; but there are quite a few who run down on their wheels. A very good bicycle-path is provided all of the way. I took the path one day in the same direction, but I went a little further and ran up into the Santa Monica Canyon; and it is a very good place for a bee-keeper and a seeker for information to go, for here is located the government forestry station. Here all kinds of shrubs and trees, both native and foreign, are planted, and their uses minutely investigated. An interest is taken in bee culture as far as to observe which trees, etc., are useful as honey-producers. Over 60 varieties of eucalyptus-trees and many other trees and shrubs are here under experimentation.

The superintendent, Mr. C. A. Colman, called my attention to a shrub in full bloom, known as *tegasaste*, or tree lucerne. A full-grown tree, with the superintendent, also full grown, is herewith presented. This little tree is adapted to growth upon arid land. The foliage is eagerly sought by cattle; and when

the tree is full grown it is not easily killed by close browsing. It is covered with a multitude of small white blossoms; and from the number of bees at work, and their enthusiasm,



VERONICA.

there must be quite an amount of nectar secreted. The tree was in bloom at the time of my visit, early in April.

Where a shrub can be of use aside from its secretion of nectar it is well to give it a trial; and I have no doubt the State University at Berkeley, Cal., could put applicants in the way of procuring seed.

My attention was called to a beautiful shrub bearing the beautiful ladylike name of Veronica, or *V. salicifolia*, which should be of some value to bee-keepers. At present it is found mostly in parks, both public and private; and until some combination of use is discovered it will remain an ornamental shrub. I believe some portion of it is used to a limited degree as an ingredient to a proprietary medicine.

The development of the leaves and blossoms is very interesting to those who love to study plant-growth. The new growth that develops at the end of each twig looks like a matured pod, as will be noted in the full-sized photo of that part resting against the cup. But instead of being mature, this pod soon commences to split open, and it is transformed into two leaves; and, behold! as it opens, there peeping out are the twin baby-spikes of buds. They follow the example of the leaves, and soon part on either side of the stalk, and are



TREE LUCERNE.

soon in full bloom, while other leaves and buds are forming above. Each spike is covered with little white flowers, and the blooming continues for several months. Bees are always busy upon the blossoms from early morning until evening, proving the shrub to be a prolific source for nectar.

It appears to the Rambler that great opportunities are being neglected in this country, and especially in Central California, where trees and shrubs can be profitably grown for uses aside from honey.

There are large areas of alkali land. This land can be purchased for about \$2.50 per acre. The eucalyptus will grow upon it, and I am not sure but tree lucerne will also do well. The idea is to purchase a large acreage,

veronica, and kindred growth, upon the mountains and in the canyons of Southern California is of vital interest to bee-keepers and to all interested in irrigation. Conserve and extend the forests upon the uplands, and you add to the water supply for the valleys.

These are matters too large for individual effort; and I am looking for the time to arrive when the government will step in and do the planting. Many of these mountains are now set apart as government reservations, and they are in charge of rangers who spend their time, as the name signifies, ranging over miles of mountain and canyon. Set them to planting trees upon the waste places, and their value will be much enhanced.

Since writing the above there comes to hand,



FORESTRY STATION APIARY.

one or more sections, and plant to eucalyptus. And here we come to another feature that has received but little attention: Eucalyptus is usually grown in California for shade or for wood. The bee-keeper planting for honey secretion could easily select those varieties not only for use as fuel but for timber, and in building there are varieties that take a high polish, and can be used for the manufacture of furniture. In fact, there are many uses if the proper variety is planted, and this planting for industrial purposes is in its veriest infancy.

The excuse that the profits are not immediate will not hold good with this tree. It is of rapid growth, as I have demonstrated recently, and can be cut for wood and profit as soon after planting as a revenue can be secured from the planting of the orange, peach, or other fruit-trees.

The planting of eucalyptus, tree lucerne,

very opportunely, news of interest in this line. The Secretary of the Interior is taking steps to organize a government forestry bureau, and establish a system of reforestation of waste lands. It seems to me that bee-keepers should be wide awake enough to have a representative in this bureau. It is for tree-planting in the East as well as in the West.

We have a representative man in Washington, Mr. Frank Benton, and he is in position where he can exert a lasting benefit to bee-keepers. I am in hopes the editors of our bee-papers will think this of enough importance to cast their influence where it will do good.

Returning to the subject, Forestry Station, we find near it a neat apiary of about 100 colonies; and, though it belongs to private parties, I have termed it the Station apiary. By referring to the photo it will be noted that it is in a forest of sycamore-trees; and the su-

perintendent of the station neglected no opportunity to make observations as to where and how much the bees worked upon the station flora. The owner of the apiary, Mr. Smith, an honest Dane, gave intelligent study in the same line.

The hives were arranged in a semi-circle, in a little clearing against the side of the canyon. The hives were supported upon stakes driven into the ground; and when ants were troublesome these supports were smeared with axle-grease, and no ants need apply. The hive has its complement of double covers, quilts, and stones, though the latter are of trifling size compared to some of the heavy weights in California.

It is a matter of fact that bee-keepers never consider how much time is taken to unload the top of a hive. Rags, called quilts; cover, shade-board, stones, and all but the cover, are useless—more of a job to take off and put on the stuff than to examine the interior of the hive. In spite of all this extra work, Mr. Smith and many other bee-keepers worry along and get there with good crops of honey. The honey resources here are excellent; and, with the proviso of a good year, the yields are large.

Mr. Smith preferred the L. frame. This preference was so strong that he changed over a lot of Heddon hives in an apiary he purchased; and by nailing two divisible chambers together, and cutting down a little, he could use his beloved frame. It was a very short-sighted piece of business, according to my notion.

Mr. Smith kept his bees near his residence; and his bees, his poultry, his vrow, and his baby were all under his eye. It is a cosy and romantic location for an apiary and a forestry station, and so near the ocean that it is sometimes easy to hear the waves dash against the rock-ribbed shore.

[In my hurried trip through California my attention was called repeatedly to the eucalyptus. It is indeed a beautiful tree, growing so rapidly as to be useful for shade in a few years. The leaves are sometimes a deep green, and then they are a light blue. I was told that the blue was due to the younger growth, and the green to the older growth of the tree.

Everywhere I heard eucalyptus or gum tree highly spoken of as a yielder of honey; and in saying *tree* I mean to include quite a variety, as there appear to be several different species.

I was also told that those \$2.50 alkali lands would grow trees, and I do not know why Rambler's suggestion would not be practicable. Were it not that it takes a little time for it to materialize, tree-planting would be begun, and bee keepers would locate everywhere on those cheap lands. But even as it is, a splendid growth of trees can be secured in five or six years; and in ten years one would have quite a little forest.

I am glad to know that the government is looking into this matter of forest-trees. At the awful rate timber is being cut, it is highly

important that a government forestry commission be organized, so that some steps may be taken to supply future generations with timber that will be sorely needed. Hive lumber, we know, for example, has been advancing very rapidly; and the fearful fact is becoming more and more apparent that in a few years soft lumber will be either very expensive, or, what may be worse, we may have none to use at *any* price.

GLEANINGS will be glad to assist in any way in its power, and we take pleasure in seconding Rambler's suggestion that Frank Benton, in Washington, do what he can to steer the proposed forestry commission in the right direction. Certainly we ought to encourage the growth of those trees that will afford a threefold use—timber, shade, and last, but not least, honey.—ED.]

THE PRODUCTION OF WAX.

Can it be Made Profitable in Cuba?

BY HARRY HOWE.

The price of honey here at present is about 2½ cents per pound net, while the price of beeswax is about 27 cents. The prices are in American money. As a matter of fact we are paid in French and Spanish gold, but I have reduced all figures to U. S. gold. Now, dividing the price per pound of wax by the price per pound of honey gives a basis on which to figure. It is evident that we must get our pound of wax without expending a greater value in honey. This is very close to ten pounds of honey; which may be used to get the pound of wax. Authorities differ so much as to the amount required that no one of them can be regarded as reliable except under the exact conditions under which that particular test was made.

The only way I see of getting estimates for my location is to run one half of an entire apiary for wax and the other half for honey. This, I think, I can afford to do at present prices. Where honey can be sold for five cents, of course it would not pay, for it is pretty certain that it would take more than 5½ pounds to the pound of wax.

Our conditions here are more favorable to wax production than any other place I know of. Our honey-flow is eight months long; and during about half of this the night temperature is high enough to insure wax secretion without excessive waste to keep up heat.

During the four months in which the flow is generally less than daily needs, although there is some honey nearly every day, the temperature is the highest of the year. During the heaviest of the honey-flow the night temperature is too low for profitable wax production.

So far I have written of things about which I know something. Now come the things of which I want to know—how best to turn the honey into wax.

It is pretty evident that it can best be done during the warmest weather. This will in-

volve storing the honey some months, and then feeding. My plan is to cut out the combs instead of extracting them, and return the frames, but only half from each hive, extracting the other half so they will at all times have store room. Then when there is no longer a surplus to be had in the fields, contract the brood nest and set out honey at one side of the apiary. As fast as they carry in the honey, melt the wax which remains; then when they have built their combs nearly down, set them out to be emptied and melted.

I think the improved condition of my bees in the beginning of the next harvest will about pay for the extra labor; but until it has been tried, no one knows how it will work.

The native system in box hives is to cut out all combs that have no worker brood, about four times a year, or as often as the bees fill the hive with combs. By this means they get about 1 lb. of wax to every 15 lbs. of honey. That is, every time they get 15 lbs. of honey they also get 1 lb. of wax.

In the old times here there were many apiaries run entirely for wax. They simply threw away the honey.

In conclusion, it is safe to say that it is only in some special location like Cuba that it could be made to pay to run for wax alone; but in many places the wax production can be profitably increased.

Artemisa, Cuba.

[I see no reason why wax production could not be carried on profitably in Cuba; and I believe you will find that, under some conditions, it will not take more than 3 lbs. of honey to make one of wax. Indeed, some experiments were conducted—just where and when and by whom I can not now recall—showing that, when conditions were right, even as low as 2¾ lbs., or about that, of honey, could be converted into a pound of wax. Perhaps I am wrong in my figures; and if so, some of our many readers who can recall the experiments may be able to give us the exact data. Referring to your proposed method, I believe it is along the right line, and we shall be glad to know just how it turns out financially.]

Several correspondents in old Mexico have asked for particulars as to the best method for converting honey into wax; but so far we have been able to give no satisfactory information, for we have had absolutely no experience. If there are any of our subscribers in the West Indies, or any other hot country where honey is abundant and cheap, and wax high-priced, and who are in position to give us information, I should be glad to have them write and tell us all about it.—ED.]

CUBA FOR BEES AND HONEY.

Wrong Notions Corrected.

BY ROBT. L. LUACES

On page 136 I call the attention of brother bee-keepers in the United States to statements made by divers American bee-keepers in regard to conditions in Cuba, trying to show that Cuba is a much better country, both for

bees and production of honey, than such statements seem to impart; and now Mr. H. G. Osburn, page 432, says I have taken some of the old experienced chaps by the neck for not printing a truthful picture of the real state of the bee industry in Cuba. Mr. O. seems not to have read well what I wrote, for in his article he goes on to prove my object; first, Cuba gives better results to the bee-keeper than what is said. The first part of Mr. O.'s article proves this, for he gives us a synopsis of the production of his apiary at Punta Brava, that can't be beaten. The second part claims that bee-keepers have been printing things about Cuba as a bee country when they know only a very small portion of the island. Mr. O. commits the same fault by his own showing, for he says that there are good locations in the middle, and along the south coast of the island, "where nobody but colored people can live. I expect to penetrate some of them next year." Now, I live in the *middle*, and am *while*, as are 70,000 of my neighbors. Mr. O. *expects to penetrate*, so he has not done so; and the south coast of Cuba is some 700 miles long; I hope I shall see Mr. O. when he does his penetration act. Mr. O. seems to indicate that a 68-hive man can't know as much about locations as a 105-hive man; ergo, my neighbor, with his 1000 hollow log hives knows more about bees than Langstroth did. If Mr. O. would come up country and look around he could say he knew what Cuba is good for.

Mr. W. W. Somerford, on page 553, gives us something very good on hive-covers and bottom-boards. So far I have nothing to complain of in regard to the Dovetailed covers. I have had them in use two years out in the open, and they are as good as new. The 16×21 inch bricks are just the thing. I don't use them, but some much the same. I use pieces of hard-wood boards—mahogany, sabicu, jucaro, etc., with the same idea and results, after having found that my queen in two cases had moved to the space under the bottom-board, and the bees had filled it with comb. If Mr. S.'s friend of the railroad iron had used old street car rails he would have come out all right, for they offer no place for the bees to harbor in, and fulfill all other conditions. The staple in the bottom corner of frames just hits where I wanted.

I should like to call the attention of Messrs. Somerford, Howe, Osburn, and others, to the following: Bees here (Puerto Principe) die off a good deal during campanilla bloom. I am the only man who keeps hives on the ground. All others follow the custom of the country, and mount them on stilts. So far I have had no losses. All the others have. Is it location, season, or situation? Italians and their crosses suffer less than blacks.

Puerto Principe, Cuba.

[It is very easy for one to judge of a whole large territory by one or two little spots in it, and it would not be strange if some of our correspondents had unwittingly fallen into this error. If so, I know they will be glad to be corrected.—ED.]



A DESULTORY TALK REGARDING THE SEASON OF 1901.

"Good morning, Mr. Doolittle. I was coming over to see my son Charlie this morning, so I thought I would run in a minute and see if I could coax you to sell me a colony of bees next spring. That is, I want you to agree to let me have one at that time if you will."

"I have not advertised bees for sale for two or three years now, thinking that I would not sell more, as I have got about the number I wish, all on good straight worker combs, and had concluded that I had better keep them than to sell more at the prices quoted by others, for the honey I sell from them each year comes to more than double what bees are quoted at. But why do you wish one of my colonies? You have a good start with the ten colonies you now have."

"You know that red clover has blossomed this year for the first time in from 15 to 20 years. That is, this year is the first time the bloom has perfected in that time, and I have watched, when working on my 200-acre farm, and I have not seen a single one of my black bees at work on the red clover, but the clover is just swarming all the time with your yellow bees, and they stick to the head one goes on for a minute or two, as if they were getting half a load from a single head."

"But don't you know that it is said that bees go but a mile or so for forage, and here you are claiming my bees as working on your clover, which is fully three miles from here?"

"I can not help what is claimed; there are no yellow bees nearer me than yours are; in fact, I know of none others nearer than eight miles. Did you not get honey from red clover before basswood opened, and then after it was past? If you did not, then I am deceived in what I saw."

"Yes, I knew the bees were at work on red clover; for with the 17th of June all desire to rob stopped, and by the 20th honey was coming in at a rate nearly equal to that from a basswood yield. From that on till basswood bloomed, I could leave a frame of honey standing out in the yard all day and not a bee look at it, except to gather propolis off the ends of the top-bar to the frame, where the bees often put in more than is agreeable. To know that this was right I went to the fields, red with clover, and, as you say, found them swarming with Italian bees, while scarcely a bee but those of the German variety was to be found on the little white clover that bloomed along the roadside."

"But you have not told me whether you got any honey or not in the section boxes."

"Yes. I took off from some hives as many as 80 one-pound sections of red-clover honey, while the average yield was not far from 65 sections. Then basswood gave a fairly good

yield, but I can not say just how much, as many fields of the mammoth red clover were still in bloom, not having been cut when basswood was over, and the bees worked on those fields from a week to ten days after basswood, till the clover was cut for hay. This helped very much, as it gave the bees a chance to finish up those only partly filled from basswood. From two colonies I have taken 176 completed sections, with an average yield of about 145 sections from such colonies as were not drawn on for queen-rearing. This is the highest average yield I have ever made, except in 1877, when the yield was 166 pounds of comb honey."

"That shows you why I wish a colony of bees from you. From my ten colonies I shall not get 300 sections, and that will be nearly all from basswood, as the new swarms did not get to work till about the time basswood blossomed, and the old colonies swarmed so much that they have done nothing."

"Well, now you have touched something not in your first idea, that it was the red clover which made the difference. Had you not allowed those old colonies to swarm themselves to death, so to speak, and kept your original three colonies at the same number, or not allowed them to increase more than to six, at most, you would have been enabled to make a much better showing, I am sure, with your black bees. My increase at the out-apiary has been only one, and here at home the count is only two greater than in the spring. If you wish a good yield of honey from each colony you will keep the bees together as much as possible, for 60,000 bees in one hive will produce very much more section honey than will the same number of bees in three hives; or, worse still, the most of them divided up in after-swarms, and in the parent colony."

"Do you pretend to say that you had any colony which contained 60,000 bees during the late honey-flow?"

"Yes. Those which gave the 176 sections contained more, I calculate, instead of less."

"On what do you base your opinion?"

"Bees live to be about 45 days old during the working season, while the eggs laid by the queen perfect into bees in 21 days, so that we can figure two and one-seventh generations coming on to where one generation dies off. Many of my hives contained 800 square inches of solid brood which would perfect in time to take advantage of the red-clover honey harvest, although, owing to wet cold weather later on, this brood was not kept up to produce the basswood workers I desired; and this had something to do with the larger yield of honey from red clover. But as brood-rearing sprung up as by magic as soon as the cold and wet ceased, we can safely count on about 700 square inches of brood, as the average, to give bees which were available during the harvest. And as each square inch gives at least 50 bees, we have an average of 35,000 bees every 21 days, and two and one-seventh times that is 75,000."

"Whew! it does figure up, doesn't it?"

"Yes. And if we remember that many

bees are killed by accident, and otherwise, so that they do not live out their allotted time, as some claim, we can cut off 15,000 for this, and still have 60,000 left, as was proposed at the start. And could the weather have been favorable for brood-rearing 37 days before basswood bloomed, several thousand more bees could have been on the stage of action, and thus 1901 might have gone on record as the best year in the history of my bee-keeping life, instead of second best."

"But how do you keep so many bees together? Mine will not stay together after they get strong enough to swarm."

"Did you try to keep them together?"

"No, I did not know how. Tell me how."

"Well, I have several plans I am trying, but have only one which is as yet perfect enough to give out. Give lots of room, with as many bait sections as possible, so as to discourage early swarming as much as you can. When you think you can hold them from swarming no longer, cage the queen. Now wait from ten to eleven days, when you will shake the bees off their combs so you are sure to see every queen-cell started, and pull every cell off. Now make a hollow plug to fit one end of the cage the queen is in, and fill the hollow with candy, such as is used in shipping queens, having the plug about 1½ inches long, so the bees will be about two days in eating out the candy and liberating the queen. This does away with all desire for swarming from that colony."

"But don't the bees fill the cells where the brood emerges with honey?"

"Yes, quite largely; but as soon as the queen is out she soon asserts her rights, if she is a good one, and this honey is removed from the brood-combs and taken to the sections, and this, together with what is coming from the fields, and the new impetus given to the bees through having the queen laying again, makes a boom in the sections which is rarely attained under any other condition, so that they are filled as by magic, and completed in the finest shape to go on the market as 'gilt edged.' But I can not tarry longer this morning, as I have at least three days' work that ought to be done to day. Come again when I am not quite so busy."

not inclined to buy, only for present wants, while in the local market 3 to 4 cts. is all that is offered for extracted." Now the bee-keepers state that half of the bees starved to death last season, and, in consequence, are not on hand to gather the honey, and the weather has been too cold for the bees to work to the best advantage. In consequence, there will not be a large crop from the lower part of this State.

The statements of Western bee-keepers are frequently doubted because they differ from the experiences of Eastern bee-keepers. I am glad to note that Mr. E. R. Root finds that Western bees have ways of their own that are peculiar to themselves, and altogether unlike their Eastern sisters. I have always been told that "bees fill their combs with brood and stores; and when there is no longer any more spare room they swarm out and leave their stores and brood behind them." This season I bred my bees up strong, giving them two brood-chambers of 8 or 10 frames each, with supers in addition. The queen had all of the combs full of brood and bees, the supers well filled with honey, when the weather turned raw and cold. After about a week of this weather it changed to warm, and the bees swarmed all along the rows. An examination of the hives showed that the bees had consumed the stores, many of the combs being "as dry as a bone." The brood had nearly all hatched out of the combs, in the brood-nest, and the queen had not laid any eggs in the vacant cells. The hive was as bare—yes, more so—than at the close of a bad winter; yet with empty combs and vacant brood-cells they had swarmed as never before. I think I shall have to change the cause of swarming, in this locality, to "bees swarm when they want to, without regard to the condition of the combs; this season because they were populous."

The rules for grading comb honey are possibly as good as can be selected; but those governing extracted honey could not be worse. Every thing hinges on color. As well might we rate maple syrup, wine, or any other liquid by color alone, as honey. I should like to see the Morse butter scoring system, with a few changes applied to extracted honey. This system gives, in 100 points, flavor, 45; body, 25; color, 15; salt, 10; package, 5. Now, why not give extracted honey—flavor, 50; body, 25; color, 25; package, 10? The present method is a reflection on the intelligence of the fraternity.

E. H. SCHAEFFLE.

Murphys Cal., June 24.



PRICES ON HONEY; HOW THE BEES OF CALIFORNIA BREAK OVER ALL RULES; GRADING EXTRACTED HONEY.

"I arise to say" "Here too!" to several articles in a late issue of GLEANINGS. I quite agree with Mr. Wallenmeyer that, to overestimate the crop of honey, is a serious blunder. The leading commission house of San Francisco writes me: "The report has gone east that there is a big crop of honey coming from lower California. In consequence, they are

[I have already published my estimate of the crop conditions in California, and that was to the effect that there was not nearly the honey actually secured that the early rains indicated there would be, and that I thought the prices would rule about the same as the year before. From recent advices from reliable sources I am pleased to know that there is a slight upward tendency in the market, as the coast buyers have come to learn they must pay more if they get any honey to sell. This is also true of Colorado and Arizona.

The grading-rules proposed by you are excellent. Now how shall we carry them into effect? The bee-journals could probably do more than any other agency, and GLEANINGS would be glad to co-operate with any of its cotemporaries.—ED.]

ABOUT HIVE-COVERS; THE USE OF SAW-CUTS ON THE UNDER SIDE.

About eight years ago I wrote you from Orlando, Fla., that I had discovered how to keep the flat hive-covers from warping. The letter was published in GLEANINGS; and when the patented Danz. hive was offered, I found one of its features was in line with my suggestion.

I called your attention to this fact, and received a very cordial letter from Mr. Danzenbaker, explaining that this particular was not included in his patent, for the obvious reason that it was not original, but had been for a long time in common use among woodworkers.

Each time I hear or read complaints of the flat cover warping, I wonder that people are so slow to profit by a good thing when told of it; and what can be simpler than to cut saw-grooves $\frac{1}{2}$ inch or $\frac{5}{8}$ deep in the under side of the cover, in line with the grain of the wood, and $1\frac{1}{2}$ or 2 inches apart? Then nail on the cleats, and the board simply *can't* warp, whether in Cuba or Alaska. With such covers Rambler can lose his harrow-tooth, and Dr. Miller stuff his rags in his smoker. It is equivalent to a cover made of $\frac{3}{8} \times 1\frac{1}{2}$ -inch strips, and the cleats hold it securely flat under all conditions. Again, it is like a $\frac{1}{4}$ -inch cover, with all the strength and weight and smoothness of a solid $\frac{3}{8}$ -inch board.

Here in Pennsylvania the solid board cover does not warp much, a $\frac{1}{4}$ -inch crack being the maximum; but in Florida I used to pile 50 lbs. of brick on diagonally opposite corners to keep them anywhere near flat. One day when applying the method to the parts of a small box which I was gluing together, I fairly blundered on the idea that it would keep my cantankerous hive-covers flat. It did, does, and will.

Try a few, and see if it is not a very effectual and simple remedy for the only fault of the flat cleated cover.

E. J. BAIRD.

Lock Haven, Pa.

[The fact is, we did give the idea of saw-kerfs on the under side of the cover-boards a most thorough test. While they might give good results in Florida, with its great amount of humidity, they will not do at all in a western or dry climate. In fact, they give a great deal of trouble right here in Northern Ohio. Boards having saw-cuts will check and split right along the line of the cut; and then we find they are bad to ship. Our conclusion was that it was far better to have solid boards. The best of hive lumber, under conditions that prevail in various parts of the United States, will check and crack soon enough without making matters worse by inviting such checks by cutting boards half way through. We have, therefore, abandoned the use of these saw-kerfs, not only on our own covers,

but on the Danzenbaker; and I believe Mr. Danzenbaker himself is satisfied that that idea was not a success, for I have sent him some samples of covers that would almost invariably start to check at the saw-kerf; and we found that, as manufacturers, we could not afford to assume the loss in shipping on such covers.—ED.]

THE ROUGH HANDLING OF A VIRGIN QUEEN.

A young queen, after her wedding-flight, returned to the wrong hive, one in which there was a laying queen. About two hours after her return I discovered, by an unusual commotion among the bees of the hive from which she took her flight, and by examination, that she had failed to return. I had seen her take her flight, and at once suspected that she had made a mistake and had gone into an adjacent hive. On opening it I found the bees "balling" her at the bottom of the hive. I at once removed this "ball," succeeded in liberating the queen, and putting her into the proper hive. The bees which balled her had torn away from her the appendage usually appearing after the wedding flight, leaving the parts gaping open as if she were injured. I watched her closely to see whether she would take another flight. She did not go out any more, but in two or three days she began to lay, has proved herself to be quite prolific, and her bees are all right. May not her accident affect the length of her egg-laying life?

H. W. WILLIAMS.

Elberton, Ga., July 12.

[The mere fact that the drone's appendages were pulled away by the bees would not, I think, necessarily imply that the queen would not lay so long on that account. Even if she had returned to the right hive in the first place, her own bees would have taken away the visible portions protruding from her body, and hence the result would have been just the same. In the arrangement of nuclei it is always desirable to have something by which young queens can discriminate between their own entrance and that of some other of the same general appearance.—ED.]

CELL-BUILDING ON DRY COMBS.

I removed the queen from one of my hives to cause them to rear queens, and I find they are building queen cells on cells where there are no larvæ. I took a frame of Carniolan larvæ from a colony, and put it into a colony of hybrids after making it queenless. My object is to raise some Carniolan queens, with the result that they are not building on *any* larvæ.

WM. J. MCCARTER.

Port Republic, N. J., Aug. 2.

[The circumstances you relate, of bees building cells on combs without any larvæ or eggs in them, is quite unusual; yet our Mr. Wardell says he has had two cases of it this season. But when they do build cells on such combs they will transfer the larvæ from the comb having them in the first place to the queen-cells that are empty.

But if your bees do not do this, there is nothing to prevent transferring bees or larvæ yourself, then taking away all brood of every sort, leaving nothing but the frame or frames with cells.—ED.]

GASOLINE IN LIEU OF BISULPHIDE OF CARBON FOR KILLING THE MOTH-WORMS IN COMBS.

I have just made an important discovery, to me at least; that is, that gasoline is as effective in killing moth-worms in bee-combs as bisulphide of carbon, and it does not cost a twelfth as much. My plan is to fill a tight box or barrel with combs, then pour in a pint or so of gasoline; close up tight for 24 or 36 hours, and the work is done. Gasoline beats sulphur far away, and is much easier used, and safer. I have used gasoline on hundreds of L. combs, and have no trouble with worms, as I think the gasoline kills the eggs as well as the worms. J. B. RAPP.

Owensville, O., Aug. 6.

[I know that gasoline can be used in place of the more expensive drug in destroying ant-nests; but it requires a larger quantity. If it will also kill moth-worms in combs it is a kink worth knowing.—ED.]

PECULIAR DISAPPEARANCE OF QUEEN.

I received the queen in good order. I had trouble during the latter part of June with my queens. Good strong colonies with plenty of brood would get queenless all of a sudden. I can't tell the cause, but I find I am not alone. It seems to be the case all over the State, and it is hard to get them to build cells, but they will accept other queens.

Newman, Cal., July 28. S. LONGMIRE.

[When I was through your vicinity I learned that queens were "turning up missing," in a way that could not be accounted for by the veterans in the business. If any one in the vicinity or elsewhere has a solution, let him be free to tell it. It may be that there is a disease that affects queens and not the rest of the bees; and it is a little strange that they should refuse to build cells.—ED.]

IDAHO AS A BEE LOCATION.

Mr. Root.—You are correct in regard to Idaho being one of the best locations for the bee industry in the United States. Our average winters here will compare favorably with those of eastern States far to the south of us. We have more days of sunshine than nine-tenths of the States have. Every few days in ordinary winters the bees can clean house and fly some. We leave them out on the summer stands unprotected all winter. Sometimes some protection would be better. Sweet clover grows wild after starting, wherever water can reach it. We have few wild flowers to make honey. Lucerne is the great crop and honey producer. We get three crops of this, yielding from four to seven tons, and selling at from \$3.00 to \$5.00. Clover yields two

crops, and is usually cut, one for hay and one for seed. The seed yields from four to six bushels to the acre; weighs 60 lbs. or more, and is superior in quality to any raised elsewhere I ever saw. Our water gives us absolute control of its ripening. Neighbors of mine realized as much as \$30 to \$35 an acre on crops of this kind last year. Wheat produces up to 50 bushels, and oats to 75 per acre. Of course, this is the best farming. Vegetables do as well, and fruit and berries equal the best raised in the United States. We have proved this in open competition. Idaho apples sold higher on the New York market last year than any other—\$1.00 a dozen. Living is nearly as cheap as in the central East. We have good society, and order; have a free-text-book system, and spend more on our schools per capita than half the States do. Our country schools have from six to nine months school annually. Teachers from Michigan and Vermont, with first-grade certificates, have trouble to secure second-grade here.

All together, any bee-keeper wanting a new location would do well to look up Southern Idaho. This is the second year for our association, and we have over 20 members. So far as I know, it is the first and only one in the State. Father gave me \$20 for his first colony of bees. They can be bought now from \$1.00 up.

F. R. FOUCH,
Sec. Parma Bee-keepers' Ass'n.

Parma, Idaho, Aug. 13.

[Were it not that the writer of the above is secretary of a recognized bee-keepers' association, I should incline to the opinion that this was a free advertisement from some land speculator; but after having gone through Idaho, and studied its conditions, I am of the opinion that much of the above, if not all of it, is true. In Idaho, alfalfa, red clover, timothy—in fact, all the various kinds of hay and fodder plants—can be grown. Sometimes I could see an alfalfa field, and next to it a fine growth of red clover. If I am not mistaken, every thing that can be grown in the East can be grown in Idaho, and a good many other things besides. There are quite a number of fine locations for bees, and not a bee in the regions. But no one should think of going to Idaho, or anywhere else, *without first making a personal visit himself*; and if he desires to keep bees in one of these new fields, he should by all means hire out for one season to some bee-keeper so that he can accustom himself to the conditions, and thus learn whether it will pay him to move his bees and family to the new climate.—ED.]

HONEY CAKES.

Mix thoroughly 1 quart of honey, $\frac{1}{2}$ pound pulverized sugar, $\frac{1}{2}$ pound fresh butter, juice of 2 oranges; then stir in gradually enough sifted flour to make a dough stiff enough to roll out easily. Turn out on a molding-board; beat well for a few minutes with a rolling-pin; then roll out into sheets half an inch thick; cut into round cakes, and bake in shallow buttered pans.—*Delineator*.

Murphys, Cal.

E. H. SCHAEFFLE.



NATIONAL BEE-KEEPERS' ASSOCIATION.

OBJECT:—To promote and protect the interests of its members; to prevent the adulteration of honey.

OFFICERS:—E. R. Root, President, Medina, O.; R. C. Aikin Vice-president, Loveland, Col.; Dr. A. B. Mason, Secretary, 3512 Monroe St., Sta. B, Toledo, O.; Eugene Secor, General Manager, Forest City, Iowa.

BOARD OF DIRECTORS:—E. Whitcomb, Friend, Neb.; W. Z. Hutchinson, Flint, Mich.; A. I. Root, Medina, O.; E. T. Abbott, St. Joseph, Mo.; P. H. Elwood, Starkville, N. Y.; E. R. Root, Medina, O.; T. G. Newman, San Francisco, Cal.; G. M. Doolittle, Borodino, N. Y.; W. F. Marks, Chapinville, N. Y.; J. M. Hambaugh, Esccondido, Cal.; C. P. Dadant, Hamilton, Ill.; C. C. Miller, Marengo, Ill.

FEES:—Annual membership fee, \$1.00. Remittances may be sent here or to General Manager as above.

OWING to a little delay in getting the pictures ready illustrating the bee-keepers' paradise, I am not able to continue my travels in this issue, but will have them in our next.

PERHAPS some of our readers may wonder why the description of my western trip does not progress more rapidly. I have gathered so much material and made so many pictures that it will take considerable time to cover the whole series. While some features of the journey have been taken out of their natural order, yet the major part of them will necessarily have to follow in chronological succession.

THERE seem to have been heavy rains in the eastern and central States. This will help to preserve the life of the young clovers, and at the same time may give us fall crops. By the by, of late years we do not seem to hear much about fall flows of honey in the central and eastern States. What I mean by "fall flows" is honey from goldenrod and other plants that come into bloom in the autumn months.

GENERAL MANAGER SECOR was nominated for Representative in the General Assembly of Iowa at the Republican district convention, composed of Winnebago and Worth Counties, Aug. 13. The nomination was unanimous, and means election. Mr. Secor is a popular and able man, and well deserves the honor. If he had made any effort, from what I learn he might have received the nomination for Representative in Congress for his district.

OUR friends will not forget the big National Convention to be held at the Pan-American, Sept. 10, 11, 12, Tuesday, Wednesday, Thursday. The place of meeting is the Buffalo Library Building, corner Washington and Clinton Sts. There will be a joint session of the National Pomological Society and the National Bee-keepers' Association, on Thursday evening, the 12th. As has been already stated, there will be no fixed program outside of the joint session, and the general discussions of the bee convention will be those furnished by the question-box. In other words, there will be no long essays of any kind. It is ex-

pected that there will be nothing but lively, crisp, interesting, offhand talks—the kind that keeps everybody awake, and alert, and awaiting a chance to get in a word. We expect to have a stereopticon on the evening of the 11th, when an entirely new set of views will be given, taking up bee-keeping in the great West, showing how it differs from the bee-keeping of the East.

The A. I. Root Co. expects to be represented by the three Roots—A. I., E. R., and H. H.

ACCOMMODATIONS FOR BEE-KEEPERS WHO EXPECT TO ATTEND THE NATIONAL CONVENTION.

UNDER date of Aug. 26, Sec. A. B. Mason writes:

Dear Ernest:—I can furnish places for about 60 delegates to the N. B. K. A., for 75 cts. for lodging and breakfast, in nice clean private families, if they will apply to me at the convention; and all others who may wish entertainment will be assigned to such places as they desire by the Dr. Pierce Free Bureau of Information at 652 Main St., if they call for Mr. Sidney S. Sleeper; and I am assured no one placed by the Bureau will be in any way dissatisfied, "provided they do not expect something entirely out of reason." The Bureau will furnish information free.

A. B. MASON,
Station B, Toledo, O.

THE ANTI-SALOON LEAGUE AT THE BUFFALO EXPOSITION.

WE have just received the following from our good friend Bro. Brant:

Dear Bro. Root:—I hope that we may be able to help locate many of the delegates to the Buffalo convention Sept. 10-12. Can you not speak another good word for us in your excellent magazine?
J. F. BRANT,
Buffalo, N. Y., Aug. 23.

Inclosed with the above letter were circulars from which I make the following extracts:

Dear Sir:—We will either give you accommodations at the "Central Park Place," or equally good in our best Christian homes, for \$1 00 and upward, breakfast and late dinner extra. A tasty luncheon will be prepared for taking on the grounds if desired, and late supper will also be served at reasonable rates. The mayor has decided not to have runners at the depots allowed, so on your arrival take the Main Street car direct to 63 Huntington Ave., or to our office, D. S. Morgan Building, just off Main on Niagara Street. Persons willing to occupy neat and comfortable cots in our annex can save from one-fourth to one-half. We are just 6 minutes' car-ride from the Exposition Grounds, and cars near at hand. Persons desiring to make definite arrangements for rooms in advance will please write promptly, enclosing postage for reply, to Rev. John F. Brant Supt. Buffalo District, 300 D. S. Morgan Building, Buffalo, N. Y.

We sincerely hope all who love temperance and godliness will avail themselves of Bro. Brant's kind offer, and at the same time get accommodations among people who love righteousness and hate iniquity.

A CALIFORNIA BEE JOURNAL.

THE new series of the *Pacific Bee Journal*, bearing the insignia of "Vol. IV., Aug. 1," is before me. The editor, B. S. K. Bennett, in heralding the reappearance of his journal, says: "We have awakened out of a sound sleep of three years to find the bees again humming, honey a flowing, and the bee-men much a going." Friend Bennett has put a good deal of life and energy into this number. He is a man who is thoroughly acquainted with all the special climatic conditions of the State of the setting sun—at least that was my

conclusion after having made a forty-mile ride with him over the mountains in the vicinity of Los Angeles. This trip, or, rather, the stops we made on it, will be illustrated in GLEANINGS, and then I shall have the pleasure of formally introducing our brother editor. In the mean time I am glad to extend to him on behalf of GLEANINGS the right hand of fellowship. There is a broad field for a bee-journal in California, and there is no reason why the old-new journal should not be a success.

CARELESSNESS IN THE HANDLING OF DISEASE INFECTED TOOLS, ETC.

SOME have written us that, even after they had used the McEvoy treatment for handling foul brood, the disease broke out again. Many bee-keepers do not realize, in spite of all that has been said, the importance of having every thing that comes in contact with foul or black brood either burned up or shut up in a tight box or room where bees can not get at it. Metal tools such as screwdrivers, pries, etc., should be put on a bed of live coals for a few seconds—not long enough to draw the temper, but to destroy every thing in the way of microbes that may still be hanging about the articles. Smokers should be painted over with a strong solution of carbolic acid, and the fire-cup can be disinfected by making a good hot roaring fire in it. Division-boards and bee-feeders, and things like that, should either be immersed in boiling water and kept there for a time, or should be dipped in a strong solution of carbolic acid—one part of the acid to fifty of water. When I speak of the acid I refer to the crystals and not to the solution that is ordinarily obtained at the drugstores.

In burning old combs I would first make a good bonfire and get a lot of live coals; then lay the combs on top of the coals one by one. But do not put them on too fast; and as a further precaution (for the wax sometimes runs down into the ground without becoming sufficiently heated) I would bury the ashes and the ground under them. Put them so far below the surface that neither plow nor spade will ever dig them up.

FEEDING MEDICATED SYRUP; HOW TO PREPARE THE CHEMICAL.

It will soon be time to feed bees in the central and northern States; and if feeding has to be resorted to I would strongly urge medicating all the syrup with the naphthol-beta solution. Such a precaution becomes exceedingly necessary just now when foul and black brood have been extending their ravages in every direction. The medicated syrup will not kill the spores of either disease, but it will destroy the bacilli as soon as the spores develop into the active stage. We gave full particulars on this subject on page 776, Oct. 1, 1900; but for fear some may have forgotten, I will repeat it.

Into an eight-ounce bottle (half pint) empty a one-ounce package of naphthol beta in the form of a fine white powder. Pour in just enough wood or common alcohol to dissolve the powder, and fill the bottle full. This

quantity of chemical in solution is just right for 140 pounds of sugar dissolved in 140 pounds of water. To mix, put 140 pounds of water in a common honey-extractor; then add sugar gradually, dipperful by dipperful, until there are about 140 pounds of sugar. While the sugar is being added, keep turning the handle of the extractor so there will be a rapid agitation and thorough mixing. After the sugar is all in, keep on turning the handle until it is all dissolved, and, last of all, pour in the naphthol-beta solution already referred to. Stir this into the mixture thoroughly by running the extractor for several minutes longer.

In handling the naphthol-beta solution, be careful not to get it on the fingers; but after it is mixed with the syrup, it is perfectly harmless to man or bees. Naphthol beta can be obtained for 25 cts. an ounce; and at this low price no bee-keeper can afford not to take the precaution.

In making the syrup we recommend half sugar and half cold water. There is no need of heating, provided thorough stirring is used, either with a stick and tub, or, better still, in an extractor in the manner explained. We have fed a half-and-half mixture for several years; and since using it we have never had any trouble from its going back to sugar in the cells after the bees have put it into the comb. For very late feeding it may be advisable to use one part of water and two of sugar.

PRICE OF EXTRACTED HONEY DECLINING SLIGHTLY; MARKET FIRM ON COMB HONEY; HOW TO CIRCUMVENT THE SMALL PRODUCER WHO IS TRYING TO BREAK THE MARKET; IMPORTANCE OF BOTTLING EXTRACTED HONEY.

FROM the best information we can get hold of up to date it begins to appear that prices on extracted honey in the East will rule a trifle lower than last year at this time; but the market on comb will be fully as high. We base this estimate on the offerings that we have received, and from other information that we are able to gather at this point.

As we have before stated, too many bee-keepers are producing extracted. See GLEANINGS, May 1st, page 384, current volume. If more would turn to the production of comb honey, or, if some of those who produce and market the liquid article in bulk would sell it in the bottled form, the net cash received would be more.

We find that this year, the same as every year, the small producers are rushing their product to market at ruinous figures. The large producers should make it a point to hunt up these people, buy their honey at the low figures, and thus prevent it from going into the centers of distribution and breaking the market. A few hundred pounds at a low figure to some buyers may be the means of bringing down the prices on hundreds of thousands of pounds not yet offered.

Bee-keepers in California, Colorado, and Arizona, where large quantities of honey are produced, should not be in haste to take the first price offered. Already buyers are begin-

ning to see that they must advance on their prices or else they will not get much honey. Producers in these States should go around and visit *all* the small producers in their localities and get them to hold their honey at a certain figure. If they will not hold, buy the honey outright. You better have the low figure than the buyer who will use it as a club on you.

If more bee-keepers who produce the extracted article would turn their attention to bottling, it would have a tendency to stiffen the market for their kind of honey. A large number are doing so now; and it is an encouraging fact that consumers are beginning to learn that, when honey is bottled, bearing the name and address of the producer, it is pretty fair evidence that the goods are pure. There is not a particle of doubt that the careful, intelligent bee-keeper may get a better price for honey for bottling it, even including all expenses, providing, of course, that he puts up an article that will not candy for a year, is neat and attractive, and providing, too, that the honey is of first quality. All off and dark grades should be sold in bulk—never, never, put it in bottles.

Our bottling business is growing larger and larger; and from what we can see and learn, the field for such goods is very large, and every one can, in his own locality, build up a nice trade. Do not be discouraged by the sales of one year; and if the grocer tells you he can buy of a certain syrup and refining company at a good deal lower price per dozen, tell him that you do not sell that kind of goods. Ask him to sample your honey and that of the city chaps with the barrels of glucose in their warehouse.

THE OPINION OF SCIENTIFIC MEN ON THE PEAR-BLIGHT MATTER.

AFTER publishing the article on page 602 of GLEANINGS for July 15, regarding the question of pear-blight as it relates to the region round about Hanford, Cal., I sent marked copies to several scientific men; and among the number was one to Prof. Waite himself (one of the government officials who places part of the blame on the bee), stating that I believed the bee-keepers in that vicinity were preparing to move their bees out of that locality during the time the trees were in bloom. In reply I received the following, dated Aug. 14, which will explain itself:

U. S. DEPARTMENT OF AGRICULTURE,
Washington, D. C.

Mr. Root:—Your favor of August 7, with a copy of GLEANINGS, came duly to hand. I am interested in your views as expressed in the journal and trust that the attention called to the subject of bees and the spread of pear-blight may lead to valuable results. In case the bee-keepers of Hanford and vicinity remove their bees to a five-mile limit from the pear-orchards, and retain them thus during the entire period of bloom, this department will try to undertake a thorough and comparative study of the results. It is hoped that this laboratory will be able to prepare a careful record of the number of spring infections or blighted branches in several leading orchards about Hanford this season—plating the orchards and charging each tree with the number of cases of spring blight it sustained in the season of 1901. At the same time next year, provided the bees have been duly removed as here outlined, the same orchards will be

again studied, and the number of spring infections which have been induced in the season of 1902 will be charged to each tree. A comparison of the records of 1901 and 1902 may then throw much light upon the influence of bees in spreading blight, and incidentally upon pollination, and, I hope, may lead to a broad and impartial adjustment of the interests now seeming to conflict.

NEWTON B. PIERCE,
Pathologist in Charge.

Santa Ana, Cal., Aug. 14.

This letter fully justifies the good opinion that I expressed concerning Prof. Pierce; namely, that he is a fair man, and will endeavor to give the bees full justice.

In a recent article in the *American Agri-culturist* Prof. Waite, another one who has incriminated the bees, has this to say:

I have thoroughly worked out the question relative to bees carrying blight. The conclusion reached is that bees carry pear-blight extensively, and, with other insects, are the principal or almost the only agency of distribution of the germs.

Bees were seen repeatedly visiting the infected flowers, and some were caught taking infected nectar, and by means of plate cultures the pear-blight germs were isolated from their mouth parts. By covering parts of the trees with sacks of various kinds of material, including mosquito-netting, and then artificially infecting certain flowers on the tree, the blight was observed to spread very freely over the uninfected and uncovered blossoms, but was entirely absent in the blossoms covered by mosquito-netting.

It may also be well to state that, as a result of this serious charge against bees, I was led to carry on an extensive series of experiments in the pollination of pomaceous fruits, and as a result of these I found that bees are indispensable to the pollination and setting of most of our pomaceous fruits, hence they should not be destroyed, as some California growers think. They simply carry the pear-blight incidentally while performing an important and necessary function.

From this it appears that Prof. Waite recognizes that "bees are indispensable to the pollination and setting of most of our pomaceous fruits." This opinion seems to be sustained by all of our agricultural colleges and all the best scientific authority throughout the United States; and it would appear that, even though the bees are declared guilty of spreading pear blight, yet the pear grower can not and would not be able to dispense with their services.

In addition to the letter from Prof. Pierce, I have letters from Prof. Cook and Prof. Gillette, both of whom, as bee-keepers well know, have been warm friends of our friends the bees. Prof. Cook writes:

DEPARTMENT BIOLOGY, POMONA COLLEGE,
Claremont, California.

The "pear-blight" is a very serious question. I shall do all I can to determine the truth. I have little doubt that bees do aid in scattering the virus; but I am far from convinced that their removal will abate the trouble, or is wise and necessary. Yet I fully approve your action, and for reasons you give. We must be fair, and shall lose nothing in the end by such concessions as made. I shall do all I can to aid in the matter. Surely bees are not at the very worst, the exclusive wrong-doers. Again, other means than insects must aid in spreading the evil. A. J. Cook,
July 29.

The following is a letter from Prof. C. P. Gillette:

THE STATE AGRICULTURAL COLLEGE,
Dep't Zoology, Entomology, and Physiology,
Fort Collins, Colorado.

All science (properly so called) is a search after truth, and not a search after evidence to establish or defend a preconceived opinion. Whoever takes up the matter of bees and blight should see to it that so good a friend to man as the honey-bee is not condemned until *proven* guilty. If the blight bacillus develops freely in the nectar of flowers it seems certain that any insect that sips nectar from flower to flower will scatter the disease. It seems to me that the first inoc-

ulations in the flowers can not be laid to the bees. After germs have in some way entered flowers, and multiplied there, bees and other insects going from flower to flower would spread the disease, and the number of cultures in flowers would rapidly increase, so that late-blooming varieties should be diseased immeasurably worse than the early-blooming varieties. So far as I can now recall late and early blooming varieties, and their tendency to twig blight, the late bloomers are not more diseased than the early-blooming varieties.

Much significant data might be collected in a single year, but I am inclined to think it will take a longer time to establish very clearly either the guilt or innocence of the honey-bee in spreading blight. I do not mean to question the results obtained by Prof. Waite, but wish to say that it seems to me it will be a considerable time before we can draw a very correct conclusion as to the extent to which the honey-bee is accountable for the spread of the disease known as blight.

C. P. GILLETTE.

July 25.

I would state that I asked of the two last-named whether they would be in position to render us any assistance in the matter of confirming or disproving the statement that bees do carry the virus of pear-blight from tree to tree.

Respecting the attitude of the Central California Bee-keepers' Association, we have received a letter from Sec. F. E. Brown, who writes under date of Aug. 14:

We met as a body in session July 1, and passed resolutions advising the bee-keepers to move their bees out from the pear-orchards during pear-blooming season, as a matter of test only, at the same time asking the fruit-men to co-operate with us in helping to furnish us suitable places to locate the bees during that period; handed a copy of the resolutions to the committee of fruit-men that had the bees and pear-blight in charge. As to the result of this, I am unable at this writing to say, as I have not had the opportunity to find out since returning home.

F. F. BROWN.

Hanford, Cal., Aug. 14.

From this it appears that the bee-keepers expect to carry out their part of the program in good faith; and from various newspaper clippings I judge that the pear-men are very much gratified at the attitude of the bee-keepers; and that, so far from being strife, there will be an honest effort on *both sides* to get at the truth, let it cut where it may. This is as it should be. There is no need of talking about poisoning bees or resorting to the courts. This whole question can, and should be, settled amicably between men of sense and fairness.

CONVENTION NOTICE.

All arrangements for the next convention of the National Bee-keepers' Association have been completed so far as possible, and the convention will be held in the audience room of the Buffalo Society of Natural Sciences, Sept. 10th, 11th and 12th; commencing on the evening of the 10th. The place of meeting is in the Buffalo Library building, corner of Washington and Clinton Streets, near the business center of the city. The president of the Natural Sciences Society, Mr. Smith, has also kindly offered our Association the use of their library and other committee rooms during the time of our convention, and to do all in the power of the society to help make our meeting a success.

Railroad rates will vary in the different passenger association territory, from one cent per mile each way to one and one-third fare for the round trip. Each person can readily learn the rate on inquiry at his railroad station.

The Buffalo bee-keepers will try to provide entertainment at reasonable rates for all attending the convention, who will notify Mr. Sidney S. Sleeper, of Holland, N. Y., by Sept. 2d, of their wish for entertainment.

In a letter just received from Mr. Sleeper he says, "We want all to come who can, for we wish to make the Buffalo meeting the most pleasant and instructive one that was ever held in America. We will have the co-operation of all the sciences as well as the school board," and names some professional men who are interested in our specialty and will be at the convention to help.

In a long letter from Mr. Hershiser, just received, he closes by saying, "Call upon me for whatever further assistance I am able to render;" and Mr. Penton, an ex-president of the Erie County Bee-keepers' Society, and others, have offered to do all they can to provide for the comfort of the delegates.

As stated in my previous convention notice in GLEANINGS, there will be no fixed program and no papers, and the time will be occupied in answering and discussing questions, except that on Thursday evening there will be a joint session of our association with the American Pomological Society, to discuss "the mutual relations of bee-keeping and fruit-growing;" and Prof. Beach, of the N. Y. Agricultural Experiment Station, and Prof. Fletcher, of the Central Experimental Farm of the Dominion of Canada, will help talk for the bees at that session, and it is hoped that much good will result to fruit-growers and bee-keepers from this joint session.

If any bee-keeper who can not be at the convention has any questions, knotty or otherwise, he would like to have answered at the convention, will send them to me I will see that they are presented.

A. B. MASON, Sec., Sta. B, Toledo, O.



The servant of the Lord must not strive, but be gentle unto all men, apt to teach, patient; in meekness instructing those that oppose themselves.—II. TIMOTHY 2:24, 25.

The test of a soldier is to see how he behaves under fire. If, when the trial of his courage comes, his behavior does not correspond with what he has formerly taught, especially with what he has at times boasted of—in other words, if he does not practice what he preaches, his preaching comes to naught. And so it is with the Christian. If he can not stand the fire of sarcasm, ridicule, and unjust accusation, his previous talk amounts to nothing. I am many times pained and astonished to see how few there are who can follow the admonition of our text, especially when they are severely tried. Of course, Satan tries to trip us up; and a great many really good Christian people seem to think it incumbent on them to defend themselves, and even strike back, when they are persecuted. Of course, I allude chiefly to a war of words. Somebody is abusive, overbearing; may be he has been drinking; or if not, perhaps Satan has got into his heart. In such cases, how quick—yes, I think I may say all of us, even the best of us, forget the injunction, "Love ye your enemies, do good to those that hate you!"

Yes, this is the old, old story that I have talked about so much, some of you may say; but, notwithstanding, I do feel that it needs to be talked about, and, more than all, needs practicing. Once in a great while we find a man who will be meek and patient, and even pleasant, when he is roughly or rudely assailed. I have said several times that this matter of returning good for evil, and gentleness for rudeness, is an almost unexplored region, and

I think so even yet. A great many of us can not even bear to be told of our faults—faults that sadly need correcting; and, oh dear me! I am afraid I too am one of that kind. I have a few friends, and God knows I wish I had more, who are not afraid to tell me kindly and pleasantly of my faults and shortcomings. I have had some tests lately along that line. Some good friend who really shows his love and regard for me reminds me of duties I owe to society and to my fellow-men. I recognize it, and thank him, and start about a reformation; but after a while I get to defending myself, and before I know it I am feeling a little spiteful toward the one who cared enough for me to tell the plain frank truth.

I am going to give you a letter right here that I have just received. The writer did not intend it for print, but I am inclined to think he will not object, especially as he is a man who is not afraid to speak out his mind. I know from past experience that many of the readers of GLEANINGS will be inclined to bristle up and feel like talking back to him for me. Please do not do it, friends. This brother is a friend of mine, even if he has not said what he felt, in as kindly a spirit as he might have done.

The A. I. Root Co.

Your paper is not quite common and practical enough to suit me—travel notes and preaching. When I pay for a bee-paper I'd like all bee. I must preach to A. I. R. a little. He seems to be stuck on his nice confessions, as though that would atone for his lapses. His Sunday excursion was just inexcusable. I think it would be better if he were not so quick to see all the handsome women, and talk to all the pretty girls. His Florida meandering was just like him—no definite aim and no settled convictions. He will excuse us if we don't take his political preachings at all seriously. He was never cut out for a leader in thought or deed; he slops over too easily. For more possession and less profession (confession). From a reader of over a quarter of a century.

Dakota, Ill., Aug. 20, 1888. WM. S. FEHR.

Dear brother, I suppose you mean by your opening sentence that I am getting to be a little too worldly, and mixing in too much with the aristocracy to suit you. Very likely you are right, and I have been feeling something of this myself. Perhaps you do not know that I go to many fashionable and "high-toned" places, so called, not because my inclinations lie that way, but because I feel that, in my position, I ought to know a good deal about this world of ours, especially the great *busy* world. Just now I feel it a duty to visit the Pan-American at Buffalo; but, to tell the truth, I should very much prefer to go off in the woods on my ranch, and grow potatoes, and play with spring water. My trip up through the summer resorts of Northern Michigan was a good deal because I thought many people who have been, like myself, out of health, ought to know about these things and the facilities that are being offered to those who are seeking health by traveling. I realized, at the time I made that confession you allude to (about going on Sunday excursions), that I should be taken to task; but so far only one other reader of GLEANINGS has mentioned the matter.

Now, dear brother, if, when I started out on that excursion on Saturday morning, I had planned a Sunday trip without going to any

place of religious worship at all, and had also figured out that I would make it all right by putting it in print in the way of a "*confession*," then I should justly deserve your criticism. Perhaps you may not believe me when I tell you that I had no thought, when I started out, of omitting attendance on Sunday services. It is true I might have guessed how it was likely to come out, but I didn't. If you think I am untruthful in this, then I would recommend that you do as you say you will, drop GLEANINGS entirely, and not waste any more time in reading my writings. I made a mistake, which I exceedingly regret; but after all I have said about remembering the Sabbath day to keep it holy, my conscience troubled me until I had confessed my mistake and owned up. How could I come before you and write these Home Papers, and leave you to suppose that I at all times and under all circumstances practiced a strict observance of the Sabbath? You say, when you pay for a bee-paper you would like it *all* bees. There are several good journals that are devoted entirely to bee culture, or almost entirely; but for almost 25 years, the time you have taken GLEANINGS, there has been a statement on the cover to the effect that our publication is "devoted to bees, honey, and home interests."

Very likely you are right in finding fault or complaining because of the way in which I spoke of the handsome women out Sunday afternoons on Mackinac Island. It is unusual for me to speak of such things as I did then, and my conscience troubled me about it afterward. While I like to see both men and women well and neatly dressed, I would not for the world do any thing or say any thing to encourage the extravagance in dress that is so common, especially in summer resorts.

When I finished my Florida trip I felt something as you do—that I had been traveling without any definite aim or settled convictions. One reason of this was poor health during almost the entire trip. I think, however, I had one pretty definite aim in starting out—that I might find the warm weather in Florida more favorable than the changeable weather here at home; but I did not find it so.

I most heartily agree with you, dear brother, that I was never "cut out for a leader in thought or deed." But the last of your sentence, about slopping over, is pretty tough. May be, however, I do sometimes; but if it is really true, you are the first person who has so far ever accused me of it, so far as I remember. I heartily agree with you, too, in wishing for *more* possession of the Holy Spirit to go with my profession. I notice you put in parenthesis the word "confession" with possession. Now, I am with you exactly in thinking that confessions are in the main bad things. A good many times in life, especially during my Christian life, when seeing the after-consequences of confession, I have questioned the wisdom of it. If there was no *transgression* there would certainly be no need of *confession*; and it behooves every one of us who are professing Christians, and everybody else, to live in such a way that there will be *nothing* to confess.

For almost 25 years, dear brother, I have been able to hold up my head and look everybody in the face, and say I had nothing to conceal in any part of my life—nothing that I would hesitate to have fully exposed or unfolded to the full light of day. The thing that troubled me, and which brought out the confession you object to, is that there was at least some sort of deliberate transgression. May God help me so to live that there may be no need of having at any time *any thing* to confess.

The last words of your letter are a little the hardest of all, "from one who has read GLEANINGS for 25 years," and *then* decided to drop it and turn his back on his old friend A. I. Root. Very likely this would have never occurred had I not listened to the voice of the tempter, and decided to do that which I *knew* had at least the "appearance of evil."

Perhaps the other readers of GLEANINGS may care to know that some others felt helped and *encouraged* in their spiritual life by my frank confession. Here is an extract from a letter that was put into my hand at just about the very time I read the severe censure from friend Fehr. Of course, this letter, too, was not intended for print, or I should not have thought of using it; but it illustrates how differently constituted we are, and how things strike one person in one way and another person in another way.

Mr. Root :—Under God I thank you — yes, I thank you. Do you say to me, "What have you to thank me for?" Because I see your candor in publicly condemning wrong-doing as an example. That is enough to call forth the grateful thanks of any one desiring to do right. To one who is conscious of his own weakness in many ways, being so much greater than yours (for which you have so publicly and earnestly condemned yourself), it comes home, I tell you. Then in the second of your texts you quote from David, showing how he struggled, or, rather, how the good in him struggled to overcome the evil that was also there. The outcome of living the good, and overcoming the evil by the good, is joy, pleasure, gladness, happiness — a boldness, a courage, a nobleness, all to that degree that comes *not* without such living and such *overcoming*.

I have thought of you often this year. Had I known when you were at your "little ranch" I should have tried to get there, and I think I should. To-day I got the August 1st issue. It seems providential that I should have opened and read your article.

Traverse City, Mich., Aug. 5. Z. C. FAIRBANKS.

In the fore part of my talk I suggested there was one other letter referring to this matter of confession. I give it here:

Mr. A. I. Root :—

In GLEANINGS for Aug. 1st you take as a part of the subject of your discourse some verses from the 51st Psalm. It should be borne in mind that this Psalm is mostly a sobbing-out to God his penitence for the deadly sins of murder and adultery. By their commission he had placed himself with the outcasts, the pariahs of his people. Did he go about proclaiming his sin and his penitence, and exhorting to righteousness? I think not. What influence for good could his exhortations have on those who knew of his transgressions? If I mistake not, the consequences of his sin followed him to the end of life, and he found the rest and peace for which he so earnestly prayed only beyond the grave. In a life of threescore and ten, in which I have not been unobservant, I have noticed that the converted murderers, adulterers, thieves, gamblers, drunkards, and whoremongers have not been kindly listened to by persons who have led clean and upright lives. It takes long, sometimes, to expel the devil from one of these; and until he is expelled, and the man knows it, he had better be modest before his fellow-men. I would not venture to write this,

only that I am older than you, and that my experiences have not been dissimilar to your own.

Leon, Ia., Aug. 8.

EDWIN BEVINS.

Dear friend B., permit me to thank you for the very kind and Christianlike way in which you make your suggestions. You are right, and I thank you for your thought in regard to that wonderful prayer that seems wrung from the very heart of one guilty of deadly sins and even crimes. I did and do recognize that the circumstances are far different; yet somehow, when I was thrown in daily and hourly contact with people who cared little or nothing for Christianity or Sabbath observance, it brought vividly to my mind David's touching and beseeching prayer—"Create in me a clean heart, O God, and renew a right spirit within me."* No, David did not go about proclaiming his sin; and I think you are a little hard on me, dear brother, if you think I was a little too ready to confess and (as you put it) "proclaim" my sins. I know from one standpoint it might look that way, and I hesitated about it for the very reason you mention; and yet my conscience was easier after I had decided to own up before the readers of GLEANINGS as I did.

There is still another point: One who criticises Sabbath-breaking and Sabbath-breakers should know exactly what he is talking about; and after my experience I felt less like censuring *severely* those who venture to go on a trip that takes in and includes the Sabbath day with other days. They were, on the whole, a nice, orderly set of people. I saw no drinking whatever, and there was little or no objectionable talk of any sort. I did not commit a crime; in fact, it was more because I did not "shun even the appearance of evil" than any thing else. Your point is a good one—that the consequences of sin usually follow us to the end of life, even if we do repent in sackcloth and ashes. I too have many times felt as if I did not care to hear some converted criminals speak from the pulpit. It is certainly praiseworthy to reform and repent; but it is better, far better, to lead clean and upright lives, as you express it, from youth to old age. May God help me to be modest and careful, even as the language of our text exhorts. Permit me to thank you again, friend B., for I feel sure I shall profit from your kind words and exhortations.

Here is another letter that comes to me like oil on the troubled waters, after having read the letter from friend Fehr:

Friend Root :—I wish I could tell you how much good your writings have done me. Your little book, "What to Do," aroused my enthusiasm some years ago, and now I am the proud possessor of the dear old homestead of 100 acres worth \$8000. Had it not been for the writings of such men as Root, Henderson, Terry, and others, strangers would have stepped in and turned me out with a broken heart.

Plymouth, O., Aug. 19.

C. RHODES.

*Perhaps the beautiful lines of the old hymn by Cowper will express better what I felt after the experience of that Sabbath day than the words of David:

Return, O heavenly Dove, return,
Sweet messenger of rest;
I hate the sins that made thee mourn
And drove thee from my breast.



FLORIDA TRAVELS, CONTINUED.

On page 608, July 1, I spoke of visiting Mr. R. M. McColley, at Sorrento; but I omitted then to mention that I found there a successful house-apiary. This house-apiary is not made tight, as we make them here in the North, so as to exclude frost and cold. The upright boards are far enough apart so the bees can get through the cracks. We might call it a sort of corncrib house-apiary, inasmuch as it has openings all around, somewhat like a corncrib, but, of course, not with so many or so large openings. Well, this house-apiary is all right. The bees can be handled just as well as outdoors; in fact, Mr. McColley thinks he prefers handling them in the house. Quite a few who have house-apiaries say the bees sting worse in a house than around a hive located outdoors. Mr. M. thinks it is the other way. I suggested that, as the hives did not receive the benefit of the direct rays of the sun on cool mornings, the bees would not start out as early as the bees outside; but after watching carefully during a cool morning when it was almost frosty, I was obliged to admit that the bees began flying, and bringing in pollen, first from the hives in the house-apiary. I suppose this whole thing will be a matter of taste. Some who get acquainted with the house-apiary will like it; but as a rule most bee-keepers seem to prefer the hives located outdoors. In tropical climates, as in Florida and Cuba, for instance, no doubt some kind of shade, either of trees or movable boards, is quite an advantage.

Mr. McColley is quite deaf, and one must raise his voice pretty well to talk with him; but aside from this he is a most interesting talker, and has a great fund of useful information to impart to his visitors. Like others who are afflicted in like manner, he has spent quite a little money in remedies for deafness. Not long ago he answered an advertisement for artificial ear-drums. He told the proprietors that he had deposited \$10 with his postmaster. If the ear-drums gave him any relief whatever the postmaster was to forward the \$10; otherwise the drums would be returned. Of course, they would not "trade" on such terms; but they made such emphatic promises of sending the money right back if the apparatus did not do all they claimed, he finally sent the \$10. The ear-drums gave him no help whatever; but the Wilson people had some very good excuse for not returning the money. A lady who is afflicted in a like manner, near him, was anxious to try them, but her experience was just the same.

One day while friend McColley was going along the street he saw a swarm of bees hanging on a limb in a neighbor's dooryard. This neighbor also was deaf, and he had faith in the much-advertised ear-drum. Friend M. laughingly told him he would give him \$10

for the swarm on the limb, and "take his chances," provided the owner of the bees would take the \$10 in ear-drums and take *his* chances. They made the swap, and my host showed me his "\$10 swarm of bees." But the man who got the ear-drums, like the rest, could perceive no benefit from their use.

I can not remember exactly just now whether I have ever told our readers that I too have had a like experience. After having the grip one winter I found I could not hear as well as usual. I tried a pair of \$10 artificial ear-drums. They were not only no help whatever, but my opinion is, it required several months for me to get fully recovered from the damage they did these delicate organs. I followed the directions very carefully, and succeeded in getting the things in my ears according to directions. From a careful examination of the way in which the things were made, my impression is that 10 cents in place of \$10 would be a pretty fair price for them.

I had an exceedingly pleasant visit at Braidentown, Manatee Co. This locality is so far south that frost has never done any great damage to the orange-trees. Our readers of six years ago may remember my mention of our friend Bannehr, and that his family came from England and stayed in Florida two or three years, but became so homesick they pulled up stakes and went back to England; but after staying in the fatherland, I think it was less than a year, they became still *more* homesick, and pulled up stakes *again* and went back to Florida. They have a very beautiful place, with enough tropical plants growing right in the open ground to delight the heart of almost any florist here in the North. Friend Bannehr has sent me quite an assortment of rare and beautiful plants which are flourishing finely in our own greenhouse.

In the town of Manatee, right near his home, I noticed, six years ago, a beautiful spring, of such volume as to make a swamp or quagmire of perhaps $\frac{1}{4}$ acre in extent. This was an unsightly place almost in the heart of the town; and I suppose everybody thought the nasty boggy place was of no value at all to anybody, and never would be. The owner, however, has lately caught on to the new celery culture in Florida. He cut channels to let off the water of the spring, threw the ground up into beds, and planted celery. Just at the time of my visit he was harvesting a crop that I think promised to net him over \$500 from that worthless $\frac{1}{4}$ acre. A neighbor over the fence had evidently caught on, for he too was growing some very fine celery. If there was any lack of rain, all they had to do was to dam up the outlet of the spring until the water came up to the roots of the celery to the desired height. The whole thing seemed very simple when you saw the men at work at it. But I am sure there are thousands of places, north, south, east, and west, where this same plan can be managed without any trouble at all. Of course, these people secured large prices by shipping celery to New York in the dead of winter.

By the way, let me mention right here something to the credit of our commission men.

Again and again I found cases where Florida growers were almost startled at the prices the New York commission men paid them for the stuff they shipped. Sometimes stuff that the grower himself did not consider any thing like first class was sold at a figure that was away above any thing they had thought of getting. This may, of course, be the result of the present general activity in all kinds of business.

Friend Bannehr's neighbor, Mr. Trueblood (rightly named I think), is also an enthusiastic bee-keeper. He is a lawyer by profession, but at the same time he is a most earnest and devoted Christian. He loved the honey-bees, and loved to care for them, and loved to grow crops better, perhaps, than he loves his profession; but I want to say to him, and perhaps to a thousand others who read GLEANINGS, that there was perhaps never, in the history of the world, a time when God-fearing lawyers were needed more than they are just now. Yes, we want lawyers, no end of them, who are not afraid to do right, especially when doing right costs something.

Mr. E. B. Rood, of Braidentown, is also one of the old-time bee-keepers; but in consequence of some bad luck in the honey business they are now keeping a very pleasant little restaurant in Braidentown.



SOME INTERVIEWS WITH SUCCESSFUL POTATO GROWERS JUST BEFORE OUR POTATO-BOOK WENT TO PRESS.

After the potato-book was all finished it occurred to me I had better visit a neighbor, Mr. George Ballasch, of Whittlesey, O., who makes a business of growing potatoes to the extent of forty or fifty acres every year; but before telling you what I saw and learned, permit me to explain that the month of July, 1901, has been the hottest of any July since the U. S. Weather Bureau has made any record—a period of about twenty years. The result of the severe drouth has been especially disastrous to potato-growers. Varieties that were disposed to blight were gone before the potatoes were half grown; and all varieties, in fact, were affected more or less, unless advantage was taken according to the best knowledge up to the present day to secure or insure, if you choose, a crop. Mr. B. makes potato-growing his entire business. He has a piece of low black ground especially adapted to this industry. It has been most thoroughly underdrained, so that it rarely suffers from excessive rains, such as we had during the month of June past.

Well, just when early potatoes were a failure everywhere, north, south, east, and west, Mr. B. has secured almost an average crop, and this, too, when the conditions are such that

one of our Cleveland daily papers quotes for to-day, Aug. 26:

Potatoes.—Per barrel, fancy Eastern stock, \$1.25@4.50; per bushel, \$1.25@1.50; Louisville and Ohio stock, per barrel \$3.75@4.00.*

Mr. Ballasch has dug and shipped three carloads already. The yield is from 175 to 200 bushels per acre, and the potatoes have sold from \$1.25 to \$1.50 per bushel, as nearly as I can make out. This remarkable yield during such a year has been made in spite of the fact that potatoes have been grown on this same land for ten years in succession. With his large acreage it is out the question to think of getting enough stable manure to go over it all. He uses chemical fertilizers to some extent. But his main reliance is on a crop of rye that is put in the ground just as soon as the potatoes are taken off. He believes emphatically in what Mr. T. B. Terry teaches, that the soil should always be green with some crop or other, every month in the year, winter and summer. The rye is sown at the rate of fully two bushels per acre. It is plowed under whenever he is ready to plant. One of the largest crops he ever grew, he said, was where the rye was fully six feet high, and was turned under just when it was coming into bloom. In fact, he had hard work to get it all under the fine black soil. The yield was very close to 400 bushels per acre.

Mr. Ballasch has, of course, experimented a good deal with varieties. I was pleased to know that his choice, not only of varieties but of methods, accords very closely with the teachings of the potato-book. At present he considers for a medium late variety the State of Maine as about the best potato he has on his farm, all things considered. I was pleasantly surprised to learn that the three carloads of potatoes he dug first and sent to market were the Early Thoroughbred that I helped to introduce five or six years ago. Friend Terry succeeded so well with this new variety, which was brought out by Wm. Henry Maule, that I bought several barrels, paying the extravagant price of \$20 a barrel, and offered these as premiums to our subscribers. For the first year or two we did very well with them, and many of our subscribers succeeded equally well; but after a while, when they were obliged to take their chances with ordinary culture, together with other extra-early potatoes, they gradually went out of sight unless it is in a few localities; and during this past season we decided not to include them in our list of perhaps a dozen or more of the best up-to-date potatoes. But Mr. Ballasch rather prefers them to any thing else for extra early.

Now, this illustrates what I have already told you. A certain variety may be the very best for one particular locality, but not for other places. There was also a splendid showing for another variety just brought out, called

*To illustrate the present state of affairs, I copy the following from the Akron *Beacon* of Aug. 15, 1901:

If the price of potatoes continues to increase for another month as it has during the past few weeks the farmers will soon be riding in automobiles and wearing diamonds. Potatoes Thursday were selling at \$2.00 a bushel.

Permit me to suggest that, before the farmers can have the automobiles and diamonds, they will have to have some potatoes to sell at the above prices.

King of the Earlies,* and our old friend the Early Rose, the one I found doing so well in the Traverse region, is also giving about as large a yield during this unfavorable season as any, although it is not as early as some others.

Mr. Ballasch has trouble with the scab as well as the rest of us; but he has very much less trouble where the seed is treated with corrosive sublimate. Ashes tend to produce scab in the soil, without doubt. We dug a number of tremendously luxuriant hills, where he had recently burned out some large stumps. There was a big yield of great handsome potatoes, but they were badly scabbed. He thinks it is not altogether the potash that produces scab; for a commercial fertilizer running high in potash does not act like ashes. The large percentage of lime contained in most wood ashes probably has as much or more to do with the production of scab than does potash.†

Carman No. 3 has been one of his best potatoes until this year; but during the past peculiar season, excessively wet in June and very hot in July, the State of Maine rather excelled the Carman.

The matter of variety is one of tremendous importance to one who grows forty or fifty acres of potatoes. He pointed out to me where hundreds of dollars would have been saved had he planted something else. On one occasion a neighbor offered him a lot of seed potatoes at 30 cts. a bushel. It was a variety, too, that has been praised largely through the press—yes, even by our experiment stations; but his loss was away up into the hundred because he chose this variety for seed where he might have taken some other.‡ He uses the Hoover digger. One reason he gave for preferring the Hoover was that it is manufactured in Ohio, close to his home. If he has a breakdown at a critical time he can get the missing part by express without delay. This is certainly something to be considered when one works on a large scale as does Mr. Ballasch. He uses the Aspinwall potato-planter. Of course, there is here and there a missing hill ;

* Since the above was written the King of the Earlies have been dug, and the yield was 218 bushels per acre of nice potatoes.

† An excess of acidity in the soil prevents scab; and any alkali, especially lime that neutralizes this acidity, encourages scab. Corrosive sublimate, and possibly leaving potatoes exposed to the light, kills the scab fungus. But to get rid of the scab fungus that is already in the soil, there is no remedy known, if I am correct, except plowed-under rye. This seems to sour or in some way produce the excess of acid we need in the soil. Just now I am unable to say whether plowing under a crop of wheat will produce the same result as rye or not. I can only say this: Where my wheat that was lodged badly was plowed under in June we have a nice crop of potatoes; and although I have dug into hills all over the patch I have not found any scab at all.

‡ Mr. Ballasch has an acre or more each of Maule's Commercial and Manum's Enormous. The Commercial is all right were it not for its exceedingly irregular and scraggly form. Our friend says he would not plant any more of them, even if they had every other good quality. We pulled up one tremendous stalk, or vine, and found just one scraggly mammoth potato, too large for table use. Manum's Enormous did better, but it was blighting badly when the State of Maine and Carman No. 3 seemed to be all right.

but he thinks this does not occur often enough to offset the expense of an additional hand required with the Robbins planter.

The man has a beautiful home. He uses gas for lighting and fuel, that was found on his own premises. His potato cellar or cave, constructed especially for his crop, is to be lighted by gas, just the same as his house; then there will be no need of letting in air or light during unsuitable weather. This man makes the growing of potatoes his sole business in life. He reads up all the literature connected with his business. He tests different varieties, and he keeps in touch with the markets, and knows where to sell to get the best prices.

May I venture to speculate a little as to what his crop is going to be worth this year? Fifty acres at 200 bushels per acre would be 10,000 bushels; and at present prices the crop may bring him from \$10,000 to \$12,000 just because he is an expert in his line, and has succeeded in growing a crop when almost everybody else has failed. He told me that just now he was getting just about \$150 per acre, over and above all expenses.

Perhaps I might mention right here that, where I turned under a heavy crop of wheat that was lodged badly, and planted potatoes, we have the best showing now of potatoes of any on our grounds. I asked Mr. Ballasch if he thought a heavy crop of wheat or rye could be worth anywhere near as much as a heavy growth of clover. He said he was sure it would not. Like myself he prefers the mammoth clover when he is growing clover to be turned under to bring up his land and for no other purpose.

I said to him, "Friend Ballasch, I know from my own experience during this past unfavorable season that you must have fought obstacles and enemies inch by inch, without any letting up." He replied:

"Mr. Root, at one time the bugs seemed just *determined* to destroy my crop; but I was equally determined to win in the fight. Why, we have actually used *200 lbs. of Paris green* this season, to say nothing about the labor required to make a good job of applying it so as to kill the bugs and not injure the vines." He used a sprayer worked by horse power.

Twenty-four hours later, in visiting a relative in the adjoining county of Summit, I mentioned Mr. Ballasch's success. My relative replied, "Now, look here. I have a potato story to tell too. Mr. ———, over here near the lake, started last spring to grow early potatoes. He paid over \$100 for a lot of the best varieties of seed. He prepared his ground all right, and every thing seemed to be promising. But the bugs and wet weather and weeds came on all at once. He fought them for a while, but began to get discouraged, hesitated about using more money to employ hired help, and finally—what do you suppose? His whole plantation now is covered with weeds, and I do not suppose there will be a potato worth digging, even at the present high prices."

During the afternoon of the same day I visited my cousin, Wilbur Fenn. I found his farm in apple-pie order from one end to the

other. The outside fences around the road had been removed, and there were no unsightly bushes or weeds anywhere. In the back yard, and out around the barn, every thing is just as clean and slick as in the front yard. In fact, I do not know but the kitchen garden in a little handsomer than the front yard.

But the one grand sight of his whole place is a six-acre field of Russet potatoes. They were planted the 10th of July, right in the midst of our severe drouth; but they came up evenly, bright and clean; and Aug. 17th, just about five weeks from the day they were planted, they were knee-high, and covered the ground, if you looked across it at a little angle. The foliage was of that light green so characteristic of the Russet. Well, these had grown so fast that they were clean, and for some unknown reason there did not seem to be any perforations by the flea-beetle, or scarcely any evidence that bugs or insects of any kind had ever touched their beautiful tops. He said he had fought bugs, however, and had had a harder fight than ever before. He fought them with both Paris green and with the tin pan and paddle. The latter implements are quite an improvement over any thing I have ever seen used for the purpose. For the pan, imagine a large-sized dish-pan fastened securely to a pole long enough to come up under the left arm. On this pole is an adjustable handle like that on a scythe-snath. This enables one to carry the pan down close to the ground without much fatigue, even when standing erect. One side of the pan is cut away just enough to let it slip under and almost clear around a hill of potatoes. The rough edge around the cut is smoothed by turning up the tin; and this lip that is turned up keeps the bugs back in the pan. The paddle is made of a small-sized shingle or an oblong piece of light pine board. This is tacked to an ordinary broom-handle. This broom-handle is laid across the board diagonally from one corner to the other. This brings the shingle square with the surface of the ground. With the left hand you place the pan right up around the hill. With the right hand strike the potato-tops with the paddle, and every beetle or slug will drop down into the pan. This makes almost a clean job, and the vines are not damaged by poison. Every little while the bugs are dumped from the pan into a tall crock of water with a little coal oil on the surface.

I must here state that the wonderfully even stand, with no missing hills, was the result of the management of Miss Ellen Fenn, now 15 or 16 years old. When she first commenced managing the planter for her father she was only 10 or 12. Mr. Fenn does not have to employ very much hired help just now, for he has a good-sized family of bright interesting children who are all interested in the potato crop of 16 or 17 acres. Very likely he will not get the prices that Mr. Ballasch does, but I think he will get a fair reward.

Special Notices by A. I. Root.

GROWING LETTUCE-PLANTS TO BE PUT UNDER GLASS LATER ON.

Now is the time, and during this month and next, to start your lettuce-plants for next winter's crop. Grow them outdoors just as long as you can, and they will stand quite a little frost. Good strong well rooted plants ready to move into the house as soon as the weather is too cold for them outdoors is half the battle in making the crop. The art and ski of man have never yet, in my opinion, invented any system of watering equal to a summer shower; and we sometimes have showers right along into November. Neither has any plan ever been discovered for keeping the plants healthy, and free from disease, like growing them in the open ground, and letting them get a few November showers. Even a soft snow will not hurt the plants a bit; but it is death to the green fly and all other enemies of healthy lettuce. I like to have them transplanted in beds where we can put on the sashes if the weather is severe, and pull them off at other times for the last transplanting, say toward Christmas, moving them into the greenhouse; and with good strong well-transplanted cold-frame plants to take into the greenhouse, you can get a crop ready to sell in three or four weeks. Now is the time to sow the seed, and we have an extra-fine lot true to name, grown specially for us. Ounce, 5 cts.; 1 lb., 50; 5 lbs., \$2. By mail, 10c per lb. extra.

There is no other forcing lettuce, if I am correct, that will take the place of Grand Rapids, or come anywhere near it.

OUR NEW POTATO-BOOK.

I have been hard at work revising the old book (by T. B. Terry) for much of the last six months. The first edition was put out in 1893—eight years ago. In order to have the new book fully up to date I have gone over every point of value found in GLEANINGS during the past eight years. I have visited potato-growers, and studied up potato-growing from Florida to Northern Michigan—yes, and I might almost say from California to the Bermuda Islands. The book also contains quite a treatise on potato-growing for the London markets, on Jersey Island. Instead of about 250 pages, the size of the old edition, it now contains almost 300; and if it does not touch on every difficulty the skillful potato grower meets, I have certainly tried hard to make it do so. The book certainly should be worth several dollars to every man who grows an acre of potatoes or more—that is, if he studies its teachings. As an illustration, last spring after I had planted two or three acres of potatoes I all at once decided to put in about a dozen acres more; and I actually started to the office to send a telegram for one of the latest styles of potato-planters. On the way I began figuring how much the planter would save me in time of team and men, if I planted a dozen acres each year. At first thought it looked as if I should pay for the machine in three or four years. Then I began to calculate that the potatoes would have to be cut just the same, even if we did have a machine. And then I wanted to know how much a bushel or how much an acre it cost to cut potatoes, say to two eyes. I got the potato-book, and I tell you I turned the pages over lively for about an hour. First I decided I would send my telegram for a digger; then in some other part of the book I found something that decided me the other way, and I changed my mind several times during the hour. This incident illustrates the importance of having a comprehensive index, and I have just got through making that index. It contains three pages, or about 300 topics, and I have "proved it" so as to be sure it "strikes the spot" every time. I believe the book will tell you almost every thing you wish to know about growing potatoes—not only how to become an expert, but it gives careful estimates of the cost of each operation all the way through. It tells you how successful men are fighting insect enemies, fungus blight, etc. It is not *exactly* the book for one who wishes to "support his family on a quarter of an acre;" but I think it exactly meets the wants of thousands who love to till the soil, say from two or three acres up to thirty or forty.

There are 41 illustrations in the book. On account of its greatly increased size, the price will be 45 cents instead of 35, the old price. Postpaid by mail, 50 cts.; cloth-bound, 68 cts.; by mail, 75. Nearly 200 pages of the book are by T. B. Terry. The remaining 100 pages were by A. I. Root and Rev. C. D. Merrill, Beloit, Wis.

HONEY QUEENS!

Leather-colored Long-tongues.—I have a breeder for which \$25 has been offered and refused. You make no mistake in buying her daughters. They are dandies.

Goldens.—The Laws strain is as good as years of patient selection and breeding can establish.

Holy Lands.—These are a deserving race of bees. With two years' acquaintance I find them great work-ers, not so vindictive traits, easily handled, are becoming popular, especially in South.

The above races of bees are each bred in separate apiaries, and you can get them in their purity. Am filling all orders by return mail, and I sell at the following low prices, with the usual guarantees. Single queen, untested, 75c; six for \$4.00. Tested, \$1.00; six for \$5.00. Breeders, either race, \$2.50 each. Address

W. H. Laws, Beeville, Texas.

3 Good Points

Good Stock ;
Low Prices ;
Prompt Service.

My stock is from J. P. Moore's long-tongue strain, A. I. Root's famous \$200 queen, and from the stock of J. F. McIntyre that filled supers when other colonies were starving. I have been selling warranted queens at 50 cts. each in any quantity, but the demand has become so great that I am compelled to raise the price to 65 cts. each. If a queen proves impurely mated, another is sent free of charge. All queens go by return mail unless otherwise ordered. I guarantee safe arrival and entire satisfaction. Otherwise, the money is refunded.

L. H. Robey, Worthington, W. Va.

Fertilizing Boxes attached to standard hives simplify queen-rearing. We have letters of recommendation from many who have used the Swarthmore devices with gratifying success. Write us if you are interested. Golden-all-over queens, \$1.00 each.
The Swarthmore Apiaries, Swarthmore, Pa.

100 Full Swarms With good laying queen in shipping-box, no hive or combs; hive extra, \$1.00. These bees are for feeding up for winter to make colonies, or to strengthen weak colonies, or may be used for re-queening. Full directions given. Orders filled as received. Write for further information regarding these bees. Address
F. H. McFarland, Hyde Park, Vermont.

ALBINO QUEENS. If you want the most prolific queens, the best honey-gatherers, the best comb-builders, the hardest and gentlest bees known, try my albinos. My untested queens, 75c.
J. D. GIVENS, Lisbon, Texas.

Bees that have a Record

Have longest tongues—handsome, gentle, and great haulers for honey; all breeding queens, and sold at rate of \$8 per dozen. Now ready.

H. ALLEY, - WENHAM, - MASS.

\$1-TESTED QUEENS=\$1.

A nice lot of young golden tested queens at \$1.00 each while they last; selected, \$1.50; warranted queens, 60c; —6 for \$3.50; select warranted, 80—6 for \$4.50. My bees are a five-band strain, selected for size, energy, working qualities, long tongue-reach—and, lastly, beauty. I have never tested a strain that excels them. A pile of letters assert the above claims are true, and also that they winter well north. Queens are sent promptly.
J. B. CASE, Port Orange, Fla.

Now is Your Time

to stock your bees with my large yellow red-clover queens, while they are low in price. If you are looking for tons of honey, don't fail at least to try a few. Read my ad. in June 15th number. Prices: Untested, 65c; 2, \$1.00; dozen, \$5.25. Tested, \$1.00; dozen, \$10. Try them.

G. Routzahn, Menallen, Adams Co., Penn.

Special Offer !!

For the next 60 days we will sell select tested superior red-clover queens from our best red-clover stock at \$1.00 each; half dozen, \$5.50; untested, 75 cts.; half dozen, \$4.25. We guarantee our bees to work on red clover. Address

LEININGER BROS., FT. JENNINGS, O.

QUEENS! Fine, large, gentle, and prolific; long-tongue reach; either 3 or 5 banded; 75 cents each; six for \$4.25. Try them and be pleased.
CHAS. H. THIES, Steelville, Ill.

Angora Goats. Delaue bucks; good stock; low prices; large circular for stamp.
ED. W. COLE & Co., Kenton, O.

QUEENS the balance of season, 50c; full colonies, \$3. MRS. A. A. SIMPSON, Swarts, Pa.

SCOTCH COLLIE DOGS, and poultry. Interesting prices. POTTS BROS., Bx 111, Parkersburg, Pa.

Write Us if you have any large or small lots of extracted honey to sell. State quantity, kind, and price expected and if possible mail sample. We pay spot cash. Reference, Wisconsin Nat'l Bank. E. R. PAHL & CO., Detroit & Bdwy, Milwaukee, Wis.

For Sale! 150 swarms of Italian bees in 10-frame hives, with ample stores for winter. Combs from foundation; thick-top frames wired; no foul brood or disease of any kind. Price \$450. Also a lot of bee-supplies. Will also sell a 40-acre farm with house and barn, situated in basswood region of Wisconsin; good schools and churches; best of neighborhoods; never have to lock a door. Price \$1500. Reason for selling, my health requires a warmer climate. Address as below
W. H. Young, Ono, Wisconsin.

Young mismated Italian queens for 30 cts. each.
C. G. FENN, Washington, Conn.

A reader of GLEANINGS who has tried Quirin's strain of bees says they are very energetic. They are out first in the morning and last at night; in fact they work so late evenings that he has baptized them "Quirin's Night Hawks." H. G. Quirin's ad. appears on the last page of cover.

WANTED.—To sell my apiary consisting of 30 colonies of bees on deep frame hives, 10 Jumbo, 7 chaff, 20 8 frame, and 12 chaff hives, 17 telescope covers, extractor, and other equipments. Write for particulars to
THO. GING, Hugo, Jackson Co., Ia.

FOR SALE.—105 colonies of bees at \$1.50 each.
H. VOGELER, New Castle, Cal.



IF IT'S GOT TO

stand USE and ABUSE, you'd better buy "PAGE,"
Page Woven Wire Fence Co., Adrian, Mich.

PINEAPPLES!

Choice fruit and plants now ready for shipment. Suitable land for sale, sheds constructed, pineries set and cared for. Correspondence solicited.

Lewisiana Pinery Company, Orlando, Florida.

C. H. Lewis, Manager.

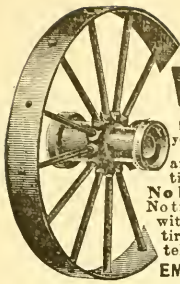

STEEL WHEELS

For your **FARM WAGONS**
 any size wanted, any width of tire. Fits to fit any axle. **No blacksmith's bills to pay.** No tires to reset. Fit your old wagon with low steel wheels with wide tires at low price. Our catalogue tells you how to do it. Address **EMPIRE MFG. CO., Quincy, Ill.**

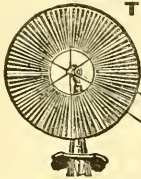

The Storm Proof KING WIND MILL

produces 25 to 50% more net power from any kind of wind than any other mill made. Wheel being only 1 in. thick, cuts the wind like a knife and is 400% more storm proof than any other. Exceedingly light, but wonderfully strong. Very sensitive—runs in lightest winds. Numerous sizes—6 ft up, both pump and power, back geared or direct stroke. Send for circulars and prices before you buy. **Medina Mfg. Co., Box 11, Medina, O.**

YOU NEVER CAN TELL

how soon you will need medicine. Get our **Large Drug Book**, keep it handy. Contains over 35,000 listed drugs, medicines, family remedies, toilet articles, etc. Mailed for 10c. We refund amount out of first order. "The Only Mail Order Drug House in the World." **HELLER CHEMICAL CO., Dept. 40 Chicago, Ill.**

Minnesota Bee-keepers' Supply Mfg. Co.,
 Manufacturers of
Bee-hives, Sections, Shipping-cases, and
Everything Used by Bee-keepers.

Orders filled promptly. We have the best shipping facilities in the world. You will save money by sending for our price list. Address

Minnesota Bee-keepers' Supply Mfg. Co.,
 Nicollet Island Power Building, Minneapolis, Minn.

D. COOLEY,

DEALER IN BEE-KEEPERS' SUPPLIES,
KENDALL, MICHIGAN.

Root's Goods at Root's Prices. : : Catalog free.

Your Order for Queens

—Tested and nutested—will be promptly filled by return mail. Our strain of Italians is unsurpassed as honey-gatherers. Every queen guaranteed. Choice tested queens, \$1.00 each; \$12.00 per dozen; choice untested, 75c; \$8.00 per dozen. Send for price list. Address . . .

J. W. K. Shaw & Co., Loreauville, La.

1200 FERRETS. All sizes; some trained; first-class stock. New price list free. **N. A. Knapp, Rochester, Lorain Co., Ohio.**

To make cows pay, use **Sharples Cream Separators.** Book "Business Dairying" & cat. 288 free. **W. Chester, Pa.**

Mr. A. I. Root's Writings

of Grand Traverse territory and Leelanau Co. are descriptive of Michigan's most beautiful section reached most conveniently via the
PERE MARQUETTE R. R.

For pamphlets of Michigan farm lands and the fruit belt, address **W. C. Tousey, D. P. A. Toledo, Ohio.**

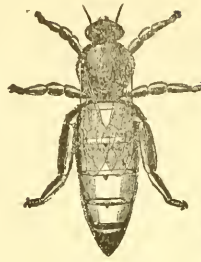

A Superior Red-clover Queen for 25 cts.

An Offer for New Subscribers:

We want to add a lot of new readers to our WEEKLY AMERICAN BEE JOURNAL list during August and September. For that reason we are making those who are not now reading our journal regularly, this liberal offer: Send us \$1.25, and we will mail you the Bee Journal for a WHOLE YEAR, and also one of our SUPERIOR LONG-TONGUED RED-CLOVER QUEENS—untested Italian.

We arranged with one of the oldest and best queen-breeders (having many years' experience) to rear queens for us this season. His bees average quite a good deal the longest tongues of any yet measured. The breeder he will use is direct from Italy, having imported her himself. Her worker-bees are large, somewhat leather-colored, very gentle, and scarcely requiring veil or smoke. They stored red clover honey last season. All queens guaranteed to arrive in good condition, and all will be clipped unless otherwise ordered. All queens mailed promptly.

Headquarters in Chicago for Root's bee-supplies at Root's prices. A free catalog and sample of the American Bee Journal on request.



George W. York & Co., Chicago, Ill.
 144, 146 Erie Street.

Standard-Bred Queens!

Acme of Perfection; Not a Hybrid among Them.

Improved Strain Golden Italians.

World-wide reputation; 75c each; six for \$4.00.

Long-tongued 3-banded Italians.

Bred from stock whose tongues measured 25-hundredths inch. These are the red clover hustlers of America. 75 cts. each; six for \$4.00. Safe arrival guaranteed. Catalog on application. Headquarters for bee-keepers' supplies.

Fred W. Muth & Co., Cincinnati, Ohio.
 South-west Corner Front and Walnut Streets.

Belgian Hares

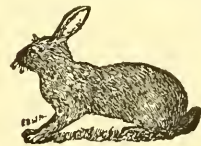

Fully pedigreed of the highest breeding, at prices that will suit. With every hare sold goes a full pedigree, register number, and score-card, scored by an official judge; and, when desired, does will be bred to one of our famous high-scoring bucks before shipment. Address **J. B. MASON,** Mangr. of The A. I. Root Co., Mechanic Falls, Me.

Belgian Hares

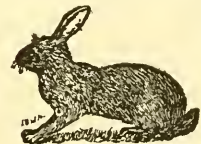

I have some fine hares for sale at reasonable prices.

J. F. Moore, : Tiffin, Ohio.

Marshfield Manufacturing Company.

Our specialty is making SECTIONS, and they are the best in the market. Wisconsin basswood is the right kind for them. We have a full line of BEE-SUPPLIES. Write for FREE illustrated catalog and price list.

Marshfield Manufacturing Company, Marshfield, Wisconsin.

Florida! Twenty good strong colonies of bees, all supplies needed for 40, a house built in 1900, 1½ acres for cultivation (wet or dry, as desired), within 10 acres securely enclosed by a barbed 8-wire fence, on Halifax River, at Oak Hill, where in good years the heaviest returns of honey are taken; half mile from railroad station—going past church, schoolhouse, and postoffice on way. A Baltimore Company with capital of \$1,000,000 has just purchased 5000 acres—Oak Hill station is their shipping depot. To let for one or two years at \$10.00 per month. The house will be vacant any time from October until January 1st. For further information apply to H. TURNER, Matthews P. O., Duval Co., Florida.

BREEDING CARNIOLAN QUEENS BELOW HALF PRICE.

To dispose of these queens at once we offer 100 fine young select tested Carniolan queens at \$1.00 each. Their bees are finely marked and gentle, and hustlers to work. Don't fail to order one of these queens. Our regular price is \$2.25 each. Now is your chance to purchase fine breeding queens cheap. Address F. A. LOCKHART & CO., Caldwell, N. Y.

CHAS. ISRAEL & BROS.,
486-490 Canal St., Corner Watt St., N. Y.

Honey and Beeswax.

Liberal Advances made on Consignments. Wholesale Dealers and Commission Merchants' Estab. 1875.

EGG FOOD! The kind that tones and keeps up the hen so that she simply must lay. LEX'S POULTRY CONDITION POWDER puts good red blood into poultry veins; kills all disease germs; tones and nourishes fowls—big and little get all there in the food when fed in conjunction with it. Price 25c pkg.; 5 for \$1. LEX'S Thoroughbred Minorca eggs, \$1 for 13. Thoroughbred Belgian Hares. **Geo. J. Ley, Florence, California.**

30 COLONIES Italian bees for sale cheap; in good condition; no disease. Also S. C. B. Leghorns; no better; circular free. H. M. Moyer, Shanesville, Pa.

WANTED.—Fancy and No. 1 white-clover honey, one-pound sections, paper cartons preferred.
BLAKE, SCOTT & LEE,
33 Commercial St., Boston, Mass.

WANTED.—10,000 pounds good clover or basswood honey. I will pay 7 cts. per lb. cash, f. o. b. cars at West Bend. 60-lb. cans a preference.
HENRY AHLERS, West Bend, Wis.

WANTED.—Comb or extracted honey in any quantity. Cash paid. State kind, quantity, how packed, and lowest price.
EARL C. WALKER,
Box 316, New Albany, Indiana.

WANTED.—Comb honey, No. 1 and fancy white and buckwheat.
THE A. I. ROOT CO., Medina, O.

FOR SALE.—Extracted honey in 60-lb. cans, No. 1 alfalfa, 7½¢ per lb.; partly from other bloom, 6½¢.
D. S. JENKINS, Las Animas, Colo.

FOR SALE.—8000 lbs. clover and basswood honey, mixed, in 60-lb. cans, as white as Michigan produces; good body and flavor; the best I ever produced in 26 years' bee-keeping. A free sample will convince you. Eight cts. per lb. at Carson City.
E. D. TOWNSEND, Remus, Mich.

We will be in the market for honey the coming season in carloads and less than carloads, and would be glad to hear from producers everywhere what they will have to offer.
SFAVEY & FLARSHHEIM,
1318-1324 Union Avenue, Kansas City, Mo.

Queens. Now is the time to requeen, when you can get the finest golden five-banded long-tongue queens for 50 cents each, or \$5.50 per dozen. Tested queens, 80 cts. each the rest of this season. I have had 35 years of practical experience with bees. I make a specialty of queen-rearing, and have 400 fine queens. Can fill orders by return mail. Remit by postal money order.

DANIEL WURTH, Coal Creek, Tenn.

Wants and Exchange.

Notices will be inserted under this head at 10c per line. You must say you want your ad. in this department, or we will not be responsible for any error. You can have the notice as many lines as you please; but all over ten lines will cost you according to our regular rates. We cannot be responsible for dissatisfaction arising from these "swaps."

WANTED.—To exchange long-distance-record homing pigeons for bees, supplies, books, bee-papers, or offers.
GEO. A. FRANCIS, Bridgeport, Conn.
1453 Sea View Ave.

WANTED.—Location for a custom saw and feed mill.
W. S. AMMON, Reading, Pa.

WANTED.—Apples. I wish to correspond with some bee-keeper in the middle West, or elsewhere, in section where there is a good crop of apples.
F. W. DEAN, New Milford, Pa.

WANTED.—One second-hand Barnes saw. Address J. G. THAYER, Ivy Depot, Albemarle Co., Va.

WANTED.—To exchange second-hand 60-lb. cans, practically as good as new, at 20c per can in lots of 20 or more, f. o. b. Chicago, for white-clover honey at market price.
B. WALKER, Clyde, Cook Co., Ill.

WANTED.—To exchange one broom-handle lathe and one automatic gauge lathe.
W. S. AMMON, 216-S Court St., Reading, Pa.

WANTED.—To exchange a St. Albans 2 h.-p. and thrasher for 3 h.-p. gasoline engine.
C. L. GOULD, East Dover, Vermont.

WANTED.—To exchange Belgian hares for bicycle, camera, etc.
R. E. NEAVE, Hughesville, Md.

WANTED.—One 2d-hand Barnes foot power circular saw. Must be in good condition.
F. R. HOWE, La Plume, Pa.

WANTED.—To sell my apiary and home at Orion, Wis.; 9 lots, five-room house, barn, good well of water, 30 acres of land, part timber, 30 colonies of bees, and every thing needed in the bee business. I use it for market-gardening, small fruit, and bees. Good home market. Will sell at a sacrifice on account of old age. Write for particulars to
W. T. STEWART, Beach, Wis.

WANTED.—An experienced bee-man; a young man preferred. Apply to
E. B. POOLE, Clinton, Miss.

WANTED.—To sell my entire and complete apiary consisting of 75 colonies of bees, on Lang and American frames, hives, winter-cases, extracting-supers with comb extractor, and all other necessary equipments. Big bargain. Write for particulars. Also good 40-acre farm to rent or sell.
W. H. ALLSWED, Sanford, Mich.

Every Hen a Paying Hen

IF YOU FEED RAW CUT BONE. Nothing produces eggs or promotes growth like it. No machine does as good work as Mann's Bone Cutter 1902 Model. New design, open hopper, enlarged table, new device to control feed. You can set it to suit any strength. Never clogs. Sent on TEN DAYS FREE TRIAL. No money asked for until you prove our guarantee on your own premises, that our new model will cut any kind of bone with atherine meat and gristle faster and easier and in better shape than any other type of bone cutter. If you don't like it, send it back at our expense. Free Catalogue explains all. F. W. MANN & CO., Box 37, Milford, Mass. Manufacturers of Clover Cutters, Granite Crystal Grit, Corn Shellers, etc.

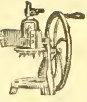

Choicest Fruit and Ornamental Trees.

Shrubs, Plants, Bulbs, Seeds. 40 Acres Hardy Roses. 44 Greenhouses of Palms, Everblooming Roses, Ficus, Ferns, Etc. Correspondence solicited. Catalogue Free. 48 Years. 1000 Acres.

THE STORRS & HARRISON CO.,

Painesville, Ohio.

THE SMITH PREMIER TYPEWRITER

Occupies an Imperishable Position in the BUSINESS WORLD.

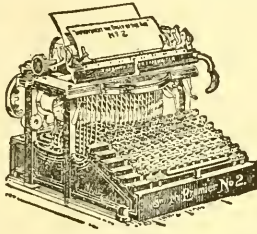

Unquestionable Superior Merit

Annually adds thousands of names to the long list of Smith Premier users, representing every line of trade and every profession.

ILLUSTRATED CATALOGUE FREE.

The Smith Premier Typewriter Co.,

158 Prospect Street, Cleveland, Ohio.

Don't Dig Potatoes by Hand

It is a slow and expensive way. The cheapest, quickest, and easiest way is to USE THE IMPROVED

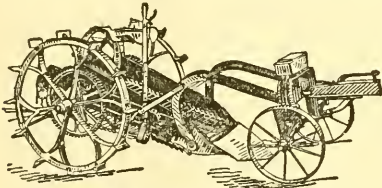

DOWDEN POTATO-DIGGER.

It gets them all, no matter how deep or shallow. Our book explains how. Book is free. Write for it now. DOWDEN MFG CO., - Box 23, Prairie City, Ia.

ONCE IN A LIFE TIME

is often enough to do some things. It's often enough to buy a wagon if you buy the right kind. The

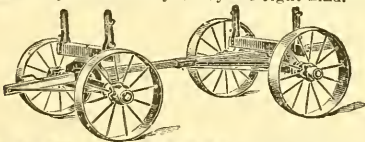

ELECTRIC HANDY WAGON

lasts that long under ordinary conditions. First the life of a wagon depends upon the wheels. This one is equipped with our Electric Steel Wheels, with straight or stagger spokes and wide tires. Wheels any height from 24 to 60 in. It lasts because tires can't get loose, no re-setting, hubs can't crack or spokes become loose, fellows can't rot, swell or dry out. Angle steel hounds.

THOUSANDS NOW IN DAILY USE.

Don't buy a wagon until you get our free book, "Farm Savings." ELECTRIC WHEEL CO., Box 95, Quincy, Ills.

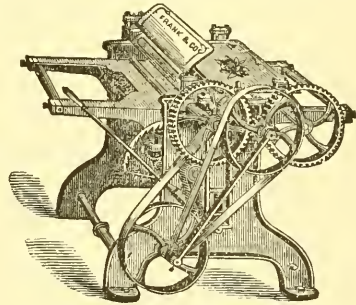

PLANERS

The above cut shows one of our small Planers, of which we make twelve different styles and sizes. Also large Planers, Band Saws, Buzz Planers, Moulders, Wood Lathes, and all kinds of

WOOD WORKING MACHINERY

Send for Catalogue.

The FRANK MACHINERY CO.

BUFFALO, N. Y.

Union Combination Saw

For Ripping, Cross-cutting, Rabbeting, Mitering, Grooving, Gaining, Boring, Scroll-sawing, Edge-moulding, Beading. Full line FOOT and HAND POWER machinery. Send for catalog A. SENECA FALLS MFG. CO., 44 Water St., Seneca Fd., N. Y.

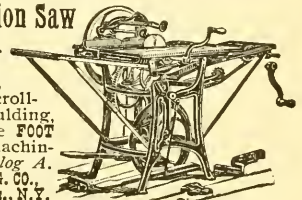

Over in Canada

are some of the best bee keepers on this continent. If you should go visiting among them you would be able to come home and give your brother bee-keepers a good many valuable pointers as to how they do "over in Canada." The editor of the *Bee-keepers' Review* recently spent two weeks, with note-book and camera, among Canadian bee-keepers, and his paper for the next two months will be telling about and showing pictures of the good things he saw and heard "over in Canada." The September *Review* will give a

picture of Mr. McEvoy, Canada's efficient Inspector of Apiaries; a view of his apiary, together with a description of how he winters his bees on their summer stands—one or two points in which are decidedly unique.

The *Review* is \$1.00 a year, but new subscribers will receive the rest of this year free; or, for \$2.00 I will send the *Review* from now to the end of 1902, and a queen of the Superior Stock.

W. Z. HUTCHINSON, Flint, Mich.

1881

PAGE & LYON MFG. CO.

1901

We manufacture a full line of the latest
BEE-SUPPLIES.

Our motto is, "Perfect Goods and Prompt Shipment."

Send for our new free illustrated catalog.

PAGE & LYON MFG. CO., New London, Wisconsin.

NOW READY!

64-PAGE CATALOG OF EVERY THING BEE-KEEPERS NEED. Illustrated and fully described. Especially valuable to beginners for the information it contains. Send your address on postal and get it now. Established 1884.

J. M. JENKINS, Wetumpka, Ala.

I. J. Stringham, 105 Park Place, New York City.

Keeps in stock a full line of modern appliances for bee-keepers.

SQUARE CANS & SHIPPING-CASES.

One-pound square flint jars with corks, \$5.00 a gross. Cartons of a superior quality at a low price. Tested Italian queens, \$1; untested, 75c. Apiaries, Glen Cove, L. I. Catalog free.

I. J. Stringham, 105 Park Place, New York City.

Red-clover Queens!



We have been telling you through our advertisements of the superior stock of queens we are furnishing this year, and we have abundant testimony from others corroborating our opinion. Look at the following, which is one of the numerous endorsements received regarding a colony from our place on the Exposition Grounds, with a tested Red-clover Queen.

Notice the date of this letter.

The bees are working as I never saw them work before, and already there is over 100 pounds of honey in the hive, and all from clover. I am led to believe that long tongues and good working qualities go together.

Buffalo, N. Y., July 5, 1901.

OREL L. HERSHISER,

Supt. N. Y. State Apiarian Exhibit, Agricultural Building,
Pan-American Exhibition, Buffalo, N. Y.

Now see this letter from one of the leading queen-breeders of the United States, regarding Root's Red-clover Bees.

Coronaca, S. C., August 8, 1901.

A. I. Root Co., Medina, Ohio.—Your letter in answer to my report on the queens you mailed me last fall was received a few days ago, and you ask for a still further report. I am so well pleased with them that I am still of the opinion that I want my whole apiary stocked with this strain of bees. All of these queens were introduced to nuclei last fall, and this spring while they were quite weak two of them have built up to be as strong as any colony I have; and one, my special breeder, I have drawn from in order to keep her from building up so strong, as it is troublesome to open up a strong colony to get larvæ for queen-raising. I consider the one I am breeding from one of the finest queens I have ever had in my apiary, and I am introducing her daughters to my colonies every opportunity.

J. D. FOOSHE.

Prices of
Red-clover
Queens!

GLEANINGS 1 year and Untested Queen, \$2.00
GLEANINGS 1 year and Tested Queen, 4.00
GLEANINGS 1 year and Sel. T'td Queen, 6.00

If you want something good you can not do better than to order one of these queens. All orders are filled promptly. No extra postage on these to foreign countries.

The A. I. Root Co., Medina, O., U.S.A.

The Best Queens of the Best Kinds.

By special arrangement with The A. I. Root Co. to furnish them QUEENS, I have secured their assistance in procuring the FINEST BREEDING QUEENS that a thorough knowledge of the bees of the country and money can procure. Among them is a SELECT DAUGHTER OF THEIR \$200 00 QUEEN THAT THEY RE-

FUSE TO QUOTE ME PRICES ON. This queen shows every superior quality of her mother. Her bees show an actual reach of 21-100 of an inch; are large, gentle, and beautiful to look upon.

MR. E. R. ROOT says: "You have as fine bees as there are in the United States; and with a direct cross of their breeders you should be able to produce queens whose bees show a reach of 25-100 of an inch."

MR. R. A. JANSEN, of Iago, Wharton Co., Texas, bought of me last fall 80 queens. He says of them: "I consider myself the queen and 50 cents per colony BETTER OFF, for the purchase of these queens, on the SPRING HONEY FLOW ALONE. They SURPASSED ALL OTHER COLONIES in my yard during the spring honey flow and KEPT UP THE LICK. Please book my order for 100 MORE queens to be delivered in the fall. I shall, in all probability, increase this order later."

Under date of July 28th, 1901, from Mr. W. E. Burch, of Los Banos, Cal., comes the following in regard to queens from my apiary: "The three that I have are the FINEST queens I ever saw, and the GENTLEST BEES TO WORK WITH. When I am working with these three colonies I do not use the smoker, and they ALWAYS SEEM TOO BUSY ATTENDING TO THEIR OWN BUSINESS to interfere with me; AND THEY ARE THE BEES THAT BRING IN THE HONEY."

From Ramey, Minn., under date of Aug. 8th, 1901, Mr. A. T. McKibber writes: "The cage of bees arrived o. k., and were measured. They ran 24-100 and 25-100, which is just a little longer than any I have, or have measured, and I think by their looks that they're good bees. The bees you sent could probably take honey $\frac{1}{4}$ inch."

Louis Werner writes under date of June 19, 1901, from Edwardsville, Ill.: "The queen I got from you is a good one, and proved to be as good as I EVER GOT FROM ANY BREEDER. When I am in need of queens I know where to get good ones."

Frank Coverdale, of Maquoketa, Iowa, says, under date of July 6, 1901:

"We like those that have hatched. They are exceedingly gentle, and queens prolific. Among the first fifty the tongue-reach is very good, generally 20; one measures 23, and another, which is best of all, measures 24. THIS QUEEN I VALUE VERY HIGH. Her bees are uniform in color. I'd like you to send me a cage from your longest-reach queen, as I'm well equipped for measuring."

This is from far off Jamaica:

"Kingston, Jamaica, B. W. I., May 14, 1901.

"Queen received on the 8th in the pink of condition. Attendants and queen appeared as if just placed in cage THE DAY BEFORE.

S. E. SURRIDGE."

If I have real good success, by next year I expect to be able to furnish a QUEEN for the Chinese that will be acceptable to the POWERS.

The A. I. Root Co. also knows a GOOD THING when it sees it. LISTEN!

"Medina, Ohio, May 1st, 1901.

"W. O. Victor.—Instead of sending us 12 untested queens per week, send us 18 in two installments, a day or so apart."

I have on hand at the Pan-American Exposition a nucleus, with queen. Mr. Orel L. Hershiser, Superintendent Apiarian Exhibit, will take pleasure in showing them, as he always "Seeks after the Good, the Beautiful, and the True."

Prices for September, October, and November Only.

Untested queens, 65c; 6, \$3.50; 12, \$6.50; 50 or more, 50c each. Select untested, 85c; 6, \$4.50; 12, \$8.50. Tested, \$1.00; 6, \$5.50; 12, \$10.00. Select tested, \$1.50; 6, \$9.00. Breeders whose best bees show a reach of 21-100, with an average of 20-100, \$3.00. Breeders whose best bees show a reach of 21-100, with an average reach of 20 $\frac{1}{2}$ -100, \$5.00. Breeders whose best reach show 22-100, with an average reach of 21-100, \$7.00. I have discovered two breeders whose best bees show 24-100, with an average reach of 22-100. These are too good to sell. Don't ask for prices. Yard No. 1.—Long-tongue Root Clover. Yard No. 2.—Imported Stock. Yard No. 3.—Golden, or Five-banded Stock. Yards No. 1 and 2 contain, without question, bees as gentle as was ever handled, and I think equal of any in the world as honey-gatherers from any flower that grows. Don't forget that my FAMOUS BEAR PICTURE goes as a premium with each order for six or more queens at prices quoted. Send for list showing description of stock and arrangement of each apiary.

W. O. VICTOR, Queen Specialist, Wharton, Texas.

To Our Shippers.

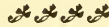

We were obliged to notify you a few weeks ago that one Joseph M. McCaul had leased our old quarters at Nos. 120-122 West Broadway, New York City, and had there started up business under the name "Hildreth, McCaul Co.," and had distributed a multitude of circulars so worded as to create the impression that his business was a successor to or a branch of the business of Hildreth & Segelken.

For the protection of our shippers and ourselves, we at once instructed our attorney to commence action to enjoin the said McCaul from using the name HILDRETH in any manner whatsoever in connection with his business. On the 10th day of July, 1901, Hon. David McAdam, Justice of the Supreme Court of the State of New York, after a full argument upon the merits, issued a peremptory injunction, of which the following is an extract:

"And it appearing that the plaintiffs have for a long time been and now are carrying on business under the style of "Hildreth & Segelken," and that the defendant has recently opened a business at 120-122 West Broadway, in the Borough of Manhattan, City of New York, and is carrying on the same under the style of "Hildreth, McCaul Co.," and that such act is in violation of the plaintiffs' rights, and that the commission or continuance thereof, during the pendency of this action, will produce irreparable injury to the plaintiffs; . . . it is

ORDERED that the defendant (Joseph M. McCaul) and each of his agents, servants, and employees, and all other persons acting under his authority and direction be, and he and they are hereby restrained and enjoined from showing, displaying, or otherwise using during the pendency of this action in or upon any papers, devices, sign or signs, or otherwise, in the business conducted by the defendant at No. 120-122 West Broadway, in the Borough of Manhattan, City of New York, or elsewhere the name of "Hildreth" separately or conjunctively with any other name, designation, or description."

Outside of our desire in our own interests to protect the name which we have built by years of satisfactory dealings with our customers, we hastened to procure this injunction as soon as possible, to prevent our shippers from being misled into sending their goods to one who would make an attempt to gain their trade by such a trick and device.

With thanks for the many expressions of good will we have received from our shippers concerning this attempt to trade under our name, we are

Sincerely yours,

HILDRETH & SEGELKEN.

265-267 GREENWICH STREET, NEW YORK CITY.

LONE STAR APIARIES

Italian Queens.

Estab'd 1885 Prices of queens from imported mothers: Tested, \$1.50; 6, \$6.50; 12, \$12.00. Untested, 75c; 6, \$4.00; 12, \$7.00. Golden, same price. Select tested of either race, \$2.50 each. For a short time I will mail tested leather-colored queens at \$1.00.

Your money back if you are not satisfied. Address **G. F. DAVIDSON & SONS, FAIRVIEW, TEX.**

WANTED. — To sell cheap, bees, hives, brood-frames, foundation, smokers, etc.; also nice R. C. B. Leghorns. **C. H. ZURBURG, Bishop, Ills.**

Dittmer's Foundation !!!

Retail---Wholesale---Jobbing.

I use a PROCESS that produces EVERY ESSENTIAL necessary to make it the BEST and MOST desirable in all respects. My PROCESS and AUTOMATIC MACHINES are my own inventions, which enable me to SELL FOUNDATION, and WORK WAX INTO FOUNDATION FOR CASH, at prices that are the lowest. Catalog giving

FULL LINE OF SUPPLIES

with prices and samples, free on application. **BEESWAX WANTED.**

GUS. DITTMER. AUGUSTA, WIS.

Get the Best Queens.

Evansville, Ind., Sept. 27th, 1900.

The Jennie Atchley Co., Beeville, Bee Co., Texas:
Dear Friends:—It gives me great pleasure to forward you this unsolicited testimonial regarding the merits of Atchley queens. The three (3) dozen queens purchased of you have made an excellent record for themselves. Not an Atchley queen among the twenty colonies lost during the severe drouth in July. I have bought queens from many breeders; and although the present crop is exceedingly short, the tiers of supers show where the Atchley queens are, and speak volumes for your method of queen-rearing. I find the progeny to be very gentle, strong-winged, uniformly marked, long-lived, of large size, and last, but not least, the best honey-gatherers I ever had. I shall want 100 more next season.

Yours fraternally, **J. C. WALLENMEYER.**

Prices for Queens.

Tested, \$1.50 each; \$8.00 for 6, or \$15.00 per dozen. Untested, February, March, April, and May, \$1.00 each; \$5.00 per 6, or \$9.00 per dozen. Fine breeders, \$5.00 each. We have as good bees and queens as money and labor produce. We breed three-band Italians, Golden, Carniolans, Cyprians, and Holy-Lands, in their purity, bred in separate yards 5 to 20 miles apart. If you want the best, call for Atchley's improved strains. Safe arrival guaranteed. Send for a sample copy of "The Southland Queen," the only southern bee-paper. \$1.00 per year. To new subscribers we offer as a premium a nice untested queen in order to get our paper introduced. Catalog, giving queen-rearing and management of apiaries for profit, FREE.

THE JENNIE ATCHLEY CO.,
Beeville, Bee Co., Texas.

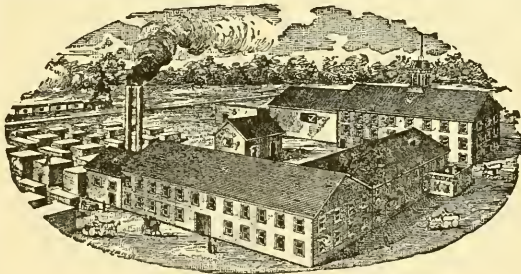

KRETCHMER M'F'G CO., Red Oak, Iowa.

BEE-SUPPLIES.

Best-equipped factory in the West; carry a large stock and greatest variety of every thing needed in the apiary, assuring BEST goods at the LOWEST prices, and prompt shipment. We want every bee-keeper to have our FREE ILLUSTRATED CATALOG, and read description of Alternating Hives, Ferguson Supers, etc. Write at once for a catalog.

— AGENCIES: —

Trester Supply Co., 103 So. 11th St., Lincoln, Nebraska; C. C. Richards, 1223 17th St., Denver, Col.

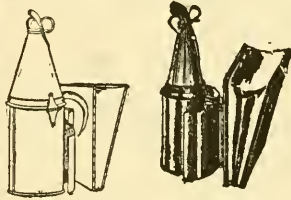

BINGHAM SMOKER.

Dear Sir:—Inclosed find \$1.75. Please send one brass smoke-engine. I have one already. It is the best smoker I ever used.
Truly yours,
HENRY SCHMIDT, Hutto, Tex.

MADE TO ORDER

Bingham Brass Smokers.

Made of sheet brass, which does not rust or burn out; should last a lifetime. You need one, but they cost 25 cts. more than tin of the same size. The little open cut shows our brass hinge put on the three larger sizes. No wonder Bingham's four-inch smoke-engine goes without puffing, and does not drop inky drops. The perforated steel fire-grate has 381 holes to air the fuel and support the fire. Heavy tin smoke-engine, 4-inch stove, per mail, \$1.50; 3 1/2-inch; \$1.10; 3-inch, \$1.00; 2 1/2-inch 90c; 2-inch, 65c. Bingham smokers are the originals, and have all the improvements, and have been the standard of excellence for 22 years. Only three larger ones brass.

T. F. Bingham, Farwell, Michigan.

Contents of this Number.

Alfalfa, Sowing in Fall.....761
 Apiaries, Movable, in Russia.....742
 Bee-ranges, Priority Rights.....756
 Brood, Too Much in August.....754
 Carbolium.....751
 Colonies, Difference Between.....754
 Combs Built to Bottom bar.....754
 Doolittle on Locality.....753
 Edwards, D. M.....761
 Fairs, Street.....761
 Frames, Shall-w, for Comb Honey.....755
 Gusseng.....761
 Guessing contests.....760
 Harrison, Mrs., Resumes Bee keeping.....749
 Hives, Rambler's Wee-waw.....745
 Honey, California, Prices on.....755
 Howe, Harry.....754
 Infidel, Johnson's Reply to.....758
 Ljunden, European.....762
 Mental science Healers Punished.....761
 Queens Fertilized in Upper Story.....756
 Queen catcher, Ramble's.....745
 Queen cells a Sign of Swarming.....742
 Rambler's Cover-holder.....744
 Rooster, Pugnacious, Dead.....762
 Saw-kerfs in Covers.....742
 Sugar, Beet v. Cane.....757, 763
 Swarms, Returning to Parent Stand.....755
 Swarthmore Queen-rearing.....743
 Sweet Clover for Horses.....762
 Texas, Travel in.....746
 Top-bars, Thick, Pettit and Miller on.....746
 Ziuc Poisoning Honey.....741

Honey Column.

GRADING-RULES.

FANCY.—All sections to be well filled, combs straight, firm ly attached to all four sides, the combs unsoiled (by travel stain, or otherwise; all the cells sealed except an occasional cell, the outside surface of the wood well scraped of propolis.
 A No. 1.—All sections well filled except the row of cells next to the wood; combs straight; one-eighth part of comb surface soiled, or the entire surface slightly soiled; the outside surface of the wood well scraped of propolis.
 No. 1.—All sections well filled except the row of cells next to the wood; combs comparatively even; one-eighth part of comb surface soiled, or the entire surface slightly soiled.
 No. 2.—Three-fourths of the total surface must be filled and sealed.
 No. 3.—Must weigh at least half as much as a full-weight section.
 In addition to this the honey is to be classified according to color, using the terms white, amber, and dark; that is, there will be "Fancy White," "No. 1 Dark," etc.

CITY MARKETS.

NEW YORK.—For this time of the year, there is a fair demand for comb honey. Prices in this market rule about as follows: Fancy white, 14@15; No. 1 white, 13@14; No. 2 white, 12@13. We are not receiving very much from this section at present, but arrivals from the South have been fairly good. Hardly any demand for extracted. Prices are about 4½@6 cents per lb. according to quality.

FRANCIS H. LEGGETT & Co.,

Franklin, West Broadway, and Varick Sts.,
 Sept. 6. New York City.

ALBANY.—Increasing demand for honey now, and very little come as yet. Fancy white comb, 16 medium, 14@15; mixed, 13; buckwheat would sell at 12@13. Extracted white, 6@6½; dark, 5½@6. We look for good demand for honey on this market, as the local crop is very light—bees having been destroyed to prevent full brood.

Sept. 11. McDOUGAL & Co., Albany, N. Y.

MILWAUKEE.—This market offers inducements to shippers of honey, as the supply is not large, and values good and prospects of good demand, as the season for consuming honey arrives and fresh fruits get out of the way. We quote fancy white 1-lb. sections, 15@17; A No. 1, 15@16; amber, nominal, 12@13. Extracted white in barrels, kegs, or cans, 7@8; amber, 5@6½. Beeswax, 25@30.

A. V. BISHOP & Co.,

Sept. 7. 119 Buffalo St., Milwaukee, Wis.

CHICAGO.—The receipts of comb honey are heavier, and the demand is hardly sufficient to take all that is being offered. Choice white, in the so-called pound sections, continues to bring 15 cts., while other lines that can scarcely be called choice nor even grading as No. 1, sell at 14 cts.; the light-amber grades bring 12@13; at present there is no dark comb on the market. Some sales have been made of white-clover extracted at 7; basswood, in some instances, has brought nearly as much, but some other grades of white are dull at 5½@6; amber ranges from 5¼@5¾, depending upon the body and flavor; buckwheat and other dark grades selling slowly at 5. There is an easier feeling in bees-wax with 28 cts. about as much as it will bring.

R. A. BURNETT & Co.,

Sept. 7. 199 South Water St., Chicago, Ill.

NEW YORK.—Comb honey is now beginning to arrive in large quantities, and, as a rule, quality is fine. The demand is good. We quote as follows: Fancy white, 14@15; No. 1, 13; No. 2, 12, amber, 11. No buckwheat on the market as yet, but are expecting some within a week or so. Extracted is selling slowly, with plenty of supply, at unchanged prices. Bees-wax dull at 27.

HILDRETH & SEGELKEN.

Sept. 10. 265 Greenwich St., New York City.

DENVER.—No. 1 comb, \$3.00 per case; No. 2, \$2.75. Extracted white, 7½@8. Beeswax, 22@24. Local demand for comb honey is still light, owing to continued warm weather and an abundance of fruit. A considerable portion of the crop of this State has been contracted for by eastern buyers.

THE COLORADO HONEY PRODUCERS' ASS'N,

Sept. 9. 1440 Market St., Denver, Col.

SCHENECTADY.—From present indications the crop of buckwheat honey will be far short of what is promised to be earlier in the season, and this will cause a firmer market for white. We quote white, 14@16; bu. wheat, 11@12. Light extracted, 6@7; dark, 5@5½.

Sept. 9. C. McCULLOCH, Schenectady, N. Y.

CINCINNATI.—Comb honey is coming in fairly. Fancy white clover brings 15c.; other grades in proportion less. Extracted honey is offered much more than a year ago. There seems to be very little demand so far. Lark honey will sell from 5@5½, and lighter grades from 6@7; white clover, extra fancy, 8@9.

Sept. 7. C. H. W. WEBER, Cincinnati, O.

SAN FRANCISCO.—Comb honey, 10@12. Extracted, water-white, 5½@6½; light amber, 4@5½; dark, 4@5. Lees-wax, 26@28.

Aug. 30. E. H. SCHAEFFLE, Murphys, Cal.

PHILADELPHIA.—Honey not arriving very freely, market price not established. Extracted fancy white, 8@9; No. 1, 7@8; amber, 6. Fancy comb, 16@17; No. 1, 14@15. Beeswax, 26. We are producers of honey—do not handle on commission. Wm. A. SELSER,

Sept. 20. 10 Vine St., Philadelphia, Pa.

WANTED.—Western honey in car lots, also northern fancy white comb in no-drip cases; state price delivered. We pay spot cash. Reference, German National Bank, Cincinnati. FRED W. MUTH & Co.,
 Front and Walnut Streets, Cincinnati, Ohio.

WANTED.—Honey; car lots or otherwise. Will send man to receive when sufficient amount to justify, and pay highest market price, spot cash. Address, stating quantity, quality, and price desired at your station.
 THOS. C. STANLEY & SON, Fairfield, Ill.

WANTED.—Write us if you have any large or small lots of extracted honey to sell. State quantity, kind, and price expected and if possible mail sample. We pay spot cash. Reference, Wisconsin National Bank. E. R. PAHL & CO., Detroit & Bdwy, Milwaukee, Wis.

WANTED.—Comb and extracted honey; will buy your honey, no matter what quantity. Mail sample of extracted; state quality of comb honey, and price expected delivered at Cincinnati. I pay promptly on receipt of goods. Refer you to Brighton German Bank, this city. C. H. W. WEBER,
 2146-2148 Central Ave., Cincinnati, O.

Wm. A. Selser, Honey Expert,

When you buy honey, send a 3-oz. bottle, have it tested, to be sure it is pure. Price \$2.50 per sample. By doing this you may avoid over ten times this amount in litigation with pure-food laws. Chemist's certificate given.

The A. I. Root's Co.'s Office, 10 Vine Street, Philadelphia, Pa.

G. B. LEWIS CO., WATERTOWN, WIS.



Bee-hives,
Lewis' White
Polished Sections,
Shipping-cases.



Perfect Goods,
Prompt Shipment.

Special Agency, C. M. Scott & Co., 1004 East Washington St., Indianapolis, Indiana.

AGENCIES: L. C. Woodman, Grand Rapids, Michigan; Fred W. Muth & Co., Southwest Corner Walnut & Front Sts., Cincinnati, Ohio; Fred Foulger & Sons, Ogden, Utah; Colorado Honey-producers' Association, Denver, Col.; Grand Junction Fruit growers' Association, Grand Junction, Colorado; Robert Halley, Montrose, Colorado; Pierce Seed and Produce Company, Pueblo, Colo.; E. T. Abbott, St. Joseph, Missouri, Special Southwestern Agent.

Queens now Ready to Supply by Return Mail

STOCK which can not be **EXCELLED!!** Bred under the **SUPERSEDING CONDITION** of the colony. **Golden Italians**, the great honey-gatherers. They have no Superior and few Equals. Each 75 cts.; 6 for \$1.00. **Red-clover Bees**, the Long-tongue Italians, which left all **Records** behind in Gathering Honey, \$1.00 each; six for \$5.00. **Safe Arrival** Guaranteed. Headquarters for Bee-supplies. **Root's Goods at Root's Prices.**

C. H. W. Weber, 2146-2148 Central Av., Cincinnati, Ohio.

Successor to Chas. F. Muth.

Catalog Free; Send for Same.

THE GLEANINGS

A JOURNAL DEVOTED TO BEES AND HONEY AND HOME INTERESTS.

BEES AND BEE CULTURE

ILLUSTRATED SEMI-MONTHLY
Published by THE A. R. ROOT CO.
\$1.00 PER YEAR MEDINA, OHIO.

Vol. XXIX.

SEPT. 15, 1901.

No. 18



EDITOR HUTCHINSON, wax from cappings is the hardest kind of wax, and the best kind for brood foundation if you don't wire frames.

"FLY-ESCAPES are needed on the windows of a dwelling as much as bee escapes are needed on the windows of a honey-house," says Editor Hutchinson. Bright idea; and he got it from that Kanuck, Jacob Alpaugh.

I'M VERY GLAD to know that the tables are turning with Bro. Doolittle, and that, instead of red clover being worthless as in past years, he has been getting the grand red-clover crop reported on page 712. What a testimonial that is for those yellow bees!

A RULE that I supposed without exception was that, if you found more than one egg in a queen-cell, you might be sure of laying workers. The other day I found two eggs in a queen-cell and a good laying queen present. "Bees do nothing invariably."

"DARK OLD COMBS give to honey a darker color. This is the experience of some—others say no. Why this difference of experience?"—*Bee-keepers' Review*. May there not be a difference as to careful observation? Will not the length of time the honey is in the comb also make a difference in color? Fill a black comb with water, and immediately throw it out, and the water will be clear. Let it soak for a number of days and it will be like ink.

CARBOLINEUM seems to be getting more popular in Germany as a substitute for oil-paint on hives. Editor Weippl, of *Illustrierte Monatsblätter*, says he has used it exclusively for years; prefers it to paint because cheaper, and because it does not close the pores of the wood so as to prevent ventilation; and in spite of its strong smell he has hived swarms in hives painted with it two hours previously, although it is better to let them dry two or three days. I wish I could get some of it to try. [Carbolineum—I can not find it in the dictionary, and do not remember to have

heard of it before. Does it go by some other name in this country? In any case, what are its main ingredients?—ED.]

F. B. SIMPSON, in *Review* and elsewhere, is looming up as a real light upon the subject of queen-rearing. Upon one point, however, it is hard to agree with him. If I understand him correctly, he says that length of tongue is of no value *per se*, only as it indicates the presence of other good qualities. Take two colonies exactly alike in industry, etc., differing only in tongue-length. Would not the greater length of tongue have a cash value *per se* on a crop of red clover? Possibly, however, I do not rightly understand him.

BEES transfer larvæ—p. 714. I don't know whether that's true or not, but I'd like some proof if the assertion is to stand. We do know that it is a very common thing for bees to start queen-cells that are never used; now, why might not queenless bees do that? [Bees transfer larvæ? I could not believe I had said anything of the kind; but, sure enough, the type stands out clear and cold. What I had in mind, and should have said, was that bees transfer eggs, for I have seen them do this. Under stress of conditions they may do the other.—ED.]

IT IS REPORTED in *Elsasz Bienenzuechter* that bees were fed honey that came from cappings that had stood in a zinc enameled dish, and half the bees died. [This might be true; but in that event the quantity of honey was probably small compared with the amount of zinc exposed; but the Californians universally store their honey in galvanized (zinc covered) cans; but the cans hold anywhere from ten to twenty tons; and the amount of surface of zinc exposed to the honey is so small that, for all practical purposes, we might say that the amount of poison is infinitesimal, and not worth considering.—ED.]

"IN THE ARRANGEMENT of nuclei it is always desirable to have something by which young queens can discriminate between their own entrance and that of some other of the same general appearance." That's what the editor says, p. 714, and it's worth saying over again. It applies to hives as well as nuclei.

It is a great mistake to suppose that distance is the main thing. If there is some object by which the entrances can be located, there is less danger of mistake with the entrances two inches apart than with them at two yards apart if the hives are in a long straight row on a dead level, with no other object than the hives to locate the entrances.

WITH SAW KERFS on the under side of hive-covers, end-cleats will prevent warping, but will they prevent twisting? No matter how firmly a cleat holds at each end of the cover, it seems to me that would not prevent the cover twisting so that the end-cleats would not lie in the same plane. [Saw-kerfs would aggravate the difficulty rather than help it. I believe the best solution of the hive-cover problem will be two boards $\frac{3}{8}$ inch thick separated by a $\frac{3}{8}$ air-space. The twisting tendency of one board would be counteracted to a great extent by the other if the two sets of boards are properly nailed and cleated.—ED.]

FORMERLY I supposed that the presence of queen-cells where there was no intention of swarming was a reliable sign that no queen was present. When I take a laying queen from a nucleus and give a ripe queen cell, the rule is that, a day or so later, I'll find the young queen present and a number of queen-cells, which latter may not be destroyed till they have young queens nearly ready to emerge. When I give a caged laying queen to a colony, the rule is that, a week later, the queen will be laying, and queen-cells will be present, although not allowed to proceed to maturity. Even the presence of cells and the absence of eggs is not proof positive that the queen is not there. Sometimes it will be more than a week before she begins laying. [This is true according to my experience. The presence of queen-cells, I think we may safely say, outside of the swarming impulse and supersedeure impulse, indicates the absence of a laying queen, especially if they are in all ages of growth. A ripe queen-cell might, however, be in a hive with a laying queen for a day or two after the queen has been introduced, and this would be the only other exception to the rule, I believe.—ED.]

MR. EDITOR, I had it laid up for you on the question of size of colonies and of bees in normal colonies destroying eggs. I intended to weigh a strong colony, and then crow over you. As a punishment for my wicked designs, when the time came for strong colonies they were not on hand, because the weather was so dry that the bees had stopped breeding. I'm not subdued enough, however, to refrain from asking you why it is that we have such beautifully even combs full of brood all uniform in age if the workers have the ugly habit of lurching upon the eggs at irregular times. Why don't we always see some cells among the sealed brood still open? You will see that Bro. Doolittle makes no allowance for that sort of lurching in his figures on page 712. [When the honey-flow is on full blast, and conditions are normal, I do not suppose there is any "lurching" business going on. Over and over again have I observed that a frame

that had been full of eggs on one day would the next day have them half or two-thirds gone. This was after the honey-flow, and it may have been that supplies were very short in the hive. Just now my memory is not very clear on this point. I still believe as I have before said, that we can figure that not *all* the eggs that a queen will lay will produce workers, by a long way.—ED.]



In speaking about movable apiaries, it seems that Russia is taking the lead in a striking way. The August *Century* gives a view of an immense floating barge anchored at a village, also birdseye view of the deck. The following, taken from *Public Opinion*, will further explain the matter besides prove interesting in other ways:

The Russian educators, in casting about for the best means of economically fulfilling their mission, decided to experiment with immense floating gardens hundreds of feet in length. These great barges, built wide enough to give a comfortable area for the laying-out of a garden, are launched with the breaking-up of the ice. As these floating agricultural-experiment stations drift slowly downstream to warmer climes, the seeds sprout, and grain grows and eventually ripens. On the deck of the great barge is an extensive building, the residence of the professors of agriculture who have the station in charge, and a smaller house for the crew. The size of these buildings, however, is dwarfed by the immensity of the barge. On its great broad deck, besides the vegetable and grain beds, are various working models of bee-hives; for the government is bending every energy to revive this industry, once famous in Russia, when honey mead was the national drink.

As the barge journeys with the current, it stops at every village. The church bell is rung, and the people gather from the fields to be led by the *starosta*, or mayor, to the floating farm. They are invited aboard, where the various plants are explained to them, while illustrated lectures are sometimes given on the advantages of diversified farming. The questions of the peasants are intelligently answered, and seed is often left with the most enterprising for planting. So far the barge experimental farms have proved the most efficient method of spreading the new knowledge of farming in Russia, for the country is one vast plain. The great rivers flowing southward through the rich agricultural prairies take their rise in the dense forests of central and northern Russia. Here the great barges are built late in the fall, the spring freshets are made to save the expense of launching, and when fall comes again the wood of the barges can be sold in the treeless southern country, where wood is dear, and thus made to pay the expenses of the trip downstream. In America we little realize the extensive use Russia makes of her waterways. In European Russia alone there are over sixty thousand miles of navigable waterways, or almost three times the mileage of navigable rivers in the United States.

AMERICAN BEE-KEEPER.

Mr. Hill kindly says:

The editor of GLEANINGS has taken a Western trip, and in consequence thereof has become enthusiastic in regard to the great extent and diversity of all things apicultural in that quarter. His mental expansion is already evinced in his journal to a marked degree. The fact that he quotes Horace Greeley, in his admonition to young men, however, strongly suggests that he has not yet "done" the South.

GENERAL CORRESPONDENCE

THE SWARTHMORE SYSTEM OF QUEEN-REARING.

Arrangement of the Fertilizing-boxes for Mating Numerous Queens in Full Colony on a Single Stand; a Plan Particularly Adapted to Honey-producers, and Those who wish to Rear Queens for Their own Use.

BY SWARTHMORE.

Through the side boards and back end of an ordinary Dovetailed hive-body cut several pairs of holes to match the zinc covered holes in the fertilizing-boxes—six on each side and four in the back, or three on each side and two in the back, according to the size of your hive and the number of boxes you wish to attach. If you object to cutting your regular hives use any old half-depth super or extemporized hive-body. To bring the flight-holes as far apart as possible, have the upper ones up and the lower ones down. Queens take no notice of colors or odd forms. It is the little cluster of anxiously waiting young bees that attracts them. Thus an entrance arrangement that separates the clusters is desirable. Young queens will fly from three to four times in a day, returning each time with the evidence of having met a drone, often repeating the performance for two and sometimes three days. These are false contacts, and are easily removed by the bees. The true connection will show a fibrous substance much resembling strands of fine flax when dry. This the bees do not seem to remove, but it comes away with the first eggs discharged, which, by the way, are not deposited. A young queen will begin laying on the second day after becoming pregnant. Many of the first eggs are drone, and are rarely allowed to develop by the bees. But I digress.

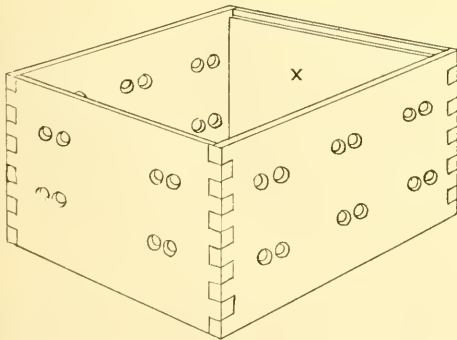

FIG. 1.

$\frac{3}{8}$ -inch holes bored through Dovetailed body, ready for attaching fertilizing-boxes outside.
X, front board, no holes.

Now adjust over each pair of holes a fertilizing-box. Hang the boxes on little wire hooks so they may be easily removed at any

time, or the back lids may be simply tacked to the hive. Have, a little to the sides of each box, small staples or screw-eyes to hold pieces of stout cord for tying the boxes firmly to the sides of the hive.

Those living in a climate where the nights are quite cool are advised to attach the boxes to the inside walls of the hive, and to bore single $\frac{3}{8}$ -inch flight-holes through the hive-body to correspond with the $\frac{1}{2}$ -inch flight-holes in the boxes. This practice is especially desirable in early spring or late autumn; also during long rainy spells. To separate the clusters, tack a plain $4\frac{1}{4} \times 4\frac{1}{4}$ section box about each flight-hole, on the outside walls of the hive.

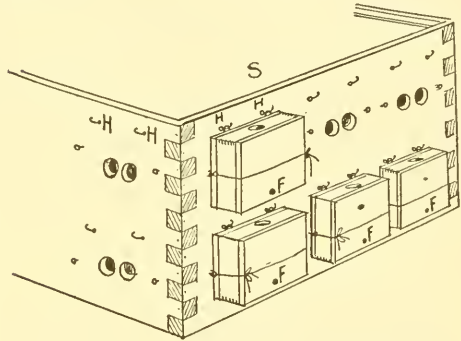

FIG. 2.

FERTILIZING-BOXES IN PLACE ON DOVETAILED HIVE BODY.

F, flight-hole; S, shell-cup queen-cell; H H, hooks to support box.

After you have supplied each fertilizing-box with one comb containing brood, mainly capped, as explained previously, attach one hatching cell to each comb (on the inside lid). A shell cup may be slipped in through a hole in the top-bar, as shown at S, Fig 2, at any time, without the necessity of opening the boxes. Put the boxes all in place on the outside of the hive-body, and tie each one firmly. Fill the hive-body with combs containing honey, capped brood, etc. Bring the brood to the outside walls to attract young bees into the boxes. Unless the queen-cells are ripe, many may fail to hatch, on account of cool nights, dampness, or insufficient bees to cover them; therefore it is far better to run just-hatched virgin queens into each box. Cells hatched in cages, inside the main hive, obviate the necessity of any special or intricate introduction proceedings; for, having hatched in the midst of the bees, each queen is as much a part of the colony as the bees themselves. Bees will not deliberately destroy virgin or laying queens if they are held apart from one another in cages or fertilizing boxes; but if a young laying queen is at large on the combs, every virgin will be balled by the bees at 24 to 48 hours of age. When the laying queen below is an old one, however, virgins will be allowed to live and mate, on the principle of superscedure.

The Swarthmore nursery cage is especially adapted to this system, as the bees can freely enter the cages through the zinc side, and can

become acquainted with each queen as she hatches. Place in cages, in the midst of the mating colony, as many fine cells as you have boxes attached; and as soon as the queens hatch, simply remove them from the cages and run one into each box. Either place the box attachments upon some queenless colony (above an excluder) that has just been used in forcing a batch of cells, or one that has been deprived of its queen three days prior. Place a guard at the grand entrance, to prevent stray queens from entering there.

After all the young queens are laying, run one into the lower chamber, and leave the others in the boxes until needed. They will do no harm if left in the fertilizing boxes for months. We keep them thus from May to November without guards of any kind.

To keep up the strength of the mating colony where no queen is run into the lower chamber, add full combs of brood inside the hive-body; but be sure that no brood given is young enough for royal appointment. When the time comes for removing the young queens for shipment, or use in the home yard, they may be taken *one* or *all* at a time; but no attempt to introduce other virgins should be made until all the laying queens have been removed from all the boxes three days.

To take away the queens, loosen the knot and remove one lid at a time, as previously directed. Northern breeders can keep extra queens for late autumn delivery way up to frost, by placing the boxes, queens, bees, and all inside an empty hive-body, directly on to the tops of the frames below. Leave ranges between the boxes so that the bees can cluster about and enter all of them. Fill the remainder of the hive-body with quilts tucked in nice and warm, then cover all with a good rain-proof lid.

By tiering hive-bodies and utilizing the top of the hives, as well as the sides and ends, provision can be made for mating forty queens at one time from one full colony.

By having cells of different ages, one to three days apart at hatching, a large number of boxes may be attached to a single hive; for by alternating the queens of different ages about in the boxes, no two coming close together are in flight on the same day; therefore the loss from possible mixing is slight. It is only a question of skill and a thorough knowledge of the habits of young queens, with a cunning planning of remote flight-holes, when any bee-keeper may successfully mate innumerable queens, all from one powerful colony, on a single stand.

[This scheme of fertilizing-boxes looks as it might work. I say *might*, because several have already written, stating that they do not believe that the Swarthmore one-comb fertilizing-boxes, as described on page 436, May 15, would work in the hands of the average person, particularly during the robbing season. The objection made is that, in small one-comb nuclei, four or five inches square, there are too few bees to secure good results. In the arrangement above, Mr. Swarthmore

seems to overcome this objection, and now it remains to be seen whether others can secure the same result Mr. S. does. A little later on, I hope we ourselves may be able to speak from experience on both methods of having queens fertilized.—ED]

RAMBLE 191.

Some Inventions.

BY RAMBLER.

After your good sense has induced you to get a good hive, it is then necessary to have a good cover; and that is a rock upon which bee-men split. We have discussed the cover matter in GLEANINGS quite a little, and the subject is not exhausted. My pet cover is made of redwood sawed shakes, and double, as shown in the drawing. This cover will hold its shape in hot climates, and gives an air-space, which is necessary in hot locations. Paper can be used on this cover, and in the air-space, where it will be protected. I use cleats, making the air-space a full inch, and nail the middle cleat an inch from the center.

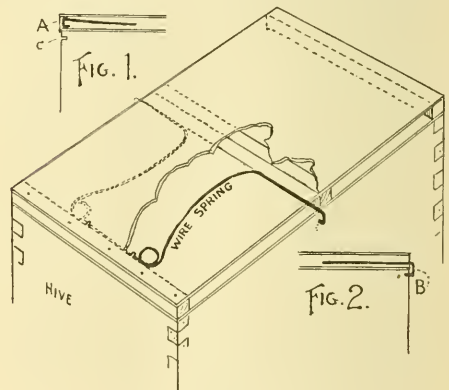

The reader of bee-lore has learned that in California, and especially in the southern part, several wagonloads of stones are distributed around on the hives in an apiary. A little improvement in my cover will enable the bee-keeper to dispense with the bothersome stones.

A stiff wire, $\frac{5}{8}$ in diameter, is bent as shown in dotted lines, and fastened inside the air-space. The hooked ends project only when in use, and then they grip strongly into the edge of the hive where a small hole is made to receive the points. The spring, or tension, of the wire causes it to grip. These grip so tightly that the whole hive can be lifted by the cover. When released from their grip on the hive the hooks retire into the air-space, entirely out of the way.

The editor saw one of these covers and fastener, and indorsed it. He might have been influenced that way by some of my flapjacks, for he had just eaten his fill of them under our fig-tree.

And now that we have exhausted the hive-and-cover matter, I will show you another device the editor indorsed. The half-tone will show you the nature of the device, without much description. It is for loading a queen-cage with queen and bees, and not touching a bee. The broad end of the cage has a sliding cover; the narrow end, a little tin gate or

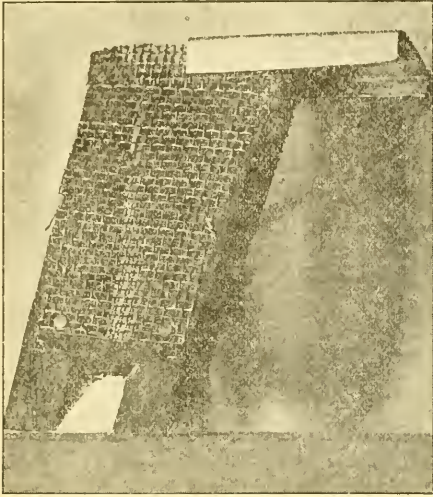

slide. To operate, take the slide off the large end; and when you have found the queen, set that end down over her. As soon as she runs up into the cage, place the finger over the end, then slip on the tin slide, and you have her. Now place the beveled small end under the wire cloth on the shipping-cage; pull out the little gate, and the queen will immediately run into the cage. Now withdraw the catcher, and with the big end and your finger scoop up a lot of bees, and run them in, or as many as you need, and the work is done. It

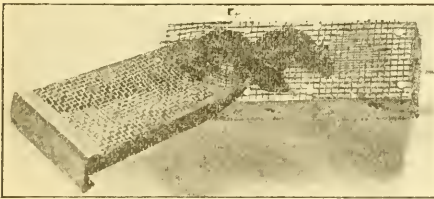

QUEEN-CATCHER.

may be done as quickly by the plan of picking up one at a time; but this way is certainly safer for the queen.

As I walked by myself I said to myself, "John Rambler, you are a back number."

An echo from the editor under the fig-tree whispers, "Not in the line of flapjacks."

I found myself asking myself a queer question a few mornings ago. Said I to myself,

and myself said unto me, "Say, John Rambler, did you know you are getting to be a back number?"

"So ho, John Rambler, that may be; but there's lots of company on the same road.

"There is Doolittle. His queen-rearing was away up to date; but now Swarthmore leaves Doolittle away down cellar under the back kitchen. Yes, sir; Doolittle feels it, and is trying to catch up by whacking at long tongues. Can't do it; out of breath; knees stiff; under the fence.

"There's Dr. Miller, a back number, holding on to the T super like a tick to a sheep's back, out of date fourteen years ago, don't you know? Then the doctor keeps grinding away with that same old Straw-cutter; cogs slip; the feed-gear all out of whack; needs oiling. If you must run the old machine, do grease it up, doctor.

"Now I am getting right down to business, there is A. I. Root. You wouldn't think it, but he is a back number. He used to tell us how to make good serviceable hives out of good well-seasoned $\frac{7}{8}$ -inch lumber. Somebody shows him a hive made of $\frac{1}{2}$ -inch lumber; claps his hand on the fellow's back, and says, 'Yes, sir; that is a good thing.' Dear me! It worries me to think of it."



WEE-WAW HIVES.

Look on the accompanying picture. The first hive on the ground is a good $\frac{7}{8}$ -inch one—has seen much service, but it is still strong. The super upon it is made from a kerosene-case, $\frac{1}{2}$ -inch sides, and improperly labeled; for if the super itself does not explode, the fellow who handles it will use explosive language. After a few months' use it becomes what I term a wee-waw super, remarkably loose jointed, and, when plac'd upon the top of the good square hive, see how much out of square it is—just the thing for a careless helper to use. He would leave half of the colonies in the apiary with center ventilation.

Anybody can readily see the season why it becomes "wee-waw." There is not enough thickness of lumber to hold the nails firmly. To be sure, it might be nailed often; but many nails weaken the holding parts, and it spreads at the corners as shown in the next hive. The only way to hold it in at the corners is with those corner-clamps used on fruit-boxes, and shown on the next two hives; but even these clamps do not prevent the wee-waw appearing in due time.

Well, let's see. Suppose we put them on with a lock corner or dovetail. That would certainly help matters; but still, there is that thinness of lumber; and unless the grain is straight there are little corners breaking out, splitting half way along the lower edge. Any way you can fix it, there is an everlasting bother in the use of a hive made with $\frac{1}{2}$ -inch sides.

Did you ever turn a wee-waw super up side-wise and sit down on it? I saw a fellow do it the other day. The super collapsed, and the fellow went to the ground with his heels in the air. A good $\frac{3}{8}$ inch hive can be used for a seat or to stand on or to dance on. It is the only hive fit to use.

[Rambler's flapjacks are all right, and so are the other things he shows, except—except—well, the half-inch hives. I saw him at Rambler's, and if they wouldn't make a fellow "explode," I don't know what would.

Some of these old "back numbers" are all right, even if they do let a "cog slip" once in a while. The fact that some of their machinery has gotten out of gear a few times helps us young fellows in that we are careful not to use the same kind of gear. The mistakes of the veterans are often more helpful than their successes.—ED.]

THICK TOP-BARS, AGAIN.

A Thorough Examination of the Subject by Two of Our Best Authorities.

BY S. T. PETTIT.

Dr. Miller and the editor seem much excited over my article on top-bars, p. 227; also p. 380. In the footnote the editor says, "We first tried top bars that were wide and only $\frac{1}{4}$ in. thick. We had trouble from such bars sagging, and the building of burr and brace combs." I want to say, had those $\frac{1}{4}$ inch-thick and $1\frac{1}{8}$ -wide top-bars by some means been kept straight, they would have remained as clean as the cleanest the editor ever looked upon—yes, they would. I can not for the life of me understand how it can possibly be that the editor's experience shows him that brace-combs are more plentiful by the use of $\frac{3}{8}$ -thick than $\frac{7}{8}$ -thick top-bars. Is it possible that the length of the L₁ top-bar allows it to sag when only $\frac{3}{8}$ thick? But after all, respectfully, I wish to say I firmly believe the editor is all mistaken in that. My experience with $\frac{3}{8}$ -thick top-bars covering about 15 or 16 years is altogether different from his statement.

Dr. Miller (p. 380) says, "His strong point is that, by having $\frac{1}{4}$ inch more depth, the space of 1600 to 2000 cells is lost." Yes, that is my strong point; but there are other strong points. I will notice them further on.

No, I did not make the mistake of "counting that the same number of bees were occupied brooding those sticks as would be occupied in brooding $\frac{1}{4}$ -inch depth of comb." I neither thought it nor said it. This is what I did say: "The saving of that space in each

hive is a matter worthy our best consideration." Most certainly 1600 to 2000 cells in an average hive are of far more value than useless lumber, adding weight and unnecessary expense. I trust, with due consideration, the doctor will agree with me; but I must not forget that prejudice is an exacting, unrelenting tyrant. Then he proceeds to use up about half a column, and proves nothing, only that he "don't know" what he is talking about. His ferocious clip at an imaginary object hit nothing—it's all wasted energy.

Further on he says: "So if the prevention of burr-combs by deep top-bars be all a delusion—which I do not believe." Well, I presume I can show the reason why he does not believe it. He did not make thorough experiments to know for himself; but he came to his belief by—well, I guess I can not do better than to give the words of E. R. Root as follows: "Dr. Miller was greatly struck with the idea; and after some extended correspondence with the doctor we decided that we would launch forth for the ensuing year the new top-bars." Then later they imagined that they evolved the new top-bar by revolving around each other by the coat-tail—a clear case of conviction not founded upon personal practical experience.

Below I quote from a letter sent me from the United States dated April 4, 1901: "I have read with much interest your article in GLEANINGS for March 15, and want to say that I indorse all you say in regard to wide and thin top-bars, and bottom-bars $\frac{3}{4}$ inch wide. For a number of years I have been using a top-bar $\frac{1}{4}$ inch thick and $1\frac{1}{8}$ wide, and not a burr-comb on a single frame in 8 years' use. A few days ago Mr. Cruikshank, near this town, called upon me, and, in alluding to this discussion, said he uses $\frac{3}{8}$ -inch thick top-bars, and has no bother with burr or brace combs." But the doctor says: "I still want the $\frac{7}{8}$ top-bars for the sake of having the sections so far from the brood-combs that the bees will not find it convenient to carry up a lot of black wax to spoil the snow-white sections." This statement reveals the fact that he has not yet learned all the valuable uses to which the queen-bar, or perforated metal queen-excluder, may be put. My practice is to get the sections just as close to the brood as I can, preserving all the necessary bee-spaces. To this end I want thin top-bars. Then to prevent the bees moving up dark wax, and to bar the drones with their filthy habits from the sections, to keep the queen in the brood-chamber, and to restrain pollen, I use a queen-bar, or an all-metal perforated zinc queen-excluder, which has a $\frac{1}{4}$ -inch-thick rim and two cross-pieces to keep it rigid.

This arrangement gives the same space between the top-bars and sections as the deep top-bars with all the extra advantages enumerated; but I would bring the sections closer to the brood if I could, and not dispense with the queen-bar.

On page 380 the editor says: "It seems to me that our friend Pettit assumes, or indirectly assumes, that those 1600 to 2000 cells are lost because of the brood that might have

been reared in them." Exactly so; and that is what hurts. Continuing he says: "But it is very seldom that brood is reared any closer than within an inch of the top-bar, with ordinary L. frames." Well, if that be so, then verily the management is faulty—yes, very bad indeed. Let me explain by giving my practice. I want practically all the brood-chamber for the queen. All stocks, weak and strong, are kept warm by keeping a warm cushion upon each; then, when the early flow sets in, to all strong stocks a super filled with comb is given, with that warm cushion on top, and a queen-bar to keep the queen down. Then the surplus honey will go into the super, and the brood and pollen will generally fill every last cell to the top-bars. Of course, there will be honey in the corners; and the thinner the top-bar the less the burr-combs and the more the brood. While the weather is cool a few cells along the top-bar, especially when the bees are not up to best condition, will contain unsealed honey and pollen; but as the heat increases, brood will come to the top-bars.

Twenty-five or twenty-six years ago I commenced to use a cushion on my hives; and when the comb or extracting-super goes on it goes up. It stays right on, or its equivalent, summer and winter. Mr. E. R. Root is just now finding out the benefits of a warm cushion, and so it will be with the thin top bars; but I hope it won't take him a quarter of a century.

Aylmer W., Ont.

[In order to enable the reader to make a better comparison of the points at issue, we deemed it best to have Dr. Miller's answer follow here instead of waiting till a later issue.—ED]

In the matter of thick or thin top-bars, there are several different points to be considered, and it is of some consequence that we keep them separate. One question is: Does thickness of the top-bar *per se* have a direct bearing upon the matter of burr-combs between top-bars and sections? Quite another question is this: If thickness of top-bar has of itself no bearing upon the matter of burr-combs, is it practicable to use thin top-bars without getting into trouble otherwise? Still separate from these is the question: Is there any sufficient reason for thick top bars aside from the matter of burr combs? And again: If the same end can be reached by other means than thick top-bars, which plan on the whole is best?

As to the first question, I have said I don't believe that the prevention of burr combs by deep top-bars is all a delusion. I have not said it is certain that deep top-bars are absolutely necessary to prevent burr-combs. I don't know. And knowing and believing are two quite different things. I'm afraid we don't know any thing on this subject as positively as we might. An experience of 16 years with top-bars $\frac{5}{8}$ thick makes friend Pettit think a greater thickness would be no better. Mr. Cruikshank says he has no trouble with burr or brace combs while using top-bars

$\frac{5}{8}$ thick. Editor Root says that actual trial gave more trouble with $\frac{5}{8}$ than $\frac{7}{8}$ of thickness. Mr. Pettit gives the remarkable testimony of a man who had "not a burr-comb on a single frame in eight years' use," and his top-bars were only $\frac{1}{4}$ inch thick! Amid this conflict of testimony, what is one to believe? One says a thickness of $\frac{7}{8}$ is necessary, and Mr. Pettit brings testimony that makes no greater thickness than $\frac{1}{4}$ inch necessary, while he finds reasons in his own experience to make $\frac{5}{8}$ necessary. Possibly a difference in hives, localities, or conditions may have something to do in the case.

Without pretending to have settled the first question, what about the second? Sufficient rigidity, in Mr. Pettit's case, required a $\frac{5}{8}$ -in. top-bar, while $\frac{1}{4}$ gave sufficient rigidity in another case. The question arises in passing: If $\frac{1}{4}$ gives sufficient rigidity, why should Mr. Pettit need two and one half times that thickness? It is probable that there would be general agreement that no more than $\frac{5}{8}$ is needed to prevent sagging.

To the third question it has been answered that the thickness of top-bars tends toward whiteness of sections by increasing their distance from the black brood-combs; and to the closely connected fourth question it is answered that a queen-excluder will answer the same purpose. This, however, does not answer the question fully, for it still leaves unsettled whether the excluder or the thick top-bar is better. Right here is a good place to allow the manufacturer a word, and I may be allowed to quote from one, who says: "This is an exceedingly important matter; for if top-bars of brood-frames under proper conditions are just as good $\frac{3}{8}$ thick as $\frac{7}{8}$ we could make twice as many out of the same material which we now use in making such a large quantity each year. It would save a good deal of freight charges to customers, and the first cost and selling price could become lower. I presume it is a question on which there will always be a difference of opinion, but there ought to be strong grounds for continuing the $\frac{7}{8}$ top-bar if it is to be continued."

Most surely this should have due consideration. It is not, however, a question, in Mr. Pettit's mind, between $\frac{3}{8}$ and $\frac{7}{8}$, but between $\frac{5}{8}$ and $\frac{7}{8}$, with our present knowledge of top-bars. If the use of an excluder makes no greater thickness than $\frac{5}{8}$ necessary, is it right to oblige one to have a greater thickness if he would in any event use an excluder? The argument for whiteness of sections loses all its force with those who produce extracted honey. It also loses its force with such as Mr. Pettit, who would probably use an excluder anyhow. But there is a large number of comb-honey producers who feel no need of an excluder for other purposes, and the question is whether it will be cheaper for them to secure whiteness of sections by means of excluders or thicker top-bars. Mr. Pettit seems to think that, if I understood the full value of excluders, I would want to use them under sections. I value excluders, and have something more than a hundred on hand; but I would rather have them lie idle, as many of them do, than

to put them under sections. His reasons do not appeal to me, for the amount of pollen in my sections would not pay for the extra trouble of handling excluders if they cost nothing, and along with this goes the trouble of the queen going up, and my drones are not addicted to filthy habits in the super. So in my case, at least, if excluders could be had free I would decidedly prefer to secure whiteness of sections by means of thicker top bars. The extra thickness costs a trifle compared with the expense of excluders, and the time taken to handle the excluders costs something.

Mr. Pettit is in error in supposing that Mr. Root and I imagined that by any process we had evolved thick top-bars. I don't know where the first evolving was done, but I suspect it was in the brain of that very practical countryman of Mr. Pettit's, J. B. Hall. Mr. Root speaks of getting the idea from him ten or twelve years ago; but my interest in thick top-bars antedates that by several years. In 1883, at the exposition at Toronto, J. B. Hall, in a neighborly way that I have never forgotten, showed me a hive containing thick top-bars, and told me why he used them of such thickness.

Mr. Pettit thinks prejudice has a strong hold upon me—a fact of which I am only too painfully conscious; but I try to be free from prejudice where my pocket is concerned, and as yet I do not see what I could gain by changing to thinner top-bars with the addition of excluders. It is only fair to say that in either case, and I have tried excluders on a somewhat large scale, and, indeed, in any case that I have tried, I am not as free from brace and burr combs as I should like. If Mr. Pettit finds it necessary for other reasons to use excluders, and if with $\frac{5}{8}$ top bars he is entirely free from trouble, then I have no quarrel with him for using no greater thickness than $\frac{5}{8}$. But I should advise those who are just beginning, before investing in a full outfit of excluders to determine whether Mr. Pettit's experience or mine would best fit them.

Marengo, Ill.

C. C. MILLER.

[I was not aware that either Dr. Miller or myself was "excited" over this thick-top-bar matter. Is it not possible that friend Pettit himself is a little bit on that order? When he talks about "ferocious flings," and intimates that both the doctor and myself are under the spell of prejudice, "an exacting and unrelenting tyrant," and our "revolving around each other by the coat-tail," one would think *his* equilibrium was a little bit disturbed. There is no occasion for excitement, for truth is what we want; but in the discussion of this question I fear we all lose sight of locality. After having gone through the great West, I am frank to acknowledge I have changed my views materially on some things; and I believe that, if our friend Pettit were to make a similar trip, he would be less positive than he now is. When one makes a strong statement he ought to limit it to his own locality.

Pine lumber behaves very differently in different parts of the United States. A top-bar that would not sag in one place might warp,

twist, and check very badly in another. Still again, we do not all use the same kind of lumber. In the South the yellow pine is used; in some parts of the middle West, whitewood; along the Pacific coast, Oregon pine, Oregon spruce, California redwood, and sugar pine are much used for top-bars, and all these timbers have peculiarities.

After all, as I understand it, Mr. Pettit, Dr. Miller, and myself are not very far apart in our views; and while I rather favor a top-bar $\frac{7}{8}$ thick, Mr. Pettit argues for $\frac{5}{8}$. As to the matter of width, I think there is no difference in opinion; therefore the only difference between us is in the thickness of the top-bar, and *that only* $\frac{1}{4}$ inch. I am willing to admit the $\frac{5}{8}$ bar gives very good results in some localities when some kinds of lumber are used; but the kind of bees, the kind of honey-flows, the depth of bee-space over the top-bars, are other factors that help to make a great variety of opinion. In discussions of this kind we should be broad enough and fair enough to believe that every man is telling the exact facts according to his locality, until we know what are the conditions of that locality.

As to the other points raised by Mr. Pettit, I can only refer to what I have already said on pages 227 and 380.

I do not wish to convey the impression that we of the Root Co. are wedded to $\frac{7}{8}$ inch, and can not change to $\frac{5}{8}$. Some conditions in the West, as I have observed them, may render it necessary to make a $\frac{5}{8}$ bar for those parts of the country. Rather than have two thicknesses and the resulting confusion, we may make for our Eastern trade a $\frac{5}{8}$ bar, even though we may have the feeling that there will be a slight increase in brace-combs.

There is one point to which Mr. Pettit refers, and that is that he succeeds in getting his brood built clear up to the top-bar in L. frames. If he can do that with pure Italians, without reversing, then he can do more than we can do with ours, even with cushions, and more than any one else I have ever met. We can accomplish the result with Syrian or Holy Land blood; but we prefer to have a little honey in the brood-nest rather than to have such bees in the yard.

There are very few producers of *comb honey* who use queen-bars or perforated zinc between the upper and lower stories. If a $\frac{5}{8}$ top-bar necessitates excluders and another bee-space, then it would be cheaper for bee-keepers to use the $\frac{7}{8}$ bar without the excluder. As a rule, excluders between the upper and lower stories are used in the production of *extracted honey*, and to only a limited extent have I noticed them being used in the production of comb.

To illustrate the difference in locality, I produce here a sample of some of the letters we have received. Here is a man, for example, who says a $\frac{5}{8}$ -thick top bar is all right, but a $1\frac{1}{2}$ top-bar, advocated by friend Pettit, is "an abomination." Well, we will let Mr. Atwater, whom I met in Idaho recently, speak for himself.

Mr. Editor:— "The *frame's* the thing with which I'll catch the conscience of the

kings" (Root, Doolittle, Dr. Miller, and others). Here comes Pettit, in *American Bee Journal*, crying for a thin-top-bar frame, but advocating width as essential for the prevention of burr-combs. Mr. Pettit, I believe, speaks from the view-point of the comb-honey producer—at least I can scarcely tolerate the $1\frac{1}{8}$ -inch-wide top-bar in extracting-supers. A few firms are pushing a thin-top-bar Hoffman frame, "better and cheaper;" believe it not; they sag, not a little, but too much. I have had wired frames of this class sag fully $\frac{1}{2}$ inch when heavy with honey. The old-style molded top-bar frame about $\frac{3}{8}$ inch thick has never sagged, even when used as extracting-frames, answering perfectly for combs weighing as much as 7 to 10 lbs. In our yard we have in use hundreds of old-fashioned triangular top-bar L. frames, $\frac{7}{8}$ inch wide; and for extracting, and ease and rapidity of uncapping, they are away ahead of the modern (?) $1\frac{1}{8}$ -inch-wide top-bar abominations, and my combs *are* built out thick, as I use only 8 combs in most of the 10-frame extracting supers.

Now Doolittle, in *Amer. Bee Journal*, tells us that he uses top-bars $\frac{7}{8} \times 1\frac{1}{8}$. If a top-bar of this thickness will not sag, it would be a little better than a thickness of $\frac{3}{8}$ inch or $\frac{7}{8}$ inch; but the width would make it any thing but a good frame for extracting. What, then, shall we have? My answer, dictated by somewhat limited experience, is that, for the producer of extracted-honey, a top-bar $\frac{7}{8}$ inch wide is the very best. The thickness must be sufficient to prevent sagging, perhaps $\frac{3}{8}$ inch. Let us hear from the veterans in the production of extracted honey, for dissatisfaction with the $1\frac{1}{8}$ inch top-bar is abroad in the land.

E. F. ATWATER.

Meridian, Idaho, Aug. 12.

[I would state for the benefit of Mr. Atwater, as well as for Mr. Pettit, there is a large number, in the West especially, of extracted-honey men who will not have a wide top-bar. They insist that their extracting-combs shall have narrow bars so they can uncup easily. If the combs bulge much, they not only uncup but cut off the bulges; and these bulges of wax, they contend, help to increase their profits, as they consider wax production an important part of the bee business.

Another, who owns 500 colonies, Mr. W. L. Chambers, of Phoenix, Ariz., wants his top-bars *one inch thick*. Yes, it is perfectly true that we can not bring every one to our standard of measure. The fact of the matter is, the Root Co. makes several different styles of frames, and we supply for the Western trade narrow top-bar frames almost by the carload. —ED.]

A RELAPSE OF BEE FEVER TO AN OLD VETERAN IN THE BUSINESS.

BY MRS L. HARRISON.

Mr. Editor:—I've had a relapse of bee fever. It appears strange, since it has been so many years since I had such a severe attack, and it came on so suddenly too.

Last season I filled the second story of an L. hive with empty combs to protect them; and in the fall, when I prepared the bees for winter, I let this colony alone, excusing myself by saying we have such near neighbors if I stir them up by taking out those combs to extract them, some one may get stung, and run after the police. So I told the bees I didn't believe they had much honey any way, and that they were welcome to all they had.

This colony verified the truth of this saying, that bees build up stronger in spring when they have a full pantry. They knew that there was no danger of their children starving, and reared a large family. They soon became so strong as to hang out, and Mr. Harrison divided them, putting empty combs into the upper story.

One morning, while enjoying my rocking-chair in the shade of a catalpa-tree, I said to myself (I'm deaf, but she can always hear), "I'll not let that colony have all the honey they gather this year—so I'll not." I left my rocking-chair, and went into the honey-house. I tackled the extractor that had long remained idle, took out the gearing, washed and oiled it, and felt so good that I oiled the pump and clothes-wringer. Spiders had taken possession of the inside of the extractor, and I enjoyed slashing the water around; washed the tin bucket for carrying combs; sharpened the uncapping-knife, and scraped out the smoker, all the time my enthusiasm growing, and tingling in my finger tips. I felt youthful, and full of love to God and man.

I lighted my smoker, and paid my respects to the bees. They were civil, and treated me like a lady. I gave them a little smoke at the entrance, and then on top of their combs, and removed them to the honey-house. How delightful to uncup and put into the extractor, and see the honey running out into a jar covered with cheese-cloth! And now we have a nice jar of honey for our cakes another winter.

A friend told me lately that, during the blooming of his tulip-trees, there was a sound as if a swarm were among the branches. These trees are large forest-trees, and were transplanted many years ago from the Wabash Valley, of Indiana. It appears that they bear honey in this locality.

During the great heat and drouth, bees carried much water, and appeared to gather some honey. It may have been from the button-bush, as the Illinois River lowered. White clover is yet blooming in yards that are watered from city hydrants, and sweet clover has taken possession of all uncultivated land. Residents call it weeds, and call on the police to cut it down; but, like the children of Israel, the more it is persecuted the more it multiplies and grows. Bees work upon it much of the time.

I doubt if this locality will ever yield honey in the future as in the past. Paved streets and shingles yield no nectar. Lands that were overflowed and left uncultivated are becoming valuable and drained; where the plow and reaper go, there is small chance for bees. It appears to me that it would be for the good

of the country if bees were evenly distributed, many persons keeping a few colonies to fertilize fruits and clovers.

Peoria, Ill.

NOTES OF TRAVEL.

That Bee-keepers' Paradise in Texas.

BY E. R. ROOT.

When I left San Antonio, Texas, I took the train for Uvalde, about 80 miles west, on the Southern Pacific R. R. There seemed to be nothing particularly inviting in the country I went through, for the land seemed to be covered with desert-like shrubbery; when, therefore, Uvalde was called out by the train-man, I could not think what there could be in that apparently God-forsaken country to support bee-life to such an extent that carloads of bee-keepers' supplies should be poured into it and train-loads of honey go out.

Uvalde proper—that is, the town—is about $1\frac{1}{2}$ miles from the station; and as we got up into the suburbs of the village I began to see evidences of thrift and good homes. I went first to the hotel, and prepared to put up for the night. At the supper-table that evening I was surprised to hear talk about bees, hives, and honey prospects, just as one does here hear talk about grain crops in a farming community. As no one knew of my coming unless he consulted the register (and probably would not know me any way), I was an interested and a silent listener. Sometimes the talk changed to cattle-raising; then it would veer over to bees, honey, and hives. Said the owner of a weather-beaten face, with scraggly beard all over it, hair somewhat disheveled, a typical Westerner, with brawny hands, and big cowhide boots, "Wall, I reckon I can make my own hives—don't cost so much. Then you know I am a jick at all trades. Yes, I am quite handy in the use of tools."

Some one across the table ventured to remark that he preferred "factory goods," as they are made better.

"Mine are good enough for me, and I will put them aside of any of your Rute goods or Lewis goods, or any of your highfalutin' stuff."

And then, as if to qualify what he had said, he continued:

"Rute goods are all right, only I just won't pay his prices—freight is high, you know; and then I guess Rute likes to make a little too much off'm us fellows. No, I can make my own goods, and save Rute's big profits; but I'll allow Rute goods are good goods."

At this juncture I could not restrain myself any longer, and, turning to him, I said:

"I am very glad to hear you make that last remark, for my name is Root."

His eyes swelled under those shaggy overhanging eyebrows, and finally, recovering himself, said:

"What! you Rute? Wall, now! Say, stranger, I did not mean to run down your goods, for they are all right; but you know a

fellow can't afford to pay freight. You a'n't to blame for that. The S. P. road robs us."

"Certainly, my friend; you spoke highly of our stuff, and that is why I spoke."

But he seemed to feel that he had given me offense; and if he apologized once he did it half a dozen times while the rest of the men at the table were having a good laugh at his expense. I assured him his logic was all right, and that I had no doubt he could make just as good goods, and save money; and that if I were situated as he was, and could do accurate work, I would do just as he was doing.

After supper I sat out on the veranda, and heard bee and cattle talk intermingled. I was still an interested listener—the more so, as I knew that only a small number had heard the conversation at the table. I finally went to my room, which was just adjoining the veranda, and when the men thought I was out of hearing I could hear them laughing at the expense of our old friend—I can not remember his name—and the "slick way" he had "punched the ribs" of one of the Roots.

Knowing that D. M. Edwards was the "great bee-king" of the whole county, and of this fact I obtained evidence afterward, I sought out that gentleman the following morning. Everybody knew him, and I was told to go down to such a street, turn to the left, go so many squares, then go down another street—well, in trying to carry out my instructions I got all mixed up; so I turned to a man who was working in a back yard of one of the homes. I asked him if he could tell me where Mr. Edwards lived.

"No sabe,"

Not catching the reply, I looked into his swarthy face, surmounted by a great peaked hat. I repeated my question, thinking I had been misunderstood. Back came the same lingo. I kept saying it over to myself, not knowing what it meant. After a little more wandering I found Mr. Edwards within a stone's throw of the "greaser" with whom I had been talking, and who persisted in hurling at me his "no sabe." Mr. Edwards was busily occupied in the rear of his pretty home when I called. I found him to be a man of pleasing address, and, after I had introduced myself, I related to him my experience with the aforesaid greaser.

"What! that man over there?" pointing.

"Yes," I said.

"Why, he knew perfectly well what you asked, but, like half the Mexicans, rather than give you a civil answer he fired at you the usual 'no sabe,' meaning 'don't understand,' when he did. But if you owed him some money, you would find he could 'sabe' with the rest of us."

All through my western trip, even extending into California, I found it was almost impossible to get a direct answer from many of the Mexicans or greasers. I had the words *no sabe* (no sobby) fired at me so many times that my impression of the average half-breed is that of a man who is suspicious of the Anglo-Saxon, and who prefers to hide under the cover of "no sabe" rather than to extend an accommodation.

Lest I may give offense to some very worthy and excellent Spaniards and Mexicans I met, I would say I do not mean to include them in the term "greaser" and "no sabe" people. Well, to return :

I pulled out my largest camera and took a picture of Mr. Edwards, and here reproduce it the size I took it. He is indeed the bee-

assistance or start ; for when one expects to go into the bee business, about the first thing he is told to do is to go and see Edwards ; and Mr. Edwards is one of those broad-hearted, kindly faced men who will give his neighbor intelligent and satisfactory answers to his questions even though that information may be the means of bringing on to his territory a



D. M. EDWARDS, ONE OF THE PIONEERS OF UVALDE BEE PARADISE.

king of the whole county—one of the pioneers. He handles bee-keepers' supplies, and is one of that kind of men who can stand up and answer questions by the hour. As nearly as I can learn of some of his friends, nearly every bee-man in the county has either come in contact with him or received some sort of

bee-keeper who will come in and divide the profits of his bee-range ; and right in this connection I would say that one of the bee-paradises—this one in Uvalde Co., is pretty well overstocked with bees now. I do not think there is a single spot in the whole county that does not have all the bees it can possibly sup-

port, and more too. When I referred to a bee-paradise in an editorial, recently, I not only included Uvalde Co. but some of the adjoining ones, and some in New Mexico; and hence when I wrote on the train, riding as I was through New Mexico, that there were not enough bees to gather all the honey, I did not have in mind Uvalde Co., which I knew perfectly well was fearfully overstocked. But Mr. Geo. F. Robbins, who has been in the vicinity, got the impression that I referred to that alone, and enters, and justly so, a vigorous protest against the sentence as it stands. As he has some other things in this connection, I publish this letter just as he gives it.

I am prompted to write these lines much from personal desire, but partly by Huber Root, with whom I had some talks at Buffalo. The cause is some statements made by Ernest, in June 15th GLEANINGS, pp. 520 and 523. I assume that the notes pertaining to the bee-keepers' paradise and to Uvalde County both refer to the latter region. I agree with him that this is a wonderful honey country. I don't think any other tract in the world, 40 miles square, will support so many bees and bee-keepers, and send out so much honey. In June, 1900, I was told at the station that they were then shipping nearly 5000 lbs. of honey per day. That was no small thing, even for a station that is the shipping-point for a radius of 25 miles in every direction except east. I can go with Ernest nearly all the way; but when he says "there are not bees enough to gather the honey," I halt. Against such teaching I, as one who lives in one of the best tracts of this land of bees and honey, must enter an earnest protest. I say it is overstocked; and I think I can safely challenge you to consult the bee-keepers of Uvalde Co. and see if the majority of them do not sustain me.

Last fall a bee-keeper near Uvalde asked me what I would take for a location we have in Nueces Co., some 20 miles northwest, saying he wanted to put an apiary there, but didn't want to intrude on others' territory. I told him I would rather he would keep out. He did, and distributed some bees he had bought among his three apiaries, I suppose because he couldn't do any better. I firmly believe the small crop of himself and his neighbors this year is largely due to the crowded condition of his range.

Last spring I tried to rent a certain location of a cattle-man. I could not get it, but he offered me a less desirable one for \$50 00 per year. He thought he could get that, for six or eight men had tried to rent bee locations of him that winter (I don't think he rented it). I could give several other instances to show that there is a perpetual scramble for bee territory.

Some five years ago Mr. Edwards told Mr. Flanagan that all the good available locations were even then taken up. I know of quite a number of apiaries that have been crowded in since then.

I want to refer to two other statements in the notes before referred to. You say, "The average is high, and there is a crop every season." There was a period some years ago when that seemed to be the case. That is what started so many in the business. But, taking the last five years as a basis, not many bee-keepers here would say that. A case of 120 lbs. is, I believe, generally considered a good crop. This means "chuck" or comb honey in cans, about 25 to 33 per cent of which, in fact, is extracted. There is often considerable variation in tracts a few miles apart. This year, for example, on the upper Nueces, from a point about 12 miles from Uvalde, the crop has been much better than in any other part of the county so far as I have heard. Taking the county at large there has been little if any over half a crop gathered in the last five years, while in 1899 failure was almost general and complete.

The third statement I question is that to the effect that a honey-flow will stop swarming. I do not directly dispute it, but I do say the broad assertion that bees will, at the advent of the surplus season, destroy cells, kill off drones, and settle down to honey-storing, needs qualification. It doesn't always prove true. As Hutchinson says in a late number of the *Review*, the idea that a copious honey-flow has a tendency to check swarming is not particularly new. Doolittle said something to that effect some years ago. These conditions for some weeks preceding the surplus season are just such as to promote swarming, and I can

readily believe that a very rapid ingathering of honey may have the effect claimed for it. I know it has not happened since I have been here, but I think, from what old bee-men here say, I have not seen one of their old-time overflows from guajilla. The season of 1900 was noted here for excessive swarming and I greatly hoped that the surplus flow would stop it as I had been told it would. You can see I was much disappointed when my bees, working in sections, some of which I had divided some time before started on a round of swarming. This year there was but little swarming but I had almost as much of it during the early half of the season as I had before that time. One bee-keeper I know had swarming all through the season. I say, then, that, while I am not prepared to dispute the doctrine, I question, and am predisposed to accept it. I have never seen such a thing happen, and am certain such teaching can not always be relied upon.

Uvalde, Tex.

GEO. F. ROBBINS.

I have already answered that point in regard to overstocking Uvalde Co. While I see that the sentence in question on page 520 might be construed, and naturally, as applying to Uvalde Co., yet, riding as I was through New Mexico, and seeing just the kind of honey-plants and honey-trees that made Uvalde Co. a veritable paradise, in the other counties where there were no bees, I wrote the sentence having in mind the counties through which I was going. With this explanation I hope our friends in Uvalde will not feel that I was trying to flood their bee-ranges with more bees when they already have more than they can use to advantage.

With regard to the swarming before the honey-flow, and its stopping afterward, I can only say that Mr. Edwards has been one of the pioneer bee-keepers of the county, and I believe he is more familiar with average conditions as they prevail than any other man in it. Mr. Udo Toepferwein, of Leon Springs, Tex., and Mr. G. F. Davidson, of Fairview, Texas, who I have just seen at Buffalo, both support the statement of Mr. Edwards; and they seemed surprised that any one should question it. Of course, they may not do this every season; but they said I might state positively that, in the beginning of a heavy honey-flow, swarming not only ceased, but that there would be a killing-off of the drones and a destruction of the cells; at least this was true of their respective localities.

My remark, however, to the effect that bees stop swarming, and destroy cells, etc., on the approach of the main honey-flow, was, perhaps, too general; but I intended to speak of the average conditions as I understood them from Mr. Edwards. At all events, I found that it is a peculiarity of the bees of the West that, on the approach of the main honey-flow, swarming either diminishes to a very appreciable extent or stops altogether. This is particularly so in Maricopa Co., Arizona, which I visited, and to a very great extent it is true of the southern counties of California, as well as of a few of the north-central. I also ran across the same peculiarity in the western part of Colorado. I have known, of course, that a heavy honey-flow has a tendency to check swarming even in the East but not to such a marked degree as in the West.

In our next issue I will tell something about the honey-plants and some of the peculiarities

of soil and climate of Uvalde Co. At that time I will give pictures of some of the celebrated honey-plants which, without irrigation, and on lands that are too dry to grow any thing else, yield such immense quantities of fine beautiful honey. These will show why some of the western counties of Texas are veritable bee paradises.



IS IT A CASE OF LOCALITY?

"Here I am from 'over the border' to have a little talk with you in regard to a part of what you told Mr. Brown in July 15th GLEANINGS, page 596, near the bottom of the second column. There you tell how you take combs of brood, together with the queen and one frame of bees from a nucleus, and, by setting the same on the stand of a populous colony which has not swarmed, make a colony ready to go into the sections in a few days, from this brood, frame of bees, and the queen, together with the returning field bees from the moved colony. Is this right?"

"That is the way I intended."

"How many colonies did you ever make that way?"

"I do not think I can tell the exact number, but probably 150 to 200, as I used the plan quite largely each year (during the week before the blooming of basswood) before I went into queen-rearing, and have used it several times since then."

"But are not the bees disconcerted by this mode of treatment?"

"Yes, to a considerable extent for an hour or so, but soon become accustomed to the changed state of affairs, very much as they do when a weaker colony is exchanged with a stronger, so that both may be benefited by the exchange. Those who have practiced strengthening weak colonies in this way know that there is considerable commotion in front of the hive for an hour or so, caused by the bees coming out of the hive and returning several times to see if they have not made a mistake as to entering the wrong hive. But after a little they make up their minds, apparently, that it is all right, and soon go to work the same as if no exchange of hives had been made."

"But don't you find that the returning bees from the moved colony kill all or nearly all of the bees you took from the nucleus?"

"No, I have never been troubled in that way, nor did I suppose others had been. Do you have bees killed when working that way?"

"Yes, they always kill the majority of the bees I put in the hive in this way."

"Well, this is news to me. We have been told for nearly half a century that laden bees, returning from the fields, will not quarrel with any thing, and I have always so found it. I

am well aware that where you undertake to run a swarm into a colony, either large or small, where no precautions are taken, that there will be a terrible slaughter of bees; but I never had such an experience where the bees returned singly, or individually, as it were, and especially where each bee is laden with provisions which it has collected from the fields. Which party is it that does the killing, in your opinion?"

"I calculate, as I hinted at in my last reply, that the bees from the removed colony kill the majority of those set in the hive from the nucleus."

"If you have bees killed in this way, and I do not dispute your word, it is something entirely new to me; for in all cases of quarrelling which have come under my observation (and I have had scores of such cases), it has always been the bees inside of the hive, or those composing the colony, which have caught, stung, and killed those trying to enter—not those entering killing those inside. In one instance a little colony of less than a quart of bees killed a large swarm which I tried to run into it, and I knew which did the killing from the little colony being composed of Italian bees, while the swarm was composed of black bees. After the struggle was over, the ground in front of the hive was two or three inches deep with dead black bees, with scarcely a dead Italian bee to be found."

"But they not only kill the bees, but (with me) the queen as well; or, if she is not killed, she 'takes to her heels and is gone.'"

"This is fully as strange as the bees being killed. When I first tried the plan I was afraid they would kill the queen; and so I caged her for a few days, when she was released; but I finally became more bold, working on the plan 'that with a general mixing of bees the queen is safe,' and never lost a queen except in one or two instances, which I could account for in some other way. I really do not know how to account for our different experiences unless 'locality' will so account. It is possible that, if the plan was tried at a time when robbers were plentiful there would be a general fight, and then the queen would probably be killed; but no one should attempt the multiplication of colonies at a time when nothing was coming in from the fields, for at such times the bees do not undertake such a thing themselves."

"I had not thought of locality making a difference. Perhaps it would, but I doubt it. Then you say colonies made as you advise are 'ready to go into the sections in a very few days.' I never, in one instance, have succeeded in getting one pound of section honey that way; for without a laying queen bees will not make section honey, or at most but very little."

"Of course, if in your locality the bees and queen are killed, the plan is not one which you should adopt, nor do I advise any to adopt any new plan, only on the most limited scale, till they have proven it will work with them; and I here and now caution you to go slow on all plans which you have never tried, especially so on a plan which is under dispute. And the caution which I would give you, I would

give to all had I their ears at this time so I could tell them. But it would not be in accord with the knowledge of such men as P. H. Elwood, Capt. Hetherington, and other practical bee-keepers of Eastern New York, to say that no section honey, or very little at most, could be secured by colonies not having laying queens, for these parties have secured tons and carloads of comb honey in just that way—that is, by having the honey stored in sections while the colonies have no laying queen. I do not recommend such a plan, for with me better success is obtained where the colonies have laying queens; but I know these gentlemen have eminent success in their locality in this way. But I have a batch of queen-cells from which the queens are just ready to emerge, and I must attend to them. But before going allow me to suggest that you try making *just one colony* by the plan given, an hour or so before sundown, next year, and see if it will not work, even in your locality. By so doing not nearly so great a force of the field bees from the old or removed colony would be thrown with the combs of brood and queen on the first day.



TOO MUCH BROOD IN AUGUST; WHAT TO DO.

I wish you would tell me what to do with my bees. They are getting just enough to make them rear brood. The frames are crowded full, and no place for the honey, if there were a surplus. I am afraid they won't get enough for winter; if I could take the queens away for a week they would fill the hives; but it is a lot of work. I never saw so many bees raised before at this time of year. If you can suggest a remedy I wish you would, for I am "stumped." JAS. HILBERT.
Bingham, Mich., Aug. 28.

[I would not stop the queens' laying if I could as well as not. Let them fill up the brood and get a good ready for winter. If you have plenty of bees I think you will get fall pasture. If you do not, then I would feed them sugar to winter over. When you get more bees than you want, they ought to sell at a good profit. If nobody around you wants bees, advertise them next spring. With your bee cellar I think you can winter them with little chance of loss, especially if they are rearing lots of brood from now on. Make your colonies all very strong when they go into winter, and you need not lose more than one or two in a hundred. If the bees get the brood-nest so full that there is really no room for storing honey, I would let them into the upper story or take out some combs of brood and swap them with some other hive for an empty comb. You can probably do this for quite a while without opening up the upper stories for room at this season of the year.—Ed.]

THE DIFFERENCE BETWEEN COLONIES.

Mr. Root:—I have just been out among the bees and I find some stands that were given sections filled with foundation and baits early in the season, that have not put up one pound of honey. Adjoining them are other stands that have been worked for extracted honey, that have given me over 200 pounds this season. Now, I do not claim that these are average colonies; on the contrary they are the exception, but show that, while some bees will put up a large amount of surplus, others will produce nothing. My comb honey has come from the strongest swarms. The quantity produced is so small in comparison with what other swarms have given of extracted honey that there is no comparison in profits, hence I claim that with me 5 cts. for extracted honey is more profitable than 25 for comb, and there is all the difference between nothing with a colony of sluggards to 200 pounds and over with a strong colony of rustlers.

E. H. SCHAEFFLE.

Murphys, Cal., Aug. 20.

[This is in reply to the statement that Mr. Schaeffle had exaggerated the possible differences between two colonies.—Ed.]

"THE EX LIGHTNING OPERATOR."

I am surprised to see such a statement in your column, and am sure that you owe the "lightning operator" an apology at once, and especially so to show to your readers what doctors are, even if they do have government handles in front of the "Dr." Mr. Howe's health is now as good as ever, and has been since last October. He is now caring for about 1000 colonies of bees. In fact, he is still the same old lightning operator that he used to be, and I can tell you that he is a hummer for a little man just in his thirties. If you don't think so, come down and run with him some; and if you are not "lightning" you will wish you were somewhere else.

W. W. SOMERFORD.

Caimito, Cuba, Aug. 11.

[Mr. Somerford refers to a statement over the signature of Harry Howe, published a few weeks ago, to the effect that he was suffering from heart trouble, and was under the care of a U. S. Army Surgeon in the General Hospital. This item came to me through the general avenues of our office, and, not noticing the date, I supposed it was fresh news, and published it. But the fact was, the letter, evidently a "stray," was a year old, and now Mr. Howe writes that he is fully recovered, and says the "joke is on me." I have no apology to make beyond the foregoing statement, and, on the other hand, I wish to congratulate Mr. Howe on his speedy recovery and return to good health.—Ed.]

GETTING COMBS BUILT DOWN TO BOTTOM-BAR ON HORIZONTAL WIRING.

Referring to Dr. Miller's Straw, page 625, and your comment, I wire horizontally, and have no difficulty in getting Hoffman frames,

either wired or unwired, built down to the bottom bar, by using them in eight-frame hives as second stories. Although I have several queens more than three years old, and the hives imperfectly shaded, I have had no swarms for several years by tiering them 3½ stories high. When using 1½-story hives, bees would frequently swarm before occupying a super, although the hives were properly shaded.

J. C. DETWILER.

W. Washington, Pa., Aug. 6.



NATIONAL BEE-KEEPERS' ASSOCIATION.

OBJECT:—To promote and protect the interests of its members; to prevent the adulteration of honey.

OFFICERS:—E. R. Root, President, Medina, O.; R. C. Alkin Vice-president, Loveland, Col.; Dr. A. B. Mason, Secretary, 3512 Monroe St., Sta. B, Toledo, O.; Eugene Secor, General Manager, Forest City, Iowa.

BOARD OF DIRECTORS:—E. Whitcomb, Friend, Neb.; W. Z. Hutchinson, Flint, Mich.; A. I. Root, Medina, O.; E. T. Abbott, St. Joseph, Mo.; P. H. Elwood, Starkville, N. Y.; E. R. Root, Medina, O.; T. G. Newman, San Francisco, Cal.; G. M. Doolittle, Borodino, N. Y.; W. F. Marks, Champaign, N. Y.; J. M. Hambaugh, Escondido, Cal.; C. P. Dadant, Hamilton, Ill.; G. C. Miller, Marengo, Ill.

FEES:—Annual membership fee, \$1.00. Remittances may be sent here or to General Manager as above.

QUITE a string of letters are coming in, inquiring about some of the localities I have visited; and it is evident that some, for financial reasons, and others for health, expect to move into localities which they hope will favor the pocketbook as well as the ailing body. It is almost impossible to give full or satisfactory information by letter; and if our friends will only wait I will try to cover the ground thoroughly, and at the same time give many illustrations. But no one should think of removing to some of these good localities without first finding whether they are already occupied. I think I can give that information along the line of my travels.

A MODIFIED PLAN OF RETURNING SWARMS TO THE PARENT STANDS.

OUR neighbor, Vernon Burt, has succeeded as usual in getting a good crop of honey. He returns all the swarms to the parent stand, giving the swarm a hive of empty combs, then putting the super from the old hive on top of the new one. If the weather is warm, he shakes or brushes all the bees off the combs of the parent hive, and then moves it to another location. Hatching brood will usually come out in time to take care of the young brood. In this way he gives the swarm all the strength it originally possessed; and by so doing he finds he gets the best working force possible. This plan is a combination of the return-swarm plan and of the Stachelhausen brush-swarm idea. But he says he is always careful to see there is hatching brood to make sure that the unsealed brood will not starve. He takes the further precaution of brushing only during hot weather. Of course, during the swarming season

there will be no robbing, and no fear need be entertained from that source.

The Root Co. bought Mr. Burt's entire crop of honey. It was in plain sections, 4×5.

SHALLOW FRAMES FOR COMB HONEY.

THE tendency among expert bee-keepers is toward a shallower frame than the standard Langstroth. Some others prefer the Langstroth because it has always given good results. But the other class consider that the frame given us by the father of American bee-keeping is a little too deep. They desire a frame just shallow enough so that there will be no honey, or very little at least, stored in the brood-nest. Said Mr. Vernon Burt, "With my shallow frames I often have no more honey in them than the size of a silver dollar; and I estimate that, if my colonies had all been in the shallow hive, I should have secured 30 lbs. more per colony." This is a strong statement, but Mr. Burt says he is ready to verify it by showing the piles of honey that have come off the shallow frames and the amounts that have come off the deeper ones. While he does not claim the bees would store any more honey in one hive than in another, if we include both the super and the brood nest, yet he says that, instead of there being from 25 to 30 lbs. of honey left in the brood-nest, which he does not want there, that amount all goes into the supers where he does want it, and where he can command the very best market price obtainable. When I asked Mr. Burt if it was not desirable to have honey in the brood-nest, he said it was not, according to his practice. "I prefer," he said, "to sell my honey, what I do get, at 12 and 15 cts., and then buy syrup at 3 or 4 cts.; and I not only make a good trade, but I give the bees a much better feed. While good honey does very well most winters, yet there are occasional ones when the syrup-fed colonies come out much better. No, sir," said he, very emphatically, "I do not want any honey in the brood-nest in late summer. I prefer to feed sugar syrup, for then I know my bees have the very best food for winter."

PRICES ON CALIFORNIA HONEY.

THERE seems to be a combination of forces at work in Southern California, probably inspired by the buyers, to create the impression that there have been 500 or 600 carloads of honey produced in the southern counties. First it was 400, next 500 cars; and if this rate of exaggeration continues, it will be up to 1000. If there are 200 or 300 in sight the Root Co. would like to know where. When I went through the territory I visited some of the largest producers; and I also secured reports from them of other producers. A large portion of the crop had already been secured, and it was then known about how much each man would have. We have taken some little pains to make an investigation. Ventura County, one of the best if not the best, shows up so far, counting up the big producers, only about 2½ tons. If we estimate 12 tons to the car, that would make only about 20 carloads

for Ventura; and at this rate we could scarcely scare up 140 carloads for *all* the southern counties. We already have men in the field who are looking this matter up, and we expect to get further reports.

As to Northern California, the best advices seem to indicate that the crop is going to be somewhat light; so, taking it all in all, prices for the whole State should advance rather than go down. I would advise the large producers, at least, to hold over unless they can sell at a figure that is somewhere within reason.

The bee-keepers of California have had three or four poor seasons in succession; and now when they do get a little honey it would be too bad for them to sell that little at a low figure, because, forsooth, there has, according to the buyers, been a "big crop." If there had been the *bees* in Southern California that there have been in times past, when the years were good, possibly the figures would reach 300 to 400 carloads; but the fact is, as I have stated in previous issues of this journal, the small producers became discouraged during the poor years, and either sold their bees or allowed them to die.

Perhaps the question may be raised right here, "What do you consider a reasonable figure for California white sage?" We of the Root Co. do not think it is wise for us to name any definite amount; for the large producers know what honey they have in sight, and know best about what they can afford to let it go for. All we can say to them is, "Do not let the buyers hoodwink you by big tales of 500 cars."

PRIORITY RIGHTS OF BEE-RANGES.

SOME years ago we used to hear a good deal about "priority rights" in bee ranges. For many years bee-keepers have been encroaching on each other's boundary; and as they continue to encroach, the individual yields per colony are cut down proportionately. The problem is being solved in many localities by the bee-keeper buying or leasing the bee-range. This is more feasible in the West, where one person or one stock company may own a square mile or several of them. The man who will pay the highest for the bee-range for a period of years is the man who will get the exclusive right for that range for his bees. I could name over a number of men who actually control by lease the bee-range for several square miles. Some pay as much as \$50 a mile per season; some get it for much less, depending on the value of the honey flora under consideration.

It is coming to pass, then, that the ranchers of the West are learning that in their vast acres, besides the growth they get from the soil direct, there is an indirect and new property right which they can sell at so much per square mile.

A few of the pioneer bee-keepers have been quick to appreciate the fact that they can lease the range and keep out others from dividing the profits; and I am glad to give a hint to many of our friends. Sometimes the rancher does not know there is much value in the way

of honey, and so he will sell a bee-range of a square mile for an insignificant sum. To have a man come and offer him \$25 for something he never considered of any value to him is somewhat of a surprise, and so much clean cash, and he will sign a contract instanter, offering to sell the range, or lease it for a period of ten years at \$25 a year. Sometimes he will sell for much less than that. But the bee-keeper is fortunate if he can be the *first* man to make the application. If half a dozen fellows get to bidding on a range, there is no telling where the price will go. So take my advice, and bid first.

I have assumed all along that a rancher has a right to lease his range to a bee-man, just as he can lease or rent cow pasture; and where such property right is acknowledged, and a purchase is made, the laws in our several States are bound to respect them.

But to buy a bee-range in the East would be quite another matter, as one might have to buy out fifty or a hundred farmers. One would have to buy the whole of them; for if *one* of them stood out this one might put just enough bees in his little spot that he would not sell, to cut the profits right in two. In the great West the conditions are quite different. If one man does not own half a square mile, there may be several that own that amount; and even if one paid each of them \$5 apiece, he would get just the range he desires.

A SUCCESSFUL PLAN OF HAVING QUEENS FERTILIZED IN AN UPPER STORY.

OUR Mr. Wardell, the man who has charge of our 700 colonies, has evolved a system of having queens fertilized in upper stories, that is a perfect success. I do not speak of it because it may be new, but because it gives excellent results. He tried it to some extent last year, and now, after having tested it most thoroughly the *whole season* with scarcely a failure, we are pleased to recommend it. By his plan he succeeds in getting three queens fertilized in one upper story at a time; that is to say, there may be three virgins, all of which will be fertilized within the usual time. The method is this:

He takes an ordinary Lingstroth upper story, and divides it off lengthwise into three bee-tight compartments of equal size. On the under side of this story and a bee space below the frames he tacks a sheet of wire cloth. The partitions comes in contact with wire cloth at the bottom, and the cover at the top thus making each little room separate and bee-tight. On two sides and one end are entrances, one entrance communicating with each compartment.

This super, as constructed, is now put on over a strong colony, wire cloth down next to the bees. Into each of the compartments he puts two frames of bees, brood, and honey. He then inserts a queen-cell or lets run into each a virgin queen. The cover is put on, and the bees are left to their own devices. He now has practically three two frame nuclei, each one with a cell or virgin queen right over a strong colony, the only separation being the

wire cloth. And right here is the feature that makes it a success: The old methods have used perforated zinc, while Mr. Wardell uses wire cloth. Now for results:

These young queens fly out from the entrances from the upper story, come back and are fertilized. If cool weather comes on it does not make any difference, because there is a large amount of heat from the cluster of bees below that rises up through the wire cloth.

The great feature in favor of this method is that, in the fall, or at the close of the season, when it is desired to unite the bees, and the young queens have all been sold from the upper story, all one has to do is to remove the wire cloth from the two stories, and let the bees run together. They all have the same scent, and there is no fighting.

This scheme has also another advantage. It economizes room in the yard, and brings the nuclei up to a nice height for the apiarist to work. We also make one colony do the work of three nuclei; and if honey is coming in, the colony can store just the same; but, of course, the frames of honey would have to be removed as fast as filled with honey. If one of the nuclei runs short of brood, all that is necessary is to remove the upper story for a minute or two, take out the empty comb from the nucleus, and substitute it for a frame of brood from the colony below. Set this, bees and all, into the nucleus, replace the upper story, and all will go on as before. There will be no fighting, because, understand, the bees are all of the same scent.

THE TRUTH ABOUT BEET AND CANE SUGAR,

SINCE printing the article by W. K. Morrison, page 672, I have received two communications—one from the youngest member of the firm, Huber H. Root, who is looking after our exhibit at the Pan-American. Under date of Sept. 2 he writes:

In reading over the article on beet sugar in Aug. 15th GLEANINGS I noticed some things I didn't believe; but thinking that perhaps I didn't know much about it I asked the beet-sugar man to give his opinion of it, and, if he wanted to, to write an article in reply, which he did. You may think that he, being interested in the beet sugar industry, would not be able to give impartial statements; but Mr. Hershiser and I both know him to be a man who would state the exact truth, and, at any rate, there would be no axe for him to grind, because bee-keepers as a rule do not know what the source of the sugar is which they buy. Ernest, in his footnote, says he was told that the canneries prefer cane sugar to beet, because the cane has a higher sweetening power. Now, I have taken the trouble to question some men, grocers, etc. who have used both; and when they say that beet sugar is not as sweet, they also generally say that it also has an unpleasant odor. This lets out the fact that they have, because cheaper, bought that which was not as highly refined as it is when bought as granulated sugar. Unrefined beet sugar has a bad odor, because I smelled it myself. Refined has none. In places where the refined has been used, no one can tell the difference.

Mr. Gilmore is a chemist, as you see by his article, and he knows what he is talking about.

We may find two things that have the same chemical formula are different such as the diamond and charcoal, but do we ever see two substances which have the same chemical formula and also the same physical characteristics which were not the same?

HUBER.

The letter referred to by Huber is one by Melvin R. Gilmore, who, it appears, is in position to know something about this whole question of sugar. He writes:

A STATEMENT FROM COMPETENT AUTHORITY.

Mr. Huber Root called my attention to an article published in GLEANINGS, August 15, and asked me to read it and give my opinion of some of its statements. The writer, W. K. Morrison, seems to think that sugar made from cane is better than that made from beets. I do not know how he or any one can know when he gets granulated sugar whether it's made from cane or beet. Of course, if he sees the name of a sugar-factory of Nebraska, Colorado, or Michigan, on the sack in which it comes, he knows that he has beet sugar, but otherwise there is no way of knowing, for, even though it be from the refineries of Havemeyer or Arbuckle, it may be from either source, for these refineries handle raw beet sugar from Germauy, Belgium, Holland, France, Austria, and Russia, as well as raw cane sugar from Java and the Indies.

One of the statements of the writer is that cane sugar is sweeter than beet sugar, "just as Jersey milk is richer than Holstein milk, and for this reason alone it commands a higher price." In the first place, I will say that cane sugar does not command a higher price than beet sugar; for in determining the price of sugar there is no question of its source but of its quality. In the next place, I will say that the sweetness of sugar, from whatever source, depends on its polarization of purity of sugar. As the chemical formula of sugar from both sources is the same ($C_{12}H_{22}O_{11}$), and their physical characteristics are both the same, it results that neither one nor the other can be said to be sweeter. The simile can not hold, for the reason that, while sugar is a fixed chemical compound of so many atoms of carbon, hydrogen, and oxygen, with certain physical characteristics resulting from the atoms of the molecule uniting in a certain way, milk, on the other hand, is a variable physical combination of many chemical compounds; and while the slightest variation in the component parts of the molecule of sugar would make it other than sugar, there can be a great variation in the composition of milk and it would still be milk. It might contain more or less water, more or less casein, more or less fat, etc., and yet it is milk.

The writer of the article claims that Dr. Wiley says that beet sugar is cane sugar and cane sugar is beet sugar. I do not think that Dr. Wiley could say that. He might say that they are identical, or that beet sugar is cane sugar, but not that cane sugar is beet sugar, for the reason that "cane sugar" is the common name of the article which is chemically known as "sucrose," just as "grape sugar" is the common name of the article chemically known as "glucose." The name "cane sugar" was given at a time when the only known source was cane; but since then it has been found in other grasses besides the cane, and in a number of roots, as the carrot, parsnip, turnip, and notably in the beet. The writer of the article further states that, by the "same process of reasoning, saccharin, which is 500 times sweeter than ordinary sugar, ought to be cane sugar also, but it is not." I should say it is not! Saccharin is not a sugar at all having none of the characteristics of sugar except that in a dilute form it gives a sensation of sweetness to the tongue, while in concentrated form it would be very bitter, and it is in no sense a food, as is sugar. I do not know what he means by "the same process of reasoning," but certainly no process of reasoning could class saccharin as sugar.

MELVIN R. GILMORE.

Supt. of Exhibit of the American Beet sugar Association at the Pan-American Exposition.
Buffalo, N. Y., Aug. 31.

I will reiterate what I have repeatedly said in these columns, that beet sugar, such as we have used for the last 20 years for feeding our bees, has been eminently satisfactory.

I will write to the parties who told me that the canners on the Pacific coast will use nothing but cane sugar, which they allege is sweeter, and ask for further information. Possibly those same canners are using beet sugar of a fine quality when they supposed they were using cane.



A few days ago a particular friend of mine handed me a tract, and said he wished I would read it and hand it back to him. I read it with much interest and attention. In fact, after reading it once I went back and read it all over again. Then I got to talking with my friends and acquaintances about it, and happened to mention it to Mr. Calvert, my son-in-law, and he exclaimed, laughing at the same time, "Why, Mr. Root, you do not even seem to know that you are contributing to the support of that very institution; that the man has been here, and that you have had a talk with him; and that you two got to be fast friends in just a little while; and now you don't seem to know any thing about it at all." Our stenographer suggests right here that this is a remarkable instance of doing good with the "left hand" and not letting the "right hand" know it. But there is no great credit due me; for in this busy life of mine, so full of first one thing and then another, I often find myself, when night comes, utterly forgetful of something I was greatly taken up with and full of enthusiasm in the morning. Now, here is the little tract that took such a hold on me. The letter from the young infidel is strikingly like quite a number that have come to me. In fact, I have given some of them in the pages of GLEANINGS. You will notice they seem to have a set of phrases that are passed around from one to the other. The infidel letter was written, as you will notice, over six years ago. We trust and hope the brother has accepted friend Johnson's offer, and come out of darkness into light. Let us now consider the tract:

A REPLY TO A YOUNG INFIDEL, OR HOW I BUILT AND HOW I RUN THE SCHOOL OF THE EVANGELISTS.

Es-kridge, Kan. Jan. 2, 1895

Ashley S. Johnson:—I take pleasure to answer your letter that came to hand a few days ago. Can say this, that the books are all sold and the parties that have the books have never paid me, and, further, I went away directly after I let them have them and just got back on a few days' visit. Will return again in a few days. Now as to the payment of them, I will do so as soon as I can get the money to spare. When away I was sick for seven months, and that is the reason I have never written. I never received your letter until I came home. You seem to be of a different motive from some Christians. I have examined into all the phenomina of nature, and can clearly see by the things of nature by which I am surrounded and have found, that there is not the slightest evidence to prove the existence of God. Religion is a perfect fraud except to the extent of the morality that it teaches. It debas and has hindered all progress of thought and science. We can't go to religion and find any such thing as science. Religion never has produced one fact. I defy you to prove the things by which it is said God has done to be done in the length of time it was said to be done. Now write me, and I challenge you to take up my argument by letter or any other means. I should like to know by what method you were called, and where was that all-wise Being, as you claimed, when he called for you? What is he putting in his time at now? Why doesn't God call the science men as well as the little bull-headed nigger and the dull and ignorant men? It seems that he calls them instead. So I close for this time. Hoping to receive a reply,

D. A. RAMSOUR.

In reply to the above, Mr. Johnson sent the following to his friend. We hope it will receive careful consideration.

Kimberlin Heights, Tenn., Jan. 7, 1895.

My dear Young Friend:—It grieves me beyond expression to read your letter; but as you so earnestly request it, I shall suggest some things in rebuttal of your ideas. In the first place, I think your claims just a little extravagant. You say: "I have examined into all the phenomina [no such word in the language] of nature." My son, "all" is a stupendous thing. Have you not overestimated your attainments somewhat? Sir Isaac Newton, who must have given fully as much thought to the physical worlds as you have, compared himself to a little child picking up here and there a pebble or a shell on the shore, while the great ocean of natural wonders stretched away before him! This must be my first answer to your letter. I now lay down a proposition which I have demonstrated in my own heart and before the world to be true: *God is; he is a living God; Jesus Christ is his Son and my Saviour; the Bible is true, and our God hears and answers prayer.* Now to the proof. Did you ever read the Bible through? Did you ever count its promises? If not, let me assure you that it is claimed, and I doubt it not, that it contains twenty thousand promises to the man who leads a pure life and obeys his Maker in all things. How many of these promises have you personally put to the test? Half of them, one thousand of them, one hundred of them, ten of them, any of them? If not, you have no right to say that they are not true. I quote twenty-four of them. I insist that you can determine their truthfulness beyond doubt:

1. O taste and see that the Lord is good; blessed is the man that trusteth in him (Ps. 34:8).

2. Mark the perfect man, and behold the upright; for the end of man is peace (Ps. 37:37).

3. He healeth the broken in heart, and bindeth up their wounds (Ps. 147:3).

4. Trust in the Lord with all thine heart; and lean not unto thine own understanding. In all thy ways acknowledge him, and he shall direct thy paths (Prov. 3:5, 6).

5. There is that scattereth, and yet increaseth; and there is that withholdeth more than is meet, but it tendeth to poverty. The liberal soul shall be made fat; and he that watereth shall be watered also himself. He that withholdeth corn, the people shall curse him; but blessing shall be upon the head of him that selleth it. He that diligently seeketh good procureth favor; but he that seeketh mischief, it shall come unto him. He that trusteth in riches shall fall; but the righteous shall flourish as a branch. He that troubleth his own house shall inherit the wind; and the fool shall be servant to the wise of heart. The fruit of the righteous is a tree of life; and he that winneth souls is wise. Behold, the righteous shall be recompensed in the earth; much more the wicked and the sinner (Prov. 11:24-31).

6. If ye be wiling and obedient, ye shall eat the good of the land; but if ye refuse, and rebel, ye shall be devoured with the sword; for the mouth of the Lord hath spoken it (Isa. 1:19, 20).

7. Bring ye all the tithes into the storehouse, that there may be meat in mine house, and prove me now herewith, saith the Lord of hosts, if I will not open you the windows of heaven, and pour you out a blessing, that there shall not be room enough to receive it (Mal. 3:10).

8. Blessed are they which do hunger and thirst after righteousness; for they shall be filled (Matt. 5:6).

9. But thou, when thou prayest, enter into thy closet; and when thou hast shut thy door, pray to thy Father which is in secret; and thy Father which seeth in secret shall reward thee openly (Matt. 6:6).

10. But seek ye first the kingdom of God and his righteousness; and all these things shall be added unto you (Matt. 6:33).

11. Ask, and it shall be given you; seek, and ye shall find; knock, and it shall be opened unto you; for every one that asketh receiveth; and he that knocketh shall be opened. Or what man is there of you, whom if his son ask bread, will he give him a stone? Or if he ask a fish, will he give him a serpent? If ye then, being evil, know how to give good gifts unto your children, how much more shall your Father which is in heaven give good things to them that ask him (Matt. 7:7-11)?

12. And all things whatsoever ye shall ask in prayer, believing, ye shall receive (Matt. 21:22).

13. Therefore I say unto you, What things soever ye

desire, when ye pray, believe that ye receive them, and ye shall receive them (Mark 11:24).

14. Jesus answered them, and said My doctrine is not mine, but his that sent me. If any man will do his will, he shall know of the doctrine whether it be of God, or whether I speak of myself (John 7:16-17).

15. He that hath my commandments, and keepeth them, he it is that loveth me; and he that loveth me shall be loved of my Father, and I will love him, and will manifest myself to him (John 14:21).

16. He that spared not his own Son, but delivered him up for us all, how shall he not with him also freely give us all things (Rom. 8:32)?

17. For ye know the grace of our Lord Jesus Christ, that, though he was rich, yet for your sakes he became poor, that ye through his poverty might be rich (II. Cor. 8:9).

18. He which sows sparingly shall reap also sparingly; and he which sows bountifully shall reap also bountifully. Every man according as he purposeth in his heart, so let him give; not grudgingly, or of necessity; for God loveth a cheerful giver. And God is able to make all grace abound toward you; that ye, always having all sufficiency in all things, may abound to every good work. * * * being enriched in every thing to all bountifulness, which causeth through us thanksgiving to God (II. Cor. 9:6-11).

19. Hereby we do know that we know him, if we keep his commandments (I. John 2:3).

20. Beloved, if our hearts condemn us not, then have we confidence toward God; and whatsoever we ask, we receive of him, because we keep his commandments, and do those things that are pleasing in his sight (I. John 3:21, 22).

21. If any man serve me, let him follow me; and where I am, there shall also my servant be; if any man serve me, him will my Father honor (John 12:26).

22. Give, and it shall be given unto you; good measure, pressed down, and shaken together, and running over, shall men give unto your bosom. For with the same measure that ye mete withal it shall be measured to you again (Luke 6:38).

23. But my God shall supply all your need according to his riches in glory by Jesus Christ (Phil. 4:19).

24. For God is not unrighteous to forget your work and labor of love, which ye have showed toward his name, in that ye have ministered to the saints and do minister (Heb. 6:10).

I have given you twenty four promises, about one out of each thousand. I have tried them, and in the love of truth and the fear of God I solemnly declare that they are true, true in every particular. The way is open. You can put these things to the test. You challenge me, but the promises of God challenge you! But probably the fact that I say they are true is no evidence to you; but wait and see what I have to offer. You ask how I was called. It is hard to explain, but my life speaks for itself. About five years ago the conviction fastened itself upon me that I should do something to help the thousands of poor and struggling young men throughout the world who want to prepare themselves to preach the gospel. I had a comfortable home, but I had neither wealthy friends nor money. I wrote to a number of prominent brethren. I remember two of the replies. One came from one of the most influential men at the North, and was almost insulting. The other came from a preacher at the South, and was just as discouraging as he had the ability to make it; but I could not get rid of my conviction of duty. Along about this time an opportunity came to me to buy the farm on which I was reared, and I moved from the city to my place in the country. Time flew. In imagination I built colleges all over the farm. In the reality of the thing however, I met most positive discouragements. My friends, instead of helping me, were disposed to discourage me. However, in the fall of 1892 a brother caught a little of my enthusiasm and voluntarily proposed to invest \$100 in the enterprise. This was a small amount compared with what I was resolved to do, but I launched out simply on such promises as the ones I have submitted to you, and ordered the plans and made a contract for the lumber. The enormity of the contract may be grasped when I tell you that I bought one hundred and seventeen thousand feet of rough lumber from one firm. I found no difficulty in making contracts for every thing needed; although, if the firms had asked me where the money was to come from I could not have told them if my life had been at stake, but I firmly believed it would come. We used in the neighborhood of, I think, sixty thousand brick, and nails beyond computation! I employed a foreman, and let me remind you that the third anniversary of moving the first load of lumber is not here. Things moved

very slowly. I asked my brethren to help me. Very little help came. I was learning to trust and pray. In the meantime the saw was flying through the logs, and we were hauling brick and digging out the foundation. Very little money came. I was also learning to wait. Now, while learning this lesson I was learning also to give. I reasoned a little, and came to this conclusion: If I can become unselfish in his work, God will raise up friends to help me. In 1882 I had written a book, and in 1885 another, and in 1892 still another. During all these years I had written for the press; and while my books were well received they had not startled any one. We grew. Mrs. Johnson was taking hold of the promises of God also. Finally, after much thought and discussion, we launched out further from the shore. Under date April 21 1893, I find this record in our diary: "*Commenced to turn all funds into the College fund.*" I now consider this the greatest event in my Christian life. Necessity compelled us to increase our force. Frequently we had nearly twenty men employed, and we paid them from 60 cents to \$2.00 a day. I remember one Saturday night that having "paid off" I had less than 60 cents left! In the meantime, financial distress prevailed everywhere. The largest banks and railroads in the country were going down into hopeless ruin, but we kept the presses flying and the mail laden with books. I got a pasteboard box and put it in my drawer, and I record it with everlasting thanks to God and his people that, to my present recollection, while we have worn out a number of boxes, the box has never been empty, and not a single mail has arrived since April 21, 1893, that did not bring something for the work. I kept no account of what came in. When an order came in I filled it, put the money in the box and paid it out to the first man who presented a bill, and thus it has continued to this day. Since that beginning we have brought from the press seventy-seven thousand books, nearly three thousand a month. Contrast this with the few editions brought out from 1882 to 1892, and ask infidelity to explain the difference. The work here surpasses only the work done by these books, for they are bringing thousands out of darkness into the clearer light of the gospel. With these facts before you, I invite you to take a walk through the building. The tower is eighty-five feet high, and the bell is one of the finest in the State, and to me is indeed a "liberty bell." Come in. We will stand here on the front piazza and look eastward. What a grand landscape! Before us is the beautiful French Broad River, and in the distance the grand old mountains. Walk into the library, and then into the chapel. It is a beautiful room finished in natural pine, seated with chairs; a beautiful chandelier hangs overhead. It will accommodate several hundred persons. Let us go into the dining-room. It is neatly furnished, and will seat exactly one hundred persons. Let us go up stairs and see the boys. Here they are, filling nearly all the (thirty-five rooms in the whole building) rooms. They represent about twenty-five States. I am feeding fully fifty of these boys just as I built the college, by trusting God and his people. Let us go outside. Here are our waterworks. The tank holds eight thousand gallons. If you will look toward the river you will see our new combination cannery, laundry, and pump house. This tank connects with the barn and garden. Let us proceed. This is Industrial Hall. Look at the corner-stone: "*Emma E. Johnson Industrial Hall; and the poor have the gospel preached unto them.*" You will notice that it is nearly completed. What a splendid cellar! We hope to fill it with the products of the farm next fall. Look this building over. It will accommodate about sixty persons. Just as soon as it is done I intend to throw the doors open to poor young preachers everywhere, the only conditions of admission being poverty and piety. You see I am not afraid to trust my God and my brethren. Look at that nice cottage beyond the big oak. That is "India." It is for Brother and Sister Brown, who have spent several years in India, and after two years here they expect to return. I trust in the providence of God you may go with them as a missionary of the cross! Beyond this cottage we expect to build two others, "China" and "Japan." Let us go down to the barn. Yes, it is a big one, 48x78, two stories high. We have about forty head of milk cattle. You notice the connection for water. We expect to have every thing needful for man and beast. This is the Lord's work. You must see evidences of it, and he will supply all our needs. Are all these things paid for? Not altogether, but we are paying every week, and we have accounts and resources enough to pay every bill; and if these fail beyond them are the children of God, my brethren, and the everlasting

promise of my Lord and King Here is a peculiar thing: Can you account for it? When I started this work I sent out a man to beg for it, and I sent out letters and newspaper appeals. Every effort of this kind has failed miserably. However, after we practically put our all into it, money has begun to come from men and women who want to share the blessedness of developing these boys into useful men. Recently a banker drove out into the country and gave a brother \$50 for the work. I had never heard of him, and he is not identified with us so far as I know. Last mail I got a letter from a stranger enclosing \$5.00. I did not ask him for it, but he sent it. Who told him to do it? Now a word about these boys. You observed that most of them are big strong fellows from the farm. They are learning the Bible. They are learning English. They are learning unselfishness. They are learning the dignity and grandeur of labor. They are learning to trust and wait. They are learning that the Christian religion is spelled out in thorns and groans and sweat and utter self-forgetfulness. I believe I could find sixty men in the building at this moment who would, if ready to graduate, go out into the benighted regions of the earth and preach to the poor, without a guaranteed salary from any one. Can you find sixty infidels who are willing to go out and deny themselves the endearments of home and the blessings of the Christian civilization, they affect to despise, and proclaim the glories and blessedness of unbelief? You can not find one! "By their fruits ye shall know them." You can flog your doubts at the Bible; you can deny the divinity of Jesus of Nazareth; but there stands the School of the Evangelists, and in it young men from all parts of the country, who are learning the way of the Lord and catching the unselfish spirit of Jesus the Christ. I candidly confess that the whole thing seems as wonderful to me as it possibly can to you. I look back over the time since we began and say that right here on Kimberlin Heights, Tenn., are evidences that God is, and that he hears when we cry in faith. I realize that this is just the beginning. Just in proportion as I take hold on God, his people take hold of this work. Money comes in small sums. In this I rejoice. It means that the work is taking root in many hearts, and that from the rising to the going down of the sun, prayers are, like incense sweet, rising from many hearts that God will not allow us to be put to shame in the presence of those who do not believe. God has all things at his command, and I am his. I make my living out of the Correspondence Bible College, and stand pledged before God and men to every dollar placed in our hands as the result of the sale of my books, or from any other source, dollar for dollar, into this work. Before my conversion I would not have done this. On the infidel hypothesis, how do you account for the fact that I do it now? Nor is this all. I sound it out far and near that I will not turn a poor young preacher away as long as we have room! I accept your challenge. Pledge yourself on honor not to mention your unbelief to any one: come here a year and see these things with your own eyes, and you may have access to all the classes, and your board will not cost you a cent. I have no time to dispute. "Come and see" (John 1:46).

Trusting that, through the rifted clouds of unbelief, you may soon "see Jesus," I am in warmest compassion,

Faithfully your friend,
ASHLEY S. JOHNSON.

After reading the above, even before I had spoken to Mr. Calvert, I wrote to Bro. Johnson, and asked him to let me know what had been done in his great work during the past six years. In reply he sent me quite a pile of literature, full of half-tone engravings of the young ministers he is educating, and of the grand buildings God has enabled him to build and pay for; and, dear reader, I wish you would write to Bro. A. S. Johnson, Kimberlin Heights, Tenn., for some of his free tracts and circulars. I tell you as he told the young infidel, "Come and see;" or perhaps, more literally, send to him for a report of the work, and see for yourself "what God has wrought." Those of you who have Muller's Life of Trust will recognize at once how similar it is in many respects to that great work.

"GUESSING-CONTESTS" AND SIMILAR GAMBLING ENTERPRISES.

We rejoice to see the following in that good home paper, the *Ohio Farmer*. Of course, we give it our hearty indorsement.

We are glad the Postmaster-General has spoken clearly in regard to the "guessing-contests" on the population of the United States and Canada, that have lately filled scores of columns of advertising and editorial space in many otherwise decent papers. It is a lottery business pure and simple, and as such should be excluded from the mails.

The scheme was urged upon *The Ohio Farmer*, and promptly rejected in the interests of common decency. It is not only a lottery—a game of chance—but a dishonest lottery. As nearly as can be computed from the data at hand, the guessing subscribers of any given periodical have only about one-tenth to one-twentieth as good a chance as they are led to believe they have—to win the \$15,000 or smaller prizes; for the prizes go not to the subscribers of that one paper, as they are tacitly led to suppose, but to them in common with those of some ten, twenty, or thirty other papers that are in the scheme. The claim that the subscribers pay nothing for their chance to guess is false, for the chance to guess is the sole objective premium or inducement offered, and often the sole subjective motive for subscribing. We are glad such contests are hereafter to be excluded from the mails—wholly, we hope, as lottery schemes, not partly as illegitimate second-class matter. We are glad, too, of the general reform promised; for if all the abuses that have crept into our postal system—including most of the free-mail matter—can be stopped, we may easily have penny postage on letters, and rural mail delivery.

MENTAL-SCIENCE HEALERS COME TO GRIEF.

We clip the following from the *Cleveland News and Herald*:

ARRESTED ON CHARGE OF USING THE MAILS FOR FRAUDULENT PURPOSES.

Daytona, Fla., August 24.—Helen Post, her husband, Colonel C. C. Post, and her son-in-law, C. F. Burgman, were arrested to day on information sworn to by Post-office Inspector Fred D. Peer, charging them with using the mails for fraudulent purposes. The three were taken to Jacksonville, where they will have a hearing before United States Commissioner William Archibald.

The offense alleged consisted in sending through the mails circulars professing to cure patients at a distance by means of mental science. Mrs. Post claimed to be able to heal all kinds of diseases, even restoring the blind, holding that no disease was incurable by her method of treatment.

I felt like shouting, "May the Lord be praised that the U. S. Postal Department comes out fairly and squarely, and declares these things frauds." The most distressing part of the affair is that so many people, and people apparently gifted with plain common sense, will insist that the government is wrong, and that these mental healers are a blessing to humanity. Our stenographer suggests that these mental healers do doubtless cure *some* kinds of "blindness." In fact, it is to be hoped they do.

STREET FAIRS, ETC.

I am glad to see the following in the *Am. Agriculturist*. I have wondered that sensible people had tolerated such an outrage as long as they have.

The street fair has about had its day. Some towns, however, do not seem to fully understand the pernicious effect of this latter-day nuisance, and quite a number are scheduled for this summer and fall. That no good will come from any of them is a foregone conclusion, as any one knows who has had experience with them.

"\$720 A YEAR, AND ALL EXPENSES PAID."

The above is what a Chicago book firm advertised. One of the readers of GLEANINGS, Mr. W. E. Birch, of Afton, Va., wrote them, and after some correspondence sent them \$10 for the outfit to go to work. After they had got his money they informed him that his salary was to be taken from what he received from other people whom he might be able to set to work; that is, his sub-agents were to pay him some money to bind the bargain, just as he paid the book firm some money, and from this money he was to get his salary. When he objected to this latter explanation, returned the cheap outfit, and wanted his money back, they refused, and called his attention to the printed agreement he had signed. I do not see how he can help himself; neither do I see how anybody should be persuaded that advertisers will do as they agree, when they promise to pay Tom, Dick, and Harry all over the country \$720 a year and all expenses. Notwithstanding, lots of people are losing \$10 or some similar sum by going into just such swindles. Nobody will hire you and pay you wages until he sees what you are able to do and how you do it



GINSENG AND ITS CULTIVATION.

While it is true our own plants did start bright and brisk in the spring, they have so far made only a very small growth. Some of them grew perhaps a few small berries; but with the richest soil we could give the plants, with proper attention, shading, etc., it is certainly the slowest thing I have ever grown in the whole vegetable kingdom. Are any of our experiment stations growing ginseng? We very much need reports from somebody in regard to the business, who does not have plants and seeds for sale. No doubt the business will pay at the present prices of roots and seeds.

ALFALFA—SOWING IT IN THE FALL.

My Root.—I have never read in your writings of your attempting to raise alfalfa on your own grounds. If you have tried it and failed, try my plan. I believe you can grow it as well as we of the West. Try sowing it this fall between the 20th of this month and the 15th of September. You can not put too much work on your ground. Give it a good plow up; harrow and roll until you get tired, firming the seed-bed down fine and smooth before sowing. Sow about 20 lbs. to the acre, with a seeder or drill, or broadcast with an even distribution; then harrow lightly; and if there is moisture, in a few days the clover will be up; and by cold weather you will find some of the roots have gone down 12 to 18 inches, and you will have a stand for all time. I will harvest four crops from mine this season, without irrigation, and get a honey crop too, right through the most terrible drouth and heat I ever saw in my 38 years' residence in Kansas. The truth has never been fully told of the benefits of alfalfa. It is king of all forage-plants, as well as a substitute for grain. All kinds of stock except hogs will fatten on the hay in shape for market, and hogs will keep in good order on the hay, without grain. I have been trying for 15 years to grow alfalfa by sowing it in the

spring. I could get a stand, but by fall it was all gone—killed out by crab-grass and hot suns during the summer.

About three years ago I sowed 7 acres, as an experiment, the latter part of August, and got a fine stand; and now we sow in the fall; and so far, when put in right, there are no failures; and, take it one year with another in this locality, land in alfalfa will pay interest on land, even if valued at \$200 per acre. If you have never tried fall sowing in Media, do so, and I believe your experiments will benefit others. The great value of this plant is known best only to those who raise it; and I believe it can be grown nearly all over the United States. Possibly it would winter kill in some of the more northern States.

Rossville, Kan., Aug. 6.

M. F. TATMAN.

Thanks for your suggestion, friend T.; and my opinion is that all kinds of clovers will succeed if the work is done thoroughly, and put in in the fall in the way you describe. The failures with fall sowing of almost any kind of clover are because the work has been done in a slipshod sort of way. Perhaps heavy clay ground will first need underdraining before we can make a success of it. If the ground is poor, and has not had manure for many years, very likely it will need some sort of fertilizer to get the alfalfa started. The fact that we have succeeded in growing crimson clover year after year, without any failure, for half a dozen years, put in almost exactly as you describe, goes far to convince me that many of our old and successful farmers have something yet to learn in regard to putting in clovers in August and the fore part of September. We have made a success with alfalfa on our grounds in small plots.

SWEET CLOVER THAT HORSES AND CATTLE WILL NOT EAT.

I have had an experiment with sweet clover, and find that no stock will eat it, not as hay and not as green pasture. It is just as thick as it can stand on the road here in some places, and cows and horses turned out on it would starve to death before they would eat it. I have seen it tried myself. It is good bee pasture, and that is all it is good for.

Bishop, Ill.

C. H. ZURBURG.

My good friend, you have made a mistake somewhere, but I do not know exactly where it is; but the plant is not sweet clover, or it is a different kind of sweet clover from that growing along the roadsides here, or else your horses and cattle have not been taught to eat it. Our horses learn the trick by grabbing at green stuff when they are cultivating or doing other work around the farm. A horse that catches on to this trick will, as you know, bite at any thing with green leaves on it; and in this way our horses learned to prefer sweet clover to any other plant. We have at different times owned a dozen horses, and they all learned to eat sweet clover in this way. Cows usually learn how when there is a severe drouth and the pasture is very short so they can not get any thing else. At such time, if they are where they can get a bite of sweet clover when it is young and tender, they very soon catch on. I never saw it fail, and I can not think the cows and horses in your locality are any different from those here. Of course, the plant may be somewhat different in different soils; but when you say they would starve to death before they would eat sweet clover, you are certainly making a mistake. Let us have a lot of reports in regard to this matter.

Has anybody else had an experience like that of friend Z.?

THE EUROPEAN LINDEN AND ITS LATER BLOOMING.

The following is of exceeding importance to bee-keepers. See if you do not agree with me. I extract it from a recent number of the *Farm and Fireside*, and it is from our friend T. Greiner, La Salle, N. Y.:

Within a few rods from the house I have a European linden, planted in 1889. It was full of bloom again this year, and, as last year its blooming season was fully a week later than that of the American linden, or basswood. My bees worked on this tree in full force long after bees had ceased to work on any of the native basswoods. Now I should like to know whether this late-blooming habit is common with all the European lindens or whether it is that of an individual tree. It seems to me of importance to the interests of our bee-keeping friends to see clear on this point, and then, if it be found that the basswood-honey season might thus be prolonged for a week, to plant lindens with the native basswood just for that purpose. Have any of our friends had experience with the European linden? Who will enlighten us?

When we planted our basswood orchard I think I had a dozen or more European lindens; but the matter has been out of mind, I am ashamed to say, so that I can not really state at the present time in regard to later blooming; but I remember this was reported to be the case when the orchard was planted. If this thing is true, then somebody wants to go to work immediately to grow European lindens for us, not by the hundred or thousand, but by the *million*. If my enthusiasm does not abate I will try to start the thing going at once. By they way, if this reaches the eye of any nurseryman who can tell us where to find such trees by the thousand, I wish he would write me at once.

JAMAICA SORREL.

I am always delighted to hear any thing Jamaican well spoken of, and am not less so at the editor's good opinion of Jamaica sorrel, page 484. In Jamaica the sauce that he speaks of has not, so far as I know, been made—at least not to any extent; but at Christmastide there is hardly a home, high or low, but has a plentiful supply of the delicious beverage known as "Jamaica drink." Few drinks there are, made from fruit, that can surpass this sorrel drink—so cool and delicate, and of a rich ruby color, like the plant it-elf when seeding, and it is considered to be to some extent a blood-purifier. It is made from the "fleshy husk," same as used for sauce. This husk is packed in a vessel, and a sufficient amount of boiling water (about four parts to one) poured on. Adding a few pieces of ginger it is allowed to steep for a day or two, is then strained off and bottled, to keep it from fermenting; and after it has settled it is fit for use when five or six days old. Sugar must be added to taste, but only to that quantity that can be used in one or two days, as it will not keep any longer when sweetened.

The sorrel is an annual, and seeds in December. It is certainly a grand sight to see even a small garden of it at that time.

I shall endeavor to send you some seeds, Mr. Editor, next season, if all goes well, just to try it along with those from Florida as I feel quite sure that Jamaica is the home of the Jamaica sorrel.

Black River, Jamaica.

ERIC FORREST.

We have at present about 40 plants growing with great vigor. Some of them are nearly a foot high; and therefore I feel quite confident we can get "fruit" in our locality if started under glass just as we start tomato-plants.

THAT PUGNACIOUS PLYMOUTH ROCK ROOSTER.

He is dead. He kept getting more and more quarrelsome. He pitched into Mr. Wardell when the latter was at work with the bees in the apiary, and he commenced driving people off the sidewalk. One day he went over into a neighbor's yard, taking his hens along with him. The neighbor's wife undertook to drive the strange poultry back to their own home where they belonged; but instead of being driven away he drove the good woman off *her own premises*. Not long after, he was found in the road dead. I conjectured he might have tackled a buggy-wheel with his undaunted courage. It made me think of Don Quixote fighting the windmill. Well, he is gone, but he left 32 strong healthy chickens. Every one that hatched lived to grow up. About half of the 32 are roosters. One of them that we are to have for dinner to-morrow weighs $5\frac{1}{4}$ lbs. He was hatched about the first of May, so he is now just about four months old. My impression is that his disposition showed vigor and vitality; and the way the chickens went through the wet month of June, out in the rain, and a cold rain at that a good part of the time, I am inclined to think pugnacity does, at least to some extent, indicate vigor and endurance. Most of his progeny are a cross between the White and the Barred Plymouth. You see I am not working for pure blood. I want vigor and strength without regard to color.

Since the above was written, I notice the Hope Farm man, in the *Rural New-Yorker*, is getting on to the same track that I am on. I have wondered several times whether he was reading GLEANINGS. In a recent number he told us of paying \$10 for a lot of choice eggs to put in his incubator. He had a very small hatch indeed, and what few chickens did hatch had so little vitality that they kept dying off until he had almost nothing left of his \$10. Then in disgust he tries the incubator again, with some eggs from his own poultry yard, and here is his report:

Out of 172 fertile eggs, 154 hatched, and only four have been lost in the same brooder which witnessed the former wholesale slaughter. You never saw a livelier lot of chickens. There is a sore place on my leg which indicates to me the chief reason for this lively crowd. It is where Don, the Wyandotte rooster, spurred me when I went to look at the egg record of his family. The sons and daughters of a nine pound bird that is willing to tackle a 175-pound man will not fall down and die without a struggle at least. The fighting blood in that old chap does those chicks more good than the lamp under the brooder! What a great privilege it is to have fight and kick in one's pedigree, so that they may be turned to worthy ends!

Heigh-ho! Since the above was put in type one of the pullets from the fighting rooster has laid several eggs—the first one, a day or two before she was four months old. So we have precocity in weight and precocity in egg-laying from the tiger rooster. No doubt part of this, at least, is accidental; but I think we are safe in saying it pays to save a vigorous, intrepid, and courageous male.

BEE AND CANE SUGAR.

The editorial on page 757, in regard to sugars, is very gratifying to me for two reasons. 1. It contains the first communication from our youngest boy, Huber, that has ever appeared in print, so far as I recollect; 2. It indorses exactly what I have been trying to tell the friends for years; namely, that the quality of sugar depends on its purity and not at all on whether it was made from beets, sugar cane, or something else. I have for some time back protested against space being given in GLEANINGS to argue the matter; and we can certainly now, it seems to me, drop it without wasting any more time or occupying space with an idle discussion. Mr Gilmore is unquestionably right.

We find the following on a scrap of newspaper:

The anti cigarette law in Minnesota has been held to be constitutional. This is one of the most stringent statutes yet enacted to prevent the sale of tobacco in that form.

A reader of GLEANINGS who has tried Quirin's strain of bees says they are very eucletic. They are out first in the morning and last at night; in fact they work so late evenings that he has baptized them "Quirin's Night Hawks." H. G. Quirin's ad. appears on the last page of cover.

EGG FOOD! The kind that tones and keeps up the hen so that she simply must lay. LEY'S POULTRY CONDITION POWDER puts good red blood into poultry veins; kills all disease germs; tones and nourishes fowls—big and little get all there is in the food when fed in conjunction with it. Price 25c pkg.; 5 for \$1. Ley's Thoroughbred Minorca eggs, \$1 for 13. Thoroughbred Belgian Hares. **Geo. J. Ley, Florence, California.**

GINSENG!

For reasons not needful to explain here we have got to move one of our largest ginseng gardens, and will close this garden out at very low rates. Seedling plants, 3c each; yearling plants, 4c; 2-year old plants, 5c; 3-year-old plants, 6c; 4-year old plants that have not borne seed, 8c; strong seed bearing plants, 1/2 to 1/2 in. in diam., 12c; over 1/2 in. in diam., 15c.

Edgewater Seed Co., Skaneateles, N. Y.

1200 FERRETS. All sizes; some trained; first-class stock. New price list free. **N. A. Knapp, Rochester, Lorain Co., Ohio.**



DON'T TOUCH IT

if you want PAGE fence, unless it is The PAGE. **Page Woven Wire Fence Co., Box 5, Adrian, Mich.**

Mr. A. I. Root's Writings

of Grand Traverse territory and Leelanau Co. are descriptive of Michigan's most beautiful section reached most conveniently via the

PERE MARQUETTE R. R.

For pamphlets of Michigan farm lands and the fruit belt, address **W. C. Tousey, D. P. A. Toledo, Ohio.**



A Superior Red-clover Queen for 25 cts.

An Offer for New Subscribers:

We want to add a lot of new readers to our WEEKLY AMERICAN BEE JOURNAL list during August and September. For that reason we are making those who are not now reading our journal regularly, this liberal offer: Send us \$1.25, and we will mail you the Bee Journal FOR A WHOLE YEAR, and also one of our SUPERIOR LONG-TONGUED RED-CLOVER QUEENS—untested Italian.

We arranged with one of the oldest and best queen-breeders (having many years' experience) to rear queens for us this season. His bees average quite a good deal the longest tongues of any yet measured. The breeder he will use is direct from Italy, having imported her himself. Her worker-bees are large, somewhat leather-colored, very gentle, and scarcely requiring veil or smoke. They stored red clover honey last season. All queens guaranteed to arrive in good condition, and all will be clipped unless otherwise ordered. All queens mailed promptly.

Headquarters in Chicago for Root's bee-supplies at Root's prices. A free catalog and sample of the American Bee Journal on request.



George W. York & Co., Chicago, Ill.
144, 146 Erie Street.

Standard - Bred Queens!

Acme of Perfection; Not a Hybrid among Them.

Improved Strain Golden Italians.

World-wide reputation; 75c each; six for \$4.00.

Long-tongued 3-banded Italians.

Bred from stock whose tongues measured 25-hundredths inch. These are the red clover hustlers of America. 75 cts. each; six for \$4.00. Safe arrival guaranteed. Catalog on application. Headquarters for bee-keepers' supplies.

Fred W. Muth & Co., Cincinnati, Ohio.
South-west Corner Front and Walnut Streets.

ALBINO QUEENS. If you want the most prolific queens, the best honey-gatherers, the best comb-builders, the hardest and gentlest bees known, try my albinos. My untested queens, 75c. **J. D. GIVENS, Lisbon, Texas.**



BELGIAN HARES!

With every hare sold goes a full pedigree, register number, and score-card, scored by an official judge. Does will be bred to one of our famous high-scoring bucks free. Write for book. Mgr. of The A. I. Root Co. **J. B. MASON, MECHANIC FALLS, MAINE.**



Belgian Hares

I have some fine hares for sale at reasonable prices.

J. F. Moore, : Tiffin, Ohio.



HONEY-PACKAGES.

We still have on hand a good supply of 1 and 2 quart Mason jars, No. 25, and No. 100 jars and tumblers. We are short on $\frac{1}{2}$ and 1 lb. square jars, but expect a new supply within a few days. We can also furnish tin cans and pails as listed. We published a list of stock on hand of the various kinds a month ago. We still have some of most of the items in that list, although the quantities have been reduced somewhat.

COMB HONEY WANTED

We are unable to secure choice comb honey fast enough to fill our orders. Buyers have been over the ground in the West picking up most of the desirable lots. There are a good many bee-keepers who have not prepared their honey for market, perhaps, for lack of time. If any such read this item I would advise them to lose no time in getting their honey ready. When there is a good demand at good prices, let it go. The demand and price usually slack in December, and sometimes before. We solicit offers of fancy and No. 1 white. If you have any to sell, write us how much and what you ask for it.

QUEENS UNTIL NOV. 15TH.

The best of warranted Italian queens, 50 cts. each, \$6.00 per dozen. We breed bees for business, and guarantee prolific queens, and fine honey-gatherers. Your orders will be promptly filled by return mail.
J. W. K. SHAW & CO., Loreauville, La.

WANTED.—Comb and extracted honey. State price kind, and quantity.
R. A. BURNETT & Co.,
199 South Water St., Chicago, Ill.

WANTED.—To buy your honey. State your lowest cash price, kind, and quantity.
EDW. WILKINSON, Wilton, Wis.

WANTED.—To buy quantity lots of fancy and No. 1 white-clover comb honey in no-drip cases.
BYRON WALKER, Clyde, Cook Co., Ill.

WANTED.—We are in the market for honey, either local or carlots commission or purchase. We especially desire Wisconsin basswood, and will be pleased to hear from that State.
EVANS & TURNER,
Town St., Cor. 4th, Columbus, Ohio.

WANTED.—Fancy and No. 1 white-clover honey, one-pound sections, paper cartons preferred.
BLAKE, SCOTT & LEE,
33 Commercial St., Boston, Mass.

WANTED.—Comb or extracted honey in any quantity. Cash paid. State kind, quantity, how packed, and lowest price.
EARL C. WALKER,
Box 316, New Albany, Indiana.

FOR SALE.—Sixteen 60 lb. cans of white-clover extracted honey at 7 cts. a pound. W. D. SOPER,
Rural Delivery No. 3, Jackson, Mich.

FOR SALE.—Extracted honey in 60 lb. cans at $7\frac{1}{2}$ cts. M. ISBELL, Norwich, N. Y.

FOR SALE.—Extracted honey in 60-lb. cans, No. 1 alfalfa, $7\frac{1}{2}$ cts per lb.; partly from other bloom. $6\frac{1}{2}$ cts.
D. S. JENKINS, Las Animas, Colo.

FOR SALE.—8000 lbs. clover and basswood honey, mixed, in 60-lb. cans, as white as Michigan produces; good body and flavor; the best I ever produced in 26 years' bee-keeping. A free sample will convince you. Eight cts. per lb. at Carson City.
E. D. TOWNSFEND, Remus, Mich.

We will be in the market for honey the coming season in carlots and less than carloads, and would be glad to hear from producers everywhere what they will have to offer.
SEAVEY & FLARSHHEIM,
1318-1324 Union Avenue, Kansas City, Mo.

PINEAPPLES!

Choice fruit and plants now ready for shipment. Suitable land for sale, sheds constructed, pinerics set and cared for. Correspondence solicited.

Lewisiana Pinery Company, Orlando, Florida.

C. H. Lewis, Manager.

100 Tested Red Clover Queens For Sale

at 75 cents each; $\frac{1}{2}$ dozen, \$4.00; untested 60 cts.; $\frac{1}{2}$ dozen, \$3.00
LEININGER BROS.,
Fort Jennings, Ohio.

CHAS. ISRAEL & BROS.,

486-490 Canal St., Corner Watt St., N. Y.

Honey and Beeswax.

Liberal Advances made on Consignments. Wholesale Dealers and Commission Merchants. Estab. 1875.

Wanted! HONEY, WAX,
MAPLE SUGAR,
SYRUP, AND
POPCORN.

A. L. JENKS, 42 W. Market St., Buffalo, N. Y.

100 Full Swarms Bees at \$1.25 a Swarm.

With good laying queen in shipping-box, no hive or combs; hive extra, \$1.00. These bees are for feeding up for winter to make colonies, or to strengthen weak colonies, or may be used for re-queening. Full directions given. Orders filled as received. Write for further information regarding these bees. Address
P. H. McFarland, Hyde Park, Vermont.

Young mismatched Italian queens for 25 cts. each.
C. G. FENN, Washington, Conn.

Wants and Exchange.

WANTED.—An experienced bee-man to manage apiary and run a one horse farm. Fine location, large orchard, good school. Address
CLAUDE SHEWMAKE, Shewmake, Laurens Co., Ga.

WANTED.—Position in Cuba, by experienced bee-keeper; young man; sober.
A. C. FAULKNER, Basking Ridge, N. J.

WANTED.—To sell or exchange gasoline engine, motor bicycle, bicycles of every description, for launch, lathe, drill-press, etc.
ROBERT B. GEDYE, LaSalle, Ill.

WANTED.—To exchange 200-egg incubator and brooder, with copper tanks complete, for bees in 8-frame Dovetailed hives
J. E. HIPPLE, Bird Island, Minn.

WANTED.—To exchange second-hand 60-lb. cans, practically as good as new, at 20c per can in lots of 20 or more f. o. b. Chicago, for white-clover honey at market price.
B. WALKER, Clyde, Cook Co., Ill.

WANTED.—To exchange one broom-handle lathe and one automatic gauge lathe.
W. S. AMMON, 216-8 Court St., Reading, Pa.

WANTED.—To exchange a St. Albans 2 h.-p. and thrasher for 3 h.-p. gasoline engine.
C. L. GOULD, East Dover, Vermont.

Marshfield Manufacturing Company.

Our specialty is making SECTIONS, and they are the best in the market. Wisconsin basswood is the right kind for them. We have a full line of BEE-SUPPLIES. Write for FREE illustrated catalog and price list.

Marshfield Manufacturing Company, Marshfield, Wisconsin.

THE SMITH PREMIER TYPEWRITER

Occupies an Imperishable Position in the BUSINESS WORLD.

Unquestionable Superior Merit

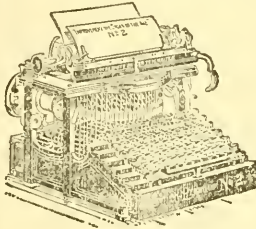

Annually adds thousands of names to the long list of Smith Premier users, representing every line of trade and every profession.

ILLUSTRATED CATALOGUE FREE.

The Smith Premier Typewriter Co.,

153 Prospect Street, Cleveland, Ohio.

Don't Dig Potatoes by Hand

It is a slow and expensive way. The cheapest, quickest, and easiest way is to USE THE IMPROVED

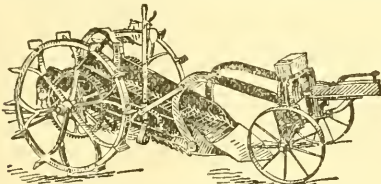

DOWDEN POTATO-DIGGER.

It gets them all, no matter how deep or shallow. Our book explains how. Book is free. Write for it now. DOWDEN MFG CO., - Box 23, Prairie City, Ia.

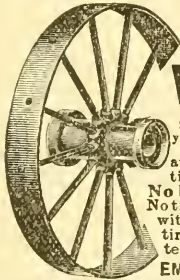

STEEL WHEELS

for your FARM WAGONS any size wanted, any width of tire. Hubs to fit any axle. No blacksmith's bills to pay. No tires to reset. Fit your old wagon with low steel wheels with wide tires at low price. Our catalogue tells you how to do it. Address EMPIRE MFG. CO., Quincy, Ill.

Union Combination Saw

For Ripping, Cross-cutting, Rabbeting, Mitering, Grooving, Gaining, Boring, Scroll-sawing, Edge-moulding, Beading. Full line FOOT and HAND POWER machinery. Send for catalog A. SENECA FALLS MFG. CO., 44 Water St., Seneca Fs., N.Y.

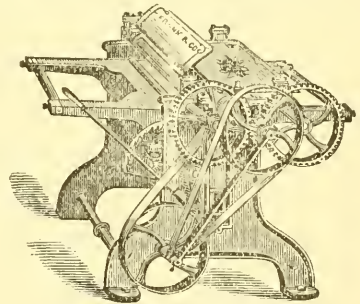
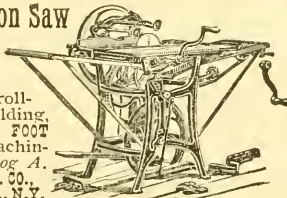

PLANERS

The above cut shows one of our small Planers, of which we make twelve different styles and sizes. Also large Planers, Band Saws, Buzz Planers, Moulders, Wood Lathes, and all kinds of

WOOD WORKING MACHINERY

Send for Catalogue.

The FRANK MACHINERY CO.

BUFFALO, N. Y.

Barnes'

Hand and Foot Power Machinery.

This cut represents our combined circular saw, which is made for bee-keepers' use in the construction of their hives, sections, boxes, etc. *Machines on trial.* Send for illustrated catalogue and prices.

W. F. & John Barnes Co., 545 Ruby St., Rockford - Ill.

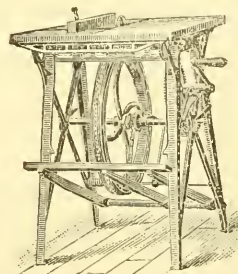

GET MORE HEN MONEY

Feed cut raw bone and double your profits; get more eggs, more fertile eggs; more vigorous and healthy fowls.

MANN'S 1902 Model BONE CUTTER

New design, open hopper, enlarged table, new device to control feed; you can set it to suit any strength; never clogs. Sent on

10 DAYS FREE TRIAL. No money asked for until you prove our guarantee on your own premises, that our New Model will cut any kind of bone, with all adhering meat and gristle, faster and easier and in better shape than any other type of bone enter. If you don't like it send it back at our expense. Free cat'g. explains all.

F. W. MANN COMPANY, Box 37, Milford, Mass.

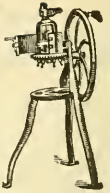

Choicest Fruit and Ornamental Trees.

Shrubs, Plants, Bulbs, Seeds. 40 Acres Hardy Roses. 44 Greenhouses of Palms, Everblooming Roses, Ficus, Ferns, Etc. Correspondence solicited. Catalogue Free. 48 Years. 1000 Acres.

THE STORRS & HARRISON CO.,

Painesville, Ohio.

1881

PAGE & LYON MFG. CO.

1901

We manufacture a full line of the latest

BEE-SUPPLIES.

Our motto is, "Perfect Goods and Prompt Shipment."

Send for our new free illustrated catalog.

PAGE & LYON MFG. CO., New London, Wisconsin.

NOW READY!

64-PAGE CATALOG OF EVERY THING BEE-KEEPERS NEED. Illustrated and fully described. Especially valuable to beginners for the information it contains. Send your address on postal and get it now. Established 1884.

J. M. JENKINS, Wetumpka, Ala.

I. J. Stringham, 105 Park Place, New York City.

Keeps in stock a full line of modern appliances for bee-keepers.

SQUARE CANS & SHIPPING-CASES.

One-pound square flint jars with corks, \$5.00 a gross. Cartons of a superior quality at a low price. Tested Italian queens, \$1; untested, 75c. Apiaries, Glen Cove, L. I. Catalog free.

I. J. Stringham, 105 Park Place, New York City.

The Best Queens of the Best Kinds.

By special arrangement with The A. I. Root Co. to furnish them QUEENS, I have secured their assistance in procuring the FINEST BREEDING QUEENS that a thorough knowledge of the bees of the country and money can procure. Among them is a SELECT DAUGHTER OF THEIR \$200 00 QUEEN THAT THEY RE-

FUSE TO QUOTE ME PRICES ON. This queen shows every superior quality of her mother. Her bees show an actual reach of 21-100 of an inch; are large, gentle, and beautiful to look upon.

MR. E. R. ROOT says: "You have as fine bees as there are in the United States; and with a direct cross of their breeders you should be able to produce queens whose bees show a reach of 25-100 of an inch."

MR. R. A. JANSEN, of Iago, Wharton Co., Texas, bought of me last fall 80 queens. He says of them: "I consider myself the queen and 50 cents per colony BETTER OFF, for the purchase of these queens, on the SPRING HONEY FLOW ALONE. They SURPASSED ALL OTHER COLONIES in my yard during the spring honey flow and KEPT UP THE LICK. Please book my order for 100 MORE queens to be delivered in the fall. I shall, in all probability, increase this order later."

Under date of July 28th, 1901, from Mr. W. E. Burch, of Los Banos, Cal., comes the following in regard to queens from my apiary: "The three that I have are the FINEST queens I ever saw, and the GENTLEST BEES TO WORK WITH. When I am working with these three colonies I do not use the smoker, and they ALWAYS SEEM TOO BUSY ATTENDING TO THEIR OWN BUSINESS TO interfere with me; AND THEY ARE THE BEES THAT BRING IN THE HONEY."

From Ramey, Minn., under date of Aug. 8th, 1901, Mr. A. T. McKibber writes: "The cage of bees arrived o. k., and were measured. They ran 24-100 and 25-100, which is just a little longer than any I have, or have measured, and I think by their looks that they're good bees. The bees you sent could probably take honey $\frac{1}{4}$ inch."

Louis Werner writes under date of June 19, 1901, from Edwarsville, Ill.: "The queen I got from you is a good one, and proved to be as good as I EVER GOT FROM ANY BREEDER. When I am in need of queens I know where to get good ones."

Frank Coverdale, of Maquoketa, Iowa, says, under date of July 6, 1901:

"We like those that have hatched. They are exceedingly gentle, and queens prolific. Among the first fifty the tongue-reach is very good, generally 20; one measures 23, and another, which is best of all, measures 21. THIS QUEEN I VALUE VERY HIGH. Her bees are uniform in color. I'd like you to send me a cage from your longest-reach queen, as I'm well equipped for measuring."

This is from far off Jamaica:

"Kingston, Jamaica, B. W. I., May 14, 1901.

"Queen received on the 8th in the pink condition. Attendants and queen appeared as if just placed in cage THE DAY BEFORE.

S. E. SURRIDGE."

If I have real good success, by next year I expect to be able to furnish a QUEEN for the Chinese that will be acceptable to the POWERS.

The A. I. Root Co. also knows a GOOD THING when it sees it. LISTEN!

"Medina, Ohio, May 1st, 1901.

"W. O. Victor.—Instead of sending us 12 untested queens per week, send us 18 in two installments, a day or so apart."

I have on hand at the Pan-American Exposition a nucleus with queen. Mr. Orel L. Hershiser, Superintendent Apiarian Exhibit, will take pleasure in showing them, as he always "Seeks after the Good, the Beautiful, and the True."

Prices for September, October, and November Only.

Untested queens, 65c; 6, \$3.50; 12, \$6.50; 50 or more, 50c each. Select untested, 85c; 6, \$4.50; 12, \$8.50. Tested, \$1.00; 6, \$5.50; 12, \$10.00. Select tested, \$1.50; 6, \$9.00. Breeders whose best bees show a reach of 21-100, with an average of 20-100, \$3.00. Breeders whose best bees show a reach of 21-100, with an average reach of 20 $\frac{1}{2}$ -100, \$5.00. Breeders whose best bees show 21-100, with an average reach of 21-100, \$7.00. I have discovered two breeders whose best bees show 21-100, with an average reach of 22-100. These are too good to sell. Don't ask for prices. Yard No. 1.—Long-tongue Root Clover. Yard No. 2.—Imported Stock. Yard No. 3.—Golden, or Five-banded Stock. Yards No. 1 and 2 contain, without question, bees as gentle as was ever handled, and I think equal of any in the world as honey-gatherers from any flower that grows. Don't forget that my FAMOUS BEAR PICTURE goes as a premium with each order for six or more queens at prices quoted. Send for list showing description of stock and arrangement of each apiary.

W. O. VICTOR, Queen Specialist, Wharton, Texas.

See What I Offer.

For \$1.50 I send a queen of the Superior Stock—a strain of dark, leather-colored Italians that is surpassed by none. I guarantee safe arrival, safe introduction, purity of mating, and entire satisfaction. Any time within two years you can return the queen and get your money back and 50 cts. extra for your trouble. The following is a sample of letters that frequently come to this office:

AURORAVILLE, WIS., Aug. 24, 1901.

W. Z. Hutchinson, Flint, Mich. Dear Sir:—The last queen you sent me is all right. She was laying in three days after being introduced. I am more than pleased with the queens that I got of you last year. One of them, or her bees, store double the quantity of honey of any other colony in the yard, and I have over 100 colonies. I have purchased queens of three other breeders, but none of them are doing so well as the ones I got of you. Their bees are out the first thing in the morning, and they stick to it all day.

Yours truly, J. MATHEWS.

Now a few words about the *Bee-Keepers' Review*. The quality of its contents, the helpfulness of its character, are unsurpassed. Some subscriber in the

West (I can't recall his name just now) once wrote me that he had often wondered how I could get \$1.00 for the Review when there were other journals published so much oftener at the same price, "but," he added, "after reading it one year I can see the reason why."

Mathilde Candler, of Cassville, Wis., when sending in her renewal, wrote as follows: "I am delighted with the Review. I am sorry that I was not a subscriber years ago. I especially admire its wholeheartedness. Then there are no side issues to take away the energies that might better be devoted to the interests of bee-keeping. It has awakened me out of a Rip Van Winkle sleep, and given me a fresh impetus in bee-keeping."

Just at present the Review is paying especial attention to discussing the subject of improvement of stock by improved methods of selection and breeding.

The Review is \$1.00 a year, but the rest of this year is sent free to all who send \$1.00 for 1902. Not only this, but, for \$2.00, I will send the Review from now to the end of next year, and also send a queen of the Superior Stock.

W. Z. HUTCHINSON, Flint, Mich.

\$1=TESTED QUEENS=\$1.

A nice lot of young golden tested queens at \$1.00 each while they last; selected, \$1.50; warranted queens, 60c;—6 for \$3.50; select warranted, 80c—6 for \$4.50. My bees are a five-band strain, selected for size, energy, working qualities, long tongue-reach—and, lastly, beauty. I have never tested a strain that excels them. A pile of letters assert the above claims are true, and also that they winter well north. Queens are sent promptly.

J. B. CASE, Port Orange, Fla.

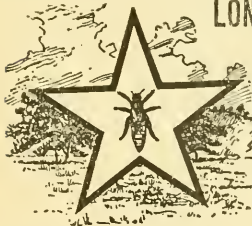

LONE STAR APIARIES

Italian Queens.

Estab'd 1885. Prices of queens from imported mothers: Tested, \$1.50; 6, \$6.50; 12, \$12.00. Untested, 75c; 6, \$4.00; 12, \$7.00. Golden, same price. Select tested of either race, \$2.50 each. For a short time I will mail tested leather-colored queens at \$1.00, not satisfied. Address

Your money back if you are not satisfied. Address G. F. DAVIDSON & SONS, FAIRVIEW, TEX.

QUEENS the balance of season, 50c; full colonies, \$3. MRS. A. A. STIMPSON, Swarts, Pa.

FOR SALE.—Will sell my half interest in one of my apiaries consisting of 300 colonies, 20 miles of N. G. Railroad; at your command. GEO. ROCKENBAUGH, Yaguajay, Cuba.

30 COLONIES Italian bees for sale cheap; in good condition; no disease. Also S. C. B. Leghorns; no better; circular free. H. M. Moyer, Shanesville, Pa.

Minnesota Bee-keepers' Supply Mfg. Co., Manufacturers of Bee-hives, Sections, Shipping-cases, and Everything Used by Bee-keepers.

Orders filled promptly. We have the best shipping facilities in the world. You will save money by sending for our price list. Address

Minnesota Bee-keepers' Supply Mfg. Co., Nicollet Island Power Building, Minneapolis, Minn.

Angora Goats. Delane bucks; good stock; low prices; large circular for stamp. ED. W. COLE & CO., Kenton, O.

For Sale! 150 swarms of Italian bees in 10-frame hives, with ample stores for winter. Combs from foundation; thick-top frames wired; no foul brood or disease of any kind. Price \$450. Also a lot of bee-supplies. Will also sell a 40-acre farm with house and barn, situated in basswood region of Wisconsin; good schools and churches; best of neighborhoods; never have to lock a door. Price \$1500. Reason for selling, my health requires a warmer climate. Address as below.

W. H. Young, Ono, Wisconsin.

QUEENS! Fine, large, gentle, and prolific; long-tongue reach; either 3 or 5 banded; 75 cents each; six for \$4.25. Try them and be pleased. CHAS. H. THURS, Steelville, Ill.

ONCE IN A LIFE TIME is often enough to do some things. It's often enough to buy a wagon if you buy the right kind. The

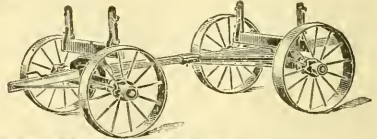

ELECTRIC HANDY WAGON

lasts that long under ordinary conditions. First the life of a wagon depends upon the wheels. This one is equipped with our Electric Steel Wheels, with straight or stagger spokes and wide tires. Wheels any height from 24 to 60 in. It lasts because tires can't get loose, no re-setting, hubs can't crack or spokes become loose, felloes can't rot, swell or dry out. Angle steel hauls.

THOUSANDS NOW IN DAILY USE. Don't buy a wagon until you get our free book, "Farm Saviors." **ELECTRIC WHEEL CO.,** Box 95, Quincy, Ills.

The Storm Proof KING WIND MILL produces 25 to 50% more net power than any other kind of wind that any other mill. Wheel being only 1 in. thick, cuts the wind like a knife and is 400% more storm proof than any other. Exceedingly light, but wonderfully strong. Very sensitive—runs in lightest winds. Numerous sizes—6 ft. up, both pumping and power, back geared or direct stroke. Send for circulars and prices before you buy. **Medina Mfg. Co.,** Box 11, Medina, O.

YOU NEVER CAN TELL how soon you will need medicine. Get our **Large Drug Book**, keep it handy. Contains over 35,000 lists of drugs, medicines, family remedies, toilet articles, etc. Mailed for 10c. We refund amount out of first order. "The Only Mail Order Drug House in the World." **HELLER CHEMICAL CO.,** Dept. 40 Chicago, Ill.

Red Clover Queens.



BLACK ROCK, N. Y., Sept. 3, 1901.

Friend Ernest:—I will try and tell you what you want to know about that queen. I got her of you in 1899 as a premium with GLEANINGS. I never saw a small colony of bees build up as that one did. In the spring of 1900 they came out in fine shape, wintered perfect. I raised them up in May and gave them 8 frames more so the queen would not want for room. I never saw such a colony of bees as they were in June, and they actually were storing honey when other bees in my yard were starving. No! they were not robbing. I never saw those two best colonies of mine trying to rob. They certainly work on red clover. This is no guesswork, as I have seen them. As you know, the past two seasons have been very poor, and what honey my bees did get in 1900 candied soon after cold weather set in. I packed this colony in a chaff hive and left them out, thinking that such a strong colony would winter perfect. The snow came on the middle of November, and those poor bees never a fly until the last of March or the first of April. When warm weather at last came I thought they were dead, as they did not seem to be flying much, so I did not pay any attention to them until in June. I noticed they were working a little, so I opened up the hive and found them in the upper story. I took the lower story out and left them in the one body. The queen was laying nicely, and I thought they would make a good colony to winter. Along the last of July I noticed that they needed more room. I gave them a super, 24 boxes, and in a few days they had it full. They have made 72 boxes of as nice honey as you ever saw, and are drawing out some starters now, Sept. 2.

Very truly yours,

GEO. B. HOWE.

Prices of Red-Clover Queens.

Gleanings in Bee Culture 1 year and Untested Queen,	\$2.00.
“ “ “ Tested Queen,	4.00.
“ “ “ Select Tested	6.00.

If you want something good you can not do better than to order one of these queens. All orders are filled promptly. No extra postage on these to foreign countries.

THE A. I. ROOT CO., Medina, Ohio, U. S. A.

HONEY QUEENS!

- Laws' Long-tongue Leather Queens.
- Laws' Improved Golden Queens.
- Laws' Holy Land Queens.

Laws' queens are the standard bred queens of America. The largest honey-producers use them and praise them. Laws' queens go everywhere, and can furnish you a queen every month in the year. Four apiaries. Queens bred in their purity. Prices, October to April: Tested or untested, \$1.00 each; 6 for \$5.00. Breeders, none better, \$3.00 each. Address

W. H. Laws, Beeville, Texas.

Dittmer's Foundation !!!

Retail---Wholesale---Jobbing.

I use a PROCESS that produces EVERY ESSENTIAL necessary to make it the BEST and MOST desirable in all respects. My PROCESS and AUTOMATIC MACHINES are my own inventions, which enable me to SELL FOUNDATION and WORK WAX INTO FOUNDATION FOR CASH, at prices that are the lowest. Catalog giving

FULL LINE OF SUPPLIES

with prices and samples, free on application. BEESWAX WANTED.

GUS. DITTMER. AUGUSTA, WIS

Get the Best Queens.

Evansville, Ind., Sept. 27th, 1900.

The Jennie Atchley Co., Beeville, Bee Co., Texas:
 Dear Friends:—It gives me great pleasure to forward you this unsolicited testimonial regarding the merits of Atchley queens. The three (3) dozen queens purchased of you have made an excellent record for themselves. Not an Atchley queen among the twenty colonies lost during the severe drouth in July. I have bought queens from many breeders; and although the present crop is exceedingly short, the tiers of supers show where the Atchley queens are, and speak volumes for your method of queen-rearing. I find the progeny to be very gentle, strong winged, uniformly marked, long-lived, of large size, and last, but not least, the best honey-gatherers I ever had. I shall want 100 more next season.

Yours fraternally, J. C. WALLENMEYER.

Prices for Queens.

Tested, \$1.50 each; \$8.00 for 6, or \$15.00 per dozen. Untested, February, March, April, and May, \$1.00 each; \$5.00 per 6, or \$9.00 per dozen. Fine breeders, \$5.00 each. We have as good bees and queens as money and labor produce. We breed three-band Italians, Golden, Carni-lans, Cyprians, and Holy-Lands, in their purity, bred in separate yards 5 to 20 miles apart. If you want *the best*, call for Atchley's improved strains. Safe arrival guaranteed. Send for a sample copy of "The Southland Queen," the only southern bee-paper. \$1.00 per year. To new subscribers we offer as a premium a nice untested queen in order to get our paper introduced. Catalog, giving queen-rearing and management of apiaries for profit, FREE.

THE JENNIE ATCHLEY CO.,
 Beeville, Bee Co., Texas.

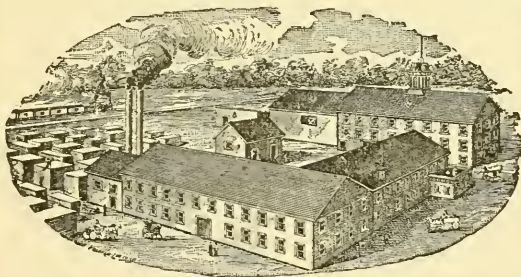

KRETCHMER M'F'G CO., Red Oak, Iowa.

BEE-SUPPLIES.

Best-equipped factory in the West; carry a large stock and greatest variety of every thing needed in the apiary, assuring BEST goods at the LOWEST prices, and prompt shipment. We want every bee-keeper to have our FREE ILLUSTRATED CATALOG, and read description of Alternating Hives, Ferguson Supers, etc. *Write at once for a catalog.*

— AGENCIES: —

Trester Supply Co., 103 So. 11th St., Lincoln, Nebraska; C. C. Richards, 1223 17th St., Denver, Col.

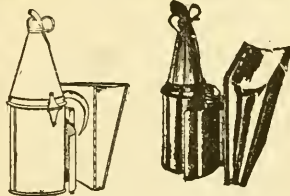

BINGHAM SMOKER.

Dear Sir:—Inclosed find \$1.75. Please send one brass smoke-engine. I have one already. It is the best smoker I ever used. Truly yours,
 HENRY SCHMIDT, Hutto, Tex.

MADE TO ORDER

Bingham Brass Smokers.

Made of sheet brass, which does not rust or burn out; should last a lifetime. You need one, but they cost 25 cts. more than tin of the same size. The little open cut shows our brass hinge put on the three larger sizes. No wonder Bingham's four-inch smoke-engine goes without puffing, and does not drop inky drops. The perforated steel fire-grate has 381 holes to air the fuel and support the fire. Heavy tin smoke-engine, 4-inch stove, per mail, \$1.50; 3 1/2-inch; \$1.10; 3-inch, \$1.00; 2 1/2-inch 90c; 2-inch, 65c. Bingham smokers are the originals, and have all the improvements, and have been the standard of excellence for 22 years. Only three larger ones brass.

T. F. Bingham, Farwell, Michigan.

Contents of this Number.

Bee and Pear Men in California.....792
 Bees, Red clover.....788
 Bricks for Hive-records.....790
 Bunting, W. D.....780
 Editor in Texas.....779
 Editors and Other People.....789
 Foundation, Thin and Extra-thin.....788
 Glucose, To Detect.....782
 Grapevine, Shade, Overhead.....782
 Cavillea Robusta.....779
 Gums, Log, Porosity of.....789
 Hand-cream.....789
 Hive-covers of Two Boards.....778
 Hive-rabbit, New.....789
 Honey, Exaggerated Reports.....792
 Honey from Corn.....788
 Honey, To Pack.....790
 Introducing to Cross Hybrids.....787
 Orioles Killing Bees in Black Locust.....791
 Pastebord in Queen-cages.....788
 Queens Living when Balled.....790
 Queen, Development of.....784
 Stings for Rheumatism.....786
 Sugar, Beet and Cane.....792
 S warming with Unsealed Brood.....787
 Terms, Correct, Use of.....778
 Texas, Views in.....781
 Wax in Slumgum.....791
 Wax-presses.....782
 Winter, Preparing for.....785

Honey Column.

GRADING-RULES.

FANCY.—All sections to be well filled, combs straight, firm ly attached to all four sides, the combs unsoiled by travel stain, or otherwise; all the cells sealed except an occasional cell, the outside surface of the wood well scraped of propolis.
 No. 1.—All sections well filled except the row of cells next to the wood; combs straight; one-eighth part of comb surface soiled, or the entire surface slightly soiled; the outside surface of the wood well scraped of propolis.
 No. 1.—All sections well filled except the row of cells next to the wood; combs comparatively even; one-eighth part of comb surface soiled, or the entire surface slightly soiled.
 No. 2.—Three-fourths of the total surface must be filled and sealed.
 No. 3.—Must weigh at least half as much as a full-weight section.
 In addition to this the honey is to be classified according to color, using the terms white, amber, and dark; that is, there will be "Fancy White," "No. 1 Dark," etc.

CITY MARKETS.

SAN FRANCISCO.—Comb honey, 10@12 Extracted, water-white, 5½@6½; light amber, 4@5½; dark, 4@5. Beeswax, 25@27.
 Sept. 11. E. H. SCHAEFFLE, Murphys, Cal.

ALBANY.—Honey market improving in demand, as the weather is colder. We quote fancy white comb, 16 No. 1, 15; No. 2, 14; mixed, 13@14; buckwheat, 12@13. Extracted receipts light, yet good demand for white and light grades at 7; dark, 6. We advise sending honey now, as we believe it will be lower later, especially extracted.
 Sept. 20. McDUGAL & Co., Albany, N. Y.

CINCINNATI.—The supply for comb honey is rather short. Fancy Southern 14½; fancy white clover sells 15@16. The market for extracted is rather dull. Dark sells for 5@5½; better grades from 6@7; extra fancy, 8@9. Beeswax, 27.
 Sept. 19. C. H. W. WEBER, Cincinnati, O.

NEW YORK.—We quote you the market as follows: The honey season is now open, and the demand is about equal to the receipts. The weather has been rather warm, and shipments have not been forthcoming as we should like to see them, but we presume shippers are waiting for cooler weather. Fancy white, 15@16; No. 1, 14@15; No. 2, 11@13; fancy buckwheat, 10@10½; No. 1, 9@10; No. 2, 8½@9. Extracted, white clover and basswood, 6@7; light amber, 5½@6; amber, 5@5½. Beeswax is dull, 27@28.
 CHAS. ISRAEL & BROS.,
 486-8 Canal St., New York City.
 Sept. 20.

NEW YORK.—Replying to yours of Sept. 17, would say that arrivals of comb honey are coming in freely, and in fair quantities. We quote: Fancy white, 14@15; No. 1 white, 13@14; No. 2 white, 12. Extracted is rather dull, and is bringing 4½@6, according to quality. No buckwheat has arrived as yet, but we expect some shortly. But little demand for beeswax at 27½.
 FRANCIS H. LEGGETT & Co.,
 Franklin, West Broadway, and Varick Sts.,
 Sept. 21. New York City.

BOSTON.—Honey is coming forward in fair quantities, and the demand is good, considering the warm weather we are having. Strctly fancy, in cartons, 16; A No. 1, 15; No. 1, 14@15. Very little No. 2 being received.
 BLAKE, SCOTT & LEE,
 Sept. 14. 31, 33 Commercial St., Boston, Mass.

CHICAGO.—No. 1 white comb honey is selling at 15c per lb., with occasionally a little more being obtained for fancy; that which does not grade No. 1, selling at 13@14, with the light amber at 12@13; dark, of various kinds, 10@11. Extracted in moderate demand at 5½@6½ for the various grades of white, some fancy white clover and basswood bringing 7; light amber ranging from 5¼@5½; dark, 5@5½. Beeswax, firm at 28@30.
 R. A. BURNETT & Co.,
 Sept. 18. 199 South Water St., Chicago, Ill.

NEW YORK.—Comb honey is now beginning to arrive in large quantities, and, as a rule, quality is fine. The demand is good. We quote as follows: Fancy white, 14@15; No. 1, 13; No. 2, 12; amber, 11. No buckwheat on the market as yet, but are expecting some within a week or so. Extracted is selling slowly, with plenty of supply, at unchanged prices. Beeswax dull at 27.
 HILDRETH & SEGELKEN,
 Sept. 20. 265 Greenwich St., New York City.

SCHENECTADY.—We have received a number of consignments of clover honey, and sold on arrival at prices quoted; but producers are late getting buckwheat ready for market, and we have been unable to fill orders. We quote white 15@16; medium, 13@14; buckwheat, 11@12. Extracted, 5@6.
 Sept. 20. C. MCCULLOCH, Schenectady, N. Y.

WANTED.—Fancy white honey in Danz. sections, also buckwheat honey, comb and extracted. Send sample of extracted, and let us know how much you have, comb or extracted, and how put up, and price at which you will sell.
 THE A. I. ROOT Co.

WANTED.—Western honey in car lots, also northern fancy white comb in no-drip cases; state price delivered. We pay spot cash. Reference, German National Bank, Cincinnati. FRED W. MUTH & Co.,
 Front and Walnut Streets, Cincinnati, Ohio.

WANTED.—Honey; car lots or otherwise. Will send man to receive when sufficient amount to justify, and pay highest market price, spot cash. Address, stating quantity, quality, and price desired at your station.
 THOS. C. STANLEY & SON, Fairfield, Ill.

WANTED.—Write us if you have any large or small lots of extracted honey to sell. State quantity, kind, and price expected and if possible mail sample. We pay spot cash. Reference, Wisconsin National Bank. E. R. PAHL & CO., Detroit & Bdwy, Milwaukee, Wis.

WANTED.—Comb honey and beeswax. State price delivered Cincinnati. C. H. W. WEBER,
 2146 2148 Central Ave., Cincinnati, Ohio.

WANTED.—We are in the market for honey, either local or carlots commission or purchase. We especially desire Wisconsin basswood, and will be pleased to hear from that State. EVANS & TURNER,
 Town St., Cor. 4th & Columbus, Ohio.

WANTED.—Fancy and No. 1 white-clover honey, one-pound sections, paper cartons preferred.
 BLAKE, SCOTT & LEE,
 33 Commercial St., Boston, Mass.

We will be in the market for honey the coming season in carloads and less than carloads, and would be glad to hear from producers everywhere what they will have to offer.
 SEAVEY & FLARSHAM,
 1318-1324 Union Avenue, Kansas City, Mo.

Wm. A. Selser, Honey Expert,

When you buy honey, send a 3-oz. bottle, have it tested, to be sure it is pure. Price \$2.50 per sample. By doing this you may avoid over ten times this amount in litigation with pure-food laws. Chemist's certificate given.

The A. I. Root's Co.'s Office, 10 Vine Street, Philadelphia, Pa.

G. B. LEWIS CO., WATERTOWN, WIS.

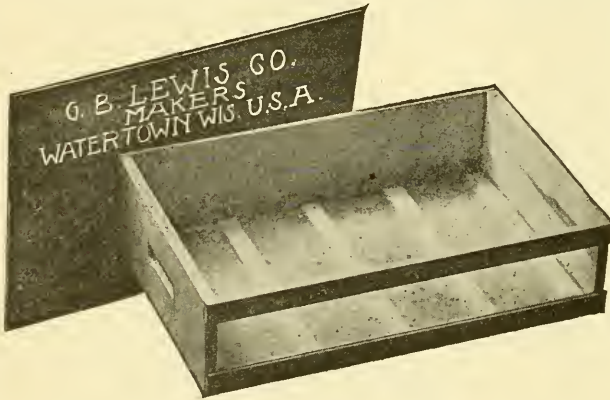

Bee-hives,
Lewis' White
Polished Sections,
Shipping-cases.

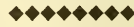

Perfect Goods,
Prompt Shipment.

Special Agency, C. M. Scott & Co., 1004 East Washington St., Indianapolis, Indiana.

AGENCIES: L. C. Woodman, Grand Rapids, Michigan; Fred W. Muth & Co., Southwest Corner Walnut & Front Sts., Cincinnati, Ohio; Fred Foulger & Sons, Ogden, Utah; Colorado Honey-producers' Association, Denver, Col.; Grand Junction Fruit growers' Association, Grand Junction, Colorado; Robert Halley, Montrose, Colorado; Pierce Seed and Produce Company, Pueblo, Colo.; E. T. Abbott, St. Joseph, Missouri, Special Southwestern Agent.

BEE - SUPPLIES!

ROOT'S GOODS
AT
ROOT'S PRICES.

C. H. W. Weber, Cincinnati, Ohio.
2146-2148 Central Ave.

A NEW AND COMPLETE stock for 1901 now on hand. I am The Root Company's representative for Cincinnati and surrounding territories. . . You save TIME and FREIGHT CHARGES by having goods shipped from here. Convenience of railroad facilities here enables me to do so. Before buying elsewhere, write for my prices and catalog, which will be mailed you free of charge.

GLEANINGS IN BEE CULTURE

A JOURNAL DEVOTED TO BEES AND HONEY AND HOME INTERESTS.

ILLUSTRATED SEMI-MONTHLY

Published by THE A. ROOT CO.
\$1.00 PER YEAR MEDINA, OHIO.

VOL. XXIX

OCT. 1, 1901.

No. 19.



"WE HAVE COMBS over 40 years old that I would not exchange for the same area of foundation," says C. P. Dadant in *Amer. Bee Journal*.

SMALL PLOTS of alfalfa have been raised at Medina, and large fields of it in my county. But if it yields no nectar, and if it is worth no more for fodder than sweet clover, why raise it?

A. I. ROOT, the poultryman, says, p. 762, he doesn't work for pure blood nor color, but for vigor and strength. I prefer pure blood; but if I can find sufficient improvement outside of pure blood, the pure blood can go.

IF RAMBLER doesn't stop throwing stones into my Straw-cutter, p. 745, I'll swap it for a meat-grinder, and put him through. [I will furnish the meat-grinder if you will "put him through." He has been throwing clods of dirt over into my wheat-fields. Yes, pulverize him.—ED.]

IT JOLTS one's feelings to have the editor talk on page 748 as if Eastern bee-keepers must take top-bars they don't like just because it serves the convenience of the manufacturers, and he at the same time so strong on "difference of locality." But one is reassured by reading on the next page that several styles of frames are made.

TO HOLD combs in frame when transferring, C. P. Dadant uses No. 16 wire bent at right angles at each end, long enough to have one end driven into the top-bar and the other into the bottom-bar, holes being previously punched with an awl. For small pieces in corners a short wire may go from top or bottom to end-bar.—*Amer. Bee Journal*.

THE WORST DANGERS of in-breeding are where two beings are mated that are of exactly the same blood, having the same fa-

ther and mother. Fortunately, the bee-keeper need take no pains to avoid such close breeding; nature takes care of that. A drone and a queen from the same mother are not full brother and sister, for the father of the queen is not father of the drone. The only way to mate two of exactly the same blood is to mate a drone to his mother, and the drone is born too late for that.

VERNON BURT's plan of leaving a hive full of brood with no bees till they hatch out, p. 755, would generally result in loss of brood in this locality. [Why? You will recall that I explained that Mr. Burt makes sure there is plenty of hatching brood, and that this work is done during the height of the honey-flow. Try the experiment, doctor. Take a note of the unsealed brood in each comb, and then see whether any of it starves or dies for want of nurses to take care of it.—ED.]

FROM WHAT is said, p. 753, some one has been losing queens by following Doolittle's instructions to set in place of a full colony a hive full of combs of brood, one of them with its bees and queen being from a nucleus. This season I did something nearly in that line, the only difference being that I put no brood except the one or two frames from the nucleus, and it is possible that if the hives had been filled with brood there would have been no failures. Out of 35 cases, 9 queens turned up missing. The queens should have been caged.

YOU THINK, Mr. Editor, that in a normal honey-flow in full blast bees don't lunch on eggs, p. 380. Now when a queen of Stachelhausen's laid 71,400 eggs in 21 days, don't you think it likely there was a normal honey-flow in full blast, or at least full enough to prevent lunching? and then where would you be with your "large force" of 40,000 or 50,000? [I am not familiar with, or perhaps I do not recall, the reference to which you refer, of Stachelhausen's queen that laid 71,400 eggs in 21 days. Mr. Stachelhausen is one of the very best bee-keepers; but how could he or any one say positively that the queen did not lay

more than the 71,400 eggs in the time stated? But such a feat of egg-laying I should think was rather exceptional; and I am still inclined to adhere to my original proposition, that, ordinarily speaking, 40,000 to 50,000 bees would be considered a large force.—ED.]

PRACTICE on a sufficiently large scale is worth more than theory. So when McEvoy has safely used 5000 hives that had contained foul brood, and the Roots have safely used beet sugar for 20 years, we may dismiss anxiety as to those two items. [I am sorry to demolish one of the settled facts; but Mr. Gilmore, that expert whom I met at Buffalo, tells me that, in all probability, we have been feeding *cane* sugar for the last ten or twenty years, and he is a beet-sugar man, you know. See editorial on this subject elsewhere.—ED.]

PROF. COOK pleads for the use of correct terms, and wants us to stop saying "worms" when talking about the larvæ of the bee-moth, which are not worms at all in the language of entomologists. My sympathies are with the professor as to using correct language, and I wish he would tell us what to say in place of "worms." The word is used so often that it would be rather expensive business to use in its place something with five times as many syllables, and say "larvæ of the bee-moth." Give us a correct name in one or two syllables, professor, and we'll all try to fall in line. And tell us, please, what to call "wormy" combs.

TAKING AWAY honey and filling up with sugar for winter is advised, p. 755. I don't know whether there is anything in the objection, but some German writers strongly object that such feeding will lead to enfeeblement of constitution. [It has been orthodox teaching in this country, or at least it used to be, that sugar syrup was the very best winter food for bees. Indeed, some used to advocate extracting the honey out of the combs, even if the sugar syrup cost as much as the honey removed, pound for pound. Now, I ask for information: Do the Germans mean that feeding induces a drain on the vitality of the bees to ripen or invert the syrup? If they do, I do not recall that any one in this country has observed such weakness.—ED.]

THE DRONE is always a half-orphan, for his father is always dead before he is born. He never has a full sister, for the father of his mother's female children is never his father. In fact, he never has any father except his grandfather, and he never lives to see any of his children. [Perhaps you are right; but how do you *know* that the father of the drone's sister does not exert some potent influence on the drone himself? If so, is he not a full brother to the queen? I have to plead ignorance, as I did not hear the discussion at the Buffalo convention on this point, being out of the room at the time on committee work. Perhaps the Germans settled this long ago; but it used to be said,

and the statement may be true, that the drones from a queen that had never met a drone were not capable of performing the function Nature designed. Really, I do not see how the matter can be proven one way or the other.—ED.]

"SWARTHMORE" makes a "digression," p. 743, so interesting and at the same time so much at variance with generally accepted belief that one wants to ask how he knows. He says young queens will meet the drone 6 to 12 times, and lay the second day after becoming pregnant. [My, oh my! I must have failed to note that "digression" of Swarthmore's, or I should have challenged it. Such a statement, unless supported by the best of proof, borders very strongly on heresy—at least heresy in bee-lore. All our authorities have taught, supported by the best of evidence, that the queen meets the drone but once. If she meets him oftener than this, it is a new and interesting fact. But the other statement, that the queen may lay in two days after becoming pregnant, may not be so far wrong. If I remember correctly, I once saw one queen coming out of her hive, bearing visible evidence of fertilization (threadlike filament), and in two days afterward I have found her laying; but my records, I think, showed that queens usually take three or four.—ED.]

"I BELIEVE," says ye editor, page 742, "the best solution of the hive-cover problem will be two boards $\frac{3}{8}$ in. thick separated by a $\frac{3}{8}$ air-space." It does me a lot of good to hear that, for it's what I've urged this long time, and I'm now using covers unfit for use because the right cover is not yet on the market. But remember the upper and lower board must not have the grain running in the same direction. Rambler says the air-space "is necessary in hot locations." So it is in cold locations, being warmer in cold weather than a single board without the air-space. [Some days ago Mr. Calvert sent some samples of covers, such as I described on page 742, to a number of prominent bee-men, as well as dealers, located in various parts of the country. A good many of the replies have now been received; and nearly all favor a single-board cover in place of the double board with air-space. Indeed, the Excelsior cover with sloping sides and ridge-board is considered quite good enough. This is a surprise, as it seems to us that a double cover would be better on all accounts.—ED.]

W. H. H., Ore.—The action of the sun on the face of comb honey is to bleach or whiten rather than to discolor or turn to dirty yellow. There is plenty of evidence to prove that. The statement that the drones lay eggs is the veriest nonsense; and any man who goes to talking that way should be ignored and pitied. Life is too short to waste on any such discussion as that.



In Maurice Maeterlinck's "Life of the Bee" we have for at least once a book on bees that is thoroughly sound, very interesting, and one that every bee-keeper should have. It is by no means technical. It is beautifully written, and abounds in moral reflections and poetical digressions. It will appeal to every bee-keeper and bee-lover. One of the most remarkable passages in the book is a description of a rural scene in Normandy, France. Outwardly it seems like a little paradise, the natural surroundings being so beautiful that man can not improve them. Here we may expect a perfect state of society; but let us, with the writer, get a little nearer. He says:

Can you distinguish the song that blended so well with the whispering of the leaves? It is made up of abuse and insult; and when laughter bursts forth, it is due to an obscene remark some man or woman has made, to a jest at the expense of the weaker—of the lurchback unable to lift his load, the cripple they have knocked over, or the idiot whom they make their butt.

I have studied these people for many years. We are in Normandy; the soil is rich and easily tilled. Around this stack of corn there is rather more comfort than one would usually associate with a scene of this kind. The result is that most of the men, and many of the women, are alcoholic. Another poison also, which I need not name, corrodes the race. To that, to the alcohol, are due the children whom you see there; the dwarf, the one with the hare-lip, the others who are knock-kneed, scrofulous, imbecile. All of them, men and women, young and old, have the ordinary vices of the peasant. They are brutal, suspicious, grasping, and envious; hypocrites, liars, and slanderers; inclined to petty, illicit profits, mean interpretations, and coarse flattery of the stronger. Necessity brings them together, and compels them to help each other; but the secret wish of every individual is to harm his neighbor as soon as this can be done without danger to himself. The one substantial pleasure of the village is procured by the sorrows of others. Should a great disaster befall one of them, it will long be the subject of secret, delighted comment among the rest. Every man watches his fellow, it is jealous of him, detests and despises him.

The book is published by Dodd, Mead & Co., New York. Price \$1.40.

PACIFIC BEE JOURNAL.

Concerning a new honey-plant and the relative value of different strains of bees, I find the following editorial too interesting to admit of condensation:

Mr. G. M. Hawley, El Cajon, writes me concerning the *Grevillea robusta* as a honey-plant. He says that the flowers are fairly swimming with nectar. By shaking the tree he can wet the ground with the sweet liquid. He remarks that he never saw any thing comparable with it before. The bees have left white sage and buckwheat entirely, and are swarming on the grevillea blossoms. Mr. Hawley also comments on some very white comb honey which some of the bees are producing. These are from a certain queen which he imported from the East last season. The honey from the other bees is much darker. Examination shows that the first bees are gathering entirely from black sage, while the others are gathering their nectar from flowers that yield a darker honey. This black sage is from two to five miles distant. I have often noticed what Mr. Hawley has discovered, that different strains of bees often gather from different

sources. I have no doubt that the vigor of the bees and the relative length of tongues may account for this. Mr. Hawley says these new ones are elegant bees, light-colored, great workers, practically non-swarmers—indeed, the ideal bee for California.

I have also noticed that the grevillea is a very excellent honey-plant, while all our sages furnish honey that is unexcelled in excellence of color and flavor.

Touching the honey crop in California for this season, Mr. F. E. Brown, of Hanford, says:

Our honey crop is the lightest up to date that has been known for the past ten years. Bees as a rule are in the poorest condition for this season of the year that I have ever seen and we shall not have more than $\frac{1}{2}$ the usual yield. What little we have we are storing, not offering any thing to the market, as the price is too weak—believing that, as soon as the buyers find out the true condition of the output, prices will be restored to a reasonable rate.

The reports as to hundreds of carloads from the southern part of California seem to have been premature.

Temescal shipped 40 tons of honey this year—a splendid yield for a little place, surely. Isaiah Anderson, of that town, has, for the first time in 26 years, secured honey from bald sage.

R. A. Holley, foul-brood inspector of Ventura Co., reports having found about 625 colonies in that county afflicted with foul brood.



EDITORS AND OTHER PEOPLE.

BY ARTHUR C. MILLER.

Mr. Root:—In a recent editorial you referred to an article of mine which appeared in your issue for May 1st, and which contained some reflections on the authors of our text-books and the editors of our papers. Another communication by me in the *Review*, leading to subsequent articles by others, has evidently given the matter an interpretation which I never intended—that is, charging the editors with general ignorance.

It is a delicate task to point out to another his ignorance of a subject on which he has written, and perhaps it would have been more considerate had I taken it up in a personal letter, though, as things have developed, and as the publication of the article has set us all to doing a little introspection, it may not turn out to have been a serious error. But a very recent article in one of the papers evinces considerable bitterness of feeling against yourself, and in consequence I feel it necessary to write a few words of caution and explanation. I feel that this devolves upon me because I, figuratively, threw the first stone.

There are none too many contributors to our bee-journals who possess a broad education, and there appear to be some who do

possess a very limited power to grasp and liberally interpret what they read, or, to use a very expressive nautical phrase, appear unable to "take things by and large."

With the utmost care, a scholarly man is not always able so to express himself as to avoid misinterpretation by the latter class above referred to; and when a hurried or careless writer contributes an article it is pretty certain to be misinterpreted by some one. If every one will bear this in mind, and forbear to retort until after sober second thought, it will save much bitterness of feeling and also much valuable space in the papers.

It is neither feasible nor desirable that communications to the apicultural press should be confined to scholarly members of the profession; on the contrary, it is necessary to encourage the eminently practical though nonscholarly bee-keepers to contribute of their experience. But there is one thing most of us, I fear, are prone to do; and that is, to express our opinions on matters about which we have only the most superficial knowledge. Without entering into a discussion as to why, I may assert that an editor's remarks generally have greater weight than those of his contributors. When he writes on a subject about which he is ignorant, or at best but indifferently posted, and attaches that as a footnote to the article of some person who may be deeply learned in that of which he has written, the editor hurts his paper and himself, and inflicts a deep injury on the contributor. It is idle for any one to charge that an editor would willfully do this. It is not within the precincts of this article to say what an editor should do, whose contributions he should encourage, whose shut off; that is a matter personal to himself. But when he misleads us, or by a careless paragraph checks investigation of new lines or profitable researches in old, then he lays himself open to just criticism from the subscribers to his paper.

In our present scrutiny of the editors it should not be forgotten that there are other persons against whom the charge of ignorance, thoughtlessness, or spleen may perhaps often be more justly made. We, the contributors, are those other persons.

Both sides may well consider the oft repeated lines of Burns:

Oh wad some power the giftie gie us
To see oursel's as ithers see us!
It wad frae monie a blunder free us,
An' foolish notion.

[While it may be true that an editor's remarks have greater weight than those of a contributor, it by no means follows that he knows more. It is his business to select the best that is sent to him for publication, and then, as far as possible, direct discussion along profitable lines as best he can. If he errs in an expressed opinion let the contributor point out the mistake. I see nothing in the foregoing article to which an editor or contributor should object. It is all true.—ED.]

NOTES OF TRAVEL.

Bee-keepers' Paradise, Uvalde Co., Texas; the most Extensive Bee-keeper in that Paradise.

BY E. R. ROOT.

Before describing some of the great honey-plants of this wonderful portion of Texas, not over 40 miles square, where a whole trainload of honey has been shipped out in one season, and where one bee-keeper, Mr. D. M. Edwards, with 500 colonies, has secured as high as 75,000 lbs., I desire to introduce to you Mr. W. D. Bunting, the most extensive producer in that paradise of bees.

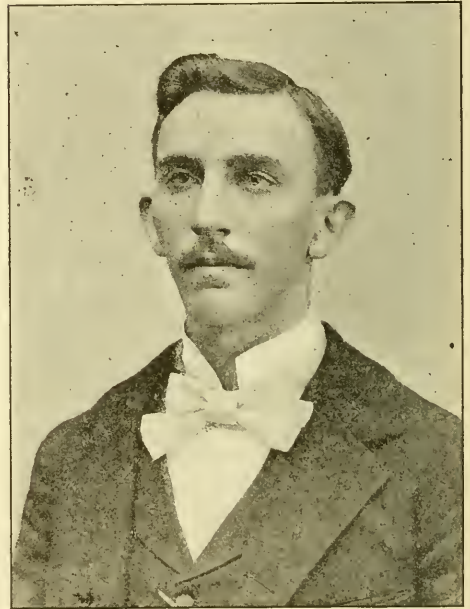

W. D. BUNTING.

Our friend is not over 31 or 32 years of age. I should say; and yet for all-around success in producing and handling a large number of colonies, no one, I believe, excels him. When Mr. Edwards and I drove up to his ranch we found him and his brother at the house, doing up the dishes, for they are "baching it." Just how much longer they propose to continue in this sort of way I can not say. This is not the first time I have run across bee-keepers doing house-work; and while I enjoyed the meals most heartily that these fellows spread out when I had the pleasure of sitting at their boards, yet I most respectfully suggest to them that, if there are any "best girls" left, they join hands for better or for worse, and keep house in the good old orthodox style. I not only believe in Horace Greeley's advice, "Go west, young man," but I also believe

in A. I. R.'s injunction to all good prosperous young men, to win some good girl. Texas is full of them.

As Mr. Edwards and I neared the home of Mr. Bunting, I saw at once the secret of his success. Right along one side of the

my pocket kodak and took a snap shot, and the result is shown in the next cut.

Many and many a time have I run into splendid bee locations, and have seen beemen fairly buried in a honey-shower, but who were not ready to take the honey in

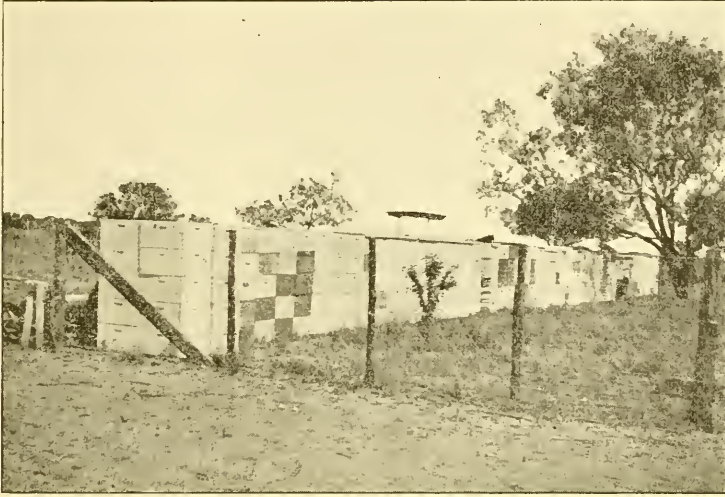

"THEY DO NOT PROPOSE TO BE CAUGHT NAPPING."



"MR. BUNTING AND HIS HELPERS STEPPED OUT IN FRONT WHILE I SNAPPED THE KODAK."

yard there were stacks and stacks of supers piled up and filled with empty combs, ready for the honey-flow. They did not propose to be caught napping; and to give you an idea of those piles of supers I whipped out

any thing save barrels, soap-boxes, and "any old thing." Well, these men seldom get a good crop of honey; and what they do get is hardly fit for market.

As we (Mr. Edwards and I) went into

the yard, having hitched our broncho, we met Mr. W. J. Bunting, and, a little later on, his brother, W. D. Bunting, who is the bee-keeper, and who, as I have said, has the reputation of being the most extensively engaged in the business of any one in the county. A little later on we went out into the apiary, located out in the open, in the sand, without a sign of shade except shade-boards. At this home yard there were between 130 and 140 colonies with a bee-range of one whole square mile, or 640 acres. Mr. Bunting has bought this mile around outright; he does not, therefore, as he says, expect any one to come in and divide up the profits of this apiary. The rest of his colonies are located on other square miles that he leases; so, taking it all in all, Mr. Bunting is shrewd enough (and it is an honest kind of shrewdness) to see that he has a bee-range for all his bees that is not encroached on by any one else. No wonder he gets the honey.

While we were talking we stepped into a one-story building, about 10x20 as nearly as I can remember, in size. As it so seldom rains in this portion of Texas during the bee season, a larger structure is rendered unnecessary. In this small building the Bunting boys do their uncapping and extracting. While we were near the building I requested Mr. Bunting and his helpers to step out in front while I snapped my kodak. The result is before you.

The man at the extreme left is W. D. Bunting; then next in order are W. J. Bunting, F. W. Miller, and D. M. Edwards. The latter will be recalled from our large picture in our previous issue, page 751.

The Bunting boys, while expert bee-keepers, are also expert with the rifle. They have a fine pack of hounds; and whenever they require a little recreation they go out for a hunt. Game is plentiful and the shooting good, and I was urgently invited to come out some time and go hunting. This was tempting, for I enjoy this kind of sport; and some day I hope I can go among our bee-friends, not only armed with a kodak, but with a good shotgun—the first named to shoot my bee-keeping friends, and the last to shoot at (not necessarily to bring down) any wild game in that country.

I had hoped to present in this issue some views of some of the principal honey-plants of this remarkable bee paradise; but as my space is already taken up, I shall have to defer doing so until our next issue. After that I will describe through two or three numbers another paradise of bees and bee-keepers in Arizona. But this paradise is also already overstocked. But, more anon.

WAX-PRESSES.

BY F. A. GEMMILL.

I observed with much pleasure in the Aug. 1st issue of GLEANINGS that you had illustrated and also listed the new Root German steam wax extractor, or press.

This machine, no doubt, is the result of your experiments with the various methods in vogue up to and since the publication and illustration of the articles on the subject of wax-extractors in GLEANINGS for April 1. As stated in correspondence with you at the time the articles appeared, I fully intended commenting on them, my own contribution included; but for want of time I did not manage to do so.

I will merely state now, in this connection, that I was quite sure that the best machine had not, up to the time mentioned, been produced, and had in mind something of my own, the principle being somewhat similar to what you now present; but whether it would be round, oval, square, or otherwise, I had not decided; but it was to combine the very important feature of strong pressure, which I see you approve. Do not, however, imagine you have stolen my thunder, Mr. Root. I am not yet an inventor, but merely one who has taken advantage of the suggestions and improvements of others.

I am, as you are aware, particularly interested in this branch of apiculture; and as I wish to show you and others how much I appreciate the new article, I am going, without delay, to experiment with one as soon as you can ship it to me.

I am quite satisfied that high pressure, while the mass is still in the machine, no matter whether melted by steam or boiling water, is the best method, all things considered, when such pressure can be brought to bear on a *good quantity* of the refuse at one time.

I need not here enumerate the reasons, as no doubt you yourselves are quite satisfied, or else you would not have gone to the expense you have done to manufacture something you have proved a good article, and which, in my humble opinion, will prove a great boon to bee-keepers generally.

On receipt of your press I will experiment with slumgum from the Boardman solar wax-extractor, and also from refuse which has been through my late hobby, the so-called Hatch-Gemmill press, and in every other way that I think will be of benefit to myself and the enlightenment of my brother bee-keepers living under any flag, particularly of America, Canada coming first, of course.

Stratford, Ont., Aug. 10.

OVERHEAD GRAPEVINE SHADE FOR THE APIARIST.

BY T. M. ADAMS.

I send by to-day's mail a view of my apiary and honey-house. It may be out of the common line to your readers to see bees shaded by scuppernon grapevines. The grape-arbor is 80 x 110 ft., 7 ft. high, and posts set 10 ft. apart each way. The hives stand in rows facing each other 10 ft. apart, with a walk at the back of each hive, 6 ft. wide. I use a wheelbarrow after the style of the Daisy, but it has two wheels instead

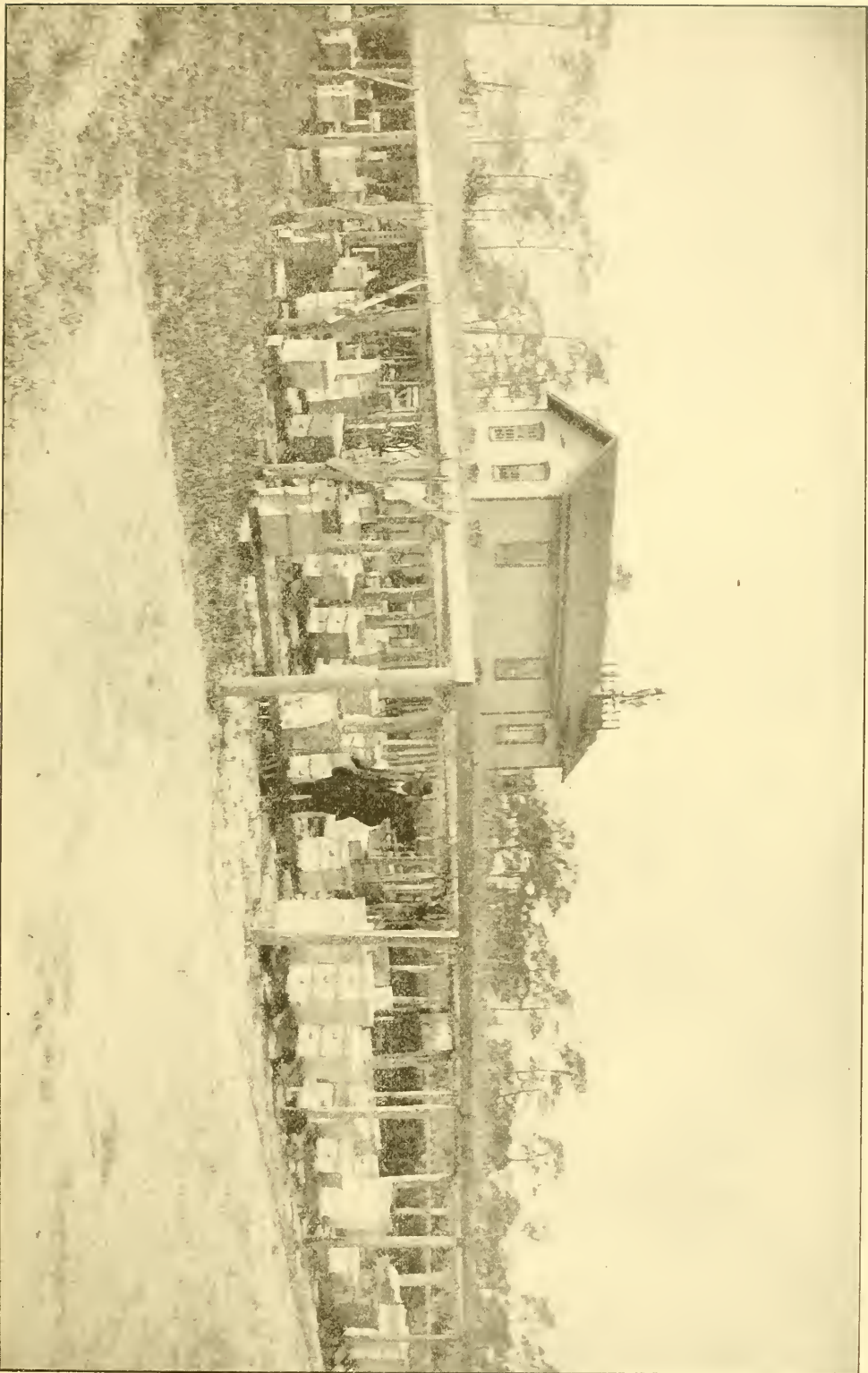

PLANTATION OF T. M. ADAMS, OAK HILL, FLORIDA.

of one, to overcome the danger of turning over. I use an incline into the honey-house, so I do not have to lift my honey. I have 112 hives in the garden. T. M. ADAMS.
Oak Hill, Fla.

[Somewhere about thirty years ago A. I. Root had high gravevine-trellises, something like those shown in the accompanying engraving; but these were subsequently abandoned for smaller ones, one trellis in front of each hive. But in Florida, the land of sand and sunshine, I should suppose that overhead trellises would be just the thing for the comfort of the apiarist as well as that of the bees.—Ed.]

DEVELOPMENT OF THE QUEEN.

From the Egg to the Hatched Queen.

BY DR. C. C. MILLER.

How long from the time the egg is laid till the larva hatches from it? How long from the laying of the egg to the sealing of the cell? How long from the laying of the egg to the emerging of the perfect queen? These are questions of interest, and at least one of them of much practical importance. There is considerable variation in the answers to the questions; and it is a little strange that, in comparing present views with those of fifty years ago, the time for the hatching of the egg has been lengthened, while the time for the emergence of the queen has been shortened.

In the *Am. Bee Journal* for 1861, p. 11, it is said, "The larvæ emerge from the eggs in the course of from 40 to 60 hours after these are laid — $1\frac{1}{2}$ to $2\frac{1}{2}$ days. On p. 43: "Gundelach says that, in one instance, they were hatched within 24 hours after being laid. Berlepsch says he has known them to remain unhatched in the hive for 48 hours, and in one case more than 72 hours." Cheshire says the eggs hatch after 3 days. Cowan and others give 3 days. The ABC says "about 3 days or a little more."

A good many incidental observations lead me to believe that 3 days can not be far out of the way, and I can not understand how one or two days could have been believed right. It is not difficult to understand how a much longer time might occur, for there is good testimony to the effect that bees have kept eggs several days or a week longer than the usual time without hatching. It seems that something more than heat is required to hatch a bee's egg; and until the necessary attention is given the egg will remain unchanged, just as a hen's egg remains unchanged until the hen begins sitting on it. But under normal conditions the generally received three days of the present time may probably be accepted with safety.

"How long from the laying of the egg to the sealing of the cell?" Gundelach says, "Eight days elapse from the time the egg is laid till the cell is capped" (*Amer. Bee Journal*, 1861, p. 11). If we allow 3 days

in the egg state, that makes 5 days of feeding. Cheshire says, "after about 4 days of feeding." Dadant's Langstroth, p. 254, gives 6 days of feeding for the worker, and I suppose the same for the queen. Add to that 3 days for the egg, and we have 9 days from the laying of the egg to the sealing of the cell. Between 9 and 10 days is given in the ABC. Cowan says 8 days. Cook gives 8 days in cases of normal swarming.

The most important of the questions, from a practical standpoint, is, "How long from the laying of the egg to the emerging of the queen?" In the *Am. Bee Journal*, Vol. I., p. 199, in a chapter of the able series of articles on the Dzierzon theory, by the Baron of Berlepsch, after detailing some experiments he says: "These experiments show that the opinion generally entertained, that the queens emerge between the 17th and 18th day after the eggs are laid, is correct." The time of writing this, however, antedates the publication of the *Journal*, 1861; and elsewhere in general throughout the volume 16 days is accounted the proper time. Indeed, on page 266 Dzierzon gives a definite case in which the time was only 15 days. Sixteen days has of late years been accounted the orthodox term, I think, in general, in all the books excepting Cowan's, which gives 15 days. This year I thought I would refer the two latter questions to the bees, so as to get a positive answer in at least one case. July 18, at 10 A.M., I took from No. 85 its brood, leaving in the hive foundation and one comb containing some sealed brood, this comb having been kept for more than a week where there was no possibility of a queen laying in it. Four days later I gave this comb to No. 35, after having removed from No. 35 its queen and brood. July 26, at 10 A.M., when the oldest brood could not have been more than 8 days old, I found 20 sealed queen-cells on the comb, and seven unsealed. The proof is clear and positive that these 20 cells that were sealed contained larvæ not any more than 8 days from the laying of the egg. It is reasonable to suppose that the 7 unsealed cells contained younger larvæ. Desiring to save all the cells, I did not wait till any of the occupants were quite 15 days old from the laying of the egg, but opened the hive at 9:45 A.M., Aug. 2. I was doomed to disappointment, for seven young queens had already emerged.

In this case there could be no question. The cells were sealed in 8 days; and allowing three days in the egg, there were 5 days of feeding; and the queens emerged 15 days from the laying of the egg. These figures agree with those of Mr. Cowan. It should not for a minute be supposed that they admit of no variation. But it is probable that, under normal conditions, they may be relied upon as coming as near the average as any thing that can be given. The question may arise, why it is that 16 days for the full development of a queen has so generally been agreed upon. Many of the observations have been made, not

upon full colonies, but upon nuclei. Development will be retarded in nuclei. In the *Am. Bee Journal*, Vol. 1., page 143, father Langstroth reports a case in which a queen in a nucleus was 21 days in coming to maturity. In my early days of bee-keeping I knew no better than to have queens started in nuclei, and I had cases like that of father Langstroth. But in full colonies I have had many, many incidental proofs that 15 days was the limit. Ought we not to change our belief from 16 to 15?

Marengo, Ill.

[I had not a little difficulty in understanding your experiment; but finally Mr. F. W. L. Sladen, of Ripple Court, England, who is visiting us now, after studying on it a while finally got your meaning. You leave out one or two important points that left us, for the time being, in the dark. As we understand it, No. 85 was a normal colony with a laying queen; and this one comb containing some sealed brood was put into the hive for the queen to lay in. After she had been laying in it for four days, you gave it to queenless colony No. 35. Eight days from that date you found plenty of queen-cells. All of this is now plain.

The only criticism I have to offer is that you are relying for your data on one experiment only, and I should not think it would be wise to change the time from 16 to 15 days until other experiments have been made and are to the same effect.—ED.]



PREPARING BEES FOR WINTER.

"Hello! what are you doing with the bees this morning? I supposed all work with them was over for this year."

"In this you are mistaken, Mr. Smith; for, in my opinion, to reap the best results in wintering bees, September is the month in which they should be prepared for winter. This gives them a chance to get their stores for winter placed just where they wish them, so that, by the latter part of October, they are ready to go into that quiescent state which is always conducive to the best results."

"Well, this is something new to me, as I always thought November would do very well as to time to fix the bees for winter. But what do you do now by way of preparation?"

"The early preparation consists in opening each hive and seeing that each colony has a good queen, plenty of bees, and, most of all, plenty of stores."

"How much do you calculate for stores?"

"I allow 25 to 30 lbs. for each colony, which should be in the hive from September 10 to 25."

"But suppose some colonies do not have that much."

"If there is not so much as this, feeding must be resorted to; and if we have to feed, it should be done in September, surely, in order that the bees may cap it over before cool or cold weather; for unsealed stores often sour and get thin during winter, thus causing disease. Multitudes of bees are lost each year, where feeding is put off till October and November, by being obliged to eat poor thin stores, this causing bee diarrhea on account of the bees not being able to hold their feces, because they can not evaporate all the water out of their food, it being so thin."

"But suppose the bees are still getting honey from the fields."

"In places where fall flowers abound, so that the bees are storing at this time of the year, of course they should need no feeding if the apiarist manages rightly."

"Do you think if *one* needed feeding *all* would?"

"This is to be ascertained by looking them over, as you see me doing. If I find some colonies are heavy with stores while others are light, the light ones can be fed by taking from the heavy; and if there are some light in stores after so equalizing, then we feed what still remain without a sufficient supply."

"Having all fixed as to stores, etc., what next is to be done? I wish to learn."

"The next thing to do is to put on the quilt, where such is used, and over this the sawdust cushion, or whatever packing material is used, thus tucking them nice, snug, and warm for winter."

"Do you use common enameled cloth for quilts?"

"I do not during winter. Some so use, but the most of our practical bee-keepers prefer some porous substance, like woolen blankets, pieces of old carpet, or something of that kind. For colonies to be left on summer stands, I use chaff hives, which chaff is left on in the hives both winter and summer. Over the tops of the frames I prefer a quilt, as just spoken of, and on top of the quilt a cushion two or three inches thick, made of common factory cotton cloth, filled with cork dust if possible; if not, then filled with dry basswood sawdust. Such cushions seem to keep the bees in better condition than any thing else I am acquainted with. The cork dust allows the moisture to pass up through it and out at the top of the hive, while the basswood sawdust will absorb nearly its bulk in water, so that either keeps all dry, warm, and nice."

"Do you do any thing else by way of preparation?"

"When winter sets in, a board about 8 or 10 inches wide should be set up slanting from the alighting-board to the hive, in front of the entrance, so as to keep out snow and cold winds, as well as to shade the front of the hive, where the hives face south, as they should during winter, so the bright

rays of the sun shall not entice the bees out when it is too cold for them to fly."

"Do you winter all your bees outdoors?"

"No. I prefer to winter a part of the bees in the cellar, for I like the idea of 'mixed wintering,' as by this plan no extreme loss is likely to occur; for a winter which is severe on the bees out of doors is generally good for cellar wintering."

"At what time do you set the bees in the cellar?"

"Somewhere about the middle of November. At any time between the 10th of November and the 1st of December, when the hives are dry, and free from frost, I set them in. If they have a flight along about this time I set them in the next day, if it does not rain so the hives are wet; and I find that this can be done, even if the weather is quite warm, much better than it can on a cold morning when the hives come up from their stands with a jar from having been frozen down."

"Do you give each hive a separate stand when in the cellar, or set them on a plank which will hold several hives?"

"Neither. A cellar stand is made by nailing four pieces of six-inch boards together so they shall be of the right size for a hive to rest on. This raises the first five six inches off the cellar bottom, and away from the damp air which is generally found right at the cellar bottom. The first five is set on this stand, when hives are piled on top of the first till the floor is reached, so that each stand holds from three to five hives, according to the depth of the cellar. In this way the cellar is filled (if I have colonies enough), except a passageway through the center to the back end, through which I pass every two or three weeks to see if all is right so far as temperature, mice, etc., are concerned. Otherwise they are left undisturbed during the winter."

"At what temperature should the cellar be kept?"

"Here practical bee-keepers differ; but I have had the best success with a temperature of from 43 to 45 degrees, or as near that as can be had. With a cellar in a bank, separate from any building, the keeping of the temperature at this point is quite easy; but with a cellar under a room or building it is not so easily done, for the changes from the outside have more effect on the interior of the cellar than they do where the cellar is wholly under ground in a bank or side hill. There are other things which might be said on this wintering subject; but with your consent we will leave them till December, when I am not so busy, when, if you will come over, we will talk them over more at length."

[This is good orthodox advice on wintering, and the average person will not go far amiss in following it. The four pieces nailed together to raise the hive off the cellar bottom make what we call a hive-stand. The same can be used outdoors as well.—
Ed.]



BEE-STINGS AS A CURE FOR RHEUMATISM.

Along in the '70's I had fever and ague four years in succession, followed immediately by typhoid fever three years in succession. The third attack was very severe, and was combined with brain fever. It left me a wreck, unable to read, write, think, or work. Then when I got up from the last attack of typhoid, rheumatism set in, and I doctored for some time for it without relief. Being unable to work, or occupy myself mentally, I bought a hive of bees and spent many days sitting over it, taking out comb after comb to watch the bees at work and become acquainted with them. I do not think it was good for the bees, and it is needless to say that I became thoroughly acquainted with the business end of a good many of them, and thereby hangs my tale. I began, as soon as my head would allow it, to read your A B C book and GLEANINGS, and soon had calls from my neighbors to handle their bees for them. The result finally was, that my rheumatism left me, its poison being counteracted by that of the bees, and I had no return of it for eight years. By that time I had removed to Wisconsin, and dropped my bee work. The law of entire renovation of the system once in seven years removed the bee-poison from my system; and I then, having exposed myself to damps in a cave I was exploring, had another attack of rheumatism. This I cured by catching bees from the flowers on the lawn, and making them sting me on the wrists. I was then free for six years more, when I again had an attack which I cured in the same way.

I have not taken to bee-keeping since I entered the ministry, 14 years ago, being afraid that my love for it would make me spend too much time with them. But as I have more frequent touches of rheumatism as I grow older, I concluded I had better spend some time with bees than to nurse the rheumatism in bed for a week or two at a time. My theory in the matter is, that one needs to be constantly inoculated with bee-poison, to prevent the rheumatic poison from getting a hold.

When I told my doctor that bees had cured me, he said he had read of that cure in medical journals, but thought it a humbug. I have learned since that in Russia it is common to cure rheumatism with bee-stings. Of course, it may not be safe for every one to use this remedy; but I find it invaluable for myself; and several others who have used it at my suggestion have found relief by it.

Sussex, Wis.

L. P. HOLMES.

[Many thanks, dear brother, for your excellent testimonial in regard to the benefit

of the bee-sting poison. Now, while we have had quite a few communications, pointing almost as plainly to the fact that the poison of the bee-sting cured the rheumatism, is it not possible that the disease disappeared of itself? or that your change of employment, enthusiasm in studying bee culture, etc., had something to do with it? I should be very glad indeed to have it proved that bee-sting poison is such a valuable medicine; but I am sure you will excuse me for being slow to accept this while we have so many remedies for almost every thing. I hardly need mention Electropoise, absent healing, etc. Bee culture is certainly a healthful occupation, and very likely it is beneficial to many to *get stung* now and then. May God help us to get at the real truth in regard to all these wonderful things that are going on around about us.—A. I. R.]

INTRODUCING TO CROSS HYBRIDS THAT ARE
DISINCLINED TO ACCEPT A QUEEN; CON-
STRUCTION OF THE GERMAN
WAX-PRESS.

What is the best way to introduce a queen in a cross hybrid colony that has been queenless some little time, and refuses to start cells, and is positively queenless, with no laying workers?

I never saw queens disappear so mysteriously, or bees to swarm regardless of queen-cells and conditions of the brood-chamber, as the past season, with as good a flow of honey. The average nearly reached the hundred mark.

For the benefit of the slim-pocket bee-keeper who wishes to tinker up a home-made wax-extractor, could you not give a better description of the construction of the wire basket and the apparatus that carries the wax to the outside of the machine?

Mohawk, N. Y.

C. R. MORTS.

[Ordinarily, if a colony refuses to accept a queen we naturally conclude that the bees have something which they regard as a queen. It may be a small virgin, or it may be a fertile worker. If the last named is present you will be likely to find eggs, and in some cases two or three of them in a cell. But if you *know positively* that the colony is queenless, and that it has no virgin, then I would take away every bit of brood of every sort, and keep it away until the bees fairly howl in distress. At the end of the second or third day give a smudge of tobacco smoke, and introduce a queen by the candy plan. But in 99 cases out of 100, where a colony refuses to accept a queen I should conclude that they were not queenless; and in any case the best advice I could give would be to give them a frame of unsealed larvæ or eggs. If they are certainly queenless they will start building cells. I never yet knew of a case where they would not do so under such circumstances. If they start queen-cups, let them alone and let them rear their own queen. I remember one colony once to which, for a matter of experiment, we introduced three

different queens, or attempted to do so, and each one of them was killed as soon as they released her. We finally gave them a frame of unsealed larvæ, when they started to build cells; but, strangely enough, after they reared a queen they killed her, because we found her balled and dead. We then gave the colony another frame of larvæ, and this time they raised a queen. Such colonies are very rare, and ordinarily it does not pay to fuss with them.

Regarding the disappearance of queens, this is something that happens very often in the fall. After a heavy season's duty, good laying queens will sometimes be found missing. They possibly use up their vitality, and die a natural death. In the case of colonies with virgin queens, the weather is usually so inclement that they do not get out; or if they do, they do not find drones. If they do not become fertilized, the bees are apt to destroy them.

Regarding the wax extractor, or press, it would be necessary to prepare an engraving showing the internal construction of our machine. We will have such a one prepared, and show it to our readers later. But it is doubtful whether the bee-keeper with a "slim pocket," unless a very good mechanic, could make a machine on the German plan. His better way is to make a Hatch-Gemmill wax-press, as described on p. 279, April 1st GLEANINGS, and render out his wax in an old iron kettle in connection with hot water. The Gemmill press can be made by any one.—Ed.]

DO BEES SWARM WHEN THEY HAVE UNSEAL-
ED BROOD? QUEENS BEING MATED
FROM UPPER STORIES.

1. Do bees ever swarm when there is *only* unsealed brood in the brood-nest, provided there is plenty of room for the bees above?

2. What is given as the reason for young queens intended to be mated from upper stories, as described in the A B C book, to "turn up missing"? Is it that the queens do not find their way back? or is it because they are killed by the bees coming up from below through the zinc? If it is the latter, why not use wire cloth and a nucleus of young bees above that?

C. S. FRITSCHER.

Waverly, Iowa, Sept. 4.

1. Yes, sir, 'e; but when a swarm is newly hived, and is given a frame of unsealed brood, *it is not as liable* to swarm out again as if it were put on a frame of sealed brood or a frame of honey with starters or empty combs. I have had swarms repeatedly come out again after I had hived them, even when the hive contained unsealed brood. When a swarm persists in coming out thus, I would hive it and take it down cellar until the bees have a chance to "cool off." Then next morning set them in an entirely new location, and let them begin flying quietly before the usual hours for swarming.

2. Both of the reasons that you suggest

may have something to do with the matter, but the second one more so than the other. We, however, are making the plan work successfully by the use of wire cloth between the upper and lower stories instead of perforated zinc. Further particulars are given on p. 756 of last issue.—ED.]

HONEY (?) FROM CORN.

Mr. Editor:—In GLEANINGS, page 702, it is denied that bees can gather any honey from maize (Indian corn). If only the blossoms are considered, this may be true; but how about the sap? Unless my imagination is very much stronger than my judgment, the drops which are to be found in the morning along the edges of the corn leaves are decidedly sweet when the weather has not been too wet. That the weather here has been very wet is perhaps the reason that my bees have neglected the corn. Last year they crowded upon it during August. It is well known that much sugar (glucose, is it not?) is produced by the maize, and also that many plants give off sugar from their pores. Some plants of sultana, after standing in the dry air of our dining-room last winter, had the edges of their leaves fringed with little stalactites of sugar, about a quarter of an inch long.

All the above leads up to what I wish to say—that I can not see why bees should not be able to gather sweets from maize.

GEO. A. BATES.

Highwood, N. J., Sept. 5.

[But, even though those drops along the edges of the corn leaves are sweet, it could not be called honey or nectar.—ED.]

A GOOD SUGGESTION ON THE USE OF PASTEBOARD FOR MAILING-CAGES FOR QUEENS.

Referring to the occasional failure of bees to gnaw the pasteboard from shipping-cages (page 669) I would suggest that this may be almost always prevented by simply touching the perforations with a little honey. This especially should be done if no moisture penetrates about the perforations from the candy within. I have not yet had a failure when this precaution has been taken.

Last autumn one of a number of queens received through the mails was thus imprisoned ten days after being placed in her new home. The bees would not (or, more likely, could not) tear away the dry pasteboard over the candy; yet this queen, to my surprise, instead of dying, as all her attendants but three had done, proved to be one of the most prolific of the lot, her bees storing over 70 pounds of surplus honey in June last.

J. F. S.

Aikin, Md., Aug. 20.

BEEES THAT WILL SPLIT RED-CLOVER COLLAR-TUBES.

I wrote you the fore part of last week in regard to the honey-flow here. Well, the flow has at this date not abated in the

least. I believe more honey came in on the 20th and 21st than in any other two days yet. They are working now on sweet clover and white, and just rolling the honey in. But I think still, as I said in my previous letter, that the bulk of the honey, until now, has been made from red clover. The bees would alight on a red-clover blow, and, by force, push their heads down to the honey by splitting the petal clear down to the nectar. I have seen them do this every time I have visited a red-clover field. Last year was the first time I ever saw it done; but no black bees were to be seen on red clover here. CHAUNCEY REYNOLDS.

Fremont, O., July 22.

[This splitting of the clover-tubes is something unusual, or at least I do not remember to have read of a case of it before. Has any one else observed it?—ED.]

A SIMPLE METHOD FOR DETECTING GLUCOSE IN SYRUPS.

Mr. Root:—In looking over your journal I see that you have had a good time up in Michigan and Texas. In your articles on sugars you speak of *natural* glucose in sugar. I was not aware that there was any kind of glucose but that made from corn. My object in writing to you is to give you a test for glucose. I can detect it if there is only an ounce in a gallon of molasses. The way I test molasses is this: Take half a tumbler of water and one teaspoonful of the molasses and stir it up thoroughly, then add, say, one-tenth of a teaspoonful of tannin, or tannic acid as it is sometimes called. If there is any glucose it will turn the mixture *black*, and I suppose it will do it in honey. In the manufacture of glucose they have to use sulphuric acid to separate it from the corn. They get rid of all the acid they can, but there is always enough left to tell the tale. Try it on honey. I believe it will work.

H. HOUP.

Birmingham, Ala., Sept. 2.

[If I understand chemistry rightly, there is a kind of glucose in natural honey, but it is not corn syrup, and its general character is very different from the artificial stuff. I am greatly obliged to you for your recipe for testing glucose in honey. I have no doubt it will work with honey just the same; for if tannic acid shows the presence of sulphuric acid, then it will show it in honey as well as in syrup.—ED.]

POROSITY OF LOG GUMS.

The old-fashioned log gum was a hollowed-out section of a log (not a section of a hollow log with a board for a cover nailed over the top). Thus it will be seen the grain in the top of the hive ran up and down. The fact that bees did well in these old clumsy hives, particularly as regards wintering, was due to this very fact of grain running up and down. Reidenbach, in *Pfalzer Bienenzeitung*, makes the assertion that any ordinary board, such as our ordi-

nary bee-hives are made of, practically prevents all exchange of air, paint or no paint, while the top of a log gum is porous and allows an exchange of air. To prove the ventilating quality of the log gum he made the following experiment: He took a round piece of beech wood, 2 inches long, and cemented a small glass funnel to each end. By blowing into the end of one funnel the air could be felt coming from the end of the other, and a lighted candle could be blown out without difficulty. This experiment is pretty good proof of the porosity of timber, grain running lengthwise. If we assume that the propolis with which all old hives are thoroughly glazed and coated over cracks sufficiently during winter, the ventilation of the log gum would be assured. Reidenbach failed to make a similar experiment with the side of a log gum, but simply asserts that air does not penetrate it. It would not be difficult to cement the funnels to a straight board, one on each side exactly opposite another; then blow into the funnel on one side and note the effect on the other. If it is true that air may be forced through timber with grain running lengthwise but not crosswise, as in ordinary lumber, then paint can not play a very important part in the wintering problem of our bees, not taking into account the gluing-up of the interior of hives by the bees.

Naples, N. Y.

F. GREINER.

[I have read somewhere of similar experiments—how one could force air from one end of a log to the other; but I do not recall the details. But now the question naturally arises, "Would the propolis in the old log gum crack sufficiently during winter to allow of the escape of the moisture up into the wood?" I should have my doubts.—ED.]

THIN AND EXTRA-THIN FOUNDATION FOR BROOD-NEST.

Mr. Editor:—Having been experimenting with extra-thin surplus foundation for brood-combs, I am able to give an additional fact in connection with this subject. This has been an exceedingly warm season—day after day continuing hot. The frames of foundation were placed at the outside of brood-chambers, and in the second story of comparatively weak colonies, with hives well ventilated. It required much care and attention to produce perfect comb. In two instances foundation broke from the weight of bees before time to fasten it thoroughly. I succeeded, however, in securing very fine comb, filled and capped to the bottom-bars; but I am of the opinion that, for practical use, ten sheets to the pound hits the nail about square on the head. One colony, weak in the spring, has built up 21 such extra-thin frames in the surplus chamber, nicely capped them, and is now filling a 32-section case of sections. The average bee-keeper—farmer—would not, nay, could not, give the necessary time to make extra-thin surplus a success. With nothing to do but

care for my bees I have concluded that the difference between ten sheets to the pound, and extra thin, does not compensate for the extra care required to succeed.

This season has not been considered extraordinarily good here; yet many of my colonies have exceeded 100 well-capped sections, and I hope some may crowd the 200 mark before the close. W. W. WHITNEY.

Kankakee, Ill., Aug. 19.

[Your experiments practically confirm our own, and I believe that your conclusion, so far as it relates to the average bee-keeper and farmer, is about correct; namely, that foundation as now made, running ten sheets to the pound, is thin enough. At the same time, if we succeed in carrying out what we have in our mind's eye—an extra-thin foundation, with natural bases having very thin delicate wires incorporated in it, about an inch apart—we shall be able to utilize a lighter weight of foundation, and which, I believe, in the end will be cheaper, per sheet, than the heavier grades we are now using; that is to say, it is not necessary to use wax to get strength when a much stronger article with less cost can be utilized; viz., fine iron wire. The problem now is, how to incorporate this delicate wire, about No. 40, in the septum of natural-base foundation.—ED.]

ANOTHER HIVE-RABBIT AND HAND-CLEAT.

GLEANINGS of Aug. 15 came yesterday. The hive construction used by Mr. Schaeffle, page 680, attracted my attention. Mr. Thos. Chantry, of Meckling, S. D., told me of a plan used by H. P. Robie, of South Dakota, which (for those who will make their own hives) has great merit, as it provides a non-warpable rabbit and hand-hold combined. Its construction will be apparent from the cut.

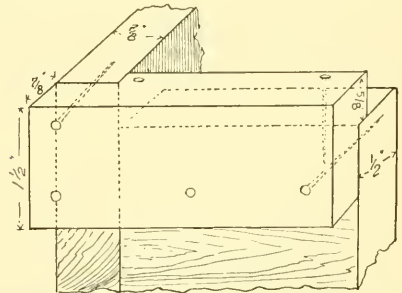

We had a fair honey crop from the second crop of alfalfa, and bees are doing a little on sweet clover and red and white clovers.

It seems to me that Harry Howe's capping-box (pages 679, 680) is rather small. I have one which just suits me, 2x3 feet in size.

E. F. ATWATER.

Meridian, Idaho, Aug. 19.

[This idea is a very good one—yes, it is excellent; and it may be well for the manufacturers of bee-supplies to give it consideration. If enough of our subscribers like

this form of rabbit, we might think seriously of adopting it some time in the future. It accomplishes a double purpose, in that it makes an excellent hand-cleat for lifting the hive, and at the same time provides a very strong durable rabbit.

Mr. Atwater is a young bee-keeper, alive and progressive, who left South Dakota for a climate more congenial to his health. I had the pleasure of meeting him at another paradise for bees, Meridian, Idaho, on my recent trip, and shall have occasion later on to introduce him more formally to our readers.—ED.]

BRICKS FOR HIVE-RECORDS; HOW TO MAKE FEEDERS OUT OF TOMATO-CANS.

I use bricks for weights on my Dovetailed hives. The position of the brick lying on its side, bottom, or end indicates certain conditions of the hives and supers. A glance over the apiary shows what is to be done. I use the Alley drone and queen trap for catching the queen when swarming in my home apiary. I prefer it to clipping the queen.

A good home-made feeder for Dovetailed hives can be made out of 3-lb. peach or tomato cans. Cut the top off so as to fit a super; fit a rim of tin about an inch wide over the can, first placing a piece of cotton cloth over the can. Invert it over the brood-frames after filling, placing an empty super and cover on.

I am getting from 15 to 20 lbs. of water-white honey with snow-white capping to each colony of bees, from a wild plant that is common to the Red River Valley in this country. The honey is equal to the best, and is in good demand in the home market.

N. P. ASPINWALL.

Wahpeton, N. D., Aug. 10.



B. M. H., N. C.—It sometimes happens that comparatively well-marked Italian bees behave and act very much like blacks or even hybrids of a darker color. It is even possible to have three-banded Italians, and yet have them the worst kind of hybrids in other respects. For example, a five-banded queen mated to a one or two banded hybrid drone might give three-banded Italians, but bees that are fearfully cross. This has happened in my own personal knowledge; and that is one trouble with four and five banded bees, that it is not always possible to tell whether one has pure Italian stock when he breeds from them.

You can put combs of honey in the upper story and have the bees empty them out; but when doing this it is advisable to break open the cells with a curry-comb or wire hair-brush.

J. W. S., Miss.—A queen balled may live a few seconds or several hours. Sometimes the queen dies of suffocation, and at other times she is stung by some one of the workers in the ball. I have known of cases where a queen has been balled probably all day, and was still alive when released; but in that case the ball was usually small. In other cases I have seen queens that were balled and were stung to death inside of a minute. It is always advisable to get the queen out of the ball as soon as possible. The best way is to use a smoker, blowing light whiffs on the ball of bees until the queen is released. Another way is to drop the ball into a pail of water. As soon as the queen is released, take her out of the water and blow the drops off from her. As a general rule I would use the smoker.

H. M. D., N. C.—From what you write, it is evident it would have been better if you had attempted to transfer only one colony at a time. However, the work is now done, and it is now advisable to make the best of things. Before you attempt to introduce a queen into any of the hives, make sure that such hives are queenless. If there are no eggs, larvæ, nor a larva in any suspected hive, give a frame of such from one of the other hives, and then wait two days. If they build cells on this frame of eggs or larvæ, then you may be sure they are queenless, and you can then introduce a queen with safety; but do not attempt it otherwise. Yes, you can introduce queens from now till cold weather sets in; but the sooner the bees get a queen, if they do not already have one, the better. You can leave foundation or combs in a hive; but it must be absolutely bee-proof and moth-proof. Combs will be perfectly safe if they are shut up tight, either in a room or in a box, or even in a hive.

D. W., Ohio.—As to the best way to pack 200 pounds of extracted honey for freight shipment, it does not require any different package for a long distance than a short one. Honey is shipped across the continent, or exported to foreign countries, for the most part in 5-gallon square cans or barrels. In the case of either package, and for a short or long distance, care should be taken to see that the package is of first-class material, and that it is well put together. We have frequently seen shipments of honey in 5-gal. cans badly damaged because the box was so poorly nailed that it came apart in shipping, or honey lost from the barrels because the hoops were not well driven down. Only last year a barrel which was made of first-class material came to us without a drop of honey in it, and one head gone, simply because the iron hoops were not driven down as tightly as they should have been. I think there is no choice of packages for a long or short distance so far as the shipping is concerned, there being only a choice with the shipper and the consignee. I presume, of course, you do not want glass packages, as these are not usually shipped long distances.



NATIONAL BEE-KEEPERS' ASSOCIATION.

OBJECT:—To promote and protect the interests of its members; to prevent the adulteration of honey.

OFFICERS:—E. R. Root, President, Medina, O.; R. C. Aikin, Vice-president, Loveland, Col.; Dr. A. B. Mason, Secretary, 3512 Monroe St., Sta. B, Toledo, O.; Eugene Secor, General Manager, Forest City, Iowa.

BOARD OF DIRECTORS:—E. Whitcomb, Friend, Neb.; W. Z. Hutchinson, Flint, Mich.; A. I. Root, Medina, O.; E. T. Abbott, St. Joseph, Mo.; P. H. Elwood, Starkville, N. Y.; E. R. Root, Medina, O.; T. G. Newman, San Francisco, Cal.; G. M. Doolittle, Borodino, N. Y.; W. F. Marks, Champaign, N. Y.; J. M. Hambaugh, Esccondido, Cal.; C. P. Badant, Hamilton, Ill.; C. C. Miller, Marengo, Ill.

FEES:—Annual membership fee, \$1.00. Remittances may be sent here or to General Manager as above.

OUR subscription-list is larger than ever before in our history, and it is still growing at a rapid rate. The increase for months and months is the greatest we have ever known it. We desire to thank our friends for this liberal patronage. We are figuring on some pleasant surprises, and hope to present them a little later on.

THE reader's attention is called to the fact that we are now using a brand-new face of type. We have for some months back been trying to decide between a typesetting machine or continuing the use of hand type in the good old-fashioned way. After considerable investigation we have concluded that, for our purpose, hand type was the best adapted for our purpose.

DURING the Buffalo convention several of us made our headquarters at the home of Mr. Orel L. Hershiser, 361 Huntington Av. He is located within 20 minutes' walk of the Pan-American, and within one block of a street-car line. His terms are \$1.00 per day for lodging and breakfast; and any bee-keepers who yet expect to go to the big exposition will do well to put up with Mr. Hershiser, for he has a nice place.

I AM satisfied that, within ten or twenty years, the larger amount of honey will be produced west of the Mississippi. The advance of intensive agriculture will make bee-keeping less and less profitable in the East, and narrow it down to small apiaries. In the great West there is much of the country that can never be cultivated, but which will always yield plenty of honey from the natural growth of tree and plant indigenous to those localities. Then the irrigated regions are so rapidly increasing in area that bees can follow in the wake without in the least interfering with the agricultural interests.

OWING to the fact that we have just changed the dress of GLEANINGS we find it impossible to give a report or hardly a brief mention, in this issue, of the Buffalo convention, and of the joint meeting of the

American Bee-keepers' Association with the American Pomological Society. But I will say this: That both meetings were exceedingly enjoyable and profitable. At the joint session the fruit-men showed a decidedly liberal spirit toward the bee-men—so much so that it looks as if we do not need to argue the question any further, whether bees are necessary to the proper setting of many kinds of fruit. But, more anon.

WAX IN ORDINARY SLUMGUM.

HERBERT FREAS sends from St. Anns, Ontario, some samples of wax and also some slumgum. Of the latter he says that one man sent him 20 pounds which had been squeezed with an ordinary hand press. From this with a screw press he extracted 7 pounds 2 ounces of fairly well-colored wax. His residue resembled plug tobacco, and had about the same odor, only not so much so, as one smoker put it.

This is only one out of many instances showing how much good wax has been thrown away as so much dross from the old processes of rendering. A good press intelligently used may earn its weight in gold.

A MYSTERY EXPLAINED.

IT will be remembered that, some little time ago, I reported that the bloom of the black-locust tree in Central California seemed to intoxicate or kill the bees, when the same bloom in Colorado would have no effect. After some little investigation it begins to appear that the dead and dying bees under the California black locust are due to the attack of the oriole, and not to the nectar in the blossoms. Mr. F. E. Brown writes me that this bird grabs the bee while it is partly covered with the petals of the locust blossoms, and then with a quick movement extracts the honey and drops the poor victim to crawl or squirm about on the ground. This clears up the mystery that was hard to explain, even on the basis of locality.

DISTINGUISHED VISITORS AT MEDINA.

WE have with us Mr. F. W. L. Sladen, of Ripple Court, England. He is one of the brightest and most intelligent bee-keepers in the British Isles. He is especially progressive, looking for that which is new and useful, and has made a trip to this country in order to study conditions of bee-keeping as they here exist. I expect to make further mention of his visit later. In the mean time I bespeak for him a most royal welcome from the American apiarists whom he may be able to visit in the brief time he may be here.

We have also had a visit from Mr. Udo Toepperwein, of San Antonio, Texas, and from Mr. G. F. Davidson, of Fairview, Texas. Both of these men attended the Buffalo convention, having been sent by their local State society as delegates to the big meeting. A little later on we had the pleasure

of a visit from Mr. and Mrs. Acklin and daughter, of St. Paul, Minn., also from the convention, and from Mr. Wm. Rohrig, of Tempe, Arizona, concerning whom I shall have more to say as I take up my line of travels. Mr. Rohrig had intended to attend the Buffalo convention; but owing to a railroad smashup he missed it by one day.

THE INTERESTS OF BEE AND PEAR MEN BEING HARMONIZED.

REGARDING the bee and pear-blight question in Central California, I am pleased to announce that many of the fruit-growers are coming to (or appear to be coming to) the conviction that the removal of the bees during the time the trees are in bloom will not materially abate the destructive effects of the pear-blight virus. It appears that the resolution passed by the bee-keepers in their convention, to move the bees out of the region of the pear-orchards during the time they were in bloom, required some ratifying action on the part of the fruit-men in filling out certain blanks. These blanks were laid before them some time ago, but nothing has been done. It is probably true that the pear-orchardists are not very sanguine as to the beneficial effects of the proposed removal, and many of them are fair men, and therefore disinclined to put the bee-keepers to this expense unnecessarily.

I talked with Prof. Waite (who, it will be remembered, originally declared the bees to be guilty), while in Buffalo, regarding this case. He was not sure the removal of the bees would bring about relief, owing to the presence of wild bees and numerous other insects that would, undoubtedly, spread the disease. He was sure, from extended experiments, that the bees were very necessary for the fertilization and proper maturing of the fruit, although he admitted that possibly conditions in California might be different. Prof. Waite is a careful, candid man, and a friend of the bees, and so much so that he deems it necessary to have a few colonies of them in his own pear-orchard, pear-blight or no pear-blight.

Taking every thing into consideration, it appears now there will be no conflicting of interests between the bee-keepers and pear-men; and it is hoped that the matter will rectify itself when the pear-blight disease loses its hold or "runs out," as we sincerely hope it may.

BEEET AND CANE SUGAR FOR BEES; FURTHER FACTS.

SOME little time ago, in referring to the use of beet and cane sugar for feeding bees I stated that I had been told that some of the Western canneries in Central California would not use beet sugar in putting up canned fruit—that they demanded cane. I have made inquiries since that time, and find that I misunderstood my informant. What he did say was that the grocers had learned that their customers who were canning particularly specified *cane* sugar, say-

ing they did not want the beet, because, when they put up fruit with beet sugar, the fruit spoiled; but that when it is put up with cane, it kept all right. But it now appears that no grocer can tell whether granulated sugar, properly refined, comes from beet or cane; and that, furthermore, not even a chemist can make the distinction. But since printing the article on page 757, from M. R. Gilmore, Superintendent of the American Beet-Sugar Association, at the Pan-American, I would state that I have had a talk with that gentleman; and I also had an interview with the representative of the cane-sugar exhibits. Both assured me that, when granulated sugar was properly refined, no one, be he scientist or farmer, could detect the difference—that they were identical; that there were certain unrefined beet sugars that had an odor. Is it not possible and even probable that some of the grocers referred to on the Pacific coast have been buying this cheap beet sugar, with the result that their customers have complained, and have since demanded and insisted on having what they *suppose* is a better sugar—the product of the cane?

I also learn from the beet and cane sugar representatives that during the last eight or ten years there has been comparatively little beet sugar on the market, when I supposed that quite the reverse was true; but they estimated that, during the past year, perhaps half of the sugar came from beet; and that, in the future, probably a much larger percentage will be from that source, because that vegetable can be produced over much larger areas of country than the cane. I shall have to confess, therefore, that in the ten or twenty years that I *supposed* we were using beet sugar we were probably using cane in the majority of instances.

It has been stated that many British bee-keepers prefer cane sugar to beet; but this is probably due to the fact that some beet sugar that finds its way into the British markets has not been properly refined; but now with the modern methods I think we may safely say that it makes no difference whether we use beet or cane sugar, provided it is *properly* refined.

In this connection I might state that there are on the market some white sugars that are adulterated with grape or corn sugar. Such sugar, if given to bees, undoubtedly would cause trouble. Therefore it behooves one to buy only the best granulated sugar. Don't waste any time in trying to learn its source. If it is granulated, and the grains are crystal and free, not lumping together, it is fit for a king as well as a bee-keeper.

AN UNMITIGATED SHAME; MORE MONSTROUS TALES ABOUT THE PRICES ON HONEY.

IN our last issue I stated that there had been gross exaggeration as to the honey crop of the southern counties of California; but at that time the inflation buyers claimed a maximum output of only 500 cars; but now

they have boosted it to 2000. As I have before stated, there seems to be a combination which has induced some of the daily papers to circulate such reports right and left. These glib falsifiers even go so far as to say, "This year's crop is estimated at 2000 cars;"* that while the prices last year ruled at 8¼ cents, they are now down to less than half that, and they will probably have to go lower; and, as if to add insult to injury, they further state that Honolulu honey is being poured into California, and from there it is being sent east.

Such stories have a strong tendency to unsettle the market; and the animus back of it all is very apparent. The Western "bears" are anxious, of course, to have the prices go down. They know the crop is light; and then when they get the producers under their thumbs, they propose, no doubt, to scoop up the honey at a low figure, and then hold it until it advances.

Moreover the Eastern buyers are being scared; and one man, whose honesty is above reproach, wrote, asking for my private opinion. He is a large buyer; and he says *if* these stories are true he would not dare to take on any more honey. But it is evident that there are some other men in collusion with the Western buyers who are anxious that these inflated yarns shall be scattered, because, forsooth, it will depress the Eastern market as well. If, for example, there were 2000 cars in California, and as much more of Honolulu honey, it would be perfectly clear that a large portion of it would have to go east. But no one need be alarmed over the matter. The facts are, I doubt whether 50 cars could be scraped up and sent eastward from California, all told. The large baking concerns have laid in quite a stock—probably all they will require; for when the price was down they snapped up every bargain they could get hold of; but now producers with business heads on them are holding the rest of the crop back.

For some weeks back we have been having men on the Pacific coast make a careful canvass; and it is very evident that the crop is light in comparison with those of some of the big years. I do not believe there is an aggregation of responsible producers anywhere in California who would guarantee to-day to deliver more than 25 cars; and as nearly as we can estimate they are holding back till these exaggerated reports have run their course, and the market seeks its natural level. It is most unfortunate that these canards should have been started at this time; for this is usually the *very* season for disposing of honey, and it may take months to correct the false impression.

The situation in the East, briefly told, is this: There is actually less comb honey produced this year than last; and what there is, seems to be of an inferior grade.

*In its best years, indeed the very best, the entire crop has not exceeded 500 cars and this year was only fair, with less than half the bees to get the honey.

We have advocated in these columns repeatedly that bee-keepers are running too much for extracted honey, in the East; at least, good comb honey sells all the way from 2½ to 3 times as much as extracted for a like quality. The market on extracted has become a little unsettled, owing to aforesaid "bears" who not only love honey but are contriving to get it for nothing. Yes, we are even told that the markets of the East were being glutted; but some of our friends went into some of those markets to buy honey in car lots. Do you believe they could get any? There was not any in sight. To state the matter fairly, there is probably a fair crop of extracted honey of Eastern production; and the prices on extracted will, therefore, rule about the same as last year, for the same season of the year. Colorado honey is evidently being held until the market recovers itself from these conflicting statements. The crop has been lighter, and so far offerings that have been very meager are as high as or higher than a year ago. There is only a moderate crop in Arizona—about 25 cars all told; and this is likewise being held for the same reason. Texas, one of the big honey States, will show up well; but much of its product will be marketed at home, while Arizona honey, a large portion of it, will have to be sold in the East.

Returning to California, latest advices show that the season has been a flat failure in the central portions of the State. Our men can not find more than three carloads all told. In Southern California it would be a large estimate to allow for 75 cars, if the general reports we get are true, and they come from men who are not inclined to "bull" the market. I know they are very close to the truth, because I was through much of that territory myself, and perhaps two-thirds of the crop had been harvested.

I shall send copies of this statement, prepared this day, to all the large buyers whom I believe to be reliable and honest, and will seek their advice and help. In the mean time, bee-keepers themselves can help us by scattering the real facts. Send to your own buyer a copy of this journal, marking this. If you want another copy, write us, and we will send you another, or as many as you can use.

Later.—Since the above was written one of the best bee-keepers in California who was sent by a San Francisco firm through the best honey country around Los Angeles, to get samples and quantities of honey, writes, after a careful canvass, that he could scarcely find all told 250 tons (20 cars), and that he is informed by reliable parties that the crop further south and east is very light. Moreover he finds that some of the buyers, in the papers, at Los Angeles, credit to a bee-keeper as many *cars* of honey as he has in tons. This may account for the outrageous exaggeration of the reports. Whether unintentionally or purposely, there is no excuse for it. As to prices, the honey is being held firm at 5 cents *or more*.



Children, obey your parents in the Lord; for this is right. Honor thy father and mother; which is the first commandment with promise; that it may be well with thee, and thou mayest live long on the earth. And, ye fathers, provoke not your children to wrath; but bring them up in the nurture and admonition of the Lord.—EPH. 6:1-4.

It was just about 25 years ago that I felt called to commence these Home Papers you are all more or less familiar with. It was when I first began to strive to lead a Christian life; and some way I was impressed that there was more need of the religion of the Lord Jesus Christ right in the family and home circle than almost anywhere else. When we get to such a point of Christian living that we can carry it out thoroughly right in the home, among those we are well acquainted with, and whom we meet in close contact every day of the year, then we are prepared to carry our religion out into the world, and hold it up as a beacon light. So it seemed to me 25 years ago; and I do not know but I feel more strongly in this direction now than I did then. My greatest temptations are many times, as I have told you, right in my own home. Before the great outside world we are under obligations to be gentle, courteous, and kind. A man who does not hesitate to let his bad feelings come out before company—well, to put it mildly, everybody is pained to see that he is but little of a gentleman. We are expected to be courteous and pleasant before company. When one is somebody's guest he would be a brute indeed if he made a fuss because things were not just to his liking. Now, then, why is it we can not show this same spirit in our own homes when the outside world is shut out? I suppose a good many think it is everybody's privilege to do as he pleases when he is at home; and perhaps a good many do not know why their lives are not fuller of happiness and joy, when the great trouble is they give vent to their feelings when they are inside the walls of their own home.

As a rule, children are kind and affectionate. The baby loves his mamma, and he loves the rest of the children, and is loved in return; and sometimes I have sadly wondered why this love for the baby could not keep right on. As he gets older he discovers that he can be a bad boy if he chooses. Unlovable traits creep in. He gets to be selfish and domineering, and learns to have no mercy on his tired mother. I think this must be a good deal the result of example. I fear he catches on to such things when his parents think he is too young to notice or to see what is going on. If this is true, how much does it behoove us to beware how *any sort* of bad example is set before the baby! Sometimes the home is a model one, or almost so, until the children get to be old enough to go

out into the rough outside world and bring in corruption.

My earliest recollections are of being one of a family of seven. With God-fearing parents our home was, as a rule, a happy one. But poor father, work as hard as he might, found difficulty in making both ends meet for that family of nine, parents and children. When my older brother was strong enough to work he got a job in a pottery in our town. His employers were infidels. They had no fear of God in their hearts; and with their infidelity they cherished vulgarity and impurity. O dear father and mother, I would never let the money that is offered be any argument in letting a child go out to work where he may have his whole life poisoned by infidelity and impurity, for they usually go together. My brother was bright, quick, and strong, and they offered him pretty good pay. Very soon he felt it was a fine thing to ridicule the faith of his parents. He is now dead and gone, and, of course, I should speak gently in referring to his mistakes; but in this case I think it was rather the mistake of the father than of the boy. The first poison that ever entered my young heart in the shape of impure thoughts came from stories related to me that he heard his employers tell. How well do I remember how my gentle Christian mother tried to counteract the effect of these new associates! My brother earned quite a little money, and clothed himself nicely, and helped to reduce the expenses of the family. But, oh dear me! who knows the load of trouble and sorrow that followed him almost if not quite through life as the consequence of evil associates at his tender age?

I have just returned from the Pan-American. I took a hurried trip through Midway. I am not either sorry or ashamed that I did so. I should like to have the fathers and mothers of our land see some of the Midway attractions. Before one tent where there was a great crowd of people, a man up on an elevated platform was using all his eloquence to get the people to come in and see their show. Every little while he would say something like this: "Now, if there is any *Sunday-school boy* in this crowd he had better go home. This is not any place for him; but if there is a boy here who wants to be a man, and learn something of the world, we can do him good."

As soon as I heard it I turned around and walked away as fast as I could conveniently. I wanted to have that speaker and all that crowd know that I belonged to the Sunday-school, and was expected to stand with it as long as God gives me breath. It is not Midway alone that indulges in this kind of talk and philosophy. I heard it at Omaha, and I heard the same lingo at a street fair in the neighboring town of Akron. These fellows seem to think this kind of talk helps them to secure a crowd. If they should discover that their crowd was dispersed instead of being drawn into the show by such talk, they would probably

give it up. Well, the average boy must sooner or later meet these things as he gets further and further away from his home, and away from his mother's teachings. I know how sadly the Christian mothers and the Christian sisters feel to see the son and the brother drawn down and away by these foolish and silly arguments. Oh how great is the need of grace from the great Father above in dealing with these young boys!

By accident I have recently had a glimpse of one home where the boy ridiculed his mother and sisters when they sought to keep him away from evil. It is sometimes a serious question as to what the mother shall do. Many mothers, and perhaps most of them, feel it a Christian duty to punish the boy in some way for deliberate disobedience. But some of these boys (of recent date), after having their minds poisoned by these things I have mentioned, have thought it a good joke to resist the gentle mother when she attempted to enforce punishment. Can one think of a sadder sight than a boy who exerts his strength to resist the feeble and perhaps broken-down mother—broken down by hard work—when she feels it a Christian duty to insist on obedience? You may suggest that at such a time the father should take the youngster in hand. Well, I presume that, as a rule, most fathers do insist that the boy shall obey the mother. Why, the boy's very life, or something more than life, depends on his being *made* to obey. Suppose he wants to go off with a bad crowd on Sunday, and the parents give way because he is too big and stout to be easily brought under subjection. Of course, the parents may overstep the limits. The time comes when the boy will often leave his home if he can not do as he pleases; but my opinion is that such a state of affairs seldom comes to pass where the boy is kindly and firmly taught obedience in his earlier years. I well remember one youngster who told his mother fairly and squarely that he was not going to school any more—he did not *care* for an education. The mother was weak and frail. I presume her boy could have picked her up and put her over the fence; but she declared then and there that he *would* obey her command, and go to school, and *keep on going*, and she did not call on the father to back her up either. She calculated on the hold she had obtained on the boy's mind and soul by years of faithful work. He made wry faces, and grumbled, and declared he would give up the books he hated, just as soon as he got a little older. But in a very little time he was able to stand alone and reason sensibly by himself. If there is any one thing in this world that makes him respect and almost reverence that mother, even to-day, it is because she insisted on his getting an education. Had he stopped going to school when he was determined on it, he would have been worse than crippled for life. Why, I am not sure but it would have been better for that boy to have lost both arms

and both feet than to have stopped his education at the very time he was determined to give it up. In both of the illustrations I have used, I have supposed that both the father and the mother were professing Christians, or at least that they were at agreement. Well, now, friends, let us suppose the husband does not sympathize with the wife in her efforts to keep the boy pure-minded, and away from evil associates. Suppose the husband just laughs, and seems to think it is a big joke when it is a question as to who will come out ahead—the boy bent on evil, or the mother who is trying to restrain him. I have seen a few such cases. Some of you will perhaps say the mother was partly to blame. Dear brother or sister, we are all more or less human, and it would be strange if, in the conflict, the mother did not exhibit some lack of wisdom or show some imperfection. Now the question confronts us, "What shall a Christian mother do under such circumstances?" She can not appeal to the neighbors, or at least until things get into a terribly bad shape; nor can she appeal to the law. Even an appeal to the pastor of the church might result in doing more harm than good. She must watch and pray. She must especially pray very hard, if I may use the expression, and *strive* very hard to be sure that no wrong spirit enters *her own* heart. Why, in a case like this it is almost beyond human power to do just exactly right. Let us always, under such circumstances, remember, however, that a soft answer turneth away wrath. I have had trials of my own of this kind. I do not mean, dear friends, trials where the dear wife would not help or was not in sympathy, but in matters outside of our own home. I have had difficulties to meet where I am sure I was right, and no one or almost no one would help me. Perhaps some soul was bent on going to ruin. His friends and relatives laughed about it. May the Lord be praised, there are shining examples round about me now to show that I, with *Jesus'* help, triumphed. Yes, and that after I had given up over and over again. "Be not weary in well doing, for in due time ye shall reap if ye faint not."

Right before the whole family is a poor place to settle difficulties of this kind. The husband and wife must, first of all, somewhere or somehow, *by themselves*, come to an agreement. Let the good wife take the opportunity when he is not contrary (if that is the right way to tell it), and plead with him, and get his promise to co-operate with her—if not to the extent she wishes, then get it as far as she can; also by private talks with the older members of the family, say with the boy's sisters. Let each one plead with him alone. Most boys at a tender age think it a fine thing to "show off," and they will often show a stubborn and contrary spirit before others that they would not think of when alone with no one else near. I know there are boys who seem to think the more the mother

does for them the more she ought to do. I know they sometimes get to be cold and unfeeling as well as rude. I do not know any remedy for this state of affairs but constant and loving prayer. Ask the dear Lord to point out to you opportunities to *win* the child's confidence and respect. Do not make the mistake of doing *every* thing for the boy. Teach him to be self-reliant and manly. I know of a poor widow who let her boy lounge on the streets while she dug her potatoes. She gave as a reason that if he dug them he chopped into them and spoiled so many she would rather do it herself. Now, this woman made the mistake of thinking more of her potatoes than she did of her boy—at least, that is the way I look at it. The boy should have been made to dig the potatoes, and dig them carefully and well, even if it cost ever so much more than the potatoes were worth. Boys will never be made *better* by letting them lounge on the streets instead of doing the work they ought to do.

Now, in closing let me say a word to these boys—that is, if they ever get hold of my writings. My young friends, very likely you will some time see that patient, hard-working, faithful mother laid in her coffin. When you do, you will think of your unkind words and acts to her. You will remember when you might have carried the wood or dug the potatoes for her when she was tired and worn out. You will, perhaps, recall every unkind speech you ever made to her. Just once in my life I resisted my good father's authority. I did not strike him, thank God, but I "talked back" as the boys call it. I had been among evil companions. They jeered me because I obeyed my father and never said a word back. They made me think it would be a fine thing if I had the courage to talk back to him. May God forgive me that one time. Father forgave it freely, for I asked forgiveness afterward; but when I sat by his bedside when he breathed his last, I thought of that one time, and I thought, too, that I would give almost every thing in this world if it had never happened. About the last work he did on earth was to dig potatoes. After he was gone it seemed to me it would be the greatest privilege that this world could offer if I had the chance once more to go and work by his side and help him when he was really too sick to work himself. But it is the mothers, I think, that bear the heaviest burdens. I have told you several times that Mrs. Root prefers to do her own work without any hired help; and every day I try to do some of the heavy work for her when I know what she wants done; but should she die first, I am sure that I shall regret—yes, bitterly regret—that I did not try *harder* to lift more of her burdens and to prevent her from getting so tired out as she does almost every day.

And finally, dear friends, there is nothing in this world that can so contribute to gentleness and Christian courtesy in the home, among all its members, as the love

of Christ Jesus. I know it is getting to be a good deal out of fashion to have family worship; but I am sure thousands of homes would be greatly benefited by having just a few words of Scripture read some time during the day before all the family. Let the children learn a text and repeat it at breakfast time, if you can not do better. Let the mother have her text too, and do not be in too much of a hurry; and, if it can be brought about, have the father or somebody else give thanks to God. One verse of some one of our many beautiful hymns is a grand thing to encourage gentleness and courtesy in the hearts of all. May God in his great mercy bless the words I have tried to speak to you; and may they be the means of letting the spirit of the dear Savior find a lodgingplace in homes where he has heretofore found no entrance or welcome.



It is really one of the fine arts to study out how you can get from place to place in traveling, especially in a strange land, and not waste time and money. You want all the aids you can possibly get hold of in the way of maps and time-tables, and study the railroads, ask questions of people you meet, look ahead and plan ahead; and even then you will find every little while, by looking back, where you could have saved dollars in money and days of time had you been thoroughly posted in regard to all the crooks and turns and queer combinations of methods of travel.

Before starting for home I wanted to visit Huntington, Putnam Co., Fla. I knew it was near Palatka, and I had planned to go to Palatka first and then find which way I would have to go to reach Huntington. Finally it occurred to me that Huntington might be on the very road I was going to take from Tampa to Palatka. Sure enough, so it was; and at just the last minute I saved going right past where I wanted to go, in the night, and being obliged to go back over the same ground the next day.

I reached Huntington about an hour before daylight. The station was dark, and, in fact, it was dark everywhere. It was pretty cold, too, for one who had been having malarial chills. I finally found a colored man camping out beside a fire in the open air. He pointed out a hotel, but he said he was afraid nobody lived there. Sure enough, it was the old story—pounding at the doors and getting no response. Then I went to the nearest dwelling, with a like result. I tried another and another. I began to feel homesick, discouraged, sick every way. When one who is sick tries day after day for a week or two to travel and meet friends, and appear as one is ex-

pected to do while visiting them, he is apt to get a severe attack of homesickness, and conclude wisely, under the circumstances, "there is no place like home." I felt especially sick of beautiful homes where nobody lived. Finally I spied a man carrying a lantern. I do not know but I said out loud, "Thank God, there is somebody in this place who has life enough to be up before daylight and to be getting ready for his work." This man took me to his home, gave me a warm place by the fire, and a warm breakfast. He informed me he was in the employ of Dr. Walker, and the latter is agent for and has charge of the large estate of Mrs. Huntington, who gave the town its name. Mr. Walker seems to be the busy man, or the business man of the town. He has charge of the sawmill, the store, of a small mill for making syrup from sugar cane, and he is not only doing every thing he can to open up the different industries of the place, but he is the prime mover in the church, Sunday-school, and all other Christian work. After I was introduced to him and was invited over to his beautiful home, I forgot most of my troubles, and partly forgot my chills.

Huntington, like the rest of Florida, is full of these strange and wonderful strong contrasts. It is my misfortune or good fortune, I hardly know which, to own 160 acres of land within a mile or two of the town of Huntington. In hunting up somebody to take me over there I ran into two or three beautiful orange-groves, pretty well laden with fruit, that promised a good crop for the coming season. I saw some kumquat-trees loaded down with little oranges that almost made one think of a gooseberry-bush but on a larger scale. The kumquat-trees and the orange-trees also, were protected by means of wooden boxes and canvas tents; but, if I am correctly informed, the money expended in canvas tents and wooden boxes and things of a like nature during the past winter were mostly a needless protection; for trees unprotected, at least as far north as Huntington, did just about as well as (and in some cases better than) those that have protection. Many of the people have taken heart as their trees begin to assume their proportions and set fruit as they did before the great freeze. I was much better pleased with the looks of my Florida ranch than I expected to be. The worst trouble is that it is about two miles from the station. Now, two miles in Ohio is near by; but when you come to pull a wagon through the Florida sand, it seems a long way off. There are beautiful lakes that run into my land, with water as clear as crystal, and grassy shores as green and inviting as anywhere in the world; yes, and some of the land along the lake would grow good crops of almost every thing that belongs to that region, including oranges and pineapples. Of course, the latter would have to have protection. At one time there were quite expensive buildings on the place; but now every thing is tumbled down and gone to

ruin. Here and there a plantation is under cultivation, and gives rich promise; but deserted houses and run-down farms are the rule.

Dr. Walker has not only a beautiful home, but a wonderful family. One of the girls tends the village store and postoffice. One of the boys has charge of the sawmill; a third one a sugar-cane mill, and soon with the various enterprises all over the place.

After leaving Palatka I made a brief stop at Lake City, where the experiment station is situated. A great deal of important work is being done here, and I was pleased to notice the improvement in many things, especially in their methods of thoroughly testing grasses, grains, fruits, and every thing else that promises to succeed in sunny Florida; but while the courteous attendant was showing me over the grounds I was taken with another of my chills, and so severely, that I went back to my hotel, and from there took the train for home.

Now, please do not get the impression from what I have written from my own experience that Florida is an unhealthy place. I met people everywhere who can live there, and be comfortable and happy, who can not stand the frosts and snows of the North; but I am inclined to think it is not the best place for one who is subject to malarial attacks.

I was obliged, although reluctantly, to break my appointment with our good friend J. M. Jenkins, of Wetumpka, Ala. I regretted this the more as he had promised to take me over to visit Booker T. Washington's industrial school for colored people.

Some of you may inquire if I found relief on getting back to Ohio. I reply that the frosty nights and the surroundings of home seemed to have for a time a beneficial effect; but just now, as I dictate this, September 17, I have my fur cap pulled down over my ears, and have on my winter flannels and a big overcoat, for I have just been having another spell of the chills. Mrs. Root and I are planning, however, to start day after to-morrow for a month's outing in the Traverse region of Michigan. This locality has seemed especially favorable for people troubled as I am.

As an apology for saying so much about myself and my infirmities, perhaps I should mention there are hundreds of afflicted people reading these travels; and I am constantly receiving inquiries as to which place I would advise for this, that, and the other malady. Dear friends, I am asking God day by day to guide and direct me in my efforts to help my fellow-men in their pursuit of health. If my money and my experience can be of benefit to you, they are freely given.

Convention Notice.

The annual meeting of the Northern Illinois Beekeepers' Association will be held in the court-house in Rockford, Ill., on Tuesday and Wednesday, Oct. 15 and 16, 1901.

B. KENNEDY, Sec.
Rockford, Ill., Rural Route, 5.



POTATOES FOR COOKING INSTEAD OF PLANTING.

I extract the following from the *Country Gentleman*. Of course, they were kind enough to send me the cut that goes along with it.

A vast amount of literature has been written in recent years on how potatoes should be planted and cultivated and sprayed in order to insure a large crop. It would seem that now attention might well be turned to the growing of potatoes which should possess good quality. This matter has been called forcibly to my attention during the past winter, when having occasion to purchase potatoes from the store. It has been almost impossible to secure any which possessed first-class cooking quality.

Most people know a good potato when they eat it, but all are not familiar with the conditions which produce the good qualities, and neither are they familiar with the inherent principles upon which quality depends. When a dish of nicely boiled potatoes is brought upon the table, we have come to recognize the white, flaky, mealy potato as one which will eat well, and we also recognize in the soggy, close-grained potato one of poor quality. Very much depends on the variety of potato grown, for a variety which possesses good quality in one section may be very inferior in another. The Carman No 3 is one of the best varieties grown in Central New York, but we have been informed that in Central Pennsylvania its quality is not good. The Rural New-Yorker No. 2 while one of the best yielders, has with us not much to recommend it in way of quality.

If potatoes then are to be grown for quality, care must be taken first to learn what varieties possess the best quality in the immediate section. But a small part of the problem is solved when the variety is de-

tato sells as well as another. This is not strictly true. Last October the potato crop at Cornell University was harvested and sold in the local market direct from the field for 60 cents per bushel. There was a greater demand for them than could be supplied. Farmers are to day bringing potatoes to the same market and selling them for 40 cents per bushel. We believe it will pay a farmer to make a special effort to grow good potatoes, and that in every market there can be created a demand for potatoes possessing special quality. Once this demand is created, it will not be satisfied with the watery, soggy potatoes grown upon clay soils, but there will be required a "mealy," dry potato, which when properly cooked is fit for a king.

I can indorse every word of the above. We grow potatoes for seed, or mainly so; but all the time we have orders for choice potatoes for cooking purposes only, and usually from people who say they are willing to pay a big price if they can only get some potatoes that will cook up dry and mealy, like the plateful in the picture. By the way, it has many times made me feel sad to see that our high-priced hotels and restaurants do not seem to have any comprehension of what a good potato is. We pay the biggest kind of prices, and almost every thing else is extra fine; but potatoes, especially the baked ones, are only once in a great while equal to what we find on the average farmer's table. Why, it just makes me hungry every time I look at that plate of potatoes. When I am sampling new varieties for quality, I often watch the process of cooking; that is, I get a potato on my plate, one like those seen in the picture, give it a sprinkle of salt and pepper, and then drop a little butter on it while the potato is hot; and is there in the whole round of food products



DISH OF POTATOES PROPERLY COOKED

cidied upon; for the best variety when grown upon improper potato-soil, or with poor care, will be deficient in quality. The ideal soil for potatoes is the sandy or gravelly loam; and where such a soil is selected and the growing crop well cared for, no difficulty will be experienced. A large yield can be secured by growing the tubers in a clay or clay-loam soil, but they will not possess the best quality.

The per cent of starch and the per cent of dry matter in the tubers determine largely whether they will cook well. Starch is manufactured in the leaves of the plants, under the action of sunlight, and from the leaves it is conveyed to and stored in the tubers. If the "bugs" or "blight" or leaf flea-beetles are permitted to impair the vigor of the foliage the starch-manufacturing organs are weakened, and the quality of the tuber grown may suffer thereby.

The assertion is frequently made that it will not pay the farmer to grow potatoes for quality; that one po-

any thing more satisfying and delicious than a real nice potato?

Our friend is right in regard to soils. We get great yields on our clay grounds; but the quality—that is, when they are dug in the fall—is never equal to that of potatoes grown by my cousin in Summit Co., or in the sandy soil of Northern Michigan. Many of our potatoes, however, that are not first-class in the fall are all right in the spring. The New Craig is one of them. Another thing, certain potatoes will be nice one season and not the next. The Mills Prize, grown on our clay soil here in Medi-

na, one fall were almost if not quite equal to Freeman. The next year they were no better than other varieties. Almost any potato will be good if we can keep the foliage bright, green, and healthy until it comes to full maturity. Bugs, blight, and early frost are sure to spoil the quality, at least for a fall potato.

All things considered, one year after another, for our locality, I do not believe we have any thing better than the State of Maine; but, unfortunately, a great many strains of this seed are either mixed or run out. My neighbor Ballasch, mentioned in our issue for Sept. 1, has recently sent to the originator for seed of the State of Maine that is absolutely pure and up to standard. I have obtained from him two barrels for planting next season. Shall we not all work a little harder for quality as well as for quantity?

You will notice the writer in the *Country Gentleman* advocates cooking potatoes with the skins on—at least so the picture shows; and I believe this is generally the farmer's style, and perhaps the best one, although Mrs. Root has a plan of her own with pared potatoes. When they are done to the proper point she pours the water off and takes the kettle (not too many potatoes at one time) to the door where there is a fresh cool breeze, and gives the potatoes a good shaking (or bouncing) in the breeze. This is too get rid of the moisture so that the potato may roll up, and crack open dry and floury. I have several times seen her take potatoes that were watery and very inferior with the ordinary way of cooking, and make them not only look nice but taste nice. There is certainly quite a knack in making poor potatoes in cooking so as not only to make them presentable but really nice to eat.

THE TRAVERSE REGION OF NORTHERN MICHIGAN FOR SUFFERERS WITH ASTHMA.

I have the asthma so bad here that I am good for nothing and I am thinking of going up into the Traverse region to live. I have been up there twice, and find that, as long as I am there, I am all right; but as soon as I come home I go to wheezing again.

I want to find out all I can about bee-keeping up there.

F. M. HAYNES.

Winchester, Ind., Aug. 26.

Friend H., I am glad to get your testimonial in regard to the Traverse region. There are a good many bee-keepers around there, but there have been only a few large reports of honey production. There is usually a steady flow of honey, enough to keep the bees from robbing, almost all through the warm months. During this season the willow-herb grows in great profusion, especially where the ground has been burned off. Although I am not afflicted with asthma, my experience so far as health is concerned is much like yours. As I write this, the 19th of September, I am preparing to go up there with Mrs. Root, for a month, mainly to see if my health will be better in that locality for a whole month at a time. Our ranch is close by what is call-

ed the Bingham Dock, about 2½ miles straight east of the town of Bingham, Leelanaw Co., Mich.

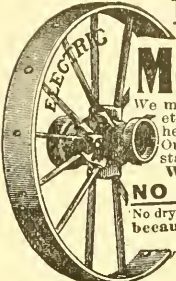

THE WHEEL OF TIME
for all time is the
Metal Wheel.
We make them in all sizes and varieties, TO FIT ANY AXLE. Any height, any width of tire desired. Our wheels are either direct or stagger spoke. Can FIT YOUR WAGON perfectly without change.
NO BREAKING DOWN.
No drying out. No resetting tires. Cheap because they endure. Send for catalogue and prices. Free upon request.
Electric Wheel Co.
Box 95 Quincy, Ills.



The Storm Proof
KING WIND MILL
produces 25 to 50% more net power from any kind of wind than any other mill as is. Wheel being only 1 ft. thick, cuts the wind like a knife and is 400% more storm proof than any other. Exceedingly light, but wonderfully strong. Very sensitive—runs in lightest winds. Numerous sizes—6 ft up, both pump and power, back geared or direct stroke. Send for circulars and prices before you buy. **Medina Mfg. Co., Box 11 Medina, O.**



IT IS A FACT
that poultry pays a larger profit for the money invested than any other business; that anybody may make a success of it without long training or previous experience; that the **Reliable Incubator and Brooder** will give the best results in all cases. Our **20th Century Poultry Book** tells just why, and a hundred other things you should know. We mail the book for 10 cents. Write to-day. We have 115 yards of thoroughbred poultry.
RELIABLE INCUBATOR & BROODER CO., Box 8-49, Quincy, Ill.

TREES Fruit and Ornamental
Shrubs, Plants, Seeds.
Best by 48 years test. Try us.
Direct deal will save you money.
Catalog free. Satisfaction guaranteed.
STORRS & HARRISON CO.,
Painesville, Ohio.

FREE Drug Book
They cost us \$2. each. 1500 illustrations. Contains over 15000 drugs, medicines, home remedies, flavoring extracts, tinctures, electric belts, pills, oils, etc. We save you 15 to 75% on any of them. Send for a mailing book which amount is refunded on your first order. Send for book to-day, you may need medicine to-morrow. One can never tell. Better get it and keep it handy.
We are "The Only Mail Order Drug House in the World."
Heller Chemical Co. Dept 40 Chicago, Ill.



STEEL WHEELS
for your **FARM WAGONS**
any size wanted, any width of tire. Hubs to fit any axle.
No blacksmith's bills to pay.
Notices to rest. Fit your old wagon with low steel wheels with wide tires at low price. Our catalogue tells you how to do it. Address
EMPIRE MFG. CO., Quincy, Ill.

In writing, mention Gleanings.

WIDE-TIRED WHEELBARROWS, ETC.

I inclose a slip. Please give your careful attention. The past three months I've had to wheel a great deal of coal at the asylum, and I fully believe that something of that kind is what is needed.

Traverse City, Mich.

R. HADLEY.

The slip referred to reads as follows:

Wide-tired wagons are becoming common. Now why in the name of common sense don't some enterprising manufacturer give us a wide tired wheelbarrow, or a wide-tired wheel-hoe?

We sometimes wonder whether wheelbarrow-makers ever attempted to wheel one of their barrows over a bit of soft ground! We also wonder if these same makers ever stopped to think that the wheel might be placed further back so as to take most of the load-weight off from a man's arms?

We doubt whether any wheelbarrow-manufacturer ever did these things; for, if he had, he never would be content to go on year after year, turning out the same identical kind of barrow that came over in the Mavflower.

What's the sense of putting the wheel way in front so that nearly all the weight comes on a man's shoulders? Why not place the wheel near the center and more under the load?

And, too, are wide-tired wheels such unheard-of things that barrow-manufacturers need to be told of the advantages of using them?

Friend H., while in Florida I heard a great many inquiries for a wide-tired wheelbarrow. I suppose that, in the sandy soil of Northern Michigan, where you are, the conditions are much the same. Our Daisy wheelbarrow formerly had a tire $1\frac{1}{2}$ inches wide. The last carload has tires $1\frac{3}{4}$ inches wide. If I am correct, soft sandy soils would need $2\frac{1}{2}$ or 3 inches. But you will find a difficulty right here. Unless there is a wooden felloe inside of the tire, the soft sand or mud will run in and pile up on the inside of the wheel, and make it run harder than a narrow tire or one filled with wood so as to prevent sand or mud from running in as I have described. A tire 3 inches wide filled with wood makes a heavy, clumsy wheel. The same objection applies to wide-tired wagon-wheels made of thin sheet steel. A good many times they are heavier to draw than common wagons. There are wheelbarrows made where the load is thrown pretty well over the wheel; but if I am right they are not generally liked. It is true the wheel sustains the greater part of the load; but it sinks into the ground worse, and is not so easy to turn. If you had a chance to try all kinds of wheelbarrows, one after the other, I think you would decide the manufacturers of the Daisy have got it about as nearly right—that is, for most localities—as it can be made. You may not be aware that there has been a great deal of experimenting on this very thing.

ADVERTISING SECRETS, ETC.

In one of our agricultural papers I found a very enticing advertisement to the effect that a secret would be sent to any one on receipt of 25 cents, for making 3 lbs. of butter from 1 lb. The butter was to be of extra quality, and even a child could make it, and with this process any one could get rich, for butter will always sell anywhere in the world. I presume the editor of the

above paper never thought that he might send the 25 cents himself, and do his whole list of readers a big lot of good (?) without its costing them a cent. Perhaps he thought it was not his affair. But I decided, as soon as I saw the advertisement, that it was *my* affair, especially where I could help so many people for so small an investment. Here is the wonderful secret:

TO MAKE THREE POUNDS OF BUTTER FROM ONE POUND.

Take one pound of fresh churned butter (not salted), and put in suitable vessel while warm and soft. Add the yolks of three eggs. Mix well together, then add (slowly) warm sweet milk (just milked from the cow), and beat rapidly with a spoon as you add the milk. The butter and eggs will take up the milk slowly until you have three pounds of butter. When it quits taking up the milk as you pour it in, it is done. Then salt and mold as other butter. Not much working required. J. E. MOLLETTE, Ridgeley, Tenn.

May be the above is all right; but I can not help wondering what will happen to this eggy mixture if it should not be used up in three or four days during hot weather. Never mind. If it turns out all right you can send your thanks to me on a postal card.

15 Months for \$1.00!

To New Subscribers.

To any one not a subscriber to the weekly *American Bee Journal*, who sends us \$1.00, we will send it

From October 1, 1901, to the End of 1902,

or 15 months; which means over 60 copies. This we will do as long as we have back numbers left from Oct. 1; after that, the subscription will begin at the time it is received and continue to the end of 1902.

The Buffalo Convention Report

will appear *in full* in the *American Bee Journal*; that alone will be worth the subscription price for a year, to say nothing of the many other good things it contains each week. Better subscribe *now*. No matter what other bee-papers you are taking, you can not afford to be without the *o'dest*, and what many bee-keepers say is *the best*. Ask for free sample copy, and also catalog of

ROOT'S GOODS AT ROOT'S PRICES.

George W. York & Co., Chicago, Ill.

144, 146 Erie Street.

100 Tested Red Clover Queens For Sale

at 75 cents each: $\frac{1}{2}$ dozen, \$4.00; untested, 60 cts.; $\frac{1}{2}$ dozen, \$3.00. LEININGER BROS., Fort Jennings, Ohio.

50c QUEENS.

100 untested Italian queens 50c each, as long as they last. CHAS. H. THIES, Steeleville, Ill.

CHAS. ISRAEL & BROS.,
486-490 Canal St., Corner Watt St., N. Y.
Honey and Beeswax.

Liberal Advances made on Consignments. Wholesale Dealers and Commission Merchants. Estab. 1875.

Minnesota Bee-keepers' Supply Mfg. Co.,
Manufacturers of
Bee-hives. Sections. Shipping-cases, and
Everything Used by Bee-keepers.

Orders filled promptly. We have the best shipping facilities in the world. You will save money by sending for our price list. Address

Minnesota Bee-keepers' Supply Mfg. Co.,
Nicollet Island Power Building, Minneapolis, Minn.



NO VACATION

for PAGE Fence. It's on duty 24 hours every day
Page Woven Wire Fence Co., Box 5, Adrian, Mich.

Wants and Exchange.

Notices will be inserted under this head at 10c per line. You must say you want your ad. in this department, or we will not be responsible for any error. You can have the notice as many lines as you please; but all over ten lines will cost you according to our regular rates. We cannot be responsible for dissatisfaction arising from these "swaps."

WANTED.—An experienced bee-man to manage apiary and run a one horse farm. Fine location, large orchard, good school. Address
CLAUDE SHEWMAKE, Shewmake, Laurens Co., Ga.

WANTED.—To sell or exchange gasoline engine, motor bicycle, bicycles of every description, for launch, lathe, drill-press, etc.
ROBERT B. GEDEY, LaSalle, Ill.

WANTED.—To exchange second-hand 60-lb. cans, practically as good as new, at 20c per can in lots of 20 or more, f. o. b. Chicago, for white-clover honey at market price. **B. WALKER, Clyde, Cook Co., Ill.**

WANTED.—To exchange one broom-handle lathe and one automatic gauge lathe.
W. S. AMMON, 216-8 Court St., Reading, Pa.

WANTED.—To exchange potatoes for sweet potatoes.
JOHN ANDERSON, Oriskany Falls, N. Y.

WANTED.—To dispose of my olive-ranch and 85 colonies of bees, located 12 miles from San Diego, California; near church, school, store, postoffice, and railroad station. Extracted 19,000 lbs. from 50 colonies, spring count, this season; have taken honey every year since I came here. The best of climate. Write for particulars.
J. B. RATCLIFFE, Helix, San Diego Co., Cal.

WANTED.—To buy quantity lots of fancy and No. 1 white-clover comb honey in no-drip cases.
BYRON WALKER, Clyde, Cook Co., Ill.

WANTED.—Comb and extracted honey. State price, kind, and quantity. **R. A. BURNETT & Co., 199 South Water St., Chicago, Ill.**

WANTED.—To buy your honey. State your lowest cash price, kind, and quantity.
EDW. WILKINSON, Wilton, Wis.

WANTED.—All the bees we can get; must be extremely cheap at this time of year. Parties who will place us in correspondence with those having bees to sell, will receive one to a half-dozen selected queens free next June, according to the number of colonies we succeed in purchasing from said parties.
H. G. QUIRIN, Parkertown, Ohio.

BERMUDA

With cable communication and equable winter temperature of 70 degrees, is reached in 48 hours from New York by the elegant steamers of the Quebec Steamship Company, sailing every ten days up to January, and then every five days. The situation of these islands—south of the Gulf Stream—renders

FROST UNKNOWN,

and the porous coral formation prevents malaria. The Quebec Steamship Company also despatches highest class passenger steamers every ten days for ST. THOMAS, SANTA CRUZ, ST. KITTS, ANTIGUA, GUADALOUPE, DOMINICA, MARTINIQUE, ST. LUCIA, BARBADOES, DEMERARA, and the principal WEST INDIA ISLANDS, affording a charming tropical trip at a cost of about \$1 a day. For descriptive pamphlets, dates of sailing and passages, apply to

A. E. OUTERBRIDGE & CO., Agents,

39 Broadway, New York.

ARTHUR AHREN, Sec., Quebec, Canada.

Mr. A. I. Root's Writings

of Grand Traverse territory and Leelanau Co. are descriptive of Michigan's most beautiful section reached most conveniently via the

PERE MARQUETTE R. R.

For pamphlets of Michigan farm lands and the fruit belt, address **W. C. Tousey, D. P. A. Toledo, Ohio.**

PINEAPPLES!

Choice fruit and plants now ready for shipment. Suitable land for sale, sheds constructed, pineries set and cared for. Correspondence solicited.

Lewisiana Pinery Company, Orlando, Florida.

C. H. Lewis, Manager.



BELGIAN HARES!

With every hare sold goes a full pedigree, register number, and score-card, scored by an official judge. Does will be bred to one of our famous high-scoring bucks free. Write for book. Mgr. of The A. I. Root Co.
J. B. MASON, MECHANIC FALLS, MAINE.

Angora Goats.

Delane bucks; good stock; low prices; large circular for stamp.
ED. W. COLE & Co., Kenton, O.

1200 FERRETS. All sizes; some trained; first-class stock. New price list free. **N. A. Knapp, Rochester, Lorain Co., Ohio.**

Marshfield Manufacturing Company.

Our specialty is making SECTIONS, and they are the best in the market. Wisconsin basswood is the right kind for them. We have a full line of BEE-SUPPLIES. Write for FREE illustrated catalog and price list.

Marshfield Manufacturing Company, Marshfield, Wisconsin.

THE SMITH PREMIER TYPEWRITER

Occupies an Imperishable Position in the BUSINESS WORLD.

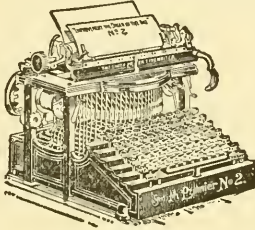

Unquestionable Superior Merit

Annually adds thousands of names to the long list of Smith Premier users, representing every line of trade and every profession.

ILLUSTRATED CATALOGUE FREE.

The Smith Premier Typewriter Co.,

158 Prospect Street, Cleveland, Ohio.

Supplies for the West!

The latest and best in the line of

BEE-KEEPERS' SUPPLIES

Kept constantly on hand.



We carry a full line and large stock of The A. I. Root Company's Goods, which we sell here at their factory prices. Estimates cheerfully given. Catalog free.



ADDRESS

Jos. Nysewander Des Moines, Iowa.
710, 712 W. GRAND AVENUE.

ALBINO QUEENS. If you want the most prolific queens, the best honey-gatherers, the best comb-builders, the hardiest and gentlest bees known, try my albinos. My untested queens, 75c. J. D. GIVENS, Lisbon, Texas.

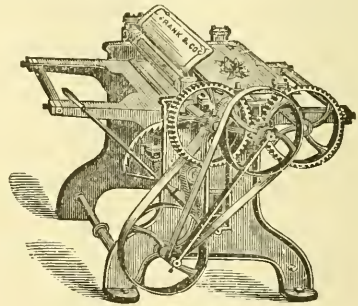

PLANERS

The above cut shows one of our small Planers, of which we make twelve different styles and sizes. Also large Planers, Band Saws, Buzz Planers, Moulders, Wood Lathes, and all kinds of

WOOD WORKING MACHINERY

Send for Catalogue.

The **FRANK MACHINERY CO.**
BUFFALO, N. Y.

Union Combination Saw

For Ripping, Cross-cutting, Rabbeting, Mitering, Grooving, Gaining, Boring, Scroll-sawing, Edge-moulding, Beading. Full line FOOT and HAND POWER machinery. Send for catalog A. SENECA FALLS MFG. CO., 44 Water St., Seneca Fs., N. Y.

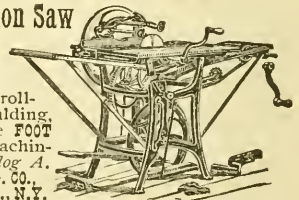

SCOTCH COLLIE DOGS. Thoroughbred swine and poultry. Interesting prices. PORTS BROS., Bx 111, Parkersburg, Pa.

GET FERTILE EGGS AND LOTS OF THEM by feeding cut raw bone. It makes vigorous chicks, too. The easiest running most rapid cutting machine for preparing it, is the **MANN'S BONE CUTTER**. 1902 New design, open hopper, enlarged table, Model new device to control feed. You can set it to suit any strength. Never clogs. Sent on **TEN DAYS' FREE TRIAL**. No money asked for until you prove our guarantee on your own premises, that our new model will cut any kind of bone with adhering meat and gristle, faster and easier and in better shape than any other type of bone cutter. If you don't like it, send it back at our expense. Free Cat'g explains all.

F. W. MANN & CO. Box 37 Milford, Mass.
 Manfrs. of Clover Cutters, Granite Crystal Grit, Corn Shellers, Etc.

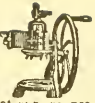

Humphrey Green Bone and Vegetable Cutter, guaranteed to run easier and make better feed than any other of your money back. Handsome Poultry Books and Egg Record Blanks free.
HUMPHREY & SONS, BOX 51, JOLIET, ILLINOIS.

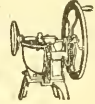

1881

PAGE & LYON MFG. CO.

1901

We manufacture a full line of the latest
BEE-SUPPLIES.

Our motto is, "Perfect Goods and Prompt Shipment."

Send for our new free illustrated catalog.

PAGE & LYON MFG. CO., New London, Wisconsin.

NOW READY!

64-PAGE CATALOG OF EVERY THING BEE-KEEPERS NEED. Illustrated and fully described. Especially valuable to beginners for the information it contains. Send your address on postal and get it now. Established 1884.

J. M. JENKINS, Wetumpka, Ala.

I. J. Stringham, 105 Park Place, New York City.

Keeps in stock a full line of modern appliances for bee-keepers.

SQUARE CANS & SHIPPING-CASES.

One-pound square flint jars with corks, \$5 00 a gross. Cartons of a superior quality at a low price. Tested Italian queens, \$1 ; untested, 75c. Apiaries, Glen Cove, L. I. Catalog free.

I. J. Stringham, 105 Park Place, New York City.

LONGEVITY.

I have never made any great claim for the longevity of the Superior Stock of bees that I am selling, but from the reports that I am getting this year I am inclined to the belief that this quality ought to be added to the other desirable traits that they possess. Here is a sample of the letters that I get :

WARSAW, N. Y., Sept. 4, 1901.

Mr. W. Z. Hutchinson, Dear Sir.—I inclose \$2.00 for Review and queen. Three years ago I lost my breeding queen in the spring, and sent to you for one of your year-old queens. I expected to use her only one season, but she proved to be so much better than I expected that I kept on using her until I now have nearly my entire apiary requeened from your stock. I started last spring with 35 colonies, increased to 75, and have nearly 4000 pounds of honey—not so bad for a village where 250 colonies are kept, besides there be-

ing other apiaries near by. One of my neighbor bee-keepers is so well pleased with my bees that he offered to trade apiaries with me, giving me *two swarms for one*, but I declined his offer. The bees of this queen have been trying hard for the last two or three months to supersede her, but I keep the cells cut out, and shall try hard to keep her over into her fifth year.

Resp. yours,
W. W. SHERWIN.

If you send in your order at *once* you will probably be able to get one of these queens this fall, and be all ready for business next spring, instead of being obliged to wait two or three months before your order can be filled.

Queen alone, \$1.50; queen and Review from *now* to the end of next year, only \$2.00.

W. Z. HUTCHINSON, Flint, Mich.

200 lbs. Fine Section Honey

is a big yield for any season, but especially so for a poor one. Read how it was done.

"I feel it my duty to let you know that the queen I received from you last spring broke the record in my apiary by storing over 200 lbs. of fine white section honey, which is fine work for this section of the country, and had it not been for the dry weather would have done much better. Dr. Mason said he could not get any white honey to speak of."

T. J. GRIGGS, care Standard Oil Co., Toledo, O.
Sept. 6, 1901.

Here's another: "During this summer bees from your queens have brought in a surplus of honey while others had to be fed." C. B. FRIERSON,
Sept. 6, 1901. Ceiba Mocha, Cuba.

Queens same stock as above, untested, 75 cts., six for \$4.00; dozen, \$7.50; set of warranted, \$1.00; six for \$5.00. Queens sent promptly.

J. B. CASE, Port Orange, Fla.

100 COLONIES leather-colored Italians for sale. My apiary took 1st premium for these this year at the Minnesota State Fair. All in standard 8 frame hives and Hoffman frames. Strong condition, and will guarantee not less than 20 lbs. sealed honey in each. Single colonies \$5.00, or the lot goes at \$4.00 each on car.

ANSELL, Box 288, Milaca, Minn.

WANTED.—Fancy white honey in Danzenbaker sections, also buckwheat honey, comb and extracted. Send sample of extracted, and let us know how much you have, comb or extracted, and how put up, and price at which you will sell.

THE A. I. ROOT Co., Medina Ohio.

FOR SALE.—Extracted honey in 60 lb. cans at 7½ cts. M. ISBELL, Norwich, N. Y.

FOR SALE.—8000 lbs. clover and basswood honey, mixed, in 60-lb. cans, as white as Michigan produces; good body and flavor; the best I ever produced in 26 years' bee-keeping. A free sample will convince you. Eight cts. per lb. at Carson City.

E. D. TOWNSEND, Remus, Mich.

FOR SALE.—5000 lbs. of clover honey; very nice; suitable for bottling. I want 7 cts. at my depot, and the party buying to furnish cans to put it in.

F. C. HUTCHINS, Massena Springs, N. Y.

FOR SALE.—Extracted honey, cans and kegs 7 to 8 cts. per lb. Sample, 5 cts. Comb honey, 13 to 14 cts. Beeswax wanted.

I. J. STRINGHAM, 105 Park Place, New York.

MISMATED and untested queens for 25c each; five for \$1.00. C. G. FENN, Washington, Conn.

YOUNG and prolific mismated Italian queens at 25c. W. F. STUART, Ottawa, Kans.

Standard-Bred Queens!

Acme of Perfection; Not a Hybrid among Them.

Improved Strain Golden Italians.

World-wide reputation; 75c each; six for \$4.00.

Long-tongued 3-banded Italians.

Bred from stock whose tongues measured 25-hundredths inch. These are the red clover hustlers of America. 75 cts. each; six for \$4.00. Safe arrival guaranteed. Catalog on application. Headquarters for bee-keepers' supplies.

Fred W. Muth & Co., Cincinnati, Ohio.
South-west Corner Front and Walnut Streets.



LONE STAR APIARIES

Italian Queens.

Estab'd 1885. Prices of queens from imported mothers: Tested, \$1.50; 6, \$6.50; 12, \$12.00. Untested, 75c; 6, \$4.00; 12, \$7.00. Golden, same price. Select tested of either race, \$2.50 each. For a short time I will mail tested leather-colored queens at \$1.00.

Your money back if you are not satisfied. Address G. F. DAVIDSON & SONS, FAIRVIEW, TEX.

QUEENS Until Nov. 15th.

The best of warranted Italian queens, 50 cts. each, \$6.00 per dozen. We breed bees for business, and guarantee prolific queens, and fine honey-gatherers. Your orders will be promptly filled by return mail.

J. W. K. SHAW & CO., Loreauville, La.

TESTED QUEENS, 50c.

A few dozen fine young queens bred for bees, at 50c, W. F. STUART, Ottawa, Kans.



HONEY-CANS.

We still have a fair supply of 5-gallon honey-cans which we can furnish at prices listed in our catalog. We can also supply the smaller sizes, 1, 1/2 and 3/4 gallon, with 1 1/4-inch screw-caps. We have also some one-gallon cans with 2 1/2-inch caps. We have a fair supply also of Record seal-cover and raised-cover tin pails as listed in catalog at catalog prices.

GLASS HONEY-PACKAGES.

Of No. 25 1-lb. jars we have a good supply put up two dozen in partition boxes, but our supply in barrels is exhausted for the present, though we hope to have a further supply soon. We have also a good supply of No. 100 jars similar to No. 25, holding 14 oz. of honey both in barrels and boxes. Owing to our surplus stock of these two sizes in boxes we will sell them at 50 cents per gross advance over the price of the same in barrels, instead of \$1.00 advance, as listed in catalog, for a short time only. We have lately secured 10 gross of pint flint Mason jars, put up one dozen in a box, which we can supply at 60 cts. per dozen; \$7.00 per gross. Our stock of quart Mason jars is getting very low, and we have still a good supply of 2 quart.

HONEY MARKET.

The market for comb honey continues good, and we are shipping on orders as fast as received, and have had to check our salesmen taking orders till we could see a larger supply in sight. We have engaged a car of comb honey to come early this month, from California. By next issue we hope to give definite announcement regarding it. We are getting 16 to 17 cts. for fancy white; 15 to 16 for No. 1 white, and other grades in proportion. We feel pretty well satisfied that prices of comb honey will not go higher, and they may be a little easier when bee keepers take the time to case their honey and get it to market. September and October are usually the best selling months. Market for extracted honey continues dull. Either the sale of extracted honey in bottles or other glass packages must be greatly stimulated or else a larger proportion of the best grades of honey should be stored in sections. Raise comb honey by all means if the conditions are favorable, and the quality of the honey good and suitable.

Special Notices by A. I. Root.

JERSEY WAKEFIELD CABBAGE SEED FOR COLD FRAME PLANTS.

When this reaches you it will be just about the right time in most localities to sow the seed in the open air in order to have plants ready at just about the right time to plant in cold-frames for cold-frame plants. With the protection of sashes only, without any bottom heat of any sort, the plants will be well rooted before severe cold weather sets in, and will winter all right in almost any place in the North. Price, for March's best selected stock seed, ounce, 20 cts.; 4 ounces, 75 cts.

FRUIT HARVESTING, STORING, AND MARKETING.

The above is the title of a new book just published by the O. Judd Co. It has often been said that it takes a smarter man to sell fruit at good prices after it is grown than it does to grow it; and I should not wonder if the statement were true. This book is intended to give all the assistance possible in teaching the beginner how to put his fruit up and how to sell it. It has 250 pages, and is amply illustrated. Price \$1.00. It can be mailed from this office. This book also considers very thoroughly the matter of storage; how to keep fruit as long as possible when there is a glutted market; all about packing and packages; how to put up apples so as to stand long shipments and bring the best prices. All sorts of tools are described and figured for the business. The book includes evaporating and canning; and, in short, it covers the whole subject from beginning to end of the saving of your fruit

from loss after you have got it grown, and also how to manage to get the best prices.

EARLY POTATOES FOR SEED.

Before another spring, all sorts of early potatoes will be held at exceedingly high prices, for the reason that growers north, south, east, and west, have been tempted to sell at the unusual prices offered for potatoes for table use. I have no idea what other dealers are expecting to ask; but we have so many applications for prices just now I have decided to offer such as we have, for the present, at the following prices:

Barrel, \$4.25; bushel, \$1.50; 1/2 bushel, 85 cts.; peck, 50 cts.; 1/2 peck, 35 cts.; 1 lb. by mail, 30 cts.; 3 lbs. by mail, 60 cts. This refers to early and extra early potatoes.

We have in stock, ready to ship, the following kinds:

Red and White Bliss Triumph, Early Ohio, Early Trumbull, Bovee, New Queen, Lee's Favorite, Freeman, and Twentieth Century. Seconds of all the above will be half price; but the half price does not apply to potatoes by mail. The Twentieth Century is put in order as being one of the latest of the extra early. This season, however, it grew potatoes as large as hens' eggs, as soon as any in the lot; but it did not arrive at maturity quite as soon as the Early Ohio and others. In making orders let it be understood that the above, firsts and seconds both, will run smaller than usual, and are not as clean and nice shaped, on account of the severe drouth. Please remember, also, I reserve the liberty of advancing the prices at any time when I find the prices from other seed-growers are going to be very much above the prices I have given. Until further notice prices of New Craig also will be as above. Prices on other late potatoes will be given later on.

Now Is the Time to Paint.

The Heller Chemical Co., of Chicago, Ill., whose advertisement appears on page 799 of this issue, have just issued one of the neatest paint catalogs ever sent through the mails. It contains a fine color page showing 60 distinct colors for out and inside painting; for barns, fences, floors, carriages, wagons, enamels, and stains. Besides this fine color selection there is a splendid line of brushes, also painters' supplies of all kinds. This company has been to a good deal of expense in getting up this catalog and making it complete in every detail. They have made it especially for the mail-order customers, and our readers will do well to send for one, especially if they have any painting to do this fall. Be sure when writing to ask for their paint catalog, and kindly mention this paper. These paints are all mixed and ready to put right on.

Wisconsin Farm Lands.

The best of farm lands can be obtained now in Marinette County, Wisconsin, on the Chi ago, Milwaukee & St. Paul Railway, at a low price and on very favorable terms. Wisconsin is noted for its fine crops, excellent markets, and healthful climate. Why rent a farm when you can buy one much cheaper than you can rent, and in a few years it will be your own property? For particulars address F. A. Miller, General Passenger Agent, Chicago, Milwaukee & St. Paul Railway, Chicago.

To make cows pay, use Sharples Cream Separators. Book "Business Dairying" & cat. 288 free. W. Chester, Pa.

I have just received from you a copy of the A B C of Bee Culture, which I value at \$10 to any apiarist. Indeed, it is a "dandy." I now own two editions of this work. Please accept my thanks for the same.
King Creek, Ky. DR. M. FIELDS

The untested clover queen, with her escorts, arrived safely last night, all alive and hearty. She is a very likely-looking insect, being as large as if not larger than any queen I have received through the mail. She is now under introduction. Bees are working nicely on swamp flowers, being able to do a good deal more than board themselves; they have no inclination to rob, which will, of course, help with the safe introduction of the queen just received.
Poole, Can. D. CHALMERS.

HONEY QUEENS!

Laws' Long-tongue Leather Queens.
Laws' Improved Golden Queens.
Laws' Holy Land Queens.

Laws' queens are the standard bred queens of America. The largest honey-producers use them and praise them. Laws' queens go everywhere, and can furnish you a queen every month in the year. Four apiaries. Queens bred in their purity. Prices, October to April: Tested or untested, \$1.00 each; 6 for \$5.00. Breeders, none better, \$3.00 each. Address

W. H. Laws, Beeville, Texas.

Dittmer's Foundation !!!

Retail---Wholesale---Jobbing.

I use a PROCESS that produces EVERY ESSENTIAL necessary to make it the BEST and MOST desirable in all respects. My PROCESS and AUTOMATIC MACHINES are my own inventions, which enable me to SELL FOUNDATION, and WORK WAX INTO FOUNDATION FOR CASH, at prices that are the lowest. Catalog giving

FULL LINE OF SUPPLIES

with prices and samples, free on application. BEESWAX WANTED.

GUS. DITTMER. AUGUSTA, WIS

Get the Best Queens.

Evansville, Ind., Sept. 27th, 1900.
The Jennie Atchley Co., Beeville, Bee Co., Texas:
Dear Friends:—It gives me great pleasure to forward you this unsolicited testimonial regarding the merits of Atchley queens. The three (3) dozen queens purchased of you have made an excellent record for themselves. Not an Atchley queen among the twenty colonies lost during the severe drouth in July. I have bought queens from many breeders; and although the present crop is exceedingly short, the tiers of supers show where the Atchley queens are, and speak volumes for your method of queen-rearing. I find the progeny to be very gentle, strong-winged, uniformly marked, long-lived, of large size, and last, but not least, the best honey-gatherers I ever had. I shall want 100 more next season.

Yours fraternally, J. C. WALLENMEYER.

Prices for Queens.

Tested, \$1.50 each; \$8.00 for 6, or \$15.00 per dozen. Untested, February, March, April, and May, \$1.00 each; \$5.00 per 6, or \$9.00 per dozen. Fine breeders, \$5.00 each. We have as good bees and queens as money and labor produce. We breed three-band Italians, Goldens, Carniolans, Cyprians, and Holy-Lands, in their purity, bred in separate yards 5 to 20 miles apart. If you want the best, call for Atchley's improved strains. Safe arrival guaranteed. Send for a sample copy of "The Southland Queen," the only southern bee-paper. \$1.00 per year. To new subscribers we offer as a premium a nice untested queen in order to get our paper introduced. Catalog, giving queen-rearing and management of apiaries for profit, FREE.

THE JENNIE ATCHLEY CO.,
Beeville, Bee Co., Texas.

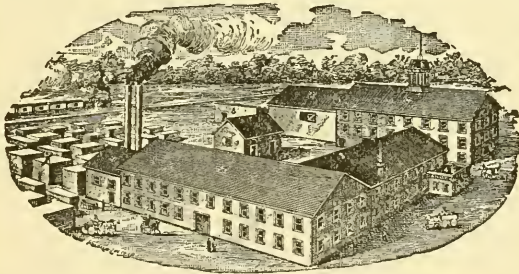

KRETCHMER M'FG CO., Red Oak, Iowa.

BEE-SUPPLIES.

Best-equipped factory in the West; carry a large stock and greatest variety of every thing needed in the apiary, assuring BEST goods at the LOWEST prices, and prompt shipment. We want every bee-keeper to have our FREE ILLUSTRATED CATALOG, and read description of Alternating Hives, Ferguson Supers, etc. Write at once for a catalog.

— AGENCIES: —

Trester Supply Co., 103 So. 11th St., Lincoln, Nebraska; C. C. Richards, 1223 17th St., Denver, Col.

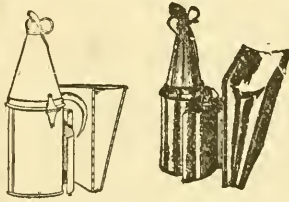

BINGHAM SMOKER.

Dear Sir:—Inclosed find \$1.75. Please send one brass smoke-engine. I have one already. It is the best smoker I ever used.
Truly yours,
HENRY SCHMIDT, Hutto, Tex.

MADE TO ORDER

Bingham Brass Smokers.

Made of sheet brass, which does not rust or burn out; should last a lifetime. You need one, but they cost 25 cts. more than tin of the same size. The little open cut shows our brass hinge put on the three larger sizes. No wonder Bingham's four-inch smoke-engine goes without puffing, and does not drop inky drops. The perforated steel fire-grate has 381 holes to air the fuel and support the fire. Heavy tin smoke-engine, 4-inch stove, per mail, \$1.50; 3½-inch; \$1.10; 3-inch, \$1.00; 2½-inch 90c; 2-inch, 65c. Bingham smokers are the originals, and have all the improvements, and have been the standard of excellence for 22 years. Only three larger ones brass.

T. F. Bingham, Farwell, Michigan.

Contents of this Number.

Balling of Queens814
 Bee in Law.....818
 Bees, Moving, Holtermann on.....816
 Bees, Uniting for Wintering.....824
 Boyden's Tri.....826
 Buffalo Convention.....827
 Collingwood's Address at Buffalo.....830
 Colonies, Double decker.....822
 Convention, Joint, at Buffalo.....829
 Ferree, J. W.....822
 Foul Brood in California.....815
 Home of the Honey-bees Growing.....826
 Honey, Price of.....827
 Queen, What is a Tested?.....813
 Queens, Laying, Confinement of.....819
 Rambler off for Cuba.....826
 Rambler's Sketches.....820
 Selling-case, Franklin's.....823
 Sugar, Beet v. Cane.....826
 Sugar, Feeding to Finish Sections.....815
 Wintering with Upper Entrance.....825

Honey Column.

GRADING-RULES.

FANCY.—All sections to be well filled, combs straight, firmly attached to all four sides, the combs unsoiled by travel stain, or otherwise; all the cells sealed except an occasional cell, the outside surface of the wood well scraped of propolis.
 A No. 1.—All sections well filled except the row of cells next to the wood; combs straight; one-eighth part of comb surface soiled, or the entire surface slightly soiled; the outside surface of the wood well scraped of propolis.
 No. 1.—All sections well filled except the row of cells next to the wood; combs comparatively even; one-eighth part of comb surface soiled, or the entire surface slightly soiled.
 No. 2.—Three-fourths of the total surface must be filled and sealed.
 No. 3.—Must weigh at least half as much as a full-weight section.
 In addition to this the honey is to be classified according to color, using the terms white, amber, and dark; that is, there will be "Fancy White," "No. 1, Dark," etc.

CITY-MARKETS.

SAN FRANCISCO.—Comb honey, 10@12 Extracted, water-white, 5½@6½; light amber, 4@5½; dark, 4@5. Beeswax, 25@27.
 Sept. 26. E. H. SCHAEFFLE, Murphys, Cal.

DETROIT.—Fancy white comb honey, 14@15; No. 1, 14; dark and amber, 11@12. Extracted white, 6½@7; dark and amber, 5@6. Beeswax 26@27
 Oct. 21. M. H. HU T & SON, Beli Branch, Mich.

BOSTON.—We quote our market as follows: Fancy white in cartons, 16; A No. 1, 15; No. 1 14½. Extracted white, 8½; light amber, 8; amber, 6½@7½.
 Sept. 27. BLAKE SCOTT & LEE, 31, 33 Commercial St., Boston, Mass.

CHICAGO.—There is a very good demand for No. 1 comb honey at 15 per lb.; that which will not grade No. 1 or fancy, sells at from 13@14; some small lots of fancy have brought more than 15 light amber selling at 12@13; dark honey of various grades range at from 10@11. Extracted sells fairly well at 5½@6½ for white, according to quality and flavor; white clover and basswood bringing 7; light amber, 5½@5¾; dark, 5@5½. Beeswax steady at 28. R. A. BURNETT & Co.
 Oct. 10. 199 South Water St., Chicago, Ill.

NEW YORK.—Demand for comb honey good; receipts not as plentiful as we should like to see them, particularly buckwheat. Comb honey is scarce, and slow in coming in. We quote you the market as follows: Fancy white clover, 16; No. 1, 15a@16; No. 2, 12@13; fancy buckwheat, 11@12; No. 1, 10@11; No. 2, 9@10. Extracted, white clover and basswood, 6@7; light amber, 5½@6; buckwheat, 5@5½. Beeswax is steady; fancy, 28@29, good average, 26½@27.
 Oct. 10. CHAS. ISRAEL & BROS., 486-8 Canal St., New York City.

CINCINNATI.—The supply for comb honey is rather short. Fancy Southern, 14½; fancy white clover sells 15@16. The market for extracted is rather dull. Dark sells for 5@5½; better grades from 6@7; extra fancy, 8@9. Beeswax, 27.
 Oct. 9. C. H. W. WEBER, Cincinnati, O.

MILWAUKEE.—The offerings of honey continue to be quite liberal from the fields of production, and the supply on this market is seemingly enough at this time to supply current demands; and values are fairly well sustained on choice qualities, and we will quote fancy white 1-lb. sections, 15@16; A No. 1, 14@15; No. 1, 13@14. amber honey not in demand, nominal, 12@13. Extracted white in barrels, kegs, or cans, 8@8½; amber, 7@7½. Beeswax, 25@30.

A. V. BISHOP & Co.,
 Oct. 10. 119 Buffalo St., Milwaukee, Wis.

ALBANY.—Honey market in good shape. Moderate receipts and good demand. White comb, fancy, 16; No. 1, 15; No. 2, 14@15; mixed, 14; buckwheat, comb, 12@13; extracted, light, 7@7½; mixed, 6½@7; buckwheat, 6@6½.
 Oct. 11. MCDUGAL & Co., Albany, N. Y.

SCHENECTADY.—We can report a very firm market. No. 1 clover selling at 15@16; No. 2, 13@14; buckwheat, 12@13. There is also quite a demand for extracted at 6@6½ for light, and 5@5½ for dark, in 150-pound kegs.
 Oct. 11. CHAS. MCCULLOCH, Schenectady, N. Y.

NEW YORK.—Arrivals of comb honey are good at present, and quality first-class. We quote fancy white at 14@15; No. 1 white, 13@14; mixed white, 11@12; buckwheat, 10. There is little doing in extracted honey—prices ruling from 5@6, according to quality. Beeswax dull at 27.

FRANCIS H. LEGGETT & Co.,
 Oct. 11. Franklin West Broadway, and Varick Sts., New York City

FOR SALE.—Extracted honey, cans and kegs 7 to 8 cts. per lb. Sample, 5 cts. Comb honey, 13 to 14 cts. Beeswax wanted.

I. J. STRINGHAM, 105 Park Place, New York.

FOR SALE.—8000 lbs. clover and basswood honey, mixed, in 60-lb. cans, as white as Michigan produces; good body and flavor; the best I ever produced in 26 years' bee-keeping. A free sample will convince you. Eight cts. per lb. at Carson City.

E. D. TOWNSEND, Remus, Mich.

WANTED.—Fancy white honey in Danz. sections, also buckwheat honey, comb and extracted. Send sample of extracted, and let us know how much you have, comb or extracted, and how put up, and price at which you will sell.
 THE A. I. ROOT CO.

WANTED.—Western honey in car lots, also northern fancy white comb in no-drip cases; state price delivered. We pay spot cash. Reference, German National Bank, Cincinnati. FRED W. MUTH & Co., Front and Walnut Streets, Cincinnati, Ohio

WANTED.—Honey; car lots or otherwise. Will send man to receive when sufficient amount to justify, and pay highest market price, spot cash. Address, stating quantity, quality, and price desired at your station.
 THOS. C. STANLEY & SON, Fairfield, Ill.

FOR SALE.—30 to 35 cases heartsease honey, two cans to a case (120 lbs.); new cans; 8 cts. per pound.
 JOHN A. THORNTON, Lima, Ills.

FOR SALE.—Fancy and No. 1 comb honey; about 2000 lbs. or more. WM. MORRIS, Las Animas, Cal.

WANTED.—Comb honey and beeswax. State price delivered Cincinnati. C. H. W. WEBER, 2146 2148 Central Ave., Cincinnati, Ohio.

WANTED.—We are in the market for honey, either local or carlots commission or purchase. We especially desire Wisconsin basswood, and will be pleased to hear from that State EVANS & TURNER, Town St., Cor. 4th., Columbus, Ohio.

WANTED.—Fancy and No. 1 white clover honey, one-pound sections, paper cartons preferred.
 BLAKE, SCOTT & LEE, 33 Commercial St., Boston, Mass.

We will be in the market for honey the coming season in carloads and less than carloads, and would be glad to hear from producers everywhere what they will have to offer.
 SEAVEY & FLARSHEIM, 1318-1324 Union Avenue, Kansas City, Mo.

Wm. A. Selser, Honey Expert,

When you buy honey, send a 3-oz. bottle, have it tested, to be sure it is pure. Price \$2.50 per sample. By doing this you may avoid over ten times this amount in litigation with pure-food laws. Chemist's certificate given.

The A. I. Root's Co.'s Office, 10 Vine Street, Philadelphia, Pa.

G. B. LEWIS CO., WATERTOWN, WIS.



Bee-hives,
Lewis' White
Polished Sections,
Shipping-cases.



Perfect Goods,
Prompt Shipment.

Special Agency, C. M. Scott & Co., 1004 East Washington St., Indianapolis, Indiana.

AGENCIES: L. C. Woodman, Grand Rapids, Michigan; Fred W. Muth & Co., Southwest Corner Walnut & Front Sts., Cincinnati, Ohio; Fred Foulger & Sons, Ogden, Utah; Colorado Honey-producers' Association, Denver, Col.; Grand Junction Fruit growers' Association, Grand Junction, Colorado; Robert Halley, Montrose, Colorado; Pierce Seed and Produce Company, Pueblo, Colo.; E. T. Abbott, St. Joseph, Missouri, Special Southwestern Agent.

BEE - SUPPLIES!

*ROOT'S GOODS
AT
ROOT'S PRICES.*

C. H. W. Weber, Cincinnati, Ohio.
2146-2148 Central Ave.

A NEW AND COMPLETE stock for 1901 now on hand. I am The Root Company's representative for Cincinnati and surrounding territories. . . You save TIME and FREIGHT CHARGES by having goods shipped from here. Convenience of railroad facilities here enables me to do so. Before buying elsewhere, write for my prices and catalog, which will be mailed you free of charge.

GLEANINGS
 IN
BEE CULTURE

A JOURNAL DEVOTED TO BEES AND HONEY AND HOME INTERESTS.

ILLUSTRATED SEMI-MONTHLY
 Published by THE A. ROOT CO.
 \$1.00 PER YEAR MEDINA, OHIO.

VOL. XXIX.

OCT. 15, 1901.

No. 20.



JUST AS I THOUGHT possible, F. B. Simpson did not mean in *Review* that long tongues were not of value *per se*. I find, however, that Hasty understood him just as I did; and when as bright a chap as Hasty gets from a sentence a meaning other than the intended one, there must have been some reckless use of the English language.

ONE OF THE ITEMS of September preparation for winter, given on p. 785, is to see that each colony has a good queen. Isn't it rather late for that, Bro. Doolittle? A good many of my colonies cease to rear brood in September. [Why late? It is a common practice with us, away up into October. Much of September with us is very warm. Sometimes we then have the hottest days in the year. Perhaps your locality is much colder.—ED.]

"DO THE GERMANS mean that feeding induces a drain on the vitality of the bees to ripen or invert the syrup?" is the question asked, p. 778. I think that is not the idea, but that the syrup lacks some elements contained in honey necessary to vigor of constitution. [If this is so, then the experience and practice of American apiarists seem to be quite the opposite of those in Germany. Of all things that were settled, I supposed it was that good sugar syrup, fed thin, and properly ripened, was a better food than any honey.—ED.]

SOMETIMES I find an article in a journal which is too much of a puzzle for me to make out its meaning, and I feel out of patience with the writer, who might easily have made all clear if he had not omitted one or two additional points. It now seems that I have sinned in that way myself, for the astute editor of *GLEANINGS* could not make out my meaning, page 785, till he got one of our good British cousins to help him. I suggest that hereafter such articles be re-

turned to the writers to have the puzzles unpuzzled.

I INDORSE Arthur C. Miller when he says, page 780, "It is necessary to encourage the eminently practical though non-scholarly bee-keepers to contribute of their experience." And I suspect most of our bee-journals are trying to do that. [That is what *GLEANINGS* is trying to do. Indeed, I have more than once rejected articles from scientific men that, in my judgment, were too scientific, too theoretical, or too something, to be useful to the plain every-day bee-keeper who keeps bees for the money or for the bread and butter he can get out of them. In saying this I do not wish to give the impression that we have no use for scientific articles.—ED.]

A QUESTION that will some of these days need to be supplied with a new answer is this: "What is a tested queen?" The answer *has been*, "A queen whose three-banded workers show that she is pure Italian in origin and mating." But since the entrance of five-banders, as the editor correctly says, p. 790, there may be black blood in a queen which produces three-banded workers. That knocks out the old answer. What shall the revised answer be? Don't ask me. I don't know. [This is one objection to the rearing of five-banded bees. But that objection would have no weight with me providing I could see in color greater longevity or more pounds of honey.—ED.]

"RIDICULOUS" is the label that F. B. Simpson, in *Review*, puts on the notion that keeping a queen in a nucleus will beget longevity in her offspring. Sure. But it had escaped me that any one advocated such a notion. He says his breeders must do their duty in a full-sized hive, so he can compare them with others. All right, F. B.; but after a queen has fully established her reputation I like to give her a light job so as to keep her as long as possible. A queen I'm now trying to winter was born in 1897. After doing extra work during four years I felt she would be insulted if I had said, "Now let's see what kind of stuff's in you,"

so I gave her a soft job for 1901. [You are doing with your breeder just the very thing that we are doing with our best queen.—ED.]

WHAT YOU SAY on page 778 in that last Straw, Mr. Editor, squints in the direction of saying that every shoe must be made on the same last. I protest most earnestly against being obliged to take something I don't want, just because it is more convenient for the manufacturers. Charge what you will for the extra trouble of making more than one kind, but give those of us who want it and are willing to pay for it a cover that will not leak, warp, or twist, and that will be warmer in winter and cooler in summer than a single-board cover. [I might have added that the Root Co. proposes, in spite of the universal preference of the dealers for the Excelsior single-thickness cover, to furnish, on option, two double-board covers, one a gable and the other a simon-pure Dr. C. C. Miller double-lid cover with paper. There, now, don't you dare say the Root Co. is trying to make every shoe fit the same last. But we feel that we are compelled to make a poorer cover, in our judgment, "regular," until we can convince the trade that the double air-space one is better. It is simply a matter of education and time.—ED.]

"I HAVE SEEN queens that were balled and were stung to death inside of a minute," says the editor, p. 790. Did you ever know such a speedy death when you let the ball entirely alone, Mr. Editor? I never did. But holding a smoker close to the ball, and blowing *hot* smoke upon it, will prove instant death to the queen, and so may punching at the ball to try to get the queen out by force. [I can not remember that a queen was ever killed inside of one minute when the ball was left alone; but the one-minute execution referred to was by Cyprians. These bees, instead of buzzing around one's face, will make a shot straight from the comb, delivering the sting in one's face at the instant of contact; and, as nearly as I can remember, when they ball the queen they are inclined to make short work of her also. But, say—I did not recommend holding the smoker close to the ball of bees. I used the term "blowing light whiffs" of smoke on the ball. Our neighbor, Mr. Harrington, once had a queen, however, that would fight her way through any ball of bees we ever saw. For the sake of experiment he dropped her repeatedly into a number of different queenless colonies. If the bees commenced to ball her she would fight like a little tiger. In a day or two afterward we would find her reigning supreme, without let or hindrance.—ED.]

I ASK, page 785, whether we ought not to take 15 days instead of 16 as the time from the laying of the egg to the emerging of the queen. And then that exasperating editor says, "You are relying for your data on one experiment only," when I had just said, "In full colonies I have had many,

many incidental proofs that 15 days was the limit." Besides, do you think a man like Cowan would brush aside all the traditions of the fathers, and announce a new time-limit with nothing but data secured from a single experiment on which to base his belief? Aroynt thee! [Yes, you may be right; but I am not going to "aroynt" just yet, for you say you had many *incidental* proofs—italics mine. When we come to split hairs, or get down to the exact day, should not the proof be something more than incidental? Should it not be clear and positive? I admit the statement of Mr. T. W. Cowan, supposing it to have been based on many experiments, goes a long way; and for the time being, unless I get better proof, the next edition of the ABC will have the figures 15 instead of 16.—ED.]

YOU ASK, Mr. Editor, p. 778, how I know that the father of the drone's sister does not exert some potent influence on the drone himself. I may answer that Dzierzon, who at 90 is still vigorous in intellect, has always held that the drone is of the same blood as his mother. I do not think, however, that the drone with which a queen mates is entirely without influence upon her male progeny. If my memory is not at fault, there are cases on record in which a white woman bore a child to a negro, and afterward to a white man, and the second child showed distinct traces of negro blood. But I think the influence is so exceptional or so slight, that, in actual practice, we may say that a drone is not affected by the drone with which his mother mated. [Another fact, taken in this connection, is somewhat interesting. I have been told that, if a rooster of a Black Langshan, Black Minorca, or any pure-blooded black stock, gets into a pen of pure White Leghorn hens, or any other white stock, even for one day, that sittings of eggs from these hens will for many months afterward show chickens with black feathers, showing that the male of one variety can exert an influence long afterward, even though other males have been among the fowls for months. Notwithstanding Dzierzon has contributed to the world one of the most interesting facts in nature, neither he nor any other great man is always infallible; so I should be inclined to take the view that a drone was at least part brother to his worker sisters of the same mother.—ED.]

"BREED FROM THE BEST" has been the watchword with myself as well as others. F. B. Simpson, in *Review*, says we're off. Given 5 queens from the same mother, which 5 queens uniformly yield about 10 lbs. more than the average, and another 5 from another mother, which 5 zigzag all around from 35 below to 90 above the average, and he will breed from the first 5 rather than from the one that runs 90 above the average. Now if F. B. will tell us, as I'm afraid he will, that all intelligent breeders of note agree with him, I'll promptly 'bout face and stand in line with him; but if he's only

giving his own opinion, I've a choice assortment of abusive epithets laid up for him, and a lot of brickbats to fling at his battlements. I ought to explain that he reasons that the one that runs 90 above the average is a freak that will not give uniform results, while the 5 of the other mother, being uniform, may be relied upon for future results. [The recommendation of F. B. Simpson is one that we have been carrying out in practice for several years. A breeder whose queens are irregular, zigzagging from one extreme to the other, is one that will cause complaints from customers; but one that will give uniform results in markings, in prolificness, in gentleness, in every one of her daughters, is the one that we select for a breeder—providing, of course, that these daughters all score a high average; but if Mr. S. or any one else can find a mother, the bees of whose daughters will average in number of pounds of honey about the same under like conditions—well, we can not do it. The daughters of our best breeder nearly all score well in honey, but there is quite a variation. While the poorest will be no worse than the average, the best will be considerably better.—Ed.]



Green were the leaves at sunset;
 To-day they're sear and red;
 Like men they play their proper part,
 Then fall to earthy bed.

AMERICAN BEE JOURNAL.

Mr. York is about to publish the proceedings of the late Buffalo convention. As it consisted entirely of discussions on live questions it is likely that these minutes will be of unusual interest to bee-keepers. No essays were read. Don't miss a copy.

In regard to the spread of foul brood in California, Mr. J. M. Hambaugh writes an article of so much interest and importance that I give herewith most of it. The reader is requested to keep in mind that, a month ago, I gave the views of a French writer who deprecated the use of movable frames as being conducive to the spread of foul brood. Mr. Hambaugh takes the exact opposite, and his position seems sound.

Here in this salubrious clime, where every month in the year, and almost every day in the year, bees can go forth in quest of pollen and nectar, opens opportunity for the spread of infectious diseases; and this, coupled with the wild waste of rocky cliffs, canyons, and wooded districts, furnishes hiding-places for bees that can wreak and fester in disease unmolesied. It is hard for the wide-awake bee-keeper to overcome these dangers beyond his reach; but there is a danger of far greater magnitude right at his very door, that he needs to recognize, and which needs a cure in the form of a little legislation.

Here is Mr. A, a practical bee-keeper, with all his combs throughout his entire apiary movable, and ac-

cessible at any time for inspection and in appropriate condition to battle against any disease that may arise. Mr. B, his next door neighbor, is of the slip-hod, go-as-you-please make-up, and allows his bees to build their combs at haphazard, half-moons and all shapes that may suit their fancy, in their brood-chambers; and the consequence is, he is locking the door against all knowledge or treatment of any disease that is likely to turn up; he is also in shape to be (as it were) hugging an adder to receive its fatal sting, and also to dispense its venom among his neighbors. When there is such a deadly foe as foul brood abroad in the land, these inaccessible hives are a veritable death-trap, and, so far as inspectors are concerned, they are simply barren from investigation, save what the exterior may reveal.

In our route through the country these troubles are so manifest, and there is such a universal cry against their toleration, that it seems to me a very easy matter to have a law placed upon our statutes, compelling every one who keeps bees to have them upon movable combs, built in movable frames, and, by so doing, minimize the chances for contagious diseases, besides doing away with the old slip-hod way of keeping bees. We believe that every wide-awake bee-keeper in the land should cry down the box-hive stationery-comb evil, until every one who dares to keep bees would understand that to do so means they must be up in movable combs, or a penalty of a fine incurred.

We also believe that a little further protection is needed to the bee-keeper, by statute enactment; and that is, when a bee-keeper contemplates moving from one location to another he should have a certificate from a lawfully appointed inspector, the said certificate to be an assurance that each and every colony is free from all infectious or contagious disease, otherwise let it be a finable offense to remove them from their old location.

Regarding the sparing of bees' lives, Mr. Hasty says:

There gets afloat at times a considerable amount of sentimental nonsense and unwisdom, which would fain make us more careful of insect life than the Creator is himself, and which would make apiculture impossible before we got to its logical conclusions.

Dr. Miller says, in reply to a correspondent:

Don't think for a minute of using even the smallest proportion of sugar to finish sections. Just now about the greatest foe bee-keepers have to fight is adulteration; and for them to band together in a national association to fight it, and then feed sugar themselves to get sections finished, would be about as consistent as is the Christian man who prays 364 days in the year for the downfall of the saloon, and then on the 355th day votes to support it. If you want to have sections finished, use diluted honey. Very few, however, have been able to make it pay. Better sell, at reduced price, sections that are not finished, and let the bees empty out any that are less than half full.

Pile up outdoors supers of sections you want bees to empty, and allow entrance for only one or two bees at a time. If you allow a larger entrance, the bees will tear the combs to pieces.

PROGRES APICOLE.

The following is recommended. For want of a better name we will call them "honey jimcracks." They are doubtless good in both French and English: Mix together one quart of honey, one quart of powdered sugar, one quart of fresh butter, and the juice of two oranges. Incorporate with this, slowly, a little fine wheat flour, and make a dough of it thick enough to be rolled out; knead it, and beat it for several minutes, and finally roll it out with a rolling-pin in layers about half an inch thick. Cut out round cakes, like biscuit, and bake them on a light plate, greased with butter, with moderate heat.



MOVING BEES.

Full Particulars; How to Ventilate the Entrance;
How to Avoid Accidents.

BY R. F. HOLTERMANN,
Formerly Editor of the Canadian Bee Journal

One hears and sees a good deal of late in connection with the question of moving bees to fall pasture. The question has been discussed at conventions and in the bee-papers. Permit me to make a statement in connection with the subject. Some years ago my attention was attracted by foreign journals to the question of migratory bee-keeping. This is carried on in England, but I believe still more in Germany; but I received no information from these sources as to the best way of moving bees. Experience and careful judgment had to be my teacher to a very great extent. For years I had to prepare and ship a large number of colonies to distant parts of Canada, and these have reached their destination in a uniformly gratifying condition; and of all the bees shipped, I know of only one case in which the colony perished, and that was where a hive of bees was shipped across the continent to British Columbia, and it was delayed by floods for about two weeks.

In our country the majority of bees are shipped for sale or purchase toward the close of spring. It is a time of year when the weather is very changeable, and, as a rule, the temperature at night is much lower than during the day. Again, on the train and perhaps on the railway platform the variations of temperature are very great. How to pack the bees, or, rather, prepare for all these emergencies, was a great problem which has been solved to my entire satisfaction. Simply putting a wire screen over the entrance and another over the top of the hive would answer all right for the hot weather or hives, but not for the cold, for we must remember that the bees do not cluster quietly over brood when constantly disturbed. First I prepared the top in the following manner: The front and rear of the top of the hive were covered with a thin board, and about a third of the top between the two boards had a wire screen, but constructed in the way of a pocket. This was an improvement. When too warm the bees could cluster in it; but it still had the great disadvantage of allowing the warmth to escape from above when the temperature was low.

I then used a portico at the entrance. This was suggested to me by Jacob Alpaugh. It is simply a wire-screen cage at the entrance of the hive, and into this the bees could pass and cluster when too warm. I make them with a wooden frame, and have

two wedges in the lower corner. These wedges shove into the entrance at either side of the hive; and help materially in holding the portico in place. Two little hooks and staples will do the rest of the holding, so not a nail need be driven when closing the hive. This has answered perfectly. It is surprising what relief such an arrangement gives to the strongest hive.

Over the combs at the top of the hive the quilt or cloth can be fastened, or even the cover with a clamp; then no air and warmth can escape from the top. The inside temperature the bees can regulate by ventilation and the number that go to cluster outside.

Let us for a moment look at the difference in the entrance with the old wire screen. The ventilation is very much checked by the wire screens across the entrance, and the current of air again retarded by the friction against the wires strung in regular order across the entrance, and the bees are absolute prisoners in the hive. With the portico made nearly the height of the brood-chamber, the width of the hive, and coming out nearly the distance of the alighting-board, the ventilation through the wires will be quite equal to the capacity of the entrance without any obstruction. Then the bees can come in large numbers out of the hive, as before stated. This applies to the preparation at all seasons.

From my experience with bee-keepers, and my own past thoughts, I know that many more would move bees if they could be prepared with less trouble than is at present generally necessary, and there will be greater certainty of a safe transfer to their destination. That this can be secured I do not think but *know*.

A hive can be used that at any time 100 colonies can be prepared in two hours before shipment. I can see no good reason for using anything else than the self-spacing Hoffman frame as the the Root Co. and doubtless others make it. Some have asked me if they could use this frame in the old Langstroth which has no follower. My unhesitating answer is, "Yes!" There is no need of a follower if you use foundation, and, better, wire; at least with the Weed process of foundation there will be nice straight comb, and you will have no difficulty in drawing out a comb to begin with. With self-spacing frames they need no fastening. When frames are not self-spacing, instead of driving a nail into each end of the top-bar I would use a thin piece of wood. A separator cut into four pieces will do. Lay this across the ends of the frames and drive a small tack through this into the bar and they will not only keep from moving sidewise, but the piece across will prevent the frame from swinging at the bottom.

However, all this is unnecessary with self-spacing frames. I want no beveled hives to move bees in; wood shrinks and swells; and, however much men may demand absolute accuracy, I have found that those who demand this, when set at the saw-

table they can not themselves produce it. (If you have any customer who demands this you can easily cure him by setting him at your tables, and letting him get out his own stuff, on condition that, if every piece is the same in two months' time, he shall have the use of the machinery and power for nothing; if not so, he shall pay double the price of the goods.) Reasonable accuracy, of course, one expects; but beveled hives are pretty sure to spring a leak, especially if they have been in use for a while. But hives with straight joints can be made by any experienced supply-dealer to have no leak. One clamp should be put at each side of the hive and one at the back. The upper story can be fastened on the same way, also the cover. I advise three for each to make interchangeable; otherwise I would have four. If the top cloth is used, free from holes, four pieces of separator with tacks will answer to keep the cloth down. The hives so arranged can be ready for loading any time within, probably, an hour.

The conveyance should be in good shape, greased, tires not liable to come off, as a hired team did once with me when it got on the hot sand. I would have nothing to do with hay-racks and hay if a platform were available, and it would be if I intended to keep up the business. An ordinary wagon will do to make a platform, if you can not rent. Make it to hold three or four rows with an inch strip between. Make at the side of the wagon an inch strip. The two outer rows can project a third over the side; the inch strip will prevent the hives from working out. Any pitch will always throw it toward the wagon; otherwise I would have it perfectly flat, and a rope bound about the load to keep the hives in place. With the porticos on inner rows, place there the weaker swarms; make the portico one inch or even more shallower, and wire cloth on top of portico; this can be done by putting a half-inch strip of wood next to the hive or portico, and bringing the wire in one piece over the front and top, and nailing the wire to this piece. This change in portico is necessary, as the inner hive will be within an inch of the hive in front. A strip one inch square or $\frac{3}{4}$ should be nailed on the platform. Now the two center rows stand back to back down the center of the wagon, and a strip between them and the outside rows, which are held in place as above described. If the wagon platform is not wide enough, three rows must do.

Use a coil spring between the wagon and platform. This can be adjusted to any lumber-wagon, and answers well. Do not use wild horses, but those that will obey promptly. For tools, have a lantern, hammer, nails of different sizes, some separators, and strips of wood, in case of accident; a watering-can, smoker and fuel. Run your wagon by hand close to the bees about the time the bees quit flying; if any are left in the apiary, a few bees shut out will not matter. Smoke gently to get the bees

hanging out in; then smoke again to put the porticos in place. If no one makes a botch it is surprising how quickly this can be done. Next loading. Set them on the ground on each side of the wagon; next to the wagon a hive with an inside portico; out from that, an outside. If any bees have accumulated, brush them off as you carry them to the wagon. What next? Load? No, not a bit of it. Would you load cattle or stock for a long journey without giving water? Water the bees. Give them plenty. If tipped up a little at the front, so water will run in, all the better; and for this, in moving bees a screen on the center row is an advantage added to the portico. You have a better chance to water on the journey. But water well; and unless a very hot night and a long journey, say over 15 miles, this will answer. This is a *great* point in moving bees. Do not forget it. Then load and off. I like to be an hour on the road before it is quite dark. Go rather slowly at first, and get off and go about to see if the load is riding right—if there are any leaks, etc.—say after half a mile, and again after another mile. Pick beforehand your road. Know just where you are going. In the middle of the night you are not likely to meet many people; and if you go to their door they often do not feel much inclined to direct you. Can you trot? A good fast-walking team I prefer; but if you are quite sure of your road you can trot. Clay roads are a little rough; but if not much rutty I prefer them to sand. The weight of the load will break down the clay. If you are going 15 or more miles, give them water again. After 8 or 10 miles, go over them again and sprinkle the porticos.

There should be on each load not only a bee-keeper, but one awake, alive, and active; and if more than one load, make them keep within close hailing distance. Instruct every teamster to unhook the moment there is the slightest accident, and run with his horses. I once moved something like 100 colonies on two wagons. The wagons and teams were hired. One horse balked, and they had to return some five miles to get another. A teamster broke open one hive, after getting the most definite and specific instructions not to sit on the hive. We had some 26 miles to go, and with one thing and another we were much longer on the road than expected. The horses had to feed, the men thought they had to; and when we got on the hot sand, one tire began coming off; and while we watched that wheel another came off entirely, which resulted in another great delay. The man with me came on the wagon on which I was; once or twice I told him he should be on his own, but gave him no absolute orders. It was high noon when we went through a village. Behind us we heard a crash. The rear teamster had fallen asleep; the horses turned a corner too short, and went into a telegraph-post, stripping some porticos from hives. The teamster jumped off to hold his horses. I called out, "Unhook!" which he

did. What the result would have been had he not, I dread to think. But it was 6 o'clock that night before the bees were unloaded. Some had three comb-honey supers on. It was between clover and basswood. They were confined to the hives all night, and through the burning heat of that day; yet all came through in splendid condition—a severe test for the porticos.

In unloading, put all in place, then at once open the hives, having the smoker ready to use. On the way, keep the lantern and smoker going, but turn down the lantern. It must be a dark night indeed when there is not some light to see.

A bee-keeper for fall pasture—indeed, any—must study the conditions, the moisture and flowers, and decide whether it pays. I think I can tell pretty well the chances beforehand, but yet not *know*. Since Adam fell, God has decreed, "In the sweat of thy face shalt thou eat bread." Romans 1:20 tells us, "For the invisible things of him from the creation of the world are clearly seen, being understood by the things that are made." I believe to-day the healthiest and happiest man is the one who, in the fear of God, seeking to live for him, does physical labor; and to produce any thing on this earth, any crop, there is needed constant battle with evil. Thorns, thistles, weeds, and adverse weather come in, and have to be battled with and overcome, to remind us that, if we would produce good fruit, we must root out, weed out, and keep down evil; constant watchfulness and vigilance are required. We know that the word of God is the good seed Christ implanted in our hearts. How many of us have begun the struggle—have Christ implanted there? How many are making no struggle, but letting the enemy have full swing? My heart often yearns over men I know in the bee-keeping profession who have not Christ, no new birth in them, who are harboring their enemy for time and eternity, in their hearts. What awful folly! what worse than physical suicide!

Brantford, Canada.

THE BEE IN LAW.

Animus Revertendi; Identity; Transportation; Larceny.—Article 3.

BY R. D. FISHER.

Bees are *feræ nature*, i. e., wild by nature, and classed with such wild animals as have what is called the *animus revertendi*, or a usual habit of returning whence they have escaped. During this temporary absence they remain the property of the original owner (2 Kent, Com. 348). The law, as Blackstone says, "extends this possession further than the mere manual occupation; for my tame hawk that is pursuing his quarry in my presence, though he is at liberty to go where he pleases, is nevertheless my property; for he hath *animus revertendi*. So are my pigeons, and bees that

are flying at a distance from their home, and likewise the deer that is chased out of my park or forest, and is instantly pursued by the keeper or forester; all which remain still in my possession, and I still preserve my qualified property in them. But if they stray without my knowledge, and do not return in the usual manner, it is then lawful for any stranger to take them" (2 Blackstone, Com. 392).

So, in the civil law, Gaius says: "In respect of such animals as are in the habit of going and returning, as pigeons and bees and deer, which are accustomed to go into the woods and fields and come again, we have this traditional rule: That if they cease to have the intention of returning they also cease to be ours, and become the property of the first taker; now they appear to cease to have the *animus revertendi* when they have discontinued their habit of returning. This theory may be compared to the rights of property in animals at common law only when *animus revertendi* is induced by artificial means, such as taming them or offering them food and shelter, but not to immigrating animals which return from natural causes. The highest authority is that the only ownership in them is *ratione soli*. In consideration of the fact that the character of the forest allows every freeman to be entitled to the honey found within his own woods, affords great countenance to the doctrine that a qualified property may be had in bees in consideration of the property of the soil whereon they are found."

IDENTITY.

One of the chief difficulties in reclaiming bees is in the almost impossible identification thereof. Many curious cases of doubtful or disputed identity might be cited to illustrate the singular fortuous resemblance between bees, not only in their general appearance, but also in the strain or accidental mark. Positive recognition of peculiar habits and workings of bees is too difficult to suffice to prove their identity. Courts judicially recognize photography as a proper means of identification of the thing in dispute; but there is no case on record, so far as we have been able to discover, where a claimant has been able to reclaim his bees by means of photography. Neither can bees be identified or proven by the concurrence of their several characteristics. This proof is too remote, and the question of identity is for the jury. The court can not presume identity of bees.

TRANSPORTATION OF BEES; CONTRACT OF CARRIAGE.

The exact character of the contract for the carriage of animals has been the subject of much judicial discussion. The prevailing opinion, however, is that common carriers are also insurers against all losses except those resulting from the acts of God or the public enemy, or from the peculiar nature of the property carried. Though it may be optional with railway companies whether they will accept the full responsi-

bility of transporting bees, yet if they do so without any express restriction they are liable as common carriers. But they may for a less hire agree simply to transport bees, furnish cars, etc.; and if the shipper and owner of the bees agrees to the lower rate, he can not hold them as common carriers. For a given reward they proffer to become his carrier; for a less reward they proffer to furnish the necessary means that the owner of the bees may be his own carrier (*Kimbal vs. Ry. Co.*, 26 Vt., 247). In the case of *Bixly v. Decmar*, 54 Fed. R., 718, the United States court held that, when a vessel struck a hidden obstruction and filled with water, and a cabin containing bees floated to the shore, but no effort was made by the master to use care in saving them, the steamboat line was held liable for damages to them, though the vessel was insured and was abandoned to the underwriters as a total loss.

BEE'S THE SUBJECT OF LARCENY.

Bees in the possession of the owner are the subjects of larceny, says the Indiana Supreme Court in *State v. Murphy*, 8 Blackf., 498. Further, the court holds that, when bees are in the possession of any person, they are the subject of larceny. Much depends upon what constitutes possession. Generally it is regarded that the owner of the soil upon which bees may be found is the possessor thereof. While the rights to animals *feræ naturæ*, as between the owner of the soil and others, have been fairly settled by a considerable series of cases, the relative rights of parties, both of whom acknowledge the superior rights of the owner of the soil, seem never to have been precisely described. But in a recent Rhode Island case (*Revroth v. Coon*, 15 R. I., 35), the plaintiff, without permission, placed a hive of bees upon the land of a third person. The defendant, also a trespasser, removed the bees and honey which had collected in the hive. The court found that there was no cause of action, holding that neither plaintiff nor defendant had any title or right to possession to the bees or to the honey. It needs scarcely follow that a trespasser can not maintain, on the basis of mere possession, an action against a later trespasser. There may be some possible doubt in a case of this kind where a person has reduced the bees to possession by collecting the bees in a hive, and left them temporarily on the land of another; and if so it would seem to give him actual physical possession sufficient for an action against one who removed them. But about the honey which the bees had collected while on the soil of a third person, there would be less doubt; but, strange to say, in no case which we have examined does the question seem to have been discussed, much less decided, as to how far the law of animals and bees *feræ naturæ* applies to their produce, such as eggs or honey. The reason on which the law about the animals is founded is wholly inapplicable to the honey; but the Rhode Island case tacitly

assumes that no distinction is to be drawn. Hence, as a dictum, it would appear that the honey, at least, belonged to the owner of the soil.

Bees are likened unto wild animals belonging to no one so long as they are in their wild state, and property in them is acquired by occupancy, hiving, and reclaiming only, and are not the subject of larceny unless they are in the owners' custody, as in a hive, bee-house, or otherwise confined and within the control of the possessor or owner.

CONFINEMENT OF LAYING QUEENS.

Queens Caged when Laying to their Fullest Capacity; does the Practice Result in Injury?

BY ARTHUR C. MILLER.

The article by Mr. F. Greiner, August 15th, on the confining of laying queens in small cages, is well worth a second reading; and his question, "Do queen-breeders practice any such thing?" is most pertinent. That injury is caused to such queens by so confining them is, I think, well established. In the *Amer. Bee-Keeper* for April, 1901, I wrote on the cause of injury to queens in shipment by mail, i. e., starvation; and it is also the cause of injury to caged laying queens, even though the bees have access to them. A laying queen is receiving an abundance of highly nutritious food, and at the same time is developing a large quantity of eggs. Suddenly shut off this food supply, and what happens? The formation of eggs does not and can not immediately cease, and the queen is soon in an exhausted condition. Just how long the development of the eggs continues I am unable to state positively; but from the fact that prolonged confinement increases the extent of the injury, I imagine that it continues for several days, though, of course, in a constantly decreasing degree. We have very little accurate data regarding this subject; and until we accumulate more we must necessarily do some guessing and more experimenting. We do *know* that the sudden confinement of a queen when in the full exercise of her natural functions almost always works serious injury, such queens seldom doing as good work as before, and generally dying early. We also *know* that a queen laying slowly, as in a small nucleus, can be caged with little or no apparent injury. Also, I think I know that the degree of harm from such restraint is modified by the kind of bees confined with the queen. If she has as an escort, young feeding or "nurse" bees, then she will have suitable nourishment for a time, perhaps until the development of the eggs has nearly stopped. But if she has few or no such bees, then she perforce starves; for while honey will keep up the animal heat it will do very little toward restoring wasted tissue. A queen confined in a cage of wire cloth or perforated zinc, even though all the

bees of a full colony have access to her, does not get fed as she would if at large. I base this statement on general observation, and the analogy that confined drones, even though they have available plenty of honey, and are accessible to the bees, soon die.

A careful microscopical and chemical examination of the stomach of queens that had been caged as stated would prove just what kind and quantity of food they do receive under such conditions. Until we know exactly how to cage laying queens safely for an indefinite period we had better avoid it altogether. And when we are compelled to cage them for shipment let us first diminish their laying by putting them in a small nucleus for perhaps a week before close confinement, and then be sure to give them a retinue of "nurse" bees. Mr. Alley's system of a little nucleus colony for the mating and retention of each queen is most excellent, and I believe it is largely accountable for the excellent results in shipping with which that veteran meets.

Properly and closely associated with this subject are Mr. Greiner's remarks on the working qualities of different colonies. A queen whose vitality has been impaired can not be expected to produce bees of full vigor; and just how much such weakened constitutions may be responsible for poor work on the part of a colony is a question worth investigating. Mr. McIntyre has given what seems to be the best plan for getting at the true value of any strain of bees; and that is, stocking a row of colonies in an apiary with queens all from one mother (and presumably all of the same hatching), and then comparing the *average* of the product of those colonies with the average of a similar number of other colonies in the same yard during the same time. Though comparisons may be odious they are certainly very helpful when we would measure the value of strains of bees.

Providence, R. I., Aug. 20.

[You may be right; but is it not putting it a little strong when you say, "We do know that the sudden confinement of a queen when in the full exercise of her natural functions almost always works serious injury. . . . We also know that a queen laying slowly, as in a small nucleus, can be caged with but little or no apparent injury"? You italicise the word *know* as if the facts were established. Now, is that true? There has been a sort of surmise entertained by many good bee-keepers that both of these propositions might be true; but has either one of them been clearly and decidedly demonstrated? Understand, I do not deny either proposition; but I raise the question whether we have so far reported facts sufficient to prove, beyond a peradventure, both statements. In partial support of one statement I will say that we have sent out sometimes, from our apiary, queens that were in full laying, and yet which on arrival at destination proved to be very unsatisfactory, laid a few eggs, and disappeared. At other times we have taken

queens from their hives in the height of the season, put them up in mailing-cages, and, later on, had most flattering reports from them. We send out a good many thousand queens in a season; and, unless I am very much mistaken, the majority of such queens (even when doing full duty) have departed themselves very creditably on arrival at their new home. If there is any queen-breeder, aside from Mr. Alley, who first cages in a small nucleus before sending out queens, I should like to have him hold up his hand. Now, understand, friend Miller, this is not offered as a challenge, but because I do honestly seek the truth. If it is demonstrated clearly that a queen removed from the hive when laying to her fullest capacity, and caged long enough to make a journey through the mails, is injured, then the sooner we prove the fact, the better it will be for the breeder as well as for his customer.—Ed.]

RAMBLE 192.

Some "Pathetic" Sketches from Real Life.

BY RAMBLER.

We have in Los Angeles one of the most accomplished flower artists in America, and a Frenchman is Mr. Longpree; and wherever you see a Longpree painting of a flower, of whatever hue or shape, it is so true to nature that you can almost smell the aroma. Mr. Longpree turns an honest penny now and then by placing his many flower-pieces on exhibition, and it is a real treat to look them over. One day I too rambled into the hall, and there was a bewilderment of subjects. I was admiring one very pretty little picture of white daisies and red clover mingled promiscuously together, with just the outline of a rail fence away in the background. Two young men came along, presumably artists, and they admired the picture. The young man with his hair parted in the middle looked lovingly at the picture, and, with his hand upon his heart, exclaimed, "So pathetic!"

I meandered, and, absent-mindedly, looked at the many pictures; but they all seemed to blend into daisies and clover, and "so pathetic" I finally found myself again before the daisies and clover—just common white daisies and red clover, and for the life of me I could see nothing pathetic about it. A stout, motherly-looking woman came along, and in my anxiety to get on the artistic side of that picture, said I, "Ma'am, can you tell me where there is any thing pathetic in that picture?"

"Why," said she, with her head critically canted to one side, "I wouldn't call it exactly pathetic; I would term it pastoral."

"That's it, ma'am; that's it," said I, with enthusiasm; "that's just my idea of it; they do look so pastoral they remind me of our old cow pasture on the west side of the stony hill in York State, where briars, burdocks, daisies, and clover mingled to-

gether. Why, it almost makes me cry to think of it."

"H-n-m-m," said she, musingly; "and what is your idea of pathetic?"

"Pathetic? Why, ma'am, we had two roosters when I lived on the farm in York State—one a big clumsy lubber, and the other just a little runt. Well, he would everlastingly wallop the big rooster. One day he knocked all of his tail feathers out. You ought to have been there to see that big rooster sneak off into the bushes. Pathetic? Well, I should say so; and that's just my idea of the term."

I know I had the best of the argument, for the lady turned right away and seemed to have urgent business at the other end of the hall. Now, I may not have reported the exact words of our conversation; but any way, it conveys my idea of the pathetic.

Then we have another artist in Los Angeles. Mr. J. W. Ferree. Now, I am not sure as to Mr. Ferree's nationality; but it sounds as much like French as Longpre; any way, he is an artist; and while Mr. Longpre's specialty is flowers and landscapes, Mr. Ferree's specialty is housescapcs. His housescapcs are to be seen and admired in all portions of the city. His reputation is so great in this line that well-to-do people in adjoining towns have employed him to paint housescapcs for them.



"HOW PATHETIC," RAMBLER!

Now, any one would naturally think that being a popular housescape artist would be 'aurels enough for one man; but that is not the case with Mr. Ferree. He is one of us. He is a bee-keeper; and, still better, he is foul-brood inspector for Los Angeles County. The board of supervisors elected him over several others who hankered for the office, attesting to his popularity in the community, and a genial companion he is, as the following episode will prove.

Mr. Ferree and I were riding along harmoniously one day; and as he removed his hat to a passing lady I artistically remarked, "So pathetic!"

"Why, Rambler, what do you observe that is pathetic?"

"Bro. Ferree, it is the top of your head—so bald—so pathetic."

"Say, Rambler, did you ever look pathetic?"

"Not as I knows on," said I.

"Well, we'll see about that," said he.

Mr. Ferree was driving his old gray mare, and leading another pie-bald critter behind the wagon. As we turned into Vernon Avenue in the southern suburbs of Los Angeles, with Messrs. Brodbeck and Shaffner following us in another rig, he stopped the procession, and remarked that he had always driven the critter on the off side, and now wished to give him a few lessons on the near side, and proceeded to form a connection from said critter's head to the near-side hame of the old gray, with a tow string, and gave me the end of the long halter rope to manage.

The program was all very simple. We started; and that critter, looking the situation in the face, and not liking it, turned right around and looked us in the face and winked his eyes, as much as to say, "There, now, who is on the off side?" The whip was applied to old gray. The critter backed a few steps, got mad, reared, bolted past the buggy, and nearly jerked my arms off as I held to the rope and the seat, and, with hat sailing to the ground, I frantically shouted "Whoa! whoa!"

Ferree laughed and shouted, "So pathetic! so pathetic!"

He was getting his revenge on me in true artistic style.

Well, the procession was stopped again, the critter tied again with the same tow string; the old gray was started again; but this time the critter bolted ahead; and as I hung balanced on the dash-board Ferree shouted again, "So pathetic! so pathetic!"

We stopped again. Bro. Brodbeck was just suggesting that I ride the critter, when his pet dog's tail was stepped on, and, what a howl! "So pathetic!" said Ferree; "so pathetic!" said I.

"What a pathetic howl!" said Ferree.

"Nothing pathetic about the howl," said I; "but that painful frown on Brodbeck's brow—so pathetic—see, Ferree?"

"Yes," said Ferree, "I see."

You would naturally infer from the foregoing, which was only a fragment of the occurrence, that Mr. Ferree is a jolly good fellow, and that's a fact. He is a genial bachelor, a member of Dr. Bresee's church; will go a long way to serve a friend; generous every day in the week; polite and condescending to the ladies; always shows an even temper, and the mantle of foul-brood inspector could not have fallen upon more worthy shoulders.

He reports his work in Los Angeles Co. as follows: Has inspected 148 apiaries; 8010 colonies; 284 foul-brood colonies. Prof. Cook commends Mr. Ferree's method of handling the disease. Where there is a chance for saving the colony it is done; otherwise it is submitted to the flames. Mr. Ferree estimates 300 bee-keepers and 20,000

colonies of bees. It will be observed that Los Angeles Co. is no small corner of the State, and the inspector must necessarily be a hustler to get over the ground.

Mr. Ferree has the disease well in hand, and it is hoped that it will soon be a past trouble so far as this portion of the State is concerned.



J. W. FERREE.

In order that you may get acquainted with our foul-brood inspector I herewith introduce him to you. Bro. Ferree, allow me to present you to the fraternity in this and in foreign lands.

Don't lo'k on life through a smoky glass;
The world is much as you take it:
'Twill yie-ld you back a gleam of light
Or a glow of warmth if you make it.
However fortune may seem to frown,
However may scorn the scorners,
Still face your fate with a fearless eye
And a mouth curved up at the corners.

DOUBLE-DECKER COLONIES.

The Use of Foundation or Empty Combs; how the Double-deckers Cut Down Swarming by Half, and Double the Amount of Honey.

BY G. B. HOWE.

Mr. Editor:—I will try to tell you my experience with large v. small hives. I have been experimenting for the last ten years, and think I have found what I want. I

think a ten-frame L. hive too large, and an eight-frame too small; but 16 frames are just right. By this I mean a double-decker. I have tried them the poorest season I ever saw, and they were ahead of any small hive I ever used; and when you get a swarm from one of them, hive it in an eight-frame hive with full combs for the queen to lay in and to store pollen in, and you have a colony for comb honey. One fault with starters in the brood-nest is that they will put pollen in the sections; and another thing is, they build so much drone comb. My advice is to use drawn combs or full sheets of foundation. I use full sheets of foundation in the boxes, and I find that it pays to use it. I have tried both ways, and know that I have lost money by using starters, also by using starters in the brood-frames. Why not save the honey that your bees make drone combs of, and buy your foundation? I used to have the same old trouble with bees that would not work in the boxes; but I find that, if you have the right kind of bees, you will have less trouble in that respect. I would change the queen quickly if the bees had to be coaxed into the supers. I put the extra body under the colony early so they do not get the swarming fever. I do not have half the swarms I did formerly, but produce twice as much honey per colony. Some of these double colonies are so full of bees I put them in the cellar that way. I had one of these double hives that made 96 boxes of honey, then swarmed and made 72 boxes more, and have honey enough to winter in good shape. I do not have any trouble with bees not storing honey over sealed honey. If you do, get a red-clover queen. The queens I have from The A. I. Root Co. and L. H. Robey will and do pile in the honey over sealed honey, and they do not swarm when they get in good shape to make honey either. Of course, the locality has something to do with it, but not so much as some think. We have had a good year here, and my bees are in fine condition for winter.

Black River, N. Y., Sept. 3.

[As our readers will remember, I have long advocated the use of two-story eight-frame colonies under some conditions; and at our basswood yard I have had an experience a good deal like that related by Mr. Howe; but at the time of telling that experience I received some protests; but since that time I have heard from quite a number who say that the double-story eight-frame colonies are all right. I have a private letter from G. W. Brodbeck, who, it seems, has been using the same plan, only his brood-frames are 7 inches instead of 9. He says he gets excellent results, and those results are so marked that some of his bee-keeping friends expect to put the plan in operation next year. I have written to Mr. Brodbeck, asking him to give us fuller particulars, so we will let him tell the rest of the story for himself. But lest I may be misunderstood I wish to say I do not advocate

double-deckers for every one and for all localities. After having traveled over the country as I have, and studied the various conditions of climate, and styles and condition of hives, my conclusion is that it is both foolish and silly to advocate any particular fad or plan as being practicable alike to every section of country; but I do feel that the two-story idea has not been exploited as much as it ought to be in some localities. If it works at all it will produce some great results, both in the reduction of swarming and in the harvesting of big crops.—Ed.]

PUTTING UP COMB HONEY IN AN ATTRACTIVE SHAPE.

A very Neat and Pretty Seiling-case.

BY BENJAMIN FRANKLIN.

Mr. Root.—I send you a photo of a style of box I call my border package. Years ago I had a nice crop of honey from the silver maple, the first in over 30 years. Last year I did not get much of any kind. This year I am getting a fine crop from the silver maple. The raspberry and silver maple come in bloom about the same time, but the bees work on the silver maple, so I don't get any raspberry honey but what is flavored with the silver maple. These mountains are covered with it. Two years ago I could not supply the demand for this style of package, for it was just the thing to carry back to the city. What I claim as original of this box is the handle. I tried wire, tape, and other things; but I came across some picture-frame wire cord that just filled the bill. I get different colors and put up nice Danz. plain sections $4 \times 5 \times 1\frac{3}{8}$, that will weigh nearly 1 lb. I can sell them like hot cakes. All I have to do is to raise a box, as you can see in the picture. I have some pink paper around the box to lift them out. I have also paper in the bottom with strips to raise them up from the bottom, like your shipping-case. The holes in the ends are glassed. Where we raised corn and potatoes it was washed away in the freshet last spring. The water came into the bee-yard, and we had to raise the bees up out of the water; but there is not so much loss but that there is some gain. The water filled in above, and washed out below, so it left a fall of 3 ft. or over, so I put in a water-wheel and turn out the molding and hole by waterpower. The wheel is 100 ft. or over from the bee-house. I run the power to the lathe with a wire clothes-line.

It is no trouble to sell nice honey

put up in these boxes. You can see I look rough and ready to sell honey, and tell them all about it. I sold these five packages at one place, and five more to the next house, all New Yorkers.

Griffin Corners, N. Y., July 31.

[Mr. Benjamin Franklin is a bee-keeper whom I met, or, rather, did *not* meet, on my first bicycle-tour through New York in 1890. I had just bought one of the latest safety bicycles, then just out, and was making a tour on the wheel—quite a novelty then—through the hill country of the Empire State. While cycling on one of those days I heard how one bicyclist had been robbed along the way, and I had been warned to look out in going over a certain route, and I did. Along one of the lonely roads a man hailed me to stop; but remembering what I had heard I put on all the steam I had. The supposed robber chased after me; but I turned a deaf ear, and peddled with all my might to gain the top of



the hill ahead of me. Having arrived at the top of it, nearly tired out, I placed my feet on the coasters and let the wheel go as fast as it would down one of those York State hills. Up to that time I had never ridden so fast in all my life. I nearly ran into various objects down the hill. Suffice it to say, I landed safely, feeling sure that I had left my pursuer miles behind, and I had. A week or so afterward, when I arrived home, I received a letter from Mr. Franklin, stating that he had seen me, mentioning the very road where he had hailed me, and saying that, instead of stopping, and being neighborly, I just ran away from him. He had read in GLEANINGS of my proposed tour; and when he saw a chap go along on a bicycle, that tallied exactly with a description of me, he concluded at once who I was.

So much for an introduction. I have long since made my apology to Mr. Franklin, and I now wish to introduce him to our readers as a bee-keeper whom I have kept track of more or less ever since. He is up to date, because he uses the plain tall section. His package is neat and pretty, and, I should judge, inexpensive. No wonder it "sells like hot cakes."—ED.]



UNITING BEES FOR WINTERING.

"Good evening, Doolittle. As the evenings are getting quite long now I came over to have a little talk with you about uniting bees, so as not to bother you during the day, as I know you are very busy getting your honey ready for market."

"For what reason do you wish to unite your bees, neighbor Smith?"

"I have several weak colonies and young after-swarms which I thought would, by placing two or more of them together, make a less number strong enough for winter; and I believe that such strong colonies can stand the winter, while the weak ones, if left to themselves, would most likely perish. Am I right in this matter?"

"I think you are; and if more of our bee-keepers so understood things we should hear of less loss of colonies in the spring than we do now. The novice is quite apt to think that, the greater the number of colonies he goes into winter with, the greater number he will be apt to have the next May; but a careful looking into things shows that such reasoning is, in nearly every case, fallacious. Two or more small colonies placed in one hive, with the right amount of stores, stand quite a good chance of coming out in the spring one good working colony; while, if left separate, the chances are that empty hives and combs will be all that will remain of the two or three the next May."

"That is my mind exactly. But you have not told me how to unite my bees."

"Well, I will tell you of a plan I have used successfully for a score or more of years. The first thing to do is to place an empty hive where you wish a colony to stand; and if you can allow that to be where the stronger of the weak colonies is now standing, so much the better, as in this case the bees from this one will not have any desire to go to any other place, as this is where they have marked their old home."

"But how can I set an empty hive there when the stand is already occupied?"

"If you do this work as you should, on some day when the bees are not flying, and yet when it is not cold enough to chill bees generally, say on some cloudy day, or near sundown, when the mercury stands at from 50° to 55°, you will have no trouble in setting this stronger colony to one side of its stand, and taking your time in arranging the empty hive thereon."

"Yes, I see now. But go on."

"Having the empty hive arranged, go to the several hives having the colonies which are to be united, to form one colony, and blow quite a volume of smoke in at the entrance of the hive, at the same time pounding with the doubled-up hand, or with a stick, on top of the hive."

"What do you pound on the hive for?"

"This pounding on the hive causes the bees to fill themselves with honey, upon which filling depends the successful uniting of bees."

"How long should I pound?"

"I pound on them for about a minute; sometimes two, if it has been cool for some time before, so the bees are quite compactly clustered, as in this case it takes them some time to cluster and fill themselves."

"Do you keep on smoking all the time you are pounding the hive?"

"I smoke only enough to keep the bees from coming out after the first few voluminous puffs. As soon as you are through with the last one, take a wheelbarrow and wheel the hives to where you wish your united colony to stand, which wheeling helps, by its jarring, to augment the fear of the bees, thus causing them more effectually to fill themselves with honey. After thus wheeling them together, do not delay in opening the hives, else the bees may disgorge their load of honey back into the cells again."

"Would not an assistant be good at this time?"

"One would do no harm; but I generally do this work alone. Having all near together by the hive they are to go in, open the hives, and take a frame of comb and bees from one hive and place in the empty one; then take a frame from the next hive, placing it beside the first, and so keep on alternating the frames from the different hives till the empty hive is filled. In doing this, select such combs as you desire, either for brood, honey, all worker comb, etc., thus putting the united colony on the best combs. Having the hive filled with comb,

close it, when you will next take a frame from the first hive opened, and shake the bees off from it down in front of the entrance, holding close down so the bees are in or as near the entrance when leaving the combs as possible."

"Why this close holding and shaking?"

"So the bees will take wing as little as possible, and so that none need fall so far from the hive but that they can readily run in with the majority. Having them off the first frame, next shake the bees off from a frame to the next hive, and so on, alternating in the shaking the same as in filling the hive, thus mixing the bees from the several hives all up."

"Why do you wish them mixed up?"

"The mixing of the bees takes the disposition to fight and kill one another all out of them when filled with honey as above; for when each bee touches another it is a stranger, so that the individuality of each colony is lost, and the combined two, three, or four colonies unite within two or three hours to make one individual colony again, which will protect itself from all intruders, the same as the separate colonies did before."

"Is that all there is of it?"

"Not quite. As soon as the bees are all shaken off their combs, gently blow a little smoke on the outside bees to make them all enter the hive, should any be slow in doing so; and as soon as all are in the hive, place a board about half as wide as the hive against it, standing the bottom out a piece from the entrance so it stands slanting up over it."

"What do you do that for?"

"This is done so that the next time the bees fly they will bump against it, as it were, this causing them to know that it is a new location they occupy, when they will mark the place the same as a new swarm does, after which they will adhere to it instead of going back to the old location they used to occupy before uniting. And to help in this matter further, it is always best to remove every thing from the old stands so that nothing home-like remains to entice them back."

"What about the queens? Do you put them all together?"

"If there is a choice of queens in any of the colonies to be united, hunt out and kill or dispose of the poorer ones, so that the best may be preserved. This hunting-out of the queens is better done some day before the uniting, for in the smoking and pounding process the queens will not be where they are readily found when uniting. If there is no choice in queens, and the extra queens are of no value, the bees will attend to the matter, killing all but one of them."

[This is good sound orthodox teaching, according to our practice in our apiaries, especially that part recommending the *mixing* of the bees to prevent their returning to their old stand.—ED.]



WINTERING IN CELLAR WITH AN UPPER ENTRANCE.

"Good morning, Mr. Carter."

"Good morning, Mr. Patterson."

Mr. P.—I came in to inquire about my bees. What makes them crawl all over the cellar-bottom, and die?"

Mr. C.—Well, as nearly as I have made up my mind it is because they have been shut up so long, and have got so full that they must get outside of the hive a short time; and, as they go one in a place, they get lost, and die.

Mr. P.—Why do you think they get lost?"

Mr. C.—In 1898 you know we had a very long winter.

Mr. P.—Yes, I remember that well, for my bees all died that winter.

Mr. C.—Well, I lost half of my bees that winter, and the other half came through in fine order.

Mr. P.—What was the difference in their wintering?"

Mr. C.—I had a $\frac{3}{4}$ -inch hole in the front of half of my hives, and the other half did not have any hole in, and the colonies that had holes in their hives all lived; and in the hives that did not have a hole in the front, the bees all died.

Mr. P.—Did you let the hives stand on the bottom-boards?"

Mr. C.—No; I raised them all up and put a block one inch thick under all of the hives I had.

Mr. P.—What did that hole have to do with it?"

Mr. C.—The bees came out of those holes and daubed the fronts of the hives nearly all over, and they would crawl back into the hive again.

Mr. P.—About how many bees were there out at a time around those holes?"

Mr. C.—There would be, near spring, a bunch from the size of a dollar to the size of your hand, and they would keep buzzing all the time, and they did not get lost and die, but they lived and went back into the hives. In the summer I keep those holes closed up, and in winter I keep them open.

Eagle Grove, Ia. C. K. CARTER.

[I can scarcely believe that the presence of a $\frac{3}{4}$ -inch hole a little way above the entrance would make all the difference between successful and unsuccessful wintering. There must have been something wrong in the food or cellar, to have caused the bees to soil up the fronts of their hives so with dysentery. It is a general practice in wintering, either to set the hives up on blocks above the bottom-board, or, better still, take the bottom-board off entirely, and place the hives in rows about 4 inches apart. The next row of hives is set on top of the lower row, over the spaces between the hives below.—ED.]



NATIONAL BEE-KEEPERS' ASSOCIATION.

OBJECT:—To promote and protect the interests of its members; to prevent the adulteration of honey.

OFFICERS:—E. R. Root, President, Medina, O.; R. O. Aikin, Vice-president, Loveland, Col.; Dr. A. B. Mason, Secretary, 3512 Monroe St., Sta. B, Toledo, O.; Eugene Secor, General Manager, Forest City, Iowa.

BOARD OF DIRECTORS:—E. Whitcomb, Friend, Neb.; W. Z. Hutchinson, Flint, Mich.; A. I. Root, Medina, O.; E. T. Abbott, St. Joseph, Mo.; P. H. Elwood, Starkville, N. Y.; E. R. Root, Medina, O.; T. G. Newman, San Francisco, Cal.; G. M. Doolittle, Borodino, N. Y.; W. P. Marks, Chappinville, N. Y.; J. M. Hambaugh, Escondido, Cal.; O. P. Dabant, Hamilton, Ill.; C. C. Miller, Marengo, Ill.

FEES:—Annual membership fee, \$1.00. Remittances may be sent here or to General Manager as above.

RAMBLER GOING TO CUBA.

YES, we have made arrangements with J. H. Martin, the Rambler, to go to the Pearl of the Antilles. He is going with camera, bicycle, and that characteristic umbrella and stovepipe hat. While he is making the trip on his own account, he is also going with the view of studying the conditions in Cuba, and writing them up in his inimitable way for GLEANINGS. His notes of travel are always interesting; and after having gone over some of the territory in California through which he had preceded me, I find that he tells the exact truth. We may, therefore, expect a very interesting and valuable series from his pen, and by this time I doubt not he is on the way. Mr. Murray, our artist, will prepare the illustrations as before.

A TRIP TO THE WEST INDIES.

THE bee-keeping industry in these islands has taken such a start in the past few years that GLEANINGS now has many subscribers there. To study the existing conditions, and learn more regarding the requirements of bee-keepers in those islands, Mr. A. L. Boyden, Secretary of The A. I. Root Co., will shortly make a trip to the British West Indies, British Guiana, Trinidad, returning via Jamaica and Cuba. As our friends in these places may wish to communicate with him we outline his trip as nearly as it can be determined at this writing.

Bridgetown, Barbados, Nov. 5.
Georgetown, British Guiana, Nov. 13.
Port of Spain, Trinidad, Nov. 16.
Kingston, Jamaica, Nov. 29.
Santiago, Cuba, Dec. 5.
Manzanillo, Cuba, Dec. 7.
Cienfuegos, Cuba, Dec. 9.
Havana, Cuba, Dec. 14.

These dates are only approximate, especially for Cuban points. Letters may be addressed to Mr. A. L. Boyden at any of the places; and if marked "General Delivery" they will reach him, without doubt. He expects to visit as many bee-keepers at each place as time will permit; therefore many of our subscribers will likely receive a call from him. To save time, as soon as

he reaches each port he will probably arrange a little trip to various points, and would, therefore, like to have parties writing him give explicit directions for reaching their homes or apiaries. No letters can reach Medina from any of these points before he starts, and should, therefore, be addressed to Bridgetown, Barbados, or other points named above.

HOME OF THE HONEY-BEES GROWING AGAIN.

OWING to the fact that the Home of the Honey-bees is being enlarged, and that we are "all torn up," it was not possible for me to continue my series of travels, finishing up my write-up of that bee-keepers' paradise, for this issue. As already hinted at, the Root establishment is being enlarged as well as improved in many ways; and while these changes are in progress it has taken the time of all of us, to a very great extent, to look after things.

Among the improvements is a new foundation-factory that is almost fire-proof. It is designed especially for making Weed process foundation. Removing this department from the basement of the main building gives us additional room to use for other purposes. The wood-working building is also being enlarged, and a new roof has been put on the boiler-house, giving us at the same time a drying-room. Besides the increased capacity of buildings, we are also putting in several thousand dollars' worth of new and perfected machinery. Among these is a new cylinder press to help out the regular GLEANINGS press that has been compelled to run almost night and day to keep up with the work.

BEEET VERSUS CANE SUGAR IN SOME OF THE FRUIT-CANNERIES OF CALIFORNIA.

I HAVE received a letter from Mr. Thomas Wm. Cowan (now sojourning in California), editor of the *British Bee Journal*, and who, through the columns of that paper, has recommended cane in preference to beet sugar for the feeding of bees. In a letter just received, he writes:

Dear Mr. Root:—I have just been staying at a fruit-cannery in the Santa Cruz Mountains, where they use nothing but guaranteed cane sugar for canning purposes, and their experience with beet sugar is very similar to ours in England. It may be that the humid climate may have something to do with it; but it is quite certain that beet sugar is bad, not only for bees but also for preserving fruits in England. I suppose in the laboratory it is possible to get perfectly pure cane sugar from beets so that, chemically, it would be identical with that obtained from sugar cane but in practice it is found that there are certain polish salts in sugar from beet which do not occur in those from sugar cane. Leather and beefsteak have chemically the same composition but there is a difference between them.

THOS. WM. COWAN.

Pacific Grove, Cal., Sept. 23

It may be possible, as Mr. Cowan suggests, that the humid climate of England may have something to do with the matter. If it is not too much trouble I should like to have him give me the address of the cannery to which he refers—not that I in the least question his word, but because I should like to get a detailed statement from

them, explaining why their experience with beet sugar has not been satisfactory.

SNAPSHOTS FROM THE BUFFALO CONVENTION.

As I have already explained in our former issue, this was a very enjoyable and profitable meeting; and, unlike any previous convention, there were no essays—no papers of any kind. It was just simply live discussion, offhand, by plain practical men who came on purpose to give to and take from their fellow-craftsmen. The general subject matter had for its foundation the question-box, and the questions themselves had been carefully prepared by several prominent bee-keepers, all duplicates being stricken out. Then the members of the convention were invited to send in questions; and so, taking it all in all, we had plenty of live material from which to draw. As I was occupied with the duties of the chair, and as I was called out at two of the sessions on committee work, I was not in a position to take notes; but after the convention was all over I asked my brother Huber, now 18 years old, and who has all at once got the bee-fever, to give me some points from memory.

"Oh!" said he; "why didn't you tell me that before, so I might have taken notes?"

But I told him he might write down as much as he could remember of the important points brought out, and this he has done, notwithstanding he was pressed for time, as he had already entered on his college work for the year.

HUBER'S REPORT.

In discussing foul brood it was considered unnecessary to disinfect the hive-bodies. It was, however, shown later, that, if any honey should be spilled on a foul-broody hive, the disease would be almost sure to break out in the colony whose bees took this spilled honey; therefore it seemed that it was far safer to disinfect the bodies. A cheap and effective way was spoken of. Light some coal-oil-soaked rags which have been wound around a stick; place the body around the flame, and, by revolving it with the hands, every particle of wood can be thoroughly scorched. But Inspector McEvoy, of Canada, insisted that when the hives were not daubed with honey it was not necessary to disinfect them.

"Carbon bisulphide," the new moth-destroyer, was thought to be much better than sulphur for getting rid of bee-moths from old combs, hives, supers, etc. Instances were given where a strong and continued application of sulphur utterly failed to kill the big worms and the eggs. A subsequent treatment with bisulphide had killed everything absolutely. It was shown that, inasmuch as the fumes of the drug are heavier than common air, the vessel containing the liquid should be put *above* the combs, not *below*; that it was safer, owing to its explosive character, to put the combs to be treated in a large tight box or, better, a tight cupboard suitably constructed *outdoors*, and then use a sufficient quantity to do the work thoroughly. Some of those who had not obtained satisfactory results had, no doubt, put the bisulphide under the combs or had used too little of it.

A majority of bee-keepers agreed that honey was slightly darkened when taken from old black combs, as compared to that taken from new white combs from the same colony and in the same season.

On the question, "Are long-tongued bees better honey-gatherers than bees of the ordinary length of tongue?" every speaker who had had experience seemed to feel that they were. It was suggested, though, that there was the danger of breeding for long tongues regardless of any other good qualities.

Most of the speakers favored full sheets of foundation in body and super, even for a new swarm.

A large number of remedies were given for cases of severe stinging. It was shown that, "to grin and bear it" would not do for some cases, especially children—as, a remedy that would cure one, may not answer for another; so a doctor was a good thing to have when serious. Among the remedies suggested was an outward application of cal oil, or kerosene.

In-breeding was thought to be unsafe for a beginner; but Prof. Benton said that very good results could be obtained, and that it was perfectly safe to do so if care be taken.

There was some argument as to whether or not a queen is injured by confinement in the mails. Prof. Benton said no; others said yes. It ended up with, "That probably a queen will not have been injured by the confinement if she can get through alive."

Niver's plan for selling extracted honey was, to go from house to house, giving a sample, explaining how the bees make the honey, wax, etc., showing them a sample of foundation, and of comb. His customers furnished their own fruit-jars, pails, pans, etc., for the honey he invariably sold from his big can in a push-cart at the door. Some objected to this on the ground that a busy bee-keeper has no time to go from house to house posting people on the habits of the bees. However that might be, Mr. Niver said, after he has *once* explained in this way he doesn't have to do so again, and has an easy time selling again at each trip to the same house. Some people, he added, would be astonished at the way supposedly intelligent people talk about bees. Show them some things; prove to them that comb honey can't be manufactured; prove to them that your extracted honey was not adulterated.

The editor of the *American Bee Journal* employed a stenographer at his own expense. There will be a verbatim report in the columns of our cotemporary; and those of our readers who would like to get the full discussion, involving all the good points, the flings and the digs, and the good-natured banter, are referred to the *American Bee Journal*, a most excellent weekly bee-paper, by the way, and one that GLEANINGS cheerfully recommends to all—that is, *providing* you can afford to take another bee-journal.

PRICE ON HONEY, AGAIN.

SINCE our editorial in October 1st GLEANINGS, having the heading, "An Unmitigated Shame," we have received two letters—one from R. A. Burnett & Co., of Chicago, one of the most reliable commission houses in the United States, and another from C. H. Clayton, of Lang, California, producers' agent for the Bee-keepers' Exchange of California. The first-named writes as follows:

My Root:—We are a little bit surprised to get a circular letter from you of date yesterday, with another enclosure entitled "An Unmitigated Shame; more Monstrous Tales about the Prices on Honey." There is nothing nowadays better understood than that the newspaper reports, especially those made up from the clippings of other newspapers, are very unreliable; but judging from the information in our possession, the reports that are sent to you by those whom you are having investigate do not agree with those in our possession which we have reason to believe are obtained from sources just as reliable. There have been some very large yields per colony in different parts of the country this season, while very close to those favored locations there have been some unusually light yields; but in nearly all locations there has been a surplus over and above that required for the use of the bees until another season. It is likely that Southern Wisconsin and Northern Illinois came as close to a failure as any one section, but up to this writing none of our correspondents claim that they will need to feed the bees, so that they may have sufficient winter stores.

The Eastern States have produced more honey than at any one time during the past five years. This cuts out the demand that has been coming from that section for the Western honey. There has been this sea-

son a greater tendency on the part of producers to hold their honey than is usually the case. We think this is in part caused by the fact that, during the honey-flow, it came in very rapidly; but as the flow was shorter than usual, this gave the impression to those having a surplus that they were about the only ones who had secured anything in the way of surplus. As much of this was gathered in the early part of the clover season, and stopped suddenly, and in a good many places, they had no more honey until the asters began to bloom. Inasmuch as this has been a favorable season for them, a great deal of late honey is being gathered and has been gathered, so that the early-gathered honey can be marketed, and is beginning to come forward more freely, now that winter stores are no longer a question.

The cry that has gone out of a large crop through the newspapers, to our minds, is a great advantage to the honey-producer, inasmuch as it gives the general public an idea that honey is plentiful, good, and cheap. This will make them feel inclined to buy it; thus the consumption of honey will be very largely increased, and it is the one thing that will sustain present prices, and make it possible for the crop of 1901 to be consumed before another one is ready.

Very truly yours,

R. A. BURNETT & Co.

Chicago, Ill., Sept. 26.

Our experience regarding offers on honey does not coincide with that of the Burnett Co. It is true there has been more honey produced in the East this year, but that is mainly extracted. On this point there is and has been no diversity of opinion. Indeed, I have already stated in the several reports that I have put forth in these columns that the crop of honey in the East was larger than for several years back, but only in extracted. The amount of comb, for some reason or other, seems to be very light. Last year we were able to get a fair supply, but this year we are not even able to supply our trade, although we can get all the extracted we need. In discussing the honey crop, don't let us get confused on these points.

Of course, it is understood by all of us that accounts in newspapers are not to be taken in any degree as authority; but the dear public, the consumers, are the ones that are misled. Some unscrupulous buyers who are not misled, seeing the opportunity to depress the market, make all the handle of it they can.

But I can not see the force of the statement that the report of a large crop of honey "is an advantage to the honey-producer," if it is untrue. It is the buyers, or middlemen, when these accounts are being floated, who depress the market. It is not the consumers, in my judgment. But the main thing that I was striking at was these exaggerated reports carrying the impression that 2000 or even 500 cars of honey had been produced in California. It is such statements that keep the extracted-honey market in a state of uncertainty.

The other letter to which I referred is one from C. H. Clayton, as above stated. Concerning the recent editorials in our columns, he says:

Mr. Root:—I note several editorials in recent issues of GLEANINGS regarding prices on California honey. I am a producer as well as a buyer and shipper of honey, and the present low prices are to be deplored. We are all wholesalers, compelled to be such from our location, and at the mercy of the Eastern buyer, who has other sources than ours from which to draw his stock. At no time this season has it been easy for us

to find buyers, even at present prices. When New York and Chicago will pay but 5 to 6 cents delivered, we can expect but $3\frac{1}{2}$ to $4\frac{1}{2}$ cents for honey here, the freight being about a cent per pound from our terminals to points named.

I do not care to enter into an argument as to whether buyers have overestimated or whether producers have underestimated the crop. It is quite likely that a few of both buyers and producers are not on the best of terms with the truth. I fail to see, however, where either buyer or seller can possibly benefit by misrepresentation.

I have found, after years of experience, that the so-called "estimates" of producers and others scattered over the country are not to be relied upon. This year I base my knowledge of the amount of extracted honey produced upon the number of cases and cans made and sold, which I think is a safe criterion, since it is not likely producers are buying and storing them for use another year. So far as my experience in the sale of them went this season, and I sold several thousand, they bought only when and what they needed from time to time. About the time Ernest Root was on the coast I had a customer for thirty cases. He said he thought he would not need to exceed sixty at the most, and would buy in small lots as needed. Well, that man has 500 cases—30 tons—of honey. The others bought just as carefully, though they did not all have the phenomenal yield that this man had.

In your editorial of Sept. 15 you name Ventura as "one of the best if not the best," and credit the county with 245 tons. I think I could name four producers in that county whose aggregate production would reach almost that figure. There are more than 75 in the county who produce for market, and whose production is from one to twenty or more tons each. I have samples of honey in my office, from producers in Orange County (the smallest county geographically), representing about 250 tons yet unsold, and which I have personally examined (the tons as well as the samples).

I have sampled only part of the honey over there, and I know there has been considerable honey shipped from the county. The counties probably range in production this year in the following order: Los Angeles, Orange, Riverside, Ventura, Santa Barbara, San Diego, and San Bernardino. There have been about 100 carloads shipped to date from these counties, and no one will claim that more than one third of the crop has been shipped, if, indeed, there has been as much as one third.

It is quite true that the loss of bees during the three dry years was enormous, but that loss has been largely repaired, and the bees are differently distributed. Old producers who have dropped out have been replaced by new ones in new localities, as I have learned in my travels during the season.

I have not advised selling at present prices, neither have I advised holding, except in one instance, for higher prices. I have uniformly given what information I had that was reliable as to production, and left the matter to the judgment of the producer. Knowing what I positively do as to the amount produced, I hesitate to advise holding for higher prices, and with that same knowledge in mind I do not advise a wholesale rush to sell. The market will absorb the honey only about so fast, and a rush would be disastrous. The market is extremely tender. A half-dozen cars thrown at once into either New York or Chicago will apparently glut the market, and prices at once go off $\frac{1}{2}$ to $\frac{1}{4}$ cent, which represents the difference between a moderate profit and an absolute loss on the honey.

Laug, Cal., Sept. 23.

C. H. CLAYTON.

You say that "no time this season has it been easy for us to find buyers." It seems to me the reason is perfectly plain. The exaggerated reports that are and have been going forth from time to time, of the bigness of the California crop, has a decided tendency to unsettle the market and to make the buyers hold off. The Root Company, as well as a number of others whom we know, hardly dared to make an offering earlier in the season on a car of honey until we knew the facts. No one of us would risk the chance of a high offer with a possibility of that offer being far above the market later on, providing the crop should prove to be as large as has been stated.

The fact is, I don't blame the buyers for being conservative and trying to get it at 3½ to 4½ cents, so long as these monstrous lies keep on traveling. Until their falsity can be proven, they will make an offer that will be safe from *their* standpoint, somewhere about 3½ cents.

You say that you base your knowledge of "the amount of extracted honey produced upon the number of cans and cans made and sold," and that you think this "is a safe criterion." An "estimate" on such a basis would be very unreliable, this year especially. I talked with many bee-keepers from Southern California, and during the early spring it was expected that the crop would be a large one, and the majority of the producers laid in a stock of cans when the prices were low, so as to be sure to have enough. They therefore bought heavily, expecting a big crop, but the big crop did not come to some of them; at least, it did not reach up to their expectations. One bee-man whom I visited had quite a stock of cans on hand, which he said he would not be able to fill this season. It is possibly true that some bought less than they thought they would require; but where there was one such instance as that, there would be dozens of others who had overestimated, and who will, as a natural result, carry cans over for next season.

If one were to "estimate" the amount of comb honey produced by the number of sections sold in a locality in one season, he would run wide of the mark, for the reason that, as a rule, thousands of sections are carried over unused, and this is true of cans.

We have had a number of men in the field who have been looking this matter up very carefully—men who are buyers as well as producers, and I have their reports in our office of the number of tons of honey in sight. Some of our men have made trips independently, and without the knowledge of the others, and their reports agree closely.

You are entirely correct in saying the market is extremely tender, and is, therefore, important that the exact truth and the real facts be presented. But you will agree with me that our eastern reports of 500 cars or 2000 cars is beyond all reason. Even 300 cars is too many, far too many, if the information that has come to me is correct.

Perhaps our estimate of the California output has been too conservative; but far more harm will be done by putting the figures too high than too low. Still, if I erred on the low side I stand ready to be corrected. But I will say this much: That within the last two days our reporters show that the amount of honey in the San Joaquin Valley will be somewhat greater than we reported or was reported to us, because there has been a late and unexpected spurt of honey; but so far as the southern counties are concerned, I still feel that the amount has been exaggerated.

I do not wish to take the view that our reports are correct, and that your estimate is all wrong; but what I do want most of all

is that the truth shall be set forth in a fair and impartial manner.

Editor York, of the *Amer. Bee Journal*, has had considerable opportunity to note the rise and fall of the honey markets. Concerning what I have already said in regard to the exaggerations of the honey crop in California and elsewhere throughout the United States he makes this comment in the last issue of his paper:

Like Messrs. Burnett & Co., we hesitate to advise those of our readers who have honey to sell what to do about marketing it. And yet we think we are safe in saying that, whenever you can get as good prices as those of last year, it would be well to accept them very promptly.

Having said that, we may also venture the opinion that, before honey is higher in price a gain, it will likely go lower than the prices quoted now. This we believe because of the feeling that more honey is being held back by bee-keepers this season than in many a year before.

It is exceedingly unfortunate that there seems to be no reliable way in which to get at the exact amount of honey produced. Were that a possibility, the matter of prices could be more easily be controlled.

THE JOINT SESSION OF THE AMERICAN POMOLOGICAL SOCIETY AND THE NATIONAL BEE-KEEPERS' ASSOCIATION AT BUFFALO, N. Y., SEPTEMBER 12.

THIS great meeting was a success in every way. Just before the opening of the session, the bee and fruit men fraternized in a way that would indicate that there never had been any trouble, and never could be, among the intelligent classes of both industries; and the subsequent discussion bore ample evidence of this. The bee-men were entertained most royally, for, indeed, we were the guests of the pomologists. President Watrous called the meeting to order, and then invited the executive officers of our Association to take seats up in front.

The first regular address to which we listened was one from Prof. J. M. Fletcher, of Ottawa, Canada, on the subject of "Bees as Fertilizers of Flowers." Prof. F. is always an interesting speaker, and he gave us a treat. By means of various charts he showed how nature had apparently designed that some sort of strong insect like the bee should scatter the pollen from one flower to another; how she had even gone so far in some instances as to put up certain obstructions, absolutely compelling the bee fairly to wallow in the pollen, dusting itself from tongue to sting before it could escape. He further gave it as his opinion that the interests of the bee and fruit men go hand in hand; that certain kinds of fruit could not mature properly without the work of the bees.

We next listened to an interesting address by Prof. S. A. Beach, of the Geneva Experiment Station, Geneva, N. Y., on the subject of "Spraying Fruit-trees When They are in Bloom." I have already placed before our readers the main portions of a similar address that he made about a year ago. I will just briefly state that, after a long series of experiments conducted by him, at Geneva, and by his colleague, at Cornell University, the conclusion was

reached that the spraying of fruit-trees while in bloom, in some cases not only did no good, but was a positive injury in others, because the poisonous fluids destroy or injure the delicate parts of some flowers as well as the pollen of others. There was no question, he thought, but that the spraying-liquids do kill bees in large numbers when these mixtures are administered at the wrong time; that so many were killed that the bee-keepers in several States secured the passage of laws forbidding spraying while in bloom. Since then a large number of experiments, at the request of the fruit-men, have been conducted, each showing that, aside from the damage done to the bee-keeper, the former could not afford, if they would consult their own interests, to spray at such times, even if the little bee were taken out of the account.

We next listened to Prof. M. B. Waite, Assistant Chief of Vegetable Physiology and Pathology of the Department of Agriculture, Washington, D. C. Prof. Waite issued a bulletin in 1895, detailing a series of experiments that showed, or seemed to show, at least, that the bee plays a very important part in the dissemination of pear-blight from tree to tree. Prof. N. B. Pierce, Pathologist of the Pacific Coast Laboratory, and Mr. N. W. Motheral, Horticultural Commissioner, of Hanford, Cal., together with Prof. Waite, referred to, it will be remembered, have placed the responsibility for the spread of the blight, or at least a part of it, in California, on the bees.

Prof. Waite is a gentleman of pleasing appearance, and, so far as one could see, as we listened to his interesting address, he is one who endeavors to be perfectly fair, and consistent with truth. While he stated before this joint meeting that the bees could and do spread the pear-blight, he did not wish to be understood as urging that they were the only means for its dissemination. He admitted that there are other insects and wild bees in sufficient numbers, possibly, to scatter the pear-blight, so that, if all the bees that are in the control of man should be removed from an infected region, it might not bring any improved condition. He further believed, from a long series of experiments that he had conducted, despite the fact that bees could spread pear-blight, they were very necessary to the fruit-man, and that he has himself, in his own pear-orchard, kept a few bees, not for the honey, nor because he was directly interested in the bee-business, but because he desired them for a purpose, and that purpose was to fertilize the bloom of his trees. Such a statement, coming from a man occupying the position he does, puts him in the attitude of one who recognizes the value of the bee, and who, so far from condemning them, feels that they are necessary to the fruit-men in spite of the damage that they may do.

The last address of the evening was one from Mr. H. W. Collingwood, editor of the

Rural New-Yorker, on the subject of "The Pomologist and the Fruit-grower." This was delivered in a clear, strong voice, and at numerous times his pungent and salient hits brought down the house with rounds of applause from both the bee and fruit men. He very kindly tendered me a copy of the address, and I take pleasure in presenting it to our readers. It is well worth reading carefully clear through.

I am not a bee-keeper, although I help keep my neighbors' bees. I don't pretend to be a pomologist. I'm a plain fruit grower, far enough along to realize that, with all his proud dominion over the lower forces of nature, man can not produce the finest and most perfect fruits without the help of his friend the bee. That, I believe, will be the conclusion of every fruit grower who will really study the question.

The relation between the fruit-grower and the bee itself are physical, mental, and moral. Interfere with a bee's notion of duty and right, and he at once administers a stinging rebuke to those faint-hearted humans who permit others to interfere with their homes and privileges. Perhaps some of you have heard of the young man who said he called his sweetheart "honey," and in 24 hours she broke out in an attack of hives.

The mental relations appear when a thoughtful man studies the wonderful life and habits of the bee, and the social order that prevails inside the hive. That man must admit that even the civilization that has been inspired by human wisdom falls short of this in some essentials of justice and equity. The moral aspect appears when, in the latter part of summer, the bees swarm to your fruits, and you try to follow out the principles of the Golden Rule in your relations with the bee-keeper. You learn then how much easier it is to be a bear than it is to be a bear. One must learn to use the memory of services rendered as oil for the rusty machinery of patience.

There are two worthy citizens who upset the theories of the scientific men—Jack Frost and Mr. Honey Bee. Ice and honey are two crops which remove no fertility from the soil. A man might cut ice on his neighbor's pond for years, and make a fortune by doing so, yet all his work would cut no ice in the great American game of robbing the soil. The pond will not be injured in the least. In like manner my neighbor's bees may take a ton of honey from my fruit-trees, and it may sell at a good price, yet my farm has not lost five cents' worth of plant food, nor would I have been a cent better off if the bees had not taken an ounce of the nectar, but had simply acted as dry nurses to my baby fruits without pay or reward. Both frost and bee bring unnumbered blessings to man, yet most of us will spend more time growling at some little injury which they do as they pass on than we will in praise and thankfulness for all the benefits they heap upon us. I have known fruit growers and pomologists who, when they find the bee sucking some cracked and worthless old fruit, to forget that the bee did more than they in the making of those fruits. If they were in the bee's place they would probably demand 75 per cent of the finest fruit in the orchard as payment for their labor. Such folks make me think of the housekeeper who found fault with the minister. The good man came into the house of sickness with a message of divine hope and love and faith. He cheered the hearts of all; and yet when he went away the housekeeper found fault with him because he forgot to wipe his feet on the doormat, and tracked some mud upon her kitchen floor. What a world this would be if we could learn to judge others, not by their little weaknesses, but by their great acts of loving service!

If one would look for the ideal relations between the fruit-grower and the bee-keeper he would find them inside the modern cucumber-house. The cucumber is "cool" way down to the courtship of its flowers. Matrimonial agents are required, and formerly these were men who went about with soft brushes dusting the pollen upon these bashful flowers. It has been found that bees will do this better than the men, and most cucumber houses now have their swarms of bees. Inside the glass house the grower has no desire to throw stones at the bee-keeper, because they both wear the same clothes; and the man who can not get on harmoniously with himself has no business out of jail. I say that, we'll knowing that some of the darkest life tragedies in the world's history have been caused by the evil side of a man's nature obtaining mastery

for the moment over the good. In the orchard or fruit-farm the conditions are very different. Here a man may feed the bees which belong to somebody else, and he does not, like the cucumber-grower, see that the bees actually save him the wages of a workman, which would be nearly as necessary without the bee. Most men do not, I think fully understand who the bee is and what he really does. Let us state his case fairly. I understand, of course, that common facts about the bee must be an old story to those who are here. The greatest value of such a meeting is the fact that one may talk over your heads or through you to the thousands who will never join either society, and yet who will profit by your work.

THE BEE AS A CITIZEN.

Man has never tamed the bee as he has the horse or dog or ox. These animals have surrendered their freedom, and tamely submit to man's dictation, changing even their shape and vital functions at his will. Turn them loose, and after a few hours of clumsy freedom they will come back and beg to be taken under shelter into slavery. Even man himself loses the savage independence and love of liberty he knew when free as the hills, and at the behest of civilization puts his neck under the heel of those who are morally his inferior. Not so the bee. He has never surrendered the freedom that goes with wild things and wild life. Man coaxes and partly directs him, but he is still untamed, and still retains the courage and fearlessness which civilization takes from the heart of most animals, including man. Left to itself the swarm of bees will not come begging shelter from man, but gladly and fearlessly fly off into the wilderness, to live as its ancestors lived.

The bee starts with the scope and purpose of its life-work clear. It does not need to go to school. From the first gleam of consciousness the bee knows that it is born to toil, without reward without hope of posterity. Instinct, heredity, spirit, call it what you will, drives the bee on to labor without ceasing, without holidays or hours of lazy ease, and for what? Simply for the future—that dim mysterious time for which he is ever prompted to provide. I said that the mental side of this question will present itself to any thoughtful man. Truly the lesson of the hive goes deep into the human heart and soul.

THE BEE AS A WORKER.

As a boy I was brought up on the "busy bee" theory. The old man who considered him-self responsible for my industrial training gave me to understand that the bee is a tireless worker who toils for the love of it and never quits. He wasn't trying to get me interested in the study of natural history—he was trying to get me to realize that some one loved to work, and he knew that he didn't. I am sorry to break down this ideal of childhood, for I have searched hard to find something that has no blood of the shirk in its veins. I can't tell my children the old story, for they will soon know that most bees in New Jersey appear to start work at 7:30 A. M., and knock off at 4 P. M. On wet days they usually quit entirely. This is much like the average hired man, who will take advantage of a light sprinkle to come in and sweep up the barn floor. The bee works on Sunday while the hired man rides his bicycle. When the bee does start he keeps at his work, while the hired man stops to look at the clock.

When you tear down the childish ideal of the busy bee, and find that it has some of the bad habits of mortals, you do not destroy the whole picture. That would be true with some men; but with the bee it only brings to view a higher ideal than ever. The bee does a fair day's work, and then goes home and puts in a part of the night. A man after doing his work in the field, will hardly help his wife wash the dishes after supper, but the bee works like a slave through the darkness at the wonderful task of manufacturing honey. The short day of hard and consistent work furnishes enough for the hive workers. If all men worked as the bee does, with as fair and just a division of labor, what a world we should have! The short, hopeful day's work would be sufficient if the idle and the rich would cease to live on the earnings of the overworked poor. The society in the hive permits but few drones, and kills them off as winter comes on, while human society increases the number. Thus as we grow older we find that the bee is not the poor aimless drudge we thought him, but rather one who lets his wits save his wings.

THE BEE'S GOOD WORK.

We can easily forgive the bee his short working days when we consider the good he does. There is no

question about the debt fruit-growers owe him. People talk about the wind and other insects in fertilizing our flowers; but I am confident that any man who will really take the time and pains to investigate for himself will see that the bee is nearly the whole story. I have seen the certain results of his good work in a neighbor's orchard. Those bees "broke the trees" down just as truly as though they had climbed on the trees by the million and pulled at them. The appearance of those trees after a few years of bee-keeping would have convinced any fair-minded man that our little buzzing friends are true partners of the fruit grower.

It has been said that the bee does not do this work because he wants to. He is pictured as a greedy, selfish fellow, born into the world with a single idea, who dusts his jacket with pollen, and does his work as dry nurse simply as an incident. Nature puts the brushes on his legs and stomach, and he can not help using them. Here again he is not unlike men. Most of us fight and slave and toil for our own selfish ends. We try to shake the good intentions out of our jacket, and a large proportion of the good we do in this world is done as a side incident, as we press on to accomplish something for ourselves. To my mind this is only another illustration of the wise and beautiful provision of Nature to lead the bee on from flower to flower with some motive of personal gain, and in this way compel him to do his work for pomology. I would that humans who toil, even past the allotted years of man's life, after wealth and power, might as surely leave behind them perfect fruits for the toil of others. The stout legs of the bee, as he crawls from flower to flower, kick life into the baby fruits. Surely with this in mind the pomologist can have nothing to "kick" about.

But ambition and the gratification of personal desires lead both bees and men to scatter evil as well as good. All wings, except those of angels, attract and will carry the germs of evil if they rub against it. It is quite likely that bees will carry the germs of pear-blight from one tree to another—perhaps in quantities sufficient to spread the disease. Let us admit that; and yet no pear-grower who knows his business would have the bees stay entirely away from his trees. The bee also injures fruit to a certain extent. There may be times when he actually leads in this bad work. When he does, he is starved to it, if he were fed at home, as every other farm animal would be at such a time, he would seldom do the mischief. In ordinary seasons I find little fault with the bee for sucking this cracked and broken fruit. We really ought to thank him this year for delivering us from the temptation to pack these worthless culls in the middle of the barrel. Our bee-keeping friends tell us that there is always some rascal that goes ahead with a punch, and breaks the skin before the bee will suck the juice. The yellow-jacket is said to be the culprit, and he is a safe one, for no one cares to argue the point with him. I don't like this hiding behind a yellow jacket. It is too much like the way some of these Christian nations have acted in China. Li Hung Chang and other yellow jackets before him have robbed the Chinese people for centuries, but that is no excuse for the looting and stealing on the part of white men. Should not the bee keeper feed his bees when their natural food is scarce and they really injure fruit? When I neglect to feed my dog at home, and he runs to the neighbor's back yard for food which might feed the pig, have I a right to complain if the neighbor lives up to his legal privilege? My neighbor ought to remember that it was my dog's bark that tamed the hide of the tramp that frightened his children; but some neighbors are not built that way. They are like some pomologists who object when the bee tries to take pay for his services in a few rotten fruit. I am not sure that home feeding would keep bees entirely away from the fruit. There are human beings who will run out of the best of homes. In fact, the more you feed them the more they run. Bees are much like humans in many respects. It is quite likely that a systematic method of feeding during honey-deaths in summer would eventually pay the bee-keeper, just as many dairy-men have become convinced against their wills that it pays to feed grain to cows at good pasture.

THE BEE AS A LAWYER.

Before the law the bee appears to have clearer rights than any other domestic animal. Recent legal decisions have made the bee's position very clear. In one noted case the bees flew into the orchard and unquestionably worked upon or damaged broken fruit. The jury finally acceded, and I think justly, that the bees committed no real damage; yet had a

cow or a hog broken into that orchard and eaten that same fruit the owners would certainly have been liable for damages.

After reading the literature of the subject with great care, I think I am justified in saying that the bee has fuller and more complete legal protection than any other domestic animal. Why should not this be so, since, even in its wild state, untrained or directed by men, the bee is led by its very instinct to labor for the benefit of humanity? Certainly no wild animal works for men as the bee does, and no domestic animal accomplishes so much without direct harness or guidance.

Invoking the law against bees is running up against a hard proposition. Laws have been passed against spraying fruit-trees while in bloom. They are intended to give the bee legal protection. These laws have actually led some tough old fellows to spray at just that time, so as to kill the bees. The law was a suggestion of slaughter to them. Some men are so perverted that they see a wrong and coddle it as a "personal right." These laws have helped the fruit-grower more than they have the bee-keeper, because they have led the scientific men to investigate and tell us why it is a mistake to spray too early.

It appears to have been settled that, before the law, bees are to be considered domestic animals—not naturally inclined to be offensive. A fair synopsis of the bee's legal status is about as follows:

1 Bees kept by a regular bee-keeper have become absolute property as domestic animals, and therefore enjoy legal rights.

2 The bee is not naturally savage. It is no more likely to commit serious damage and mischief than dogs, cats, cows, or horses.

3 The law looks with most favor upon those animals which are most useful to man. No animal is of more actual service to man in proportion to his size and the mischief it commits than the bee.

4 After bees have been kept in a certain situation for a reasonable time without serious injury, it can not be said that it is dangerous to keep them there.

5. The bee-keeper becomes liable for injuries done by bees, only on the ground of actual or presumed negligence.

This seems to give the bee a clear field to go ahead about his business in his own way. It must be said that this strong legal position of the bee is largely due to the fact that bee-keepers have picked up some of the strong traits of the bees. When one of their number is attacked, they do not sew up their pockets and run off with their share of the honey, and as much more as they can get. They fly at once to the defense of their comrade, and make, not an individual, but a society matter of it.

The fruit grower will obtain little satisfaction in a lawsuit against the bee or the bee keeper. The bee is too good a friend of the judge. The relations between these two classes should be settled, not by the scales but by the Golden Rule. Every man who receives a benefit should remember where the benefit comes from. The bee keeper might say with truth: "It is true that my bees feed upon my neighbor's trees; but they have not injured his farm, because they took no fertility away! He has no reason to kick, because they kicked life into his fruit-buds."

This is all true enough, but it is only one side. The fruit-grower may say:

"These bees have increased my crop of fruit, but have they not been well paid for their work? I fed them, and the money in their owner's pocket comes from my farm!"

Two classes of men with interests which lap and nick in this way should never fight; for when one of them hits the other in the nose he is sure to blacken his own eye. They should recognize their mutual dependence, and treat each other fairly. The bee-keeper may say that the law gives him a right to put his hives close to another's dwelling. Still, if that location is offensive to his neighbor the law which is higher than the decision of any human judge should lead him to put them elsewhere. I have heard of an old farmer who insisted on keeping an old bridled calf tied on his lawn. The calf was in every way offensive to his neighbors, and he had ample space for it behind the barn; but he thrust that calf under the very noses of his neighbors, because the law said he had a right to do as he pleased with his own. That man, like many others, figured that such magnifying of his legal rights gave increased dignity to his personal rights; and what a foolish mistake he made! The man who will use his legal privileges as an offensive weapon against others, when it should be drawn only in defense of true principles, is not a true pomologist or bee-keeper.

I regard the raising of fine fruits, and the training and rearing of bees, as the highest types of soil culture, and hence of human industry. He who can direct and watch the slow development of the perfect fruit, and lovingly guard it from plant disease and injurious insects through the long road to perfect maturity; and he who can patiently and skillfully guide and train the honey-bee through its long summer's work—such men ennoble and dignify labor.

Their work may be hard and constant. Their hands may be hard and rough; but the callous on the palm is not a badge of servitude, but an honorable scar from labor's battlefield. Such men are not mere drudges with body and spirit broken on the hard wheel of labor; but, dealing with the fine and most delicate problems of nature, they keep step with the Creator; they are in direct partnership with God himself; and, as such partners, they of all men should be guided by the wisdom and justice of the Golden Rule.

A. I. R. says that the *Rural New-Yorker* fairly bristles with bright, witty, sensible, and practical talk all through. It is a clean Christian paper that takes no advertising of a doubtful or questionable character, and its editor, Mr. Collingwood—well, you can judge of the man by his address as above given. GLEANINGS would like to have every one of its subscribers also a patron of that grand paper, the *Rural New-Yorker*. We will club GLEANINGS and this paper for \$1.75. We can club other papers of equal size for less money; but they may not and probably do not contain the real worth that this does.



STARTING A NEW HOME.

Therefore I hated life; because the work that is wrought under the sun is grievous unto me; for all is vanity and vexation of spirit.—Ecc 2:17.

But Martha was cumbered about much serving, and came to him, and said, Lord, dost thou not care that my sister hath left me to serve alone? Bid her, therefore, that she help me. But Jesus answered and said unto her, Martha, Martha, thou art careful and troubled about many things. But one thing is needful.—LUKE 10:40-42.

There are many points about the two texts I have chosen that might be considered; but just now I am going to talk about only one of them. Doubtless thousands have felt something as Solomon did, when considering the demands of society and fashion of the present time—so much care and worry if one half tries to do as other people do. Solomon probably kept lots of "help," and very likely the "hired girls" of oriental time were much like those of the present day. Any way, he says he "hated life" because he found it all "vanity and vexation of spirit." Now mind you, friends, I have no special grievance with the hired girls, for I rather think Solomon was *some-what* at fault; and, by the way, I fear we are *all* more or less wrong when we complain of our help. How bright and pleasant the words of the Savior come to us after listening to Ecclesiastes! He knew *all* about the *care* and *worry*, and yet he tells us so plainly it is all, or at least a great part of it, unnecessary!

You know I have been considering for months a very humble, inexpensive "home in the woods." Perhaps I should say *we* instead of *I*, for Mrs. Root and I have talked it over, and planned, for more than a year; but it was not until Sept. 19 that we got away from our old home. Boxes, trunks, etc., had been shipped ahead, so that, when we reached the new home, our house with its one room, 14 by 20, was pretty well filled up. I went on ahead on my wheel to get the keys, and Mrs. R. came with a friend the last part of the way. As she came out of the bushes and got a glimpse of the house, I waved my cap, and said:

"Well, how do you like the looks of the new home?"

Before she had a chance to answer, her companion replied:

"I think, Mr. Root, perhaps she likes the 'home' rather better than the *road* that leads to it."

Although my leafy avenues are usually very pretty and inviting, they are not exactly suited for a high-seated vehicle so early in the morning. Her hat was pulled off her head by the bushes that meet overhead, and she was drenched with the dew that is always very heavy, and which sometimes lasts until almost noon. Mr. Hilbert's folks had urged us to stay and rest up over Sunday; but we were both very anxious to get to work on our own ground. In a twinkling she was in the midst of the boxes and things, while I stood by as her "obedient servant." While I was gone to the "spring for water" she had planted a box in one corner, covered it with a white spread, and the china and other useful things began to look homelike and inviting as well as useful. With hammer and nails, scissors, tacks, pins, etc., she has been at work now, as I write, a whole week; and I really believe both of us will often look back and call this one of the happiest weeks of our life. My experiment is, at least so far, a decided success; in fact, it is one of the "happy surprises" of my life. I will tell you why. There are thousands who do not make "both ends meet," and are sinking in debt, because they think they must conform to the usages of society. There are other thousands of young people who might get married and start a happy home all of their own if they only knew how few things are really "needful" (the Master has said, "but *one* thing is needful"). Let us look at the matter a moment. This house, where I sit writing, and which is dearer to me than any home I ever saw before, cost, all told, less than \$100. When we moved in, it had cost less than \$40. Of course, lumber is cheap here. A big team drew all the materials complete at one load, and *in one day* the house was fit to live in, in warm weather.*

* The walls are made of inch hemlock that cost, delivered, \$9 per thousand. We took boards 16 feet long and cut them once in two so that one piece was 9½ and the other 6½ feet long. The short pieces made the lowest side, under the eaves, and the long ones the tall side, the roof sloping only one way. The same kind

Let us go back to that first day. Notwithstanding the hurry and disorder, a little before dinner-time Mrs. R. had a repast on our little round table, fit for a king. I don't believe any king *ever* enjoyed a dinner as we did that. We had spotted trout from the bay;* Early Michigan baked potatoes, grown on our own ground; Early Crawford peaches from our nearest neighbors, and every thing else that two tired children ("children" over sixty years old) could ask for.

When I wrote about potatoes for table use, and gave you that picture, I had never tasted the Early Michigan, grown in this region, and really did not *know* until that time how nice a baked potato *could be*. This locality, with its bracing air, of course makes every thing nice.

I want to tell you of some of our happy surprises that we never could have had if we had not been doing the work ourselves. Many people who come to this region for a summer outing go to the hotels and pay several dollars a day for board and lodging. Of course, that is all right if they wish to do so; but Mrs. Root and I find happiness in a different way. On the spot I chose for our cottage there is no level ground. Our house is on a side hill. Well, wood is cheap here, so Mrs. Root asked me to have some of the nice maple-trees made into stovewood when we were clearing off a place for the garden last winter. When the wood was nice and dry we had it split fine, and piled under the floor of the building to keep it out of the rain. For several days I got the wood out from under the building, carried it around to the door, and put it behind the little cook-stove almost exactly over, but a foot or two *above*, the spot where it is stored in bulk.

One evening Mrs. Root startled me by suggesting if we had a *trapdoor* in the floor, right under the "door" to the stove, "carrying in wood" could be done away with. In a twinkling, that very evening, I made the trapdoor, and now our shavings, kindling, and dry maple wood are all close by the stove, and yet they are where there is never any dirt or litter to be swept up. The surface of the ground (which is *always* dry in this region) is about two feet below the floor. I offer this suggestion to those

of 16-foot boards made the ends by cutting them in two once on a bevel. The carpenter said several times my plan would not work; but he was one of the kind who went ahead when I told him I would "take the chances." The ends of the boards were not squared at all, and there was no need of it, for they were all out of sight when the building was done. Building-paper was put over the rough board walls, and then walls as well as roof were covered with cedar shingles. As this is where cedar grows, the shingles cost me but 90 c per M. The window-casings, cornice, corner boards, etc., are painted green, which makes a very pretty contrast with the cedar shingles.

* Very fair-sized fish, large enough, in fact, for one fish to make me a comfortable meal, are sold here for only fifteen cents a dozen. They are scaled and the insides removed, at this very low price. I verily believe one secret of my good health here is the abundance of nice fresh fish. A great deal of the time my diet is "bread and fishes," "milk and honey." If you will just think of it, it is what the Savior gave his followers when he wanted to give them a little banquet.

who like things nice and tidy, and who may be glad to know of a way of abolishing the whole business of carrying in wood, and its attendant trouble—dust and an empty wood-box. Mrs. Root found that a spring thirty rods from the house would be found a great inconvenience; but so far I have rather enjoyed the walk. We have a rain-water barrel close by the door, and it has so far contained enough, only it is pretty strongly flavored (and tinted) with the cedar shingles.

You may remember I was here in May, and planted a garden. Well, we supposed most of the stuff would have been matured and gone by the latter part of September. Not so. This wonderfully fertile soil (at least wonderfully fertile on our new soil of "woods dirt") seems to have kept the stuff growing; and green corn that was in its prime a month ago is even yet the most delicious green corn I ever ate; and Mrs. Root declared at dinner to-day that the snap beans I brought in were nicer than she ever thought snap beans could be, and yet there were dry pods of mature beans on the same stalks. Well, it surprises us to know what a very small piece of rich ground it takes to provide a great plenty for two people, even if the two *do have* wonderful appetites. A good dinner at 50 cents is usually considered cheap enough; but our meals do not cost 15 cents for both of us, and yet we have fish, meat, fruit, and every thing we want. One great reason for this is that not a thing is wasted. At first we were in somewhat of a quandary without a refrigerator; but Mrs. R. sent to the store for a box, and wire cloth enough to cover one open side. This wire cloth was put on a door to open and shut; and after our meat, fish, milk, etc., were placed on shelves in this box it was placed on a shelf on the north side of the house. The nights are cool, and the air is cool nearly all day, out of the sun. There is nobody around to steal, for we are too far away from the main road; and who would expect to find people living away out here in the dense woods? Our windows slide horizontally instead of up and down, and I greatly prefer this arrangement. Under one of the north windows we have a shelf outside on which to place any thing that is to be kept cool. This shelf and window, and, in fact, all the windows, are covered outside with mosquito-netting to keep out flies.

For a kitchen table we procured a large dry-goods box, of the proper height. One side and one end are open. The box has shelves inside; and as fast as the utensils are washed they are placed on these shelves. Not only every day, but almost every hour, we discover some new short cut in the work of getting the meals. For the first time in our forty years of married life we are working side by side all day long. You may say it is not every man who can afford to drop business and be "hired girl." Well, most men can take a vacation at least a part of the year, and this is *my* vacation.

If king Solomon had carried in wood for his wife (?) to bake with, brought water from the spring, and "whacked" carpets, he would never have "hated life," and called it all "vanity and vexation of spirit."

Ask the doctor why so many people are sick, and he will tell you it is because we are getting so far away from nature and plain and simple living. We two are in the woods all the time, and, in fact, we are out of doors most of the time, in ordinary, rather light clothing. At home I wore an overcoat and fur cap, even when the temperature was above 70; but here I am out of doors in my shirtsleeves, and quite comfortable at 50. Candidly, I do not know *why* this is so. This health-giving locality has much to do with it, no doubt; but "out in the woods" *all the time* is *something* of a factor, I am sure.* Not only my garden but my fruit-trees are growing *wonderfully*. They lay at the depot until in bad shape, and were put out quite late, because I was delayed in getting here. I found several peach-trees to-day that filled the wire attached to the label until said wire had nearly cut off the top of the tree. I went over them in July, and thought I fixed all the labels; but it seems I didn't. My neighbor, Mr. James Hilbert, is now fitting the ground to plant 30 acres of peach-trees in the spring. These sandy hills seem to be specially adapted to peaches. The quality is beyond any thing I ever saw; but the usual way of managing is to let the tree break all its limbs off by its overload of fruit about the third or fourth year.

I have been very anxious to know if Mrs. Root would share my enthusiasm; and I was, therefore, greatly pleased, a few days ago, to hear her say she would like to stay here till Christmas if it were not for the awful job of housecleaning that looms up before her day and night—not housecleaning here (with our one room), but in the big brick house in Medina. You get a glimpse of it in the ABC book. Why not *hire* help? We can't get any. A few years ago, when women were scarce who would clean house, several young men "took lessons," and did very well; but now they too have gone out of the business. She says that, even though a large part of the house is now unused, the empty rooms must be "cleaned" twice a year, just the same. A few years ago we had paper collars that were never cleaned. In some restaurants, even now, they have paper napkins. When they are soiled they are burned up and new ones bought. Well, why can't we have "homes," or perhaps I should say *houses*, that can be burned up or given away when housecleaning time comes, and then just get a new one, bright

*I have told you Mrs. Root has been for years troubled greatly with insomnia. Now she goes to bed early, and sleeps all night until daylight. In fact, she is now sound asleep on the lounge by my side while I am writing. She did the washing for us two this forenoon, because there isn't a washwoman to be hired within miles of us. She had it nearly done before I knew any thing about it. Now, is this great gift of health and enjoyment due to the locality, or is it because we are getting back to pioneer times?

and clean? Of this I feel sure: Our houses are, many of them, too large. Mrs. R. has for years longed for a little house that can easily be cared for, and now she has one.

What shall we do with friends when they come to see us? Well, that is a serious matter. We might "fix 'em up" on the roof, in warm weather; and, in fact, our roof is only a little way up. So far as meals are concerned, our garden is full of stuff we are trying to give away, and our nearest neighbor has butter, milk, and eggs to sell, the year round.

Dear friends, I have talked about the first text some, but have had little to say in regard to the last. Do you not believe the dear Savior meant to say to us that we are making too much of things that are comparatively *unimportant*? Are we keeping in mind sufficiently the "one thing" needful? It is the fashion almost everywhere to have a great lot of dishes with which to serve a meal. Next time you go to a city hotel, suppose you count the number of dishes brought you. All these must be washed; and in "our homes" dishwashing is almost as much dreaded as housecleaning. In our home in the woods there are only a few dishes to wash, for, to tell the truth, we haven't got them; but please do not understand that our table is uninviting in its appearance. Our 14×20 room is divided in the middle by soft white curtains, and our dining-room and its appointments would do credit to a first-class city restaurant. It is, in fact, *cleaner* than many of them (for you may be sure no liquors are served), and the table contains fewer dishes. Mrs. Root has just declared it is easier to do the work here than in that other home that cost—I declare I am almost afraid to tell the truth, for it *really* cost *forty or fifty times* as much.*

What *should* we do with our money if all the world lived as we do? First, feed the millions that are starving. Send missionaries and expert teachers to the uttermost parts of the earth, and teach the unfortunates how to grow potatoes, and how to make *every* land "a land flowing with milk and honey."

Now, although it seems to me such an *easy* thing to get a living here, I meet people almost every day who are selling out and moving away. They say it is awful hard work getting a living where there are so many "stumps" and "hills." Oh dear me! I only wish we could get rid of our one *saloon* as easily as we get rid of *stumps*. The saloon is taking the earnings of the poor hard-working people, and then they attribute their bad luck to the "stumps."

It is now the season for "husking-bees," and I told Mrs. Root I thought *we* would

*One reason for this is, that here there is no dust, and almost no mud. Dusting furniture would be labor lost, for no dust can be found. As soon as it stops raining we can walk, or ride a wheel; and the harder it rains, the better the roads, unless in a few spots on swampy ground. With very little care, no mud or dirt need be tracked into the house. No water ever stands in puddles and underdraining is practically unknown except in springy places.

go; but when some one said the boys would not "turn out" unless a keg of beer were provided from the saloon, I uttered a mental prayer that husking-bees, at least that kind, *might* go out of fashion. I have no quarrel with the big wide world. Let every one seek and find happiness according to his own notion; but I have been so happy of late, and in such an innocent and inexpensive way, I felt as if I must tell you about it. Yes, I have thought of Diogenes and his tub, and his freedom from care and worry; but I don't think I should like his extreme doctrine. If he would make that tub about "14×20 feet," with a good roof over it, perhaps I might agree with him.

Does some one suggest that, if I don't look out, I shall get into "small" and "stingy" ways in my old age? God forbid! It has been my privilege for years past to give material help to missions and industrial schools in our own and foreign lands. I do not expect these annual contributions to be lessened as the years go by; in fact, I hope it may be the other way. And now that I think of it, these industrial schools are finding happiness and great success along just the lines I have been writing about. The school for ministers, described in our Sept. 15th issue, is one of that kind.

Finally, dear readers, did not the greater part of our great and good men come from very humble homes, where modern luxuries were entirely unknown?

"Wherefore do ye spend money for that which is not bread, and labor for that which satisfieth not?"

15 Months for \$1.00!

To New Subscribers.

To any one not a subscriber to the weekly *American Bee Journal*, who sends us \$1.00, we will send it

**From October 1, 1901, to
the End of 1902,**

or 15 months; which means over 60 copies. This we will do as long as we have back numbers left from Oct. 1; after that, the subscription will begin at the time it is received and continue to the end of 1902.

The Buffalo Convention Report

will appear *in full* in the *American Bee Journal*; that alone will be worth the subscription price for a year, to say nothing of the many other good things it contains each week. Better subscribe *now*. No matter what other bee-papers you are taking, you can not afford to be without the *oldest*, and what many bee-keepers say is *the best*. Ask for free sample copy, and also catalog of

ROOT'S GOODS AT ROOT'S PRICES.

George W. York & Co., Chicago, Ill.

144, 146 Erie Street.

ONCE IN A LIFE TIME
is often enough to do some things. It's often enough to buy a wagon if you buy the right kind. The

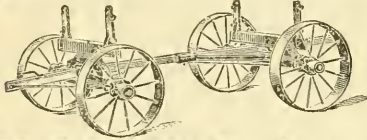

ELECTRIC WAGON

lasts that long under ordinary conditions. First the life of a wagon depends upon the wheels. This one is equipped with our **Electro-Steel Wheels**, with straight or stagger spokes and wide tires. Wheels any height from 24 to 60 in. It lasts because tires can't get loose, no re-setting, hubs can't crack or spokes become loose. Fellos can't rot, swell or dry out. Angle steel hounds. **THOUSANDS NOW IN DAILY USE.** "Don't use a wagon if it is not our kind," says our slogan. **ELECTRIC WHEEL CO., Box 35, Quincy, Ills.**

Union Combination Saw

For Ripping, Cross-cutting, Rabbering, Mitering, Grooving, Gaining, Boring, Scroll-sawing, Edge-moulding, Beading. Full line **FOOT** and **HAND POWER** machinery. Send for catalog A. **SENECA FALLS MFG. CO., 44 Water St., Seneca Es., N.Y.**

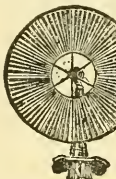
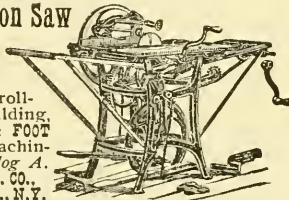

The Storm Proof KING WIND MILL

produces 25 to 50% more net power from any kind of wind than any other mill. Its wheel being only 1 in. thick cuts the wind like a knife and is 400% more storm proof than any other. Exceedingly light, but wonderfully strong. Very sensitive—runs in lightest winds. Numerous sizes—6 ft up, both pumping and power, back peared or direct stroke. Send for circulars and prices before you buy. **Medina Mfg. Co., Box 14 Medina, O.**

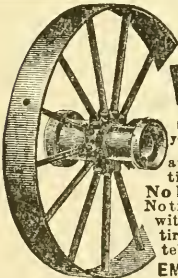

STEEL WHEELS

for your **FARM WAGONS** any size wanted, any width of tire. Hubs to fit any axle. **No blacksmith's bills to pay.** No tires to reset. Fit your old wagon with low steel wheels with wide tires at low price. Our catalogue tells you how to do it. Address **EMPIRE MFG. CO., Quincy, Ill.**



PAGE

IF YOU WANT

Fence to last long, buy the **LONG-LASTING PAGE**. Page Woven Wire Fence Co., Box 5, Adrian, Mich.

GINSENG!

For reasons not needful to explain here we have got to move one of our largest ginseng gardens, and will close this garden out at very low rates. Seedling plants, 3c each; yearling plants, 4c; 2-year old plants, 5c; 3-year-old plants, 6c; 4-year old plants that have not borne seed, 8c; strong seed bearing plants, 1/2 to 1/2 in. in diam., 12c; over 1/2 in. in diam., 15c.

Edgewater Seed Co., Skaneateles, N. Y.

Wants and Exchange.

WANTED.—To exchange potatoes for sweet potatoes. **JOHN ANDERSON, Oriskany Falls, N. Y.**

WANTED.—To sell 8 bushels Egyptian winter onion sets at a bargain. **WM. VAN AUKEN, Ellisburg, N. Y.**

WANTED.—To exchange Root's No. 5 extractor and Dadant uncapping can for honey. **O. H. HYATT, Shenandoah Iowa.**

WANTED.—To sell or exchange a 120-acre farm, in Phelps Co., Mo.; house, spring, and orchard. Address 4430 South 10th St., St. Louis, Mo.

WANTED.—To sell cheap, bees, hives, brood-frames, foundation, smokers, etc.; also nice R. C. B. Leg-horns. **C. H. ZURBURG, Bishop, Ills.**

WANTED.—To buy quantity lots of fancy and No. 1 white-clover comb honey in no-drip cans. **BYRON WALKER, Clyde, Cook Co., Ill.**

WANTED.—Comb and extracted honey. State price, kind, and quantity. **R. A. BURNETT & Co., 199 South Water St., Chicago, Ill.**

WANTED.—To buy your honey. State your lowest cash price, kind, and quantity. **EDW. WILKINSON, Wilton, Wis.**

WANTED.—To exchange second-hand 60-lb. cans, practically as good as new, at 20c per can in lots of 20 or more. f. o. b. Chicago, for white-clover honey at market price. **B. WALKER, Clyde, Cook Co., Ill.**

WANTED.—To sell cheap, 20 acres of good Florida land, well situated, at a low price. Address for particulars. **MRS. I. B. WEIR, Toledo, Florida.**

WANTED.—To dispose of my olive-ranch and 85 colonies of bees, located 12 miles from San Diego, California; near church, school, store, postoffice, and railroad station. Extracted 19,000 lbs. from 50 colonies, spring count, this season; have taken honey every year since I came here. The best of climate. Write for particulars. **J. B. RATCLIFFE, Helix, San Diego Co., Cal.**

WANTED.—All the bees we can get; must be extremely cheap at this time of year. Parties who will place us in correspondence with those having bees to sell, will receive one to a half-dozen selected queens free next June, according to the number of colonies we succeed in purch. sing from said parties. **H. G. QUINN, Parkertown Ohio.**

WANTED.—To sell our entire plant and situation, including a complete line of machinery for manufacturing bee-hives, comb-foundation, etc. In connection with same we have a first-class up-to-date planing-mill in every respect. Our good will and list of customers goes with it. This is a bargain and will pay you to investigate. Address **W. R. GRAHAM & SON, Greenville, Texas.**

WANTED.—To sell 104 colonies Italian bees in the A. I. Root Co.'s 10-frame hives; heavy top frames; wired full brood sheets of medium foundation; all drawn combs; queen excluders; combination stands and bottom boards; 3/4 gable top, 3/8 super covers; all new and well painted; located in a 6000 acre pasture just above the mouth of Leona River, on the Frio; the natural home of the honey-bee, and no apiary near; every thing on the range that produces honey in Texas, with over two years' privilege yet to run. This is a bargain—the most complete outfit in Texas; can give time on part; six miles from railroad. I have not extracted since early last spring. My wounds have again broken out, and I can secure no assistance from U. S. Pension Department, no friends on earth to assist me, so I will close out apiary, and go back to the Los Angeles, Cal., Soldiers' Home and wait patiently for reveille to blow lights out for me. Prompt action necessary. **J. M. MCCURDY, Box 28, Pearsall, Frio Co., Texas.**

To make cows pay, use Sharples Cream Separators. Book "Business Dairying" & cat. 288 free. **W. Chester, Pa.**

Angora Goats.

Delane bucks; good stock; low prices; large circular for stamp. **ED. W. COLE & Co., Kenton, O.**

IT TAKES FIVE CATALOGUES

printed in five different languages to tell the people of the many points of superiority of our **SUCCESSFUL Incubators & Brooders.** One 200 egg machine will hatch more chicks than 20 steady old hens each time it is filled with eggs. They will be stronger, more healthy chicks, too. These machines will do for you just what they have done for thousands of others. Write for 158 page Catalog enclosing 6c to pay postage. We ship machines and handle correspondence for the East from our new house in Buffalo. Write nearest office.

DES MOINES INCUBATOR COMPANY,
Box 503, Des Moines, Iowa, or Box 503, Buffalo, N. Y.

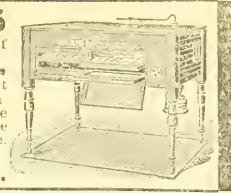

How Your Hens Would Lay!

If you fed cut raw bone. Doubles your profit; more fertile eggs for hatching, more vigorous chicks.

MANN'S BONE CUTTER 1902 MODEL

New design, open hopper, enlarged table, new device to control feed. You can set it to suit any strength. Never clogs. Sent on

Ten Days' Free Trial. No money asked for until you prove our guarantee on your own premises; that our new model will cut any kind of bone with adhering meat and gristle, faster and easier and in better shape than any other type of bone cutter. If you don't like it, send it back at our expense. Free Catalog explains all.

F. W. MANN CO., BOX 37, MILFORD, MASS.

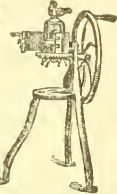

It Brings More Eggs
Get a Dandy Green Bone Cutter and double your egg yield. Our new catalogue tells all about feeding green bone, and the best machine for cutting it.

Sold Direct PRICE, \$5
on 30 days' trial. and up
Straiton Mfg. Co., Box 64, Erie, Pa.

Humphrey
Green Bone & Vegetable Cutter is guaranteed to cut more bone in less time and with less labor than any other cutter made. Your money back if it doesn't. Handsome book and egg re- or I sent free upon request.
Humphrey & Sons, Box 67, Joliet, Ill.

A FRIEND to poultrymen—to chickens.
Adam's GREEN BONE Cutter
It runs easily because it has ball bearings. It cuts clean, quickly and perfectly. Makes a fine bone shaving such as chickens require. Before you buy send for free catalogue No. 39
W. J. ADAM, JOLIET, ILL.

IT IS A FACT
that poultry pays a larger profit for the money invested than any other business; that anybody may make a success of it without long training or previous experience; that the **Reliable Incubator and Brooder** will give the best results in all cases. Our 20th Century Poultry Book tells just why, and a hundred other things you should know. We mail the book for 10 cents. Write to-day. We have 115 yards of thoroughbred poultry.
RELIABLE INCUBATOR & BROODER CO., Box B-49, Quincy, Ill.

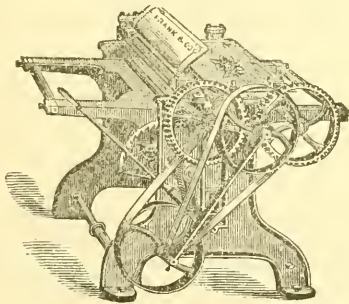

PLANERS

The above cut shows one of our small Planers, of which we make twelve different styles and sizes. Also large Planers, Band Saws, Buzz Planers, Moulders, Wood Lathes, and all kinds of

WOOD WORKING MACHINERY

Send for Catalogue.

The **FRANK MACHINERY CO.**
BUFFALO, N. Y.

1200 FERRETS. All sizes; some trained; first-class stock. New price list free. **N. A. Knapp, Rochester, Lorain Co., Ohio.**

Over 15,000
drugs, medicines, home remedies, tablets, salves, plasters, veterinary remedies, sick room appliances, toilet articles, optical goods, flavoring extracts, paints, oils, etc., are listed in the

Illustrated Drug Book.
We sell them all by mail and guarantee to save you 15 to 75 per cent on every article ordered. This book contains everything you could possibly want at any time in the drug and medicine line. It is therefore a valuable book of reference and should be in every household. They cost us \$2 a piece. We send them out for 10 cents each—merely enough to pay mailing charges, and refund this on the first order that you send us. Write for it at once. You can never tell how soon you are going to need help.

REMEMBER:
Ours is "The Only Mail Order Drug House in the World."

Heller Chemical Co.
Dept. 40 Chicago, Ill.

TREES Fruit and Ornamental Shrubs, Plants, Seeds. Best by 48 years test. Try us. Direct deal will save you money. Catalog free. Satisfaction guaranteed.
STORRS & HARRISON CO., Painesville, Ohio.

THE SMITH PREMIER TYPEWRITER

Occupies an Imperishable Position in the BUSINESS WORLD.

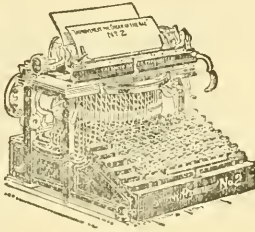

Unquestionable Superior Merit

Annually adds thousands of names to the long list of Smith Premier users, representing every line of trade and every profession.

ILLUSTRATED CATALOGUE FREE.

The Smith Premier Typewriter Co.,

158 Prospect Street, Cleveland, Ohio.

1881

PAGE & LYON MFG. CO.

1901

We manufacture a full line of the latest
BEE-SUPPLIES.

Our motto is, "Perfect Goods and Prompt Shipment."

Send for our new free illustrated catalog.

PAGE & LYON MFG. CO., New London, Wisconsin.

NOW READY!

64-PAGE CATALOG OF EVERY THING BEE-KEEPERS NEED. Illustrated and fully described. Especially valuable to beginners for the information it contains. Send your address on postal and get it now. Established 1884.

J. M. JENKINS, Wetumpka, Ala.

I. J. Stringham, 105 Park Place, New York City.

Keeps in stock a full line of modern appliances for bee-keepers.

SQUARE CANS & SHIPPING-CASES.

One-pound square flint jars with corks, \$5.00 a gross. Cartons of a superior quality at a low price. Tested Italian queens, \$1; untested, 75c. Apiaries, Glen Cove, L. I. Catalog free.

I. J. Stringham, 105 Park Place, New York City.

The Best Queens of the Best Kinds.

By special arrangement with The A. I. Root Co. to furnish them QUEENS, I have secured their assistance in procuring the FINEST BREEDING QUEENS that a thorough knowledge of the bees of the country and money can procure. Among them is a SELECT DAUGHTER OF THEIR \$200 00 QUEEN THAT THEY RE

FUSE TO QUOTE ME PRICES ON. This queen shows every superior quality of her mother. Her bees show an actual reach of 21-100 of an inch; are large, gentle, and beautiful to look upon.

MR. E. R. ROOT says: "You have as fine bees as there are in the United States; and with a direct cross of their breeders you should be able to produce queens whose bees show a reach of 25-100 of an inch."

MR. R. A. JANSEN, of Iago, Wharton Co., Texas, bought of me last fall 80 queens. He says of them: "I consider myself the queen and 50 cents per colony BETTER OFF, for the purchase of these queens, on the SPRING HONEY FLOW ALONE. They SURPASSED ALL OTHER COLONIES in my yard during the spring honey flow and KEPT UP THE LICK. Please book my order for 100 MORE queens to be delivered in the fall. I shall, in all probability, increase this order later."

Under date of July 28th, 1901, from Mr. W. E. Burch, of Los Banos, Cal., comes the following in regard to queens from my apiary: "The three that I have are the FINEST queens I ever saw, and the GENTLEST BEES TO WORK WITH. When I am working with these three colonies I do not use the smoker, and they ALWAYS SEEM TOO BUSY ATTENDING TO THEIR OWN BUSINESS to interfere with me; AND THEY ARE THE BEES THAT BRING IN THE HONEY."

From Ramey, Minn., under date of Aug. 8th, 1901, Mr. A. T. McKibber writes: "The cage of bees arrived o. k., and were measured. They ran 24-100 and 25-100, which is just a little longer than any I have, or have measured, and I think by their looks that they're good bees. The bees you sent could probably take honey $\frac{1}{4}$ inch."

Louis Werner writes under date of June 19, 1901, from Edwardsville, Ill.: "The queen I got from you is a good one, and proved to be as good as I EVER GOT FROM ANY BREEDER. When I am in need of queens I know where to get good ones."

Frank Coverdale, of Maquoketa, Iowa, says, under date of July 6, 1901:

"We like those that have hatched. They are exceedingly gentle, and queens prolific. Among the first fifty the tongue reach is very good, generally 20; one measures 23, and another, which is best of all, measures 21. THIS QUEEN I VALUE VERY HIGH. Her bees are uniform in color. I'd like you to send me a cage from your longest-reach queen, as I'm well equipped for measuring"

This is from far off Jamaica:

"Kingston, Jamaica, B. W. I., May 11, 1901.

"Queen received on the 8th in the pink of condition. Attendants and queen appeared as if just placed in cage THE DAY BEFORE. S. E. SURRIDGE."

If I have real good success, by next year I expect to be able to furnish a QUEEN for the Chinese that will be acceptable to the POWERS.

The A. I. Root Co. also knows a GOOD THING when it sees it. LISTEN!

"Medina, Ohio, May 1st, 1901.

"W. O. Victor.—Instead of sending us 12 untested queens per week, send us 18 in two installments, a day or so apart."

I have on hand at the Pan-American Exposition a nucleus, with queen. Mr. Orel L. Hershiser, Superintendent Apiarian Exhibit, will take pleasure in showing them, as he always "Seeks after the Good, the Beautiful, and the True."

Prices for September, October, and November Only.

Untested queens, 65c; 6, \$3.50; 12, \$6.50; 50 or more, 50c each. Select untested, 85c; 6, \$4.50; 12, \$8.50. Tested, \$1 00; 6, \$5.50; 12, \$10 00. Select tested, \$1.50; 6, \$9 00. Breeders whose best bees show a reach of 21-100, with an average of 20-100, \$3 00. Breeders whose best bees show a reach of 21-100, with an average reach of 20 $\frac{1}{2}$ -100, \$5.00. Breeders whose best reach show 22-100, with an average reach of 21-100, \$7.00. I have discovered two breeders whose best bees show 24-100, with an average reach of 22-100. These are too good to sell. Don't ask for prices. Yard No. 1.—Long-tongue Root Clover. Yard No. 2.—Imported Stock. Yard No. 3.—Golden, or Five-banded Stock. Yards No. 1 and 2 contain, without question, bees as gentle as was ever handled, and I think equal of any in the world as honey-gatherers from any flower that grows. Don't forget that my FAMOUS BEAR PICTURE goes as a premium with each order for six or more queens at prices quoted. Send for list showing description of stock and arrangement of each apiary.

W. O. VICTOR, Queen Specialist, Wharton, Texas.

Marshfield Manufacturing Company.

Our specialty is making SECTIONS, and they are the best in the market. Wisconsin basswood is the right kind for them. We have a full line of BEE SUPPLIES. Write for FREE illustrated catalog and price list.

Marshfield Manufacturing Company, Marshfield, Wisconsin.

LONGEVITY.

I have never made any great claim for the longevity of the Superior Stock of bees that I am selling, but from the reports that I am getting this year I am inclined to the belief that this quality ought to be added to the other desirable traits that they possess. Here is a sample of the letters that I get :

WARSAW, N. Y., Sept. 4, 1901.

Mr. W. Z. Hutchinson, Dear Sir:—I inclose \$2.00 for Review and queen. Three years ago I lost my breeding queen in the spring, and sent to you for one of your year-old queens. I expected to use her only one season, but she proved to be so much better than I expected that I kept on using her until I now have nearly my entire apiary requeened from your stock. I started last spring with 35 colonies, increased to 75, and have nearly 400.0 pounds of honey—not so bad for a village where 250 colonies are kept, besides there be-

ing other apiaries near by. One of my neighbor beekeepers is so well pleased with my bees that he offered to trade apiaries with me, giving me two swarms for one, but I declined his offer. The bees of this queen have been trying hard for the last two or three months to supersede her, but I keep the cells cut out, and shall try hard to keep her over into her fifth year.

Resp. yours,
W. W. SHERWIN.

If you send in your order at once you will probably be able to get one of these queens this fall, and be all ready for business next spring, instead of being obliged to wait two or three months before your order can be filled.

Queen alone, \$1.50; queen and Review from now to the end of next year, only \$2.00.

W. Z. HUTCHINSON, Flint, Mich.

Long Tongues Valuable South as well as North.

How Moore's strain of Italians roll in the honey down in Texas:

Hutto, Texas, Nov. 19th, 1900.

J. P. Moore.—Dear Sir:—I wish to write you in regard to queens purchased of you. I could have written sooner, but I wanted to test them thoroughly and see if they had those remarkable qualities of a three-banded Italian bee. I must confess to you I am more surprised every day as I watch them. They simply "roll the honey in." It seems that they get honey where others are idle or trying to rob; and for gentleness of handling, I have never seen the like. Friend E. R. Root was right when he said your bees have the longest tongues; for they get honey where others fail. I will express my thanks for such queens. I am more than pleased. I will stock my out-apiaries next spring with your queens.

Yours truly,
HENRY SCHMIDT.

The above is pretty strong evidence that red clover is not the only plant which requires long-tongued bees to secure the greatest quantity of nectar.

Daughters of my 23-103 breeder, the prize-winner: Untested, 75c; six, \$4.00; doz., \$7.50. Select untested, \$1.00; six, \$5.00; dozen, \$9.00. Safe arrival and satisfaction guaranteed. Descriptive circular sent free. I am filling all orders by return mail, and shall probably be able to do so till the close of the season.

J. P. Moore, Lock box 1, Morgan, Pend. Co., Ky.

(Mr. J. P. Moore is entirely reliable.—A. I. R. Co.)

No more Untested Clover Queens

will be sent this season. All orders received after this date will be filled next season. We are preparing to winter over a large number of our best clover queens, and expect to be fully equipped to take care of all orders next season.

THE A. I. ROOT CO., Medina, Ohio.

Standard-Bred Queens!

Acme of Perfection; Not a Hybrid among Them.

Improved Strain Golden Italians.

World-wide reputation; 75c each; six for \$4.00.

Long-tongued 3-banded Italians.

Bred from stock whose tongues measured 25-hundredths inch. These are the red clover hustlers of America. 75 cts. each; six for \$4.00. Safe arrival guaranteed. Catalog on application. Headquarters for bee-keepers' supplies.

Fred W. Muth & Co., Cincinnati, Ohio.

South-west Corner Front and Walnut Streets.

Queens.
Queens.

From my breeders, 75 cts.; select, \$1.00; tested, \$1.25. For particulars, see former advts. and circulars.

J. B. CASE, Port Orange, Fla.

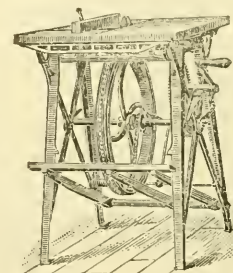

Barnes' Hand and Foot Power Machinery.

This cut represents our combined circular saw, which is made for beekeepers' use in the construction of their hives, sections, boxes, etc. Machines on trial. Send for illustrated catalogue and prices.

W. F. & John Barnes Co., 545 Ruby St., Rockford - Ill.

FOR SALE.—First class Angora cats and kittens, Mrs. HATTIE S. WEBBER, Monroe Ctr., Minn.

BERMUDA

With cable communication and equable winter temperature of 70 degrees, is reached in 48 hours from New York by the elegant steamers of the Quebec Steamship Company, sailing every ten days up to January, and then every five days. The situation of these islands—south of the Gulf Stream—renders

FROST UNKNOWN,

and the porous coral formation prevents malaria. The Quebec Steamship Company also despatches highest class passenger steamers every ten days for ST. THOMAS, SANTA CRUZ, ST. KITTS, ANTIGUA, GUADALOUPE, DOMINICA, MARTINIQUE, ST. LUCIA, BARBADOES, DEMERARA, and the principal WEST INDIA ISLANDS, affording a charming tropical trip at a cost of about \$4 a day. For descriptive pamphlets, dates of sailing and passages, apply to

A. E. OUTERBRIDGE & CO., Agents,
39 Broadway, New York.

ARTHUR AHREN, Sec., Quebec, Canada.

Mr. A. I. Root's Writings

of Grand Traverse territory and Leelanau Co. are descriptive of Michigan's most beautiful section reached most conveniently via the

PERE MARQUETTE R. R.

For pamphlets of Michigan farm lands and the fruit belt, address W. C. Tousey, D. P. A. Toledo, Ohio.



BELGIAN HARES!

With every hare sold goes a full pedigree, register number, and score-card, scored by an official judge. Does will be bred to one of our famous high-scoring bucks free. Write for book, Mgr. of The A. I. Root Co. J. B. MASON, MECHANIC FALLS, MAINE.



Belgian Hares

I have some fine hares for sale at reasonable prices.

J. F. Moore. : Tiffin, Ohio.

Wanted! HONEY, WAX, MAPLE SUGAR, SYRUP, AND POPCORN.

A. L. JENKS, 42 W. Market St., Buffalo, N. Y.

Supplies for the West!

The latest and best in the line of

BEE-KEEPERS' SUPPLIES

kept constantly on hand.



We carry a full line and large stock of The A. I. Root Company's Goods, which we sell here at their factory prices. Estimates cheerfully given. Catalog free.



ADDRESS

Jos. Nysewander, Des Moines, Iowa.
710, 712 W. GRAND AVENUE.

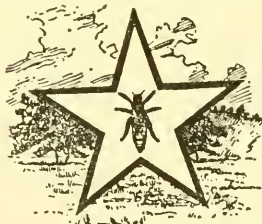

Clover Queens!

We will be prepared to furnish the Root long-tongued queens for 1902.

G. F. Davidson & Sons,
Fairview, Texas.

Minnesota Bee-keepers' Supply Mfg. Co.,
Manufacturers of
Bee-hives, Sections, Shipping-cases, and
Everything Used by Bee-keepers.

Orders filled promptly. We have the best shipping facilities in the world. You will save money by sending for our price list. Address

Minnesota Bee-keepers' Supply Mfg. Co.,
Nicollet Island Power Building, Minneapolis, Minn.

CHAS. ISRAEL & BROS.,
486-490 Canal St., Corner Watt St., N. Y.

Honey and Beeswax.

Liberal Advances made on Consignments. Wholesale Dealers and Commission Merchants. Estab. 1875.

FOR SALE.—Two cars comb and extracted alfalfa clover honey. VOGELER SEED & PRODUCE Co., Salt Lake City, Utah.

Moore's Prize-winner.

The demand for daughters of this famous queen was so great that we had to withdraw the ad. for a while in order to catch up with orders, but you will find it in this issue, page 840.

HONEY QUEENS! Get the Best Queens.

Laws' Long-tongue Leather Queens.
Laws' Improved Golden Queens.
Laws' Holy Land Queens.

Laws' queens are the standard bred queens of America. The largest honey-producers use them and praise them. Laws' queens go everywhere, and can furnish you a queen every month in the year. Four apiaries. Queens bred in their purity. Prices, October to April: Tested or untested, \$1.00 each; 6 for \$5.00. Breeders, none better, \$3.00 each. Address

W. H. Laws, Beeville, Texas.

Dittmer's Foundation !!!

Retail---Wholesale---Jobbing.

I use a PROCESS that produces EVERY ESSENTIAL necessary to make it the BEST and MOST desirable in all respects. My PROCESS and AUTOMATIC MACHINES are my own inventions, which enable me to SELL FOUNDATION, and WORK WAX INTO FOUNDATION FOR CASH, at prices that are the lowest. Catalog giving

FULL LINE OF SUPPLIES

with prices and samples, free on application. BEESWAX WANTED.

GUS. DITTMER, AUGUSTA, WIS

Evansville, Ind., Sept. 27th, 1900.
The Jennie Atchley Co., Beeville, Bee Co., Texas.
Dear Friends:—It gives me great pleasure to forward you this unsolicited testimonial regarding the merits of Atchley queens. The three (3) dozen queens purchased of you have made an excellent record for themselves. Not an Atchley queen among the twenty colonies lost during the severe drouth in July. I have bought queens from many breeders, and although the present crop is exceedingly short, the tiers of supers show where the Atchley queens are, and speak volumes for your method of queen-rearing. I find the progeny to be very gentle, strong-winged, uniformly marked, long-lived, of large size, and last, but not least, the best honey-gatherers I ever had. I shall want 100 more next season.
Yours fraternally, J. C. WALLENMEYER.

Prices for Queens.

Tested, \$1.50 each; \$8.00 for 6, or \$15.00 per dozen. Untested, February, March, April, and May, \$1.00 each; \$5.00 per 6, or \$9.00 per dozen. Fine breeders, \$5.00 each. We have as good bees and queens as money and labor produce. We breed three-band Italians, Goldens, Carniolans, Cyprians, and Holy-Lands, in their purity, bred in separate yards 5 to 20 miles apart. If you want *the best*, call for Atchley's improved strains. Safe arrival guaranteed. Send for a sample copy of "The Southland Queen," the only southern bee-paper, \$1.00 per year. To new subscribers we offer as a premium a nice untested queen in order to get our paper introduced. Catalog, giving queen-rearing and management of apiaries for profit, FREE.

THE JENNIE ATCHLEY CO.,
Beeville, Bee Co., Texas.

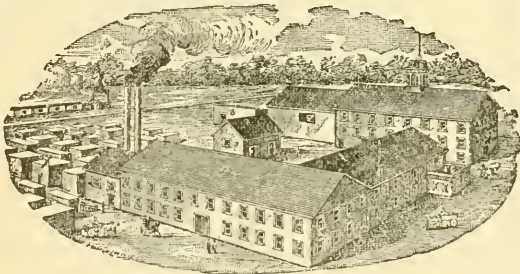

KRETCHMER M'F'G CO., Red Oak, Iowa.

BEE-SUPPLIES.

Best-equipped factory in the West; carry a large stock and greatest variety of every thing needed in the apiary, assuring BEST goods at the LOWEST prices, and prompt shipment. We want every bee-keeper to have our FREE ILLUSTRATED CATALOG, and read description of Alternating Hives, Ferguson Supers, etc. *Write at once for a catalog.*

— AGENCIES: —

Trester Supply Co., 103 So. 11th St., Lincoln, Nebraska; C. C. Richards, 1223 17th St., Denver, Col.

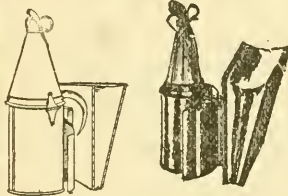

BINGHAM SMOKER.

Dear Sir:—Inclosed find \$1.75. Please send one brass smoke-engine. I have one already. It is the best smoker I ever used.
Truly yours,
HENRY SCHMIDT, Hutto, Tex.

MADE TO ORDER

Bingham Brass Smokers.

Made of sheet brass, which does not rust or burn out; should last a lifetime. You need one, but they cost 25 cts. more than tin of the same size. The little open cut shows our brass hinge put on the three larger sizes. No wonder Bingham's four-inch smoke-engine goes without puffing, and does not drop inky drops. The perforated steel fire-grate has 381 holes to air the fuel and support the fire. Heavy tin smoke-engine, 4-inch stove, per mail, \$1.50; 3 1/4-inch; \$1.10; 3-inch, \$1.00; 2 1/2-inch 90c; 2-inch, 65c. Bingham smokers are the originals, and have all the improvements, and have been the standard of excellence for 22 years. Only three larger ones brass.

T. F. Bingham, Farwell, Michigan.

Contents of this Number

Anarchy, Cause of 851
 Bees, Moving them a few Rods 861
 Bees, 108,000 in a Hive 850
 Bee-papers, Value of 862
 Brood-frames Deep v. Shallow 853
 Corn Cure 819
 Drones, Virility of 850
 Foul Brood in California 862
 Foul Brood vs. Drone Brood 862
 Foundation, Using Full Sheets 860
 Frame, Hoffman, Hyde on 856
 Gardening in Michigan 868
 Honey in Statue of Lee 851
 Honey, California 857
 Honey-jar, Hershiser's 851
 Location and Overstocking 859
 Mesquite 863
 Officers of N. B. K. A. 864
 Paths 866
 Pear-blight on Seedlings 849
 Queens, Balled, Treatment of 861
 Rambler at Stearns' 853
 Swarming in Florida 860
 Swarming, Automatic 851
 Syrup, How to Make 862
 Transferring and Italianizing at Once 862
 Wintering at Medina 864

Honey Column.

GRADING-RULES.

FANCY.—All sections to be well filled, combs straight, firmly attached to all four sides, the combs unsoiled by travel-stain or otherwise, all the cells sealed except an occasional cell, the outside surface of the wood well-scraped of propolis.

No. 1.—All sections well filled except the row of cells next to the wood; combs straight; one-eighth part of comb surface soiled, or the entire surface slightly soiled; the outside of the wood well-scraped of propolis.

No. 2.—All sections well filled except the row of cells next to the wood; combs comparatively even; one-eighth part of comb surface soiled, or the entire surface slightly soiled.

No. 3.—Three-fourths of the total surface must be filled and sealed.

No. 4.—Must weigh at least half as much as a full-weight section.

In addition to this the honey is to be classified according to color, using the terms white, am. er, and dark; that is, there will be "Fancy White," "No. 1 Dark," etc.

CITY MARKETS.

MILWAUKEE.—The receipts of honey, both comb and extracted continue very fair, and we have noted a better inquiry for honey and increased sales of comb honey, and the week closes with an encouraging outlook, that, as we have before noted, a better demand would exist when cold weather comes on, and we will now quote fancy 1-lb. sections, 15a16; A No. 1, 14a15; No. 1, 13a14; amber, nominal, 11a12; extracted, white, in bbls., kegs, cans, and pails, 8a9; dark, or amber, 7a7½; beeswax, 26a28. A. V. BISHOP & Co., 119 Buffalo St., Milwaukee, Wis.

NEW YORK.—Demand for comb honey good; receipts small; buckwheat comb honey scarce, and bringing good prices. We quote the market as follows: Fancy white comb, 15a17; No. 1, 14a15; No. 2, 11a13; fancy buckwheat, 12a13; No. 1, 11a12; No. 2, 9a11. Extracted, dull; white, 6a7; light amber, 5½a6; buckwheat, 5a5½. Beeswax, 27a28. CHAS. ISRAEL & BROS., 486-490 Canal St., New York City, N. Y.

CHICAGO.—There is a very good demand for No. 1 comb honey at 15; that which will not grade No. 1 or fancy, 13a14; some small lots of fancy bringing more than 15; light amber selling at 12a13; dark honey of various grades range from 10a11. Extracted sells fairly well at 5½a6½ for white, according to quality and flavor; white clover and basswood bringing 7; light amber, 5½a5¾; dark, 5a5½. Beeswax steady at 28. K. A. BURNETT & Co., 199 South Water St., Chicago, Ill.

PHILADELPHIA.—Comb honey arriving very freely, and prices declining. We quote fancy white, 15a16; A No. 1, 14a15; buckwheat, 11a12; extracted, fancy white, 8c; amber, 5½a6; beeswax, 26. We do not handle on commission. WM. A. SELSER, 10 Vine St., Philadelphia, Pa.

ALBANY. Honey market steady with good demand. White comb fancy, 15a16; No. 1, 14a15; medium, 13a14; buckwheat, 12a13. Extracted white, 7a7½; amber, 6½a7; buckwheat, 6. This is the time to sell honey to give satisfaction. Weather is right for shopping, and people have the relish for honey now. MACDOUGAL & Co., Albany, N. Y.

NEW YORK.—Comb honey is in good demand, and finds ready sale at the following quotations: Fancy white, 15; No. 1 white, 13a14; amber, 12; buckwheat, 10a11. Extracted rather quiet at 6a6½ for white, and 5½a5¾ for amber. Beeswax quiet at 27a28. HILDRETH & SEGELKEN, 82, 84 Murray St., New York City, N. Y.

CINCINNATI.—Fancy white comb honey sells at 15a15½; lower grades, 13a11. Extracted dark, 5a5½; light amber, 5½a6½; clover, 7a8. C. H. W. WEBER, 2116 Central Ave., Cincinnati, Ohio.

SCHENECTADY.—Market continues in good shape without change in prices. Fancy white, in cartons, 16; No. 1, 14a15; No. 2, 13a11; buckwheat, 12a13. Extracted, light, 6a6½; dark, 5a5½. CHAS. MCCULLOCH, Schenectady, N. Y.

DENVER.—No. 1 comb honey, \$3.00 per case; No. 2, \$2.75. Most bee-keepers have marketed their crops now, and, owing to cooler weather, local demand is more active. White extracted, 7a8. Beeswax, 22a25. COLORADO HONEY-PRODUCERS' ASS'N., 1110 Market St., Denver, Col.

BUFFALO.—Demand for honey fair; receipts rather light, and still there is no scarcity. Fancy No. 1 white clover, 15a16; A No. 1, 14½a15; No. 1, 14a14½; No. 2, 13a11; No. 3, 12a12½; No. 1 dark, 11a12; No. 2 dark, 10a11. Extracted white, 5½a6½; dark, 1½a5. Beeswax, 28a30. W. C. TOWNSEND, 81, 86 W. Market St., Buffalo, N. Y.

BOSTON.—There is a fairly good demand for stocks, with ample supplies at the present writing. Fancy No. 1 in cartons, 15½a16; A No. 1, in cartons, 15a15½; No. 1, 15; very little No. 2 is being received. Glass-front cases will bring about ¼c per pound less. Light California extracted, 7½a8; Florida honey, 6½a7. BLAKE, SCOTT & LEE, 31, 33 Commercial St., Boston, Mass.

DETROIT.—Fancy white comb honey, 14a15; No. 1, 14c; dark and amber, 11a12; extracted, white, 6½a7; dark and amber, 3a6; beeswax, 26a27. M. H. HUNT & SON, Bell Branch, Mich.

FOR SALE.—Extracted honey in 160-lb. kegs. Buckwheat, 5½; mixed, 6; basswood, 7. Send postoffice money-order on Moravia, N. Y., and will ship promptly. N. L. STEVENS, Venice, N. Y.

FOR SALE.—Fine ripe extracted touch-me-not honey, in 60-lb. square tin cans, 2 cans to a case, delivered at R. R. station at 7½c. Sample postpaid, 8c. C. A. BUNCH, La Paz, Marshall Co., Ind.

WANTED.—Honey; car lots or otherwise. Will send man to receive when sufficient amount to justify, and pay highest market price, spot cash. Address, stating quantity, quality, and price desired at your station. THOS. C. STANLEY & SON, Fairfield, Ill.

FOR SALE.—8000 lbs. clover and basswood honey, mixed, in 60-lb. cans, as white as Michigan produces; good body and flavor; the best I ever produced in 26 years' bee-keeping. A free sample will convince you. Eight cts. per lb. at Carson City. E. D. TOWNSEND, Remus, Mich.

WANTED.—Fancy and No. 1 white clover honey, one-pound sections, paper cartons preferred. BLAKE, SCOTT & LEE, 33 Commercial St., Boston, Mass.

WANTED.—Western honey in car lots, also northern fancy white comb in no-drip cases; state price delivered. We pay spot cash. Reference, German National Bank, Cincinnati. FRED W. MUTH & Co., Front and Walnut Streets, Cincinnati, O.

FOR SALE.—Fancy and No. 1 comb honey; about 2000 lbs. or more. WM. MORRIS, Las Animas, Co.

Wm. A. Selser, Honey Expert,

When you buy honey, send a 3-oz. bottle, have it tested, to be sure it is pure. Price \$2.50 per sample. By doing this you may avoid over ten times this amount in litigation with pure-food laws. Chemist's certificate given.

The A. I. Root's Co.'s Office, 10 Vine Street, Philadelphia, Pa.

G. B. LEWIS CO., WATERTOWN, WIS.



Bee-hives,
Lewis' White
Polished Sections,
Shipping-cases.



Perfect Goods,
Prompt Shipment.

Special Agency, C. M. Scott & Co., 1004 East Washington St., Indianapolis, Indiana.

AGENCIES: L. C. Woodman, Grand Rapids, Michigan; Fred W. Muth & Co., Southwest Corner Walnut & Front Sts., Cincinnati, Ohio; Fred Foulger & Sons, Ogden, Utah; Colorado Honey-producers' Association, Denver, Col.; Grand Junction Fruit-growers' Association, Grand Junction, Colorado; Robert Halley, Montrose, Colorado; Pierce Seed and Produce Company, Pueblo, Colo.; E. T. Abbott, St. Joseph, Missouri, Special Southwestern Agent.

BEE - SUPPLIES!

*ROOT'S GOODS
AT
ROOT'S PRICES.*

C. H. W. Weber, Cincinnati, Ohio.
2146-2148 Central Ave.

A NEW AND COMPLETE stock for 1901 now on hand. I am The Root Company's representative for Cincinnati and surrounding territories. . . . You save TIME and FREIGHT CHARGES by having goods shipped from here. Convenience of railroad facilities here enables me to do so. Before buying elsewhere, write for my prices and catalog, which will be mailed you free of charge.

GLEANINGS IN BEE CULTURE

A JOURNAL DEVOTED
TO BEES
AND HONEY
AND HOME
INTERESTS.

ILLUSTRATED
SEMI-MONTHLY

Published by THE A. I. ROOT CO.
\$1.00 PER YEAR MEDINA, OHIO.

VOL. XXIX.

NOV. 1, 1901.

No. 21.



HEARTY THANKS, Mr. Editor, for recognizing the demand for a three-ply hive-cover with dead-air space. Now we're good friends again—for the present.

"ORDINARY queen-cells," as the designation for those intended for swarming or superseding, and "emergency" for the other kind that are post-constructed, is the suggestion of E. E. Hasty, in *Amer. Bee Journal*. Good. [So say I. I am glad you agree.—ED.]

CURE FOR CORNS.—After a warm foot-bath, apply to the corn a plaster of beeswax, or, still better, of propolis, spread upon paper or cloth, and leave undisturbed for three or four days. If the corn is not then easily removed, repeat the process.—*Centralblatt*.

A GOOD DEAL of previous observation, and closer observation this fall, lead me to believe that the rule is that queens continue laying for a time after workers cease rearing brood in the fall. At least it is a very common thing to find eggs and sealed brood present, but no unsealed brood.

MR. EDITOR, when you tell a story, why do you leave us partly in the dark? You tell us, p. 823, that when B. Franklin chased you you peddled with all your might; but please tell us whether you peddled honey, bee supplies, or what. [That was a typographical error. It should have been pedaling. The "goak" is on us.—ED.]

F. C. HOLBROOK relates in *Amer. Bee Journal* that he lost many pear-trees from pear-blight, among others a seedling that never had a blossom. He wants to know how the bees could be to blame in the latter case. [Just what I thought when I saw several thousand sprouts that had never been in bloom in California, all struck down by the blight.—ED.]

IN MOVING BEES, I formerly used a wire-screen cage at the entrance. As said on p. 816, "It is surprising what relief such an arrangement gives to the strongest hive;" but unless the cage be securely fastened it may come off, and then the whole hive will come pouring out of the hive, especially if a strong hive be in an old, rotten hive. Much better, however, than such a cage, it is to have a bottom-board two inches deep, with an entrance the same depth. It is more quickly and easily closed than with the cage. All that is needed is a single piece of wire cloth with folded edges, just large enough to close the entrance, with a stick nailed to the hive across the upper part of the wire cloth.

REPLYING to your question, p. 813, Mr. Editor, it would be a troublesome thing for me to tell in all cases in September whether a colony has a good queen. In some cases there will be no eggs or unsealed brood present, and it is unusually difficult to find the queen. If I do find her, how can I know she is a good queen? [What Doolittle meant, I think, was that, if a colony had an inferior queen, as judged by its past record, or if a queen was past the prime of life, that the month of September was a good time to remove all such, and put in their stead young, vigorous mothers; that is to say, if the inferior queens have not been removed up to that time, in order to save the colony from succumbing to the rigors of winter, a good queen should be substituted.—ED.]

WHAT IS SAID by A. C. Miller and the editor, p. 819, raises some questions. Is it certain that sudden cessation of laying hurts a queen? Is there really any sudden cessation? Does not the queen keep right on dropping her eggs when caged? Does not all the harm come from mailing her while still heavy? Perhaps the whole thing may be something like this: Several men are sent on a railroad train, each one to stand in the middle of a car, having bound on his back a heavy burden. One gets several falls, and is badly hurt; another goes

through unhurt, a third strikes on his head and is killed, and so on. Without the burden, each one might have gone through safely. Moral: Cage your queen a day before mailing. [All of these points are worth consideration, but I do not believe we can give a positive answer to any one of the questions, with our present knowledge.—ED.]

I'M AFRAID, Mr. Editor, that you and I do not attach the same meaning to the word "incidental," or you would not object to "incidental proofs" that 15 days are enough for the development of a queen. To go by the dictionary, proofs "happening or coming without regularity or design" may be as positive and emphatic as those coming in the course of a carefully planned experiment. Such proofs I have had, and they are none the less reliable because incidental. [I attached exactly the same meaning that you do; but my point was this: That if these proofs happened to come along without regularity or design, you, the observer, would not be watching the matter as closely as if you had set in motion a train of events to prove or disprove the proposition. We may see a thing happen a thousand times, but learn nothing from it, either as to its cause or prevention; but, however, I accept the 15 days, as I think at present the balance of evidence is in favor of that length of time rather than in favor of 16.—ED.]

AFTER TRYING for years to get people to say "colony" when colony was meant, GLEANINGS has given up being so hide-bound, and now allows "stand" for "colony," and on page 816 "hive" is used for "colony." Of course, "swarm" for colony is equally admissible, and is, in fact, used, p. 817. It gives variety to have several names for the same thing and several things for the same name. It's a good deal of trouble always to choose carefully the right word, and it will be a good deal easier if any old word will do. Then there will be a pleasing variety in the various ways in which the same article will be understood. [If you had to read all the proof that goes into a bee-periodical, I am afraid you would find it difficult to *always* substitute the word "colony" for "swarm." But for the sake of avoiding repetition our plan is to allow the use of the word "stock" or "stand" for "colony;" but we always aim to make a discrimination between "swarm" and "colony." Certainly, doctor, you would not compel a farmer always to use the word "cattle," and never say "stock," as applied to the same class of animals. Indeed, the great power of the English language rests in its choice of words.—ED.]

DOOLITTLE, in *Amer. Bee Journal*, speaks of 108,000 bees from one queen being in a hive at the same time, as if it were an easy possibility. I commit him to the tender mercies of the editor of the bee-journal called GLEANINGS. [I have just consulted Doolittle's article, and I can not make out that its writer considers 108,000 bees as within

the range of "easy possibilities" for one colony. To quote him exactly, he says, "We *can* have in that hive, barring accidents, if the hive is properly managed, 108,000 bees." Italics mine. What he means, I take it, is that such a number is a *possibility*, not as if it were a common or "easy possibility," as you put it. Say, doctor, those glasses of yours are slant-eyed—eh? Now, I will make you a proposition. If you can find in any one of your eight-frame colonies next summer—yes, we will make it a two-story eight-framer, 100,000 bees, by actual weight, shaken off the combs into a box, and weighed, and counting 5000 bees to the pound—well, I will give you the best laying queen, outside of our best breeder, we have in our apiary. Perhaps 100,000 bees might be crammed into a two-story hive with comb and brood; but in the ordinary course of events, I do not believe one will find more than half that number as the progeny of one queen. Understand, I am giving you a pick of your *whole* apiary.—ED.]

"ARE THE DRONES from a queen that has never met a drone virile?" is a question suggested by the editor, p. 778. Dzierzon holds that they are. On p. 224 of *American Bee Journal*, Vol. I., the baron of Berlepsch gives a *posteriori* proof that is almost conclusive. On p. 246 of the same volume is given the testimony of no less an authority than Prof. Leuckart, which, I think, settles the question. He says: "Those originating from the eggs of unfecundated or drone-producing queens are, as I have ascertained, as perfectly developed and as fully virile as others. So likewise are those dwarf or diminutive drones, which are occasionally bred in worker cells. Nay, even in a drone hatched in a royal cell, though prematurely dead, sent to me by Mr. Kleine, I have unquestionably found seminal filaments and male organs. The case is precisely similar also with drones hatched from eggs laid by fertile workers. Mr. Vogel inserted in a hive of common bees a drone comb containing eggs laid by an Italian worker (which he had seen laying in a queenless stock), and removed the colony to an isolated locality. Italian drones were hatched, and two common queens, fecundated while these drones were flying, producing partly common and partly Italian workers. As there were then no other Italian drones in that neighborhood, those queens must have been fertilized by drones produced from the eggs of the fertile worker." [This ought to be sufficient proof.—ED.]

T. P. KY.—The statement has been made several times that pure Italian bees are not so subject to the ravages of black brood as are black bees. Beyond this we can give you no information. But if I were in a locality afflicted with that disease I would Italianize as rapidly as possible, as I believe it would pay, whether the yellow bees were or were not immune to black brood.



Summer's reign is almost o'er;
Birds have sought a southern shore;
Leafless trees and meadows bare
Show the work of autumn's air.

In the days of Virgil, and even later, it was generally believed that bees generate spontaneously in the carcasses of oxen—the belief arising, probably, from the fact that bees have been seen around such objects. But it remains for our day to prove that bees sometimes come from a dead horse; and not only bees but honey too. The Richmond *Evening Leader* tells us all about it as follows:

The Lee statue, both horse and rider, has found a new and interesting opportunity for usefulness in these latter days in becoming the home of an enormous swarm of honey-bees. Or, to be more exact, probably of a considerable number of swarms. It is more than likely that the interior of the equestrian statue is well filled with as good honey as ever was found in a Hanover bee-tree.

For some time bees have been noticed in considerable numbers about the small openings at the mouth and nostrils of the horse and the mouth of the rider. More than once considerable swarms have come out of these openings, which are believed to be the only openings to the interior of the statue. When it is remembered that the statue of both horse and rider is merely a shell less than a half-inch thick it will be at once seen what a commodious and comfortable home and retreat for honey-gatherers the interior of the statue provides.

It is not known whether the openings to the statue are large enough to allow sparrows to enter. If so, the statue is probably partially full of the trash which they collect to make their nests. As sparrows can get through a wonderfully small opening this is quite possible; but no sparrows or other small birds have been noticed going in or out of the statue, as has been the case with the bees. The latter have certainly found a safe place for gathering their winter's supplies, and one in which they will not and can not be molested. It will give an added interest to the statue to the many who visit it, to know that it is probably well filled with honey of the best make and reputation.

THE MODERN FARMER.

I fear many do not know what a good journal Mr. E. T. Abbott is sending out. In the last number received he has an editorial on "Anarchy," which, it seems to me, covers the whole ground and goes clear down to the cause of this evil. It will be seen that Mr. Abbott believes there are many anarchists who do not train under a red flag. He says:

The natural home and congenial breeding-place of this vile and perverted monster is the crowded quarters of large cities. Anarchy is bred in saloons, in brothels, in gambling dens, in the wine-rooms, and even in high society where vice is condoned and violations of law and order are winked at because the culprit belongs to "our set."

Whoever violates a known law, whoever winks at such a violation of law, is sowing broadcast the seeds of anarchy. The police board that winks at the open saloon door on the Sabbath day is helping to breed anarchy. The policeman who is sworn to execute the law, and then winks at these violations on the plea that it is a "side door," or a "back door," is breeding anarchy many times in spite of his "side door" plea. It was said of old that all roads lead to Rome. All doors into a Sunday saloon lead to perdition, and it matters but little to the man who finds himself in hell

by what door he made the start. "But these are bad laws," we are to d. Ah! there's the rub. Any law which men wish to violate is a "bad law," to hear them tell it; but the violation of any law creates a disrespect for law, and this is the beginning—nay, the anarchy. Every man who disregards law, whether it be in the name of capital, or in the name of labor, in the name of an individual or in the name of a corporation, has started on the road which leads to anarchy.

The only improvement on the above would be to say that a Sunday saloon is just as good as a Monday one.

THE BEE-KEEPERS' REVIEW.

The issue for October is a gem, and equal to any that Mr. Hutchinson has ever printed. The contributed articles are of a high order, especially one from F. B. Simpson, on selection in breeding. The presswork on the *Review* is as good as that in our big magazines, and that is what enables the editor to give such a fine half-tone engraving in each issue. Mr. Hutchinson does his own photographing; and in that line of work he well deserves the title of "artist."

As I was one of O. L. Hershiser's guests while in Buffalo, I take pleasure in copying the following:

Mr. O. L. Hershiser showed me, at the Pan-American, a new style of glass jar that he had just gotten up for putting honey on the market. It is of flint glass, and square, like the Muth jar; but instead of being closed with a cork it has a screw cap after the style of the Mason fruit-jar. There is a cork lining inside the top of the cap, which makes the whole thing self-sealing. The cost is only a trifle more than for corks, tin-foil caps, and waxing, and, considering the lessening in labor, is really about as cheap. Mr. Hershiser is making arrangements to have this style of jar put up on the market.

Mr. Hershiser takes a keen interest in bee-keeping, and a relation of some of his experiments went far toward keeping me from feeling lonesome.



NATURAL SWARMING AND AUTOMATIC HIVING.

Can the Latter be Counted a Practical Success?

BY F. H. CYRENIUS.

During the past fifteen years it has been my study and determination to perfect a device to allow bees to swarm, and safely have them without the necessary time in watching and risk in running away. Now that I have succeeded to my entire satisfaction I feel in duty bound to offer the same to my fellow bee-keepers, believing they will appreciate my efforts. My bees are all in outyards run for comb honey, and allowed to swarm as they please. I have been unable to visit them oftener than once a week, and during these visits it was a great pleasure to find those which had cared to swarm securely hived by the use of the hiver.

Some years ago, while working at crude

hivers, I discovered that, to cage a queen with a zinc entrance-guard beside her own hive, would secure part of the swarm, at least, every time, and they would enter the new hive and begin work with as much certainty as though they were hived by any other process.

To test this plan, remove a queen from her colony and cage her with an entrance-guard in a new hive beside the old one, and shake in front of the hives about the number of bees that would naturally go with the first swarm, and see how quickly you will have a new swarm established and working. This is just what the hiver does; and in less two hours, treated as above, I have observed both eggs and honey deposited in combs to receive them, which should always be provided if possible.

After trying numerous experiments of this character it was conclusive to me that the only remaining feature was to be sure to get the queen thus caged at the issuing of the swarm. As a result, the swarm would be securely hived by the returning plan, and with much more certainty than by any other plan of natural swarming.

My latest hiver affords all possible inducements to lead the queen through the large cone, thus caging her directly in front of the new hive as though she were caged with an entrance-guard.

An important offset in the zinc leads the queen directly to the cone; the end of the hiver over the old hive-entrance is darkened by a shutter, and the end over the new hive is provided with light through wire cloth, all of which are required to produce the best results. When the queen is thus caged, hiving is assured.

To secure convenience in manipulating and adjusting the hivers, the bottom-boards should be placed on double stands about three inches apart, and project about four inches beyond the entrance of the hives, which furnishes a good support. In order to place the empty hive on *either* side of the old hive, the hivers are made *reversible*, the cone always pointing toward the empty hive.

The hivers are securely held in place by a wire spring passing between the hives, one end against the back of the old hive, and the other end over the front and center of the hiver.

The plan I prefer for comb honey is to have all hives arranged on double stands in early spring. At the beginning of the honey harvest one hive (the weaker one) is removed from each stand to another double stand (two on a stand), each of which is to be worked later, as those remaining on the old stand; i. e., if the swarming season is not over when they have gained sufficient strength to work in boxes, and swarm. The remaining hives at once receive the field bees from the hives removed, and boxes are at once given them.

In about one week preparations for swarming may be expected when an empty hive is placed beside the old swarm in the

place made vacant by the one previously removed.

The hiver is now placed in position, being sure that no bee can enter either hive without passing through the zinc.

To empty the hiver of dead drones as often as occasion may require is all the attention required until swarming is over.

When the swarm issues and is hived, about half of the bees will return to the old hive. This is not objectionable, as they are just as valuable in the old hive to store in the boxes as though they remained in the new hive.

Any time within eight days after swarming, the unfinished boxes are removed from the old to the new stand, as also the working force, by any plan best suited to the bee-keeper. He may exchange hives, or he may shake the larger part of the bees off the combs of the old hive in front of the new swarm. He may remove the old hive to a new stand, or divide into nuclei, or use any manipulation to prevent second swarming, and build up in good shape for winter.

I have much confidence just now in a simple chute which covers the entrance of the old hive, and extends to the edge of the entrance of the new hive with a passageway for the bees, so that, returning from a fly, they unite with the new swarm, making the new swarm very strong through the honey-harvest, and making the old one too weak to send out a second swarm. The chute, of course, is to be removed before the young queens wish to fly, or when enough bees have been exchanged to accomplish the desired result. If you wish these hivers to hive your bees successfully, don't allow an accumulation of dead drones to *remain* in them. Don't allow your hives to contain much drone comb. Mr. Doolittle says, "I never knew a swarm to have too few drones to be profitable." Don't use the hiver until the approach of the swarming season. Don't leave it on long after the swarm has been hived and working. Don't remove it before they begin work, and the danger of running away is over.

And now, kind reader, if you follow these directions carefully you will find the above a pleasing way of hiving your bees and securing nice comb honey, besides the satisfaction and gratification of saving the absconding swarms.

Oswego, N. Y.

[Complaint has been made once or twice that I have, in a footnote, weakened or entirely nullified the force of an article. When I have done so, however, it was because I *believed* I was fulfilling a duty to our readers. In this particular case I do not like to throw cold water on the automatic hiving described by Mr. Cyrenius; but as I have had quite an extended experience in the very things he speaks of, I feel it my duty to utter a word of caution.

As our older readers will remember, I succeeded in hiving swarms automatically; and at one time I felt quite enthusiastic

over it. I even succeeded to the extent of having automatic-hived swarms store honey in their new quarters. Now, having said all this, as time goes on I am free to acknowledge that automatic hiving, as well as I succeeded in carrying it out, was not a practical success in every sense of the word. It means a double hive-stand, an extra expense; it requires the use of a complicated trap or box made of perforated metal—another expense; it does not save labor as one might expect. If one counts the time necessary to arrange hives on double stands, the further time of finishing up hiving by dumping the rest of the bees that did not go down into the new quarters, as mentioned by Mr. Cyrenius, he will see that labor is not very appreciably economized, if at all. Automatic hiving at best means doing the work over again. About the only thing that can be said in favor of it is that the swarm is taken care of automatically whenever it arrives at the swarming-pitch, independently of the apiarist, who may be absent. But there are other methods of handling swarms, averting them, or controlling them, which I believe to be more economical of labor.

Perhaps Mr. Cyrenius may say that I am talking about one thing and he another—that he has improved on the methods that I used. From his description, and the trap he has sent, I used practically the same principle, and succeeded as perfectly as he. My conclusion is, then, that automatic hiving is possible but not practicable. Mr. E. L. Pratt, now known as Swarthmore, then of Beverly, Mass., devised one or two of the best automatic hivers I ever saw; but I think his conclusions, if I am not very much mistaken, were about the same as mine. Mr. Henry Alley, the veteran queen-breeder of Wenham, Mass., went all over this ground years ago, and he likewise has abandoned it.—Ed.]

DEEP VS. SHALLOW BROOD-FRAMES.

BY F. GREINER.

After an experience of many years with both styles of brood-frames I have at last come to the conclusion that all things considered, the frame of normal depth gives the best satisfaction in the end. Under shallow frames I include such as are less than 7 inches deep. The Langstroth frame is regarded as of normal depth. For a long time I have been on the fence—undecided which one to choose. Each kind seemed to possess some advantages. I did not want to give up, so I kept using half-stories and full stories, shallow and deep (11 inches) frames in equal numbers. I can get along very well in my home yard with the shallow hives; but when it comes to outyards, give me deep-frame hives every time. In stocking up an outyard I was obliged to make out the desired number with half-story hives partly. I anticipated difficulties at the time, and I found them when it

came to managing the hives. When two or more sectional hives are used as one, the combs or frames of the upper section will generally be more or less fastened to the lower one by bits of comb or otherwise, making it unpleasant to separate the two; then it requires so much more handling of frames to get through a hive just when time is most valuable that it almost seems like wasting it. When using only one shallow chamber as a hive, the bees have a way of boiling over as soon as opened up, which is very annoying.

I used to think that the shallow frame would be very nice for nuclei; but after trying it for years by the side of deep frames it does not suit me nearly as well as the latter. I can find queens much quicker on a deep frame, because they are not so apt to hide in the space between the lower edge of the brood-comb and the bottom-bar of the frame. Particularly is this so with black bees, as they are inclined to run off the comb and take the queen with them. When taking a deep frame out of a hive the bees have not time enough to run off, while with a shallow one they would. I have decided to decrease my shallow-frame colonies gradually, and change back to the deep frame.

The most vicious colony may be handled with ease as follows: Approach the hive, give smoke liberally at the entrance, and close it up. Proceed to drum on the hive for half a minute; give more smoke, and drum again. After a few minutes the bees will have filled themselves with honey. If the hive is now opened up in the usual manner the most difficult operation may be performed without any material resistance on the part of the bees. We learned this trick during the first years of our bee-keeping when driving and transferring bees. Even without smoke it is possible to conquer a colony of bees by this method if one is quick enough to close the hive without any bees escaping. The drumming alone will have the desired effect. FR. GREINER.

Naples, N. Y.

[This is a very knotty question; but most of those who have tested the two depths of frames seem to incline to the shallow depth. Certainly this is true: That if the standard, or L., frame is just as good, we should by all means use it because it is standard. If we can say that of a frame we have advanced one of the strongest arguments we can for it.—Ed.]

RAMBLE 193.

A Visit with Mr. O. W. Stearns, of San Joaquin Valley, Cal.; How he Manages to Work his Apiaries Without any Tools or Building in them.

BY RAMBLER.

I formed the acquaintance of Mr. O. W. Stearns, of Selma, in the San Joaquin Valley, some seven years ago. He then owned some 200 colonies of bees. Upon a recent visit to Selma I found he had increased con-

siderably in all directions. In the matter of bees he owns 500 colonies, and was running 100 more on shares. He had moved from an humble cottage on a back street to an elegant new mansion in the fashionable center of Selma, and the house appointments were all new and elegant, and as neat as wax—kept so, of course, by the worthy wife and daughter. An elegant upright piano graced the front parlor, and Kitty evidently knew how to touch the keys for harmony.

An older daughter, and she scarcely out of her teens, married about eighteen months ago, also living in Selma, has fairly upset the whole family; for one fine morning Mr. Stearns found himself grandpa, Mrs. Stearns grandma, and Kitty a full-fledged aunt, and I really believe that is the most wonderful girl baby the world ever saw. Well, babies

he is a veritable trick horse—will open gates and doors, and it is decidedly comical to see him turn on the water from the hydrant when he needs a drink. Both horses will eat honey; and if it is not coming fast enough they will whinner for it; and when bees are stinging mad they have learned to carry themselves with due decorum.

The photo shows Mr. Stearns in the wagon, ready for a start to the out-apiary. Mrs. Stearns is on the veranda to bid him *bon voyage*, and many returns with many loads of sweetness.

Mr. S. has no honey-house and outfit at the out-apiaries, but carries it all in that wagon. On account of its compactness and portability the two-frame Cowan extractor is used. Then there is the tall tank, capacity about 50 gallons. A common galvanized-iron wash-tub is telescoped over the top of

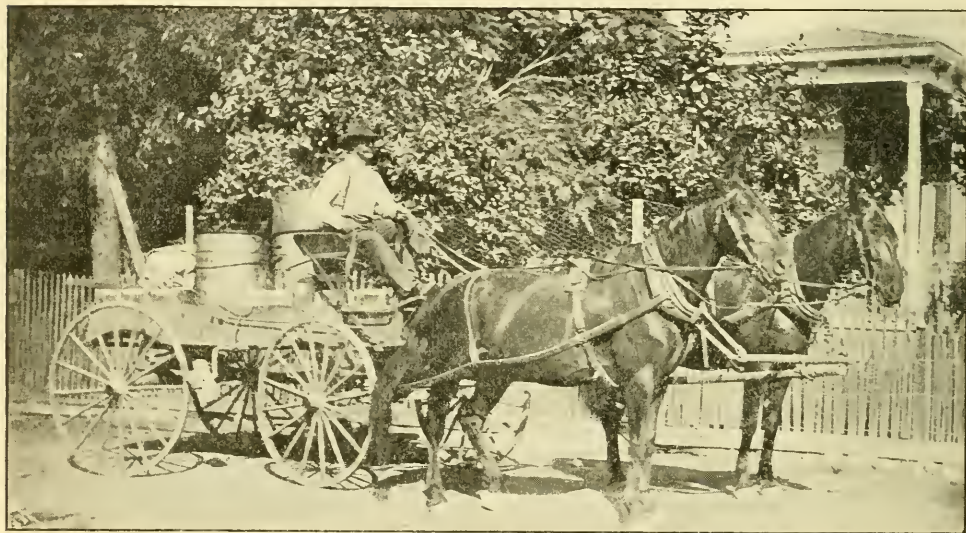

MR. STEARNS STARTING FOR THE OUT-APIARY.

will arrive, and will crow and grow, and I am sure we all wish that the richest blessings may be showered upon them.

Mr. Stearns commenced bee-keeping at the age of 14, in Iowa. He has been in California about 10 years; and although he is now owner of 500 colonies he is not satisfied, but is ready to buy any apiary that happens to be for sale. He manages all of his apiaries, and manufactures quite an amount of foundation, and does nearly all of the work himself, and I propose to give you just a little glimpse of how he does it. His bees are in four or five apiaries, all away from home, one apiary being nearly 20 miles away.

The first essential in the management of out-apiaries is a good lively team, and the photo shows such; and, by the way, the front horse deserves special attention, for

it. This is for cappings. Tent and tent-poles, and several five-gallon tin cans for the honey, complete the load.

Upon arrival at the apiary the tent is erected; and right here allow me to remark that, when the temperature is above 100°, that tent is a fearfully hot place, and Mr. S. contemplates using a portable wire-cloth arrangement with a covering of willow branches. This would be a great improvement over the tent.

The tent in place, the extractor is mounted upon a hive, and held firm with a strong cord or wire from the top, to pegs in the ground right and left. If a super is ripe for extracting, the combs are removed and shaken one by one. No brush is used. If the bees do not all shake off, they are taken to the tent, and escape as they may. No wheelbarrow is used. The super in which

the combs are placed is carried in arms. The reason for not using a wheelbarrow is the trouble of carrying it around; but I am quite sure if Mr. S. would get one of those light Daisy wheelbarrows he would not mind the trouble of tying it to the wagon somewhere.

The uncapping-arrangement is made from two five-gallon tin cans. The side is cut from one; the side and the center of the opposite side cut from another, a piece of wire cloth is put over this center hole, and, when placed on No. 1, it is ready for use, and is a very simple arrangement.

The fifty-gallon tank is mounted on another hive; and when the extractor is full the honey is drawn off into another five-gallon can. One side of this can is cut through

Owing to the honey being so thin, all particles soon rise to the surface, and no strainer is used. There is necessarily much refuse comb and lots of dead bees on the surface, and all of this is taken home in the tank, and strained. The temperature also has something to do with the thinness of the honey. When I observed operations it was up to 106°. Mr. S. has never been troubled with sour honey; but as one of my hobbies is having honey thoroughly strained, I believe Mr. Stearns' would be improved by the use of one.

When the apiary is done in one, two, or three days, according to size of apiary, honey-flow, etc., the whole outfit is loaded into the wagon and taken to the next apiary. Every night the team is driven home with a



ONE OF MR. STEARNS' OUT-APIARIES.

the center lengthwise, and the parts rolled back and over the sides. These rolls of tin serve as handles, and a good grip can be secured, though the hands may be sticky with honey. Mr. S. is not a tall man, and he has to lift that honey nearly as high as he is tall. The two-frame extractor works like a charm. I really believe that, owing to the ease in stopping and starting, and the few whirls it takes to extract the honey, just about as much can be done with it as with a four or even a six frame machine. Will some one get up a competitive trial and settle the matter?

Mr. S. aims to fill that fifty-gallon tank twice during the day; and, of course, it has to be drawn right off into cans. The honey is quite thin as it comes from the hives, for it is not much more than a third capped.

load of honey. In the height of the honey season this means work almost night and day. The start for the apiary is made as early as 4 o'clock in the morning, and it is nearly midnight before the load gets home, sticky with honey; and, weary, he often sleeps on the way while the faithful team keeps plodding along.

One of Mr. Stearns' best yields was about 23 tons; and in the securing of it there is something more than a holiday exercise. It requires as much downright hard work as any other rural occupation; but when the work is done, there is the satisfaction of accomplishing large results from a very insignificant source, the little bee.

I present a photo of one of Mr. Stearns' best apiaries, close to Willow Lake. At certain seasons this is a very pretty lake,

and the cooling breeze is wafted from it through the apiary. A firmisternal, tailless, amphibious animal resorts here in great numbers in the winter. They are very musical, though somewhat monotonous. They hardly ever leave their element to perch upon hives, and are perfectly harmless. Not so, however, with the black ant. These pests were so numerous in this apiary that it had to be elevated from the ground, placed upon those benches, and the legs smeared with a mixture of corrosive sublimate. These ants will attack and destroy every bee that happens to miss the alighting-board, and even enter the hive to grasp their victims. I have never seen them so numerous in any apiary as I found them here, and I am sure that the soil so near the lake was adapted to their propagation; but Mr. Stearns has taken prompt and efficient means to get rid of them.

[As one travels through the country it is a little interesting to see how varied are the methods used by extensive bee-keepers—those that can and do produce great results when there is any thing like a honey-flow. Those methods are so different one almost wonders how this one and that one can produce honey economically, for it would seem that certainly one has a good method, and the other a very poor one. "By their fruits ye shall know them," and the same good rule applies to bee-men and the honey they harvest. It seems to be a general rule to have a small extracting-house, be it ever so humble, at each outyard; but here we have the case of a man who actually hauls his extractors—in fact, all his tools—to and from the outyards, besides bringing back the honey.

Opinions seem to be about equally divided between a two-frame extractor and a four and six frame machine. The advocates of the first named will claim every time that they can extract just as much honey, and do it easier; while those who talk in favor of the big machines say they can not afford to fuss with the little ones. I did some extracting while in California, or at least I helped. My own opinion is that a six-frame machine is too large for one man to turn comfortably. Even a four-frame extractor is large enough. I came home with the conviction firmly rooted in my mind that these large machines ought to be run by some cheap gasoline power of a half or a third horse power in size. In the course of a month or six weeks I think we shall have something that will run these big machines, and actually save the time of a big strong man. Labor in California is rather expensive; and the cost of maintaining a little gasoline-engine during the honey season would not exceed two cents a day while being operated. Contrast this with the expense of a \$1.50 man, and figure out how much would be saved. Of course, a man can do something besides turn the extractor; but with a little power he can make his own labor go twice as far, and at the same time do the work more thoroughly.—Ed.]

THE HOFFMAN FRAME.

Criticisms and Suggestions.

BY H. H. HYDE.

I have noted with much interest the recent articles in regard to brood-frames; and while I do not set myself up as authority, yet I have in mind a frame that we have been using the last two years with entire success. We had the Root Co. make us some Hoffman frames as follows: Top-bar, extreme length, 19 inches; width, $1\frac{1}{8}$; thickness, $\frac{1}{2}$; end-bars, $\frac{5}{8}$ thick, and at the top it is spaced as usual with both edges square instead of one square and one V-edge bottom bar $\frac{3}{4} \times \frac{5}{8}$. Now the reasons for this style, or, rather, specifications. We will take the bottom-bar first. I want it $\frac{3}{4}$ wide so as to render it highly improbable that the bees will continue any comb below the bottom-bar, as they will do when it is not wide enough. I want both end and bottom bars $\frac{5}{8}$ thick, as I find that the usual thickness of $\frac{1}{2}$ is hardly rigid enough in proportion to the other parts of the frame, especially where they are intended to support wires in the frames. I want the spacers on the end-bars to have square edges, both of them, for several reasons; viz., easier manipulation, no V edges to split off in manipulation, as so many of the V edges do; and, best of all, permits the use of a top-bar 19 inches long instead of the full length of $19\frac{1}{8}$. This small difference in length makes them very easily manipulated.

I shall order the next top-bars only one inch wide, as we find that is wide enough to prevent burr-combs, and then this width gives a wider space between the brood-frames at the top, consequently freer communication from brood-nest to super. We have found that $\frac{1}{2}$ is thick enough to prevent sagging, burr-combs, etc., and by their use we do not have the brood-nest so far from the super, neither do we have so much useless wood, the space being taken up with comb.

You can experiment as much as you will, but you will always find that, where the above top-bar is used in lieu of the old "fence rails," there will be a decided improvement in the way bees enter the supers, and quite a little less amount of honey will be found in the brood-nest.

There is an objection to this top-bar; and that is, unless it was made thicker the wedge system of fastening in foundation could not be adapted to it. This might be a consideration with some; but with ourselves, where we use our machine and melted wax for fastening in the foundation, we would not turn around for the difference in time it takes, or in the quality of the work done by either method. But why use the long-top-bar frame when the so-called "improved end staples" have been adopted?

I wish to say, in all deference to Mr. Root, that, had they not placed them before the people, and announced that they were all right, there would now be very few of

them in use, and why? Because it is quite an extra cost in time and money to use them; and, besides, after two or three years' use they are a positive nuisance, for, no matter how accurately the staples have been driven in, they are continually getting driven further up; and the result is, that the edges of the top-bars pass each other, and then we have worse than no self-spacing frame. Then the bees commence and put propolis all over the staples, so that they are soon nothing but a ball of wax. The frames are much harder to get out and hold to with the cut-off top-bar frames; and, in fact, they are a nuisance generally. If I were going to buy bees, and found them on that kind of frame, I would knock off half the price on account of the frames. During the year it has been my privilege to see and talk to quite a number of the leading Texas bee-keepers, and they one and all condemned the cut-off top-bar frames. Even Mr. Root's two agents, Robert Rogers and Udo Toepferwein, severely condemn them, and, in fact, I have seen but one man in Texas (and he was from Iowa, and has since gone home) who said he really wanted them. I do not want any of these cut-off top-bar frames in mine, and you couldn't hire me to use them. It is my honest and sincere belief that, if a vote were taken from all who have tried them, the verdict would be about ten to one against them.

Mark my prediction—that, while the frame finally adopted may be very far from the one I use and have herewith described, yet it will not be a frame with cut-off top-bars.

Hutto, Texas.

[Perhaps I shall have to say to Mr. Hyde as I did to Mr. Pettit on this same subject—that he has not taken into consideration other localities with different conditions. His sphere of observation seems to be confined to Central and Southern Texas; and what he says may be true in his localities. As to Mr. Toepferwein, if he at first objected to the short top-bars, he has since changed his mind, or at all events he did not give me the impression Mr. H. does, and he is quite familiar with the conditions in Texas. It is rather unwise for even the veterans to make a prophecy as to what will and will not prevail at some future time. Even so eminently practical a bee-keeper as Mr. Heddon once said, referring to the use of slat honey-boards, that when we could throw a brick up in the air, and have it stay up, then possibly that device, the honey-board, would be a thing of the past. For nearly ten years now the slat honey-board has not been offered for sale by any of the supply-manufacturers in the United States. Many other eminent bee-keepers have made predictions that turned out a good deal in the same way. Mr. Hyde, although an excellent bee-keeper, is only just of age, if I am correct, and yet he says, "Mark my prediction." He should remember that—

There's many a slip 'twixt cup and lip.
And, again, that—
The best-laid schemes o' mice an' men
Gang aft a-gley.

Having seen, as I have, the different conditions that prevail in different portions of the United States, I do not feel that I am competent to contradict the statement of any one man for his locality, because I am well aware that, if I were in his environment, I might think just as he does; but speaking for localities in general, I may say that only in Texas, and that in only a comparatively limited area, have there been any objections to the shortened top-bar or the V edge to the Hoffman frames. Knowing that preference, we have made a small proportion of the frames for that locality with long top-bars. In fact, we are prepared to make for any locality what the bee-keepers in it seem to ask and call for.

The end-bars of our Hoffman frames are made $\frac{3}{8}$ thick; and we can make them just as well, without any additional expense, $\frac{3}{8}$ if any one prefers them so.

With regard to having one edge square, and the other with a V, I am well aware that some in Texas do not like them so; but there are others who do. If the edges are V'd properly, and left blunt, not sharp, I do not think there will be very much breaking of the end-bars as spoken of. On the other hand, if both edges are square, spacing will be destroyed; for in most localities in the United States it will be much more difficult to separate the frame. An interesting fact in this connection is that one who strenuously advocated square edges had a sample thousand of such frames made; and, after trying them on a larger scale, decided that the square edge was a mistake. He is now ordering the frames regular—one edge V'd.

As to having the top-bar shortened, some few have objected to that; but the "howl" would be much greater if we went back to the long top-bar than if we left it as it is.

As to the staples driving in, as explained—that is something I can not understand. I shall have to make another visit to see these things.—ED.]

CALIFORNIA HONEY.

Effect of Local News Items; Where Prices are Made; Low Prices Caused by Crowding One Market; Power of Work Necessary to Organize Bee-men.

BY B. S. K. BENNETT.

For three years past, California has produced no surplus honey for Eastern shipment. The home demand could not be supplied with the small amount produced. Central California and Arizona had found ready market here at fancy prices. Local product last year brought $7\frac{1}{2}$ and even 8 cents a pound for extracted. Comb honey sold at 15 to 20 cents a pound.

Throughout the United States the prices

for both comb and extracted honey last year averaged up with the prices here, showing that the supply was much less than the demand. All markets were steady, and all lots found a ready customer.

Here in California the dawn of the new year and the new century was heralded by plenteous rains which not only gave hopes to the bee-man but to all people. "Now for a good season," was the slogan. Bee-men talked to newspaper workers of the past good seasons, big crops, and what the bees would surely do this year. The reporters got their data mixed, of course, and published stories about enormous expected yields. Eastern buyers and consumers read these stories, repeated in Eastern papers, or received the clippings from California papers, and reasoned thus: "California is to have a big crop again! Well, we'll wait and see how many cars," and then for self-protection, for fear of low prices, they said: "We'll set our figures at four and five cents a pound here for the California crop."

On good authority I learn that the large confectioners and candy-makers thus agreed. And that was why our local buyers quoted three and four cents, regretting that they could not offer more.

Then the careless newspaper man got in his deadly work, reporting 50 tons of honey from 200 colonies when bee-keepers know that it takes 1000 colonies to make 50 tons. The honey-buyers and the general public believed these lurid tales, and the buyers reasoned again: "If bees make honey like that in one locality, what will all California produce, for it is a big State?"

We bee-men know that only a tenth of the area of Southern California yields honey. The general public does not.

Now all is mixed. The honey-buyer wants the honey, and would buy the whole crop at a price he knows will not go lower. Protection! The bee-man gets scared (I've met him), and when buyers show up he is overwhelmed with offers and conflicting prices. Bee-men are at once competitors of one and another. Down go prices. Then when the bee-man gets a good offer he says: "I won't sell, for prices are going up." With the next buyer he plays the same game, sells some honey low, and refuses good offers. Protection!

Whenever California gets a good crop of honey, the small poor lots come tumbling into Los Angeles, crowding the market, and demoralizing prices. These lots may not reach two cars, yet they set a price for the whole crop of 250 carloads.

In my travels I have noticed the following county variations: In Ventura Co., 5 cents is the holding figure. In Los Angeles Co., 4½ cents a pound rules. Inland, throughout Riverside Co., 4¼ cents is the price. Down in San Diego Co. the standard price is 4 cents.

Why is it thus? "Lack of information."

Honey-buyers left San Francisco (nearly 500 miles north) in August to buy at 5 cents,

buying several cars in Ventura Co. When they found that 4½ cents prevailed at Los Angeles they came on to this city and learned of four-cent honey. They were disgusted, and returned to San Francisco to await settled conditions. Then they learned that they could buy cheaper by staying at home.

The world's crop this year is estimated by many good authorities as less than last year; and here we are with only half a crop in California, actually cutting prices in two. Why? "Lack of information." But with this crushing blow will the bee-keeper keep informed? Our comb honey, only 25 cars, has all gone at prices two to five cents per pound less than it would bring now!

Organizing bee-men is a big job. Simple organization would help. Setting a price would advance figures. Co-operation would steady the market. Protecting buyers against low prices would stimulate a demand. Management would compel a better product. Advertising would make new markets. An association would make one seller in place of many. The bee-man stops to think. He says to himself: "Where is the benefit?" "Will my neighbor reap the benefit too?" "Can I market my own honey?" Then he says to others: "The bee-men must run an association if we have one," or, "I won't go in if so and so do." And there is a lot more of selfish reasoning.

Now I say to the bee-men, do not stop to quibble and question. Join your association. You can not be worse off than you are now. With half a small crop still on hand, prospects for a good year ahead, with plenty of bees, three-cent honey in sight, surely you could not be worse off.

Careful management in the hands of men who have the business and mercantile interests of California at heart, who have built up their own business, who buy your honey, they are interested in seeing the crop bring a high figure, for does it not return to them in your increased trade in merchandise?

Be not afraid of the buyer. Protect him and yourself, and he can show you prices, an increased industry, a marketing of the crop before it is ready, and thus a happy united brotherhood of honey producers.

Los Angeles, Cal., Oct. 9.

[There is a great deal of truth and hard sense in this article, and our California readers will do well to give it careful consideration. While the buyer, a man who is influenced solely by the almighty dollar, and who, as you say, against the interests of the bee-keeper is anxious to depress the market, there is a lot of bee-keepers who can not take a bee-journal because they think they know it all. Something ought to be done by which the bee-keepers of California could scatter information at the right time throughout the whole State. There is no reason in the world why extracted honey in California should have sold for less than 5 cents, and it certainly ought to bring as much as that now, or more. Our own read-

ers—in fact, the readers of any bee-journal, I am sure, do not have a hand in this fool policy of rushing their product off to market at any price. It is the bee-keepers who, while saving the price of a live bee-journal that would keep them posted, actually throw away a hundred times its price through ignorance of the market.—Ed.]



LOCATION AND OVERSTOCKING.

"Here I come from Western New York to have a little chat with you regarding a location, and whether there is danger of overstocking a place with too many colonies of bees. What would you advise regarding a location?"

"If I were at liberty to choose a location, when and where I desired, and could find such a one, it would be in a place where the land sloped gently to the southeast."

"But the lay of the land would not be the main feature for a selection, would it?"

"No, by no means; but this has much to do with getting our bees ready for an early harvest. Besides the 'lay of the land,' I should want flowers as follows: some willow to stimulate early brood-rearing, with sugar maple to follow; then apple-blossoms, as an assurance of plenty of honey from them to white clover, which should be in abundance. Next I should want plenty of basswood, and that on a hillside or mountain, so as to prolong its bloom; and, lastly, where buckwheat is raised as the main crop. Of course, if asters and goldenrod could be plentiful in the late fall this would make it still better."

"But I do not wish to go far from my old home. What am I to do in such a case?"

"This shows that you are much like the majority of bee-keepers who have other ties besides the bees which fix their location, and, owing to these ties, they put up with such locations as they may have. And allow me to say that the man is to be honored who can be contented and bring about good results with only limited bee-pasturage about his home, where duty calls him to remain."

"Which of the flowers mentioned do you consider the best for the bees?"

"If I could have but one of the sources named for honey, and were at liberty to choose, I would select basswood first, clover second, and, lastly, buckwheat."

"Why select basswood?"

"Because, from all sources of information which I can gather, basswood is the greatest honey-producer in the United States for the length of time it is in bloom; and if the apiary is located at the foot of a hill or mountain which is covered with basswood-trees, the season is prolonged to such an

extent that nectar is secured from basswood for from 25 to 30 days."

"Which way would you have the hives face?"

"To the south or east, if possible, as the bees start earlier in the morning than when they face north or west; also our prevailing winds are from the north and west; and when blowing in at the entrance during spring and early summer such tend to retard brood-rearing."

"What do you think about overstocking a locality?"

"My views on overstocking may not be considered quite orthodox by some, yet I think I can give facts to prove my position. If I had a location like the first I described to you I should not fear overstocking it with from 300 to 500 colonies; but I think from 150 to 200 would be as many as an average location would support to the best advantage, while there are places I know of that 50 colonies would be as many as would give good results to their owner. When we take into consideration that bees fly, from choice, from two to four miles from home, and are often led on by receding bloom to five, six, and sometimes seven miles, this matter of overstocking is not so much to be feared as many imagine."

"But I have read that bees do not go more than one and a half miles from home; and if they should ever do so it could not be made profitable, as so much time would be consumed in flying that it would not pay."

"I know we sometimes so read; but to the first I would say that plenty of proof can be brought that such are mistaken ideas. In my earlier years in bee-keeping the Italian bee was brought into a village three miles distant in a straight line. The next spring, before there were any other Italian bees about here, I saw those bees at work on the apple-bloom in our orchard; and upon counting I found about one of the Italians to five blacks, and this with apple-bloom in profusion everywhere. It was not necessary for them to come all the three miles for nectar from apple-bloom, for there was orchard upon orchard white with bloom all about where they were kept."

"And you say those Italian bees were at least three miles from home when at work in your orchard?"

"Yes. And this is not all. In haying time, that year, I was cutting a field of red clover which was in full bloom; and on seeing bees at work on this clover I made an examination, and, to my surprise, found an average of about five Italians to two blacks at work on that clover, which was one mile from home, or four miles from those Italian bees, in a direct line. And there were fields red with clover everywhere at the time, so these bees were not compelled to come over this distance of four miles in search of food."

"Well, that does seem to do away with the mile-and-a-half idea. But how about its being unprofitable for bees to fly thus far?"

"To the southeast of my apiary the land rises gradually for about six miles, and at the end of the distance it is nearly 1000 feet higher than at the bee-yard. Unless interrupted by rain the bees follow the receding bloom of basswood till the top of the hill is reached; and I can see no slackening of work in the sections as long as the bloom is plentiful on this hill. And the bees, also, all work in this direction at this time, while during the first half of the bloom they work in all directions."

"But how about the length of time consumed in flying thus far?"

"Well, I can not tell exactly about this, but I judge it does not take nearly so long for a bee to fly five or six miles as many imagine. From what I have seen I judge a bee can fly at the rate of thirty miles or more an hour; and, if so, ten minutes would be sufficient for a covering of the trip one way, or twenty minutes for the round trip."

"But they do not seem to fly as fast as that when coming to the hives loaded."

"Of course, they do not fly as fast when nearing the hives, or when about the apiary; but when they get out and away they move very fast. I have often gone to an elevated portion of ground which the bees must pass over in going to the top of this hill, and, by lying flat on my back and placing my hands on either side of my face so as to cut off the side light, and looking steadily up for a little time, until the eyes became accustomed to the surroundings, the bees could be seen going and coming quite plainly against the sky, while the rapidity of flight seems to approach that of a rapidly moving passenger train on one of our railroads."

"Well, I am glad I came; for if what you say is true I have a fairly good location where I am, when I come to consider all the flora within four to five miles of me in all directions."



FULL SHEETS OF FOUNDATION; WHEN IT PAYS AND DOES NOT PAY TO HAVE A HONEY-EXTRACTOR.

1. Are full sheets of foundation equal to natural-built combs, for use as brood-combs for extracting?

2. Would it pay for a person who keeps 10 or 15 colonies of bees, and to whom a pound of extracted honey would be equal to a pound of comb honey, to buy an extractor? That is, would the extra amount of honey secured justify the expenditure?

3. How could I secure the greatest amount of liquid honey without having an extractor?

4. How is the Red River Valley, in North Dakota, for keeping bees? AMATEUR.

[1. I do not know that I quite understand your question. If you ask whether combs

from full sheets of foundation are better than those built *without* foundation, I would unhesitatingly say yes. If you inquire whether full sheets of foundation not built out are equal to natural-built combs, then I would say yes and no. Natural-built combs if they are true and straight—in fact, any combs—are more serviceable in the apiary than foundation. Where one is running for extracted honey he will be able to get much more honey if he has combs already drawn out than if he has to depend on sheets of foundation; but if he wishes to run for *comb* honey, and keep down swarming, then he should have either full sheets or starters of foundation.

2. If you mean that you could sell a pound of extracted at the same price as a pound of comb, then it surely would pay you to get an extractor. This question will depend largely on the market. It is usually admitted by practical men that more extracted honey than comb can be produced. Some say twice as much, others one-half more; but a conservative estimate, perhaps, would be one-third more. If the market prices are in proportion, then it would pay you to get an extractor, for the liquid honey can be obtained from weak as well as strong colonies. It is not practicable to produce comb honey except from full-sized colonies. In most localities, and especially at the present time, or within the last two years, say, the bee-keeper of 15 colonies had better confine himself entirely to comb honey. Extracted honey is apt to be a drug on the market, while comb honey can scarcely be obtained at any price.

3. It is not practicable to produce liquid honey without an extractor. Do not fool away your time and money.

4. I am not able to advise you; but, speaking generally, North Dakota ranks well as a honey State.—ED.]

HOW SWARMING STOPS IN FLORIDA AT THE COMMENCEMENT OF THE HEAVY HONEY-FLOW.

Your description of how the bees manage their swarming in Southwest Texas and in New Mexico, fits us here in Southern Florida very closely; but Mr. Robbins (p. 752) is right in saying, "The broad assertion that bees will, at the advent of the honey season, destroy cells, kill off drones, etc., needs qualification." I never knew bees to destroy cells or kill off drones at the commencement of the honey harvest; but there are few if any swarms afterward. We have a fair flow of honey, say an average of 20 to 50 lbs. of honey per colony, during December to February inclusive, then a very light flow, usually just enough to keep bees breeding heavily during March, and in April until the heavy flow commences. Practically all of our swarming occurs during the last of February and in March. A hundred miles north of here, swarming lasts longer and more persistently than it does here; and often, entirely too often, swarms issue from hives that do not contain

a single pound of honey. The use of the extractor cuts no figure in preventing swarms there.

Instead of killing off drones at the beginning of honey harvest, they keep all they have, and keep raising more all summer.

Stuart, Fla. O. O. POPPLETON.

[Yet we here in the North have for years been practically ignorant of the peculiar swarming conditions as they exist in Florida, Texas, Arizona, and California; and even at the present time many are inclined to discredit the statement made by me, even when confirmed by you men who have lived in the field for years.—ED.]

TO MOVE BEES A FEW RODS TO A SHED FOR WINTER; CAN IT BE DONE?

Would it be prudent to move bees from summer stands, a few rods, to a shed (it is open to the south), and pack them close together? These bees are in single-walled hives.

In making nuclei by the Somerford method, it tells us to cage the queen. What kind of cage is used, and where is it kept when the queen is in it? AMOS FELEY.

West Hartland, Ct.

[I would not advise putting the bees into a shed just now if they are to be moved only a few rods. You might leave them in their present location until settled cold weather comes on, and then move. Change the appearance of things as much as possible at the old location, taking away all hives and every thing else that may be familiar to the flying bees. If the weather should continue cold for three or four weeks after moving, there would be very few bees returning on the next warm day.

Any kind of queen-cage will answer for the purpose named, providing it is or can be supplied with food.—ED.]

HONEY FROM CORN; THE PROOF OF THE PUDDING.

Do bees gather honey from corn? According to Mr. Gale we might as well expect "figs from thistles" as honey from corn. In Mr. Gale's experience, "We may as well expect to get honey from ferns or mosses as from grasses, or expect a hen that is without ovaries to lay eggs, as to expect honey from a plant that has no nectaries. Bees can not gather honey from maize, because the flowers have no glands wherewith to secrete it." Now, a nectariferous glandule is one that produces nectar or honey. It has been said, that "Seeing is believing; but feeling is the naked truth." If you would determine this "corn honey" secretion for yourself, go out in the corn-field before sunrise; walk in among the stalks, and watch the bees. You will find them fairly swarming over the tops of the corn. Step up closer, and you will observe that they insert their heads well into the bell-shaped cups, and work most industriously. Now pick off some of these cups,

and strip them between the thumb and finger nail, and you will see exuding a starch-like liquid, sweet to the taste. Return to this same corn-patch an hour after the sun has shone on it, and the bees will be absent. If the bees were simply after pollen they would continue their trips throughout the day; but as they are in search of nectar they discontinue their visits as soon as the sun has evaporated the nectar from the flowers. Since the corn nectar is to be had only in the early morning, the bees naturally gather from other sources throughout the day, and, in consequence, the "corn honey" of one section will not be of that of another section, as the mid-day sources of honey will differ. Corn, more than any other plant, closes its flow of nectar early, in consequence of its flowers being all exposed on the extreme tops of the stalks, and is, therefore, more in the direct rays of the sun. Go out into a corn-field and test the matter for yourself.

Within the past month I was asked to take the honey from the apiary of Ira Flinders, of Big Trees, Cal. I found three hives with body and super filled with honey; three with a few combs just started, and twelve with not even a comb started, in the supers. These bees were all in one row, and yet there are honest bee-keepers who *will not* believe that such conditions can exist, because they do not meet with them. E. H. SCHAEFFLE.

Murphys, Cal., Sept. 8.

[Mr. Schaeffle seems to offer indisputable proof, at least for his locality. Strange that no one has before suggested testing the corn-blossoms just as we test the blossoms of white and red clover. It is too late to make a similar test in our locality; but I suggest that those of our readers who can do so try it at the proper season next summer. For the present, at least, I think we may conclude that Mr. Schaeffle is right, and that corn does, in some localities at least, produce honey; but it would be folly to assume that it does do so in all localities. Alfalfa, for example, one of the best honey-plants in the world, yields little or no nectar in the East, although it makes a fairly good fodder for cattle.—ED.]

TREATMENT OF BALLED QUEENS.

I have bought about 25 queens this year, beginning during May, having received the last ones this week. With the ordinary mailing-cage, where the bees are allowed to release the queen in from 12 to 48 hours, as the case may be, I have in one or two cases opened the hive in three days and found the queen balled. To introduce her again I put her back in the cage and make a mixture of honey and sugar, so thick that it will not run, and fasten her in the cage with it, and then try her in the hive again. By this means I have not lost one, and I have in some instances introduced this way, so the queen was not in the hive more than six hours before she was released, and I

have had better success than in any other way. I have not lost out of the 25 a single queen.

When the queen is balled, do the bees try to sting her, or do they simply smother her? I should think they would very quickly kill her if they tried to sting her.

If I remove the queen from a hive in which there are plenty of drones, would the bees save these drones until they could rear another queen?
J. S. WISE.

Hazlehurst, Miss.

[Daubing the queen with syrup or honey to introduce has been practiced with more or less success for the last 20 years. The object is to get the bees to clean her off, an act which gives her the same scent as the bees to which she is being introduced; but the plan is not to be recommended in all cases; indeed, I believe it is rarely used. Sometimes the bees will attack the queen as soon as they get her well cleaned off, and there are cases on record where the queen has been attacked before she was hardly clean. It is a risky job at best to daub a queen with honey in order to get the bees to accept her.]

There are some instances where it is evident a balled queen was smothered to death, and there are other instances where it is perfectly plain that she has actually been stung.

Removing a queen from a colony in which there are drones will usually have the effect of keeping the bees peaceable toward the drones, or until a laying mother is supplied or reared.—ED.]

THE PROPORTION OF SUGAR AND WATER FOR SYRUP.

Would 10 lbs. of sugar and 10 to 11 lbs. of water be reckoned as 20 lbs. of syrup for feeding bees for winter, or what amount would it be reckoned at, as the bees evaporate it some?
JOSEPH COOKE.

Enderby, B. C., Sept. 28.

[The proportion you name would be all right, although those who advocate feeding syrup thin recommend 10 lbs. of water to 10 lbs. of sugar. This, when fed, would make 20 lbs. of syrup; but the bees would evaporate it down, probably, to about 13 or 14 lbs. of sealed stores. If they are fed very late, it is advisable to make the proportion two of sugar to one of water.—ED.]

FOUL BROOD NOT AFFECTING DRONE BROOD.

I noticed in GLEANINGS, page 685, the report that any one having foul brood in a frame, and also having drone brood not affected, would report. We had a case of it in my bees here. They would die in the cells while the drones would grow and crawl from their cells.
MAGGIE RICH.

Mahaffey, Pa.

[But we have since had other instances reported where the drone brood was also affected.—ED.]

TRANSFERRING AND ITALIANIZING AT ONE AND THE SAME OPERATION.

I have only two colonies of bees, hybrids, which I wish to Italianize this fall. They are in hives of late pattern, containing Hoffman frames; but, owing to the small amount of foundation used, and the manner in which it was fastened in the frames, the bees did not build their combs straight, and consequently it is very difficult, if not altogether impossible, to manipulate these frames.

Now, my idea was this: When I am ready to Italianize, I shall, no doubt, in order to find the queen of said hives, have to use the method you describe on page 163 of your A B C book: i. e., remove the old hive a short distance. Place an empty hive on the old stand, putting on it an entrance-guard. Now take the frames from the old hive, and (one at a time) shake them in front of the empty hive. The queen, not being able to pass the entrance-guard, will be easily found.

Now, if I should have this hive full of comb foundation, why could I not, when the bees get nearly all inside, introduce my Italian queen? and, after so doing, would not the bees stay and build new combs in the frames of foundation?

You understand my idea is, to get frames of straight comb. I could, no doubt, find one or two frames of comb that are nearly straight, and I could place these in the new hive, and in the rest of the frames have comb foundation.
HARRY GRIFFIN.

Alcona, Ill., Aug. 19.

[The plan you describe would work all right, providing you gave the bees a stimulating feed of $\frac{1}{2}$ pint of sugar syrup daily until the combs were built out and filled.—ED.]

THE VALUE OF BEE-PAPERS.

From what I can glean, Mr. G. R. Frye and myself are the only ones who have secured a good crop of honey. We owe our success to GLEANINGS and other bee-papers. We improved our scrub stock that we started with, by buying queens of different breeders; and the result is, there is a little more vigor in our bees than in our "fence corner" bee-keepers'.

River Falls, Wis. A. D. SHEPARD.

FOUL-BROOD INSPECTIONS FOR VENTURA COUNTY, CAL.; A CORRECTED STATEMENT.

On page 779 you quote the *Pacific Bee Journal* to the effect that I have found 625 cases of foul brood in Ventura Co. This is as wide of the truth as some of the estimates of the California honey crop. I have found, up to date, just 103 cases of foul brood in this county this year. I expect to find a few more, but not many. The number is as large as it is because we have had no inspector for the last year or two.

Sespe, Cal., Oct. 9. R. A. HOLLEY.



We are getting good reports of the young clover that is growing all over the country.

MORE proof is coming in, showing that the amount of honey in the country has been greatly exaggerated. We admit and have admitted all along that there is more extracted in the East, but not nearly the

amount that has been stated in the daily press. Several write that Mr. Clayton, on page 828, overestimated the crop.

It is a real pleasure to me to say a good word for the *Bee-keepers' Review*. That journal shows on the part of its editor a good deal of time and thought. A strong feature of it is the editorial department. Mr. Hutchinson is a good reviewer; and if any man can pick up valuable little kinks at conventions or when traveling, or can glean from the current bee literature of the day, it is W. Z. Hutchinson, of Flint, Mich.

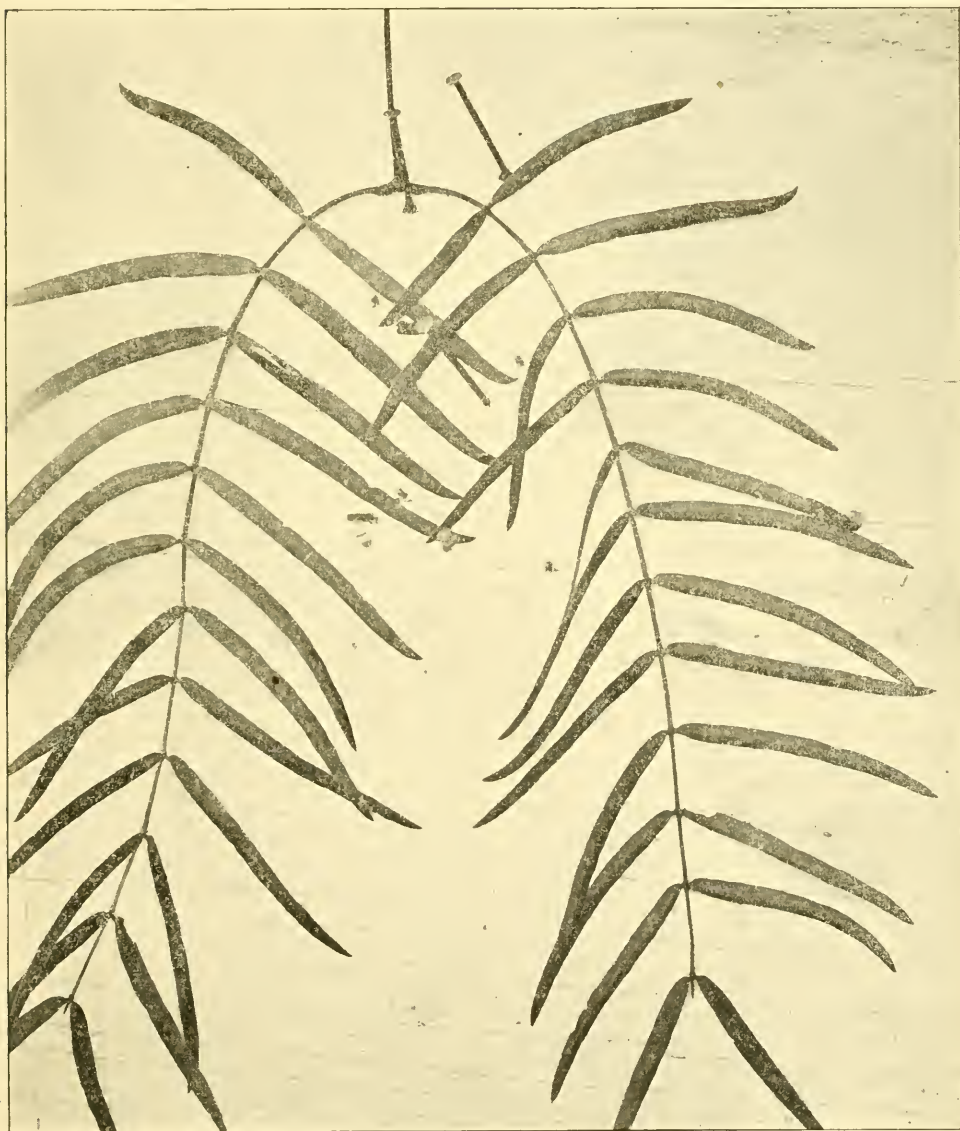

FIG. 6.—MESQUITE LEAF AND BRANCH (LIFE SIZE).

THE stenographic report of the 32d annual convention of the National Bee-keepers' Association, held in Buffalo last September, is now being published in the *American Bee Journal*. As nearly as one can judge, it is not only verbatim but accurate as well.

NEW ADDITIONS AT THE HOME OF THE BEE-KEEPERS' REVIEW.

It is just 23 years this month since GLEANINGS offered its congratulations to Mr. and Mrs. Hutchinson on the advent to their home of twin girls. Later on we showed a picture of the Hutchinson apiary with those same twins in a wheelbarrow, wheeled by their proud dad. At various times since, we have made mention of these girls — once when one of them appeared in a prize picture, holding a swarm of bees; at another time, when the other twin appeared as Mr. Hutchinson's compositor. Well, what is up now? I have just received a note from Bro. H., who is just as proud as he can be over his two new boys — not baby twins, but twins-in-law — who married those first twins. You see a double wedding has just taken place. Mr. H. says of the boys, "They are bright, honest, wholesome fellows, of whom I can feel proud." We all know what the girls are, because — because, you know, they are the "better halves." We offer our congratulations, not only to the parents but to the quartette.

CELLAR V. OUTDOOR WINTERING AT MEDINA.

WE have about 100 colonies at our basswood yard. Most of them are in single-walled hives. Our general practice has been to winter outdoors; but as we have now between 700 and 800 colonies, all told, we found ourselves short of chaff hives. Then the question, in view of the splendid results we secured in our cellar under the machine-shop this past winter, naturally arose as to whether we should put our surplus of colonies in new double-walled hives or winter in the cellar. At our home yard we expect to put all our extra colonies (some 200) under the machine-shop, in the place where the consumption of stores was so very light, and the number of dead bees on the floor so insignificantly small. Now, then, for the basswood yard would it be cheaper for the Root Co. to make a lot of new chaff hives, nail and paint them, and transfer the colonies into them, or would we save money by building a modern bee-cellar and putting all of the single-walled hives in this cellar? A little calculation showed that for the Root Co., at least, it would be just as cheap to build a cellar.

We are now digging one along the lines described by Mr. T. M. Bingham, on p. 174 for last year. It will be remembered that this cellar was wholly underground, access to it being gained through the building, down through the floor.

For some years we have had over on our fairground a display-building, but which

during the last two or three fairs has not been used. We are about to move this down to the apiary, and under it put a modern cellar, embodying the Bingham plan, about 7 feet deep. This will make a repository 12×20 feet, and 7 feet deep. There will be no windows — no two feet of brick walls above ground, as is the case with the ordinary house basement under a private dwelling. While it will be larger than is needed to take 100 colonies, yet we are going on the theory that a large room, with plenty of cubic air capacity, is much better than a small stuffy room just large enough to accommodate a given number of hives. An electric railway, nearly completed, runs directly by this basswood yard, so it will put us in easy connection so that we can watch developments.

We propose to determine, if possible, whether we can duplicate the results of last winter; and whether or not in our comparatively warm climate the indoor method can be rendered more economical than the outdoor plan.

I should, perhaps, have explained that one reason for having the cellar at the out-yard is because the hives have been robbed during the winter on their summer stands. The new cellar will be thief-proof.

OFFICERS OF THE NATIONAL BEE-KEEPERS' ASSOCIATION; SHALL NOMINATIONS BE MADE IN ADVANCE? AND IF SO, HOW?

THIS was the question that was discussed by the Board of Directors at Buffalo. It was finally voted that Mr. Hutchinson prepare a short editorial, submit it to some of the Directors, receive corrections, if any, and place it before the public. This he has done in the last issue of the *Bee-keepers' Review*. He writes:

Nominations in advance of the election of a General Manager, and the Directors of the National Bee-keepers' Association, would be very desirable. As it is now, when a member receives a voting-blank, he does not know for whom any other member will vote. In his desperation, he votes for the man whose term of office is about to expire. As a result, each officer succeeds himself, year after year. Should it ever become desirable to elect a new man, it would be well-nigh impossible with the present system. This question was discussed by the Directors present at Buffalo, but they were unable to devise a plan that seemed wholly satisfactory, and it was finally decided to have the matter taken up in the bee journals for discussion. Suggestions from the readers of the *Review* will be welcomed.

The foregoing was sent to E. R. Root, one of the Directors, for his criticisms, or suggestions. He considered it brief and to the point, and passed it on to Bro. Abbott, who is chairman of the Board of Directors. He penciled on the back of the sheet the following: "While it is desirable to keep the same parties in office as long as they attend to business, and give satisfaction, yet it is important not to have too many Directors in one locality, and to place in office men who will attend the annual meeting as often as possible."

The suggestion that we put in Directors and a General Manager who will attend the annual conventions as often as possible is worthy of consideration. At the Buffalo convention, six of the Directors were present (one more would have given us a quorum) and we did more business than could have been transacted in weeks or months of correspondence. There is nothing like a face-to-face discussion of a knotty question. Other things being equal, we should give our preference to those men who are usually present at the annual convention.

Perhaps I might suggest in this connection, that the Board, in discussing this matter, did not have in mind any director or officer, now holding position; but the facts are, the present set of officers, for the most part, have held their positions uninterruptedly for a number of years, with almost no change. Is this desirable?

Mr. O. O. Poppleton, of Florida, on seeing this editorial, writes, stating that there is not a single Director in the whole South; and, as one will see by consulting the head of this editorial department, there are two or three cases where there are two Directors in one State. For example, there are two in Ohio, two in New York, and two in California. This is hardly a fair representation. A. I. Root, with whom I have been talking, and who is not so much interested in bees as he formerly was, requests that his name be not used again at the next general election; and as for myself, I desire that some one else be put in my place on the Board of Directors, for I feel that my interest in the organization is sufficiently strong to work just as hard for it out of the Board as in it.* In making this suggestion I do not do so with the idea that some other Director in some other State will follow suit, for that would be disastrous. The fact is, all the men who represent the Board are most vitally interested in the success of the Association. The fact that the organization has been successful in every case brought before the courts; that it has prosecuted adulterators; that it has been the means of helping secure new laws; that it now has a membership of nearly 1000; that with its hundreds of dollars in the treasury it is a tremendous moral force—all this and more goes to show that the N. B. K. A. has not lacked for good men to look after its interests; but it should be borne in mind that there are *other* good men who are *not represented* in any official capacity.

CARBOLINEUM AS A WOOD-PRESERVATIVE.

SINCE I called for information concerning this new preservative, I have received a number of circulars and letters. It appears from these that railroad companies have for years been using this substance to preserve wood that is either buried in the earth or exposed to especially trying climatic conditions. It is a preparation of German manufacture, probably having creosote for a basis. Unlike ordinary paint, this preservative, when applied to the surface of the wood, *strikes clear through it*.

Mr. James L. Montgomery, of Americus, Ga., says that "it penetrates the fiber and causes a chemical change which affects the wood, as tanning-fluids affect hides. . . . I have a sample, with which I can paint one

coat on one side of a hive-body (Root's white pine), and in 24 hours a splinter or shaving from the opposite side will taste of the preparation." He further says that it costs less than half the price of good paint. From some of the circulars received it would appear that some of the preservatives in the market bearing that name are mere imitations, and do not in any sense preserve the wood like the original article from Germany.

In one circular I find this: "The effects of carbolineum are partly chemical and partly mechanical. The mechanical effects are the following: By its specific weight, 1.14, it enters easily, expelling the water contained in the pores of the wood, and does not allow any water to circulate in the capillary tubes of the material. Then the fatty matter of the oil protects the wood in a direct way against rain, water, and other atmospheric influences. . . . Among the chemical influences of carbolineum, its antiseptic properties are the most important. Its high contents of specific properties against putrefaction and coagulation of present albuminous parts, operate to prevent them from producing and continuing decay. . . . As an insecticide, it keeps afar all little gnawing and boring enemies of the surface." This last statement lets out the fact that possibly the new material would not be adapted to the use of beekeepers. If a hive preserved in it is obnoxious to insects, why would it not be distasteful to bees? But however that may be, there seem to be testimonials from railroad companies to the effect that railroad ties soaked in carbolineum will last three times as long as those not so treated.

Those who desire to secure circulars can write to the following named: C. A. Manufacturing Co., Austin, Texas; Fisher, Thorsen & Co., Portland, Oregon; Carbolineum Wood-Preserving Co., 13-21 Park Row, New York, N. Y.

It appears that it can be used on bottomboards. In regard to that use I have two letters that will speak for themselves. Mr. J. W. Jackson writes:

Some here use carbolineum on sills, sleepers, and all timbers of buildings that go near the ground. I use it on hive-stands and fence-posts; but so far I have not used it on the hives themselves, because it turns the wood a dark color—carbonizes it to some extent—and I feared the dark color would absorb heat and cause the bees to suffer. It will blister tender skin, but not the inside of the hands of a working person; and it is usually applied with a paint-brush.

J. W. JACKSON.

Mr. O. O. Poppleton, one whose statements certainly can be relied on, writes:

Friend Root:—Carbolineum has been very largely used in this country, especially by the railroads, for the preservation of bridge timbers and foundations of houses from decay and white ants. I have painted the bottoms of my hives with it for some years past for the above purposes.

There are two strong objections to its general use as paint for hives—its strong odor of creosote, and its dark (almost black) color. This last almost or quite prevents its being used on hives allowed to stand in the sun. It is cheap and durable. It can be easily obtained of the trade in New York, or in many of our stores here in Florida.

O. O. POPPLETON.

Palm Beach, Fla., Sept. 28.

* Perhaps some one may feel that I am sore, or am not satisfied with the work done. Nothing could be further from the fact. I love the National Beekeepers' Association more than any one man in it; but in order to get a larger and more equally distributed representation, I desire to make room for some Southern man—that's all.



In all thy ways acknowledge him, and he shall direct thy paths.—Prov. 3:6.

But the path of the just is as the shining light, that shineth more and more unto the perfect day.—Prov. 4:18.

I am going to talk about *paths*, and may not, at least until toward the close, have very much to say about the spiritual sense of the two texts above. For a year past I have been very much interested in "foot-paths" and "wheel-paths," and, of course, the whole matter of "good roads," the subject that is at present taking the attention of our whole nation, comes in more or less. One of the pleasant problems to solve, in connection with our present location here in the woods, is the matter of getting access to and with the outer world. The nearest highway is a good quarter mile through woods, fields, and over hills. This is toward the east. There is another on the north, half a mile away, and on the west, perhaps three-fourths of a mile. All of these points are reached by foot-paths. *Some* of these paths are over old lumber-roads, as I have already explained. Another part is of my own making and planning. James Heddon once remarked in one of our bee conventions, that humanity, for some unaccountable reason, always follow *crooked* paths. Who ever saw a foot-path across a field on a straight line, or anywhere near straight? In deciding where to have a path located over to our nearest neighbor (and to the nearest highway), I first stretched a strong slender cord where I wanted people to walk. It would, of course, have been desirable to have the path along the line between two owners; but this would have made it much longer, besides going over bad hills. With my neighbor's consent I went right through one of the best fields diagonally. First, I worked for the shortest cut; secondly, for an even grade. As we are, perhaps, 40 higher, a gradual down grade was desirable; but to get this there had to be more or less winding around rising ground. Please notice, we can not choose a *straight* line, nor can we go to unreasonable extremes in winding about in order to have no ups and downs. Our steam (and especially electric) railways have made a real science of this matter. I am sure it would save a great amount of time and useless fatigue if *we* around *our* homes would make more of a science of the matter. Children in going to school waste hours every day, and strength that might well be put to a better use, because of the lack of a short easy path to and from school. Why, my "scientific" foot and wheel paths right through the woods are already appropriated by the schoolchildren; and if you could see them these October afternoons as they return from school through our woods on "Clematis Avenue," singing as they come

along in their neat school clothing, you would surely be converted to the importance of my new hobby — *better foot-paths* everywhere that many people want to go.

An excuse for the unscientific and absurd paths has been given, that somebody first walked through a field with no thought that it would ever become a "beaten path," and then everybody "just followed" his crooked footsteps. My friend, is it not just possible that *you, to-day*, are going to "break a path" for *somebody*? Read our two texts and then tell me if it is not important that you take some pains to have the great "Judge of all the earth" direct and assist you in this work of path-making?

But I have not yet done with the paths around "Our Homes." Will you not go this minute to see if the path to the well, to the spring, to the barn, to the pigpen, to the out-buildings, to the clothes-line, and everywhere else that you and the children go (especially the women folks and girls), is just the best it can be? I almost forgot the woodpile; but I hope you have by this time got some arrangement so the firewood is piled by the men either *under* the stove, as I described on page 833, or somewhere indoors in the dry, so no woman ever has to go outdoors for wood.

Now for the paths. If you can, by a *day's work*, save just *one foot* of going up and down, it will be a day's work well invested. If some obstacle stands in the way of a shorter cut by just *one yard*, use quite a good deal of time and some money to remove it. Read this Home Paper to your wife (that is, if she hasn't read it first) and ask her if I am not exactly right. We are two miles from the store and postoffice) and my short cuts are appreciated here, I tell you. Of course, I am doing work on land that is not my own; and some of the paths I have spent money on are liable to be plowed up in the spring; but I have had the fun of making them, and have demonstrated their value, so I expect to get help in my work in due time.

Every sort of obstruction should be got out of the patch. In riding a wheel, a round stone the size of a marble often gives the rider a disagreeable wrench, and it has seemed to me that every such round stone or piece of root takes a malicious pleasure in rolling into the middle of the path, and bothering you every time you happen to pass, especially when you are going up a grade, carrying a load. At such a time you make a crookeder course, especially when you slow up when almost at the very summit; and then to have a pebble or root throw you off just when you have exerted your utmost strength to keep *on* — why, it almost makes bad words come into your thoughts, even if you have tried ever so hard to keep them out. Now, whenever I go that way again on foot I make it my business to pick up all such objects and hurl them far away. If you just kick them to one side you are sure to be bothered by that very same crooked stick again. I have some-

times wondered if they "wiggle" back again as soon as you are out of sight. Take a look at the tired horses on almost any highway, and notice the strength that is wasted in making the heavy wheels grind and crunch over round stones scattered all along the road. The next team pulls laboriously over the same stones. They are rolled about in every direction; but the "pesky" things *never* roll out of the road into the ditch, or at least so it seems. I once saw a man picking up these stones, on a stony sidehill in front of his home. He said it was a part of his religion to remove the *cause* of bad words from traveling teamsters. Shall we not all make it a part of *our* religion to remove *all* stumbling-blocks from the paths of tired struggling humanity? Mrs. Root is in full sympathy with me in this work, and I sometimes smile to see *her* stop to clear the path when I thought we were *both* too tired for such *missionary* work.

When a hill is round-top, like the half of a sphere, it is folly to think of going over it, either with path or wagon-road, for it is no further around it, on level ground, than climbing over the top. In laying out roads, it is desirable to follow division-lines between different owners, and for this reason roads are often carried over instead of around hills. But few hills, however, are round, like the half of an apple, and, taking hills as we find them, how far will it be advisable to go around to save climbing over the top? This is one of the problems that are hard to settle. With a wheel I have often thought I could save time and strength by going *two* miles over a good level road rather than go *one* mile over a hilly and stony road; and it is usually easier to get a *smooth* hard road, on level ground, than on hilly or uneven ground.

Going around a valley or hollow is much like going around a hill. In cutting my wheel-path, a very deep ravine lay right in my course. To go around on a level was too far, so I made a curve that was *lowest* where it was furthest from the course I desired to go; and this arrangement makes a very pretty curve, first gradually down, then gradually up again, and the spot of ground we go around is my "ravine garden," where every thing grows so luxuriantly. A few nasturtiums and balsams along the path give a very pretty effect. A path that is easy for the wheel—that is, hard and smooth—and the ups and downs gradual, I have found easiest for foot travel. One who has had much poor health learns to appreciate every thing that saves strength; and I have sometimes thought there was, perhaps, a kind providence in giving me many periods in life when I was really obliged to make it a study how best to ease the burdens I felt compelled to bear. I have chosen the lightest tools for my use that would do the work; the lightest clothing that would keep me warm enough, and, finally, the very easiest paths and short cuts to and from my daily toil. May the Lord be prais-

ed that here in this Traverse region I am not obliged to use so much of this kind of economy, for now I often climb great hills, "just for the fun of it." In fact, the very ground I am clearing off to-day for peaches and potatoes is right over large hills.

I believe I have always had a fondness for paths, especially paths through the woods. Just now the pathways through our woods are all carpeted with soft leaves of the most brilliant hues; and the colors of the beeches and maples overhead, contrasting with the rich green of the hemlocks, make a picture that might call forth words of praise from any one. This view is all the time around "our cabin in the woods;" and the red squirrels and chipmunks, since they have found we are friendly, make an agreeable second to it all by coming clear up on our front doorstep and looking at us inquiringly with their beautiful bright eyes. Yes, and if one *looks* and *listens* he may *hear* and *see*, also, birds of many colors. Why, who is there who doesn't feel a thrill, when pleasure or business calls him into a path through the woods, during these October or November days?

Every foot-path is more or less for the people; it is more or less for the great wide world to travel over, and, therefore, he who makes a better path, or even removes the stone or root that has tripped or caused many people to stumble has done missionary work. "Path-making" is an unselfish work. It not only saves the strength of exhausted, tired, suffering humanity, but it often saves the utterance of oaths and curses. I do not think I ever enjoyed any work of my life more than studying up, and making to my notion, a good foot-path where one is needed. When I first went down through where my ravine garden is now, a year ago, it took me a long time to get through the bushes and climb over rotten logs piled up over each other; and when I got across I was pretty well tired out. Now I go around the curve on my wheel in little more than a second. Since the neighbors have found it is a pleasant and agreeable "short cut," it is traveled so much that the ground keeps hard and smooth, and all the weeds are kept down. This is one of the pleasant things about path-making. After you once get it *started right*, the busy feet of the great wide world keep it in good repair.

Dear friends, is it not so with every thing good and pure and lovely? The person who starts honest and wholesome amusement in any neighborhood, in the place of intemperance and saloon-visiting, is a path-maker, and so with a thousand other good things. Path-making reminds me of that grand old text, "He which converteth the sinner from the error of his way shall save a soul from death, and shall hide a multitude of sins."

I have no hesitation in saying your ABC is the best bee-book ever published, and up to date in every way.

W. P. MEADOWS.
System (near Leicester), England.



HIGH-PRESSURE GARDENING IN THE TRAV-
ERSE REGION OF NORTHERN MICHIGAN.

I have told you already of the fertile soil where I cleared up my garden-patch in the woods. Well, at this date, Oct. 17th, every thing is still growing unharmed by frost, although we have had several nights when the thermometer went below freezing. I am told this is the rule in this locality with so much water around us, and, in fact, I have seen it during two falls. We have had snow and ice, but no frost; and our beans, tomatoes, and all tender things, are still unharmed. In Ohio I have learned to expect frost when the temperature is 50 or below at sundown—that is, if the night is clear and bright starlight; but here it is 40, or still lower, night after night, at sundown, with the brightest starlight I ever saw, and no sign of such frosts as we have in Ohio.

You may wonder what "gardening" I have been doing here in October. To be exact, it has been rather getting ready for gardening next year, or, perhaps we had better say, farming. Our 40 acres is not quite all woods. About 22 years ago four or five acres were cleared and brought under cultivation; but since then nothing has been done with any part of the 40 unless it was to pasture it to some extent. The cleared part was soon covered with a dense and heavy sod of June grass, and, later, sumac has proceeded to make a most luxuriant growth, pushing out further and further every season. Well, the "high pressure" work we have been doing this fall is cutting off the sumac with brush-scythes, and then turning the sod with a strong team and a heavy plow. Besides the sumac, little maples (and, worst of all, elms) we found scattered here and there. It looked to me almost out of the question to get rid of elms 6 to 8 inches through, so as to do a good job of plowing; but we have got it done. They were chopped off about 4 ft. from the ground, the big roots were grubbed and chopped off, and then with a chain hitched to the top of the stump, by alternate pulling and more cutting of roots we got them out. We are getting the land ready to sow rye, at the rate of two bushels to the acre. This rye is to be turned under next June when in bloom, and potatoes planted on the "Bal-lasch" plan.

You may be surprised when I tell you there are no land-rollers around here. The farmers say they have no use for them, for there are never any lumps to be crushed. The harrows used here, especially for new land, are the spring-tooth, and it was one of my "happy surprises" to see what just "once going over" did in the way of making a nice seed-bed. The ground was not only comparatively level, but it was fine and soft, without a lump of any kind—

nothing to be crushed, nothing to be made finer. Mr. Hilbert uses a "float" to make the ground smooth and level for his strawberries; but farmers rarely use any thing of the kind here for their grain crops. Now, this ground is not sand, mind you. It is a sort of loam, and the new virgin soil (like that in our garden) is a sort of black loamy "woods dirt." Of course, the old experienced farmers around here are, as a rule, prepared to teach me; but I have taught them a few things, and compelled them to own up. To get a team and man to do this heavy work of breaking up new ground I had to pay \$3.50 per day, and it took another man at \$1.50 to cut the brush, burn up the trash, etc. Now, when you are paying \$5.00 a day, or 50 cents an hour, it pays to avoid false moves. It is expensive business turning a 30-hundred team clear around 20 or 30 times a day when it isn't really necessary; yet few farmers, so far as I can learn, seem to be aware of this. On this account I urged for long straight furrows. But several other things must be taken into account. First, it is always desirable to turn a furrow down hill unless the ground is quite level; and when there are roots and trash to make the plowing extremely difficult, then it is most important that no furrow be turned the least bit up hill. Our land is quite uneven, much of it made up of quite steep hills. Now, there are several ways of avoiding the necessity of turning any furrow up hill. Of course, there are sidehill plows; but these are complicated, not as strong, and they do not, as a rule, do as good work as the best common plows. Now, then, how can we manage so as to plow hilly land with a common plow, and not turn any furrows very much up hill? First, if the hill admits we can commence at the bottom and plow around it. Second, if there is a ravine between two hills we can run up one side and down the other. This works all right until you get part way up the hill on each side. How shall you cross over from one side to the other? We might go "empty;" but if you are going to waste your own time and the strength of the team in drawing an empty plow, why not plow your sidehill by turning a furrow only one way, and going back "empty"? I do not like this way of plowing, even if Mr. Terry, in the "Potato-book," does give it a sort of sanction. You can cross over from one side of the ravine to the other by turning around on a curve when crossing the bottom of the ravine, so that your strip of plowed ground will be oval-shaped, or at least oval, or egg-shaped, across the ends. Third, if you have level land, or nearly level, turn one furrow up at the bottom of the hill, and back-furrow against it, curving the ends egg-shape as before, so that you turn a furrow down hill, even when going across the ends. If the top of the hill has some level land on it, or nearly level, do the same with the top of the hill and one of the sides. (In my case the opposite side of the hill belongs to my neighbor.) In this case

you must stake out your ground and plow first along the outside, turning all your furrows out. Start it oval, or egg-shaped, as the lay of the land may require. Irregular-shaped hills may require a combination of all—first, second, and third; but whatever you do, never plan so as to turn the team around if it can be avoided. Imagine a big team fussing with little triangles or squares to finish up. One such may be necessary; but some plowmen will have a number of them in plowing five or ten acres in hilly or uneven land.

By the way, do any of our readers know of a book that tells all about plowing—especially plowing on uneven ground, and clearing-up of uneven woodland? Our land here is particularly suited to fruit-trees, especially peaches; and the peaches seem to be particularly suited to the hills—yes, the very tall and steep hills. Now, if you turn a furrow down hill, year after year, where will the trees be, especially those near the top? In our "Potato-book" Terry directs that the plowing be so managed that the fields be not thrown out of shape by repeated plowing, and this is all right for level ground. How about the hills?

How many farmers plow so as to have a stout team do some useful work when going to and from the fields, morning, noon, and night? If every one of them were obliged to pay 35 cents (or more) for man and team every hour he had them, perhaps he would do a little more figuring. I am going to try five or six acres of potatoes on this new land, hiring every bit of the work, and I will try to let you know how it turns out. I do not mean to find fault with my helpers, and so far they are skillful, capable men; but I really wish they had a little more enthusiasm in pushing the work along. Something seems all the while coming along to make them want "a day off." After dinner to-day it rained; but by the middle of the afternoon the weather was beautiful, but not one of them "showed up." Of course, I hire men and teams by the day. I could get my clearing and plowing done by the acre; but then I should get only an ordinary job. If I am going to show people some "high-pressure" work I want the stones picked off, and every thing else that will hinder a first-class job of plowing. Then I want it "first class" all the way through. If I don't get my money back the first year, I have faith to believe I shall later.

Very little manure is used in this region. They say the land, especially the new land, doesn't need it. After the new land is once made clean it is very easy to work and keep out the weeds.

To make cows pay, use Sharples Cream Separators. Book "Business Dairying" & cat. 288 free. W. Chester, Pa.

WANTED.—A man with a small family, who has had some practical knowledge of bee-keeping, to work in apiary and on small fruit-farm.

A. E. WOODWARD, Grooms, Saratoga Co., N. Y.



PLAIN SECTIONS 25 CENTS PER 1000 CHEAPER.

We have decided, for the coming year, to make the price of plain sections 25 cents per 1000 less than the beeway sections. This applies to the Danzeubaker, 4x5x1 $\frac{3}{8}$, the Ideal 3 $\frac{3}{4}$ x5x1 $\frac{1}{2}$, and the 4 $\frac{1}{4}$ x4 $\frac{1}{2}$ x1 $\frac{3}{8}$, 1 $\frac{1}{2}$, or 1 $\frac{3}{4}$. All other widths to remain at last year's prices. This reduction applies to No. 2 as well as No. 1 grade.

HONEY-CANS HIGHER.

We have just received prices on cans from the trust, and find we shall have to mark up our list prices on $\frac{1}{2}$, 1, and 5 gallon cans for the coming season; $\frac{1}{2}$ and 1 gallon cans will be \$1.00 per 100 higher, or 10c per box; and 5-gallon cans, 2 in a box, will be 5 cents per box higher; one in a box, about 3 cents per box higher.

HONEY-PACKAGES.

We are now well supplied with No. 25 jars, both in barrels and boxes, and we hereby renew the special offer made a month ago, to supply these and the No. 100 in boxes at 50 cts. per gross more than the price in barrels. These jars are becoming more and more popular for honey, because they are so valuable as a fruit jar after the honey is used up. With our present stock we can ship promptly large or small lots as may be needed.

A BARGAIN IN MACHINERY.

Any one in want of good second-hand machinery for hive-making can secure a bargain at Knoxville, Iowa. A good wood-frame rip-table and an 18-inch Gem planer can be had for \$60; planer has been used but little, and is a bargain alone at this price. A 10 H. P. boiler and engine, with about about 25 feet of line shafting, pulleys, hangers, etc., can be had for \$165; all together for \$220. We shall be pleased to hear from any one interested. The owner has made other plans, and must move the machinery promptly, as it is in the way; hence the very low offer. If you wish further particulars regarding the outfit, write to J. W. Bittenbender, at Knoxville, Iowa, who will cheerfully give you what information he can.

HONEY MARKET.

We are now well supplied with both comb and extracted honey, and prepared to make prompt shipment. We shall be pleased to hear from those in need of honey, either comb or extracted. For comb we are getting from retailers 17c for fancy 16 for No. 1 white; 15 for fancy amber, and 14 for No. 1; one cent per pound less in large lots. We have two or three good-sized lots of very nicely flavored white honey in well-filled plain sections which is somewhat travel-stained, and not very carefully graded. We offer these lots at No. 1 white price, although there is quite a proportion of fancy in them. We have just received a car of comb honey from Inyo Co., Cal. This contains over 1100 cases of fancy and No. 1. Inquiries solicited.

CONVENTION NOTICE.

THE COLORADO ANNUAL MEETING.

- The place? Denver.
- The dates? November 18th, 19th, and 20th.
- The papers? By successful bee-keepers.
- The discussions? By men and women who know something.
- The stereopticon lectures? By E. R. Root and Prof. C. P. Gillette.
- The exhibition? Of the best and sweetest and whitest (and yellowest) honey in the United States; and the sharpest vinegar.
- The premiums? Valuable enough and varied enough to appeal to every competent bee-keeper.
- Interested? Write for a premium list to box 432, Denver, Colorado.

D. W. WORKING, Sec'y.

FOR SALE.—Two cars comb and extracted alfalfa clover honey. VOGELER SEED & PRODUCE Co., Salt Lake City, Utah.



Red Glover Queens -FOR- 1902

Warranted Purely Mated.
The Long-Tongue Variety.

How to get One for Only 30 cts.

We have arranged with the queen-breeder who furnished Long-Tongue Red Clover Queens for us during the past season, to fill our orders next season. Although fully 95 percent of the untested queens he sent out were purely mated, next season all he mails for us will be **warranted** purely mated.

We want every one of the readers of Gleanings in Bee-Culture, who is not now a reader of the old weekly American Bee Journal, to have one of these Superior Red Clover Queens. We have received most excellent reports from the Queens we supplied during the past season. And next year our breeder says he expects to be able to send out even better Queens, if that is possible. He is one of the very oldest and best queen-breeders. His bees average quite a good deal the longest tongues of any yet measured. The Breeder he will use is direct from Italy, having imported her himself. Her worker-bees are large, of beautiful color, very gentle, scarcely requiring veil or smoker.

Orders for these fine, "long-reach" **warranted** Queens will be filled in rotation—"first come, first served"—beginning as early in June, 1902, as possible. It is expected that orders can be filled quite promptly (even better than the past season), as a much larger number of queen-rearing nuclei will be run. (But never remove the old queen from the colony until you receive the new queen, no matter from whom you order).

In order that all who are not now readers of the American Bee Journal can have one of these fine Queens, we will make the price **only 30 cents** each, when taken in connection with a year's subscription. That is, send us \$1.30 (if you are a **NEW** subscriber), and we will book your order for a **Warranted Queen**, and enter your name on our list of subscribers and send you the **Bee Journal every week** from the time we receive your name and \$1.30 **until the end of next year (1902)**. So the sooner you send in your order the more copies of the Bee Journal you will receive. If you have not seen the weekly American Bee Journal, send for a free sample copy. Address,

GEORGE W. YORK & CO.

144 & 146 Erie Street, CHICAGO, ILL.

 We are headquarters in Chicago for **ROOT'S BEE-KEEPERS' SUPPLIES AT ROOT'S PRICES.**
Catalog Free....

CALIFORNIA SAGE HONEY.

The world again sweetened with our famous sweet. Bees increasing fast. Bee-men very active. Tons of nectar lost for want of bees to gather. The PACIFIC BEE JOURNAL controls thousands of acres of fine field. Many fields to let. A few bees for sale—and climate too. Four hundred pounds to the colony, twenty tons to the 100 colonies in some instances.

Pacific Bee Journal, Los Angeles, Cal.

\$1 per year; 25c for 3 months' trial; 50c this year and six months of 1902; \$1 for this year and all of 1902; with Gleanings, \$1.25 a year.

Mr. A. I. Root's Writings

of Grand Traverse territory and Leelanau Co. are descriptive of Michigan's most beautiful section reached most conveniently via the

PERE MARQUETTE R. R.

For pamphlets of Michigan farm lands and the fruit belt, address W. C. Tousey, D. P. A. Toledo, Ohio.

BELGIAN HARES!

With every hare sold goes a full pedigree, register number, and score-card, scored by an official judge. Does will be bred to one of our famous high-scoring bucks free. Write for book, Mr. of The A. I. Root Co. J. B. MASON, MECHANIC FALLS, MAINE.



Belgian Hares

I have some fine hares for sale at reasonable prices.

J. F. Moore. : Tiffin, Ohio.



Subscription Combinations!!

We take pleasure in offering the readers of GLEANINGS a few of our combinations. If you do not see what you want we have a 14-page catalog free for the asking. These prices are for a full year, and may be either for new or renewal, except where stated. Sent to different addresses if desired, and will be mailed direct from the publisher the same as they would if you ordered direct. The offers are made by the publishers, and we are their special agents. Success, Leslie's Monthly, and Cosmopolitan, \$2.00. In the above offer, in place of Leslie's or Cosmopolitan you may substitute any of the following: Gleanings, Farm Poultry, Good Housekeeping, Household, Practical Farmer, Designer, Health Culture, Hints, The Era, new subscription to Recreation. Success must be in any list made from above—the others are interchangeable. Everybody's Magazine, Practical Farmer (new subscription), and your choice of a new subscription to either Harper's Bazar, American

Box, Little Folks, or Sunday School Times.....	\$1.75
Gleanings and Great Round World.....	1.99
Gleanings and Century.....	4.65
Gleanings and Scribner's.....	3.30
Gleanings and Outing.....	3.00
Gleanings and Farm Poultry.....	1.00
Gleanings and Country Gentleman.....	1.50

Youtan's Companion may be added to any offer for \$1.75, and new subscribers get November and December free, also art calendar. Ladies' Home Journal may be added for \$1.00. McClure's may also be added for \$1.00. By our arrangements with publishers these offers are good until Sept. 1st, 1902. We want to send you our catalog. Ask for it, and address all orders to C. M. Woodspeed, Box 791, Skaneateles, N. Y.



PAGE

FOR HARD USAGE

we don't think you can find any thing better. Page Woven Wire Fence Co., Box S, Adrian, Michigan.



HUNTER-TRADER-TRAPPER—A monthly. Sample copy, 5 cts. All about Hunting, Trapping and Raw Furs. A. R. Harding, Gallipolis, O.

Strong Testimony in Favor of Moore's Prize-winners.

Oland, Mo., Sept. 13, 1901.
 J. P. Moore, Dear Sir:—Enclosed please find \$2.25, for which you will send me three of your red-clover queens. I am pleased with the one I got of you. They make honey when other bees are idle.
 Yours truly, JOS. T. WHITTIG.

Daughters of my 23-100 breeder, the prize-winner: Untested, 75c; six, \$1.00; dozen, \$7.50. Select untested, \$1.00; six, \$5.00; dozen, \$9.00. Safe arrival and satisfaction guaranteed. Descriptive circular sent free. I am filling all orders by return mail, and shall probably be able to do so till the close of the season.

J. P. Moore, Lock box 1, Morgan, Pend. Co., Ky.
 (Mr. J. P. Moore is entirely reliable.—A. I. R. Co.)

Wisconsin Farm Lands.

The best of farm lands can be obtained now in Marinette County, Wisconsin, on the Chicago, Milwaukee & St. Paul Railway, at a low price and on very favorable terms. Wisconsin is noted for its fine crops, excellent markets, and healthful climate. Why rent a farm when you can buy one much cheaper than you can rent, and in a few years it will be your own property? For particulars address F. A. Miller, General Passenger Agent, Chicago, Milwaukee & St. Paul Railway, Chicago.

FOR SALE.—15 colonies of bees at \$2.50 each; all in 8-frame Langstroth hives; all strong healthy colonies; have plenty of honey to winter on. Put on train in good shipping condition.
 GUY LIPSCOMB, Demapolis, Ala.

We will be in the market for honey the coming season in carloads and less than carloads and would be glad to hear from producers everywhere what they will have to offer.
 SEAVEY & FLARSHHEIM,
 1318-1324 Union Avenue, Kansas City, Mo.

WANTED.—We are in the market for honey, either local or carlots, commission or purchase. We especially desire Wisconsin basswood, and will be pleased to hear from that State.
 EVANS & TURNER,
 Town St., Cor. 4th, Columbus, Ohio.

FOR SALE—Extracted honey, cans and kegs, 7 to 8 cts. per lb. Sample, 5 cts. Comb honey, 13 to 14 cts. Beeswax wanted.
 I. J. STRINGHAM, 105 Park Place, New York.

WANTED.—Comb honey and beeswax. State price delivered Cincinnati.
 C. H. W. WEBER,
 2146 2148 Central Ave., Cincinnati, Ohio.

FOR SALE—30 to 35 cases heartsease honey, two cans to a case (120 lbs.); new cans; 8 cts. per pound.
 JOHN A. THORNTON, Lima, Ills.

An Old Friend.

Among the very first of the incubator and brooder concerns of the country to advertise in our columns was the "Reliable," of Quincy, Ill. Although a number of years has passed since their first advertisement appeared in our paper, there has not been a year since that first time when they have not been with us during the regular advertising season. It affords us, therefore, more than usual pleasure to state that they will advertise with us again this season, and their announcement appears on another page of this issue. Our relationship with these people has been most pleasant through all these years; and while we feel that our paper has been the means of doing them much good, we also know that they have done much good to our readers. The Reliable goods are reliable in works and results as well as in name, and those of our readers who contemplate the purchase of machines of this class can do no better than to buy the time-tested old Reliable. Their 20th Century Catalog is, as usual, a work of great value. Write them to-day for a copy. Address Reliable Incubator & Brooder Co., Quincy, Ill., and mention this paper.



200-Egg Incubator for \$12.80
 Perfect in construction and action. Hatches every fertile egg. Write for catalogue to-day.
 GEO. H. STAHL, Quincy, Ill.

Angora Goats. Delance bucks; good stock; low prices; large circular for stamp.
 ED. W. COLE & Co., Kenton, O.

FOR SALE.—80 colonies of bees at \$1.50 each.
 H. VOGELER, New Castle, Cal.

Books for Bee-keepers and Others.

Any of these books on which postage is not given will be forwarded by mail postpaid, on receipt of price. In buying books, as every thing else, we are liable to disappointment if we make a purchase without seeing the article. Admitting that the book-seller could read all the books he offers, as he has them for sale, it were hardly to be expected he would be the one to mention all the faults, as well as good things about a book. We very much desire that those who favor us with their patronage shall not be disappointed and therefore we are going to try to prevent it by mentioning all the faults, so far as we can, that the purchaser may know what he is getting. In the following list, books that we approve we have marked with a *; those we especially approve, **; those that are not up to times, †; books that contain but little matter for the price, large type, and much space between the lines, ‡; foreign, §. The bee-books are all good. As many of the bee-books are sent with other goods by freight or express, incurring no postage, we give prices separately. You will notice that you can judge of the size of the books very well by the amount required for postage on each.

BIBLES, HYMN-BOOKS, AND OTHER GOOD BOOKS.
 Postage.] [Price without postage.

8	Bible, good print, neatly bound	20
10	Bunyan's Pilgrim's Progress**	40
	Christian's Secret of a Happy Life,** 50c; cloth 1 00	
3	John Ploughman's Talks and Pictures, by Rev. C. H. Spurgeon*	10
1	Gospel Hymns, consolidated, Nos. 1, 2, 3, and 4, words only; cloth, 10c; paper.....	5
2	Same, board covers	20
5	Same, words and music, small type, board cov.	45
10	Same, words and music, board covers.....	75
3	New Testament in pretty flexible covers.....	05
<i>One-third off on all Gospel Hymns mentioned above.</i>		
5	New Testament, new version, paper covers.....	10
4	Stepping Heavenward**.....	18
5	Tobacco Manual**.....	45

This is a nice book that will be sure to be read, if left around where the boys get hold of it, and any boy who reads it will be pretty safe from the tobacco habit.

BOOKS ESPECIALLY FOR BEE-KEEPERS.

20	A B C of Bee Culture, cloth.....	1 00
	Advanced Bee Culture, by W. Z. Hutchinson ...	50
3	Amateur Bee-keeper, by J. W. Rouse.....	22
14	Bees and Bee-keeping, by Frank Cheshire, England, Vol. I, §.....	2 36
21	Same, Vol. II, §.....	2 79
	Same, Vols. I. and II., postpaid	5 25
10	Bees and Hovey, by T. G. Newman.....	65
10	Cook's Manual, cloth.....	1 15
5	Doolittle on Queen-rearing	95
2	Dzierzon Theory.....	10
3	Foul Brood; Its Natural History and Rational Treatment	22
1	Honey as Food and Medicine	05
10	Langstroth Revised, by Chas. Dadant & Son.....	1 10
15	Quinby's New Bee-keeping.....	90
	British Bee-keeper's Guide-book, by Thomas William Cowan, England §.....	40
	The Honey-bee, by Thos. William Cowan.....	95
3	Merrybanks and His Neighbor, by A. I. Root... ..	15
	Bienezucht und Honiggewinnung.....	50

Or "Bee Culture and the Securing of Honey," a German bee-book by J. F. Eggers, of Grand Island, Neb. Postage free.

MISCELLANEOUS HAND-BOOKS.

5	A B C of Carp Culture, by Geo. Finley.....	25
5	A B C of Strawberry Culture,** by T. B. Terry... ..	35

Probably the leading book of the world on strawberries.

5 | A B C of Potato Culture, Terry**.....35
This is T. B. Terry's first and most masterly work.

8 | Barn Plans and Out-buildings*..... 90
Canary birds, paper 50

2 | Celery for Profit, by T. Greiner**..... 25
The first really full and complete book on celery culture, at a moderate price, that we have had. It is full of pictures, and the whole thing is made so plain that a schoolboy ought to be able to grow paying crops at once without any assistance except from the book.

15 | Draining for Profit and Health, Warring..... 30

10 | Fuller's Grape Cultivist**.....1 15

8 | Domestic Economy, by I. H. Mayer, M. D.** ... 30
This book ought to save at least the money it costs, each year, in every household. It was written by a doctor, and one who has made the matter of domestic economy a life study. The regular price of the book is \$1.00, but by taking a large lot of them we are enabled to make the price only 30 cents.

10 | Farming for Boys*.....1 15
This is one of Joseph Harris' happiest productions, and it seems to me that it ought to make farm-life fascinating to any boy who has any sort of taste for gardening.

7 | Farming with Green Manures, postpaid**..... 90

7 | Farm, Gardening, and Seed-growing** 90

12 | Gardening for Pleasure, Henderson*.....1 35

12 | Gardening for Profit**.....1 35

8 | Gardening for Young and Old, Harris**..... 90
This is Joseph Harris' best and happiest effort. Although it goes over the same ground occupied by Peter Henderson, it particularly emphasizes thorough cultivation of the soil in preparing your ground; and this matter of adapting it to young people as well as old is brought out in a most happy vein. If your children have any sort of fancy for gardening it will pay you to make them a present of this book. It has 187 pages and 46 engravings.

3 | Grasses and Clovers, with Notes on Forage Plants 20
This is by Henry A. Dreer, author of the book, "Vegetables Under Glass" that has had such a large sale of late. This little book tells how six tons of grass has been grown to the acre, and gives much other valuable matter.

10 | Greenhouse construction, by Prof. Taft**.....1 15
This book is of recent publication, and is as full and complete in regard to the building of all glass structures as is the next book in regard to their management. Any one who builds even a small structure for plant-growing under glass will save the value of the book by reading it carefully.

12 | Greenhouse Management, by Prof. Taft**.....1 15
The book is a companion to Greenhouse Construction. It is clear up to the times, contains 400 pages and a great lot of beautiful half-tone engravings. A large part of it is devoted to growing vegetables under glass, especially Grand Rapids lettuce, as well as fruits and flowers. The publisher's price is \$1.50; but as we bought quite a lot of them we can make a special price as above.

5 | Garden and Farm Topics, Henderson**..... 60

5 | Gregory on Cabbages, paper* 20

5 | Gregory on Squashes, paper*..... 20

5 | Gregory on Onions, paper*..... 20
The above three books, by our friend Gregory, are all valuable. The book on squashes especially is good reading for almost anybody, whether they raise squashes or not. It strikes at the very foundation of success in almost any kind of business.

1 | Handbook for Lumbermen..... 05

5 | Home Pork-making; 125 pages, illustrated..... 40
I think it will pay well for everybody who keeps a pig to have this book. It tells all about the care of the pig, with lots of pictures describing cheap pens, appliances, all about butchering, the latest and most approved short cuts; all about making the pickle, barreling the meat, fixing a smoke-house (from the cheapest barrel up to the most approved arrangement); all about pig-troughs; how to keep them clean with little labor; recipes for cooking pork in every imaginable way, etc. Publisher's price is 50 cents, ours as above.

10 | Household Conveniences.....1 40

15 | How to Make the Garden Pay**.....1 35

2 | How to Propagate and Grow Fruit, Green*..... 15

2 | Injurious Insects, Cook..... 10

10 | Irrigation for the Farm, Garden, and Orchard* 85
By Stewart. This book, so far as I am informed, is almost the only work on this matter that is attracting so much interest, especially recently. Using water

from springs, brooks, or windmills to take the place of rain, during our great drouths, is the great problem before us at the present day. The book has 274 pages and 142 cuts.

3 | Maple Sugar and the Sugar-bush**..... 32

4 | Peabody's Webster's Dictionary..... 10
Over 30,000 words and 250 illustrations.

5 | Manures; How to Make and How to Use Them; in paper covers..... 30

6 | The same in cloth covers..... 65

1 | Nut Culturist, postpaid.....1 50

3 | Onions for Profit**..... 40
Fully up to the times, and includes both the old onion culture and the new method. The book is fully illustrated, and written with all the enthusiasm and interest that characterizes its author, T. Greiner. Even if one is not particularly interested in the business, almost any person who picks up Greiner's books will like to read them through.

1 | Onr Farming, by T. B. Terry**..... 1 50
In which he tells "how we have made a run-down farm bring both profit and pleasure."
If ordered by express or freight with other goods, 10c less.

1 | Poultry for Pleasure and Profit.**..... 10

8 | Practical Floriculture, Henderson* 1 10

10 | Profits in Poultry,* 75

1 | Silk and the Silkworm 10

2 | Small-Fruit Cultivator, Fuller 1 10

2 | Sorghum, Stock Beets, Strawberries, and Cement Floors. By Waldo F. Brown..... 08

10 | Talks on Manures* 1 35

10 | The New Agriculture; or, the Waters Led Captive (a \$1.50 book) 40

11 | The New Egg-Farm, Stoddard**..... 70
This is an enlarged edition of the 50-cent book published 25 or 30 years ago by H. H. Stoddard. If I could have only one poultry-book it would be the New Egg-farm. This book is of special value to me because it not only discusses most emphatically the value of exercise to poultry, but it touches on the value of exercise to all other animated nature, including humanity. The book has over 300 pages and 150 illustrations. It is entirely different from any other poultry-book in the world, inasmuch as it discusses mechanical contrivances so that all the varied operations of a poultry-farm may be done as much as possible with the aid of machinery. The regular price is \$1.00, but by buying a quantity we are able to furnish it at price given.

2 | Treatise on the Horse and his Diseases..... 10

5 | Tile Drainage, by W. I. Chamberlain..... 35
Fully illustrated, containing every thing of importance clear up to the present date.
The single chapter on digging ditches, with the illustrations given by Prof. Chamberlain, should alone make the book worth what it costs, to every one who has occasion to lay ten rods or more of tile. There is as much science in digging as in doing almost anything else; and by following the plan directed in the book, one man will often do as much as two men without this knowledge.

5 | Tomato Culture 35
In three parts.—Part first.—By J. W. Day, of Crystal Springs, Miss., treats of tomato culture in the South, with some remarks by A. I. Root, adapting it to the North. Part second.—By D. Cummins, of Conneaut, O., treats of tomato culture especially for canning-factories. Part third.—By A. I. Root, treats of plant-growing for market, and high-pressure gardening in general.

3 | Vegetables under Glass, by H. A. Dreer**..... 20

3 | Vegetables in the Open Air*..... 20
This is a sort of companion book to the one above. Both books are most fully illustrated, and are exceedingly valuable, especially at the very low price at which they are sold. The author, H. A. Dreer, has a greenhouse of his own that covers one solid acre, and he is pretty well conversant with all the arrangements and plans for protecting stuff from the weather, and afterward handling to the best advantage when the weather will permit out of doors.

3 | Winter Care of Horses and Cattle,..... 25
This is friend Terry's second book in regard to farm matters; but it is so intimately connected with his potato-book that it reads almost like a sequel to it. If you have only a horse or a cow, I think it will pay you to invest in a book. It has 41 pages and 4 cuts.

3 | Wood's Common Objects of the Microscope**.. 47

8 | What to Do and How to be Happy While doing It, by A. I. Root 65

1881

PAGE & LYON MFG. CO.

1901

We manufacture a full line of the latest
BEE-SUPPLIES.

Our motto is, "Perfect Goods and Prompt Shipment."

Send for our new free illustrated catalog.

PAGE & LYON MFG. CO., New London, Wisconsin.

Marshfield Manufacturing Company.

Our specialty is making SECTIONS, and they are the best in the market. Wisconsin basswood is the right kind for them. We have a full line of BEE-SUPPLIES. Write for FREE illustrated catalog and price list.

Marshfield Manufacturing Company, Marshfield, Wisconsin.

I. J. Stringham, 105 Park Place, New York City.

Keeps in stock a full line of modern appliances for bee-keepers.

SQUARE CANS & SHIPPING-CASES.

One-pound square flint jars with corks, \$5.00 a gross. Cartons of a superior quality at a low price. Tested Italian queens, \$1; untested, 75c. Apiaries, Glen Cove, L. I. Catalog free.

I. J. Stringham, 105 Park Place, New York City.

Standard - Bred Queens !

Acme of Perfection ; Not
a Hybrid among Them.

Improved Strain Golden Italians.

World-wide reputation ; 75c each ; six for \$4.00.

Long-tongued 3-banded Italians.

Bred from stock whose tongues measured 25 hundredths inch. These are *the* red-clover hustlers of America ; 75 cts. each ; six for \$4.00. Safe arrival guaranteed ; Catalog on application. Headquarters for bee-keepers' supplies.

Fred W. Muth & Co., Cincinnati, Ohio.
South-west Corner Front and Walnut Streets.

CHAS. ISRAEL & BROS.,
486-490 Canal St., Corner Watt St., N. Y.

Honey and Beeswax.

Liberal Advances made on Consignments. Wholesale Dealers and Commission Merchants. Estab. 1875.

Minnesota Bee-keepers' Supply Mfg. Co., Manufacturers of Bee-hives, Sections, Shipping-cases, and Everything Used by Bee-keepers.

Orders filled promptly. We have the best shipping facilities in the world. You will save money by sending for our price list. Address

**Minnesota Bee-keepers' Supply Mfg. Co.,
Nicollet Island Power Building, Minneapolis, Minn.**

Queens. From my breeders, 75 cts.; select, \$1.00, tested, \$1.25. For particulars, see former advts. and circulars.
Queens. J. B. CASE, Port Orange, Fla.

For Sale. 100 strong colonies bees in 10-frame hives (mostly Dov'd), with ½ story supers for comb honey; every frame full of sealed honey and winter stores; about 50 lbs. net weight to hive—at \$3.00 per colony, one mile from railroad; healthy bees—no disease ever been in these parts. Am going to Florida in 10 days; bees must be sold before I go. Write, wire, or phone. ALBERT WITTENMYER, Emison, Ind.



STERN OLD MOTHER EXPERIENCE

has enabled us after 15 years to make perfect **The Reliable Incubators and Brooders.** You ought to have our 24th Century Poultry Book in the house. It will cost you but 10 cents and will make you a master in the poultry business. **Reliable Incubator & Brooder Co., Box 5-49 Quincy, Ills.**

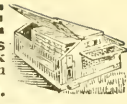

ALWAYS READY.
The **ADAM** Green Bone CUTTER

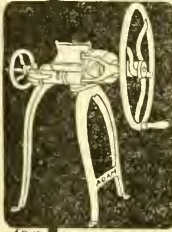

is always clean and ready for work. Impossible to choke it up. Cleans itself. **The Only Bone Cutter** with all ball bearings. Works quick and easily. No choking or injuring of fowls by shivers or sharp pieces. Cuts a clean light shave that is easily digested by smallest chicks. Send for Catalog No. 33. Contains much valuable information on the cut bone question. You will be pleased with it. Sent free upon request.
W. J. ADAM, JOLIET, ILLS.

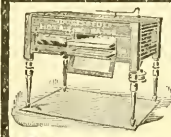

1 2 3 4 5 6
Count the Chicks as they come out. Then count the eggs, and you will see why so many people are using

Successful

Incubators and Brooders.
The healthy egg becomes the vigorous, husky, moneymaking hen. You will want our beautifully illustrated catalogue. Five different editions in five languages. English edition 4 cents; others free. It is a poultry Bible.
Des Moines Incubator Co.,
Box 503, Des Moines, Ia., or Box 503, Buffalo, N.Y.

A SHORT CUT TO POULTRY SUCCESS

Double your egg yield, double your profit by feeding cut raw bone.

MANN'S BONE CUTTER 1902 Model

New design, open hopper, enlarged table, new device to control feed. You can set it to suit any strength. Never clogs. Sent on **TEN DAYS FREE TRIAL.** No money asked for until you prove our guarantee on your own premises, that our new model will cut any kind of bone with adhering meat and rattle, faster and easier and in better shape than any other type of bone cutter. If you don't like it, send it back at our expense. Free Catalog explains all.

F. W. MANN & CO., Box 37, Milford, Mass.

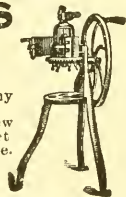

"GET A DANDY"

the fastest cutting bone cutter made, and double your egg yield. Sold direct on 30 days trial. \$5 up. Catalogue free.
Stratton Mfg. Co., Box 54, Erie, Pa.

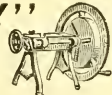

MAKE POULTRY PAY by feeding green cut bone. The Humphrey Green, Bone and Vegetable Cutter is guaranteed to cut more bone in less time with less labor than any other cutter made. Send for free book containing blanks for one year's egg record.
Humphrey & Sons, Box 51, Joliet, Ill.

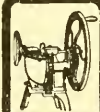

A Good Wagon

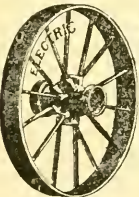

begins with good wheels. Unless the wheels are good the wagon is a failure. **IF YOU BUY THE ELECTRIC STEEL WHEEL** made to fit any wagon—your wagon will always have good wheels. Can't dry out or rot. No loose tires. Any height, any width tire. Catalog free.
ELECTRIC WHEEL CO.,
Box 95 QUINCY, ILL.

STEEL WHEELS

for your **FARM WAGONS** any size wanted, any width of tire. Hubs to fit any axle. No blacksmith's bills to pay. No tires to reset. Fit your old wagon with low steel wheels with wide tires at low price. Our catalogue tells you how to do it. Address **EMPIRE MFG. CO., Quincy, Ill.**

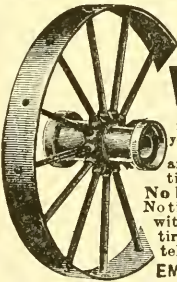

The Storm Proof KING WIND MILL

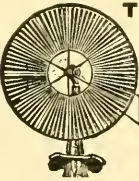

produces 25 to 50% more net power from any kind of wind than any other mill made. Wheel being only 1 in. thick, cuts the wind like a knife and is 400% more storm proof than any other. Exceedingly light, but wonderfully strong. Very sensitive—runs in lightest winds. Numerous sizes—6 ft up, both pumping and power, back gear or direct stroke. Send for circulars and prices before you buy. **Medina Mfg. Co., Box 11 Medina, O.**

Union Combination Saw

For Ripping, Cross-cutting, Rabbeting, Mitering, Grooving, Gaining, Boring, Scroll-sawing, Edge-moulding, Beading. Full line FOOT and HAND POWER machinery. Send for catalog A.
GENECA FALLS MFG. CO.,
44 Water St., Seneca Fs., N.Y.

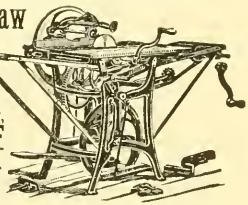

BUY MEDICINE BY MAIL

Beware "The Only Mail Order Drug House in the World." Our large and handsome illustrated Drug Book contains a list of 15,000 drugs, medicines, family remedies, sick room necessities, tonics, flavoring extracts, oils, paints, etc. 1500 illustrations. We send it for 10c to pay cost of mailing, and refund the amount out of the first order you send us. Send for a copy. You cannot tell how soon you may need something.
HULLER CHEMICAL CO., Dept. 40 Chicago, Ill.

1200 FERRETS. All sizes; some trained; first-class stock. New price list free
N. A. Knapp, Rochester Lorain Co., Ohio.

FOR SALE.—First class Angora cats and kittens.
MRS. HATTIE S. WEBBER, Monroe Ctr., Maine.

GREAT CLUBBING OFFERS!

My friends, how many of you are reading some of the many most excellent magazines of the day? If you are reading none, you are missing a great treat. Perhaps you regard them as luxuries. Possibly they are in some instances. They certainly help to fill out our lives, and give to us broader views. They are like windows that allow us to look out over the wide world. This life is not wholly one of dollars and cents—at least it ought not to be. Enjoyment, pure and simple, enjoyed just for the sake of enjoyment, is desirable and beneficial. To many there are few things that are more enjoyable than the bright pages of a really good magazine. To those who wish to give the magazines a trial, and to those who are already reading them, I can offer some of the lowest clubbing rates that have ever been offered. Here is a list of magazines, together with the regular prices at which they are published:

Review of Reviews.....	\$2.50	Cosmopolitan.....	\$1.00
Current Literature	\$3.00	Leslie's Popular Monthly.....	1.00
New England Magazine.....	3.00	The Household.....	1.00
Leslie's Weekly	4.00	Good Housekeeping.....	1.00
North American Review.....	5.00	The Designer.....	1.00
Success.....	1.00		

If you subscribe for one or more of these magazines, in connection with the Bee-keepers' Review, I can make the following offers:

Success and the Bee-keepers' Review for only.....	\$1.75
Success and any one of the above \$1.00 magazines and the Bee-keepers' Review for only.....	2.50
Success and any two of the above \$1.00 magazines and the Bee-keepers' Review for only.....	3.00
Success and any three of the above \$1.00 magazines and the Bee-keepers' Review for only.....	3.50
Success, Review of Reviews (new), and the Bee-keepers' Review for only.....	3.00
Success, Review of Reviews (old), and the Bee-keepers' Review for only.....	4.00
Success, Current Literature (new), and the Bee-keepers' Review for only.....	3.00
Success, Current Literature (old), and the Bee-keepers' Review for only.....	4.00
Success, the New England Magazine, and the Bee-keepers' Review for only.....	3.00
Success, Review of Reviews (new), any one of the above \$1.00 magazines, and the Review, for only.....	3.50
Success, Leslie's Weekly, and the Bee-keepers' Review for only.....	3.75
Success, Review of Reviews (new), Leslie's Weekly, and the Bee-keepers' Review for only.....	4.75
Success, North American Review (new), Review of Reviews (new), and the Review for only.....	5.00

Magazines will be sent to one or different addresses as desired.
 New subscribers to the Review will receive the rest of this year free.

W. Z. Hutchinson, Flint, Michigan.

THE SMITH PREMIER TYPEWRITER

Occupies an Imperishable Position in the BUSINESS WORLD.

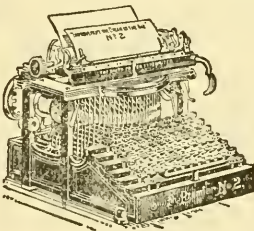

Unquestionable Superior Merit

Annually adds thousands of names to the long list of Smith Premier users, representing every line of trade and every profession.

ILLUSTRATED CATALOGUE FREE.

The Smith Premier Typewriter Co.,

158 Prospect Street, Cleveland, Ohio.

NOW READY!

64-PAGE CATALOG OF EVERY THING BEE-KEEPERS NEED. Illustrated and fully described. Especially valuable to beginners for the information it contains. Send your address on postal and get it now. Established 1884.

J. M. JENKINS, Wetumpka, Ala.

Notice!

QUIRIN, the queen-breeder, still has 100 of those long-tongued red-clover queens on hand at \$1 each, or 6 for \$5. If you want one speak quick. For testimonials see former adv'ts.

Bees Wanted!

We are expecting to establish several out-apiaries next season and desire all the bees we can get; want 'em on movable frames, and near home. They must be cheap at this time of year. Parties placing us in correspondence with those having bees to sell will be remembered next season when we have a nice lot of those long-tongued red-clover queens on hand (in case we succeed in purchasing of said parties).

In our circular we list numerous articles used by bee-keepers, on which we will give 10 to 20 per cent discount from now until the coming March. Address all orders and inquiries to

H. G. Quirin, Parkertown, Ohio.

BERMUDA

With cable communication and equable winter temperature of 70 degrees, is reached in 48 hours from New York by the elegant steamers of the Quebec Steamship Company, sailing every ten days up to January, and then every five days. The situation of these islands—south of the Gulf Stream—renders

FROST UNKNOWN,

and the porous coral formation prevents malaria. The Quebec Steamship Company also despatches highest class passenger steamers every ten days for ST. THOMAS, SANTA CRUZ, ST. KITTS, ANTIGUA, GUADALOUPE, DOMINICA, MARTINIQUE, ST. LUCIA, BARBADOS, DEMERARA, and the principal WEST INDIA ISLANDS, affording a charming tropical trip at a cost of about \$4 a day. For descriptive pamphlets, dates of sailing and passages, apply to

A. E. OUTERBRIDGE & CO., Agents.

39 Broadway. New York.

ARTHUR AHREN. Sec.. Quebec. Canada.

Wants and Exchange.

Notices will be inserted under this head at 10 cts. per line. You must SAY you want your adv't in this department, or we will not be responsible for any error. You can have the notice as many lines as you please; but all over ten lines will cost you according to our regular rates. We can not be responsible for dissatisfaction arising from these "swaps."

WANTED.—To exchange Buff Cochins bantams for Dauenbaker hives or offers. VAUGHAN,
86 Lander St., Newburgh, N. Y.

WANTED.—To exchange first-class bees for Collie dog, incubator, Brown Leghorn fowls.
DR. CORYA, Dupont, Ind.

WANTED.—To exchange Angora goats, or first-class bees, for incubator, or Brown Leghorn fowls.
DR. CORYA, Dupont, Ind.

WANTED.—To exchange new Tokologys; less than half price (MRS.) A. L. DCPRAY, Folletts, Ia.

WANTED.—To exchange or sell, a 2d-hand bicycle in good condition Write H. C. WEST, Medina, O.

WANTED. To exchange Root's No. 5 extractor and Dadant uncapping-can for honey.
O. H. HYATT, Shenandoah, Iowa.

WANTED.—To buy quantity lots of fancy and No. 1 white-clover comb honey in no-drip cans.
BYRON WALKER, Clyde, Cook Co., Ill.

WANTED.—Comb and extracted honey. State price, kind, and quantity. R. A. BURNETT & Co.,
199 South Water St., Chicago, Ill.

WANTED.—To buy your honey. State your lowest cash price, kind, and quantity.
EDWARD WILKINSON, Wilton, Wis.

WANTED.—To exchange second-hand 60-lb. cans, practically as good as new, at 20c per can in lots of 20 or more, f. o. b. Chicago, for white clover honey at market price. B. WALKER, Clyde, Cook Co., Ill.

WANTED.—To sell cheap, 20 acres of good Florida land, well situated, at a low price. Address for particulars. MRS. I. B. WEIR, Toledo, Florida.

WANTED.—To dispose of my olive-ranch and 85 colonies of bees, located 12 miles from San Diego, California; near church, school, store, postoffice, and railroad station. Extracted 19,000 lbs. from 50 colonies, spring count, this season; have taken honey every year since I came here. The best of climate. Write for particulars.
J. B. RATCLIFFE, Helix, San Diego Co., Cal.

WANTED.—All the bees we can get; must be extremely cheap at this time of year. Parties who will place us in correspondence with those having bees to sell, will receive one to a half-dozen selected queens free next June, according to the number of colonies we succeed in purchasing from said parties.
H. G. QUIRIN, Parkertown, Ohio.

WANTED.—To sell our entire plant and situation, including a complete line of machinery for manufacturing bee-hives, comb-foundation, etc. In connection with same we have a first-class up-to-date planing-mill in every respect. Our good will and list of customers goes with it. This is a bargain and will pay you to investigate. Address
W. R. GRAHAM & SON, Greenville, Texas.

WANTED.—To sell 104 colonies Italian bees in the A. I. Root Co.'s 10-frame hives; heavy top frames; wired full brood sheets of medium foundation; all drawn combs; queen excluders; combination stands and bottom boards; 3/4 gable top, 5/8 super covers; all new and well painted; located in a 6000 acre pasture just above the mouth of Leona River, on the Frio; the natural home of the honey-bee, and no apiary near; every thing on the range that produces honey in Texas, with over two years' privilege yet to run. This is a bargain—the most complete outfit in Texas; can give time on part; six miles from railroad. I have not extracted since early last spring. My wounds have again broken out, and I can secure no assistance from U. S. Pension Department, no friends on earth to assist me, so I will close out apiary, and go back to the Los Angeles, Cal., Soldiers' Home, and wait patiently for reveille to blow lights out for me. Prompt action necessary.
J. M. MCCURDY,
Box 28, Pearsall, Frio Co., Texas.

HONEY QUEENS!

Laws' Long-tongue Leather Queens.
 Laws' Improved Golden Queens.
 Laws' Holy Land Queens.

Laws' queens are the standard bred queens of America. The largest honey-producers use them and praise them. Laws' queens go everywhere, and can furnish you a queen every month in the year. Four apiaries Queens bred in their purity. Prices, October to April: Tested or untested, \$1.00 each; 6 for \$5.00. Breeders, none better, \$3.00 each. Address

W. H. Laws, Beeville, Texas.

Dittmer's Foundation !!!

Retail---Wholesale---Jobbing.

I use a PROCESS that produces EVERY ESSENTIAL necessary to make it the BEST and MOST desirable in all respects. My PROCESS and AUTOMATIC MACHINES are my own inventions, which enable me to SELL FOUNDATION, and WORK WAX INTO FOUNDATION FOR CASH, at prices that are the lowest. Catalog giving

FULL LINE OF SUPPLIES

with prices and samples, free on application. BEESWAX WANTED.

GUS. DITTMER. AUGUSTA, WIS

Get the Best Queens.

Evansville, Ind., Sept. 27th, 1900.

The Jennie Atchley Co., Beeville, Bee Co., Texas:

Dear Friends:—It gives me great pleasure to forward you this unsolicited testimonial regarding the merits of Atchley queens. The three (3) dozen queens purchased of you have made an excellent record for themselves. Not an Atchley queen among the twenty colonies lost during the severe drouth in July. I've bought queens from many breeders; and although the present crop is exceedingly short, the tiers of supers show where the Atchley queens are, and speak volumes for your method of queen-rearing. I find the progeny to be very gentle, strong-winged, uniformly marked, long-lived, of large size, and last, but not least, the best honey-gatherers I ever had. I shall want 100 more next season. Yours fraternally,

J. C. WALLENMEYER.

Prices for Queens.

Tested, \$1.50 each; \$8.00 for 6, or \$15.00 per doz. Untested, February, March, April, and May, \$1.00 each; \$5.00 per 6, or \$9.00 per doz. Fine breeders, \$5.00 each. We have as good bees and queens as money and labor produce. We breed three-band Italians, Golden Carniolans, Cyprians, and Holy-Lands, in their purity, bred in separate yards 5 to 20 miles apart. If you want the best, call for Atchley's improved strains. Safe arrival guaranteed. Send for a sample copy of *The Southland Queen*, the only southern bee-paper. \$1.00 per year. To new subscribers we offer as a premium a nice untested queen in order to get our paper introduced. Catalog, giving queen-rearing and management of apiaries for profit, FREE.

THE JENNIE ATCHLEY CO.,
Beeville, Bee Co., Texas.

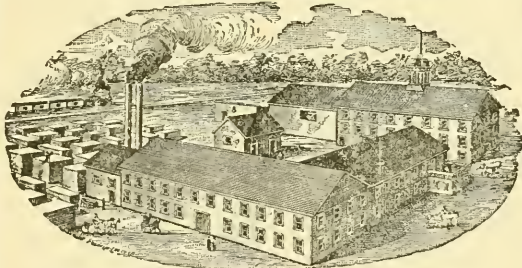

BEE-SUPPLIES.

Best-equipped factory in the West; carry a large stock and greatest variety of every thing needed in the apiary, assuring BEST goods at the LOWEST prices, and prompt shipment. We want every bee-keeper to have our FREE ILLUSTRATED CATALOG, and read description of Alternating Hives, Ferguson Supers, etc. Write at once for a catalog.

— AGENCIES: —

Trester Supply Co., 103 So. 11th St., Lincoln, Nebraska; C. C. Richards, 1223 17th St., Denver, Col.

KRETCHMER M'F'G CO., Red Oak, Iowa.

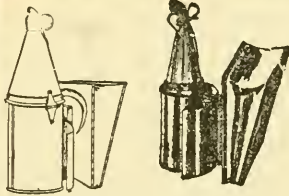

BINGHAM SMOKER.

Dear Sir—Inclosed find \$1.75. Please send one brass smoke-engine. I have one already. It is the best smoker I ever used. Truly yours,
 HENRY SCHMIDT, Hutto, Tex.

MADE TO ORDER

Bingham Brass Smokers.

Made of sheet brass, which does not rust or burn out; should last a lifetime. You need one, but they cost 25 cts. more than tin of the same size. The little open cut shows our brass hinge put on the three larger sizes. No wonder Bingham's four-inch smoke-engine goes without puffing, and does not drop inky drops. The perforated steel fire-grate has 381 holes to air the fuel and support the fire. Heavy tin smoke-engine, 4-inch stove, per mail, \$1.50; 3 1/4-inch; \$1.10; 3-inch, \$1.00; 2 1/2-inch 90c; 2-inch, 65c. Bingham smokers are the originals, and have all the improvements, and have been the standard of excellence for 22 years. Only three larger ones brass.

T. F. Bingham, Farwell, Michigan.

Contents of this Number.

Bees, To Kill Quickly891
 Drones, Their Consumption of Honey.....889
 Eggs, Weight of.....889
 Egg-laying, Sudden Stoppage of.....898
 Feed for Bees, How to Make.....891
 Hives, v. Stands.....892
 Honey, Good Sale of Alsike.....892
 Honey-house, Adobe.....892
 Honey-producers Scored.....908
 Larvæ, Bees Choosing Too Old.....894
 Low Prices, Blame for.....907
 Northern Michigan, Notes from.....911
 Notes of Travel in Arizona.....913
 Quinby, Mrs., Death of.....908
 Rambler at Stearns'.....892
 Rohrig, William.....906
 Rural Mail Delivery.....912
 Staples, Shouldered, Miller's.....890
 Statistics Needed on Honey.....897
 Stearns, Mrs., and Foundation-mill.....893
 Swarms, Shook.....896
 Top-bar, Fisher's New.....907
 Unqueening Too Soon.....892

Honey Column.

GRADING-RULES.

FANCY.—All sections to be well filled, combs straight, firmly attached to all four sides, the combs unsoiled by travel, stain or otherwise; all the cells sealed except an occasional cell, the outside surface of the wood well scraped of propolis.
 No. 1.—All sections well filled except the row of cells next to the wood; combs straight; one-eighth part of comb surface soiled, or the entire surface slightly soiled; the outside of the wood well scraped of propolis.
 No. 2.—All sections well filled except the row of cells next to the wood; combs comparatively even; one-eighth part of comb surface soiled, or the entire surface slightly soiled.
 No. 3.—Three-fourths of the total surface must be filled and sealed.
 No. 4.—Must weigh at least half as much as a full-weight section.
 In addition to this the honey is to be classified according to color, using the terms white, amber, and dark; that is, there will be "Fancy White," "No. 1 Dark," etc.

CITY MARKETS.

CHICAGO.—The market is easier in tone, while prices are nominally the same, but would be shaded to effect sales. Some cars of honey en route to the eastern cities have been diverted to this and surrounding points, which is having a depressing effect. Comb brings 14 @ 15 for best grades of white; light amber, 12@13; dark grades, 10@11. Extracted white, 5½@6½, according to quality, flavor, and package. Light amber, 5¼@5¾; amber and dark, 5@5½. Beeswax 28.

R. A. BURNETT & Co.,
 Nov. 1. 199 South Water St., Chicago, Ill.

SCHENECTADY.—There is a very good supply now of white comb honey on our market, but buckwheat is scarce. We quote the former at 13@16, according to style and quality; buckwheat, 12@13. There has been quite a demand for extracted. We quote light, 6@7; dark, 5@5½.
 CHAS. McCULLOCH,
 Nov. 7. 1 Eagle St., Schenectady, N. Y.

CINCINNATI.—Fancy white comb honey sells at 15@15½; lower grades, 13@14. Extracted dark, 5@5½; light amber, 5½@6½; clover, 7@8.

C. H. W. WEBER,
 Nov. 7. 214 Central Ave., Cincinnati, Ohio.

BOSTON.—There is a fairly good demand for stocks, with ample supplies at the present writing. Fancy No. 1 in cartons, 15½@16; A No. 1, in cartons, 15@15½; No. 1, 15; very little No. 2 is being received. Glass-front cases will bring about ½¢ per pound less. Light California extracted, 7½@8; Florida honey, 6½@7.

BLAKE, SCOTT & LEE,
 Nov. 8. 31, 33 Commercial St., Boston, Mass.

ALBANY.—Honey market steady, especially for buckwheat comb, which is most sought after for its price, 12½@13. White comb, 15; No. 1, 14@15. Extracted white, 7½; mixed, 6½@7; buckwheat, 6. Beeswax, 27 @30.

MACDUGAL & Co.,
 Nov. 9. 380 Broadway, Albany, N. Y.

NEW YORK.—The demand for comb honey of all grades is exceptionally good, and prices are ruling as follows: Fancy white, 15; No. 1, 14; No. 2, 12; buckwheat, 10½. Beeswax is very quiet at 27.

FRANCIS H. LEGGETT & Co.,
 Nov. 7. Franklin and Varick Sts., New York.

NEW YORK.—Comb honey is in good demand, and, while the market is not overstocked, receipts are sufficient to supply the demand. Fancy white sells at 15, with an occasional sale at 16 for attractive lots; No. 1 white, 14; No. 2, 13; fancy buckwheat, 11@11½; No. 1 and 2, 10@10½. Extracted remains quiet at 6@6½ for white, and 5½@5¾ for amber. Very little demand for dark at 5¼@5½. Beeswax quiet at from 27@28.

HILDRETH & SEGELKEN,
 Nov. 8. 82, 84 Murray St., New York City, N. Y.

MILWAUKEE.—The receipts and offerings of all kinds of honey have increased since our last, and sales also have been somewhat improved; yet the demand is not what it should be at this particular season. Yet we feel, to encourage, that it will be better later on. We now quote fancy 1-lb. sections, 15@16; A No. 1, 14 @15; No. 1, 13½@14. Extracted white, in bbls, kegs, and cans, 7½@9; amber, 7@7½. Beeswax, 26@28.

A. V. BISHOP & Co.,
 Nov. 7. 119 Buffalo St., Milwaukee, Wis.

BUFFALO.—Below I quote you the honey market as it is now. Demand is slow for this time of the year. Expect better trade soon. Fancy No. 1 white comb, 15 @16; A No. 1, 14½@15; No. 1, 14@14½; No. 2, 13@14; No. 3, 12@13; No. 1 dark, 11@12; No. 2 dark, 10@11. Extracted white, 5½@6½; dark, 4½@5. Beeswax, 28@30. White extracted honey in jelly-glass, \$1.15@1.25 per dozen.

W. C. TOWNSEND,
 Nov. 11. 84, 86 W. Market St., Buffalo, N. Y.

PHILADELPHIA.—Comb honey has been arriving quite freely, and lower prices are the result. There seems to be very little fancy honey in the market. We quote fancy, 15; No. 1, 13@14; amber, 12. Extracted white, 7; amber, 6. Beeswax, 26. We are producers of honey—do not handle on commission.

WM. A. SELSER,
 Nov. 9. 10 Vine St., Philadelphia, Pa.

NEW YORK.—Quite a little honey has been arriving of 1-lb. and the trade, having been supplied for the present, there seems to be a little quietness in the market. We quote as follows: Fancy white, 15@16; No. 1, 14@15; No. 2, 12@13; fancy buckwheat, 11@11½; No. 1, 10@11; No. 2, 9@10. Extracted white, 6@7; light amber, 5½@6; buckwheat, 5@5½. Beeswax, 27@29.

CHAS. ISRAEL & BROS.,
 Nov. 11. 486-490 Canal St., New York City, N. Y.

FOR SALE.—Basswood, clover, and sweet-clover extracted honey at 7¢, in kegs and cans.

DR. C. L. PARKER, Station A, R. F. D.,
 Syracuse, N. Y.

FOR SALE.—Extracted honey in 160-lb. kegs. Buckwheat, 5½; mixed, 6; basswood, 7. Send postoffice money-order on Moravia, N. Y., and will ship promptly.

N. L. STEVENS, Venice, N. Y.

FOR SALE.—Fine ripe extracted touch-me-not honey, in 60-lb. square tin cans, 2 cans to a case, delivered at R. R. station at 7½¢. Sample postpaid, 8¢.

C. A. BUNCH, La Paz, Marshall Co., Ind.

FOR SALE.—8000 lbs. clover and basswood honey, mixed, in 60-lb. cans, as white as Michigan produces; good body and flavor; the best I ever produced in 26 years' bee-keeping. A free sample will convince you. Eight cts. per lb. at Carson City.

E. D. TOWNSEND, Remus, Mich.

WANTED.—Honey; car lots or otherwise. Will send man to receive when sufficient amount to justify, and pay highest market price, spot cash. Address, stating quantity, quality, and price desired at your station.

THOS. C. STANLEY & SON, Fairfield, Ill.

WANTED.—Western honey in car lots also northern fancy white comb in no-drip cases; state price delivered. We pay spot cash. Reference, German National Bank, Cincinnati. FRED W. MUTH & Co.,
 Front and Walnut Streets, Cincinnati, O.

FOR SALE.—Fancy and No. 1 comb honey; about 2000 lbs. or more. WM. MORRIS, Las Animas, Col.

Wm. A. Selser, Honey Expert,

When you buy honey, send a 3-oz. bottle, have it tested, to be sure it is pure. Price \$2.50 per sample. By doing this you may avoid over ten times this amount in litigation with pure-food laws. Chemist's certificate given.

The A. I. Root's Co.'s Office, 10 Vine Street, Philadelphia, Pa.

G. B. LEWIS CO., WATERTOWN, WIS.

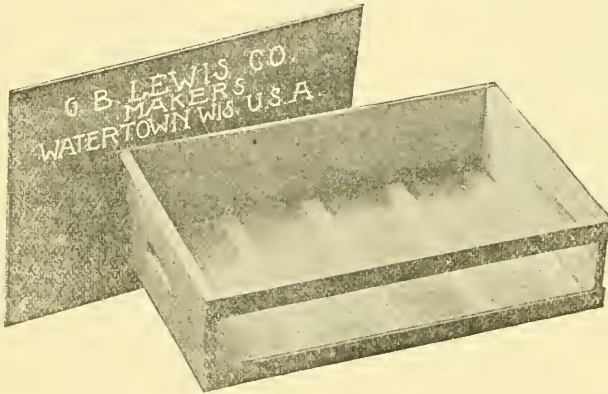

Bee-hives,
Lewis' White
Polished Sections,
Shipping-cases.



Perfect Goods,
Prompt Shipment.

Special Agency, C. M. Scott & Co., 1004 East Washington St., Indianapolis, Indiana.

AGENCIES: L. C. Woodman, Grand Rapids, Michigan; Fred W. Muth & Co., Southwest Corner Walnut & Front Sts., Cincinnati, Ohio; Fred Foulger & Sons, Ogden, Utah; Colorado Honey-producers' Association, Denver, Col.; Grand Junction Fruit growers' Association, Grand Junction, Colorado; Robert Halley, Montrose, Colorado; Pierce Seed and Produce Company, Pueblo, Colo.; E. T. Abbott, St. Joseph, Missouri, Special Southwestern Agent.

BEE - SUPPLIES!

ROOT'S GOODS
AT
ROOT'S PRICES.

C. H. W. Weber, Cincinnati, Ohio.
2146-2148 Central Ave.

A NEW AND COMPLETE stock for 1901 now on hand. I am The Root Company's representative for Cincinnati and surrounding territories. . . You save TIME and FREIGHT CHARGES by having goods shipped from here. Convenience of railroad facilities here enables me to do so. Before buying elsewhere, write for my prices and catalog, which will be mailed you free of charge.

GLEANINGS
 A JOURNAL DEVOTED TO BEE AND HONEY AND HOME INTERESTS.
BEE CULTURE
 ILLUSTRATED SEMI-MONTHLY
 Published by THE A. ROOT CO.
 \$1.00 PER YEAR MEDINA, OHIO.

VOL. XXIX.

NOV. 15, 1901.

No. 22.



MY OBSERVATION has been that, in a good year, a large part of the queens will be superseded, and but few in a poor year.

B. C. HUGENTOBLE writes: "Sweet clover yielded two tons for me, while the severest drouth of years was upon us." Just like sweet clover.

I'M GLAD you're going to do some more cellar wintering, Mr. Editor. That may be a real benefit to some of us who wish we could winter outdoors but can't.

W. Z. HUTCHINSON has my hearty congratulations. To have those twin daughters married to two young men whose lips are never defiled by tobacco, whisky, or profanity, is something to be profoundly grateful for.

THE EGG of a queen-bee, according to German bee-journals, weighs $\frac{1}{4}$ of a milligram. According to that, 170,097 eggs weigh an ounce, and 2,721,552 weigh a pound. If a queen lays 3000 eggs in a day, it takes her 8 weeks to lay an ounce.

CARBOLINEUM ought to be fine for bottom-boards. It would keep away the large wood ants that make bottom-boards dangerous in moving, for they honeycomb them, leaving a mere shell. What's the cost? [I have not yet obtained the price, but I understand it is less than that of paint.—ED.]

F. BEUHNE, in *Australian Bee Bulletin*, says that, when he has in a nucleus a queen more than two years old, he gives a cell in a protector, leaving the old queen in the nucleus, and in three cases out of four the young queen will begin laying without disturbing the old one, when the young queen can be removed and another cell given.

I DON'T UNDERSTAND, as you do, that J. S. Wise, p. 861, daubed the queen with honey, but that he put her back in the cage and then plugged the cage with soft candy. That would be all right. [You are right.

I misread Mr. Wise. But my advice in the matter of daubing queens was all right, even if I did shoot clear over the head of our querist.—ED.]

IMBEDDING WIRE in foundation, says M. F. Reeve, in *Amer. Bee-Keeper*, works better if the board on which the foundation is placed be first covered with burlap, or with tapestry carpet reverse side up. [I suppose this is to prevent the marring of the cells of the foundation, because the board has a hard and unyielding surface; but if imbedding is done as it ought to be, by means of electricity, it will make no difference what sort of backing is used.—ED.]

COLOSSAL LADINO is the name of a new white clover originating in Germany, and well spoken of in *Revue Internationale*. It winters well, does well on poor soil, is larger every way than common white clover, and yields about 70 per cent more green fodder and 38 per cent more dry fodder than the common. [Why, see here; here is a little gold-mine. I am interested, as I am sure all American bee-keepers will be. Now, Dr. Miller, can you not arrange for us to get some of that seed?—ED.]

DR. PACHNER says 1000 drones consume a little more than 4 oz. daily. That means that the drones reared in 28 square inches of comb will, in 5 weeks, consume about 9 lbs. of honey. [This is interesting and valuable, and, moreover, it has a most practical bearing, because, many times, bee-keepers are careless in allowing a considerable quantity of drone comb to be in the brood-nest. Assuming that the brood-nest is broken open only once during the height of the season, it will be possible for a large quantity of drone brood to mature and hatch out drones. The wise bee-keeper will look to his profits by preventing this waste of energy and loss of what might otherwise be surplus honey.—ED.]

DR. B. F. JONES, in *Review*, quotes from *GLEANINGS*, p. 522, "When one practices clipping for a series of years he will be surprised how many colonies he will come across that have changed queens unbeknown to him," and takes that as proof that clip-

ping has caused the death of the queens! Why, bless your heart, doctor, in the natural course *every* queen is superseded, clip or no clip, making a fourth to half the queens in an apiary superseded every year. [This is a good point well made, but I should not have thought of it. This illustrates the importance of having a prominent apicultural writer almost constantly working with the bees during the height of the season, so that he may be able at once to recognize truth from fallacy in deductions.—ED.]

MR. EDITOR, on p. 850 I committed Doolittle to your tender mercies, and then you proceed to let him alone and to go for me. Bless your heart! I didn't say it was a possibility, easy or hard, to have 108,000 bees the progeny of one queen. Go for Doolittle. [Why, bless your heart, doctor, Bro. Doolittle was as much on my side of the fence as on yours; in fact, I claim that, if you had not read him with slant-eyed glasses, you would have seen he was, if any thing, more on *my* side of the fence. Mr. Doolittle is no doubt laughing in his sleeve over the rumpus that he has unwittingly kicked up between us. We may yet have to call on him to explain what he did mean, and thus settle the row. Well, he is respectfully requested to do so.—ED.]

"LAST WINTER," says A. C. Miller in *Amer. Bee-Keeper*, "I had two colonies, each in a ten-frame Dovetailed hive with a half-story full of sawdust over the enameled mat, and the whole hive from the under edge of cover to the ground surrounded by a single thickness of tarred paper." They wintered so finely that he will repeat the experiment on a larger scale. [In packing hives for outdoor wintering, experiments have shown that a good generous supply of packing material over the top of the brood-nest is much more important than around the sides. Of course, it is desirable to have it all around the hives—top, sides, bottom, and ends. We have had reports where whole apiaries have wintered outdoors by simply having the upper story packed with packing material; but better results are secured, of course, by packing all around.—ED.]

"IT MIGHT not be a bad idea for each annual convention to nominate three candidates for General Manager, and nine candidates to succeed the three directors whose terms expire with the following December." That's a suggestion of Editor York as to the National. It's worth considering for the future. [I do not believe it would be wise to bring about conditions or a precedent whereby the office of General Manager, at least, should be changed as often as once in two or three years. When we get a good man, as in the case of our present General Manager, we ought to hang on to him. One who has been in the harness, and knows how to pull, should not be made to give place to one who may be merely popular in the eyes of bee-keepers or members of the Association, and yet possibly be entirely unfitted for the exacting and important du-

ties of the office. But I do believe Bro. York's suggestion is all right for the Board of Directors. Some of us who have been so long on that Board could just as well get out, and thus place the responsibility for the success of the organization on other men whose help we need.—ED.]

I WANT to say, in language somewhat emphatic, that some better way should be provided than to have Directors' meetings that keep Directors out of the sessions of the annual convention of the National. It isn't fair to the Directors; and if they are good for any thing it isn't fair to the convention. [You are right; but the time of our national conventions is so much taken up by general convention work that it is often difficult to squeeze in a little side-committee work between the sessions. I think the time will have to come when the Directors will have to consult by letter, and that the discussion of some of these questions will have to be done through correspondence. Such a plan is unsatisfactory, in that it gives the chairman of the Board almost exclusive power to direct, if he chooses, the work of the entire Board.* If he suggests, for instance, that such and such a thing ought to be done, and gives his reasons therefor, in the absence of any counter-argument his proposed policy is sure to carry, when it may not always be wise.—ED.]

CUT-OFF TOP-BARS spaced endwise have been condemned by some, and I have wondered why. H. H. Hyde now says, p. 857, that the staples are continually driven further in. Surely I shouldn't like that. I think I have used them about as long as any one, and I find them a boon. It is much easier to handle the frames than with long top-bars glued at each end. Not a staple has ever been driven further in, to my knowledge. But my end-bars are $\frac{3}{8}$ thick, and



top-bars $\frac{7}{8}$ thick; so the staple is driven through the end-bar into the top-bar.

What is really wanted—I've hankered after it for years—is a spacer that *can't* be driven in more than the right depth, say a nail with a head $\frac{1}{4}$ inch thick. If that can't be got, why not a shouldered staple? I can't understand Mr. Hyde's saying the staples become a ball of propolis. Propolis is so bad here that a Hoffman frame is a nuisance; but there has been no trouble with propolis on the end staples. [I take it that staples do not push in with (you even without the shoulder) under the projections of the top-bar; but what you desire is something that can be used as spacers *between* the bars. If there were demand enough to warrant it we could make staples shaped as in the diagram you have made, and the expense would be insignificant; indeed, an order for 100 lbs., sent to the wire-goods people, would bring the desired article, and at a price within the range of all bee-keep-

* I speak from an experience based on the time I was Chairman of the Board; and at that time I saw how easy it was to get indorsed any plan I had.

ers, I suspect. Mr. Hyde's experience, as related by him, is quite unusual; but I did find this in California, that the short top-bar was objected to because there was not handle enough to handle the extracting-frames by. This is because bee-keepers making that objection have not become accustomed to handling brood-frames at the corners, or, rather, at the intersection of the end of the top-bar and the top of the end-bar.—Ed.]

HALF THE TIME to election has expired since the Buffalo convention, and there has been some talk in the bee journals, but not a candidate named. Wake up, Mr. Gleanings; name the Directors whose term expires in December, and then name candidates for their successors. Editor York says, "Suppose a hundred members nominate as many different candidates." Well, that will be better than no nominations. [At the suggestion of Mr. O. O. Poppleton, of Florida, I would nominate a capable and honest gentleman, and one who is greatly interested in the success of the Association, Editor H. E. Hill, of the *American Bee-Keeper*, Fort Pierce, Fla. He would represent a good portion of the South. Then I would respectfully make mention of another, Mr. Wm. Rohrig, of Tempe, Ariz. Arizona is one of the great territories for the production of honey, and should not be ignored in the representation of our Board of Directors. Mr. Rohrig came all the way from Tempe to Buffalo, a distance of 2500 miles, to attend the meeting of our Association; but owing to a railroad wreck he just barely missed it. A man who has such an interest in our organization, and who went paying his own way, ought to be honored with an office in the Association. There are two of the old Directors, A. I. Root and myself, who, when our terms of office expire, desire to drop out and let the two gentlemen named be nominated in their stead.—Ed.]

I AGREE with you, Mr. Editor, page 862, that 10 lbs. sugar and 10 or 11 lbs. water would make 14 lbs. sealed stores, and just because of that I wouldn't have very late feed so thin as two of sugar to one of water, but five of sugar to two of water, which would make 14 of syrup from 10 of sugar. I've fed barrels of it that way. [I should rather hesitate about feeding bees sugar so thick as a proportion of 5 to 2, because that surely would not give them an opportunity to invert the syrup. The chances are limited enough with 2 to 3. One year when we fed syrup as thick as honey we had a loss the following spring that was the heaviest we have ever known. Some of the syrup turned back to sugar, and that sugar was shoved out of the entrance of those colonies that survived. Whether the food was responsible for it or not I am not able to say; but of this fact I am sure: That a *thin* syrup, about like raw nectar, which the bees can invert, is far to be preferred to thick, which they can not change in their most wonderful of all laboratories to a food that

has been digested, or partially so, at least. Prof. Cook, at one time, was almost persecuted for advancing the "heresy," as it was then called, of "digested nectar." While the term, perhaps, may have been unfortunate, yet he struck at a grand truth; and the foundation of that truth is that honey, having been predigested by the bees, is far more easily assimilated than the ordinary cane sugars of commerce. Bee-keepers, I believe, can not make too much of a handle of this point. Slowly and surely the great physicians are waking up to this fact, and are urging the consumption of honey rather than the sugars of commerce. Pardon me for making so much of a side point not directly suggested by your Straw; but I propose to "harp" on it, and keep on harping, until our friends, the great consuming public, will begin to recognize the fact, and thus shall we be able to open up a new avenue of trade never before known.—Ed.]

FROM THE biological standpoint the bees are doing their natural work in visiting blossoms; and, in spite of what harm they do, they are necessary to the best results in our orchards.—*Editorial in Farmers Review*. [This is only one out of a thousand favorable comments that have been coming right straight along from sources that are in no way biased, because they have no connection with bee-keeping. It is a pleasant and interesting fact that the great outside world of intelligent farmers and fruit-growers now recognize the almost indispensable office of the bee in bringing about the perfection and full development of certain plants and fruits.—Ed.]



Nature slowly sinks to rest;
Fields and trees are bare;
Bees rejoice within the hive
As their common wealth they share.

A writer in the *Bee-keepers' Record*, in speaking of an easy and quick method of destroying bees when it is necessary, as in the case of foul brood, says:

Close the doors, separate two frames, and push between them a little tow, cotton, wool, or shaying. On this, pour a tablespoonful of bisulphide of carbon; drop a lighted match on the tow, and immediately cover up with the quilt. The unfortunate bees will be dead in less than a minute. When the light is applied there is a slight explosion, but nothing alarming, only care must be taken to hold one's head away from the top of the hive.

A year ago a friend from New York tasted some alsike-clover honey here. Last summer he wrote he had been tasting that honey, in imagination, ever since, and ordered a gallon, then four gallons for another party, who says, "Never tasted any thing like it—can't get such honey here."

Send —." The result is, the supply is about all gone. These parties would not have hesitated to pay 20 cts. a pound there for such honey, and, in fact, it did cost them about that.

A few days ago a friend from a neighboring town in this county was taking dinner with the writer. We had some of that identical alsike honey on the table, and he was as much pleased with it as were the New York parties; but he was surprised at its cheapness, 10 cts., and said he wondered why folks in his town would pay 25 and 30 cents a pound, as they do, for comb honey, when 10 cents would get so much more. He took a gallon. Each one can make his own moral from this.



AMERICAN BEE JOURNAL.

In regard to unqueening too soon. Mr. York says:

Quite a number of beginners in bee-keeping make a big mistake when, after they have ordered queens from a dealer or breeder, they immediately kill the queens of the colonies where they wish to introduce the new queens when they arrive. This is a risky and unnecessary thing to do. Never destroy a reigning queen until the queen sent for is received. Very often queens can not be sent by return mail, even if so advertised. A breeder may be able to send by return mail almost invariably, but more than likely the beekeeper who has been so hasty as to kill the old queen before the new one arrives is so unfortunate as to have the mailing of his queen unavoidably delayed several days or a week. Even a queen-breeder can not control all circumstances at all times. So the safest way is to wait until the new queen is on hand, then proceed to remove the old queen and introduce the new one according to directions.



The editor pleads for a careful discrimination in the use of the words "stand" and "colony." He says:

A reputable journal has so many times used the word "stand" when "colony" was meant that it can hardly be otherwise understood that such use is approved. The word "stand" having a specific use in bee-keeping as designating the thing upon which a hive stands, its use in another sense serves just as much for confusion as for variety. Is there any argument for the use of "stand" when colony is meant, that will not equally support the use of "hive" in the same way?

While the word "stand" may at times be used for "hive," the word "swarm" should certainly be applied only to a colony of bees when swarming. As well might we call a thousand men in the street a "regiment" when they are not organized as such. Yet here comes a writer who speaks of the bees he put into the cellar Nov. 20 as good *swarms*, when he never saw a swarm that month. I feel sure that more than half the writers on bees use "swarm" for "colony;" and at times we are utterly at a loss to tell which word to use, as one might be as good as the other. But the outside world will probably always speak of a hive of bees as a swarm; and in doing so it nearly follows the German custom of using the word *Schwarm* loosely

for any collection of bees; also the French *essaim* and Spanish *enjambre* in the same way. As illustrative of how the gentiles get things mixed, I will mention that the editor of a Coshocton, O., paper, a little south of us, saw a hive of bees from the Root Co., *en route* for the South, at their station. He makes some ado over it, but calls it a hive of *queens*.



RAMBLE 194.

A Visit with Mr. O. W. Stearns, of San Joaquin Valley, Cal.; How Mrs. S. Managed to Make the Foundation-mill Work; Continued from Last Issue.

BY RAMBLER.

When Mr. Stearns purchases as apiary, if it is in a good location he usually secures the right to keep the bees there. Such a purchase and such a right he secured from Charley Williams, in Tulare Co. This was an excellent bargain for Mr. Stearns, for, adjoining the apiary, is an adobe honey-house, and a charming place in which to run an extractor on a hot day. The walls are a foot thick, and the openings on the four sides are covered with wire cloth, and all can be used for doors or windows as desired. The shake roof, instead of resting on the walls, is elevated with studding some 18 inches above the walls, and that space entirely around the building is covered with wire cloth, giving plenty of air. The roof terminates in a point, as shown in the photo; and instead of a chimney, as you might think from the appearance, that is a square ventilating-hole through which the bees escape, and it is at such an elevation that robber bees never try to enter it.

When I visited the apiary with my camera there was only a portion of the family at home; and the pig portion was so familiar that a hatful of pears from the adjoining

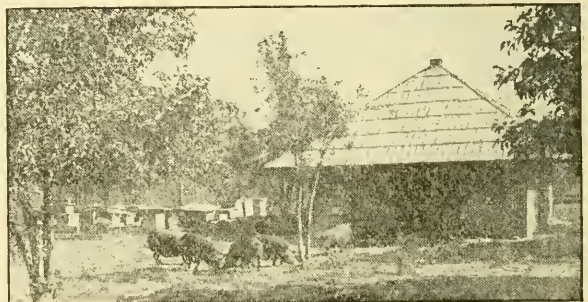

AN ADOBE HONEY-HOUSE.

trees had to be thrown down as an inducement for them to pose for a photo. They fulfilled their part admirably. The piggybacks are fairly good for the destruction of weeds, and do not molest the hives.

Mr. Stearns and I could not agree on the subject of hives. He uses a half-inch side and the attendant weewaw. I called attention to one hive with a piece split out to a loose knot. You could almost chuck your fist through it.

"Oh! that's nothing," said Mr. Stearns.

He then related an incident where an old gummy sack had been thrown on to a bush. A swarm of bees had taken possession of the limb under it, and made it their home. I told Mr. S. that he had better adopt that sort of hive in the future. It would be nearly as good as the half-inch hive.

"Much better," said he, "than the Heddon hive. Nobody but the veriest cranks use that and the Hoffman frame."

If Mr. S. purchases an apiary in which are Hoffman frames, out comes the jack-knife and off come the spacing sides to the frame, or, as he terms it, he cuts off their ears.

When buying bees, Mr. Stearns has occasion to move many colonies. His moving plan is very simple. He drives into the apiary after dark, and just loads the hives right on without fastening the covers or stopping the entrances. Of course the bees cluster to quite an extent on the outside of the hives. "But what is the harm?" says Mr. S.; "they will get back again when the wagon stops." He had moved bees over sixty miles; was two days on the road, and every colony arrived at destination all right. During the day the wagon and its load were left alone, and the bees went to work without much confusion.

When Mr. Stearns first came to California he worked his bees for comb honey, as did nearly every bee-keeper in this valley; but owing to low prices there has been a revolution, and extracted honey is now almost exclusively the product. A good share of the crop comes late, and Mr. S. cited an instance where a colony with only two frames of brood on the first of June built up and produced 64 lbs. of comb honey. Quite a few bee-men claim that only half of the crop is secured up to Sept. 1; but this is a varying condition, owing to climatic changes.

Mrs. Stearns and the two daughters are quite an important factor in Mr. Stearns' prosperity. They can nail hives and crates as dextrously as a professional carpenter; dip wax, roll foundation, and, if the rush of the season demands, they can work the extractor.

It is right that Mr. Stearns should be

proud of his helpers, for they have helped him to lay by many dollars. For instance, Mr. Stearns needed a new foundation-machine, and sent to The A. I. Root Co. for one. In due course of time it arrived all right, and as bright as a new dollar, and Mr. Stearns proceeded to roll some foundation; but he found it one thing to proceed.



"NONSENSE! YOU STAY RIGHT HERE; I'M GOING TO WIN THAT NEW DRESS!"

and quite another to roll. Although he was already an expert at the business, all of his experience was thrown away upon this machine. After repeated efforts it would not work. Mr. S. evidently became nervous. Almost anybody would in such a case. Mrs. Stearns heard unusual sounds in the shop. She knew right off something was going wrong, and she presented herself before her husband. His hat was off, hair tousled, sleeves rolled up, a frown upon his usually placid brow, and "his mouth was drawn down at the corners."

"Why, Orville! what is the matter?" said she, as she beamed kindly upon him.

"What is the matter, hey? Why, Anna, this machine a'n't worth a—a—" He was going to use a real bad word, but a better spirit prevailed, and he said, "It a'n't worth a row of pins. I'm going to send it right back to the Root Co. Why, they don't know how to make a mill that will work. The good-for-nothing mangy thing!" And he looked as though he could kick the machine and the Root Co. into the middle of next week.

"Well, Orville," said Mrs. Stearns, "men are always impatient. Now, I believe I can make that machine work. The rolls look so nice, bright, and perfect, that I believe it will work—it *must* work."

"See here, Anna," said Mr. Stearns,

and there was less hardness in his voice. "I'll tell you what I'll do. If you will make that machine work all right I will buy you a new dress."

"All right, Orville," said Mrs. Stearns; and she went into the house and soon returned with a box of pearline and a stiff scrubbing-brush. "Now you see, Orville, you men don't know how to scrub things. Those rolls may have had oil or acid on them, and it must be scrubbed out."

So Mrs. Stearns went at it with hot water and cold, and, after a long scrubbing, the sheets of wax were tried again, but the machine would not work.

"There, Anne, I told you the measly thing wouldn't work. I'll send it right back to the Roots;" and he grasped the screwdriver to loosen the mill from the table. But Mr. S. didn't reckon right. That promise of a new dress, and a woman's will, had that machine in hand, and the hot water and pearline were again applied with more vigor than ever. Scrub, scrub, scrub. Mr. Stearns stood first on one foot and then on the other; pulled his mustache occasionally, and lent a helping hand now and then. But Mr. Stearns suddenly remembered something.

"Oh! say, Anna, there is the mail train. I must go to the postoffice."

"No, you don't, Orville. You have got to stay right here and see this thing out. In the words of General Grant, 'I'll fight it out on this line, if it takes all summer.' I am bound to have that new dress. I'm just thinking it will be brown alpaca, made up biasing."

The machine was all ready for the wax again. It was tried, and the trial was a failure. Scrub, scrub, scrub, hot water and cold.

"Oh! say, Anna, what in the name of common sense is the use of scrubbing the thing any more? Why, you'll wear the thing out, and then the Root Co. will not allow me any thing if I return it; but if you have got to scrub, I'll go and feed the chickens. I've clean forgot them."

"Here, Kitty," said Mrs. Stearns, "you stop nailing hives, and feed the chickens. Your pa wants to stay and help me."

"Scrub, scrub, scrub, hot water and cold. All the forenoon the exercise continued. Mr. S. was clear out of patience, times without number; but finally, just before dinner-time, after an unusually long scrub and strong scrub, the machine was tried, and, to the surprise of Mr. Stearns, and the gratification of Mrs. S., the sheet went through like a charm, and sheet after sheet followed in quick succession.

"There, Orville, I told you so," said Mrs. Stearns, waving her scrubbing-brush in triumph. "Now, my dear Orville, this evening we will consider the new dress."

Of course, Mrs. Stearns received the dress. It was a good one; and now whenever the machine has a tantrum Mr. Stearns knows who can scrub it into good behavior. In fact, an energetic "Mrs." to mind the

house and the husband is something I would heartily recommend to quite a number of bachelor bee-men in California.

[I especially indorse your last sentence, Mr. Rambler; but why not practice your own preaching? How you Western bee-keeper bachelors (and there are many of them) can get along and keep house, and find things when you are in a hurry, without a "Mrs.," is beyond my comprehension. Why, when my "Mrs." is gone for only one week things get all mixed up, somehow.

Mrs. Stearns has our thanks for vindicating the Root Co. by demonstrating that the machine was all right; but perhaps the "Mr." did not read the directions thoroughly.

But, say; Mr. S. does something that many of us can not do, even if he can't handle Hoffman frames or run a foundation-machine; and that is, haul a load of bees without shutting up the hives. I am not sure but if we went at it right, we might do it too.

As to those Hoffman frames, I suggest that he give his wife a chance to show him how to use them. She would earn the dress.—ED.]

DO QUEENLESS BEES PREFER TOO OLD LARVAE FOR QUEEN-REARING?

Some Final Conclusions.

BY DR. C. C. MILLER.

Last year I attempted to get an answer to this question. I think the result was conclusive; but Hon. R. L. Taylor thought the position of the combs was such as to favor starting queen-cells from the younger brood. This year I thought I would make the test in such a way that no such objection could be made. At the same time I simplified the question put to the bees, putting it in this form:

"Which do you prefer for queen-rearing, a cell in which an egg was laid not less than six days ago or one in which an egg was laid not more than four days ago?" Or, assuming that the larva hatches from the egg in three days, the question would be, "Which do you prefer, a larva three days old or one 24 hours old?"

July 16th, at 10 A.M., I took from a nucleus the only comb it had, which comb we will call comb *a*. The queen in the nucleus had been laying about a week, and during that time had been confined to one comb, so I could be morally certain that eggs had been laid just before removal. The comb was about two-thirds filled with brood and eggs. I put it in an upper story of a strong colony over an excluder, along with other unsealed brood that had been there for some days, a feeder being on top, so that it would be well cared for.

July 18th, at 10 A.M., I took from a nucleus (in which was my best queen) its two

brood-combs, and gave it a comb that had not been with a queen for more than a week. It had a few cells of sealed brood, and its cells were well polished, ready for immediate use. This I called comb *b*.

July 22d, at 10 A.M. I took from a full colony its queen and all its brood, putting in the center of the hive combs *a* and *b*, and filling out the hive with combs containing some honey. A feeder was on top.

The combs were thus put on equal footing, so far as I could determine, nearly the same amount of brood being in each, comb *a* having a little the most. Being side by side, in the middle of the hive, neither one could have any advantage in position.

July 24th, at 10 A.M. I examined comb *a* and comb *b*. (I must confess that I forgot to look at them July 23.) On comb *a* I found one cell started. On comb *b* there were 28, a few of them not yet drawn out, only the cells were enlarged. I may as well say here that no other cells were started later, somewhat to my surprise. Perhaps the bees thought it was enough to start 29. All but one were completed.

In this case the bees had their choice of brood of all ages from eggs just laid to sealed brood, *excepting* larvæ between the ages of one and three days. If it were true that they were in such haste for a queen that they would select too old larvæ, certainly one would have expected comb *a* to have greatly the preference, instead of their being content with larvæ so young as 24 hours. But their general preference was for something younger than the three-day larvæ—not only younger, but very much younger. Just one cell was started with a larva as old as three days. One can not be positive as to the age of that one, but one can be very positive as to the other 28. July 24th, when they were inspected, not a larva on the comb could have been more than three days old, so it is not possible that a cell on that comb was at any time started with a larva beyond that age. As they were all started *before* 10 A.M. of that day, it is certain that none of them could have been as much as three days old, and probable that most of them were much younger.

Some one may ask, "Why are you so persistent in trying to show that the universally accepted opinion is wrong? What difference does it make, anyway?" The simple desire to have the truth known ought to be incentive enough. But there is something else that makes it seem to me a matter of very great consequence.

It is probable that not one in fifty of the bee-keepers of the land takes the pains to use the means that are now taught to be necessary to secure the best queens, using cell-cups and that sort of thing. Nor will they. It looks like too formidable an affair. So forty-nine out of the fifty might be supposed to talk something after this fashion:

"I am told I ought to breed from my best stock. I can make queenless the colony having my best queen, and start queen-cells galore, and from these I can have all the queens

I want. But if I do that the bees will select larvæ too good for old queens, and I can't use the complicated plans that queen-breeders use, so all I can do is to go on as I have done." And that means to have his increase and his queens from swarming colonies instead of honey-gathering colonies. And so the persistence of the fallacy that queenless bees prefer too old larvæ cheats that man out of the chance of easily improving his stock.

He should be told the truth in something like these words:

"A queenless colony will rarely, if ever, prefer larvæ too old for good queens. None of the most improved methods of modern times will produce queens a whit better than those the bees will rear in a colony you have made queenless, so long as they have young enough larvæ to select from. After the larvæ have become too old they may still start cells, and these will produce poor queens. If you give to a nucleus or a colony two or three good-looking cells, there is small chance of a poor queen. Or you may give to the queenless colony a fresh frame of brood and eggs five or six days after being made queenless, and then you need have no fear of poor cells on any of the previous frames."

Marengo, Ill.

[If I understand you, doctor, this last experiment fully confirms the former one you made, and which you related in GLEANINGS. Bees, then, if given their choice, do not take larvæ too old. Nature's plans are usually not so far faulty that they result in a retrograde of stock. We may, therefore, assume that, even in this case, Nature does not make a mistake, but takes, when she can have them, young larvæ—those which, according to best practice, are the most suitable for the growing of vigorous full-sized queens.

Here is something more on the same subject.—Ed.]

THE CHOICE OF LARVÆ IN QUEEN-REARING; APPARENT CONTRADICTIONS HARMONIZED.

Mr. Editor:—Dr. Miller's remarks on the choice of larvæ, p. 717, cause me to write of the following observation. I gave, as an index, to a colony I believed to be queenless, a frame containing brood in all stages, from the egg to the sealed cell. Looking at it two days later I found that the bees had been distributing royal jelly in the most indiscriminate way. They had started queen-cells in the regular way; but some of the full-grown worker larvæ were sloppy with food, and were being sealed up in dome-shaped coverings that made them look like drone brood. There were also all stages between the two extremes. I then gave the frame to a nucleus with a young virgin, when all the cells were destroyed except those of the normal worker brood. If the dome-shaped cells had contained drones (they were certainly on worker comb) they would hardly have been destroyed. Don't

you think they would have produced fertile workers if I had left them with the first bees?

As little more than a beginner (this is my second year) I hardly know how much my observations are to be trusted, but I am confident that the facts are as stated.

GEORGE A. BATES.

Highwood, N. J., Sept. 5.

[In reply to the above, Dr. Miller says:]

Taking the last part of your letter first, I may say that I haven't the slightest idea.

The item to which you refer, p. 717, 1900, was written more than a year ago, and was a reminder of a challenge to Messrs. Brice, Taylor, Hutchinson, and others, to produce proof that, when a colony is made queenless, the bees are in such haste for a queen that they choose larvæ too old for good results. I said the season was well along, and neither of the gentlemen named had offered any proof, adding: "Here's a simple thing that any one can try: Take away a queen; then watch whether the first queen-cells started contain small or large larvæ. Either give a proof that queenless bees are in such haste for a queen that they choose to their hurt, or else abandon the belief as a false tradition of the dead past." Another year has now passed, making an opportunity of two full seasons to furnish the required proof; and as they have not furnished it the conclusion must be that the matter was not worth their while, or else that they could not give the proof. It isn't reasonable to believe that they did not think worth while, from the fact that they had already taken the pains to give the matter as much time in trying to refute my view as it would to furnish the proof if it were possible to furnish such proof: so I think I am justified in saying that they could furnish no such proof.

In your observations you found that, two days after giving brood to queenless bees, they were sealing full-grown larvæ. That leaves the matter a little indefinite. If you had observed when they were sealed we should have something more definite. If you are not familiar with such matters it is possible you might think they "were being sealed up" a considerable time before the actual sealing. Suppose, however, a still greater advance than you name, and that the cells were actually sealed two days after the brood was given. The bees having been already queenless would begin work upon the queen-cells immediately upon the brood being given, and there would be two days of feeding before sealing. As there are five days of feeding, the bees would, under our supposition, have chosen larvæ three days old. As the worker larvæ are not weaned till three days old, or, in other words, are fed for three days the same as royal larvæ, they would not appear to be too old for good queens. So you will see that the case you cite is not a proof that the bees chose larvæ too old.

In the absence of any proof to the contra-

ry, I am strongly of the opinion that the larvæ were not actually sealed until more than two days after the brood was given. I base my opinion upon observations extending over a period of forty years, and especially upon observations of hundreds of cases during the last two years, with my attention carefully directed to the matter. In no case have I ever found the bees selecting a larva that seemed to be as much as three days old, and I feel pretty sure that Messrs. Brice, Taylor, and Hutchinson would mention it if they had found a larva more than three days old chosen. I may say, in passing, that I do not believe that a larva three days old is quite as good as one younger, in spite of the fact that such larva has not yet been weaned. My only reason for this belief is the fact that I have never known the bees to select by preference a larva as old as three days.

You ask if I don't think that the "dome-shaped cells" would have produced laying workers if they had been allowed to come to maturity. I do not at all believe they would. It was formerly supposed by some that laying workers had in some way secured some royal jelly during their larval period. Later investigations have shown that, where laying workers are found, a large number are present, perhaps half of the workers in the hive containing eggs; and in some cases laying workers appear so soon after queenlessness that their larval period must have been completed before the colony became queenless.

You are entirely right in thinking that what you call dome-shaped cells did not contain drone brood; but you are just as far wrong if you think such cells could not contain good queens. If you find at any time a queen-cell that is rather small and smooth, *in a place where there is plenty of room for it to be made larger*, as on or near the edge of a comb, you are safe to reject it as one not likely to produce a good queen. The case is different if the cell is in the middle of a comb with all the surrounding cells occupied with brood. The bees do not seem to have room to enlarge and ornament such a cell; and all that I have ever seen in such situations had the surfaces as smooth as the cappings of drone-cells, a slight difference in size and shape being the only thing to distinguish such a cell from a drone-cell. But you may generally expect a good queen from such a cell; and I think it probable that, if you had allowed the cells you mention to go on to maturity, instead of laying workers you might have had good queens.

C. C. MILLER.

Marengo, Ill.

"SHOOK" SWARMS.

The Ideal Plain Section.

BY GEO. SHIBER.

The past season I have practiced quite largely the plan of "shook-off" swarms, the same as described by Mr. L. Stachel-

hausen (p. 840, 1900). I have found that, as a rule, this method of swarming of normal colonies toward the time of natural swarming obtains the best results in comb honey, and is a tiptop method in my locality, where the only surplus comes from clover and basswood, if done at the right time. I followed almost precisely the same method as Mr. Stachelhausen, at the beginning of the flow; but I added, during fruit-bloom, another story of eight empty combs below the brood-chamber to prevent swarming until clover bloomed. I think this had a tendency to make colonies build up faster and stronger than if I had not added the empty combs below.

When the time came to put on the supers (each one had a few baits) a new hive with starters in six frames, and some with only five frames, was placed on a stand of the colony to be operated on, and every bee was shaken from the combs into a new hive. A frame of brood I put in the new hive for a few days to hold bees; but this comb of unsealed brood served a double purpose—it kept the pollen out of the sections, for I noticed when this comb was not added the bees carried pollen into the sections. Mr. Stachelhausen used half-story bodies, while mine were full-size eight-frame. I like the plan first rate. It is just what I want; for, with very near neighbors, on each side of the apiary, it's not just the thing to have swarms come off, filling the air in the neighborhood with bees.

One colony so treated gave me 146 filled sections ($3\frac{3}{8} \times 5$) of white-clover honey. My average was 91 sections to the colony.

I have tried the Ideal sections this year for the first time. I am pleased with them. It is my opinion that a super of 30 of them will be filled about as quickly as a 24-section $4\frac{1}{4} \times 4\frac{1}{4}$ super.

Speaking about red-clover queens reminds me that this year both black and yellow bees worked on red clover in July.

I think the effort for breeding longer tongues is all right. But if we will use a little logic that we used to study in school, we shall find that queens have always been raised with the one thing in view; i. e., better workers. The queen-breeders and honey-producers, large and small, have always bred from their best queen, the one whose bees have done the best, and that's just what is being done now. All that we gain is the *knowledge* that the "long tongue" is what does it; so the matter can be summed up by the following syllogism: All good workers (bees) have long tongues. These workers (bees) have long tongues. Therefore they are good workers. So all we have gained is that we know what makes good workers, provided it is entirely long tongues that do the trick.

Since writing the above, GLEANINGS for Oct. 15 has come to hand, and I see that Mr. G. B. Howe (page 822) gives two eight-frame bodies to his colonies to enable them to build up in the spring; and I suppose we are to understand that he leaves them the 16

combs when he puts on the supers. I have used only the one body when the sections were put on. But anyhow, I think the practice of giving colonies two bodies in which to build in the spring is all right, and has a very great tendency to delay swarming until the time of the flow, and makes booming colonies.

Franklinville, N. Y.

[It is not yet proved that long tongues "will do the trick." All we know is that some good workers have extra-long tongues; but we have no absolute proof yet that the amount of honey is in proportion to the length of the tongue. But even if long tongues are an important factor, there will have to be *other* factors in order to produce a good all-around worker-bee.

I do not know what is the practice of Mr. Howe; but at our out-yard we sometimes leave on the two stories; but as a general rule we take off one story and put in its place supers of empty sections with foundation.—ED.]

HONEY STATISTICS NEEDED.

Seeking Government Aid; how shall it be Done?

BY W. A. H. GILSTRAP.

Some time after the honey crop for this year in Central California made such a poor record, it occurred to the writer that all honey-producers and dealers should know it. Some way the dealers learned there was a large crop in the southern counties. They failed to learn that comparatively few bees were left to gather it. GLEANINGS kept the actual facts before the public eye, or tried to, but who saw it? A few dealers and a sprinkle of the honey-producers. How many dealers believe such reports from an apicultural editor? Not very many, perhaps. To my mind, a "long-felt want" would be supplied by having the Department of Agriculture report the condition of bees and yield of honey at proper times of the year. A statement of the need of such information, with some reasons for the same, was sent to the Statistician of the Department. His reply expressed a desire to take up the work when Congress places sufficient funds in the Department's hands for the work. My reply contained the following:

"While thanking you for your kind letter in regard to reports of honey-bees and their chief product, I am especially pleased that you state why reports are not made; and it seems to me that such objection could and should be overcome. When Congress becomes convinced that the measure is decidedly for the public good, the funds will be placed in your hands with which to conduct the work.

"If you will kindly give me some estimate or data to work on I shall place the same before those most interested, and endeavor to have the matter brought before

Congress on the earliest practical occasion. As to how your office can handle this additional work to best advantage—bees and other lines, or bees and their products alone—of course you can best judge.”

UNITED STATES DEPT. OF AGRICULTURE,
DIVISION OF STATISTICS,
Washington, D. C., Oct. 17, 1901.)

Dear Sir:—In reply to your letter of October 12, I can only repeat the statement made in my previous letter, that the funds at the disposal of the Department for making statistical investigations are inadequate to pursue subjects other than those already dealt with. There are many agricultural products of interest that the Department would be glad to include in its investigations were the funds sufficient; but unless substantial additions are made by Congress to the appropriations for these purposes it will be impossible to enlarge the statistical investigations to any great extent. I should be very glad if you can present the matter in such a way as to induce favorable legislation, as communications are constantly received from persons interested in various agricultural products of importance not dealt with by this office, which show the desirability of including them.

Thanking you for the interest you take in this matter, and trusting that your efforts may be successful, I am
Very truly yours,
JOHN HYDE.

It will be noted that my main inquiry was not replied to; but it may be better to let the amount of the needed appropriation remain indefinite for the present. However, we know a few things.

1. While bee-keepers know more about the honey crop than others, they are not properly posted.

2. We have no way of getting such information, or of making such information sufficiently public, at present.

3. The Department of Agriculture can give us the desired assistance, and will do so if we make the proper effort.

This is a big work, and every journal of our pursuit can help, perhaps, more in stirring the fraternity than in all other ways. To the honey-producers I would say, “Let’s be enterprising and public-spirited for once, and that once all the time.” If each bee-keeper in the United States would present the matter to his Representative in Congress it would have weight. Honey-producers should report their townships to the Statistician when possible. By so doing we may influence legislation, and will be in position to get reliable information when apianian reports come in. See that crop reports are posted monthly in all postoffices. That will keep statistical work before the people. When the people call for an increase in statistical service it will come. Bee-keepers’ societies, especially our National Association, may exert a strong influence.

We need a report in the spring, say May 1, showing how bees have wintered. The report on both comb and extracted honey should be taken the first of July or August, also Oct. 1. These reports should be as accurate and public as possible. If there is any other plan as good as the above, let us have it. If not, let us all take hold of the above plan, and we can get it to work. This widespread ignorance and uncertainty is too costly to be endured.

Grayson, Cal., Oct. 28.

[Mr. Gilstrap is on the right track. If there ever was a time when bee-keepers needed reliable statistics as to the amount of honey produced, that time is now. Private enterprise can hardly secure them. Even if all those who produce honey would take a bee-journal, there would still be a lack of exact data. Mr. Gilstrap is quite right in saying that we should write to our Representatives and Senators in Congress; but until Congress meets it would be quite useless to waste our powder now. I would, therefore, suggest that he take this matter in hand, and at the proper time make a general request, through the bee-papers, calling on their subscribers to write to their Representatives in such a way that we can at least start the ball rolling, even if we do not secure at once the needed appropriation. In the first place, some one in Washington—perhaps Mr. Danzenbaker or any one else who is equally interested—can ascertain for us what would be the *proper time* to pour in this deluge of letters.—ED.]

SUDDEN STOPPAGE OF EGG-LAYING.

Is it Proven that the Removal of a Queen in the Height of Her Egg-laying, from a Strong Colony, and Sending Her Through the Mails, is Detrimental to Her?

BY ARTHUR C. MILLER.

Mr. Editor:—In your footnotes to my article in GLEANINGS for Oct. 15 you express doubt as to whether sufficient data exist on which to base so positive an assertion as I made regarding the effect of the sudden confinement of laying queens. Some years ago Mr. Alley and Mr. Doolittle made extended experiments to determine this very point, and they arrived at the conclusion that the injury so often noticed in queens received by mail was caused by the *sudden cessation of egg-laying*. I expect to prove to you that it is *starvation* which does the damage. They found, and you have found, that not all queens caged when at the height of their laying showed signs of harm. If you will consult the back volumes of our papers you will find many records of *fine queens from full colonies “going bad”* after shipment. *Contra*, you will find very few records of *untested* queens acting the same way. I believe this is because nearly all “untested” queens have not reached the height of their egg-production, and are generally shipped from a “nucleus,” which, when newly formed, contains mostly young bees—“feeding” bees, so the queen is pretty sure of a retinue which can supply her with *proper* nourishment. A constant supply of nitrogenous food is more essential to the well-being of a laying queen than to any other bee in the hive, as you can well realize. Mr. Simmins is very emphatic on the folly of keeping young queens confined in frame nurseries for a number of days after hatching, claiming at that age, while they feed themselves, they need nitrogenous

food, and that it is vitally important to their development. But, on the other hand, so careful a breeder as Mr. Alley keeps virgin queens in cages for a *short* time, and presumably with no ill effects, or he would discontinue the practice. The nuclei from which his queens are fertilized, and in which they usually remain until shipped, contain five frames, five inches square. You can see that there is little chance for full rate of egg-production. Mr. Alley, I believe, very seldom has reports of his queens "going bad" after shipment.

Isn't the foregoing evidence of sufficient weight to warrant a pretty positive assertion? But I will amplify and elucidate: If a queen taken from a full colony in the height of her activity has caged with her, say twelve attendants which happen to have their stomachs charged with a full supply of pollen and honey, there is a fair chance of her receiving sufficient nutriment to take the place of the waste of tissue caused by egg-development. But if such queen has as attendants twelve bees, only a few of which are so supplied, how and from whence is she to get the needed food? And that she does need such food I believe is indisputable.

I think you gave in the A B C the advice to pick for escort bees those with their heads in a cell, getting honey. Such bees are usually the field bees, and are very seldom the "nurse" bees with a full supply of chyle. Cage such a queen alone and put the cage in a full colony, and she is little, if any, better off than in the shipping-cage with the attendants; worse off, unless she is near unsealed brood. To appreciate this, please note that, except in the exercise of the latent "mother instinct" in feeding larvae, a worker-bee never *voluntarily* gives food to any other bee, either queen, drone, or worker. Food always has to be *asked* for—sometimes apparently taken by force. Under such conditions, what hope has the caged queen of getting needed nourishment? She has to depend on the chance of a properly supplied worker coming within asking distance, and then risk getting her to give up some of her supply. If her cage is near unsealed brood the nurse-bees are numerous; but if she is in an upper story, do you wonder that she suffers for want of nitrogenous food?

A bee wanting food (other than honey or when honey is not accessible) "holds up" all comers until one is found with a supply. As soon as the latter can be persuaded to give, she opens her mouth and the hungry bee puts its tongue well into it. The *giving* bee at the same time generally curves and contracts its abdomen, much as if to sting, which is probably necessary to enable it to disgorge the food when the stomach is not *full*. The curving of the abdomen is not always done. The tongue of the giving bee during the operation is curved back under her "chin" nearly as close as it is normally carried when not in use. The abdomen of the *taking* bee palpitates

just as when taking nectar from the flowers or honey from a cell. I have often seen a drone seize the worker by the "cheeks," tip up the worker's face to a convenient angle, and hang on until either it had no more to give or he had gotten his fill. The sudden show of tongues when a queen or other bee is getting food thus is purely a case of trying to get dainties, and is *not* an offering of food to their royal mother or distressed sister.

Remember that a queen in the full exercise of her functions is developing two and a half times her own weight of eggs every 24 hours. It is not the sudden taking of the queen from a place in which to deposit her eggs that injures (for she can and will continue to extrude them as they develop), but it is the lack of sufficient proper food to restore the drain on her system. If such food is not available in sufficient quantity, she starves, and on the duration of such starvation depends the extent of injury to her vitality. Knowing these things, and knowing that a queen free in her hive can ask and obtain food from thousands of bees, is it irrational to believe and assert that she must suffer when compelled to depend on *twelve* bees, only a few of which may be able to supply her needs? These statements may be readily verified by any one who cares to take the necessary pains.

Mr. Editor, have I made my case good? Providence, R. I., Oct. 22.

[You have presented some facts that seem to point in one direction; but so far, if I am any judge of evidence, not enough has yet been offered to warrant a positive assertion one way or the other. True science would demand more and better proof than an opinion based on certain phenomena that might take place from a combination or a variety of causes. Too many times have we sent queens in the height of their egg-laying, from strong colonies, without any bad results, and the escorts were those having their heads in honey, for I have put them up myself. You may be aware that the Root Co. has probably had as extensive an experience in queen-rearing as anybody in the United States. Queens "go bad" for all the breeders, and even for Mr. Alley. While he does produce some very fine queens, some of them, as I have known, have gone very bad.

Now, having said this much, I do not wish to appear set in my way. I am open to conviction; and to show you that I am anxious for the truth I present a letter that seems to support your views. Mr. H. G. Quirin, one of the largest queen-breeders in the United States, writes:

Mr. Root:—When first engaging in the queen-traffic we used and adopted the two-frame full-sized frame, L. size; but it soon occurred to us that it took too many bees to stock 600 or 800 of these boxes, so we gradually changed to a smaller frame, just a trifle less than half the L. size. By having a division in our old nucleus-boxes we can have two nuclei where we formerly had but one. Of course, these small nuclei can not stand the extremes that a larger one will; but by giving them the proper attention, just as many queens can

be taken from them as from a large box (did not Mr. Sladen tell you about our small nuclei?); besides, queens kept in these small boxes are never so heavy with eggs as in the larger boxes.

As to queens being injured when heavy with eggs when stripping, this is quite reasonable. Our experience would indicate that queens taken from full colonies, when heavy with eggs, do not turn out quite as well. We have had some very discouraging reports from some such queens sent out; but it rarely happens that we have a bad report from queens taken from these small boxes. As a rule our higher-priced queens are kept in full colonies or in three or four frame nuclei. It unfortunately happens that these queens appear to get the worst of it; in fact, we have come to the conclusion that hereafter we shall be obliged to keep our very best queens in nuclei instead of in full colonies.

It often happens that a queen receives a dent in the abdomen when sent in the mails. Many might give a queen a passing glance and call her O. K., but this dent will prevent her from being a good layer unless it is removed. The removing of the same is very simple. Take the queen between two fingers, and press gently. If done properly the dent will snap out. To illustrate, take a sheet of writing-paper, roll it up the size of your thumb, then dent it; then try to remove the same by pressing on each side of the dent. Practice with the paper, then try the queen. It may take a little practice to do it. We have gotten so we can take a dent in two or three seconds.

Of late years we have come to the conclusion that many queens are injured while being introduced, both as virgins and as laying queens, the bees themselves doing the mischief. But in our own apiary we have practically overcome even this difficulty. The remedy is to have brood of the proper stage in the nuclei; and when no honey is coming in, feed them. Permanent feeders are attached to all our nuclei. An ounce or two of feed to such a small nucleus is equivalent to five or six pounds to a full colony; and should there be no nectar in the flowers we can very easily make an artificial honey-flow, which we consider quite an essential to get the young virgins developed into good laying queens as it is to feed the cell-building colonies to get good cells.

H. G. QUIRIN

Parkertown, Ohio, Oct. 31.

[We should be glad of further evidence from queen-breeders. Those who make a business of sending queens by mail in large numbers are more competent to give an opinion in this matter than the general bee-keeping public who buy them. In saying this, I do not in the least question the ability of Mr. Miller. It is important that we get at the truth of this, let that truth cut where it may. If a sudden stoppage of egg-laying, or if the queen, as Mr. Miller believes, is starved for want of proper food, then knowing the fact we can provide the remedy. As to how much the queen needs of one element of food over another I should like to hear from Prof. Cook. And right here, let me ask, has it been demonstrated that a queen needs more nitrogenous food in the time of her egg-laying than at other times? All of this is deep water, and I hesitate to wade out where I can not swim.—ED.]

THE SWARMING IMPULSE AND A GOOD HONEY-FLOW.

The Relation of the One to the Other; an Interesting Theory that Possibly Explains Certain Phenomena in the Bee-hive Economy.

BY L. STACHELHAUSEN.

Since E. R. Root mentioned, page 520, that in Southern Texas "the bees commence swarming early in the spring, and, when the

main honey-flow commences, actually stop swarming," this matter was discussed somewhat in the bee-papers. I observed this fact when I commenced bee-keeping here in Texas, 21 years ago. If we consider all the circumstances we shall find it not so very astonishing.

In our climate the bees commence breeding when the first pollen-spending plants are in bloom. This is at the end of January or the first half of February. From this time we have a moderate honey-flow, more or less according to the weather. If the conditions are favorable our bees build up very fast. I had swarms as early as the middle of March. Generally they are strong enough to swarm the first half of April. The main honey-flow in my locality generally commences in May, about a month later than the regular swarming time.

If we use small brood-chambers, the colonies will have cast prime and after-swarms, and these will build up to good colonies before the main honey-flow commences. This is so in favorable years, and then we get more honey from these divided colonies than from an undivided one. In this case it is quite natural that we should not expect more swarms during this comparatively late honey-flow.

If we use large brood-chambers, by which we can, to a certain degree, prevent swarming, we may think, as some say, the bees would swarm later, and would give larger swarms. In some very favorable springs, when these large hives get full of brood before the main honey-flow commences, they will, in fact, swarm more or less. So it was in 1900. In most years the colonies will not reach this maximum of brood before the main honey-flow commences; and during this honey-flow even these strong colonies will not swarm any more.

Why this is so is a problem very little understood as yet. We knew, long ago, that a good honey-flow will stop swarming, sometimes even when queen-cells are already started. I do not know who the first one to observe this, but I do know that Gravenhorst told us so about 25 years ago, without explaining why.

The question, then, is, "By what circumstances are the impulses of the bees incited and governed?" At present we have a theory based on the knowledge of the nourishment of the bees. In my opinion this knowledge of the nourishment is as important as the Dzierzon theory for practical bee-keeping, of which A. I. Root says: "It is the cornerstone and solid rock upon which nearly all we know about bees is based." But I am sorry to say this theory of nourishment is so much neglected as yet by the bee-keepers of this country that one of our prominent writers confounds "chyme" and "chyle."

It would take too much space to explain all this thoroughly. As briefly as possible I will say that the fully digested food called chyle, which is prepared in the true

stomach of the bee, is fully identical with the blood of the bee; the only difference is that the latter has gone, by osmosis, through the walls of the stomach. The young bees prepare this chyle, and feed it to the young larvæ, to drones and queen, and sometimes even to old workers. As long as the number of young bees is small compared with the number of larvæ, the bees will have enough customers for the chyle; but at a certain state the queen will not lay enough eggs compared with the number of young bees; the chyle will remain longer in the stomach; more of it goes through the walls of the stomach, and this causes a certain extension of the blood. This causes at first the wax-glands of the bee to secrete wax. The material for the wax is, of course, taken from the blood; but no albumen is necessary for it, consequently the blood will get richer in albumen, and hereby the drone impulse is induced. At first, drone-cells are built. As the same chyle is fed to the queen she is governed by the same impulses, and will lay eggs in the drone-cells. But still more and more young bees are gnawing out, while the queen either has no room to lay more eggs or is not able to do so. More chyle is accumulated, and the blood is still getting richer in albumen, till the swarming-impulse is incited, queen-cells are built, and the queen will lay eggs in them, and a swarm is a necessity. That is, theory teaches that the impulses of the bees are, *gradatim*, advanced from breeding-impulses to wax-secretion, drone-impulse, and swarming, by the different extension and chemical composition of the blood of the bees.

If, at the right time, a very good honey-flow commences, the swarming-impulse will not be incited, for different reasons. The first one is, the bees gather less pollen, which is the albuminous food of the bees. The main reason, I think, is that a large part of the young bees will be engaged in changing the nectar to honey, as Doolittle explained years ago, consequently they can't prepare chyle. The old bees are busily engaged in field work, and this needs a good nourishment of the muscles with blood rich in albumen. These old bees do not prepare chyle, but the same is fed to them by the young bees. We see now we have plenty of customers for the prepared chyle, even if the brood is diminishing. The blood of the bees will get poorer in albumen, consequently the swarming-impulse is diminishing.

It is easy to see, the faster the honey-flow the more it will suppress the swarming-impulse, and may even diminish the desire for brood. Many other astonishing actions of the bees may be explained by this theory, for which we have had no explanations. Converse, Tex.

[Mr. Stachelhausen draws a distinction between chyme and chyle, and very properly. *Chyme* is pollen *partially* digested. Chyle is the *fully* digested product, and is what is commonly known as "royal jelly."

Chyme is fed to nearly full-grown larvæ just before capping, while chyle is probably fed to the very young larva up to three days old. But this young larva in a queen-cell is fed continuously with this rich food till the cell is capped over. The theory advanced by Mr. Stachelhausen, in a nutshell, as I understand it, is this: The swarming impulse is incited by too much albumen in the blood—that is, too much digested pollen food; and as soon as a heavy honey-flow commences, this rich food is diminished (for lack of pollen), and the surplus previously stored in their chyle-stomachs is given off to the field-bees to supply the rapid waste incident to the flights to and fro with the heavy loads of nectar from the fields. The nurse-bees then do not have enough of this rich food to bring about the conditions favorable to drone-brood rearing and queen-cell building; consequently swarming will cease.

But there is one thing that this theory does not fully explain. It will be remembered that in Texas and Arizona the cessation of swarming is often followed by the destruction of cells and of drones. The cells that have been capped over, and the drones that have been raised to maturity, do not require the rich food, which is getting short. Why, then, should this capital (cells and drones) be destroyed *unless* the bees feel that swarming at a time of year when honey is coming at its height will be not only wasteful but a great loss in the amount of honey secured?—Ed.]



PURITY VS. GOOD WORKERS.

"Hello, Doolittle! I came over this morning to have a little talk with you about the purity of bees. Are your bees absolutely pure?"

"What do you mean, Mr. Brown, by absolutely pure?"

"Well, I supposed you would know, and so I asked you. I see in some old bee-papers I ran across that pure stock was the best, and so I asked the question I did to see if you had the best."

"Much has been said during the years that are past about a standard of purity for our bees; and I have often been led to ask myself the question, 'Can we, as apiarists of America, adopt a standard of purity that will always secure to us the best working qualities in our bees?'"

"And how did you answer this question?"

"As doubtful."

"But queen-breeders have a standard of purity, do they not?"

"Possibly some do; a standard which they adopt as breeder of Italian, Carniolan,

Syrian, Cyprian, etc.; but for the masses of honey-producers to adopt the same standard would be quite another thing."

"Why so?"

"Because the workers from different queens of the same color and general appearance show a vast difference as to working qualities; at least, such is my experience."

"Oh! Then you think the honey-producer should breed from his queen that gives workers proving the most valuable in bringing in nectar from the fields, rather than for those of the most uniform markings or purity?"

"That has been my idea all through the past 30 years, since I tried for better working stock."

"Thirty years! That is a good while. And do you think you have better bees to-day than when you first commenced—better bees regarding their honey-gathering qualities?"

"Well, I do not know that I secure a larger yield from single colonies now than I did then; but the average yield of the whole apiary is very much better as compared with the best colony than it was then."

"Please explain."

"When I first began work along this line of improvement of stock I would have some single colony in the yard that would produce a large yield of honey, while at the same time it would take a dozen of the poorer ones to give as much surplus as did this one, quite a few often giving scarcely a single pound of surplus."

"That is just the way I find it with my bees. Do you think that such a state of affairs can be remedied?"

"Perhaps a bit of experience will best help you to understand what I mean. In 1877 I had one colony in the yard, which had not swarmed when all the other colonies, or nearly all, had got through swarming. Thinking it a little strange that such was the case I went to it and found that it had 60 pounds of comb honey nearly ready to come off. About a week later this colony gave a fine swarm, which was hived; and, although the parent colony had none of its queen-cells cut, it never offered to swarm again; and the result, at the end of the season, was, according to an old diary bearing that date, 195 pounds of box honey from the parent, and 114 lbs. from the swarm, or 309 lbs. from the old colony in the spring, all told. And that same year I had other colonies that did very little."

"Whew! Of course you raised queens from the mother of those bees which did so well?"

"Yes, I reared nearly all of my queens from this one as long as she lived, and found many of them giving good workers which were long-lived, and great honey-gatherers. I always raising from the best and superseding the poorest. After the old queen died I began to secure queens from other parties who reported good yields of

honey through the bee-papers; but as many of these did not prove equal to those I had, these were superseded as soon as I found out that such was the case."

"Did you use any of those obtained from others as breeders?"

"Yes. Some of them proved very good indeed, and these were used, in connection with those I have told you about, although I have kept the first very largely in the majority ever since, till to-day the yield from all colonies is more nearly equal each year, unless it is from colonies from queens which I have procured from other apiaries. Working in this way I have bred up a strain of bees which please me; and from the many queens I receive from other parties, by way of exchange and by purchase, I am led to believe that any one taking this majority can breed up a race of bees second to none as to honey-gathering qualities. But I am free to confess that, for purity and yellow bands, there are bees in the United States which far excel those bred in this way."

"And I suppose you think that your bees thus bred are very near or quite perfect?"

"No. All I claim is that a great improvement has been made, for I am still striving to advance my bees further along the honey-gathering line, so each year finds me procuring queens from the most approved sources, although it is seldom I find one I care to use in connection with my own for breeding purposes; but as this 'seldom one' is of great value, I consider myself well paid for all trouble."

"But have you not got tired of sticking to this one thing for so long a time?"

"No, not by any means. There is nothing in all the realm of bee-keeping that gives me more pleasure than does this improvement of stock for its honey-gathering qualities; and as we have several of our most prominent apiarists at work along this same line, I believe the day is not far distant, if it has not already come, when the bees of America will be considered and conceded to be the best in the world."

"This, probably, is only your own thought. I suppose each nation might think the same of its bees."

"I may have been a little egotistical regarding our American bees; but the sending here for queens from nearly every bee-keeping nation in the world would show that I could not be far wrong in my conclusions. If I am correct, The A. I. Root Co. has had orders for queens from many of the nations of the Old World, and from the islands of the sea. And I have sent queens to fully fourteen different countries besides our own. It may not seem so to you, but I do not consider it an unpardonable sin to have a feeling of pride over the achievements brought about in our American bees through the untiring energy and well-directed efforts of our apiarists to bring about the results in the honey-gathering qualities of our bees which we now enjoy."

NOTES OF TRAVEL.

Another Bee-keepers' Paradise, in Arizona; some Peculiar Conditions as we Find them in the Tropical West.

BY E. R. ROOT.

In my remarks concerning the bee-keepers' paradise of Central Texas I spoke of the desert-like appearance of the country for miles and miles; of the vast tracts of sand; low shrubbery, and how utterly impossible it seemed that such a country could produce so many carloads of mellifluous sweetness from such land and such plant-life. On leaving Uvalde Co., Texas, and riding all one day and one night and the next day, I saw thousands and thousands of acres of just such land as I had seen in that paradise—land totally undeveloped, without animal life, except, perhaps, the jack-rabbit and the coyote, and without inhabitants except here and there small settlements along the railroad. So far as I could see, all of this country, or at least a great portion of it, would support bee-life, for there were mesquite and catclaw by the square mile. As civilization pushes on, we shall find bee-keeping, probably, following in its wake.

On and on I rode into Arizona, and still there was a desert-like country, until I came to Maricopa County, and then I began to see irrigation and the evidences of tropical vegetation. On the one side of the railroad, I might see ranch after ranch of alfalfa, and on the other a perfect desert of thorns, sage brush, and mesquite. On arriving at Tempe, where there was an uncle of mine living, the delightful aroma of new-mown hay, of the well-known alfalfa, greeted me for the first time, in all its perfection. Along the irrigating-ditches, and wherever irrigation went, in fact, there was the most beautiful and luxuriant growth of all kinds of vegetation.

At the train I was met by my uncle, Mr. J. H. Root, my father's youngest brother, and a typical Root he is. Indeed, it seemed as if I were shaking hands and looking into the face of my father as he looked ten years ago, for Uncle Jess is a younger man. It was not long before one of the principal bee-keepers of the place, Mr. Wm. Rohrig, drove up to the residence of my uncle. I explained that my time was limited, and that I desired to make the most of it, and both of the gentlemen kindly offered to help me make it go as far as possible. We got into Mr. Rohrig's carriage with scarcely a moment's delay, and drove out to the first apiary—that of Mr. J. Webster Johnson, a short distance from Tempe. All the way along I was struck with the beautiful tropical vegetation. All was new and interesting, and I kept my uncle and Mr. Rohrig busy answering questions about as fast as I could ply them. Arriving at the Johnson residence we found our friend away; but he soon returned. He is now Secretary and Manager of the Arizona Honey Ex-

change, a flourishing organization that handles a large part of the honey of this Arizona paradise. Of this organization I will have more to say later on. I requested him to sit out in his front yard close to one of the century-plants that grow so luxuriantly (a very common "weed" for that country), where I might take his picture, and thus give the readers of GLEANINGS something of an idea of what I saw. Here is the result.

Mr. Johnson sits in a chair, *painfully* close to that species of cactus with its sharp spines sticking out in every direction. I have not forgotten the exquisite pain I felt when I stepped back of him in order to size up the position of the camera, for just then I backed up against three or four of those needle-like spines which you can see in the picture. Posing Mr. Johnson, I went back, touched the shutter, and the effect is here reproduced.

But one picture was not enough, so I requested our friend to step in front of another big plant—one of those magnificent over-spreading palms. This he did, in the full glory of the sunshine; and while he stood there, again the shutter clicked—there, you can just see him fairly wreathed in the splendor of the plant, for it is a most beautiful thing.

I have seen these palms 50 or 60 feet high; but when so tall they lose much of their enchanting beauty. The older the tree, the higher the branches. The palm before us is not so very old—just how old, I will not venture to say, as my guess would be wide of the mark.

I produce both of these pictures, not because they are directly related to bee-keeping, for they are not, but because they illustrate better than any thing else that I can show the wonderful fertility of some of the lands in Arizona, which can be and are being reclaimed by irrigation—lands which are destined to be the garden spots of the United States, equaled only by some portions of California. No wonder, then, that in this portion of Arizona alfalfa grows the most luxuriantly of any place in the United States. I have seen this celebrated honey-plant in California, in Utah, and in Colorado—States where it is grown so extensively, and where it is such a valuable hay crop; but in none of the States does it grow as rank as it does in Arizona. But the trouble now is the want of water for irrigation purposes. There is no lack of water, if I understand aright, because there are millions of barrels of it going to waste from the melting snows down the mountain-sides; but at present there are no appropriations from State or nation to provide for the building of great ditches whereby this water can be carried into lands that will yield as abundantly as do those now under irrigation.

Thousands of people have been flocking to Phoenix and Tempe from the East and North, away from the long bleak cold winters—away from the damp bone-chilling at-



ANOTHER SPECIMEN OF PLANT LIFE IN ARIZONA; THE PALM IN THE FOREGROUND.

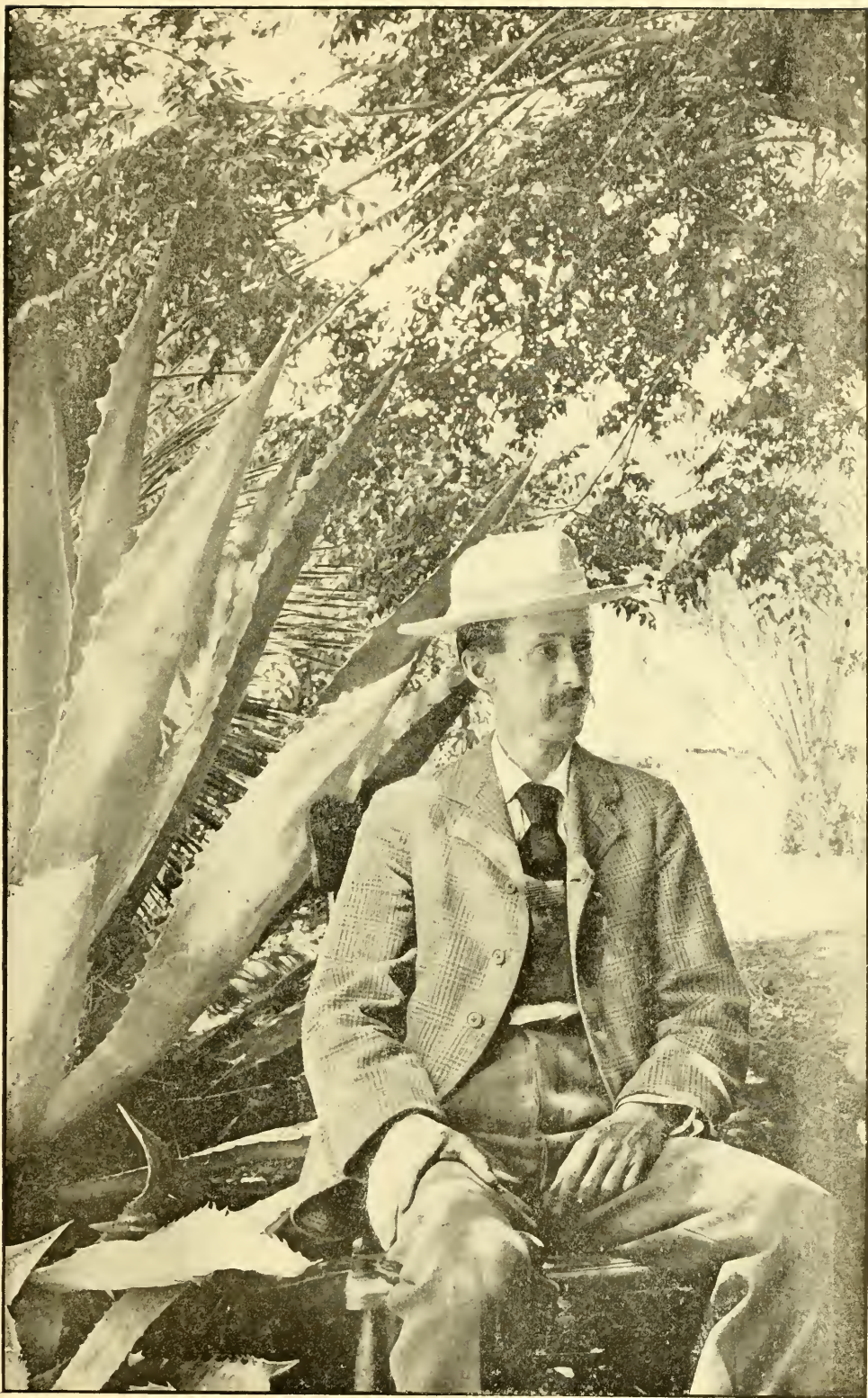

J. WEBSTER JOHNSON, OF PHOENIX, ARIZONA; A SPECIMEN OF LUXURIANT PLANT LIFE.

mospheres to the warm balmy air of Arizona—"God's country," as people call it who have moved there. Indeed, they say there is "no other place in all the earth" that is quite as delightful, luxuriant, so beautiful, and so perfect in every respect, as these reclaimed desert lands, and, if we except portions of California, I don't know but that I agree with them.

It was quite warm the day I arrived, and during some of the subsequent days the mercury ran up to 110, I think, and I had heard of its going up to 120; but the people who told me that that was "God's country" denied that it ever went up as high as that; indeed, they doubted if I ever saw the mercury up to 110; but I insisted that I *did* see it, for I remembered distinctly how

the hot sun poured down on my back, and that I wanted to get out of "God's country," and go where he had made it cooler. Why, I became so tanned that I looked every whit as black as—as—a typical Mexican greaser. But however warm it may be in summer for a time they do not seem to mind the heat; notwithstanding, it was comfortable for the old residents to go around in shirtsleeves. And, by the by, I must introduce to you Mr. Wm. Rohrig, of Tempe, who sits on a hive with his coat off, rough and ready. He objected to being shown up in GLEANINGS in that style, but I told him not to mind, as I would apologize for him.

In our next issue I shall, perhaps, give you some views of typical Arizona apiaries, how they are placed under sheds or trellis-



WILLIAM ROHRIG, IN ONE OF HIS APIARIES AT TEMPE, ARIZONA.

es, something as shown in the picture herewith. In the mean time, if there are questions that our subscribers desire to ask regarding these bee paradises, I should be pleased to answer them as I go on. Let me tell you right now that the bee paradises about Tempe and Phoenix are already overstocked with bees. The only way a bee-keeper can get into them at all honorably is to buy of some one else who is already located—or go out on the desert, buy a water privilege, and go at it in true Arizona style. But, more anon.



A NEW SCHEME FOR A TOP-BAR.

I send by this mail a sample of top-bar. Draw the four small brads, and you will then have it. These pieces can be used for bottom-bars—a very economical top-bar. It has the advantage of the thick top-bar for strength, with none of the sawlog disadvantages.

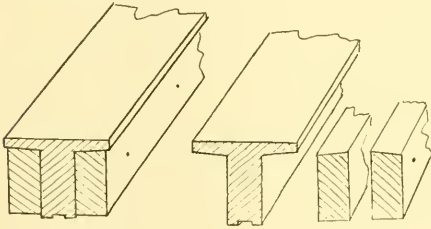

FISHER'S PLAN FOR A TOP-BAR.

The last four years have been failures with me with the bees. I have had no chance yet to test this top-bar. This is why I should like to have you bring it before the public so they can have a chance to test it as to its merits; then should the bee-keepers in general pronounce it a meritorious invention, all I shall ask is justice.

A. J. FISHER.

East Liverpool, O., Oct. 8.

[I do not think that you would find this kind of top-bar would prevent burr and brace combs. While it might not sag, yet so far as those nuisances are concerned I am of the opinion that you will find many more of them on it than you would of the old-fashioned $\frac{3}{8}$ bar. The two pieces taken out of the side would be no direct saving in expense, for every supply-manufacturer has usually enough refuse to make all the bottom-bars he can possibly use; so that what would be saved out of the top-bar would be of no particular value. After an experience of one or two years you will probably find that your bar will be much better with the wood all left in.—ED.]

RESPONSIBILITY FOR LOW PRICES; PUTTING THE SHOE ON THE OTHER FOOT.

Your article in the Oct. 1st issue, page 792, has the right ring to it; but let us see if it is all the "animus" of the "bears," or if some of it is not the stupidity of the bee-men themselves. There is a small town in this county, Escondido by name, which boasts of a bee-association. Just on the eve of extracting-time, this association called a meeting to ascertain (so I am told) how many honey-cases would be needed among the members, and in a day or two after I heard they had decided that there would be 10,000. Think of it—1,200,000 pounds of honey, 40 carloads of 30,000 pounds each, and the area covered by the bee-keepers of the association is a mere speck compared with the rest of San Diego Co.; and there are other locations in the county that are much better. With such a yield through the entire State of California, I am thinking you folks in the East, who are in the bee and honey business, would have to hunt another job or "go west."

Now, the next issue of the *San Francisco Chronicle*, after the meeting referred to, had a clipping from a paper printed at Escondido, stating that there would be 10,000 honey-cases needed in that vicinity. I think it was the next issue after the one referred to above, or the next but one at furthest, that quoted honey half a cent lower, and it's been going lower ever since, until within the last two or three weeks, and now buyers who would hardly answer a letter from a producer are writing, asking the producer *his* price. I think we should not blame the "bears" too much when such statements come from bee-keepers and bee-associations themselves. There is no excuse for such statements being printed and sent abroad to be reprinted. Why do not the members of the association see to it that such reports are given the lie? If they are to benefit the bee-keepers, that is one way, and one of the very best ways, they could do it. This is only one of many instances I could cite; but this one is sufficient to show that the honey-buyers have something to base their reports on.

I was in San Diego a short time ago, and met a bee-keeper from Escondido, and he told me there was not nearly so good a crop in that section as there was last year, and the average would not be more than half a crop.

E. M. G.

Jamul, Cal., Oct. 10.

[What you say is very true; and while it may and probably does apply to some subscribers of bee-papers, yet the very persons who ought to see it are the ones who do not take any bee-paper, but they *think* they know it all. It was a strange thing to me that so many large bee-keepers in the West do not take any journal at all. If they but knew it they could save the price of a paper a thousand times over, even by the market reports alone, to say nothing of keeping

in touch with the rest of their brethren in the craft.

The reference to those 10,000 cans is one of many to show that Mr. Clayton's estimate of the California honey crop, based as it was on the number of cans sold, was far too large.—Ed.]

THE EUROPEAN LINDEN.

In regard to the article about European linden, in GLEANINGS for Sept. 15, I would advise you to be careful to find out if all European lindens bloom later than the American kind. In Germany they have two kinds—one with small leaves, *Tilia parvifolia*, and a large-leaved kind, *Tilia grandifolia*. I think this is the botanical name. The first has leaves that measure about 3½ inches across, and the other leaf measures about 5 inches. Some that I have seen were almost 7 inches. The trees don't differ in any other way. I don't know whether both kinds blossom at the same time. The small-leaved kinds seem to be more common.

In front of our house in Germany were two lindens of the large-leaved kind, and I never saw blossoms on them. They were planted in 1872, came from a nursery, and were about 12 feet high. In 1889, when I left home, they were almost as high as the house, but had never bloomed.

CARL VOLLMER.

Columbus, Montana.

[The size of basswood leaves depends largely on the season and locality, but more particularly on the size of the tree. A sapling will have much larger leaves than a tree ten inches through at the base, and yet both may be of the same variety. Whether the *Tilia grandifolia* is the same as our *Tilia Americana*, I am not botanist enough to say; but I am of the impression they are one and the same.—Ed.]

BEE AND HONEY BUSINESS AT SPOKANE, WASHINGTON.

Will the editor, or some one else, please tell me through GLEANINGS what the possibilities are for the bee and honey business at Spokane, Washington? I would write to some real-estate man there, but think I am more sure of getting the facts through GLEANINGS.

I have spent the summer here in Colorado, and, being afflicted with dyspepsia, I have found that, between the very hot sunshine and alkali water, I shall be forced to "move on." I don't suppose Washington is perfect; but I am told they have an abundance of soft water, the best of fruit, and more moderate weather. I must say this is a fine country for those who have good health; but you can't build up a good digestion on alkali water.

Sterling, Col.

J. O. HAYNES.

[Will some correspondent please answer?—Ed.]



A. I. R. is once more at home, and at his desk; and although he has not as yet looked over the great heap of letters awaiting him he will do so at once.

ON a second reading of my footnote in this issue to A. C. Miller, where I refer to some of Mr. Alley's queens as going "very bad," I see the impression might be gathered that his queens were worse than others'. This I did not mean. I only meant to show that the simple fact of his using small nuclei does not prevent good queens from going to the bad after their journey. I believe his queens average well with others'.

NOT A HONEY TRUST BUT A NEW HONEY EXCHANGE IN CALIFORNIA.

OWING to the fact that there have been great exaggerations as to the California honey crop, and to the further fact that prices have been slashed and cut to pieces on the coast, simply from a lack of co-operation, a movement was started by B. S. K. Bennett, of the *Pacific Bee Journal*, to organize a honey trust, to take in all the large honey-producers as well as the small ones. The object was to control prices by taking the entire output of honey; but the effort, I understand, fell flat, as bee-keepers do not take kindly to trusts, although they do believe in co-operation. A meeting was held in Los Angeles, and, instead of a trust being formed, a sort of exchange was organized that will be known as the Southern California Honey Association. To this all bee-keepers having 50 or more colonies will be eligible to membership. The Board, as announced in the newspapers, takes in some of the most influential bee-keepers of California. This Board consists of W. T. Richardson, of Ventura; Frank McNay, of Los Angeles; W. W. Bliss, of Grange; M. H. Mendleson, of Ventura; G. W. Brodbeck, of Santa Ana; D. A. Wheeler, of Riverside; G. S. Stubblefield, of Los Angeles; H. C. Williamson, of Redlands. Full particulars will probably be furnished our readers. For the present we are able to give them only the reports as we gather them from newspaper accounts.

THE DEATH OF MRS. MOSES QUINBY.

We have just received notice of the death of Mrs. Martha Quinby, wife of the lamented Moses Quinby, which took place Oct. 31, at the residence of her son-in-law, Mr. L. C. Root, Stamford, Ct., in the 88th year of her age. Her husband died in 1875, so that she survived her husband over a quarter of a century.

In the rapid advancement and many changes in bee culture that have taken

place during late years, and the advent on the stage of many new leaders, we of the younger generation are liable to forget the names of two of the great bee-lights, fathers Quinby and Langstroth, who, more than any one else during the infancy of bee-keeping in the United States, first placed the industry on a paying and substantial basis. Quinby was one of the most successful bee-keepers who ever lived; indeed, if I am right, Mr. Quinby was the first to produce and ship a whole boatload down the Hudson to New York city. Such an amount of honey at that time (the early 50's) literally broke "the market," for no one knew what to do with so much honey. This remarkable feat was performed with *bar* hives. Yes, father Quinby made his bees pay; and, as I understand from Capt. Hetherington and others who knew him, he was one of the most lovable and unselfish persons the world has known. Never a beginner went to him for instructions without receiving generous advice, even though that advice might bring into his territory new and disagreeable competitors.

As is often true in the case of a great man, we know little or nothing of the wives who shared their toils equally in their successes and failures. This is true of Mrs. Quinby; but I think we may safely say that some degree of her husband's success was due to his kind and loving helpmeet who has for so many years survived him.

HONEY-PRODUCERS THAT OUGHT TO BE SCORED.

WE are just getting in considerable quantities of comb honey. It is evident that some of it, having been held back, is now being unloaded on the market. This is unfortunate, but I do not know that it can be helped.

But there is one thing I feel like *scolding* about, if I may use this disagreeable word, and that is the carelessness of some comb-honey producers. Much of otherwise good comb honey that we have received is not properly graded, with the result that we are compelled to go over it section by section. We now have on hand about a carload that will all have to be re-sorted before we could offer any of it as fancy and No. 1. This we must charge up to the producers, for we can not afford to do this grading for nothing, nor risk our reputation in putting out such a mixed lot. Much of it was graded, or an attempt made at it; but, such grading! And, to make matters still worse, some lots were unseparated, and a little was either broken or leaking.

I do not blame the commission men for being disgusted occasionally, and for charging good round commissions, if this is the way honey sometimes goes to market. The use of separators first, last, and all the time, will, in the great majority of instances, earn from one to two cents a pound; and why will bee-keepers be so foolish as not to separator (or, better, fence) their supers?

Still again, we are continually getting lots not scraped. One little lot was wormy; and—would you believe it?—the producer even went so far as to dust flour on the surface of the sections to cover up the tracks of the nasty things.

It does not cost any more to produce first-class honey, or but very little more, than it does second-rate goods; and after having produced some good honey, to mix that with No. 2 puts it all down to No. 2 grade.

For the sake of good prices and fair dealing, brother bee-keepers, do be careful. When I say this I am afraid I am not reaching the very people who ought to read it; but if a man will not take a bee-journal, or, still worse, will not read it when he does take one, he surely ought to take the consequences, and will.

MARKETING COMB HONEY; WHY GOOD HONEY SOMETIMES BRINGS LOW PRICES; INEXCUSABLE IGNORANCE.

THE honey-man, Mr. A. L. Boyden, of our firm, has been having some "experience" of late; and in response to my request he has prepared a statement which producers of comb honey should read carefully.—E. R. R.

As most of our readers know, we handle large quantities of comb and extracted honey each season. Without thought of going into this as a source of profit, we have for years taken honey, sometimes as a convenience to bee-keepers who had more than they could use in their home markets, and wanted us to handle it for them. Other times we have taken it in exchange for supplies; and during the past few years we have been obliged to buy large quantities to supply the demand of our established trade. Many times we have received complaints from bee-keepers that they have been unfairly dealt with by commission merchants and others to whom they had sent their honey, and we are aware that these complaints are often justly made. It has been our experience, however, that many bee-keepers do not realize the importance of using every means to insure the delivery of their honey to the merchants in a condition that will be creditable to them, and bring for them the best price. For years we have recommended that the cases be packed in crates like those shown below. As a matter of information we publish here the directions we send out to our shippers.

TO SHIPPERS OF HONEY.

1. Put your name on the *crate*. *No name on cases.*
2. Put a caution card on each crate.
3. Put the gross weight, tare, and net weight on each case before packing honey.
4. Put the total weight of all cases on the upper side of the crate, so this can be found without opening the crate.
5. Mark each case with the grade.
6. Mark each crate with the grade.
7. Put only one grade in a case.
8. Put only one grade in a crate if possible.

Never think of shipping your cases of nice comb honey unprotected, for they are almost sure to go through in a broken or damaged condition. The cases of comb honey should always be crated something as shown below: and in the bottom of the crate,

under the honey, should be a quantity of loose straw, the purpose of which is to act as a cushion. Honey put up in this way can go by freight, and is rarely if ever broken in transit.

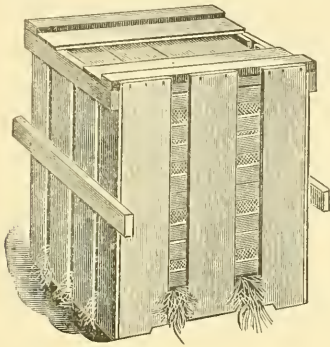

Our shipping-cases when sold are put up in the flat in a crate of this description. This crate will hold fifty 21-lb. shipping-cases in the flat, or eight of the same filled with comb honey; or it will hold 100 2-row 12-lb. cases, or 16 of the same when filled with comb honey. In the latter cases, handles are nailed on the sides to insure careful handling. Additional comb-honey crates in the flat, 50 cts. each, or \$1.00 for 10.

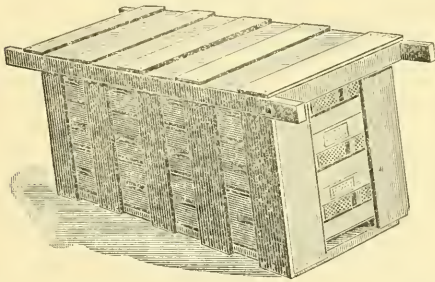

This crate holds twelve 3-row 12-lb. cases, and has been used successfully by Geo. E. Hilton and others, without any straw, and, so far as our experience goes, we would not hesitate to snip in this crate without straw. If you use a larger case, however, making a different-sized crate, then we would recommend the straw. The success of this crate we think lies in its shape, and unless you conform to this shape closely we would fear the results would be a lot of broken honey.

There is something like 3000 lbs. in each lot, and there is not a case in either lot that is not badly soiled by dripping honey. The honey is well filled out in sections, and a caution card is on each case; but in spite of this, enough honey has been broken to make a very sticky mess of it. Another party sent us some put up in crates as we requested, and has used covers on his cases made of two pieces not tongued and grooved or shiplapped, consequently there is a little crack in the cover where the two boards meet, and the honey is badly soiled by dirt sifting in through these cracks. This might have been avoided by using paper, which we recommend, even though his covers were not exactly suitable.

In another respect bee-keepers fail because they omit the marking of the cases with the gross weight, weight of the cases, and net weight. If the little labels which are had for this purpose are not convenient it is much better to mark the cases with pencil than to omit it. Otherwise the dealer must weigh up every case separately, entailing a vast amount of work. In another lot we have just received, billed to us as "fancy honey," we find unmistakable signs of the bee-moth; and on examination we find quite a number of cases in bad order from the work of these pests.

It seems to us if bee-keepers would use more care in putting up their honey they would earn just the difference between a high and a low price on their honey. We can not see why they will allow it to be sold for less than it is worth, simply because they have neglected two of the most important points—grading and shipping.

We have also to call the attention of our readers to the great difference in price received by bee-keepers for the honey produced in the same locality. During the past month we have paid from 13½ to 15½ cents for No. 1 and fancy white honey. At one time we were entirely out, and could have used several tons at the latter figure had we known exactly where to get it without delay. Since then we have been informed that bee-keepers in Western New York have in a number of instances sold the same grades, and equally good honey, at 11 cts. per pound, or at least 25 per cent less than its real value at the time they made their sale. Bee-keepers who take a bee-journal, and know the value of their crop, do not lose in this way, and it would be to their interest to induce their neighbors to take such a journal, so that their market may not be demoralized by sales being made at such figures. Not many years ago, good honey was selling at 10 to 11 cts. per pound, and very likely bee-keepers who sell at 11 cts. now think that they are getting a good price simply because it is as much as was received in previous years.

We heartily wish all of our readers would give their best attention to the grading and shipping of their honey, and help the industry by getting other bee-keepers to post themselves on the market price of honey.

Gross WeightLbsOz.
Case WeighsLbs.Oz.
Honey WeighsLbs.Oz.

CAUTION CARDS.

These cards are 5x7 inches, to tack on crates of comb honey, cautioning against rough handling. Printed in red ink.

When these rules are followed we seldom have a shipment reach us in bad order, and we think it will pay bee-keepers everywhere, when shipping their honey in less than carload lots, to put it up as described above. We have just received two large lots which have been sent us without crates.



In all thy ways acknowledge him, and he shall direct thy paths.—PROV. 3:6

Yesterday afternoon I gave the children at a Sunday-school convention a talk on "paths and path-making," using the above for my text. For a week or more I have been getting much happiness in repeating the text over. No matter how many times I repeat it, each time it comes over me like a strain of sweet music. I have in times past told you of how my life is made joyous by texts of Scripture that come to me suddenly with a new light and a new meaning. It was so with this one. While thinking about my subject of path-making, and the number of beautiful texts containing the word *path*, this one suddenly occurred to me, and I began wondering if it was not one I had already used. We have no concordance of any kind in our humble home out here in the woods, and I began to wonder if we could find where it was in our little Bible. Mrs. Root said she thought it was in Proverbs, and in less than a minute I had it. It seemed to burst on me like a volume of sunshine, all at once. What a glorious promise it contains for *all* who are, day by day, all through their lives, striving to "acknowledge him" in all their daily acts and ways! How often do we say, "If I only *knew* what to do"! or, better still, "If I only knew what *God* would have me do in the matter"! and here is the promise, that, while we are acknowledging him, he *will* direct our paths for us.

Sometimes it is a little hard to stop our busy work long enough, or, if you choose, to *interrupt* our busy work, to acknowledge him. A man was plowing for me, breaking up ground in the woods. It was trying work for both man and team, and he commenced to swear. I hesitated a little about hindering him long enough to remonstrate; and, in fact, I feared, tired and heated up as he was (for it was near dinner-time), he might swear worse. Well, the result was one of my "happy surprises." He stopped, looked a little foolish, and then began to laugh. He said his wife would be "awful glad" if I could *cure* him of swearing, and finally admitted *he* would be glad too. He said he got "into it" among the lumbermen, and he had tried hard many times to break off. I stopped him several times when he forgot, for a few days, and it is now months since I have heard him swear at all. Later on I learned he told some of his friends how I had helped him to get over and away from his bad habit.

Now, friends, this kind of work is "acknowledging him" before men. It is letting everybody know, *especially* when you are among strangers, that you belong to Christ Jesus, heart and soul. Of course you know I mean a *reasonable* and *consis-*

lent acknowledging. If a man engages to work *for* you, and may be *with* you for some little time, it is your duty—*nay*, your *privilege*—to try to do him good.

Well, God *promises* to "direct" the "paths" of all who are in this way "showing their colors" for him and his work. Is it not a glorious promise? and is it not a glorious *privilege* to feel that the great Father above is *directing* and *guiding* us?

Now, I often feel it is a strange thing that I have felt called to come away off here in this out-of-the-way place and start a little humble home. I have wondered at it myself, and I have often prayed over it. I have asked God to indicate to me plainly if it was his *will* and his *call*, instead of only one of my many hobbies, and only a craze for something new and different. When I urged Mrs. Root to come with me and share this "cabin in the woods" she felt sure she would be homesick; and when I was absent on my wheelrides, etc., she felt sure she "couldn't stand it." This seemed reasonable, and I confess I feared it would only prove a blunder and a loss of time and money. Now for the result.

We came here for three or four weeks; but she enjoyed this new life in the woods so much she proposed extending it to *eight* weeks or more. When I was away last evening (at the convention) she was alone, far from neighbors, during a pretty severe storm, after night, but she wrote home to the children, explaining the situation, but added she was well and *happy*, and not the least bit homesick. *Why* (do you ask?) does God want us off here? Well, I don't know exactly just yet, but I think I can now see pretty clearly *one reason*. By this experience I am learning more about the *homes* of the average country people than I ever could have learned otherwise. Perhaps I should say of the *humble* country homes rather than of the average. Let me go into detail a little.

Our home in Ohio is warmed by an apparatus (hot water and exhaust steam from the factory), so automatic that we have nothing to do with fuel. Last night the rainstorm turned to snow, and to-day the ground is white; but we have a new wood-house filled with blocks of dry wood, and we can get to it all through that trapdoor near the stove, which I have told you about. The smallest size of cooking-stove was our first purchase; but we found that expensive in two ways—the wood must be cut up very fine to go into it; and to keep the room warm the stove needed almost constant replenishing. The wood itself costs nothing, and during the winter it is cut into 18-inch blocks, and piled up, for about 50 cents a cord. Well, after we decided to stay until after November we built an annex (8½ × 10) for the cook-stove and utensils. Then we got a very pretty drum stove (named the "Flirt"), for \$4.50, that will take any of the blocks of wood without splitting; in fact, the opening in the top for fuel is a circle 11 inches across. This stove will make

our whole room, 14×20, nice and warm, and it can be closed up so as to stop instantly, and it holds fire all night or even longer.

Our first stove had the pipe go out through the wall, and then up into the air; and, in fact, most of the houses in our neighborhood have stovepipes sticking out through the roof. But this arrangement was always an "eyesore" to me. I asked the carpenter who built the annex if he could build a chimney. When he admitted that he built the chimneys to his own house I borrowed his team and hauled the brick, and now we have a very pretty chimney that answers for both our stoves, and yet it cost less than \$5.00; the brick cost only \$1.50, and brick is very expensive here. Every home, no matter how humble, should have one of these fuel-saving air-tight stoves. Get one to take big knotty *blocks*, so as to save the expense of splitting. Our stove will take a cut from a log 10 inches in diameter and 2 feet long. Such a block of hard wood will keep fire 24 hours.

We soon learned that, to keep the house warm, every thing must be tight and snug under the floor. This we managed with rough boards covered with shingles, putting building-paper between the boards and shingles, using this in place of a wall, so no wind could possibly ever get under the floor. Our little "annex" has building-paper all over under the floor and under the shingles on the roof. The result is, we can go into it to take a bath, and not feel the least bit of a draft of air through any crevice or crack. For a bath-tub we use one of the largest-sized galvanized tubs, costing only 70 cents. During a short dry spell we ran out of rain water, and Mrs. Root then put in strong for a cistern. There are very few cisterns in this neighborhood. They depend on tubs and barrels; and when there is a dry spell they get along with hard water. Very few of the springs or wells are really soft water. Every home—yes, every *individual*—should have plenty of soft water the year round. The shower bath with cold spring water, such as I have described, for warm weather, may be taken with hard water.

Before I forget it let me say, use building-paper for every thing you build (unless it be "the corn-crib"), for it costs less a cent a square yard, and it keeps off drafts of air that might cause much sickness (if not death) to some loved one.

TWO AND A HALF MILES FROM THE POST-OFFICE.

We have had another experience out here in the woods. People who have all their lives been in the habit of having mail brought to their places of business three or four times a day can hardly imagine the inconvenience of having to go two or three miles to the postoffice. We have got along very well by getting the schoolmaster to give our mail to the children coming our way through the woods (we give them a nickel each trip); but when it is very bad

weather, and on Saturdays, the children do not go to school. I have also had glimpses of the way our neighbors manage. During busy seasons the mail is often left almost a week. At other times journey after journey of several miles is made for an important letter that doesn't come. You see Mrs. Root and I are now ready to discuss understandingly "free delivery of mails in country places" that is so much talked about. We take a daily Cleveland paper (*News and Herald*), and we could hardly get along without it; and you may judge with how much interest we read the following in the daily of Nov. 2:

GOOD NEWS FOR THE FARMER.

WITHIN FIVE YEARS EVERY RUSTIC IN THE COUNTRY WILL HAVE MAIL DELIVERED AT HIS DOOR.

Washington, Nov. 1.—Within five years every farmer in the country will have his mail delivered at his door. Superintendent Machin, of the free-delivery division of the Postoffice Department, made this prediction to-night, and is confident it will be fulfilled.

"At the rate we are extending the system," he said, "it will spread all over the United States in the period mentioned. It will cover an area of one million square miles, and include practically all the inhabited area of the country.

"There will be in operation by Dec. 1 about 6000 rural routes. Of these, 4700 will have been established since July 1, 1900. During the fiscal year ending June 30, 1900, 1900 routes were put in operation. There are now on file 6000 applications for new routes, and they are coming in by the hundreds. It will take us from a year to a year and a half to dispose of those already on hand. The people living in the country are wildly enthusiastic for this service, and we are supplying it as fast as our appropriation permits."

It is Superintendent Machin's aim to apportion the routes among the Congressional districts as uniformly as possible. Congress will be asked to make a largely increased appropriation for this service at its next session.

Our nearest country store is where the postoffice is kept, and we have had some new experiences in finding ourselves all at once out of soap, matches, coal oil, sugar, and even flour. I can now see a very good reason why land may be very cheap in remote places compared with that near towns and cities. I can also see, I think, how it is that poor hard-working people waste so much valuable time, even a busy season, in going to the "store and postoffice." By free delivery of the mail Uncle Samuel says to these folks, "You keep right on with your work. When there is any mail for you I will bring it right to your door." In the matter of groceries, both *time* and *money* are saved in getting enough to last.

"In all thy ways acknowledge him, and he shall direct thy paths." The great Father not only directs the "paths" of his followers when they go through the woods to the postoffice, but it is on account of the fact that we are as a people a *Christian nation* that he is just now directing our government in this matter of free delivery of mails to both *rich* and *poor*. I believe God was directing *my* path when he gave me this longing for a life in the woods; and I verily believe that the experience of the two months that are now almost ended will help *me*, all the rest of my life, to feel more than I ever did before that I know at least *something* of the trials and difficulties that

beset great masses of the hard-working people. May God be praised that it is my privilege, even in advancing years, to be *one* of them, outdoors, under his clear skies, and in his woods, claiming the promise he has given, to direct *my paths*.



POTATOES IN LEEANAW CO., MICHIGAN:
TESTING DIFFERENT VARIETIES.

Some time in May I sent friend Hilbert a barrel of assorted potatoes, of our best varieties, to be tested on his farm. Along in July I found we had about a barrel of Red Triumphs that we had no room for. They had been spread out in the light on the barn floor for nearly two months, and were a wilted, dried-up, sorry-looking lot. I shipped these also to him, telling him he might get from them enough for seed next year. They were so poor his boys threw out a large part of them as "no good" at all; but when Mr. Hilbert saw them, remembering what I had said, and perhaps also from some of his own experience, he had the "poor trash" planted also. They were put on new ground, and had very little care, or cultivation of any sort; in fact, they were put in so late no one thought they would amount to much. Let me say here, that, during the past season in Medina, we have had so much trouble with blight on the Triumphs I had about decided not to plant any more here. About four years ago they gave good yields with but very little blight; but since then it has been worse and worse every year. In Medina they don't stand hot dry weather at all. Well, here at Mr. Hilbert's there was very little or no blight at all, and the poor dried-up wilted seed gave the handsomest smooth, round, red potatoes I ever saw; in fact, they looked more like beautiful fruit than like potatoes. They are exactly like the Bermuda Triumphs; and, in fact, this soil is about as soft and yielding as that in Bermuda. No wonder the potatoes are of such nice shape, for there are no lumps of dirt or any thing else to hinder them from taking shape just as the apples and cherries do right out in the air. The yield was very fair, considering.

Now, I have a small test-plot of potatoes in my ravine garden, and a dozen hills of Triumphs there gave a beautiful yield—no blight, and some of the potatoes are as big as a goose egg. Of course, we can not, so far north, grow potatoes for the early city markets; but we *can* grow Triumphs and other extra-early potatoes *for seed* for all the rest of the world. Some one may suggest that, after potatoes have been grown so many years on the same ground, we shall have blight here, perhaps, as badly as we now have it in Medina, O., and other places.

Early Ohio does hardly as well here as in Medina, and it seems of late to be rather strongly disposed to blight everywhere, but not nearly as badly as is the Triumph.

Bovee has been a fair success here, both on Mr. Hilbert's test-ground and in the ravine garden. In fact, it yields equal to some of the best late potatoes, and is almost as early as the Early Ohio. As with the Freeman, there are a good many small ones, but the shape is not as good as the Freeman. The latter has given a fine yield on this soil—in fact, about as well as it used to do for Terry. It is not only ahead of every thing else in quality, but it is the smoothest and best-shaped of all the potatoes. The eyes on good specimens grown in this soil are almost exactly on a level.

Maule's Commercial gives a very good yield. The potatoes are all large (almost none so small as to be called seconds), and the shape is very much better than in Medina. Carman No. 3 is beautiful in shape, all good table size, and the yield is the largest of any of the five kinds I sent for trial. I was not disappointed in this, for I expected it to show quite a little improvement over the Rural that is so common through this region. It is so much like the Rural it will doubtless be sold as such. The Carman (and I think the Rural also) has the very valuable trait of giving a very even stand. There are almost no missing hills where the planting is carefully done.

The New Craig was the greatest disappointment of all. In the ravine garden, with its rich "woods dirt," the accumulation of decaying vegetation of no one knows how long, I expected something wonderful of the Craig, and, in fact, there was a great show of tops. I could find hills where I could raise up the vines and twine them about my neck; but after they were killed by the frosts, about Oct. 20, to my great surprise we had only a lot of rather small immature potatoes. It was the same at friend Hilbert's. He said he wanted no more of the Craig. Now just contrast the above with the following letter I just received from Medina:

Dear Mr. Root:—We got 200 bushels of Craigs in the swamp, and they were fine. I wish you could have seen them roll out. They lay thick in the rows. We got 95 bushels of Craigs by the windmill, and they were nice ones too—very few scabby. We got 20 bushels of Craigs across the creek, about 155 bushels of Sir Walter by the windmill. They were of good size but not quite so smooth as the Craigs. We dug about 200 bushels of Russets, but they were not very nice in shape. Most of them were prongy, and not very big. We got about 20 bushels of Whitton's White Mammoth. They were all fair potatoes, and good yield.
Medina, Oct. 21. FRANK RITTER.

The swamp mentioned in the fore part of the letter is a little less than one acre; and for this poor season, when almost all potatoes are pretty nearly a failure, the Craig on our Medina clay soil has scored away ahead. Another thing, they are clean, and free from scab and blight, on upland, when almost every other kind is more or less affected. We always get a big yield of nice clean Craigs on any of our Medina ground; but up here in this great potato region they

are "no good." I wonder if it can be that the season here is not long enough for the Craig. In both tests the potatoes looked as if they were only half grown, yet both were planted near the first of May. I think I will try again next year, planting them in April, or just as soon as they *can* be planted.

Now for the Russet. Frank says the yield was small, and the potatoes were "prongy," in Medina. I think this was due largely to severe drouth that almost stopped their growth, but that they afterward started a new growth with our abundant rains in August. Well, there was something of the same conditions here; but, listen to my story.

A few days ago my help was all missing. I soon found the farmers were getting anxious about their potatoes, and were offering 4 cts. a bushel for digging and picking up. One of the boys whom I had been hiring for \$1.00 a day was making \$2.00 in the potato-field. Another boy, only 14 years old, was sure he could do the same (dig and pick up 50 bushels a day), and he did it. Then came a report that Holly Hilbert, aged 19, and his sister Erna, aged 15, had (the two together) dug and picked up 125 bushels in a day. Mr. Hilbert sent word I must come over at once and bring my kodak. Let me go back a little.

Last fall I sent friend Hilbert a copy of the book entitled "Farming with Green Manners,"* and he has become quite taken up with it. Some time in the fall he plowed under a fine field of clover, and sowed rye. This spring, just after the rye was out of bloom, he turned it under and planted Russet potatoes. His neighbors thought it a great waste; but to-day he has been getting *three hundred bushels per acre*, during this poor season, of the handsomest Russets any one ever saw. The potatoes are all large or very large, and they are almost as handsome and smooth as the Carmans, only of different shape. It was these beautiful Russets that Miss Erna and Holly got out 125 bushels of in a day. Their mother told me they did not commence till after 7, and they stopped at night before 6 o'clock.

I noticed Holly pulled out his potatoes with a light hook, such as is in general use about here; but he told me he preferred a fork, as a rule; but on this crop the rye straw, that was not fully decayed, interfered with the fork more than it did with the hook. Both forks and hooks are made much lighter for use in this locality than in Ohio.

I find, by conversing with experts, that there is a difference of opinion as to which is best. Holly says he could have dug 150 bushels or more, had he been able to use the fork. I find, in the country about here, that most of the schools have a vacation during potato-digging time. Buyers are now offering about 50 cts. per bushel. Perhaps I might here mention that the Russet

is about the whitest, inside, of any potato known, and it now commands as high a price as any other potato in the market. A scabby Russet is something I have never seen in this locality, although they have had trouble with scab with almost all other kinds—that is, when potatoes have been grown on the same ground year after year. My kodak pictures of the potatoes and the Hilbert family I expect to show you in due time.

Potatoes are kept over winter right in the field where they are dug, all over this region. Just dig an oblong pit, say from 3 to 6 feet across, 2 or 3 feet deep, and have the top of the potatoes about level with the surface of the ground. Put on an armful of straw, then a foot or two of dirt; and if you are in a depression where the snow will drift over the heap, and not blow off, your potatoes are safe. Scattering the potato-tops over the heap will help to keep the snow from blowing off. If your pit is in the sand, say in soil sandy enough to dig easily, there is never any need of making any provision for drainage.

Since the above was written Mr. Hilbert tells me he dug a square rod, carefully measured, and it showed at the rate of 354 bushels to the acre. Mr. Martin Olsen, of Keswick (the carpenter who built our "cabin"), has also succeeded in getting this season 300 bushels of Empire State potatoes to the acre on a part of one of his fields. On the same field he has, on former seasons, taken 200 bushels of corn from an acre, and this is not considered a corn country. Now, both Mr. Olsen and Mr. Hilbert are "high-pressure" farmers. I might tell you of seven acres of potatoes near here that gave only a little over 100 bushels all together.

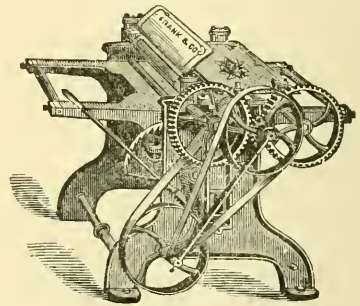

PLANERS

The above cut shows one of our small Planers, of which we make twelve different styles and sizes. Also large Planers, Band Saws, Buzz Planers, Moulders, Wood Lathes, and all kinds of

WOOD WORKING MACHINERY

Send for Catalogue.

The FRANK MACHINERY CO.
BUFFALO, N. Y.

* This is the book that Alice, when she hastily read the title, called "Farmers with Green Manners." Never mind. Alice picked up 97 bushels the same day her sister did 125, and Alice is only 12 years old.

GET MORE HEN MONEY

Feed cut raw bone and double your profits; get more eggs, more fertile eggs; more vigorous and healthy fowls.

1902 MODEL BONE CUTTER

New design, open hopper, enlarged table, new device to control feed; you can set it to suit any strength; never clogs. Sent on

10 DAYS FREE TRIAL. No money asked for until you prove our guarantee on your own premises, that our New Model will cut any kind of bone, with all adhering meat and gristle, faster and easier and in better shape than any other type of bone cutter. If you don't like it send it back at our expense. Free cat'g. explains all.

F. W. MANN COMPANY, Box 37, Milford, Mass.

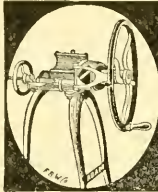
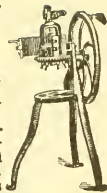

Why Not Buy the Best?

It costs no more than inferior styles. We claim that **Adam's Green Bone Cutter** is the best because it is the only Ball Bearing machine on the market. It works on the shear principle, turns easier, cuts faster and cleaner, and prepares the bone in better shape than any other. Write at once.

Catalogue No. 59 Is Free.
W. J. ADAM, JOLIET, ILL.

IF IT'S AN ADAM IT'S THE BEST



IT WILL PAY YOU

to send for our new poultry book describing the **DANDY Green CUTTER**

It tells how to increase the egg yield. The Dandy, the easiest turning of all bone cutters, is sold

direct on 30 days' trial. Price, \$5 up. Hand-some Book Free.

STRATTON MANFG. CO.,
Box 54, Erie, Pa.

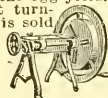

HENS EAT BUGS.

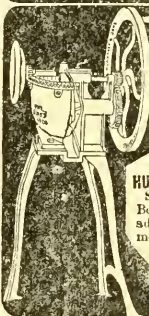

because they need animal to feed cut bone and get eggs when eggs are eggs.

HUMPHREY

Green Bone and Vegetable Cutter

is guaranteed to cut more bone in less time and with less labor than any other cutter made. Get your money if not perfectly satisfied. Catalogue free.

HUMPHREY & SONS, Box 51, Joliet, Ill.
Sales Agents: Joseph Beck & Sons, Boston, Mass.; Johnson & Stokes, Philadelphia; Griffith & Turner Co., Baltimore; Sure Hatch Incubator Co., Clay Center, Neb.; E. J. Bowen, Portland, Oregon; Seattle, Wash., and San Francisco.



1 2 3 4 5 6

Count the Chicks as they come out. Then count the eggs, and you will see why so many people are using

Successful

Incubators and Brooders,

The healthy egg becomes the vigorous, husky, money-making hen. You will want our beautiful illustrated catalogue. Five different editions in five languages. English edition 4 cents; others free. It is a poultry Bible.

Des Moines Incubator Co.,

Box 503, Des Moines, Ia., or Box 503, Buffalo, N. Y.



A Combination

of brains, experience and high grade material has made the

RELIABLE Incubator

known throughout the civilized world. If you are after results represented in dollars and cents, you want one of our popular 20th Century Poultry Books. Bright, instructive and worth ten times the price asked. Sent for 10c. As full list free as an egg. Reliable Incubator & Brooder Co., Box B-49 Quincy, Ills.

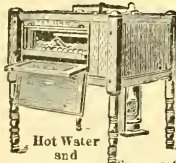

Satisfied People.

That's the kind that run the

MARILLA

Incubators and Brooders.

If they are not satisfied we refund their money. Larger batches, perfect system of regulating temperature, moisture and ventilation. All these points explained in our catalog. Sent for two 1c stamps.

MARILLA INCUBATOR COMPANY, BOX 62, ROSE HILL, N. Y.

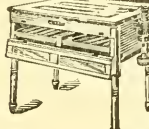

200-Egg Incubator

for \$12.80

Perfect in construction and action. Hatches every fertile egg. Write for catalogue to-day.

GEORGE H. STAHL, Quincy, Ill.



A Good Wagon

begins with good wheels. Unless the wheels are good the wagon is a failure. IF YOU BUY THE **ELECTRIC STEEL WHEEL** made to fit any wagon—your wagon will always have good wheels. Can't dry out or rot. No loose tires. Any height, any width tire. Catalog free.

ELECTRIC WHEEL CO.,
Box 95 QUINCY, ILL.

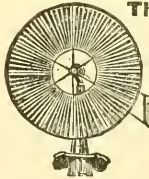

The Storm Proof KING WIND MILL

produces 25 to 50% more net power from any kind of wind than any other mill, size. Wheel being only 1 in. thick, cuts the wind like a knife and is 400% more storm proof than any other. Exceedingly light, but wonderfully strong. Very sensitive—runs in lightest winds. Numerous sizes—6 ft. up, both pumping and power, back geared or direct stroke. Send for circulars and

prices before you buy. Medina Mfg. Co., Box 11 Medina, O.

To make cows pay, use Sharples Cream Separators. Book "Business Dairying" & Cat. 288 free. W. Chester, Pa.

1200 FERRETS. All sizes; some trained; first-class stock. New price list free. N. A. KNAPP, Rochester, Lorain Co., Ohio.



OUR NEW POTATO BOOK—A CORRECTION.

On page 877, Nov. 1, the price of Terry's A B C of Potato Culture is given as 35 cts. That applies to the old edition. On account of a considerable increase in the size of the 1901 edition we are compelled to put the price of the new edition at 45 cts., paper; by mail, 50. Bound in cloth, 68 cts.; mail, 75.

BUSINESS OUTLOOK.

The prospects for the coming year's business are quite promising from present indications and reports from various fields. We are booking orders earlier this year than has been customary in the past. We have the work on the revision of our catalog well advanced, and hope to have them ready to mail some time next month. There are practically no changes in price to note, other than those already mentioned in this column. Make up your orders early, and take advantage of leisure time in winter to get your supplies all ready for the bees when the spring rush comes.

HONEY MARKET.

A carload of comb honey from the West had just arrived as we were going to press with the last issue. We have since shipped several tons out of this car. It is packed in single-tier cases of 24 sections each, with a wood slide in the place of glass. The honey is very thick and of heavy body, and sections well scraped. In lots of 10 cases and upward we are selling fancy at 16, and No. 1 at 15 cts. We have also a good stock of eastern comb honey of various grades. Inquiries solicited from those wanting honey, either comb or extracted. We are having a good trade in the latter, and solicit offers of amber, with samples. State how put up, and price asked. We have a good supply of clover and basswood and white sage; have also several lots of buckwheat. We need some of an intermediate grade.

SEED POTATOES FOR 1902.

On page 676, Aug. 1, I gave prices on seed potatoes for planting in 1902 as follows: ½ peck, 35 cts.; peck, 50 cts.; ½ bushel, 85 cts.; bushel, \$1.00; barrel, \$4.00. Small seconds, half the above prices. I have been watching quotations since then, and no reliable seedsman has made any better prices. Our potatoes are now all dug and safely stored away; but we will ship them the remainder of this month at our risk against frost, at the above figures; or we will keep them safely for you till next spring in our specially arranged potato-cellar. We can furnish, at the above prices, White Bliss Triumph, Early Ohio, Bovee, Sir Walter Raleigh, New Russet, and Craig. As our supply of many is limited, you had better order at once if you want them. Seed potatoes, especially the earlies and extra earlies, are likely to be away up before another spring. Our seconds will probably all be gone very soon at the above low figures.

CONVENTION NOTICE.

The Minnesota Bee-keepers' Association meets in Plymouth Church, corner Eighth St. and Nicollet Ave., Minneapolis, Wednesday and Thursday, Dec. 4, 5, 1901. W. Z. Hutchinson, Flint, Mich., will give a stereopticon lecture on Wednesday evening, and a good program is prepared and now in the hands of the printer. Joining the National Bee-keepers' Association in a body will be voted on Wednesday. All bee-keepers are invited. H. G. ACKLIN, Chairman Ex. Com.

Minnesota Bee-keepers' Supply Mfg. Co. Manufacturers of Bee-hives, Sections, Shipping-cases, and Everything Used by Bee-keepers.

Orders filled promptly. We have the best shipping facilities in the world. You will save money by sending for our price list. Address

Minnesota Bee-keepers' Supply Mfg. Co.,
Nicollet Island Power Building, Minneapolis, Minn.

Standard - Bred Queens!

Acme of Perfection; Not
a Hybrid among Them.

Improved Strain Golden Italians.

World-wide reputation; 75c each; six for \$4.00.

Long-tongued 3-banded Italians.

Bred from stock whose tongues measured 25-hundredths inch. These are the red-clover hustlers of America; 75 cts. each; six for \$4.00. Safe arrival guaranteed; Catalog on application. Headquarters for bee-keepers' supplies.

Fred W. Muth & Co., Cincinnati, Ohio.
South-west Corner Front and Walnut Streets.

Union Combination Saw

For Ripping, Cross-cutting, Rabbeting, Mitering, Grooving, Gaining, Boring, Scroll-sawing, Edge-moulding, Beading. Full line FOOT and HAND POWER machinery. Send for catalog A. SENECA FALLS MFG. CO., 44 Water St., Seneca Falls, N. Y.

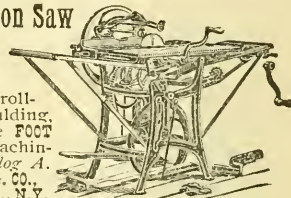

CHAS. ISRAEL & BROS.,
486-490 Canal St., Corner Wall St., N. Y.

Honey and Beeswax.

Liberal Advances made on Consignments. Wholesale Dealers and Commission Merchants. Estab. 1875.

Wanted! HONEY, WAX,
MAPLE SUGAR,
SYRUP, AND
POPCORN.

A. L. JENKS, 42 W. Market St., Buffalo, N. Y.

We will be in the market for honey the coming season in carloads and less than carloads and would be glad to hear from producers everywhere who they will have to offer. SEAVEY & FLARSHHEIM,
1215-1221 Union Avenue, Kansas City, Mo.

WANTED. Comb honey in any quantity. Please advise what you have to offer. EVANS & TURNER,
Town St., Cor. 4th, Columbus, Ohio.

WANTED.—Fancy and No. 1 white-clover honey, one-pound sections, paper cartons preferred.
BLAKE, SCOTT & LEE,
33 Commercial St., Boston, Mass.

WANTED.—Comb honey and beeswax. State price delivered Cincinnati. C. H. W. WEBER,
2146 2148 Central Ave., Cincinnati, Ohio.

FOR SALE.—Extracted honey, cans and kegs, 7 to 8 cts. per lb. Sample, 5 cts. Comb honey, 13 to 14 cts. Beeswax wanted.

I. J. STRINGHAM, 105 Park Place, New York.

FOR SALE.—4000 lbs. light amber extracted honey at 5c per lb. W. C. GATHRIGHT, Las Cruces, N. M.

FOR SALE.—Extracted white clover and basswood honey in 60-lb cans, two in a case, at 7½c. Honey is well-ripened, and O. K. Sample for stamp. Order soon, as this offer will not last long. Reference, Wilton Bank. EDW. WILKINSON, Wilton, Wis.

FOR SALE.—30 to 35 cases heartsease honey, two cans to a case (120 lbs.); new cans; 7 cts. per pound.

JOHN A. THORNTON, Lima, Ills.

FOR SALE.—Two cars comb and extracted alfalfa clover honey. VOGELER SEED & PRODUCE CO.,
Salt Lake City, Utah.

1881

PAGE & LYON MFG. CO.

1901

We manufacture a full line of the latest
BEE-SUPPLIES.

Our motto is, "Perfect Goods and Prompt Shipment."

Send for our new free illustrated catalog.

PAGE & LYON MFG. CO., New London, Wisconsin.

Marshfield Manufacturing Company.

Our specialty is making SECTIONS, and they are the best in the market. Wisconsin basswood is the right kind for them. We have a full line of BEE-SUPPLIES. Write for FREE illustrated catalog and price list.

Marshfield Manufacturing Company, Marshfield, Wisconsin.

I. J. Stringham, 105 Park Place, New York City.

Honey-jars.

1-lb. square jars, \$5.00 per gross; No. 25 jar, porcelain top, \$6.00 per gross; Nickel-cap jar, fancy, \$5.50 per gross. All are clear flint glass. Discount on quantities. We ship from New York City, N. Y.

Labels.—60 cts. per gross. A full line of Apiarian Supplies always in stock. Catalog free. . . . Apiaries located at Glen Cove, Long Island, New York.

I. J. Stringham, 105 Park Place, New York City.



WE SELL YOU DRUGS BY MAIL

and can save you 15 to 75 per cent on every article you select from our Illustrated Drug Book. It contains a list of 15,000 drugs, medicines, family remedies, surgical instruments, sick room appliances, trusses, veterinary preparations, flavoring extracts, paints, oils, etc. Over 1500 illustrations. Quality and purity of every article guaranteed by us. Drug Book costs us \$2 each. We send it for 10 cents—just enough to pay mailing charges. We refund that amount on the first order you send us. Get a copy at once and keep it for reference. You can never tell when you will need help. We are: "The Only Mail Order Drug House in the World."

HELLER CHEMICAL COMPANY, DEPT. 40 CHICAGO, ILLS.

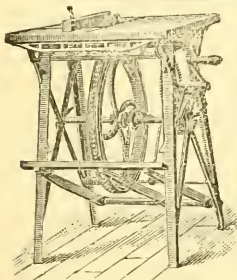

BARNES' Hand and Foot Power Machinery.

This cut represents our combined circular saw, which is made for bee-keeper's use in the construction of their hives, sections, boxes, etc., etc.

Machines on Trial. Send for illustrated catalog and prices. Address **W. F. & Jno. Barnes Co., 545 Ruby St.,** Reckford, : Illinois.

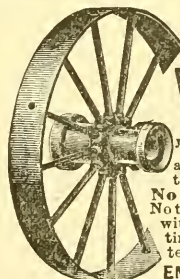

STEEL WHEELS

for **FARM WAGONS**

any size wanted, any width of tire. Hubs to fit any axle. **No blacksmith's bills to pay.** Not tires to reset. Fit your old wagon with low steel wheels with wide tires at low price. Our catalogue tells you how to do it. Address **EMPIRE MFG. CO., Quincy, Ill.**

CALIFORNIA SAGE HONEY.

The world again sweetened with our famous sweet. Bees increasing fast. Bee-men very active. Tons of nectar lost for want of bees to gather. The PACIFIC BEE JOURNAL controls thousands of acres of fine field. Many fields to let. A few bees for sale—and climate too. Four hundred pounds to the colony, twenty tons to the 100 colonies in some instances.

Pacific Bee Journal, Los Angeles, Cal.

\$1 per year; 25c for 3 months' trial; 50c this year and six months of 1902; \$1 for this year and all of 1902; with Gleanings, \$1.25 a year.

Subscription Combinations!!

We take pleasure in offering the readers of GLEANINGS a few of our combinations. If you do not see what you want we have a 44-page catalog free for the asking. These prices are for a full year, and may be either for new or renewal, except where stated. Sent to different addresses if desired, and will be mailed direct from the publisher the same as they would if you ordered direct. The offers are made by the publishers, and we are their special agents. Success, Leslie's Monthly, and Cosmopolitan, \$2.00. In the above offer, in place of Leslie's or Cosmopolitan you may substitute any of the following: Gleanings, Farm Poultry, Good Housekeeping, Household, Practical Farmer, Designer, Health Culture, Hints, The Era, new subscription to Recreation. Success must be in any list made from above—the others are interchangeable.

Everybody's Magazine, Practical Farmer (new subscription), and your choice of a new subscription to either Harper's Bazar, American Boy, Little Folks, or Sunday School Times..... \$1.75
 Gleanings and Great Round World..... 1.90
 Gleanings and Century..... 4.05
 Gleanings and Scribner's..... 3.30
 Gleanings and Outing..... 3.00
 Gleanings and Farm Poultry..... 1.00
 Gleanings and Country Gentleman..... 1.50

Youtas' Companion may be added to any offer for \$1.75, and new subscribers get November and December free, also art calendar. Ladies' Home Journal may be added for \$1.00. McClure's may also be added for \$1.00. By our arrangements with publishers these offers are good until Sept. 1st, 1902. We want to send you our catalog. Ask for it, and address all orders to C. M. Goodspeed, Box 791, Skaneateles, N. Y.

FOR SALE.—Will sell cheap, one 10-p.-p. engine with upright boiler all complete; one 18-inch planer, one saw-table. Inquire of J. W. BITTENBENDER, Knoxville, Iowa.

Mr. A. I. Root's Writings

of Grand Traverse territory and Leelanau Co. are descriptive of Michigan's most beautiful section reached most conveniently via the **PERE MARQUETTE R. R.**

For pamphlets of Michigan farm lands and the fruit belt, address W. C. Tousey, D. P. A. Toledo, Ohio.



BELCIAN HARES!

With every hare sold goes a full pedigree, register number, and score-card, scored by an official judge. Does will be bred to one of our famous high-scoring bucks free. Write for book. Mer. of The A. I. Root Co. J. B. MASON, MECHANIC FALLS, MAINE.



Belgian Hares

I have some fine hares for sale at reasonable prices.

J. F. Moore, : Tiffin, Ohio.



PAGE

An ELASTIC Elastic

is not more satisfactory than Elastic Page Fence. Page Woven Wire Fence Co., Box S. Adrian, Michigan.

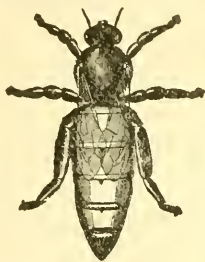

Red Glover Queens -FOR- 1902

Warranted Purely Mated.
The Long-Tongue Variety.

How to get One for Only 30 cts.

We have arranged with the queen-breeder who furnished Long-Tongue Red Clover Queens for us during the past season, to fill our orders next season. Although fully 95 percent of the untested queens he sent out were purely mated, next season all he mails for us will be warranted purely mated.

We want every one of the readers of Gleanings in Bee-Culture, who is not now a reader of the old weekly American Bee Journal, to have one of these Superior Red Clover Queens. We have received most excellent reports from the Queens we supplied during the past season. And next year our breeder says he expects to be able to send out even better Queens, if that is possible. He is one of the very oldest and best queen-breeders. His bees average quite a good deal the longest tongues of any yet measured. The Breeder he will use is direct from Italy, having imported her himself. Her worker-bees are large, of beautiful color, very gentle, scarcely requiring veil or smoker.

Orders for these fine, "long-reach" warranted Queens will be filled in rotation—"first come, first served"—beginning as early in June, 1902, as possible. It is expected that orders can be filled quite promptly (even better than the past season), as a much larger number of queen-rearing nuclei will be run. (But never remove the old queen from the colony until you receive the new queen, no matter from whom you order).

In order that all who are not now readers of the American Bee Journal can have one of these fine Queens, we will make the price only 30 cents each, when taken in connection with a year's subscription. That is, send us \$1.30 (if you are a NEW subscriber), and we will book your order for a Warranted Queen, and enter your name on our list of subscribers and send you the Bee Journal every week from the time we receive your name and \$1.30 until the end of next year (1902). So the sooner you send in your order the more copies of the Bee Journal you will receive. If you have not seen the weekly American Bee Journal, send for a free sample copy. Address,

GEORGE W. YORK & CO.

144 & 146 Erie Street, CHICAGO, ILL.



We are headquarters in Chicago for ROOT'S
BEE-KEEPERS' SUPPLIES AT ROOT'S PRICES.
Catalog Free....

GREAT CLUBBING OFFERS!

My friends, how many of you are reading some of the many most excellent magazines of the day? If you are reading none, you are missing a great treat. Perhaps you regard them as luxuries. Possibly they are in some instances. They certainly help to fill out our lives, and give to us broader views. They are like windows that allow us to look out over the wide world. This life is not wholly one of dollars and cents—at least it ought not to be. Enjoyment, pure and simple, enjoyed just for the sake of enjoyment, is desirable and beneficial. To many there are few things that are more enjoyable than the bright pages of a really good magazine. To those who wish to give the magazines a trial, and to those who are already reading them, I can offer some of the lowest clubbing rates that have ever been offered. Here is a list of magazines, together with the regular prices at which they are published:

Review of Reviews.....	\$2.50	Cosmopolitan.....	\$1.00
Current Literature	\$3.00	Leslie's Popular Monthly.....	1.00
New England Magazine.....	3.00	The Household.....	1.00
Leslie's Weekly	4.00	Good Housekeeping.....	1.00
North American Review.....	5.00	The Designer.....	1.00
Success.....	1.00		

If you subscribe for one or more of these magazines, in connection with the Bee-keepers' Review, I can make the following offers:

Success and the Bee-keepers' Review for only.....	\$1.75
Success and any one of the above \$1.00 magazines and the Bee-keepers' Review for only	2.50
Success and any two of the above \$1.00 magazines and the Bee-keepers' Review for only	3.00
Success and any three of the above \$1.00 magazines and the Bee-keepers' Review for only	3.50
Success, Review of Reviews (new), and the Bee-keepers' Review for only.....	3.00
Success, Review of Reviews (old), and the Bee-keepers' Review for only.....	4.00
Success, Current Literature (new), and the Bee-keepers' Review for only.....	3.00
Success, Current Literature (old), and the Bee-keepers' Review for only.....	4.00
Success, the New England Magazine, and the Bee-keepers' R-view for only.....	3.00
Success, Review of Reviews (new), any one of the above \$1.00 magazines, and the Review, for only..	3.50
Success, Leslie's Weekly, and the Bee-keepers' Review for on y.....	3.75
Success, Review of Reviews (new), Leslie's Weekly, and the Bee-keepers' Review for only.....	4.75
Success, North American Review (new), Review of Reviews (new), and the Review for only.....	5.00

Magazines will be sent to one or different addresses as desired.

New subscribers to the Review will receive the rest of this year free.

N. B.—For \$1.00 in addition to any of the above offers I will look your order for a Superior Stock queen, to be delivered next spring.

W. Z. Hutchinson, Flint, Michigan.

THE SMITH PREMIER TYPEWRITER

Occupies an Imperishable Position in the BUSINESS WORLD.

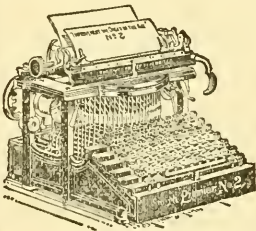

Unquestionable Superior Merit

Annually adds thousands of names to the long list of Smith Premier users, representing every line of trade and every profession.

ILLUSTRATED CATALOGUE FREE.

The Smith Premier Typewriter Co.,

158 Prospect Street, Cleveland, Ohio.

NOW READY!

64-PAGE CATALOG OF EVERY THING BEE-KEEPERS NEED. Illustrated and fully described. Especially valuable to beginners for the information it contains. Send your address on postal and get it now. Established 1884.

J. M. JENKINS, Wetumpka, Ala.

Notice!

QUIRIN, the queen-breeder, still has 100 of those long-tongued red-clover queens on hand at \$1 each, or 6 for \$5. If you want one speak quick. For testimonials see former adv'ts.

Bees Wanted!

We are expecting to establish several out-apiaries next season and desire all the bees we can get; want 'em on movable frames, and near home. They must be cheap at this time of year. Parties placing us in correspondence with those having bees to sell will be remembered next season when we have a nice lot of those long-tongued red-clover queens on hand (in case we succeed in purchasing of said parties).

In our circular we list numerous articles used by bee-keepers, on which we will give 10 to 20 per cent discount from now until the coming March. Address all orders and inquiries to

H. G. Quirin, Parkertown, Ohio.

BERMUDA

With cable communication and equable winter temperature of 70 degrees, is reached in 48 hours from New York by the elegant steamers of the Quebec Steamship Company, sailing every ten days up to January, and then every five days. The situation of these islands—south of the Gulf Stream—renders

FROST UNKNOWN,

and the porous coral formation prevents malaria. The Quebec Steamship Company also despatches highest class passenger steamers every ten days for ST. THOMAS, SANTA CRUZ, ST. KITTS, ANTIGUA, GUADALOUPE, DOMINICA, MARTINIQUE, ST. LUCIA, BARBADOS, DEMERARA, and the principal WEST INDIA ISLANDS, affording a charming tropical trip at a cost of about \$4 a day. For descriptive pamphlets, dates of sailing and passages, apply to

A. E. OUTERBRIDGE & CO., Agents.

39 Broadway, New York.

ARTHUR AHERN, Sec., Quebec, Canada.

Queens! Untested, \$1 00; tested, \$1 25 and upward. See former ads. and circular.
J. B. Case, Port Orange, Florida.

Angora Goats. Delane bucks; good stock; low prices; large circular for stamp.
ED. W. COLLE & CO., Kenton, O.

PARTIES in Southern California having small poultry and bee ranches for sale, please write with description to
N. A. BLAKE, Newhall, Cal.

PRINTED noteheads, 35c 100; 250, 75c postpaid. Circulars, price lists—cash saved. List and samples free.
Downer Printing Co., Box 544, South Haven, Mich.

Wants and Exchange.

Notices will be inserted under this head at 10 cts. per line. You must say you want your adv't in this department, or we will not be responsible for any error. You can have the notice as many lines as you please; but all over ten lines will cost you according to our regular rates. We can not be responsible for dissatisfaction arising from these "swaps."

WANTED—To exchange Dadant uncapping-cans, Root's No. 5 extractor, and other supplies, for honey or wax
O. H. HYATT, Shenandoah, Iowa.

WANTED—To buy quantity lots of fancy and No. 1 white-clover comb honey in no-drip cases.
BYRON WALKER, Clyde, Cook Co., Ill.

WANTED—To sell cheap, 20 acres of good Florida land, well situated, at a low price. Address for particulars,
MRS. I. B. WEIR, Toledo, Florida.

WANTED—To exchange second-hand 60-lb. cans, practically as good as new, at 20c per can in lots of 20 or more, f. o. b. Chicago, for white clover honey at market price.
B. WALKER, Clyde, Cook Co., Ill.

WANTED—To exchange or sell, a choice 5-acre lot in Florida; near church and depot. Address
C. G. ADAMS, Sorrento, Florida.

WANTED—Comb and extracted honey. State price, kind, and quantity.
R. A. BURNETT & Co.,
199 South Water St., Chicago, Ill.

WANTED—To buy your honey. State your lowest cash price, kind, and quantity.
EDWARD WILKINSON, Wilton, Wis.

WANTED—To sell 12 acres land, good house; fine location for apiary. Address
SABATIER, Bernstadt, Laurel Co., Ky.

WANTED. A man with a small family, who has had some practical knowledge of bee-keeping, to work in apiary and on small fruit-farm.
A. E. WOODWARD, Grooms, Saratoga Co., N. Y.

WANTED—A good farm hand, with temperate habits, by the year who wishes to learn the bee-business. I keep 500 colonies.
W. J. STAHMANN, Bruce, Wis.

WANTED—To buy 300 colonies bees in Mississippi, Louisiana, Arkansas, or Texas. Write
M. STEVENSON, Wardeine, Missouri.

WANTED—To exchange or sell, gent's bicycle; second-hand, but in good condition. Make offers or write for particulars.
H. C. WEST, Medina, O.

WANTED—All the bees we can get; must be extremely cheap at this time of year. Parties who will place us in correspondence with those having bees to sell, will receive one to a half-dozen selected queens free next June, according to the number of colonies we succeed in purchasing from said parties.
H. C. QUIRIN, Parkertown, Ohio.

WANTED—To sell our entire plant and situation, including a complete line of machinery for manufacturing bee hives, comb-foundation, etc. In connection with same we have a first-class up-to-date planing-mill in every respect. Our good will and list of customers goes with it. This is a bargain and will pay you to investigate. Address
W. R. GRAHAM & SON, Greenville, Texas.

HONEY QUEENS!

Laws' Long-tongue Leather Queens.
 Laws' Improved Golden Queens.
 Laws' Holy Land Queens.

Laws' queens are the standard bred queens of America. The largest honey-producers use them and praise them. Laws' queens go everywhere, and can furnish you a queen every month in the year. Four apiaries Queens bred in their purity. Prices, October to April: Tested or untested, \$1.00 each; 6 for \$5.00. Breeders, none better, \$3.00 each. Address

W. H. Laws, Beeville, Texas.

Dittmer's Foundation !!!

Retail---Wholesale---Jobbing.

I use a PROCESS that produces EVERY ESSENTIAL necessary to make it the BEST and MOST desirable in all respects. MY PROCESS and AUTOMATIC MACHINES are MY OWN inventions, which enable me to SELL FOUNDATION, and WORK WAX INTO FOUNDATION FOR CASH, at prices that are the lowest. Catalog giving

FULL LINE OF SUPPLIES

with prices and samples, free on application. BEESWAX WANTED.

GUS. DITTMER. AUGUSTA, WIS

Get the Best Queens.

Evansville, Ind., Sept. 27th, 1900.

The Jennie Atchley Co., Beeville, Bee Co., Texas:
 Dear Friends:—It gives me great pleasure to forward you this unsolicited testimonial regarding the merits of Atchley queens. The three (3) dozen queens purchased of you have made an excellent record for themselves. Not an Atchley queen among the twenty colonies lost during the severe drouth in July. I've bought queens from many breeders; and although the present crop is exceedingly short, the tiers of supers show where the Atchley queens are, and speak volumes for your method of queen-rearing. I find the progeny to be very gentle, strong-winged, uniformly marked, long-lived, of large size, and last, but not least, the best honey-gatherers I ever had. I shall want 100 more next season. Yours fraternally,
 J. C. WALLENMEYER.

Prices for Queens.

Tested, \$1.50 each; \$8.00 for 6, or \$15.00 per doz. Un- tested, February, March, April, and May, \$1.00 each; \$5.00 per 6, or \$9.00 per doz. Fine breeders, \$5.00 each. We have as good bees and queens as money and labor produce. We breed three-band Italians, Goldens, Carniolans, Cyprians, and Holy-Lands, in their purity, bred in separate yards 5 to 20 miles apart. If you want the best, call for Atchley's improved strains. Safe arrival guaranteed. Send for a sample copy of *The Southland Queen*, the only southern bee-paper, \$1.00 per year. To new subscribers we offer as a premium a nice untested queen in order to get our paper introduced. Catalog giving queen-rearing and management of apiaries for profit, FREE.

THE JENNIE ATCHLEY CO.,
Beeville, Bee Co., Texas.

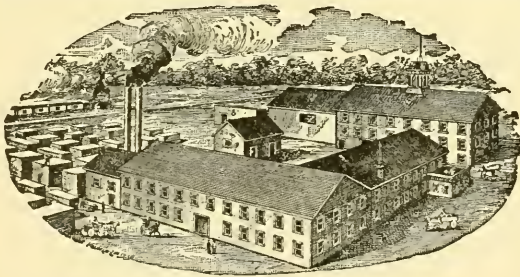

KRETCHMER M'FG CO., Red Oak, Iowa.

BEE-SUPPLIES.

Best-equipped factory in the West; carry a large stock and greatest variety of every thing needed in the apiary, assuring BEST goods at the LOWEST prices, and prompt shipment. We want every bee-keeper to have our FREE ILLUSTRATED CATALOG, and read description of Alternating Hives, Ferguson Supers, etc. Write at once for a catalog.

— AGENCIES: —

Trester Supply Co., 103 So. 11th St., Lincoln, Nebraska; C. C. Richards, 1223 17th St., Denver, Col.

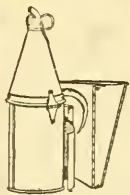

BINGHAM SMOKER.

Dear Sir:—Inclosed find \$1.75. Please send one brass smoke-engine. I have one already. It is the best smoker I ever used.
 Truly yours,
 HENRY SCHMIDT, Hutto, Tex.

MADE TO ORDER

Bingham Brass Smokers.

Made of sheet brass, which does not rust or burn out; should last a lifetime. You need one, but they cost 25 cts. more than tin of the same size. The little open cut shows our brass hinge put on the three larger sizes. No wonder Bingham's four-inch smoke-engine goes without puffing, and does not drop inky drops. The perforated steel fire-grate has 381 holes to air the fuel and support the fire. Heavy tin smoke-engine, 4-inch stove, per mail, \$1.50; 3½-inch; \$1.10; 3-inch, \$1.00; 2½-inch 90c; 2-inch, 65c. Bingham smokers are the originals, and have all the improvements, and have been the standard of excellence for 22 years. Only three larger ones brass.

T. F. Bingham, Farwell, Michigan.

Contents of this Number.

Apiaries, Shaded, in Arizona..... 943
 Arizona Apiaries..... 943
 Bee in Law..... 357
 Bees under Machine shop..... 941
 Bees with Heads in Cells..... 359
 Bees: Forcing into Sections..... 916
 Bee-clothers, Ventilation of..... 353
 Bee-keeping, Starting in..... 358
 Feed for Bees, Proportions of..... 330
 Frames, Wired, without Foundation..... 337
 Heredity in Animals..... 336
 Hive-covers..... 916
 Hive-tool, England's..... 339
 Honey in Ireland, Prices of..... 312
 Honey, Comb, Jones's Canard..... 941
 Honey, Different Flavors of..... 930
 Maeterlinck's Book on Bees..... 337
 Mountserratt, Bee-keeping in..... 911
 Mountains, their Use..... 947
 Poison, Bee-sting..... 329
 Profits, per Colony..... 338
 Smoking Bees, Excessive..... 947
 Sulphuric Acid, Proportion of..... 947
 Utter Brothers..... 931
 Wintering Indoors and Out..... 931

Honey Column.

GRADING-RULES.

FANCY.—All sections to be well filled, combs straight, firmly attached to all four sides, the combs unsoiled by travel-stain or otherwise; all the cells sealed except an occasional cell, the outside surface of the wood well scraped of propolis.
 No. 1.—All sections well filled except the row of cells next to the wood; combs straight; one-eighth part of comb surface soiled, or the entire surface slightly soiled; the outside of the wood well scraped of propolis.
 No. 1.—All sections well filled except the row of cells next to the wood; combs comparatively even; one-eighth part of comb surface soiled, or the entire surface slightly soiled.
 No. 2.—Three-fourths of the total surface must be filled and sealed.
 No. 3.—Must weigh at least half as much as a full-weight section.
 In addition to this the honey is to be classified according to color, using the terms white, am, and dark; that is, there will be "Fancy White," "No. 1 Dark," etc.

CITY MARKETS.

PHILADELPHIA.—Comb honey has been arriving quite freely, and lower prices are the result. There seems to be very little fancy honey in the market. We quote fancy, 15; No. 1, 13@14; amber, 12. Extracted white, 7; amber, 6. Beeswax, 26. We are producers of honey—do not handle on commission.

WM. A. SELSER,

Nov. 21. 10 Vine St., Philadelphia, Pa.

DENVER.—No. 1 comb honey, \$3.00 per case; No. 2, \$2.75. White extracted, 7@8. Beeswax, yellow, 24@25.

COLORADO HONEY-PRODUCERS' ASS'N.

Nov. 22. 1140 Market St., Denver, Col.

NEW YORK.—Demand for comb honey is not as brisk as it has been, with the supply about equal to the demand. We quote as follows to-day: Fancy white, 15@16; No. 1, 14@15; No. 2, 12@13; extracted, 10@12. Extracted, dull; white clover or basswood, 6@7; light amber, 5½@6; amber and buckwheat, 5@5½. Beeswax, 27@28.

CHAS. ISRAEL & BROS.,

Nov. 23. 486-490 Canal St., New York City, N. Y.

CINCINNATI.—There is a good deal of extracted honey offered, and prices if any thing, are a little lower. Fancy white comb honey sells at 15@16; lower grades, 12½@14½. Extracted dark, 5; lighter, 5½@6; fancy, 6½@8.

C. H. W. WEBER,

Nov. 23. 2146 Central Ave., Cincinnati, Ohio.

MILWAUKEE.—The supply of honey of all kinds—good, bad, and indifferent, comb and extracted—seems quite sufficient for the demand, and values are ruling easy, especially for the grades below standard grade, and we continue to quote fancy 1-lb. sections, 15@16; A No. 1, 14@15; No. 1 amber or white, 13@14. Extracted white, in bbls., kegs, and cans, 8@9; amber, 7@7½. Beeswax, 26@28.

A. V. BISHOP & CO.,

Nov. 22. 119 Buffalo St., Milwaukee, Wis.

NEW YORK.—The receipts of comb honey at present are very good. Prices are quite firm at the low quotations below with a good brisk demand. We quote fancy white, 15; No. 1, 13@14; No. 2, 12@13; buckwheat, 10@11. Extracted, fair demand, 5@6½, according to quality. FRANCIS H. LEGGETT & Co.,
 Nov. 21. Franklin and Varick Sts., New York.

CHICAGO.—Honey is selling fairly well at about the prices that have prevailed for the last two months; viz., choice grades white comb honey, 11½@15; good to No. 1, 14; light amber, 13; dark grades, 10@12. Extracted white, 5½@7; amber, 5¼@5¾, according to quality, flavor, and package. Beeswax, good demand at 28. R. A. BURNETT & Co.,
 Nov. 19. 199 South Water St., Chicago, Ill.

ALBANY.—Honey market steady, with a scarcity of buckwheat comb honey. Fancy white comb, 15@16. No. 1, 14@15; amber and buckwheat, 13@14. Extracted white, 7@7½; mixed, 6@6½; dark, 6. Beeswax, 27@29. MACDUGGAL & Co.,
 Nov. 21. 380 Broadway, Albany, N. Y.

BOSTON.—The demand for honey is easing up somewhat, due in part to the holiday season, at which time it is much neglected. Our market at the present time runs as follows: Strictly fancy in cartons, 16; No. 1, 14@15; No. 2, 12½@13. Extracted light amber, 7½@8; amber, 7. BLAKE, SCOTT & LEE,
 Nov. 20. 31, 33 Commercial St., Boston, Mass.

SCHENECTADY.—There are no new features to note in our market. Sales are about equal to receipts, and prices unchanged. We quote fancy clover, 16; No. 1, 14@15; No. 2, 13@14; buckwheat, 12@13. Extracted is selling freely at 6@6½ for light, and 5@5½ for dark. CHAS. McCULLOCH,
 Nov. 20. 1 Eagle St., Schenectady, N. Y.

WANTED. Comb honey in any quantity. Please advise what you have to offer. EVANS & TURNER,
 Town St., Cor. 4th, Columbus, Ohio.

FOR SALE.—Two cars extracted alfalfa and sweet-clover honey. VOGELER SEED & PRODUCE Co.,
 Salt Lake City, Utah.

FOR SALE.—Extracted honey, basswood or clover, in 160-lb. kegs, at 7c; amber, 6c; buckwheat in kegs, cans, or 30 to 75 lb. wooden pails, 5½c; sample, 6c. C. B. HOWARD, Romulus, N. Y.

FOR SALE.—How much am I offered for 500 lbs. of Michigan white clover and basswood comb honey, mostly in plain sections, put up in new 12-lb. 3-row cases, with 3-inch glass, all labeled? CHAS. C. CHAMBERLIN, Romeo, Mich.

We will be in the market for honey the coming season in carloads and less than carloads and would be glad to hear from producers everywhere what they will have to offer. SEAVEY & FLARSHEIM,
 1318-1324 Union Avenue, Kansas City, Mo.

FOR SALE.—30 to 35 cases heartsease honey, two cans to a case (120 lbs.); new cans; 7 cts. per pound. JOHN A. THORNTON, Lima, Ills.

FOR SALE.—Basswood, clover, and sweet-clover extracted honey, at 7c, in kegs and cans. DR. C. L. PARKER, Station A, R. F. D.,
 Syracuse, N. Y.

FOR SALE.—Extracted honey in 160-lb. kegs. Buckwheat, 5½; mixed, 6; basswood, 7. Send postoffice money-order on Moravia, N. Y., and will ship promptly. N. L. STEVENS, Venice, N. Y.

WANTED.—Honey; car lots or otherwise. Will send man to receive when sufficient amount to justify, and pay highest market price, spot cash. Address, stating quantity, quality, and price desired at your station. THOS. C. STANLEY & SON, Fairfield, Ill.

FOR SALE.—Fancy and No. 1 comb honey; about 2000 lbs. or more. WM. MORRIS, Las Animas, Col.

FOR SALE.—Extracted honey, cans and kegs, 7 to 8 cts. per lb. Sample, 5 cts. Comb honey, 13 to 14 cts. Beeswax wanted. I. J. STRINGHAM, 105 Park Place, New York.

Wm. A. Selser, Honey Expert,

When you buy honey, send a 3-oz. bottle, have it tested, to be sure it is pure. Price \$2.50 per sample. By doing this you may avoid over ten times this amount in litigation with pure-food laws. Chemist's certificate given.

The A. I. Root's Co.'s Office, 10 Vine Street, Philadelphia, Pa.

G. B. LEWIS CO., WATERTOWN, WIS.

*	<p>Our new catalog, describing and listing the FINEST LINE OF BEE KEEPERS' SUPPLIES IN THE WORLD, will be ready about the first of the year. If you have not been receiving a copy annually, send us your name and address and one will be mailed to you free. Prices will be same as last season with the exception of the narrow plain sections with no beeways. which will be 25 cts. per M less.</p>	*
*		*
*		*

Special Agency, C. M. Scott & Co., 1004 East Washington St., Indianapolis, Indiana.

AGENCIES: L. C. Woodman, Grand Rapids, Michigan; Fred W. Muth & Co., Southwest Corner Walnut & Front Sts., Cincinnati, Ohio; Fred Foulger & Sons, Ogden, Utah; Colorado Honey-producers' Association, Denver, Col.; Grand Junction Fruit-growers' Association, Grand Junction, Colorado; Robert Halley, Montrose, Colorado; Pierce Seed and Produce Company, Pueblo, Colo.; E. T. Abbott, St. Joseph, Missouri, Special Southwestern Agent.

BEE - SUPPLIES!

**ROOT'S GOODS
AT
ROOT'S PRICES.**

C. H. W. Weber, Cincinnati, Ohio.
2146-2148 Central Ave.

A NEW AND COMPLETE stock for 1901 now on hand. I am The Root Company's representative for Cincinnati and surrounding territories. . . You save TIME and FREIGHT CHARGES by having goods shipped from here. Convenience of railroad facilities here enables me to do so. Before buying elsewhere, write for my prices and catalog, which will be mailed you free of charge.

A JOURNAL DEVOTED TO BEES AND HONEY AND HOME INTERESTS.

ILLUSTRATED SEMI-MONTHLY

Published by THE A. F. ROOT CO. \$1.00 PER YEAR MEDINA, OHIO.

VOL. XXIX.

DEC. 1, 1901.

No. 23.



ARTHUR C. MILLER says that, when he said sudden confinement of a queen works injury, he did not mean that sudden cessation of laying was the trouble, but starvation.

R. C. AIKIN, in *American Bee Journal*, says his average for ten years has been 40 lbs. per colony, and the general average for all except the best bee-keepers in his region has been only half that.

I HARDLY THINK that shouldered staple, p. 890, would suit me as well as a common wire nail for a spacer *between* bars. But for those who find that the common staple used as an end spacer will not stay in place, the shoulder might make all the difference between failure and success.

"SHOOK SWARMS," p. 896. It's a small matter, but it might be as well to use correct English, and call them "shaken swarms." [Ye-s-s-s; but the correct grammatical form does not, to my mind, express the idea. A "shook" swarm indicates to me one that has been *jarred* or *bumped*, not "shaken" by a feeble backward and forward motion.—ED.]

I SECOND the nominations of Messrs. Hill and Rohrig for directors. And in that connection I want to ask that, when my term expires, my friends will do me the kindness to vote for a new man in my place. [Look here, doctor, it is not going to do at all for all the other directors to follow the example of A. I. R. and myself. There ought to be some old timber left on the Board. No, sir; I will nominate you again, see if I don't.—ED.]

"WHEN A COLONY is made queenless, will the bees, in their haste to rear a successor, select larvae too old to secure the best results?" When that question was up at Buffalo, you and I were absent at a directors' meeting, Mr. Editor, and on now

reading the excellent report in the *American Bee Journal*, I am surprised to find there was not one (Hutchinson was absent with us) to say a good word for the hoary error that teaches that bees can not be trusted to select young larvae.

THE TWO AMERICANS are not agreed as to the profits of bee-keeping, the *American Bee-Keeper* supporting the statement that at least \$5.00 a year for each colony is a conservative estimate. I wish I could be sure of at least \$1.00 a year. [Here again is a case where locality should have something to say. In Marengo, perhaps you might be satisfied with \$1.00 per colony; but in Florida, Texas, Arizona, California, and Colorado, during *some* seasons as much as \$5.00 might be made. I say *some* seasons, because the *year* likewise has something to do with it.—ED.]

THE QUESTION is whether it is starvation that hurts a queen in the mails or being bumped about when heavy with eggs. Possibly both. It seems reasonable that she will not be so well fed as when surrounded by thousands anxious to feed her. But with the cessation of laying will there be the same need of food? And if the trouble comes from starvation, ought there not to be about the same damage in each case? Instead of that, some queens are fatally injured and others unharmed—seeming to favor the accident theory. [It looks somewhat that way.—ED.]

THANKS, Stenog, for turning your batteries with such good effect on the use of "swarm" for "colony," page 895. Now please train them on the wrong use of the word "stand." This last error has not yet got so strong a foothold as the first, and will be more easily routed. [There is no use in your laboring with Stenog. He maintains, as does your humble servant, that the word "stand," as we have used it in our columns, is correct enough; and, besides, it avoids the repetition of the word "colony" every time. Then by general acceptance it has crept into all bee-literature to such an extent that I doubt whether we could change it if we tried.—ED.]

I'VE READ with some care Maeterlinck's "Life of the Bee." Its charming style and exquisite word-painting delighted me, and for some pages I thought, "Here's a book at once thoroughly reliable and delightful." Then an occasional error in its teachings jolted me. Further on, bee-lore became more and more diluted, and many pages in succession without a word about bees were occupied with outside philosophizing that was much of it pessimistic, and some of it left a bad taste in the mouth. One familiar with Root's A B C will learn nothing from this book about bees, and the cutting-out of a third of its pages would leave the book improved. On the whole it is not a book for unqualified commendation.

YOU SAY, Mr. Editor, page 897, that you sometimes leave two stories of brood-combs when putting on supers. I wish you could tell us how the yield compares with that of the colonies that have the one story removed. I tried it pretty thoroughly, and was obliged to give up sorrowfully that I couldn't get as much surplus with two stories as when I took one story away. [If the two colonies are the same in strength, then the one that is contracted down to one story would, of course, have more honey. But if one colony is so strong, so boiling over in bees that it could not be squeezed down into the brood-nest of a single hive-body, then I should expect more honey from that stock than if we tried to squeeze it into one brood-nest and then made it get the loafing or swarming fever.—ED.]

FROM FAR-OFF NEW ZEALAND comes a good hive-tool invented by C. E. England. It is of $\frac{3}{8}$ -inch steel, 10 inches long, $2\frac{1}{2}$ wide at one end, and continuing that width for $2\frac{1}{4}$ inches; then one side is abruptly cut away to $1\frac{1}{2}$ in width, tapering from that to the smaller end, which is $\frac{1}{4}$ wide, making it very nice to clean out tin rabbits. Near the small end a notch is cut so as to make a hook to lift out a dummy by the end of the top-bar—a useful thing. The large end is good for raising covers and supers, and for a scraper. [We illustrated a similar instrument of Mr. England on p. 645; but the new tool you describe embodies, as I understand it, later improvements. One like it was sent here; but if I were making a special hive-tool I would have it somewhat different, and Dr. Miller would have his still different. After all, I doubt whether we shall get any thing much better than the screwdriver and putty-knife that every one can get.—ED.]

I THINK, Mr. Editor, that hereafter it will be better for you to come to Marengo each time you write footnotes to Straws. Then we could have a better understanding, and not get so much mixed up. We're tangled up about that feeding business, p. 891. I think that you forget that what we were talking about was the advice, p. 862, to use 2 of sugar to 1 of water for *very late* feeding. You are entirely right that a syrup as thin as nectar is the right sort of thing,

but it will not do to feed it *very late*. If fed very late, do you think the bees would either invert or evaporate it? If they will do neither, is it not best at least to do the evaporating for them? I have fed barrels of 5 sugar to 2 water, as already said, and none of it ever turned to sugar; but then I used acid with it. [Yes, I understood that you had reference to late feeding; but our own experience had been so disastrous that I felt like putting in a word of caution. But we did not try the use of acid, and therein might be the difference between our failure and your success.—ED.]

THE BEES with heads in cells getting honey, says A. C. Miller, p. 899, are usually field bees, seldom nurse bees. As that runs directly counter, so far as I know, to all previously expressed authority, don't you think, Arthur, that you ought to furnish a bit of proof? [I had not thought of this before; but my own recollection is that the great majority of the bees that have their heads in the cells have put them there to get away from the smoke poured in by the bee-keeper during the operation of opening the hive. In the height of the honey season, perhaps a good portion of such bees would be those just from the field; but if Doolittle's observation is correct (and I believe it is), to the effect that the field bees in the rush of the season give their loads gathered to the nurse bees, and that these in turn deposit them in the cells; then those bees that have their heads in the cells are *not* the field bees. I have observed this: That most of the bees thus engaged appear to be young ones. The burden of proof rests on your distant cousin to show that the contrary is true.—ED.]



Thanks! thanks for the peace that reigns
 Within our land to day;
 Thanks for the harvest, thanks for all things
 For which we're taught to pray.
 Thanks for the hopes the present brings
 Concerning future days;
 Thanks for the firm belief we have
 That thanks are half God's praise.

W

In cases of great weakness, accompanied with constant thirst, a remedy will be found by pouring the white of an egg into a glass and mixing with it about two teaspoonfuls of liquid honey and a few drops of lemon juice or a little citric acid. As a general rule in the sick-room, food and drinks should be fresh—nothing warmed up, and not too much at a time.—*From the German.*

W

In Stray Straws Dr. Miller has something to say about Maeterlinck's Life of the Bee. Although I spoke highly of the work

in our issue for Oct. 1, the doctor's criticism is about right, although I do not think "pessimism" is necessarily an evil. The *Irish Bee Journal* gave about three pages of quotation from the book, and praised it highly, and here comes *Le Rucher Belge* giving a translation from it in French. The writer of it himself says no one will learn how to open a hive by reading his book. Bees are his text but not his subject, as I understand it.

On page 862 Mr. R. A. Holley says :

On page 779 you quote the *Pacific Bee Journal* to the effect that I have found 625 cases of foul brood in Ventura Co. This is as wide of the truth as some of the estimates of the California honey crop. I have found, up to date, just 103 cases of foul brood in this county this year.

The fault was not on the part of the journal quoted. The mistake arose from my concluding that the total number of colonies examined was the number affected with foul brood. I beg Mr. Bennett's pardon for causing him to appear so inaccurate. But the revised report by Mr. Holley is certainly bad enough, and should arouse vigorous action among bee-keepers there.

THE IRISH BEE JOURNAL.

This new paper was started last spring, and has all the outward marks of an old journal. It is devoted to the development of apiculture in Ireland, and presents a table of contents that is very creditable. It has 16 pages the size of this. It is the organ of the Irish Bee-Keepers' Association, and is edited by J. G. Diggs, M. A., Lough Rynn, Dromod, Ireland. In regard to overstocking the market the editor well says :

Low prices are entirely due to bee-keepers themselves. One correspondent lays the blame on the "women bee keepers, who think that they can never sell their honey quick enough." We do not know whether the complaint lies properly in that quarter. But certain it is that the prices are made by the sellers, and that the drop last month from 7 s. 6 d. to 4s. was caused by the sudden rushing of honey on to the market in very large quantities. In the first week in August one large firm in Dublin was looking everywhere for sections at 7s. 6d. per dozen. Within five days glazed sections were going a-begging at 5s., and there is no knowing how far the prices may fall if sellers throw discretion to the winds in this fashion. Honey will keep, and it should be kept until the price is raised again to a fair level. £14,000 worth of foreign honey was imported into England in July, and sections were selling in Scotland last month at 1s. 6d. each. The bee-men who poured their honey into Dublin at 5d. per lb. got all that they deserved, and should not complain.

AMERICAN BEE JOURNAL.

Mr. York has given us a treat in his issue for Nov. 21. Chicago is a suburb of Marengo, where Dr. C. C. Miller lives, and Bro. York has been out there on the trolley to see the doctor and to get some permanent impressions of things around the doctor's home. And he succeeded. First we have a view of the genial doctor himself with an immense hat on, looking very "summery." Then follows a picture of his residence; a surreyful of John Wilson's children; a picture of Miss Emma Wilson, just ready to

smoke the bees; a picture showing the doctor at his typewriter, thrashing out Straws, perhaps; and a number of other half-tones equally interesting. Few pictures have ever interested me more than these; and they come in very opportunely with Prof. Cook's words in the same issue, where he says: "Our American homes could not exist outside of America. Britain is the only other country that comes within telephone call of us in the matter of homey homes; and Britannia pales as poverty crowds comfort, health, and even life, from so many of Britain's households. Think! any boy, the poorest, can safely aspire to his own beautiful home in this grand American country."

These inspiring articles of Prof. Cook on the domestic life of the nation deserve universal attention. Some might disagree with him in his rigid rule of never contracting debt, as it is often a great benefit to both parties to lend and borrow; but by a general application of his rule the world would be far better off. He says our national debt is \$14 a head; Russia, \$24; England, \$72; France, \$150. These foreign countries are sinking deeper and deeper in the mire, while our debt is so small as not to be felt, is rapidly disappearing, and can be paid by 1920.



WINTERING INDOORS AND OUT.

Why a Combination of the Two Methods is Advisable; Feeding and Feeders; Heddon Hives and their Advantages for Feeding Back; Feeding Back on Foundation.

BY J. E. HAND.

"Good morning, friend Hand. I see you are busy among the bees as usual."

"Yes, I am taking advantage of these fine days to prepare my bees for their winter quarters."

"Do you practice cellar wintering, or packing on the summer stands?"

"Outdoor wintering in packed hives has my preference; but there are some advantages in cellar wintering, so I combine the two methods. I examine each colony carefully as to bees and stores. Those that are heavy in stores and strong in bees are packed in chaff or other material on the summer stand. Those that are a little light in stores, or are not so well supplied with bees, are carried into the cellar about Nov. 20, usually. These are good average colonies, but are not quite up to the standard for outdoor wintering, and will do better in a good cellar. Since adopting this plan my losses in wintering have been very much lessened."

"But would it not be better to winter them all in the cellar? As they consume so much less honey, would it not be a great saving in stores?"

"It is true that there would be a considerable saving in stores, other things being equal; but some winters are favorable for cellar wintering, while others are much better suited to outdoor wintering; and so a combination of the two methods is the safest plan."

"Would not location make a difference in this matter of wintering?"

"Possibly. But these rules will hold good wherever it is at all desirable to winter in the cellar."

"Do you prefer permanently packed hives or winter cases?"

"You will notice that most of my bees are in Heddon hives, and therefore can not well be permanently packed. For this and other reasons I prefer some kind of outside case for each hive wintered outdoors, with 2 inches of packing on the sides, and 5 or 6 inches on the top of the hive. The cover can be left on, or the hive may be covered with pieces of heavy cloth or carpet, with a good tight cover over the whole case. I know of nothing better for this purpose than the winter case made by the Root Co."

"But what are these boxes with slat partitions—something new?"

"Oh, no! on the contrary, they are older than the movable-frame hive. Those are Quinby feeders. I got the idea from an illustration in Quinby's *Mysteries of Bee-keeping Explained*, published in 1858. I do not know whether they are mentioned in the revised edition or not. You will notice it is a bottom feeder, and was made for feeding bees in box hives. The hive rests square on the feeder, which is 2 inches deep, the same width as the hive, and 3 inches longer. This space is at the back of the hive, and is to fill the feeder. It is covered with a little board. The feed flows through a wire screen into 10 or 12 little troughs, or partitions, $\frac{5}{8}$ wide by 2 inches deep the length of the hive, excepting about an inch in front for the bees to come up. The inside of the feeder is lined with tin to keep it from leaking. There is no feeder illustrated in any of the catalogs that can approach this one. It is especially adapted to feeding back."

"What about those other feeders with the glass jar?"

"Oh! that is my own invention. Like the other it is a bottom feeder, and it is at the back end of the hive. It is on the 'atmospheric' principle. The feed flows through a hole in the top of the inverted glass jar through a wire screen into a trough which extends the width of the hive. The bees have access to the feeder by removing the cleat from the back end of the bottom-board. The trough is always full. As long as there is any in the jar, the bees can not pass beyond the trough, and are not in the least disturbed in removing and refilling the feeder; and the feed is in a lit-

tle trough right under their noses, and will be taken up very rapidly. I mention these two feeders at length because they have been the means of solving the problem of feeding back and reducing it to a science. No top feeder is of any account for feeding back. You may paste that in your hat."

"Do you find it profitable to feed back extracted honey to have it stored in the sections?"

"Yes, with the right kind of hive and appliances, and considering the difference in price, as well as the greater demand for comb honey, I find it very profitable. Note what E. R. Root says on page 828, about the demand for comb and extracted honey. I had noticed that, and had about concluded to produce comb honey next year."

"What do you think of Mr. Doolittle's experience in feeding back, as given in the Aug. 1st GLEANINGS?"

"I am not at all surprised at the results of his experiments. I have had about the same experience, and so will any one else who tries to feed back with a frame as deep as the one he uses. However, I consider his frame about as well adapted to feeding back as it is to producing comb honey when gathered from the fields."

"Then you consider that a hive that is well suited to the production of comb honey is just as well suited to feeding back?"

"Yes, that is my experience exactly. Mr. Doolittle fed his bees 50 lbs. of honey, and they only just got to building comb nicely, and then they struck and refused to do any thing, after which he gave up the whole business in disgust, as almost every one else does who tries it."

"What do you think became of that 50 lbs. of honey?"

"Well, I will tell you what I think became of it. You will notice he says he fed them about 15 lbs. each, which they carried off during the day. At that rate it would take only a little over three days to carry off the 50 lbs. They were not building any comb; and as it takes three or four days of feeding to start comb-building, there could be no place to store the feed except in the brood-chamber; and as his frame is $11\frac{1}{4}$ inches deep, there was plenty of room for it, or the queen might have been a poor one, and the bees simply crowded her out and filled up the brood-chamber. I have often found this the cause of a failure in feeding back. A good queen will compel the bees to move the honey out and give her room, while a poor one will be crowded out completely, and the brood-chamber crammed full of honey, after which the bees will work about as Mr. Doolittle says his did."

"Do your bees ever refuse to work in the feeders?"

"Well, not so bad as that; but there is a great difference in the working qualities of bees. Some will build comb faster, and cap their honey whiter. I keep a pedigree of these bees, and use them for feeding back. They are also likely to do better field work. I had three colonies this year

out of fifty that I could not make do satisfactory work. Two of them were poor comb-builders, and the other capped the honey so badly that it was not fit to sell. Those queens will lose their heads next spring."

"How much do you find it profitable to feed at a time?"

"I give them all they will take up in 12 hours if they are building comb; if not, I feed about a quart per day until comb-building is started nicely. My best colonies would take about 2 qts. every 12 hours."

"How long would they keep this up?"

"They kept it up this year from Aug. 1 to Sept. 25, when the weather became too cool for comb-building."

"What kind of hive do you consider the best suited to feeding back?"

"There is only one kind of hive that I know any thing about that is at all suited to feeding back. It must have a very shallow frame, and must be capable of contraction horizontally so that the brood will be spread out evenly under the super. The Heddon is the only one that will do it."

"How deep is the frame in the hive you use?"

"My frame is $4\frac{1}{4} \times 17$ inches, comb surface, and 8 of these combs make a section of my brood-chamber as I use it for feeding back. There is a queen-excluding honey-board between the brood-chamber and super, just as in hiving swarms."

"But will not such contraction of the brood-chamber, combined with heavy feeding, induce swarming?"

"No, not to amount to anything. I wish it would, for then they would build comb faster and cap the honey whiter. I had only two such swarms this year."

"Have you ever tried producing comb honey from foundation by this feeding-back process?"

"Yes, I have produced over 2000 lbs. this year of extra-fancy comb honey from foundation by this system. I can assure you it is no mere theory with me, and there is nothing I like better."

"Well, friend H., how is it that you succeed in getting your bees to accept foundation when others report nothing but failure?"

"Well, friend Charles, it is as I told you before—it all depends on using the right kind of appliances. There are several different kinds and makes of foundation, and it may be possible that they have not tried them all yet, and this may account for it in a measure. If you will excuse me, it is getting nearly time for the local, and I have to ship two crates of honey. Come over again and I will tell you all about how it is done, as well as I can."

"Thank you, friend H. I am very much interested in this subject, and I assure you I shall not fail to avail myself of this privilege."

[Mr. Hand has promised to write a series of articles telling of his experience along

various lines, and this is the first of the series. He uses the conversational method, as that is very easy to follow, and, besides, it has the further advantage that the question brings out in every case the reason for using this or that method. Mr. Hand, it seems, has made a success of feeding back on foundation. This is going further than most of us have practiced, and we await with interest what he will have to say on this subject next time.—ED.]

THE VENTILATION OF BEE-CELLARS.

The Construction of the Bingham Bee-cellar.

BY E. R. ROOT.

As explained elsewhere in this issue, we have at our basswood yard a 12×20 beecellar, built on the lines of the Bingham repository, which we described early last year. As some will probably have forgotten how this was built, I present a cross-sectional view, giving its general construction. As indicated in the diagram, the cellar is 16 feet square at the top, and 12 at

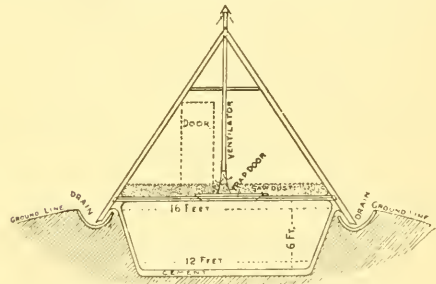

the bottom. The sides are sloping (to prevent caving in), and lined with cement. A double floor, packed with sawdust, covers it, and over this is a gable roof. Through this floor there is a trap-door, and along about the center a 16-inch ventilating-flue connects through the top of the cellar to the roof in the upper structure. Mr. Bingham's idea seemed to be that the bees need a great deal of ventilation. In the drawing the ventilator is shown to be only about 3 inches in diameter; but, as he explains, this was not found to be large enough, and was subsequently replaced by the larger one.

Our cellar at the out-yard was built on the same general plan, with the exception that the sides are less sloping, and are lined with a single thickness of hard brick laid in cement—that is, the sides are lined with a 4-inch wall. In our clay soil we were afraid to trust the cement lining; but to strengthen the wall further, the sides and ends were made slanting, so that the top of the cellar is 8 inches wider and longer than the bottom.

Instead of constructing a plain cheap gable roof we moved a building, which was out of use, over this cellar, put in it a double floor packed with sawdust 10 in. thick,

this floor serving as a ceiling to the room below. The building had been constructed, and bees put into the cellar, before I happened to think that no ventilator had been provided; then remembering that some of the prominent advocates of indoor ventilation had said that no ventilation, or but very little, was required, I began to wonder whether any was really needed. I accordingly wrote to Mr. Doolittle (a no-ventilator man), who has used successfully for a number of years a bee-cellar built on a side hill, having walls somewhere about 20 inches thick. I explained the construction of our cellar, and asked him if, in his opinion, a ventilator would be needed. This is his reply:

Mr. E. R. Root:—I have made no provision for ventilation of my underground bee-cellar for the past 15 years. It is 24x7, and 7 feet deep, and I winter from 60 to 85 colonies in it each winter with good success. The walls are of stone mason work, 16 inches thick, and the top covered with 4-inch-thick flag-stone, with 3 feet of dry earth over this. But the joints between the flag-stones are so open that a little dirt sometimes sifts through. Then, of course, a little air gets in through the four doors used for the entrance. I suppose you will have an entrance also with doors. If so, the only question would be whether your double floor, packed with sawdust, will give less ventilation than my flag stones. I confess to not being able to answer that question satisfactorily in my own mind, as dry dirt is quite porous, and the cracks between the flag-stones are large enough to stick your finger through in some places.

On one still, damp, misty time, holding on a week, I went into my cellar, and the air was so impure that the candle would not burn; and, when nicely burning between the entrance doors, it would fade away and soon go out on going into the cellar. It seemed a little hard for me to breathe, but the bees came out all right. This was the only time but that the air has seemed pure. At the time the candle would not burn there was four feet of wet snow all over the whole ground, roof and all. Just what advice to give you I hardly know; but if your cellar were mine I think I would risk it without a ventilator; but I do not feel like advising you to do so. Perhaps my experience as given above may help you a little in deciding what to do. I know nothing personally of clamps.

Borodino, N. Y.

G. M. DOOLITTLE.

On receiving this I sent copies of it to Dr. Miller and Mr. Bingham. Concerning this matter, Dr. Miller writes:

Dear Ernest:—I've studied over the problem as to your cellar quite a little, but without feeling competent to advise. With the right kind of soil and covering I think there would be no need of special attention to ventilation. But if conditions were not all just right the results might be disastrous. Perhaps the safe thing to do would be to have the shaft put in and closed up just as if no shaft were there. If all went well it could be left thus all winter, and you would practically have no shaft. But if an inspection every two or three weeks should show that the danger-line was reached, then you could open up the ventilator. The point is that, with the ventilator, you can do either way, and without it you are helpless if it should be needed. The temperature and the number of colonies have something to do in the case.

Marengo, Ill.

C. C. MILLER.

Following is the letter from Mr. Bingham:

Mr. Root:—Your esteemed letter is at hand, also Doolittle's. The door on the level of the floor of his cellar, and the difference shown by his candle, would demonstrate that the carbonic laden air found a place where it could be mixed with pure air at the door. My experiments with a three-inch tin conductor-pipe opening into the room over the cellar demonstrated that, under such conditions, it would not be safe to enter such a cellar or any other place where a lamp would go out. If there was no danger one would like to be able to see his bees now and then.

If a 16-inch-square flue does not reduce the tempera-

ture below 32° (and mine did not as low as that last winter), it would seem needless to endanger oneself, even if the bees were not injured by an air-tight cellar. It may safely be borne in mind that a cellar entered from the top would not have as reasonable opportunity to mix its vitiated air as one with an entrance on a bottom level.

My bees were taken into my cellar yesterday afternoon, Nov. 15. The temperature is about 35°, flue and doors above them open. The upper room has two large ventilators, one at each end darkened partially, and located at the point of the gable.

If the temperature should fall below 30° my doors will be closed. At 32 to 40° the light does not seem to cause the bees to fly out. It would be a nice temperature outside. Your cellar being new may need more constant ventilation than if older. My ventilating-flue stops on the ceiling-floor. Said flue is supported on 6-inch joists on the lower side of said joists, covering a space about 4 feet square. Thick building-paper, two thicknesses, is secured by cleats. This leaves two 4 feet by 6 inch entrances as a supply for the flue, and no light is let in. The top of the flue has a cap over it to keep out dirt, rags, and rain.

The greatest enemy to wintering out or in doors is dampness, either in the air or hives. The reason why your bees under the machine-shop were so quiet was because so dry with sweet good air.

I intended to put in another duplicate flue before my bees went into the cellar, but was so busy I did not. If I were to build another cellar I would double the size and increase the height of my flue ventilation all I could.

It is the upper air in a cellar that needs removal. The steam and dampness are there while the lower stratum of air remains ready to supply the flue-draft, which is proportionally greater according to its immense elevation. This is not the sub-ventilation idea, you see. The lower stratum is all right if sufficient y mixed with air that goes down the flue from an altitude of 20 or more feet. The flue must not reach below the ceiling, or be away from the center of the cellar. A flue reaching to the bottom of the cellar showed a temperature at its lower end nearly equal to that outside, while the general air of the cellar remained at 40 to 45° a few feet away from the inlet, and the air was stuffy and damp. The large tall flue enables the cellar to be kept dry and cool without admitting light. This is valuable when bees become uneasy from any cause, most noticeably in the spring. Mr. D., I think, has been in the habit of opening his doors at night in spring. The large tall flue from the ceiling would have prevented that. That others have found y air in cellars, and not reported, shows the value of bee-journals, all of which placed my lantern experience before the bee-keepers at once as soon as received.

Farwell, Mich.

T. F. BINGHAM.

P. S.—Nov. 18.—Clear, 25° at 6 A.M.; air in cellar, doors open, better, it, and the room above, 35°; room above cellar, 32°; doors all around open all day the 17th; cellar at 40°; bees hibernating peacefully, as if outdoors; no effort to fly to the open doors. T. F. B.

It appears from these letters that much depends on special conditions. Taking the advice of Dr. Miller I have had a ventilator put in. But this was made before the receipt of the letter from Mr. Bingham, and is only 6 inches square instead of 16; and I am now wondering whether I have made it large enough. If I had it to do over I would make it fully 16 inches square as described by Mr. Bingham, and will do so later if the bees become uneasy during winter.

But the special feature of the Bingham cellar is that it is virtually a cistern—that is, the walls of the cellar proper are all under ground, without any part of them projecting to the outside air to get through, thus affecting the temperature inside.

Our experience in wintering bees in the machine-shop cellar last winter was most favorable; indeed, I never heard or read of a case where there were so few dead bees as we had on our cellar bottom. As Mr. Bingham points out, it was absolutely dry, and then it received a great amount of ven-

tilation from the larger cellar surrounding the wintering-room; and, as I have before stated, the larger cellar contained several carloads of potatoes, and it was necessary to keep the temperature down for these as low as possible. During warm weather the cellar was kept closed to keep out the warm air. In cold weather it was ventilated, and that quite often. Perfect ventilation, and an entire absence of moisture or dampness, resulted in the phenomenally good wintering of all the bees. This year we have in that same cellar 250 colonies instead of 40, and about the same number outdoors. These are in addition to 100 colonies in the Bingham cellar at our outyard.

It is my purpose to make repeated observations to determine the effect of ventilation or no ventilation, and report through these columns.

THE BEE IN LAW.

Finding Bee-trees; Early Code; Licensees; Recovery of Reclaimed Bees.—Article 4.

BY R. D. FISHER.

Having laid down the general rules that govern property in bees, their identity, transportation and larceny thereof, it will be our purpose in this article to give the result of the different actions at law growing out of the finding of "bee-trees." In primeval days "bee-hunting" and "honey-gathering" were both profitable and fascinating pastimes. Even in this day, old bee-hunters can not refrain from following a "course" when it points to the forest. As evidence of this, a bee-tree was cut recently on the Young-farm forest, five miles west of Kokomo, Ind., which beats all records for size and yield. The "gum" in which the honey was stored was 18 inches in diameter and 11 feet in length. Pieces of solid comb 15 inches wide and 10 feet long were taken out. There were nearly two barrels of choice honey, weighing nearly 600 lbs. George Harness, who helped cut the tree, is 84 years old, and says he has hunted bee-trees all over the West for 70 years, but declares that this tree beats all former records.

There was a sort of code among bee-hunters in the earlier days of this country, and it is said to have been generally observed. It was to the effect that, when a bee-tree was located and marked with the initials of the finder, his rights were *prima facie*, and zealously observed. But this code did not hold good in law, especially against those holding an interest in the land. "If a person finds a bee-tree containing honey, or a hive of bees on another's land, and marks it with his initials, he does not reclaim the bees and vest the exclusive property of bees or honey in himself, as against one of the heirs having an interest in the land; nor does he acquire the right to bring an action of trespass against the heir for cutting down the tree and carrying away the bees and

honey," says the New York Supreme Court in the case of *Gillett v. Mason*, 7 Johns. N. Y., 16. An early and noted case is reported in 1 (Root) Conn., 209. Goodwin sued Merrill for cutting down a tree in the forest, that had a swarm of bees in it, and taking the honey which he (Goodwin) had previously discovered. Merrill plead that said bees were a swarm from his hive; that he had frequently "lined" them to near said tree, and that said bees were his property. The plaintiff replied that he found them wild in the woods, and had a good right to take them. The trial court gave the plaintiff judgment of 30 shillings damage. The Supreme Court reversed this judgment, and said: "A man's finding bees in a tree standing upon another man's land gives him no right, either to the tree or bees; and a swarm of bees going from a hive, if they can be followed and known, are not lost to the owner, but may be reclaimed."

As early as 1804 the New Hampshire Supreme Court held that one who finds a swarm of bees in a tree on another's land, marks the tree with his initials, and notifies the land-owner, can not maintain trover against the land-owner for the bees and honey which he obtained and converted to his own use by felling the tree.—*Fisher & Parmlee versus Smith*, *Smith's New Hampshire Report*, page 60.

LICENSE; POSSESSION.

Where one discovers bees in a tree, obtains a license from the owner of the soil to take them, and thereupon marks the tree with his own initials, he gains no property till he takes possession; nor can he maintain trespass against a third person who cuts the tree and takes possession of them on a subsequent license from the owner of the soil. The two licensees stand on an equal footing; and he who first takes possession becomes the owner.—*Ferguson vs. Miller*, 1 Cow. (New York), 243.

This case has been commented on adversely, and critics say it is bad law. The better law on this point is promulgated by the Vermont Supreme Court in *Adams vs. Burton*, 43 Vermont, 36, where it is held that one who has obtained a tacit consent from the owner of the soil to cut down a bee-tree thereon, and get the honey, has, while in the act of cutting down the tree, a superior right over a third person to whom the owner has given subsequent consent, but without revoking the former's authority. The court said: "These parties stand, as between themselves and as respects the legal principles applicable to the case, in precisely the same position as though neither had any authority from the owner of the tree, and both were trespassers upon his rights, or as though there were no individual owner of the tree. How, then, would the case stand? No principle is better settled than that a person in possession of property can maintain trespass against any one who interferes with such possession who can not show a better right or title."

The law of the bee-trade, so far as discovery is concerned, seems to be in an unsatisfactory state as to the relative rights of trespassers. The relative rights of parties, both of whom acknowledge the superior right of the owner of the soil, seem never to have been precisely described.

RECLAIMED BEES MAY BE RECOVERED FROM TREE.

We have treated bees found in trees as wild and unreclaimed; but a different rule of law applies to bees that have been reclaimed and once hived. If bees temporarily escape from the hive of their owner who keeps them in sight, and marks the tree into which they enter, and is otherwise able to identify them, they belong to him and not to the owner of the soil. In such a case the property draws after it possession sufficient to enable the owner of the bees to maintain trespass and recover damages against a third person who fells the tree, destroys the bees, and takes the honey, notwithstanding such owner himself is liable to trespass for entering on the land of another for a similar purpose without authority. The right of ownership continues; and, though he can not pursue and take them without being liable for trespass, still this difficulty does not operate as an abandonment of the bees to their liberty by nature. Hence the dictum that "the owner of the soil is entitled to the tree and all within it" is true only so far as respects an unreclaimed swarm.

We have endeavored, so far as case law is concerned, to define the rights of the finder of bees and a person interested in the soil, and between persons each claiming to be the finder, and between licensees having authority to enter the land of another to take bees and honey.

In addition to authorities already cited, see *Idol v. Jones*, 2 Dev. (N. Car.), L., 162; *Goff v. Kiltz*, 15 Wend. (N. Y.), 550; *Wallis v. Mease*, 3 Brim. (Pa.), 546.

HEREDITY AND THE VARIATION IN ANIMALS.

The Fundamental Rule of Uniformity.

BY RIP VAN WINKLE.

Referring to a *Straw*, in your Oct. 15th edition, asking a question, "What is a tested queen?" I will take the risk of your quoting Pope's celebrated line, "Fools rush in where angels fear to tread," and make a suggestion if you will permit; and with all due deference to Dr. Miller, for I may always say of him on bee-keeping, as James Russell Lowell does of the "Boston" people, "What they don't know ain't hardly wuth the knowin'." I do not see much difficulty in determining the matter if we go by the fundamental rule of *uniformity* in her workers. Any queen which produces all uniformly marked workers—all three-banded or all five-banded—I should pronounce pure Italian. Mr. Darwin, in his "Plants and

Animals under Domestication," has shown by abundant evidence that the tendency of all crosses is for offspring to revert back to some previous ancestor, near or remote. This, of course, is among vertebrates; for we have few if any well-defined experiments as to insects. We know that the cross between a black drone and Italian queen produces workers of all three degrees; viz., of pure black, one band; two bands and three bands, from the same queen. I should expect to find the rule hold good among five-banded bees, which I regard as only a recent "sport" from the Italian, *not* a distinct variety. A queen of the five-banded stock may throw a variety of *bands* in her workers, and still be pure or purely mated; but if she throws a black worker, or one with less than the three normal *Italian bands*, then I would say she was impurely mated.

Heredity, the variation of animals under domestication, the laws of breeding, are very interesting studies, and all the more from being intensely intricate, as is instanced by another fact bearing on this same subject, mentioned by Dr. M. and yourself on the next page of *Straws*, 814, about the influence, or, as Mr. Darwin would call it, the "prepotency," of the male in the matter of the negro and white woman, and black and white fowls. These are not isolated instances. There are many such on record, and it is extremely difficult to say what the extent of such influence is.

Prof. Cook, in his "Manual of the Apiculture," second edition, 1878, page 89, under the general heading of "Influence of the Drone," is inclined to think, as Dr. Miller does, that the influence is not sufficient to vitiate the blood of the offspring in mammals, but only a temporary one. It might add to our knowledge if some one would breed from one of these marked offspring and note the result; and I would say the point to be ascertained would be whether such influence produced not merely change of color, but any well-defined change in the program from the known characteristics of the brood, which would be of most importance to the breeder. There is a case on record of a thoroughbred English mare being bred to a jack, and having a mule colt; and, though bred to thoroughbreds afterward, her progeny showed mule markings. But it is not stated that their other thoroughbred qualities were changed, which, I repeat, would be the practical question for the breeder.

Just how far the question of parthenogenesis in bees, discovered by Dzierzon, would modify the fundamental laws of heredity which we have learned about other domestic animals, remains to be ascertained; for upon this subject, to quote the words of Darwin, "Our ignorance is profound."

[There may be something in what you say, to the effect that queens of the five-banded stock would, if they had met a black drone or a hybrid, show the fact in

their progeny, in accordance with the "fundamental rule of uniformity" in pure stock; but I never yet have seen *all* the bees of so-called five-banded queens show uniformly five yellow bands. The best average for one queen is, perhaps, 50 per cent with five bands; 25 per cent with four, and the rest with three. As a rule we do well to get 25 per cent five-banded workers, and the rest three and four banded, all from the same queen. I never yet have seen a uniform number of bands from any one queen of the extra-yellow stock; therefore I have my doubts whether the "rule of fundamental uniformity" would apply in this case, although it might do so.—Ed.]

BEE-KEEPING IN MONTSERRAT.

BY A. J. JORDAN, AGRICULTURAL INSTRUCTOR.

Montserrat is a small island 16° 45' N., 62° 7' W., 8 miles broad and 12 miles long, forming one link in the chain of beautiful islands known as the Lesser Antilles. The bare statement of the length and breadth of the island would give the bee-keepers used to a flat country no idea of the possibilities of a place like this. There is not an acre of level land in the whole island. As in the case of Dominica and St. Kitts, Montserrat is of volcanic origin, and was, in ages past, thrown up into the most fantastic peaks. The heavy rains, too, have lent themselves to the cutting-up of the surface of the land. As the water pours down on the steep slopes of the mountain-sides it gathers together and forms torrents which cut deep chasms, called here "guts," in the surface of the earth. Many of the trees and plants growing at or near the top of the guts send down their long aerial roots to the bottom of the gut; and upon these many of the climbing plants (iponeas, legumes, etc.), which obtain sufficient soil to root in at the bottom, climb upward. The mountain-sides are like a greenhouse stage, rising in such a way as to enable the plants to grow far more thickly than they could possibly do on the level.

Bee-keeping has been carried on for many years in a rough-and-ready way, the bees being kept in boxes and barrels, and the combs containing young bees as well as honey being periodically cut out. The comb, when cut, was, as a rule, put into a coarse cloth, and squeezed; and you may guess that the honey obtained was not of the best quality, and was useless but for consumption among the people themselves.

Some two or three years ago Mr. I. T. Allen commenced to keep bees in the modern hives, and a little more than a year ago Mr. E. F. Dyett obtained two ten-frame hives; but the actual beginning of the present bee-keeping stimulus was the sending, by the Imperial Commissioner of Agriculture for the West Indies, of Mr. W. K. Morrison to lecture here on bee-keeping. Since then

several people have got hives, and are experimenting in a small way. Three colonies of black bees were obtained by the Agricultural Department, in barrels, from one of the people here, and were transferred to ten-frame hives. Nine colonies have since been obtained from these three, making a total of twelve.

The two Italian queens you sent are working well. It is interesting to see how the bees from these queens dash in and out of the hives, very differently from the deliberate movements of the Creole black bee.

The three difficulties the bee-keepers have to overcome here are bullfrogs, moth, and lizards. The first is, I suppose, peculiar only to this place. Bee-keeping with the hives on the ground would be a failure here, for the frogs would simply lick up the bees as fast as they could come home. We keep the hives two feet from the ground.

The moth has given a little trouble in slack time—that is, September, March, April, and May; but they do not trouble strong colonies.

Nothing as yet has been discovered to prevent the lizards from attacking the bees; but as about three bees satisfy a lizard the damage done is not great.

I see by GLEANINGS that "covers" are still under discussion. I may say those sent here are a failure in this climate. No matter what is done, water finds its way to the combs.

WIRED FRAMES WITHOUT FOUNDATION.

Are they Practicable? Use of Woollen Stays in Place of Wire; an Unwelcome Fact about Alfalfa-growing.

BY O. R. WEAVER.

I wish to secure the advantages of wired combs without the expense of using full sheets of foundation. I am not able to stand the expense. Can I have combs built from starters on a wired frame? I never tried it, but don't think I can have them built that way.

I have another plan that I never heard of any one using, so I wish to ask your idea of it. This is my plan: Take strips of $\frac{1}{8} \times \frac{1}{4}$ -inch stuff; cut them off $\frac{1}{16}$ inch longer than the distance from the top of the bottom-bar to the bottom of the sawed grooves on the under side of the top-bar. Cut a notch $\frac{3}{8}$ deep in top of the bottom-bar; spring the bottom-bar down a little, and slip the strip in, putting one end in the groove where foundation goes. First, one would have to cut the starters so they would go in between the strips, and strips and end-bars of frames. Now, would the bees cover the strips with comb so the comb would be stronger? I am up 6500 ft. high; winters are cold, and snow gets deep. Don't you think double-walled hives would give better results?

While you are writing so much about alfalfa, I think it would be advisable to sound

a word of warning. It is this: The experiment stations are advising the cutting of alfalfa when from 10 to 25 per cent in bloom, and the farmers are beginning to put it into practice. At this place it used to be two crops; now they are beginning to cut three. At Aztec, N. M., they used to cut three; now some are cutting four, and more will do so in a few years. When cut three times here and four at Aztec it is no use for bees. I believe that, in a few years, it will do bees no good except where kept for seed.

How many strips should I use in a standard frame to make it good and strong, so it will stand the extractor?

Bayfield, Col., Oct. 12.

[It is perfectly feasible to use wired frames without foundation, providing one understands the art of getting *worker* combs built. The presence of the wires interferes little if any with such work; but when starters of foundation are used, the bees will draw out the starters, extend them down over the wires, and the work is almost as perfect (providing one knows how to get all worker comb) as when full sheets are used. But the majority of beekeepers who have tested the matter agree, I believe, that, as a rule, and under conditions as they ordinarily exist, it is better to use full sheets of foundation on wires, and mainly because of the difficulty of getting all worker comb. Your wooden "stays" might answer, but they would be too large and clumsy, and the tendency would be for the bees to build ridges, or what we call "dead furrows," along the line of each stick. Better—far better—use wire.

With regard to alfalfa-growing, I fear there is too much truth in what you say. If the ranchmen keep on in this way, then the great alfalfa-fields, where hay is the object, will, as time goes on, be no more the paradise of the bee-keeper. All along the line of travels I heard how the ranchmen were, year after year, cutting their alfalfa earlier and earlier, until it seems now that, just as soon as it comes into bloom, they must start their mowers, and that, too, when bees are just beginning to roll in the honey by the earload. Ed.]

G. H. H., Maine.—Yes, excessive smoking does have a bad effect on bees, as I believe it has a tendency to shorten their lives even if it does not kill them on the spot. Beginners are apt to smoke their bees to excess. Very often two little whiffs of smoke are sufficient. If the bees are very cross, and are inclined to rob, a little more smoke to bring the colony under control may be necessary. Too much smoke has a tendency to couse the bees to gorge themselves, and even uncap comb honey. This gorging is wasteful of honey, and the uncapping spoils the appearance of the face of the honey.



STARTING IN BEE-KEEPING.

"Good morning, Mr. Doolittle. I am about to make a start in the bee business. I think of buying 50 colonies of Mr. Smith, and I came over to see what I could find out in the matter which would be helpful to me."

"What do you have to pay Mr. Smith for bees?"

"He said he would let me have 50 colonies this fall, hives and all, for \$200, or he would let me have them next May for \$250, as there is some risk to run in wintering bees. Which would you prefer to do—buy them this fall or next May?"

"How many colonies has Mr. Smith?"

"He has about 250."

"If Mr. Smith will give you your choice out of the 250 colonies next spring, I should prefer to wait till next May, and pay the \$250 extra. Otherwise I would take them now."

"Why?"

"Because, in the former case Mr. Smith practically insures the bees against all loss in wintering; while if you do not have your pick he agrees to give you only so many colonies; and you might not have as good an average if you took them as they come as you would have did you take all good colonies this fall. But why do you wish to buy so many colonies?"

"So as to have a good start, and a sufficient number to pay me for 'dabbling' in bees at all."

"I hardly think this the part of wisdom. It seems to me that 50 colonies of bees would be about twelve times as many as a beginner should buy."

"Why?"

"Have you had any experience with bees?"

"No—nothing more than that I have been at Mr. Smith's two or three times, and have read about the profit there was in bees, out of a paper I picked up."

"As I thought. You are a beginner, and the beginner should guard against going recklessly into bee-keeping by putting a lot of money into a business he knows nothing of. It is this getting crazy over a business which looks to be a good thing, but with which we are not acquainted, and putting a lot of our hard-earned money in it, expecting to make a fortune, which ruins so many. To be successful in any thing, a man must 'grow up' into it, as it were, by years of patient toil and study, till he becomes master of the business, when, in 99 cases out of 100, he will succeed."

"When and how did you begin?"

"During the winter of 1868 I became interested in bees by reading a book on the subject, which I found in the house; and,

as father had kept bees several years before, I knew something about them, but not after the improved fashion, as father kept his bees in box hives. Next I subscribed for the *American Bee Journal*, read Quinby's and Langstroth's books, and in March bought two colonies of bees, and the hives which I needed for two years, at a cost of \$30 for the whole."

"How did you succeed?"

"There being a poor season in 1869 I had but one swarm from the two colonies purchased, and had to feed \$5 worth of sugar to get the three through the winter of 1869."

"Whew! If I had such success as that with my 50 I should wish I had never gone into the business, as that would add \$125 to the first cost of commencing. But did you do no better the next year?"

"During 1870 I received enough from the bees to buy all the fixtures I wished for 1871, and a little to help on my other expenses on the farm, for farming was my main business at that time; and the first \$35 was all I ever paid out for the bees but what they brought me in; for I resolved, after this first \$35, I would lay out no more money on them than they brought in, believing that, if I could not make 3 colonies pay, I could not 300. But had I had 75 colonies at that time, with little or no experience, the loss of throwing the business up would have been greater by many times than \$35."

"But it seems you did not throw it up."

"No. During 1871 I got enough from the bees to a little more than pay expenses, besides a lot of experience, which was of more value to me during the years to come than many dollars would have been without the experience; for in the fall of 1872 I found that I had an average yield of 80 pounds of comb honey from each colony in the spring, which was sold so as to give me \$559, free of all expense incurred by the bees."

"Pretty good pay, was it not?"

"Well, yes. But you will see that this was the first I had really gotten, so it must be spread out so as to cover a period of four years. At this time I did not have as many bees as you propose buying to start with. My opinion is that, had I bought 50 colonies to start with, I should have turned from the business in disgust, with a loss of several hundred dollars, and that the bee-world would have been spared the scribbling done over Doolittle's name for the past 30 years."

"But you succeeded?"

"Yes. But before we go further I wish to tell you about something which pleased me during 1872. I bought an extractor, and, being determined to give the bees the care they needed, and knowing that the time the bees needed the most attention came in haying time, I hired a man to take my place in the hay-field. It so happened that he commenced work on the day bass-wood commenced to bloom. Previously I had hived a prime swarm, and concluded to devote them to extracted honey. The man worked 16 days at \$1.75 a day, and I

extracted honey enough from that swarm during those 16 days to pay the man for his work. I tell you this to show that, when properly managed, in a fairly good season, one swarm of bees is equivalent to a man at work in the hay-field, and so it will not pay to neglect a whole apiary to go into the field to work, as many would-be bee-keepers so generally do, and afterward growl about the bees not paying them. You can hire a man to take your place in the hay or harvest field; but if you expect to become master of the bee business, so as to make it pay, you can not hire a man to take your place in the apiary during the honey season, as it takes much more skill to be a successful honey-producer than it does to pitch hay successfully. When the bees do not require any special attention, then they can be left to do other work as we have time; but if the bee-keeper would be successful, he can not afford to neglect them for a single day, when that day will put them in condition to bring him dollars in the near future."

"I think I begin to see that much which I have thought about 'bees working for nothing and boarding themselves' has been merely an idle dream. But what of the years after 1872?"

"Since then my average income from the bees has not been far from \$1200 a year, above the expense incurred by them. In other words, the bees have paid me a salary of not far from \$1200 a year, on an average, for the past 28 years, and that with only about 75 colonies on an average each year. I have not kept a larger number, on account of other things which demand my attention more or less of the time. Had I bought 50 or more colonies to start with, the expense in starting would have been from \$350 to \$500, which, in all probability, I should have lost in the business, for I should not have had a knowlege equal to doing so large a business on the start."

"I am glad to have had this talk with you; and now on leaving tell me in brief just what you would advise in the matter of my keeping bees."

"My advice to you, and all others thinking of bee-keeping as a business, would be, purchase from two to four colonies of bees; post yourself by reading and experimenting with them, as you can find time from the business you are already in, and thus find out for yourself which is the better for a livelihood—the business you are already in, or keeping bees. If successful after a series of years, you can give up your other business if you wish to; and if bees are a failure in your hands, then you are but little out for having tried your hand at it."

[Although Mr. Doolittle has cautioned beginners against expecting too much from bees, yet in spite of that caution some may imagine they can do as well as he. When he began, prices on honey were much higher than now, and the results, from a dollars-and-cents point of view, would be cor-

respondingly higher. Then Mr. Doolittle is also a queen-breeder; and had he not been such it would have been difficult for him with only 75 colonies, average, to secure such good results. I do not mean to belittle what our friend has done—not in the least; but one who begins *now* should understand that the possibilities from so few bees are not so great.—ED.]



LONG tongues are getting to be too much on the order of a "craze." See next issue.

MR. HARRY S. HOWE, of Artemisa, Cuba, the well-known lightning operator, and Miss Maria Habrera, of Hotorro, Cuba, were married at the home of the bride, on the evening of Oct. 11, 1901. Mr. Howe may well consider himself a lucky man, as his wife comes from one of the best families in Cuba.



E. M. E., Ohio.—Queens will sometimes lay two eggs in a cell, provided they are crowded for room; but if a queen is somewhat defective she may do so when there is plenty of room.

L. L. B., Va.—It is a very difficult matter to get queens purely mated in localities where black bees have been for a number of years. You will probably have a mixed progeny just as you describe. In regard to the queen that curled up and appeared to be dead, I would state that she had what we call the cramps. It very frequently happens that when a queen is picked up by the wings she will curl up so tightly that she seems to get a hitch in the back, and, as a consequence, lies down and remains apparently lifeless; but if put into a cage, and left alone a few minutes, she will be found running about as lively as ever.

E. O. O., Vt.—I think you could use the bees in the greenhouse. There will be some loss from their bumping their heads against the glass, and dying. If possible, keep the temperature higher than 50, at least during the day time. If the temperature goes up to 70 or 80, so the bees can fly, and remains there four or five days, or possibly a week, and then goes down to 50 or lower, a great deal of young brood will be destroyed. You can, if you have had experience enough, transfer the bees in a greenhouse; but I would now advise you to defer the matter till next spring—say about fruit-blooming time. I should be pleased to have you give us an account of your experience this winter—particularly so if you are successful in avoiding the loss of bees.

CONVENTION NOTICE.

The Michigan State Bee-keepers' Association will be held at Petoskey, Jan. 1, 2, 1902. This promises to be the largest-attended meeting of the Association in years. You are invited to attend. Reduced rates on all railroads. Tickets can be bought the 30th and 1st, good to return not later than the 1th. There will be no set programme, but another of our open-congress meetings; those who have attended in the past know what that means, and those who don't should come and find out. A novel design for badge has been ordered in honor of Petoskey.

GEO. E. HILTON, Pres.

GLEANINGS proposes to have some articles on wintering. While this question of cellaring bees has been thrashed over and over again, yet I am satisfied there is a good deal to learn along lines that have not been exploited as thoroughly as they might. One is the matter of having a cellar large in proportion to the number of bees confined in it.

I WAS planning to attend the meeting of the Colorado State Bee-keepers' Association; but on account of a great pressure of work I found it impossible to get away. The one I did go to two years ago was certainly a very enthusiastic and profitable meeting. The bee-keepers of the Mountain State can get up about as good a convention as those in any other portion of the country. The last meeting, I understand, was a good one—"the best in the history of the Association."

SINCE I wrote about one of the bee-paradises, the one in Texas (indeed, there are several in that State), I have learned with some degree of pleasure that one of my friends, a hustling young man, is about to start a bee-journal. If writing about bee-paradises results in part in the starting-up of healthy competition, I shall feel that I have done good, even if I do have to work a little harder on our own journal. When I say that I wish all our new rivals success, I mean it. My little trip of six thousand miles has convinced me that this country, with its magnificent distances, is so very large there is no need of our getting jealous of each other. There is plenty of room for all. Come on, boys! we will join hands, i. e., if the "magnificent distances" will permit.

WILL THERE BE LESS ALFALFA HONEY IN THE FUTURE?

A CORRESPONDENT in this issue refers to the fact that the growers of alfalfa hay are beginning to cut earlier than usual; that instead of two cuttings in a season they now get three. The result is that the mower now begins its work just about as soon as the plant begins to bloom. If it should

be found more profitable, in point of hay, to cut early and often, and before full bloom, the ranchmen will, of course, look to their own interests, and not to those of the bee-keepers. There is a bare possibility that the time will come when bee-keeping in the alfalfa regions, where hay is the sole object, will not be as profitable as now. Those who think of going into these new localities would do well to take this into consideration.

THE BEES UNDER THE MACHINE-SHOP.

I HAVE just been down in our bee-cellar under the machine-shop—see p. 868. There was a perfect rumble and roar of machinery overhead. Every now and then some one would drop a heavy casting on the floor, *k'thump*. This produced no disturbance that I could discover. I then turned on the electric lights, and still the bees seemed perfectly quiet. Indeed, I stuck an electric-light globe clear up to the entrance of one hive, and not a bee came out to "see what was up."

We are trying the experiment of opening the cellar-door at night and closing it in the morning, before daylight sets in. As a natural result, the air in the cellar smells sweet and clean; and those magnificent clusters of bees, so quiet, are indeed a pretty sight. Perhaps the fun will come next spring, for there are 250 colonies in a space 8×37; but loose burlap hangs over one end of the inclosure, so the bees really have the air of a cellar 48×96. One thing we have so far demonstrated is that noise, even violent, continual, or intermittent, does not disturb the bees, and this makes it all the better when we enter the cellar, because they have somehow become accustomed to a disturbance.

MOUNTAINS; WHAT ARE THEY GOOD FOR?

THESE great excrescences of rock and earth that tower thousands of feet into the skies, standing, as it would seem, in some cases as impassable barriers to the vanguard of civilization, barren and bleak, wild and dangerous from their rocky precipices, are in reality Godsend to that same civilization. What would the great deserts of the West do without irrigation? and how could there be irrigation unless there were millions of tons of snow and ice stored on top of those lofty peaks? The water from wells in those regions is generally brackish, and unfit for any purpose; but melted snow, right from the very heavens—what could be better for man or beast? A barren plain remote from the mountains will probably always be a desert; but some of the most arid portions of our country, within one or two hundred miles of those "impassable barriers," have been reclaimed, and there are millions of acres more just like those that will be made wonderfully productive as fast as civilization pushes onward.

In some cases I found that a triple use is made of this snow. Standing thousands of

feet up in the air on the plateaus, or in the canyons of the mountains, it melts and runs into a reservoir, natural or artificial. It is then conveyed by an enormous flume down to some power-house that may utilize anywhere from five to ten thousand horse power. This water is made to drive immense turbines, and these in turn furnish whole cities with power and light; and all this comes from the mere force of gravity. After the water has subserved its purpose in making electricity it is then diverted into the city mains to supply the city with water; and what is left—and that constitutes by far the greater portion of it, is used for irrigation.

There is any quantity of melting snow now going to waste that might be similarly used. It only awaits the progress of Young America to dam it up and run it into the valleys. If I ever felt like seconding Horace Greeley's injunction to "go west, young man," I do now since I have seen the great possibilities of the West. "But," you say, "what has all of this to do with bee-keeping? Mountains mean snow; snow means water; water, irrigation; irrigation, alfalfa; alfalfa, honey."

I used to wonder, when I was a small boy, why God, when he made this earth, did not make it perfectly level; and especially was the conviction forced on me when riding a bicycle in later years. But suppose he had made it level—what then? Saying nothing about the mineral wealth, possibly half of this land of ours would be an irreclaimable desert, and the same would be true of other parts of the world. But we of the East, with our rainfalls, often pity those who have to depend on irrigation. Last year, when there was such a drouth in Kansas, Nebraska, and Iowa, the people in California, Colorado, Arizona, and in all irrigated regions, were fairly laughing in their sleeves. Said they, "This great drouth will make honey scarce; we fear no drouth, because we can always have water. We can have moist soils when we want them; we can control the conditions. When there is a heavy drouth in the East, there will be a scant supply of honey in New York and Chicago. But we who have plenty of water on tap, and can make the ground moist or dry, *just as we want it*, we will go in, produce the honey, and *rake in the shekels*;" and they have.

At another time I will have something to say about how those Western people actually *make water run up hill*. No, they do not overcome the law of gravity, but in effect they cause the water to flow over the entire land, on the hills and in the valleys, everywhere, without pumps or engines.

HONEY AND ITS DIFFERENT FLAVORS.

I THINK mention has been made already of the carload of honey from California. Mr. Calvert says the freight alone on it was almost \$1000 (really \$934.00). Well, while they were putting it up for shipment in dif-

ferent directions I found a section that was a little broken, and took it over home; and I want to tell you that, although it is different from any honey in the East, to me the aromatic, minty taste is just exquisite. Mrs. Root said there was too much mint about it to suit her. But one thing I enjoy about honey is the wonderful variety of flavors. It is like going into a peach-orchard where there are a dozen or more different kinds. You may pronounce the peaches from the first tree the finest you ever tasted. But when you taste one from another tree, you may change your mind, and so on till you have sampled the dozen, all different, but each one so wonderfully entrancing to the taste that you get bewildered, and can only say, "May God be praised for having given us this beautiful fruit, with its many exquisite and delicious flavors." Now, I think it is so of honey. Perhaps I should tire of this from California if I should have it right along, but I rather think not. Ernest says it is probably a combination of sweet clover and mountain sage. I have always liked honey from sweet clover—that is, where it is perfectly ripened—ever since I first tasted it in Salt Lake City. It is intensely sweet. Well, now, the sage just gives this a beautiful minty aroma, perhaps a little like wintergreen in choice confectionery. The honey is so thick that you have to spread it on your bread as you spread butter. Now, I like to have samples of these choice honeys from different parts of the world to exhibit to our friends when they call on us—especially the bee-keeping friends. When you are ordering goods from us I think you had better have at least a sample put in of that choice honey from sweet clover and sage.—A. I. R.

A MOST UNFORTUNATE AND GLARING ERROR
THAT HAS BEGUN TO FLOAT OVER THE
COUNTRY, LIKE THE OLD WILEY
CANARD.

ALONG about the middle of last November, Special Food Commissioner Jones, of Illinois, made an inroad on the honey-adulterators, or vendors of adulterated honey, in Chicago. He did some splendid work, and for this he has the heartiest thanks of bee-keepers; but, most unfortunately, he has nullified it to a great extent by sending out a statement to the press to the effect that all fancy white comb honey is bogus, and only that which is travel-stained, or, as he says, has a "brown coloring around the cells," is genuine. The market has already been shaken, not only in Chicago and vicinity, but over the whole country.

This same Commissioner Jones appeared before the National Bee-keepers' Association at its convention in Chicago two years ago. At that time he showed an earnest desire to work in harmony with and for the bee-keepers of the country. He followed up the glucose-mixing business in Chicago so energetically that he practically drove adulterated honey out of the city; but now,

in his zeal to carry out the lines of his official duties, he has gone too far, and has unwittingly, as I believe, classed a large portion of the finest and best honey that the bees can produce as bogus. Here is what he is reported to have said in the Chicago *Tribune* of Nov. 18:

"Genuine honey," he declared, "has brown coloring around the cells. Glucose honey is perfectly white. The purchaser can detect the fraud by this simple rule. Honey, butter, and vinegar are the three articles in the purchase of which citizens are most subject to imposition just at present, and they are causing most of the work for the commission. Syrups may be classed with honey in this respect."

Such a statement is as wide of the truth as it can possibly be; for by this definition of pure honey all "No. 1" and "Fancy" comb honey is bogus; and how an intelligent food commissioner could have made such a fearful mistake I can not understand. If he had only consulted some bee-keeper (and there are a hundred or so in the city) he would not have made such a blunder. It is to be feared that, notwithstanding all the refutation that can be made through the papers, this misstatement will take the wings of the wind, as did the old Wiley canard, disseminating untruth and prejudice in a way that will do untold mischief to honest producers of honey. It is the more prejudicial, because the statement, coming as it does from such a person, will be read by thousands of consumers, and what will they do? They will go without honey.

It is to be hoped that the Commissioner will make haste to correct his error; and if he is the man we take him to be he will do so by calling upon competent bee-keepers who can show him that all white comb honey, which he indirectly calls bogus, is the genuine product of the hive, just as much as the second-grade stuff he calls pure, which he says "has a brown coloring around the cells." The honey he describes is what bee-keepers call, technically, "travel-stained"—that is to say, the bees under some conditions incorporated into the cappings foreign matter to such an extent that the face of the honey is darkened in the manner explained.

Mr. R. A. Burnett, of Chicago, who sent the clipping above, writes:

We inclose you the clipping, which will be self-explanatory. It is our opinion that such publications as this have a tendency to turn people from the use of honey, many of them taking the view that Dr. A. J. Park does, which is indeed a very unhappy one. While Jones's ignorance of the subject upon which he gives a very positive opinion is plain to you and me, it is safe to say that 75 per cent of the people will accept his statement as being the truth, and thus the sale of honey will be largely curtailed.

Chicago, Ill.

R. A. BURNETT.

Mr. Burnett is one of the few strictly honorable commission men of the country. He is one who is in close touch with the honey market, and an ardent friend of bee-keepers. He, like the Root Co., sees evil forebodings. It's too bad.

What shall be done? Bee-keepers everywhere should promptly answer it if it appears in their local dailies.

NOTES OF TRAVEL.

The Arizona Bee Paradise: Shaded Apiaries.

BY E. R. ROOT.

In our last issue I referred to the wonderful fertility of the soil in that bee-keeping paradise—so fertile, indeed, that alfalfa and other honey-plants grow more luxuriantly there than anywhere else in the United States. But of this I shall have more to say at another time. For the present I desire to call attention to the universal method of furnishing artificial shade for whole apiaries. When it is remembered that Arizona is one of the hottest regions in the United States, and that one of its towns, Yuma by name, on the Southern Pacific R. R., has the reputation of being the "hottest place" in the whole country, one can readily see the importance of providing shade for bee-hives. But, like all hot dry climates, that of Arizona is not so insufferable as one might imagine. Notwithstanding the temperature goes up to 110, and sometimes temporarily to 120 in the shade, one does not suffer from the heat nearly as much there as he would in the East with the mercury at 90 or 100 in the shade. Why this difference? It is simply a matter of humidity. A large amount of moisture with a high temperature is killing, as I have before stated. But a high temperature and a low humidity is quite endurable,

as I found it in Arizona, or, as some of the old residents prefer to call it, "God's country." But, moisture or no moisture, unless the hives are shaded combs will surely melt down, and it is absolutely necessary to provide shade. Trees are rather scarce in that irrigated country; and, besides, their shade would not give protection during the *whole* day; so the bee-keepers have found it necessary to construct a substitute in the form of a large trellis, wide enough to shade at least two rows of hives, and long enough to take in 100 colonies, hives spaced about 4 inches apart. But, mark you, these trellises run in the direction of *east* and *west*; so when the sun rises in the morning and passes on its onward journey through the heavens, and down again in the west, it never gets a chance to pour its direct rays on the hives. It can be readily seen that, if the trellis ran north and south, the hives would be shaded only in the middle of the day. While that might do for the East, it will not answer for Arizona.

While I was visiting Mr. J. Webster Johnson and Mr. Wm. Rohrig, both of Tempe, I took three or four views that show how these sheds are constructed. As will be seen, they consist of ordinary skeleton trellises. The uprights in some cases are 2x4's, and in other cases they consist of poles. In some across the tops a bracing of wire is used; in others, light strips of wood. All that seems to be needed is a

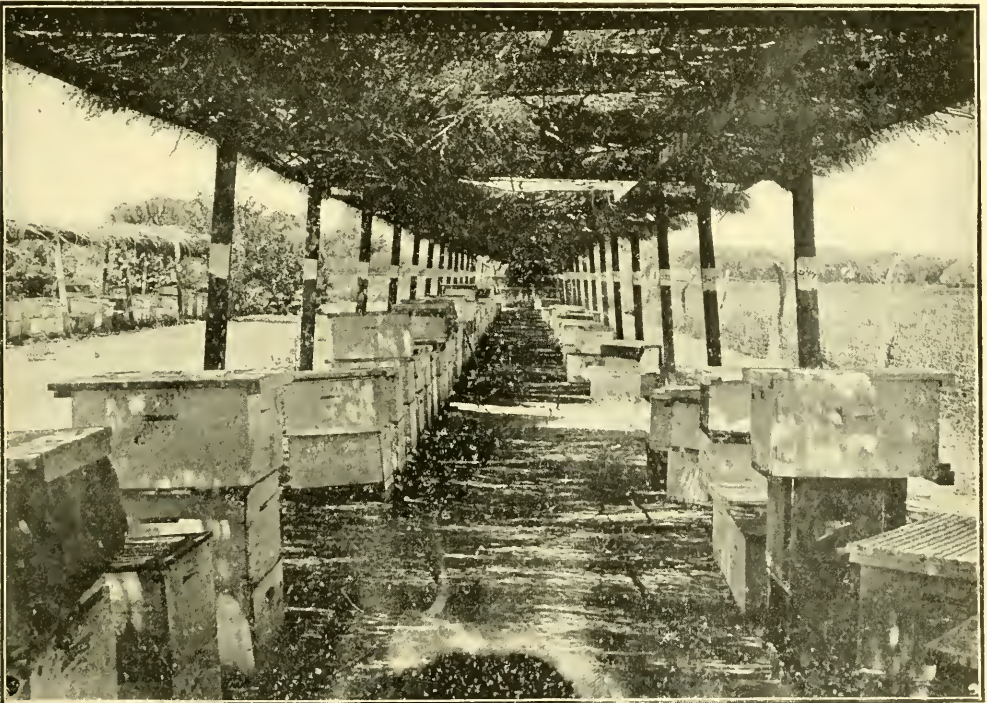

FIG. 1.—J. WEBSTER JOHNSON'S APIARY.



FIG. 2.—J. WEBSTER JOHNSON'S APIARY, SIDE VIEW.

structure strong enough to stand the winds and support a bed of dried weeds, palm leaves—any sort of shrubbery that can be easily obtained. Of course, it dries up under the influence of the sun, but that makes no difference, for all that is needed is something to break or split the rays of old Sol. The loose stuff is piled loosely on top, and then the whole is held down by means of wire. In some of the views will be seen end-braces that are put up to prevent the general collapse of the structure endwise. Then every one of these is further braced across the top by means of strips or wire. No attempt seems to be made to shut out the light entirely by piling up grasses or weeds, as that would be unnecessary. All that is required is simply to break up the sun's rays. Even if the light does streak through, as appears in the picture in patches, it does no harm.

Every apiary that I visited in Arizona was covered with this kind of trellis, with one exception; and this was the case of a bee-man who had his bees under some great cottonwood-trees along an irrigating-ditch. Let us now examine these pictures.

Fig. 1 is a view of a portion of J. Webster Johnson's apiary where I visited. The long rows of hives in such perfect straight lines, under a shade alike comfortable to man and his bees, presents a rather pretty perspective. Indeed, it is really cool and delightful under these sheds, especially in a light breeze; and, as these structures are very

cheap, I wonder that more of them are not in use in other hot, arid climates. The beekeepers of Texas, Central California, and of the whole South would do well to adopt them. In the Arizona sheds one can perform all necessary work with the bees, because the hives face outwardly, leaving a nice clean pathway in the center, unobstructed by the flight of bees. Combs can be taken out and strewn all around without the least danger of the sun doing any mischief; and it is indeed a pretty sight to walk down one of these long avenues and watch the bees piling in from the alfalfa-fields. And that reminds me that the field at the right in Fig. 1 as seen in the picture is alfalfa. All the bees had to do was to go across the fence and help themselves, and then go rolling and tumbling in at the entrances with big loads of honey.

Mr. Johnson, as will be seen by Fig. 1, numbers his posts. One post, for instance, will be marked 344, and the next one 348. Between these numbers there will be four hives about four inches apart, so it is easy to see which hive, for example, would be 345 and which 347. It is not, therefore, necessary to tag the individual hives.

Another fact in this connection is that, all the hives shown under the Johnson sheds are of the Jumbo type; that is to say, they are 10-frame Langstroth hives, but 2 inches deeper. Their owner seems to be satisfied that this big hive is better for him than the regular L. depth; and the consequence is

that all his hives—some 375—are of this big size.

As the Johnson bees were as nicely put up as any I had seen, I show a number of views. The proprietor was absent at the time; and as he knew nothing of my proposed visit, or probably did not, one can see how neat and orderly he keeps things about his apiary; and when I say "apiary" it comprises three different sheds all constructed in the manner I have described.

Figs. 2 and 3 show other views of the same yards and the same bees. It will be noted that the space between the sheds, as well as under them, is entirely free of grasses or weeds. To bring about such a result in the East costs more in labor than it is worth. But in an irrigated country it is perfectly simple and easy—why, just cut off the water, and vegetation of all kinds will die off. It is the rule, then, that no water is allowed to flow near an apiary—result, a patch of ground as clean as a floor.

Fig. 4 is a view of a portion of the apiary of Mr. Wm. Rohrig, of Tempe. His sheds differ from those of Mr. Johnson in that, instead of using strips of wood across the top to support the weeds and grasses, he makes use of wire braided back and forth. He finds that this answers every purpose, and is somewhat cheaper.

Usually near one or the other of these long sheds there will be an extracting-house. Sometimes it stands about midway. This

is particularly the case where there are two or three rows of sheds, and it is desirable to have the extracting-house at a point where it will save steps as much as possible. In Fig. 4, that showing the Rohrig apiary, the building is centrally located, or about half way down the long aisle. The extracting-building of Mr. Johnson was located just back of the camera where I stood when these pictures were taken; that is, at the ends of the sheds.

All through Arizona I found a decided preference for hives made of redwood rather than white pine. I was shown hive after hive, of the same age—that is, made and put up at the same time, one of redwood and one of white pine. The very dry climate would affect the latter very seriously, while the former, in nearly every case, seemed to be sound and good. This California redwood is quite expensive, and costs more than white pine. Still, the bee-keepers of that country, if they can not buy such hives of supply-manufacturers, make their own hives on foot-power buzz-saws and horse-power machines, because they find that redwood hives are cheaper in the end, even if they are not so well made. But redwood will not do for brood-frames, as it is too brittle. As a rule these are made of white pine, and shipped from the East.

Mr. Wm. Rohrig, whose picture I presented in our last issue, the gentleman sitting on one of his hives, is the local supply-dealer for that country. Indeed, he sees ns

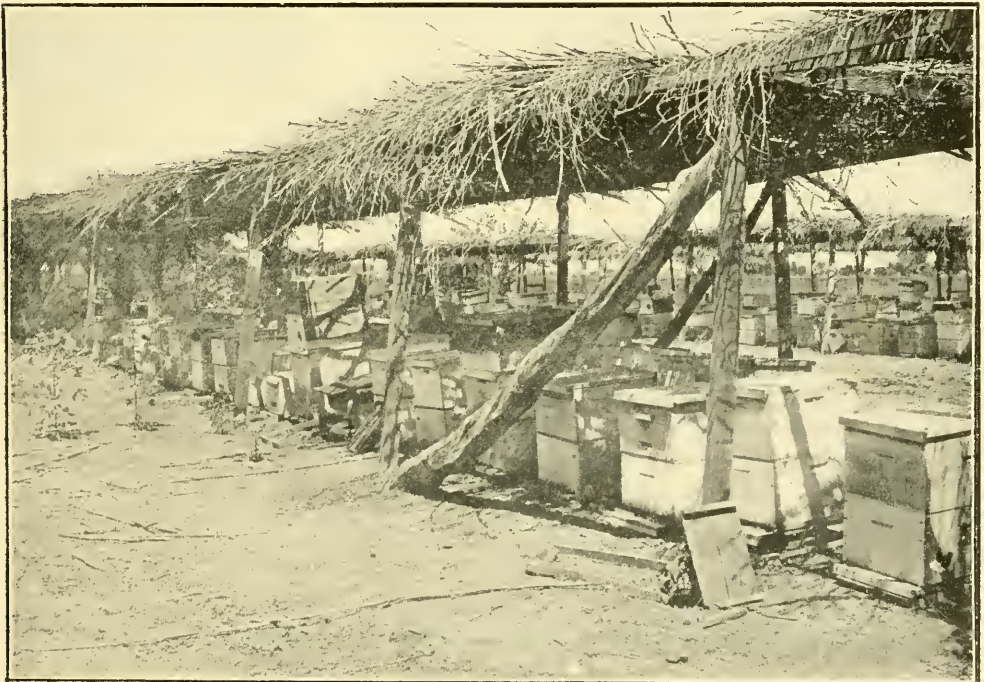

FIG. 3.—J. WEBSTER JOHNSON'S APIARY, SIDE AND END VIEW.



FIG. 4.—WM. ROHRIG'S APIARY, TEMPE.

to be a man who is willing to help his brother bee-keepers, answering all their questions. I found him about as well posted as to the actual condition of things in Arizona as any bee-keeper I met. The fact that he owns about 800 colonies in Arizona, and some 200 or 300 in California, goes to show he is a bee-keeper who not only knows how to handle so many, but also understands the art of making them bring in for him the dollars. He was one of the Arizona bee-keepers who came clear to Buffalo to attend the National Convention.

and placed on a new stand and gave them a queen-cell. It forces them into sections in a hurry. This comes pretty nearly getting all of the advantages of both the deep and shallow frames for comb honey. Two of the shallow cases are just about right for a body for the deep frames. I rather think this plan is going to be the thing for the production of section honey. If no increase is desired in the fall, unite the bees back together and it will make strong hives for winter.

A. N. DRAPER.

Upper Alton, Ill.

[But why not have shallow frames in both the upper and lower story? This would save handling two depths of frames, and at the same time permit of handling hives instead.—Ed.]



A SCHEME FOR FORCING BEES INTO SECTIONS.

I tried a few hives this last season on the following plan, and shall try a lot of them next season. I use two of the shallow bodies for a brood-chamber, with five of the deep brood-frames in the center, and ten of the shallow frames above and below in the same two bodies. When the time arrived to put on sections I placed the ten shallow frames in one of the shallow cases and gave them about all of the bees. I took the five deep combs away from them, and five from another hive I had treated the same way,

HIVE-COVERS.

Rambler has "diskivered" a new fastening for covers. Not meaning any disrespect to Rambler, allow me to ask, "What is wrong with the old Van Deusen hive-clamps? The Van Deusen can be relied upon to hold a cover in fair weather or foul, preventing its warping or sailing away; 5 cents will pay for a pair, which, when attached to the cover, are there to stay. There has been a season's discussion of a non-warping cover, and the verdict is a ventilated cover. I have in use the Madary cover, which has a $\frac{3}{8}$ -inch board over the frames, an air-space of $\frac{1}{2}$ -inch, and a $\frac{1}{2}$ -inch to one inch at center redwood cover on top. This cover holds

its shape in exposed positions. The only fault is in the thinness of the inside cover. I winter my bees on their summer stands, and $\frac{3}{8}$ of an inch of lumber is not enough when the thermometer crawls down to zero and below. I recollect that my father's ice-house, in Pennsylvania, kept cool in summer because the space between the studding was packed with sawdust; and I also recollect that, when living at Leadville, Col., I wanted to give my California wife a warm reception, and so packed the spaces between the sills and studding with sawdust, and the rooms in that house would get so hot we were compelled to put a ventilator in the ceiling; and when the stove got down to business it was sometimes necessary to open an outside door to cool off. Now, why can't the ventilated covers be sold with a small strip to close the sides, and the bee-keeper fill in the space between the two covers with sawdust? This would give us a cover warm in winter and cool in summer. The added cost would not exceed a cent a cover, as sawdust can be had everywhere for the asking, and it would not be necessary to pay freight on it, as the bee-keeper would fill the covers when nailing them up. I should like to see this sawdust cover tested in hot and cold climates in comparison with the ventilated cover, and the results given—two hive-bodies with a thermometer in each, over these a cover of each style, and the record of the thermometer in heat and cold given. Arizona and Minnesota bee-keepers could test it thoroughly. It is the actual test that proves the merit of an invention. Sawdust may be an ideal padding in ice-house and iceland sections, and be found wanting in a hive-cover.

Murphys, Cal. E. H. SCHAEFFLE.

[You will see by the 1902 catalog of the Root Co., soon to be issued, that we have already anticipated the demand for a double cover. This cover is provided with side cleats so that the space between the two boards can be filled with packing-material or left empty according to circumstances and conditions.—ED.]

BEE-STING POISON IN HOMEOPATHIC PRACTICE.

Mr. Root:—One evening while waiting my turn in a barber shop I picked up the Oct. 1st number of GLEANINGS, and came across the article by Mr. S. P. Holmes, in which he reports the cure of rheumatism by bee-stings. I also noted your editorial notes in which you question whether the disease might not have disappeared or have been removed by the outdoor exercise of taking care of bees. Either one may have been true; but it is also the case that we, especially of the homeopathic school, use *Apis mellifica* a great deal, and for some conditions it is the most powerful remedy of which we know. But it must be in a case in which it is well indicated, as, in fact, of all other remedies, that it will do brilliant work. Its most common use is in in-

flammation of the kidneys, accompanied by dropsy, and also the summer trouble known as urticaria, or "hives." It is not at all unreasonable to suppose that Mr. Holmes' case was one well adapted to treatment by the bee-poison—in fact, many cures of rheumatism have been accomplished by it.

H. R. MINER, M. D.,
Secretary of Nebraska State Homeopathic Medical Society.
 Falls City, Neb., Oct. 7.

PROPORTION OF SULPHURIC ACID.

You state in GLEANINGS that sulphuric acid in water will clean dark beeswax, and turn it yellow, but you don't give the proportion. Please tell me the amount to a gallon. I tried it, but it was not satisfactory.

B. HAYNES.
 Grand Isle, Vt., Oct. 30.

[Sometimes a five-per-cent solution will do the work; then as strong as is required. That is to say, one part raw acid to ten parts water; but if the wax is very dirty or black you may require to use as high as 25 per cent. Use acid enough to get the yellow color. It is cheap; and when you have secured the proper color you can make your wax enough more valuable to more than pay the expense of the acid.—ED.]

HOW THE LITTLE UTTER BROTHERS RAN FROM THE CROAKING FROGS.

This story is about two brothers who used to live in York State. Their names, as I remember, were Joe and Bill Utter. They were two little boys. They, at the time this happened, had been fishing. They were told not to stay late, as something might catch them. Well, they disobeyed, and they began to be somewhat superstitious. Strange noises were heard in the woods. Pretty soon they heard the deep bullfrog guttural, "Bill Utter! Bill Utter-r-r-r! That ain't you, Bill." Then it came, "Joe Utter! Joe Utter-r-r-r-r!" The boys dropped their line and ran. At last account Bill was still running.

Oberlin, O. CHALON FOWLS.

[Mr. Fowls does not say whether these two boys were the same as the two brothers in the now celebrated Utter bee and fruit case; but from the fact that "Bill was still running," the fruit-man who was defeated in the recent lawsuit, we are left to infer that he is the same one. ED.]

Will you please tell me how you form nuclei to the best advantage where you keep nuclei over a strong colony separated by screen wire?

CARL F. BUCK.
 Augusta, Kan., Nov. 8.

[We generally use hatching brood. Two frames of such brood, with adhering bees, are set down in one of the compartments. Even if the adhering bees go back, the young brood just hatched will, of course, remain in their new quarters. You will

understand, of course, it does not require so many bees in these nuclei over lower stories, for the simple reason that the warmth from the cluster below rises and gives plenty of heat for the babies above. As an additional precaution, we keep the entrance of this nucleus closed for 24 hours, or until the young bees are hatched out and can defend their home. Of course, there are other ways of forming nuclei, but the hatching-brood plan we consider best. The Somerford method, as described in our A B C book, under "Nucleus," could be used very well—in fact, any other good plan whereby too many bees do not leave for their old home.—ED.]



And the Lord said, It is not good that the man should be alone. I will make a help meet for him.—GEN. 2:18.

Eye hath not seen, nor ear heard, neither have entered into the heart of man, the things which God hath prepared for those that love him. I COR. 2:9.

I wish to talk to-day to married people who have brought up families—especially those where the children are married and gone away, or perhaps have gone away without being married. I wish to talk to the husbands and wives who are living alone together, or perhaps mostly alone, much as they did when they were first married, before God sent any children into their home. It is a subject I have touched on once or twice before; but it is one that has so much to do with the happiness of the homes in the world that I think I may be excused for taking it up again and again. Come to think of it, I do not know but it is a talk that *all* married people need, from the time they are first married until God calls them.

Somehow during my brief life I have had quite a little to do with husbands and wives who could not get along together. I have talked and plead with both, before divorce proceedings were started, and I have talked with both *after* the divorce. I have urged that the teachings and the spirit of Christ Jesus would do away with all this trouble and anxiety, unrest, and misery. In talking with a neighbor I was visiting a few days ago he said there were four families right in his neighborhood where the father and mother separated after the children were grown up and gone. They lived together and got on very well, apparently, while busy with the cares of rearing the family; but after the children were gone, and the father and mother were in shape to take a little rest, or, suppose we say, in shape to take a good long *vacation* with occasional visits to the children—I should say just when they were at the best time in their lives to have a really good time together, they *quarreled*, and finally—were

separated by law. Why, what a sad thing this is! I suggested to this friend of mine that the gospel of the dear Savior would have made such a thing impossible. And then he told me this story. He said he knew the two parties quite well. They were pious in the extreme; had family worship regularly, no matter what was on hand. He gave me the following incident:

One day he went over to these neighbors quite early, on an errand. It was just time for prayers, and he was asked to sit down and wait until worship was over, then they would attend to his wants. The boys were outdoors, but they had to be called in. The father read from the Bible, then he and his wife sang a part of a hymn, and perhaps the children joined in. I can imagine the older girls would, even if the boys didn't. Then all were expected to kneel down, even the stranger who was with them. If I remember correctly, he, even as a boy, did not "take much stock" in such proceedings, and did not kneel down; but he did wait until it was all through before he could get the thing he came for.

You know, friends, I have often exhorted you to hold fast to the old-fashioned style of family worship. I have said that, if discord did not drive away family worship, then family worship would certainly drive away discord. Well, my informant thinks the Bible-reading, the hymns, and the prayers, kept right on; but notwithstanding all these influences, after the children were gone this father and mother began to have disagreements. It grew upon them gradually; and in a couple of years it culminated in the old gentleman giving the poor wife a *pounding*. Why, it fairly makes my blood chill to write it; and this was simply because he *happened* to be the stronger of the two. He took upon himself the responsibility of striking the poor woman whom God had given as a help and companion, as in the language of our text. Some of you may say the less such things are mentioned, the better. They are too sad and shameful even to talk about. Well, God knows, dear friends, I would much rather not talk about them; and I have taken this subject up only because I wish to inquire into the matter, and find out, if I can, the remedy. It is a very strong case—at least so it seems to me—of going through a *form* of worship without making any practical application of it to the affairs of every-day life. It is *profession* without *possession*; and, oh how much there is of it in this world!

In one of David C. Cook's Sunday-school papers a few weeks ago I read a story of a great missionary conference. A wonderful address was made by a missionary right from Africa. The audience was moved to tears, and a great contribution was raised. Well, *during* this stirring address from one of the world's greatest mission workers, two "street Arabs" crept slyly into the building to get out of the storm. One of them was a colored boy who was already well along in consumption. The great

speaker and his companion passed by these two boys while they were talking animatedly about the great work they were going to bring about among the colored people away off across the water. All at once one of the two caught a view of the two ragged urchins, almost out of sight in one of the pews, and he was proceeding to hustle them out in a jiffy, asking them what *business* they had to come into God's holy place in such a plight as that. A young lady, a Sunday-school teacher, happened to be near; and, even if the great doctors of divinity did not notice the awful inconsistency of the thing, this girl did. She protested, and insisted that the great truths that had just been proclaimed from the desk should be put into *practice*, and that, too, *at once*. The colored boy was cared for as long as he lived; the other one, despite the inconsistency of his treatment, had gotten hold of the wonderful truths expressed in the eloquent sermon, and with a little encouragement soon accepted Christ as his Savior. This may be fiction; but, oh dear me! God knows it is not *all* fiction, and I do not know that the story is overdrawn. It has been a hint to me ever since I read it, to look out for the ragged and sin-stained urchins who may lurk about *my* path.

Now, about this husband and wife, or, if you choose, these husbands and wives who have separated, are separating, or who are (*may* be) contemplating separation, just as their eyes rest on these pages. Dear brother and sister, I know something about the matter. I have had some experience, even if I am only 62 years old. When people get to be of my age, some sooner and some later, gradual changes come over them. First the man and his wife, without knowing it, become forgetful and absent-minded. Why, for a year back I have been appalled when proof I could not dispute has been brought me to show I have been doing things I had declared I did not do. I have room for only one illustration here.

A few days ago Mrs. Root and I were on that beautiful woodland path on the way to Sunday-school. All at once she said, "There, I have not got my specs." I volunteered to go and get them, but she tripped off ahead of me, saying she was not sure I could find them. But I had the door-key in my pocket, and so I ran on ahead of her and unlocked the door. She got her glasses and handed them to me, saying she thought she had better have the case. Then she handed the case to me and I put the spectacles inside of it, and supposed I handed them back to her. We locked up the house again, and hurried back so as not to lose time; but when we got to Sunday-school she excused herself for not taking a class by saying she could not find her glasses. When we arrived home, there they were, inside of the case, on the table in the center of the room. We both went back after them to make sure, and then we both left them lying on the table, hurrying back with the happy consciousness of having done our

duty. Of course, we had a big laugh about it; and now every little while we two do things of this kind. I have put something away that we may want in the future; and for fear I may forget where I put it I say, "Now, Sue, will you help me to remember that I put this thing here—do you see?"

"Yes," she replies, "I see, and I think I will remember."

Well, when the thing is wanted we have both forgotten where we put it. Now, friends, do you not see what a chance this gives Satan? If there should not be perfect trust and harmony and love between these two elderly people, they might easily get to blaming one another. I heard a man say, a few days ago, "Now, who took my *Rural New-Yorker*? It just came from the postoffice yesterday, and I laid it right up here" (putting his hand on a shelf pretty well up out of the way), "but somebody has taken it. Where is it?"

The wife and children all went to hunting for the *Rural New-Yorker*. I myself had asked him to let me see it, as I did not get it up in our "cabin," and we both wanted it right away, for we were in a hurry. Finally he said something like this: "Mr. Root, I have threatened to do it before, and now I believe I will do it. I will have me a secretary that I can lock up, and will put the papers in it, and turn the key and *put it in my pocket*, and the rest can have them after I get through with them."

I suppose that, if his good wife had told him then and there that she found the paper in another place, exactly where he laid it, he might have declared, even before company, that he did *not* lay it down there, but on the high shelf. His wife, however, is one of those discreet, gentle, lovable women. She had more wisdom than some women who refuse to be abused for things that are the fault of the abuser. She handed him the paper, but said nothing; but she afterward told Mrs. Root she found it right where she was quite sure he himself left it. Now, I have known a trifling thing like this to stir up wicked feelings in the heart of perhaps more than one member of the family. By the way, I wonder what our good friend Collingwood, of the *Rural New-Yorker*, will say when I inform him that, when his paper comes from the postoffice, everybody at this home wants it at once, and this, too, in a family where there is a great number of papers and periodicals of all kinds. And let me say here to my good friend (he is a bee-keeper, so he will excuse me) that, instead of feeling cross, and making threats about locks and keys, he should thank God from the bottom of his heart for two things especially. One is that he has a good-sized family of children, who, wife included, want to read and *do* read such a good Christian paper as the *Rural New-Yorker*; and, secondly, he should thank God from the bottom of his heart that he has been so prospered as a farmer that he can subscribe regularly for such a multitude of papers that it is some-

times a hard matter to find any particular one on short notice. And this illustrates how we often get cross, and grumble about the very things we ought to be devoutly thankful for.

I have thought many times of late that God has spoiled us by giving us too much. He has been too kind, and we are getting to be ungrateful; and this certainly is true in a majority of cases with husbands and wives who quarrel after the family has grown up. One of the reasons why trouble comes between the man and his wife is, as I have suggested, that they are becoming forgetful, and do not realize it. Another is, that their health begins to fail, perhaps in many ways. They do not *hear* what is said as distinctly as they used to do. They do not *see* as well. The glasses get lost. As we get older there is more apt to be indigestion unless we are careful. We do not take as much outdoor exercise as we used to do, and we suffer in consequence. When there are no children (or other people) around we are not as careful to be courteous and kind as we used to be. Satan puts it into our heads to think it is a fine thing to speak out plainly. Both of us become more careless than we used to be because things are not crowding, perhaps. Little by little an irritable spirit gets into one or both of our hearts. Family worship may be gone through with as a form, but the spirit may be lacking. In other words, the Spirit may be *grieved* away, as we are warned in Ephesians.

Some months ago I told you of an experience I had that frightened me. I dreaded to speak of it then, but I felt that it might prove a warning to others as it had been and still is a warning to me. Something that belonged particularly to myself was out of place. I did not mean to be unpleasant or unkind, but I fear I must have been so, thoughtlessly. At any rate I spoke in a complaining tone. I was informed that nobody had touched it but myself. Whatever the condition of things, it was certainly my own doings. I attempted to explain that it was not my own doings, and could not have been. By this time I certainly was out of temper; a bad spirit had entered my heart. Now, dear brothers and sisters, let me assure you that you do not know how *contagious* a bad spirit or a bad temper is. The reply I received was something different from any thing I had ever heard from the person who uttered it. It raised a tempest in my heart—such a tempest as I never dreamed, especially of late years, was possible. That little warning began to ring out sharp and clear, "Lord, help." But for some reason or other the Lord did not help. I prayed earnestly, but Satan had gotten a foothold. He kept declaring that I was wronged without reason, and that it was not my duty to bear it. I knew it was Satan. God knows I have, through my poor life, felt his clutches *often* enough so I ought to know him. I prayed most earnestly. I tried to read my papers; but my eyes

went away out into vacancy beyond the papers, and pictured the wrong I had suffered in different forms. Words came thronging in troops—hard bitter words. I arose and went out into the darkness of the night, but they followed me still. I could only groan and pray. I did not understand it then, and I do not understand it now. The whole thing was preposterous. All of it grew out of a little unimportant matter. Suppose I *was* wrongfully accused; suppose I *was* right, and somebody else wrong—what did it matter, any way? See what Peter says:

What glory is it, if, when ye are buffeted for your faults, ye shall take it patiently? but if when ye do well, and suffer for it, ye take it patiently, this is acceptable with God.—1. PETER 2:20.

I knew all these things, and I knew I had taught all my life the beauty of suffering for Christ's sake—of returning good for evil, and all that; but I was caught in Satan's toils, and I could not get out. Thank God, I did have sense enough to keep still and not say a word. This mental conflict, this mental *wrestling*, if you choose, with the prince of darkness, kept his hold on me for hours; and all next day I felt like one who had been through a fit of sickness, or had labored beyond his strength. It was not my *muscles* that were sore, however—it was my spirituality. Since that time I look with horror at the thought of the demon that lurks out of sight, almost unknown, in my own heart. The Bible says, "The heart is deceitful above all things, and desperately wicked: who can know it?" I know, if others do not, that this is true. The memory of this thing I am telling about has made me afraid.

I presume people are unhappy *after* they have separated. I know by what some have confessed to me how much mental suffering they endure while considering the matter of divorce. I am pretty sure that language can not express the misery and suffering that would be mine if any thing serious were to happen between myself and the companion God has given me. After this thing I have spoken of, I resolved over and over again that I would avoid even the *appearance* of evil along this line. I decided to set the example of avoiding any sort of dispute or disagreement between us two when we were alone. I resolved to keep back *all* fretful or impatient speeches, and declared to myself and before my Savior that I would be gentle and kind and courteous to "the woman I love" as I would be to any other woman whom I might meet on the street, for instance, or to the bee-keepers' wives or grown-up daughters where I may be visiting. Some people may smile at the idea of being as pleasant and courteous and obliging to *your own wife* as to other women; but, my good friend, if you are, *every moment of your life*, as gallant and civil to your wife as to any other woman, you are a model husband.*

*It sometimes transpires that something *must* be said to your wife that you know pretty well will produce unpleasant feelings. I have had several experiences of this kind, some of them quite recently. Be-

After having had a hand-to-hand tussle with Satan, we often have some of our happiest and most pleasant surprises—that is, if we come out victorious. After Satan did his best to tempt the Lamb of God, and failed, we are told that angels ministered to that well-beloved Son, and I am sure it is so in our own experience.

You know I wanted Mrs. Root to go with me on a vacation, and live in that cabin in the woods. The idea seemed to her—yes, and to lots of other people—in some respects preposterous. Just think of it—leaving a good nice home with all modern comforts and conveniences, and going away off in the woods, four hundred or five hundred miles away from home where there was not *any thing!* I told you in one of these talks that I “captured” her forty years ago, and I was going to capture her this time, and take her up to my cage in the woods. When she finally consented, and was safely landed there, I set myself to work to make her happy. I succeeded. Even she herself admitted that my project was a success, and we are talking about it now, every day, of another trip there in the spring.

Dear brothers and sisters, I have asked you to undertake some difficult things, perhaps. You may say it is not worth while to take such pains to try to be kind and civil, and to be careful of every word and act. I am now going to try to tell you of the rewards we get for this kind of service. Several times I have decided it was not in my power to tell you of the real happiness and joy that has filled my heart for the past two months. Perhaps I can succeed in one way. When I first became acquainted with Mrs. Root it seemed to me this whole wide world had no joy for me that would equal having her for a daily companion. Yes, I remember well the day after our marriage when we rode together quite a number of miles to a railroad station. As she sat by my side it gave me a great thrill of happiness. My heart fairly bounded at the thought of being with her and laboring for her all the rest of my life. It was our honeymoon. I looked forward to much happiness and to great happiness. You know my enthusiastic disposition. Well, dear friends, what I wish to say is this: My expectations and anticipations on that day have been *more* than realized. But the best part of our honeymoon came after we had been married more than *forty years*. Years ago, when a young man seemed to care so

before you do any thing or say any thing, pray earnestly for grace from on high; pray for the Holy Spirit in such quantity (if that is the way to express it) that Satan can not possibly get any hold on you; then go to your wife alone, put your arm about her to assure her of your love and kindly feeling. Present the matter carefully, and, above all, *lovingly*. So far as you are personally concerned, consent to bear any burden for her sake, God helping you, and he always will help you, and you will come out triumphant. God planned in the beginning of the world that you *two* should be *one*; and through Christ Jesus, his only Son, you *may* be *one*; and this world may be to you both a world of joy and happiness instead of being a “wilderness of woe,” as it is with some husbands and wives because they *persist* in letting Satan manage.

very much for some good girl, I have heard people say, “Why, he loves the very ground she treads on.” Well, if this was ever really true in my experience, it was when we were up there in the woods together. Now, this is exactly what God intended. It was what he planned in the beginning. Our text tells about it in Genesis, and the same thing is repeated over and over again on almost every page of that dear old Bible; and when we read that wonderful concluding text from Corinthians, “Eye hath not seen, nor ear heard, neither have entered into the heart of man, the things that God hath prepared for them that love him,” I believe this promise is largely fulfilled in the relations that God intended should exist between husband and wife. I am convinced that oftentimes surroundings hinder this loving trust and confidence. We two were off together away from the care and worry of business and other things here at home. We were so situated that I could take part in all the household cares in a way I had never done before—not even when we were first married; yes, and she could take part in all *my* work. She used to go out in the woods a part of every day, and enter into full sympathy with me and my work just as I did in the house with her and her work. Our regard for each other is of a different kind now from what it was in the days of courtship. It is a quieter, steadier, purer, and a more holy and sacred regard—certainly more unselfish.

Now, please, dear brother, do not understand that I am thinking Mrs. Root has any unusual merit more than your wife would have under like circumstances. If she is not willing to go with you as Mrs. Root consented to go with me, it is most likely your own fault. You can win her if you choose and if you will, not only to the home of your choice, but it is your privilege to win her, if she is not already there, to Christ Jesus; and it is the privilege of both of you to enter together *here in this life* into the happiness and joy described in the second of our texts.



CREATING IN DOMESTIC ANIMALS AN APPE-
TITE FOR FOODS THEY ARE NOT ACCUS-
TOMED TO USE.

Last summer we planted some of Mills' Prizewinner beans in my garden in the woods in Northern Michigan. You will remember the Prizewinner bean is the one that enabled me here in Ohio to grow two crops of dry beans on the same ground, with the same seed, in one season. Well, these beans made a prodigious growth in the rich woods dirt. In fact, when I was there, just before they were getting ready

to blossom. I thought they would be all vines and no beans; but later on, Mr. Hilbert wrote me there was an astonishing yield of beans on those same vines. The stalks were something like two feet high and two feet broad, and just yellow with bean-pods. I told friend Hilbert that, as he took such a fancy to them, he might save the seed and plant it another year. He took the beans home and put them on the barn floor till he could get time to thrash them out. Pretty soon the chickens got to breaking the pods open and eating the beans. He was astonished at this, for he says he never before saw a dry bean that a chicken would eat. As he regarded the seed as valuable, he covered the beans up, as he supposed, so the chickens could not get at them. But they seemed determined to have them. In fact, he had to fight, almost, to keep the chickens away. Now, he decided that this unusual occurrence was because the beans were of a different variety, and something the chickens liked; and, by the way, they cook quicker than any other bean I ever saw—in fact, they are cooked all to pieces before you know it, and I do think they are the best table beans—that is, in the shape of a dry bean—I ever got hold of. I will not except even lima beans.

Well, it may be the chickens discovered that this bean was different from other white beans. My impression is, however, that they simply acquired an appetite for them under the circumstances. Probably they were confined to the barn some rainy day, and wanted something to do. Chickens are curious, especially young ones. They broke open the pods, swallowed a few beans, found they digested all right, and one after another learned the trick. By the way, I wish Bro. Hilbert would try those same chickens with the common Navy white bean, and see if they will not eat them since they have learned how.

You may suggest that beans at the present price are rather expensive feed for fowls. My dear friend, cull beans can be bought in great quantity at a very low price where beans are grown largely. After the chickens have learned to eat good beans they will eat the culls, without a doubt. Then here is another thing: Hundreds of bushels of beans—may be thousands—are thrown away, or put among the culls, just because they have a little stain on the outside. This stain does not hurt them a particle—it only makes them look bad. We have for years cooked our cull beans for poultry.* I have told you with what avidity they eat them, especially in winter, when they do not have a great variety of food, and how it starts

* Since the above was put in type I have had some old red kidney beans cooked for my new strain of young poultry—the progeny of that fighting rooster. They had not yet learned to eat beans, and wouldn't. I took away their other feed, and tried starving them to it, but they would not eat them, even then. Finally I mashed the beans up and stirred in them some chop feed, so as to make it look like their daily mash, and it was all gone in a twinkling. I was obliged to go to all this pains in order to convince them that beans are good to eat, and *now* they eat them with avidity.

them to laying. Well, one day when we cooked up some beans for the chickens (they were sorted beans that had already been sorted once) they looked so good I decided to taste them. They were just exactly as good to eat as beans that are all white. People who are suffering from the want of a good wholesome food might use these cull beans.

A few days ago one of my neighbors in the Traverse region, who raised quite a few beans was throwing the bean straw out on the manure-heap. These beans had got caught by the frost, and a good many of them did not thrash out. I suggested the straw was valuable for cattle, if kept under shelter until cold winter weather gave them an appetite, and also that the unripened beans could be easily thrashed out for the poultry. They keep a large lot of poultry, and all kinds of grain are expensive away up north. Now, their chickens had not learned to eat beans, and the owner of the beans had not learned to cook them for the chickens nor for the pigs (they keep pigs also); and although they grew beans by the acre, they had been in the habit of wasting bean-stalks and the cull beans.

Now, this matter touches on another one—the of the cows and horses not eating sweet clover. The successful farmer should see to it that his chickens, pigs, cows, and horses are *educated* to eat things that might otherwise be thrown away. Here is an article I just took from the *Rural New-Yorker*, that touches on this matter; and it contains so much other valuable information that I give it entire. The truck farmer, and farmers in general, keep, as a rule, more or less poultry. They can not afford to lose the valuable stuff poultry will consume. Here is the article:

CLOVER AND COW-PEA BENEFITS.

Reference has been made in these notes to the usefulness of crimson clover and cow peas as hen forage. We are able to report an increasing partiality for these nitrogenous foods among the two flocks of chickens kept on the Rural grounds and correspondingly good results in the way of egg production. Hens readily take to clover in any variety, but they are often shy of beans, seldom eating them uncooked. An appetite for raw peas or beans may be considered an acquired taste coming on gradually. Our hens ignored the cow-pea seeds the first season they were grown here, and developed the taste only late in the winter when scratching the pods open by chance in a sheltered part of the field. The example of contented old biddies coming in with comfortably extended craws and an urgent thirst for water to complete the swelling process proved contagious, and they all now hurry to the field at once on being released from the yard. There can be no doubt as to the beneficial effect of the exercise needed to get the pods open, nor of the high food value of the beans themselves. The Rural grounds lie in a strip about 800 feet long by 200 wide. There are poultry houses near each end, and the flocks have but little chance to mingle, as they are necessarily kept yarded most of the time; yet the cow-pea habit, which we heartily approve, seems to have been communicated. The second flock has no access to the field, but acquired the taste from scratching the gathered pods shelled for seed. An increase in egg yield was noted in both cases as quickly following the ripening of the Early Black cow peas, which is the variety best suited for us. Cow-pea seeds, when ready for market, are too costly for poultry food, but we are convinced that a patch of these bustling land-improvers handy to the chicken-yard is a good investment where practicable. Crimson clover has become a necessity, sown in August between bush fruits and after early

crops to improve our soil and diminish washing by winter rains, and incidentally as forage for the fowls, who keep the more accessible strips sheared as closely as with a lawn-mower. The season has been favorable, and the plants on early-sown strips are now seven to eight inches high; but we find such leafy plants do not, as a rule, winter as well as those closely picked by the fowls. Chickens are fond of green food, but eat very few weeds with relish. If not provided with clover in this manner they are very troublesome on the lawn, when at liberty. These clover strips entice them away, and thus fit in all along the line.

The above touches on another thing that has been on my mind a good deal. It costs so much to hire labor nowadays (more in Michigan than down here in Ohio) that we must study to grow crops that can be produced with little labor. I have told you about our winter onions. They have never had any attention whatever except to gather the crop of sets. Well, in the Traverse region they grow beautiful grapes on the hillsides, without any cultivation whatever. The owners say they do better to let them trail on the ground; and they ripen quicker because of the heat of the sun on those sandy hills.

Well, there is quite a list of things that may be grown for poultry, and the poultry be allowed to gather the crop and do their own feeding; and I doubt if any system of feeding will give as good results as letting the fowls go out in the fields and gather their own food, helping themselves to the sweet corn as it stands in the fields, shelling out the cow peas, and helping themselves to grains of different kinds sown in waste places expressly for the poultry. They will lay more eggs and raise more chickens, and I do not know but I may say *better* ones, where they are *educated* to do this kind of foraging. I have seen a great brood of chickens hatched out in a buckwheat-field, and they grew to maturity without ever being fed or cared for in any shape or manner. The mother hen happened to hatch her chickens just as the buckwheat was far enough along so the chicks could eat it.

Now, friends, do not let any stuff be thrown away or go to waste until you have faithfully tried getting some of your domestic animals to *learn how* to eat it.

CONVENTION NOTICE.

There will be a bee-keepers' convention (annual) held in Canadaigua, N. Y., by the Ontario Co. B. K. A., on Dec. 12 and 13. FRIEDEMANN GREINER, Naples, N. Y., Nov. 15. Secretary.

Minnesota Bee-keepers' Supply Mfg. Co., Manufacturers of Bee-hives, Sections, Shipping-cases, and Everything Used by Bee-keepers.

Orders filled promptly. We have the best shipping facilities in the world. You will save money by sending for our price list. Address

Minnesota Bee-keepers' Supply Mfg. Co.,
Nicollet Island Power Building, Minneapolis, Minn.

Queens! Untested, \$1.00; tested, \$1.25 and upward. See former ads. and circular.
J. B. Case, Port Orange, Florida.

Wants and Exchange.

WANTED.—To sell my entire bee business, consisting of a 10-acre ranch three miles west of Phoenix, all in alfalfa, with water, for \$1300; a 20-acre ranch with water, 8 miles from Phoenix, for \$1000; bee sheds and fixtures on a rented 5-acre lot, wagons, two extractor tanks, 500 colonies of bees at \$5.00 per colony, in two-story hives. Reason for selling, I wish to retire, because I am tired of doing my own cooking, and have enough to live on anyway.

JOHN NIPPERT, Box 1051, Phoenix, Arizona.

WANTED.—To exchange Dadant uncapping-cans, Root's No. 5 extractor, and other supplies, for honey or wax. O. H. HATT, Shenandoah, Iowa.

WANTED.—To sell cheap, 20 acres of good Florida land, well situated, at a low price. Address for particulars, MRS. I. B. WEIR, Toledo, Florida.

WANTED.—A good farm hand, with temperate habits, by the year, who wishes to learn the bee-business. I keep 500 colonies

W. J. STAHMANN, Bruce, Wis.

WANTED.—To buy 300 colonies bees in Mississippi, Louisiana, Arkansas, or Texas. Write M. STEVENSON, Dardenne, Missouri.

WANTED.—To sell a custom saw and feed mill and 27 swarms of bees with supplies, all in first-class condition. F. I. RIGGS, Box 48, Buckton, N. Y.

WANTED.—To exchange Barred Plymouth Rocks—single birds, trios, and breeding pens—and eggs in season, for Root's 8-frame hives, extractor, or offers. My birds are a combination of best strains in America. Chamberlin Hill Poultry Farm, Jordan, N. Y.

WANTED.—To sell or exchange three saw-benches with saws (\$15 each), one ditto (\$20), machines for boring, matching, sanding, dovetailing, and press-cutting (\$5 to \$15 each), leather belting, sh. fling, pulleys, etc., at half price; all in good running order; will take honey or offers; will take 10 per cent less for cash. Write. C. W. COSTELLOW, Sanford, Maine.

WANTED.—To exchange a No. 15 two-frame Cowan honey-extractor for a No. 5 Novice extractor. ADOLPH SEGERLIN, Anita, Pa.

WANTED.—A queen-breeder with experience. Correspondence solicited. Reference s required and given. Address G. F. DAVIDSON, Fairview, Texas.

WANTED.—To sell 600 colonies of bees in 8 and 10 frame Dov'd and Danzenbaker hives at \$2.00 and \$2.25 each. W. N. CANNON, Greenville, Ala.

WANTED.—To sell our entire plant and situation, including a complete line of machinery for manufacturing bee hives, comb-foundation, etc. In connection with same we have a first-class up-to-date planing-mill in every respect. Our good will and list of customers go with it. This is a bargain, and will pay you to investigate. Address

W. R. GRAHAM & SON, Greenville, Texas.

WANTED.—To buy a home somewhere in a good bee locality, and in a mild climate, and where there is a good chance for good schools. DANIEL DANIELSEN, Clarkson, S. D.

WANTED.—A situation as assistant apiarist, or charge of small apiary and fruit or poultry farm, in the southern or western States. Good reference can be given. CHAS. G. GIBBS, Brunswick, O.

FOR SALE.—Fine ripe extracted touch-me-not honey, in 60-lb. square tin cans, 2 cans to a case, delivered at R. R. station at 7½c. Sample postpaid, 8c. C. A. BUNCH, La Paz, Marshall Co., Ind.

FOR SALE.—1000 lbs. light amber extracted honey at 5c per lb. W. C. GATHRIGHT, Las Cruces, N. M.

WANTED.—Comb and extracted honey. State price, kind, and quantity. R. A. BURNETT & Co., 199 South Water St., Chicago, Ill.

WANTED.—Comb honey and beeswax. State price delivered at Cincinnati. C. H. W. WEBER, 2146-2148 Central Ave., Cincinnati, O.

Notice!

QUIRIN, the queen-breeder, still has 100 of those long-tongued red-clover queens on hand at \$1 each, or 6 for \$5. If you want one speak quick. For testimonials see former adv'ts.

Bees Wanted!

We are expecting to establish several out-apiaries next season and desire all the bees we can get; want 'em on movable frames, and near home. They must be cheap at this time of year. Parties placing us in correspondence with those having bees to sell will be remembered next season when we have a nice lot of those long-tongued red-clover queens on hand (in case we succeed in purchasing of said parties).

In our circular we list numerous articles used by bee-keepers, on which we will give 10 to 20 per cent discount from now until the coming March. Address all orders and inquiries to

H. G. Quirin, Parkertown, Ohio.

BERMUDA

With cable communication and equable winter temperature of 70 degrees, is reached in 48 hours from New York by the elegant steamers of the Quebec Steamship Company, sailing every ten days up to January, and then every five days. The situation of these islands—south of the Gulf Stream—renders

FROST UNKNOWN,

and the porous coral formation prevents malaria. The Quebec Steamship Company also despatches highest class passenger steamers every ten days for ST. THOMAS, SANTA CRUZ, ST. KITTS, ANTIGUA, GUADALOUPE, DOMINICA, MARTINIQUE, ST. LUCIA, BARBADOS, DEMERARA, and the principal WEST INDIA ISLANDS, affording a charming tropical trip at a cost of about \$4 a day. For descriptive pamphlets, dates of sailing and passages, apply to

A. E. OUTERBRIDGE & CO., Agents.

39 Broadway, New York.

ARTHUR AHERN, Sec., Quebec, Canada.



YOU CAN AFFORD

to use PAGE 1 ENCE. It costs US more, but not YOU. Why not try a piece and be convinced?

Page Woven Wire Fence Co., Box S. Adrian, Michigan.

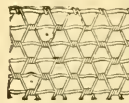

FENCE! STRONGEST MADE.

Bull-tight, Chicken-tight. Sold to the Farmer at Wholesale Prices. Fully Warranted. Catalog Free. COLLETS SPRING FENCE CO., Box 101 Winchester, Indiana, U. S. & C.

White Wyandottes!

Bred from Dustin's best. Some fine cockerels on hand already to ship.

J. F. MOORE, : TIFFIN, OHIO.

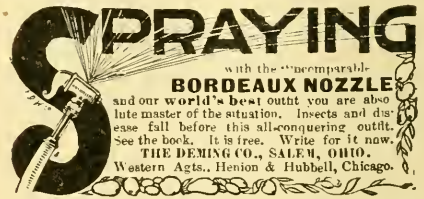

with the incomparable BORDEAUX NOZZLE

and our world's best outfit you are also lute master of the situation. Insects and disease fall before this all-conquering outfit. See the book. It is free. Write for it now. THE DEMING CO., SALEM, OHIO. Western Agts., Henion & Hubbell, Chicago.

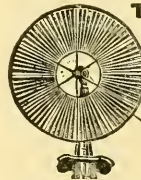

The Storm Proof KING WIND MILL

produces 25 to 50% more net power from any kind of wind than any other mill on sale. Wheel being only 1 in. thick, beats the wind like a knife and is 400% more storm proof than any other. Exceedingly light, but wonderfully strong. Very sensitive—runs in lightest winds. Numerous sizes—6 ft up, both pumping and power, back geared or direct stroke. Send for circulars and prices before you buy. Medina Mfg. Co., Box 11 Medina, O.



\$2 for 10c.

Our large Illustrated Drug Book contains 15000 listed drugs, medicines, family remedies, trusses, instruments, veterinary preparations, paints, oils, flavoring extracts, etc. We save you 15 to 75% on any of them. The book costs us \$2. We mail it to you for ten cents and refund the amount on your first order. Kessler Chemical Co., Dept. 49 Chicago.

Union Combination Saw

For Ripping, Cross-cutting, Rabbling, Mitering, Grooving, Gaining, Boring, Scroll-sawing, Edge-moulding, Beading Full line FOOT and HAND POWER machinery. Send for catalog A. SENECA FALLS MFG. CO., 44 Water St., Seneca F., N.Y.

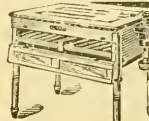
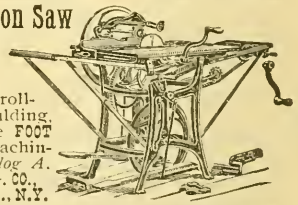

200-Egg Incubator for \$12.80

Perfect in construction and action. Hatches every fertile egg. Write for catalogue to-day. GEO. H. STAHL, Quincy, Ill.



THE GYPHERS INCUBATOR

IS THE STANDARD HATCHER OF THE WORLD.

Used with uniform success on twenty-six Government Experiment Stations in the U. S., Canada, Australia and New Zealand, also by America's leading poultrymen and many thousands of persons in every walk of life. Guaranteed to give satisfaction or price refunded. The original and only genuine non-moisture incubator, fully covered by patent. Winner of

GOLD MEDAL AND HIGHEST AWARD AT THE PAN-AMERICAN,

Oct., 1901. Illustrated, descriptive, 32-page circular FREE. Complete Catalogue and Poultryman's Guide, 224 pages, 8x11 inches, weighing one and a quarter pounds, 10c in stamps for postage. Ask for Book No. 74, and address our nearest office.

Gypthers Incubator Co., Buffalo, N. Y., Chicago, Ill., Boston, Mass., New York, N. Y.

IT TAKES FIVE CATALOGUES

printed in five different languages to tell the people of the many points of superiority of our **SUCCESSFUL Incubators & Brooders.**

One 200 egg machine will hatch more chicks than 20 steady old hens each time it is filled with eggs. They will be stronger, more healthy chicks, too. These machines will do for you just what they have done for thousands of others. Write for 158 page Catalog enclosing 6c to pay postage. We ship machines and handle correspondence for the East from our new house in Buffalo. Write nearest office.

DES MOINES INCUBATOR COMPANY,

Box 503. Des Moines, Iowa, or Box 503, Buffalo, N. Y.

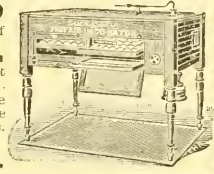

STERN OLD MOTHER EXPERIENCE

has enabled us after 16 years to make perfect **The Reliable Incubators and Brooders.** You ought to have our **20th Century Poultry Book** in the house. It will cost you but 10 cents and will make you a master in the poultry business. Reliable Incubator & Brooder Co., Box 8-49 Quincy, Ills.

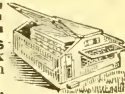

How Your Hens Would Lay!

If you fed cut raw bone. Doubles your profit; more fertile eggs for hatching, more vigorous chicks.

MANN'S BONE CUTTER 1902 MODEL

New design, open hopper, enlarged table, new device to control feed. You can set it to suit any strength. Never clogs. Sent on

Ten Days' Free Trial. No money asked for until you prove our guarantee on your own premises, that our new model will cut any kind of bone with adhering meat and gristle, faster and easier and in better shape than any other type of bone cutter. If you don't like it, send it back at our expense. Free Cat'g explains all.

F. W. MANN CO., BOX 37, MILFORD, MASS.

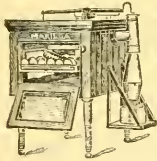
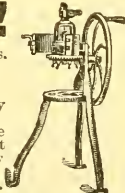

A LITTLE BEAUTY is what they call the 55 egg.

MARILLA INCUBATOR.

"Pretty is as pretty do's" applies here, too. It is not a toy—made just like our large machines. Guaranteed to please you. "Satisfaction or no sale" our motto. Marilla Brooders the best made. It hatched like

a house. Crowding impossible. Complete catalogue for 4 cents. MARILLA INCUBATOR COMPANY, BOX 62, ROSE HILL, N. Y.



The Sure Hatch

is the incubator for the poultry raiser, whether farmer or fancier. Anyone can run them, because they run themselves. Anyone can own them, because the price is right. Machine and results guaranteed; you take no risk. Our Common Sense Brooder is the best at any price, and we sell it very low.

Handsome catalogue containing hundreds of views and full of honest poultry information, mailed free. When writing address nearest office. Sure Hatch Incubator Co., Clay Center, Neb., or Columbus, O.



JUST AS NATURAL as the bird and a good deal more reliable. Doesn't break its eggs or make its chicks lousy.

Doesn't stay off the nest and allow the eggs to chill but hatches every egg that can be hatched.

THE PETALUMA INCUBATOR

is absolutely perfect as to incubator essentials—proper application and distribution of heat and moisture, regulation and ventilation. For 54 to 824 eggs. WE PAY FREIGHT ANYWHERE in the U. S. Handsome catalog free. Petaluma Incubator Co., Box 125 Petaluma, Cal.

Bushels of Eggs

if you get a fast cutting Dandy Bone Cutter. Price \$9 up. Sold direct on 30 days trial. Handsome catalogue free. STRATTON MFG. CO., BOX 54, ERIE, PA.

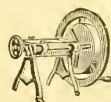

ALWAYS READY.

The ADAM Green Bone CUTTER

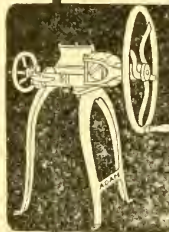

is always clean and ready for work. Impossible to choke it up. Cleans itself. **The Only Bone Cutter with all ball bearings.**

Works quickly and easily. No choking or injuring of fowls by shivers or sharp pieces. Cuts a clean light shave that is easily digested by smallest chicks. Send for Catalog No. 39. Contains much valuable information on the cut

bone question. You will be pleased with it. Sent free upon request.

W. J. ADAM, JOLIET, ILLS.

The Egg Question Solved

by the HUMPHREY Green Bone CUTTER

Guaranteed to cut more bone, easier and quicker than any other of your money back. Only open hopper machine. Catalog and Egg Record free.

HUMPHREY & SONS, Box 31, Joliet, Ills.

EASTERN AGENTS, JOSEPH BRECK & SONS, Boston.

JOHNSON & STORES, Philadelphia.

GRIFFITH & TURNER CO., Baltimore.

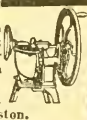

A MILLION TESTIMONIALS DON'T CONVINCE 30 DAYS TRIAL WILL

Our 50 egg compartment hatchers have advantages over all other incubators. Pantams at \$5, \$9.50 and \$15 for 50, 100 and 200 egg sizes. Hatch every good egg. Send 2 cents for No. 64 catalogue.

BUCKEYE INCUBATOR CO., Springfield, Ohio.

GRAND - CLUBBING - OFFERS.

Magazines and Post Fountain Pen
to the amount of \$9.00 for \$5.00.

Gleanings in Bee Culture.....	\$1 00
Review of Reviews (new).....	2 50
Success.....	1 00
Cosmopolitan.....	1 00
Good Housekeeping.....	1 00
Post Fountain Pen.....	2 50
	9 00
All sent to one or separate addresses, one year.....	5 00

One-dollar Magazines:

- Cosmopolitan Magazine,
- Frank Leslie's Popular Monthly,
- The Householder,
- Good Housekeeping,
- The Designer.

READ EVERYTHING ON THIS PAGE. * Here are a few Special Combinations.

SPECIAL COMBINATIONS.

Regular Price. Our Price

Gleanings and Success.....	\$2 00	\$1 25
Gleanings, Success, and any one of our dollar magazines (see list above).....	3 00	1 75
" " and any two of our dollar magazines.....	4 00	2 25
" " and any three of our dollar magazines.....	5 00	2 75
" " and the Review of Reviews (new).....	4 50	2 25
" " and the Review of Reviews (old).....	4 50	3 25
" " and Current Literature (new).....	5 00	2 25
" " and Current Literature (old).....	5 00	3 25
" " and the New England Magazine.....	5 00	2 25
" " Review of Reviews (new), and any one of our dollar magazines... 5 00	5 00	2 75
" " and Leslie's Weekly.....	6 00	3 00
" " Review of Reviews (new), and Leslie's Weekly.....	8 50	4 00
" " North American Review (new), and Review of Reviews (new)....	9 50	4 25

Other Combinations can be made from the Table Below.

Every order must include Gleanings.

No. 1. * 25 cents	No. 2. * 50 cents.	No. 3 * 75 cents	No. 4 * \$1.00.	No. 5 * \$1.25.	No. 6. * \$1.50.
Am. Poultry Advo. Poultry Keeper. Rel. Poultry Jour. Poultry Monthly. Am Poultry Jour. Farm Poultry. Farm and Home. Farm & Fireside. Ag. Epitomist. Prairie Farmer.	Ohio Farmer. Mich. " Practical " Kansas " Indiana "	Rural N.-Yorker Nat'l Stockman and Farmer Success. Woman's Home Companion. Cosmopolitan. Frank Leslie's Pop. Monthly. The Household. Good Housekpg. The Designer.	Am. Gardening. Christian Herald Post Pen.	Rev. of Reviews. Country Gentle- man. Youths Compa'n <i>Orders for these three must be for new subscribers.</i>	Pacific Rural Pres- Country Gentle- man (renewal)

*These prices are not the publishers' prices for these papers, but they are our special reduced prices when taken in connection with GLEANINGS. In many cases they are just one-half the regular rate.

How to get the Price for any or all of the Papers Named Above:

1. Gleanings in Bee Culture, one year, \$1.00.
2. If you want only one additional paper, add the price found in the top of the column in which that paper appears
3. If you want several papers in addition to Gleanings, each one may be had at the price named at the top of the column. For instance: Gleanings, Success (3rd col.) and Rural New-Yorker (3rd col.), will cost you \$2.50.
4. You may select as many papers from each column as you wish.
5. Every order sent us must include Gleanings.
6. Foreign postage extra.

CONDITIONS.—Offers are subject to withdrawal at any time. Subscriptions to the Review of Reviews, Youth's Companion, and Country Gentleman must be strictly new. New subscriptions sent for Success, Youth's Companion, or Gleanings will receive the balance of this year free. Neither the Review of Reviews nor Post Fountain Pen will be sent in any combination amounting to less than \$2.50.

CHRISTMAS PRESENTS.—We will send all papers or pen to one or separate addresses as desired. In this way you can easily make desirable Christmas Presents.

THE A. I. ROOT COMPANY, MEDINA, O.

1881

PAGE & LYON MFG. CO.

1901

We manufacture a full line of the latest BEE-SUPPLIES.

Our motto is, "Perfect Goods and Prompt Shipment."

Send for our new free illustrated catalog.

PAGE & LYON MFG. CO., New London, Wisconsin.

Marshfield Manufacturing Company.

Our specialty is making SECTIONS, and they are the best in the market. Wisconsin basswood is the right kind for them. We have a full line of BEE-SUPPLIES. Write for FREE illustrated catalog and price list.

Marshfield Manufacturing Company, Marshfield, Wisconsin.

I. J. Stringham, 105 Park Place, New York City.

Honey-jars.

1-lb. square jars, \$5.00 per gross ; No. 25 jar, porcelain top, \$6.00 per gross ; Nickel-cap jar, fancy, \$5.50 per gross. All are clear flint glass. Discount on quantities. We ship from New York City, N. Y.

Labels.—60 cts. per gross. A full line of Apiarian Supplies always in stock. Catalog free. . . . Apiaries located at Glen Cove, Long Island, New York.

I. J. Stringham, 105 Park Place, New York City.

BEE SUPPLIES!

- Complete Line. . . .
- Manufacturers' Prices.
- Send for Our Catalog.

FRED W. MUTH & CO., Cincinnati, O.
South-west Corner Front & Walnut.

CHAS. ISRAEL & BROS.,
486-490 Canal St., Corner Watt St., N. Y.

Honey and Beeswax.

Liberal Advances made on Consignments. Wholesale Dealers and Commission Merchants. Estab. 1875.

Mr. A. I. Root's Writings

of Grand Traverse territory and Leelanau Co. are descriptive of Michigan's most beautiful section reached most conveniently via the

PERE MARQUETTE R. R.

For pamphlets of Michigan farm lands and the fruit belt, address W. C. Tousey, D. P. A. Toledo, Ohio.

BELGIAN HARES !



With every hare sold goes a full pedigree, register number, and score-card, scored by an official judge. Does will be bred to one of our famous high-scoring bucks free. Write for book. Mgr. of The A. I. Root Co. J. B. MASON, MECHANIC FALLS, MAINE.

Angora Goats

are handsome, hardy, profitable. Prize stock; low price; circular. Ed. W. COLE & Co., Kenton, O.

CALIFORNIA SAGE HONEY.

The world again sweetened with our famous sweet. Bees increasing fast. Bee-men very active. Tons of nectar lost for want of bees to gather. The PACIFIC BEE JOURNAL controls thousands of acres of fine field. Many fields to let. A few bees for sale—and climate too. Four hundred pounds to the colony, twenty tons to the 100 colonies in some instances.

Pacific Bee Journal, Los Angeles, Cal.

\$1 per year; 25c for 3 months' trial; 50c this year and six months of 1902; \$1 for this year and all of 1902; with Gleanings, \$1.25 a year.

Subscription Combinations!!

We take pleasure in offering the readers of GLEANINGS a few of our combinations. If you do not see what you want we have a 44-page catalog free for the asking. These prices are for a full year, and may be either for new or renewal, except where stated. Sent to different addresses if desired, and will be mailed direct from the publisher the same as they would if you ordered direct. The offers are made by the publishers, and we are their special agents. Success, Leslie's Monthly, and Cosmopolitan, \$2.00. In the above offer, in place of Leslie's or Cosmopolitan you may substitute any of the following: Gleanings, Farm Poultry, Good Housekeeping, Household, Practical Farmer, Designer, Health Culture, Hints, The Era, new subscription to Recreation. Success must be in any list made from above—the others are interchangeable.

Everybody's Magazine, Practical Farmer (new subscription), and your choice of a new subscription to either Harper's Bazar, American Boy, Little Folks, or Sunday School Times..... \$1.75
 Gleanings and Great Round World..... 1.99
 Gleanings and Century..... 4.05
 Gleanings and Scribner's..... 3.30
 Gleanings and Outing..... 3.00
 Gleanings and Farm Poultry..... 1.00
 Gleanings and Country Gentleman..... 1.50

Youtas' Companion may be added to any offer for \$1.75, and new subscribers get November and December free, also art calendar. Ladies' Home Journal may be added for \$1.00. McClure's may also be added for \$1.00. By our arrangements with publishers these offers are good until Sept. 1st, 1902. We want to send you our catalog. Ask for it, and address all orders to

C. M. Goodspeed, Box 791, Skaneateles, N. Y.

FOR SALE.—Will sell cheap, one 10 h p. engine with upright boiler all complete; one 18-inch planer, one saw-table. Inquire of

J. W. BITTENBENDER, Knoxville, Iowa.



HUNTER-TRADER-TRAPPER—A monthly. Sample copy, 5 cts. All about Hunting, Trapping and Raw Furs. A. R. Harding, Gallipolis, O.

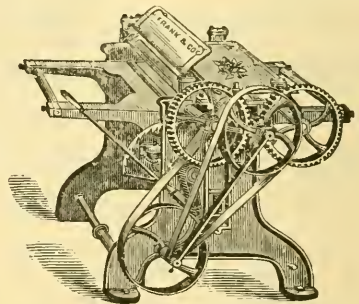

PLANERS

The above cut shows one of our small Planers, of which we make twelve different styles and sizes. Also large Planers, Band Saws, Buzz Planers, Moulders, Wood Lathes, and all kinds of

WOOD WORKING MACHINERY

Send for Catalogue.

The FRANK MACHINERY CO.

BUFFALO, N. Y.



Red Glover Queens -FOR- 1902

Warranted Purely Mated.
The Long-Tongue Variety.

How to get One for Only 30 cts.

We have arranged with the queen-breeder who furnished Long-Tongue Red Clover Queens for us during the past season, to fill our orders next season. Although fully 95 percent of the untested queens he sent out were purely mated, next season all he mails for us will be **warranted** purely mated.

We want every one of the readers of Gleanings in Bee-Culture, who is not now a reader of the old weekly American Bee Journal, to have one of these Superior Red Clover Queens. We have received most excellent reports from the Queens we supplied during the past season. And next year our breeder says he expects to be able to send out even better Queens, if that is possible. He is one of the very oldest and best queen-breeders. His bees average quite a good deal the longest tongues of any yet measured. The Breeder he will use is direct from Italy, having imported her himself. Her worker-bees are large, of beautiful color, very gentle, scarcely requiring veil or smoker.

Orders for these fine, "long-reach" **warranted** Queens will be filled in rotation—"first come, first served"—beginning as early in June, 1902, as possible. It is expected that orders can be filled quite promptly (even better than the past season), as a much larger number of queen-rearing nuclei will be run. (But never remove the old queen from the colony until you receive the new queen, no matter from whom you order).

In order that all who are not now readers of the American Bee Journal can have one of these fine Queens, we will make the price **only 30 cents** each, when taken in connection with a year's subscription. That is, send us \$1.30 (if you are a **NEW** subscriber), and we will book your order for a Warranted Queen, and enter your name on our list of subscribers and send you the Bee Journal **every week** from the time we receive your name and \$1.30 **until the end of next year (1902)**. So the sooner you send in your order the more copies of the Bee Journal you will receive. If you have not seen the weekly American Bee Journal, send for a free sample copy. Address,

GEORGE W. YORK & CO.

144 & 146 Erie Street, CHICAGO, ILL.



We are headquarters in Chicago for **ROOT'S BEE-KEEPERS' SUPPLIES AT ROOT'S PRICES.**
Catalog Free....

GREAT CLUBBING OFFERS!

My friends, how many of you are reading some of the many most excellent magazines of the day? If you are reading none, you are missing a great treat. Perhaps you regard them as luxuries. Possibly they are in some instances. They certainly help to fill out our lives, and give to us broader views. They are like windows that allow us to look out over the wide world. This life is not wholly one of dollars and cents—at least it ought not to be. Enjoyment, pure and simple, enjoyed just for the sake of enjoyment, is desirable and beneficial. To many there are few things that are more enjoyable than the bright pages of a really good magazine. To those who wish to give the magazines a trial, and to those who are already reading them, I can offer some of the lowest clubbing rates that have ever been offered. Here is a list of magazines, together with the regular prices at which they are published:

Review of Reviews.....	\$2.50	Cosmopolitan.....	\$1.00
Current Literature.....	\$3.00	Leslie's Popular Monthly.....	1.00
New England Magazine.....	3.00	The Household.....	1.00
Leslie's Weekly.....	4.00	Good Housekeeping.....	1.00
North American Review.....	5.00	The Designer.....	1.00
Success.....	1.00		

If you subscribe for one or more of these magazines, in connection with the Bee-keepers' Review, I can make the following offers:

Success and the Bee-keepers' Review for only.....	\$1.75
Success and any one of the above \$1 00 magazines and the Bee-keepers' Review for only.....	2.50
Success and any two of the above \$1 00 magazines and the Bee-keepers' Review for only.....	3 00
Success and any three of the above \$1 00 magazines and the Bee-keepers' Review for only.....	3.50
Success, Review of Reviews (new), and the Bee-keepers' Review for only.....	3 00
Success, Review of Reviews (old), and the Bee-keepers' Review for only.....	4 00
Success, Current Literature (new), and the Bee-keepers' Review for only.....	3 00
Success, Current Literature (old), and the Bee-keepers' Review for only.....	4 00
Success, the New England Magazine, and the Bee-keepers' Review for only.....	3 00
Success, Review of Reviews (new), any one of the above \$1 00 magazines, and the Review, for only.....	3 50
Success, Leslie's Weekly, and the Bee-keepers' Review for only.....	3.75
Success, Review of Reviews (new), Leslie's Weekly, and the Bee-keepers' Review for only.....	4 75
Success, North American Review (new), Review of Reviews (new), and the Review for only.....	5.00

Magazines will be sent to one or different addresses as desired.

New subscribers to the Review will receive the rest of this year free.

N. B.—For \$1.00 in addition to any of the above offers I will book your order for a Superior Stock queen, to be delivered next spring.

W. Z. Hutchinson, Flint, Michigan.

THE SMITH PREMIER TYPEWRITER

Occupies an Imperishable Position in the BUSINESS WORLD.

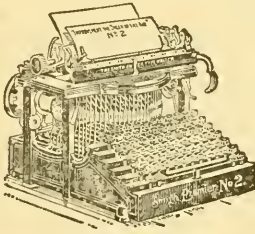

Unquestionable Superior Merit

Annually adds thousands of names to the long list of Smith Premier users, representing every line of trade and every profession.

ILLUSTRATED CATALOGUE FREE.

The Smith Premier Typewriter Co.,

158 Prospect Street, Cleveland, Ohio.

NOW READY!

64-PAGE CATALOG OF EVERY THING BEE-KEEPERS NEED. Illustrated and fully described. Especially valuable to beginners for the information it contains. Send your address on postal and get it now. Established 1884.

J. M. JENKINS, Wetumpka, Ala.



DECLINE IN GLASS.

There has been a sharp decline in the price of glass, so that we are able to restore our list prices on shipping-case glass, and we can offer 8x10 glass for cold-frames and greenhouse sash, until further notice, at \$3.50 per box; 5 boxes, \$17; 10 boxes, \$32.50. We do not think the present low prices will continue long, as the manufacturers' association is as strong as ever, and prices will undoubtedly advance again after the first of the year. If you will need glass in the next few months we advise you laying in a stock now while prices are down.

GLASS HONEY-JARS.

We have spoken a number of times in this department in regard to the increasing popularity of the No. 25 jar for retailing extracted honey. They hold an even pound, seal with a rubber ring between the edge of the jar and the porcelain cap, sealed tight by means of a tin rim screwed on. After the honey is used there is nothing nicer than this jar for putting up choice canned fruit. We find that, during the past year, we have disposed of 200 gross of No. 25, besides 50 gross of No. 143, the same style jar, holding 14 oz. of honey. Last June we had a carload of these jars and the Masons. We have just ordered another carload. The manufacturers are able to pack them cheaper in crates than in barrels, and say they carry safely in these crates. We offer them from now on, put up in crates, at \$5.75 per gross; 3 gross or more at \$5.50. In partitioned boxes of 2 dozen each, \$1.00 per gross more. Packed in barrels, 50 cts. per gross more than in crates. No. 143, holding 14 oz., will be 25 cents per gross less than No. 25.

MASON FRUIT-JARS DECLINED.

It may be out of season to advertise fruit-jars; but now is the time to buy them cheap. For orders placed this month, we offer them at the following special prices. We will not list them any lower in our catalog than last season, as the price will no doubt rise again next spring, therefore these special prices are limited to the forehanded ones who buy early. If you can use a quantity, write us for special prices. These are best machine-made jars, with zinc porcelain-lined caps and rubbers, put up one dozen in a partitioned box.

Pint jars, 52c doz.,	6 doz.,	\$2.90;	12 doz.,	\$5.75.
Qt. " 55c "	6 "	3.10;	12 "	6.00.
2-qt. " 75c "	6 "	4.10;	12 "	8.00.

Special Notices by A. I. Root.

GIANT GIBRALTAR ONION SEED.

Last season the seed was all sold, and no more could be obtained. Several of our friends were disappointed. We can now fill orders, however, with new seed if you send in at once. Ounce, 20 cts.; 1 lb., \$2.50. About a dozen plants were sent rather late up to my woods garden in Michigan last season. They all made fine large onions. One of them now stands on my desk, and is 16 inches around, and weighs 1 lb. 11 ounces. It looks exactly like the Spanish onions seen in the markets. The flavor is very mild. Many people eat them raw like apples; and for cooking they are the nicest onion I ever tasted. My impression is, the seed had better be started in the greenhouse or in a cold-frame, and grow them by the transplanting method. There has been some complaint about their keeping qualities. The one on my table I propose to keep there as a test.

SEED POTATOES FOR 1902.

On page 656, Aug. 1, I gave prices on seed potatoes for planting in 1902 as follows: 1/2 peck, 25 cts.; peck, 40 cts.; 1/2 bushel, 75 cts.; bushel, \$1.40; barrel, \$4.00. Small seconds, half the above prices. I have been watching quotations since then, and no reliable seedsmen has made any better prices. We will ship them (when they go south, where wanted before April 1, 1902), from now until December 15 at our risk against

frout, at the above figures; or we will keep them safely for you till next spring in our specially arranged potato-cellar. We can furnish, at the above prices, White Bliss Triumph, Early Ohio, Bovee, Sir Walter Raleigh, New Russet, and Craig. As our supply of many is limited, you had better order at once if you want them. Seed potatoes, especially the earlies and extra earlies, are likely to be away up before another spring. Our seconds will probably all be gone very soon at the above low figures.

OTHER POTATOES IN SMALL QUANTITIES.

We can furnish the following kinds in small quantities, say not to exceed a peck or half a bushel: Early Trumbull, New Queen, Lee's Favorite, Freeman, State of Maine, Maule's Commercial, Carman No. 3, White Mammoth, Early Michigan.

Any of the above potatoes will be furnished in very small quantities at 5 cents per lb., or by mail at 15 cts. per lb., or 3 lbs. for 40 cts. Potatoes for premiums can be sent by mail, but 10 cts. per lb. extra for postage and packing will be required.

POTATOES TO BE GIVEN AWAY.

Everybody who sends \$1.00 for GLEANINGS may have 25 cents' worth of potatoes providing he mentions it when he sends in the money; and every subscriber who sends us \$1.00 for a new subscriber so that GLEANINGS may go into some neighborhood or family where it has not been before, may have 50 cents' worth of potatoes; but you must pay all postage, express, or freight on your potatoes. We can give away potatoes, but we can not give away postage stamps.

POTATOES FOR TABLE USE.

In our last issue I mentioned that friend Hilbert was offered 50 cents a bushel for his Russets. In a week they were up to 63 cents; and to-day, Nov. 30, potatoes are quoted in the Cleveland markets at 85 to 90 cents. By this you can see that my price of \$4.00 a barrel is not very high for choice seed potatoes true to name. If potatoes continue to rise I may be obliged to advance prices before our next issue.

PRICES ON CLOVER SEEDS AT THIS DATE.

Although the market is not very well settled as yet for 1902, as nearly as we can make out the prices will be about as follows. But let it be understood there are liable to be fluctuations, and we can not be responsible unless for immediate orders.

Alsike clover, bu., \$10; 1/2 bu., \$5.25; peck, \$2.75; 1 lb., 20 cts., or by mail 30 cts.

Medium clover, bu., \$7.00; 1/2 bu., \$3.75; peck, \$2.00; 1 lb., 18 cts., or 28 cts. by mail.

White Dutch clover is the same as alsike.

Peavine, or Mammoth Red clover, same as medium. Alfalfa, bu., \$6.00; 1/2 bu., 3.25; peck, \$1.75; 1 lb., 15 cts., or 25 cts. by mail.

Crimson, or scarlet clover, bu., \$4.50; 1/2 bu., \$2.40; peck, \$1.25; 1 lb., 10 cts., or by mail 20 cts.; 3 lbs. by mail, 50 cts.

Sweet clover, 100 lbs., 10 cts. per lb.; 10 lbs. at 12 cts.; 1 lb., 15 cts.; by mail, 25 cts. per lb.

The prices of garden seeds in general will probably be much the same as last year. Peas will probably be still higher. Beans may be higher. We expect to quote prices on all kinds of garden seeds through our journal some time in January. If any of the friends should want prices earlier, we will make the very best figures we can; and should there be a decline in the market after the goods are shipped—that is, where the amount is sufficiently great to warrant it, we will make a rebate, even after the seeds are sold and paid for.

Wisconsin Farm Lands.

The best of farm lands can be obtained now in Marinette County, Wisconsin, on the Chicago, Milwaukee & St. Paul Railway, at a low price and on very favorable terms. Wisconsin is noted for its fine crops, excellent markets, and healthful climate. Why rent a farm when you can buy one much cheaper than you can rent, and in a few years it will be your own property? For particulars address F. A. Miller, General Passenger Agent, Chicago, Milwaukee & St. Paul Railway, Chicago.

1200 FERRETS. All sizes; some trained; first-class stock. New price list free. N. A. KNAPP, Rochester, Lorain Co., Ohio.

To make cows pay, use Sharples Cream Separators. Book "Business Dairying" & cat. 288 free. W. Chester Pa.

HONEY QUEENS!

- Laws' Long-tongue Leather Queens.
- Laws' Improved Golden Queens.
- Laws' Holy Land Queens.

Laws' queens are the standard bred queens of America. The largest honey-producers use them and praise them. Laws' queens go everywhere, and can furnish you a queen every month in the year. Four apiaries Queens bred in their purity. Prices, October to April: Tested or untested, \$1.00 each; 6 for \$5.00. Breeders, none better, \$3.00 each. Address

W. H. Laws, Beeville, Texas.

Dittmer's Foundation !!!

Retail---Wholesale---Jobbing.

I use a PROCESS that produces EVERY ESSENTIAL necessary to make it the BEST and MOST desirable in all respects. My PROCESS and AUTOMATIC MACHINES are MY OWN INVENTIONS, which enable me to SELL FOUNDATION, and WORK WAX INTO FOUNDATION FOR CASH, at prices that are the lowest. Catalog giving

FULL LINE OF SUPPLIES

with prices and samples, free on application. BEESWAX WANTED.

GUS. DITTMER. AUGUSTA, WIS

Get the Best Queens.

Evansville, Ind., Sept. 27th, 1900.

The Jennie Athley Co., Beeville, Bee Co., Texas:
 Dear Friends:—It gives me great pleasure to forward you this unsolicited testimonial regarding the merits of Athley queens. The three (3) dozen queens purchased of you have made an excellent record for themselves. Not an Athley queen among the twenty colonies lost during the severe drouth in July. I've bought queens from many breeders; and although the present crop is exceedingly short, the tiers of supers show where the Athley queens are, and speak volumes for your method of queen-rearing. I find the progeny to be very gentle, strong-winged, uniformly marked, long-lived, of large size, and last, but not least, the best honey-gatherers I ever had. I shall want 100 more next season.

Yours fraternally,
 J. C. WALLENMEYER.

Prices for Queens.

Tested, \$1.50 each; \$8.00 for 6, or \$15.00 per doz. Untested, February, March, April, and May, \$1.00 each; \$5.00 per 6, or \$9.00 per doz. Fine breeders, \$5.00 each. We have as good bees and queens as money and labor produce. We breed three-band Italians, Goldens, Caruolans, Cyprians, and Holy-Lands, in their purity, bred in separate yards 5 to 20 miles apart. If you want the best, call for Athley's improved strains. Safe arrival guaranteed. Send for a sample copy of *The Southland Queen*, the only southern bee-paper, \$1.00 per year. To new subscribers we offer as a premium a nice untested queen in order to get our paper introduced. Catalog, giving queen-rearing and management of apiaries for profit, FREE.

**THE JENNIE ATCHLEY CO.,
 Beeville, Bee Co., Texas.**

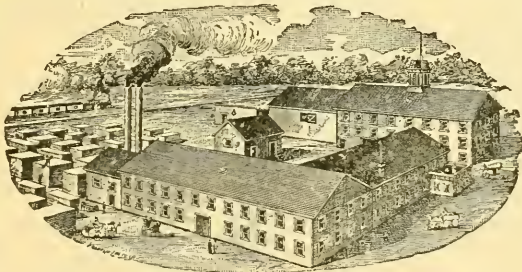

KRETCHMER M'FG CO., Red Oak, Iowa.

BEE-SUPPLIES.

Best-equipped factory in the West; carry a large stock and greatest variety of every thing needed in the apiary, assuring BEST goods at the LOWEST prices, and prompt shipment. We want every bee-keeper to have our FREE ILLUSTRATED CATALOG, and read description of Alternating Hives, Ferguson Supers, etc. Write at once for a catalog.

— AGENCIES: —

Trester Supply Co., 108 So. 11th St., Lincoln, Nebraska; C. C. Richards, 1223 17th St., Denver, Col.

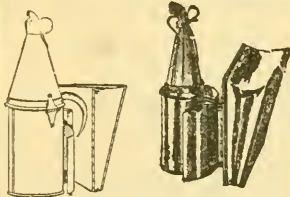

BINGHAM SMOKER.

Dear Sir:—Inclosed find \$1.75. Please send one brass smoke-engine. I have one already. It is the best smoker I ever used.
 Truly yours,
 HENRY SCHMIDT, Hutto, Tex.

MADE TO ORDER

Bingham Brass Smokers.

Made of sheet brass, which does not rust or burn out; should last a lifetime. You need one, but they cost 25 cts. more than tin of the same size. The little open cut shows our brass hinge put on the three larger sizes. No wonder Bingham's four-inch smoke-engine goes without puffing, and does not drop inky drops. The perforated steel fire-grate has 381 holes to air the fuel and support the fire.

Heavy tin smoke-engine, 4-inch stove, per mail, \$1.50; 3½-inch; \$1.10; 3-inch, \$1.00; 2½-inch 90c; 2-inch, 65c. Bingham smokers are the originals, and have all the improvements, and have been the standard of excellence for 22 years. Only three larger ones brass.

T. F. Bingham, Farwell, Michigan.

Contents of this Number.

Arizona, Editor in983
 Cabin in the Woods980
 California, Central976
 Clover, Sweet, Pro and Con.....983
 Doolittle's Report for 1901975
 Drones and Queens979
 Foul Brood in Colorado.....973
 Foul Brood in Michigan.....982
 Foul-brood Legislation for New Jersey981
 Grand Traverse Region.....989
 Honey, Canded, Aikin's Sales of981
 Jones, Commissioner972
 Nominations981
 Potatoes, Digging, at Hilbert's901
 Queens, Breeding from Freak best.....971
 Rambler in Cuba.....980
 Sections, Tall v. Square981
 Tongues, Long, Burlesque on973
 Ungrammatical Expressions972

Honey Column.

GRADING-RULES.

FANCY.—All sections to be well filled, combs straight, firmly attached to all four sides, the combs unsoiled by travel-stain or otherwise; all the cells sealed except an occasional cell, the outside surface of the wood well scraped of propolis.
 No. 1.—All sections well filled except the row of cells next to the wood; combs straight; one-eighth part of comb surface soiled, or the entire surface slightly soiled; the outside of the wood well scraped of propolis.
 No. 2.—All sections well filled except the row of cells next to the wood; combs comparatively even; one-eighth part of comb surface soiled, or the entire surface slightly soiled.
 No. 3.—Three-fourths of the total surface must be filled and sealed.
 No. 4.—Must weigh at least half as much as a full-weight section.
 In addition to this the honey is to be classified according to color, using the terms white, amber, and dark; that is, there will be "Fancy White," "No. 1 Dark," etc.

CITY MARKETS.

MILWAUKEE.—The supply of honey is very fair on this market, and the demand seems very moderate—not quite what it should be, although there may be a reason; the attention of the consumers is attracted to the fancy show-windows of articles that please the eye as we'll as taste. We quote fancy 1-lb. sections, 15¢@16; A No. 1, 14¢@15; amber almost nominal 12¢@14. Extracted white, in bbls, cans, and pails, 8¢@9; amber, 7¢@7½. Beeswax, 26¢@28.
 A. V. BISHOP & Co.,
 119 Buffalo St., Milwaukee, Wis.

CINCINNATI.—There is a good deal of extracted honey offered, and prices if any thing, are a little lower. Dark sells for 5; lighter, 5½¢@6; fancy, 6½¢@8. The prices of comb honey keep up, fancy sells at 15¢@16; lower grades, 12½¢@14½.
 C. H. W. WEBER,
 2146 Central Ave., Cincinnati, Ohio.

PHILADELPHIA.—Honey in good demand and arriving freely. Sales not so brisk on account of holidays. Trade always dull in January. We quote fancy comb, 15¢@16; No. 1, 14¢@15; buckwheat, 12. Extracted, amber, 6; white, 7¢@8. Beeswax, 26. We are producers of honey—do not handle on commission.
 WM. A. SELSER,
 10 Vine St., Philadelphia, Pa.

CHICAGO.—The honey market is of a slow nature, with little change in price of any of the grades. At this season of the year many of the retailers have laid in a supply sufficient to carry them over the holidays. Choice grades of white comb honey, 14½¢@15; good to No. 1, 13½¢@14; light amber, 12½¢@13; dark grades, including buckwheat, 10¢@12. Extracted white, 5½¢@7; amber, 5¼¢@5½; dark, 5¢@5¼. The scale of prices varying according to flavor, body, and package. Beeswax steady at 28.
 R. A. BURNETT & Co.,
 199 South Water St., Chicago, Ill.

NEW YORK.—The demand for comb honey continues to be brisk, while stock held here is not very large, the receipts are sufficient to supply all demand so far. We quote fancy white, 15; No. 1, 14; No. 2, 12¢@13; buckwheat, 10½.
 FRANCIS H. LEGGETT & Co.,
 Dec. 7. Franklin and Varick Sts., New York.

WANTED.—Comb honey in any quantity. Please advise what you have to offer.
 EVANS & TURNER,
 Town St., Cor. 1th, Columbus, Ohio.

FOR SALE.—Extracted honey, basswood or clover, in 160-lb. kegs, at 7¢; amber, 6¢; buckwheat in kegs, cans, or 30 to 75 lb. wooden pails, 5½¢; sample, 6¢.
 C. B. HOWARD, Romulus, N. Y.

We will be in the market for honey the coming season in carloads and less than carloads and would be glad to hear from producers everywhere what they will have to offer.
 SEAVEY & FLARSHHEIM,
 1318-1324 Union Avenue, Kansas City, Mo.

FOR SALE.—30 to 35 cases heartsease honey, two cans to a case (120 lbs.); new cans; 7 cts. per pound.
 JOHN A. THORNTON, Lima, Ills.

FOR SALE.—Basswood, clover, and sweet-clover extracted honey, at 7¢, in kegs and cans.
 DR. C. L. PARKER, Station A, R. F. D.,
 Syracuse, N. Y.

FOR SALE.—Extracted honey in 160-lb. kegs. Buckwheat, 5½; mixed, 6; basswood, 7. Send postoffice money-order on Moravia, N. Y., and will ship promptly.
 N. L. STEVENS, Venice, N. Y.

WANTED.—Honey; car lots or otherwise. Will send man to receive when sufficient amount to justify, and pay highest market price, spot cash. Address, stating quantity, quality, and price desired at your station.
 THOS. C. STANLEY & SON, Fairfield, Ill.

FOR SALE.—Fancy and No. 1 comb honey; about 2000 lbs. or more.
 WM. MORRIS, Las Animas, Col.

FOR SALE.—10,000 lbs. light-amber alfalfa extracted honey in 75-lb. cans, at 5¢ a pound.
 R. T. STINNETT, Mesilla Park, N. M.

FOR SALE. Extracted honey, from alfalfa, at 7¢ per pound. Send for sample.
 D. S. JENKINS, Las Animas, Col.

WANTED.—Comb and extracted honey. State price, kind, and quantity.
 R. A. BURNETT & Co.,
 199 South Water St., Chicago, Ill.

WANTED.—Comb honey and beeswax. State price delivered at Cincinnati.
 C. H. W. WEBER,
 2146-2148 Central Ave., Cincinnati, O.

FOR SALE.—Fine ripe extracted touch-me-not honey, in 60-lb. square tin cans, 2 cans to a case, delivered at R. R. station at 7½¢. Sample postpaid, 8¢.
 C. A. BUNCH, La Paz, Marshall Co., Ind.

Wanted! HONEY, WAX,
 MAPLE SUGAR,
 SYRUP, AND
 POPCORN.
 A. L. JENKS, 42 W. Market St., Buffalo, N. Y.

CHAS. ISRAEL & BROS.,
 486-490 Canal St., Corner Wall St., N. Y.
Honey and Beeswax.

Liberal Advances made on Consignments. Wholesale Dealers and Commission Merchants. Estab. 1875.

Minnesota Bee-keepers' Supply Mfg. Co.,
 Manufacturers of
Bee-hives, Sections, Shipping-cases, and
Everything Used by Bee-keepers.

Orders filled promptly. We have the best shipping facilities in the world. You will save money by sending for our price list. Address

Minnesota Bee-keepers' Supply Mfg. Co.,
 Nicollet Island Power Building, Minneapolis, Minn.

GRAND - CLUBBING - OFFERS.

Magazines and Post Fountain Pen
to the amount of \$9.00 for \$5.00.

Gleanings in Bee Culture.....	\$1 00
Review of Reviews (new).....	2 50
Success.....	1 00
S. S. Times.....	1 00
Good Housekeeping.....	1 00
Post Fountain Pen.....	2 50
	9 00

One-dollar Magazines :

- S. S. Times,
- American Boy,
- The Household,
- Good Housekeeping,
- The Designer.

All sent to one or separate addresses, one year..... 5 00

READ EVERYTHING ON THIS PAGE. * Here are a few Special Combinations.

SPECIAL COMBINATIONS.

Regular Price. Our Price

Gleanings and Success.....	\$2 00	\$1 25
Gleanings, Success, and any one of our dollar magazines (see list above).....	3 00	1 75
" " and any two of our dollar magazines.....	4 00	2 25
" " and any three of our dollar magazines.....	5 00	2 75
" " and the Review of Reviews (new).....	4 50	2 25
" " and the Review of Reviews (old).....	4 50	3 25
" " and Current Literature (new).....	5 00	2 25
" " and Current Literature (old).....	5 00	3 25
" " and the New England Magazine.....	5 00	2 25
" " Review of Reviews (new), and any one of our dollar magazines... 5 50	2 75	
" " and S. S. Times.....	6 00	3 00
" " Review of Reviews (new), and S. S. Times.....	8 50	4 00
" " North American Review (new), and Review of Reviews (new).....	9 50	4 25

Other Combinations can be made from the Table Below. Every order must include Gleanings.

No. 1. * 25 cents.	No. 2. * 50 cents.	No. 3 * 75 cents.	No. 4 * \$1.00.	No. 5 * \$1.25.
Poultry Keeper. Rel. Poultry Jour. Poultry Monthly. Am Poultry Jour. Poultry Topics. Farm and Home. Farm & Fireside. Ag. Epitomist. Prairie Farmer. Green's Ft Grower Am. Issue (Anti Sa- loon League Organ	Ohio Farmer. Practical " American Boy. Farm Poultry. Farm Journal 5 years.	Rural N.-Yorker Nat'l Stockman and Farmer Woman's Home Companion. S. S. Times. The Household. Good Housekpg. The Designer.	American Gardening. Christian Herald. *Review of Reviews. *Current Literature. *N. E. Magazine. <i>*Orders for these three must be for new subscribers.</i> Country Gentleman. New or renewal not more than three months in arrears. Post Pen.	Youths Compa'n (new sub. only.) No. 6. \$2.50 Scientific Ameri- can.

*These prices are not the publishers' prices for these papers, but they are our special reduced prices when taken in connection with GLEANINGS. In many cases they are just one-half the regular rate.

How to get the Price for any or all of the Papers Named Above:

1. Gleanings in Bee Culture, one year, \$1.00.
2. If you want only one additional paper, add the price found in the top of the column in which that paper appears.
3. If you want several papers in addition to Gleanings, each one may be had at the price named at the top of the column. For instance: Gleanings, S. S. Times, (3rd col.) and Rural New-Yorker (3rd col.), will cost you \$2.50.
4. You may select as many papers from each column as you wish.
5. Every order sent us must include Gleanings.
6. Foreign postage extra.
7. We will send all papers or pen to one or separate addresses as desired.

CONDITIONS.—Offers are subject to withdrawal at any time. Subscriptions to the Review of Reviews, Youth's Companion, Current Literature, and N. E. Magazine must be strictly new. Neither the Review of Reviews nor Post Fountain Pen will be sent in any combination amounting to less than \$2.50.

THE A. I. ROOT COMPANY, MEDINA, O.

Gleanings in Bee Culture

[Established in 1873.]

Devoted to Bees, Honey, and Home Interests.

Published Semi-monthly by

The A. I. Root Co., - - Medina, Ohio.

A. I. ROOT, Editor of Home and Gardening Dep'ts.
E. R. ROOT, Editor of Apicultural Dept.
J. T. CALVERT, Bus. Mgr.
A. L. BOYDEN, Sec.

TERMS. \$1.00 per annum; two years, \$1.50; three years, \$2.00; five years, \$3.00, *in advance*; or two copies to one address, \$1.50; three copies, \$2.00; five copies, \$3.75. The terms apply to the United States, Canada, and Mexico. To all other countries 48 cents per year extra for postage.

DISCONTINUANCES. The journal is sent until orders are received for its discontinuance. We give notice just before the subscription expires, and further notice if the first is not heeded. Any subscriber whose subscription has expired, wishing his journal discontinued, will please drop us a card at once; otherwise we shall assume that he wishes his journal continued, and will pay for it soon. Any one who does not like this plan may have his journal stopped after the time paid for by making this request when ordering.

RATES OF ADVERTISING. These will be furnished on application.

Notice!

QUIRIN, the queen-breeder, still has 100 of those long-tongued red-clover queens on hand at \$1 each, or 6 for \$5. If you want one speak quick. For testimonials see former adv'ts.

Bees Wanted!

We are expecting to establish several out-apiaries next season and desire all the bees we can get; want 'em on movable frames, and near home. They must be cheap at this time of year. Parties placing us in correspondence with those having bees to sell will be remembered next season when we have a nice lot of those long-tongued red-clover queens on hand (in case we succeed in purchasing of said parties).

In our circular we list numerous articles used by bee-keepers, on which we will give 10 to 20 per cent discount from now until the coming March. Address all orders and inquiries to

H. G. Quirin, Parkertown, Ohio.

FANCY EXTRACTED HONEY.—An extra-fine lot of clover honey that I had reserved for bottling, but owing to change of plans will sell in bulk. From combs entirely capped and fully ripened, thick and rich. Now candied perfectly hard and dry. Cans hold 74 lbs. net. Per can, \$5.50. Fancy comb honey, 22 lbs. in case, per case, \$3.30

J. A. GREEN, Ottawa, Ill.

FOR SALE!—U. S. Patent Apiary. Protect your bees, and get more honey. You can do so with the aid of my new improved bee-hive swing, which securely protects the bees from various classes of insects and small animals, and provides a neat warm housing for winter. Will sell State, county, or farm rights upon application. Address

Chas. O. Lett, Eclectic, Ala.

Wants and Exchange.

Notices will be inserted under this head at 10 cts. per line. You must SAY you want your adv't in this department, or we will not be responsible for any error. You can have the notice as many lines as you please; but all over ten lines will cost you according to our regular rates. We can not be responsible for dissatisfaction arising from these "swaps."

WANTED.—To exchange Dadant uncapping-cans, Root's No. 5 extractor, and other supplies, for honey or wax. O. H. HYATT, Shenandoah, Iowa.

WANTED.—To exchange 50 T supers, mostly unused; 25 section-holder supers, unused; 25 second-hand supers, 25 eight-frame hive-bodies, many new; 100 L. combs, 10-inch fdn. mill, Novice extractor, Porter bees-escapes, all-zinc honey-boards, queen and drone traps, zinc-perforator for making queen-excluding zinc, greenhouse or hotbed sash, made up or in flat; a large quantity of 8x10 glass, also odd sizes. Send for prices. Wanted—queens, honey, wax, St. Bernard dog, or offers. J. A. GREEN, Ottawa, Ill.

WANTED.—To exchange a No. 15 two-frame Cowan honey-extractor for a No. 5 Novice extractor. ADOLPH SEGERLIN, Anita, Pa.

WANTED.—A situation as assistant apiarist, or charge of small apiary and fruit or poultry farm, in the southern or western States. Good reference can be given. CHAS. G. GIBBS, Brunswick, O.

WANTED.—Position as bee-keeper by young man, single; have handled bees all my life; own 40 colonies at present; can furnish references. I am teaching school now but shall be at liberty Feb. 14, 1902. Distance no objection; shall not hire for less than 4 months. State wages and nature of work. B. E. GOODNOUGH, Coventry, Vt.

WANTED.—Buyer for 100 colonies; eight and ten Hoffman frame hives. Overstocked; all or part. R. A. YEAMSHAW, Walnut Grove, Cal.

WANTED.—To exchange extracted honey for foot-power saw or offers. Also wanted Texas horse-mint seed. W. C. GATHRIGHT, Las Cruces, N. M.

WANTED.—To purchase from two to four hundred colonies of bees, Langstroth hives preferred, in or near the State of Virginia. Please write. G. BOOMHOWER, Gallupville, N. Y.

WANTED.—A position by an experienced and practical bee-man to take charge of an apiary, or supply house. California, Florida, or Cuba preferred. Address "E," care of GLEANINGS, Medina, Ohio.

WANTED.—To correspond with honey producers east of Ohio, with the idea of adding high-grade honey to established family route. F. W. PROCTOR, Box 302, Spencer, Mass.

WANTED.—To sell 105 colonies of bees at \$2.50 each; or will rent them. H. VOGELER, New Castle, Calif.

WANTED.—One copy each 1888 and 1895 editions of the ABC of Bee Culture. Must be in good condition. Will give a year's subscription to GLEANINGS, or a copy of the 1901 edition of the A. B. C. Do not send until you write us. THE A. I. ROOT CO., Medina, O.

WANTED.—To exchange a Columbia talking-machine with 15 records, and gen'l mds., for bee-supplies or empty worker-combs in Hoffman frames; also want to buy some bees, but must be cheap and near here. PRESTON STORE & PRODUCE CO., Dority, W. Va.

WANTED.—To exchange high-grade L. Colton surveyor's compass and tripod for good bicycle, or offers. F. VAN DE MARK, Ripley, Okla. 1 cr.

Wm. A. Selser, Honey Expert,

When you buy honey, send a 3-oz. bottle, have it tested, to be sure it is pure. Price \$2.50 per sample. By doing this you may avoid over ten times this amount in litigation with pure-food laws. Chemist's certificate given.

The A. I. Root's Co.'s Office, 10 Vine Street, Philadelphia, Pa.

G. B. LEWIS CO., WATERTOWN, WIS.

*	<p>Our new catalog, describing and listing the FINEST LINE OF BEE KEEPERS' SUPPLIES IN THE WORLD, will be ready about the first of the year. If you have not been receiving a copy annually, send us your name and address and one will be mailed to you free. Prices will be same as last season with the exception of the narrow plain sections with no beeways, which will be 25 cts. per M less.</p>	*
*		*
*		*

Special Agency, C. M. Scott & Co., 1004 East Washington St., Indianapolis, Indiana.

AGENCIES: L. C. Woodman, Grand Rapids, Michigan; Fred W. Muth & Co., Southwest Corner Walnut & Front Sts., Cincinnati, Ohio; Fred Foulger & Sons, Ogden, Utah; Colorado Honey-producers' Association, Denver, Col.; Grand Junction Fruit-growers' Association, Grand Junction, Colorado; Robert Halley, Montrose, Colorado; Pierce Seed and Produce Company, Pueblo, Colo.; E. T. Abbott, St. Joseph, Missouri, Special Southwestern Agent.

BEE - SUPPLIES!

**ROOT'S GOODS
AT
ROOT'S PRICES.**

C. H. W. Weber, Cincinnati, Ohio.
2146-2148 Central Ave.

A NEW AND COMPLETE stock for 1901 now on hand. I am The Root Company's representative for Cincinnati and surrounding territories. . . You save TIME and FREIGHT CHARGES by having goods shipped from here. Convenience of railroad facilities here enables me to do so. Before buying elsewhere, write for my prices and catalog, which will be mailed you free of charge.

A JOURNAL
DEVOTED
TO BEES
AND HONEY
AND HOME
INTERESTS.

GLEANINGS
BEE CULTURE

ILLUSTRATED
SEMI-MONTHLY
Published by THE A. I. ROOT CO.
\$1.00 PER YEAR MEDINA, OHIO.

VOL. XXIX.

DEC. 15, 1901.

No. 24.



I'M AFRAID that, after reading p. 939, some beginner will expect a little more than he will realize. I suppose that \$28 dollars from a swarm in a fairly good season would be considered by Mr. Doolittle as rather exceptional.

I AM SURPRISED to find that, with a single exception, Maeterlinck's *Life of the Bee* is spoken of on both sides of the ocean as a work without fault. Can it be that its brilliancy and beauty blind the eyes to what are really serious defects?

IMPRISONMENT of nuclei for 24 hours, as mentioned p. 148, would not only give time for young bees to hatch out, but would go a great way toward making the bees stay that were already hatched out. [Yes, I think that is a good point.—ED.]

THE CHICAGO CONVENTION, Dec. 5, was a great success, both as to interest and numbers in attendance. C. P. Dadant, W. L. Cogshall, and others brought it up nearly if not quite on a level with the old Northwestern conventions which were so popular. No reason why there should not be a Northwestern at Chicago every fall. Editor York is a capital presiding officer.

"NO SET PROGRAM" is mentioned in the notice of Michigan convention, page 940. That seems to be getting to be quite the rule, and a good rule it is. The long papers can be read just as well in the bee-journals, but the face-to-face discussions can not be had without the meeting together. [Yes, providing we had live men to do the discussing; and usually our bee conventions have such men on hand.—ED.]

J. E. HAND says, p. 932, that the rule to winter outdoors colonies heavy in bees and stores, and cellar those light in either, holds good "wherever it is at all desirable to winter in the cellar." Perhaps, perhaps, friend Hand; but whenever I've tried win-

tering strong colonies out it has been at a loss. [But, generally speaking, I think friend Hand's rule a good one. Here is the situation for a large number. They have more bees than one cellar can accommodate. Obviously some colonies will have to be outdoors—which shall they be? The strong ones, of course.—ED.]

THERE YOU GO again, Mr. Editor, on a side track. You say, p. 929, that in *some* seasons \$5.00 per colony might be made in Florida, etc. Sure; and a good deal more than that in Marengo. But I don't begin to reach \$1.00 in the worst year; and I ought to reach \$5.00 in the *very worst* year if it is correct to say "that at least \$5.00 a year is a conservative estimate." [I beg pardon, doctor; I was giving you rather moderate wages. Let me see. Some time ago you figured up what the earning capacity of your bees was per colony. Have you got the data handy? If so, let us have it so that we can see how much you *are* satisfied with.—ED.]

F. B. SIMPSON, in *Review*, stands sponsor himself for the idea that freak best queens should not be selected to breed from, and tells me to come on with my brickbats. Well, here comes one, F. B. G. M. Doolittle says that for 30 years he has followed the plan of breeding from the best (and, if I understand him correctly, the more of a freak a queen was by way of securing exceptional yields, the better she suited him as a breeder), and as a result he has not only brought up his average, but has secured a much greater uniformity in the yields of different colonies. I don't say your plan is not better, F. B., but I believe breeding from the greatest yielders—freaks, if you please—yields excellent results; and it is easier to follow out than your plan for us common folk.

THAT SLEEPY FELLOW on p. 936 says he would pronounce a queen pure Italian if her workers were all three-banded or all five-banded. Please wake up, Rip, long enough to tell us some things. Would you pronounce pure a queen such as the editor mentions on the next page, with workers

varying from three to five bands? If not, and if there are no queens which produce all five-banders, do you pronounce impure all that produce part five-banders? Suppose I take the yellowest five-banders I can find, and have a queen of that stock mate with a drone of stock having black blood, but so little of it that no worker of that stock has less than two bands. The progeny of such union would not, of course, be pure Italian; and, if kept without any mingling, would not the black blood remain? By persistent selection from that stock, don't you believe I could get uniform three-banders? and would you call those uniform three-banders with the black blood still left in them—would you call them pure Italians?

AN EDITOR who will insist upon ungrammatical expressions ought to be "took" and "shook" until "well shaken." If "shook" (aside from its grammatical form) expresses to your mind an idea different from the idea expressed by "shaken," Mr. Editor, then there's something wrong with your mind, and the sooner you send it to some country school for repairs the better. If you mean bumped, say "bumped," as I think they do in England, but don't say "shook" when you mean either "bumped" or "shaken." I've had enough work trying to learn correct English without any bad examples "in high places." [Look here, doctor; if you are going to correct all the accepted ungrammatical English, you will have a job on your hands. For instance, when you sit on your doorstep, and call your wife out to admire the beautiful sunset, do you speak of the *setting* or *sitting* sun? Come now; there are bigger giants that are setting bad examples for you. Go for *them*. Now, honor bright, don't you think it sounds better to say the sun *sets* than *sits*?—Ed.]

COMMISSIONER JONES, of the Illinois Pure-food Commission, is severely blamed on p. 942. I don't know, but I think he is not guilty. Newspapers are not always reliable. Some one else may have said what is credited to Mr. Jones, or what he did say may have been distorted. But severe blame is due somewhere, and, according to the *Amer. Bee Journal*, the *Chicago Tribune* is not willing to do its fair share to help undo the mischief already wrought. [I think you are probably correct, for I have already had intimations that a subordinate, instead of Commissioner Jones himself, furnished the reporter with that rank nonsense. In my editorial, you will remember, I stated that the Commissioner is *reported* to have said so and so; but whether he did or did not say it, if his sentiments are not expressed it is his bounden duty to correct the mistake. In the absence of any statement to the contrary, he stands as approving the nonsense. My own feeling is that, if I were in his shoes, the "subordinate" would be politely told to turn the reporters over to his superior; and, further, there would be a corrected statement over my own

signature that would set me right before a very large class of people—the honey-producers.—Ed.]

THE MOUNTAINS have a big credit to their account, p. 941, for storing snow and ice to be used afterward to irrigate the great deserts. But ought not the debit side be given also? If the mountains were not there would there be any desert? Does not the mountain condense and stop the moisture that would otherwise descend in beneficent showers on the now desert plain? [That is a hard question to answer. But even if the mountains did not act as a barrier to the moisture or rains, they still have the advantage that they are great storage reservoirs, if I may use so incongruous a term, for millions of tons of snow. Suppose, for instance, that Illinois, Iowa, Kansas, and Nebraska had always had to depend on irrigation. Think you they would have had the drouth of last season, or ever would have one? Never. Then, besides this, the land in the vicinity of the mountains can be watered whenever plant life requires it. The mountains make it possible to have a *dry* and hot atmosphere; and with storage reservoirs for water the conditions are such that certain kinds of crops can be grown that can not be grown with any success in the rain-belts. Understand, I am not claiming that irrigated lands are better than lands in the East; but the fact is, one supplements the other.

Again, some people positively can not live in a rain-belt, owing to pulmonary troubles. There are thousands and thousands who have to find life and health by moving to these dry climates—climates made so, if your theory is correct, by the mountains. Somewhere I saw the statement that over half of the inhabitants of Denver and Los Angeles are "one-lungers." While this is probably greatly overdrawn, yet you would be surprised to see how many among your casual acquaintances have gone to these places because they had to or die in the East.—Ed.]



Who says the winter has no cheer
For man or bird or beast?
If summer reigns within the heart,
Stern Zero brings a feast.



We have just received from Mr. Wartmann, of Bienne, Switzerland, two maps of that country by cantons, or counties. By the various colors one can see by one map just how many colonies of bees per 1000 inhabitants there are in a given locality; and by the other, how many colonies there are at certain elevations, which latter vary immensely, of course, in that country—"the

New Hampshire of Europe." Such an arrangement for the different States here would certainly be interesting, and perhaps profitable. The European governments pay great attention to such things. We thank Mr. Wartmann for sending the maps, of which he himself is the author.

We have just received a copy of a French bee-journal, published quarterly in Tunis, Algeria, Africa, entitled *Bulletin de la Société d'Apiculture de Tunisie*. Algeria being an integral part of France, this journal is fully abreast with the times, although it says that bee-keeping there is mostly in the hands of the natives. It contains 32 pages the size of this, with a table of contents of great merit, especially good for beginners. Those who can read French will find this journal worthy of particular attention. The French have had control of Algeria since 1856. On the northern coast, nearly parallel with the shore of the Mediterranean, running a thousand miles west of Tunis (near ancient Carthage), there is a well-equipped railroad, built by French engineers. Morocco, on the west, has not a mile of railroad, but is still in practical savagery under Mohammedan rule.

AMERICAN BEE JOURNAL.

Mr. York wrote a vigorous protest to the *Chicago Tribune* relative to Commissioner Jones's misleading statement about the bogus nature of white comb honey, as explained in our previous issue. He delivered the article in person, with a section of his own best white comb honey. The *Tribune* printed a few garbled extracts from the article, but in a way that seems more like a defense of its course than an attempt to right a wrong. Doubtless that paper poses as a "friend of American labor," yet it rides rough-shod right over it. But the regard the *Chicago* dailies have for authentic information is shown by their treatment of the canteen question in that place. Bro. York, those sheets are hopeless. As you say, it is "exasperating" to read them.

ROCKY MOUNTAIN BEE JOURNAL.

This journal is holding its own in point of interest, and even gaining a little. The two following editorial items are worth pondering over:

The only logical outcome of the present great era of trust formation is national, State, and municipal operation of all industries dependent upon the concession of special privileges.

The "cellar apiaries" in Los Angeles and San Francisco are credited with enormously augmenting the honey crop of California, and greatly to the detriment of producers of honest honey. Here is work for the new honey association. The glucose-mixers should be relentlessly prosecuted to the full extent of the law. No mercy should be shown them—nor the adulterator of any other food product.

A new source of danger to the bees is described below:

At the recent meeting of the Utah State Bee-keepers' Association a good many bee fatalities are reported as resulting from the poisonous fumes exhaled by

the great smelter-stacks. Both bees and smelters are numerous in the vicinity of Denver, but we have never heard of the latter being fatal to the former. Possibly a different system of smelting, employing more virulent chemicals, is necessary for the extraction of the precious values from the ores of Utah. The remedy would seem to lie in the use of smoke-consumers; and their use would need to be compelled by a stringent State statute, as trust corporations have never been known to be influenced except by brute force or self-interest.

Concerning foul brood in Colorado, the following editorial is strong but interesting:

In years past, Colorado has, perhaps, suffered more from the ravages of foul brood, in proportion to the number of colonies kept than any other State. The truth is, in some of the districts nearly all the large apiaries were swept away before their owners realized the fatal character of the disease. These men never read a text-book on apiculture nor a bee-journal, nor belonged to a bee-keepers' association, and resisted the bee-inspectors until their bees were dead and their hives a rotten mess of corruption. Most of these fossilized apiarists have never re-entered the ranks, and the few that did have stepped out into the light and have become progressive apiarists in all that the phrase implies.

Here is the next paragraph, which is more hopeful:

While foul brood whipped out many of the original apiarists of the State, it is not considered a serious menace by the intelligent "new blood" that has succeeded them. In the "locality" broadly included in the term Colorado (probably just as applicable to the entire Rocky Mountain region) the character of the honey-flow is such as to permit a system of management for comb honey that practically renders the apiary immune from the disease.



A BURLESQUE ON LONG TONGUES.

The Factor of Time in Producing New Varieties.

BY S. E. MILLER.

For some time past, the wheels in my head have been working on a new problem. I have conceived the idea of developing a strain of bees whose tongues will be long enough to reach the nectar in the red-clover blossoms. It should not take over three to six months to bring this strain to perfection, and—just think! what an acquisition this would be for the queen-rearer! and it might also indirectly benefit the honey-producer. I think it was Dr. Miller who, some years ago, suggested that all jokes should be labeled. I will, therefore, state that the above is a joke. However, there is a serious side to this question, and it is the serious side which I propose to discuss.

The long-tongue discussion has hardly been discussed. There has scarcely been time to rear a tested queen and ascertain the merits of her workers since the discussion commenced, until—presto, change! and we have the long-tongued bees made to order, guaranteed to cure or money refunded. If your druggist does not keep them, send a dollar direct to Dr. Long Tongue, golden-banded red-clover queen-breeder.

Now, brother bee-keepers of the queen-rearing persuasion, do not conclude that I wish to compare you with the fellow who induces simple credulous people suffering from some imaginary affliction to send their hard-earned cash for his nostrums in the hope of being benefited. The advertiser has, of course, a right to say what he likes in the space which he pays for, provided he uses no bad language; but when we say we have been or pretend to be able to furnish queens whose workers will gather the nectar from red clover, are we not, in ninety-nine cases out of a hundred, claiming what is not true? Are we not going too fast in pretending to have now that which we may hope to develop in a decade or perhaps a century? Great improvement in the animal and vegetable kingdoms has not been accomplished in a day or a year.

Many patient, energetic, studious, and intelligent minds have worked on these problems for decades, even centuries. Many men have devoted almost their lifetime to the improvement of a single species, or certain varieties of various fruits, flowers, animals, and fowls. Note, Mr. Burbank, of California, has devoted a great portion of his life to the improvement of plums, potatoes, etc., and has also, I believe, by hybridization, produced some new and rare gladioli. Considering the above, how can we claim to have the desired long-tongued bee? Such a bee is something not to be found every day in every queen-rearer's apiary. Among many hundreds of queens that I have had under my observation in the past 16 years, I had one real red-clover queen.

One of the chief if not the first essential to the development of the red-clover bees of the future is the controlling of the mating of queens. With this accomplished we shall be in a fair way toward accomplishing our object. In the absence of this the best we can do is to prevent the flight of undesirable drones. The red-clover bee of the future will not come up to our standard simply by having a long tongue. The ideal long-tongued bee, in addition to possessing the long tongue, must be industrious, vigorous, hardy, as gentle as possible without detracting from any of the first four essentials; and in order to please some of us it must have yellow bands around it or be yellow all over. The queens must be prolific, and possess all other desirable traits.

Now, Mr. Queen-rearer (I almost said queen-breeder, but you are not a queen-breeder—you rear the queens, and they breed according to their own sweet will), have I set before you a hard task? If so, do not be discouraged, but go forth and set to work; and after you have done all you can, and your son has taken up the work where you left off on account of old age, and has devoted a score of years to the development of the ideal long-tongued bee, he may come back and report that he has lengthened the bee's tongue by a third, and has not let any of the other essentials retrograde, but, on

the contrary, has improved them; but don't you come back to-morrow or next week or next year, and say, "I've got that queen now," or I will tell you you're another.

Remember, now, ninety per cent of that queen's daughters (no, I will drop to fifty per cent) must be as good as she is; but if only ten per cent come up to the standard I can not take her, and your son will have to go back and teach his son to take up the work, and labor to reach the goal.

I should like to tell all about that red-clover queen; but as this article is already longer than I had intended I will simply state that her workers gathered nectar from red clover, and stored it in quantities in 1-lb. sections, while all other bees in the yard gathered practically nothing.

Bluffton, Mo.

[I have been thinking myself that something more ought to be said along the lines presented by Mr. Miller. There was a time when there was a great craze for yellow bands. It grew to such intensity that many breeders were looking only for color, forgetting every thing else. While this was true, there were a few who looked for excellence as well as beauty. But the temptation in most cases was to breed out dark and breed in the yellow, at a sacrifice of many very desirable qualities. It was J. M. Rankin or Dr. Miller, I believe, who started the discussion about long tongues. It will be remembered that I discouraged the latter, and even ridiculed the idea; notwithstanding, he insisted that the Europeans had found that there was considerable variation in the length of tongues, and that we in America ought to give the matter some thought.

Two seasons ago, when red clover was at its height, I determined to look into the matter. The bees were working on a field of red clover near our out-yard. I noticed how the Italians (there were no blacks) probed down into the shorter flower-tubes of the clover-heads near the edges; how they would reach down into the longer tubes, and apparently reach in vain. I watched the bees come and go on one head for some little time. After they had secured all the nectar it was possible for them to get out of the little tubes, I pulled the head; then, taking the end of each tube in turn, I squeezed it up till I could force the drop of nectar out. In the long tubes I observed that the bees could not get more than a tenth, or merely a taste of the nectar. The shorter ones they sucked dry. I then began to see that, if those same bees had longer tongues, or tongues long enough to reach into the longest tubes, we should be able to get *tons* and *tons* of good honey that now literally goes to waste. It was during this season we had one colony from an imported queen that far outstripped every thing else in the apiary on red clover; and, as I have before stated, this colony would gather honey and store it when other bees would be trying to rob, or would starve

to death without a supply of honey already in the hive. I immediately began to measure the tongues of its bees, and I was not a little gratified to see that these same bees had longer tongue-reach than those that were inclined to rob at the same time. Fearing that I might have made a mistake I had one of our men do some measuring, and his observations were the same as mine. I then began to think that there might be something in long tongues. We called for reports. A few came in, that for the time being seemed to confirm the theory, but they really proved nothing. We asked for more reports, but they have not come in. As I have already said, no *substantial* proof has been advanced that long tongues are in proportion to the honey yield, and so far there is only a theoretical advantage. And now that two seasons have gone by, it is but fair to say that the proof is still lacking, either because of the apathy of bee-keepers to report or because there is no real direct relation between the two. But the value of our red-clover queen under consideration we considered rested not on the length of the tongues of her bees, but on the fact that they gathered honey from red clover when other bees were idle; and her daughters were sold because the mothers' bees gathered honey in excess of other colonies; and I believe that those who are advertising long-tongued stock are really placing more stress on their honey-gathering qualities, and not because they may have long tongues as compared with other bees in the yard.

Mr. Miller is strictly correct in saying that it will take years to stretch the tongues of our present varieties. But in the mean time let us concentrate our efforts toward breeding bees for business. If we get long tongues, well and good; but let us not go so far as to concentrate all our energies on yellow bands or long tongues, or some other feature that of itself amounts to nothing.—Ed.]

THE SEASON OF 1901.

A Big Honey-flow for our Big Friend; Long Tongues and Honey-gathering.

BY G. M. DOOLITTLE.

I commenced to keep bees in the spring of 1869, so have been in the bee-keeping business for nearly 33 years. During those years we have had many peculiar seasons, but none so much so as that of 1901; therefore I thought the readers of GLEANINGS might like to know something about it.

We have been in the habit, of late, of laying considerable stress on location, which was right and proper; but the bee-keeper who fails to realize that seasons are *not* alike, and so conforms to set rules of working, expecting that the same rule will work the same result each season, if applied to the same locality, will find that success

will not always follow such a course. The successful apiarist must keep an eye out for *all* the little and big kinks which often come up in the business, so as to turn each and every thing to the best advantage, leaving no stone unturned which will allow of a pound of honey being obtained which would otherwise have gone to waste by not being treasured in the hive, and, finally, into some of the necessities or luxuries of home life for himself and family. These thoughts suggest themselves from the fact that a honey-flow came so suddenly from an unexpected source this season that Doolittle came very near being caught with his "porridge-dish bottom side up," last June. The bees were set from the cellars about the middle of April; but the weather was so bad for the next two weeks that it seemed that the results would have been better had they been left in the cellar till May 1. High winds, with mostly cool, cloudy weather, prevailed all through the last half of April, yet there would often come a few minutes of sunshine, by the sun's peeking out through some rift in the clouds, when the bees would go out in search of water and early pollen, only to get lost by the clouds going over the sun again. With May came nice weather for the bees, and they went to brooding with a will, as plenty of pollen was to be obtained from the different early pollen-bearers, while early honey came in from the willows and soft and hard maple. Then it came on to rain, and it did rain most of the time for nearly or quite a month, being cool withal the most of the time, so that, in spite of all I could do by way of feeding or coaxing, brood-rearing stopped pretty much entirely in all colonies, the "pretty much" being at the out-apiary, and the "entirely" here at home. I was so eager about this brood matter, as brood at this time meant workers in the basswood-honey harvest, that, before I was hardly aware of it, the red clover, standing on the hundreds of acres in this locality, commenced to assume a pinkish hue, and then turn red, something not known for nearly or quite 20 years, owing to a midge working in the head, thus blighting the buds just before the blossoms opened, so that we had neither blossoms nor seed in these parts for that length of time.

At about the same time the rain ceased, the skies' cleared off, and the weather became warm, and then hot—so hot it could hardly be endured by humanity from June 20 to July 10. June 15th I stopped feeding, and on the 17th I thought it would be best to take the feeders off, some of which were placed on the hives in extra-surplus arrangements. When I came to the first of these surplus arrangements I found the bees in there building comb with a little thin nectar in the cells, the sight of which stimulated me to greater activity, if possible, than that manifested by the bees. Feeders were rushed off, and the supers, filled with sections, rushed on, so that the night of the 18th found every thing in readiness for the

harvest, which, by the 20th, was coming in at a good basswood rate, only that the nectar from clover is much thinner than that from basswood. Had I not had every thing in readiness to set right on the hives (the surplus arrangements being all filled during the winter with sections having foundation and baits in them) I should have lost much from this rush of nectar coming on so rapidly from an unexpected source. The red clover continued in bloom from June 15 till nearly August 1, that giving nectar in June and the first third of July being mostly from the small kind, while, beginning with July 10, the mammoth kind gave the most, the yield from each being curtailed to quite an extent, as field after field was cut for hay. Basswood yielded fairly well, but the yield from this was mixed with the clover yield, so that it was impossible to tell just what the basswood yield would have been had no clover been in bloom.

With August came a dearth of honey which lasted till about the middle of that month, when buckwheat began to yield very moderately, and continued thus for about two weeks, when the season for 1901 was over, so far as honey was concerned. The larger number of colonies in each apiary were heavily drawn on for queen-rearing, those at the out-apiary to supply bees for nuclei, and those at home by having their queens taken from them to supply early orders, so that I can not tell what the yield from the whole would have been had these colonies not been robbed in this way. From the few colonies which were not drawn on in this way I obtained an average yield per colony of 180 lbs. of section honey, here at the home yard, and about 175 at the out-apiary, this being the highest average yield of any year in my bee-keeping history. The best before was in 1877, when the average yield was 166½ pounds per colony. But in 1877 a small part was extracted honey, while this year I extracted none.

Having the results at my command, and seeing that Prof. Gillette, of the Colorado Experiment Station, desired bees for the purpose of measuring their tongues, I sent him 12 bees from each of four colonies, numbering them as 1, 2, 3, and 4. No. 1 was from my old honey-gathering stock, which I have been about 30 years in trying to perfect. No. 2 was from a queen I got by way of exchange in 1900; No. 3 was from a golden breeder, and No. 4 was from a queen of the long-tongued stock introduced April 29, 1901.

Colony 1 gave 261 completed one-pound sections, 21 partly filled, and had about 42 lbs. in their hive October 1 for wintering, or about 317 lbs., all told.

Colony 2 gave 44 poorly filled sections, and had 12 lbs. in the hive October 1, or about 54 lbs. in all.

Colony 3 gave 68 completed sections, and had 37 pounds in the hive October 1, or 105 lbs. in all. But this colony was drawn on for brood for queen-rearing several times a week during the whole of the season, so it

would be impossible to tell just what it would have done had it been otherwise.

Colony 4 gave 65 sections and had 28 lbs. for winter. The result of Prof. Gillette's measurements is as follows: No. 1 gave an average tongue-length of 25.4 hundredths of an inch; No. 2, 25.6; No. 3, 25.6; and No. 4, 25.8. From these measurements it will be seen that the bees from the long-tongued stock really had the longest tongues by four-tenths of a hundredth of an inch over No. 1. It will also be seen that the colony having the shortest tongues gave more honey by 65 pounds than all of the other three colonies, having longer tongues, combined. All were worked as nearly alike as possible, with the exceptions noted.

It may be claimed that all these colonies gave bees with unusually long tongues. This may be so; but it does *not* prove that the gathering was in proportion to the length of tongue.

On page 401, May 1, 1901, I see a proposition to send the measurements of tongues from both good and poor workers to Dr. Miller, so he could tabulate a report of the same. I have been looking anxiously for that report; but if it has been given I have failed to see it. When Rambler reads the above he may feel different from what he did when he wrote on "back numbers" on page 745. No, no, Rambler; Doolittle *always* rejoices when one brings out something ahead of what has been done in the past, and *never* thinks of "whacking" back because some one has been enabled to give an advanced thought on something he has dug out. I have been experimenting and writing these 30 years only that I might be of some little help to the bee-keeping world; and to the one who is thus working, improvements which are *real* are always a cause for rejoicing. True Christianity consists, in part, according to the Bible, in making the world better for having lived in it.

[A partial answer to this is given in the answer to Mr. Miller, just preceding. In the record of your four colonies, the measurements of the tongues are so nearly alike that really there is no difference, at least for practical purposes—that is, honey production. Between the bees in No. 1 and those in No. 4 there is only $\frac{1}{10000}$. This is so infinitesimal that it counts for nothing. If, however, No. 1 showed a tongue-reach of $\frac{16}{100}$ and No. 4 $\frac{23}{100}$ or $\frac{2}{10}$, then there would be a decided variation. It is evident, however, that colony No. 1 did not produce the 317 lbs. of honey, all told, because its bees had longer tongues than those of the others. Its honey-gathering qualities were dependent on some other characteristic or combination of them. Prof. Gillette's figures show tongue *length*. Now, it may be that the actual tongue *reach* was much greater in the colony that produced the largest amount of honey than in the others. You will remember I have drawn a distinction between tongue *reach* and tongue *length*.—Ed.]

RAMBLE 195.

Peculiar Conditions in Central California ; the Rapid Growth of Alfalfa ; too Much Irrigation the Cause of Blight in the Blossoms.

BY RAMBLER.

It does not take a great amount of observation in Central California to learn soon that the conditions for honey-production are entirely different from what they are in the older and more familiar fields in the United States; and, furthermore, the conditions are very perplexing. In New York, where I first learned to sling honey, and, in fact, in all portions of the East, if honey comes at all we know within a few days when the flow will be at its best, and we can prepare our colonies accordingly; or, in other words, the wide-awake bee-keeper will have his dish right side up and will catch the liquid. It is the same in the sage districts of Southern California. But in the great San Joa-

quin Valley the bee-man does not know where he is at, half of the time. The bees start in very nicely in February upon the almond bloom, and then through March and into April there is a succession of fruit bloom; and just as the colonies begin to get ready to swarm, and do swarm sometimes, there comes a dearth of honey; and all through May, and often through June, the bees use up what little surplus honey they have gathered, and, unless fed, they starve.

I am told that the bees do commence work sometimes in June upon alfalfa; but during the two years of my experience, this commencing to work has been between July 1 and not until late in the season. If the yield commences early in June, some of that big force bred in March and April holds out to gather some honey and to hold up the breeding of bees, and a good honey crop is secured. The same may be said with some modifications if the yield does not commence until July. During the past season the honey-yield was deferred until well up to September, and the alfalfa cut but a small figure in the yield; and upon this point I should like to compare notes with bee-keepers in other alfalfa districts, where irriga-



A CALIFORNIA BEE-KEEPER WITH DOG AND GUN.

It is during this starvation period that the bees are brought up with a round turn in their swarming plans; and, no matter how much honey they may get afterward, the fever does not return; and I am wondering, Mr. Editor, if it is the same conditions that check swarming in Texas and other points.

My experience in this location covers two years; and during this time all of the breeding from fruit bloom has been a useless tax

tion is practiced, and learn if the same conditions exist.

In Central California we have an abundance of water for irrigation. It is used lavishly upon the alfalfa-fields, and the growth of the foliage is rapid and rank. In the height of the season I planted a stake in the field, and every 24 hours measured a particular stalk, and for several days the average growth was $1\frac{3}{4}$ inches per day. All through April and May the alfalfa comes to maturity, and is mown; but the blossoms are of no use to the bees, for they are blasted.

The editor of GLEANINGS will remember the rank growth of alfalfa all around my cabin, and the fuzzy white tips of blasted blossoms. This condition continued all through the period of irrigation; and, as a consequence, alfalfa yielded but little honey. When I observe such effects I naturally try to find the cause; and I had a

suspicion that it was from too much flooding with water. In comparing notes with my neighbor, Mr. Fray, he entertained the same idea. He has kept bees in this valley for several years, and his explanation of the cause of blasted blossoms is very reasonable. He says that, when there is a light rainfall through the winter, little snow on the mountains, there is less water for irrigation, and it is taken from the ditches in June. Then the non-irrigated fields of alfalfa will bloom, and yield honey. But if there is a heavy rainfall, and all of the mountain reservoirs are filled, and the water is not taken off until August, there will be but little alfalfa bloom and honey, and that has been the condition during the past season.

To verify Mr. Fray's opinion, there was a patch around my cabin that did not get its drenching with water, and that particular spot was well covered with blossoms. It seems, then, that the conditions in Central California are directly the opposite of the conditions in the South. There they must have the rain; but here only a small amount is necessary; but with either a light or a heavy rainfall there is an uncertainty when the flow will commence.

The past season has been one of extreme uncertainty. Up to Sept. 1 but little honey had been extracted; but late fall flowers came on in abundance; our hopes were revived; the extractor was operated clear up to Oct. 30; and in my case, where I expected barely three tons, nearly a carload was secured.

The great problem in this valley is to learn how to hold the bees in when they want to increase, and make them increase when they don't want to. I think the problem is not very hard to solve; but as my plan is as yet theoretical I will not now present it.

Before I leave Central California I wish to say a word about my good neighbors, and somehow I always have splendid neighbors. Mr. W. W. Westcott and his good wife are bee-keepers, and always working together in the apiary. Mr. W. could hardly open a hive unless the "Mrs." was on the other side of it operating the smoker. Perhaps her knowledge of bee-keeping was not very bookish, but upon one point she excelled; and that was in the baking of graham bread, an article of food for which the Rambler is partial.

Mr. Fray was another good neighbor. His portable honey-house was described some months ago. When not engaged with the bees he has a habit of taking long trips to the mountains, with dog and gun; and many a deer and bear and mountain lion have scented powder from his trusty rifle.

I herewith present his photo, with said gun and dog. He thought the pile of honey cans and cases around my cabin would show up well as a background. Said cans and cases were nearly all filled afterward, which is not a very discouraging feature.

Another good neighbor is a fine old Swiss

gentleman, and his combination is bees and a vineyard, and the product is honey and wine. That is not according to my idea for the use of grapes; but upon my first visit my neighbor did not know my sentiments, and he brought out a bottle of his choice wine. I told him I never drank wine.

There was a perplexed expression on his face, and in his broken English he said, "You vas him Ramplear; tid I not zee he peekture in him bee-baper you vas had him a pottle?"



"Ha! you vas him Ramplear; tid I not zee he peekture in him bee-baper you vas had him a pottle?"

"Oh! no, sir;" said I, laughing; "that was not a bottle, it was my camera. See, I have it with me now." He put up his hands as though to ward off any intention of picture-taking on my part, and I let that part pass; but in his apiary I found a great curiosity—a hive of bees and growing grass,

Bermuda grass is a genuine pest in this country; and when it gets into a vineyard, or an alfalfa-field, if neglected at all it will

soon take full possession. A hive placed near it, with a crack in the bottom, is sure to be invaded. The bees have a vexatious time with their octopus. I mentioned the case to other bee-men, but they treated it as nothing new, for they had all experienced the same thing, and a simple remedy is a tight bottom-board.

[The cause that brings about the cessation of swarming in Central California is very different from that which operates in Texas and Arizona. In the former, the bees stop swarming because starvation stares them in the face; in the latter, the very opposite extreme—an onrush of honey—checks increase.

All through the line of my travels I heard complaints about alfalfa-blossoms blighting at certain seasons and in certain localities. I remember distinctly my conversation with the Rambler at his cabin home on this point during the past summer; but at that time I think he had not fully settled in his own mind what was the cause. If it is indeed too much irrigation, then bee-keepers ought to contrive some way, if they have a grain of influence, to get their ranchmen neighbors to use less water. I should be inclined to believe that the very thing that brings about the blight of the blossoms would also operate to affect the quality and quantity of the hay. This is a matter for experiment stations to take up providing they have not already done so. In the mean time I should be glad to hear from any in the alfalfa regions, and have them give their experience and observations.—Ed.]



DRONES AND QUEENS.

"Good morning, Mr. Doolittle. Did you ever read any of Mr. Kirby's writings?"

"Yes, I think so. He was quite a prominent man years ago, and thought by some to be quite an authority about matters pertaining to bee culture at that time."

"An old gentleman visited me a few days ago, and he said Kirby claimed that the drones assisted quite largely in the production of royal jelly, which he believed; and that good queens could not be produced unless there were plenty of drones in the hive where queens were being reared. I tried to make the old gentleman think that he was mistaken, but it was of no use; so I have come to see you to see what you think of the claim."

"This is only the unearthing of the old theory which Kirby and others believed in forty to fifty years ago."

"Why do you call it a theory?"

"Because all of my experience goes to

prove that the drones are of no use whatever except to fertilize the queens, with the possibility of adding their mite to the warmth necessary during cool nights for the development of the brood, and possibly in helping to maintain the desired heat for comb-building."

"But suppose a colony is very anxious for drones. Do you not suppose they would be more contented if they had such?"

"Undoubtedly, if a colony which was anxious for drones could be kept actually droneless, both in the brood and mature drone shape, drones would aid toward contentment; but I have never known a case of a colony desiring drones but that they would manage to raise some in some corner of the hive. So I reason that such a thing as keeping a colony, desiring drones, absolutely droneless, is pretty nearly, if not quite, a myth."

"But what was your experience going to prove—that Kirby's claims were only theory?"

"When this theory was being resurrected, some 25 years ago, I had a number of queens superseded early in May, before there were any drones in the apiary, and they were as good queens as I had ever reared. Now, if the drones assist in the preparation of royal jelly these queens should have been inferior, to say the least, to those reared when drones were plentiful. Is not this right?"

"It would look that way, certainly."

"Again, I have many times had queens reared in March and April, when there would be no drone brood in the hive, or any in any hive in the whole apiary; and after a month or more, when drones had emerged and were flying, had them fertilized and become fair queens. However, queens reared in a season when no honey or pollen is being gathered, and at a time when regular feeding can not be done, are usually inferior to those reared when honey and pollen are plentiful."

"But the old gentleman told me that if I would remove a queen from a colony having plenty of drones I would see a profusion of queen-cells dotting the combs, which I could not secure at a time when there were but few drones in the hive."

"This is another of the old ideas, and something I have proved as fallacious. In August, 1873, I think it was (I could tell by referring to my diary), I had the largest lot of queen-cells built by the removal of a queen which I ever had. The number, as I recollect it, was 163, yet this hive was devoid of drones at the time, having killed them after the basswood-honey flow was over."

"Were these cells all good ones, and did they produce all good queens?"

"Of course, all did not give good queens; but the number of as good queens as can be reared this way was in proportion to the cells built. If my memory serves me right, queens were reared from this colony on account of the queen showing no disposition

to rear drones, as she rarely laid eggs in drone comb before the middle of June."

"The old gentleman further said that, if a queenless colony of black bees was supplied with eggs from an extra choice pure Italian queen, the offspring would not be pure, on account of their being contaminated with the royal jelly produced through the black drones and nurses. What do you think of this matter?"

"Pallacious as any of the rest."

"Why do you say that?"

"The first Italian queen that ever came into these parts was an extra good one. In fact, I have had very few queens that would so nearly duplicate themselves in their queen progeny as this one would. As she came late in July, not a drone was reared from her brood that season, nor was there a single Italian drone or queen in all this section of country when she came. She was introduced into a colony of black bees, as there were no others to introduce her to; and as soon as the larvæ from the black queen were all sealed, she was taken out and introduced to another colony, when the former colony went to work rearing queens. Thus she was changed until queens were obtained for the whole apiary of about 25 colonies. These queens mated with black drones, of course, as well as to be raised by black bees. Now, according to what we have always been taught, these queens, having all mated with black drones, should have produced hybrid workers, or bees, a part of which should have been black, to say nothing about their being nursed by black bees, and fed royal jelly in which there was an element coming from the black drone, according to what the old gentleman would have us think."

"Yes. And did you not find it so?"

"No. Not one of those queens ever produced a black bee."

"That is strange."

"Yes, and I thought so at the time; but since then we have had other instances where queens were so thoroughly bred along the Italian side that their daughters never gave a black bee, though they met pure black drones. But when the daughters of these queens came to produce bees, then it was that part of the bees emerging from the cells were black. I used to think the theory of black nurses imparting impurity to the royal larvæ was invented to palm off poorly marked Italian stock. But as we have heard so little about this matter of late, I have not touched it before in some time."

"What is royal jelly, or what is it composed of?"

"As to what royal jelly is composed of, I do not feel competent to tell, not being a chemist. But all of my experience goes to prove that the drones have nothing whatever to do with it."

"Well, what is your idea then?"

"Ideas are of little value by the side of facts; still, I will tell you what I think, and perhaps some one will tell us in the

near future how far these ideas are out of the way. My idea is that royal jelly is the same food as that given to the worker larva during the first 48 to 60 hours of its existence, and that it is the abundance of the supply that is kept up from the time the larva hatches till the cell is sealed that changes the egg laid for a worker into a queen. It is also my opinion that said food is composed of honey, pollen, and water, taken into the stomachs of the nurse-bees and formed into chyme, when it is fed to the larva. But I must leave you now, as I have an article due for the *American Bee Journal*, which must be written yet to-day."



J. H. MARTIN, ALIAS "THE RAMBLER," IN CUBA.

MR. MARTIN, whom we sent from California to Cuba to write up bee-keeping in that island, famous for its honey, arrived there safe and sound. He writes us he is so well pleased with the country that he will sojourn there for a while. He will continue making the production of honey his business, and during his spare time he will make tours over the island, taking along his camera and gathering material for his Rambles. This series of articles will be unusually interesting, and will begin soon.

NOMINATIONS.

A SHORT time ago I nominated Mr. Wm. Rohrig, of Tempe, Arizona, and Mr. Harry E. Hill, of Fort Pierce, Fla., as possible members of the Board of Directors of the National Bee-keepers' Association. The latter, it will be remembered, is editor of the *American Bee-keeper*. While he appreciates the honor thus conferred, he says he deeply regrets the use of his name in this connection; that the *American Bee-keeper* prefers remaining outside, with the assurance that it will earnestly co-operate with the Association in every move which it recognizes as beneficial to the fraternity. He prefers, then, not to have his name appear as a candidate. Mr. Rohrig feels that he is not competent to fill the position; and that, if he thought his name would be seriously considered, he would ask to have some other name put in its place.

I can guarantee that either or both of the men would fill the office very acceptably; but I do not wish to push their names forward if they do not wish to be considered.

SLANDERS ON THE HONEY BUSINESS.

EVER since the alleged interview with Commissioner Jones, in which the latter is made to say in effect that all fancy and No. 1 comb honey is adulterated because it has

white cappings, there has been an unusual crop of slanders in the papers concerning the honey business. The result of this is that the bee-keeping industry has been damaged to the extent of a good many thousand dollars. We have sent every paper publishing such stuff a respectful protest, telling them the facts and sending a copy of our \$1000 reward card,* to the effect that we will pay that much to any one furnishing proof that comb honey is successfully manufactured, and so perfect an imitation that it can not be detected from the genuine. We have made our replies in such a way that it will be easy for them to back down if they will. The editor of the *American Bee Journal* and of the *Modern Farm and Busy Bee*, I note, are also engaged in the same work.

It is the duty of every bee-keeper who sees such false reports to answer them at once. The refutation should be couched in respectful language, and should be accompanied with proof or \$1000 reward offer.

I shall be glad to believe that Commissioner Jones did not utter the foolish statements that are imputed to him. I am also pleased to learn that, so far as he is concerned, he is probably quite willing to have all such statements corrected providing the papers will print his denial. At the Chicago convention recently, a committee consisting of Geo. W. York, C. P. Dadant, and Dr. C. Miller was appointed. But our subscribers must not expect these gentlemen to do all the work of answering these canards. A bee-keeper in his own locality has more influence—much more—than an outsider hundreds of miles away.

CANDIED HONEY—"EDUCATING" THE PUBLIC.

In a letter recently received from R. C. Aikin, of Loveland, Col., he writes that he put up over 20,000 lbs. of honey in lard-pails, let it candy, and that now there is less than a fourth of it left, or a total of 16,000 lbs. of candied honey sold in three months. He is now buying more extracted, and proposes to put it in paper bags, just "to save money and to head off the tin trust," as he says. This goes to show what can be accomplished in one's own locality by educating the consumers. In the East they have been taught to call for extracted, not candied. It may be well, in view of the large amount of the glucosed product on the market in jelly-tumblers, with a little piece of dry comb in it, to educate our consumers to the use of candied honey. Just imagine, if you please, the glucose people trying to make their product candy solid. If the consumers of the whole United States were "educated," or made to understand that our product in the granulated form of a certain amount of consistency was absolutely pure, they would buy honey in that shape and give the glucosed

* We will furnish \$1000 reward cards free for this purpose.

jelly-tumbler the go-by. There, now, I do not mean to advocate that we of the East should put out candied honey exclusively. Oh, no! but I only desire to show that, where a locality is "educated" to the use of honey in this form, it would buy quantities and quantities of it, as well as clear extracted, because it would know it was getting *pure* honey.

SQUARE VERSUS TALL SECTIONS.

THE demand for the tall is certainly increasing. Already in several markets it is outselling the square shape. A short time ago I picked out two fancy plain sections from our stock, one of each type, photographed them, and here is the result.

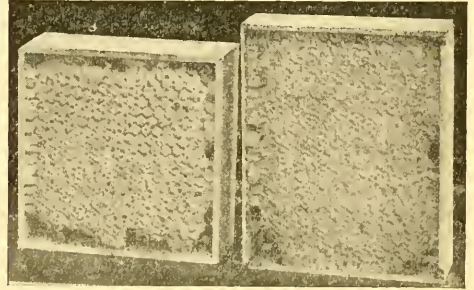

They are both equally well filled, and weigh the same. One section is $1\frac{3}{8} \times 4 \times 5$ inches; the other one, $1\frac{1}{2} \times 4\frac{1}{4}$ square. While the figures above show an actual difference in thickness the appearance does not. Now, then, which box looks to be the larger of the two? If you were the consumer, and the same price were charged for each, which one would you take?

It costs the producer no more to produce one than the other. Many grocers find that the tall ones are taken in preference, and have been obliged to advance the price a cent or two, so that in some localities the tall box brings a higher price.

Now, please do not understand me as saying that this applies to all localities, for I know it does not; but many a bee-keeper would do well to produce the two kinds and let them stand on their merits on the market.

PROPOSED FOUL-BROOD LEGISLATION FOR NEW JERSEY AND THE STATE OF MAINE.

ELSEWHERE I have referred to the fact that an effort will be made to get a foul-brood law passed in New Jersey. Black and foul brood have crept over into that little State, and some of the bee-men there are beginning to realize that something must be done. The State is small, and an inspector's expenses would be comparatively light. While an appropriation of \$500 would be enough for Wisconsin, \$100 or \$200 would do for New Jersey.

Mr. George N. Wanser wrote me, asking for suggestions. In reply I told him it was

very important that there be a State bee-keepers' association; and that the first business of that association should be to pass suitable resolutions calling attention to the prevalence of foul brood in that State, and the need of legislation; that it would not be possible, ordinarily, to get a foul-brood bill passed unless the law-makers of the State know that the State organization of beekeepers is back of the movement.

Mr. Wanser, complying with my suggestion, is very desirous that such an organization be formed in his State. Every person interested in the welfare of the bee industry is therefore requested to send him, at Cranford, N. J., his name and address, so arrangements can be made for a date and place of the first meeting.

Mr. J. B. Mason, of Mechanic Falls, Me., is making a similar effort to call a State meeting for a like purpose. Those interested will of course put themselves in communication with him at once.

FOUL BROOD IN MICHIGAN; INSPECTOR RANKIN'S REPORT.

We have just received a report which will speak for itself. I well remember when we were trying to get the law passed, under which Inspector Rankin was working, the statement was made that there was no need of this law; that foul brood was confined to small localities, and quite isolated from the great honey sections of the State. But what are the facts? Out of 3286 colonies, the Inspector finds 402 diseased. This does not look so bad; but when he says he found the disease present in 119 apiaries, or 57.7 per cent of *the whole number*, then the situation is worse than we had reason to suspect. It goes to show that the law was passed none too soon. If it had been enacted two years ago, foul brood would not have got such a start.

Another fact, somewhat alarming to Ohio bee-keepers, is that the disease is "more prevalent in the older sections of the country; that is, they are more diseased in *Central and Southern Michigan* than in the northern part of the State." Italics mine. That means to the Ohio bee-keepers that the disease is working very fast over into our State already. Originally it was in Ontario and Wisconsin; and it became so bad that foul-brood legislation had to be enacted in those States. When it was brought under control in Ontario and Wisconsin the disease naturally worked toward the State where there was no law—Michigan. After getting a good foothold, then the law was passed. The whole logic of events shows that Ohio must follow suit, for we can not and must not be the dumping-ground of Wisconsin, Michigan, and Ontario.

In a similar way the bee-keepers in the States bordering on New York (where there is a good law) can well stop and reflect. In fact, an effort is already being made in New Jersey, or will be made, rather, to get

protective legislation. California has a good law, but it is already evident that the disease had got a big start before the inspectors could get in their work.

To the Honorable Dairy and Food Commissioner:

SIR—I herewith submit my report for the work done during the months of July, August, September, and October, as State Inspector of Apiaries. I have visited in all 206 apiaries, having in them a total of 3286 colonies. I have found 402 diseased colonies, making a total of 12.1 per cent of those inspected. I have found the disease present in 119 apiaries, which is 57.7 per cent of the whole number inspected. It will be noticed that the majority of the yards that contained the disease have in them only a few, and many times only one colony. It is impossible to tell exactly how many of the diseased colonies have been destroyed by the owners—perhaps 50 per cent of those condemned. I have been compelled to burn only one colony against the will of the owner. These apiaries were scattered through the counties of St. Joseph, Hillsdale, Lenawee, Washtenaw, Jackson, Calhoun, Barry, Eaton, Ingham, Livingston, Oakland, Macomb, St. Clair, Lapeer, Genesee, Shiawassee, Clinton, Ionia, Muskegon, Montcalm, Gratiot, Saginaw, Iosco, Sanilac, Oceana, Mason, Lake, Manistee, Wexford, Benzie, Kalkaska, and Antrim.

I have found the disease more prevalent in the older sections of country; that is, there is more disease in Southern and Central Michigan than in the northern part of the State. In the north it is confined to localities, and is not of very long standing. In almost every case it can be traced back to the bringing-in of diseased bees or fixtures from the South. In the Southern part, however, the disease is scattered promiscuously, and breaks out in yards, infecting many colonies, without any apparent source of contamination.

I have found many bee-keepers who are perfectly ignorant of the disease; and, even when it is present in their yards, and a large proportion of their bees are diseased, they fail to see that anything serious is wrong. These bee-keepers, of course, belong to the class who keep a few bees as a side issue, and are not posted in modern apiculture. Then, again, I have found the disease present in the apiaries of specialists in bee culture, who are unfortunate enough to be located in the same vicinity with one of these other bee-keepers who are not posted. The uninformed man will not listen to the advice and pleadings of the specialists, but will leave diseased colonies to die, and be robbed out by the bees from the larger yard, in this way working ruin on the helpless specialist, who can not control the action of his ignorant neighbor. Then, oftentimes, when this specialist resorts to the protection of the law to compel his neighbor to clean up the diseased yard he is looked upon by the people of his vicinity with the utmost contempt.

The most active agents in spreading the disease are, first, that of robbing out colonies which have become weak and run down; and, second, that of using old hives in which the bees have died from the disease.

A grave difficulty arises when treating the bees to overcome foul brood, in that it is a very hard matter to impress upon the uneducated man the necessity of careful work and the nature of bacteria. He will neglect some small but important matter, or fail to take some necessary precaution in order to insure success. As a consequence, the treatment is frequently a failure. This is not always the case, however; many apiarists are eager to learn all that is to be known about the disease, and by careful, persistent work have stamped it out of their yards. The treatment used by many apiarists has been to kill the infected colony with sulphur, remove the hive to a cellar, and cut out and save for home use all good honey, scrape clean, and disinfect the hive, finally burning all refuse, scrapings, and inside furniture. This method of treatment entails much less work than attempting to cure the colony, and the honey and also the hive are saved.

The needs are great, and many localities where the disease is known to exist have not been visited at all. Many of the localities visited this summer must be covered again at the beginning of next season to insure the effectual stamping-out of the disease. I have met with the most hearty co-operation on the part of the intelligent apiarists of the State. They have not only manifested an interest in the work, but in many cases have materially assisted in the eradication of the disease in their locality.

Respectfully submitted,

JOHN M. RANKIN.

Iansing, Mich.

NOTES OF TRAVEL.

The Most Extensive Bee-keeper for his Age in the United States; More about Arizona Bee-keeping.

BY E. R. ROOT.

I desire to introduce to you to-day the youngest "big" bee-keeper in the United States, Mr. W. L. Chambers, of Phoenix, Ariz. For one so young he owns more bees than any other person in the land. Short in stature, slight in frame, boyish in face, he has achieved results in the little time he has kept bees that even some of our veterans who have been years in the business might well envy. At the age of 15 he started with seven colonies which he bought and paid for out of his own savings in chicken money. But, unfortunately, foul brood got into those precious seven the first season; but, nothing



W. L. CHAMBERS.

The youngest big bee keeper in the world.

daunted, he went about to cure them. Said his neighbors, "He never will make a bee-keeper; he is too frail—too small. He would have done better to stay in the chicken business;" and when foul brood broke out and his \$15 investment nearly proved a failure they said, "I told you so." But give up bee-keeping just because he had a little bad luck at the start? Not he. He was made of better stuff. Even if he was small and only a boy, he meant business. In spite of his loss from foul brood he saved out of what was alive more than enough to make up for his loss. Listen: He actually made one colony out of the seven the next season bring him in a revenue of \$20 of clean cash. If we add to this the increase and what the other colonies did we can see

that his investment panned out probably better than the chicken business would have done. But this was because he *started* right and had a business head, because he adopted the good rule of making the bees pay their way; for the only money he ever invested outside of that earned by the bees themselves was that \$15 of chicken money. He soon increased the seven colonies up to a fair-sized apiary. His bee money, as fast as he earned it, he kept and invested it in more bees and hives. So successful was he in his management that *he bought one whole yard outright, and made that yard pay for itself in one season.*

He could not afford to buy factory supplies; but somehow he managed to get a foot-power buzz-saw operated by means of a crank. He was too small and light to furnish the power, so he hired a man, turning the crank while he did the cutting of the boards. Mere boy as he was, there are no factory hives that are better made, and I think I know what I am talking about. He kept on working this way economically, keeping always before him the good rule of investing no money unless the bees furnished it; and so successfully has he carried out this policy that now he has over 500 colonies, and is *only 20 years old.* Think of it. This feat is the more remarkable from the fact that he was so frail and health so poor that he had to be taken out of school early. He could not do the ordinary hard work on the fruit-ranch of his father; neither could he confine himself to school, and therefore he took up bee-keeping. With the exception of the little help he hires, he does all the work himself. By using brains he manages to avoid the lifting of heavy extracting-supers, and thus saves his back (none too strong for such work) some strains that might otherwise be put upon him. Since engaging in bee-keeping he has had fairly good health, and, what is more, he not only makes both ends meet in his business but he is making money.

As soon as Mr. Chambers found I was in that vicinity he chased up and down the country on his bicycle, trying to find me. Finally, after going hither and yon, just missing me, he located me out in the country, going to the home of Mr. Wm. Rohrig in the night. I then made an appointment to meet him the next day, and, sure enough, bright and early he was on hand with a pretty little trotter and a nice light easy single buggy, both of which were bought and paid for out of the profits of his bees.

We first drove over to his father's, who, we found, was running a fruit-ranch in one of the most favored sections in all Arizona, for that business. And such fruit! On arriving at his home a big dish of luscious mammoth strawberries was placed before me. Hot and dry as I was, those berries filled a long-felt want. While engaged in taking care of the fruit a younger sister of Mr. Chambers brought out an old hen which had come from an egg that had been hatched on the shelf in the house; for you

will remember that I said the climate in Arizona is so very warm and uniform that even eggs, under some conditions, if left long enough, will hatch right on the pantry shelves.

After stopping at the beautiful fruit-ranch of the senior Mr. Chambers we took the road again to visit some of the out-yards. The next place we stopped at was the Chambers Asylum apiary, so named because of a public institution in that vicinity. The yard is right in the midst of a lot of alfalfa-fields, and hence it is, of course, very favorably located.

Fig. 2 shows an interior view and how the hives stand on low benches running from one end of the shed inclosure to the other.

The object of this is to bring the hives up to convenient working distance. Some of them are deep square hives which he bought up that he does not like.

All through this part of Arizona are used very extensively little square frames; and when one buys up apiaries he very often is impelled to take a hive and frame that he does not like, and that was the case with Mr. Chambers. As fast as he can, he is trans-

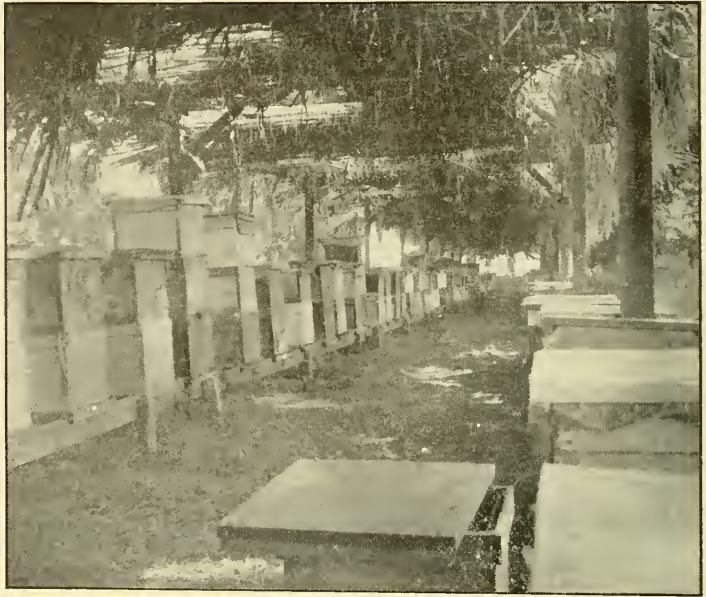

FIG. 2.—CHAMBERS' ASYLUM APIARY.

ferring them into hives of Langstroth dimensions, as he finds they are more convenient, and better in every way; and in this connection I will state that he is very emphatic in that he wants thick-top-bar frames one inch wide, and gentle Italians. He thinks life is too short to fuss with poor contrivances when it costs but little more to have things right. I noticed that the bees at this apiary—in fact, at all his yards

that I stopped at—were very gentle. This is owing to the fact that there are no breaking of burr-combs, or very little of it, to irritate the bees during extracting time, and the bees themselves are from imported Italian stock. We could go all through the yard without veil or smoker; and this was in marked contrast to my experience at some of the other apiaries I visited in that part of Arizona where hybrids and thin top-bars are used.

Right adjoining the Asylum apiary was an extracting-house, Fig. 3, having wire-cloth sides at one end, and covered with cheap cloth for a shade. Mr. Chambers has these structures at each yard; and during times of robbing he can carry on extracting secure from intrusion; and

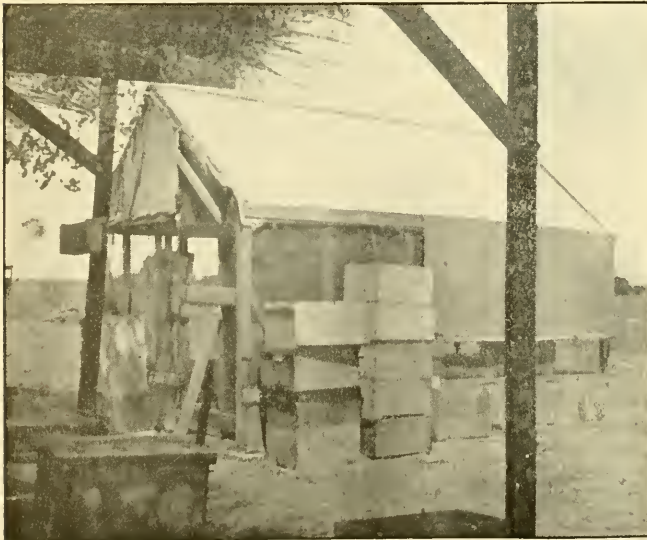

FIG. 3.—THE CHAMBERS EXTRACTING-HOUSE.



FIG. 4.—ANOTHER OF MR. CHAMBERS' OUT-VARDS.}]

those bees that do get inside are allowed to get out by means of bee-escapes.

HOW MR. CHAMBERS AVOIDS THE USE OF
QUEEN-EXCLUDERS.

He prefers Langstroth hives, ten-frame in width. The full ten frames are used in the brood-nest, making a spacing of $1\frac{1}{8}$ from center to center. The extracting-supers are of the same width, and in these are put eight frames spaced far enough apart to fill out the space. This, he says, discourages the queen from going above, because the combs are too deep for ordinary brood-rearing. When he uncaps he cuts the combs down to the width of the top-bar, leaving the cells deep at the bottom as well as at the top. He acknowledges that some prefer excluders; but he says thick combs, in his experience, prevent the queen from entering them, and they are easier to uncap.

THE ECONOMIC IMPORTANCE OF COTTONWOODS TO ARIZONA.

I have already said that all the apiaries in Arizona, so far as I knew, were under those long sheds, with one exception; and that one is

the apiary of H. L. Sanderson, of Phoenix, located under a long row of cottonwood-trees, as shown in Fig. 5. Mr. S. himself stands in the foreground. These trees, I think, were only about four or five years old; and yet, look at their size! Give them five years more and they would be veritable monarchs.

Like the eucalyptus of California, cottonwoods are veritable God-sends to the arid climate of Arizona. They are very rapid growers — so rapid, in fact, that they in a few years come to be mammoth shade-trees.

This portion of Arizona was originally a perfect desert; and even after it was reclaimed by means of irrigation there were no trees. It was soon found that the cottonwoods would thrive amazingly, and they were set along near the ditches, in front of residences, or wherever water could be easily obtained; for nothing will grow here in Arizona, as I have already explained, un-



FIG. 5.—H. L. SANDERSON AND HIS APIARY UNDER THE COTTONWOODS.

less there is water. The climate and soil are such that, given water, the most luxuriant growth can be obtained; and this is especially true of the cottonwood. Nearly all the roadsides are skirted on one or both sides with irrigation-ditches; and along the ditches are these trees. In one of our drives with Mr. Chambers or with Mr. Rohrig, I do not remember which, we passed a line of them some 15 or 20 inches in diameter, and through them was running barbed wire. Posts had been set out, and wire tacked on them. The posts began to sprout at the roots and at the top, and grew into trees; and there they were, mammoth spreading shade-trees, with the wire running right centrally through them. They grow so rapidly that they can be grown and cut for firewood; but for building purposes the timber is almost valueless.



THICK HONEY DURING DRY SEASONS.

The past summer has cut our honey crop down to a mere pittance of what we expected in the spring. Bees can not make honey when there is none to gather. I managed to fill two alcohol-barrels with a mixed variety of extracted. I never saw such hard work in extracting as this year. It seemed as though the water was all evaporated out of the honey, and it was as thick as old buckwheat honey is in cold weather. Did you ever notice that the dry season seemed to work that way with the honey you were extracting? I shall sell my honey as it is, for I have had poor luck in canning it in glass cans. It seems funny that people will pay 15 cts. for a section of honey that will not weigh a pound, and lots of comb at that, when they can for a shilling get a pound of pure honey.

E. L. BLACKMORE.

Aplington, Ia., Sept. 25.

[In hot dry climates, especially those in the West, the honey is always thicker. It is not surprising that, during a very severe drouth in a locality usually having considerable humidity, the honey should be thicker.—ED.]

A CORRECTION FROM CALIFORNIA.

Friend Root:—Referring to your last issue of GLEANINGS, page 907, letter from Jamul and your comments thereon: Both letter and comments are misleading. Your correspondent avers, "so he is told," they decided "there would be 10,000," and then goes on, without even an "if," to make his figures, portraying the immensity of the crop from "a mere speck." Here is no information as to the number of cases actually needed or used. Then, in your footnote,

you cite it just as if it were a fact that these people had bought 10,000 cases, and apparently assume that they must necessarily have many of them left on hand—to show that my estimate of the crop must be wrong. False premises lead to erroneous conclusions. On Feb. 3, 1901, the Escondido people asked me to submit prices on cases and cans, saying they might want from "3000 to 5000, if the yield is a big one." The yield was not a big one with them, and they did not take even as many as their lowest estimate. I am in position to *know* just how many they, as well as others, did take, and it was upon positive knowledge in the premises that I based my estimate for the whole of California. Of course the careful reader will see that there is absolutely nothing said as to actual yield, but the average reader will say, "Escondido is a little bit of a side station, and they bought 10,000 cases and did not have honey enough to fill half of them, therefore Clayton's a Bull, and the truth is not in him." C. H. CLAYTON.

Lang, Cal., Nov. 23.

WASHINGTON AS A BEE COUNTRY.

Please tell J. O. Haynes, page 908, that, if he wishes to keep out of alkali water and hot weather, by coming to the State of Washington he will have to come west of the Cascade Mountains; then he will be in God's *chosen* country for water, climate, fruit, etc. Here we have no hot weather; 70° is the average in summer; and for a few days, not to exceed two weeks, it goes up to 80 or possibly 90. He will find no mosquitos, chigoes, ticks, flies, or gnats, and scarcely any fleas; only one kind of snake, and that a garter snake. In winter, away up here in the northwest corner of the northwest State of the Union, he will scarcely see it below 40°. I can now pick the finest of roses, pansies, daisies, sweet peas, red clover, white clover, and dandelion blooms all on my five lots, and can do so almost every week in the year. He will find no windstorms here; no thunder and lightning, and plenty of nature's best and purest spring and snow water he ever saw, and living is as cheap as anywhere, and plenty of every thing. But he won't find this a very good bee country, for the simple reason that the summers are entirely too cool, caused by a continued northwest wind which blows over the Olympic Mountains, which are continually covered with snow for many miles in distance. I have kept bees here six years. The first year I was away out in the woods, and they made over 100 lbs. per colony, part extracted and part comb. For the next four years they made from nothing to 25 lbs.; but this year they did well, making 125 lbs. of comb honey right here in town, and the country around here is overstocked with bees, and also cattle, which run loose and eat up all the bee-pasture.

A SUBSCRIBER.

Centralia, Wash., Nov. 27.



Rejoice, and be exceeding glad.—MATT 5:12.

The Bible is a hopeful book; in fact, it holds out hope when nothing else in the world does, and when the whole wide world has absolutely nothing to offer to make one hopeful or cheerful. It runs all through the book. It offers encouragement and cheer to the fainting heart under all circumstances. In that celebrated sermon on the mount, called the "beatitudes," Jesus offered encouragement to those in trouble. He said, "Blessed are the poor in spirit; they that mourn; the meek; those who hunger and thirst after righteousness; the merciful; the pure in heart; the peacemakers." What a beautiful character all these things in a single person would make up! Then he closes by saying that a blessing will come to us when we are persecuted and misrepresented for doing right. He says we may rejoice and be glad; and this thought is what I have taken for my text. Let us go on a little further in that chapter from which I have quoted. He tells us we are the salt of the earth and the light of the world. Oh what a power for good in the world is the man or woman who can always "rejoice and be glad"! I do not mean that one should always have a broad grin or be exhibiting joy or gladness by noisy demonstration. What I have more in mind is a quiet inward joy and gladness that is so deeply rooted it can stand the knocks and jars of the busy world. I do not see how there can be any real joy and gladness in any human heart without faith in God, or a dependence upon him. When you get up in the morning you ought to be glad. You *may* be glad. Thank God for giving you a human life to live, the *first thing you do*, and keep the thought in your mind all day long. Keep saying to yourself, if you can not do it otherwise, "Thank God for the *privilege* of showing faith and hope in him, in my daily contact with the world." I know how hard it is, for I am trying it right along. A letter was just laid on my table. The writer of it is a young man, and he tells me some of his troubles and trials. He says in the outset that it seems to him that "God is pretty hard on him." I presume we are almost all of us tempted at different times to let such thoughts come into our minds. We ask how it is that God *could* allow things to occur in this way. Do not harbor such a thought for an instant, dear friends. It is anarchy, or something worse than that. When Satan can persuade you that God is not *fair*, or that he is not doing his best for you, he will very soon get you into trouble; therefore thank God the first thing you do every morning as soon as you wake up. Then thank him for the difficulties that are

going to beset your path before the night comes. If you are letting God lead, you surely *will* meet with difficulty. You will be tempted to be cross and impatient and uncourteous. When I was up there in the woods I did not have nearly as much temptation of that sort as I do now. I was relieved of my responsibilities for the time being. Yes, I *might* stay up there and *shirk* my responsibilities. I might let letters lie on my desk from people scattered all over where GLEANINGS goes, wanting my advice in regard to matters of health. Others want advice about spiritual matters. Sometimes some of the great writers for our standard periodicals, because they have read these Home Papers, want me to give them my opinion in regard to their difficulties. Sometimes I am surprised and almost startled to think my opinion should be valued on matters away up above my quiet life. Suppose I should become cross and impatient, and inform the writers that I have more business on hand now than I can profitably attend to. It just now occurs to me that the above *may* be true; but what a poor specimen of a follower of Christ Jesus I should be if I should *refuse* to lend a helping hand!

The only way for me to do effective work is to keep hopeful, pleasant, good-natured, and brave. I do not get very much persecution nowadays; but I see a good many others who are persecuted oftentimes because they are helpless. I am sometimes tempted to do as Moses did when he struck down the Egyptian. But that was Moses' first and greatest blunder—that is, if I read correctly. I wish to do the very best and wisest thing for both oppressed and oppressor. How shall I do it? By being hopeful, thankful, and cheerful. It is the same way with you, my friend; for you can not expect to conquer difficulties at all unless you are hopeful and thankful, and, I should say, unless you are continually praying the great Father for help and advice and instruction.

The President of the United States is just now making himself exceedingly popular with the American people at large by putting men into the various important offices who are *best fitted* for them. In another direction he is making a host of bitter enemies by this new way of proceeding. May God give him grace, and may our people give him such encouragement that he will not *care* what his enemies *do* and *say*. I need not remind you that there is a tremendous need of capable men to fill important places—more need than the world ever knew before. A few days ago an engineer on the Wabash road made a mistake resulting in the death of about a hundred people. I mention this to suggest to you the need of careful men, or men who are competent in every way to take charge of important positions. Not long ago somebody on our premises turned a certain valve. I suppose there are a thousand or more valves in our whole establishment. Then

there are about as many electric buttons and switches. Once in a great while some boy comes to work for us who does not seem to have sense enough, or does not seem to have caught on to present times enough, to keep his restless fingers away from the valves or electric buttons. Well, as I was saying, somebody (we have not been able to find out who), at half-past four in the afternoon, turned a valve. It very soon threw things out of joint. Investigation was started; but as nothing *seemed* to be out of place anywhere, the matter was dropped till the next morning; then it was found that, had a fire occurred during the night, it would have found us with the water supply cut off. Now, it is not alone the engineers who occupy positions of grave responsibility, but even the small boys have more or less responsibility resting on their shoulders almost as soon as they enter any big establishment.

Well, some people seem to have the idea that one can not bear responsibility and keep good-natured. Some time ago we had an engineer in our employ who objected to the increased responsibilities (on account of enlarging our works) that rested on his shoulders. He said the responsibility was getting to be too great for any man; that, if we kept on, it would make a man crazy, and he would have to go to the insane-asylum. Well, I have thought since that time there might be a grain of truth in his remark. His successor is a very good-natured, active, intelligent man who has studied electricity, steam, etc., in a technical school. For many months he shouldered his cares and worries with wonderful cheerfulness and good nature; but when that valve I have mentioned was shut, without giving him any notice, or without his authority, he was pretty full of indignation. It may have been righteous indignation, for it was a serious matter. And by the way, it is a very difficult matter indeed to protest against certain kinds of carelessness or thoughtless meddling, and keep in a Christian frame of mind. With all of my talk, and with all my exhortations, I am afraid I am, in this line, only a poor bungling follower of the Lord Jesus.

The Bible teaches us that we should be hopeful under all emergencies, and I believe it is possible.

Our old pastor, Rev. W. S. Ament, who has been for years a missionary in China, gave us a talk last Sunday at our church. He was with the little band at Peking when they were surrounded by Boxers, and expected to lose their lives every minute. He said he was not afraid nor disturbed when he heard the first gunshot that seemed to be the opening of the attack on their little band. He said it gave him a thrill of joy, notwithstanding the danger, for it meant to him the *redemption of China* from heathenism. Now, I hope I should have the same courage if called upon to stand before the cannon's mouth; but I am really *afraid* my courage would not be equal to Bro. Ament's.

A good many public servants seem to think it is a part of their business to be overbearing and domineering. When I am traveling on the cars, and have my bicycle along with me, I am always in a hurry to get it from the baggage-car; and in order to save the time of the busy baggage-master I have been in the habit of taking the check off my wheel and handing both checks to the baggageman. A few days ago I commenced to slip off the leather strap, when the baggageman yelled out, "Let go of that wheel until I get ready to take the check off myself." I apologized, and assured him I had no thought of taking liberties; that in traveling I often did that way to save the baggageman's time. I was careful to catch his eye and let him see I was not only friendly and good-natured, but not at all appalled by his domineering way. He softened down a little, and said if he should let everybody help themselves to their own baggage the baggage would soon be gone, and he would get "fired" in no time. Now, this man could just as well have enforced his authority by telling me in a gentle way that my proceeding was contrary to the rules.

Not only should the Christian man or woman be cheerful and pleasant and courteous and kind to *humanity*, whether it be high or low, rich or poor, but he should be courteous and kind to domestic animals. I can hardly tell you how I have been pained within the last year by seeing horses scolded, whipped, and sworn at, when they were doing their very level best. When a horse comes out of the stable in the morning he thanks God for having given him a life to live. He is glad, too, at the prospect of going to work and helping along the great machinery of this world. How do I know? Well, I admit he has not told me so in plain words, but I know pretty well how horses feel by their actions, exactly as I know how bees feel by *their* actions. The horse enjoys life—that is, if his owner will let him enjoy it. It is fun for him to learn new tricks; to be taught to adapt himself to circumstances; to watch his master and see what is wanted, and to learn to do it in the very best possible manner. Oh how I have longed to see the owner or the driver give his horse a pat on the neck, and hear him tell him, with kind words, that he has done *well*, in order that *even the horse* may "rejoice and be glad"!

On our ranch we were pulling stumps and tearing out roots. Sometimes it was a question whether the team could pull the stump or whether they *ought* to pull it. The owner said they would pull it if we gave them a little time. When the horses had done their best, and the obstruction did not come, the wise driver would say, as he patted their glossy necks, "Well, girls, you have done pretty well; but I guess we will let you try it *now* in another direction." His team was a big heavy pair of mares. They understood what he meant by pulling off in another way, and they swung around

without trouble or getting tangled in the whiffletrees. When they pulled in the new direction some of the roots snapped, and they knew *as well as he did* that the stump was coming. After he had rested them a little he tried them in the direction they went first, and the stump was out. Now, it would be better for the team to let them succeed, even if it did take considerable time, than to have the horses see we tried the stump and gave it up. Horses easily learn to lose confidence in their driver. They take his "dimensions" about as quickly as he takes theirs. Now, suppose that driver had called his horses fools, and scolded them, and may be whipped them unreasonably because he got angry. It would have spoiled the enjoyment and happiness of the horses as well as their driver, perhaps, for all day. Do you smile because I suggest that a horse may be made miserable all day because some incident of the morning has broken his spirits or spoiled his peace of mind? Why, I have seen a horse that started out in the morning with head up, eyes bright and ears erect, catching in every word that was said, and every thing that was going on. I have seen such a horse hang his head in a sort of listless despair that was almost pitiful to behold, just because the man who happened to be over him for the time had whipped and scolded and sworn at him until his ambition was all gone, and he did not take any more interest in the work being done than the plow he was laboring to pull. The man who has the love of God in his heart so that it overflows constantly, even in the direction of his horse, will find a thousand things to indicate to him day by day that his horses know more of what is said and of what is being done than anybody gives them credit for. I have seen a driver, just because he was tired, fly into a passion, and yell at and jerk his horses when they were doing the best they knew how, but made a mistake. On one occasion I had a team that worked for me two days. A different man drove the team the second day. These two men had a different phraseology in talking to their horses. The first day the horses had been taught a peculiar way of operating to do their work best. When the new man got hold of the lines he did not know about this, and so he whipped, cursed, and yelled at them just because they followed the custom of the day before. I remonstrated, and explained matters; but as soon as I got out of sight this fellow was abusing the horses in just the same way. Why, I think the horses were entirely right and he entirely wrong. It seemed to me that day, from every point of view, that the brutes had more sense, and ever so much more of a human spirit, than the man who was trying to drive them.

I have not handled horses much for many years; but I told Mrs. Root I was beginning to want a horse. I wish especially to show the world there is at least *one* man who appreciates this wonderful gift that

God bestowed on his children when he gave them such a bright, strong, kind, intelligent, brave animal for a helper.*

Horses, above all other domestic animals, seem to have a sort of dignity about them. When I see their noble traits, and their willingness to endure almost any thing in the way of toil, even when not properly watered and fed, it touches my heart. When somebody confesses to me that his horse has not had a bit of water all day, and yet he is required to keep on with his unremitting hard work, I feel like losing my Christian courtesy and denouncing the man and defending the horse. Oh how I *should* rejoice to see every hard-working horse in our land in charge of a Christian driver—a driver who administers correction lovingly when it is needed, and who *loves* his horses, and loves God *more* because he, in his loving kindness, has given us this grand and noble domestic animal to minister to our wants!



SOME GLIMPSSES OF THE GRAND TRAVERSE REGION.

On the next page are two kodak views of that "cabin in the woods" I have told you so much about.

While my daughter Carrie was looking at the picture she wanted to know which one of the above views shows the front door. Well, I rather think we shall have to call Fig. 1 the *front* door. There is not any highway within a quarter of a mile; but my bicycle-path that leads from the highway runs up to the open door. So I think this must be the front door. In the foreground you get a glimpse of the lawn made of lawn grass and white clover, that I made before Mrs. Root would consent to go there. The two large stones at each side of the peach-tree in the foreground were too heavy to get away handily, so we left one of them for a seat, and the other one goes down into the ground. The peach-tree was very handsome before the foliage dropped off, or most of it, and the same with the other one down in the corner.

When Mrs. Root came on to the ground she insisted on a platform in front of the

*Some of you may get the impression that I would let a horse run over me, and that *he* would soon get to be the *master*; but I assure you you are mistaken. I have remonstrated with my men frequently because they would start out to work without a whip. I would always let a horse see that I had a whip in my hand, or one where I could get hold of it, even if I did not use it. One man made himself hoarse in yelling at his horses to get them to start. After a while they learned to wait till he told them to go ahead about three or four times, and then they would slowly begin to move. I cut a whip for him; and after they saw it in his hand they started up promptly at the first word of command. I believe the horse loves the master *more* who makes him *obey* orders than one who lets him get into the habit of having his own way.

door: then everybody who came in was to scrape his shoes and rub off the sand on the doormat. The paths were all of clean sandy loam; but she said she did not want

there. But that was my mistake. Well, just below the floor line, on the south side, we have two long doors hinged along the top. These can be raised up, and propped

up with a stick so as to look like an awning or porch; and this place under the building we use for a wood-shed on one end and for a tool-house on the other end. When we get through work the tools are all laid in the Daisy wheelbarrow, the swinging door raised up, and tools and all are quickly pushed in out of the rain. The window beside the door is covered with mosquito-netting, as you notice. Just over the

roof you get a glimpse of the chimney, made of white bricks. I hauled the bricks and sand, and a carpenter built the chimney. He objected at first; but when questioned he admitted he

the sand tracked in on the carpet, even if it was so white and clean. Then she wanted a board walk to the out-building. This structure was concealed by shrubbery before the leaves had fallen. At each side of this narrow board walk I raked off some level beds and sowed rye, so we had a very green lawn, even in November. The cornice, corner-posts, window-casings, etc., are painted green to harmonize with the woods; and it made a very pretty contrast with the cedar shingles. When the nights began to be cold we found the cold air coming up through the floor so as to make it rather breezy. First I

shall have to explain that there are no windows on the south side, because I understood her to say she did not want windows

once built a chimney for himself. I told him I thought we two together could make one that would do.

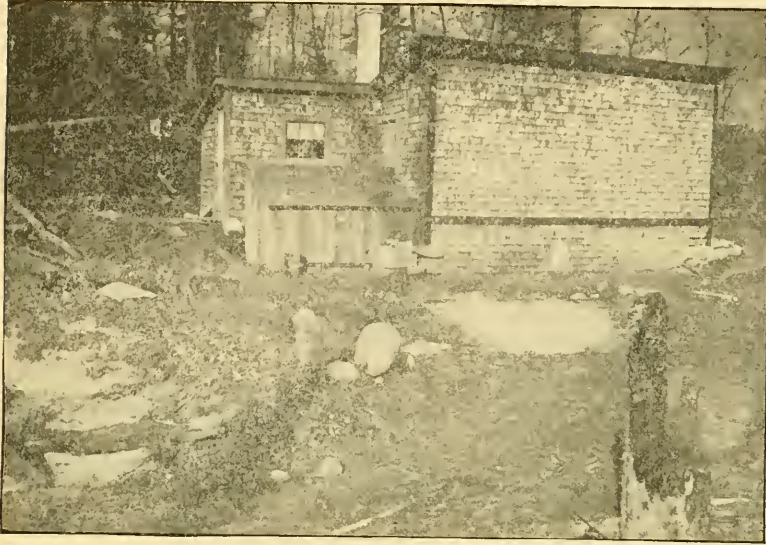

FIG. 2.—OUR "CABIN IN THE WOODS." REAR VIEW.



FIG. 1.—FRONT VIEW OF "CABIN IN THE WOODS."

Cut No. 2 gives a view of the back door. After we had been a month or more in a single room 14x20 we concluded we ought to have a little room by itself for the cook-stove. We had a few boards and shingles left, and so I made a woodshed that you see just under the window. This woodshed communicates with the cellar under the floor of the main building, so the wood can be pushed through right under the trap-door in front of the kitchen stove as I have explained. The back yard was not slicked up as I meant to have it. We did not get many sunshiny days in November; so when the sun came out from the clouds, I got my camera hastily and took it just as it was. At the right-hand corner you get a glimpse of the

thought it would not burn very fast; but, notwithstanding, it was so hot we could hardly touch the panes of glass in the windows of the buildings, and the shingles be-

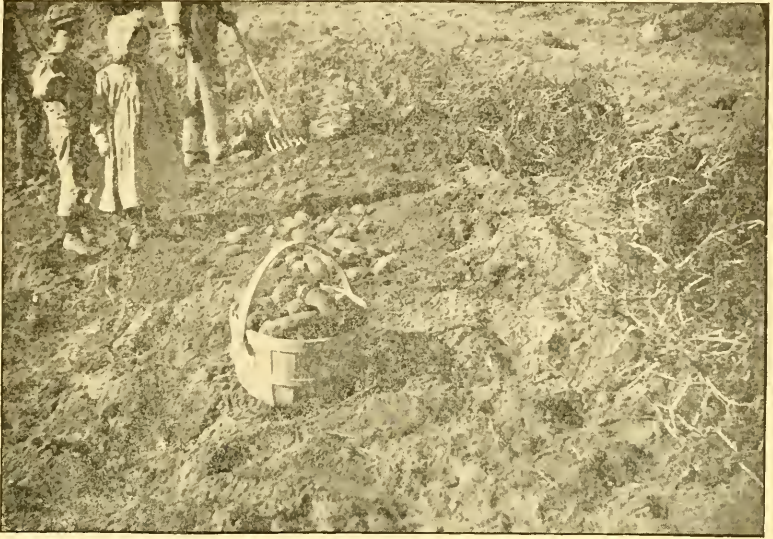

DIGGING POTATOES IN THE TRAVERSE REGION.



THE HILBERT FAMILY IN THE POTATO-FIELD.

remains of the big log-heap. We waited for a day when the wind was away from the house. It was wet and snowy, so we

gan to smoke. Had the wind swung around so as to blow toward the building while the heat was at its greatest (the flames went almost as high as the tall forest trees), I do not think any thing could have saved our little home; and the wind *did* swing around right toward the building about 20 minutes after the fire was at its height. After two such experiences I think I shall be more careful about burning big log-heaps or locating them so near the dwelling after this. The white spot near the building is where there was a heap of white sand—some we drew up from the bay to build the chimney. Although the soil is all more or less sandy, it is nothing like that very white sand that

comes from the shore of the bay. At the left of the picture, near the top, you get a glimpse of the evergreens mixed in with the beeches and maples. I think no view of the woods is so inviting—I might almost say entrancing—to me as one where evergreens are sprinkled here and there among the deciduous trees. All the soil around that little cabin in every direction is of wonderful fertility. Of course, weeds spring up also, like magic; but where you keep them down, and give the garden stuff a chance, this new woods soil seems to be equal to our old land in Ohio, even when it has tons of manure added. I will now give you some glimpses of cleared land.

I wanted to get a glimpse of the little folks—Jimmie and Gladys Hilbert. I meant to have friend Hilbert also, who holds the potato-fork; but in my desire to get the children and the potatoes I did not get the whole of him. By the way, I do not know but I would give quite a little money to have the readers of GLEANINGS see Jimmy and Gladys, and hear them talk. They are away off all over the farm, up to every thing and into every thing, and they talk like a couple of magpies. I can not tell what they are saying, but they talk back and forth, and understand each other without a bit of trouble. I am learning their language now, however, and can catch on pretty well. By the way, don't you think those are handsome potatoes? This is the crop I told you about on p. 914, last issue—that one of 300 bushels to the acre. The frost caught them or they probably would have made more yet. It was about the finest stand of potatoes I ever saw. There was not a scabby one in the whole field of between three and four acres.

Here is a view of friend Hilbert and his family—three girls and two boys. On the right you see my little friend Alice I have told you about so many times. She did not want her picture taken; but her father made her come up and stand with the rest. It was pretty cold weather, and by some means she had got one of the boys' caps on when I snapped the kodak. Friend Hilbert and the two little chicks, I have already de-

scribed. The young man leaning on his potato-hook is Holly, aged 19, the boy who dug 125 bushels of russet potatoes in less than ten hours. The young lady standing near the basket of potatoes is Miss Erna, aged 14, who picked up the 125 bushels as fast as Holly dug them. Now, don't you think friend Hilbert ought to be a happy man with that nice little family?* They are workers, every one of them, and I don't think they ever ought to be scolded—that is, not very hard, even if they are sometimes forgetful, or do not feel like getting up as early in the morning as might be desired.

You see these potatoes are rounded up a little; but they are in a deep oblong pit, so they come but little above the surface of the ground. A little straw is put on, and the dirt is thrown over from each side a foot or more in thickness. Some say six inches of dirt is plenty above the straw—that is, if it is located on a spot where the snow is pret-



100 BUSHELS OR MORE OF RUSSET POTATOES READY TO BE BURIED.

ty sure to be drifted over them during severe weather. In order to hold the snow, the potato-tops are usually spread over the heaps. Friend Hilbert had something like 1000 bushels of those russets on a little over three acres. I have explained that it was done by turning under clover in the fall

*It just occurs to me that we ought to have had Mrs. Hilbert also. I do not believe any of the crowd will feel hurt if I suggest that she is the best-looking one of the whole lot. There, hold on; I think I shall have to except Gladys. Well, Mrs. Hilbert is not only a very pleasant and nice-looking woman, but I tell you she is a hustler. May be friend H. does not know it; but if she had not been right by his side during these years they have struggled from poverty up to very comfortable circumstances, he never could have been standing where he is now, financially and every other way; and I wish to tell him once more that he should thank God from the bottom of his heart for the great blessings that are all round about him.

and sowing rye, and then turning the rye under when it was in blossom. He thinks the rye should have been turned under a little sooner. The russets would then have had more time to grow before the frost, and the straw would have been more thoroughly decayed. As it was, it bothered Holly about digging with a hook, as I have told you. Better turn the rye under before it gets to be hard and woody (say just as it is heading out), if you wish it to decay thoroughly by the time the potatoes are dug. On our Medina clay I have never found rye straw to bother in digging, even though we have sometimes waited until there were small grains in the heads. Well, the prospect now is that friend Hilbert will get toward \$1000 for the potatoes grown on that piece of ground. But, mind you, he can not do it *every* year. A good many times potatoes in the Traverse region bring only 20 cents; and they have sold for 18 cents—yes, *even* 15, when the markets were glutted. A good many are prophesying that the price will be low next year because everybody in that region is going to plant his "whole farm" to potatoes. I am inclined to think, however, if business keeps up generally as it is now, potatoes are not likely to be away down as they were four or five years ago.



SWEET CLOVER—IS IT A VALUABLE PLANT FOR HORSES AND CATTLE AFTER THEY LEARN TO EAT IT?

My request for reports from experience has brought out the following letters:

Mr. Root.—Having seen the statement by C. H. Zurburg, Bishop, Ill., in regard to sweet clover, I would simply say that is exactly the case in this vicinity. I have never known a horse or cow to touch it, although it grows abundantly along the roadside, stems as big as a man's finger, five to six feet high; but the bees gather lots of honey from it. ISAAC PARKER, Lansing, Mich., Sept. 27.

Miss Nellie Adams writes me that, from her 20 colonies, she has taken 2100 pounds of section honey, and that the colonies have the upper and lower stories nearly all filled for winter. She has sold all the crop at good figures. She is the boss bee keeper, I think.

Some time ago you spoke about sweet clover being a good hay for stock. We are just overrun with it, and it is called a nuisance. We are obliged by the trustees to keep it mowed down along the road around each farm; and in all my travels I have found but one man who said his stock would eat it. I have seen cattle tied along my road fences, but the cows would not eat a bit of it if there was a bit of other grass that they could possibly get. I really believe they would starve before they would eat it. But it is a great honey-plant. R. L. MCCOLLEY, Tontogony, O., Oct. 5.

Mr. Root.—I indorse all C. H. Zurburg, of Bishop, Ill., says on page 761, except the starving to death. Stock or man will eat anything before starving to death, as I witnessed in 1862 to '65. Sweet clover abounds in Western Indiana and Eastern Illinois, greatly to the detriment of the land-holders. We remember to our sorrow the many good things that were said about it in bee-papers. All but the one that it is

good for bees is untrue. I have pulled plants on a four-acre lot for thirteen years, to rid the lot of the stuff. I got only three plants in 1901—some hopes. We have the pure stuff, sold and described by bee-papers. Land-owners and tenants are much incensed at those who sowed it and the bee-papers that recommended it. We have to cut it along the highway.

You certainly have had enough evidence, such as Mr. Zurburg's, to convince a jury or an honest man. Why should we wish our stock to learn to eat it? You seem to think we should take particular pains to teach stock to eat it, which means starve them to it. That trick of your horses you mention sounds as if you had seed to sell yet. Be honest with God and man. We have had the severest drouth here in 1901 since 1857, yet cows and horses failed to eat sweet clover. Green Hill, Ind., Sept. 21. J. A. JOHNSTON.

Friend J., in the above three letters we certainly have evidence enough, as you say, to convince a jury—that is, if we did not have any witnesses on the *other* side. You say that the trick I mentioned about our horses sounds as if I had seed to sell *yet*. Yes, I have seed to sell, even at the present time. We sell all kinds of clover seed because the clovers are all honey-plants, and valuable ones, and we think we are doing good by furnishing sweet clover, because we believe it is a valuable plant, not only for horses and cattle, notwithstanding the above letters, but because it will bring up poor soil in localities where the land is so poor (or so full of alkali) that no other known plant will grow. I *am* trying to be honest with God and man; and if I had the time I still think I could teach *your* horses and cattle to eat sweet clover. Now please read the two following letters on the other side of the question:

Mr. Root.—I noticed your comment on that sweet-clover letter in GLEANINGS for Sept. 15, and give you my experience with sweet clover.

There is a large irrigating-canal running through my ranch, and for several years both banks of it have been a thicket of sweet clover all summer, as the canal runs through cultivated fields, and no stock could get at it while green. The clover finally became so thick that it obstructed the water, and some of the ranchmen cut it with scythes on their places. I had heard of sweet clover being good stock feed, and decided to experiment, as I have nearly half a mile of that canal on my place. I put a wire fence along each side of the ditch, about 20 ft from the water, thus fencing in the ditch its full length on my land, and left an opening into the feed-corral, where I had two cows and from two to three horses most of the time. The next morning after finishing the fence the two cows started in on that sweet clover, although the mangers were full of good alfalfa hay, and the cows in fine condition. The horses went at it that afternoon. The mangers were kept full all the time, and the stock always had access to them; but you ought to see those ditch banks now. They are as clean as if a mower had been used on them. The cows and horses are fat, and I was saved a job of running a scythe or *armstrong* mower. I have 50 stands of bees, but the clover had to go. P. WILKINSKY.

Farmington, N. M., Oct. 5, 1901.

Mr. Root.—I see that C. H. Zurburg has sweet clover that horses will not eat. My experience is different. Last fall I sowed some five acres in timothy. The winter was hard, and, supposing I would have a light catch in February, I sowed sweet clover, got a fair stand, and more than half a stand of timothy. When the timothy seed was ripe and had begun to fall, the sweet clover was from 18 in. to 2 ft. high. I turned in three horses which had never learned to eat sweet clover. After a few days I noticed they were eating the clover and leaving the other grasses, of which there was an abundance, not only timothy but bluegrass and Bermuda grass; but they ate nothing but the clover until they got the last bit of it, and, owing to the extreme drouth, I fear the sweet clover will be all killed. My buggy horse ate sweet-clover hay greedily the first time he ever saw any.

Bees gave no surplus this season, owing to the dry weather and absence of white clover, which was killed by last winter's freezes and absence of snow to protect it. Aster is blooming, and plenty of it.

Boston Sta., Ky., Sept. 21. M. S. GOSNEY.

These contradictory reports would almost seem to indicate that sweet clover is a different plant in some localities from what it is in others; but we frequently have contradictory reports on the matter, right in the same neighborhood. It certainly makes a difference in regard to the stage of growth at the time it is given to the horses and cattle. When it first comes up, before the stalks have had time to become tough and woody, I have seen it eaten with avidity by any horses or cattle I have offered it to—that is, after they found out it was good to eat.

1200 FERRETS. All sizes; some trained; first-class stock. New price list free. N. A. KNAPP, Rochester, Lorain Co., Ohio.

To make cows pay, use Sharples Cream Separators. Book "Business Dairying" & cat. 288 free. W. Chester, Pa.



FENCE! STRONGEST MADE. Bull-tight. Sold to the Farmer at Wholesale Prices. Fully Warranted. Catalog Free. COLLED SPRING FENCE CO., Box 101 Winchester, Indiana, U. S. A.

Over 15,000

drugs, medicines, home remedies, tablets, salves, plasters, veterinary remedies, sick room appliances, toilet articles, optical goods, flavoring extracts, paints, oils, etc., are listed in the

Illustrated Drug Book.

We sell them all by mail and guarantee to save you 15 to 75 per cent on every article ordered. This book contains everything you could possibly want at any time in the drug and medicine line. It is therefore a valuable book of reference and should be in every household. They cost us \$2 a piece. We send them out for 10 cents each—merely enough to pay mailing charges, and refund this on the first order that you send us. Write for it at once. You can never tell how soon you are going to need help.

REMEMBER:
Ours is "The Only Mail Order Drug House in the World."

Heller Chemical Co.
Dept. 40 Chicago, Ill.

Union Combination Saw

For Ripping, Cross-cutting, Rabbling, Mitering, Grooving, Gaining, Boring, Scroll-sawing, Edge-moulding, Beading. Full line FOOT and HAND POWER machinery. Send for catalog A. SENECA FALLS MFG. CO., 44 Water St., Seneca Fs., N. Y.

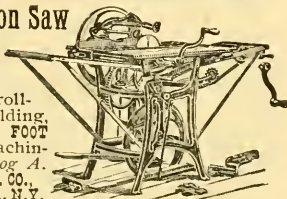

WE ARE MAKING

thousands of miles of Page Fence annually—more this year than ever before. Don't you want some? Page Woven Wire Fence Co., Box S, Adrian, Michigan.

SPRAYING

with the "mermaid-BORDEAUX NOZZLE"

and our world's best outfit you are also sure master of the situation. Insects and diseases fall before this all-conquering outfit. See the book. It is free. Write for it now. THE DEMING CO., SALEM, OHIO. Western Agts., Henion & Hubbell, Chicago.

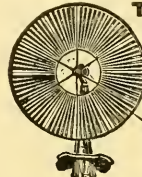

The Storm Proof KING WIND MILL

produces 20 to 60% more net power from any kind of wind than any other mill made. Wheel being only 1 in. thick cuts the wind like a knife and is 400% more storm proof than any other. Exceedingly light, but wonderfully strong. Very sensitive—runs in lightest winds. Numerous sizes—6 ft up, both pumping and power, back gear or direct stroke. Send for circulars and prices before you buy. Medina Mfg. Co., Box 11 Medina, O.

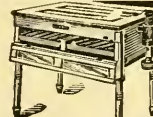

200-Egg Incubator for \$12.80

Perfect in construction and action. Hatches every fertile egg. Write for catalogue to-day. GEO. H. STAHL, Quincy, Ill.

\$5 INCUBATORS FREE 50 EGG SIZE
Self regulating. Guaranteed for 2 years. Hatches every good egg. Send for catalogue No 64. Sell six and get one free. INVINCIBLE HATCHER CO., SPRINGFIELD, OHIO

White Wyandottes!

Bred from Dustin's best. Some fine cockerels on hand already to ship. J. F. MOORE, TIFFIN, OHIO.

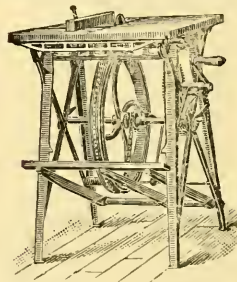

BARNES' Hand and Foot Power Machinery.

This cut represents our combined circular saw, which is made for bee-keeper's use in the construction of their hives, sections, boxes, etc., etc. **Machines on Trial.** Send for illustrated catalog and prices. Address W. F. & Jno. Barnes Co., 545 Ruby St., Rockford, Illinois.

Queens! Untested, \$1.00; tested, \$1.25 and upward. See former ads. and circular. J. B. Case, Port Orange, Florida.

THE STORRS & HARRISON CO., PAINSVILLE, OHIO.
Leading American Nurserymen offer one of the Most Complete Assortments of **FRUIT AND ORNAMENTAL TREES, SHRUBS, ROSES, BULBS, ETC.**
48 Years. 44 Greenhouses. 1000 Acres. Correspondence Solicited. Catalog Free.

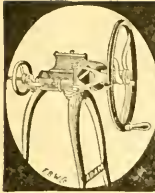

Why Not Buy the Best ?

It costs no more than inferior styles. We claim that **Adam's Green Bone Cutter** is the best because it is the only Ball Bearing machine on the market. It works on the shear principle, turns easier, cuts faster and cleaner, and prepares the bone in better shape than any other. Write at once.

Catalogue No. 59 Is Free.
W. J. ADAM, - - - **JOLIET, ILL.**

IF
**IT'S AN
 ADAM
 IT'S THE
 BEST**

A SHORT CUT TO POULTRY SUCCESS

Double your egg yield, double your profit by feeding cut raw bone.

MANN'S BONE CUTTER 1902 Model

New design, open hopper, enlarged table, new device to control feed. You can set it to suit any strength. Never clogs. Sent on **TEN DAYS' FREE TRIAL.**

No money asked for until you prove our guarantee on your own premises, that our new model will cut any kind of bone with adhering meat and gristle, faster and easier and in better shape than any other type of bone cutter. If you don't like it, send it back at our expense. Free Catalog explains all.

F. W. MANN & CO., Box 37, Milford, Mass.

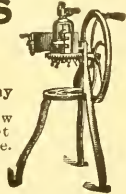

THE CYPHERS INCUBATOR

IS THE STANDARD HATCHER OF THE WORLD.

Used with uniform success on twenty-six Government Experiment Stations in the U. S., Canada, Australia and New Zealand; also by America's leading poultrymen and many thousands of persons in every walk of life. Guaranteed to give satisfaction or price refunded. The original and only genuine non-moisture incubator, fully covered by patent. Winner of **GOLD MEDAL and HIGHEST AWARD AT THE PAN-AMERICAN, Oct., 1901.** Illustrated, descriptive, 32-page circular FREE. Complete Catalogue and Poultryman's Guide, 224 pages, 8 1/2 inches, weighing one and a quarter pounds, 10c in stamps for postage. Ask for Book No. 74, and address our nearest office.

Cyphers Incubator Co., Buffalo, N. Y., Chicago, Ill., Boston, Mass., New York, N. Y.

GET A DANDY

It Brings More Eggs

Get a Dandy Green Bone Cutter and double your egg yield. Our new catalogue tells all about feeding green bone, and the best machine for cutting it.

Sold Direct PRICE, **\$5** and up
 on 30 days' trial.

Straiton Mfg. Co., Box 54, Erie, Pa.

It Brings the Eggs.

HUMPHREY Green Bone CUTTER

is sold on a positive guarantee to cut more bone in less time and with less labor than any other or your money back. Handsome Catalog, and Egg Record free.

HUMPHREY & SONS, Box 51, Joliet, Ill.

JOSEPH BRECK & SONS, Boston.
JOHNSON & STOKES, Philadelphia.
GRIFFITH & TURNER CO., Baltimore.

CALIFORNIA RED WOOD

Twelve ounce cold rolled copper tanks; hydro-safety lamps; climax safety heater; corrugated wafer regulator, and the best system of heating and ventilation is what makes the **Sure Hatch Incubators** hatch sure.

Common sense - rooders take good care of little chicks. Our fr-e-e-catalogue contains hundreds of actual photographs of the **Sure Hatch** at work and is full o' honest poultry informat-on. You ought to have it. Let us send it to you. Write at once, addressing nearest house.

Sure Hatch Incubator Co., Clay Center, Neb., or Columbus, O.

JUST AS NATURAL

as the old hen and a good deal more reliable. Doesn't break its eggs or make its chicks lousy. Doesn't stay off the nest and allow the eggs to chill but hatches every egg that can be hatched.

THE PETALUMA INCUBATOR

is absolutely perfect as to incubator essentials—proper application and distribution of heat and moisture, regulation and ventilation. For 64 to 324 eggs. **WE PAY FREIGHT ANYWHERE** in the U. S. Handsome catalog free.

Petaluma Incubator Co., Box 125 Petaluma, Cal.

1 2 3 4 5 6

Count the Chicks

as they come out. Then count the eggs, and you will see why so many people are using

Successful

Incubators and Brooders,

The healthy egg becomes the vigorous, husky, moneymaking hen. You will want our beautifully illustrated catalogue. Five different editions in five languages. English edition 4 cents; others free. It is a poultry Bible.

Des Moines Incubator Co.,
 Box 503, Des Moines, Ia., or Box 503, Buffalo, N. Y.

HOW DIFFERENT

is the perfect system of regulating temperature and moisture in the

MARILLA

INCUBATORS AND BROODERS

from all others. You will understand when you receive our new catalogue. Fully guaranteed. Money back if you want it. Send 4c in stamps and we will mail catalogue at once.

MARILLA INCUBATOR COMPANY, BOX 62, ROSE HILL, N. Y.

A Combination

of brains, experience and high grade material has made the

RELIABLE Incubator

known throughout the civilized world. If you are after results represented in dollars and cents, you want one of our popular 20th Century Poultry Books. Bright, instructive and worth ten times the price asked. Sent for 10c. As full of meat as an egg.

Reliable Incubator & Brooder Co., Box B-49 Quincy, Ills.

1881

PAGE & LYON MFG. CO.

1901

We manufacture a full line of the latest BEE-SUPPLIES.

Our motto is, "Perfect Goods and Prompt Shipment."

Send for our new free illustrated catalog.

PAGE & LYON MFG. CO., New London, Wisconsin.

Marshfield Manufacturing Company.

Our specialty is making SECTIONS, and they are the best in the market. Wisconsin basswood is the right kind for them. We have a full line of BEE-SUPPLIES. Write for FREE illustrated catalog and price list.

Marshfield Manufacturing Company, Marshfield, Wisconsin.

I. J. Stringham, 105 Park Place, New York City.

Honey-jars.

1-lb. square jars, \$5.00 per gross ; No. 25 jar, porcelain top, \$6.00 per gross ; Nickel-cap jar, *Jancy*, \$5.50 per gross. All are clear flint glass. Discount on quantities. We ship from New York City, N. Y.

Labels.—60 cts. per gross. A full line of Apiarian Supplies always in stock. Catalog free. . . . Apiaries located at Glen Cove, Long Island, New York.

I. J. Stringham, 105 Park Place, New York City.

BEE SUPPLIES!

- Complete Line.
- Manufacturers' Prices.
- Send for Our Catalog. . .

FRED W. MUTH & CO., Cincinnati, O.

South-west Corner Front & Walnut.

THE HANDSOMEST CALENDAR

of the season (in ten colors) six beautiful heads (on six sheets 10x12 inches), reproductions of paintings by Moran, issued by General Passenger Department, Chicago, Milwaukee, & St. Paul Railway, will be sent on receipt of twenty-five cents. Address: F. A. Miller, General Passenger Agent, Chicago.

Mr. A. I. Root's Writings

of Grand Traverse territory and Leelanau Co. are descriptive of Michigan's most beautiful section reached most conveniently via the

PERE MARQUETTE R. R.

For pamphlets of Michigan farm lands and the fruit belt, address W. C. Tousey, D. P. A. Toledo, Ohio.

BELCIAN HARES!



With every hare sold goes a full pedigree, register number, and score-card, scored by an official judge. Does will be bred to one of our famous high-scoring bucks free. Write for book. Mgr. of The A. I. Root Co. J. B. MASON, MECHANIC FALLS, MAINE.

Angora Goats

are handsome, hardy, profitable. Prize stock; low price; circular. ED. W. COLE & Co., Kenton, O.

GREAT CLUBBING OFFERS!

My friends, how many of you are reading some of the many most excellent magazines of the day? If you are reading none, you are missing a great treat. Perhaps you regard them as luxuries. Possibly they are in some instances. They certainly help to fill out our lives, and give to us broader views. They are like windows that allow us to look out over the wide world. This life is not wholly one of dollars and cents—at least it ought not to be. Enjoyment, pure and simple, enjoyed just for the sake of enjoyment, is desirable and beneficial. To many there are few things that are more enjoyable than the bright pages of a really good magazine. To those who wish to give the magazines a trial, and to those who are already reading them, I can offer some of the lowest clubbing rates that have ever been offered. Here is a list of magazines, together with the regular prices at which they are published:

Review of Reviews.....	\$2.50	Cosmopolitan.....	\$1.00
Current Literature.....	\$3.00	Leslie's Popular Monthly....	1.00
New England Magazine.....	3.00	The Household.....	1.00
Leslie's Weekly.....	4.00	Good Housekeeping.....	1.00
North American Review.....	5.00	The Designer.....	1.00
Success.....	1.00		

If you subscribe for one or more of these magazines, in connection with the Bee-keepers' Review, I can make the following offers:

Success and the Bee-keepers' Review for only.....	\$1.75
Success and any one of the above \$1.00 magazines and the Bee-keepers' Review for only.....	2.50
Success and any two of the above \$1.00 magazines and the Bee-keepers' Review for only.....	3.00
Success and any three of the above \$1.00 magazines and the Bee-keepers' Review for only.....	3.50
Success, Review of Reviews (new), and the Bee-keepers' Review for only.....	3.00
Success, Review of Reviews (old), and the Bee-keepers' Review for only.....	4.00
Success, Current Literature (new), and the Bee-keepers' Review for only.....	3.00
Success, Current Literature (old), and the Bee-keepers' Review for only.....	4.00
Success, the New England Magazine, and the Bee-keepers' Review for only.....	3.00
Success, Review of Reviews (new), any one of the above \$1.00 magazines, and the Review, for only..	3.50
Success, Leslie's Weekly, and the Bee-keepers' Review for only.....	3.75
Success, Review of Reviews (new), Leslie's Weekly, and the Bee-keepers' Review for only.....	4.75
Success, North American Review (new), Review of Reviews (new), and the Review for only.....	5.00

Magazines will be sent to one or different addresses as desired.

New subscribers to the Review will receive the rest of this year free.

N. B.—For \$1.00 in addition to any of the above offers I will book your order for a Superior Stock queen, to be delivered next spring.

W. Z. Hutchinson, Flint, Michigan.

THE SMITH PREMIER TYPEWRITER

Occupies an Imperishable Position in the BUSINESS WORLD.

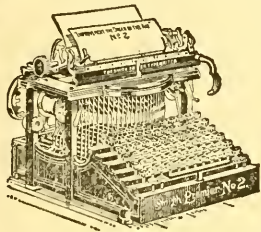

Unquestionable Superior Merit

Annually adds thousands of names to the long list of Smith Premier users, representing every line of trade and every profession.

ILLUSTRATED CATALOGUE FREE.

The Smith Premier Typewriter Co.,

158 Prospect Street, Cleveland, Ohio.

NOW READY!

64-PAGE CATALOG OF EVERY THING BEE-KEEPERS NEED. Illustrated and fully described. Especially valuable to beginners for the information it contains. Send your address on postal and get it now. Established 1884.

J. M. JENKINS, Wetumpka, Ala.



Red Glover Queens -FOR- 1902

Warranted Purely Mated.
The Long-Tongue Variety.

How to get One for Only 30 cts.

We have arranged with the queen-breeder who furnished Long-Tongue Red Clover Queens for us during the past season, to fill our orders next season. Although fully 95 percent of the untested queens he sent out were purely mated, next season all he mails for us will be **warranted** purely mated.

We want every one of the readers of Gleanings in Bee-Culture, who is not now a reader of the old weekly American Bee Journal, to have one of these Superior Red Clover Queens. We have received most excellent reports from the Queens we supplied during the past season. And next year our breeder says he expects to be able to send out even better Queens, if that is possible. He is one of the very oldest and best queen-breeders. His bees average quite a good deal the longest tongues of any yet measured. The Breeder he will use is direct from Italy, having imported her himself. Her worker-bees are large, of beautiful color, very gentle, scarcely requiring veil or smoker.

Orders for these fine, "long-reach" **warranted** Queens will be filled in rotation—"first come, first served"—beginning as early in June, 1902, as possible. It is expected that orders can be filled quite promptly (even better than the past season), as a much larger number of queen-rearing nuclei will be run. (But never remove the old queen from the colony until you receive the new queen, no matter from whom you order).

In order that all who are not now readers of the American Bee Journal can have one of these fine Queens, we will make the price **only 30 cents** each, when taken in connection with a year's subscription. That is, send us \$1.30 (if you are a **NEW** subscriber), and we will book your order for a **Warranted Queen**, and enter your name on our list of subscribers and send you the Bee Journal **every week** from the time we receive your name and \$1.30 **until the end of next year (1902)**. So the sooner you send in your order the more copies of the Bee Journal you will receive. If you have not seen the weekly American Bee Journal, send for a free sample copy. Address,

GEORGE W. YORK & CO.

144 & 146 Erie Street, CHICAGO, ILL.



We are headquarters in Chicago for **ROOT'S BEE-KEEPERS' SUPPLIES AT ROOT'S PRICES.**

Catalog Free...

CALIFORNIA SAGE HONEY.

The world again sweetened with our famous sweet. Bees increasing fast. Bee-men very active. Tons of nectar lost for want of bees to gather. The PACIFIC BEE JOURNAL controls thousands of acres of fine field. Many fields to let. A few bees for sale—and climate too. Four hundred pounds to the colony, twenty tons to the 100 colonies in some instances.

Pacific Bee Journal, Los Angeles, Cal.

\$1 per year; 25c for 3 months' trial; 50c this year and six months of 1902; \$1 for this year and all of 1902; with Gleanings, \$1.25 a year.

Subscription Combinations!!

We take pleasure in offering the readers of GLEANINGS a few of our combinations. If you do not see what you want we have a 44-page catalog free for the asking. These prices are for a full year, and may be either for new or renewal, except where stated. Sent to different addresses if desired, and will be mailed direct from the publisher the same as they would if you ordered direct. The offers are made by the publishers, and we are their special agents. Success, Leslie's Monthly, and Cosmopolitan, \$2.00. In the above offer, in place of Leslie's or Cosmopolitan you may substitute any of the following: Gleanings, Farm Poultry, Good Housekeeping, Household, Practical Farmer, Designer, Health Culture, Hints, The Era, new subscription to Recreation. Success must be in any list made from above—the others are interchangeable. Everybody's Magazine, Practical Farmer (new subscription), and your choice of a new subscription to either Harper's Bazar, American Boy, Little Folks, or Sunday School Times..... \$1.75
 Gleanings and Great Round World..... 1.99
 Gleanings and Century..... 4.05
 Gleanings and Scribner's..... 3.30
 Gleanings and Outing..... 3.00
 Gleanings and Farm Poultry..... 1.00
 Gleanings and Country Gentleman..... 1.50

Youtans' Companion may be added to any offer for \$1.75, and new subscribers get November and December free, also art calendar. Ladies' Home Journal may be added for \$1.00. McClure's may also be added for \$1.00. By our arrangements with publishers these offers are good until Sept. 1st, 1902. We want to send you our catalog. Ask for it, and address all orders to

C. M. Goodspeed, Box 791, Skaneateles, N. Y.

FOR SALE.—Will sell cheap, one 10 h p. engine with upright boiler all complete; one 18-inch planer, one saw-table. Inquire of
 J. W. BITTENBENDER, Knoxville, Iowa.

BERMUDA

With cable communication and equable winter temperature of 70 degrees, is reached in 48 hours from New York by the elegant steamers of the Quebec Steamship Company, sailing every ten days up to January, and then every five days. The situation of these islands—south of the Gulf Stream—renders

FROST UNKNOWN,

and the porous coral formation prevents malaria. The Quebec Steamship Company also despatches highest class passenger steamers every ten days for ST. THOMAS, SANTA CRUZ, ST. KITTS, ANTIGUA, GUADALOUPE, DOMINICA, MARTINIQUE, ST. LUCIA, BARBADOS, DEMERARA, and the principal WEST INDIA ISLANDS, affording a charming tropical trip at a cost of about \$4 a day. For descriptive pamphlets, dates of sailing and passages, apply to

A. E. OUTERBRIDGE & CO., Agents.

39 Broadway, New York.

ARTHUR AHERN, Sec., Quebec, Canada.



In this issue, as will be noted, the index for 1901 is omitted; but we will furnish it as an insert in our next issue. Owing to a combination of circumstances it was impossible for us to prepare it as usual for the last number of the year.

MAPLE SUGAR.

There is a great shortage of maple products, both sugar and syrup; and the new crop will not be in for two or three months. We have upward of a ton of nice sugar made up from syrup that was slightly tainted, and with the addition of about 20 per cent of granulated sugar to make it grain. We shall be pleased to mail samples to those interested, and will sell in 100-pound lots or more at 10 cts. per pound.

HONEY MARKET.

We have a good stock of honey, both comb and extracted; and while it has been moving quite freely it has not been going as fast as we should like to see it go. We shall be glad to hear from those interested, stating what quantity you can use, either comb or extracted, and we shall be pleased to give you an attractive price. We still have some 800 cases of the choice thick western honey in cases of 24 sections, with wood slides in place of glass. We have also choice comb honey from New York, Pennsylvania, Alabama, and Michigan. December is usually a good month for honey. If in need, let us hear from you.

GERMAN WAX-PRESS.

We are getting some splendid reports from those who have been trying our new wax-press. Mr. E. T. Flanagan, one of the oldest customers on our books, says: "I have bought goods of you for quite 20 years, but have never received any thing from you that has given me the satisfaction the wax-press has." And he seconds his appreciation by ordering another machine. We have found it impossible to produce a machine thoroughly satisfactory at as low a price as we expected to make. From now on the price will be \$12 each. It will be so listed in our new catalog. If you have many old combs to render, you can pay for it from the increased amount of wax secured the first year.

CATALOG FOR 1902.

The revision of our catalog for 1902 is completed, and we will begin printing them before Jan 1. It will be some weeks before we get around to our large list of names, but we will do so as early as possible. Among the first to be mailed will be those to our list of subscribers. If you do not get one within a month, let us hear from you. All the matter has been reset, and much of it rewritten, with many new illustrations. Very few changes in prices have been made. Some glass and tin honey-packages formerly listed have been omitted. A new arrangement of hives has been made, which I think will please those who have had difficulty in understanding our system of hive numbers. We continue the same system, but we have arranged right under a picture of each style of hive a table of prices of that hive nailed and in flat, 8 and 10 frame, in different quantities.

Special Notices by A. I. Root.

MARCH'S CAULIFLOWER AND JERSEY WAKEFIELD CABBAGE SEED.

Last year we bought of friend March \$60 worth of cauliflower seed. It was from his new improved strain of Snowball, the kind that makes a nice white head for every seed you plant, if every thing is favorable. Of course, this amount is not very much compared with what some of the large seedsmen pay; but it is more than twice as much as we ever sold before. We had also a tremendous lot of orders for March's strain of extra-early Jersey Wakefield cabbage seed; and after buying every ounce of seed he had to spare, we were unable to fill all orders. This season we have

a nice stock of both cabbage and cauliflower seed grown by friend March expressly for us; but to be sure not to be disappointed, perhaps you had better send in your orders early. The practice of growing cold-frame cabbage and cauliflower plants by planting in the fall has been mostly dropped, if I am correct. A later method is to sow the seed in the greenhouse; and when it begins to show the second leaf, transplant to cold-frames and let them grow slowly all winter. This hardens them and gives a big stocky root. The man who gets nice home-grown cabbage and cauliflower in the market first, gets a good profit; and there is always a big demand for nice stocky well-hardened plants in the spring.

Wakefield cabbage seed will be at the old price—20 cts. per oz.; \$2.50 per lb. But this new improved strain of cauliflower seed will be as follows: ¼ ounce, 30 cts.; ½ ounce, 50 cts.; 1 ounce, \$1.75. Postage paid at above prices except the cabbage seed by the pound. This will be 10 cents more if wanted by mail.

ANIMAL BREEDING, BY THOMAS SHAW.

The above is the title of a new book just out, by the O. Judd Co. Prof. Shaw, who at present is connected with the University of Minnesota, has made himself well known to our readers, or at least many of them, doubtless, by his book on "weeds" and other valuable books later. See what Prof. Shaw says in his preface in regard to the matter:

Animal breeding is in many of its phases a most intricate subject. While it has its shallows it has also its great depths that have never yet been fathomed. They would take an intellectual giant over his head at the very first plunge. The difficulty, therefore, of writing effectively on such a subject will be at once apparent.

Now, I confess the above gives me confidence in the author of the book. I did not know before that we had a good writer who was honest enough to confess as much as he has in the extract above. The chapter on the "influence of previous impregnation" ought to be worth the price of the book, *even for poultry-breeders*. If we have a flock of white fowls, and a black rooster gets in among them, how much damage will it do, and how long will it last? Prof. Shaw tells us there are good authorities who claim the white hens will be apt to produce speckled chickens all their lives after this one mating. Perhaps that is putting it pretty strong; but with my short experience in such matters I am prepared to accept some such statement.

The book has over 400 pages and about a dozen illustrations. We can mail it from this office for \$1.50. It is probably the most complete and comprehensive work ever published on this subject.

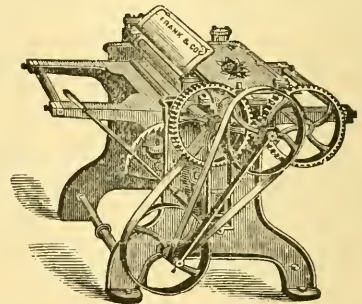

PLANERS

The above cut shows one of our small Planers, of which we make twelve different styles and sizes.

Also large Planers, Band Saws, Buzz Planers, Moulders, Wood Lathes, and all kinds of

WOOD WORKING MACHINERY

Send for Catalogue.

The **FRANK MACHINERY CO.**
BUFFALO, N. Y.

The Sure-Hatch Incubator hatches sure. See advertisement on page 995.

CONVENTION NOTICES.

The Wisconsin State Bee-keepers' Association will hold its annual convention in the State Capitol at Madison, Feb. 5 and 6, 1902. The convention promises to be largely attended. Excursion rates of 1½ fare, good for all of the first week in February. All are invited to attend. ADA L. PICKARD, Secretary.
N. E. FRANCE, President.

The California State Bee-keepers' Association will hold its annual convention at the Chamber of Commerce, Los Angeles, on Jan. 15 and 16, 1902. We will try to have a good program. Come, and exchange your bright ideas with your neighbors, and get some of the moss rubbed off your back.
J. F. MCINTYRE, Sec.

G. S. STUBBLEFIELD, Pres.

The next meeting of the Michigan Bee-keepers' Association will be held at Petosky, January 1 and 2, 1902, and promises to be one of the most interesting meetings in the history of the Association. W. Z. Hutchinson, of the *Bee-keepers' Review*, will be there with his camera, and other prominent men will be there, and we want you to receive this letter as a special invitation to be present. There will be no set program, but such topics as we, as bee-keepers, are interested in, will be taken up and discussed, and we hope you will come prepared to ask questions and answer others. Reduced rates on all railroads. Tickets can be bought Dec. 31 and Jan. 1, good to return not later than Jan. 4. There is no place like these conventions for exchanging views, receiving and imparting knowledge; and as we are all more or less dependent on each other, let us meet in that spirit of friendship and harmony that has always prevailed at our meetings, and make it possible for us to go back to our homes and tell our friends that we were glad we went; that it was just that "feast of reason and flow of soul" that we needed. Trusting that we will meet you there we are Very resp. yours,

GEO. E. HILTON, Pres.

WM. G. VOORHEIS, Sec.

W. Z. HUTCHINSON, Treas.

P. S.—This meeting will be held in the new Normal Hall.

Kind Words from our Customers.

OUR TRANSPLANTING-MACHINE.

Enclosed find \$2.50, for which send me two transplanting-tools. They are the finest thing I ever saw to transplant strawberries with, and nearly every one who has seen them says he must have some. These are for another party.

Alvin, Texas, Sept. 14.

A. J. KIMMONS.

SOMETHING IN REGARD TO THE HOME TALK IN GLEANINGS FOR SEPT. 1.

Mr. A. J. Root:—I have waited some time in order that some older friend and admirer of yours might say something with regard to the criticisms of your Home Talks which came for Sept. 1. As none better able have done so, perhaps you will allow me a chance to ventilate some of my ideas on the subject.

As to Mr. Wm. S. Fehr, he scarcely deserves recognition, for his letter was simply inexcusable. You were altogether too gentle in your reply, as he did not deserve such gentlemanly forbearance. Pray, upon whose authority or example does Mr. Fehr proclaim his *ipse dixit* that "it would be better if you were not so quick to see all the handsome women, and talk to all the pretty girls"? Is that not exactly and precisely what they were made for? are not they the absolute perfection of perfect work, from hands whose work is all perfect? Is there a more pleasurable and attractive thing in all God's universe, to a properly constituted man? Why, Mr. Fehr, handsome women were made to be admired. Pretty girls were made to be talked to; and pity the man who does not think so, no matter how old he may be. Of course, it goes without saying that beauty is to be approached decorously and respectfully—yes, *reverently*, as should be every perfect work of our Master's hands; but forbid that any vandal is to teach us to avoid them. If there are any such men, which I do not believe for one moment, I

would not give a piece of drone comb for a Junco brood-nest full of them. Come, come, Mr. Fehr, cure that dyspepsia or else seek a hermitage.

Arbuckle, Cal., Nov. 7.

H. B. JONES.

[Bro. Jones is not quite correct in taking it for granted that no one else has written on the same line that he has in the above.* There has been quite a number of very able articles on the subject; but I have thought best not to give them a place in print, and very likely I would not have given the above were it not for a postscript that he sends along with it. I think it is a little too strong, both the article and the postscript; but as it expresses the feelings of quite a goodly number of our subscribers I have decided to let it pass just as he writes it. Here is the postscript:]

P. S.—Now see here, Mr. Root. In your usual forbearing spirit you will be disinclined to publish this; but will you excuse me if I insist that you should do so, from consideration for the rest of us? Why, how do you suppose we felt on reading that intolerable letter? My wife was so outraged and indignant that she has not been able to cook a good meal since, and many other families are in a similar condition. Why, dear sir, our digestions are to be considered, and you have no right, as a fair man, to devote twelve thousand honest gentlemen (more or less) to burnt beefsteak and underdone bread. "Say" (as Ernest says), how would you like it yourself? You have not a particle of "old scrach" in you; but some of us have, and you must let us "claw" back now and then.

I am a small rancher here in the foothills of Colusa Co., where I am almost entirely without frost. I grow oranges, lemons, olives, etc.; I have a few bees which will increase as I learn to manage them. I have your A B C and "Gleanings," which keep us in touch with you. With very much respect

I am yours,

H. B. JONES.

[Will all the dear friends who have so warmly taken my part in the above accept my most hearty thanks?]

* Permit me, in this brief footnote, to take the part of Bro. Fehr a little. I think he has some grounds for taking it for granted that, in working for Christ, Jesus and his kingdom, I gave more attention to the "handsome women" and "pretty girls" than I did to mankind in general. One who is filled with the Holy Spirit should give just as much attention—nay, more—to elderly women, those who may be plain in feature and dress—yes, those who may be poor and afflicted. And that is the very thing I have been trying to do—to look up those who seem to have been passed by or overlooked; and may God help me to remember that Jesus died for all. In this line I thank Bro. Fehr for his criticisms along this line of thought.

Free to Poultry-raisers.

Cut green bone has long been recognized as the most valuable of all poultry foods, but only in recent years has there been a machine made which will cut it with ease and rapidity. The Humphrey green-bone and vegetable cutter (the open-hopper machine) has come rapidly to the front, largely because of its guarantee to cut more bone in less time and with less labor than any other, or your money back.

The manufacturers put out a beautiful book describing the machine, the use of green bone, and other poultry topics. It also contains blank pages for a year's record of your poultry. Send for a free copy. Address Humphrey & Sons, Box 51, Joliet, Ill.

A Handsome Helpful Book.

"More Money from Your Hens" is the title of a new book issued by the Stratton Mfg. Co., of Erie, Pa., manufacturer of the well known line of Dandy green-bone cutters. It is attractively printed in two colors, well illustrated, and goes into the question of making poultry profitable, in a very thorough manner. Of course it places special emphasis on the value of freshly cut green bone as an egg producer and growth-promoter. There is no doubt in the minds of poultry-raisers that a little green bone added to the feeding ration is productive of the very best results in two ways; it not only saves in the grain bill, an important feature this fall when grain is high, but it also makes the poultry more productive in every way. It is a double-headed money-maker.

The Dandy bone cutter has been on the market a number of years with increased popularity. It has an automatic feeding-device, is strongly and substantially built, has a large cutting capacity, and we know that numerous of our readers have demonstrated that it is a satisfactory machine in every way. You will be interested in the handsome book which they send free.

HONEY QUEENS!

- Laws' Long-tongue Leather Queens.
- Laws' Improved Golden Queens.
- Laws' Holy Land Queens.

Laws' queens are the standard bred queens of America. The largest honey-producers use them and praise them. Laws' queens go everywhere, and can furnish you a queen every month in the year. Four apiaries. Queens bred in their purity. Prices, October to April: Tested or untested, \$1.00 each; 6 for \$5.00. Breeders, none better, \$3.00 each. Address

W. H. Laws, Beeville, Texas.

Dittmer's Foundation !!!

Retail---Wholesale---Jobbing.

I use a PROCESS that produces EVERY ESSENTIAL necessary to make it the BEST and MOST desirable in all respects. My PROCESS and AUTOMATIC MACHINES are my OWN inventions, which enable me to SELL FOUNDATION, and WORK WAX INTO FOUNDATION FOR CASH, at prices that are the lowest. Catalog giving

FULL LINE OF SUPPLIES

with prices and samples, free on application. BEESWAX WANTED.

GUS. DITTMER. AUGUSTA. WIS

Get the Best Queens.

Evansville, Ind., Sept. 27th, 1900.

The Jennie Atchley Co., Beeville, Bee Co., Texas:

Dear Friends:—It gives me great pleasure to forward you this unsolicited testimonial regarding the merits of Atchley queens. The three (3) dozen queens purchased of you have made an excellent record for themselves. Not an Atchley queen among the twenty colonies lost during the severe drouth in July. I've bought queens from many breeders; and although the present crop is exceedingly short, the tiers of supers show where the Atchley queens are, and speak volumes for your method of queen-rearing. I find the progeny to be very gentle, strong-winged, uniformly marked, long-lived, of large size, and last, but not least, the best honey-gatherers I ever had. I shall want 100 more next season. Yours fraternally,

J. C. WALLENMEYER.

Prices for Queens.

Tested, \$1.50 each; \$8.00 for 6, or \$15.00 per doz. Un- tested, February, March, April, and May, \$1.00 each; \$5.00 per 6, or \$9.00 per doz. Fine breeders, \$5.00 each. We have as good bees and queens as money and labor produce. We breed three-band Italians, Goldenes, Carniolans, Cyprians, and Holy-Lands, in their purity, bred in separate yards 5 to 20 miles apart. If you want the best, call for Atchley's improved strains. Safe arrival guaranteed. Send for a sample copy of *The Southland Queen*, the only southern bee-paper. \$1.00 per year. To new subscribers we offer as a premium a nice untested queen in order to get our paper introduced. Catalog, giving queen-rearing and management of apiaries for profit, FREE.

THE JENNIE ATCHLEY CO.,
Beeville, Bee Co., Texas.

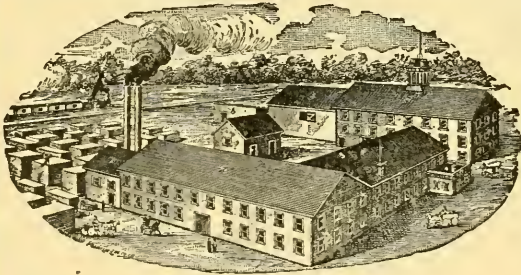

KRETCHMER M'F'G CO., Red Oak, Iowa.

BEE-SUPPLIES.

Best-equipped factory in the West; carry a large stock and greatest variety of every thing needed in the apiary, assuring BEST goods at the LOWEST prices, and prompt shipment. We want every bee-keeper to have our FREE ILLUSTRATED CATALOG, and read description of Alternating Hives, Ferguson Supers, etc. Write at once for a catalog.

— AGENCIES: —

Trester Supply Co., 103 So. 11th St., Lincoln, Nebraska; C. C. Richards, 1223 17th St., Denver, Col.

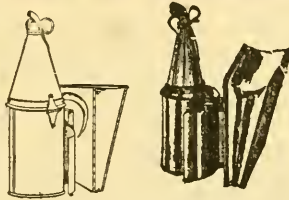

BINGHAM SMOKER.

Dear Sir:—Inclosed find \$1.75. Please send one brass smoke-engine. I have one already. It is the best smoker I ever used. Truly yours,
HENRY SCHMIDT, Hutto, Tex.

MADE TO ORDER

Bingham Brass Smokers.

Made of sheet brass, which does not rust or burn out; should last a lifetime. You need one, but they cost 25 cts. more than tin of the same size. The little open cut shows our brass hinge put on the three larger sizes. No wonder Bingham's four-inch smoke-engine goes without puffing, and does not drop inky drops. The perforated steel fire-grate has 381 holes to air the fuel and support the fire. Heavy tin smoke-engine, 4-inch stove, per mail, \$1.50; 3½-inch; \$1.10; 3-inch, \$1.00; 2½-inch 90c; 2-inch, 65c. Bingham smokers are the originals, and have all the improvements, and have been the standard of excellence for 22 years. Only three larger ones brass.

T. F. Bingham, Farwell, Michigan.

INDEX TO GLEANINGS IN BEE CULTURE.

VOLUME XXIX.

General Correspondence.

A B C Criticised by Cook 274. Absorbents v. Sealed Covers 241. Acid, Formic, for Foul Brood 381. Adulterated Honey—see Honey, Adul't. Adulteration Detected by Tannic Acid 788. Adulteration in Germany 381. Adulterator, German, Punished 502. Alfalfa in Nevada 46. Alfalfa Injured by Bees 240. Alfalfa in California 185. Alfalfa Blighted by Too Much Irrigation 978. Alfalfa, an Unwelcome Fact about 937. Alfalfa, New Facts about 470. Alfalfa, Sowing in Fall 761. Alfalfa, Rapid Growth of 977. Alley, Henry, Visit to 586. Alsike Clover—see Clover. American Bee Journal Office Burned 81. American Coffee-berry 111, 159. Anarchy, Abbott on 851. Ants, to Kill 519. Apiary, Exper't, in Paris 81. Apiaries, Arrangement of 184. Apiaries, movable, in Russia 742. Apiaries, Roof 275, 341. Apiaries, shaded—see Shaded Apiaries. Apple, Kaw's Genet 410. Arizona and its Wonderful Resources 903, 943. Arizona Cottonwood trees 985. At-water's Hive-rabbit 789. Automatic Hiving of Swarms 851.

Barometers, Aneroid 531. Bath, Shower, Cold 689. Bean Soja 111, 159. Beans, Soja, Planting and Harvesting 356. Bears in the Apiary 599. Bee Fever, Mrs Harrison's 749. Bee Poison Nct a Vegetable Acid 429. Bee in Law 583, 674, 818, 935. Bee in Law, Foreign Legislation 627. Bee Poison 429. Bee Poison, Antidote for 238. Bee Paradise in Texas 750. Bee Paradise 582. Bee Papers, Value of 862. Bee Culture in Italy 582. Bee Loads 502. Bee Business at Spokane 908. Bee, Caucasian 431. Bees Freezing 146. Bees on Shares 143, 218, 239. Bees a Subject of Larceny 819. Bees and Freezing 399. Bees in Lee Statue 851. Bees in Philippines 133. Bees in Italy with One Yellow Band 382. Bees and Fruit 44, 91, 139, 218, 244, 339, 397, 514. Bees and Grapes 244, 514, 518. Bees Clustering Out 519. Bees and Fruit Discussed 244. Bees as Fertilizers 891. Bees that are Workers 507. Bees Eating Eggs 777. Bees Dying of Old Age 292. Bees as Fertilizers of Red Clover 286. Bees in a Greenhouse 940. Bees, Profits in 971. Bees, Scent-producing Organ of 639. Bees Priority Right in 583. Bees, to Destroy 891. Bees, Number in Good Colony 379, 430, 712. Bees, Weights of 327. Bees, Nurse 930. Bees, Peculiar, in California 713. Bees, Moving Short Distance 861. Bees, Digestive Stomach of 545. Bees, Moving Holtermann on 816. Bees, Hallucination of 328. Bees, 600 Colonies in one Dooryard 198. Bee-keeper, Wages of 230. Bee-keeper, Youngest Big 983. Bee-keepers' Paradise in Texas, Plants of 863. Bee-keepers' Paradise in Arizona 903, 983. Bee-keepers, Amateur 10. Bee-keeping for Women 839, 892. Bee-keeping in the West—see Notes of Travel by E. R. R. Bee-keeping Increasing 381. Bee-keeping in Montserrat 937. Bee-keeping in Texas 677. Bee-keeping in Oklahoma 557. Bee-keeping, Profits in 929. Bee-keeping, Starting in 938. Bee-1 ads, how Much? 79. Bee-load 325, 327. Beemoth, Ravages of 642. Bee-papers, Value of 547. Bee-paralysis 519. Bee-sting Poison in Homeopathic Practice 947. Bee-stings for Rheumatism 786. Bee-trees, Finding 935. Bee-et Sugar—see Sugar, Beet. Beginners' Questions 143. Belgian Hares a Fake 226. Belgian Hares, Fair Statement 86. Belgian-hare Business

Dead 81. Benj. Franklin on Selling Comb Honey 823. Birds Killing Bees 599. Bisulphide of Carbon, Fumigating with 637. Bisulphide of Carbon 705. Bisulphide of Carbon v. Gasoline for Moths 715. Black Brood, Italians Immune to 183. Black Locust 669. Bleaching—see Comb Honey. Booker T. Washington and Class 23. Bottled Goods v. those put up in 8 lb. Pails 220. Bottled Honey, to Sell 189. Bottled Honey, to Keep 547. Bottles, Washing 93, 190. Bottling Fancy 187. Bottling and Sealing Honey 187. Bottling Foot Grades 187. Bottling in Mason Jars 194. Bottling Honey, to Li'quefy for 188. Bottling Honey, Weber's Method 547. Bottling Honey, Fowls on 12, 220. Bottling Honey, Heating it 131. Bottling Honey, Washing Jars 220. Bottling Honey, Symposium 93, 98. Bottling Honey 8, 140, 517. Bottling Honey and Packing for Shipment 220. Bottling Honey, Wallenmeyer on 187. Bottom-bars as Wide as Top-bars 275. Bordeaux Mixture 502. Borer, Apple-tree 566. Bougainvillea 528. Breeding Stock, Value of 85. Brood, Excessive, in Fall 754. Brood-chamber, Divisible—see Divisible Brood Ch. Brood-chamber, Double 335. Brood, Chilled 519. Brood-chambers, Shallow—see Frames, Shallow. Brood-combs Kept out of the Extractor 671. Brood-combs, Use of Old 503. Brood-frames, Material for 545. Broom, Sedge 52. Buckwheat, Report on 53. Building, Farm, Suggest ons 415. Bunting Brothers of Texas 780.

California, Central, Peculiarities of 437. California, Rains in 192. Candied Honey—see Honey, Candied. Cans v Barrels 81. Caramels, Honey 431. Carbolinum 741, 869. Catclaw, Leaf and Blossom 863. Cauliflower, March's Improved 60. Celery-growing in Florida 722. Celery-growing by Sub irrigation in Florida 352. Cellar Wine'ing, Barber on 218. Cellar, Large, for Wintering 683. Cellar, Noise in 149. Cellar, Bee, Ventilation of 933. Cellars, Ventilation of, by Doolittle, Miller, and Bingham 933. Cells, Emergency, and Swarming 626, 705, 706. Cells, Emergency and Swarming Defined 670. Cells, Pre and Post Constructed—see Cells, Emergency. Cell building on Dry Combs 714. Chambers, W. L. 983. Chambers' Asylum Apiary 984. Chicago Convention 971. Chickens Hatching over Bees 399. Chunk Honey—see Honey Chunk. Clamp for Wintering 14, 15. Clover and Cow Peas for Poultry 952. Clover Influenced by Snow 79. Clover Queens—see Queens. Clover, a New White 889. Clover Alsike 52. Clover, Crimson 611. Clover, Red, with Short Tubes 217. Clover, Sweet 9, 43, 217, 889. Clover, Sweet, in Ireland 9. Clover, Sweet, Yellow 434. Clover, Sweet, Hay of 557. Colonies, Difference in 671, 751. Colonies, Double-decker 822, 930. Colonies, Queenless, for Comb Honey 753. Colonies, Size of 742. Colony, Number of Bees in 712, 850, 890. Comb 40 Years Old 513. Comb and Ex'd Honey, Producing 591. Comb or Extracted Honey, which? 510. Comb and Ex'd Honey at the Same Time 635. Combs Over Load 777. Combs, Blue, Not Moldy 326. Combs, Old 131, 430. Combs, Old, for Brood-rearing 141. Combs, Very Old 332. Combs, Old, Affecting Honey 741. Comb Honey v. Ex'd 381. Comb Honey Loaded Crosswise 326. Comb Honey in Attractive Shape, Putting up 823. Comb Honey, Base for 285. Comb Honey, Barber's

Method 143, 184, 219, 274, 379. Comb Honey, Removing from Supers 398. Comb Honey, Working for 396. Comb Honey, Discrimination Against by Railroads 327. Comb Honey, Moving on Wagons 101. Comb Honey, Canded 556. Comb Honey, Aikin's Method 335. Comb Honey, Facing 335. Comb Honey, Bleaching 387. Comb Honey, Arrangement of 70. Comb Honey, how to Load on Wagon 468, 469. Comb-honey Supers, Double-walled 285. Combs Crosswise or Parallel with Entrance 243. Combs Built down to Bottom-bar 754. Combs, Old 216. Combs, Old, for Brood-rearing 516. Combs, to Protect 431. Combs, Drawn, Hiving on 239. Combs, Movable, Invention of 388. Combs, Age of 80, 141. Combs, Old, v. Foundation 675. Congress, International 45. Congress, Int., Dadant on 45. Contraction of Brood-chamber 225. Co-operating against Trusts 46. Co-operative Organized Work 46, 82. Co-operative Organization 386, 387. Corn and Honey 707. Corns Cured by Beeswax 351. Cottonwood-trees of Arizona 985. Cover for Warm Climates 507. Cuba, Bee-keeping in 432, 587. Cuba, Facts Concerning 90. Cuba Glimpes of, by Boyden 134, 228, 283 336. Cuba, Favorable Statement 136. Cuba, Harry Howe on 135. Cuba, Large Honey Yields in 587. Cuba, Peculiar Conditions in 553. Cuba, Wrong Notions Corrected 711. Cyprians 275.

Dark Clothing and Bees 430. Davidson, Visit to 677. Day, J. W., Visit to 197. Detwiler, J. W. 354. Dickel Theory 393. Divisible Brood-chambers 591, 592 635. Divisible-brood-chamber Hives—see Frames, Shallow. Domestic Animals Eating Strange Food 951, 993. Doolittle on Selling Honey 681. Doolittle's Success in Bee-keeping 938. Drone a Half-orphan 778. Drone and Store Cells 43. Drones and Queens, Doolittle on 979. Drones from Drone-laying Queen Wirtle 850. Drones from Laying Workers and Drone-laying Queens 646. Drones from Queen cells 557. Drones Necessary to Colony 242. Drones Warming Brood 45. Drones Wasteful Consumers 889. Drones, Relationship of 814. Drone-trap, Improved 556. Drone-trap, New 557. Dzierzon, John 132. Dzierzon Not the Inventor of Movable Frames 219. Dzierzon and Langstroth on Movable Combs and Frames 388. Dzierzon on Removable Combs 429.

Ear-drums 309. Editors and Other People 779. Edwards, Bee-king of Uvalde Co. 750, 781. Egg of Queen, Weight of 889. Eggs, High-pressure 357. Eggs, to Get in Winter 109. Eggs, Unfertilized, Producing Drones 148. Egg farm, Stoddard's New 26. Egg-farm, Visit to 109. Egg-laying, Sudden Stoppage—see Queens, Sudden Confinement. Electric Hen Man, O. W. Mapes 108. Entrance-contractors 238. Eucalyptus, Growth of 472. Extracted Honey from Black Combs 545. Extracted Honey from Dark Combs 242. Extracted Honey a Drug on the Market 384. Extracted Honey for the Poor 138. Extracted Honey, Glass v. Tin 138. Extracted Honey, Grading 713. Extracted Honey, Straining 516. Extracted Honey, to Pack for Shipment 790. Extracted Honey, to Produce Light-colored 441. Extracting Combs, Shallow 75. Extracting Rambler on 185. Extracting combs Cleaned by the Bees 466. Extracting-house, Buntings' 782. Extracting-house Chambers' 984. Extracting-outfit 48. Extractors, Double-pocket 243. Extractors, Large or Small 855, 856.

Fairs, Street 760. Feeding Back 643. Feeding Back for Comb Honey 242. Feeding Back on Foundation 931. Feeding in Mid-winter 214. Feeding in the Spring 244. Feeding to Start Brood-rearing 668. Feeding, a Drain on Vitality 813. Ferris Wax-extractor, Experience with 511. Fertile Workers, Remedy for 517. Fertilizing Queens in Small Nuclei 434. Fertilization of Queens in Hive 386. Fertilizing-boxes, Swarthmore 743. Florida Home, Florida 303. Florida Travels 196, 305, 352. Forestry Commission, Government 708. Forestry Station in California 709. Foundation from Rolls v. that from Press 626. Foundation in Sections 243. Foundation or Empty Combs 822. Foundation wired Vertically and Horizontally 391. Foundation, Full Sheets of 860. Foundation, Wire for Imbedding 889. Foundation, Thin, for Brood-frames 223. Foundation, Staying with Wood Splints 597, 625, 937. Foundation, Wiring, at Medina 625. Foundation, Preventing from Sagging 509. Foundation, Extra Thin, for Brood-nest 391. Foundation, New, in Austria 466. Foundation, Feeding Back on 931. Foundation, Fastening in Brood-frames 509. Foundation, Experiments by Rankin 391. Foundation, Thin, for Brood-frames 244. Foundation, Tool for Fastening 509. Foundation, Extra Thin, for Brood-frames 789. Foundation-making at Stearns' 892. Foul Brood in California 815. Foul Brood in Ohio 433. Foul Brood, McEvoy's Non-disinfection Hive 778. Foul Brood, Ma-

lignant and Mild 706. Foul Brood, France's Report 466. Foul Brood, Relation of Frames to 670. Foul-brood Inspections for Ventura Co., Cal. 862. Foul-brood Law in Colorado 465, 973. Frame, Hoffman, Criticisms and Suggestions 856. Frames, Distance for Spacing 79. Frames, Movable, v. Movable Combs 388. Frames, Shallow 131, 331, 334, 591, 635 931. Frames, Shallow, Hiving Swarms on 89. Frames, Shallow, Not Sati factory 89. Frames, Shallow, Use and Abuse 88. Frames, Shallow, v. Deep 853. Frames, Wired Without Foundati-on 937. Frames, Wiring 223, 287, 288. Fruits, why some Burst 139.

Galvanized Iron, Effect of on Honey 741. Gambling Enterprises 760. Gambling Mania 610. Gemmill on Wax-presses 782. German Wax Beans 163. Ginseng Culture 160, 528, 761. Girls, Traffic in 446. Gleanings Family a Picked Company 242. Glossometer, German 502. Glossometer, to Make 147. Glossometer, Swarthmore's 233. Glossometer, Whiting's 556. Glossometer, Wright's 585. Glucose Detected by Tannic Acid 788. Glucose for Bees 518. Glucose, Detecting in Syrups 788. Granulated Honey—see Honey, Canded. Grape Fruit in Florida 159. Grapevine Shade for Apiaries 782. Greville's Robusta 779. Guajilla Brush, of Texas 864. Guajilla Leaf 865. Guessing-contests 760.

Heddon Hives—see Frames, Shallow. Heredity and Variation in Animals 936. Hick's Almanac, Protecting Trees by 302. Hints, Useful 644. Hive with Special Rabbit 680. Hive 133 Years Old 351. Hive v. Stand 892. Hive, Scholl 591. Hives of Plaster of Paris 502. Hives for New Zealand 599. Hives Outdoors Packed for Winter 890. Hives Affected by California Climate 745. Hives, Doolittle on 51. Hives, Mold in 292. Hives, Double-decker 822, 930. Hives, Home-made 680. Hives, Size of 339. Hives, Elevated 218. Hives, Shallow—see Frames, Shallow. Hives, Large, Checking Swarming 235. Hives, arrangement of 181. Hives, Jumbo, and 8 frame 329. Hive-records, Bricks for 790. Hive-cover for Colorado 501. Hive-covers for Everbody 814. Hive-covers and Saw-cuts 714. Hive-tool, England's 930. Hive-covers, Construction of 553. Hive-covers 467, 644. Hive-cover, Flat 581. Hive-covers, Heat on in California 231. Hive-tool, Putty-knife 670. Hive-covers, Double 946. Hive-covers, Saw-cuts Under 742. Hive cover Problem, Solution of 778. Hive-covers, Rambler on 185. Hive-tool, Muench 705. Hive-cover, Rambler's 744. Hoffman Frames and Propolis 329. Hoffman Frame Criticised by Hyde 856. Holtermann on Hauling Bees 816. Home, Stating a New 833. Honey Business, Slandered in Chicago 972. Honey Cough Medicine 242. Honey from Corn 788, 861. Honey Cakes 715. Honey from Apple-blossoms 190. Honey Statistics, Government Aid for 897. Honey Statistics Needed 897. Honey for Kidney Troubles 8, 9. Honey as a Diet 131. Honey v. Sugar for Winter 778. Honey Jimcracks 815. Honey Markets in the South 285. Honey Candying 244. Honey Candying in Sections 136, 337. Honey Without Bees, Caird 707. Honey from Pennyroyal 431. Honey Exchange, National 46, 82. Honey Plants and Resources of Texas 627. Honey, Canded 12, 274. Honey, Marketing—see Marketing Honey. Honey, Canded v. Liquid 138. Honey, California, Berrett on 857. Honey, Adulteration of in California 230. Honey, Chunk, in the South 285. Honey, Extracted—see Ex Honey. Honey, Prices on 713. Honey, Adulterated 132. Honey, to Take During Dry Seasons 986. Honey, Sage 81. Honey, Marketing 9, 637. Honey, Canded, Burning 79. Honey, Extracted, to Put up 140. Honey, Marketing, Doolittle on 681. Honey, Price of in Ireland 931. Honey, Rose, Artificial 381. Honey, Bottling—see Bottling Honey. Honey, Canded, Desired 431. Honey, Temperature for Bottling 93. Honey extractor, when it Pays 860. Honey-plants of Texas 863. Honey-strainer 239. Honey-plants best for Honey Alone 244. Honey-house, Portable 287. Honey-jar, Bershiser 851. Horses, Treatment of 989. House apiary, Portable 288. Honey-apiary and Workshop 237. Humbugs and Swindles 161, 687. Hutchinson's Twins Married 889.

Idaho as a Bee Location 715. In-breeding, Scientific 383. In-breeding, Simpson on 546. Increase and its Prevention 473. Infidel, Reply to 758. Introducing Mean Stocks 217. Introducing to Cross Hybrids 787. Introducing, Bonney Plan 599. Italians Immune to Black Brood 183, 850. Italians, Three-banded, Hybrids 790, 971.

Jenkins, J. M., Visit to 551, 592. Jones, Commissioner 972. Jones, Commissioner, Report of 466. Johnson, J. W., of Arizona 904, 905.

Kandratieff, of Russia 431.

Larvæ, Age of, Miller on 784. Larvæ, Too Old or Too Young 929. Law Relating to Bees—see Bee in

Law. Leaflets for Free Distribution 116. Legislation for Bee-keepers 9. Legislation, Pure-food, York on 132. Lettuce Seed, Grand Rapids, Gilt-edge 357. Lettuce, Cold frame, in New Jersey 159. Lettuce, Importance of Good Seed 60. Linden, European 762, 908. Loading Comb Honey Crosswise 326. Loading Lengthwise or Crosswise 241. Locality in Honey Production of Bees. Longer or Shorter Tongues 598. Longevity of Bees 582. Long Tongues—see Tongues. Long-tongue Fad 974. Lucerne, Tree, of California 707.

Maeterlinck's Life of the Bee 779, 930, 971. Map of Switzerland, Bee 972. Market Quotations in Gleanings 681. Marketing in Mason Jars 194. Mesquite Leaf 867. Mesquite-tree of Texas 866. Michigan Beekeepers' Convention 155. Midway at Pan-American 794. Morrison on Sugars 672. Mountains and Their Economic Value 972. Moving Bees Without Screens 894. Moving Bees, Full Particulars 816.

Naphthol Beta 509. National Association, Joining 470. National Association, Nominations for 890. National B. K. Association, Fowls on 290. Negro on Same Footing as Whites 107. Negro Problem in the South 551, 594. Nevada Statistics 45. Nominations for N. B. K. A. 929. Nomination of Candidates 890. Notes of Travel by E. R. Root 551, 592, 627, 677, 750, 780, 863, 903, 943, 983. Nuclei, Forming 226. Nuclei, to Form at Medina 947. Nuclei, Making, by Doolittle 440. Nuclei over Upper Stories at Medina 947.

Old Combs, Rendered Up 276—283. Old Grimes 142. Onions, Giant Gibraltar 961. Operator, Ex-lightning 754. Orange-sheds 526. Overstocking and Location 859.

Pan-American Honey Exhibits 595. Pan-American Exposition 133. Parthenogenesis and Other Mysteries 393—395. Path-making 870. Pecan Industry in the South 302. Periwinkle Soup 355. Pettit on Thick Top-bars 227, 716. Pineapple-growing in Florida 408. Pineapple-sheds 526, 609. Plain Sections, Ideal 896. Pollen in Sections 100, 331. Pollen Going to Waste 501. Pollen, How Gathered 390. Pollen, Substitutes for 397. Pollen, Too Much 236. Potato, Gregg 567. Potatoes in Leelanaw Co., Mich. 913. Potatoes for Cooking 798. Potatoes, Scab proof 358. Potato growing, Successful 723. Potato-planter, Grand Traverse 157. Poultry, High-pressure 309. Poultry-yards at Willow Crest, N. Y. 25. Prices, Low, Responsibility for 907. Property Right in Bees 674. Propolis 9. Propolis for Paint 502. Propolis, Salve Made from 101. Purity v Good Workers 901.

Queen Mating Several Times 778. Queens Breeding in Little Hives 587. Queens Fertilized in the Hive 386. Queens Fertilized in Small Nuclei 434. Queens Fumigated in Foreign Mails 136. Queens Mated in Confinement 218. Queens Fertilized in Small Nuclei a Failure 630. Queens Mating where Black Bees are 940. Queens Caged when Laying Fully 813, 819, 848, 898, 929. Queens Laying Two Eggs in Cell 940. Queens Disappearing in California 715. Queen, Development of 784. Queen, Balled 790, 814. Queen, how She may be Worth Thousands of Dollars 582. Queen Tested, What is One? 813. Queens, High priced 85. Queens, Balled, Treatment of 861. Queens, Cost of Rearing 706. Queens, Keeping over 644. Queens, Freak-best, Simpson on 971. Queens, Confining, a Bad Practice 671. Queens, In and Cross Breeding 383. Queens, Breeding from the Best 814. Queens, Influence of on Bees 582. Queens, Virgin, Rough Handling 714. Queens, Best 581. Queens, Our Premium 518. Queens, Fertilizing in Confinement 507, 551. Queens, Bees Superseding 474. Queens, Clipping 85, 345, 465, 889. Queens, Thoroughbred 382. Queens, Sudden Confinement of in Cages 803, 819, 848, 898, 929. Queens, Introducing with Honey 184. Queens, Caging, to Prevent Swarming 244. Queens, In-breeding 705, 777. Queens, Longevity of 598. Queens, Virgin, Plurality in one Hive 743. Queen-cages, Pasteboard on 669, 788. Queen-catcher, Rambler's 744. Queen-cell Building in France 11. Queen-cell, Incubation of 814. Queen-cells Indicative of Swarming 742. Queen-excluders for Sections 546. Queen - fertilizing Boxes, Swarthmore 743. Queen rearing, Alley Style 587, 705. Queen-rearing, Modern Methods of 507. Queen-rearing, Scientific 581. Queen-rearing, Selection of Sire and Dam 582. Queen-rearing in France 11. Queen-rearing, Simpson on 741. Queen - rearing, Strenuous 291. Queen rearing by Swarthmore — see Swarthmore. Queen - rearing, Swarthmore's System 434.

Rabbit, Hive, Atwater's 789. Rambler in the Bunk 675. Rambler Strikes it Rich 640. Rambler at Stearns' Apiary 853, 892. Rambler at McCubbin Apiary 143. Rambler and Central California 977. Rambler's Definition of Pathetic 821. Red Clover Fertilized by Bees

286. Red Clover Increasing Honey Crop 289. Red Clover for Bees 712. Red Clover, Doolittle on 712. Red-clover Tubes, Bees that will Split 788. Resorts, Summer, Northern Michigan 653. Rheumatism and Stings 8. Rhododendron 528. Rhubarb Culture, New 415. Robber Bees 705. Robbers, to Frighten Away 131. Roof, Bee Culture 341. Rooster, Our Fighting 357, 762. Roof, E. R., Notes of Travel—see Notes of Travel by E. R. R., Root-German Wax press 637. Royal Jelly by Medicines-dropper 241. Royal Jelly in Cell Cups 705. Russian Drone Story 675.

Salary of \$720 and Expenses 761. San Joaquin Valley 977. Scent-producing Organ of Bees 639. Science Healers in Trouble 760. Scholl, L., Visit to 627. Schollicup Plan for Queen-cells 588. Screens, Fly 707. Sealed Covers v. Absorbents 241. Secrets, Valuable 529. Sections Discussed in England 220, 327. Sections by the Piece 326. Sections, Tall v. Square, Weight of 147, 148, 223. Sections, Snow-white 8. Sections, Plain, Ideal 896. Sections, Unfinished, Liable to Candy 337, 338. Sections, Starting Bees in 467. Sections, Plain, and Fence Separators 328. Sections, Ext'g when Partly Filled 398. Sections, Bait 598. Sections, Honest Weight 218. Sections, Forcing Bees into 946. Separators or No Separators 335. Separators for Plain Sections 645. Separators, Harrison's 645. Separators, Early History of 503. Section-folder, Mintle's 50. Shaded Apiaries 984. Shade for Hives 406, 407. Shaded Apiaries in Arizona 943, 984, 985. Shade, Grapevine 782. Shallow Brood-chambers—see Frames, Shallow. Shallow Extracting Combs—see Ex. Combs, Smoker with Continuous Blast 325. Smoker, Double-blast 293. Snakes and Bees 10. Solar Extractors Condemned 326. Solar Extractor, Cart-wheel 326. Solar Wax extractor, Reversing 287. Sorrel, Jamaica 762. Sparrows a Nuisance 547. Spraying During Bloom 193, 284. Spraying During Bloom Not Recommended by Exp. Stations 284. Spring, to Fix Up 688. Stachelhausen, Visit to 627. Steam Wax presses 276—283. Stearns, O. W., his Management of Apiaries 883, 892. Stings of Bees, Effects of 382. Strainers v. Settling-tanks in California 437. Strong Colonies for Honey 502. Sugar as a Food 79. Sugar to Finish Sections 815. Sugar, Beet 4. Sugar, Beet v. Cane 192, 218, 245, 672, 706. Sugar, Beet, Feeding 644. Sugar, Granulated, Adulterated 325. Sulphuric Acid, Proportion of 947. Sulphuric Acid for Wax 8, 101. Surplus Arrangement, Doolittle's Adjustable 99. Swarm Going to the Woods 557. Swarming Controlled by Large Hives 235. Swarming and Section Honey 596. Swarming with Unsealed Brood 787. Swarming Controlled without Queens 753. Swarming Controlled by Double-decker Hives 822. Swarming Checked by Honey-flow 752, 860, 900. Swarming Plan, Burt's 777. Swarming, Scheme to Control 335. Swarming, how Conducted 515. Swarming, Questions on 682. Swarming, Sudden Stoppage of in California 978. Swarming, Excessive, bad Effect 998. Swarming, Natural, and Automatic Hiving 851. Swarms Absconding 555. Swarms Running to another Colony 753. Swarms, Making 554. Swarms, Brushed, for Comb Honey 333. Swarms, Hiving on Full Combs 467. Swarms, Brushed, by Stachelhausen 235. Swarms, Right of Pursuer 674. Swarms, Reclaiming by Law 818. Swarms, Brushed, Danzenbaker on 87. Swarms, Brushed or Shook 896. Swarms, Reclaimed, Law of 955. Swarthmore's Pressed Cell Cups 505. Swarthmore's Queen nursery Cage 506. Swarthmore's System of Queen-rearing 504, 588, 634, 743. Swarthmore's Management of Miniature Nuclei 504. Swarthmore Cell-forming Sticks 634. Swarthmore System of Fertilizing Criticised 630. Sweet Clover—see Clover Sweet. Sweet Clover for Horses and Cattle 761. Symposium on Wax-presses 276. Syrup for Feeding, to Make 862. Syrup, Consistency of 891. Syrup, Thick or Thin 468. Tall Sections—see Sections, Tall. Tank for Settling Honey 243. Temperance and the Railroads 530. Temperance in Government 60. Texas, Bee Paradises of 750, 780. Texas, Honey Resources of 627. Thick Top-bar, New Scheme for 907. Thick Top-bars East and West 777. Thick Top-bars, Atwater on 749. Thick Top-bars, Hyde and Miller on 890. Thick Top-bars, Pettitt 746.

Thick Top-bars, Origin of 227. Thick v. Thin Top-bars 380. "Tired," Why Folks Get 834. Tobacco, Relation to Health 563, 609. Topcetterwein, Visit to 677. Tomales 412. Tongues Measured by Rankin 54. Tongues and Pollen 429. Tongues, Long v. Longevity 234. Tongues, Apparatus for Measuring 101. Tongues, Long, Good for other than Red Clover 508. Tongues, Losing our Heads on 326. Tongues, how Measured at Medina 399. Tongues, how Used in Sipping Honey 597. Tongues, Measuring 193, 234, 383, 584. Tongues, Long 132. Tongues, Relation to Honey 84. Tongues, Long, Burlesque on 973. Tongues, Long, and Honey 79, 81

Tongues, Long, in South 220 Tools for the Apiary 626
Tools, Hive, 645 Top-bars, Thick—see Thick Top-
bars. Transferring 343 Transferring and It Itianizing
at Once 862 Trap Lanterns—Warning 487, 610 Trap
Nest, New 410, 528 Trap Nests for Poultry 24, 160
Traverse Region of Michigan 57 Traverse Region,
Glimpses of 989 Traverse Region and Asthma 799
Tunis, Bee-keeping in 973.

Uncapping, Deep, Condemned 229 Uncapping, Slic-
ing Deep 182 Uncapping—arrange me t, Stearns' 855
Uncapping-box, Howe's 679 Uniting for Winter 824
Uniting in Winter 53 Uniting with Peppermint 518
Unqueening, Premature 892 Utter Trial, Personnel
of 91 Uvalde Co., Texas, for Bees 750, 780.

Veils, Use of in Apiary 519 Veronica, of California
708.

Wallenmeyer on Bottling Honey 187 Wax and Sulphuric
Acid—see Sulphuric Acid. Wax from Cappings
741 Wax in Old Combs 518 Wax Scales from Bees 581
Wax, Producing Profitably 710 Wax to Prevent Cracks
in 79 Wax, Production of 710 Wax-press Operated

by Steam or Hot Water 379 Wax-press, Economical
use of 518 Wax-press, Gemmill 782 Wax-press, Root-
German 637 Wax-presses, Hot Water for 581 Wax-
presses, Various 276—283 Wax-rendering, Symposium
on 276—293 Wax-works, Rambler's 513 Weight of
Egg of Queen 889 Wings of Queens, Sitting 381 Winter,
Preparing Bees for 785 Winters in the South 465
Wintering, Questions Answered 240 Wintering, Barber
on 184 Wintering, Combination of Two Methods
931 Wintering in Large Cellar 683 Wintering Bees
in Clamp 14, 15 Wintering in Cellar 825 Wintering
Indoors and Out 193, 241, 244, 931, 971 Wintering In-
doors, Barber on 391 Wintering Bees in a Cave 399
Wintering under Snow 101 Wintering and Increas-
ing Spacing 327 Wintering in the South 90 Winter-
ing indoors, Something to Learn 246 Wintering In-
doors with High Temperature 390 Wm Rohrig, of
Arizona 906, 943, 946 Woman with 500 Colonies 339
Woodland, Clearing Up 872 Words, Use of Proper 892,
Yazoo Region 275 Yield, Large 345 Yield of Honey,
Big, Stearns' 855.

Zinc, Effect of on Honey 741.

Editorial Items.

A B C Reviewed by Cook 297, 400, 401, 443. Adulteration
Law, Anti, in California 647. Advertising in
Bee Papers 246. Alfalfa Hay v. Alfalfa Honey 940.
Alfalfa Honey Not always Light 600. Alfalfa, Dis-
couraging Feature about 940. Alley's Queens 908.
American Bee-keeper 400 Apple-blossom Honey 150.
Association of Bee-keepers in Europe 523. Association,
N. B. K.—see National B. K. A.

Barrel Talk by France 195. Barrel, to Test for
Leakage 195. Bee and Wasp Jaws 152. Bees and
Fruit in Farm Papers 295. Bee and Fruit Case at
Hanford 558, 602. Bees and Fruit, American Gardening
on 346. Bee Business Gravitating Toward West
791. Bee Paradises in the West 647. Bees and Neighbors
475. Bees as Pollenizers 56 104 600 Bees and
Pear-blight 558, 602. Bees and Fruit 19, 56, 629. Bees
in Court 18. Bees in Law 442. Bees Not a Nuisance
475, 685. Bees, Busy and Lazy 601. Bees, More, Hutchin-
son on 600. Bee-brush, New 475. Bee-brush, Double
476. Bee Journal, New, in Texas 940. Bee-keepers'
Paradise in Texas 520. Bee-keeping as a Sole
Business 559. Bee-keepers' Review Commended 867,
868. Bee-ranges, Priority Rights of 756. Benton on
the Witness Stand 20. Black Brood in New York Un-
der Control 18 55. Black Locust of California 617, 791.
Blacks and Italians, Characteristics of 578. Boyden
in the West Indies 826. Breeding-stock, Too High a
Price 44. Buffalo Convention 827. Burt's Plan of Re-
turning Swarm 755.

California Bee Journal 716. California Crop of 1901
194. California Honey Crop 828. California Reports,
Conflicting 792. California, Distances in 558. Canded
Honey, Educating to 980. California Honey, Prices
on 600. Carbolium as Preservative 869. Cellar Win-
tering at Medina 195, 400, 442, 868. Clipped Wings 522.
Clovers Started by Snow 442. Clover, Red, Its Impor-
tance 559. Comb Honey, Bogus 942, 980. Comb Honey,
Freight Rates on 400. Comb Honey, Marketing 909.
Combs, Old Black, to Render 296. Convention in Buf-
falo 827. Convention, Madison 150. Convention, Onta-
rio 55, 102. Convention, Wisconsin 150. Convention,
York State 55. Commissioner Jones 942, 980. Colling-
wood, Mr 647. Cook's Review of A B C 297, 401, 443.
Cotton-fields of South 475. Craig Wm 442.

Desert R' claimed in the West 558. Distances, Magni-
ficent, in California 558. Doolittle in Arkansas 102.
Doolittle on Long Tongues 476. Drone Brood Immune
to Foul Brood 685. Drone Comb, Cost of 521. Drouth
and Irrigation 941.

Editors of Bee Journals 560.

Feeding Medicated Syrup—see Syrup, Medicated.
Fertilizers, Bees as 56 104, 600, 829. Fertilizing Queens
in Confinement 247, 347. Fertilization in Confinement
684. Fletcher's Papers—Bees as Pollenizers 55. Foul-
brood Legislation, to Get 152, 153. Foul Brood, Dis-
ease-infected Tools 717. Foul-brood Inspector's Re-
port for Michigan 982. Foul-brood Law in California
296. Foul-brood Law Passed in Michigan 520. Foul-
brood Legislation 981. Foul-brood Legislation 981.
Foul-brood Bill, Michigan 152, 194, 346. Foul-brood in

Ontario 55. Frames, Shallow, for Comb Honey 755.
France N E, 150.

Geneva Experiments 103. German Wax-press 684.
Gilmore on Bees and Cane Sugar 757.

Hall's Wit 151. Hive-covers, Neponset Paper 522.
Honey Exchange in California 908. Honey Reports,
Exaggerated 867. Honey Sea on for 1901 648. Honey
Canards 942. Honey, Canded, Educating to 981. Honey,
P. dding 718. Honey-plants by the Mile 520. Honey-
plants with Long Tubes 521, 647. Honey-producers
Condemned 909. Honey-producers, Fool Policies of
150. Howe, Harry, Married 940.

Idaho as a Bee Country 600. Irrigated Regions, Gen-
eral Impressions of 647. Irrigation in the West 941.

Jaws of Bees and Wasps 152. Jenkins, Visit to 475.
Joint Meeting with Fruit-men 54.

Legislation in Wisconsin 151. Long Tongues—see
Tongues, Long.

Mandibles of Bees and Wasps 152. Marketing Comb
Honey 969. Martin, Dr., and Paper-covered Covers
522. McEvoy's Blarney 151. Morley's Honey-makers
347. Mountains, Use of 941.

Naphthol Beta 717. National Convention at Buffalo
716. National B. K. A., Good Showing 17. National
Association, Officially of 102. National B. K. A. Nom-
inations 868, 980. National Ass'n, What it did for
Bee-keepers 50 54.

Out-Apiaries for Comb Honey 523.

Pan-American 17. Pear-blight in California 558, 602,
718, 792, 830. Pickled Brood 55. Pollinizers, Bees as
56, 104, 600. Poppleton, O O 54. Prices for 1901 648.
Prices on Honey 681, 717, 827. Prices on Honey, Ex-
aggerated Reports 792. Priority Rights in Bee-ranges
756. Pure-food Commissioners 246.

Queen Laying when Needed 442. Queens, Fertilizing
in Confinement 247, 347. Queens, Too High a Price
444. Queens, Too High a Value of 558. Queens Fertil-
ized in Upper Story 756. Queen breeders who will Not
Write 601. Queen-rearing at Medina 684. Quinby, Mrs
Moses 900. Rambler Going to Cuba 826. Rambler in
Cuba 980. Rambler's Report on Foul Brood 982. Red
Clover, Depth of Tubes 295, 521.

Robbed Colonies Left to Fate 475. Root Exhibit at
Buffalo 475. Root's Factory Enlarged 684, 826. Root E
R, Trip of 445, 647. Royal Jelly with Medicine-drops
per 150.

Sections, Tall v. Square 53, 246, 981. Session, Joint
829. Shallow Frames—see Frame, Shallow. Snow-
storm of April 20 400. Solar Extractor, Use and Abuse
296. Spraying Fruit-trees in Bloom 829. Spraying in
Bloom Condemned 346. Spraying While in Bloom 103.
Spraying in Bloom Experiments at Geneva 103. Sta-
tistics, Honey 648, 717, 867. Statistics for California 759.
Sugar, Cane and Beet 245, 792. Sugar, Beet and Cane,
Truth about 757. Sugar, Beet, in Canneries 826. Syrup,
Feeding Medicated 717. Swarms, Returning, Modified
Plan of 755. Swarming Problem in Texas 523. Swarm-
ing Problem in Texas 523. Swarming Checked by
Honey-flow 523.

Taunton Bee Case 685 Texas Honey-plants 520
Tongues, How Measured 477 Tongues, Long, Not
Necessary for variety of Plants 521 Tongues, Long,
for Red Clover 295 Tongues, Long, for the South 520
Tongues, Long, Probable Disappointments 295, 296
Tongues, Long, Craze for 296, 340 Tongues, Long,
Condemned by Doolittle 476 Tongue-reach and Honey-
yield 101 Tongue-reach and Tongue-length 401
Tongue-reach and Honey-reach 445 Trip, My Long
600 Trip of E R Root to West 716, 755.

Utter v Utter 18 Utter Trial Not Appealed 150
Utter Trial, Personnel of 53
Visitors, Distinguished at Medina 791.
Weather, Steady Cold 194 Western Bee Country.
Impressions of 617 Western Trip of E R Root 445
West for Bee-keepers 558 West Good for Bee-keeping
791 Wilkin, R. Career of 560 Wintering Indoors at
Medina 195, 400 Wintering Indoors, Large Reportory
246 Wintering Under Machine-shop 195, 400, 442, 868,
911 Wintering, In and Out It.
York State Convention 55.

Contributors.

Adams J Q, 239 Adams Geo W, 513 Adams T M, 782
Ahlers H P, 518 Aikin R C, 46 82, 335 Alley H, 416
Allswede W H, 691 American Tramp, 90 Andes M D,
338 Archilion R, 417 Aspinwall N P, 790 Atwater
E F, 89, 749, 789 Averill B F, 597 Avon Ben, 239

Baird E J, 714 Baldrige M M, 434 Ba her Mrs A J,
85 337 598 Bartlett C C, 345 Barber Ira 390 Bassett
D F, 163 Bates F E, 101 Bates G A, 788, 896 Bedell E,
163 Beginner, 240 Bell L B, 243 Bennett S K, 857
Benton J M, 163 Bender C F, 2, 6 597 Berg J P, 386
Bevins Edwin, 721 Bingham T F, 934 Blackmore E
L, 986 Bodze A R, 212 Bonney C T, 599 Boyden A L,
134 228, 283, 336 Brant J F, 530, 716 Bromwich H J,
416 Brown C W, 159 Brown F E, 719 Buck C F, 947
Burnett R A, 828, 942 Burrell H D, 468.

Carson A W, 416 Carter C K, 825 Cary R J, 417
Case W W, 516 Chalmers D, 805 Chrysler W A, 280
Clayton C H, 828, 986 Collier G, 243 Cook A J, 718
Cooke J, 862 Cowan T W, 826 Cox T W, 416 Craig
Wm, 616 Cyrenius F H, 242, 851.

Danz-nbaker F, 101 Davenport C, 87, 509 Dead-
man G A, 93 Detmers Henry, 242 Detwiler J C, 755
Doo'llittle, 15, 51, 99, 136, 146, 190 236, 292, 343, 396, 440,
473, 515 554, 596 643, 681, 712 753, 785, 824, 859, 901, 934,
938, 975, 979. Draper A N, 945.

Edholm Charlton, 447 Eldridge J L, 517 E M G, 907
England Charles F, 599, 645.

Fairbanks Z C, 721 Fehr, Wm S, 720 Feley A, 861
Felt E P, 487 Fether G F, 276 Fetheroff S S, 557 Fields
Dr M, 614, 805 Fisher A J, 907 Fisher R D, 583, 674,
818 935 Flower W E, 160 Fortest E, 762 Fouch F R,
715 Fowls Chalton, 12 138, 220 290, 433 469, 947 Fox
Elias, 101, 193, 516 518 Fox R J, 242 Fox Wm, 557
Franklin James L, 148 Fritschel C S, 787.

Gemmill F A, 278 782 Gerbracht J H, 345 383 Getaz
Adrian, 147, 285 Gillette C P, 719 Gill M A, 335 467
Gilmore M R, 757 Gilstrap W A H, 48 163 225, 243, 398,
399, 897 Giraud Pabou II Golden R A, 645 Gosney
M S, 994 Green W J, 169 Greiner F, 289, 328 393, 499,
503, 644, 671, 789, 853 Greiner T, 762 Griffin H, 862
Grimsley J O, 234 Gross Gustave, 242.

Hadley R, 800 Hains J B, 514 Hall C, 691 Ham,
Ham, & Ham 475 Hand J E, 931 Hanegan G F, 149
Harmer W, 345 Harris L C, 339 Harrison Mr L, 53
441, 719 Harrison G W, 616 H zeltine S A, 566 Haw-
ley H H, 525 Haw n R G, 339 Haynes B 947 Haynes
J O, 908 Haynes F M, 799 Henderson Chip 644 Her-
shiser O L, 133, 567 595 Herbert C M, 193 Higgins D
A, 387 Hilbert J, 754 Hilton G E, 521 Hinkle R C,
528 Holmes L P, 786 Holley R A, 862 Holtermann
R F, 816 Houp t H, 788 Howe G B, 822 Howe Harry,
135, 644, 679, 710 Huber 757, 827 Hubbard G K, 192
Hutchinson W Z, 15 Hyde J, 898 Hyde H H, 856.

Jackson Mrs Geo 392 Jackson J W, 99, 869 Jeffrey
H L, 85, 139 386, 442 Jennings B A, 398 J F S, 788
Johnson M M, 101 Johnson A S, 760 Johnson J A,
993 Jones H B, 1001 Jordan A J, 937.

Kephart W D, 193 555 Kimmons A J, 1001 Kinsel
Chris, 556 Kuehne M R, 239.

Lathrop Harry, 592 Lewis W H, 416 Longmire S,
715 Luaces Robt L, 136, 711 Lyttle T, 193

Manley W J, 469 March H A, 60 Marks W F, 685
Martin J H, 80, 439 Mason A B, 636 691, 716, 719 Mas-
sie T K, 331 Maxwell S, 416 M'Carter Wm J, 714
M'Colley R L, 993 M'Connell W P, 246 M'Cubbin
J E, 558 M'Donough Chas, 683 M'Phaill R C, 412
M'Queen J, 159 Moore H F, 243 Meloy E L, 294
Miller S E, 973 Miller C C, 239, 331, 388, 508, 599, 748,
784, 894, 896, 934 Miller Arthur C, 142, 150, 239, 275, 382,
586, 779, 819, 898 Miner H R, 947 Minkler G W, 53
Morehouse H C, 238 Morrison S W, 101 Morrison W
K, 86, 235, 672 Morse H I, 294 Morris C R, 787 Muudy
W T, 599 Meess H F, 243.

Neill Jessie, 399 Night Hawk, 140,
Osburn H G, 432 Overfelt J B, 163.

Parker I, 993 Passage Benj, 294 Pearce J A, 286
Penny N O, 159 Pettit S T, 227, 746 Peirce M B, 603,
718 Pierce C H, 399, 598 Pierce Irving, 474 Pillar H,
164 Pinkham J R, 241 Poole Jerome, 258 Poppleton
O O, 54, 861, 869 Postler H H, 241 Ponder Walter S,
98 Prange Mrs F C, 294 Pridgen W H, 507, 557 Pryor
J E, 240.

Quirin H G, 241, 557, 900

Rambler, 10, 143, 185, 231, 287, 437, 470, 511, 640, 675,
708, 744, 820, 853 892, 977 Ramsour D A, 758 Rankin
J M, 84, 391, 521, 982 Rapp J B, 715 Reed E M, 416
Reed W H, 518 Reid J L, 416 Resnau, 598 Reynolds
C, 557, 788 Rhods C, 721 Rich M, 862 Ritter F, 913
Kip Van Winkle, 936 Robbins G F, 572, 752 Robin-
son B, 332 Robinson Wm, 52.

Safford E Y, 241 Schaeffle E H, 229, 507, 680, 713 715,
754, 861 947 Scherrif L, 163 Schmidt J R, 547 Schnei-
der J, 397 Scholl L, 591 635 Segelken H, 384 S-ls-er
W A, 5, 0 Shaw J W K, 416 Shearman J O, 338 Shep-
ard A D, 862 Sh pard M W, 474 Shepard W W, 148,
329 Shiber G, 683, 896 Shute G M, 160 Siler J T, 518
Slack T, 60, 222 Sl den F W L, 639 Smoll, Maynard
& Co, 23 Smith H L, 416 Smith E J, 417 Smyth H H,
416 S-vder S J, 53 Snyder A, 54, 517 Somerford
F N, 587 S-omerford W W, 553 754 Stachelhausen L,
235, 333 390, 900 Stebbins E E, 518 Stedman J M, 566,
610 Steph-nsen W T, 141 Steiger C, 147 Subscriber,
242, 986 Swarthmore, 233 334, 504, 588, 634, 743.

Tatman M F, 399 761 Tousey W C, 567 Townsend
F L, 398 Treas H, 518 Truax A J, 644 Turner H, 164,
Umboltz J, 294 Upp I C, 646.

Van De Mark F W, 557 Vande Vord G J, 630 Vic-
tor W O, 599, Volmter C, 908.

Wagner Ferdinand, 397 Walker E C, 96, 637 Walk-er
B, 556, 691 Wallace H, 26 Wallenmeyer J C, 187, 517
Weaver O R, 937 Weber C H W, 341 West N D, 416,
557 Whitney W W 789 Whitney W M, 223 Williams
H W, 714 Wilkaisy P, 993 Wilson W M, 356 Wise
J S, 862 Woodhouse M E, 133 Wright A J, 584 Wret-
ting C A, 18

York & Co G W, 162.

Zurbug C H, 761.

Illustrations.

Aikin's Racket Honey 139
Albert's Wander Wagon 288
Apiary in Weed-patch 232

Apiary at Forestry Station, Califor-
nia 769
Apiary of J. W. Johnson 943-945

Apiary of Dr Toribio 336
Apiary of Richardson 677
Apiary of R. B. Fray 257

- Apiary of Somerford 337
 Apiary of Mrs. Harris 340
 Apiary of W. Rohrig 946
 Apiary, Adams' 782
 Apiary, Haw'n's 339
 Apiaries of Chambers 984, 985
 Apiaries, Jenkins' 503
 Apiary, Marchant's 406
 Apiary, McCubbin's, and Orchard 186
 Apiary, Rambler's 437
 Apiary, Roof, Weber's 342
 Apiary, S. Anderson's 985
 Apiary, Stearns' 855
 Arizona Bee-keeping 904, 944
 Arizona Plant Life 904
 Atwater's Hive-rabbit 789
 Azalea 485
 Bees and Fruit 514
 Bee-brush, Hammond's 476
 Bee-keeping, Class of Colored Girls 22
 Bee-moth Ravages 642
 Bellflower of Cuba 283
 Bingham's Bee-cellar 933
 Bleaching house, Higgins' 387
 Blue Curls, Bees on 471
 Bottles, Sealing 95
 Bottling Honey, Deadman and Boys 94
 Bottling Honey, Filling Jars 188
 Bottling Honey, Labeling 189
 Bottling Honey, Temperature of 96
 Bottling Honey, Wallenmeyer's Liquefying Apparatus 187
 Bottling Honey, Washing and Cleaning 93
 Bottling Honey, Weber's Plan 548, 549
 Bottling, Preparing for Shipment 221
 Brodbeck in Oil Business 641
 Bunting and Helpers 781
 Bunting Extracting-supers 781
 Bunting, W. D. 780
 Cabin in the Woods 990
 California Bee keeper 977
 California Song and Dance 641
 Cardenas, Cuba 228
 Catclaw Leaf and Twig 863
 Catclaw-tree 865
 Cauliflower, Six Heads of March's 60
 Cellar, Bingham's 933
 Cell-building, Pabou's 11
 Cell-getting Contrivance, Swarthmore 589
 Cell-forming Sticks, Swarthmore 634
 Chambers, W. L. 983
 Chambers' Apiaries 984
 Clamps, Wintering in 14
 Comb Honey Bleaching-house 387
 Comb Honey in Plain Sections 385
 Comb Honey, Crated 910
 Co-operative Organization, Map of 83
 Cottonwoods in Arizona 985
 Covers, Rambler and McCubbin 232
 Covers, Rambler's Wee-waw 231
 Craig, W. J. 442
 Crates of Comb Honey 910
 Cuban Bellflower 283
 Davidson, G. F. 679
 Davitte's Fertilizing-tent 348
 Drone-trap, Frick's 556
 Edwards, D. M. 751
 Eucalyptus tree 10 Years Old 472
 Extracting, Rambler's Plan 438
 Extracting-house, Bunting's 781
 Extracting-house, Take-down 552
 Extracting-outfit, Gilstrap's 49
 Entrance-contractor, Poole's 238
 Ferree, J. W. 822
 Ferris' Wax-rendering 276
 Fertilizing Queens, Davitte's Plan 348
 Foul Brood, Situation of in Ohio 433
 Foundation, Making, in California 893
 Foundation, Method of Wiring 223
 Fowls and the Owl Man 13
 Fowls on Bottling 221
 Frame, Barless 634
 Frames, Wiring 223, 288
 Franklin, Benjamin 823
 Frick's Drone-trap 536
 German Wax-press 637
 Gilstrap's Extracting-outfit 49
 Glossometer, Getaz' 147
 Glossometer, Swarthmore's 233
 Glossometer, Wright's 586
 Grace Cell-compressor 505
 Grapes Punctured by Bees 514
 Grapevine Apiary 782
 Greenhouse, A. I. Root's, in March 486
 Guajilla Brush of Texas 864
 Guajilla Leaf 865
 Hall, J. B. 145
 Hammond's Brush 476
 Havana, Street in 337
 Hilbert Family in Potato-field 992
 Hive rabbit, Atwater's 789
 Hive, Schaeffle's 680
 Hives, Shading, in Florida 406, 407
 Hives, Stand for Painting 288
 Hives, Wee-waw, Rambler's 745
 Hive-cover, Paper 522
 Hive cover, Rambler's 744
 Hive-tool, Golden's and England's 645
 Hoarhound of Texas 632
 Honey in Extracting-House, Jenkins' 552
 Honey, Bottling—see Bottling Honey
 Honey-house, Adobe 892
 Honey-house, Portable, Fray's 287
 Horsemint, Texas 630
 House-apiary Portable 288
 Jaws of Bee and Wasp 152
 Jenkins' Apiaries 593
 Jenkins' Take-down Honey-house 552
 Johnson's Apiaries 943
 Johnson, J. W. 905
 Mandibles of Bee and Wasp 152
 Map of Co-operative Organization 83
 Marchant's House and Apiary 406
 Marigold of Texas 631
 McCubbin and Eucalyptus 472
 McCubbin's Peach-orchard 186
 McEvoy, W. 151
 Martin's Paper Cover 522
 Martin, Dr. G. M. 522
 Matanzas, Bridge at 134
 Mesquite Leaf and Branch 867
 Mintel's Section-folder 50
 National Association and the Dollar 470
 Neponset Cover 522
 Pabou and Wife 12
 Palms in Arizona 904
 Passage's Smoker 293
 Pineapple-sheds in Florida 408, 409
 Poppleton, O. O. 47
 Potatoes Planted with Acme Planter 158
 Potatoes Properly Cooked 798
 Potatoes, Burying, at Hilbert's 992
 Potatoes, Digging, in Traverse Region 991
 Samaritan, Good 290
 Scent-producing Organs 639
 Scholl Working among Bees 629
 Scholl, L. 620
 Sections of Comb Honey, Plain 385
 Sections, Plain, Devices for 646
 Sections, Tall v. Square 224, 981
 Section-folder, Mintel's 50
 Separators for Plain Sections 646
 Sladen's Scent-producing Organs 639
 Smoker, Double-blast 293
 Stachelhausen, L. 628
 Steam Wax-press—see Wax-presses
 Stearns Starting for Out-apiary 854
 Strainer, Honey 239
 Sun Extractor, Cartwheel 289
 Swarthmore Cell-compressor 505
 Swarthmore Feeding-frame 504
 Swarthmore Fertilizing-boxes 435, 436
 Swarthmore Mating-box 743
 Swarthmore Queen-nursery Cage 506
 Swarthmore Queen-nursery Frame 590
 Swarthmore's Glossometer 233
 Texas Honey-plants 630, 632, 863
 Tepperwein, Udo 678
 Tongue, Wardell Measuring 478
 Tool for Hives 645
 Top-bar, Fisher's 907
 Trap Nest for Poultry 410, 411
 Tree Lucerne, California 708
 Utter Trial, Personnel of 91, 92
 Veronica, California 708
 Queens, Fertilizing in Swarthmore Boxes 435
 Queens, Fertilizing, Davitte's Plan 348
 Queen-catcher, Rambler's 745
 Queen-mating Box, Swarthmore 743
 Queen-mating Super, Rauchfuss' 633
 Queen-nursery Cage, Swarthmore 506
 Queen-nursery Frames, Swarthmore 590
 Rambler Bunking 676
 Rambler Crossing San Susanna Pass 676
 Rambler Struck it Rich 640
 Rambler Turns up 143
 Rambler, How Pathetic 821
 Rambler's Cool Retreat 437
 Rambler's Honey-elevator 438
 Rambler's Honey-house and Residence 185
 Rambler's Shake Cover 232
 Rambler's Swiss Friend 978
 Rauchfuss' Queen-mating Super 633
 Richardson's Apiary 677
 Rohrig, W., and Apiary 906
 Rohrig's Apiaries 946
 Wagon, Wander 288
 Wallenmeyer Liquefying Honey 187
 Wardell Measuring Tongue 478
 Washington, Mrs B T 23
 Wax Rendered by Ferris 278
 Wax, Six Cords Rendered 276
 Wax extractor, Ferris 276
 Wax-press, Dietrich's 281
 Wax-press, Fritz's 281
 Wax-press, Goold's 281
 Wax-press, Hatch-Gemmill 279
 Wax-press, Kolb & Grober's 282
 Wax-press, Robert-Aubert 282
 Wax-press, Root-German 637
 Wax-refiner, Ferris' 277
 Waxworks, Rambler's 513
 Weber on Bottling Honey 548, 549
 Weber's Roof Apiary 342
 Whitney on Wiring Foundation 223
 Wilkin, R 561
 Wintering in Clamps 14
 Wiring Frames 223, 288

Books for Bee-keepers and Others.

Any of these books on which postage is not given will be forwarded by mail postpaid, on receipt of price.

In buying books, as every thing else, we are liable to disappointment if we make a purchase without seeing the article. Admitting that the book-seller could read all the books he offers, as he has them for sale, it were hardly to be expected he would be the one to mention all the faults, as well as good things about a book. We very much desire that those who favor us with their patronage shall not be disappointed and therefore we are going to try to prevent it by mentioning all the faults, so far as we can, that the purchaser may know what he is getting. In the following list, books that we approve we have marked with a *; those we especially approve, **; those that are not up to times, †; books that contain but little matter for the price, large type, and much space between the lines, ‡; foreign, §. The bee-books are all good.

As many of the bee-books are sent with other goods by freight or express, incurring no postage, we give prices separately. You will notice that you can judge of the size of the books very well by the amount required for postage on each.

BIBLES, HYMN-BOOKS, AND OTHER GOOD BOOKS.

Postage.]	[Price without postage.
8	Bible, good print, neatly bound..... 20
10	Bunyan's Pilgrim's Progress**..... 40
	Christian's Secret of a Happy Life,** 50c; cloth 1 00
3	John Ploughman's Talks and Pictures, by Rev. C. H. Spurgeon*..... 10
1	Gospel Hymns, consolidated, Nos. 1, 2, 3, and 4, words only; cloth, 10c; paper..... 5
2	Same, board covers..... 20
5	Same, words and music, small type, board cov. 45
10	Same, words and music, board covers..... 75
3	New Testament in pretty flexible covers..... 05
<i>One-third off on all Gospel Hymns mentioned above.</i>	
4	New Testament, new version, paper covers..... 10
4	Stepping Heavenward**..... 18
5	Tobacco Manual**..... 45

This is a nice book that will be sure to be read, if left around where the boys get hold of it, and any boy who reads it will be pretty safe from the tobacco habit.

BOOKS ESPECIALLY FOR BEE-KEEPERS.

20	A B C of Bee Culture, cloth..... 1 00
	Advanced Bee Culture, by W. Z. Hutchison..... 50
3	Amateur Bee-keeper, by J. W. Rouse..... 22
14	Bees and Bee-keeping, by Frank Cheshire, England, Vol. I., §..... 2 36
21	Same, Vol. II., §..... 2 79
	Same, Vols. I. and II., postpaid..... 5 25
10	Bees and Honey, by T. G. Newman..... 65
10	Cook's Manual, cloth..... 1 15
5	Doolittle on Queen-rearing..... 95
2	Dzierson Theory..... 10
3	Foul Brood; Its Natural History and Rational Treatment..... 22
1	Honey as Food and Medicine..... 05
10	Langstroth Revised, by Chas. Dadant & Son..... 1 10
15	Quincy's New Bee-keeping..... 90
	British Bee-keeper's Guide-book, by Thomas William Cowan, England §..... 40
	The Honey-bee, by Thos. William Cowan..... 95
3	Merrybanks and His Neighbor, by A. I. Root..... 15
	Bienenzucht und Honiggewinnung..... 50

Or "Bee Culture and the Securing of Honey," a German bee-book by J. F. Eggers, of Grand Island, Neb. Postage free.

MISCELLANEOUS HAND-BOOKS.

5	A B C of Carp Culture, by Geo. Finley..... 25
5	A B C of Strawberry Culture,** by T. B. Terry. New edition, revised and enlarged; paper, 45c; cloth, 68c; by mail, 75c.
5	A B C of Potato Culture, Terry** New edition, revised & enlarged; paper, 45c; cloth, 68c, mail 75c. This is T. B. Terry's first and most masterly work.
8	Barn Plans and Out-buildings*..... 90
	Canary birds, paper..... 50
2	Celery for Profit, by T. Greiner**..... 25
The first really full and complete book on celery culture, at a moderate price, that we have had. It is full of pictures, and the whole thing is made so plain that a schoolboy ought to be able to grow paying crops at once without any assistance except from the book.	
15	Draining for Profit and Health, Warring..... 30
10	Fuller's Grape Culturist**..... 1 15

8 | Domestic Economy, by I. H. Mayer, M. D.** ... 30
This book ought to save at least the money it costs, each year, in every household. It was written by a doctor, and one who has made the matter of domestic economy a life study. The regular price of the book is \$1.00, but by taking a large lot of them we are enabled to make the price only 30 cents.

10 | Farming for Boys*..... 1 15
This is one of Joseph Harris' happiest productions, and it seems to me that it ought to make farm-life fascinating to any boy who has any sort of taste for gardening.

	Farming with Green Manures, postpaid**.....	90
7	Farm, Gardening, and Seed-growing**.....	90
12	Gardening for Pleasure, Henderson*.....	1 10
12	Gardening for Profit**.....	1 10
8	Gardening for Young and Old, Harris**.....	90

This is Joseph Harris' best and happiest effort. Although it goes over the same ground occupied by Peter Henderson, it particularly emphasizes thorough cultivation of the soil in preparing your ground; and this matter of adapting it to young people as well as old is brought out in a most happy vein. If your children have any sort of fancy for gardening it will pay you to make them a present of this book. It has 187 pages and 46 engravings.

3 | Grasses and Clovers, with Notes on Forage Plants..... 20
This is by Henry A. Dreer, author of the book, "Vegetables Under Glass" that has had such a large sale of late. This little book tells how six tons of grass has been grown to the acre, and gives much other valuable matter.

10 | Greenhouse construction, by Prof. Taft**..... 1 15
This book is of recent publication, and is as full and complete in regard to the building of all glass structures as is the next book in regard to their management. Any one who builds even a small structure for plant-growing under glass will save the value of the book by reading it carefully.

12 | Greenhouse Management, by Prof. Taft**..... 1 15
The book is a companion to Greenhouse Construction. It is clear up to the times, contains 400 pages and a great lot of beautiful half-tone engravings. A large part of it is devoted to growing vegetables under glass, especially Grand Rapids lettuce, as well as fruits and flowers. The publisher's price is \$1.50; but as we bought quite a lot of them we can make a special price as above.

5	Garden and Farm Topics, Henderson**.....	60
5	Gregory on Cabbages, paper*.....	20
5	Gregory on Squashes, paper*.....	20
5	Gregory on Onions, paper*.....	20

The above three books, by our friend Gregory, are all valuable. The book on squashes especially is good reading for almost anybody, whether they raise squashes or not. It strikes at the very foundation of success in almost any kind of business.

Handbook for Lumbermen..... 05

5 | Home Pork-making; 125 pages, illustrated..... 40
I think it will pay well for everybody who keeps a pig to have this book. It tells all about the care of the pig, with lots of pictures describing cheap pens, appliances, all about butchering, the latest and most approved short cuts; all about making the pickle, barreling the meat, fixing a smoke-house (from the cheapest barrel up to the most approved arrangement); all about pig-troughs; how to keep them clean with little labor; recipes for cooking pork in every imaginable way, etc. Publisher's price is 50 cents, ours as above.

10	Household Conveniences.....	1 40
15	How to Make the Garden Pay**.....	1 35
2	How to Propagate and Grow Fruit, Green*.....	15
2	Injurious Insects, Cook.....	10
10	Irrigation for the Farm, Garden, and Orchard*.....	85

By Stewart. This book, so far as I am informed, is almost the only work on this matter that is attracting so much interest, especially recently. Using water from springs, brooks, or windmills to take the place of rain, during our great droughts, is the great problem before us at the present day. The book has 274 pages and 142 cuts.

3	Maple Sugar and the Sugar-bush**.....	32
4	Peabody's Webster's Dictionary.....	10

Over 30,000 words and 250 illustrations.

5 | Manures; How to Make and How to Use
 Them; in paper covers..... 30

6 | The same in cloth covers..... 65

 | Nut Culturist, postpaid.....1 50

3 | Onions for Profit**..... 40

 | Fully up to the times, and includes both the old
 onion culture and the new method. The book is fully
 illustrated, and written with all the enthusiasm and
 interest that characterizes its author, T. Greiner.
 Even if one is not particularly interested in the busi-
 ness, almost any person who picks up Greiner's books
 will like to read them through.

 | Our Farming, by T. B. Terry**..... 1 50

 | In which he tells "how we have made a run-down
 farm bring both profit and pleasure."
 If ordered by express or freight with other goods,
 10c less.

1 | Poultry for Pleasure and Profit.**..... 10

8 | Practical Floriculture, Henderson.* 10

10 | Profits in Poultry.* 75

1 | Silk and the Silkworm 10

10 | Small-Fruit Culturist, Fuller 75

2 | Sorghum, Stock Beets, Strawberries, and Ce-
 ment Floors. By Waldo F. Brown..... 08

10 | Talks on Manures* 1 35

10 | The New Agriculture; or, the Waters Led Cap-
 tive (a \$1.50 book) 40

11 | The New Egg-Farm, Stoddard**..... 70

 | This is an enlarged edition of the 50-cent book pub-
 lished 25 or 30 years ago by H. H. Stoddard. If I
 could have only one poultry-book it would be the New
 Egg-farm. This book is of special value to me be-
 cause it not only discusses most emphatically the
 value of *exercise* to poultry, but it touches on the value
 of exercise to all other animated nature including hu-
 manity. The book has over 300 pages and 150 illustra-
 tions. It is entirely different from any other poultry-
 book in the world, inasmuch as it discusses mechanical
 contrivances so that all the varied operations of a
 poultry-farm may be done as much as possible with
 the aid of machinery. The regular price is \$1.00, but
 by buying a quantity we are able to furnish it at price
 given.

2 | Treatise on the Horse and his Diseases..... 10

5 | Tile Drainage, by W. I. Chamberlain..... 35

 | Fully illustrated, containing every thing of impor-
 tance clear up to the present date.
 The single chapter on digging ditches, with the il-
 lustrations given by Prof. Chamberlain, should alone
 make the book worth what it costs, to every one who
 has occasion to lay ten rods or more of tile. There is
 as much science in digging as in doing almost any
 thing else; and by following the plan directed in the
 book, one man will often do as much as two men with-
 out this knowledge.

5 | Tomato Culture 35

 | In three parts Part first.—By J. W. Day, of Crystal
 Springs, Miss., treats of tomato culture in the South,
 with some remarks by A. I. Root, adapting it to the
 North. Part second.—By D. Cummins, of Conneaut.,
 O., treats of tomato culture especially for canning-
 factories Part third.—By A. I. Root, treats of plant-
 growing for market, and high-pressure gardening in
 general.

3 | Vegetables under Glass, by H. A. Dreer**..... 20

3 | Vegetables in the Open Air*..... 20

 | This is a sort of companion book to the one above.
 Both books are most fully illustrated, and are exceed-
 ingly valuable, especially at the very low price at
 which they are sold. The author, H. A. Dreer, has a
 greenhouse of his own that covers one solid acre, and
 he is pretty well conversant with all the arrangements
 and plans for protecting stuff from the weather, and
 afterward handling to the best advantage when the
 weather will permit out of doors.

3 | Winter Care of Horses and Cattle..... 25

 | This is friend Terry's second book in regard to farm
 matters; but it is so intimately connected with his po-
 tato-book that it reads almost like a sequel to it. If you
 have only a horse or a cow, I think it will pay you to
 invest in a book. It has 44 pages and 4 cuts.

3 | Wood's Common Objects of the Microscope**.. 47

8 | What to Do and How to be Happy While doing
 It, by A. I. Root 65

THE A. I. ROOT CO., MEDINA, O.

The A B C of Bee Culture

1900 Edition. 500 Pages.
 The only Encyclopædia on Bees.

The last edition, 5000 copies, issued in October, 1899, was exhausted in the short space of one year. Even before the edition was out of the press, 1500 copies had been sold; and before thirty days had passed, 1000 more copies were taken. We immediately set to work to print a new edition. While the edition of 1899 was more thoroughly revised than any previous one, that for 1900 has received even larger additions of new matter, so that the book from beginning to end is almost entirely new. It now contains 500 double-column pages. It has been most carefully gone over by Dr. C. C. Miller, who has prepared a new set of comments, and by Prof. A. J. Cook, of Pomona College, Cal. As before, old subjects have been rewritten. Descriptions of obsolete methods have in all cases been stricken out, and the very latest put in their place.

This 1900 Edition Marks the 75th Thousand.

While the book has been enlarged, and hundreds of pages have been rewritten and revised, the price will be the same as before: \$1.20 postpaid, or \$1.00 by express or freight with other goods; or when sent with our journal, GLEANINGS IN BEE CULTURE, which is a constant appendix to the A B C book, a journal beautifully printed and illustrated, 42 pages, for the very low price of \$1.75 for the two. For quantity of up-to-date bee-literature there is nothing else offered at this low price.

The A. I. Root Co., Medina, Ohio, U. S. A.

